



MODEL:
PPC-FxxA-H81

Industrial Panel PC for 4th Generation Intel® Core™, Pentium® or Celeron® CPU, Intel® H81 Chipset, Touchscreen, Dual PCIe Mini, USB 3.0, SATA 6Gb/s, Dual PCIe GbE, iRIS-2400, IP 65 Compliant Front Panel and RoHS Compliant

User Manual

Revision

Date	Version	Changes
December 8, 2017	1.03	Updated product spec
September 29, 2016	1.02	Updated Section 1.8.4: PPC-F24A-H81 Dimensions
August 8, 2016	1.01	Added Section 3.8: Wireless LAN Module Installation (Optional)
June 3, 2015	1.00	Initial release

Copyright

COPYRIGHT NOTICE

The information in this document is subject to change without prior notice in order to improve reliability, design and function and does not represent a commitment on the part of the manufacturer.

In no event will the manufacturer be liable for direct, indirect, special, incidental, or consequential damages arising out of the use or inability to use the product or documentation, even if advised of the possibility of such damages.

This document contains proprietary information protected by copyright. All rights are reserved. No part of this manual may be reproduced by any mechanical, electronic, or other means in any form without prior written permission of the manufacturer.

TRADEMARKS

All registered trademarks and product names mentioned herein are used for identification purposes only and may be trademarks and/or registered trademarks of their respective owners.

Manual Conventions

**WARNING**

Warnings appear where overlooked details may cause damage to the equipment or result in personal injury. Warnings should be taken seriously.

**CAUTION**

Cautionary messages should be heeded to help reduce the chance of losing data or damaging the product.

**NOTE**

These messages inform the reader of essential but non-critical information. These messages should be read carefully as any directions or instructions contained therein can help avoid making mistakes.

**HOT SURFACE**

This symbol indicates a hot surface that should not be touched without taking care.

Table of Contents

1 INTRODUCTION.....	1
1.1 OVERVIEW.....	2
1.2 MODEL VARIATIONS	3
1.3 FEATURES.....	4
1.4 FRONT PANEL.....	5
1.5 REAR PANEL.....	5
1.6 BOTTOM PANEL.....	6
1.7 INTERNAL OVERVIEW.....	8
1.8 DIMENSIONS.....	9
1.8.1 PPC-F15A-H81 Dimensions.....	9
1.8.2 PPC-F17A-H81 Dimensions.....	10
1.8.3 PPC-F22A-H81 Dimensions.....	11
1.8.4 PPC-F24A-H81 Dimensions.....	12
1.9 SPECIFICATIONS	13
2 UNPACKING	15
2.1 UNPACKING.....	16
2.2 PACKING LIST.....	17
2.3 OPTIONAL ITEMS.....	18
3 INSTALLATION	19
3.1 ANTI-STATIC PRECAUTIONS	20
3.2 INSTALLATION PRECAUTIONS	20
3.3 PREINSTALLED COMPONENTS.....	21
3.4 INSTALLATION AND CONFIGURATION STEPS	21
3.5 REMOVING THE BACK COVER	22
3.6 HDD INSTALLATION.....	23
3.6.1 PPC-F15A/F17A-H81 HDD Installation	23
3.6.2 PPC-F22A/F24A-H81 2.5”HDD Installation	25
3.6.3 PPC-F22A/F24A-H81 3.5” HDD Installation	27
3.7 mSATA MODULE INSTALLATION	29

3.8 WIRELESS LAN MODULE INSTALLATION (OPTIONAL)	32
3.9 IRIS-2400 MODULE INSTALLATION.....	36
3.10 AT/ATX MODE SELECTION	37
3.11 MOUNTING THE SYSTEM	38
3.11.1 Wall Mounting	38
3.11.2 Panel Mounting.....	41
3.11.3 Rack and Cabinet Installation.....	45
3.11.4 Arm Mounting	48
3.11.5 Stand Mounting	49
3.12 EXTERNAL PERIPHERAL DEVICE CONNECTION	50
3.12.1 Audio Device Connection.....	50
3.12.2 HDMI Display Device Connection	52
3.12.3 LAN Connection.....	53
3.12.4 Serial Device Connection	53
3.12.5 USB Device Connection.....	54
3.12.6 VGA Connector Connection.....	55
3.13 RESET THE SYSTEM	56
3.14 CLEAR CMOS.....	57
3.15 USB POWER SELECTION	57
3.16 IPMI SETUP PROCEDURE	58
3.16.1 Managed System Hardware Setup	58
3.16.2 Using the IEI iMAN Web GUI.....	58
4 SYSTEM MAINTENANCE	60
4.1 SYSTEM MAINTENANCE INTRODUCTION	61
4.2 MOTHERBOARD REPLACEMENT	61
4.3 BACK COVER REMOVAL.....	61
4.4 SO-DIMM REPLACEMENT.....	62
4.5 SYSTEM COOLING FAN REPLACEMENT.....	63
4.5.1 Remove the Old System Cooling Fans	63
4.5.2 Install the New System Cooling Fans	64
5 BIOS SETUP	66
5.1 INTRODUCTION.....	67
5.1.1 Starting Setup.....	67

PPC-FxxA-H81 Panel PC

5.1.2	Using Setup	67
5.1.3	Getting Help.....	68
5.1.4	Unable to Reboot after Configuration Changes	68
5.1.5	BIOS Menu Bar.....	68
5.2	MAIN.....	70
5.3	ADVANCED.....	71
5.3.1	ACPI Settings.....	72
5.3.2	RTC Wake Settings.....	73
5.3.3	CPU Configuration.....	75
5.3.4	SATA Configuration.....	77
5.3.5	USB Configuration.....	78
5.3.6	F81866 Super IO Configuration.....	79
5.3.6.1	Serial Port n Configuration.....	80
5.3.7	iWDD H/W Monitor.....	84
5.3.8	Serial Port Console Redirection.....	86
5.3.8.1	Console Redirection Settings.....	86
5.3.9	iEi Feature.....	89
5.4	CHIPSET.....	90
5.4.1	PCH-IO Configuration.....	91
5.4.1.1	PCI Express Configuration.....	93
5.4.1.2	PCH Azalia Configuration.....	94
5.4.2	System Agent (SA) Configuration.....	96
5.4.2.1	Graphics Configuration.....	97
5.4.2.2	Memory Configuration.....	99
5.5	BOOT.....	100
5.6	SECURITY.....	102
5.7	SAVE & EXIT.....	102
6	DRIVER INSTALLATION.....	104
6.1	AVAILABLE SOFTWARE DRIVERS.....	105
6.2	STARTING THE DRIVER PROGRAM.....	105
6.3	CHIPSET DRIVER INSTALLATION.....	106
6.4	VGA DRIVER INSTALLATION.....	110
6.5	AUDIO DRIVER INSTALLATION.....	114
6.6	LAN DRIVER INSTALLATION.....	116

6.7 USB 3.0 DRIVER INSTALLATION	120
6.8 RESISTIVE TYPE TOUCHSCREEN DRIVER INSTALLATION	123
6.8.1 <i>Calibrating the Resistive Type Touchscreen</i>	126
6.9 KEYPAD AP INSTALLATION.....	129
7 INTERFACE CONNECTORS	133
7.1 PERIPHERAL INTERFACE CONNECTORS.....	134
7.2 INTERNAL PERIPHERAL CONNECTORS	135
7.2.1 <i>+12V Power Source Connector (CPU12V1)</i>	137
7.2.2 <i>ATX Power Connector (ATX1)</i>	137
7.2.3 <i>Debug Port (DBG_PORT1)</i>	138
7.2.4 <i>DIO Connector (DIO1)</i>	138
7.2.5 <i>EC Debug Port (LPT_DB1)</i>	139
7.2.6 <i>Fan Connectors (CPU_FAN1/SYS_FAN1/SYS_FAN2)</i>	139
7.2.7 <i>Front Panel Connector (F_PANEL1)</i>	140
7.2.8 <i>°C Connector (CN5)</i>	140
7.2.9 <i>IPMI Active LED Connector (LEDCN1)</i>	140
7.2.10 <i>Keyboard and Mouse Connector (KBMS1)</i>	141
7.2.11 <i>Keypad Connector (HOTKEY_CN1)</i>	141
7.2.12 <i>LAN Active LED Connectors (LED_LAN1/LED_LAN2)</i>	141
7.2.13 <i>LVDS Connector (LVDS1)</i>	142
7.2.14 <i>Panel Power Supply Connector (INVERTER1)</i>	142
7.2.15 <i>PCIe Mini (MINI_PCIE1) and mSATA (MSATA1) Card Slots</i>	143
7.2.16 <i>Resistive Touchscreen Connector (TOUCH1)</i>	144
7.2.17 <i>SATA 6Gb/s Connectors (S_ATA1/S_ATA2)</i>	144
7.2.18 <i>SATA Power Connectors (SATA_PWR1/SATA_PWR2)</i>	145
7.2.19 <i>SMBus Connector (CN1)</i>	145
7.2.20 <i>SPI Flash Connector (JSPI1)</i>	145
7.2.21 <i>SPI Flash (EC) Connector (JSPI2)</i>	146
7.2.22 <i>U3 Firmware Programming Connector (JP1)</i>	146
7.2.23 <i>USB 2.0 Connector (USB1)</i>	146
7.3 EXTERNAL INTERFACE PANEL CONNECTORS	147
7.3.1 <i>HDMI Connector (HDMI1)</i>	147
7.3.2 <i>RS-232 Serial Ports (COM1/COM2, COM3/COM4)</i>	148
7.3.3 <i>USB 2.0 Connectors (USB_CON1)</i>	148

PPC-FxxA-H81 Panel PC

7.3.4 RJ-45 GbE and USB 2.0 Connectors (LAN2_USB2).....	148
7.3.5 RJ-45 GbE and USB 3.0 Connectors (LAN1_USB1).....	149
7.3.6 RS-422/485 Serial Port and VGA Connector (COM5/VGA1).....	150
7.4 PRECONFIGURED JUMPERS	150
7.4.1 Flash Descriptor Security Override Jumper (J_FLASH1).....	151
7.4.2 LVDS Panel Resolution Selection Switch (JLCD_SET1)	151
7.4.3 Panel Voltage Selection Jumper (JLCD_PWR1).....	152
7.4.4 Touchscreen Selection Jumper (JTOUCH1).....	152
A REGULATORY COMPLIANCE	153
B BIOS CONFIGURATION OPTIONS.....	157
B.1 BIOS CONFIGURATION OPTIONS	158
C SAFETY PRECAUTIONS.....	160
C.1 SAFETY PRECAUTIONS.....	161
C.1.1 General Safety Precautions.....	161
C.1.2 Anti-static Precautions	162
C.1.3 Product Disposal.....	162
C.2 MAINTENANCE AND CLEANING PRECAUTIONS	163
C.2.1 Maintenance and Cleaning	163
C.2.2 Cleaning Tools.....	164
D WATCHDOG TIMER	165
E HAZARDOUS MATERIALS DISCLOSURE	168

List of Figures

Figure 1-1: PPC-FxxA-H81 Panel PC	2
Figure 1-2: Front View	5
Figure 1-3: PPC-F15A-H81 Rear View	6
Figure 1-4: Bottom View	7
Figure 1-5: PPC-F15A-H81 Internal Components	8
Figure 1-6: PPC-F22A-H81 Internal Components	8
Figure 1-7: PPC-F15A-H81 Dimensions (mm)	9
Figure 1-8: PPC-F17A-H81 Dimensions (mm)	10
Figure 1-9: PPC-F22A-H81 Dimensions (mm)	11
Figure 1-10: PPC-F24A-H81 Dimensions (mm)	12
Figure 3-1: PPC-F15A-H81 Back Cover Retention Screws	22
Figure 3-2: PPC-F15A/F17A-H81 HDD Bracket Retention Screws	23
Figure 3-3: HDD Retention Screws	24
Figure 3-4: Replacing the PPC-F15A/F17A-H81 HDD Bracket	24
Figure 3-5: PPC-F22A/F24A-H81 HDD Bracket Retention Screws	25
Figure 3-6: Connecting the Hard Drive to the HDD Bracket	26
Figure 3-7: 2.5" HDD Retention Screws	26
Figure 3-8: Replacing the PPC-F22A/F24A-H81 HDD Bracket	27
Figure 3-9: Connecting the Hard Drive to the HDD Bracket	28
Figure 3-10: 3.5" HDD Retention Screws	28
Figure 3-11: Replacing the PPC-F22A/F24A-H81 HDD Bracket	29
Figure 3-12: PCIe Mini Card Slot which supports mSATA	30
Figure 3-13: Removing the Retention Screws	30
Figure 3-14: Inserting the PCIe Mini Card into the Slot at an Angle	31
Figure 3-15: Securing the PCIe Mini Card	31
Figure 3-16: Knockouts for Wireless Antenna	32
Figure 3-17: PCIe Mini Slot Location	33
Figure 3-18: Removing the Retention Screws and Standoffs	33
Figure 3-19: Installing the Standoffs	34
Figure 3-20: Inserting the WLAN Module	34
Figure 3-21: Securing WLAN Module and Connecting RF Cables	35

PPC-FxxA-H81 Panel PC

Figure 3-22: Securing SMA Connector and External Antenna Installation	35
Figure 3-23: iRIS-2400 Module Slot.....	36
Figure 3-24: iRIS-2400 Module Installation	37
Figure 3-25: AT/ATX Mode Selection.....	38
Figure 3-26: Wall-mounting Bracket.....	39
Figure 3-27: Mount the Chassis	40
Figure 3-28: Secure the Chassis.....	41
Figure 3-29: PPC-F15A-H81 Mounting Bracket Installation	42
Figure 3-30: PPC-F15A-H81 Panel Cutout Dimensions	42
Figure 3-31: PPC-F17A-H81 Panel Cutout Dimensions	43
Figure 3-32: PPC-F22A-H81 Panel Cutout Dimensions	43
Figure 3-33: PPC-F24A-H81 Panel Cutout Dimensions	44
Figure 3-34: Tighten the Mounting Clamp Screws.....	45
Figure 3-35: The Rack/Cabinet Bracket.....	46
Figure 3-36: Secure the Rack/Cabinet Bracket.....	47
Figure 3-37: Install into a Rack/Cabinet	48
Figure 3-38: Arm Mounting Retention Screw Holes.....	49
Figure 3-39: Stand Mounting Retention Screw Holes.....	50
Figure 3-40: Audio Connector	51
Figure 3-41: HDMI Connection	52
Figure 3-42: LAN Connection	53
Figure 3-43: RS-232 Serial Device Connector	54
Figure 3-44: USB Device Connection	55
Figure 3-45: VGA Connector	56
Figure 3-46: Reset Button Location.....	56
Figure 3-47: Clear CMOS Button Location.....	57
Figure 3-48: IEI iMAN Web Address.....	59
Figure 3-49: IEI iMAN Web GUI.....	59
Figure 4-1: SO-DIMM Module Locations.....	62
Figure 4-2: SO-DIMM Module Installation.....	63
Figure 4-3: System Cooling Fans Motherboard Connectors	64
Figure 4-4: System Cooling Fan Retention Screws	64
Figure 6-1: Drivers	106
Figure 6-2: Chipset Driver Welcome Screen.....	107
Figure 6-3: Chipset Driver License Agreement	108

Figure 6-4: Chipset Driver Read Me File	108
Figure 6-5: Chipset Driver Setup Operations	109
Figure 6-6: Chipset Driver Installation Finish Screen.....	110
Figure 6-7: VGA Driver README FILE.....	111
Figure 6-8: VGA Driver Screen	111
Figure 6-9: VGA Driver Welcome Screen	112
Figure 6-10: VGA Driver License Agreement.....	112
Figure 6-11: VGA Driver Readme File Information.....	113
Figure 6-12: VGA Driver Setup Progress	113
Figure 6-13: VGA Driver Installation Finish Screen	114
Figure 6-14: Audio Driver Welcome Screen.....	115
Figure 6-15: Audio Driver Installation.....	115
Figure 6-16: Audio Driver Installation Complete	116
Figure 6-17: LAN Driver Welcome Screen	117
Figure 6-18: LAN Driver License Agreement	117
Figure 6-19: LAN Driver Setup Options.....	118
Figure 6-20: LAN Driver Installation	119
Figure 6-21: LAN Driver Installation Complete.....	119
Figure 6-22: USB 3.0 Driver Welcome Screen	120
Figure 6-23: USB 3.0 Driver License Agreement.....	121
Figure 6-24: USB 3.0 Driver Read Me File	122
Figure 6-25: USB 3.0 Driver Setup Operations	122
Figure 6-26: USB 3.0 Driver Installation Finish Screen	123
Figure 6-27: Welcome Screen	124
Figure 6-28: Touchscreen Driver License Agreement.....	124
Figure 6-29: Choose Destination Folder	125
Figure 6-30: Setup Status	125
Figure 6-31: Select Touch Features.....	126
Figure 6-32: Touchscreen Driver Installation Finish Screen	126
Figure 6-33: Select Control Panel	127
Figure 6-34: Touchscreen Control Panel	127
Figure 6-35: Select Calibration Type	128
Figure 6-36: Calibration Window.....	128
Figure 6-37: Keypad AP Welcome Screen	129
Figure 6-38: Select Installation Folder.....	130

PPC-FxxA-H81 Panel PC

Figure 6-39: Confirm Installation	130
Figure 6-40: Keypad AP Installation Complete.....	131
Figure 6-41: Keypad AP Installation Complete.....	131
Figure 6-42: Keypad AP	132
Figure 7-1: Main Board Layout Diagram (Front Side).....	134
Figure 7-2: Main Board Layout Diagram (Solder Side).....	135

List of Tables

Table 1-1: Model Variations	4
Table 1-2: System Specifications.....	14
Table 2-1: Packing List.....	17
Table 2-2: Optional Items.....	18
Table 3-1: BIOS Options and Configured USB Ports.....	57
Table 3-2: USB Power Source Setup	57
Table 5-1: BIOS Navigation Keys	68
Table 5-2: BIOS Options and Configured USB Ports.....	92
Table 7-1: Peripheral Interface Connectors	136
Table 7-2: +12V Power Source Connector (CPU12V1) Pinouts	137
Table 7-3: ATX Power Connector (ATX1) Pinouts.....	137
Table 7-4: Debug Port (DBG_PORT1) Pinouts.....	138
Table 7-5: DIO Connector (DIO1) Pinouts	138
Table 7-6: EC Debug Port (LPT_DB1) Pinouts.....	139
Table 7-7: Fan Connector Pinouts	139
Table 7-8: Front Panel Connector (F_PANEL1) Pinouts.....	140
Table 7-9: I ² C Connector (CN5) Pinouts	140
Table 7-10: IPMI Active LED Connector (LEDCN1) Pinouts	140
Table 7-11: Keyboard and Mouse Connector (KBMS1) Pinouts.....	141
Table 7-12: Keypad Connector (HOTKEY_CN1) Pinouts.....	141
Table 7-13: LAN Active LED Connectors (LED_LAN1/LED_LAN2) Pinouts	141
Table 7-14: LVDS Connector (LVDS1) Pinouts.....	142
Table 7-15: Panel Power Supply Connector (INVERTER1) Pinouts	142
Table 7-16: PCIe Mini (MINI_PCIE1) and mSATA (MSATA1) Card Pinouts.....	143
Table 7-17: Resistive Touchscreen Connector (TOUCH1) Pinouts.....	144
Table 7-18: SATA 6Gb/s Connectors (S_ATA1/S_ATA2) Pinouts	144
Table 7-19: SATA Power Connectors (SATA_PWR1/SATA_PWR2) Pinouts.....	145
Table 7-20: SMBus Connector (CN1) Pinouts.....	145
Table 7-21: SPI Flash Connector (JSPI1) Pinouts	145
Table 7-22: SPI Flash (EC) Connector (JSPI2) Pinouts.....	146
Table 7-23: U3 Firmware Programming Connector (JP1) Pinouts	146

PPC-FxxA-H81 Panel PC

Table 7-24: USB 2.0 Connector (USB1) Pinouts.....	146
Table 7-25: Rear Panel Connectors	147
Table 7-26: HDMI Connector (HDMI1) Pinouts.....	148
Table 7-27: RS-232 Serial Port Pinouts	148
Table 7-28: USB 2.0 Connector (USB_CON1) Pinouts.....	148
Table 7-29: RJ-45 GbE Connector (LAN2_USB2) Pinouts.....	148
Table 7-30: USB 2.0 Connector (LAN2_USB2) Pinouts	149
Table 7-31: RJ-45 GbE Connector (LAN1_USB1) Pinouts.....	149
Table 7-32: USB 3.0 Connector (LAN1_USB1) Pinouts	149
Table 7-33: RS-422/485 Serial Port (COM5) Pinouts	150
Table 7-34: VGA Connector (VGA1) Pinouts	150
Table 7-35: Preconfigured Jumpers	151
Table 7-36: Flash Descriptor Security Override Jumper (J_FLASH1) Settings	151
Table 7-37: LVDS Panel Resolution Selection.....	151
Table 7-38: Panel Voltage Selection Jumper (JLCD_PWR1) Settings	152
Table 7-39: Touchscreen Selection Jumper (JTOUCH1) Settings.....	152

Chapter

1

Introduction

1.1 Overview



Figure 1-1: PPC-FxxA-H81 Panel PC

The PPC-FxxA-H81 is a heavy industrial panel PC with rugged and trendy design which can be applied in harsh industrial environments and enriches aesthetic experience at the same time. The PPC-FxxA-H81 not only provides all the features of a PC, but also combines with resistive/projected capacitive touchscreen for mouse and keyboard free data input.

With the latest Intel® H81 platform, the PPC-FxxA-H81 offers various CPU choices and equips with SATA 6Gb/s interface, supporting both SATA HDD and SSD. In addition, the PPC-FxxA-H81 features Intelligent Platform Management Interface 2.0 (IPMI 2.0) that helps lower the overall costs of server management by enabling users to maximize IT resource, save time and manage multiple systems. The PPC-FxxA-H81 supports IPMI 2.0 through the optional iRIS-2400 module.

The major external device connections include USB 3.0, USB 2.0, serial port, VGA and HDMI connectors. Furthermore, the PPC-FxxA-H81 has two full-size/half-size PCIe Mini card slots, allowing installation of a wide variety of PCIe Mini card solutions, such as a Wi-Fi module and mSATA module.

PPC-FxxA-H81 Panel PC

1.2 Model Variations

The model numbers and model variations are listed below.

Model	CPU	Touchscreen	Power	Screen
PPC-F15AA-H81i-P/4G/R	Intel® Pentium® G3220 (dual-core, 3.0 GHz, max. TDP=53 W)	Resistive	AC input	15"
PPC-F15AA-H81i-P/4G/PC		Projected capacitive	AC input	15"
PPC-F15AA-H81i-i3/4G/R	Intel® Core™ i3-4330 (dual-core, 3.5 GHz, max. TDP=54 W)	Resistive	AC input	15"
PPC-F15AA-H81i-i3/4G/PC		Projected capacitive	AC input	15"
PPC-F15AA-H81i-i5/4G/R	Intel® Core™ i5-4570S (quad-core, up to 3.6 GHz, max. TDP=65 W)	Resistive	AC input	15"
PPC-F15AA-H81i-i5/4G/PC		Projected capacitive	AC input	15"
PPC-F15AD-H81i/R	N/A	Resistive	DC input	15"
PPC-F15AD-H81i/PC		Projected capacitive	DC input	15"
PPC-F17AA-H81i-P/4G/R	Intel® Pentium® G3220 (dual-core, 3.0 GHz, max. TDP=53 W)	Resistive	AC input	17"
PPC-F17AA-H81i-P/4G/PC		Projected capacitive	AC input	17"
PPC-F17AA-H81i-i3/4G/R	Intel® Core™ i3-4330 (dual-core, 3.5 GHz, max. TDP=54 W)	Resistive	AC input	17"
PPC-F17AA-H81i-i3/4G/PC		Projected capacitive	AC input	17"
PPC-F17AA-H81i-i5/4G/R	Intel® Core™ i5-4570S (quad-core, up to 3.6 GHz, max. TDP=65 W)	Resistive	AC input	17"
PPC-F17AA-H81i-i5/4G/PC		Projected capacitive	AC input	17"
PPC-F17AD-H81i/R	N/A	Resistive	DC input	17"
PPC-F17AD-H81i/PC		Projected capacitive	DC input	17"
PPC-F22AA-H81i-P/4G/PC	Intel® Pentium® G3220 (dual-core, 3.0 GHz, max. TDP=53 W)	Projected capacitive	AC input	21.5"
PPC-F22AA-H81i-i3/4G/PC	Intel® Core™ i3-4330 (dual-core, 3.5 GHz, max. TDP=54 W)	Projected capacitive	AC input	21.5"
PPC-F22AA-H81i-i5/4G/PC	Intel® Core™ i5-4570S (quad-core, up to 3.6 GHz, max. TDP=65 W)	Projected capacitive	AC input	21.5"
PPC-F22AD-H81i/PC	N/A	Projected capacitive	DC input	21.5"

Model	CPU	Touchscreen	Power	Screen
PPC-F24AA-H81i-P/4G/PC	Intel® Pentium® G3220 (dual-core, 3.0 GHz, max. TDP=53 W)	Projected capacitive	AC input	23.8"
PPC-F24AA-H81i-i3/4G/PC	Intel® Core™ i3-4330 (dual-core, 3.5 GHz, max. TDP=54 W)	Projected capacitive	AC input	23.8"
PPC-F24AA-H81i-i5/4G/PC	Intel® Core™ i5-4570S (quad-core, up to 3.6 GHz, max. TDP=65 W)	Projected capacitive	AC input	23.8"
PPC-F24AD-H81i/PC	N/A	Projected capacitive	DC input	23.8"

Table 1-1: Model Variations

1.3 Features

Some of the features of the PPC-FxxA-H81 panel PC include:

- Supports iRIS remote management solution
- Robust aluminum IP 65 compliant front bezel
- Aesthetic ultra-thin bezel for seamless panel mount installation
- Supports LGA1150 Intel® 4th generation Core™, Pentium® and Celeron® processors
- Intel® H81 chipset
- Two 204-pin DDR3 SO-DIMM slots (system max. 16 GB)
- Two full-size/half-size PCIe Mini card slots (one supports mSATA SSD)
- Supports SATA 6Gb/s interface for both SATA HDD and SSD
- Dual video output: HDMI and VGA
- Optional PCIe Mini 802.11b/g/n wireless module
- Rich I/O interfaces, including four RS-232, one RS-422/485, two USB 3.0, four USB 2.0, line-out and mic-in audio jacks
- RoHS compliant

PPC-FxxA-H81 Panel PC

1.4 Front Panel

The front side of the PPC-FxxA-H81 (**Figure 1-2**) is a flat panel LCD screen surrounded by an aluminum frame.

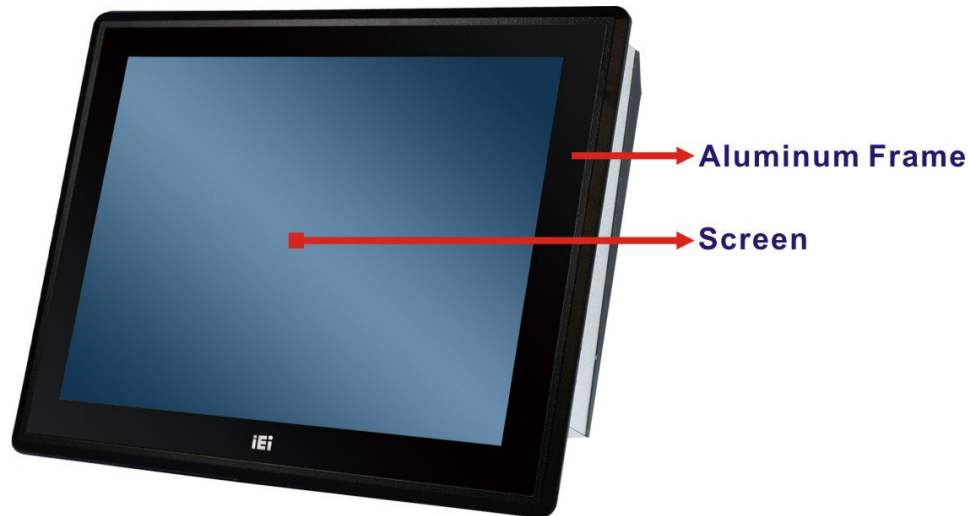

Figure 1-2: Front View

1.5 Rear Panel

The rear panel has a fan vent, four VESA 100x100 mounting holes and several retention screw holes. The VESA 100x100 mounting holes are circled in **Figure 1-3**.



NOTE:

The PPC-F24A-H81 supports also VESA 100x200 mounting standard.

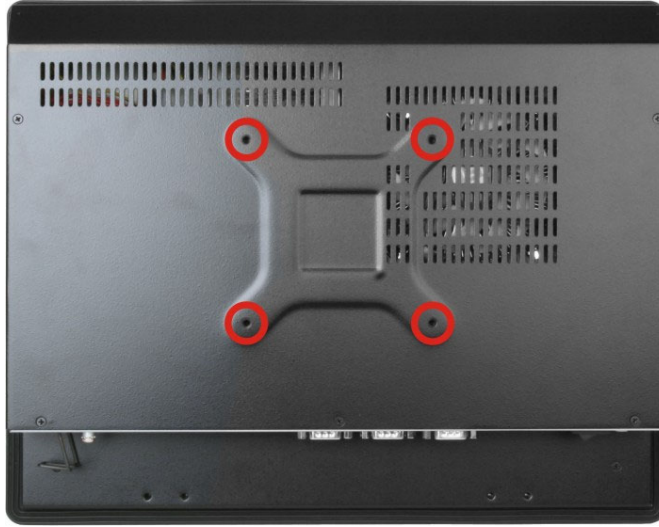

Figure 1-3: PPC-F15A-H81 Rear View

1.6 Bottom Panel

The bottom panel has the following interfaces:

- 1 x Power input connector
- 1 x Power switch
- 2 x USB 3.0 connectors
- 4 x USB 2.0 connectors
- 1 x Reset button
- 1 x Clear CMOS button
- 2 x RJ-45 GbE connectors
- 4 x RS-232 connectors (COM1, COM2, COM3 and COM4)
- 1 x RS-422/485 connector (COM5)
- 1 x Line-out jack
- 1 x Mic-in jack
- 1 x VGA connector
- 1 x HDMI connector
- 1 x AT/ATX switch

PPC-FxxA-H81 Panel PC

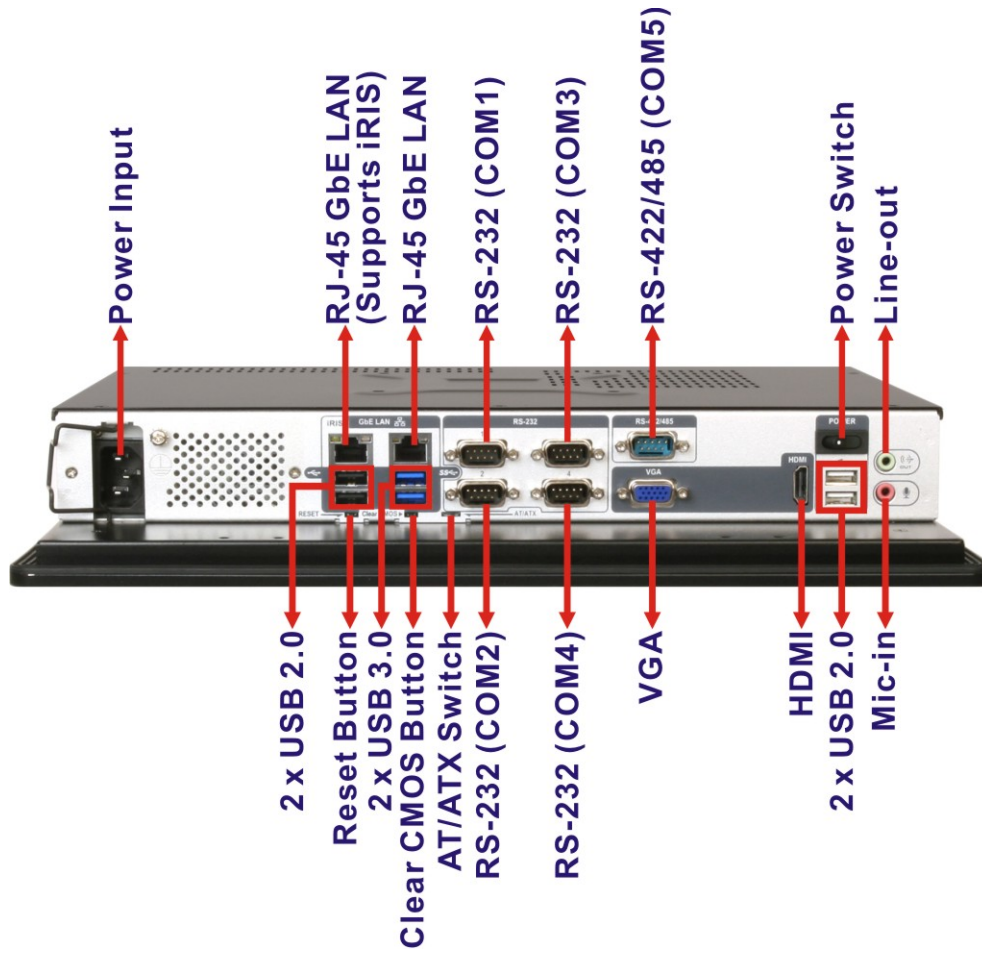

Figure 1-4: Bottom View

1.7 Internal Overview

An overview picture of the internal components is shown in **Figure 1-6** below.

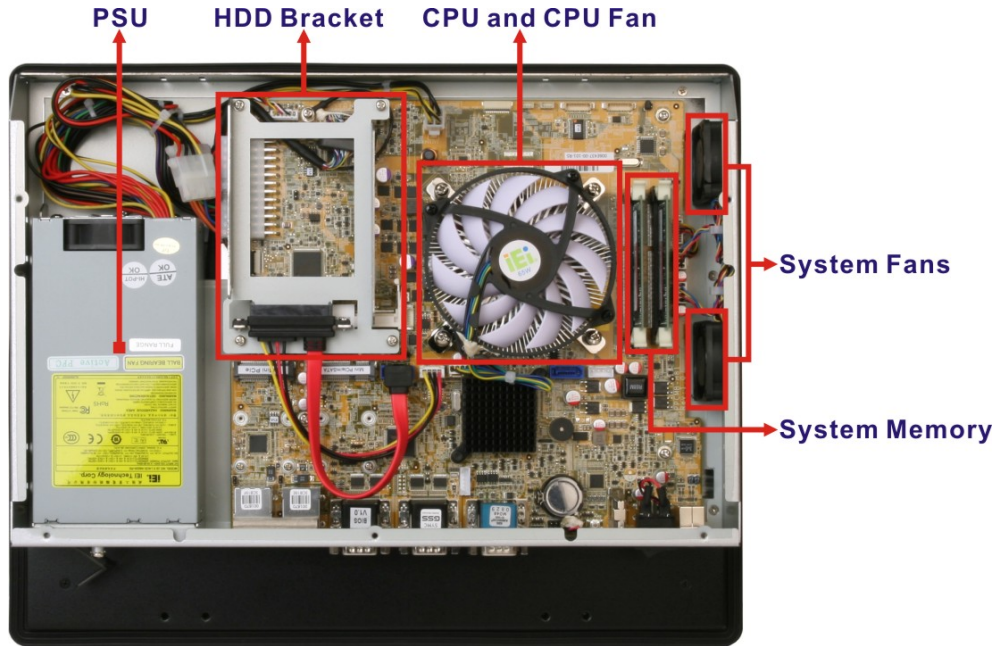

Figure 1-5: PPC-F15A-H81 Internal Components

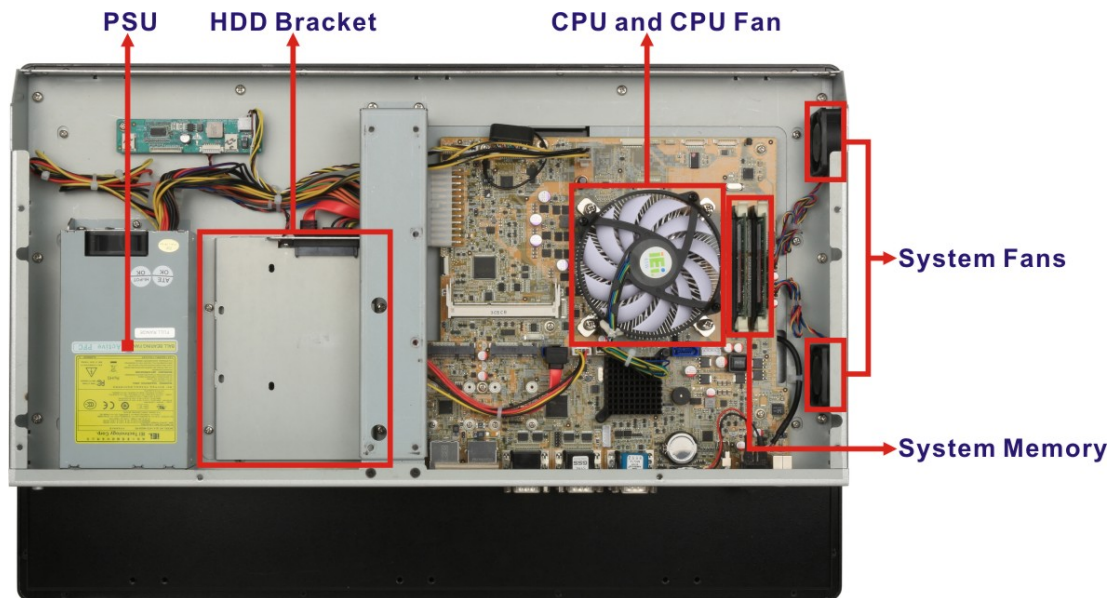

Figure 1-6: PPC-F22A-H81 Internal Components

PPC-FxxA-H81 Panel PC

1.8 Dimensions

1.8.1 PPC-F15A-H81 Dimensions

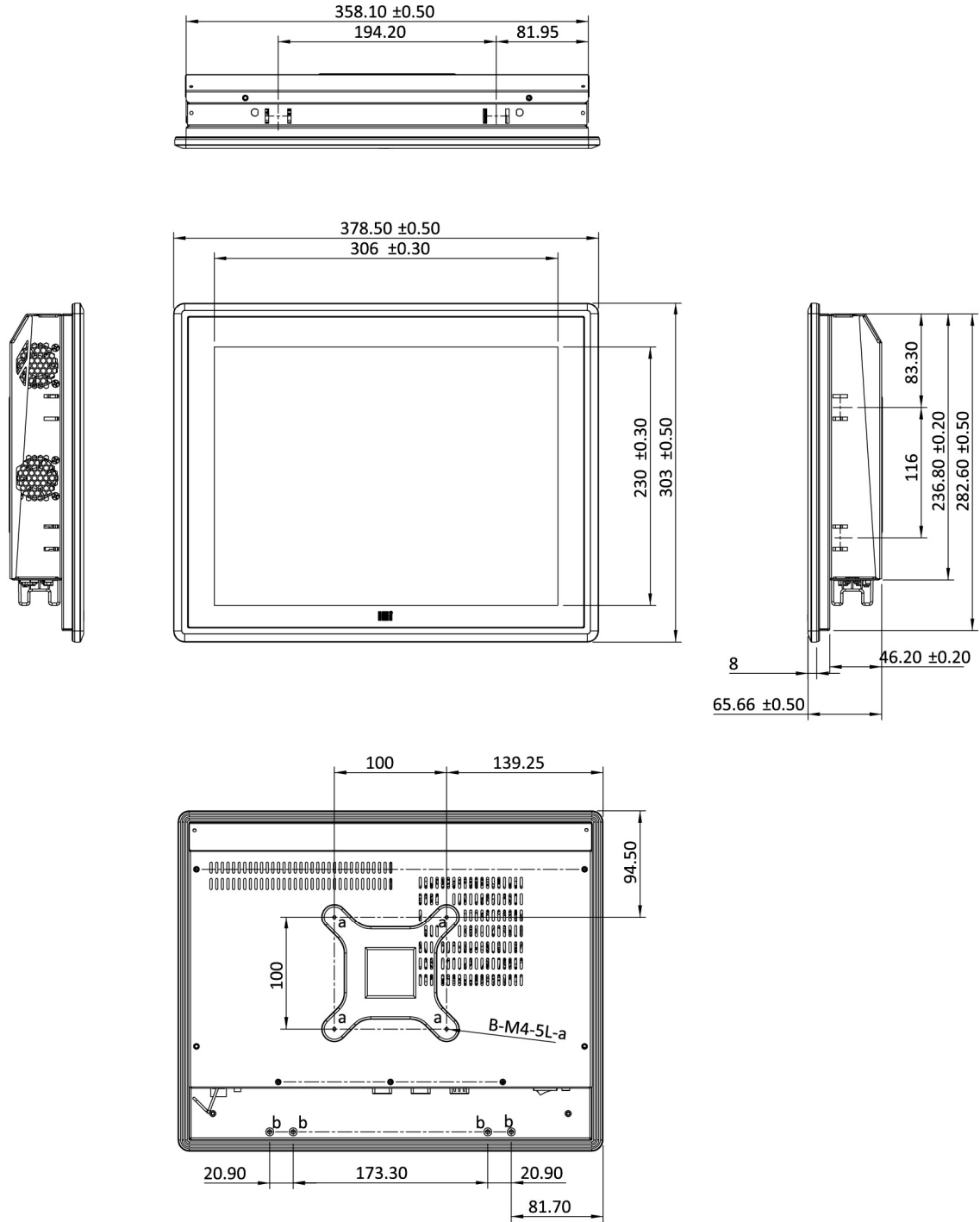

Figure 1-7: PPC-F15A-H81 Dimensions (mm)

1.8.2 PPC-F17A-H81 Dimensions

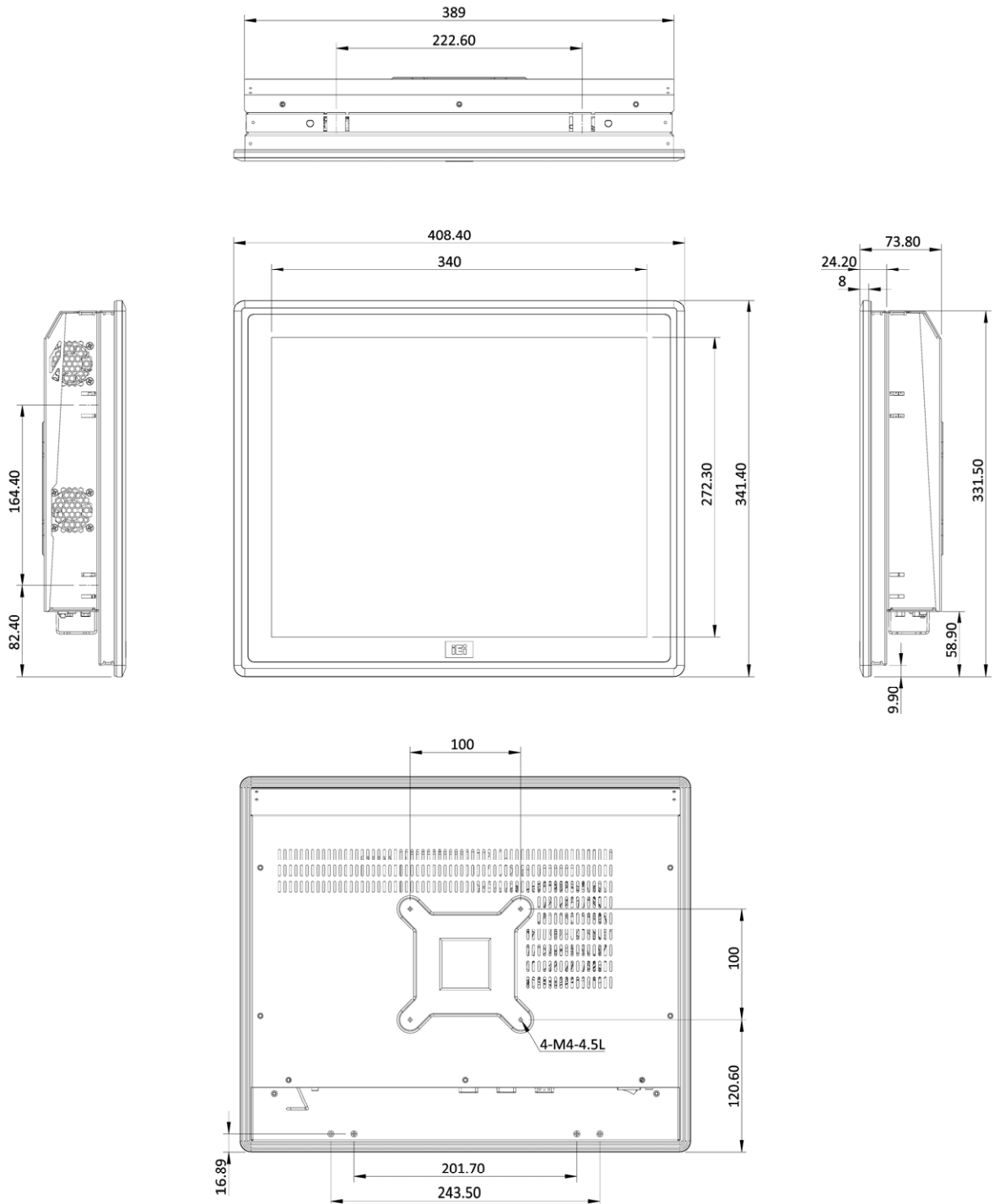

Figure 1-8: PPC-F17A-H81 Dimensions (mm)

PPC-FxxA-H81 Panel PC

1.8.3 PPC-F22A-H81 Dimensions

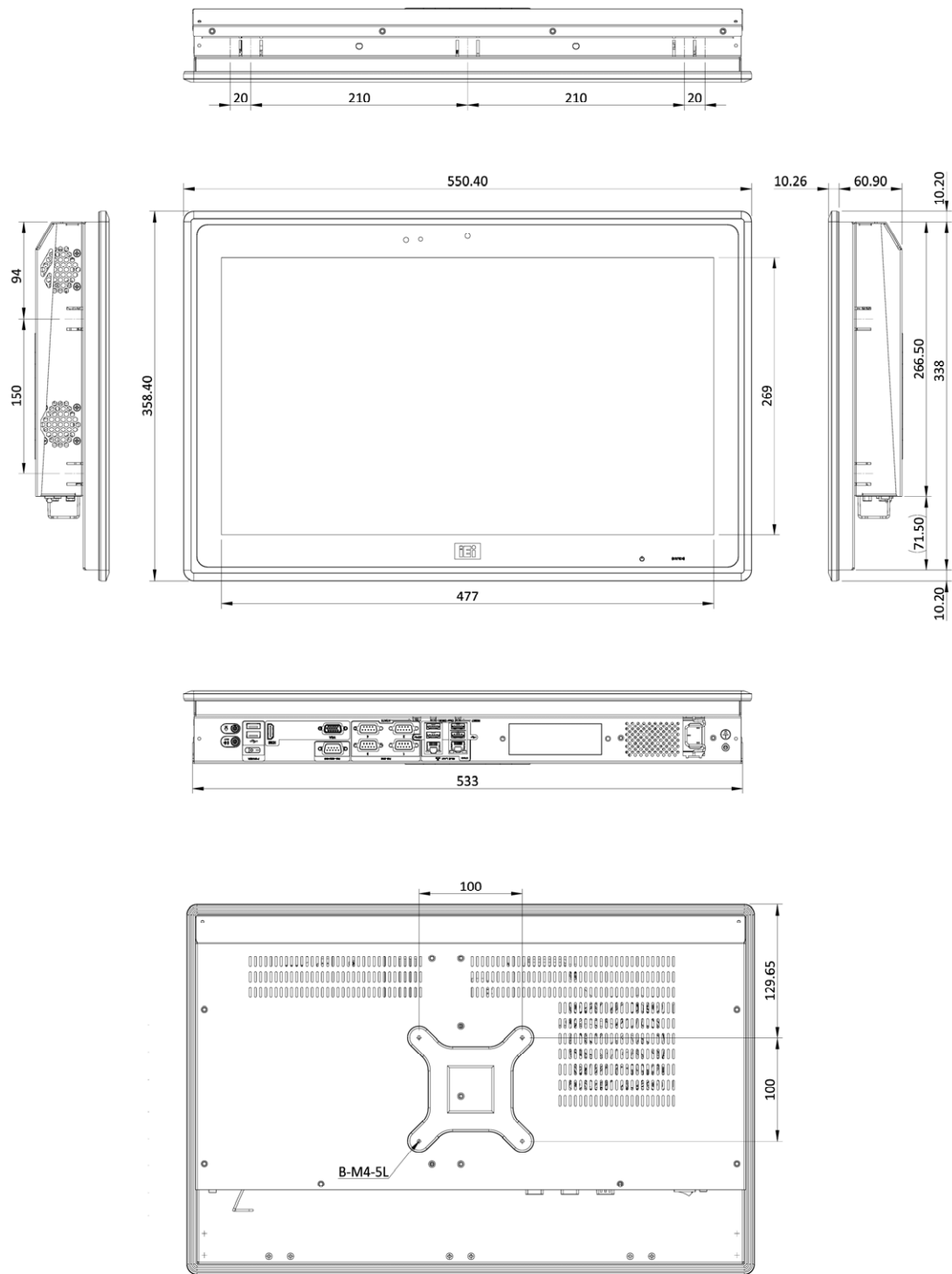

Figure 1-9: PPC-F22A-H81 Dimensions (mm)

PPC-FxxA-H81 Panel PC

1.9 Specifications

The technical specifications for the PPC-FxxA-H81 system are listed in **Table 1-2**.

	PPC-F15A-H81	PPC-F17A-H81	PPC-F22A-H81	PPC-F24A-H81
LCD Display	15" (4:3)	17" (5:4)	21.5" (16:9)	23.8" (16:9)
Max. Resolution	1024 (W) x 768 (H)	1280 (W) x 1024 (H)	1920 (W) x 1080 (H)	1920 (W) x 1080 (H)
Brightness	450 cd/m ²	350 cd/m ²	250 cd/m ²	250 cd/m ²
Contrast Ratio	800:1	800:1	1000:1	3000:1
LCD Color	16.2M	16.7M	16.7M	16.7M
Pixel Pitch (mm)	0.297 x 0.297	0.26 x 0.26	0.25 x 0.25	0.28 x 0.28
Viewing Angle (H-V)	160°/150°	170°/160°	170°/160°	178°/178°
Backlight MTBF	70,000 hours	50,000 hours	30,000 hours	30,000 hours
SBC Model	PPCMB-H81			
CPU Supported	LGA1150 Intel® 4th generation Core™/Pentium®/Celeron® CPU, supporting TDP up to 65 W			
Chipset	Intel® H81			
Memory	Two 204-pin DDR3 SO-DIMM slots (system max. 16 GB)			
Touchscreen	5-wire resistive type or projected capacitive type		Projected capacitive type	
Drive Bay	One 2.5" HDD/SSD drive bay		One 2.5"/3.5" HDD/SSD drive bay	
iRIS Remote Management Solution	iRIS-2400 slot			
Ethernet	LAN1: Intel® I211 PCIe GbE controller LAN2: Intel® I210 PCIe GbE controller with NC-SI support			
Expansion	Two full-size/half-size PCIe Mini card slots (one supports mSATA)			
Mounting	VESA 100 mm x 100 mm Panel, wall, rack, stand and arm		VESA 100 mm x 100 mm Panel, wall, stand and arm	VESA 100 mm x 100 mm VESA 100 mm x 200 mm Panel, wall, stand and arm

	PPC-F15A-H81	PPC-F17A-H81	PPC-F22A-H81	PPC-F24A-H81
Construction Material	Aluminum front cover and sheet metal rear cover			
Enclosure Color	Black			
I/O Ports, Switches and Buttons	2 x USB 3.0 4 x USB 2.0 4 x RS-232 (COM1 ~ COM4) 1 x RS-232/422/485 (COM5) 1 x HDMI connector 1 x VGA connector 2 x RJ-45 GbE connectors (one supports iRIS) 2 x Audio jacks (Line-out and Mic-in) 1 x Power switch 1 x Clear CMOS button 1 x Reset button 1 x AT/ATX switch			
Power Supply	AC input (AA model): ACE-A622A , 220 W DC input (AD model): ACE-4520C, 250 W			
Operating Temperature (With air flow)	-10°C ~ 50°C			
Storage Temperature	-20°C ~ 60°C			
Humidity	10% ~ 95%, non-condensing			
IP Level	IP 65 compliant front panel			
Safety and EMC	CE, FCC			
Dimensions (H x W x D) (mm)	303 x 378.5 x 65.7	341.4 x 408.4 x 73.8	358.4 x 550.4 x 71.2	382 x 600 x 71.7
Weight (Net/Gross)	5.6 kg/8.3 kg	7.5 kg/10.7 kg	10.1 kg/14.4 kg	10.5 kg/14.8 kg

Table 1-2: System Specifications

Chapter

2

Unpacking

2.1 Unpacking

To unpack the panel PC, follow the steps below:



WARNING!

The front side LCD screen has a protective plastic cover stuck to the screen. Only remove the plastic cover after the panel PC has been properly installed. This ensures the screen is protected during the installation process.

- Step 1:** Use box cutters, a knife or a sharp pair of scissors that seals the top side of the external (second) box.
- Step 2:** Open the external (second) box.
- Step 3:** Use box cutters, a knife or a sharp pair of scissors that seals the top side of the internal (first) box.
- Step 4:** Lift the monitor out of the boxes.
- Step 5:** Remove both polystyrene ends, one from each side.
- Step 6:** Pull the plastic cover off the panel PC.
- Step 7:** Make sure all the components listed in the packing list are present.

PPC-FxxA-H81 Panel PC

2.2 Packing List

The PPC-FxxA-H81 panel PC is shipped with the following components:







Quantity	Item	Image
1	PPC-FxxA-H81	
1	Power cord (P/N: varies by regions)	
1	Screw kit	
1	Touch pen (P/N: 43125-0002C0-00-RS) (resistive type models only)	
1	User manual and driver CD	
1	One Key Recovery CD	

Table 2-1: Packing List

If any of the above items are missing or damaged, contact the distributor or sales representative immediately.

2.3 Optional Items

The following items are optional accessories for the PPC-FxxA-H81:

Item	PPC-F15A-H81	PPC-F17A-H81	PPC-F22A-H81	PPC-F24A-H81
Arm	ARM-31			
Panel mounting kit	FPK-04-R10		FPK-05-R10	FPK-06-R10
Rack mounting kit	FRK15-R10	FRK17-R10	N/A	
Stand	STAND-A21 STAND-A19 STAND-C19	STAND-C19 STAND-A21		
Wall mounting kit	WK-190MS-R10			
Wi-Fi kit	EMB-WIFI-KIT11-R20			
iRIS remote management module	iRIS-2400-R10			

Table 2-2: Optional Items

Chapter

3

Installation

3.1 Anti-static Precautions

**WARNING:**

Failure to take ESD precautions during the maintenance of the EP series may result in permanent damage to the EP series and severe injury to the user.

Electrostatic discharge (ESD) can cause serious damage to electronic components, including the PPC-FxxA-H81. Dry climates are especially susceptible to ESD. It is therefore critical that whenever the PPC-FxxA-H81 is accessed internally, or any other electrical component is handled, the following anti-static precautions are strictly adhered to.

- **Wear an anti-static wristband:** - Wearing a simple anti-static wristband can help to prevent ESD from damaging the board.
- **Self-grounding:** - Before handling the board touch any grounded conducting material. During the time the board is handled, frequently touch any conducting materials that are connected to the ground.
- **Use an anti-static pad:** - When configuring the PPC-FxxA-H81, place it on an anti-static pad. This reduces the possibility of ESD damaging the PPC-FxxA-H81.
- **Only handle the edges of the PCB:** - When handling the PCB, hold the PCB by the edges.

3.2 Installation Precautions

When installing the panel PC, please follow the precautions listed below:

- **Power turned off:** When installing the panel PC, make sure the power is off. Failing to turn off the power may cause severe injury to the body and/or damage to the system.
- **Certified Engineers:** Only certified engineers should install and modify onboard functionalities.

PPC-FxxA-H81 Panel PC

- **Mounting:** The PPC-FxxA-H81 is a heavy device. When mounting the system onto a rack, panel, wall or arm, please make sure that at least two people are assisting with the procedure.
- **Anti-static Discharge:** If a user open the rear panel of the panel PC, to configure the jumpers or plug in added peripheral devices, ground themselves first and wear an anti-static wristband.

3.3 Preinstalled Components

The following components are all preinstalled.

- Motherboard
- TFT LCD
- Touchscreen
- Power supply
- System cooling fans

Preinstalled OEM customizations may include the following.

- CPU
- DDR3 memory module
- HDD
- Wi-Fi module

3.4 Installation and Configuration Steps

The following installation steps must be followed.

Step 1: Unpack the PPC-FxxA-H81.

Step 2: Install HDD, mSATA SSD and iRIS-2400 module.

Step 3: Mount the PPC-FxxA-H81 panel PC.

Step 4: Connect peripheral devices to the bottom panel of the PPC-FxxA-H81.

Step 5: Configure the system.

3.5 Removing the Back Cover

Remove all the retention screws on the back cover. Lift the cover up to remove.



NOTE:

The number of retention screws on the back cover varies by models.



Figure 3-1: PPC-F15A-H81 Back Cover Retention Screws

PPC-FxxA-H81 Panel PC

3.6 HDD Installation

3.6.1 PPC-F15A/F17A-H81 HDD Installation

To install a 2.5" HDD into the PPC-F15A/F17A-H81, please follow the steps below:

Step 1: Remove the back cover. See Section 3.5.

Step 2: Remove the HDD bracket from the PPC-F15A/F17A-H81. The HDD bracket is secured on the panel PC with four retention screws (Figure 3-2). Remove the four retention screws and lift the bracket off the panel PC.

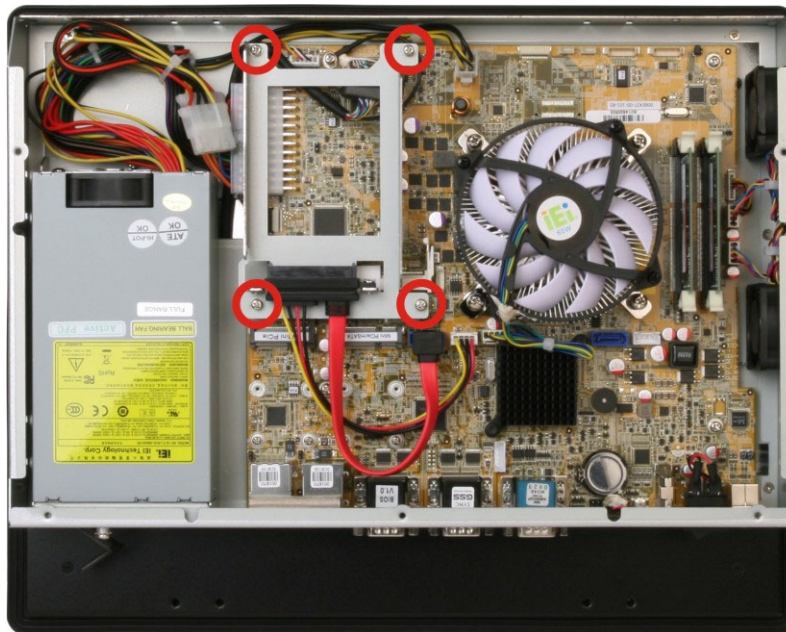

Figure 3-2: PPC-F15A/F17A-H81 HDD Bracket Retention Screws

Step 3: Attach the hard drive to the bracket. To do this, slide the hard drive onto the bracket until it connects with the SATA connector at the back.

Step 4: Secure the hard drive to the bracket. Secure the hard drive to the bracket with four retention screws (Figure 3-3).

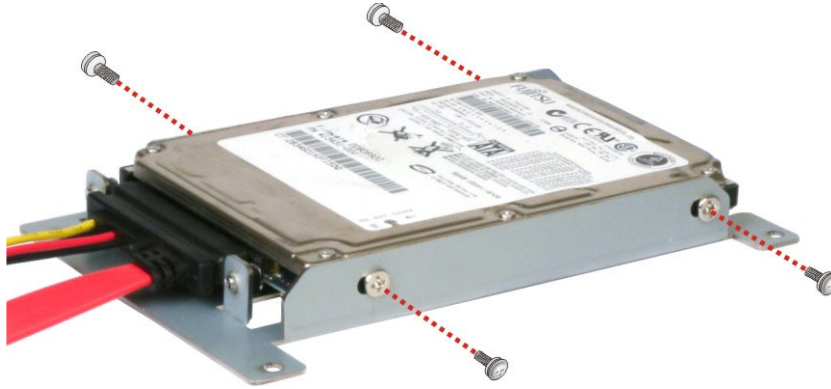

Figure 3-3: HDD Retention Screws

Step 5: Reinstall the HDD bracket into the PPC-FxxA-H81 and fasten the four hard drive bracket screws (**Figure 3-4**).

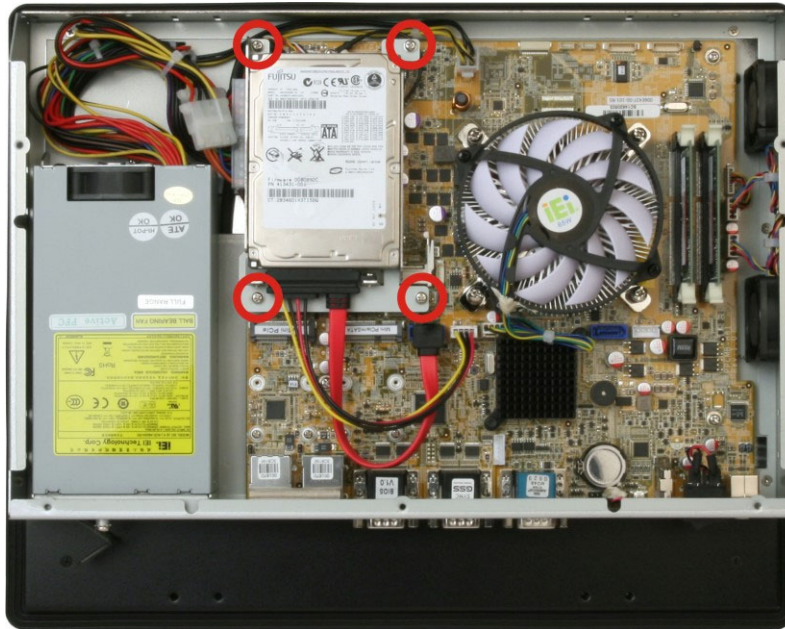

Figure 3-4: Replacing the PPC-F15A/F17A-H81 HDD Bracket

PPC-FxxA-H81 Panel PC

3.6.2 PPC-F22A/F24A-H81 2.5" HDD Installation

The PPC-F22A/F24A-H81 allows installation of either a 2.5" or 3.5" HDD. To install a 2.5" HDD into the PPC-F22A/F24A-H81, please follow the steps below:

Step 1: Remove the back cover. See Section 3.5.

Step 2: Remove the HDD bracket from the PPC-F22A/F24A-H81. The HDD bracket is secured on the panel PC with four retention screws (Figure 3-5). Remove the four retention screws and lift the bracket off the panel PC.

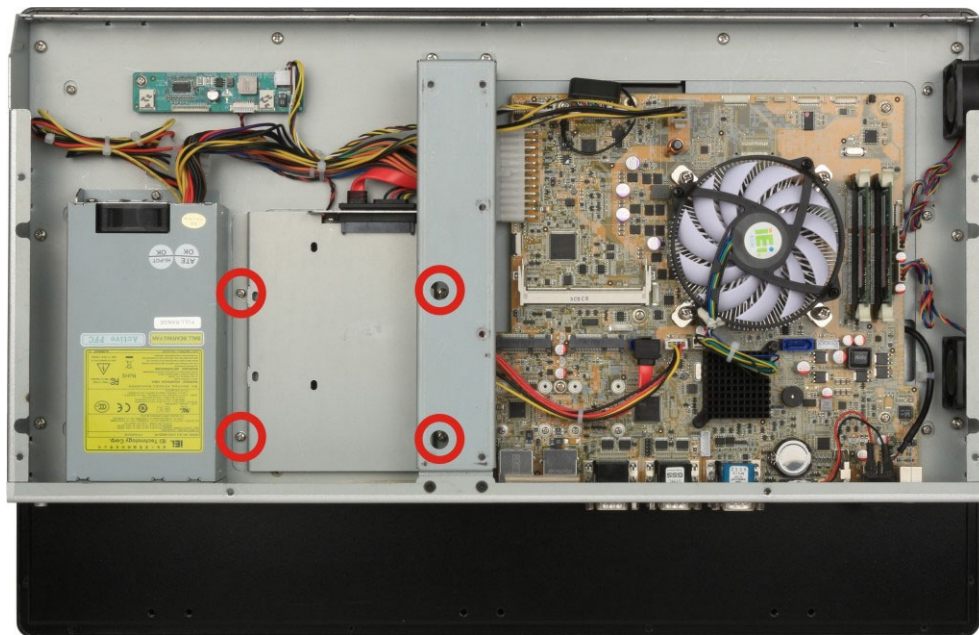

Figure 3-5: PPC-F22A/F24A-H81 HDD Bracket Retention Screws

Step 3: Attach the hard drive to the bracket. To do this, slide the hard drive onto the bracket until it connects with the SATA connector at the back (**Figure 3-6**).

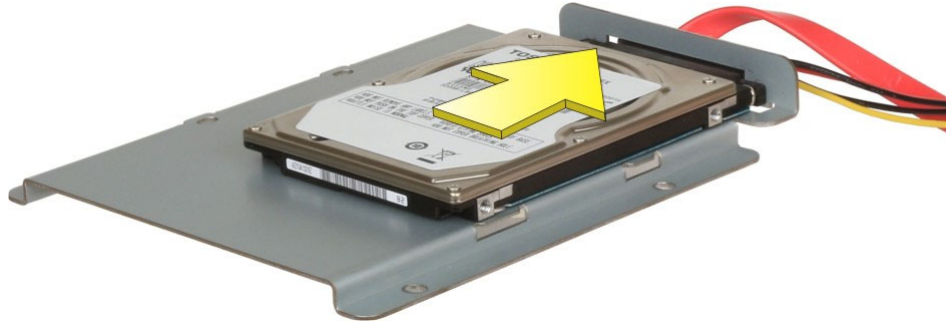

Figure 3-6: Connecting the Hard Drive to the HDD Bracket

Step 4: Secure the hard drive to the bracket. Secure the hard drive to the bracket with four retention screws as shown in **Figure 3-7**.

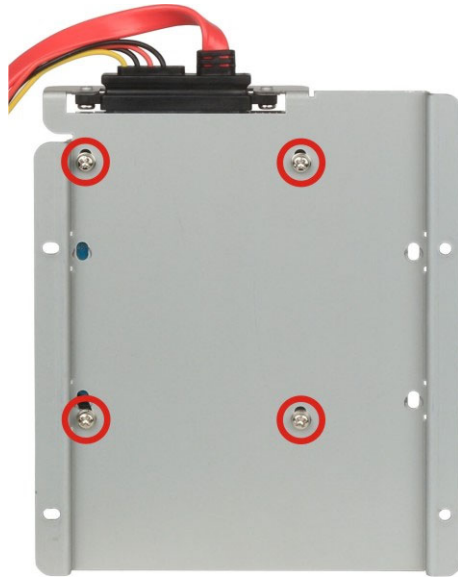

Figure 3-7: 2.5" HDD Retention Screws

Step 5: Reinstall the HDD bracket into the PPC-FxxA-H81 and fasten the four hard drive bracket screws (**Figure 3-8**).

PPC-FxxA-H81 Panel PC

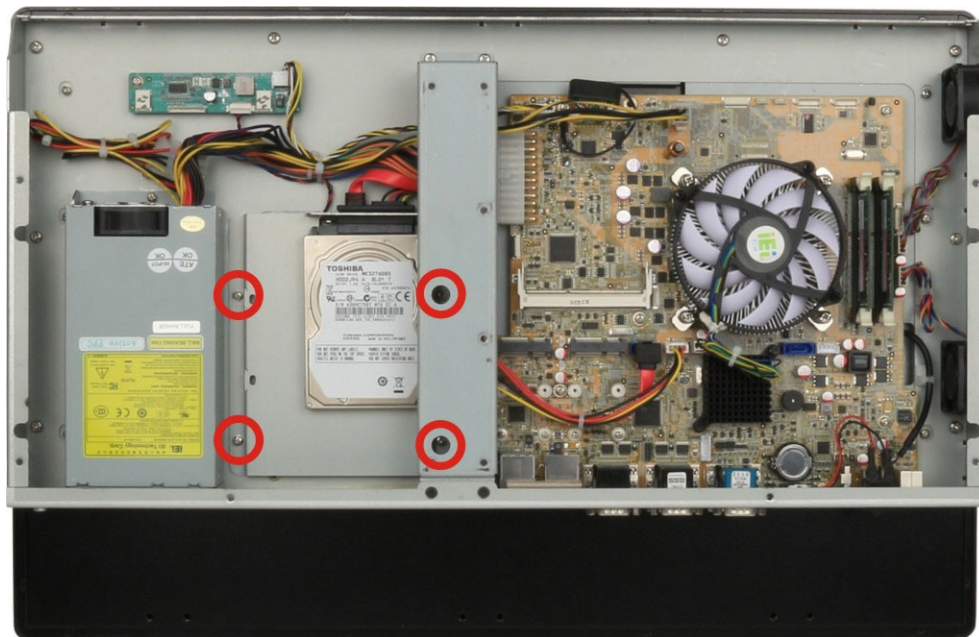

Figure 3-8: Replacing the PPC-F22A/F24A-H81 HDD Bracket

3.6.3 PPC-F22A/F24A-H81 3.5" HDD Installation

The PPC-F22A/F24A-H81 allows installation of either a 2.5" or 3.5" HDD. To install a 3.5" HDD into the PPC-F22A/F24A-H81, please follow the steps below:

- Step 1:** Remove the back cover. See Section 3.5.
- Step 2:** Remove the HDD bracket from the PPC-F22A/F24A-H81. The HDD bracket is secured on the panel PC with four retention screws (Figure 3-5). Remove the four retention screws and lift the bracket off the panel PC.

Step 3: Attach the hard drive to the bracket. To do this, slide the hard drive onto the bracket until it connects with the SATA connector at the back (**Figure 3-9**).



Figure 3-9: Connecting the Hard Drive to the HDD Bracket

Step 4: Secure the hard drive to the bracket. Secure the hard drive to the bracket with four retention screws as shown in **Figure 3-10**.



Figure 3-10: 3.5" HDD Retention Screws

Step 5: Reinstall the HDD bracket into the PPC-FxxA-H81 and fasten the four hard drive bracket screws (**Figure 3-11**).

PPC-FxxA-H81 Panel PC

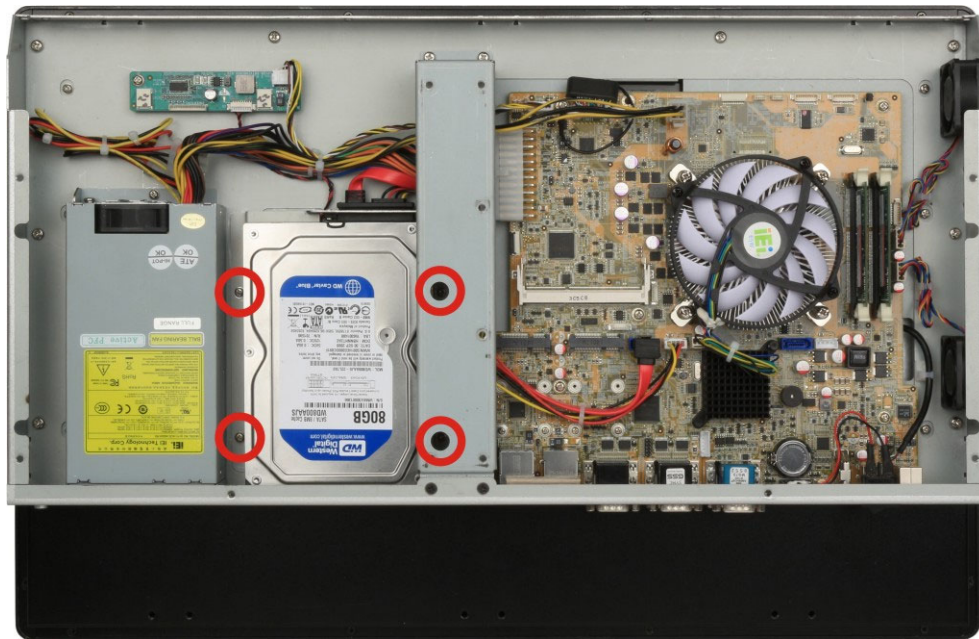

Figure 3-11: Replacing the PPC-F22A/F24A-H81 HDD Bracket

3.7 mSATA Module Installation

One of the PCIe Mini card slots on the motherboard of the PPC-FxxA-H81 supports mSATA module. To install an mSATA module, please follow the steps below.

Step 1: Remove the back cover. See Section 3.5.

Step 2: Locate the PCIe Mini card slot which supports mSATA. The location of the PCIe Mini card slot is shown in Figure 3-12.

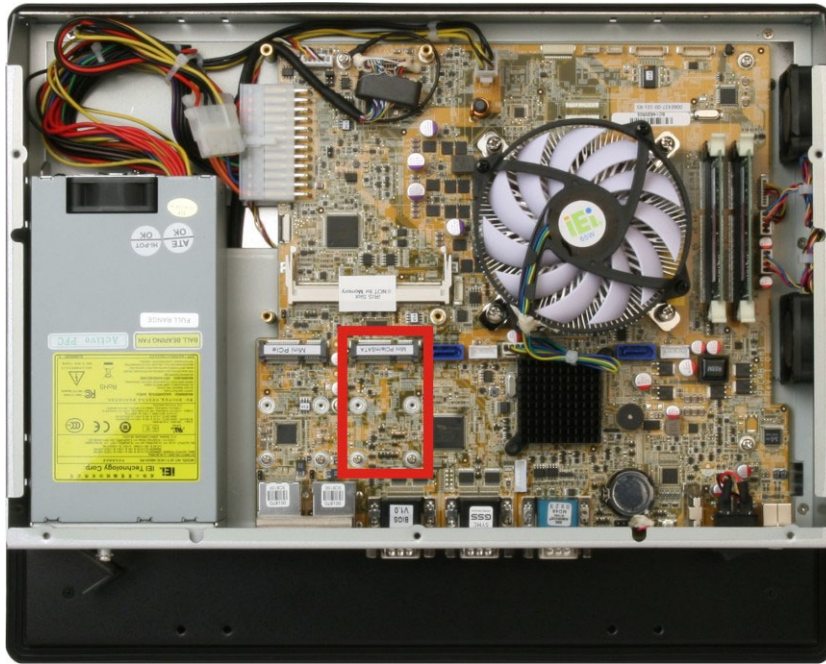

Figure 3-12: PCIe Mini Card Slot which supports mSATA

Step 3: Remove the retention screws. Remove the two retention screws as shown in Figure 3-13.

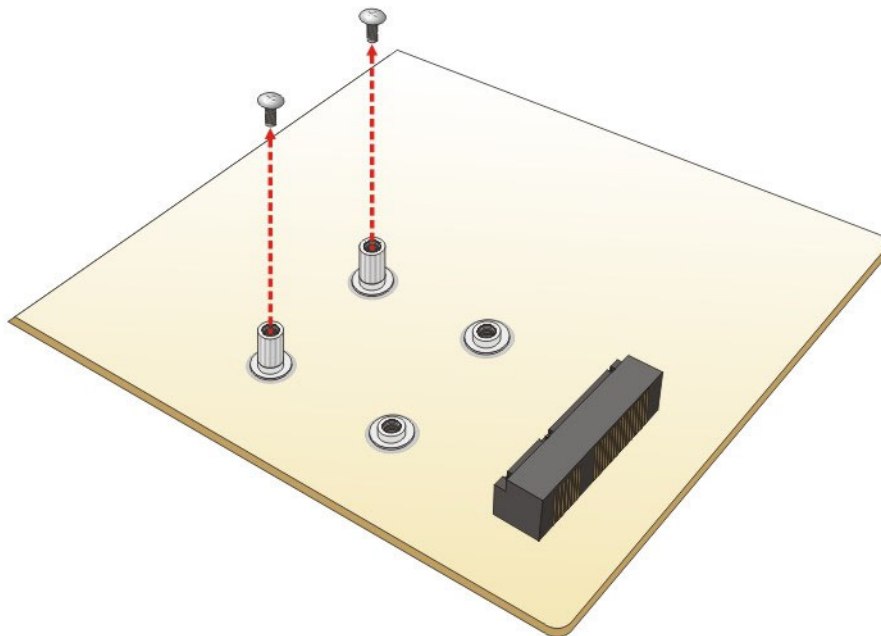

Figure 3-13: Removing the Retention Screws

PPC-FxxA-H81 Panel PC

Step 4: Insert into the socket at an angle. Line up the notch on the card with the notch on the slot. Slide the PCIe Mini card into the socket at an angle of about 20° (Figure 3-14).

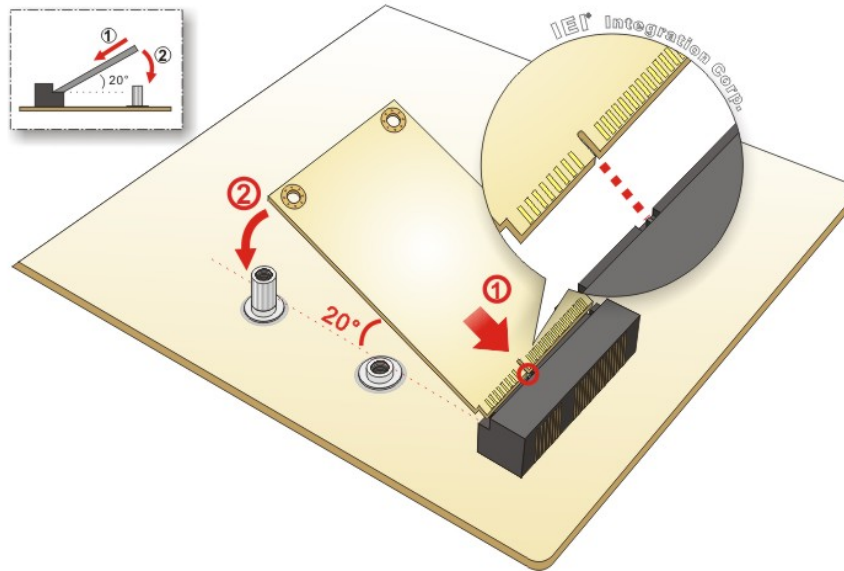

Figure 3-14: Inserting the PCIe Mini Card into the Slot at an Angle

Step 5: Secure the PCIe Mini card. Secure the PCIe Mini card with the retention screws previously removed (Figure 3-15).

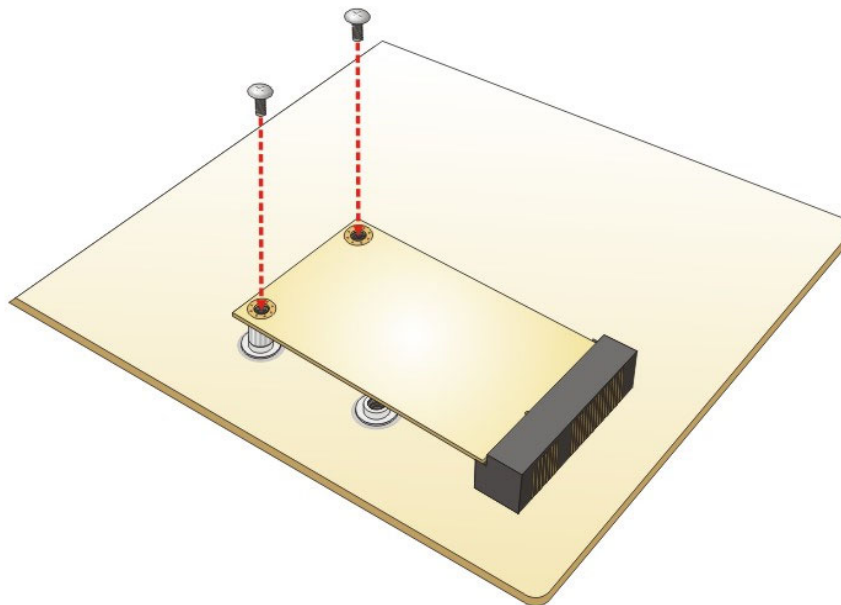

Figure 3-15: Securing the PCIe Mini Card

3.8 Wireless LAN Module Installation (Optional)

To install the optional wireless LAN (WLAN) module, please follow the steps below.

Step 1: Remove the back cover. See **Section 3.5**.

Step 2: Remove the two knockouts for antenna installation. The two knockouts are located on the top panel of the PPC-FxxA-H81 as shown in **Figure 3-16**.

PPC-F15A-H81:

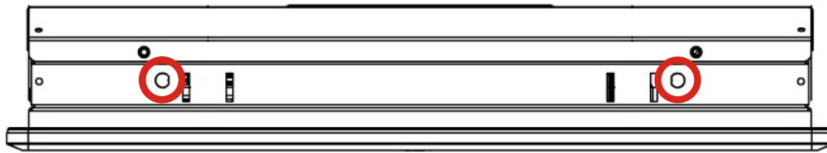

PPC-F17A-H81:

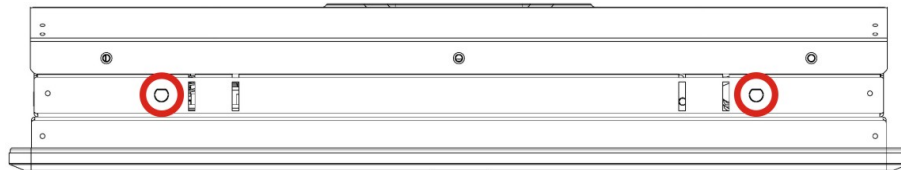

PPC-F22A-H81:



PPC-F24A-H81:



Figure 3-16: Knockouts for Wireless Antenna

PPC-FxxA-H81 Panel PC

Step 3: Locate the PCIe Mini slot (Figure 3-17).

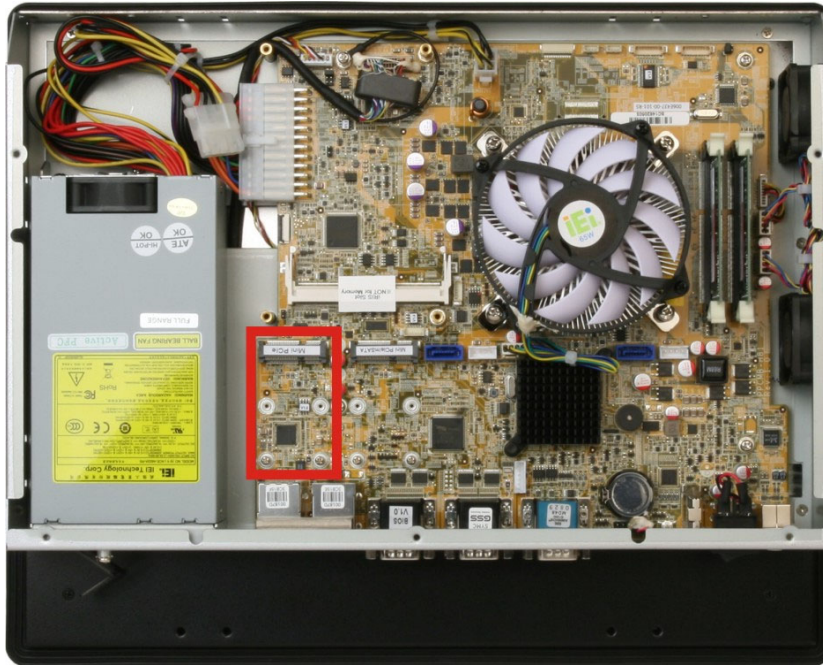

Figure 3-17: PCIe Mini Slot Location

Step 4: Remove the retention screws and the standoffs secured on the motherboard as shown in Figure 3-18.

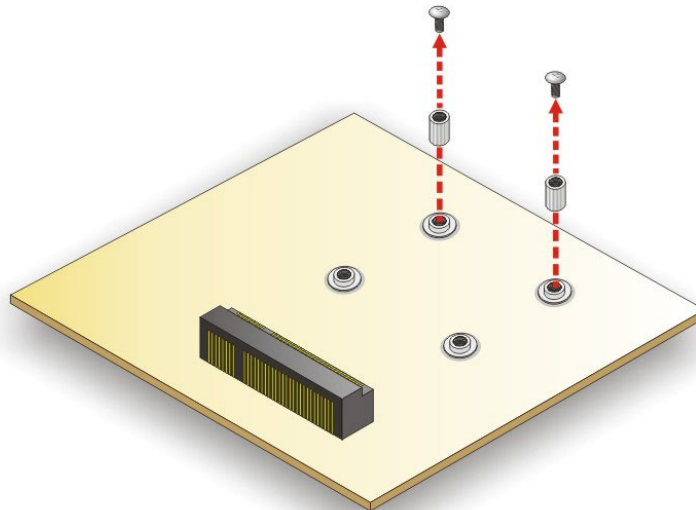

Figure 3-18: Removing the Retention Screws and Standoffs

Step 5: Install the previously removed standoffs to the screw holes for the WLAN module (**Figure 3-19**).

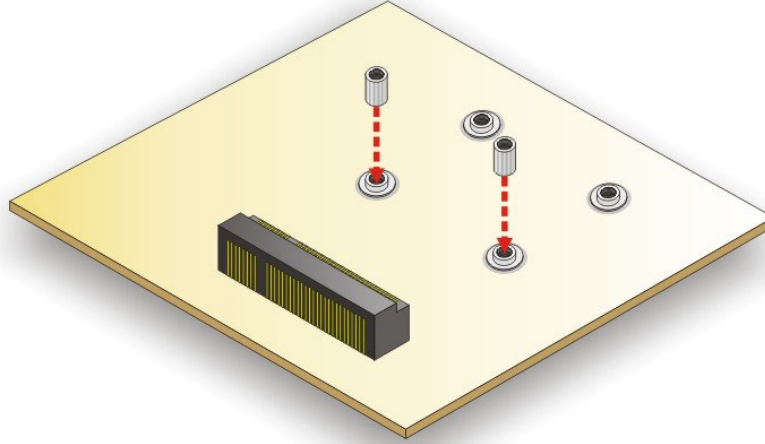

Figure 3-19: Installing the Standoffs

Step 6: Line up the notch on the WLAN module with the notch on the slot. Slide the WLAN module into the slot at an angle of about 20° (**Figure 3-20**).

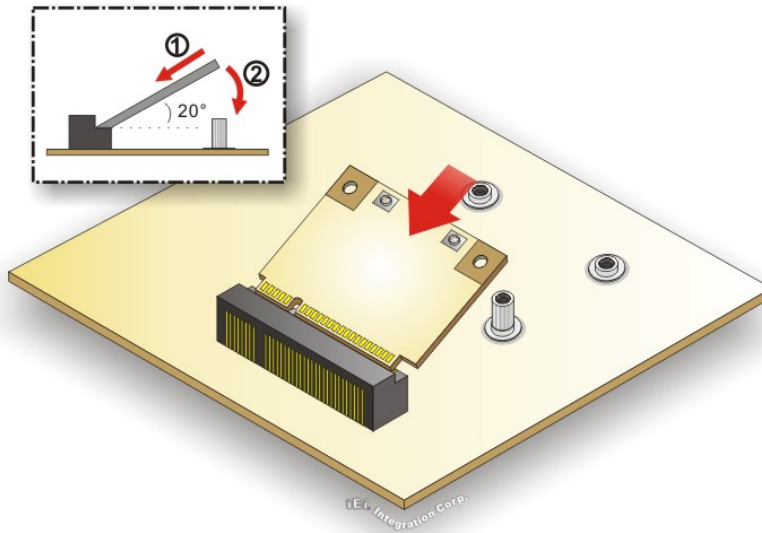

Figure 3-20: Inserting the WLAN Module

PPC-FxxA-H81 Panel PC

Step 7: Secure the WLAN module with the retention screws previously removed (Figure 3-21).

Step 8: Connect the two RF cables to the antenna connectors on the WLAN module (Figure 3-21).

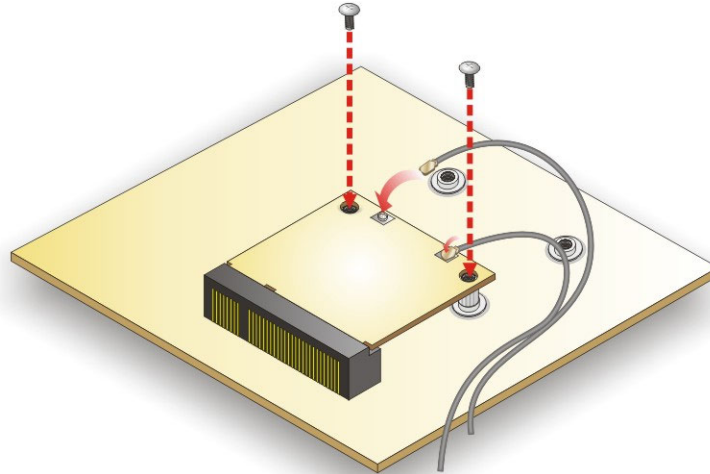

Figure 3-21: Securing WLAN Module and Connecting RF Cables

Step 9: Remove the nut and washer from the SMA connector at the other end of the RF cable.

Step 10: Insert the SMA connector to the antenna connector holes on the top panel.

Step 11: Secure the SMA connector by inserting the washer and tightening it with nut.

Step 12: Install the external antenna.

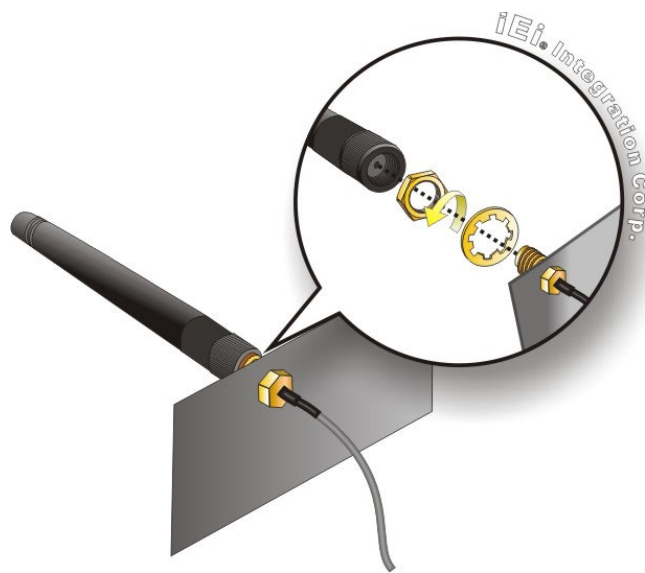

Figure 3-22: Securing SMA Connector and External Antenna Installation

3.9 iRIS-2400 Module Installation



WARNING:

The iRIS-2400 module slot is designed to install the iRIS-2400 module only. DO NOT install other modules into the iRIS-2400 module slot. Doing so may cause damage to the PPC-FxxA-H81.

To install the iRIS-2400 module, please follow the steps below.

Step 1: Remove the back cover. See **Section 3.5**.

Step 2: Remove the HDD bracket to expose the iRIS-2400 module slot (PPC-F15A/F17A-H81 only). Refer to **Step 2** in **Section 3.6** to remove the HDD bracket.

The location of the iRIS-2400 module slot is shown in **Figure 3-23**.

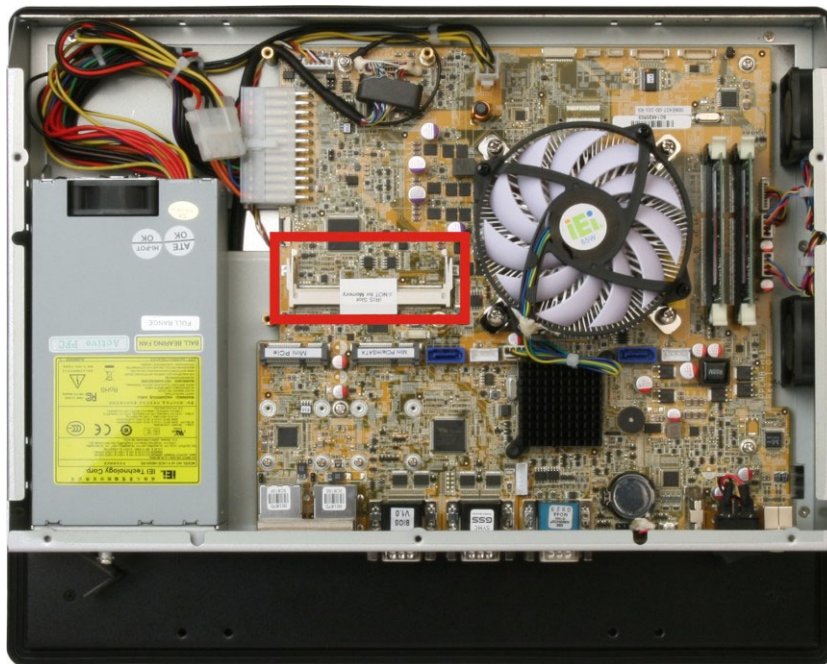

Figure 3-23: iRIS-2400 Module Slot

PPC-FxxA-H81 Panel PC

Step 3: Align the iRIS-2400 module with the iRIS-2400 module slot. Align the notch on the module with the notch on the iRIS-2400 module slot (**Figure 3-24**).

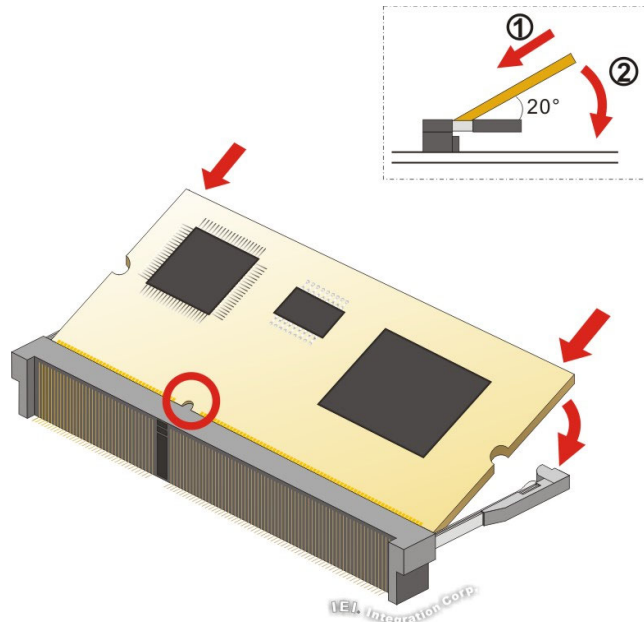

Figure 3-24: iRIS-2400 Module Installation

Step 4: Insert the iRIS-2400 module. Push the module in at a 20° angle (**Figure 3-24**).

Step 5: Seat the iRIS-2400 module. Gently push downwards and the arms clip into place (**Figure 3-24**).



NOTE:

After installing the iRIS-2400 module, use the LAN port with **iRIS** label (**Figure 1-4**) to establish a network connection. Please refer to **Section 3.13** for IPMI setup procedures.

3.10 AT/ATX Mode Selection

AT and ATX power modes can both be used on the PPC-FxxA-H81 panel PC. The selection is made through an AT/ATX switch on the I/O interface panel. The switch is shown below.

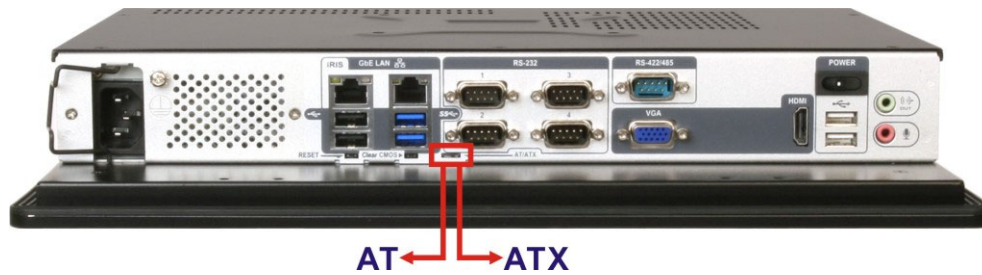

Figure 3-25: AT/ATX Mode Selection

3.11 Mounting the System



WARNING!

When mounting the PPC-FxxA-H81 panel PC, it is advisable to have more than one person help with the installation to prevent accidental damage to the panel and avoid personal injury.

The methods of mounting the PPC-FxxA-H81 are:

- Wall mounting
- Panel mounting
- Arm mounting
- Stand mounting
- Rack mounting

The mounting methods are described in the following sections.

3.11.1 Wall Mounting

To mount the PPC-FxxA-H81 panel PC onto a wall, please follow the steps below.

Step 1: Select the location on the wall for the wall-mounting bracket.

Step 2: Carefully mark the locations of the four bracket screw holes on the wall.

Step 3: Drill four pilot holes at the marked locations on the wall for the bracket retention screws.

Step 4: Align the wall-mounting bracket screw holes with the pilot holes.

PPC-FxxA-H81 Panel PC

Step 5: Secure the mounting bracket to the wall by inserting the retention screws into the four pilot holes and tightening them (**Figure 3-26**).

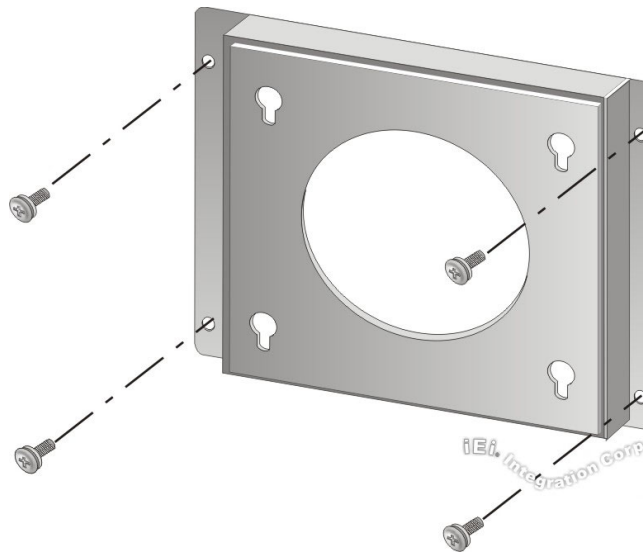

Figure 3-26: Wall-mounting Bracket

Step 6: Insert the four monitor mounting screws provided in the wall mounting kit into the four screw holes on the rear panel of the monitor and tighten until the screw shank is secured against the rear panel (**Figure 3-27**).

Step 7: Align the mounting screws on the monitor rear panel with the mounting holes on the bracket.

Step 8: Carefully insert the screws through the holes and gently pull the monitor downwards until the monitor rests securely in the slotted holes (**Figure 3-27**). Ensure that all four of the mounting screws fit snugly into their respective slotted holes.

**NOTE:**

In the diagram below the bracket is already installed on the wall.

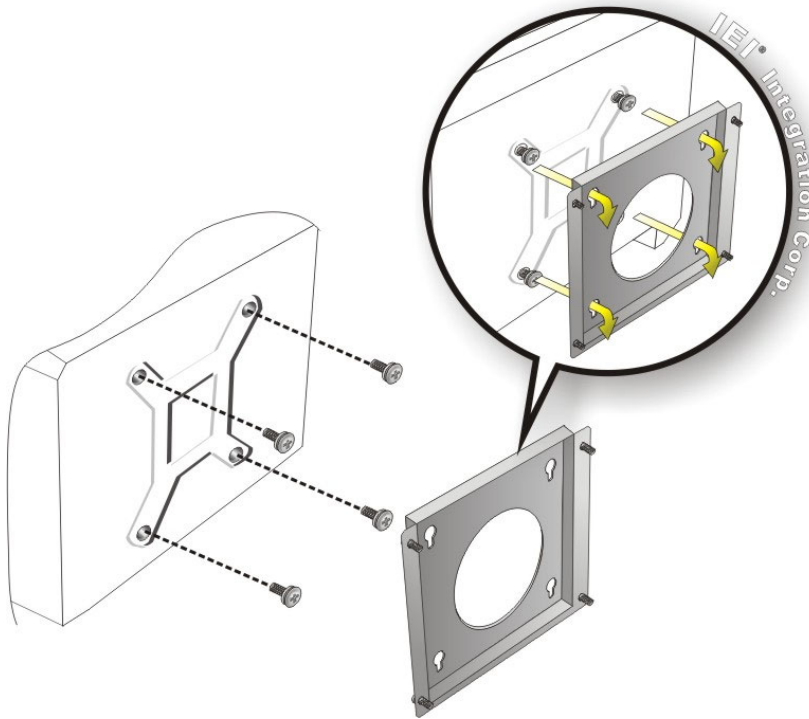

Figure 3-27: Mount the Chassis

- Step 9:** Secure the panel PC with the wall-mounting kit. To do this, stick the protective cushion to the wall-mounting kit first. Then, put the wall-mounting kit on the top panel of the panel PC. Carefully mark the location of the wall-mounting kit screw holes on the wall. Drill a pilot hole at the marked location on the wall. Secure the wall-mounting kit to the wall by inserting a retention screw into the pilot hole on the wall (**Figure 3-28**). This step is to avoid the panel PC being pushed apart from the wall-mounting bracket accidentally.

PPC-FxxA-H81 Panel PC

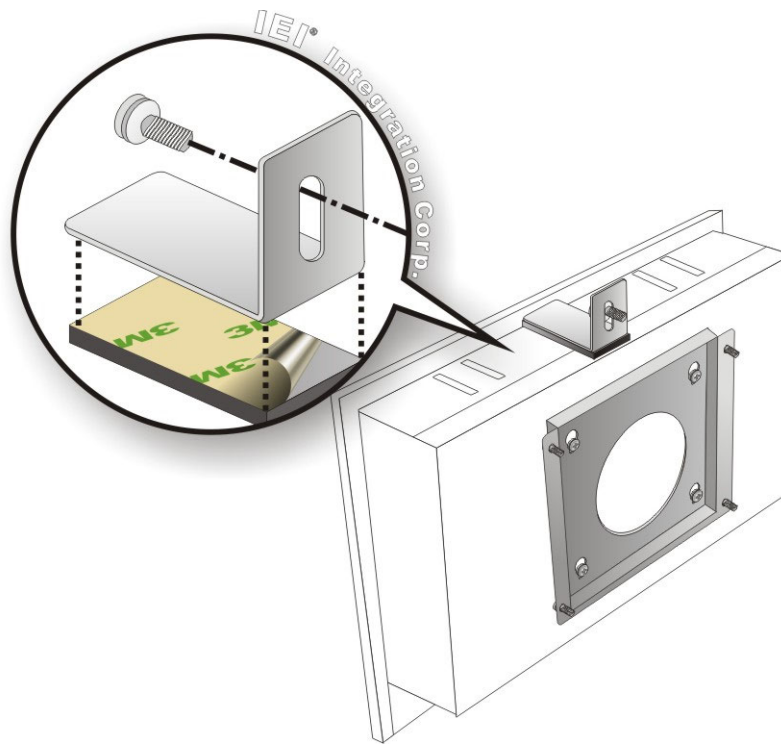

Figure 3-28: Secure the Chassis

3.11.2 Panel Mounting

To mount the PPC-FxxA-H81 panel PC into a panel, please follow the steps below.

Step 13: Install the mounting brackets onto the rear panel (**Figure 3-29**). The required number of mounting brackets may vary by models.



Figure 3-29: PPC-F15A-H81 Mounting Bracket Installation

Step 14: Select the position on the panel to mount the PPC-FxxA-H81.

Step 15: Cut out a section of the panel that corresponds to the rear panel dimensions of the PPC-FxxA-H81. The recommended cutout sizes are shown below (Figure 3-30, Figure 3-31, Figure 3-32 and Figure 3-33).

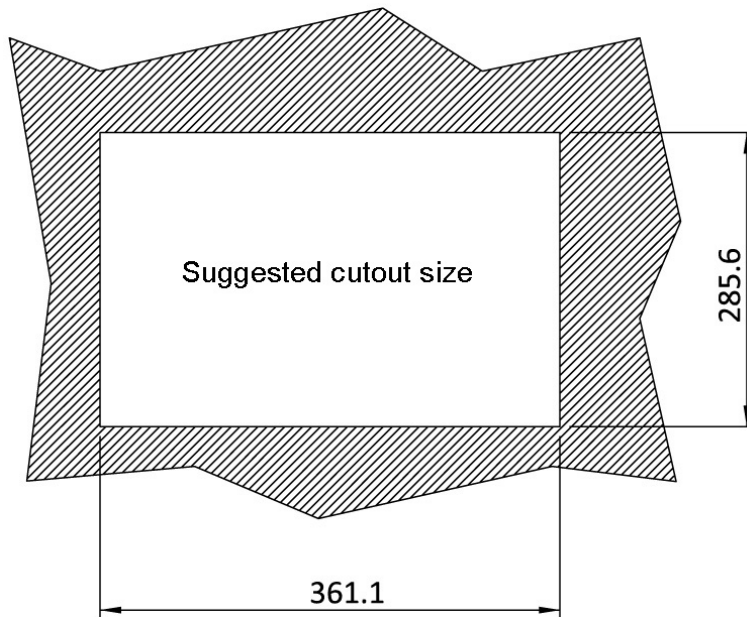

Figure 3-30: PPC-F15A-H81 Panel Cutout Dimensions

PPC-FxxA-H81 Panel PC

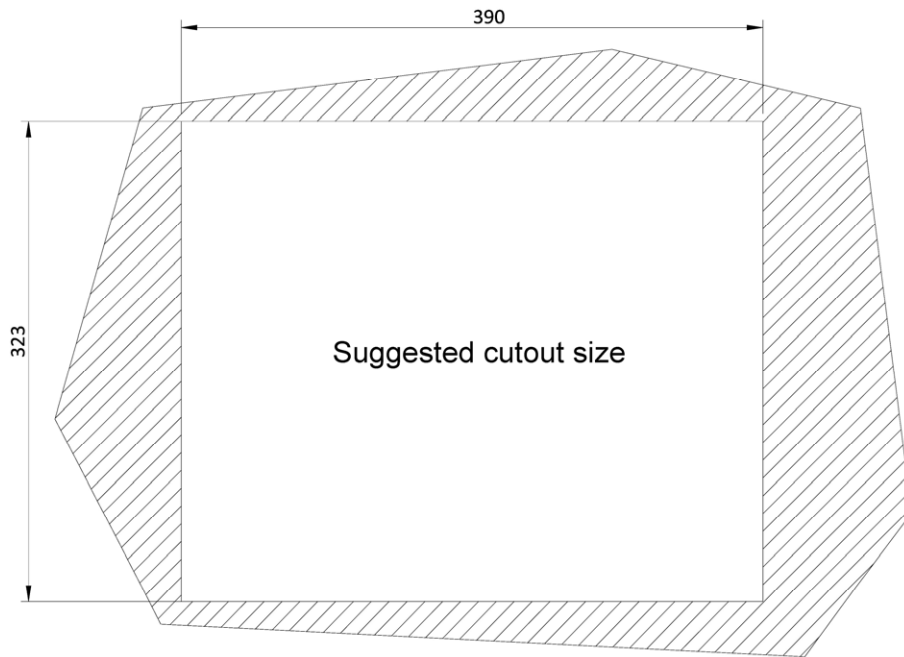

Figure 3-31: PPC-F17A-H81 Panel Cutout Dimensions

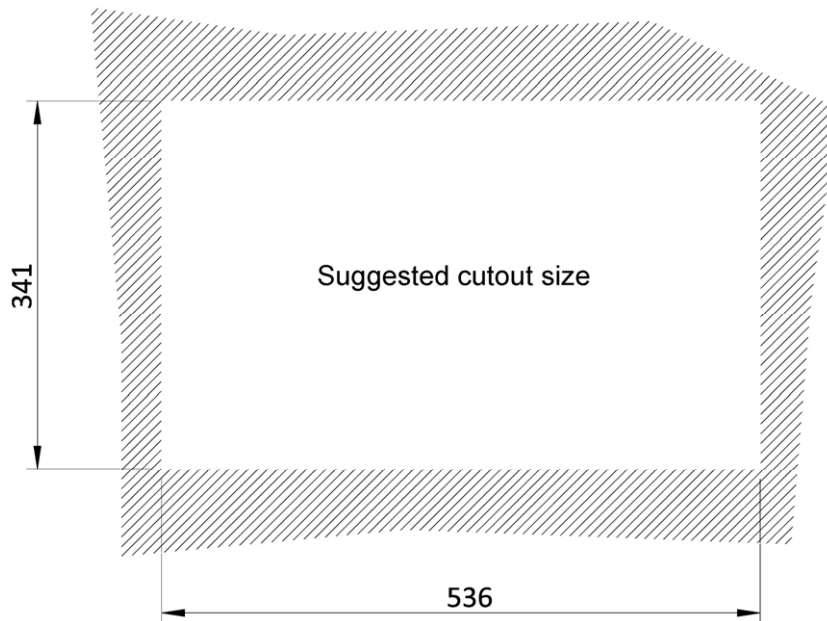

Figure 3-32: PPC-F22A-H81 Panel Cutout Dimensions

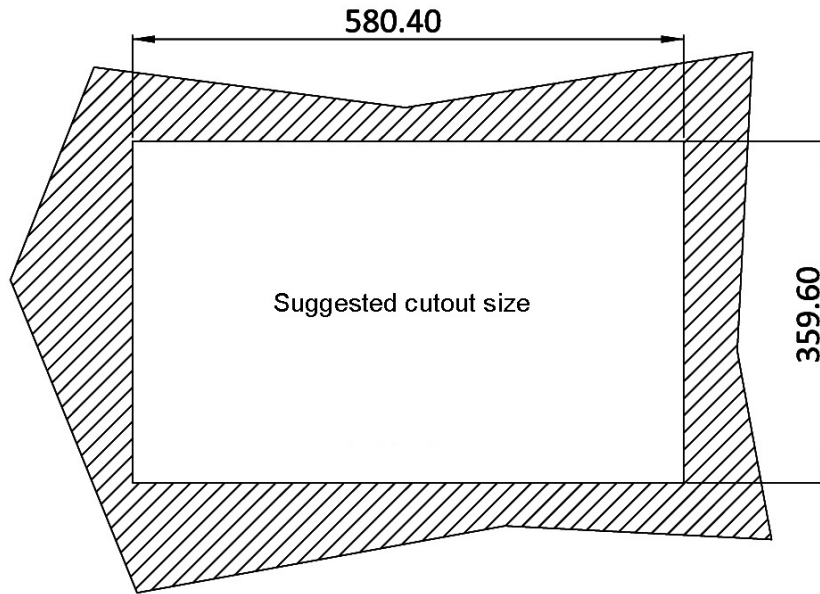

Figure 3-33: PPC-F24A-H81 Panel Cutout Dimensions

- Step 16:** Slide the PPC-FxxA-H81 through the hole until the aluminum frame is flush against the panel.
- Step 17:** Insert the mounting clamps into the mounting brackets and pre-formed holes along the edges of the PPC-FxxA-H81, behind the aluminum frame (Figure 3-34). The required number of mounting clamps may vary by models.
- Step 18:** Tighten the screws that pass through the mounting clamps until the plastic caps at the front of all the screws are firmly secured to the panel (Figure 3-34).

PPC-FxxA-H81 Panel PC

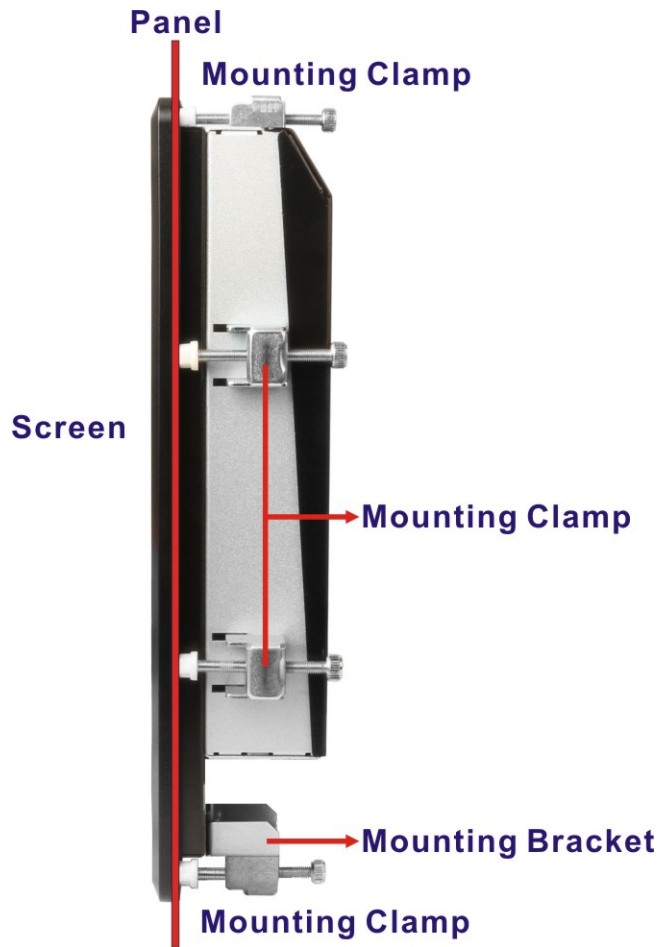

Figure 3-34: Tighten the Mounting Clamp Screws

3.11.3 Rack and Cabinet Installation

The PPC-FxxA-H81 flat panel PC can be installed into a cabinet or rack. The installation procedures are similar to the panel mounting installation. To do this, please follow the steps below:

**NOTE:**

When purchasing the cabinet/rack installation bracket, make sure it is compatible with both the PPC-FxxA-H81 flat panel PC and the rack/cabinet into which the PPC-FxxA-H81 is installed.

Step 1: Install the mounting brackets onto the rear panel (**Figure 3-29**). The required number of mounting brackets may vary by models.

Step 2: Slide the rear of the PPC-FxxA-H81 flat panel PC through the rack/cabinet bracket until the aluminum frame is flush against the front of the bracket (**Figure 3-35**).

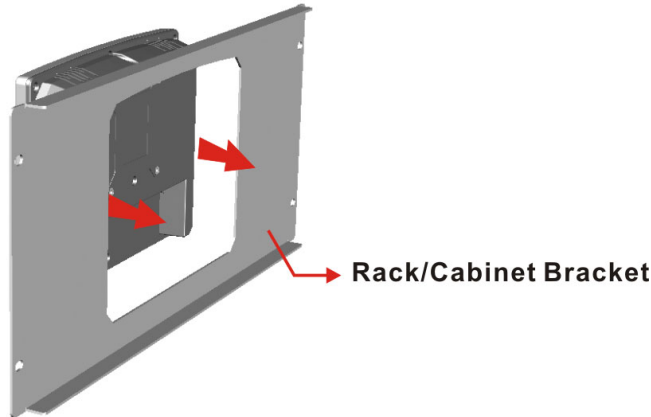

Figure 3-35: The Rack/Cabinet Bracket

Step 3: Insert the mounting clamps into the mounting brackets and pre-formed holes along the edges of the PPC-FxxA-H81, behind the aluminum frame (**Figure 3-36**). The required number of mounting clamps may vary by models.

Step 4: Tighten the screws that pass through the mounting clamps until the plastic caps at the front of all the screws are firmly secured to the bracket (**Figure 3-36**).

PPC-FxxA-H81 Panel PC

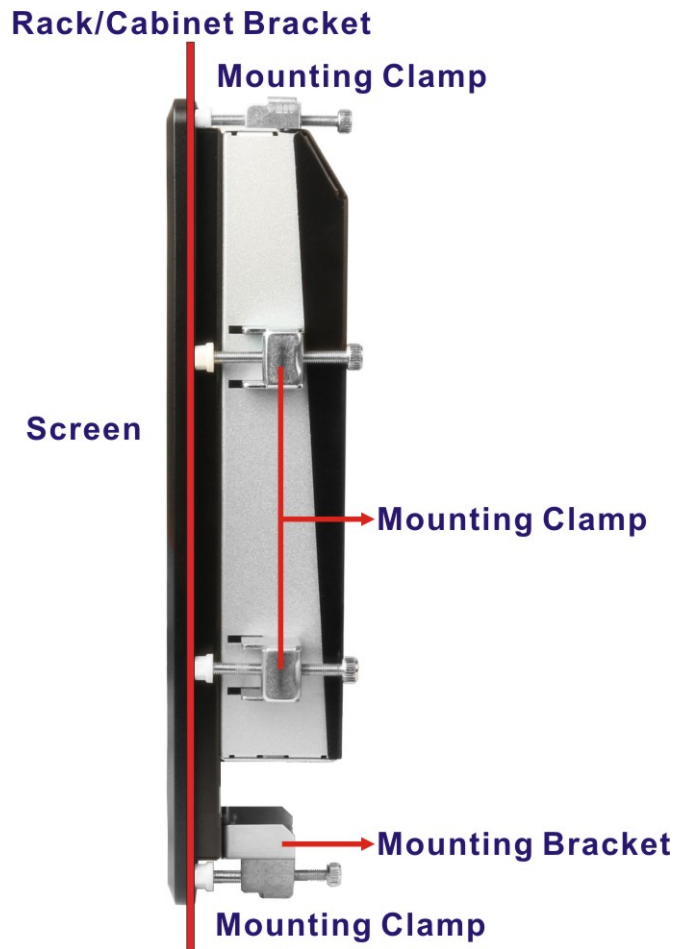

Figure 3-36: Secure the Rack/Cabinet Bracket

Step 5: Slide the PPC-FxxA-H81 with the attached rack/cabinet bracket into a rack or cabinet (Figure 3-37).

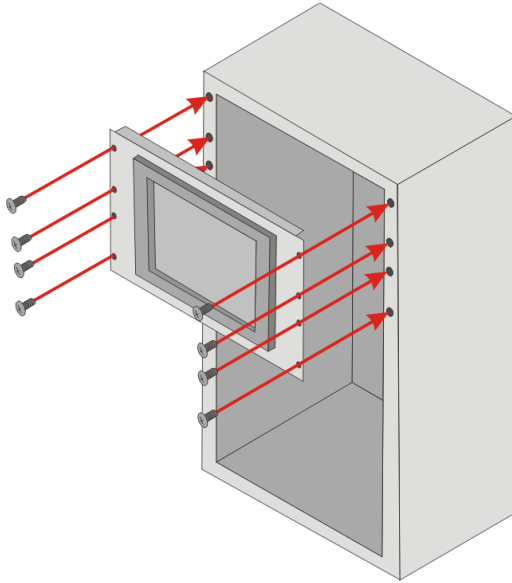

Figure 3-37: Install into a Rack/Cabinet

Step 6: Once the flat panel PC with the attached rack/cabinet bracket has been properly inserted into the rack or cabinet, secure the front of the rack/cabinet bracket to the front of the rack or cabinet (**Figure 3-37**).

3.11.4 Arm Mounting

The PPC-FxxA-H81 is VESA (Video Electronics Standards Association) compliant and can be mounted on an arm with a 100 mm interface pad. To mount the PPC-FxxA-H81 on an arm, please follow the steps below.

Step 1: The arm is a separately purchased item. Please correctly mount the arm onto the surface it uses as a base. To do this, refer to the installation documentation that came with the mounting arm.



NOTE:

When purchasing the arm please ensure that it is VESA compliant and that the arm has a 100 mm interface pad. If the mounting arm is not VESA compliant, it cannot be used to support the PPC-FxxA-H81 panel PC.

PPC-FxxA-H81 Panel PC

- Step 2:** Once the mounting arm has been firmly attached to its surface, lift the PPC-FxxA-H81 panel PC onto the interface pad of the mounting arm.
- Step 3:** Align the retention screw holes on the mounting arm interface with those in the PPC-FxxA-H81 panel PC. The arm mounting retention screw holes of the PPC-FxxA-H81 panel PC are shown in **Figure 3-38**.

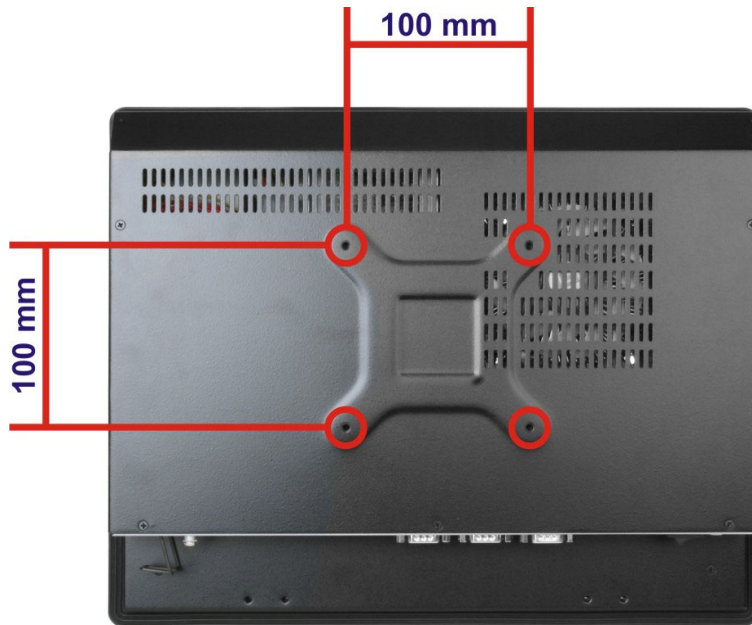

Figure 3-38: Arm Mounting Retention Screw Holes

- Step 4:** Secure the PPC-FxxA-H81 to the interface pad by inserting four retention screws through the mounting arm interface pad and into the PPC-FxxA-H81 panel PC.

3.11.5 Stand Mounting

To mount the PPC-FxxA-H81 using the stand mounting kit, please follow the steps below.

- Step 1:** Locate the screw holes on the rear of the PPC-FxxA-H81. This is where the bracket will be attached.

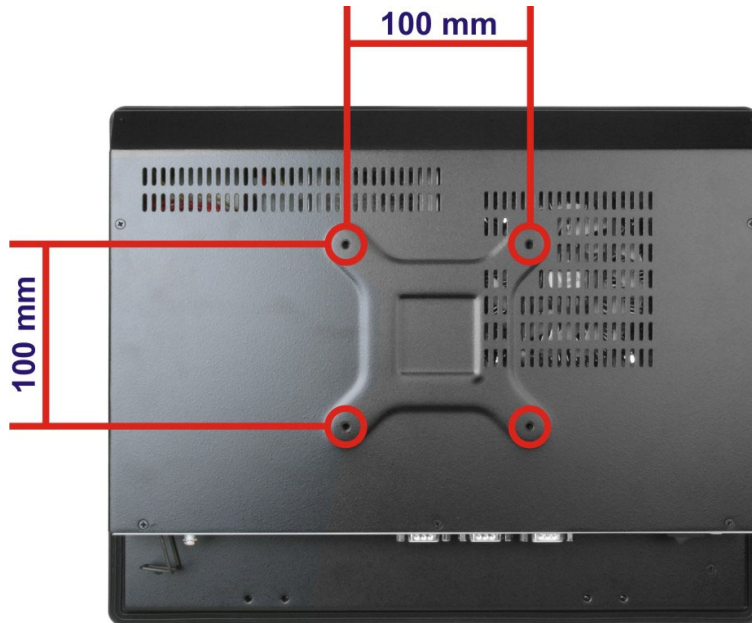

Figure 3-39: Stand Mounting Retention Screw Holes

Step 2: Align the bracket with the screw holes.

Step 3: To secure the bracket to the PPC-FxxA-H81, insert the retention screws into the screw holes and tighten them.

3.12 External Peripheral Device Connection

The following external peripheral devices can be connected to the external peripheral interface connectors on the bottom panel.

- Audio devices
- RJ-45 Ethernet cable connector
- Serial devices
- VGA or HDMI display device
- USB devices

To install these devices, connect the corresponding cable connector from the actual device to the corresponding PPC-FxxA-H81 external peripheral interface connector making sure the pins are properly aligned.

3.12.1 Audio Device Connection

The audio jacks on the external audio connector enable the PPC-FxxA-H81 to be connected to the speaker or microphone. To install the audio devices, follow the steps below.

PPC-FxxA-H81 Panel PC

Step 1: Identify the audio plugs. The plugs on your home theater system or speakers may not match the colors on the rear panel. If audio plugs are plugged into the wrong jacks, sound quality will be very bad.

Step 2: Plug the audio plugs into the audio jacks. Plug the audio plugs into the audio jacks. If the plugs on your speakers are different, an adapter will need to be used to plug them into the audio jacks.

- **Line Out port (Lime):** Connects to a headphone or a speaker.
- **Microphone (Pink):** Connects to a microphone.

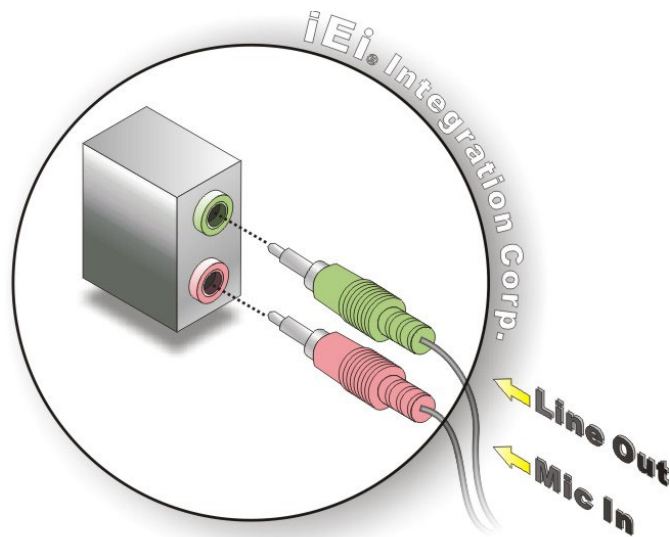



Figure 3-40: Audio Connector



NOTE:

If there is no audio device connected to the line-out port, the volume icon on the Windows notification area displays .

When the line-out port is connected with an audio device, the volume icon will be displayed , allowing the user to adjust the volume and open a file with audio.

3.12.2 HDMI Display Device Connection

The HDMI connector transmits a digital signal to compatible HDMI display devices such as a TV or computer screen. To connect the HDMI cable to the PPC-FxxA-H81, follow the steps below.

Step 1: **Locate the HDMI connector.** The location is shown in **Figure 1-4**.

Step 2: **Align the connector.** Align the HDMI connector with the HDMI port. Make sure the orientation of the connector is correct.

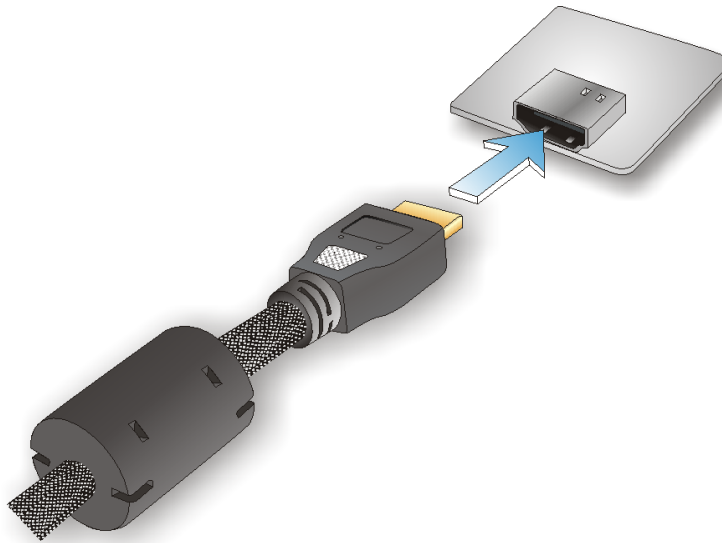

Figure 3-41: HDMI Connection

Step 3: **Insert the HDMI connector.** Gently insert the HDMI connector. The connector should engage with a gentle push. If the connector does not insert easily, check again that the connector is aligned correctly, and that the connector is being inserted with the right way up.

PPC-FxxA-H81 Panel PC

3.12.3 LAN Connection

The RJ-45 LAN connectors allow connections to external networks. To connect the PPC-FxxA-H81 to a network through the RJ-45 LAN connectors, follow the steps below.

Step 1: **Locate the RJ-45 connectors.** The locations of the RJ-45 connectors are shown in **Figure 1-4**.

Step 2: **Align the connectors.** Align the RJ-45 connector on the LAN cable with one of the RJ-45 connectors on the PPC-FxxA-H81. See **Figure 3-42**.

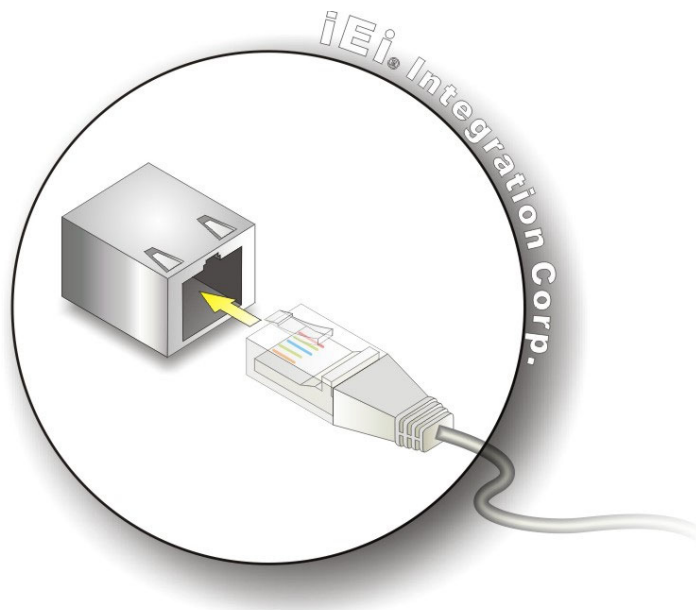

Figure 3-42: LAN Connection

Step 3: **Insert the LAN cable RJ-45 connector.** Once aligned, gently insert the LAN cable RJ-45 connector into the on-board RJ-45 connector.

3.12.4 Serial Device Connection

Follow the steps below to connect a serial device to the DB-9 connector of the PPC-FxxA-H81.

Step 1: **Locate the DB-9 connector.** The locations of the DB-9 connectors are shown in **Figure 1-4**.

Step 2: **Insert the serial connector.** Insert the DB-9 connector of a serial device into the DB-9 connector on the bottom panel. See **Figure 3-43**.

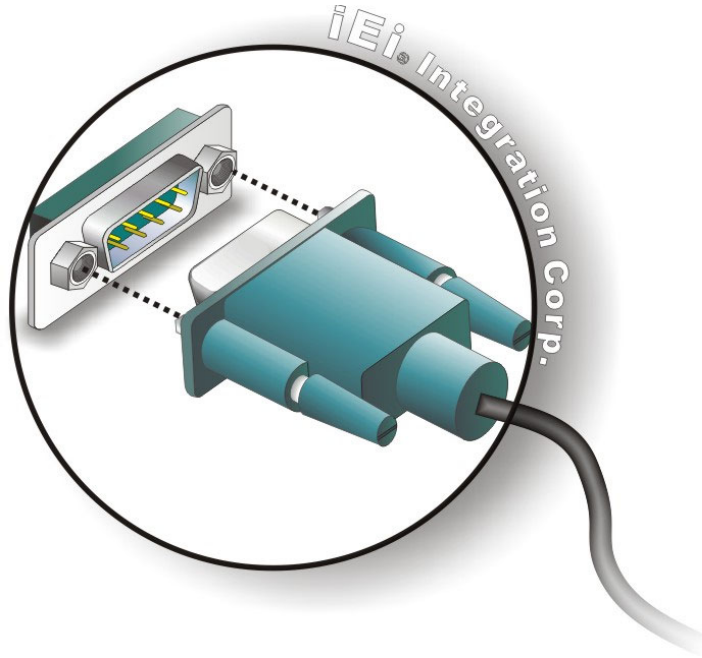

Figure 3-43: RS-232 Serial Device Connector

Step 3: **Secure the connector.** Secure the serial device connector to the external interface by tightening the two retention screws on either side of the connector.

3.12.5 USB Device Connection

To connect a USB device, please follow the instructions below.

Step 1: **Located the USB connectors.** The locations of the USB connectors are shown in **Figure 1-4**.

Step 2: **Align the connectors.** Align the USB device connector with one of the USB connectors on the bottom panel. See **Figure 3-44**.

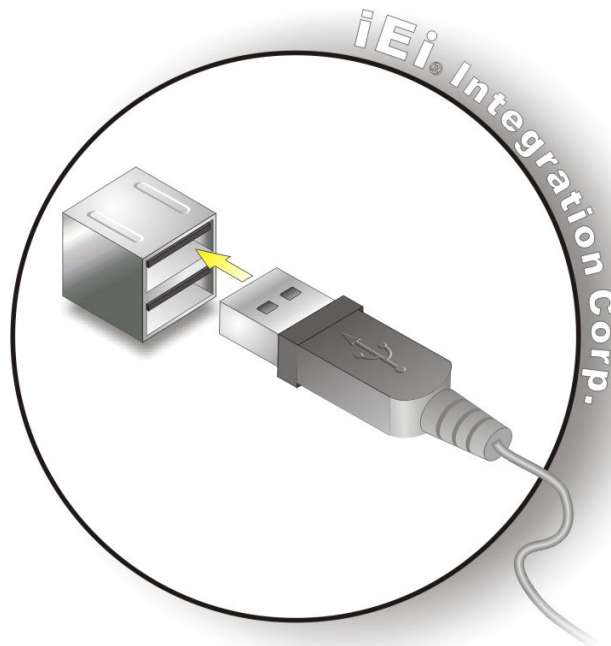

Figure 3-44: USB Device Connection

Step 3: **Insert the device connector.** Once aligned, gently insert the USB device connector into the onboard connector.

3.12.6 VGA Connector Connection

The VGA connector connects to a monitor that accepts VGA video input. To connect the PPC-FxxA-H81 to a VGA monitor, follow the steps below,

- Step 1:** **Locate the female DB-15 connector.** The location of the female DB-15 connector is shown in **Figure 1-4**.
- Step 2:** **Align the VGA connector.** Align the male DB-15 connector on the VGA screen cable with the female DB-15 connector on the external peripheral interface.
- Step 3:** **Insert the VGA connector.** Once the connectors are properly aligned, insert the male connector from the VGA screen into the female connector on the PPC-FxxA-H81. See **Figure 3-45**.

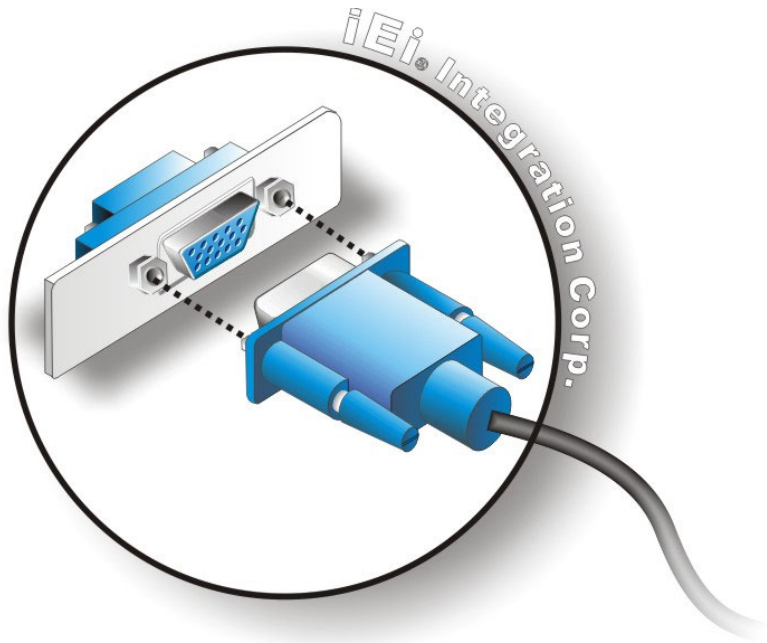

Figure 3-45: VGA Connector

3.13 Reset the System

The reset button enables users to reboot the system when the system is turned on. The reset button location is shown in **Figure 3-46**. Press the reset button to reboot the system.

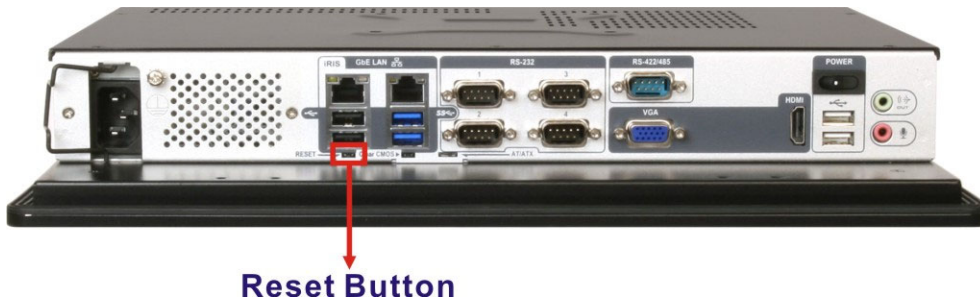

Figure 3-46: Reset Button Location

PPC-FxxA-H81 Panel PC

3.14 Clear CMOS

If the PPC-FxxA-H81 fails to boot due to improper BIOS settings, the clear CMOS button clears the CMOS data and resets the system BIOS information. To do this, push the clear CMOS button for three seconds, and then restart the system. The clear CMOS button location is shown in **Figure 3-47**.

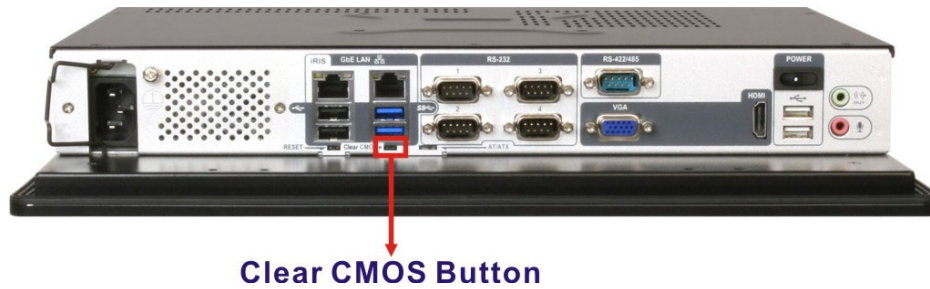

Figure 3-47: Clear CMOS Button Location

3.15 USB Power Selection

The PPC-FxxA-H81 can select the USB power through the BIOS menu (Chipset → PCH-IO Configuration). Use the **USB SW1 Power** and the **USB SW2 Power** BIOS options to configure the correspondent USB ports (see **Table 3-1**) and refer to **Table 3-2** to select the USB power source.

BIOS Options	Configured USB Ports
USB SW1 Power	KBMS1 (internal keyboard and mouse port) LAN1_USB1 (external USB 3.0 ports) LAN2_USB2 (external USB 2.0 ports)
USB SW2 Power	USB1 (internal USB 2.0 ports) USB_CON1 (external USB 2.0 ports)

Table 3-1: BIOS Options and Configured USB Ports

Options	Description
+5V DUAL	+5V dual (default)
+5V	+5V

Table 3-2: USB Power Source Setup

Please refer to **Section 5.4.1** for detailed information.

3.16 IPMI Setup Procedure

The PPC-FxxA-H81 features Intelligent Platform Management Interface (IPMI) that helps lower the overall costs of server management by enabling users to maximize IT resources, save time and manage multiple systems. The PPC-FxxA-H81 supports IPMI 2.0 through the optional iRIS-2400 module. Follow the steps below to setup IPMI.

3.16.1 Managed System Hardware Setup

The hardware configuration of the managed system (PPC-FxxA-H81) is described below.

Step 1: Install an iRIS-2400 module to the iRIS-2400 module slot (refer to **Section 3.8**).

Step 2: Make sure at least one DDR3 DIMM is installed in one of the DIMM sockets. If multiple DIMMs are installed, all of the DIMMs must be same size, same speed and same brand to get the best performance.

Step 3: Connect an Ethernet cable to the RJ-45 LAN port with **iRIS** label (**Figure 1-4**).

3.16.2 Using the IEI iMAN Web GUI

To manage a client system from a remote console using IEI iMAN Web GUI, follow the steps below.

Step 1: Obtain the IP address of the managed system. It is recommended to use the IPMI Tool on the managed system to obtain the IP address. To use IPMI Tool to obtain IP address, follow the steps below:

- a. Copy the **ipmitool.exe** file to a bootable USB flash drive.
- b. Insert the USB flash drive to the PPC-FxxA-H81
- c. The PPC-FxxA-H81 boots from the USB flash drive
- d. Enter the following command: **ipmitool 20 30 02 01 03 00 00**
(there is a space between each two-digit number)
- e. A serial of number shows. The last four two-digit hexadecimal numbers are the IP address. Convert the hexadecimal numbers to decimal numbers.

PPC-FxxA-H81 Panel PC

Step 2: On the remote management console, open a web browser. Enter the managed system IP address in the web browser (**Figure 3-48**).

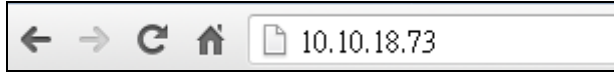

Figure 3-48: IEI iMAN Web Address

Step 3: The login page appears in the web browser.

Step 4: Enter the user name and password to login the system. The default login username and password are:

-Username: **admin**

-Password: **admin**

Step 5: Press the login button to login the system.

Step 6: The IEI iMAN Web Interface appears.

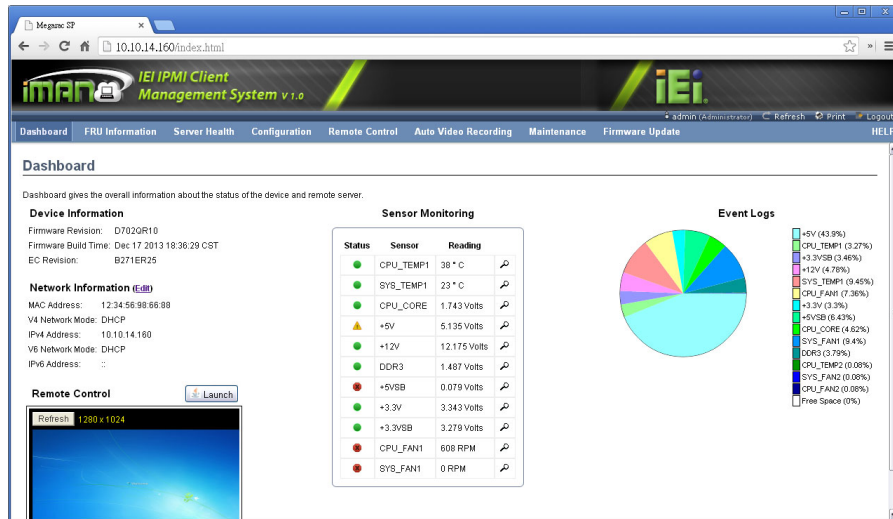

Figure 3-49: IEI iMAN Web GUI



NOTE:

To understand how to use the IEI iMAN Web GUI, please refer to the iRIS-2400 Web GUI user manual in the utility CD came with the PPC-FxxA-H81. The user manual describes each function in detail.

Chapter

4

System Maintenance

PPC-FxxA-H81 Panel PC

4.1 System Maintenance Introduction

The following system components may require maintenance.

- Motherboard
- Memory module
- Cooling fans

If these components fail, they must be replaced. Please contact the system reseller or vendor to purchase replacement parts. Replacement instructions for the above listed components are described below.

4.2 Motherboard Replacement

A user cannot replace a motherboard. If the motherboard fails it must be shipped back to IEI to be replaced. If the system motherboard has failed, please contact the system vendor, reseller or an IEI sales person directly.

4.3 Back Cover Removal



WARNING!

Before removing the back cover, make sure all power to the system has been disconnected. Failing to do so may cause severe damage to the PPC-FxxA-H81 and injury to the user.



WARNING!

Please take anti-static precautions when working with the internal components. The interior of the PPC-FxxA-H81 contains very sensitive electronic components. These components are easily damaged by electrostatic discharge (ESD). Before working with the internal components, make sure all anti-static precautions described earlier have been observed.

To access the panel PC internal components, the back cover must be removed. To remove the back cover, please refer to **Section 3.5** for back cover removal instructions.

4.4 SO-DIMM Replacement

Please read the warnings at the beginning of the previous section before attempting to access any PPC-FxxA-H81 internal components.

To install/replace the SO-DIMM modules, please follow the steps below.

Step 1: Remove the back cover (**Section 3.5**).

Step 2: Locate the SO-DIMM module on the motherboard.

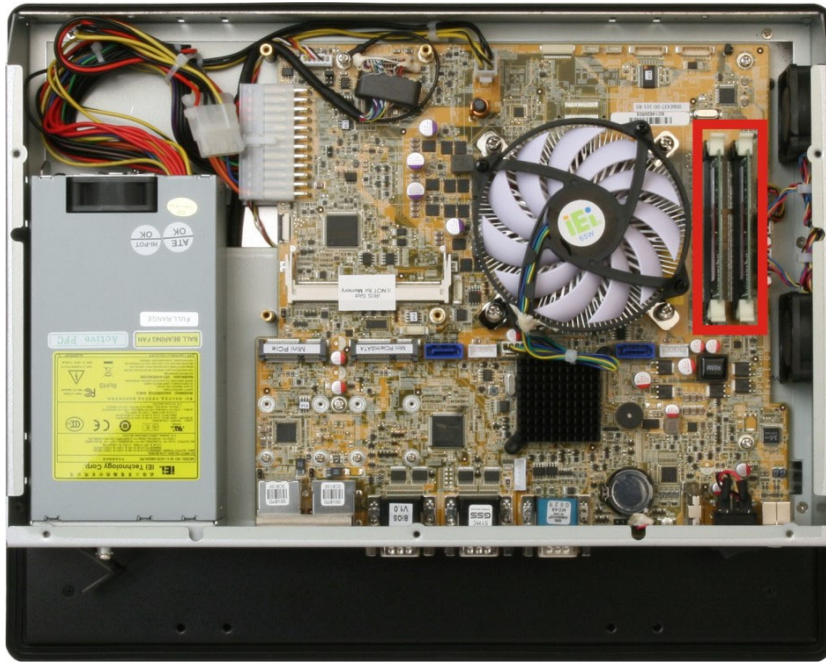

Figure 4-1: SO-DIMM Module Locations

Step 3: Push the two handles outwards (**Figure 4-2**). The memory module is ejected by a mechanism in the socket.

Step 4: Grasp the SO-DIMM module by the edges and carefully pull it out of the socket.

Step 5: Align the new SO-DIMM so the notch on the memory lines up with the notch on the memory socket (**Figure 4-2**).

PPC-FxxA-H81 Panel PC

Step 6: Once aligned, press down until the SO-DIMM is properly seated. Clip the two handles into place.

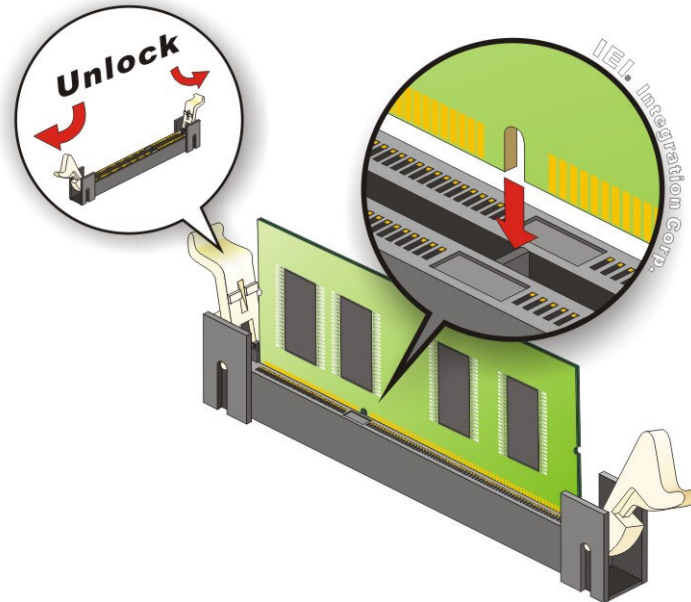

Figure 4-2: SO-DIMM Module Installation

4.5 System Cooling Fan Replacement

If the system cooling fans have been damaged, they must be replaced. To replace the system cooling fans, please follow the steps below.

4.5.1 Remove the Old System Cooling Fans

Step 1: Remove the back cover (Section 3.5).

Step 2: Disconnect the system cooling fans from the motherboard (Figure 4-3).

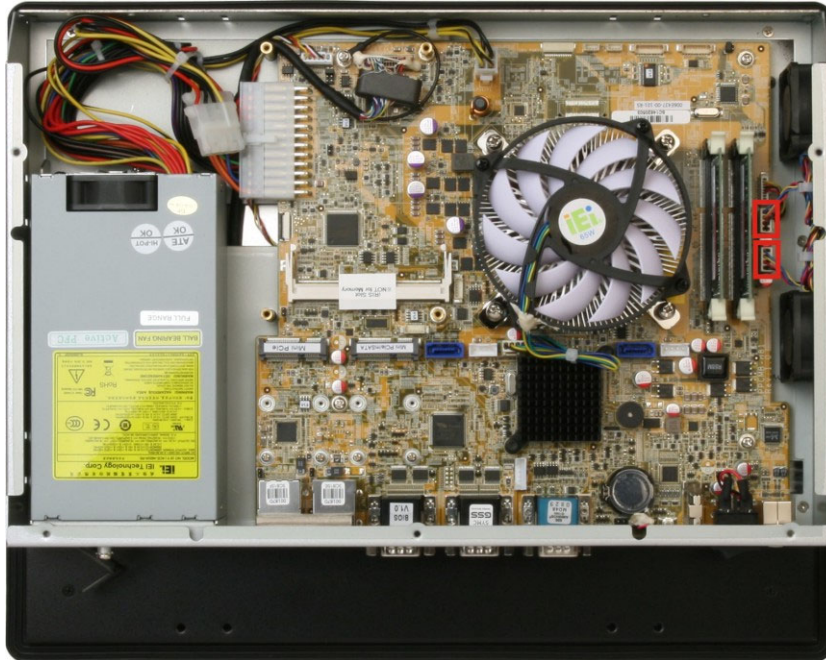

Figure 4-3: System Cooling Fans Motherboard Connectors

Step 3: Remove the system cooling fan retention screws from the left panel (Figure 4-4).

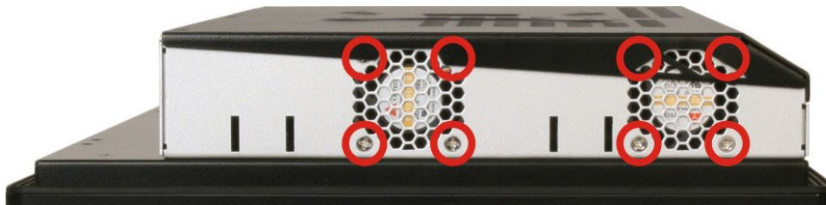

Figure 4-4: System Cooling Fan Retention Screws

Step 4: Remove the system cooling fans from the chassis.

4.5.2 Install the New System Cooling Fans

To install the new system cooling fans, please follow the steps below.

Step 1: Insert the system cooling fans into the chassis and attach to the left panel with the previously removed retention screws.

PPC-FxxA-H81 Panel PC

- Step 2:** Rebundle the new fan wires and tie them to the chassis like the old fan wires.
- Step 3:** Reconnect the new fan connector to the motherboard.
- Step 4:** Replace the back cover.

Chapter

5

BIOS Setup

5.1 Introduction

The BIOS is programmed onto the BIOS chip. The BIOS setup program allows changes to certain system settings. This chapter outlines the options that can be changed.



NOTE:

Some of the BIOS options may vary throughout the life cycle of the product and are subject to change without prior notice.

5.1.1 Starting Setup

The UEFI BIOS is activated when the computer is turned on. The setup program can be activated in one of two ways.

1. Press the **DELETE** or **F2** key as soon as the system is turned on or
2. Press the **DELETE** or **F2** key when the “**Press DELETE or F2 to enter SETUP**” message appears on the screen.

If the message disappears before the **DELETE** or **F2** key is pressed, restart the computer and try again.

5.1.2 Using Setup

Use the arrow keys to highlight items, press **ENTER** to select, use the PageUp and PageDown keys to change entries, press **F1** for help and press **ESC** to quit. Navigation keys are shown in the following table.

Key	Function
Up arrow	Move to the item above
Down arrow	Move to the item below
Left arrow	Move to the item on the left hand side
Right arrow	Move to the item on the right hand side
+	Increase the numeric value or make changes

Key	Function
-	Decrease the numeric value or make changes
Page up	Move to the next page
Page down	Move to the previous page
Esc	Main Menu – Quit and do not save changes into CMOS Status Page Setup Menu and Option Page Setup Menu -- Exit current page and return to Main Menu
F1	General help, only for Status Page Setup Menu and Option Page Setup Menu
F2	Load previous values
F3	Load optimized defaults
F4	Save changes and Exit BIOS

Table 5-1: BIOS Navigation Keys

5.1.3 Getting Help

When **F1** is pressed a small help window describing the appropriate keys to use and the possible selections for the highlighted item appears. To exit the Help Window press **Esc** or the **F1** key again.

5.1.4 Unable to Reboot after Configuration Changes

If the computer cannot boot after changes to the system configuration are made, press the Clear CMOS button on the bottom panel to clear the CMOS data and reset the system BIOS information. The location of the CMOS button is shown in **Figure 1-4**.

5.1.5 BIOS Menu Bar

The **menu bar** on top of the BIOS screen has the following main items:

- Main – Changes the basic system configuration.
- Advanced – Changes the advanced system settings.
- Chipset – Changes the chipset settings.
- Boot – Changes the system boot configuration.

PPC-FxxA-H81 Panel PC

- Security – Sets User and Supervisor Passwords.
- Save & Exit – Selects exit options and loads default settings

The following sections completely describe the configuration options found in the menu items at the top of the BIOS screen and listed above.

5.2 Main

The **Main** BIOS menu (**BIOS Menu 1**) appears when the **BIOS Setup** program is entered.

The **Main** menu gives an overview of the basic system information.

Aptio Setup Utility - Copyright (C) 2012 American Megatrends, Inc.					
Main	Advanced	Chipset	Boot	Security	Save & Exit
BIOS Information					Set the Date. Use Tab to switch between Data elements.
BIOS Vendor			American Megatrends		
Core Version			4.6.5.4		
Compliance			UEFI 2.3.1; PI 1.2		
Project Version			H773AR10.ROM		
Build Date and Time			07/28/2014 11:53:40		
iWDD Vendor			iEi		
iWDD Version			H773ER18.bin		
IPMI Module			N/A		
Processor Information					-----
Name			Haswell		→←: Select Screen
Brand String			Intel(R) Core(TM) i5-457		↑↓: Select Item
Frequency			3200 MHz		Enter: Select
Processor ID			306c3		+/-: Change Opt.
Stepping			C0		F1: General Help
Number of Processors			4Core(s) / 4Thread(s)		F2: Previous Values
Microcode Revision			16		F3: Optimized Defaults
GT Info			GT2 (700 MHz)		F4: Save & Exit
IGFX VBIOS Version			2178		ESC: Exit
Memory RC Version			1.6.2.1		
Total Memory			4096 MB (DDR3)		
Memory Frequency			1333 MHz		
PCH Information					
Name			LynxPoint		
PCH SKU			H81		
Stepping			05/C2		
LAN PHY Revision			N/A		
ME FW Version			9.1.10.1005		
ME Firmware SKU			1.5MB		
SPI Clock Frequency					
DOFR Support			Supported		
Read Status Clock Frequency			50 MHz		
Write Status Clock Frequency			50 MHz		
Fast Read Status Clock Frequency			50 MHz		
System Date			[Fri 08/08/2014]		
System Time			[15:10:27]		
Access Level			Administrator		
Version 2.15.1236. Copyright (C) 2012 American Megatrends, Inc.					

BIOS Menu 1: Main

PPC-FxxA-H81 Panel PC

The **Main** menu has two user configurable fields:

→ **System Date [xx/xx/xx]**

Use the **System Date** option to set the system date. Manually enter the day, month and year.

→ **System Time [xx:xx:xx]**

Use the **System Time** option to set the system time. Manually enter the hours, minutes and seconds.

5.3 Advanced

Use the **Advanced** menu (**BIOS Menu 2**) to configure the CPU and peripheral devices through the following sub-menus:



WARNING!

Setting the wrong values in the sections below may cause the system to malfunction. Make sure that the settings made are compatible with the hardware.

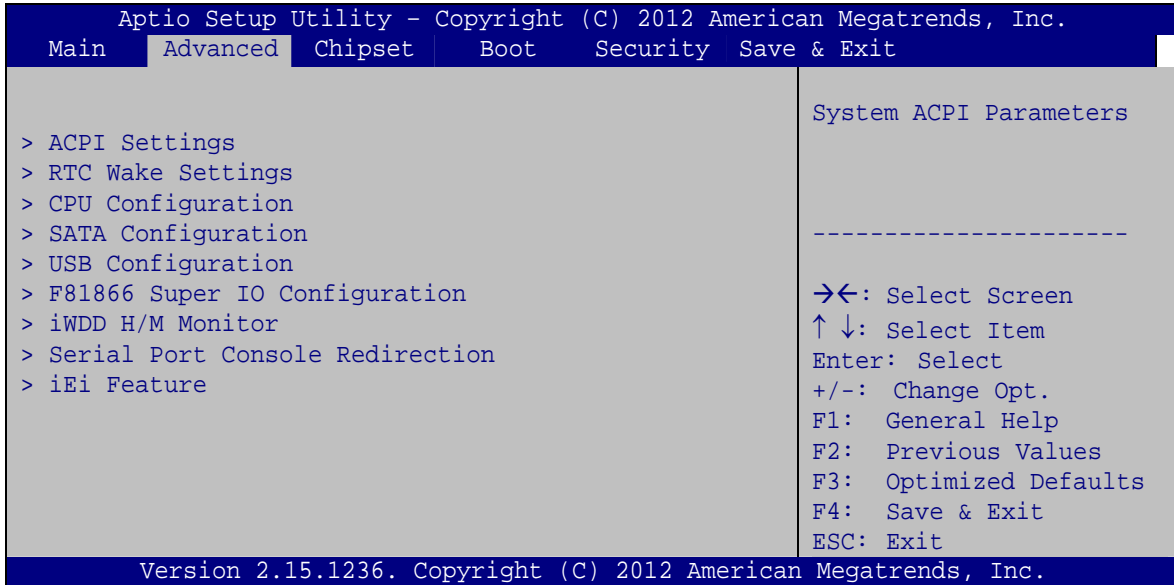

BIOS Menu 2: Advanced

5.3.1 ACPI Settings

The **ACPI Settings** menu (**BIOS Menu 3**) configures the Advanced Configuration and Power Interface (ACPI) options.

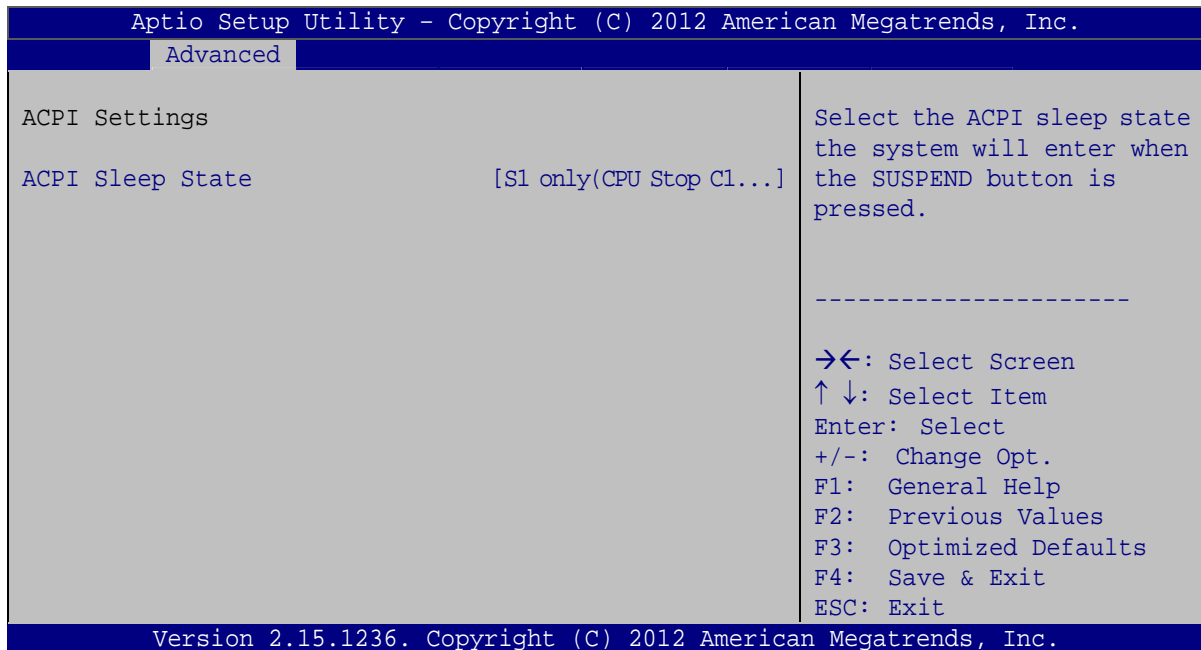

BIOS Menu 3: ACPI Settings

PPC-FxxA-H81 Panel PC

→ ACPI Sleep State [S1 only (CPU Stop Clock)]

Use the **ACPI Sleep State** option to specify the sleep state the system enters when it is not being used.

- **S1 only (CPU Stop Clock)** **DEFAULT** The system enters S1(POS) sleep state. The system appears off. The CPU is stopped; RAM is refreshed; the system is running in a low power mode.
- **S3 only (Suspend to RAM)** The caches are flushed and the CPU is powered off. Power to the RAM is maintained. The computer returns slower to a working state, but more power is saved.

5.3.2 RTC Wake Settings

The **RTC Wake Settings** menu (**BIOS Menu 4**) enables the system to wake at the specified time.

```

Aptio Setup Utility - Copyright (C) 2012 American Megatrends, Inc.
  Advanced
Wake system with Fixed Time      [Disabled]
Enable or disable System
wake on alarm event. When
enabled, System will
wake on the
date::hr::min::sec
specified
-----
→←: Select Screen
↑↓: Select Item
Enter: Select
+/-: Change Opt.
F1: General Help
F2: Previous Values
F3: Optimized Defaults
F4: Save & Exit
ESC: Exit
Version 2.15.1236. Copyright (C) 2012 American Megatrends, Inc.
  
```

BIOS Menu 4: RTC Wake Settings

→ **Wake system with Fixed Time [Disabled]**

Use the **Wake system with Fixed Time** option to enable or disable the system wake on alarm event.

→ **Disabled** **DEFAULT** The real time clock (RTC) cannot generate a wake event

→ **Enabled** If selected, the **Wake up every day** option appears allowing you to enable to disable the system to wake every day at the specified time. Besides, the following options appear with values that can be selected:

Wake up date

Wake up hour

Wake up minute

Wake up second

After setting the alarm, the computer turns itself on from a suspend state when the alarm goes off.

PPC-FxxA-H81 Panel PC

5.3.3 CPU Configuration

Use the **CPU Configuration** menu (**BIOS Menu 5**) to view detailed CPU specifications and configure the CPU.

```

Aptio Setup Utility - Copyright (C) 2012 American Megatrends, Inc.
-----
Advanced
-----
CPU Configuration
Number of cores to enable
in each processor package.
-----
Intel(R) Core(TM) i5-4570S CPU @ 2.90GHz
CPU Signature                306c3
Processor Family             6
Microcode Patch              16
FSB Speed                     100 MHz
Max CPU Speed                 2900 MHz
Min CPU Speed                 800 MHz
CPU Speed                     3200 MHz
Processor Cores               4
Intel HT Technology           Supported
Intel VT-x Technology         Supported
Intel SMX Technology          Supported
64-bit                       Supported
CPU C3 state                  Supported
CPU C6 state                  Supported
CPU C7 state                  Supported

L1 Data Cache                 32 KB x 4
L1 Code Cache                 32 KB x 4
L2 Cache                      256 KB x 4
L3 Cache                      6144 KB

Active Processor Cores        [All]
Intel Virtualization Technology [Disabled]
EIST                          [Enabled]
Intel TXT(LT) Support         [Disabled]

-><: Select Screen
↑↓: Select Item
Enter: Select
+/-: Change Opt.
F1: General Help
F2: Previous Values
F3: Optimized Defaults
F4: Save & Exit
ESC: Exit

Version 2.15.1236. Copyright (C) 2012 American Megatrends, Inc.
  
```

BIOS Menu 5: CPU Configuration

The CPU Configuration menu (**BIOS Menu 5**) lists the following CPU details:

- CPU Signature: Lists the CPU signature value.
- Processor Family: Lists the processor family.
- Microcode Patch: Lists the microcode patch being used.
- FSB Speed: Lists the FSB speed.
- Max CPU Speed: Lists the maximum CPU processing speed.
- Min CPU Speed: Lists the minimum CPU processing speed.

- CPU Speed: Lists the CPU processing speed.
- Processor Cores: Lists the number of the processor core
- Intel HT Technology: Indicates if Intel HT Technology is supported by the CPU.
- Intel VT-x Technology: Indicates if Intel VT-x Technology is supported by the CPU.
- Intel SMX Technology: Indicates if Intel SMX Technology is supported by the CPU.
- 64-bit: Indicates if 64-bit system is supported by the CPU.
- EIST Technology: Indicates if EIST Technology is supported by the CPU.
- CPU C3 state: Indicates if CPU C3 state is supported by the CPU.
- CPU C6 state: Indicates if CPU C6 state is supported by the CPU.
- CPU C7 state: Indicates if CPU C7 state is supported by the CPU.
- L1 Data Cache: Lists the amount of data storage space on the L1 cache.
- L1 Code Cache: Lists the amount of code storage space on the L1 cache.
- L2 Cache: Lists the amount of storage space on the L2 cache.
- L3 Cache: Lists the amount of storage space on the L3 cache.

➔ **Active Processor Cores [All]**

Use the **Active Processor Cores** BIOS option to enable numbers of cores in the processor package.

- ➔ **All** **DEFAULT** Enable all cores in the processor package.
- ➔ **1** Enable one core in the processor package.
- ➔ **2** Enable two cores in the processor package.
- ➔ **3** Enable three cores in the processor package.

➔ **Intel Virtualization Technology [Disabled]**

Use the **Intel Virtualization Technology** option to enable or disable virtualization on the system. When combined with third party software, Intel® Virtualization technology allows several OSs to run on the same system at the same time.

- ➔ **Disabled** **DEFAULT** Disables Intel Virtualization Technology.
- ➔ **Enabled** Enables Intel Virtualization Technology.

➔ **SATA Mode Selection [IDE]**

Use the **SATA Mode Selection** option to determine how SATA devices operate.

- ➔ **IDE** **DEFAULT** Configures SATA devices as normal IDE device.
- ➔ **AHCI** Configures SATA devices as AHCI device.

5.3.5 USB Configuration

Use the **USB Configuration** menu (**BIOS Menu 7**) to read USB configuration information and configure the USB settings.

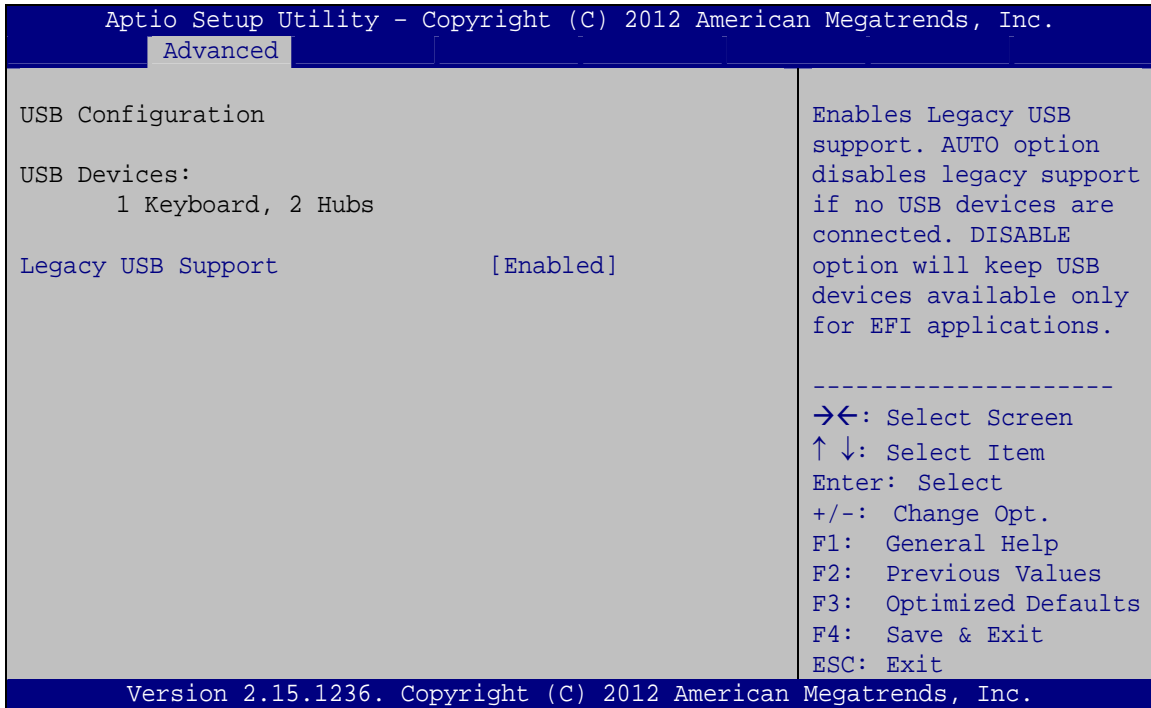

BIOS Menu 7: USB Configuration

➔ **USB Devices**

The **USB Devices** field lists the USB devices that are enabled on the system

➔ **Legacy USB Support [Enabled]**

Use the **Legacy USB Support** BIOS option to enable USB mouse and USB keyboard support. Normally if this option is not enabled, any attached USB mouse or USB keyboard

PPC-FxxA-H81 Panel PC

does not become available until a USB compatible operating system is fully booted with all USB drivers loaded. When this option is enabled, any attached USB mouse or USB keyboard can control the system even when there is no USB driver loaded onto the system.

- ➔ **Enabled** **DEFAULT** Legacy USB support enabled
- ➔ **Disabled** Legacy USB support disabled
- ➔ **Auto** Legacy USB support disabled if no USB devices are connected

5.3.6 F81866 Super IO Configuration

Use the **F81866 Super IO Configuration** menu (**BIOS Menu 8**) to set or change the configurations for the serial ports.

```

Aptio Setup Utility - Copyright (C) 2012 American Megatrends, Inc.
  Advanced
F81866 Super IO Configuration
F81866 Super IO Chip          F81866
> Serial Port 1 Configuration
> Serial Port 2 Configuration
> Serial Port 3 Configuration
> Serial Port 4 Configuration
> Serial Port 5 Configuration

Set Parameters of Serial
Port 1 (COMA)

-----
-><: Select Screen
↑↓: Select Item
Enter: Select
+/-: Change Opt.
F1: General Help
F2: Previous Values
F3: Optimized Defaults
F4: Save & Exit
ESC: Exit

Version 2.15.1236. Copyright (C) 2012 American Megatrends, Inc.
  
```

BIOS Menu 8: F81866 Super IO Configuration

5.3.6.1 Serial Port n Configuration

Use the **Serial Port n Configuration** menu (**BIOS Menu 9**) to configure the serial port n.

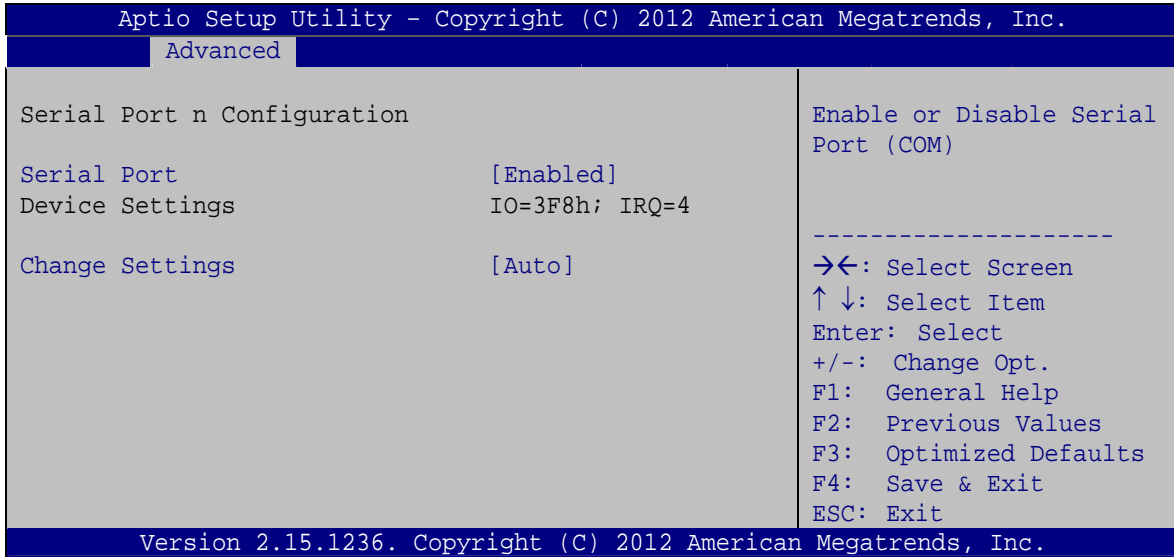

BIOS Menu 9: Serial Port n Configuration Menu

5.3.6.1.1 Serial Port 1 Configuration

→ Serial Port [Enabled]

Use the **Serial Port** option to enable or disable the serial port.

- **Disabled** Disable the serial port
- **Enabled** **DEFAULT** Enable the serial port

→ Change Settings [Auto]

Use the **Change Settings** option to change the serial port IO port address and interrupt address.

- **Auto** **DEFAULT** The serial port IO port address and interrupt address are automatically detected.
- **IO=3F8h;**
IRQ=4 Serial Port I/O port address is 3F8h and the interrupt address is IRQ4

PPC-FxxA-H81 Panel PC

- ➔ **IO=3F8h;**
IRQ=3, 4 Serial Port I/O port address is 3F8h and the interrupt address is IRQ3, 4
- ➔ **IO=2C0h;**
IRQ=3, 4 Serial Port I/O port address is 2C0h and the interrupt address is IRQ3, 4
- ➔ **IO=2C8h;**
IRQ=3, 4 Serial Port I/O port address is 2C8h and the interrupt address is IRQ3, 4

5.3.6.1.2 Serial Port 2 Configuration

➔ Serial Port [Enabled]

Use the **Serial Port** option to enable or disable the serial port.

- ➔ **Disabled** Disable the serial port
- ➔ **Enabled** **DEFAULT** Enable the serial port

➔ Change Settings [Auto]

Use the **Change Settings** option to change the serial port IO port address and interrupt address.

- ➔ **Auto** **DEFAULT** The serial port IO port address and interrupt address are automatically detected.
- ➔ **IO=2F8h;**
IRQ=3 Serial Port I/O port address is 2F8h and the interrupt address is IRQ3
- ➔ **IO=3F8h;**
IRQ=3, 4 Serial Port I/O port address is 3F8h and the interrupt address is IRQ3, 4
- ➔ **IO=2F8h;**
IRQ=3, 4 Serial Port I/O port address is 2F8h and the interrupt address is IRQ3, 4
- ➔ **IO=2C0h;**
IRQ=3, 4 Serial Port I/O port address is 2C0h and the interrupt address is IRQ3, 4
- ➔ **IO=2C8h;**
IRQ=3, 4 Serial Port I/O port address is 2C8h and the interrupt address is IRQ3, 4

5.3.6.1.3 Serial Port 3 Configuration

→ **Serial Port [Enabled]**

Use the **Serial Port** option to enable or disable the serial port.

- **Disabled** Disable the serial port
- **Enabled DEFAULT** Enable the serial port

→ **Change Settings [Auto]**

Use the **Change Settings** option to change the serial port IO port address and interrupt address.

- **Auto DEFAULT** The serial port IO port address and interrupt address are automatically detected.
- **IO=2D0h;
IRQ=10** Serial Port I/O port address is 2D0h and the interrupt address is IRQ10
- **IO=2D0h;
IRQ=10, 11** Serial Port I/O port address is 2D0h and the interrupt address is IRQ10, 11
- **IO=2E8h;
IRQ=10, 11** Serial Port I/O port address is 2E8h and the interrupt address is IRQ10, 11
- **IO=2D8h;
IRQ=10, 11** Serial Port I/O port address is 2D8h and the interrupt address is IRQ10, 11

5.3.6.1.4 Serial Port 4 Configuration

→ **Serial Port [Enabled]**

Use the **Serial Port** option to enable or disable the serial port.

- **Disabled** Disable the serial port
- **Enabled DEFAULT** Enable the serial port

PPC-FxxA-H81 Panel PC

→ Change Settings [Auto]

Use the **Change Settings** option to change the serial port IO port address and interrupt address.

- | | | | |
|---|--------------------------------|----------------|---|
| → | Auto | DEFAULT | The serial port IO port address and interrupt address are automatically detected. |
| → | IO=2E8h;
IRQ=10 | | Serial Port I/O port address is 2E8h and the interrupt address is IRQ10 |
| → | IO=3E8h;
IRQ=10, 11 | | Serial Port I/O port address is 3E8h and the interrupt address is IRQ10, 11 |
| → | IO=2E8h;
IRQ=10, 11 | | Serial Port I/O port address is 2E8h and the interrupt address is IRQ10, 11 |
| → | IO=2D0h;
IRQ=10, 11 | | Serial Port I/O port address is 2D0h and the interrupt address is IRQ10, 11 |
| → | IO=2D8h;
IRQ=10, 11 | | Serial Port I/O port address is 2D8h and the interrupt address is IRQ10, 11 |

5.3.6.1.5 Serial Port 5 Configuration

→ Serial Port [Enabled]

Use the **Serial Port** option to enable or disable the serial port.

- | | | | |
|---|-----------------|----------------|-------------------------|
| → | Disabled | | Disable the serial port |
| → | Enabled | DEFAULT | Enable the serial port |

→ Change Settings [Auto]

Use the **Change Settings** option to change the serial port IO port address and interrupt address.

- **Auto** **DEFAULT** The serial port IO port address and interrupt address are automatically detected.
- **IO=2D0h;**
IRQ=10 Serial Port I/O port address is 2D0h and the interrupt address is IRQ10
- **IO=2C0h;**
IRQ=10, 11 Serial Port I/O port address is 2C0h and the interrupt address is IRQ10, 11
- **IO=2C8h;**
IRQ=10, 11 Serial Port I/O port address is 2C8h and the interrupt address is IRQ10, 11
- **IO=2D0h;**
IRQ=10, 11 Serial Port I/O port address is 2D0h and the interrupt address is IRQ10, 11
- **IO=2D8h;**
IRQ=10, 11 Serial Port I/O port address is 2D8h and the interrupt address is IRQ10, 11
- **IO=2E0h;**
IRQ=10, 11 Serial Port I/O port address is 2E0h and the interrupt address is IRQ10, 11

→ **Device Mode [Normal]**

The **Device Mode** option is used to set the Serial Port 5 signaling mode.

- **RS422/**
RS485 Enables serial port RS-422/485 support.

5.3.7 iWDD H/W Monitor

The iWDD H/W Monitor menu (**BIOS Menu 10**) displays operating temperature and fan speeds.

PPC-FxxA-H81 Panel PC

```

Aptio Setup Utility - Copyright (C) 2012 American Megatrends, Inc.
Advanced
PC Health Status
> Smart Fan Mode Configuration
CPU temperature           : +53 C
System temperature       : +45 C
CPU_FAN1 Speed           : 1908 RPM
SYS_FAN1 Speed           : 160 RPM
SYS_FAN2 Speed           : 160 RPM
CPU_CORE                  : +1.415 V
+5V                       : +5.090 V
+12V                      : +12.026 V
DDR                       : +1.508 V
+3.3VSB                   : +3.311 V

-----
-><: Select Screen
↑↓: Select Item
Enter: Select
+/-: Change Opt.
F1: General Help
F2: Previous Values
F3: Optimized Defaults
F4: Save & Exit
ESC: Exit

Version 2.15.1236. Copyright (C) 2012 American Megatrends, Inc.
    
```

BIOS Menu 10: iWDD H/W Monitor

→ PC Health Status

The following system parameters and values are shown. The system parameters that are monitored are:

- System Temperatures:
 - CPU Temperature
 - System Temperature
- Fan Speeds:
 - CPU_Fan1 Speed
 - SYS_Fan1 Speed
 - SYS_Fan2 Speed
- Voltages:
 - CPU_CORE
 - +5V
 - +12V
 - DDR
 - +3.3VSB
 - VBAT

5.3.8 Serial Port Console Redirection

The **Serial Port Console Redirection** menu (**BIOS Menu 11**) allows the console redirection options to be configured. Console redirection allows users to maintain a system remotely by re-directing keyboard input and text output through the serial port.

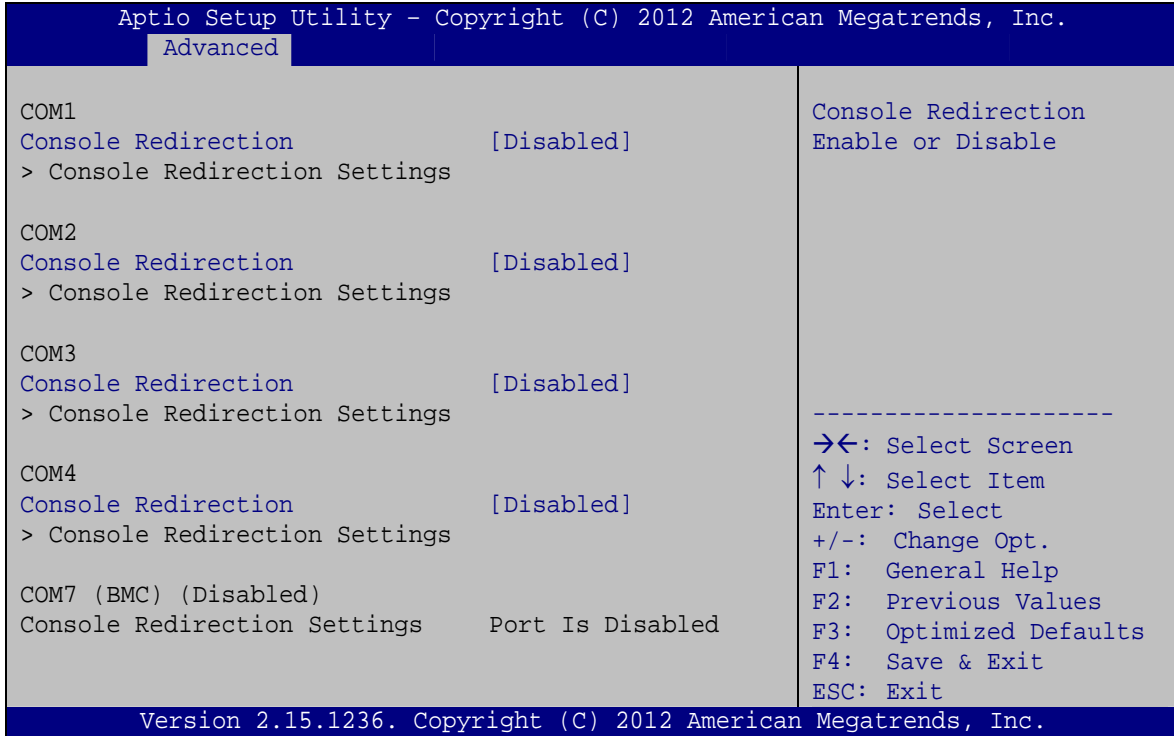

BIOS Menu 11: Serial Port Console Redirection

➔ Console Redirection [Disabled]

Use **Console Redirection** option to enable or disable the console redirection function.

- ➔ **Disabled** **DEFAULT** Disabled the console redirection function
- ➔ **Enabled** Enabled the console redirection function

5.3.8.1 Console Redirection Settings

Use the **Console Redirection Settings** menu (**BIOS Menu 12**) to configure console redirection settings of the specified serial port. This menu appears only when the Console Redirection is enabled.

PPC-FxxA-H81 Panel PC

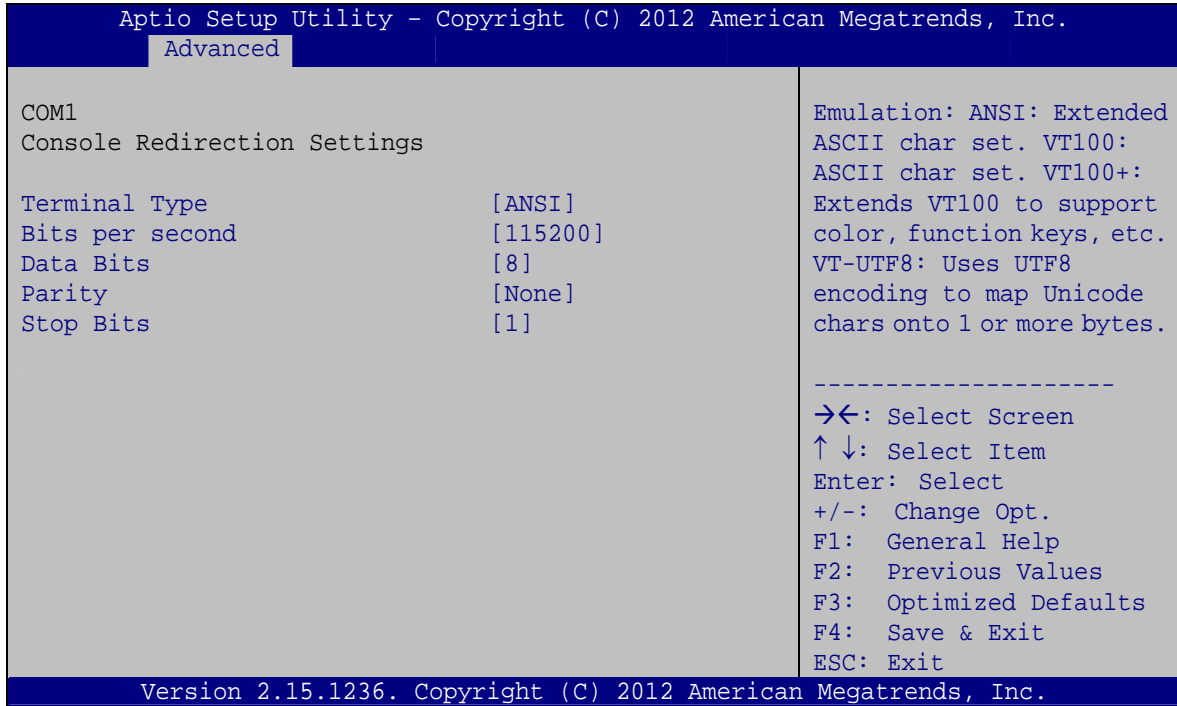

BIOS Menu 12: Console Redirection Settings

→ Terminal Type [ANSI]

Use the **Terminal Type** option to specify the remote terminal type.

- **VT100** The target terminal type is VT100
- **VT100+** The target terminal type is VT100+
- **VT-UTF8** The target terminal type is VT-UTF8
- **ANSI** **DEFAULT** The target terminal type is ANSI

→ Bits per second [115200]

Use the **Bits per second** option to specify the serial port transmission speed. The speed must match the other side. Long or noisy lines may require lower speeds.

- **9600** Sets the serial port transmission speed at 9600.
- **19200** Sets the serial port transmission speed at 19200.
- **57600** Sets the serial port transmission speed at 57600.
- **115200** **DEFAULT** Sets the serial port transmission speed at 115200.

→ Data Bits [8]

Use the **Data Bits** option to specify the number of data bits.

- 7** Sets the data bits at 7.
- 8** **DEFAULT** Sets the data bits at 8.

→ Parity [None]

Use the **Parity** option to specify the parity bit that can be sent with the data bits for detecting the transmission errors.

- None** **DEFAULT** No parity bit is sent with the data bits.
- Even** The parity bit is 0 if the number of ones in the data bits is even.
- Odd** The parity bit is 0 if the number of ones in the data bits is odd.
- Mark** The parity bit is always 1. This option does not provide error detection.
- Space** The parity bit is always 0. This option does not provide error detection.

→ Stop Bits [1]

Use the **Stop Bits** option to specify the number of stop bits used to indicate the end of a serial data packet. Communication with slow devices may require more than 1 stop bit.

- 1** **DEFAULT** Sets the number of stop bits at 1.
- 2** Sets the number of stop bits at 2.

PPC-FxxA-H81 Panel PC

5.3.9 iEi Feature

Use the **iEi Feature** menu (**BIOS Menu 12**) to configure One Key Recovery function.

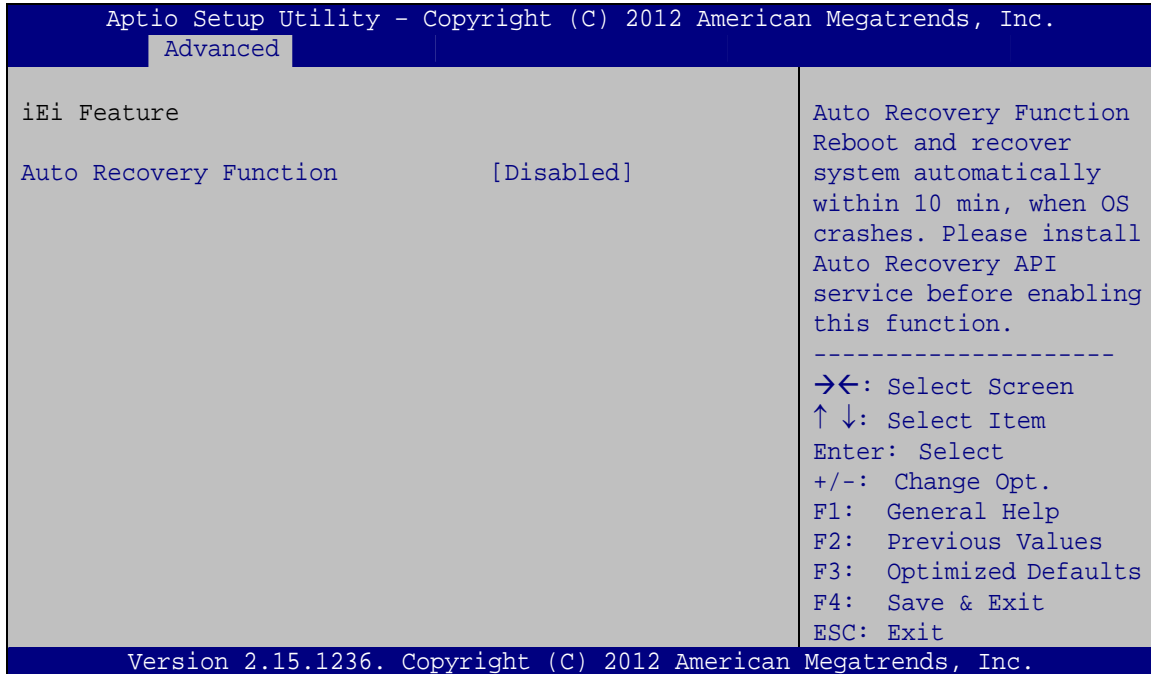

BIOS Menu 13: iEi Feature

→ Auto Recovery Function [Disabled]

Use the **Auto Recovery Function** BIOS option to enable or disable the auto recovery function of the IEI One Key Recovery.

- **Disabled** **DEFAULT** Auto recovery function disabled
- **Enabled** Auto recovery function enabled

5.4 Chipset

Use the **Chipset** menu (**BIOS Menu 14**) to access the PCH and System Agent (SA) configuration menus.



WARNING!

Setting the wrong values for the Chipset BIOS selections in the Chipset BIOS menu may cause the system to malfunction.

```
Aptio Setup Utility - Copyright (C) 2012 American Megatrends, Inc.
Main   Advanced  Chipset  Boot   Security  Save & Exit
-----
> PCH-IO Configuration          PCH Parameters
> System Agent (SA) Configuration

-----
-><: Select Screen
↑↓: Select Item
Enter: Select
+/-: Change Opt.
F1: General Help
F2: Previous Values
F3: Optimized Defaults
F4: Save & Exit
ESC: Exit

Version 2.15.1236. Copyright (C) 2012 American Megatrends, Inc.
```

BIOS Menu 14: Chipset

PPC-FxxA-H81 Panel PC

5.4.1 PCH-IO Configuration

Use the **PCH-IO Configuration** menu (**BIOS Menu 15**) to configure the PCH IO settings.

```

Aptio Setup Utility - Copyright (C) 2012 American Megatrends, Inc.
Chipset
Auto Power Button Function      [Disabled (ATX)]      Select AC power state when
Restore AC Power Loss           [Last State]          power is re-applied after
                              a power failure.
> PCI Express Configuration
> PCH Azalia Configuration
Power Saving Function(ERP)      [Disabled]
USB SW1 Power                   [+5V DUAL]
USB SW2 Power                   [+5V DUAL]
-----
-><: Select Screen
↑↓: Select Item
Enter: Select
+/-: Change Opt.
F1: General Help
F2: Previous Values
F3: Optimized Defaults
F4: Save & Exit
ESC: Exit
Version 2.15.1236. Copyright (C) 2012 American Megatrends, Inc.

```

BIOS Menu 15: PCH-IO Configuration

→ Restore AC Power Loss [Last State]

Use the **Restore AC Power Loss** BIOS option to specify what state the system returns to if there is a sudden loss of power to the system.

- **Power Off** The system remains turned off
- **Power On** The system turns on
- **Last State DEFAULT** The system returns to its previous state. If it was on, it turns itself on. If it was off, it remains off.

→ Power Saving Function(ERP) [Disabled]

Use the **Power Saving Function(ERP)** option to enable or disable the power saving function.

- **Disabled DEFAULT** Disables the power saving function.
- **Enabled** Enables the power saving function.

➔ **USB SW1 Power [+5V DUAL]**

Use the **USB Power SW1** BIOS option to configure the USB power source for the corresponding USB connectors (**Table 5-2**).

- ➔ **+5V** Sets the USB power source to +5V
- ➔ **+5V DUAL** **DEFAULT** Sets the USB power source to +5V dual

➔ **USB SW2 Power [+5V DUAL]**

Use the **USB Power SW2** BIOS option to configure the USB power source for the corresponding USB connectors (**Table 5-2**).

- ➔ **+5V** Sets the USB power source to +5V
- ➔ **+5V DUAL** **DEFAULT** Sets the USB power source to +5V dual

BIOS Options	Configured USB Ports
USB SW1	KBMS1 (internal keyboard and mouse port) LAN1_USB1 (external USB 3.0 ports) LAN2_USB2 (external USB 2.0 ports)
USB SW2	USB1 (internal USB 2.0 ports) USB_CON1 (external USB 2.0 ports)

Table 5-2: BIOS Options and Configured USB Ports

PPC-FxxA-H81 Panel PC

5.4.1.1 PCI Express Configuration

Use the **PCI Express Configuration** menu (**BIOS Menu 16**) to configure the PCI Express slots.

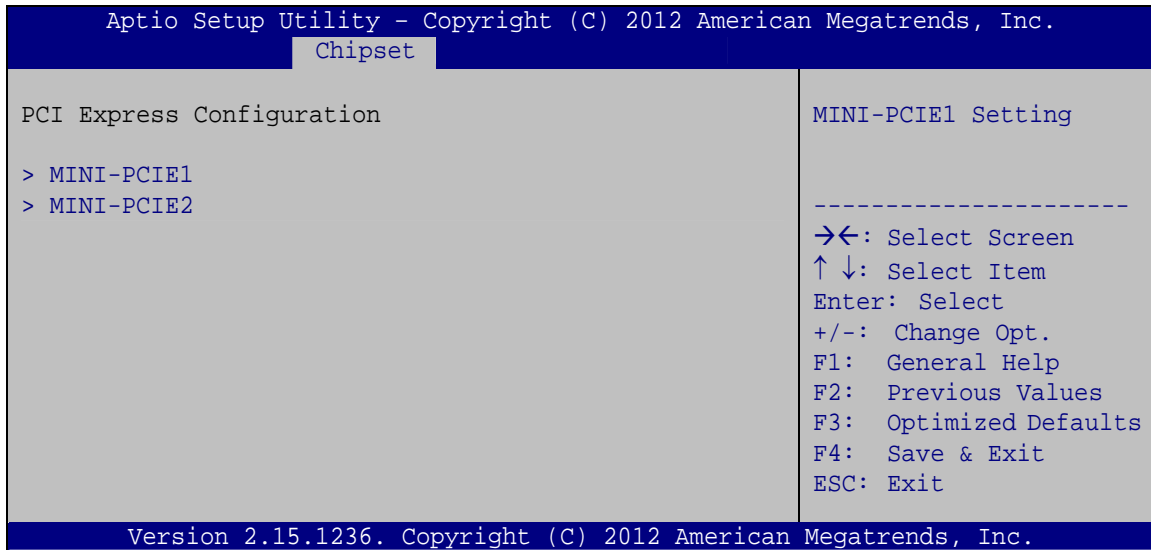

BIOS Menu 16: PCI Express Configuration

5.4.1.1.1 MINI-PCIE1 and MINI-PCIE2

Use the **MINI-PCIE1** and **MINI-PCIE2** menus (**BIOS Menu 17**) to configure the **MINI_PCIE1** and **MSATA1** slot settings.

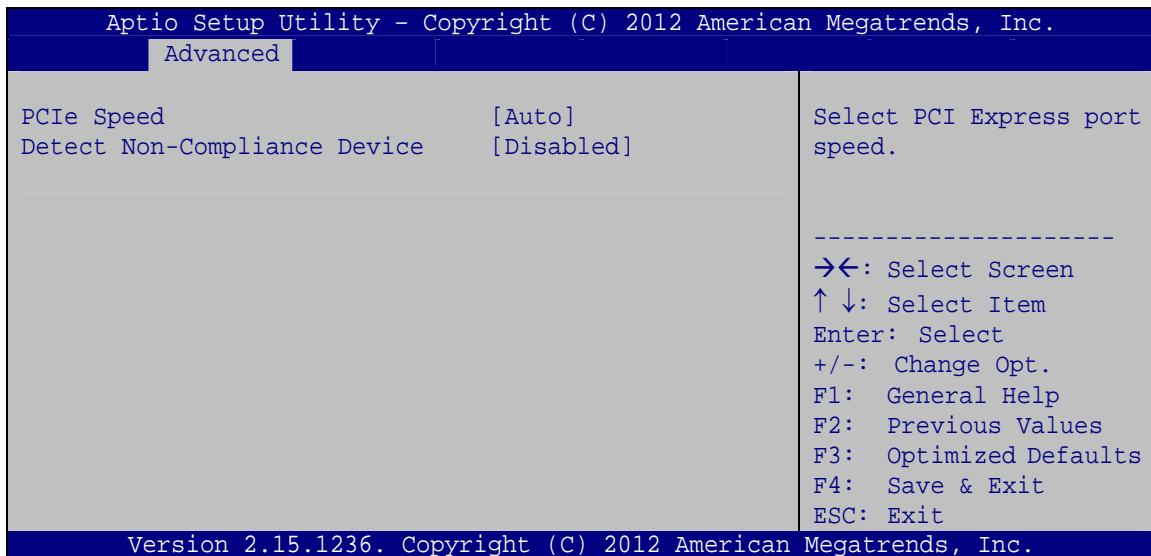

BIOS Menu 17: PCIEX1_1 and PCIEX4_1 Configuration Menu

→ PCIe Speed [Auto]

Use this option to select the support type of the PCIe Mini slots. The following options are available:

- Auto **Default**
- Gen1
- Gen2

→ Detect Non-Compliance Device [Disabled]

Use the **Detect Non-Compliance Device** option to enable or disable detecting if a non-compliance PCI Express device is connected to the PCI Express slot.

- Disabled DEFAULT** Disables to detect if a non-compliance PCI Express device is connected to the PCI Express slot.
- Enabled** Enables to detect if a non-compliance PCI Express device is connected to the PCI Express slot.

5.4.1.2 PCH Azalia Configuration

Use the **PCH Azalia Configuration** menu (**BIOS Menu 18**) to configure the PCH Azalia controller.

PPC-FxxA-H81 Panel PC

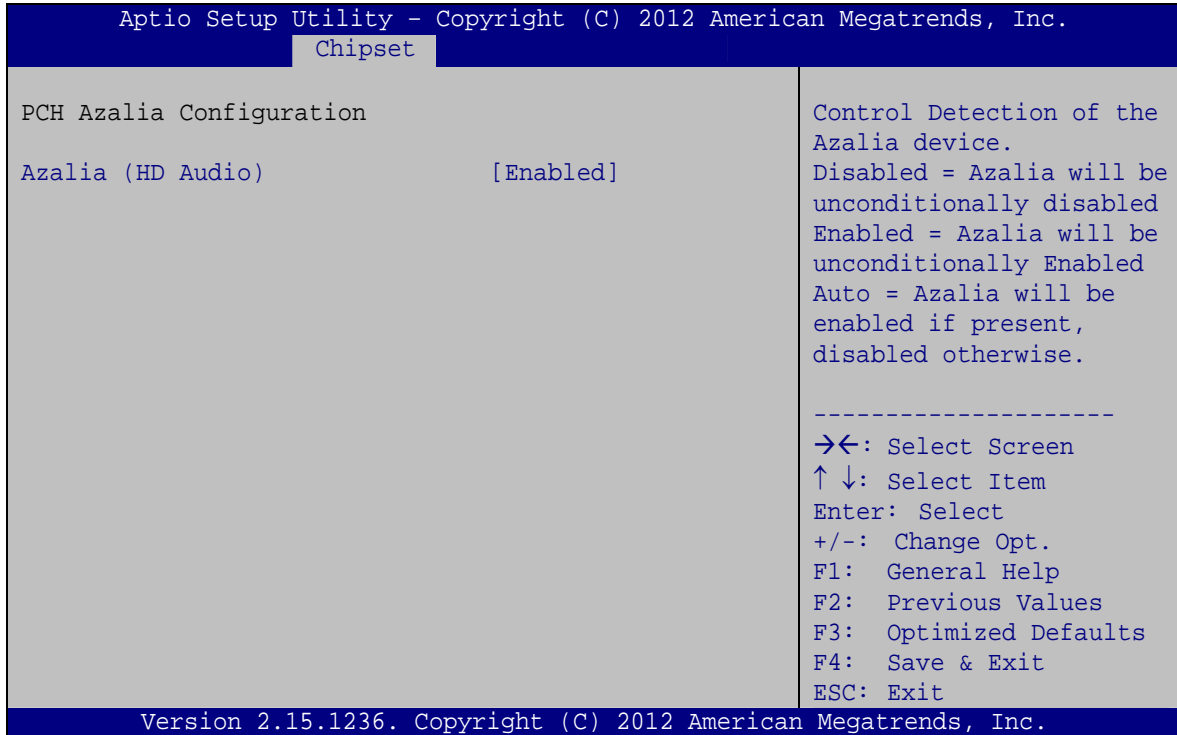

BIOS Menu 18: PCH Azalia Configuration

→ Azalia (HD Audio) [Enabled]

The **Azalia** option enables or disables the HD Audio controller.

- **Enabled** **DEFAULT** The onboard HD Audio controller is enabled.
- **Disabled** The onboard HD Audio controller is disabled.

5.4.2 System Agent (SA) Configuration

Use the **System Agent (SA) Configuration** menu (**BIOS Menu 19**) to configure the System Agent (SA) parameters.

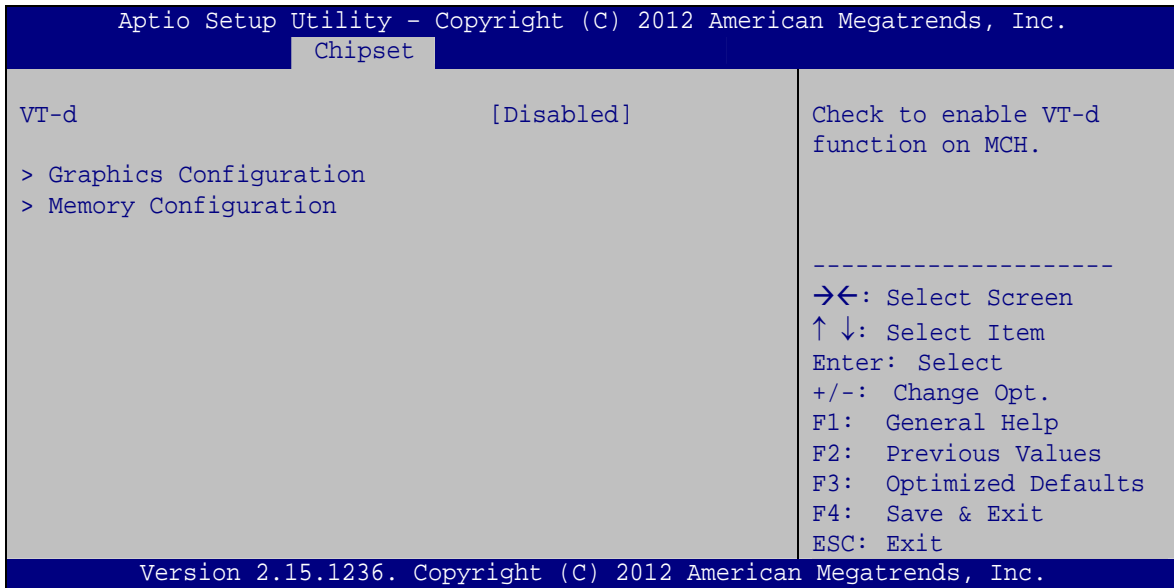

BIOS Menu 19: System Agent (SA) Configuration

→ VT-d [Disabled]

Use the **VT-d** option to enable or disable VT-d support.

- **Disabled** **DEFAULT** Disables VT-d support.
- **Enabled** Enables VT-d support.

PPC-FxxA-H81 Panel PC

5.4.2.1 Graphics Configuration

Use the **Graphics Configuration** menu (**BIOS Menu 20**) to configure the graphics settings

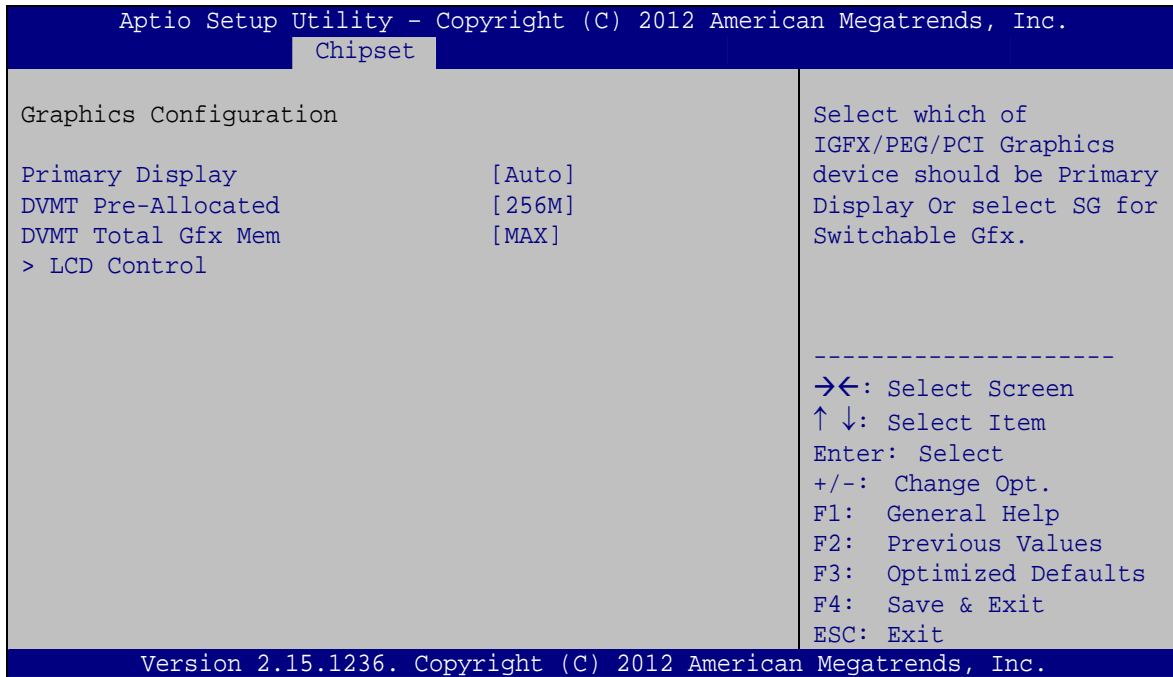

BIOS Menu 20: Graphics Configuration

→ Primary Display [Auto]

Use the **Primary Display** option to select the graphics controller used as the primary boot device.

- Auto **DEFAULT**
- IGFX

→ DVMT Pre-Allocated [256M]

Use the **DVMT Pre-Allocated** option to specify a fixed amount of memory that can be allocated for the internal graphics device. Configuration options are listed below.

- 32M
- 64M
- 128M

- 256M **DEFAULT**
- 512M

→ **DVMT Total Gfx Mem [MAX]**

Use the **DVMT Total Gfx Mem** option to specify the maximum amount of memory that can be allocated for the internal graphics device. Configuration options are listed below.

- 128M
- 256M
- MAX **DEFAULT**

5.4.2.1.1 LCD Control

Use the **LCD Control** menu (**BIOS Menu 21**) to display the LCD Control settings.

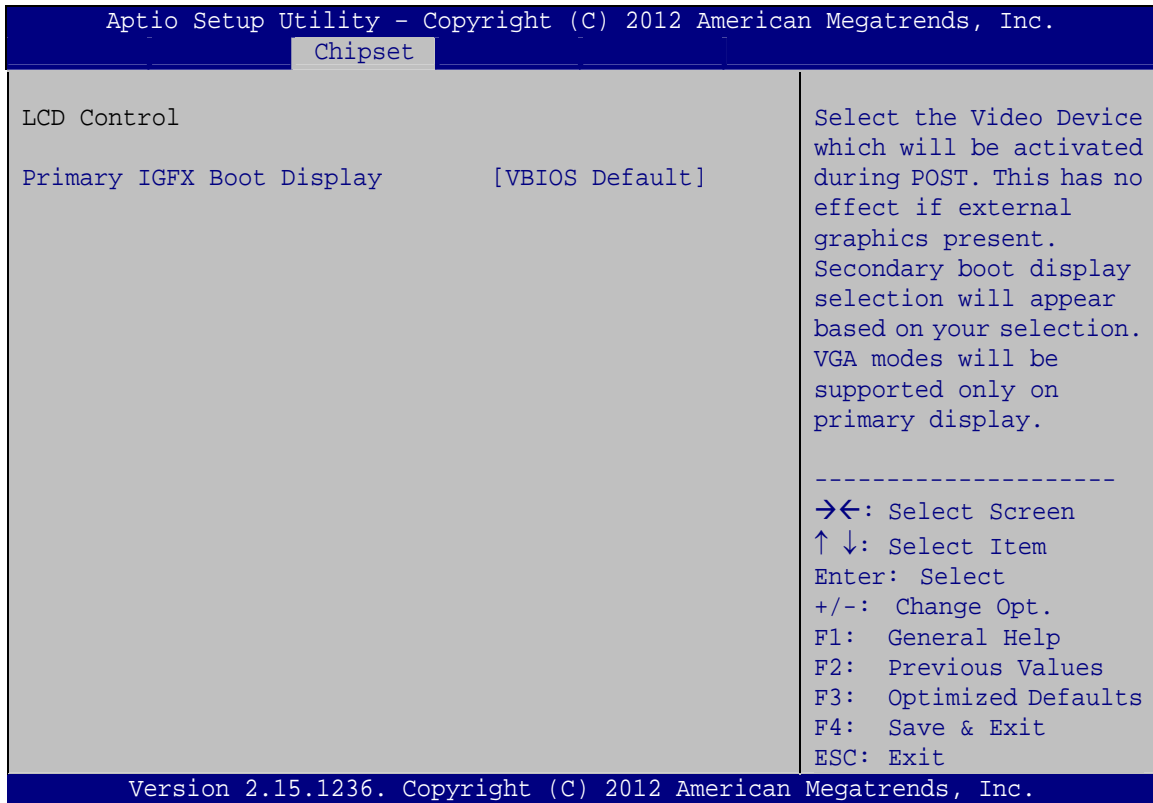

BIOS Menu 21: LCD Control

PPC-FxxA-H81 Panel PC

→ Primary IGFX Boot Display [VBIOS Default]

Use the **Primary IGFX Boot Display** option to select the display device used by the system when it boots. Configuration options are listed below.

- VBIOS Default **DEFAULT**
- CRT
- HDMI
- LVDS

5.4.2.2 Memory Configuration

Use the **Memory Configuration** menu (**BIOS Menu 22**) to display the memory information.

```

Aptio Setup Utility - Copyright (C) 2012 American Megatrends, Inc.
Chipset
-----
Memory Information
Total Memory          4096 MB (DDR3)
CHA_DIMM1             2048 MB (DDR3)
CHB_DIMM1             2048 MB (DDR3)

-----
→←: Select Screen
↑↓: Select Item
Enter: Select
+/-: Change Opt.
F1: General Help
F2: Previous Values
F3: Optimized Defaults
F4: Save & Exit
ESC: Exit

Version 2.15.1236. Copyright (C) 2012 American Megatrends, Inc.

```

BIOS Menu 22: Memory Configuration

5.5 Boot

Use the **Boot** menu (**BIOS Menu 23**) to configure system boot options.

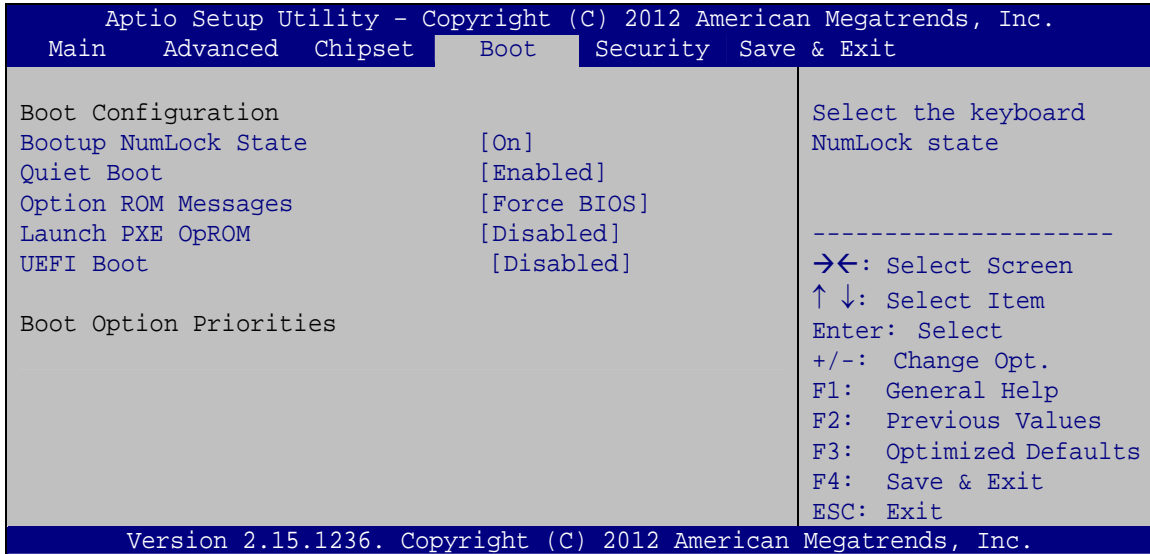

BIOS Menu 23: Boot

→ Bootup NumLock State [On]

Use the **Bootup NumLock State** BIOS option to specify if the number lock setting must be modified during boot up.

- **On** **DEFAULT** Allows the Number Lock on the keyboard to be enabled automatically when the computer system boots up. This allows the immediate use of the 10-key numeric keypad located on the right side of the keyboard. To confirm this, the Number Lock LED light on the keyboard is lit.
- **Off** Does not enable the keyboard Number Lock automatically. To use the 10-keys on the keyboard, press the Number Lock key located on the upper left-hand corner of the 10-key pad. The Number Lock LED on the keyboard lights up when the Number Lock is engaged.

PPC-FxxA-H81 Panel PC

→ Quiet Boot [Enabled]

Use the **Quiet Boot** BIOS option to select the screen display when the system boots.

- **Disabled** Normal POST messages displayed
- **Enabled** **DEFAULT** OEM Logo displayed instead of POST messages

→ Option ROM Messages [Force BIOS]

Use the **Option ROM Messages** option to set the Option ROM display mode.

- **Force BIOS** **DEFAULT** Sets display mode to force BIOS.
- **Keep Current** Sets display mode to current.

→ Launch PXE OpROM [Disabled]

Use the **Launch PXE OpROM** option to enable or disable boot option for legacy network devices.

- **Disabled** **DEFAULT** Ignore all PXE Option ROMs
- **Enabled** Load PXE Option ROMs

→ UEFI Boot [Disabled]

Use the **UEFI Boot** option to enable or disable to boot from the UEFI devices.

- **Enabled** Boot from UEFI devices is enabled.
- **Disabled** **DEFAULT** Boot from UEFI devices is disabled.

5.6 Security

Use the **Security** menu (**BIOS Menu 24**) to set system and user passwords.

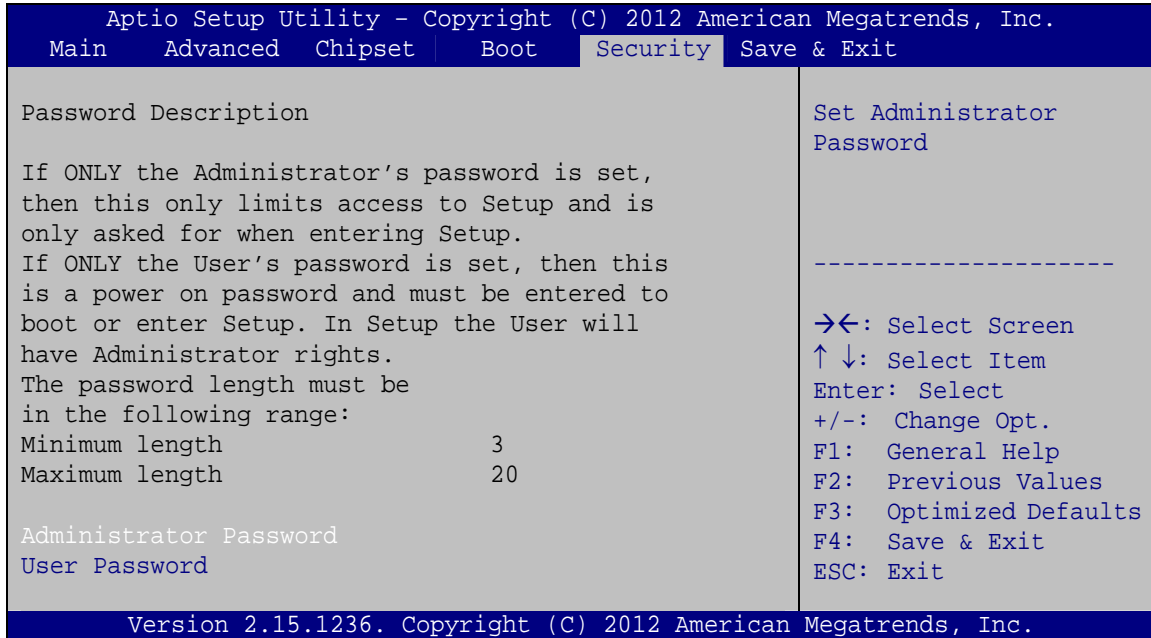

BIOS Menu 24: Security

→ Administrator Password

Use the **Administrator Password** to set or change an administrator password.

→ User Password

Use the **User Password** to set or change a user password.

5.7 Save & Exit

Use the **Save & Exit** menu (**BIOS Menu 25**) to load default BIOS values, optimal failsafe values and to save configuration changes.

PPC-FxxA-H81 Panel PC

```

Aptio Setup Utility - Copyright (C) 2012 American Megatrends, Inc.
Main   Advanced   Chipset   Boot   Save & Exit

Save Changes and Reset
Discard Changes and Reset

Restore Defaults
Save as User Defaults
Restore User Defaults

Exit the system after
saving the changes.

-----
->←: Select Screen
↑ ↓: Select Item
Enter: Select
+/-: Change Opt.
F1:  General Help
F2:  Previous Values
F3:  Optimized Defaults
F4:  Save & Exit
ESC: Exit

Version 2.15.1236. Copyright (C) 2012 American Megatrends, Inc.

```

BIOS Menu 25: Save & Exit**→ Save Changes and Reset**

Use the **Save Changes and Reset** option to save the changes made to the BIOS options and reset the system.

→ Discard Changes and Reset

Use the **Discard Changes and Reset** option to exit the system without saving the changes made to the BIOS configuration setup program.

→ Restore Defaults

Use the **Restore Defaults** option to load the optimal default values for each of the parameters on the Setup menus. **F3 key can be used for this operation.**

→ Save as User Defaults

Use the **Save as User Defaults** option to save the changes done so far as user defaults.

→ Restore User Defaults

Use the **Restore User Defaults** option to restore the user defaults to all the setup options.

Chapter

6

Driver Installation

6.1 Available Software Drivers



NOTE:

The content of the CD may vary throughout the life cycle of the product and is subject to change without prior notice. Visit the IEI website or contact technical support for the latest updates.

The following drivers can be installed on the system:

- Chipset
- VGA
- Audio
- LAN
- USB 3.0
- Touchscreen
- Keypad AP

Installation instructions for the drivers are given in the following sections.

6.2 Starting the Driver Program

To access the driver installation programs, please do the following.

Step 1: Insert the CD that came with the system into an optical disk drive connected to the system.



NOTE:

If the installation program doesn't start automatically:
Click "Start->Computer->CD Drive->Autorun.exe"

Step 2: The list of drivers in **Figure 6-1** appears.



Figure 6-1: Drivers

6.3 Chipset Driver Installation

To install the chipset driver, please do the following.

- Step 1:** Access the driver list. (See **Section 6.2**)
- Step 2:** Click "1. Chipset".
- Step 3:** Double click the setup file.
- Step 4:** When the setup files are completely extracted, the **Welcome Screen** in **Figure 6-2** appears.

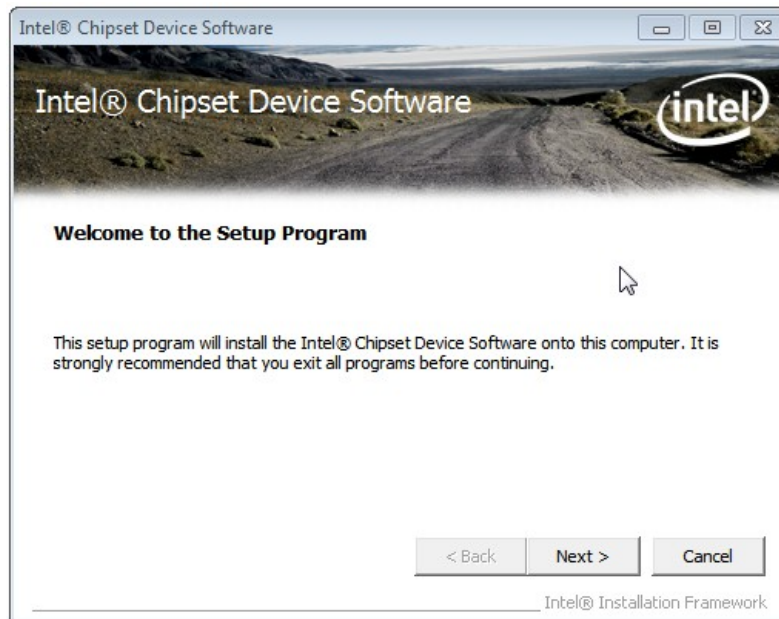

Figure 6-2: Chipset Driver Welcome Screen

- Step 5:** Click **Next** to continue.
- Step 6:** The license agreement in **Figure 6-3** appears.
- Step 7:** Read the **License Agreement**.
- Step 8:** Click **Yes** to continue.



Figure 6-3: Chipset Driver License Agreement

Step 9: The Read Me file in **Figure 6-4** appears.

Step 10: Click **Next** to continue.

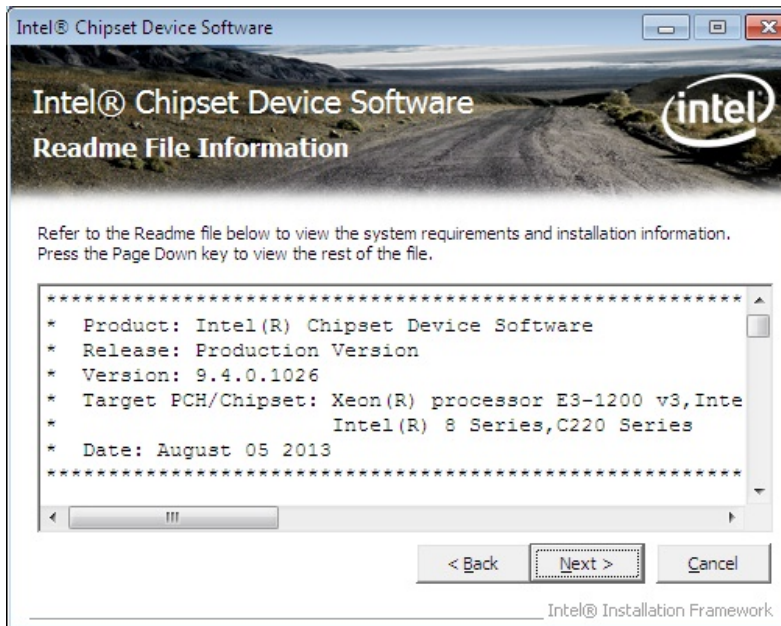

Figure 6-4: Chipset Driver Read Me File

PPC-FxxA-H81 Panel PC

Step 11: Setup Operations are performed as shown in Figure 6-5.



Figure 6-5: Chipset Driver Setup Operations

Step 12: Once the Setup Operations are complete, click **Next** to continue.

Step 13: The **Finish** screen appears.

Step 14: Select “**Yes, I want to restart the computer now**” and click the **Finish** icon.

See **Figure 6-6**.



Figure 6-6: Chipset Driver Installation Finish Screen

6.4 VGA Driver Installation

To install the VGA driver, please do the following.

- Step 1:** Access the driver list. (See **Section 6.2**)
- Step 2:** Click "**2.VGA**".
- Step 3:** Double click the **Win32_15338** or **Win64_15338** file that corresponds to your OS version.
- Step 4:** The **README FILE** screen in **Figure 6-7** appears. Click **Next** to continue.

PPC-FxxA-H81 Panel PC

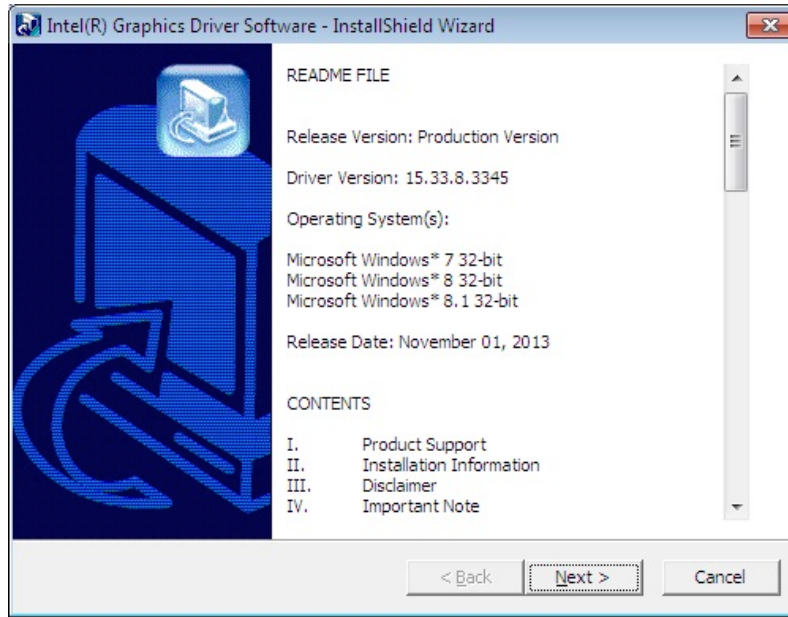

Figure 6-7: VGA Driver README FILE

Step 5: The setup files are extracted as shown in **Figure 6-8**.

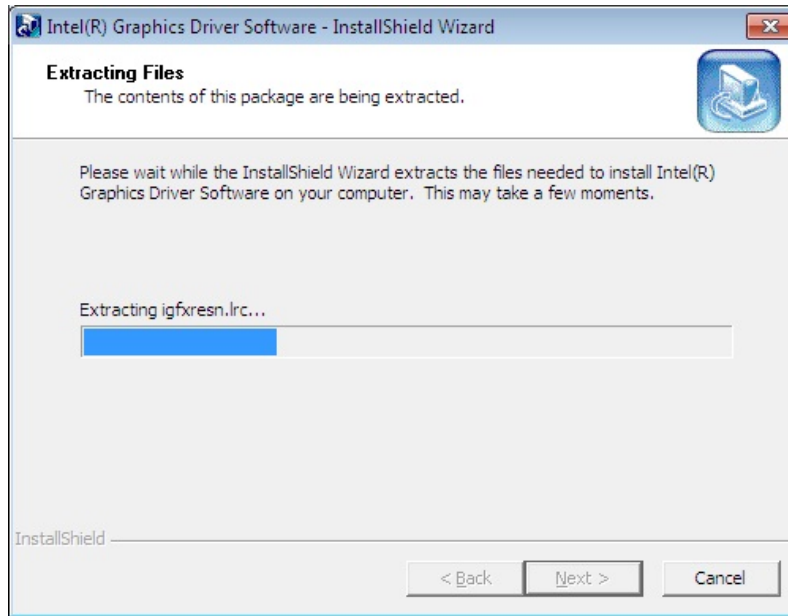

Figure 6-8: VGA Driver Screen

Step 6: When the setup files are completely extracted, the **Welcome Screen** in **Figure 6-9** appears. Click **Next** to continue.

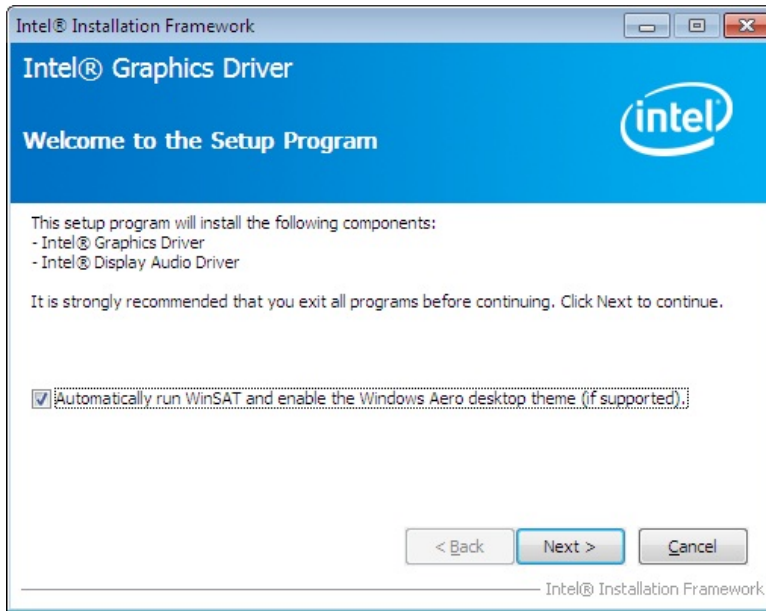

Figure 6-9: VGA Driver Welcome Screen

Step 7: The license agreement in **Figure 6-10** appears.

Step 8: Read the **License Agreement**.

Step 9: Click **Yes** to continue.

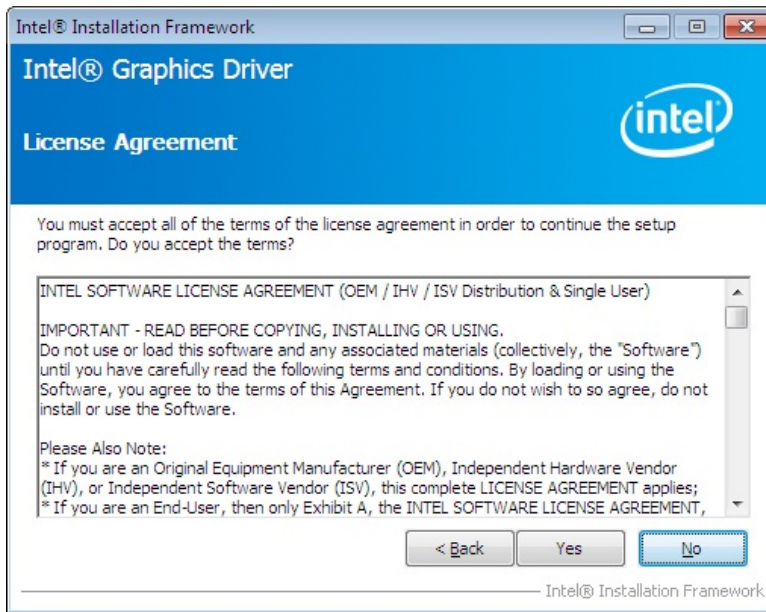

Figure 6-10: VGA Driver License Agreement

PPC-FxxA-H81 Panel PC

Step 10: The **Readme File Information** screen in **Figure 6-11** appears. Click **Next** to continue.

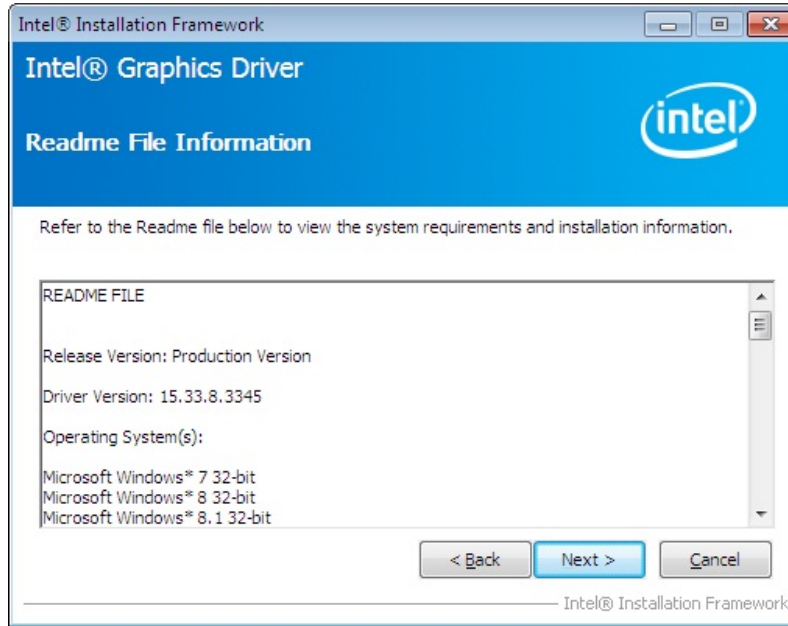

Figure 6-11: VGA Driver Readme File Information

Step 11: **Setup Progress** is performed as shown in **Figure 6-12**.

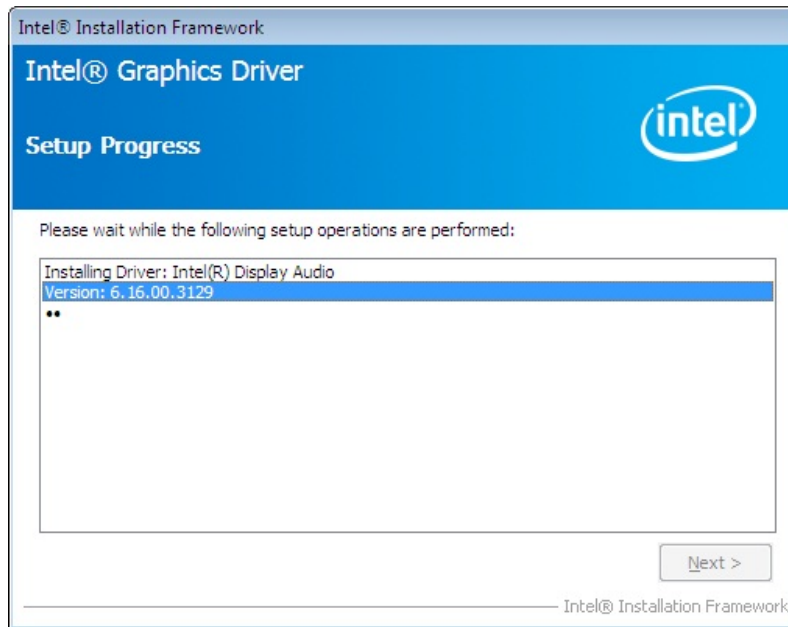

Figure 6-12: VGA Driver Setup Progress

Step 12: Once the setup operations are complete, click the **Next** icon to continue.

Step 13: The **Finish** screen appears.

Step 14: Select “**Yes, I want to restart the computer now**” and click the **Finish** icon.

See **Figure 6-13**.

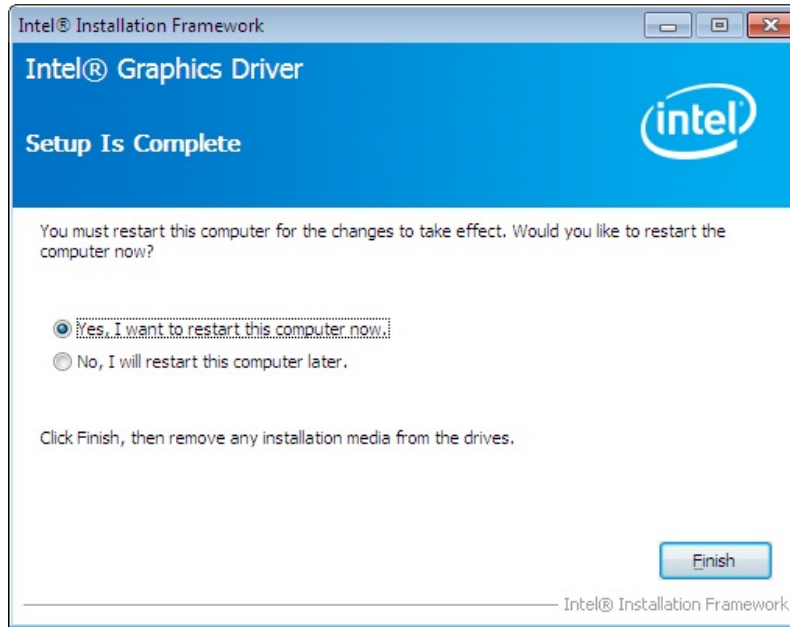

Figure 6-13: VGA Driver Installation Finish Screen

6.5 Audio Driver Installation

To install the Audio driver, please do the following.

Step 1: Access the driver list. (See **Section 6.2**)

Step 2: Click “**3.Audio**”.

Step 3: Double click the setup file.

Step 4: The **InstallShield Wizard** is prepared to guide the user through the rest of the process.

Step 5: Once initialized, the **InstallShield Wizard** welcome screen appears (**Figure 6-14**).

PPC-FxxA-H81 Panel PC



Figure 6-14: Audio Driver Welcome Screen

Step 6: Click **Yes** to continue.

Step 7: The program begins to install. See **Figure 6-15**.

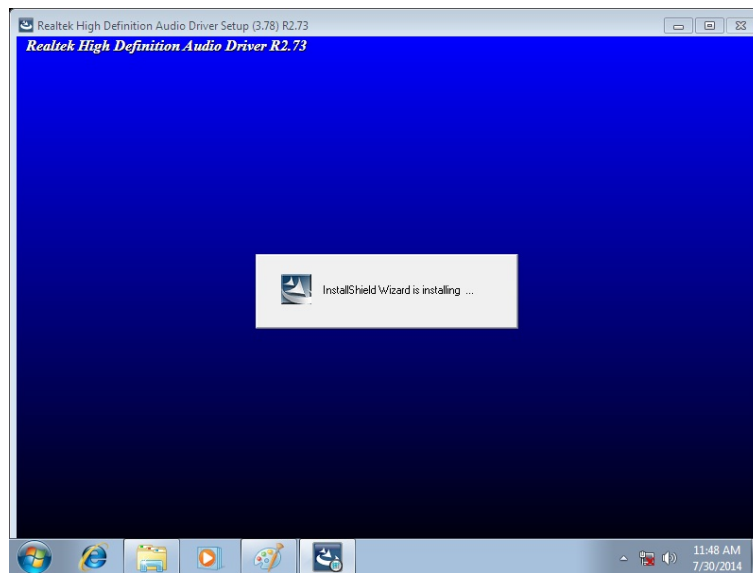

Figure 6-15: Audio Driver Installation

Step 8: When the driver installation is complete, the screen in **Figure 6-16** appears.

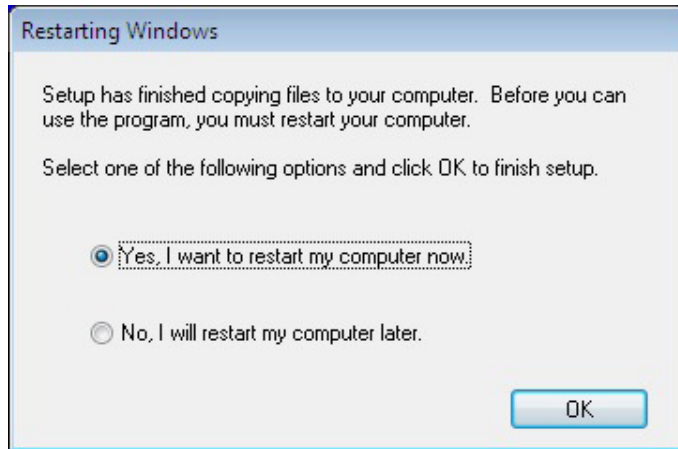

Figure 6-16: Audio Driver Installation Complete

Step 9: Select “Yes, I want to restart my computer now” and click **OK**.

Step 10: The system reboots.

6.6 LAN Driver Installation

To install the LAN driver, please do the following.

Step 1: Access the driver list. (See **Section 6.2**)

Step 2: Click “**4.LAN**”.

Step 3: Locate and double click the **PRO Win32** or **PRO Winx64** file that corresponds to your OS version.

Step 4: When the setup files are completely extracted, the **Welcome** screen in **Figure 6-17** appears. Click **Next** to continue.

PPC-FxxA-H81 Panel PC

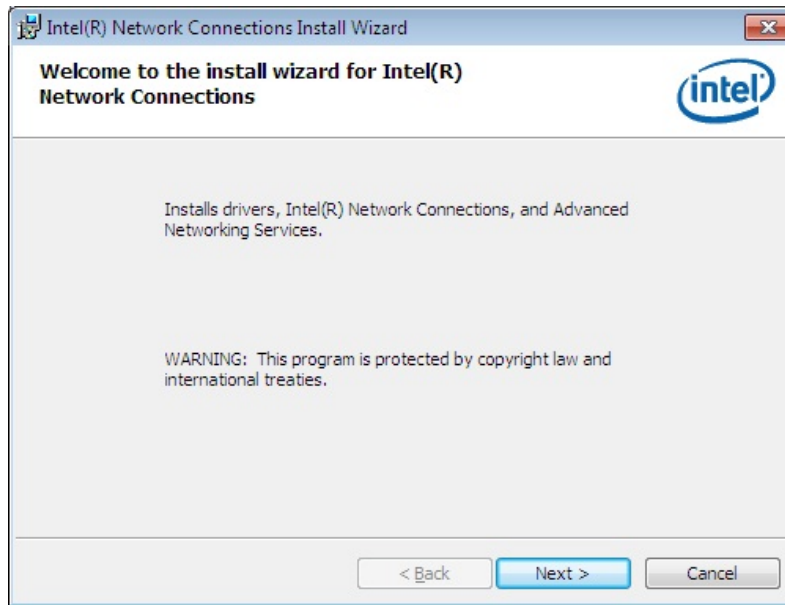

Figure 6-17: LAN Driver Welcome Screen

Step 5: The **License Agreement** in **Figure 6-18** appears.

Step 6: Accept the agreement by selecting "I accept the terms in the license agreement".

Step 7: Click **Next** to continue.



Figure 6-18: LAN Driver License Agreement

Step 8: The **Setup Options** screen in **Figure 6-19** appears.

Step 9: Select program features to install.

Step 10: Click **Next** to continue.

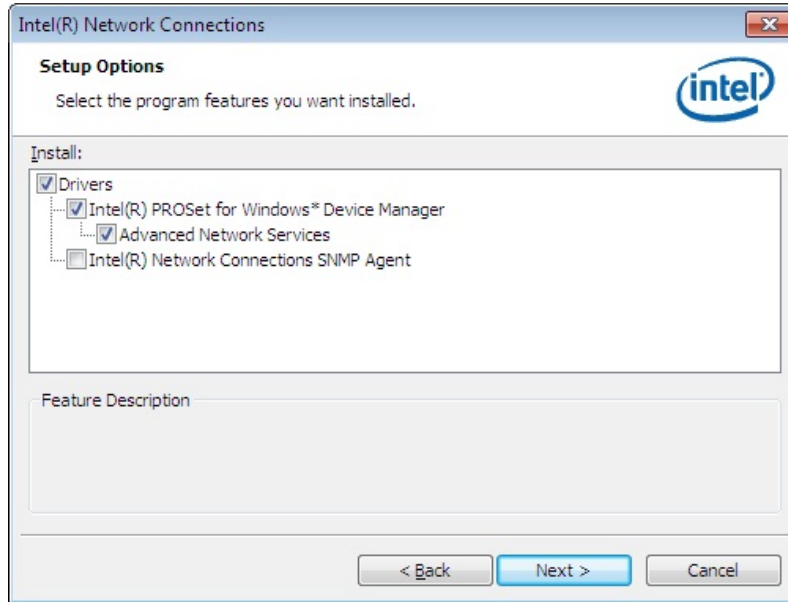

Figure 6-19: LAN Driver Setup Options

Step 11: The **Ready to Install** screen in **Figure 6-20** appears.

Step 12: Click **Install** to proceed with the installation.

PPC-FxxA-H81 Panel PC

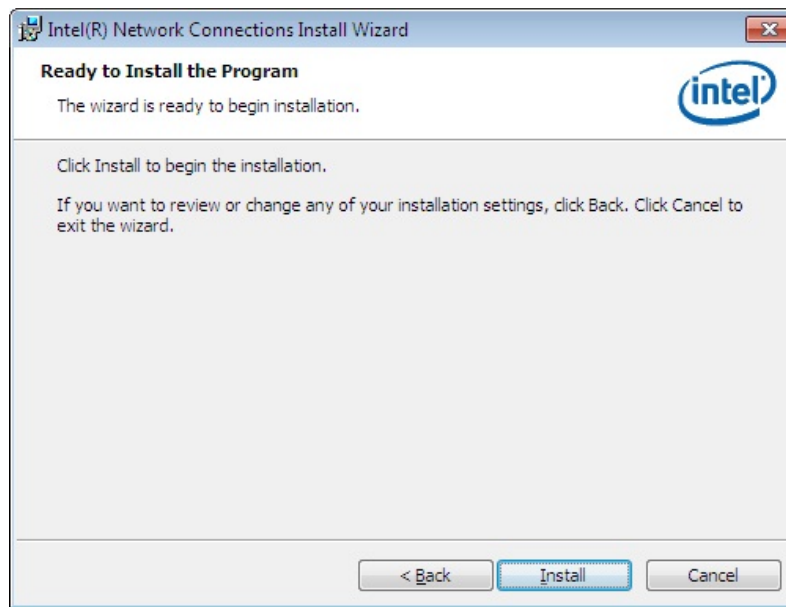

Figure 6-20: LAN Driver Installation

Step 13: The program begins to install.

Step 14: When the driver installation is complete, the screen in **Figure 6-21** appears.

Step 15: Click **Finish** to exit.

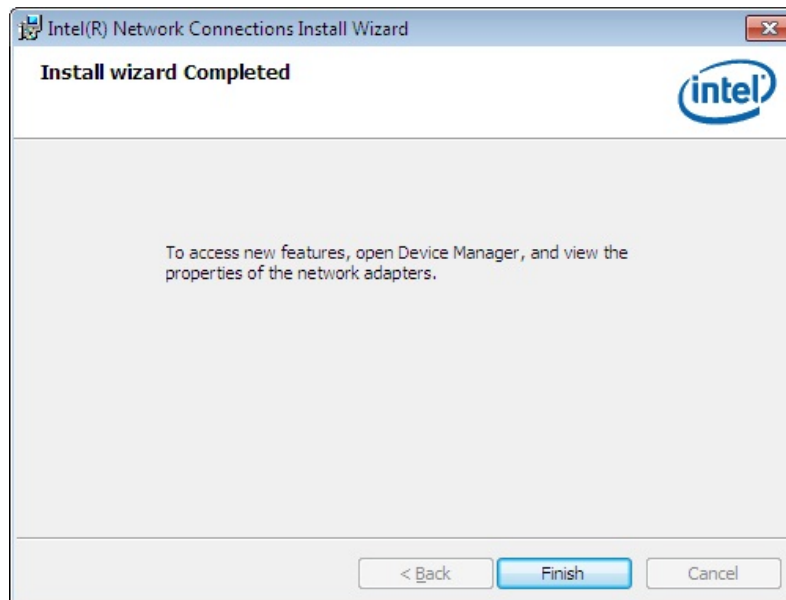

Figure 6-21: LAN Driver Installation Complete

6.7 USB 3.0 Driver Installation



WARNING:

Do not run this driver's installer (Setup.exe) from a USB storage device (ie. external USB hard drive or USB thumb drive). For proper installation, please copy driver files to a local hard drive folder and run from there.

To install the USB 3.0 driver, please follow the steps below.

- Step 1:** Access the driver list. (See **Section 6.2**)
- Step 2:** Click “**6.USB 3.0**”.
- Step 3:** Locate the setup file and double click on it.
- Step 4:** The **Welcome Screen** in **Figure 6-22** appears.
- Step 5:** Click **Next** to continue.



Figure 6-22: USB 3.0 Driver Welcome Screen

PPC-FxxA-H81 Panel PC

Step 6: The license agreement in **Figure 6-23** appears.

Step 7: Read the **License Agreement**, and then click **Yes** to continue.



Figure 6-23: USB 3.0 Driver License Agreement

Step 8: The **Read Me** file in **Figure 6-24** appears. Click **Next** to continue.



Figure 6-24: USB 3.0 Driver Read Me File

Step 9: Setup Operations are performed as shown in Figure 6-25.

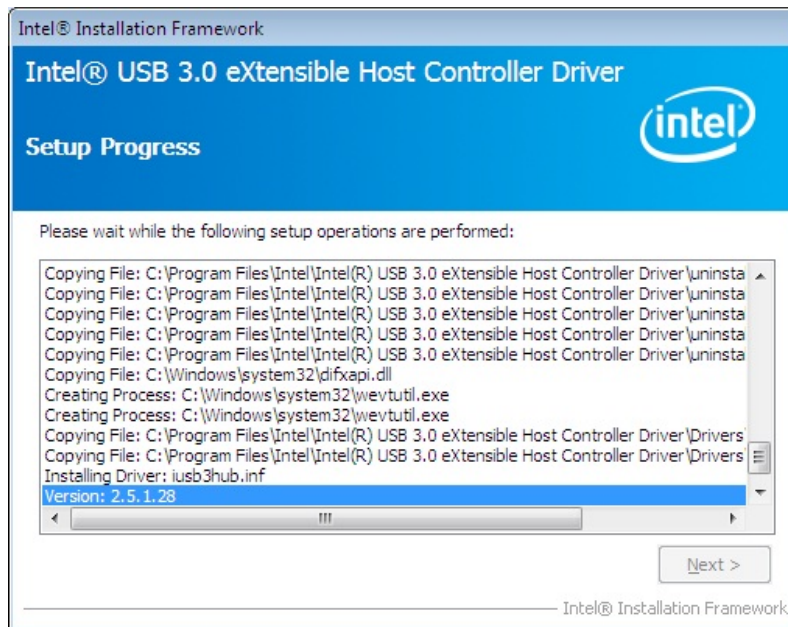

Figure 6-25: USB 3.0 Driver Setup Operations

Step 10: Once the Setup Operations are complete, click Next to continue.

PPC-FxxA-H81 Panel PC

Step 11: The **Finish** screen in **Figure 6-26** appears.

Step 12: Select “**Yes, I want to restart this computer now**” and click **Finish**.



Figure 6-26: USB 3.0 Driver Installation Finish Screen

6.8 Resistive Type Touchscreen Driver Installation

To install the resistive type touchscreen driver, please follow the steps below.

Step 1: Access the driver list. (See **Section 6.2**)

Step 2: Click “**5.Touch**”.

Step 3: Select **Resistive touch** folder.

Step 4: Locate and double click the setup file.

Step 5: The Welcome screen in **Figure 6-27** appears. Click **Next** to continue.

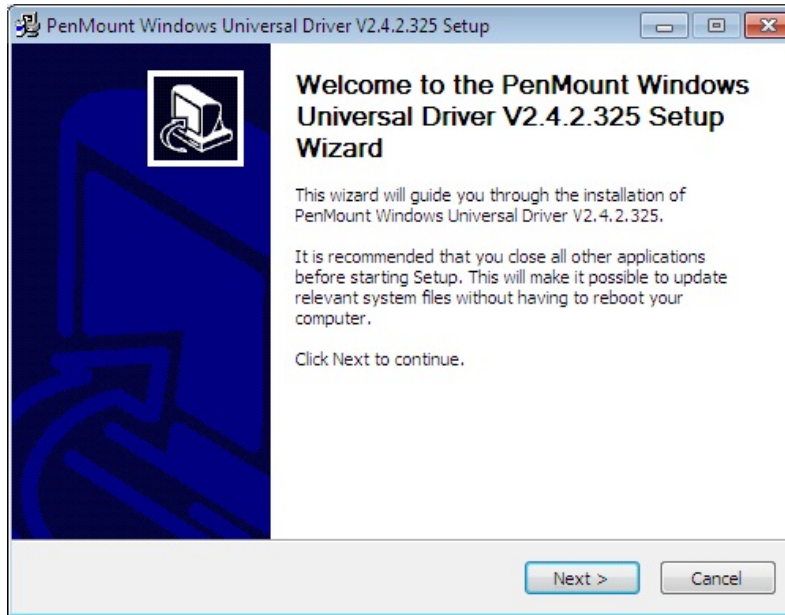

Figure 6-27: Welcome Screen

Step 6: The license agreement in **Figure 6-28** appears.

Step 7: Read the **License Agreement**.

Step 8: Click **I Agree** to continue.

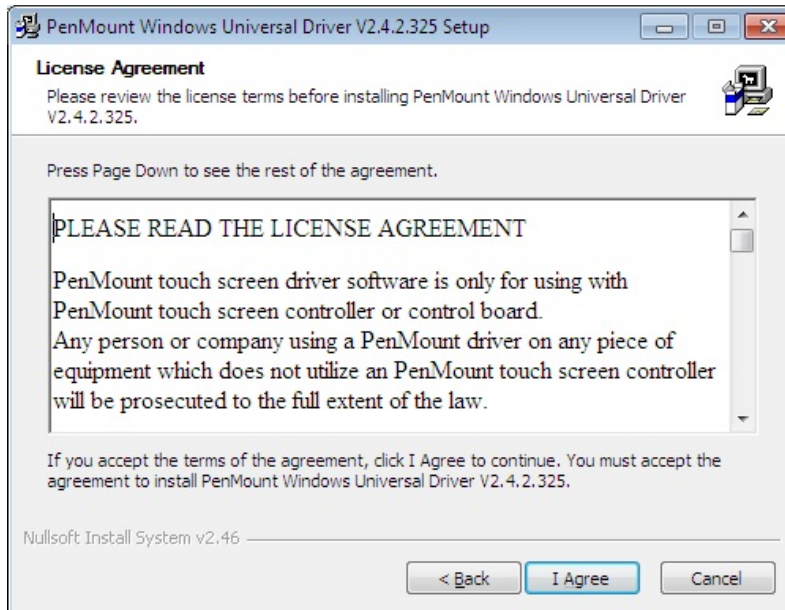

Figure 6-28: Touchscreen Driver License Agreement

Step 9: Select the destination folder where the setup files will be copied to (**Figure 6-29**).

PPC-FxxA-H81 Panel PC

Step 10: Click **Install** to start installation.

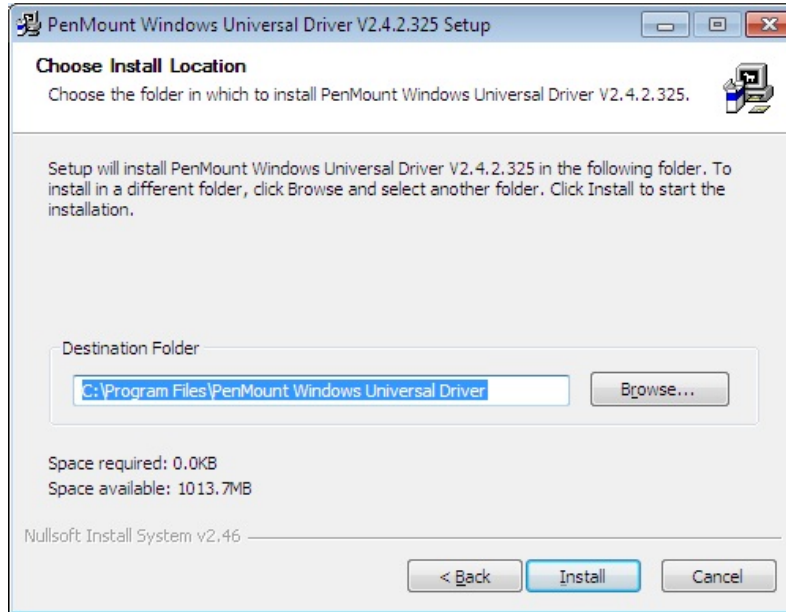

Figure 6-29: Choose Destination Folder

Step 11: The installation begins. See **Figure 6-30**.

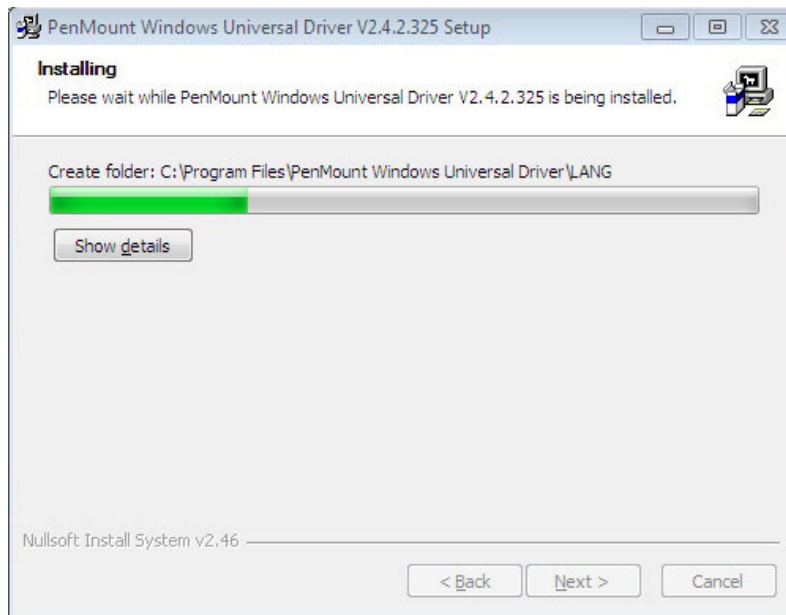

Figure 6-30: Setup Status

Step 12: A dialog box as shown in **Figure 6-31** appears. Select **Yes** to use the PenMount touch features or **No** to use the system touch gestures.

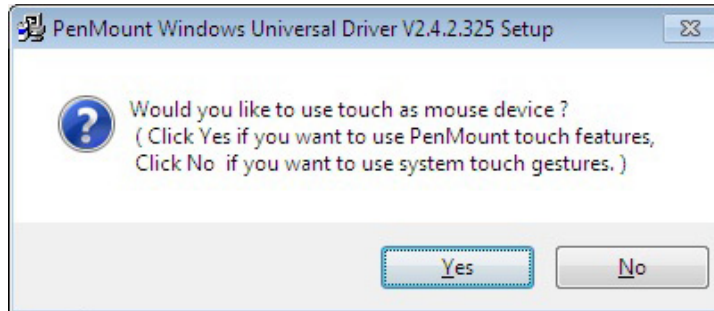

Figure 6-31: Select Touch Features

Step 13: When the installation is complete, the screen in **Figure 6-32** appears. Click **Finish** to close the setup wizard.

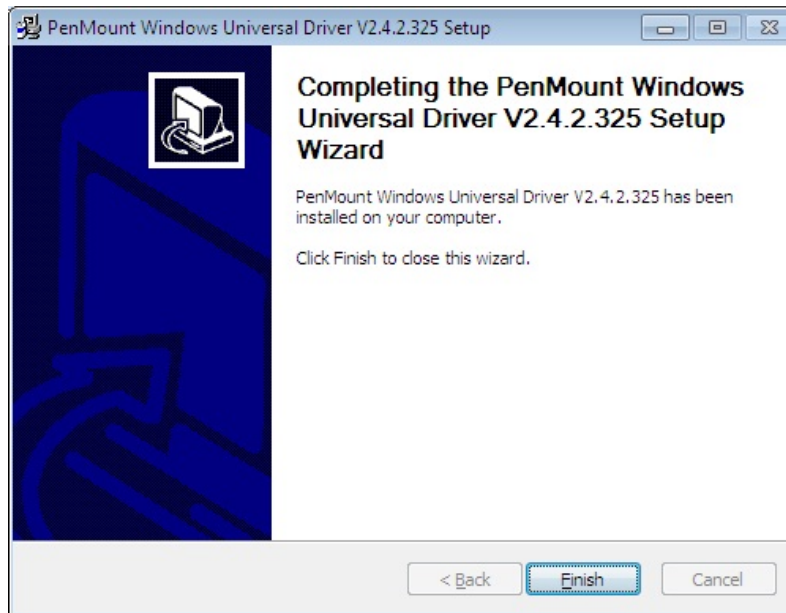



Figure 6-32: Touchscreen Driver Installation Finish Screen

6.8.1 Calibrating the Resistive Type Touchscreen

To calibrate the resistive type touchscreen, please follow the steps below.

Step 1: Click the  icon on the Windows notification area.

PPC-FxxA-H81 Panel PC

Step 2: Click **Control Panel** from the menu (Figure 6-33).

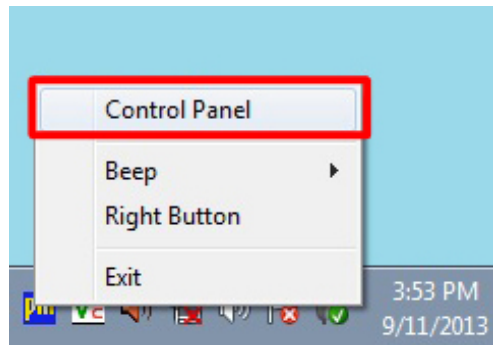

Figure 6-33: Select Control Panel

Step 3: The touchscreen control panel appears (Figure 6-34). Click **Configure**.

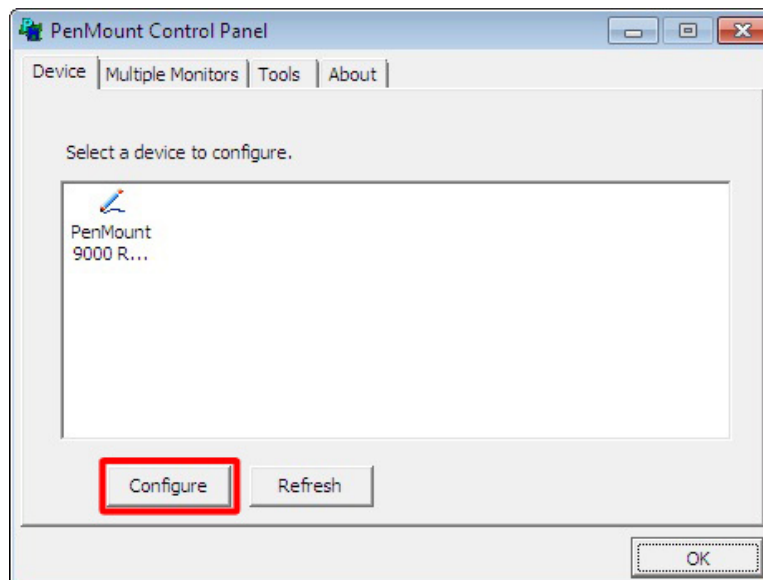

Figure 6-34: Touchscreen Control Panel

Step 4: The user can click **Standard Calibration** or **Advanced Calibration** to proceed with standard or advanced calibration.

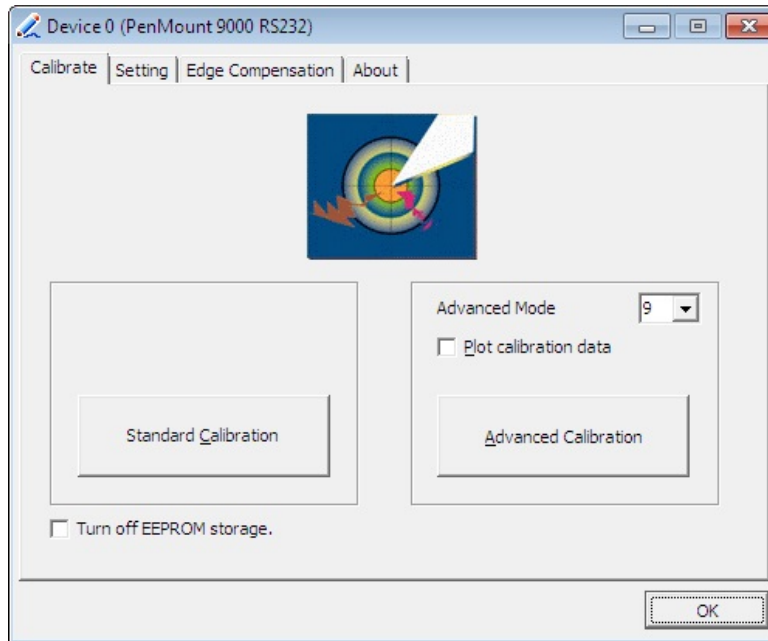

Figure 6-35: Select Calibration Type

Step 5: The calibration window in **Figure 6-36** appears. The user is asked to touch the screen at five specified points, if Standard Calibration is selected. Follow the screen guide to touch and hold each red square in the calibration window until it shows “Lift off to proceed”.

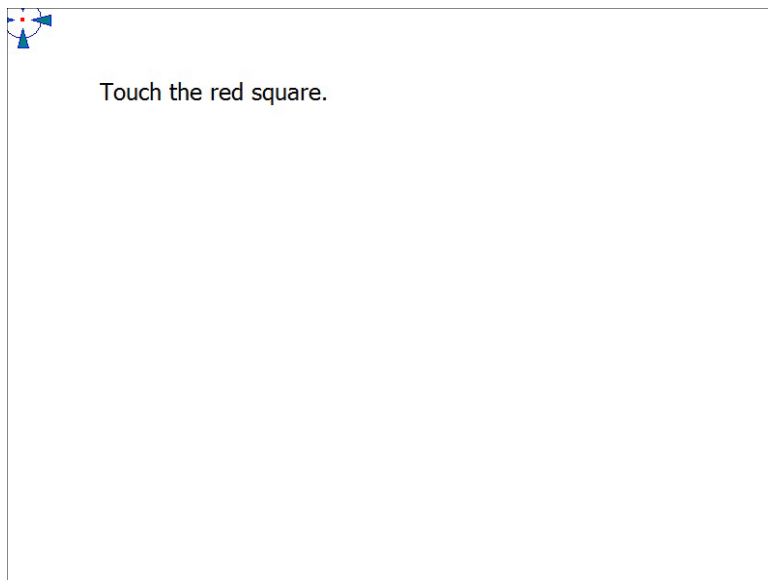

Figure 6-36: Calibration Window

PPC-FxxA-H81 Panel PC

Step 6: When the calibration is complete, the setup returns to the control panel. Click **OK** to exit.

6.9 Keypad AP Installation

The Keypad AP is an OSD control tool developed by IEI. To install and use the Keypad AP, please do the following.

Step 1: Access the driver list. (See **Section 6.2**)

Step 2: Click **“8.Keypad AP”**.

Step 3: Select the **KeypadAP V2.6 x64** or **KeypadAP V2.6 x86** file that corresponds to your OS version.

Step 4: Double click the setup file.

Step 5: The **Welcome** screen in **Figure 6-37** appears. Click **Next** to continue.

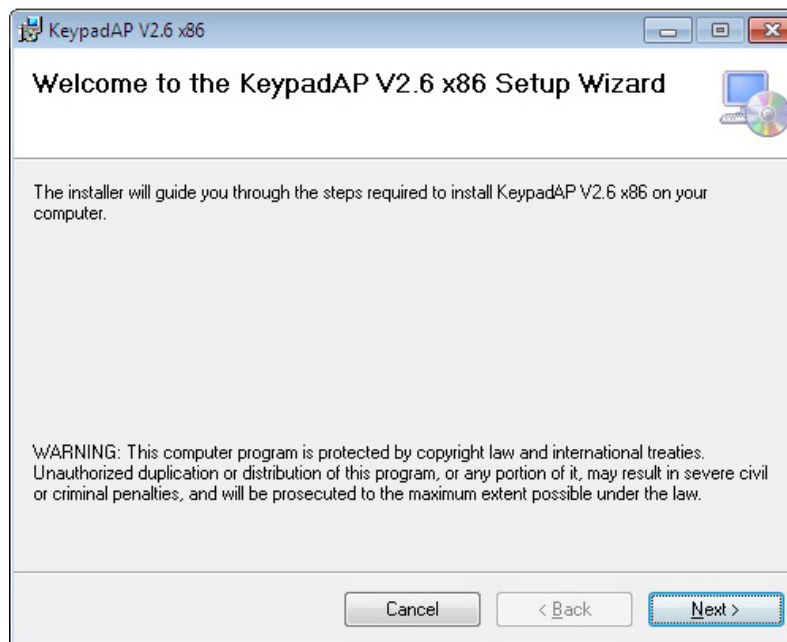

Figure 6-37: Keypad AP Welcome Screen

Step 6: The **Select Installation Folder** screen in **Figure 6-38** appears.

Step 7: Select the installation folder, and then click **Next** to continue.

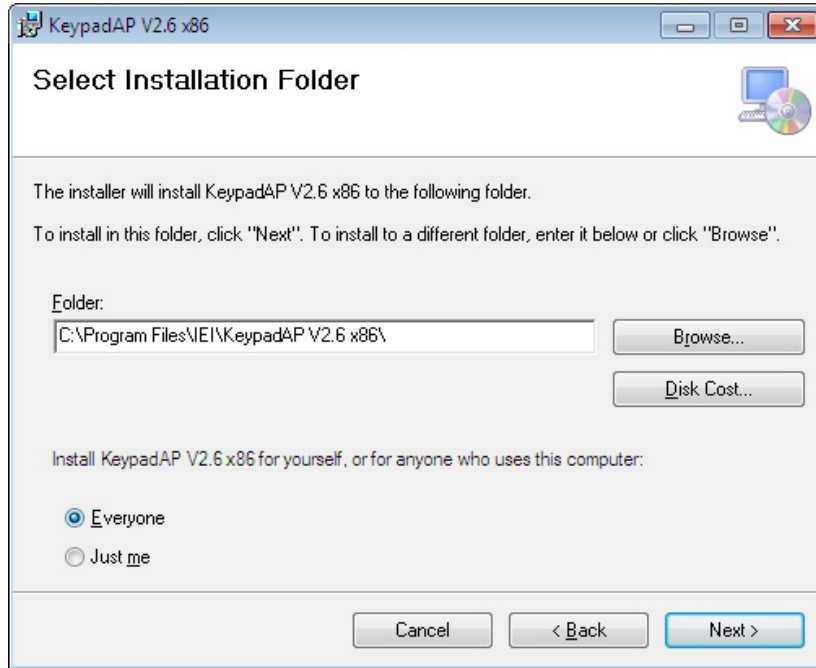

Figure 6-38: Select Installation Folder

Step 8: The **Confirm Installation** screen in **Figure 6-39** appears. Click **Next** to proceed with the installation.

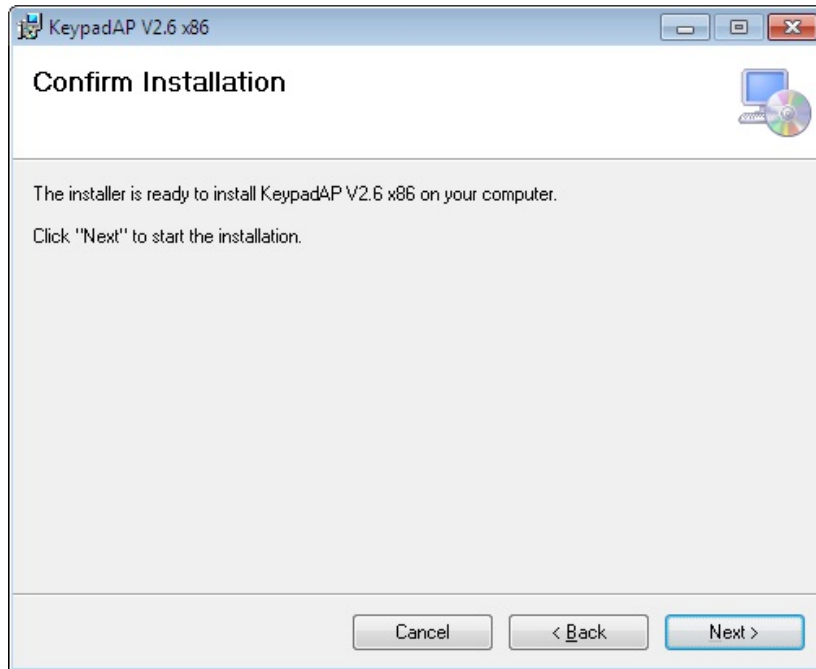

Figure 6-39: Confirm Installation

PPC-FxxA-H81 Panel PC

Step 9: The program begins to install.

Step 10: When the installation is complete, the screen in **Figure 6-40** appears. Click **Close** to exit.

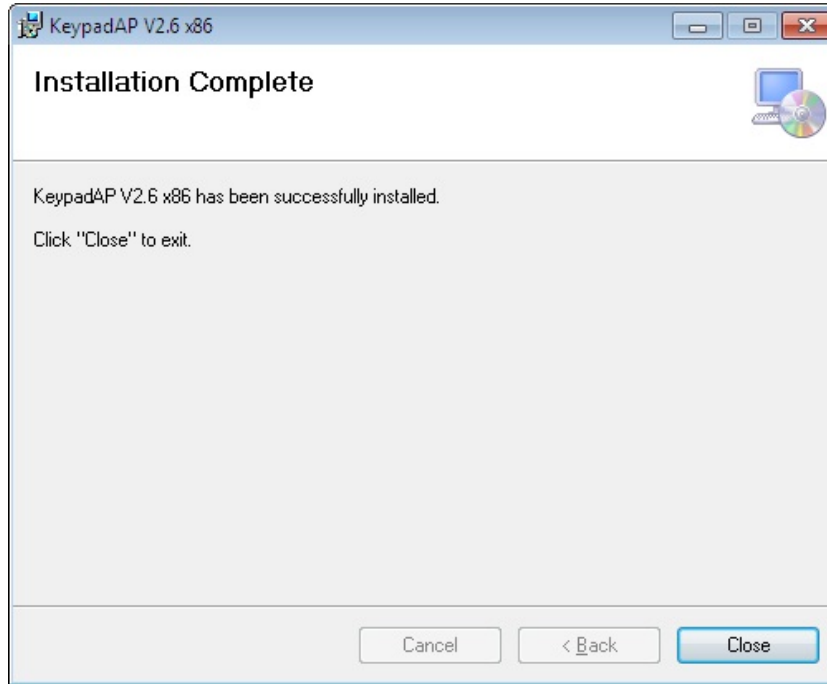

Figure 6-40: Keypad AP Installation Complete

Step 11: The screen in **Figure 6-41** appears. Click **Yes** to restart the system.

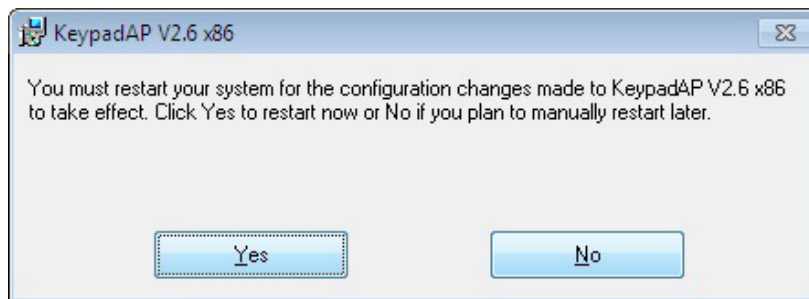

Figure 6-41: Keypad AP Installation Complete

Step 12: To use the Keypad AP, the user must connect an audio device to the line-out port on the bottom panel. Refer to **Section 3.12.1** for an audio device connection.

Step 13: Click the  icon on the Windows notification area to access the Keypad AP. It allows the user to control screen brightness and audio volume.



Figure 6-42: Keypad AP

Chapter

7

Interface Connectors

7.1 Peripheral Interface Connectors

The PPC-FxxA-H81 panel PC motherboard comes with a number of peripheral interface connectors and configuration jumpers. The connector locations are shown in **Figure 6-1** and **Figure 6-2**. The Pin 1 locations of the on-board connectors are also indicated in the diagrams. The connector pinouts for these connectors are listed in the following sections.

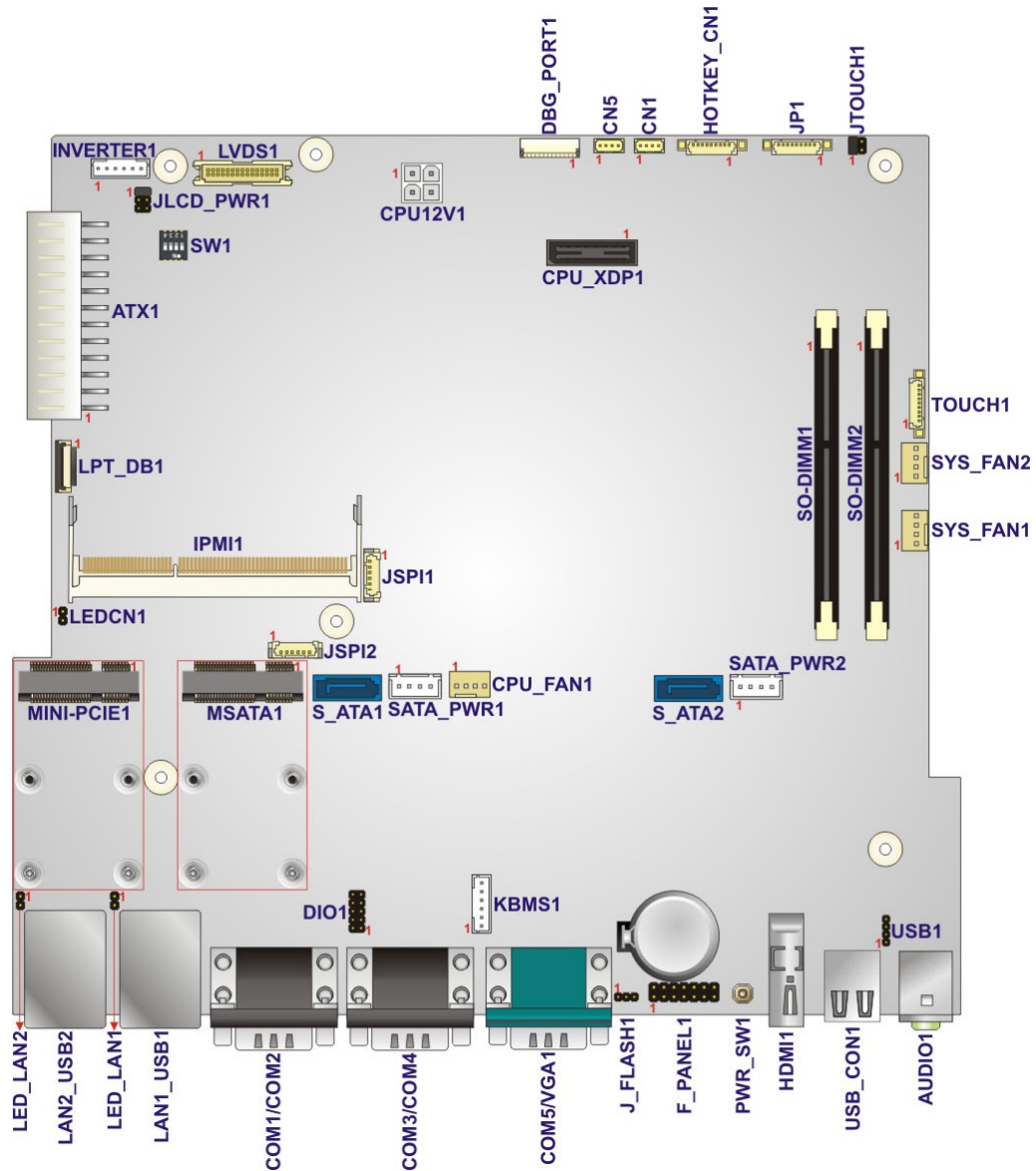

Figure 7-1: Main Board Layout Diagram (Front Side)

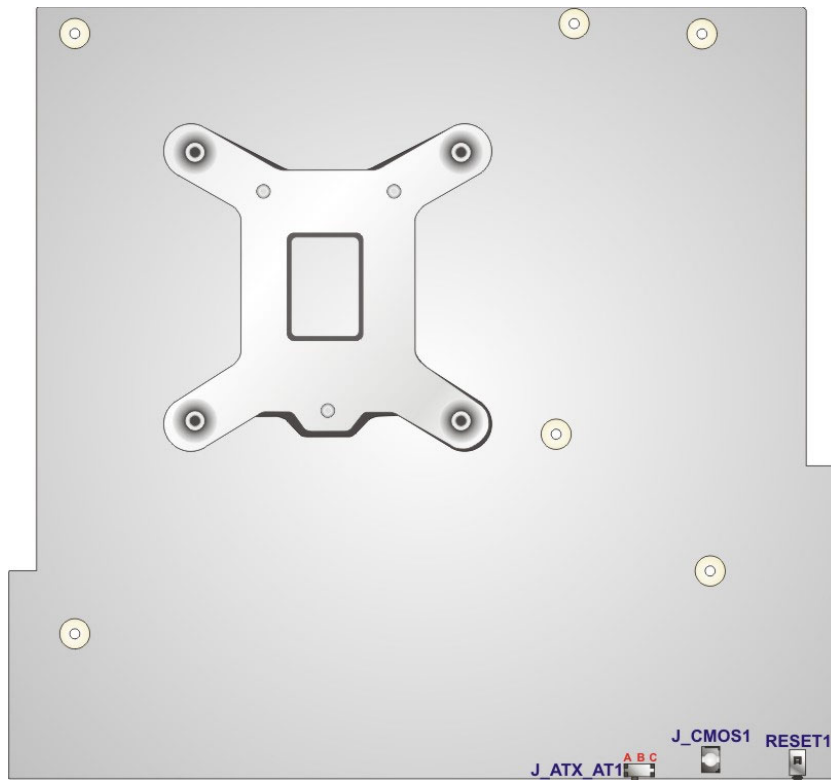

Figure 7-2: Main Board Layout Diagram (Solder Side)

7.2 Internal Peripheral Connectors

Internal peripheral connectors are found on the motherboard and are only accessible when the motherboard is outside of the chassis. The table below shows a list of the peripheral interface connectors on the PPC-FxxA-H81 motherboard. Pinouts of these connectors can be found in the following sections.

Connector	Type	Label
+12V power source connector	4-pin Molex	CPU12V1
ATX power connector	24-pin ATX	ATX1
Debug port	12-pin wafer	DBG_PORT1
DIO connector	10-pin header	DIO1
EC debug port	18-pin wafer	LPT_DB1
Fan connector (CPU)	4-pin wafer	CPU_FAN1

Connector	Type	Label
Fan connectors (system)	4-pin wafer	SYS_FAN1, SYS_FAN2
Front panel connector	14-pin header	F_PANEL1
I ² C connector	4-pin wafer	CN5
Internal power button connector	Push button	PWR_SW1
IPMI active LED connector	2-pin header	LEDCN1
iRIS module slot	iRIS-2400 slot	IPMI1
Keyboard and mouse connector	6-pin wafer	KBMS1
Keypad connector (for RD test)	9-pin wafer	HOTKEY_CN1
LAN active LED connectors	2-pin header	LED_LAN1, LED_LAN2
LVDS connector	30-pin crimp	LVDS1
Panel power supply connector	6-pin wafer	INVERTER1
PCIe Mini card slot	PCIe Mini card slot	MINI_PCIE1
PCIe Mini card slot (supports mSATA)	PCIe Mini card slot	MSATA1
Resistive touchscreen connector	9-pin wafer	TOUCH1
SATA 6Gb/s connectors	SATA connector	S_ATA1, S_ATA2
SATA power connectors	4-pin wafer	SATA_PWR1, SATA_PWR2
SMBus connector	4-pin wafer	CN1
SO-DIMM connectors	SO-DIMM connector	SO_DIMM1, SO_DIMM2
SPI flash connector	6-pin wafer	JSPI1
SPI flash (EC) connector	6-pin wafer	JSPI2
U3 firmware programming connector	9-pin wafer	JP1
USB 2.0 connector	8-pin header	USB1

Table 7-1: Peripheral Interface Connectors

7.2.1 +12V Power Source Connector (CPU12V1)

PIN NO.	DESCRIPTION
1	GND
2	GND
3	+12V
4	+12V

Table 7-2: +12V Power Source Connector (CPU12V1) Pinouts

7.2.2 ATX Power Connector (ATX1)

PIN NO.	DESCRIPTION	PIN NO.	DESCRIPTION
1	+3.3V	13	+3.3V
2	+3.3V	14	-12V
3	GND	15	GND
4	+5V	16	PS_ON
5	GND	17	GND
6	+5V	18	GND
7	GND	19	GND
8	Power good	20	-5V
9	5VSB	21	+5V
10	+12V	22	+5V
11	+12V	23	+5V
12	+3.3V	24	GND

Table 7-3: ATX Power Connector (ATX1) Pinouts

7.2.3 Debug Port (DBG_PORT1)

PIN NO.	DESCRIPTION
1	GND
2	CLK_PCI_TPM
3	PLTRST_N
4	LPC_FRAME#
5	LPC_AD0
6	LPC_AD1
7	LPC_AD2
8	LPC_AD3
9	INT_SERIRQ
10	GND
11	+3.3V
12	+5V

Table 7-4: Debug Port (DBG_PORT1) Pinouts

7.2.4 DIO Connector (DIO1)

PIN NO.	DESCRIPTION	PIN NO.	DESCRIPTION
1	GND	2	VCC
3	Output 3	4	Output 2
5	Output 1	6	Output 0
7	Input 3	8	Input 2
9	Input 1	10	Input 0

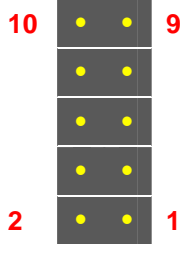

Table 7-5: DIO Connector (DIO1) Pinouts

7.2.5 EC Debug Port (LPT_DB1)

PIN NO.	DESCRIPTION
1	EC_EPP_STB#
2	EC_EPP_AFD#
3	EC_EPP_PD0
4	NC
5	EC_EPP_PD1
6	EC_EPP_INIT#
7	EC_EPP_PD2
8	EC_EPP_SLIN#
9	EC_EPP_PD3
10	GND
11	EC_EPP_PD4
12	NC
13	EC_EPP_PD5
14	EC_EPP_BUSY
15	EC_EPP_PD6
16	EC_EPP_KSI5
17	EC_EPP_PD7
18	EC_EPP_KSI4

Table 7-6: EC Debug Port (LPT_DB1) Pinouts

7.2.6 Fan Connectors (CPU_FAN1/SYS_FAN1/SYS_FAN2)

PIN NO.	DESCRIPTION
1	GND
2	+12V
3	FANIO
4	PWM

Table 7-7: Fan Connector Pinouts

7.2.7 Front Panel Connector (F_PANEL1)

FUCNTION	PIN NO.	DESCRIPTION	FUCNTION	PIN NO.	DESCRIPTION
Power LED	1	+5V	Speaker	2	BEEP_PWR
	3	NC		4	NC
	5	GND		6	NC
Power Button	7	PWRBTN_SW#		8	PC_BEEP
	9	GND		10	NC
HDD LED	11	+5V	Reset	12	EXTRST-
	13	SATA_LED#		14	GND

Table 7-8: Front Panel Connector (F_PANEL1) Pinouts

7.2.8 I²C Connector (CN5)

PIN NO.	DESCRIPTION
1	GND
2	PCH_GP38
3	PCH_GP39
4	+5V

Table 7-9: I²C Connector (CN5) Pinouts

7.2.9 IPMI Active LED Connector (LEDCN1)

PIN NO.	DESCRIPTION
1	IPMI_LED+
2	IPMI_LED-

Table 7-10: IPMI Active LED Connector (LEDCN1) Pinouts

7.2.10 Keyboard and Mouse Connector (KBMS1)

PIN NO.	DESCRIPTION
1	VCC5_KBMS
2	MSDATA
3	MSCLK
4	KBDATA
5	KBCLK
6	KBGND

Table 7-11: Keyboard and Mouse Connector (KBMS1) Pinouts

7.2.11 Keypad Connector (HOTKEY_CN1)

PIN NO.	DESCRIPTION
1	+5V
2	AUTO_DIMMING
3	LOCK_BUTTON
4	VOL+
5	VOL-
6	BRIGHT+
7	BRIGHT-
8	LCD ON_OFF
9	GND

Table 7-12: Keypad Connector (HOTKEY_CN1) Pinouts

7.2.12 LAN Active LED Connectors (LED_LAN1/LED_LAN2)

PIN NO.	DESCRIPTION
1	LINK_ACT+
2	LINK_ACT-

Table 7-13: LAN Active LED Connectors (LED_LAN1/LED_LAN2) Pinouts

7.2.13 LVDS Connector (LVDS1)

PIN NO.	DESCRIPTION	PIN NO.	DESCRIPTION
1	GND	2	GND
3	LVDS_A_TX0-P	4	LVDS_A_TX0-N
5	LVDS_A_TX1-P	6	LVDS_A_TX1-N
7	LVDS_A_TX2-P	8	LVDS_A_TX2-N
9	LVDS_A_TXCLK-P	10	LVDS_A_TXCLK-N
11	LVDS_A_TX3-P	12	LVDS_A_TX3-N
13	GND	14	GND
15	LVDS_B_TX0-P	16	LVDS_B_TX0-N
17	LVDS_B_TX1-P	18	LVDS_B_TX1-N
19	LVDS_B_TX2-P	20	LVDS_B_TX2-N
21	LVDS_B_TXCLK-P	22	LVDS_B_TXCLK-N
23	LVDS_B_TX3-P	24	LVDS_B_TX3-N
25	GND	26	GND
27	+LCD Vcc	28	+LCD Vcc
29	+LCD Vcc	30	+LCD Vcc

Table 7-14: LVDS Connector (LVDS1) Pinouts

7.2.14 Panel Power Supply Connector (INVERTER1)

PIN NO.	DESCRIPTION
1	+12V
2	+12V
3	Backlight ON/OFF
4	Backlight Brightness Control
5	GND
6	GND

Table 7-15: Panel Power Supply Connector (INVERTER1) Pinouts

7.2.15 PCIe Mini (MINI_PCIE1) and mSATA (MSATA1) Card Slots

PIN NO.	DESCRIPTION	PIN NO.	DESCRIPTION
1	PCIE_WAKE#	2	VCC3
3	N/C	4	GND
5	N/C	6	1.5V
7	N/C	8	N/C
9	GND	10	N/C
11	CLK-	12	N/C
13	CLK+	14	N/C
15	GND	16	N/C
17	PCIRST#	18	GND
19	N/C	20	VCC3
21	GND	22	PCIRST#
23	PERN2(SATA_RX4+)	24	3VDual
25	PERP2(SATA_RX4-)	26	GND
27	GND	28	1.5V
29	GND	30	SMBCLK
31	PETN2(SATA_TX4-)	32	SMBDATA
33	PETP2(SATA_TX4+)	34	GND
35	GND	36	USBD-
37	N/C	38	USBD+
39	N/C	40	GND
41	N/C	42	N/C
43	SATA_DET4_R_N	44	N/C
45	N/C	46	N/C
47	N/C	48	1.5V
49	N/C	50	GND
51	MSATA_SEL#	52	VCC3

Table 7-16: PCIe Mini (MINI_PCIE1) and mSATA (MSATA1) Card Pinouts

7.2.16 Resistive Touchscreen Connector (TOUCH1)

PIN NO.	8-Wire	4-Wire	5-Wire
1	Right Sense	N/A	N/A
2	Left Sense	N/A	N/A
3	Bottom Sense	N/A	N/A
4	Top Sense	N/A	Sense (S)
5	Right Excite	Right	LR (X)
6	Left Excite	Left	LL (L)
7	Bottom Excite	Bottom	UR (H)
8	Top Excite	Top	UL (Y)
9	GND	GND	GND

Table 7-17: Resistive Touchscreen Connector (TOUCH1) Pinouts

7.2.17 SATA 6Gb/s Connectors (S_ATA1/S_ATA2)

PIN NO.	DESCRIPTION
1	GND
2	SATA_TX+
3	SATA_TX-
4	GND
5	SATA_RX-
6	SATA_RX+
7	GND

Table 7-18: SATA 6Gb/s Connectors (S_ATA1/S_ATA2) Pinouts

7.2.18 SATA Power Connectors (SATA_PWR1/SATA_PWR2)

PIN NO.	DESCRIPTION
1	+V12S
2	GND
3	GND
4	+V5S

Table 7-19: SATA Power Connectors (SATA_PWR1/SATA_PWR2) Pinouts

7.2.19 SMBus Connector (CN1)

PIN NO.	DESCRIPTION
1	GND
2	SMB_DATA
3	SMB_CLK
4	+5V

Table 7-20: SMBus Connector (CN1) Pinouts

7.2.20 SPI Flash Connector (JSPI1)

PIN NO.	DESCRIPTION
1	+V3.3M_SPI_CON
2	SPI_CS
3	SPI_SO_SW
4	SPI_CLK_SW
5	SPI_SI_SW
6	GND

Table 7-21: SPI Flash Connector (JSPI1) Pinouts

7.2.21 SPI Flash (EC) Connector (JSPI2)

PIN NO.	DESCRIPTION
1	+V3.3M_SPI_CON_EC
2	SPI_CS#0_CN_EC
3	SPI_SO_SW_EC
4	SPI_CLK_SW_EC
5	SPI_SI_SW_EC
6	GND

Table 7-22: SPI Flash (EC) Connector (JSPI2) Pinouts

7.2.22 U3 Firmware Programming Connector (JP1)

PIN NO.	DESCRIPTION
1	MCLR
2	VCC5_MCU
3	GND
4	ICSPCLK
5	ICSPDAT
6	GND
7	MCU_IR
8	AUTO_CLK
9	AUTO_DATA

Table 7-23: U3 Firmware Programming Connector (JP1) Pinouts

7.2.23 USB 2.0 Connector (USB1)

PIN NO.	DESCRIPTION	PIN NO.	DESCRIPTION
1	VCC	2	NC
3	USB_DATA-	4	NC
5	USB_DATA+	6	NC
7	GND	8	NC

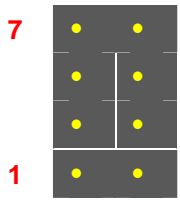

Table 7-24: USB 2.0 Connector (USB1) Pinouts

7.3 External Interface Panel Connectors

The table below lists the rear panel connectors on the PPC-FxxA-H81 motherboard. Pinouts of these connectors can be found in the following sections.

Connector	Type	Label
ATX/AT mode switch	Switch	J_ATX_AT1
Audio connector (line-out and mic-in)	Audio jack	AUDIO1
Clear CMOS button	Push button	J_CMOS1
HDMI connector	HDMI	HDMI1
RJ-45 GbE and USB 2.0 connectors	RJ-45, USB 2.0 port	LAN2_USB2
RJ-45 GbE and USB 3.0 connectors	RJ-45, USB 3.0 port	LAN1_USB1
Reset button	Push button	RESET1
RS-232 serial ports	DB-9	COM1/COM2, COM3/COM4
RS-422/485 serial port and VGA connector	DB-9, 15-pin female	COM5/VGA1
USB 2.0 connectors	USB 2.0 port	USB_CON1

Table 7-25: Rear Panel Connectors

7.3.1 HDMI Connector (HDMI1)

PIN NO.	DESCRIPTION	PIN NO.	DESCRIPTION
1	HDMI_DATA2+	11	GND
2	GND	12	HDMI_CLK#
3	HDMI_DATA2#-	13	N/C
4	HDMI_DATA1+	14	N/C
5	GND	15	HDMI_SCL
6	HDMI_DATA1#-	16	HDMI_SDA
7	HDMI_DATA0+	17	GND
8	GND	18	+5VCC

PIN NO.	DESCRIPTION	PIN NO.	DESCRIPTION
9	HDMI_DATA0#-	19	HDMI_HPD
10	HDMI_CLK+		

Table 7-26: HDMI Connector (HDMI1) Pinouts

7.3.2 RS-232 Serial Ports (COM1/COM2, COM3/COM4)

PIN NO.	DESCRIPTION	PIN NO.	DESCRIPTION
1	DCD	2	RXD
3	TXD	4	DTR
5	GND	6	DSR
7	RTS	8	CTS
9	RI		

Table 7-27: RS-232 Serial Port Pinouts

7.3.3 USB 2.0 Connectors (USB_CON1)

PIN NO.	DESCRIPTION
1	VCC
2	DATA-
3	DATA+
4	GND

Table 7-28: USB 2.0 Connector (USB_CON1) Pinouts

7.3.4 RJ-45 GbE and USB 2.0 Connectors (LAN2_USB2)

PIN NO.	DESCRIPTION	PIN NO.	DESCRIPTION
1	TRD2P0	5	TRD2P2
2	TRD2N0	6	TRD2N2
3	TRD2P1	7	TRD2P3
4	TRD2N1	8	TRD2N3

Table 7-29: RJ-45 GbE Connector (LAN2_USB2) Pinouts

PPC-FxxA-H81 Panel PC

PIN NO.	DESCRIPTION	PIN NO.	DESCRIPTION
1	VCC	5	VCC
2	USB_DATA-	6	USB_DATA-
3	USB_DATA+	7	USB_DATA+
4	GND	8	GND

Table 7-30: USB 2.0 Connector (LAN2_USB2) Pinouts

7.3.5 RJ-45 GbE and USB 3.0 Connectors (LAN1_USB1)

PIN NO.	DESCRIPTION	PIN NO.	DESCRIPTION
1	LAN1_MDI0P	5	LAN1_MDI2P
2	LAN1_MDI0N	6	LAN1_MDI2N
3	LAN1_MDI1P	7	LAN1_MDI3P
4	LAN1_MDI1N	8	LAN1_MDI3N

Table 7-31: RJ-45 GbE Connector (LAN1_USB1) Pinouts

PIN NO.	DESCRIPTION	PIN NO.	DESCRIPTION
1	VCC	10	VCC
2	USB_DATA-	11	USB_DATA-
3	USB_DATA+	12	USB_DATA+
4	GND	13	GND
5	USB3_RX-	14	USB3_RX-
6	USB3_RX+	15	USB3_RX+
7	GND	16	GND
8	USB3_TX-	17	USB3_TX-
9	USB3_TX+	18	USB3_TX+

Table 7-32: USB 3.0 Connector (LAN1_USB1) Pinouts

7.3.6 RS-422/485 Serial Port and VGA Connector (COM5/VGA1)

PIN NO.	DESCRIPTION
1	RS422_TX- (RS485_D-)
2	RS422_TX+ (RS485_D+)
3	RS422_RX+
4	RS422_RX-
5	
6	
7	
8	
9	

Table 7-33: RS-422/485 Serial Port (COM5) Pinouts

PIN NO.	DESCRIPTION	PIN NO.	DESCRIPTION
1	RED	9	VCC
2	GREEN	10	GROUND
3	BLUE	11	NC
4	NC	12	DDCDA
5	GROUND	13	HSYNC
6	GROUND	14	VSYNC
7	GROUND	15	DDCCLK
8	GROUND		

Table 7-34: VGA Connector (VGA1) Pinouts

7.4 Preconfigured Jumpers

The following jumpers are preconfigured for the PPC-FxxA-H81. Users should not change these jumpers (Table 7-35). It is only for reference.

Jumper Name	Label	Type
Flash descriptor security override	J_FLASH1	3-pin header
LVDS panel resolution selection	SW1	DIP switch

PPC-FxxA-H81 Panel PC

Jumper Name	Label	Type
Panel voltage selection	JLCD_PWR1	6-pin header
Touchscreen selection	JTOUCH1	4-pin header

Table 7-35: Preconfigured Jumpers

7.4.1 Flash Descriptor Security Override Jumper (J_FLASH1)

Pin	Description
Short 2-3	Enabled

Table 7-36: Flash Descriptor Security Override Jumper (J_FLASH1) Settings

7.4.2 LVDS Panel Resolution Selection Switch (JLCD_SET1)

* ON=0, OFF=1; Single=S, Dual=D

SW1 (4-3-2-1)	Description
0000	800x600 18-bit S (default)
0001	1024x768 18-bit S
0010	1024x768 24-bit S
0011	1280x768 18-bit S
0100	1280x800 18-bit S
0101	1280x960 18-bit S
0110	1280x1024 24-bit D
0111	1366x768 18-bit S
1000	1366x768 24-bit S
1001	1440x960 24-bit D
1010	1400x1050 24-bit D
1011	1600x900 24-bit D
1100	1680x1050 24-bit D
1101	1600x1200 24-bit D
1110	1920x1080 24-bit D
1111	1920x1200 24-bit D

Table 7-37: LVDS Panel Resolution Selection

7.4.3 Panel Voltage Selection Jumper (JLCD_PWR1)

Pin	Description
Short 1-2	+3.3V (Default)
Short 3-4	+5V
Short 5-6	+12V

Table 7-38: Panel Voltage Selection Jumper (JLCD_PWR1) Settings

7.4.4 Touchscreen Selection Jumper (JTOUCH1)

Type	Pin 1-2	Pin 3-4
5-Wire (Default)	Short	Open
4-Wire and 8-Wire	Open	Short

Table 7-39: Touchscreen Selection Jumper (JTOUCH1) Settings

Appendix

A

Regulatory Compliance

DECLARATION OF CONFORMITY

This equipment is in conformity with the following EU directives:

- EMC Directive (2004/108/EC, 2014/30/EU)
- Low-Voltage Directive (2006/95/EC, 2014/35/EU)
- RoHS II Directive (2011/65/EU, 2015/863/EU)

If the user modifies and/or install other devices in the equipment, the CE conformity declaration may no longer apply.

If this equipment has telecommunications functionality, it also complies with the requirements of the Radio Equipment Directive 2014/53/EU.

English

IEI Integration Corp declares that this equipment is in compliance with the essential requirements and other relevant provisions of Directive 2014/53/EU.

Български [Bulgarian]

IEI Integration Corp. декларира, че този оборудване е в съответствие със съществените изисквания и другите приложими правила на Директива 2014/53/EU.

Česky [Czech]

IEI Integration Corp tímto prohlašuje, že tento zařzení je ve shodě se základními požadavky a dalšími příslušnými ustanoveními směrnice 2014/53/EU.

Dansk [Danish]

IEI Integration Corp erklærer herved, at følgende udstyr overholder de væsentlige krav og øvrige relevante krav i direktiv 2014/53/EU.

Deutsch [German]

IEI Integration Corp, erklärt dieses Gerät entspricht den grundlegenden Anforderungen und den weiteren entsprechenden Vorgaben der Richtlinie 2014/53/EU.

Eesti [Estonian]

IEI Integration Corp deklareerib seadme seadme vastavust direktiivi 2014/53/EÜ põhinõuetele ja nimetatud direktiivist tulenevatele teistele asjakohastele sätetele.

PPC-FxxA-H81 Panel PC

Español [Spanish]

IEI Integration Corp declara que el equipo cumple con los requisitos esenciales y cualesquiera otras disposiciones aplicables o exigibles de la Directiva 2014/53/EU.

Ελληνική [Greek]

IEI Integration Corp ΔΗΛΩΝΕΙ ΟΤΙ ΕΞΟΠΛΙΣΜΟΣ ΣΥΜΜΟΡΦΩΝΕΤΑΙ ΠΡΟΣ ΤΙΣ ΟΥΣΙΩΔΕΙΣ ΑΠΑΙΤΗΣΕΙΣ ΚΑΙ ΤΙΣ ΛΟΙΠΕΣ ΣΧΕΤΙΚΕΣ ΔΙΑΤΑΞΕΙΣ ΤΗΣ ΟΔΗΓΙΑΣ 2014/53/EU.

Français [French]

IEI Integration Corp déclare que l'appareil est conforme aux exigences essentielles et aux autres dispositions pertinentes de la directive 2014/53/EU.

Italiano [Italian]

IEI Integration Corp dichiara che questo apparecchio è conforme ai requisiti essenziali ed alle altre disposizioni pertinenti stabilite dalla direttiva 2014/53/EU.

Latviski [Latvian]

IEI Integration Corp deklarē, ka iekārta atbilst būtiskajām prasībām un citiem ar to saistītajiem noteikumiem Direktīvas 2014/53/EU.

Lietuvių [Lithuanian]

IEI Integration Corp deklaruoja, kad šis įranga atitinka esminius reikalavimus ir kitas 2014/53/EU Direktyvos nuostatas.

Nederlands [Dutch]

IEI Integration Corp dat het toestel toestel in overeenstemming is met de essentiële eisen en de andere relevante bepalingen van richtlijn 2014/53/EU.

Malti [Maltese]

IEI Integration Corp jiddikjara li dan prodott jikkonforma mal-ħtiġijiet essenzjali u ma provvedimenti oħrajn relevanti li hemm fid-Dirrettiva 2014/53/EU.

Magyar [Hungarian]

IEI Integration Corp nyilatkozom, hogy a berendezés megfelel a vonatkozó alapvető követelményeknek és az 2014/53/EU irányelv egyéb előírásainak.

Polski [Polish]

IEI Integration Corp oświadcza, że wyrobu jest zgodny z zasadniczymi wymogami oraz pozostałymi stosownymi postanowieniami Dyrektywy 2014/53/EU.

Português [Portuguese]

IEI Integration Corp declara que este equipamento está conforme com os requisitos essenciais e outras disposições da Directiva 2014/53/EU.

Româna [Romanian]

IEI Integration Corp declară că acest echipament este în conformitate cu cerințele esențiale și cu celelalte prevederi relevante ale Directivei 2014/53/EU.

Slovensko [Slovenian]

IEI Integration Corp izjavlja, da je ta opreme v skladu z bistvenimi zahtevami in ostalimi relevantnimi določili direktive 2014/53/EU.

Slovensky [Slovak]

IEI Integration Corp týmto vyhlasuje, že zariadenia spĺňa základné požiadavky a všetky príslušné ustanovenia Smernice 2014/53/EU.

Suomi [Finnish]

IEI Integration Corp vakuuttaa täten että laitteet on direktiivin 2014/53/EU oleellisten vaatimusten ja sitä koskevien direktiivin muiden ehtojen mukainen.

Svenska [Swedish]

IEI Integration Corp förklarar att denna utrustningstyp står i överensstämmelse med de väsentliga egenskapskrav och övriga relevanta bestämmelser som framgår av direktiv 2014/53/EU.

Appendix

B

BIOS Configuration Options

B.1 BIOS Configuration Options

Below is a list of BIOS configuration options described in **Chapter 5**.

System Date [xx/xx/xx]	71
System Time [xx:xx:xx]	71
ACPI Sleep State [S1 only (CPU Stop Clock)]	73
Wake system with Fixed Time [Disabled]	74
Active Processor Cores [All]	76
Intel Virtualization Technology [Disabled]	76
EIST [Enabled]	77
SATA Controller(s) [Enabled]	77
SATA Mode Selection [IDE]	78
USB Devices	78
Legacy USB Support [Enabled]	78
Serial Port [Enabled]	80
Change Settings [Auto]	80
Serial Port [Enabled]	81
Change Settings [Auto]	81
Serial Port [Enabled]	82
Change Settings [Auto]	82
Serial Port [Enabled]	82
Change Settings [Auto]	83
Serial Port [Enabled]	83
Change Settings [Auto]	83
Device Mode [Normal]	84
PC Health Status	85
Console Redirection [Disabled]	86
Terminal Type [ANSI]	87
Bits per second [115200]	87
Data Bits [8]	88
Parity [None]	88
Stop Bits [1]	88
Auto Recovery Function [Disabled]	89
Restore AC Power Loss [Last State]	91

PPC-FxxA-H81 Panel PC

Power Saving Function(ERP) [Disabled].....	91
USB SW1 Power [+5V DUAL].....	92
USB SW2 Power [+5V DUAL].....	92
PCIe Speed [Auto].....	94
Detect Non-Compliance Device [Disbled]	94
Azalia (HD Audio) [Enabled]	95
VT-d [Disabled].....	96
Primary Display [Auto]	97
DVMT Pre-Allocated [256M]	97
DVMT Total Gfx Mem [MAX].....	98
Primary IGFX Boot Display [VBIOS Default]	99
Bootup NumLock State [On].....	100
Quiet Boot [Enabled]	101
Option ROM Messages [Force BIOS].....	101
Launch PXE OpROM [Disabled]	101
UEFI Boot [Disabled]	101
Administrator Password	102
User Password	102
Save Changes and Reset	103
Discard Changes and Reset	103
Restore Defaults	103
Save as User Defaults	103
Restore User Defaults	103

Appendix

C

Safety Precautions

**WARNING:**

The precautions outlined in this chapter should be strictly followed. Failure to follow these precautions may result in permanent damage to the EP series.

C.1 Safety Precautions

Please follow the safety precautions outlined in the sections that follow:

C.1.1 General Safety Precautions

Please ensure the following safety precautions are adhered to at all times.

- **Follow the electrostatic precautions** outlined below whenever the EP series is opened.
- **Make sure the power is turned off and the power cord is disconnected** whenever the EP series is being installed, moved or modified.
- **Do not apply voltage levels that exceed the specified voltage range.** Doing so may cause fire and/or an electrical shock.
- **Electric shocks can occur** if the EP series chassis is opened when the EP series is running.
- **Do not drop or insert any objects** into the ventilation openings of the EP series.
- **If considerable amounts of dust, water, or fluids enter the EP series**, turn off the power supply immediately, unplug the power cord, and contact the EP series vendor.
- **DO NOT:**
 - Drop the EP series against a hard surface.
 - Strike or exert excessive force onto the LCD panel.
 - Touch any of the LCD panels with a sharp object
 - In a site where the ambient temperature exceeds the rated temperature

C.1.2 Anti-static Precautions



WARNING:

Failure to take ESD precautions during the installation of the EP series may result in permanent damage to the EP series and severe injury to the user.

Electrostatic discharge (ESD) can cause serious damage to electronic components, including the EP series. Dry climates are especially susceptible to ESD. It is therefore critical that whenever the EP series is opened and any of the electrical components are handled, the following anti-static precautions are strictly adhered to.

- ***Wear an anti-static wristband:*** Wearing a simple anti-static wristband can help to prevent ESD from damaging any electrical component.
- ***Self-grounding:*** Before handling any electrical component, touch any grounded conducting material. During the time the electrical component is handled, frequently touch any conducting materials that are connected to the ground.
- ***Use an anti-static pad:*** When configuring or working with an electrical component, place it on an anti-static pad. This reduces the possibility of ESD damage.
- ***Only handle the edges of the electrical component:*** When handling the electrical component, hold the electrical component by its edges.

C.1.3 Product Disposal



CAUTION:

Risk of explosion if battery is replaced by an incorrect type. Only certified engineers should replace the on-board battery.

Dispose of used batteries according to instructions and local regulations.

PPC-FxxA-H81 Panel PC

- Outside the European Union - If you wish to dispose of used electrical and electronic products outside the European Union, please contact your local authority so as to comply with the correct disposal method.
- Within the European Union:

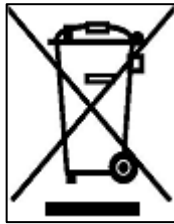

EU-wide legislation, as implemented in each Member State, requires that waste electrical and electronic products carrying the mark (left) must be disposed of separately from normal household waste. This includes monitors and electrical accessories, such as signal cables or power cords.

When you need to dispose of your display products, please follow the guidance of your local authority, or ask the shop where you purchased the product. The mark on electrical and electronic products only applies to the current European Union Member States.

Please follow the national guidelines for electrical and electronic product disposal.

C.2 Maintenance and Cleaning Precautions

When maintaining or cleaning the EP series, please follow the guidelines below.

C.2.1 Maintenance and Cleaning

Prior to cleaning any part or component of the EP series, please read the details below.

- Except for the LCD panel, never spray or squirt liquids directly onto any other components. To clean the LCD panel, gently wipe it with a piece of soft dry cloth or a slightly moistened cloth.
- The interior of the EP series does not require cleaning. Keep fluids away from the EP series interior.
- Be cautious of all small removable components when vacuuming the EP series.
- Turn the EP series off before cleaning the EP series.
- Never drop any objects or liquids through the openings of the EP series.
- Be cautious of any possible allergic reactions to solvents or chemicals used when cleaning the EP series.
- Avoid eating, drinking and smoking within vicinity of the EP series.

C.2.2 Cleaning Tools

Some components in the EP series may only be cleaned using a product specifically designed for the purpose. In such case, the product will be explicitly mentioned in the cleaning tips. Below is a list of items to use when cleaning the EP series.

- **Cloth** – Although paper towels or tissues can be used, a soft, clean piece of cloth is recommended when cleaning the EP series.
- **Water or rubbing alcohol** – A cloth moistened with water or rubbing alcohol can be used to clean the EP series.
- **Using solvents** – The use of solvents is not recommended when cleaning the EP series as they may damage the plastic parts.
- **Vacuum cleaner** – Using a vacuum specifically designed for computers is one of the best methods of cleaning the EP series. Dust and dirt can restrict the airflow in the EP series and cause its circuitry to corrode.
- **Cotton swabs** - Cotton swaps moistened with rubbing alcohol or water are excellent tools for wiping hard to reach areas.
- **Foam swabs** - Whenever possible, it is best to use lint free swabs such as foam swabs for cleaning.

Appendix

D

Watchdog Timer



NOTE:

The following discussion applies to DOS environment. IEI support is contacted or the IEI website visited for specific drivers for more sophisticated operating systems, e.g., Windows and Linux.

The Watchdog Timer is provided to ensure that standalone systems can always recover from catastrophic conditions that cause the CPU to crash. This condition may have occurred by external EMI or a software bug. When the CPU stops working correctly, Watchdog Timer either performs a hardware reset (cold boot) or a Non-Maskable Interrupt (NMI) to bring the system back to a known state.

A BIOS function call (INT 15H) is used to control the Watchdog Timer:

INT 15H:

AH – 6FH Sub-function:	
AL – 2:	Sets the Watchdog Timer's period.
BL:	Time-out value (Its unit-second is dependent on the item "Watchdog Timer unit select" in CMOS setup).

Table D-1: AH-6FH Sub-function

Call sub-function 2 to set the time-out period of Watchdog Timer first. If the time-out value is not zero, the Watchdog Timer starts counting down. While the timer value reaches zero, the system resets. To ensure that this reset condition does not occur, calling sub-function 2 must periodically refresh the Watchdog Timer. However, the Watchdog timer is disabled if the time-out value is set to zero.

A tolerance of at least 10% must be maintained to avoid unknown routines within the operating system (DOS), such as disk I/O that can be very time-consuming.

**NOTE:**

When exiting a program it is necessary to disable the Watchdog Timer, otherwise the system resets.

Example program:

```
; INITIAL TIMER PERIOD COUNTER
;
W_LOOP:

    MOV     AX, 6F02H      ;setting the time-out value
    MOV     BX, 05        ;time-out value is 5 seconds
    INT     15H

;
; ADD THE APPLICATION PROGRAM HERE
;

    CMP     EXIT_AP, 1    ;is the application over?
    JNE     W_LOOP       ;No, restart the application

    MOV     AX, 6F02H     ;disable Watchdog Timer
    MOV     BX, 0        ;
    INT     15H

;
; EXIT ;
```

Appendix

E

Hazardous Materials Disclosure

PPC-FxxA-H81 Panel PC

The details provided in this appendix are to ensure that the product is compliant with the Peoples Republic of China (China) RoHS standards. The table below acknowledges the presences of small quantities of certain materials in the product, and is applicable to China RoHS only.

A label will be placed on each product to indicate the estimated “Environmentally Friendly Use Period” (EFUP). This is an estimate of the number of years that these substances would “not leak out or undergo abrupt change.” This product may contain replaceable sub-assemblies/components which have a shorter EFUP such as batteries and lamps. These components will be separately marked.

Please refer to below table.

Part Name	Toxic or Hazardous Substances and Elements					
	Lead (Pb)	Mercury (Hg)	Cadmium (Cd)	Hexavalent Chromium (CR(VI))	Polybrominated Biphenyls (PBB)	Polybrominated Diphenyl Ethers (PBDE)
Housing	O	O	O	O	O	O
Display	O	O	O	O	O	O
Printed Circuit Board	O	O	O	O	O	O
Metal Fasteners	O	O	O	O	O	O
Cable Assembly	O	O	O	O	O	O
Fan Assembly	O	O	O	O	O	O
Power Supply Assemblies	O	O	O	O	O	O
Battery	O	O	O	O	O	O
<p>O: This toxic or hazardous substance is contained in all of the homogeneous materials for the part is below the limit requirement in SJ/T11363-2006 (now replaced by GB/T 26572-2011).</p> <p>X: This toxic or hazardous substance is contained in at least one of the homogeneous materials for this part is above the limit requirement in SJ/T11363-2006 (now replaced by GB/T 26572-2011).</p>						

此附件旨在确保本产品符合中国 RoHS 标准。以下表格标示此产品中某有毒物质的含量符合中国 RoHS 标准规定的限量要求。

本产品上会附有“环境友好使用期限”的标签，此期限是估算这些物质“不会有泄漏或突变”的年限。本产品可能包含有较短的环境友好使用期限的可替换元件，像是电池或灯管，这些元件将会单独标示出来。

部件名称	有毒有害物质或元素					
	铅 (Pb)	汞 (Hg)	镉 (Cd)	六价铬 (CR(VI))	多溴联苯 (PBB)	多溴二苯醚 (PBDE)
壳体	○	○	○	○	○	○
显示	○	○	○	○	○	○
印刷电路板	○	○	○	○	○	○
金属螺帽	○	○	○	○	○	○
电缆组装	○	○	○	○	○	○
风扇组装	○	○	○	○	○	○
电力供应组装	○	○	○	○	○	○
电池	○	○	○	○	○	○
<p>○: 表示该有毒有害物质在该部件所有物质材料中的含量均在 SJ/T11363-2006 (现由 GB/T 26572-2011 取代)标准规定的限量要求以下。</p> <p>X: 表示该有毒有害物质至少在该部件的某一均质材料中的含量超出 SJ/T11363-2006 (现由 GB/T 26572-2011 取代) 标准规定的限量要求。</p>						