

QBiX-TGLA1135G7-A1/ QBiX-TGLA1115G4E-A1

QBiX Industrial Embedded System
Quick Start Guide

Copyright Notice

This document is copyrighted, 2022. All rights are reserved. The original manufacturer reserves the right to make improvements to the products described in this manual at any time without notice.

No part of this manual may be reproduced, copied, translated, or transmitted in any form or by any means without the prior written permission of the original manufacturer. Information provided in this manual is intended to be accurate and reliable. However, the original manufacturer assumes no responsibility for its use, or for any infringements upon the rights of third parties that may result from its use.

The material in this document is for product information only and is subject to change without notice. While reasonable efforts have been made in the preparation of this document to assure its accuracy, GIGAIPC assumes no liabilities resulting from errors or omissions in this document, or from the use of the information contained herein.

GIGAIPC reserves the right to make changes in the product design without notice to its users.

Acknowledgement

All other products' name or trademarks are properties of their respective owners.

- AMD is trademark of Advanced Micro Devices.
- Microsoft Windows is a registered trademark of Microsoft Corp.
- Intel, Pentium, Celeron, and Xeon are registered trademarks of Intel Corporation
- Core, Atom are trademarks of Intel Corporation
- ITE is a trademark of Integrated Technology Express, Inc.
- IBM, PC/AT, PS/2, and VGA are trademarks of International Business Machines Corporation.

All other product names or trademarks are properties of their respective owners.

Packing List

Before setting up your product, please make sure the following items have been shipped:

Item	Quantity
System kit	1
19.5V / 135W adapter	1
Power cord (May vary based on local distribution)	1
Wall Mount Bracket	2

If any of these items are missing or damaged, please contact your distributor or sales representative immediately.

About this Document

This User's Manual contains all the essential information, such as detailed descriptions and explanations on the product's hardware and software features (if any), its specifications, dimensions, jumper/connector settings/definitions, and driver installation instructions (if any), to facilitate users in setting up their product.

Users may refer to the GIGAIPC.com for the latest version of this document.

Safety Precautions

Please read the following safety instructions carefully. It is advised that you keep this manual for future references

1. All cautions and warnings on the device should be noted.
2. Make sure the power source matches the power rating of the device.
3. Position the power cord so that people cannot step on it. Do not place anything over the power cord.
4. Always completely disconnect the power before working on the system's hardware.
5. No connections should be made when the system is powered as a sudden rush of power may damage sensitive electronic components.
6. If the device is not to be used for a long time, disconnect it from the power supply to avoid damage by transient over-voltage.
7. Always disconnect this device from any AC supply before cleaning.
8. While cleaning, use a damp cloth instead of liquid or spray detergents.
9. Make sure the device is installed near a power outlet and is easily accessible.
10. Keep this device away from humidity.
11. Place the device on a solid surface during installation to prevent falls
12. Do not cover the openings on the device to ensure optimal heat dissipation.

13. Watch out for high temperatures when the system is running.
14. Do not touch the heat sink or heat spreader when the system is running
15. Never pour any liquid into the openings. This could cause fire or electric shock.
16. As most electronic components are sensitive to static electrical charge, be sure to ground yourself to prevent static charge when installing the internal components. Use a grounding wrist strap and contain all electronic components in any static-shielded containers.
17. If any of the following situations arises, please the contact our service personnel:
 - i. Damaged power cord or plug
 - ii. Liquid intrusion to the device
 - iii. Exposure to moisture
 - iv. Device is not working as expected or in a manner as described in this manual
 - v. The device is dropped or damaged
 - vi. Any obvious signs of damage displayed on the device
18. This product requires connection to protective earth by means of powercord(s) connected to socket-outlet(s) with protective earthing connection .
- 19. DO NOT LEAVE THIS DEVICE IN AN UNCONTROLLED ENVIRONMENT WITH TEMPERATURES BEYOND THE DEVICE'S PERMITTED STORAGE TEMPERATURES (SEE CHAPTER 1) TO PREVENT DAMAGE.**

FCC Statement

Warning!



This device complies with Part 15 FCC Rules. Operation is subject to the following two conditions: (1) this device may not cause harmful interference, and (2) this device must accept any interference received including interference that may cause undesired operation.

Caution:

There is a danger of explosion if the battery is incorrectly replaced. Replace only with the same or equivalent type recommended by the manufacturer. Dispose of used batteries according to the manufacturer's instructions and your local government's recycling or disposal directives.

Attention:

Il y a un risque d'explosion si la batterie est remplacée de façon incorrecte. Ne la remplacer qu'avec le même modèle ou équivalent recommandé par le constructeur. Recycler les batteries usées en accord avec les instructions du fabricant et les directives gouvernementales de recyclage.

High Temperature Warning

(1) This equipment is intended to be used in Restrict Access Location. The access can only be gained by Skilled person or by Instructed person who have been instructed about the metal chassis of the equipment is so hot that Skilled person have to pay special attention or take special protection.



Only authorized by well trained professional person can access the restrict access location.

(2) External metal parts are hot!! Before touching it, special attention or protection is necessary

Table Contents

QBiX Industrial Embedded System Quick Start Guide	1
Copyright Notice	2
Acknowledgement	3
Packing List.....	4
About this Document	5
Safety Precautions	6
FCC Statement.....	8
High Temperature Warning	8
Chapter 1 - Product Specifications	12
1.1 Specifications	14
Chapter 2 – QBiX Industrial Embedded System Kit	16
2.1 Dimension	17
2.2 Getting Familiar with Your Unit.....	18
2.3 A) Wireless Module : How to safely install the Module (Wireless Module inclusion may vary based on local distribution)	20
2.4 B) Memory Installation: DDR4 SO-DIMM	21
2.5 Antenna Installation (Antenna inclusion may vary based on local distribution)	22
2.6 Wall mount bracket Installation.....	23
2.7 RAL	24
2.8 Support	25
2.9 Safety and Regulatory Information.....	26

Chapter 3 – Hardware Information 27

3.1	Jumpers and Connectors	28
3.2.1	ATX_IN (ATX IN Connector)	31
3.2.2	BATTERY (Battery connector)	32
3.2.3	M2E (E-key, Supports NGFF-2230 (WiFi/BT) Slot).....	33
3.2.4	M2M (M-key, Supports NGFF-2280 (PCIe x4, SATA 6Gb/s)	34
3.2.5	F_USB2 (USB 2.0 header)	35
3.2.6	F_PANEL (Front panel Connector).....	36
3.2.7	ME (ME Enable jumper)	37
3.2.8	TPM (TPM header).....	38
3.2.9	FP_AUDIO (Front panel audio header).....	39
3.2.10	SODIMM1, SODIMM2 (DDR4 SO-DIMM Slot).....	40
3.2.11	CPU FAN (CPU FAN connector)	41
3.2.12	COM1 (Serial port connector, RS-232/422/485).....	42
3.2.13	USB31_2 (USB 3.2 Gen 2x1 Port).....	43
3.2.14	DC_IN (Screw type DC Jack connector)	44
3.2.15	USB31_1 (USB 3.2 Gen 2x1 connector)	45
3.2.16	HDMI_21 (HDMI connector).....	46
3.2.17	LAN1, LAN2 (GbE LAN port connector)	47

Chapter 4 – BIOS 48

4.1	Introduction	49
4.2	The Main Menu.....	50
4.3	Advanced	51
4.3.1	TPM Configuration.....	52

4.3.2	SATA And RST Configuration.....	54
4.3.3	CPU Configuration	55
4.3.4	Super IO Configuration	56
4.3.5	Hardware Monitor	57
4.3.6	S5 RTC Wake Settings	58
4.3.7	Network Stack Configuration.....	59
4.3.8	NVMe Configuration	60
4.3.9	Offboard SATA Controller Configuration	61
4.4	Chipset	62
4.5	Security	63
4.6	Boot.....	66
4.7	Save & Exit	67

Chapter 1

Chapter 1 - Product Specifications

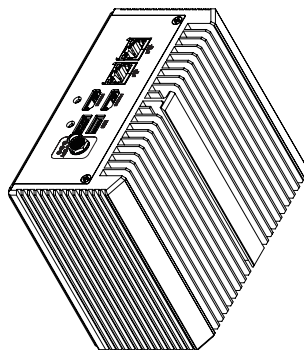
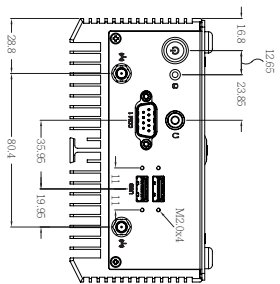
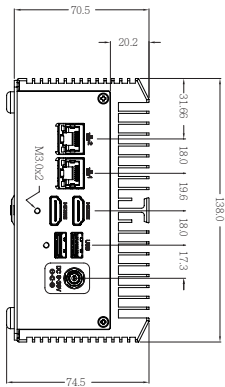
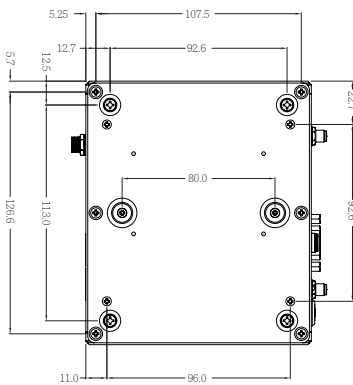
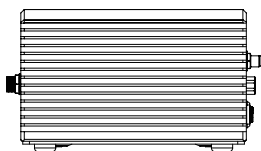
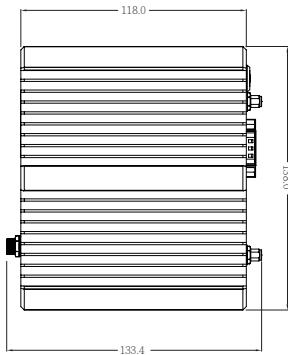
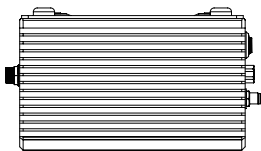

1.1 Specifications

	QBiX-TGLA1135G7-A1 (QB-1135A)	QBiX-TGLA1115G4E-A1 (QB-1115A)
Dimension	System Size : 138W x 118D x 74.2H (mm)	
CPU	Intel® Core™ i5-1135G7 Processor 10nm SuperFin, 4 cores, 8 threads, up to 4.2 GHz	Intel® Core™ i3-1115G4E Processor 10nm SuperFin, 2 cores, 4 threads, up to 3.90 GHz
Chipset	SoC	
Memory	2 x DDR4 SO-DIMM socket, Max. Capacity 64 GB Support Dual Channel DDR4 3200 MHz memory modules	
Ethernet	1 x GbE LAN Port (Intel® I219V) 1 x GbE LAN Port (Realtek® RTL8111HS)	
Graphic support	Integrated Graphics Processor - Intel® Iris® X ^e Graphics: 2 x HDMI 2.0 ports, supporting a maximum resolution of 4096x2160 @60Hz (2 independent display outputs)	
Audio	Realtek® Audio Codec	
Storage	—	
Expansion Slots	1 x 2280 M.2 M-Key (PCIe x4, SATA 6Gb/s) 1 x 2230 M.2 E-Key (WiFi/BT)	
Front I/O	2 x USB 3.2 Gen 2x1 1 x Power button with LED 2 x External Antenna Holes (Optional) 1 x HDD LED 1 x COM Port (RS-232/422/845) 1 x Headphone Jack	
Rear I/O	2 x HDMI 2 x RJ45 LAN Ports 2 x USB 3.2 Gen 2x1 1 x Screw type DC Jack	
Side I/O	—	
Power	+9V~48VDC (Adapter 19.5V/135W)	

	QBiX-TGLA1135G7-A1 (QB-1135A)	QBiX-TGLA1115G4E-A1 (QB-1115A)
Operation temperature	Operating temperature: 0°C to 50°C Operating humidity: 0-90% (non-condensing) Non-operating temperature:-40°C to 85°C Non-operating humidity: 0%-95% (non-condensing) Use wide temperature range memory and storage	
Vibration During Operation	Operation: IEC 60068-2-64, 3 Grms, random, 5 ~ 500 Hz, 1 hr / Per Axis, With SSD Non-operation: IEC 60068-2-6, 2 G, Sine, 10 ~ 500 Hz, 1 Oct/min, 1 hr / Per Axis	
Shock During Operation	Operation: IEC 60068-2-27, 50 G, half sine, 11 ms duration, With SSD	
Packaging Content	Carton size: 416 x 409 x 296 (mm) Packing Capacity: 6pcs Including: PSU ADP 19.5V 135W 100-240VAC x 1 (P/N: 25EP4-201352-C1S) Power Cord : Optional (by region) Wall Mount Bracket x 2 (P/N: 25HB2-CGAA20-CHR)	
Order Information	System: 6BQB1135AMR-SI	System: 6BQB1115AMR-SI

Chapter 2

Chapter 2 – QBiX Industrial Embedded System Kit

2.1 Dimension

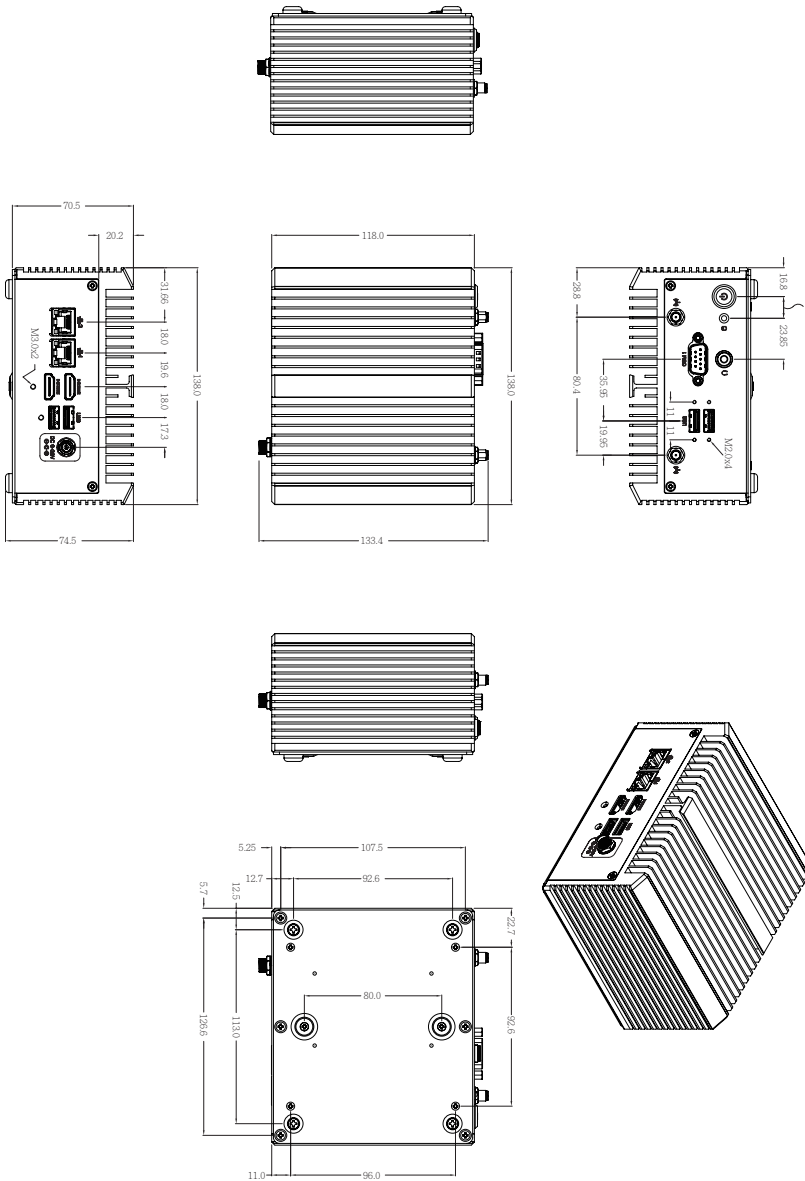

2.2 Getting Familiar with Your Unit

[Front Side]

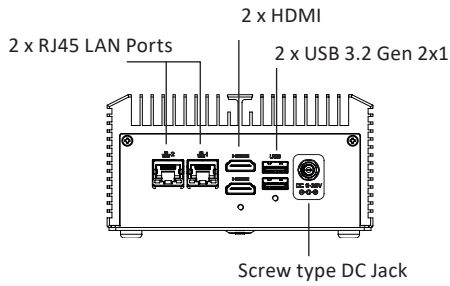

[Left Side]

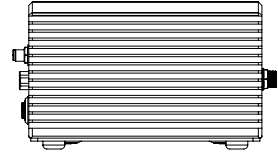

[Rear Side]

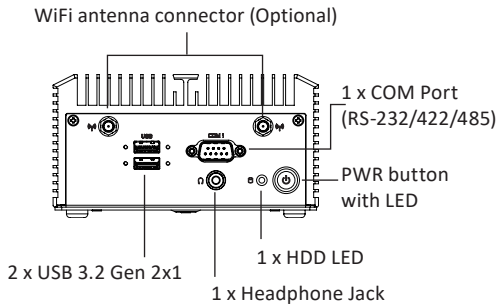

[Right Side]



[Bottom Side]

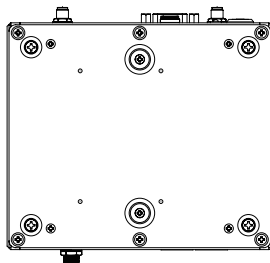

[Install]

- * Before opening the case, make sure to unplug the power cord.
- * 打開機殼前，請確實移除電源。
- * Before Connecting the power, make sure to fasten the case securely.
- * 接上電源前，請確實將機殼完整鎖附。

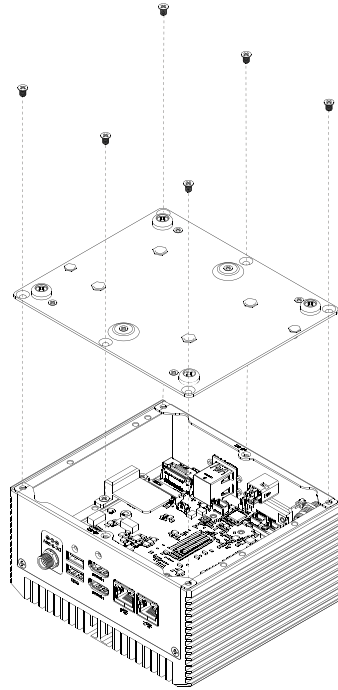

[Bottom PCB Side]

	Information
A	1 x M.2 slot (Support NGFF-2280 SATA/PCIe x4)
B	1 x M.2 slot (Support NGFF-2230 Wifi/BT)
C	2 x DDR4 SO-DIMM socket, Max. Capacity 64 GB

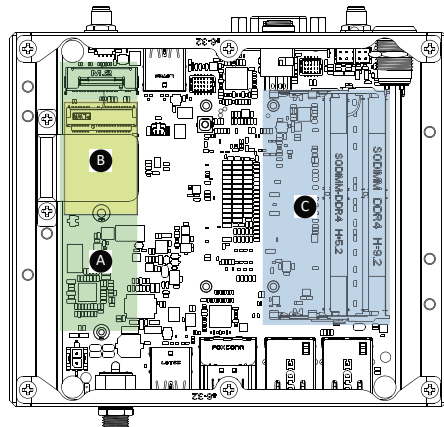

2.3 A) Wireless Module : How to safely install the Module (Wireless Module inclusion may vary based on local distribution)

①

Carefully insert the wireless module into the M.2 slot

小心地將無線模組安裝於M.2插槽中。

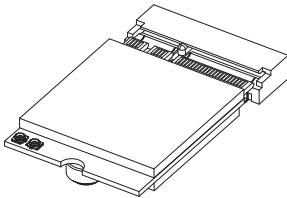

②

Lock the screw in the middle.

鎖入固定於無線模組中央頂端的螺絲。

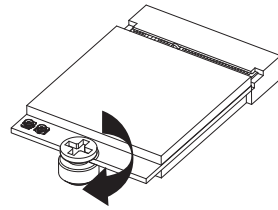

③

Install the antenna on the left side of the connection wireless module down.

向下安裝連結於無線模組左側頂端天線。

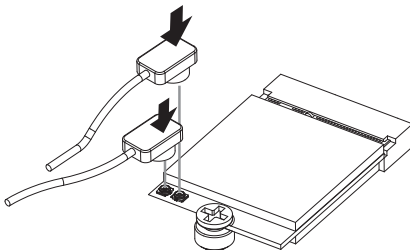

2.4 B) Memory Installation: DDR4 SO-DIMM

1

Carefully insert SO-DIMM memory modules.

小心地由下至上將 SO-DIMM 記憶體安裝於記憶體插槽。

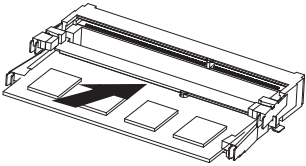

2

Push down until the modules click into place.

當記憶體固定於插槽後，再輕輕下壓至定點。

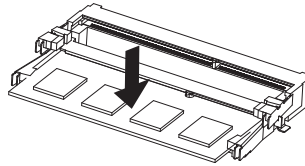

3

Carefully insert SO-DIMM memory modules.

安裝下層記憶體後，重覆前述動作安裝上層記憶體。

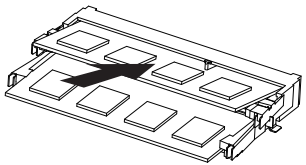

4

Push down until the modules click into place.

當記憶體固定於插槽後，再輕輕下壓至定點。

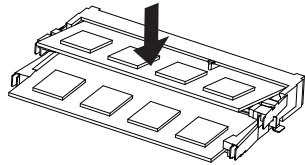

2.5 Antenna Installation (Antenna inclusion may vary based on local distribution)

①

Carefully insert the antennas into the connectors.
小心地將天線插入天線插孔中。

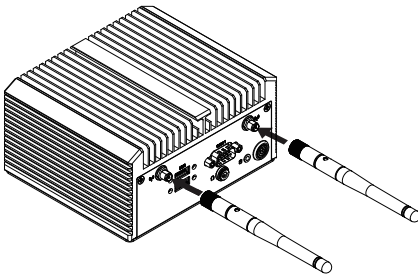

②

Turn the antennas clockwise until they are completely secure on the connectors.

握住天線接頭底端，按順時針方向將天線旋入插孔中牢固固定。

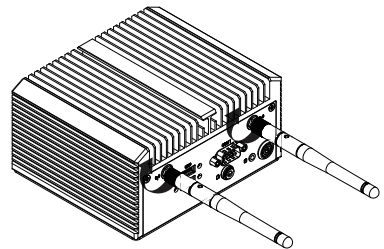

③

Flip up the antenna heads so that they are perpendicular to the machine.

栓緊後請將天線拉起朝上呈垂直狀。

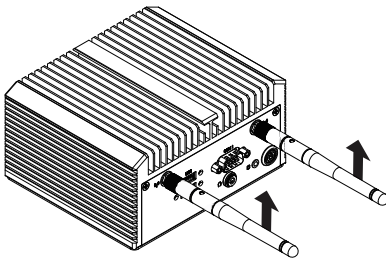

2.6 Wall mount bracket Installation

1

After Remove 4 screws with rubber foot, remove the rubber foot from screw, and keep these 4 screws for assemble afterwards.

拆卸底蓋4顆螺絲與腳墊後，自螺絲上移除腳墊，並保留這4顆螺絲備用。



2

Use 4 screws which removed earlier to assemble wall mount bracket.

使用先前保留的4顆螺絲組裝bracket。



3

Install the system, suggest using 4 x M4x10L type screws to fix on the wall. (not included in the shipment)
suggest screw type : M4x10L pan head with Spring washer + flat washer (3 in 1), P/N : 25983G-1C017-S00

建議使用4顆 M4x10L 螺絲將系統固定於牆上。(出貨不附)
螺絲規格: M4x10L 圓頭螺絲，包含彈簧墊圈 + 墊片 (3合1)
P/N : 25983G-1C017-S00



4

Please make sure the direction of installation.

請務必確認組裝之方向性。



2.7 RAL

This equipment is intended to be used in Restrict Access Location. The access can only be gained by Skilled person.
Only authorized by well trained professional person can access the restrict access location.

2.8 Support

- For a list of tested memory, M.2, 2.5'' SSD, wireless adapters and OS supported, go to: <http://www.gigaipc.com>
- To download the latest drivers and BIOS updates, go to: <http://www.gigaipc.com>
- For product support, go to: <http://www.gigaipc.com>

2.9 Safety and Regulatory Information

Risk of explosion if the battery is replaced with an incorrect type. Batteries should be recycled where possible.

Disposal of used Batteries must be in accordance with local environmental regulations.

Failure to use the included Power Adapter may violate regulatory compliance and may expose the user to safety hazards.

HDMI™
HIGH DEFINITION MULTIMEDIA INTERFACE



At the end of its serviceable life, this product should not be treated as household or general waste. It should be handed over to the applicable collection point for the recycling of electrical and electronic equipment, or returned to the supplier for disposal.

Chapter 3

Chapter 3 – Hardware Information

3.1 Jumpers and Connectors

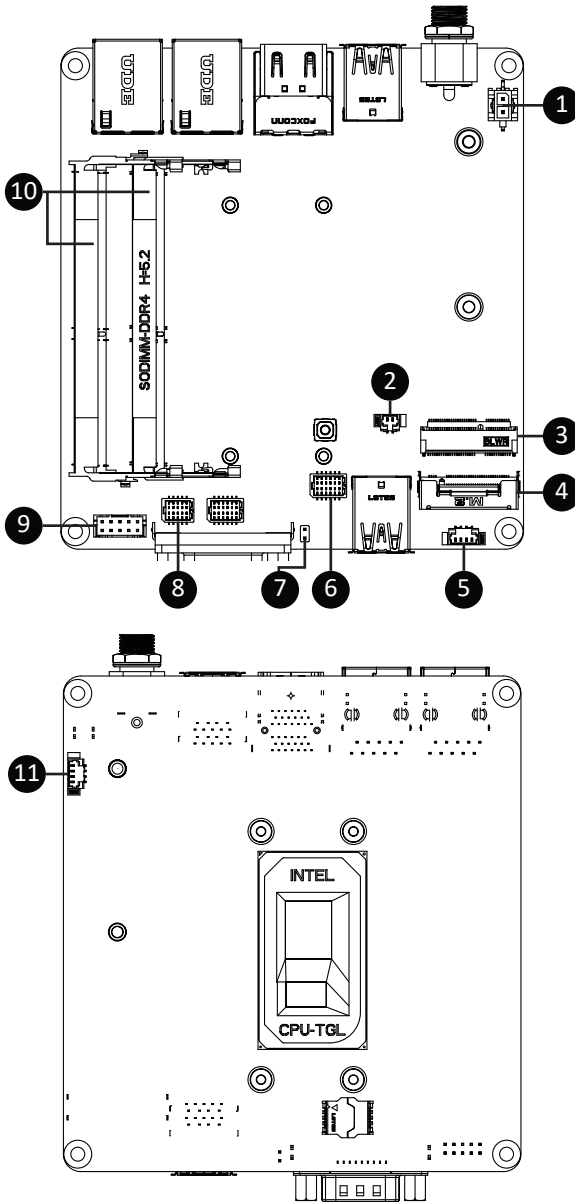

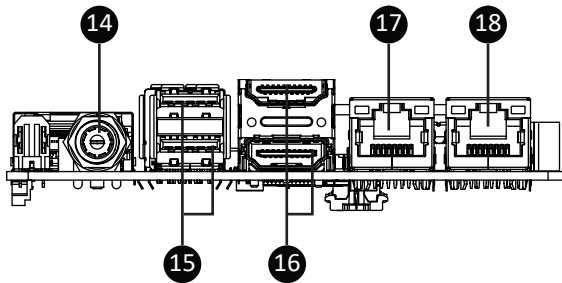
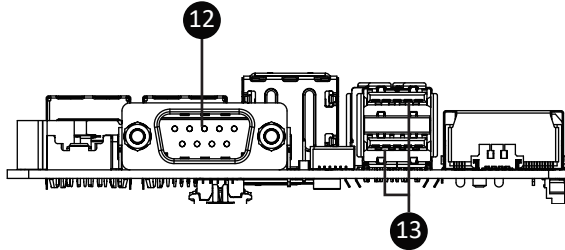

No	Code	Description
1	ATX_IN	ATX IN Connector
2	BATTERY	Battery Connector
3	M2E	E-key, Supports NGFF-2230 (WiFi/BT)
4	M2M	M-key, SATA 6.0 Gb/s, PCIe x4, Supports NGFF-2280 card
5	F_USB2	USB 2.0 header
6	F_PANEL	Front panel header
7	ME	ME Enable jumper
8	TPM	TPM header

No	Code	Description
9	FP_AUDIO	Front panel audio header
10	SODIMM1 SODIMM2	DDR4 SO-DIMM Slot
11	CPU_FAN	CPU FAN Connector
12	COM1	Serial port connector (RS-232/422/485)
13	USB31_2	USB 3.2 Gen 2x1 Port x 2
14	DC_IN	Screw type DC Jack
15	USB31_1	USB 3.2 Gen 2x1 Port x 2
16	HDMI_21	HDMI Port
17	LAN2	GbE LAN Port
18	LAN1	GbE LAN Port

3.2.1 ATX_IN (ATX IN Connector)

1

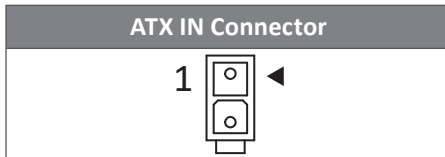
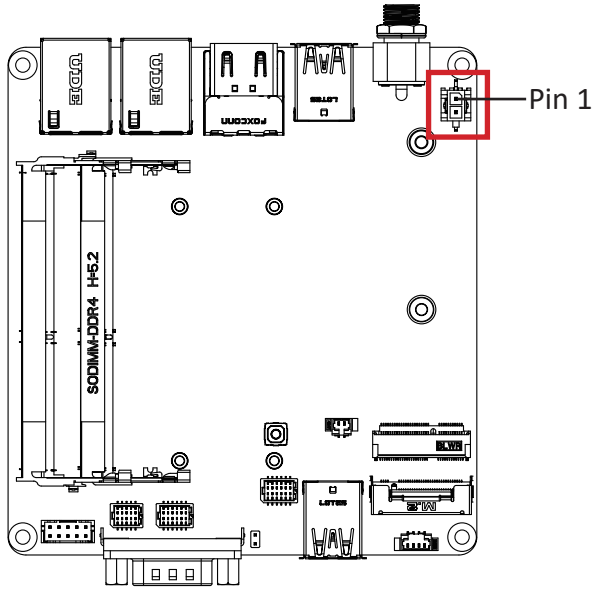

Pin No.	Definition
1	GND
2	DC IN

Connector PN	Vendor
99-01740-B004-A	TCONN

3.2.2 BATTERY (Battery connector)

2

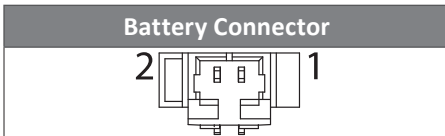
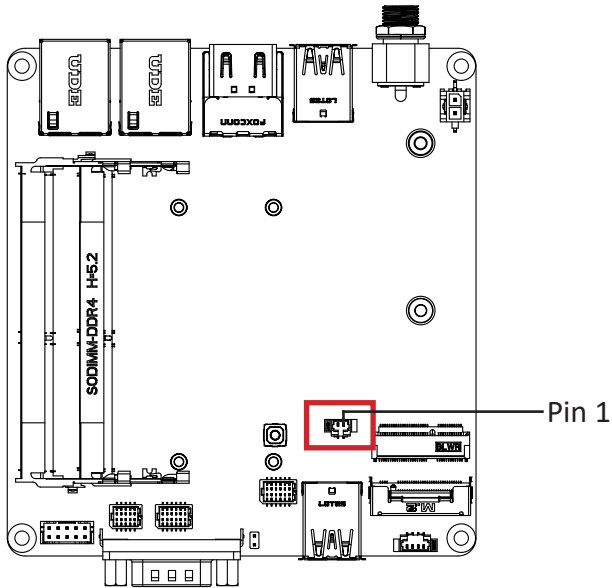

Pin No.	Definition
1	3V
2	GND

3.2.3 M2E (E-key, Supports NGFF-2230 (WiFi/BT) Slot)

3

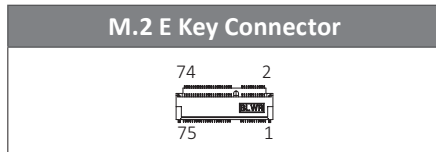
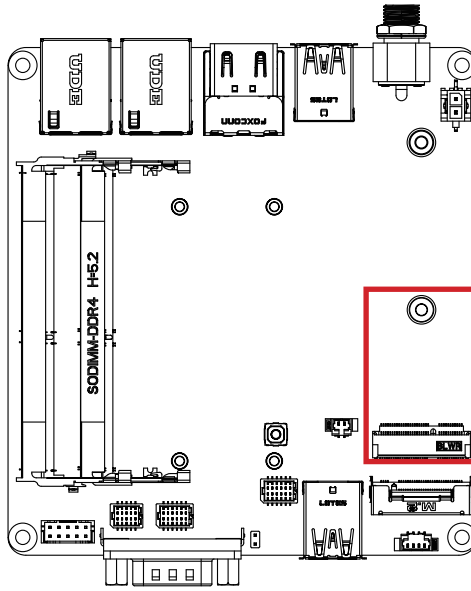

Pin No.	Definition	Pin No.	Definition
1	GND	2	3V
3	USB_D+	4	3V
5	USB_D-	6	NC
7	GND	8	NC
9	NC	10	NC
11	NC	12	NC
13	NC	14	NC
15	NC	16	NC
17	NC	18	GND
19	NC	20	BT_WAKE
21	NC	22	NC
23	NC		

Pin No.	Definition	Pin No.	Definition
33	GND	32	NC
35	WLAN_TXp	34	NC
37	WLAN_TXn	36	NC
39	GND	38	CL_Reset

41	WLAN_RXp	40	CL_DATA
43	WLAN_RXn	42	CL_Clock
45	GND	44	NC
47	Clock_Dp	46	NC
49	Clock_Dn	48	NC
51	GND	50	SUSCLK
53	Clock_Request	52	PLT_Reset
55	PCIE_Wake up	54	BT_Disable
57	GND	56	WIFI_Disable
59	NC	58	NC
61	NC	60	NC
63	GND	62	NC
65	NC	64	NC
67	NC	66	NC
69	GND	68	NC
71	NC	70	NC
73	NC	72	3V
75	GND	74	3V

Connector PN	Vendor
80152-4221	BELLWETHER

3.2.4 M2M (M-key, Supports NGFF-2280 (PCIe x4, SATA 6Gb/s))

4

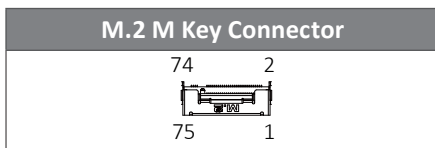
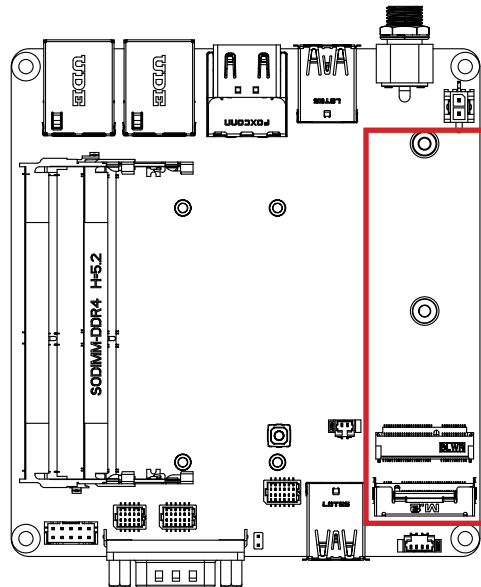

Pin No.	Definition	Pin No.	Definition
1	GND	2	3.3V
3	GND	4	3.3V
5	NC	6	NC
7	NC	8	NC
9	GND	10	M2_LED
11	NC	12	3.3V
13	NC	14	3.3V
15	GND	16	3.3V
17	NC	18	3.3V
19	NC	20	NC
21	GND	22	NC
23	NC	24	NC
25	NC	26	NC
27	GND	28	NC
29	PCIE_RXn	30	NC
31	PCIE_RXp	32	NC
33	GND	34	NC

Pin No.	Definition	Pin No.	Definition
35	PCIE_TXn	36	NC
37	PCIE_TXp	38	DEVSLP
39	GND	40	SMB Clock
41	SATA_RXp	42	SMB DATA
43	SATA_RXn	44	SMB ALERT
45	GND	46	NC
47	SATA_TXn	48	NC
49	SATA_TXp	50	PLT_Reset
51	GND	52	CK_Request
53	Clock_n	54	PCIE_Wake up
55	Clock_p	56	NC
57	GND	58	NC

Pin No.	Definition	Pin No.	Definition
67	NC	68	SUSCLK
69	M2_SSD_Detect	70	3.3V
71	GND	72	3.3V
73	GND	74	3.3V
75	GND		

Connector PN	Vendor
2E0BC41-C85CM-LH	FOXCONN

3.2.5 F_USB2 (USB 2.0 header)

5

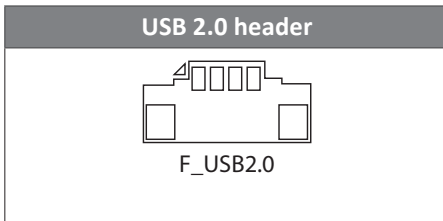
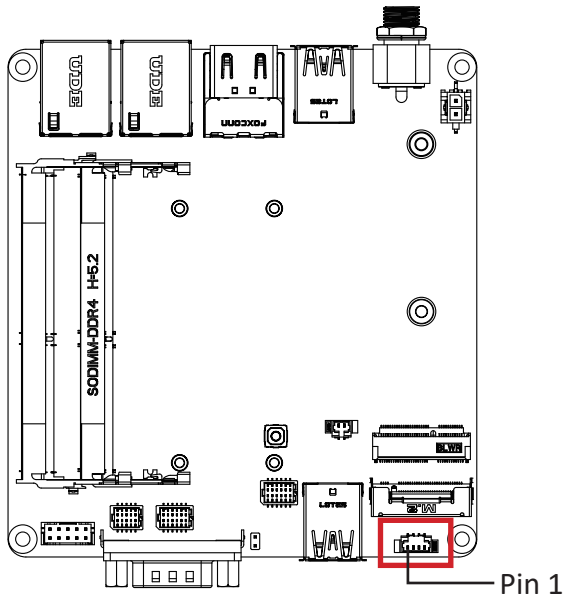

Connector PN	Vendor
A1250WV-S-04PNLBT1TOOL	JOINT-TECH
50273-0047N-001	ACES

Pin No.	Definition
1	VCC
2	D- (USBN)
3	D+ (USBP)
4	GND

3.2.6 F_PANEL (Front panel Connector)

6

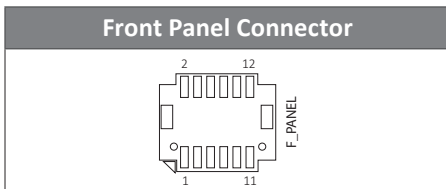
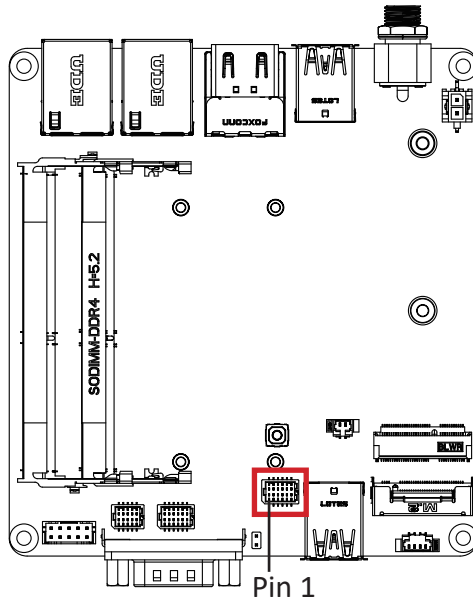

Connector PN	Vendor
87216-1206-06	ACES

Pin No.	Definition
1	SATA_LED_P (3.3V)
2	MPD+
3	GND
4	MPD-
5	GND
6	Panshw_D
7	PMU_RSTBTN_N_D
8	GND
9	5V
10	3.3V
11	5V
12	NC

3.2.7 ME (ME Enable jumper)

7

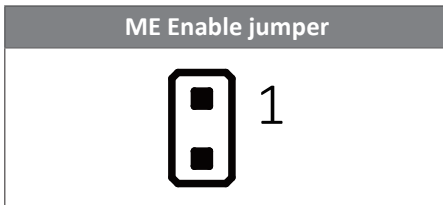
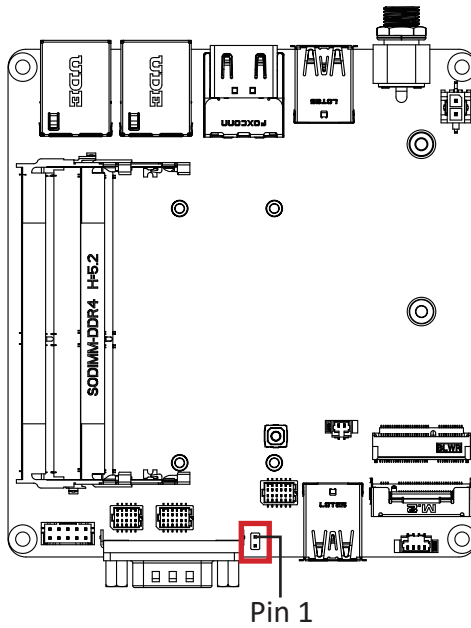

ME Enable Jumper	
	Enable
	Disable

3.2.8 TPM (TPM header)

8

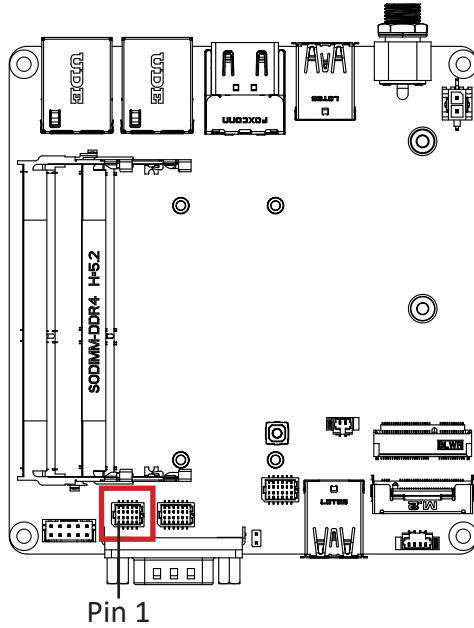

TPM header	

Pin No.	Definition
1	Clock
2	GND
3	SPI_CS#
4	SPI_SO
5	SPI_RST#
6	SPI_SI
7	NC
8	NC
9	3.3V
10	NC

Connector PN	Vendor
87216-1004-06	ACES

※Note : TPM module must be SPI interface.

3.2.9 FP_AUDIO (Front panel audio header)

9

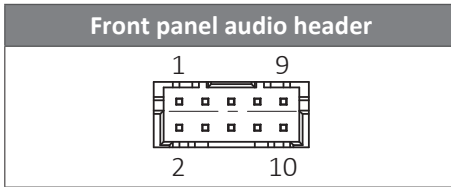
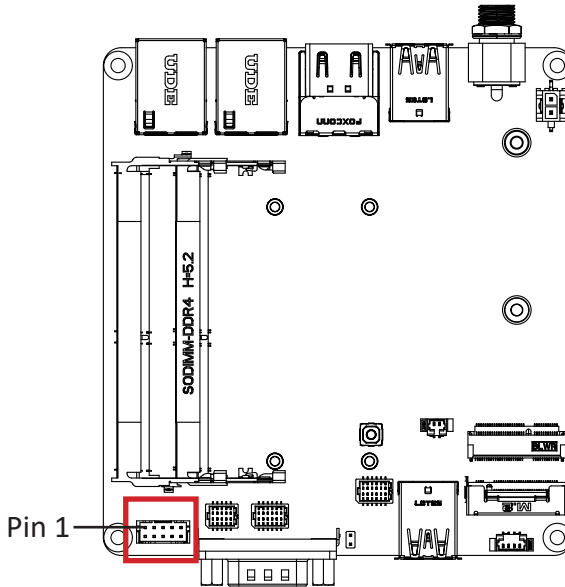

Connector PN	Vendor
725-81-10TW00	PINREX
A2004WV-2X05P46	JOINT-TECH

Pin No.	Definition	Pin No.	Definition
1	MIC_Left	2	GND
3	MIC_Right	4	NC
5	HP_Right	6	MIC_JD_SENSE
7	FAUDIO_JD_C	8	NC
9	HP_Left	10	HP_JD_SENSE

3.2.10 SODIMM1, SODIMM2 (DDR4 SO-DIMM Slot)

10

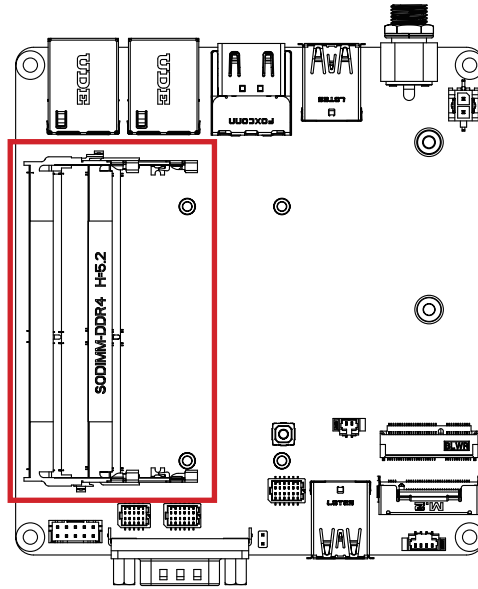

3.2.11 CPU FAN (CPU FAN connector)

11

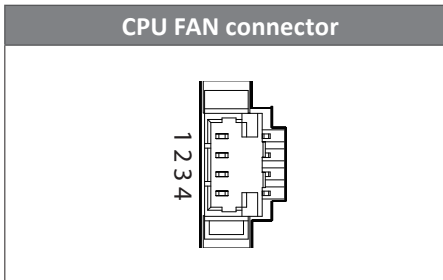
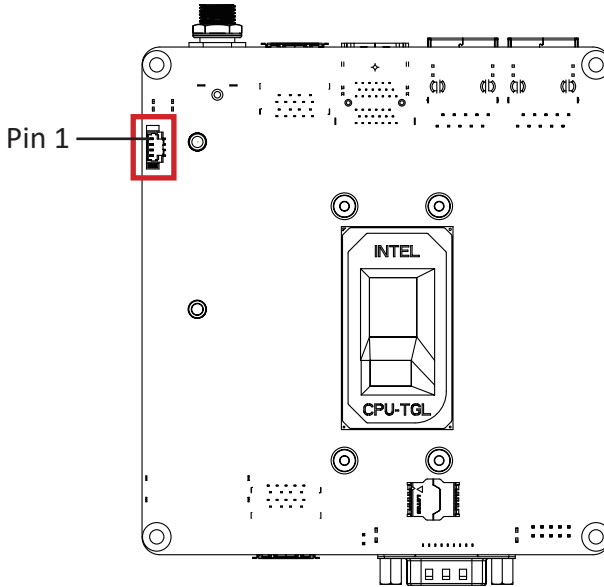

Connector PN	Vendor
85205-0470N	ACES
A1250WV-S-04PC	JOINT-TECH

Pin No.	Definition
1	GND
2	12V
3	Detect
4	Speed Control

3.2.12 COM1 (Serial port connector, RS-232/422/485)

12

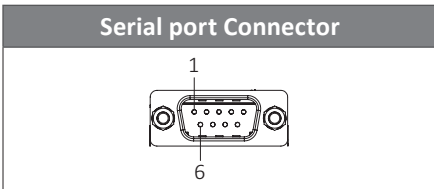
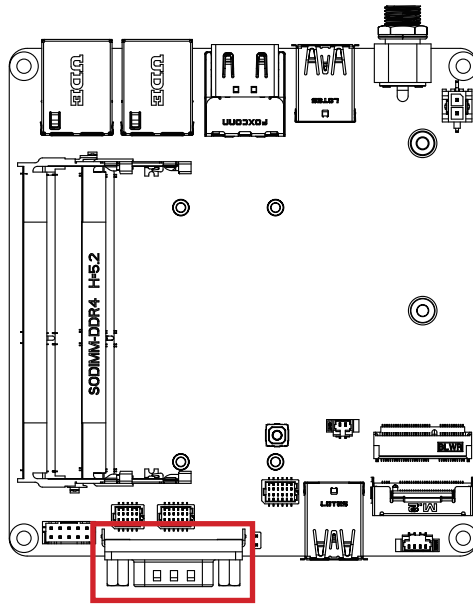

Connector PN	Vendor
SM41D1P1122N33N1	FENYING

Pin No.	RS-232	RS-422 Full Duplex	RS-485 Half Duplex
1	DCD	TXD-	D-
2	RXD	TXD+	D+
3	TXD	RXD+	-
4	DTR	RXD-	-
5	GND		
6	DSR	-	-
7	RTS	-	-
8	CTS	-	-
9	RI	-	-

3.2.13 USB31_2 (USB 3.2 Gen 2x1 Port)

13

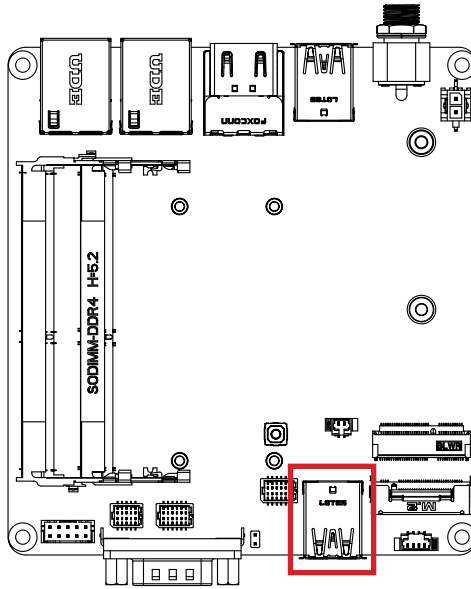

USB 3.2 Gen 2x1 connector

Connector PN	Vendor
18-A5950-6A33-A	TCONN

Pin No.	Definition	Pin No.	Definition
1	5V	10	5V
2	USB_D-	11	USB_D-
3	USB_D+	12	USB_D+
4	GND	13	GND
5	USB3_RX-	14	USB3_RX-
6	USB3_RX+	15	USB3_RX+
7	GND	16	GND
8	USB3_TX-	17	USB3_TX-
9	USB3_TX+	18	USB3_TX+

3.2.14 DC_IN (Screw type DC Jack connector)

14

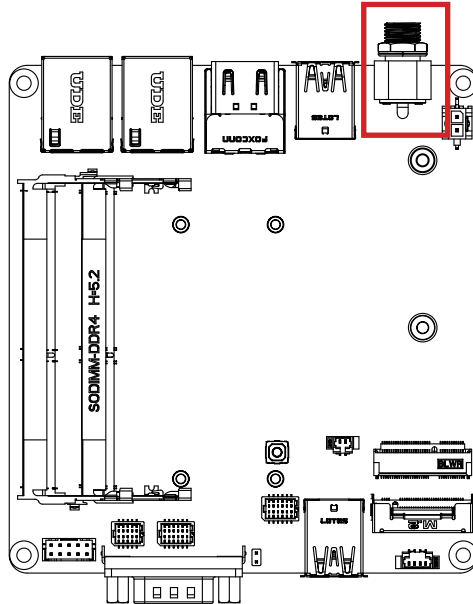

Screw Type DC Jack Connector

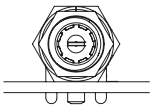

Connector PN	Vendor
655-360-000	SHEN-MING

3.2.15 USB31_1 (USB 3.2 Gen 2x1 connector)

15

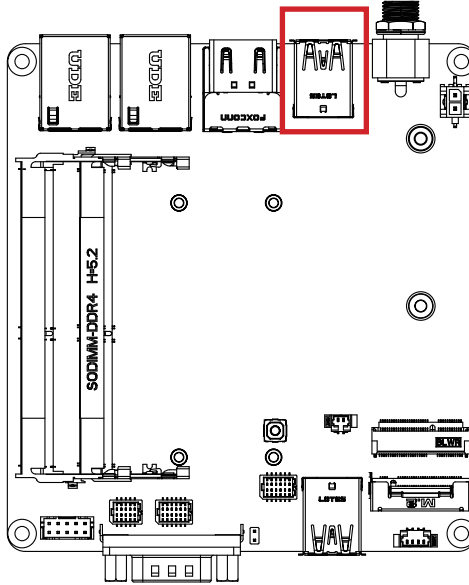

USB 3.2 Gen 2x1 connector

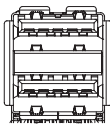

Connector PN

18-A5950-6A33-A

Vendor

TCONN

Pin No.	Definition	Pin No.	Definition
1	5V	10	5V
2	USB_D-	11	USB_D-
3	USB_D+	12	USB_D+
4	GND	13	GND
5	USB3_RX-	14	USB3_RX-
6	USB3_RX+	15	USB3_RX+
7	GND	16	GND
8	USB3_TX-	17	USB3_TX-
9	USB3_TX+	18	USB3_TX+

3.2.16 HDMI_21 (HDMI connector)

16

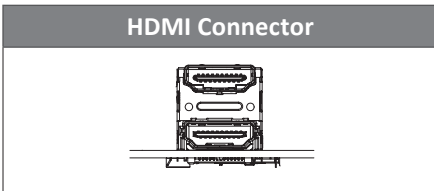
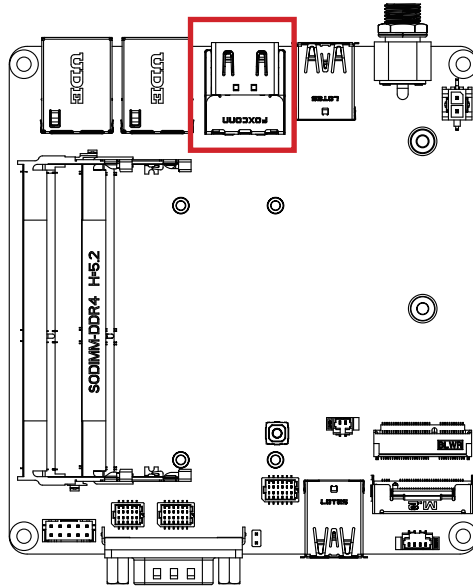

Connector PN	Vendor
QJ11191-DFB1-4F	FOXCONN

Pin No.	Definition	Pin No.	Definition
1	HDMI_D2+	11	GND
2	GND	12	HDMI_CLK-
3	HDMI_D2-	13	NC
4	HDMI_D1+	14	NC
5	GND	15	HDMI_SCL
6	HDMI_D1-	16	HDMI_SDA
7	HDMI_D0+	17	GND
8	GND	18	5V
9	HDMI_D0-	19	HDMI_HPD
10	HDMI_CLK+		

3.2.17 LAN1, LAN2 (GbE LAN port connector)

17 18

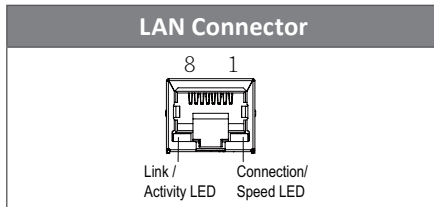
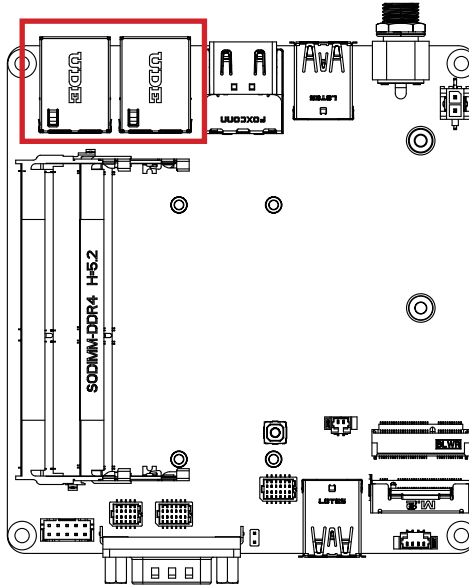

State	Description
Orange On	1Gbps data rate
Green On	100Mbps data rate
Off	10Mbps data rate

Pin No.	Definition
1	TX+_D1
2	TX-_D1
3	RX+_D2
4	BI+_D3
5	BI-_D3
6	RX-_D2
7	BI+_D4
8	BI-_D4

Connector PN	Vendor
RT7-GB-0003	UDE

Chapter 4

Chapter 4 – BIOS

4.1 Introduction

BIOS (Basic input/output system) provides hardware detailed information and boot-up options, which include firmware to control, set-up and test all hardware settings. Therefore, BIOS is the communication bridge between OS/application software and hardware.

4.1.1 How to Entering into BIOS menu

Once the system is power on, press the key as soon as possible to access into BIOS Setup program.

4.1.2 Function Keys to setup in BIOS Setup program

Function keys	Description
→←	Select Screen
↑↓	Select Item
Enter	Execute command or enter the submenu
+	Increase the numeric value or make changes
—	Decrease the numeric value or make changes
F1	General Help
F2	Previous Values
F3	Load Optimized Defaults Settings
F4	Save changes & Exit the BIOS Setup program
ESC	Exit the BIOS Setup program

4.2 The Main Menu

The main menu shows the basic system information. Use arrow keys to move among the items.

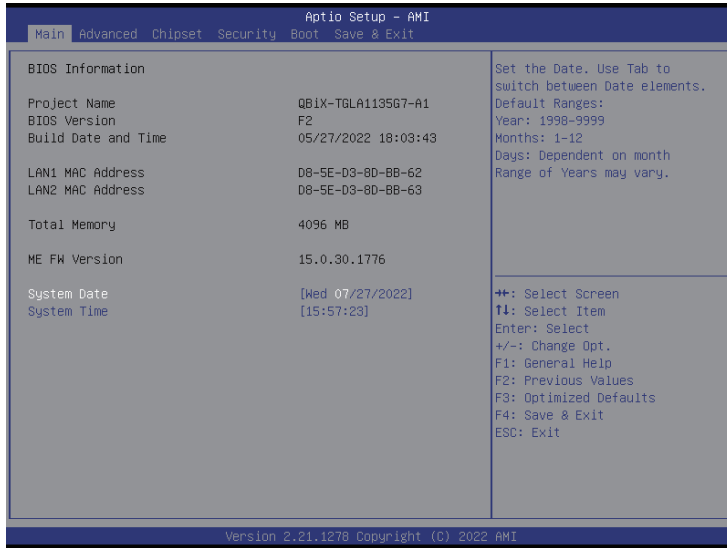

Items	Description
Project Name	Shows Project name information
BIOS Version	Shows the BIOS version of the system
Build Date and Time	Shows the Build Date and Time when the BIOS was created.
LAN1 MAC Address	Shows LAN1 MAC Address information
LAN2 MAC Address	Shows LAN2 MAC Address information
Total Memory	Shows the total memory size of the installed memory
ME FW version	Shows ME firmware version
System Date	Set the Date for the system (Format : Week - Month - Day - Year)
System Time	Set the time for the system (Format : Hour - Minute - Second)

4.3 Advanced

The Advanced menu is to configure the functions of hardware settings through submenu. Use arrow keys to move among the items, and press <Enter> to access into the related submenu.

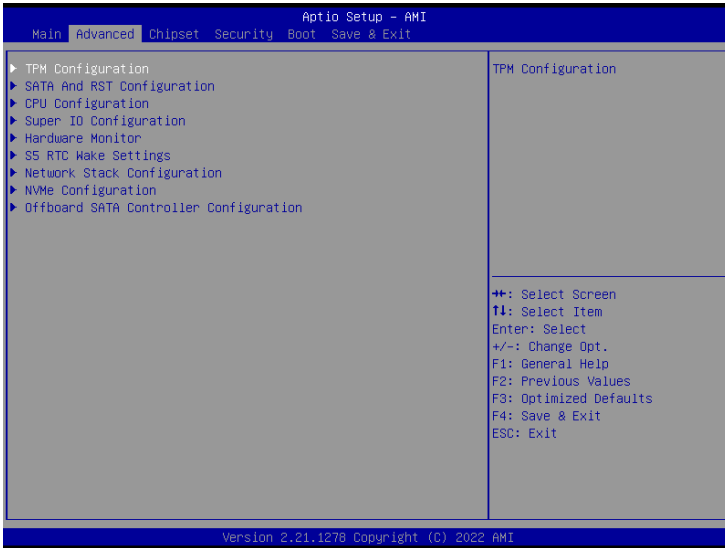

4.3.1 TPM Configuration

Use TPM Configuration submenu to choose TPM interface.

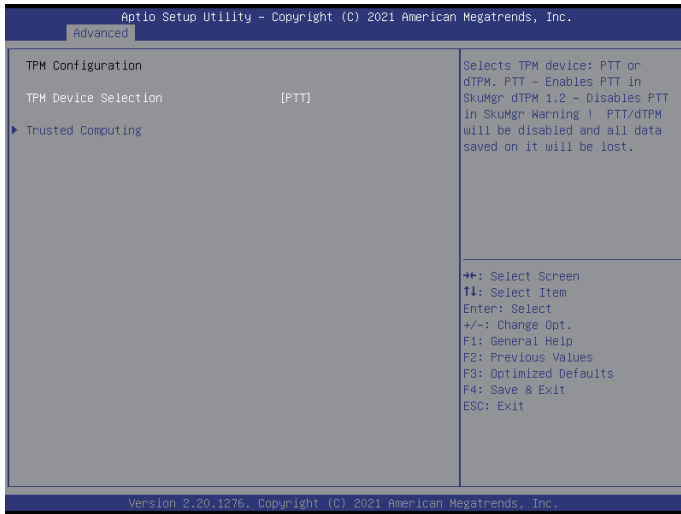

Item	Description
TPM Device Selection	PTT : Internal TPM (Default setting) dTPM : External TPM (When using External TPM module or having TPM chip on MB)

Trusted Computing : Shows TPM information, and TPM module configuration setting.

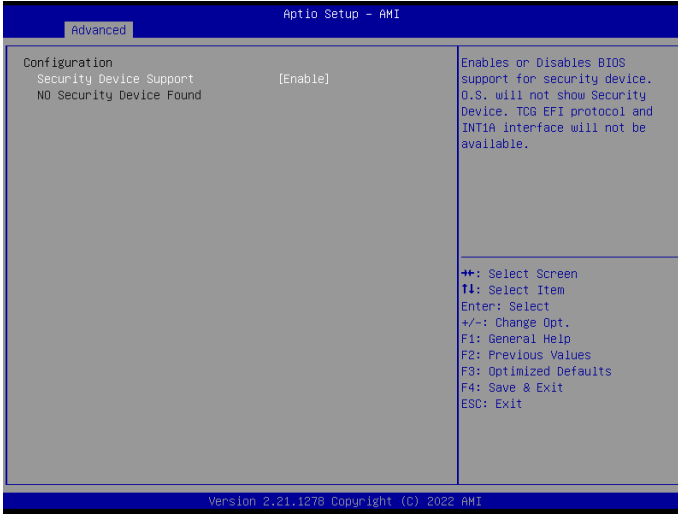

Item	Description
Security Device support	Enabled : Enables TPM feature (Default setting) Disabled : Disables TPM feature

4.3.2 SATA And RST Configuration

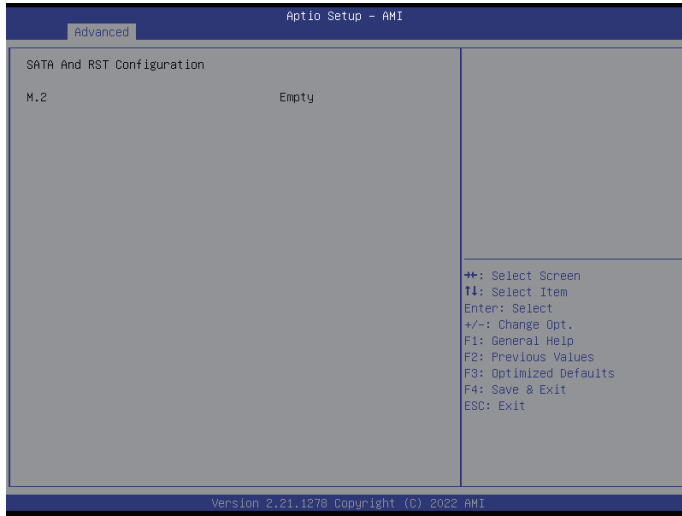

Item	Description
M.2	shows M.2 SSD information

4.3.3 CPU Configuration

This submenu shows detailed CPU informations.

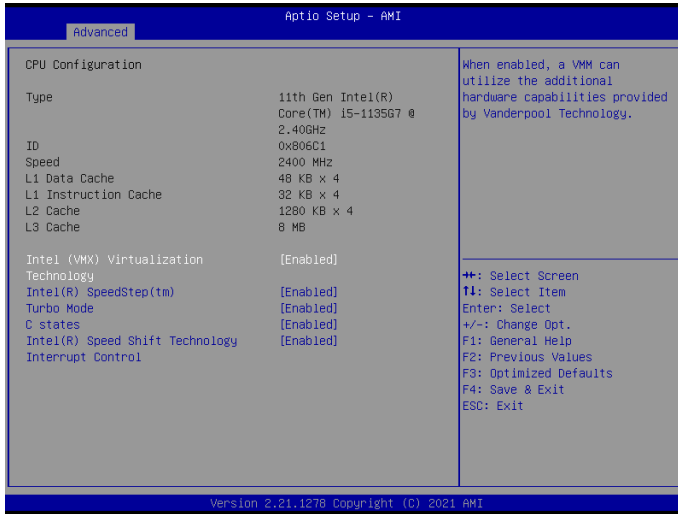

Item	Description
Intel (VMX) Virtualization Technology	Virtualization enhanced by Intel® Virtualization Technology will allow a platform to run multiple operating systems and applications in independent partitions. With virtualization, one computer system can function as multiple virtual systems. Enabled : Enables Intel Virtualization Technology (Default setting) Disabled : Disables Intel Virtualization Technology
Intel(R) SpeedStep(tm)	According to Intel CPU loading, Intel SpeedStep Technology will automatically adjust the CPU voltage and core frequency to decrease heat and power consumption for power saving. Enabled : Enables Intel SpeedStep Technology (Default setting) Disabled : Disables Intel SpeedStep Technology
Turbo Mode	Enabled : Enables Turbo Mode (Default setting) Disabled : Disables Turbo Mode
C states	Command CPU to enter into low power consumption mode when CPU is under idle mode. Enabled : Enables C states (Default setting) Disabled : Disables C states
Intel(R) Speed Shift Technology Interrupt Control	To speed up CPU frequency transition time from basic frequency to maximum frequency. Enabled : Enables Intel(R) Speed Shift Technology Interrupt control (Default setting) Disabled : Disables Intel(R) Speed Shift Technology Interrupt control

4.3.4 Super IO Configuration

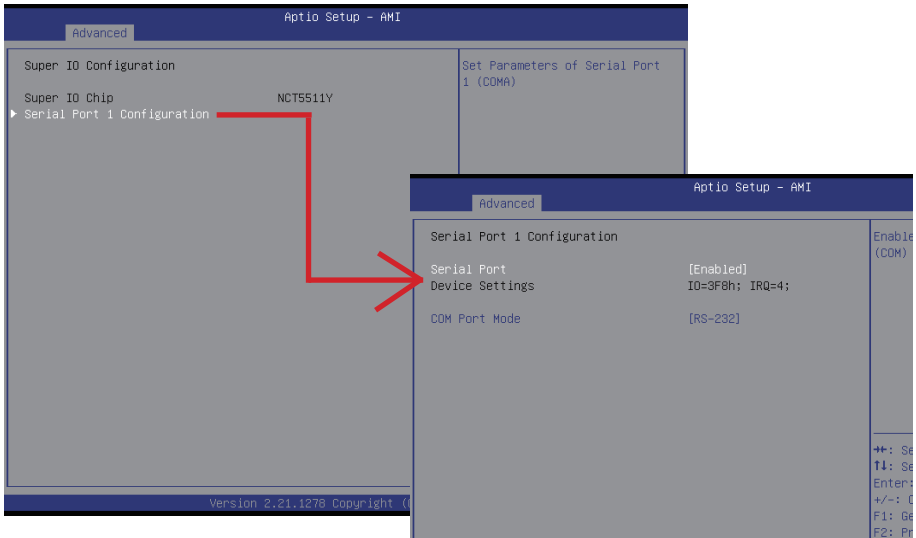

Item	Description
Super IO Chip	Shows Super I/O chip model
Serial Port 1 Configuration	<p>Press [Enter] to configure advanced items :</p> <p>Serial Port : Enabled : Enables Serial Port function (Default setting) Disabled : Disables Serial Port function</p> <p>Device settings : Display the specified Serial Port base I/O address and IRQ</p> <p>COM Port Mode : Choose RS-232, RS-422, or RS-485 feature</p>

4.3.5 Hardware Monitor

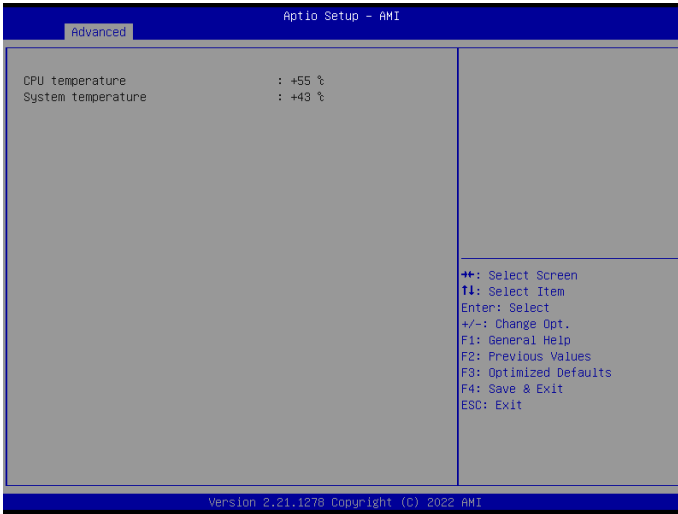

Item	Description
CPU Temperature	Shows current CPU temperature
System Temperature	Shows current system temperature

4.3.6 S5 RTC Wake Settings



Item	Description
<p>Wake system from S5</p>	<p>Enable or Disable System to wake on a specific time. Disabled : Disables system to wake on a specific time (Default setting) Fixed Time : Enables system to wake on a specific time (Format : hr : min : sec)</p>

4.3.7 Network Stack Configuration

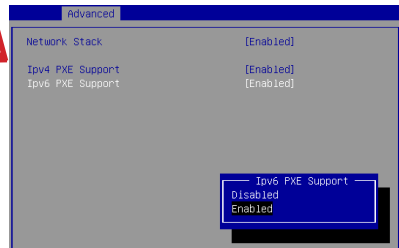
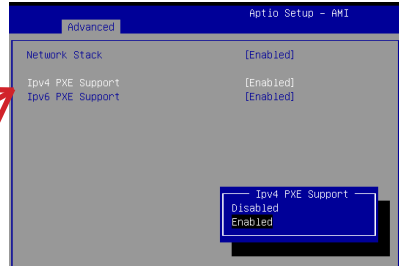
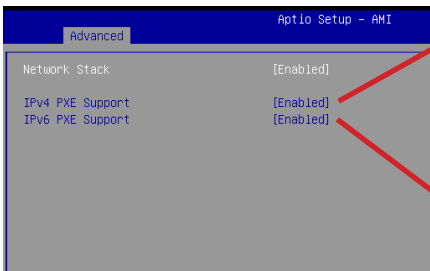
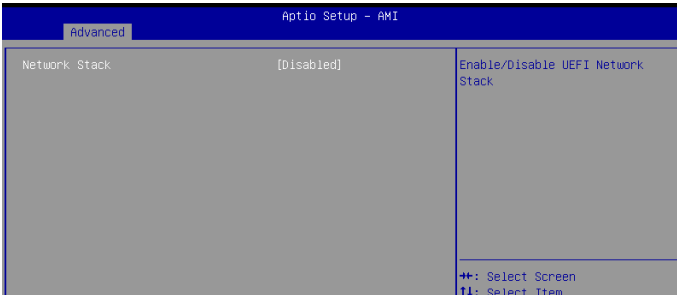

Item	Description
Network Stack	When system is power on, install LAN driver under UEFI mode Disabled : Disables UEFI Network Stack (Default setting) Enabled : Enables UEFI Network Stack
Ipv4 PXE Support	When Network stack is enabled : Disabled : Disables Ipv4 PXE Support Enabled : Enables Ipv4 PXE Support
Ipv6 PXE Support	When Network stack is enabled : Disabled : Disables Ipv6 PXE Support Enabled : Enables Ipv6 PXE Support

4.3.8 NVMe Configuration

NVMe Configuration shows information when your M.2 NVMe PCIe SSD is installed.



4.3.9 Offboard SATA Controller Configuration

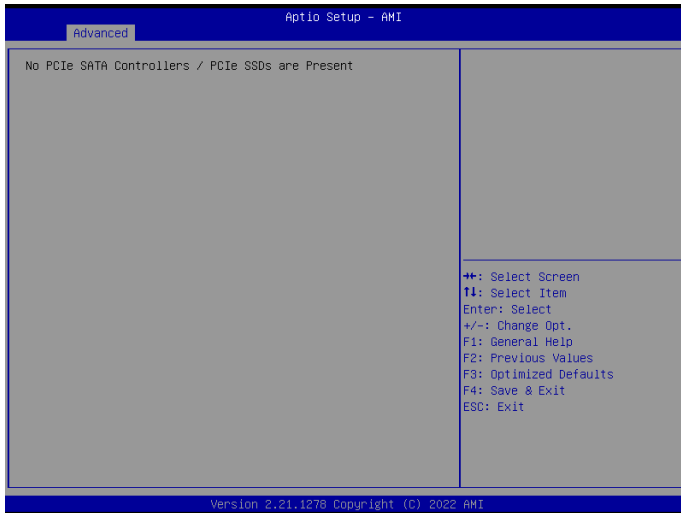

4.4 Chipset



Item	Description
VT-d	Enabled : Enables VT-d function (Default setting) Disabled : Disables VT-d function
DVMT Pre-Allocated	Use DVMT Pre-Allocated to set the amount of system memory which is installed to the integrated graphics processor Option items : 32M , 64M(Default setting), 128M, 256M
Onboard LAN1 Onboard LAN2	Enable/Disable onboard LAN controller Enabled : Enables onboard LAN controller (Default setting) Disabled : Disables onboard LAN controller
HD Audio	Enable/Disable onboard audio controller Enabled : Enables onboard audio controller (Default setting) Disabled : Disables onboard audio controller
ERP Lowest Power State Mode	Enable/Disable power saving function Enabled : Enables ERP Lowest Power State Mode Disabled : Disabled ERP Lowest Power State Mode (Default setting)
Restore AC Power Loss	To set which option the system should returns if a sudden power loss occurred Power on : System power on when the power is back Power off : Do not power on when the power is back (Default setting) Last state : Restore the system to the state before power loss occurs
XHCI Hand-off	Enable/Disable XHCI Hand-off function Enabled : Enables XHCI Hand-off function (Default setting) Disabled : Disables XHCI Hand-off function
Watchdog Timer	Enable/Disable Watchdog Timer function Enabled : Enables Watchdog Timer function Disabled : Disabled Watchdog Timer function (Default setting)
BIOS Lock	Enable/Disable BIOS Lock function Enabled : Enables BIOS Lock function (Default setting) Disabled : Disabled BIOS Lock function

4.5 Security

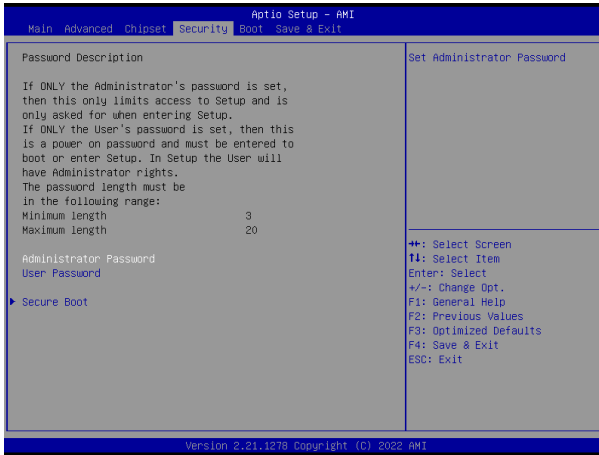

Item	Description
Administrator Password	To set up Administrator's password Minimum length : 3 Maximum length : 20
User Password	To set up User's password Minimum length : 3 Maximum length : 20
Secure Boot	Press <Enter> to configure the advanced items



Item	Description
Secure Boot	Secure Boot requires all the applications that are running during the booting process to be pre-signed with valid digital certificates Enabled : Enables Secure Boot function Disabled : Disables Secure Boot function (Default setting)
Secure Boot Mode	Standard : Standard mode Custom : Custom mode (Default setting)
Restore Factory Keys	To restore factory settings Yes : Agree to restore factory settings No : Cancel to restore factory settings
Reset To Setup Mode	Yes : Agree to setup mode No : Cancel to setup mode
Key Management	Enables expert users to modify Secure boot policy variables without full authentication Press <Enter> to configure the advanced items

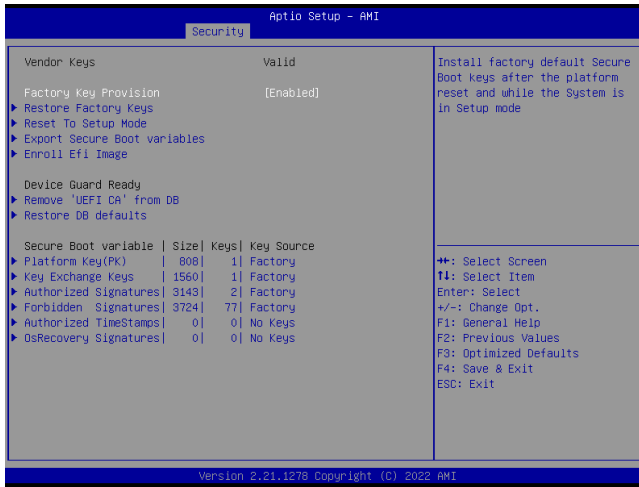

Item	Description
Factory Key Provision	Install factory default Secure Boot keys after the platform reset and while the system is in Setup mode Enabled : Enables Factory Key Provision Disabled : Disables Factory Key Provision (Default setting)
Restore Factory Keys	To restore factory settings
Reset To Setup Mode	Delete all Secure boot key databases from NVRAM
Export Secure Boot variables	Copy NVRAM content of Secure Boot variables to files in a root folder on a file system device
Enroll Efi Image	Allow the image to run in Secure Boot mode
Remove 'UEFI CA' from DB	To remove 'UEFI CA' from database
Restore DB defaults	Restore DB variables to factory defaults Yes : Agree to restore DB defaults No : Cancel to restore DB defaults

Item	Description
Platform Key (PK)	These items allows you to enroll factory defaults or load Certificates from a file.
Key Exchange Keys	
Authorized Signatures	
Forbidden Signatures	
Authorized TimeStamps	
OsRecovery Signatures	

4.6 Boot

This Boot menu allows you to set/change system boot options



Item	Description
Full Screen LOGO Show	Enable/Disable full screen LOGO show on POST screen Enabled : Enables Full screen LOGO Show on POST screen Disabled : Disables Full screen LOGO Show on POST screen (Default setting)
Boot Option #1 Boot Option #2	Shows the information of the storage that be installed in the system Choose/set the boot priority

4.7 Save & Exit

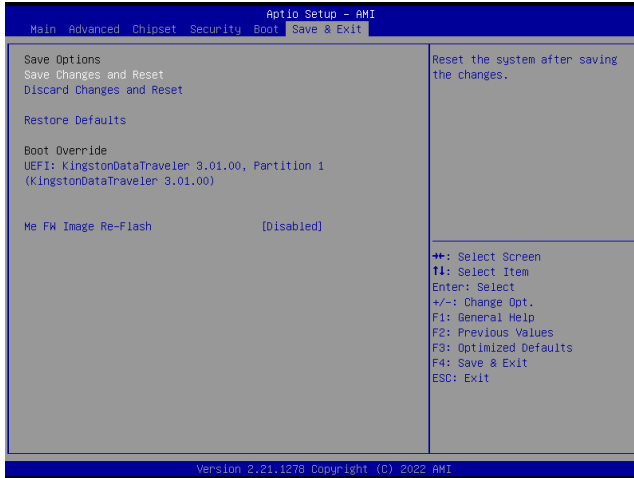

Item	Description
Save Changes and Reset	After configuring all the options that you wish to change, choose this option to save all the changes and reboot the system Yes : Agree to save and reset No : Cancel to save and reset
Discard Changes and Reset	Choose this option to reboot the system without saving any changes Yes : Agree to discard changes and reset No : Cancel to discard changes and reset
Restore Defaults	Restore/Load default values for all the setup options Yes : Agree to load optimized defaults No : Cancel to load optimized defaults
Me FW Image Re-Flahs	Enable/Disable Me FW image re-flash function Enabled : Enables Me FW image re-flash function Disabled : Disables Me FW image re-flash function (Default setting)