

QBiX-Pro-ADLA1255H-A2
QBiX-Pro-ADLA1235H-A2
QBiX-Pro-ADLA1215EH-A2

QBiX-Pro Industrial Embedded System
Quick Start Guide

Copyright Notice

This document is copyrighted, 2023. All rights are reserved. The original manufacturer reserves the right to make improvements to the products described in this manual at any time without notice.

No part of this manual may be reproduced, copied, translated, or transmitted in any form or by any means without the prior written permission of the original manufacturer. Information provided in this manual is intended to be accurate and reliable. However, the original manufacturer assumes no responsibility for its use, or for any infringements upon the rights of third parties that may result from its use.

The material in this document is for product information only and is subject to change without notice. While reasonable efforts have been made in the preparation of this document to assure its accuracy, GIGAIPC assumes no liabilities resulting from errors or omissions in this document, or from the use of the information contained herein.

GIGAIPC reserves the right to make changes in the product design without notice to its users.

Acknowledgement

All other products' name or trademarks are properties of their respective owners.

- Microsoft Windows is a registered trademark of Microsoft Corp.
- Intel, Pentium, Celeron, and Xeon are registered trademarks of Intel Corporation
- Core, Atom are trademarks of Intel Corporation
- ITE is a trademark of Integrated Technology Express, Inc.
- IBM, PC/AT, PS/2, and VGA are trademarks of International Business Machines Corporation.

All other product names or trademarks are properties of their respective owners.

Packing List

Before setting up your product, please make sure the following items have been shipped:

Item	Quantity
System kit	1
HDD screw, M3 x 8L (25KSG-130081-K1R)	4
SATA Cable (25CRI-070000-S9R)	1
Exsiccator (25g)	1
Thermal pad for Memory (25ST3-200086-T5R)	1
Power Cord : Optional (by region)	1
PSU ADP 19.5V 135W 100-240VAC (25EP4-201352-C1S)	1

If any of these items are missing or damaged, please contact your distributor or sales representative immediately.

About this Document

This User's Manual contains all the essential information, such as detailed descriptions and explanations on the product's hardware and software features (if any), its specifications, dimensions, jumper/connector settings/definitions, and driver installation instructions (if any), to facilitate users in setting up their product.

Users may refer to the GIGAIPC.com for the latest version of this document.

Safety Precautions

Please read the following safety instructions carefully. It is advised that you keep this manual for future references

1. All cautions and warnings on the device should be noted.
2. Make sure the power source matches the power rating of the device.
3. Position the power cord so that people cannot step on it. Do not place anything over the power cord.
4. Always completely disconnect the power before working on the system's hardware.
5. No connections should be made when the system is powered as a sudden rush of power may damage sensitive electronic components.
6. If the device is not to be used for a long time, disconnect it from the power supply to avoid damage by transient over-voltage.
7. Always disconnect this device from any AC supply before cleaning.
8. While cleaning, use a damp cloth instead of liquid or spray detergents.
9. Make sure the device is installed near a power outlet and is easily accessible.
10. Keep this device away from humidity.
11. Place the device on a solid surface during installation to prevent falls
12. Do not cover the openings on the device to ensure optimal heat dissipation.

13. Watch out for high temperatures when the system is running.
14. Do not touch the heat sink or heat spreader when the system is running
15. Never pour any liquid into the openings. This could cause fire or electric shock.
16. As most electronic components are sensitive to static electrical charge, be sure to ground yourself to prevent static charge when installing the internal components. Use a grounding wrist strap and contain all electronic components in any static-shielded containers.
17. If any of the following situations arises, please the contact our service personnel:
 - i. Damaged power cord or plug
 - ii. Liquid intrusion to the device
 - iii. Exposure to moisture
 - iv. Device is not working as expected or in a manner as described in this manual
 - v. The device is dropped or damaged
 - vi. Any obvious signs of damage displayed on the device
18. **DO NOT LEAVE THIS DEVICE IN AN UNCONTROLLED ENVIRONMENT WITH TEMPERATURES BEYOND THE DEVICE'S PERMITTED STORAGE TEMPERATURES (SEE CHAPTER 1) TO PREVENT DAMAGE.**

FCC Statement

Warning!



This device complies with Part 15 FCC Rules. Operation is subject to the following two conditions: (1) this device may not cause harmful interference, and (2) this device must accept any interference received including interference that may cause undesired operation.

Caution:

There is a danger of explosion if the battery is incorrectly replaced. Replace only with the same or equivalent type recommended by the manufacturer. Dispose of used batteries according to the manufacturer's instructions and your local government's recycling or disposal directives.

Attention:

Il y a un risque d'explosion si la batterie est remplacée de façon incorrecte. Ne la remplacer qu'avec le même modèle ou équivalent recommandé par le constructeur. Recycler les batteries usées en accord avec les instructions du fabricant et les directives gouvernementales de recyclage.

High Temperature Warning

(1) This equipment is intended to be used in Restrict Access Location. The access can only be gained by Skilled person or by Instructed person who have been instructed about the metal chassis of the equipment is so hot that Skilled person have to pay special attention or take special protection.

Only authorized by well trained professional person can access the restrict access location.

(2) External metal parts are hot!! Before touching it, special attention or protection is necessary

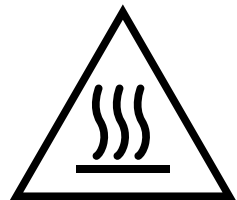

Table Contents

QBiX-Pro Industrial Embedded System Quick Start Guide	1
Copyright Notice	2
Acknowledgement	3
Packing List.....	4
About this Document.....	5
Safety Precautions	6
FCC Statement.....	8
High Temperature Warning	8
Chapter 1 - Product Specifications	13
1.1 Specifications	15
Chapter 2 – QBiX-Pro-ADLA1255H-A2 (QP-1255A-SI)	17
QBiX-Pro-ADLA1235H-A2 (QP-1235A-SI)	
QBiX-Pro-ADLA1215EH-A2 (QP-1215A-SI)	
Industrial Embedded System Kit	
2.1 Dimension	18
2.2 Getting Familiar with Your Unit.....	19
2.3 A) Memory Installation: DDR4 SO-DIMM	21
2.4 B) Mini PCIe Card Installation: How to safely install the Mini PCIe Card	22
2.5 C) M.2 SSD Installation: How to safely install the M.2 2280 SSD	23
2.6 D) Wireless Module: How to safely install the Module (Wireless Module inclusion may vary based on local	

	distribution)	24
2.7	E) 2.5" HDD/SSD installation: How to install 2.5" HDD/SSD	25
2.8	Antenna Installation (Antenna inclusion may vary based on local distribution)	26
2.9	Cable Pin-define	27
2.10	Support	28
2.11	Safety and Regulatory Information.....	29

Chapter 3 – Hardware Information 30

3.1	Jumpers and Connectors	31
3.2.1	CPU_FAN (CPU fan connector)	34
3.2.2	SYS_FAN (System fan connector)	35
3.2.3	COM1 (Serial port connector, (RS-232/422/485 & RI/5V/12V)).....	36
3.2.4	LAN1, LAN2 (2.5GbE LAN connector)	37
3.2.5	HDMI2_21 (HDMI connector).....	38
3.2.6	USB32_1, USB32_2 (USB 3.2 Gen 2x1 connector).....	39
3.2.7	TPM_SPI (Trusted Platform Module Connector).....	40
3.2.8	SODIMM1, SODIMM2 (DDR4 SO-DIMM Slot).....	41
3.2.9	LSW (LVDS resolution jumper)	42
3.2.10	LVDS (LVDS connector).....	43
3.2.11	BKL_CN (Backlight control header).....	44
3.2.12	SPK_OUT (Speaker out connector)	45
3.2.13	FP_AUDIO (Front Audio connector)	46
3.2.14	GPIO_CNT (General Purpose input/output header)	47
3.2.15	SYS_PANEL (Front panel header)	48

3.2.16	DC_IN (DC IN 1x4 pin power connector)	49
3.2.17	AT_CN (AT/ATX mode select jumper)	50
3.2.18	COM2, COM3, COM4 (Serial port header, RS-232/422/485)	51
3.2.19	FUSB1, FUSB2 (USB 2.0 headers)	52
3.2.20	ME_DIS (ME Disable jumper).....	53
3.2.21	JCOM1 (RI# pin RI#/5V/12V Select jumper for COM1 port)	54
3.2.22	SATAPWR (SATA power connector).....	55
3.2.23	SATA0 (SATA 6Gb/s connector)	56
3.2.24	M2E (M.2 Slot, 2230 E-key).....	57
3.2.25	MPCIE (Mini PCIe Slot)	58
3.2.26	BATTERY (Battery cable Connector)	59
3.2.27	M2M_CPU (M.2 Slot, 2280 M-key).....	60

Chapter 4 – BIOS 61

4.1	Introduction	62
4.2	The Main Menu.....	63
4.3	Advanced	64
4.3.1	TPM Configuration.....	65
4.3.2	CPU Configuration	67
4.3.3	SATA Configuration	68
4.3.4	IT8786 Super IO Configuration	69
4.3.5	Hardware Monitor	70
4.3.6	S5 RTC Wake Settings	71
4.3.7	Network Stack Configuration.....	72

4.3.8	NVMe Configuration	73
4.3.9	Offboard SATA Controller Configuration	74
4.3.10	Digital IO Port Configuration	75
4.3.11	Tls Auth Configuration	76
4.4	Chipset	77
4.5	Security	78
4.6	Boot.....	81
4.7	Save & Exit	82

Chapter 1

Chapter 1 - Product Specifications

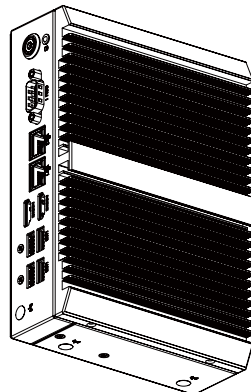
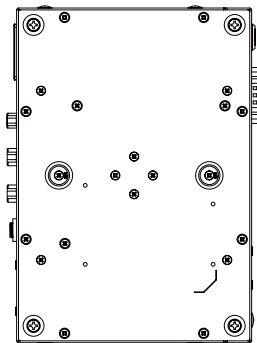
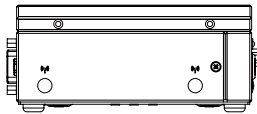
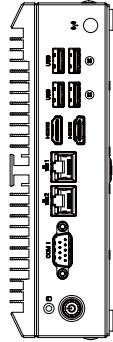
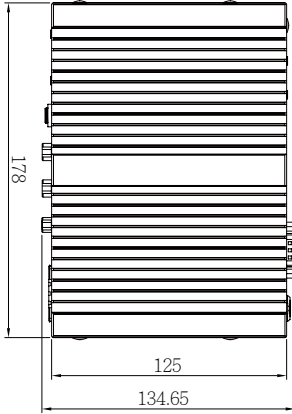
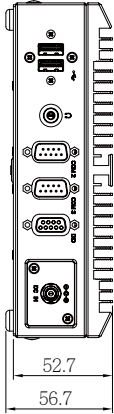
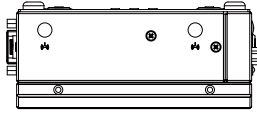

1.1 Specifications

System	QBiX-Pro-ADLA1255H-A2 (QP-1255A-SI)	QBiX-Pro-ADLA1235H-A2 (QP-1235A-SI)	QBiX-Pro-ADLA1215EH-A2 (QP-1215A-SI)
Dimension	System Size : 178W x 125D x 52.7H (mm)		
CPU	Intel® Core™ i7-1255U Processor 10nm Enhanced Superfin (Intel 7), 10 cores, 12 threads, up to 4.7 GHz	Intel® Core™ i5-1235U Processor 10nm Enhanced Superfin (Intel 7), 10 cores, 12 threads, up to 4.4 GHz	Intel® Core™ i3-1215UE Processor 10nm Enhanced Superfin (Intel 7), 6 cores, 8 threads, up to 4.4 GHz
Chipset	SoC		
Memory	2 x DDR4 SO-DIMM sockets, Max. Capacity 64 GB Support Dual channel DDR4 3200 MHz memory modules		
Ethernet	2 x 2.5GbE LAN Ports (Intel® I226V)		
Graphics support	Integrated Graphics Processor - Intel® Iris® Xe Graphics: 2 x HDMI 2.0 ports, supporting a maximum resolution of 4096x2160 @60Hz (2 independent display outputs)		Integrated Graphics Processor - Intel® UHD Graphics : 2 x HDMI 2.0 ports, supporting a maximum resolution of 4096x2160 @60Hz (2 independent display outputs)
Audio	Realtek® ALC269		
Storage	1 x 2.5" HDD/SSD (SATA 6Gb/s)		
Expansion Slots	1 x 2280 M.2 M-Key (PCIe Gen 4x4, SATA 6Gb/s) 1 x 2230 M.2 E-Key 1 x Full-size Mini PCIe with SIM slot		
Front I/O	2 x RJ45 LAN Ports 4 x USB 3.2 Gen 2x1 2 x HDMI 1 x Power button with LED 1 x HDD LED 1 x COM Port (RS-232/422/485 & RI/5V/12V) 1 x External Antenna Hole (Optional)		

System	QBiX-Pro-ADLA1255H-A2 (QP-1255A-SI)	QBiX-Pro-ADLA1235H-A2 (QP-1235A-SI)	QBiX-Pro-ADLA1215EH-A2 (QP-1215A-SI)
Rear I/O	2 x USB 2.0 2 x COM Ports (RS-232/422/485) 1 x GPIO (8 bits) 1 x Headphone Jack 1 x Screw Type DC Jack		
Side I/O	2 x External Antenna Holes (Optional)		
Power	+12V~36VDC (Adapter 19.5V/135W)		
Operation Temperature	Operating temperature: 0°C to 50°C Operating humidity: 0-90% (non-condensing) Non-operating temperature: -40°C to 85°C Non-operating humidity: 0%-95% (non-condensing) Use wide temperature range memory and storage		
Vibration During Operation	Operation: IEC 60068-2-64, 5 Grms, random, 5 ~ 500 Hz, 1 hr / Per Axis, with SSD/M.2 2280 Non-operation: IEC 60068-2-6, 2 G, Sine, 10 ~ 500 Hz, 1 Oct/min, 1 hr / Per Axis		
Shock During Operation	Operation: IEC 60068-2-27, 50 G, half sine, 11 ms duration, With SSD		
Packaging Content	Carton size: 505 x 333 x 231 (mm) Packing Capacity: 5pcs Including: Screw I Head for 2.5" HDD M3x8L x 4 (P/N: 25KSG-130081-K1R) Thermal Pad for Memory x 1 (P/N: 25ST3-200086-T5R) SATA Cable x 1 (P/N: 25CRI-070000-S9R) Power Cord : Optional (by region) PSU ADP 19.5V 135W 100-240VAC x 1 (P/N: 25EP4-201352-C1S)		
Order Information	System: 6BQP1255AMR-SI (Box packing)	System: 6BQP1235AMR-SI (Box packing)	System: 6BQP1215AMR-SI (Box packing)

Chapter 2

Chapter 2 – QBiX-Pro-ADLA1255H-A2 (QP-1255A-SI)
QBiX-Pro-ADLA1235H-A2 (QP-1235A-SI)
QBiX-Pro-ADLA1215EH-A2 (QP-1215A-SI)
Industrial Embedded System Kit

2.1 Dimension

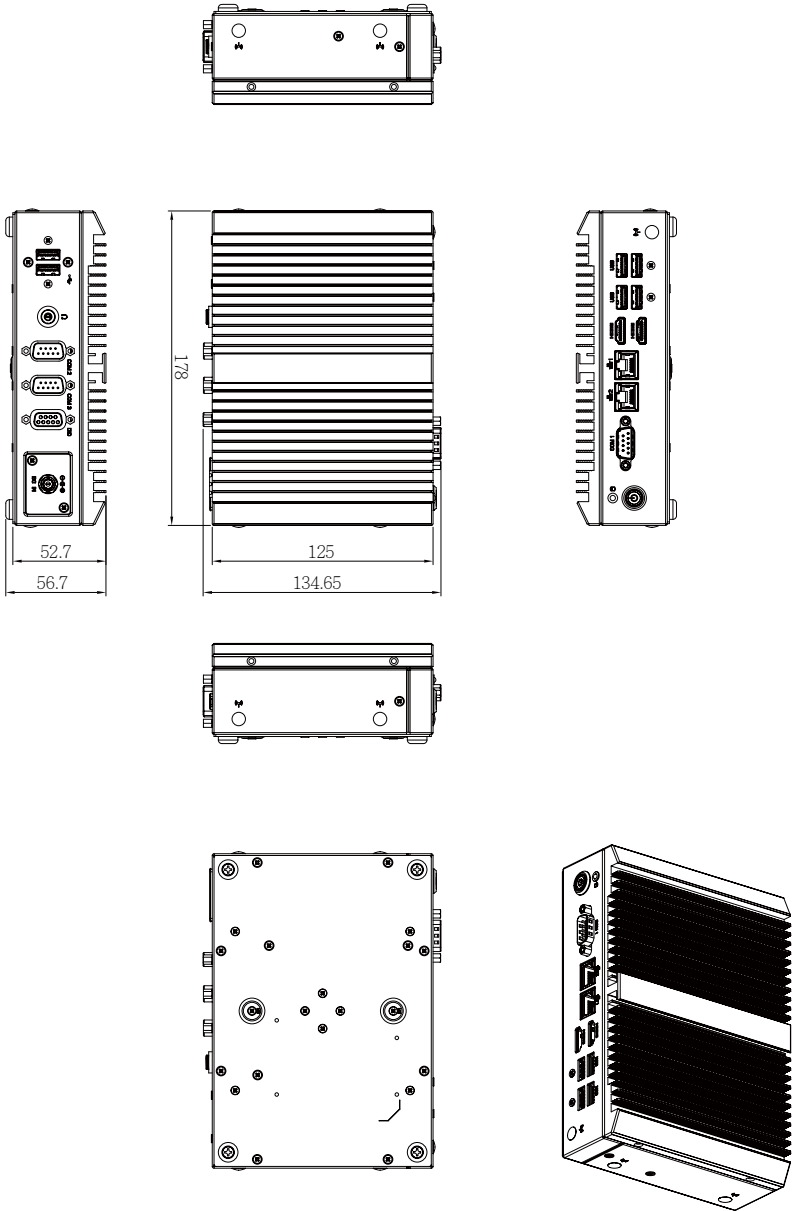

2.2 Getting Familiar with Your Unit

[Front Side]

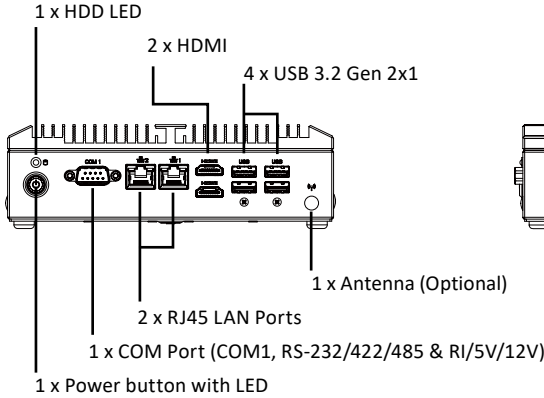

[Left Side]

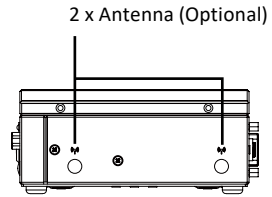

[Rear Side]

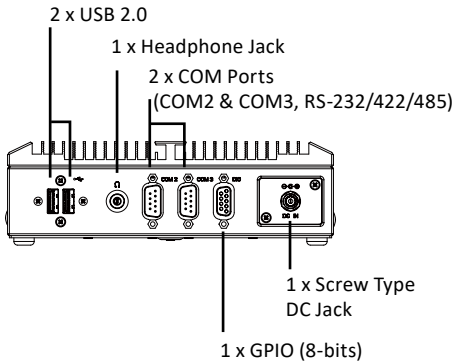

[Right Side]

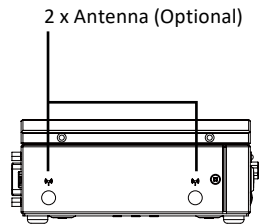

[Install]

- * Before opening the case, make sure to unplug the power cord.
- * Before Connecting the power, make sure to fasten the case securely.

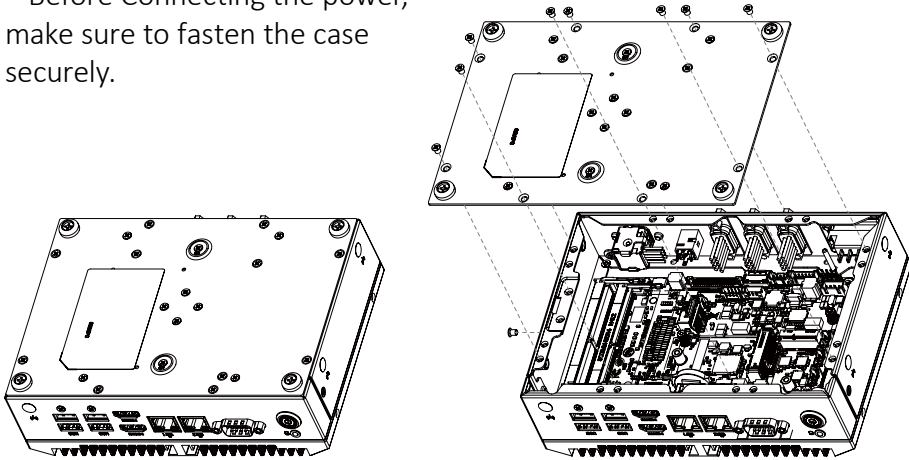

[Bottom PCB Side]

Information	
A	2 x DDR4 SO-DIMM sockets
B	1 x Mini PCIe slot with SIM Slot

Information	
C	1 x M.2 slot 2280 M-key
D	1 x M.2 slot 2230 E-key
E	support 2.5" Hard drive/SSD

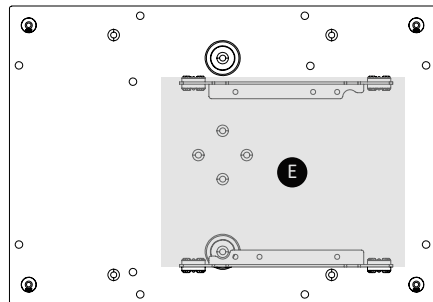
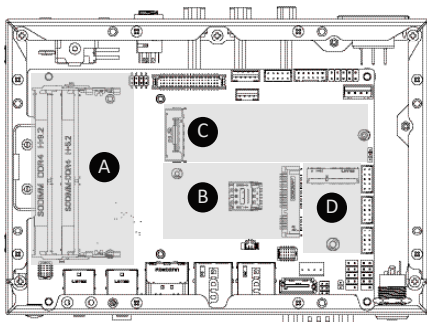

2.3 A) Memory Installation: DDR4 SO-DIMM

1

Carefully insert SO-DIMM memory modules.

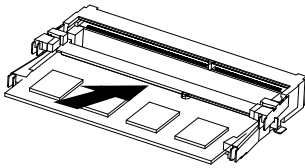
**2**

Push down until the modules click into place.

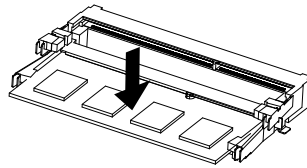
**3**

Carefully insert SO-DIMM memory modules.

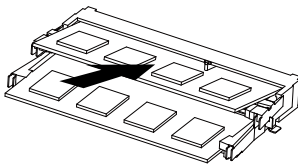
**4**

Push down until the modules click into place.

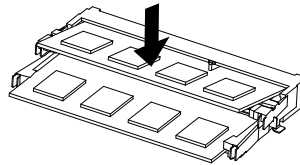

2.4 B) Mini PCIe Card Installation: How to safely install the Mini PCIe Card

1

Remove the screw from the screw hole (Location : MSO4)

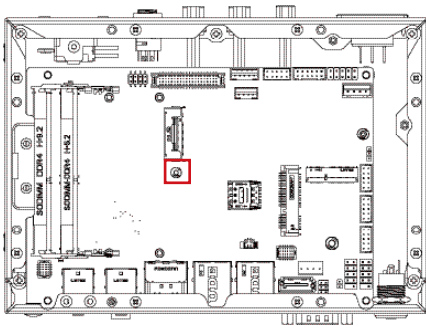

2

Carefully insert the Mini PCIe Card into the slot.

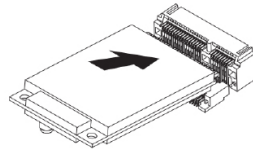

3

Secure the Mini PCIe Card with screw.

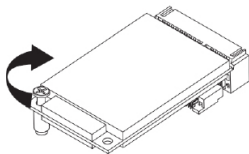

2.5 C) M.2 SSD Installation: How to safely install the M.2 2280 SSD

1

Remove the screw from the screw hole (Location : MSO2)

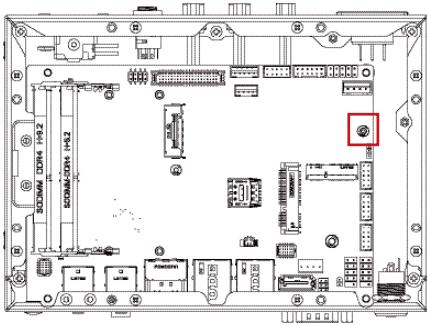
**2**

Carefully insert the M.2 SSD into the slot, and secure with the screw.

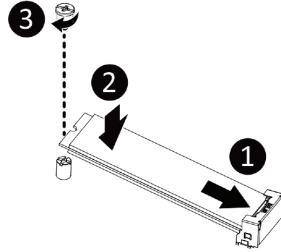

2.6 D) Wireless Module: How to safely install the Module (Wireless Module inclusion may vary based on local distribution)

1

Carefully insert the wireless module into the M.2 slot

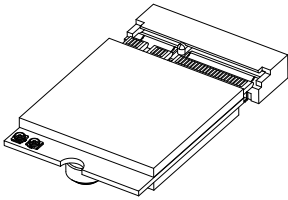

2

Lock the screw in the middle.

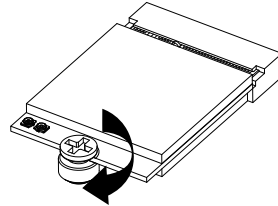

3

Install the antenna on the left side of the connection wireless module down.

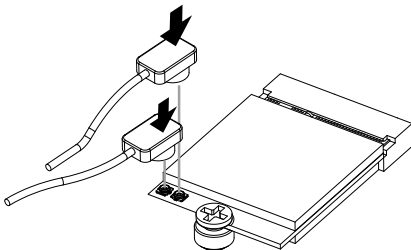

2.7 E) 2.5" HDD/SSD installation: How to install 2.5" HDD/SSD

- 1 Remove 3 screws to remove the bracket. (Corresponding 3 screw locations can be found in the bottom right drawing.)
- 2 First : assemble the SATA cable and 2.5" HDD/SSD.
Second : remove 2 release papers on the thermal pad which located on the bottom cover.
Third : install 2.5" HDD/SSD (Gold finger of 2.5" HDD/SSD must face down), and secure with 4 screws.
Fourth : install the bracket back with 3 screws.
- 3 Assemble the SATA cable on the SATA connector, and lock the bottom cover.

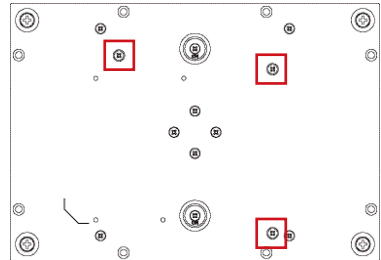
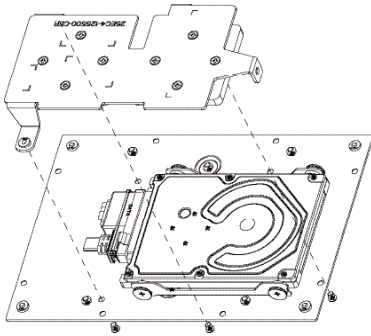

2.8 Antenna Installation (Antenna inclusion may vary based on local distribution)

1

Carefully insert the antennas into the connectors.

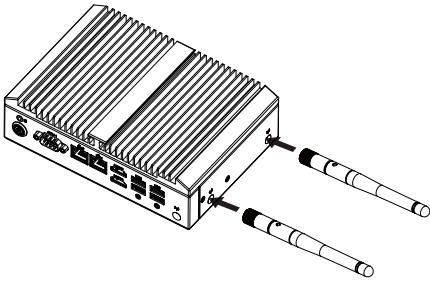

2

Turn the antennas clockwise until they are completely secure on the connectors.

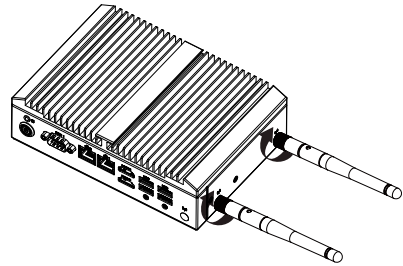

3

Flip up the antenna heads so that they are perpendicular to the machine.

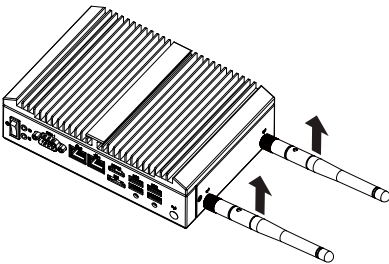

2.9 Cable Pin-define

1. DB9 COM (25CF8-210620-S9R)

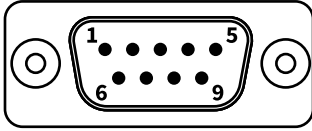

DB9 Pin Define

DB9 Pin	RS-232	RS-422 Full Duplex	RS-485 Half Duplex
1	DCD	TXD-	D-
2	RXD	TXD+	D+
3	TXD	RXD+	-
4	DTR	RXD-	-
5	GND		
6	DSR	-	-
7	RTS	-	-
8	CTS	-	-
9	RI	-	-

2. DBP DIO (25CR5-150606-S9R)

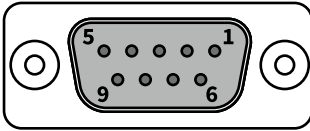

DBP DIO Pin	Pin Name
1	GPIO-output_1
2	GPIO-input_1
3	GPIO-output_2
4	GPIO-input_2
5	GPIO-output_3
6	GPIO-input_3
7	GPIO-output_4
8	GPIO-input_4
9	5V

2.10 Support

- For a list of tested memory, M.2, 2.5" SSD, wireless adapters and OS supported, go to: <http://www.gigaipc.com>
- To download the latest drivers and BIOS updates, go to: <http://www.gigaipc.com>
- For product support, go to: <http://www.gigaipc.com>

2.11 Safety and Regulatory Information

Risk of explosion if the battery is replaced with an incorrect type. Batteries should be recycled where possible.

Disposal of used Batteries must be in accordance with local environmental regulations.

Failure to use the included Power Adapter may violate regulatory compliance and may expose the user to safety hazards.

HDMI™
HIGH DEFINITION MULTIMEDIA INTERFACE



At the end of its serviceable life, this product should not be treated as household or general waste. It should be handed over to the applicable collection point for the recycling of electrical and electronic equipment, or returned to the supplier for disposal.

Chapter 3

Chapter 3 – Hardware Information

3.1 Jumpers and Connectors

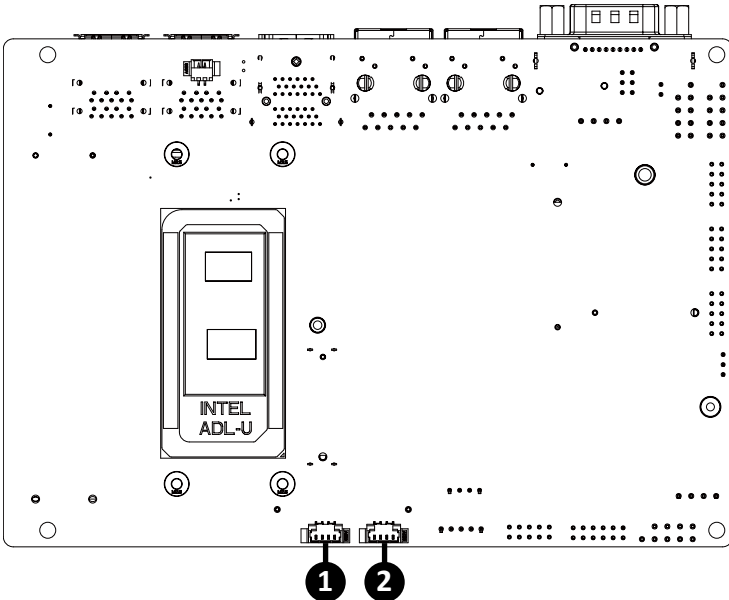
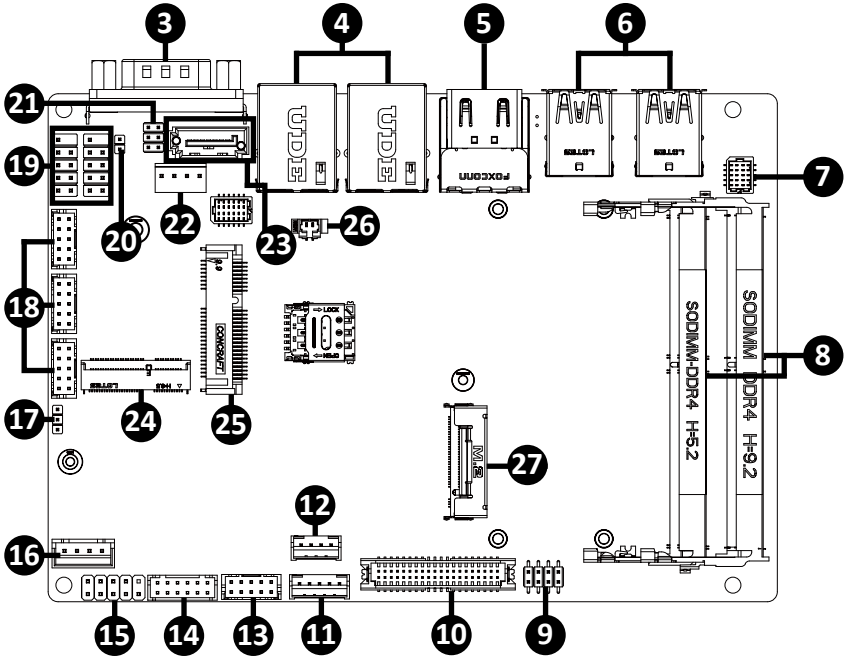

No	Code	Description
1	CPU_FAN	CPU fan connector
2	SYS_FAN	System fan connector
3	COM1	Serial port connector (RS-232/422/485 & RI/5V/12V)
4	LAN1, LAN2	2.5GbE LAN connector
5	HDMI2_21	HDMI connector
6	USB32_1 USB32_2	USB 3.2 Gen 2x1 connector
7	TPM_SPI	Trusted Platform Module connector
8	SODIMM1 SODIMM2	DDR4 SO-DIMM Slot
9	LSW	LVDS resolution jumper
10	LVDS	LVDS connector
11	BKL_CN	Backlight control header
12	SPK_OUT	Speaker out connector
13	FP_AUDIO	Front Audio connector
14	GPIO_CNT	General purpose input / ouput header
15	SYS_PANEL	Front panel header
16	DC_IN	DC IN 1x4 pin power connector
17	AT_CN	AT/ATX mode select jumper
18	COM2, COM3, COM4	Serial port header (RS-232/422/485)
19	FUSB1, FUSB2	USB 2.0 headers
20	ME_DIS	ME Disable jumper

No	Code	Description
21	JCOM1	RI# pin RI#/5V/12V Select jumper for COM1 port
22	SATAPWR	SATA power connector
23	SATA0	SATA 6Gb/s connector
24	M2E	M.2 Slot , 2230 E-key
25	MPCIE	Mini PCIe Slot
26	BATTERY	Battery cable connector
27	M2M_CPU	M.2 Slot , 2280 M-key

3.2.1 CPU_FAN (CPU fan connector)

1

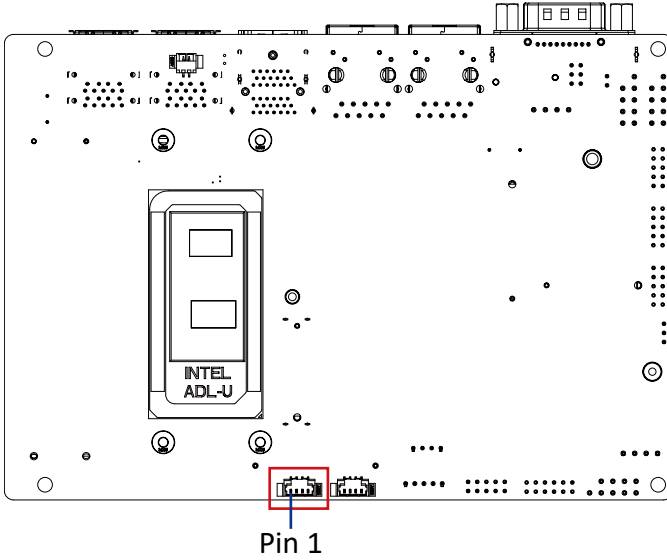

CPU fan Connector

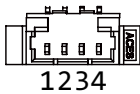

1 2 3 4

Connector PN

85205-0470N

A1250WV-S-04PC

Vendor

ACES

JOINT-TECH

Pin No.	Definition
1	GND
2	12V
3	Detect
4	Speed control

3.2.2 SYS_FAN (System fan connector)

2

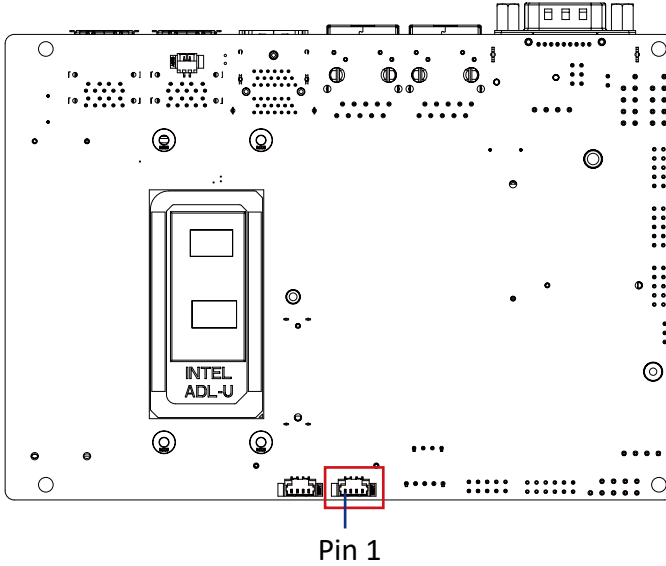

System fan Connector	
	
1234	

Connector PN	Vendor
85205-0470N	ACES
A1250WV-S-04PC	JOINT-TECH

Pin No.	Definition
1	GND
2	12V
3	Detect
4	Speed control

3.2.3 COM1 (Serial port connector, (RS-232/422/485 & RI/5V/12V))

3

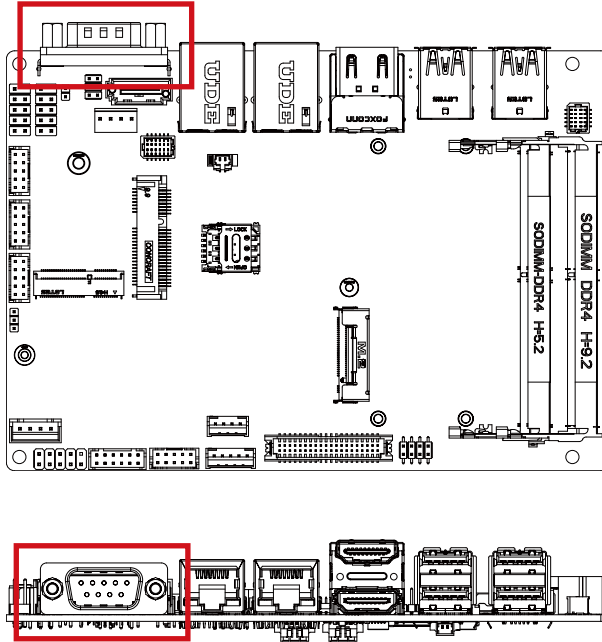

Serial Port Connector

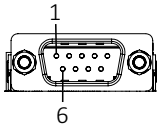

Connector PN

SM41D1P1122N33N1

Vendor

FENYING

Pin No.	RS-232	RS-422 Full Duplex	RS-485 Half Duplex
1	DCD	TXD-	D-
2	RXD	TXD+	D+
3	TXD	RXD+	-
4	DTR	RXD-	-
5	GND		
6	DSR	-	-
7	RTS	-	-
8	CTS	-	-
9	RI	-	-

3.2.4 LAN1, LAN2 (2.5GbE LAN connector)

4

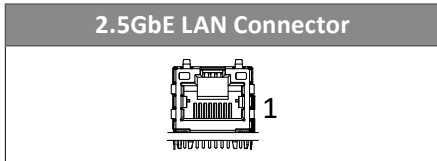
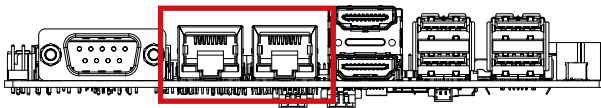
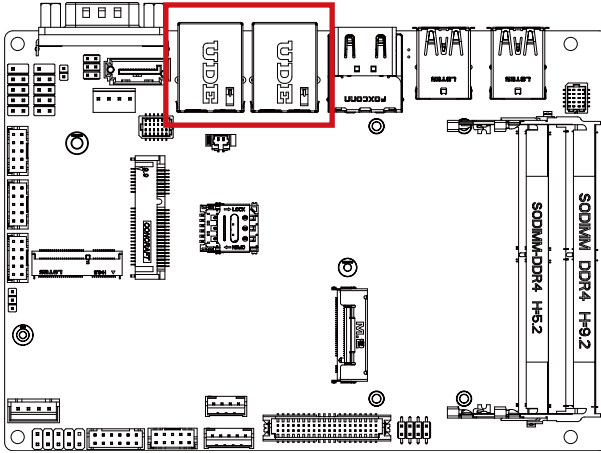

State	Description
Yellow On	2.5Gbps data rate
Green On	1Gbps data rate
Off	100Mbps data rate
	10Mbps data rate

Pin No.	Definition
1	BI_DA+
2	BI_DA-
3	BI_DB+
4	BI_DC+
5	BI_DC-
6	BI_DB-
7	BI_DD+
8	BI_DD-

Connector PN	Vendor
RB1-GB-0009	UDE

3.2.5 HDMI2_21 (HDMI connector)

5

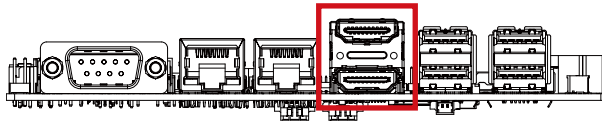
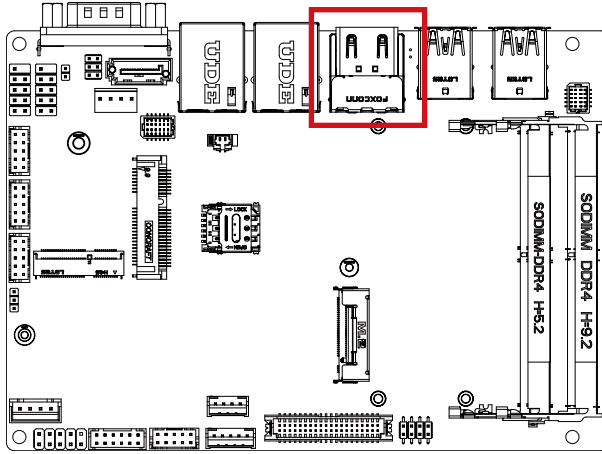

HDMI Connector

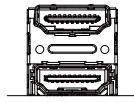

Connector PN

QJ11191-DFB1-4F

Vendor

FOXCONN

Pin No.	Definition	Pin No.	Definition
1	TX2p	11	GND
2	GND	12	CLKn
3	TX2n	13	NC
4	TX1p	14	NC
5	GND	15	SCL
6	TX1n	16	SDA
7	TX0p	17	GND
8	GND	18	5V
9	TX0n	19	Hot Plug Detect
10	CLKp		

3.2.6 USB32_1, USB32_2 (USB 3.2 Gen 2x1 connector)

6

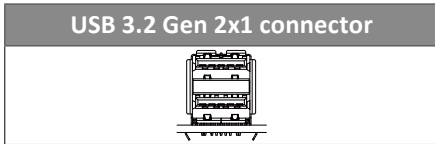
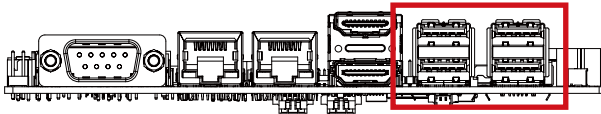
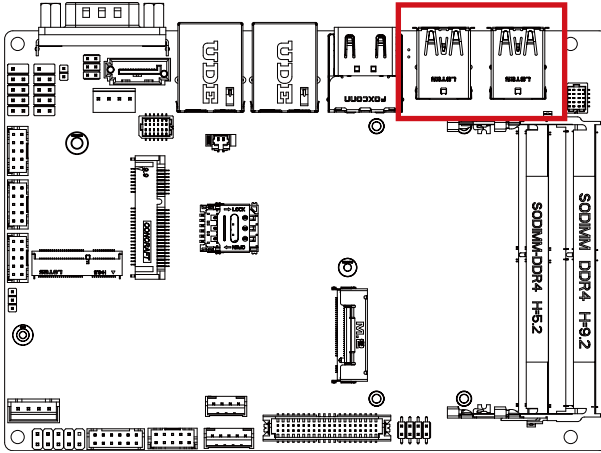

Connector PN	Vendor
18-A5950-6A33-A	TCONN

Pin No.	Definition	Pin No.	Definition
1	USB_D1n	10	USB_D2n
2	USB_D1p	11	USB_D2p
3	USB_Dp	12	USB_Dp
4	GND	13	GND
5	USB3_RX1n	14	USB3_RX2n
6	USB3_RX1p	15	USB3_RX2p
7	GND	16	GND
8	USB3_TX1n	17	USB3_TX2n
9	USB3_TX1p	18	USB3_TX2p

3.2.7 TPM_SPI (Trusted Platform Module Connector)

7

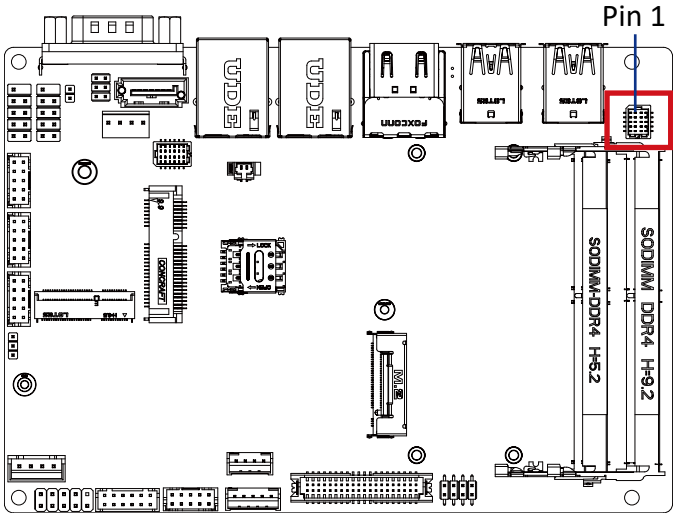

TPM Module Connector

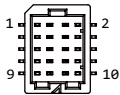

Connector PN

87216-1004-06

Vendor

ACES

Pin No. Definition

Pin No.	Definition
1	TPM_CLK
2	GND
3	SPI_CS#2
4	TPM_SO
5	TPM_RST#
6	TPM_SI
7	NC
8	NC
9	+V3.3A
10	GND

3.2.8 SODIMM1, SODIMM2 (DDR4 SO-DIMM Slot)

8

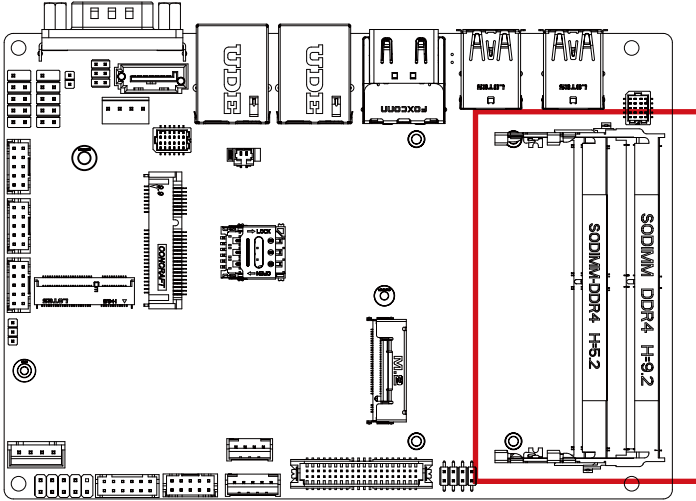

3.2.9 LSW (LVDS resolution jumper)

9

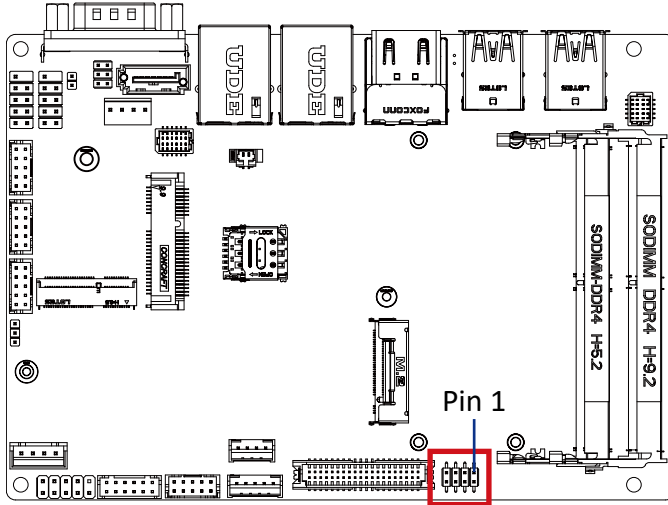

LVDS Resolution Jumper			
Jumper Setting	Resolution	Jumper Setting	Resolution
	800 x 600 18bit		1366 x 768 24bit
	1024 x 768 18bit		1440 x 900 24bit
	1024 x 768 24bit		1400 x 1050 24bit
	1024 x 600 18bit		1600 x 900 24bit
	1280 x 800 18bit		1680 x 1050 24bit
	1280 x 960 18bit		1600 x 1200 24bit
	1280 x 1024 24bit		1920 x 1080 24bit
	1366 x 768 18bit		1920 x 1200 24bit

Connector PN	Vendor
222-97-04GBE1	PINREX

3.2.10 LVDS (LVDS connector)

10

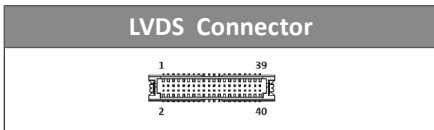
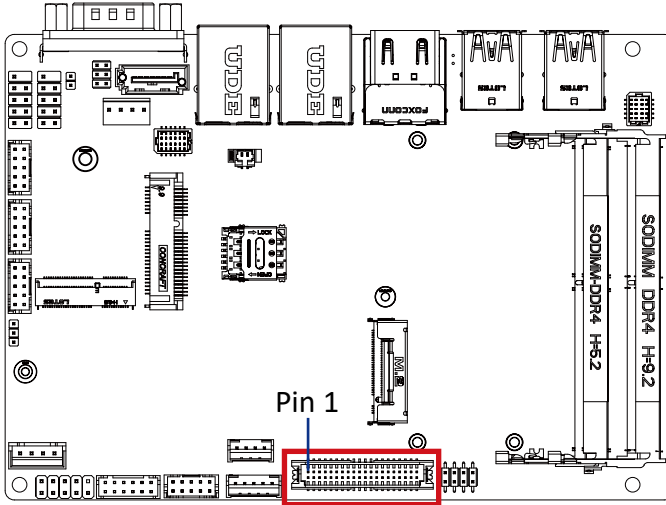

Pin No.	Definition	Pin No.	Definition
1	3.3V	21	A5+
2	5V	22	A4+
3	3.3V	23	A5-
4	5V	24	A4-
5	SPECO	25	GND
6	SPEDO	26	GND
7	GND	27	A7+
8	GND	28	A6+
9	A1+	29	A7-
10	A0+	30	A6-
11	A1-	31	GND
12	A0-	32	GND
13	GND	33	CLK2+
14	GND	34	CLK1+
15	A3+	35	CLK2-

Pin No.	Definition	Pin No.	Definition
16	A2+	36	CLK1-
17	A3-	37	GND
18	A2-	38	GND
19	GND	39	12V
20	GND	40	12V

Connector PN	Vendor
712-76-40GWE0	PINREX
A1252WV-SF-2X20PD01	JOINT-TECH

For each model support LVDS function.
 But below model no need to add.
 A0~A3 is odd channel 0~3, A4~A7 is even channel.

Note: *The LVDS output connector of the unit is only intended to be connected to an UL/IEC/EN approval equipment with fire enclosure.

3.2.11 BKL_CN (Backlight control header)

11

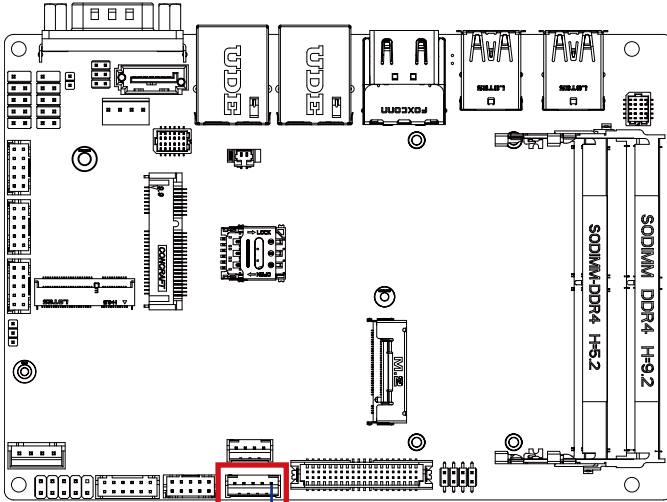

Pin 1

Backlight control header

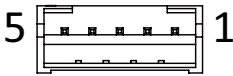

Connector PN

721-81-05TW00

A2001WV-05P146

Vendor

PINREX

JOINT-TECH

Pin No.

Definition

1	5V
2	PWM
3	Back Light Enable
4	GND
5	12V

3.2.12 SPK_OUT (Speaker out connector)

12

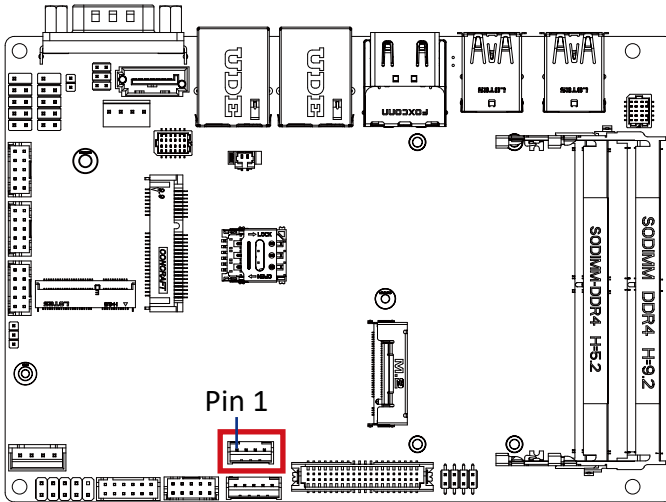

Audio Amplifie Connector	
	
1	

Connector PN	Vendor
721-81-045W00	PINREX
A2001WV-04P146	JOINT-TECH

Pin No.	Definition
1	Speaker Out L+
2	Speaker Out L-
3	Speaker Out R-
4	Speaker Out R+

3.2.13 FP_AUDIO (Front Audio connector)

13

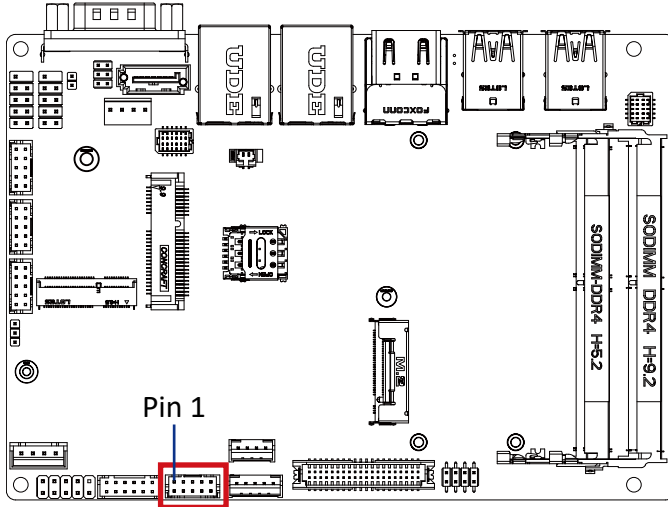

Front Audio Connector

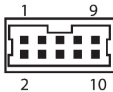

Connector PN

725-81-10TW00

A2004WV-2X05P46

Vendor

PINREX

JOINT-TECH

Pin No.	Definition	Pin No.	Definition
1	MIC_L	6	MIC_JD
2	GND	7	FAUDIO_JD
3	MIC_R	8	No Connect
4	Detect	9	HPOUT_L
5	HPOUT_R	10	GND

3.2.14 GPIO_CNT (General Purpose input/output header)

14

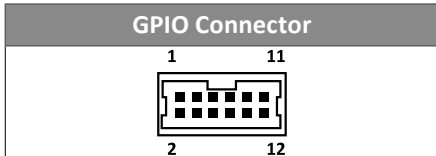
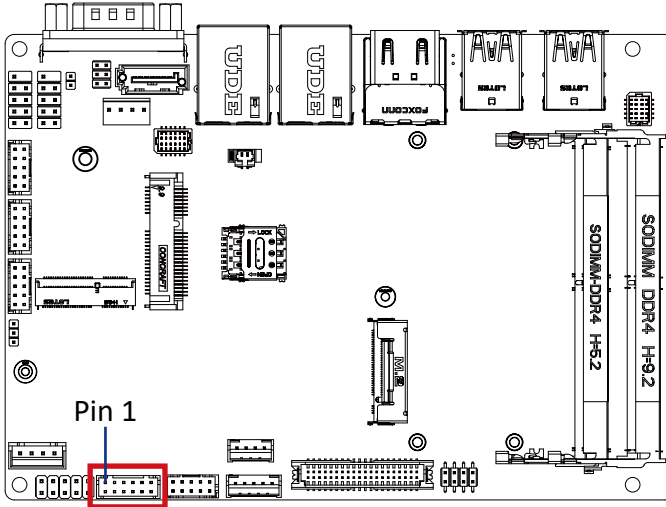

Pin No.	Definition
1	GPIO-output_1
2	GPIO-input_1
3	GPIO-output_2
4	GPIO-input_2
5	GPIO-output_3
6	GPIO-input_3
7	GPIO-output_4
8	GPIO-input_4
9	SMBus Clock

Pin No.	Definition
10	SMBus DATA
11	5V
12	GND

Connector PN	Vendor
725-81-12TW00	PINREX
A2004WV-2X06P46	JOINT-TECH

3.2.15 SYS_PANEL (Front panel header)

15

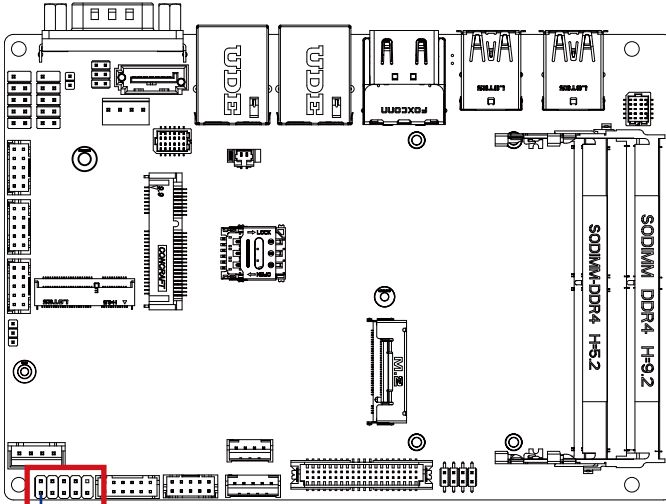

Pin 1

System Panel Header



Connector PN

210-92-05GW5W

Vendor

PINREX

Pin No.	Definition
1	HDD LED+
2	Power LED+
3	HDD LED-
4	Power LED-
5	GND
6	Power Button+
7	Reset Button
8	Power Button-
9	No Connect
10	No Pin

3.2.16 DC_IN (DC IN 1x4 pin power connector)

16

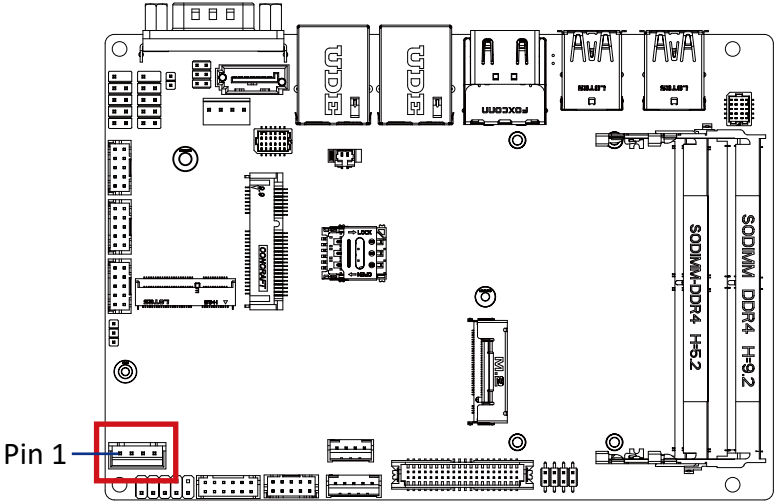

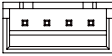
DC IN connector	
 1 2 3 4	
Pin No.	Definition
1	GND
2	Power
3	Power
4	GND

Connector PN	Vendor
753-81-04TW00	PINREX

3.2.17 AT_CN (AT/ATX mode select jumper)

17

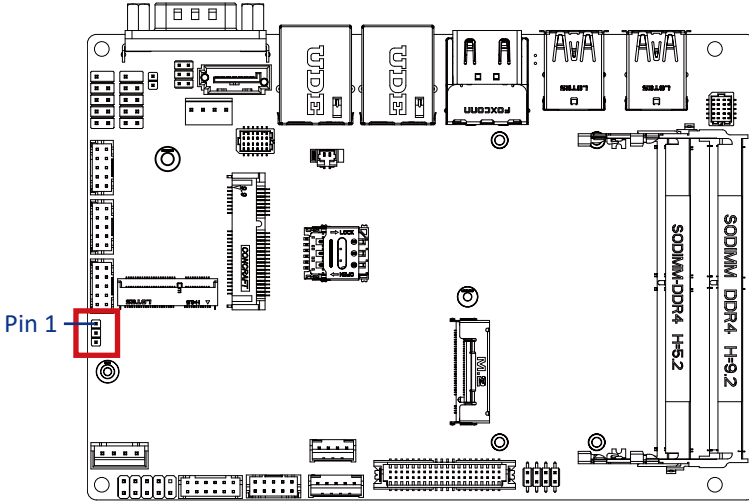

AT/ATX mode select jumper



Connector PN

220-96-03GB001K

Vendor

PINREX

Pin No.	Definition
1	AT MODE
2	TXD5
3	ATX MODE

Jumper setting

1-2 Close : AT mode.

2-3 Close : ATX mode.(Default setting)

3.2.18 COM2, COM3, COM4 (Serial port header, RS-232/422/485)

18

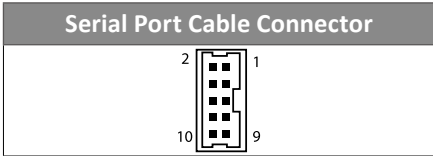
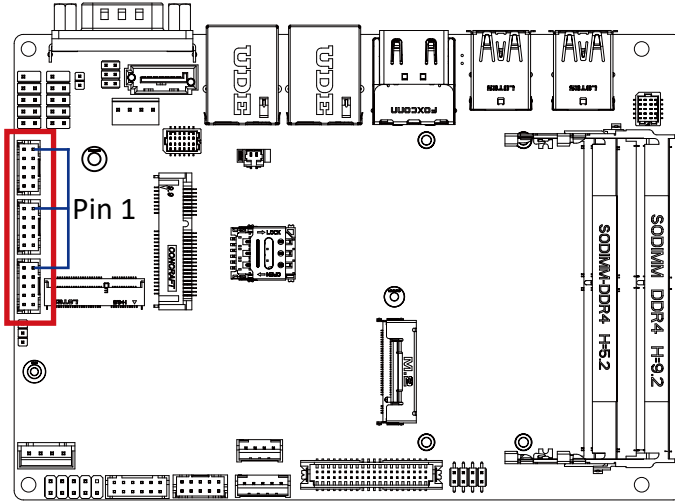

Connector PN	Vendor
725-81-10TW00	PINREX
A2004WV-2X05P46	JOINT-TECH

Pin No.	RS-232	RS-422 Full Duplex	RS-485 Half Duplex
1	RXD	TXD+	D+
2	DCD	TXD-	D-
3	DTR	RXD-	—
4	TXD	RXD+	—
5	DSR	—	—
6	GND	—	—
7	CTS	—	—
8	RTS	—	—
9	No Connect	—	—
10	RI/5V/12V	—	—

3.2.19 FUSB1, FUSB2 (USB 2.0 headers)

19

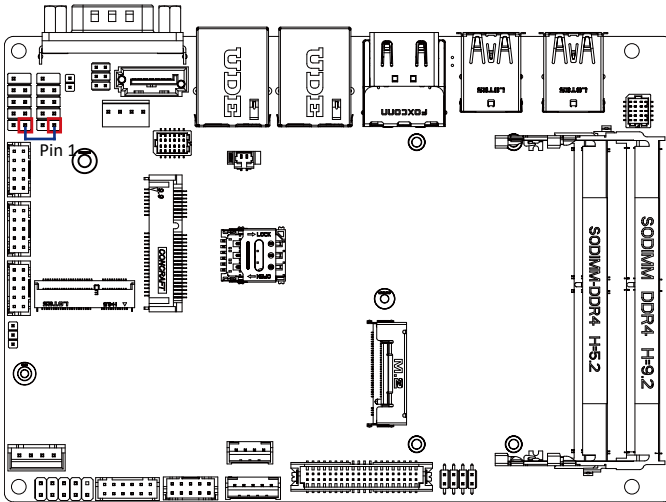

USB 2.0 Header



Connector PN

210-92-05GB04

PH10R53BAZ009

Vendor

PINREX

HORNGTONG

Pin No.

Definition

Pin No.	Definition
1	5V
2	5V
3	DX-
4	DY-
5	DX+
6	DY+
7	GND
8	GND
9	No Pin
10	No Connect

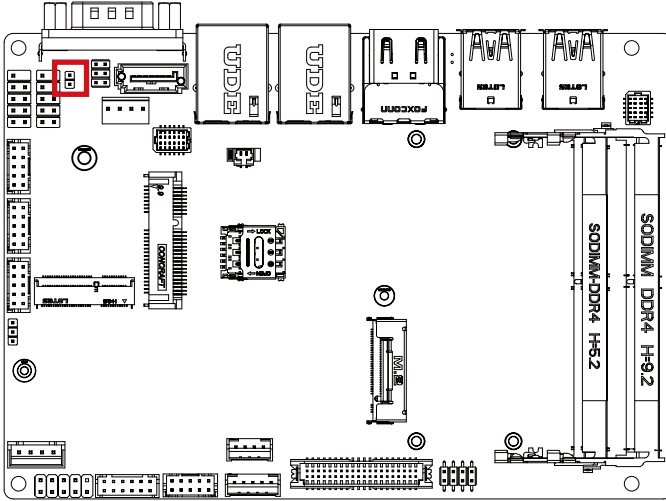

3.2.20 ME_DIS (ME Disable jumper)

20



ME Disable Connector	
	

Connector PN	Vendor
220-96-02GBK1	PINREX

ME Disable jumper	
	Default
	Enable

3.2.21 JCOM1 (RI# pin RI#/5V/12V Select jumper for COM1 port)

21

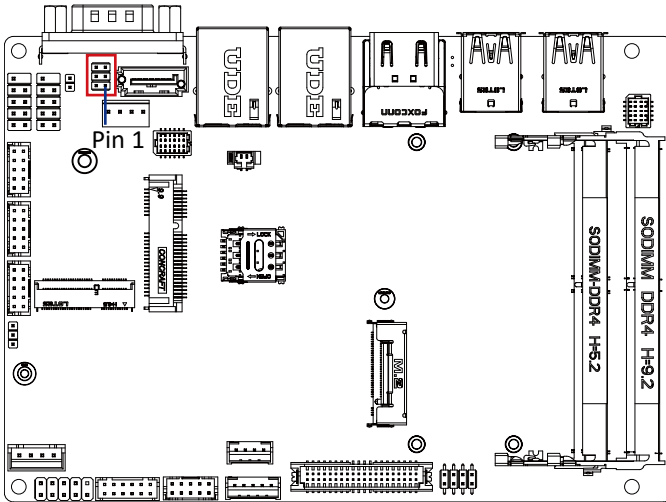



JCOM1 Jumper Select	
<p>6 5 2 1</p>	1-2 Close: 5V (Power COM)
<p>6 5 2 1</p>	3-4 Close: RI (Stand COM) (Default-Setting)
<p>6 5 2 1</p>	5-6 Close: 12V (Power COM)

Connector PN	Vendor
220-97-03GB01	PINREX
PH06N53BAZ000	HORNGTONG

3.2.22 SATAPWR (SATA power connector)

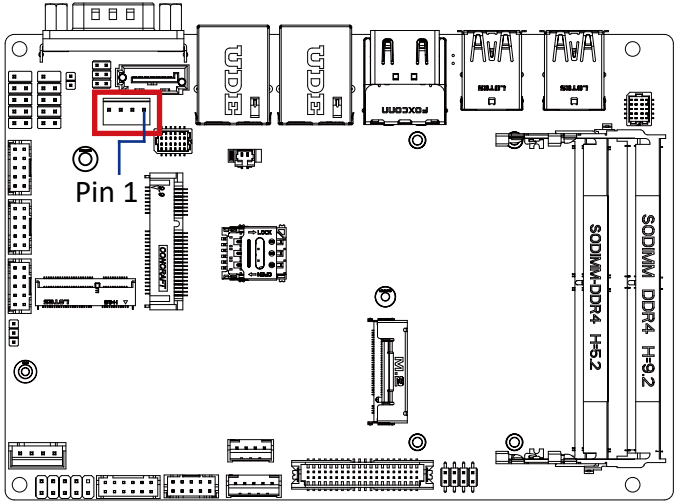
22



Hard Disk Power Connector	
4	

Connector PN	Vendor
743-81-04TW00	PINREX

Pin No.	Definition
1	12V
2	GND
3	GND
4	5V

3.2.23 SATA0 (SATA 6Gb/s connector)

23

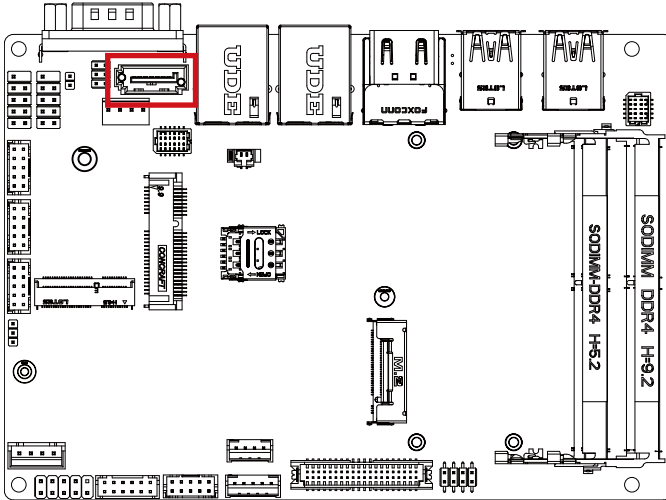

SATA Connector



Connector PN

WATF-07DBLBA1UW

Vendor

WINWIN

Pin No. Definition

Pin No.	Definition
1	GND
2	TXp
3	TXn
4	GND
5	RXn
6	RXp
7	GND

3.2.24 M2E (M.2 Slot, 2230 E-key)

24

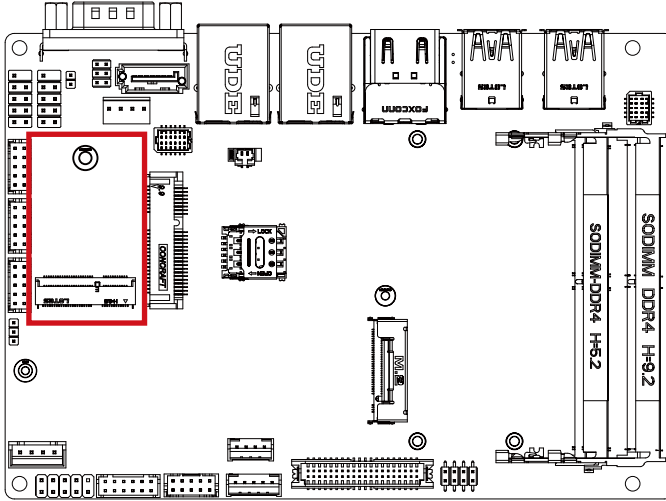

M.2 E Key Connector



Pin No.	Definition	Pin No.	Definition
1	GND	2	3.3V
3	D1p	4	3.3V
5	D1n	6	NC
7	GND	8	NC
9	NC	10	NC
11	NC	12	NC
13	NC	14	NC
15	NC	16	NC
17	NC	18	GND
19	NC	20	NC
21	NC	22	NC
23	NC		

Pin No.	Definition	Pin No.	Definition
33	GND	32	NC
35	PCIE_TXp	34	NC
37	PCIE_TXn	36	NC
39	GND	38	CL_RST

41	PCIE_RXp	40	CL_DATA
43	PCIE_RXn	42	CL_Clock
45	GND	44	NC
47	PCIE_CLOCKp	46	NC
49	PCIE_CLOCKn	48	NC
51	GND	50	SUSCLK
53	PCIE Clock Request	52	PCIRST
55	PCIE wake up	54	BT_Disable
57	GND	56	WLAN_DISABLE
59	NC	58	NC
61	NC	60	NC
63	GND	62	NC
65	NC	64	NC
67	NC	66	NC
69	GND	68	NC
71	NC	70	NC
73	NC	72	3.3V
75	GND	74	3.3V

Connector PN	Vendor
80152-8521	BELLWETHER
APCI0095-P002A	LOTES

3.2.25 MPCIE (Mini PCIe Slot)

25

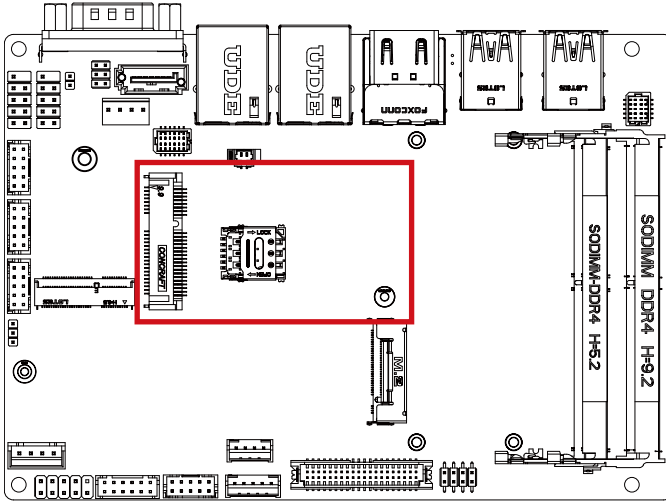

Mini PCIe Connector

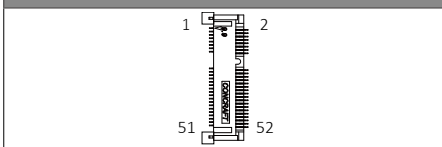

Pin No.	Definition	Pin No.	Definition
1	PCIE WAKE	2	3.3V
3	NC	4	GND
5	NC	6	NC
7	PCIE Clock Request	8	SIM PWR
9	GND	10	SIM DATA
11	PCIE Clock n	12	SIM Clock
13	PCIE Clock p	14	SIM Reset
15	GND	16	UIM VPP3
17	NC	18	GND
19	NC	20	WLAN_DISABLE
21	GND	22	Reset

Pin No.	Definition	Pin No.	Definition
23	PCIE RXn	24	3.3V
25	PCIE RXp	26	GND
27	GND	28	NC
29	GND	30	SMB Clock
31	PCIE TXn	32	SMB DATA
33	PCIE TXp	34	GND
35	GND	36	USB Dn
37	GND	38	USB Dp
39	3.3V	40	GND
41	3.3V	42	NC
43	GND	44	NC
45	NC	46	NC
47	NC	48	NC
49	NC	50	GND
51	NC	52	3.3V

Connector PN	Vendor
A50B221-S99Q-7H	FOXCONN

3.2.26 BATTERY (Battery cable Connector)

26

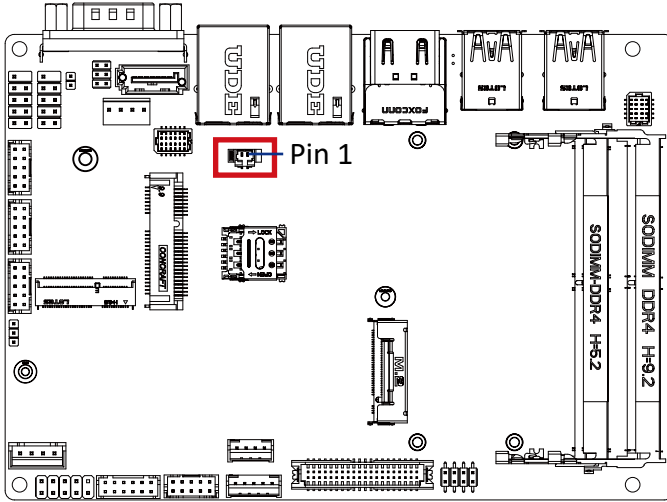

Battery cable Connector	

Connector PN	Vendor
85205-0270L	ACES
A1250WV-S-02PC	JOINT-TECH

Pin No.	Definition
1	3.3V
2	GND

3.2.27 M2M_CPU (M.2 Slot, 2280 M-key)

27

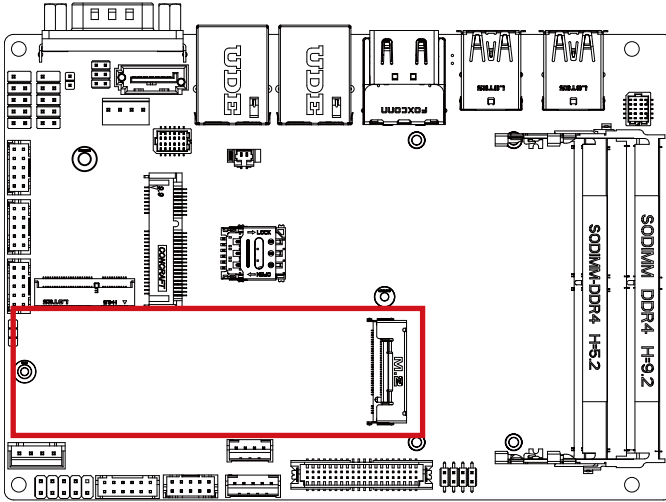

M.2 M Key Connector



Pin No.	Definition	Pin No.	Definition
1	GND	2	3.3V
3	GND	4	3.3V
5	NC	6	NC
7	NC	8	NC
9	GND	10	SSD LED
11	NC	12	3.3V
13	NC	14	3.3V
15	GND	16	3.3V
17	NC	18	3.3V
19	NC	20	NC
21	GND	22	NC
23	NC	24	NC
25	NC	26	NC
27	GND	28	NC
29	PCIE1 RXn	30	NC
31	PCIE1 RXp	32	NC
33	GND	34	NC

Pin No.	Definition	Pin No.	Definition
35	PCIE2 TXn	36	NC
37	PCIE2 TXp	38	DEVSLP
39	GND	40	SMB Clock
41	PCIE0 RXn/SATA Bp	42	SMB Data
43	PCIE0 RXp/SATA Bn	44	SMB Alert
45	GND	46	NC
47	PCIE0 TXn/SATA An	48	NC
49	PCIE0 TXp/SATA Ap	50	PCI Reset
51	GND	52	PCIe Clock Request
53	PCIe Clock n	54	PCIe Wake#
55	PCIe Clock p	56	NC
57	GND	58	NC

Pin No.	Definition	Pin No.	Definition
67	NC	68	SUSCLK
69	Detect	70	3.3V
71	GND	72	3.3V
73	GND	74	3.3V
75	GND		

Connector PN	Vendor
2E0BC41-C85CM-LH	FOXCONN

Chapter 4

Chapter 4 – BIOS

4.1 Introduction

BIOS (Basic input/output system) provides hardware detailed information and boot-up options, which include firmware to control, set-up and test all hardware settings. Therefore, BIOS is the communication bridge between OS/application software and hardware.

4.1.1 How to Entering into BIOS menu

Once the system is power on, press the key as soon as possible to access into BIOS Setup program.

4.1.2 Function Keys to setup in BIOS Setup program

Function keys	Description
→←	Select Screen
↑↓	Select Item
Enter	Execute command or enter the submenu
+	Increase the numeric value or make changes
—	Decrease the numeric value or make changes
F1	General Help
F2	Previous Values
F3	Load Optimized Defaults Settings
F4	Save changes & Exit the BIOS Setup program
ESC	Exit the BIOS Setup program

4.2 The Main Menu

The main menu shows the basic system information. Use arrow keys to move among the items.



Items	Description
Project Name	Shows Project name information
BIOS Version	Shows the BIOS version of the system
Build Date and Time	Shows the Build Date and Time when the BIOS was created.
LAN1 MAC Address	Shows LAN1 MAC Address information
LAN2 MAC Address	Shows LAN2 MAC Address information
Total Memory	Shows the total memory size of the installed memory
ME FW version	Shows ME firmware version
System Date	Set the Date for the system (Format : Week - Month - Day - Year)
System Time	Set the time for the system (Format : Hour - Minute - Second)

4.3 Advanced

The Advanced menu is to configure the functions of hardware settings through submenu. Use arrow keys to move among the items, and press <Enter> to access into the related submenu.

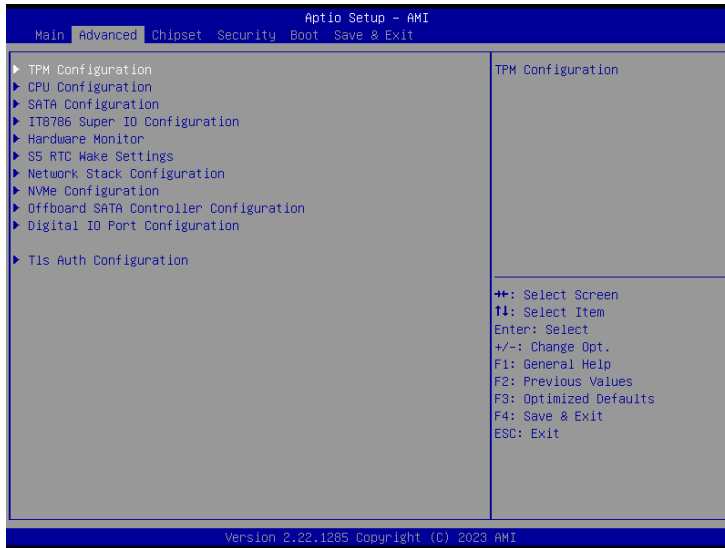

4.3.1 TPM Configuration

Use TPM Configuration submenu to choose TPM interface.



Item	Description
TPM Device Selection	PTT : Internal TPM (Default setting) dTPM : External TPM (When using External TPM module or having TPM chip on MB)

Trusted Computing : Shows TPM information, and TPM module configuration setting.



Item	Description
Security Device support	Enabled : Enables TPM feature (Default setting) Disabled : Disables TPM feature
Pending operation	None : No execution will be conducted (Default setting) TPM clear : Set to clear data on TPM

4.3.2 CPU Configuration

This submenu shows detailed CPU informations.

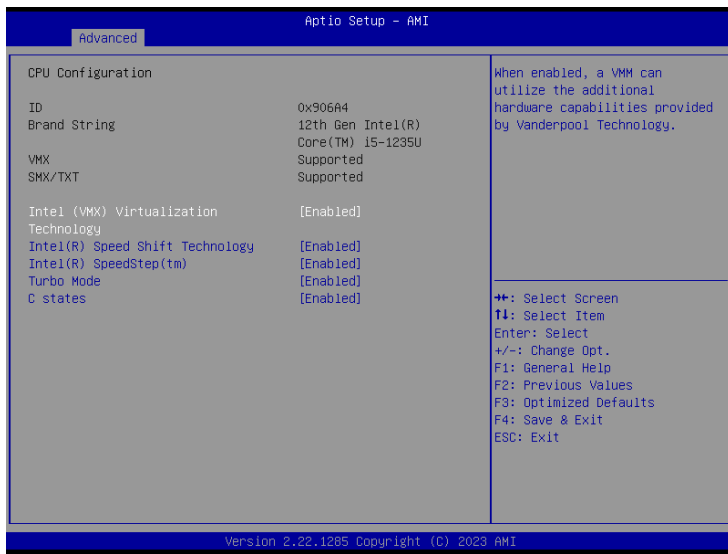

Item	Description
Intel (VMX) Virtualization Technology	Virtualization enhanced by Intel® Virtualization Technology will allow a platform to run multiple operating systems and applications in independent partitions. With virtualization, one computer system can function as multiple virtual systems. Enabled : Enables Intel Virtualization Technology (Default setting) Disabled : Disables Intel Virtualization Technology
Intel(R) Speed Shift Technology	To speed up CPU frequency transition time from basic frequency to maximum frequency. Enabled : Enables Intel(R) Speed Shift Technology Interrupt control (Default setting) Disabled : Disables Intel(R) Speed Shift Technology Interrupt control
Intel(R) SpeedStep(tm)	According to Intel CPU loading, Intel SpeedStep Technology will automatically adjust the CPU voltage and core frequency to decrease heat and power consumption for power saving. Enabled : Enables Intel SpeedStep Technology (Default setting) Disabled : Disables Intel SpeedStep Technology
Turbo Mode	Enabled : Enables Turbo Mode (Default setting) Disabled : Disables Turbo Mode
C states	Command CPU to enter into low power consumption mode when CPU is under idle mode. Enabled : Enables C states (Default setting) Disabled : Disables C states

4.3.3 SATA Configuration

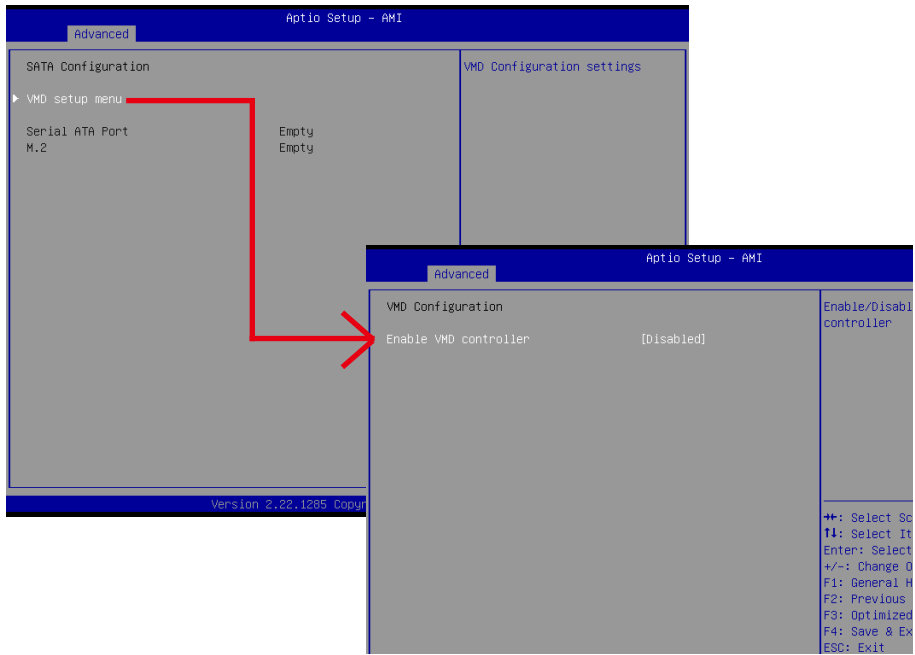

Item	Description
VMD setup menu / Enable VMD controller	Intel VMD feature helps you to control and manage NVMe PCIe SSD. Enabled : Enables Intel VMD feature Disabled : Disables Intel VMD feature (Default setting)
Serial ATA Port	shows 2.5" SATA HDD/SSD information
M.2	shows M.2 SATA interface SSD information

4.3.4 IT8786 Super IO Configuration

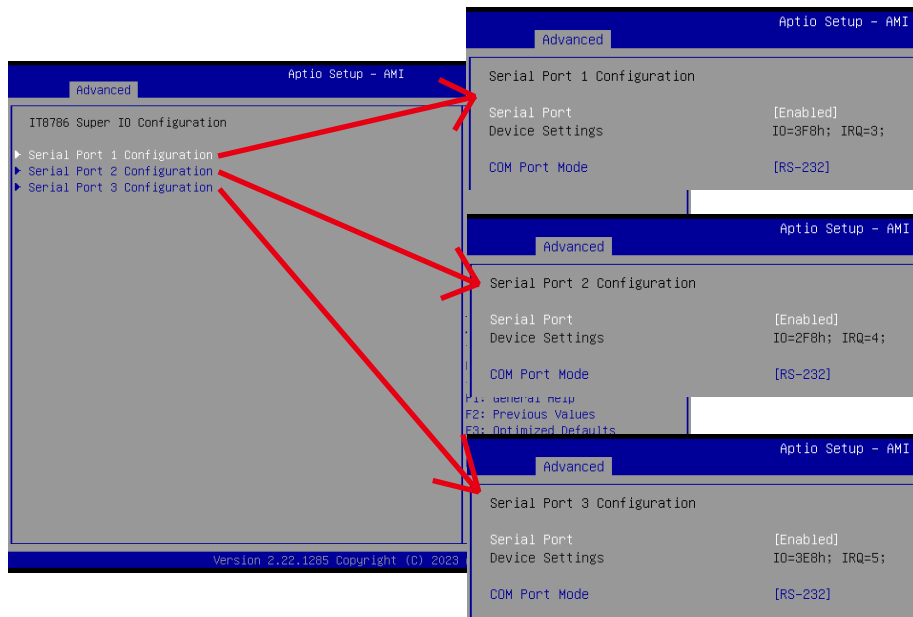

Item	Description
Serial Port 1 Configuration	Press [Enter] to configure advanced items :
Serial Port 2 Configuration	Serial Port : Enabled : Enables allows you to configure the serial port settings Disabled : if Disabled, displays no configuration for the serial port
Serial Port 3 Configuration	Device settings : Display the specified Serial Port base I/O address and IRQ
	COM Port Mode : Choose RS-232, RS-422, or RS-485 feature

4.3.5 Hardware Monitor

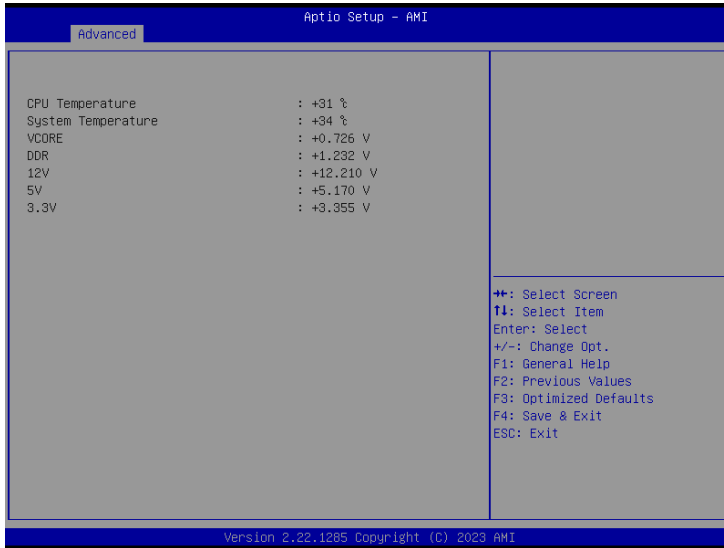

Item	Description
CPU Temperature	Shows current CPU temperature
System Temperature	Shows current system temperature

4.3.6 S5 RTC Wake Settings



Item	Description
Wake system from S5	<p>Enable or Disable System to wake on a specific time.</p> <p>Disabled : Disables system to wake on a specific time (Default setting)</p> <p>Fixed Time : Enables system to wake on a specific time (Format : hr : min : sec)</p>

4.3.7 Network Stack Configuration

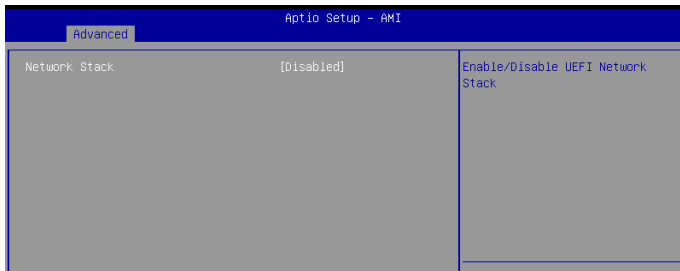

When Network stack is enabled :

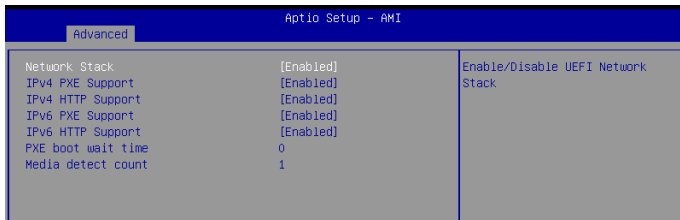

Item	Description
Network Stack	When system is power on, install LAN driver under UEFI mode Disabled : Disables UEFI Network Stack (Default setting) Enabled : Enables UEFI Network Stack
IPv4 PXE Support	When Network stack is enabled : Disabled : Disables IPv4 PXE Support Enabled : Enables IPv4 PXE Support
IPv4 HTTP Support	When Network stack is enabled : Disabled : Disables IPv4 HTTP Support Enabled : Enables IPv4 HTTP Support
IPv6 PXE Support	When Network stack is enabled : Disabled : Disables IPv6 PXE Support Enabled : Enables IPv6 PXE Support
IPv6 HTTP Support	When Network stack is enabled : Disabled : Disables IPv6 HTTP Support Enabled : Enables IPv6 HTTP Support
PXE boot wait time	Wait time in seconds, or use ESC key to abort the PXE boot.
Media detect count	Number of times the presence of media will be checked.

4.3.8 NVMe Configuration

NVMe Configuration shows information when your M.2 NVMe PCIe SSD is installed.

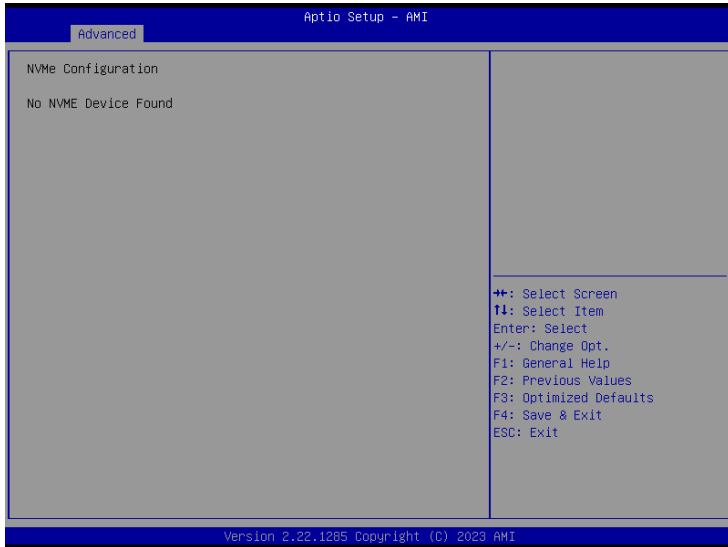

4.3.9 Offboard SATA Controller Configuration

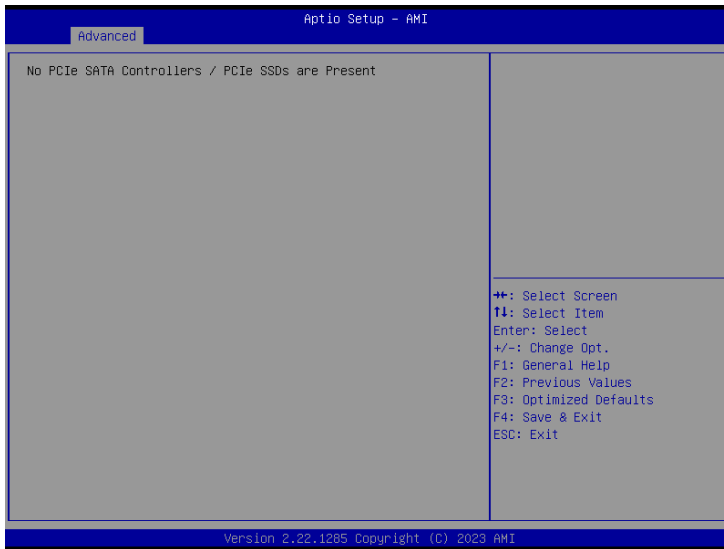

4.3.10 Digital IO Port Configuration

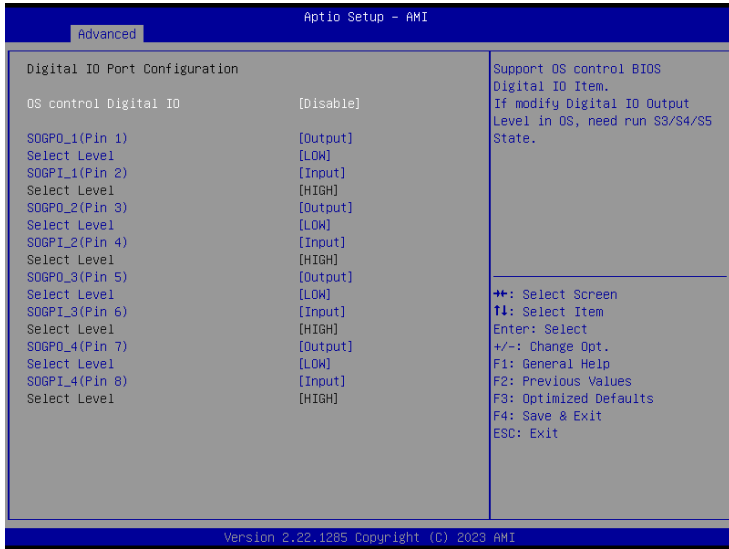

Item	Description
OS control Digital IO	<p>Disabled : If Digital IO Output value/level is modified in OS, they will not be memorized and kept. (Default setting)</p> <p>Enabled : If Digital IO Output value/level is modified in OS, they will be memorized and kept.</p>
SOGPO_1 (Pin 1) SOGPI_1 (Pin 2) SOGPO_2 (Pin 3) SOGPI_2 (Pin 4) SOGPO_3 (Pin 5) SOGPI_3 (Pin 6) SOGPO_4 (Pin 7) SOGPI_4 (Pin 8)	Configure Digital IO Input or Output values for each pin.

4.3.11 Tls Auth Configuration

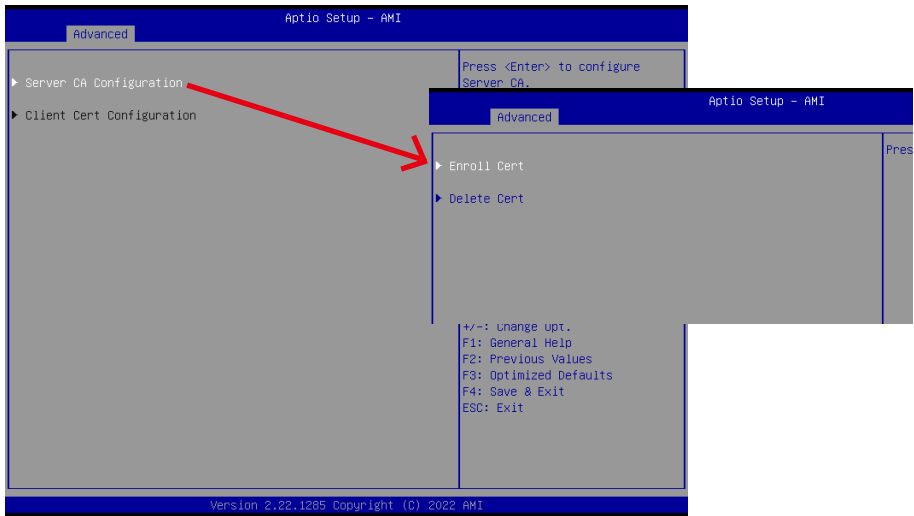

Item	Description
Enroll Cert	<p>Press [Enter] to configure advanced items :</p> <p>Server CA Configuration :</p> <p>Enroll Cert :</p> <ol style="list-style-type: none"> 1. Enroll Cert Using File 2. Cert GUID : Input digit character in 11111111-2222-3333-4444-1234567 890ab format. 3. Commit Changes and Exit 4. Discard Changes and Exit

4.4 Chipset

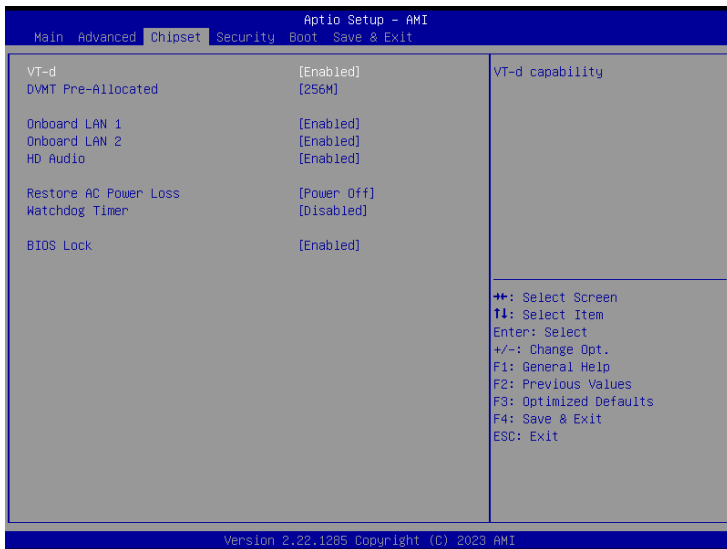

Item	Description
VT-d	Enabled : Enables VT-d function (Default setting) Disabled : Disables VT-d function
DVMT Pre-Allocated	Use DVMT Pre-Allocated to set the amount of system memory which is installed to the integrated graphics processor Option items : 32M , 64M, 128M, 256M (Default setting)
Onboard LAN1 Onboard LAN2	Enable/Disable onboard LAN controller Enabled : Enables onboard LAN controller (Default setting) Disabled : Disables onboard LAN controller
HD Audio	Enable/Disable onboard audio controller Enabled : Enables onboard audio controller (Default setting) Disabled : Disables onboard audio controller
Restore AC Power Loss	To set which option the system should returns if a sudden power loss occurred Power on : System power on when the power is back Power off : Do not power on when the power is back (Default setting) Last state : Restore the system to the state before power loss occurs
Watchdog Timer	Enable/Disable Watchdog Timer function Enabled : Enables Watchdog Timer function Disabled : Disabled Watchdog Timer function (Default setting)
BIOS Lock	Enable/Disable BIOS Lock function Enabled : Enables BIOS Lock function (Default setting) Disabled : Disabled BIOS Lock funtion

4.5 Security



Item	Description
Administrator Password	To set up Administrator's password Minimum length : 3 Maximum length : 20
User Password	To set up User's password Minimum length : 3 Maximum length : 20
Secure Boot	Press <Enter> to configure the advanced items



Item	Description
Secure Boot	Secure Boot requires all the applications that are running during the booting process to be pre-signed with valid digital certificates Enabled : Enables Secure Boot function Disabled : Disables Secure Boot function (Default setting)
Secure Boot Mode	Standard : Standard mode Custom : Custom mode (Default setting)
Restore Factory Keys	To restore factory settings Yes : Agree to restore factory settings No : Cancel to restore factory settings
Reset To Setup Mode	Yes : Agree to setup mode No : Cancel to setup mode
Key Management	Enables expert users to modify Secure boot policy variables without full authentication Press <Enter> to configure the advanced items

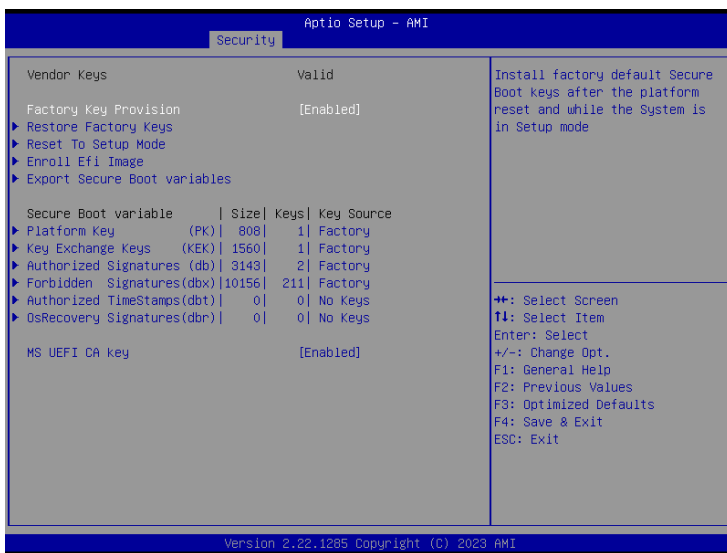

Item	Description	Item	Description
Factory Key Provision	Install factory default Secure Boot keys after the platform reset and while the system is in Setup mode Enabled : Enables Factory Key Provision (Default setting) Disabled : Disables Factory Key Provision	Platform Key (PK)	These items allows you to enroll factory defaults or load Certificates from a file.
Restore Factory Keys	To restore factory settings Yes : Agree to restore factory settings No : Cancel to restore factory settings	Key Exchange Keys	
Reset To Setup Mode	Yes : Agree to setup mode No : Cancel to setup mode	Authorized Signatures	
Enroll Efi Image	Allow the image to run in Secure Boot mode	Forbidden Signatures	
Export Secure Boot variables	Copy NVRAM content of Secure Boot variables to files in a root folder on a file system device	Authorized TimeStamps	
		OsRecovery Signatures	

4.6 Boot

This Boot menu allows you to set/change system boot options

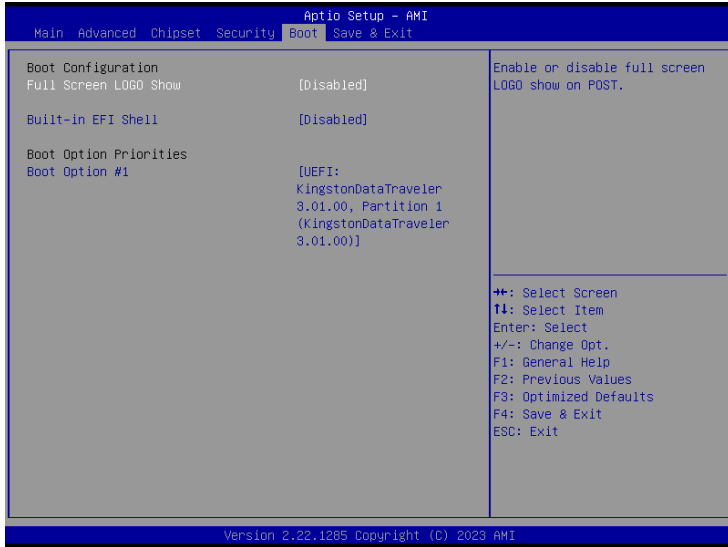

Item	Description
Full Screen LOGO Show	Enable/Disable full screen LOGO show on POST screen Enabled : Enables Full screen LOGO Show on POST screen Disabled : Disables Full screen LOGO Show on POST screen (Default setting)
Built-in EFI shell	Enable/Disable Built-in EFI Shell Enabled : Enables Built-in EFI Shell Disabled : Disables Built-in EFI Shell (Default setting)
Boot Option #1	Shows the information of the storage that be installed in the system Choose/set the boot priority

4.7 Save & Exit



Item	Description
Save Changes and Reset	After configuring all the options that you wish to change, choose this option to save all the changes and reboot the system Yes : Agree to save and reset No : Cancel to save and reset
Discard Changes and Reset	Choose this option to reboot the system without saving any changes Yes : Agree to discard changes and reset No : Cancel to discard changes and reset
Restore Defaults	Restore/Load default values for all the setup options Yes : Agree to load optimized defaults No : Cancel to load optimized defaults
Me FW Image Re-Flash	Enable/Disable Me FW image re-flash function Enabled : Enables Me FW image re-flash function Disabled : Disables Me FW image re-flash function (Default setting)