

QBi-1355A (MRLU7AH)

Embedded Compact Board with Intel® i7-1355U Processor, Dual Channel DDR5 memory, 1 x COM, 2 x HDMI, 6 x USB, TPM on board

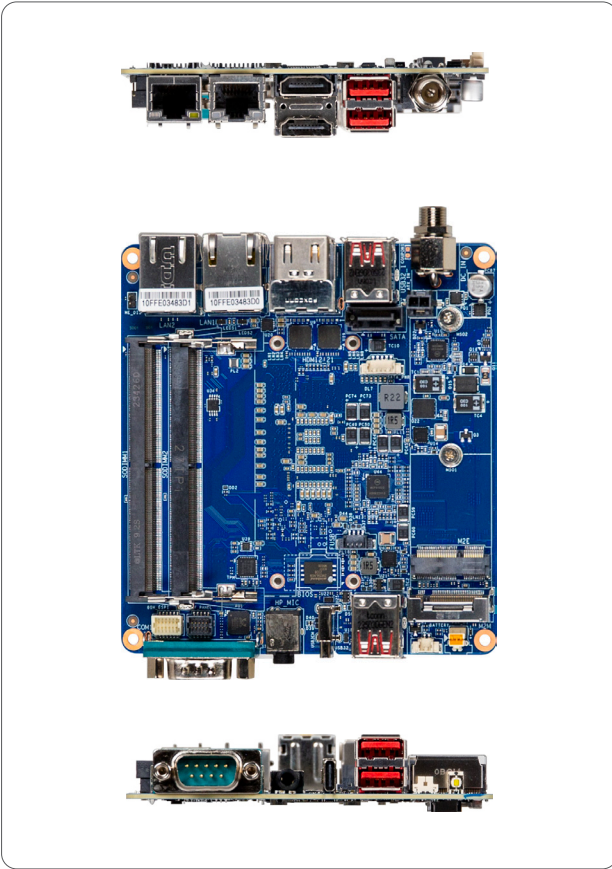

Features

- Embedded IPC Motherboard
- Intel® Core™ i7-1355U Processor
- Dual Channel DDR5, 2 x SO-DIMMs
- 1 x 2.5GbE LAN Port
- 1 x GbE LAN Port
- Ultra-Fast M.2 with PCIe Gen4 x4 Interface
- 2 x HDMI Ports
- 1 x COM Port (RS-232/422/485)

Specifications

Form Factor	Embedded Compact Board 105W x 110D (mm)
CPU	Intel® Core™ i7-1355U Processor Intel® 7, 10 cores, 2P+8E, 12 threads, up to 5.0 GHz TDP 15W 12 MB Smart Cache
Socket	1 x FCBGA1744
Chipset	—
Memory	2 x DDR5 SO-DIMM sockets, Max. Capacity 64 GB, Support Dual Channel DDR5 5200 MHz memory modules
Ethernet	1 x 2.5 GbE LAN Port (Intel® I226V) 1 x GbE LAN Port (Realtek® RTL8111H)
Video	Integrated Graphics Processor - Intel® Iris® Xe Graphics eligible: 2 x HDMI 2.0 ports, supporting a maximum resolution of 4096x2160 @60Hz 1 x DP 1.4 through USB Type C (DP Alt. mode), supporting a maximum resolution of 7680x4320 @30Hz, requires designated graphic driver (3 independent display outputs)
Audio	Realtek® ALC269
Storage	1 x SATA 6Gb/s port

Raid	RAID 0/1
Expansion Slots	1 x 2280 M.2 M-Key (PCIe Gen 4x4, SATA 6Gb/s) 1 x 2230 M.2 E-Key (PCIe x1, USB 2.0)
Internal I/O	1 x 2-pin power connector 1 x SATA Power header 1 x CPU fan header 1 x Front panel header 1 x USB 2.0 header
Front IO	2 x USB 3.2 Gen 2x1 1 x USB 3.2 Type C Gen 2x1 (with DP Alt. mode) 1 x Power button with LED 1 x COM Port (RS-232/422/485) 1 x Combo audio jack (Headphone & Headset)
Rear IO	2 x RJ45 LAN Ports 2 x USB 3.2 Gen 2x1 2 x HDMI 1 x Screw type DC Jack (+12V~24VDC)
Side IO	—
TPM	Onboard TPM 2.0 security chip INFINEON SLB9672VU2.0
OS Compatibility	Windows 10/11 (x64)
Operating Properties	Operating temperature: 0°C to 60°C Operating humidity: 0-90% (non-condensing) Non-operating temperature: -40°C to 85°C Non-operating humidity: 0%-95% (non-condensing)
Packing Content	Carton size: 465 x 351 x 217 (mm) Packing Capacity: 10pcs Single Box size: 221 x 178 x 65 (mm) Including: SATA power cable 150mm x 1 (P/N: 25CRI-150621-K1R)
Order Information	9MRLU7AHMR-SI (Box packing)

GIGAIPC reserves the right to modify or change technical data without prior notice.

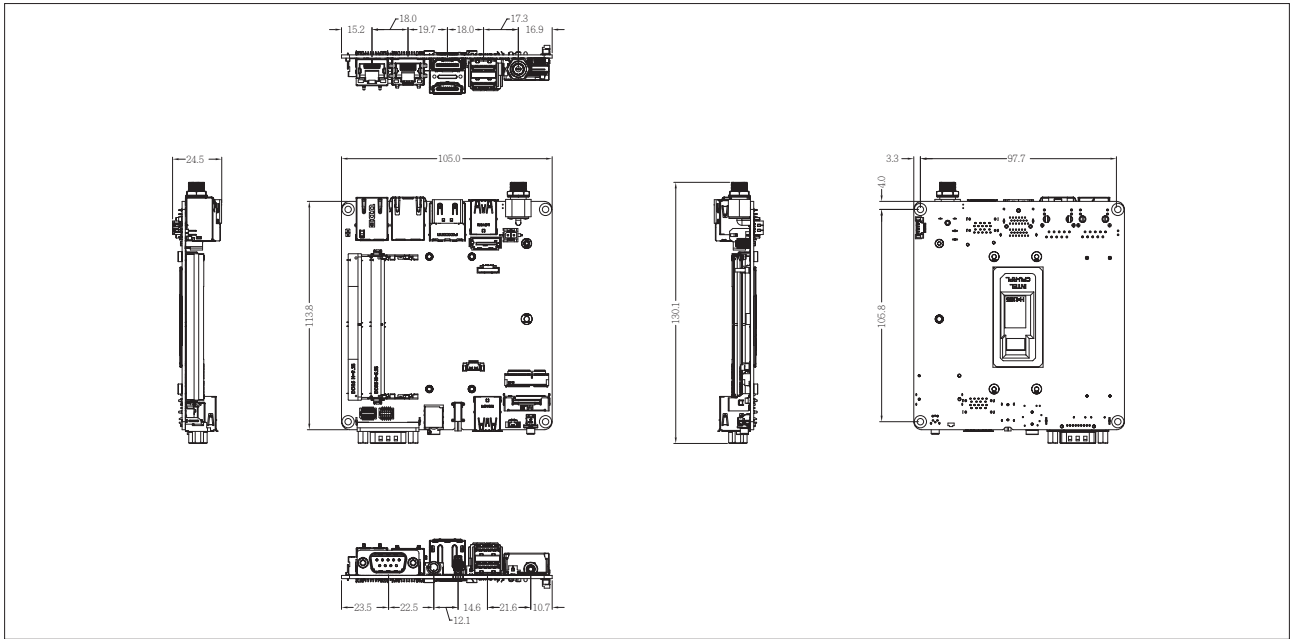

Block Diagram

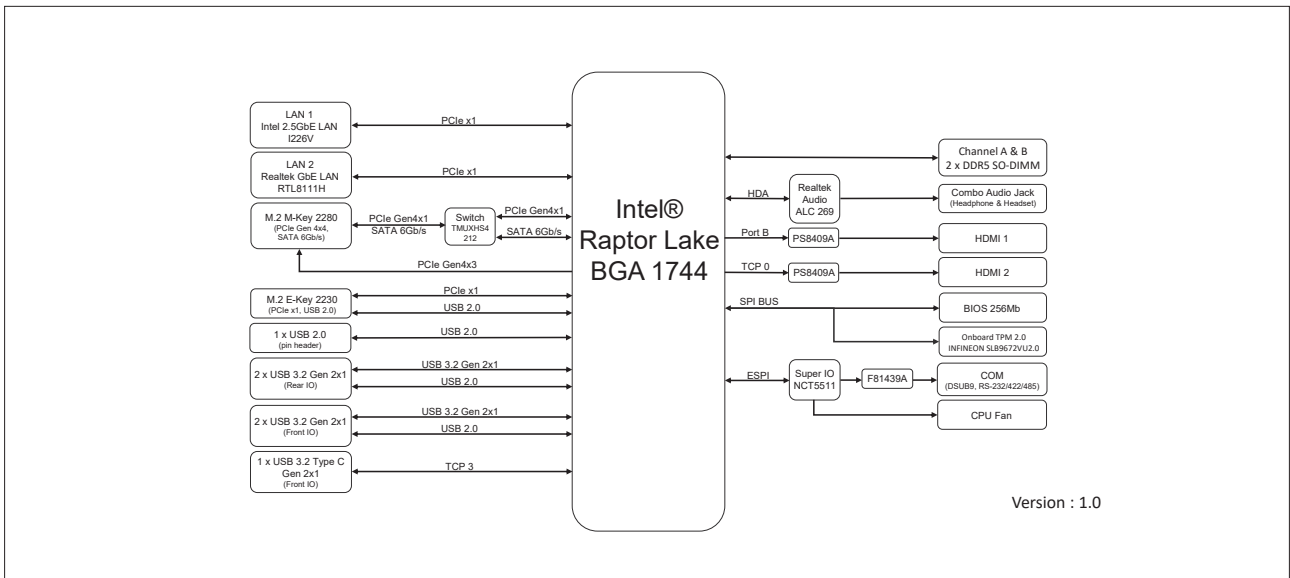

Optional Kit

Part No.	Description	Quantity
25ST4-113104-A7R	Fansink	1
25ST1-713000-Y0R	Heat spreader	1