

HSB-800I-A11

Half-Sized ISA SBC

User's Manual 1st Ed

Copyright Notice

This document is copyrighted, 2021. All rights are reserved. The original manufacturer reserves the right to make improvements to the products described in this manual at any time without notice.

No part of this manual may be reproduced, copied, translated, or transmitted in any form or by any means without the prior written permission of the original manufacturer. Information provided in this manual is intended to be accurate and reliable. However, the original manufacturer assumes no responsibility for its use, or for any infringements upon the rights of third parties that may result from its use.

The material in this document is for product information only and is subject to change without notice. While reasonable efforts have been made in the preparation of this document to assure its accuracy, AAEMON assumes no liabilities resulting from errors or omissions in this document, or from the use of the information contained herein.

AAEMON reserves the right to make changes in the product design without notice to its users.

Acknowledgement

All other products' name or trademarks are properties of their respective owners.

- Microsoft Windows is a registered trademark of Microsoft Corp.
- AMD and AMD Geode™ are registered trademarks of Advanced Micro Devices, Inc.
- ITE is a trademark of Integrated Technology Express, Inc.
- IBM, PC/AT, PS/2, and VGA are trademarks of International Business Machines Corporation.
- CompactFlash™ is a registered trademark of the CompactFlash Association

All other product names or trademarks are properties of their respective owners. The publisher of this document neither assumes nor implies ownership of any trademarks not herein listed.

Packing List

Before setting up your product, please make sure the following items have been shipped:

Item	Description	Quantity
HSB-800I-A11	Half-Sized Board	1
1701260307	Flat Cable.9P/DB9P MALE&25P DB25P FEMALE.10P 2mm&26P 2mm/IDC NO FOLD.30cm.W/BKT	1
1701400453	Cable.40P 2.54mm IDC W/Nose W/Fold.40P 2.54mm IDC W/Nose W/Fold.45cm.Blue ATA-100	1
1700060192	Cable.6P-6P-6P.19cm.IVORY PS2/KB&Mouse	1
1701340704	Flat Cable.34P.70cm.GRAY for FDD	1
1703030501	Wire.3P 2.5mm Housing.3P 2.5mm Housing.50cm	1
170910020A	USB Cable.USB*2.5P 2.mm Housing*2.20cm.W/Bracket	1
1709140302	Cable.Phone Jack*3.t0 14P 2.54mm Housing.DB9P(M) 10P 2.0mm IDC.4P 2.54mm Housing.30cm.W/Backet	1
1701200301	Flat Cable.9P DB9P MALE.10P 2.0mm Pitch*2.30cm.IDC NO FOLD.W/BRACKET	1

If any of these items are missing or damaged, please contact your distributor or sales representative immediately.

About this Document

This User's Manual contains all the essential information, such as detailed descriptions and explanations on the product's hardware and software features (if any), its specifications, dimensions, jumper/connector settings/definitions, and driver installation instructions (if any), to facilitate users in setting up their product.

Users may refer to the product page at AAEON.com for the latest version of this document.

Safety Precautions

Please read the following safety instructions carefully. It is advised that you keep this manual for future references

1. All cautions and warnings on the device should be noted.
2. Make sure the power source matches the power rating of the device.
3. Position the power cord so that people cannot step on it. Do not place anything over the power cord.
4. Always completely disconnect the power before working on the system's hardware.
5. No connections should be made when the system is powered as a sudden rush of power may damage sensitive electronic components.
6. If the device is not to be used for a long time, disconnect it from the power supply to avoid damage by transient over-voltage.
7. Always disconnect this device from any AC supply before cleaning.
8. While cleaning, use a damp cloth instead of liquid or spray detergents.
9. Make sure the device is installed near a power outlet and is easily accessible.
10. Keep this device away from humidity.
11. Place the device on a solid surface during installation to prevent falls
12. Do not cover the openings on the device to ensure optimal heat dissipation.
13. Watch out for high temperatures when the system is running.
14. Do not touch the heat sink or heat spreader when the system is running
15. Never pour any liquid into the openings. This could cause fire or electric shock.
16. As most electronic components are sensitive to static electrical charge, be sure to ground yourself to prevent static charge when installing the internal components. Use a grounding wrist strap and contain all electronic components in any static-shielded containers.

17. If any of the following situations arises, please the contact our service personnel:
 - i. Damaged power cord or plug
 - ii. Liquid intrusion to the device
 - iii. Exposure to moisture
 - iv. Device is not working as expected or in a manner as described in this manual
 - v. The device is dropped or damaged
 - vi. Any obvious signs of damage displayed on the device
18. **DO NOT LEAVE THIS DEVICE IN AN UNCONTROLLED ENVIRONMENT WITH TEMPERATURES BEYOND THE DEVICE'S PERMITTED STORAGE TEMPERATURES (SEE CHAPTER 1) TO PREVENT DAMAGE.**

Warning!



This device complies with Part 15 FCC Rules. Operation is subject to the following two conditions: (1) this device may not cause harmful interference, and (2) this device must accept any interference received including interference that may cause undesired operation.

Caution:

There is a danger of explosion if the battery is incorrectly replaced. Replace only with the same or equivalent type recommended by the manufacturer. Dispose of used batteries according to the manufacturer's instructions and your local government's recycling or disposal directives.

Attention:

Il y a un risque d'explosion si la batterie est remplacée de façon incorrecte. Ne la remplacer qu'avec le même modèle ou équivalent recommandé par le constructeur. Recycler les batteries usées en accord avec les instructions du fabricant et les directives gouvernementales de recyclage.

China RoHS Requirements (CN)

产品中有毒有害物质或元素名称及含量

AAEON Main Board/ Daughter Board/ Backplane

部件名称	有毒有害物质或元素					
	铅 (Pb)	汞 (Hg)	镉 (Cd)	六价铬 (Cr(VI))	多溴联苯 (PBB)	多溴二苯醚 (PBDE)
印刷电路板 及其电子组件	○	○	○	○	○	○
外部信号 连接器及线材	○	○	○	○	○	○
<p>O: 表示该有毒有害物质在该部件所有均质材料中的含量均在 SJ/T 11363-2006 标准规定的限量要求以下。</p> <p>X: 表示该有毒有害物质至少在该部件的某一均质材料中的含量超出 SJ/T 11363-2006 标准规定的限量要求。</p> <p>备注: 此产品所标示之环保使用期限, 系指在一般正常使用状况下。</p>						

China RoHS Requirement (EN)

Poisonous or Hazardous Substances or Elements in Products

AAEON Main Board/ Daughter Board/ Backplane

Component	Poisonous or Hazardous Substances or Elements					
	Lead (Pb)	Mercury (Hg)	Cadmium (Cd)	Hexavalent Chromium (Cr(VI))	Polybrominated Biphenyls (PBB)	Polybrominated Diphenyl Ethers (PBDE)
PCB & Other Components	○	○	○	○	○	○
Wires & Connectors for External Connections	○	○	○	○	○	○
<p>O: The quantity of poisonous or hazardous substances or elements found in each of the component's parts is below the SJ/T 11363-2006-stipulated requirement.</p> <p>X: The quantity of poisonous or hazardous substances or elements found in at least one of the component's parts is beyond the SJ/T 11363-2006-stipulated requirement.</p> <p>Note: The Environment Friendly Use Period as labeled on this product is applicable under normal usage only</p>						

Table of Contents

Chapter 1 - Product Specifications	1
1.1 Specifications	2
Chapter 2 – Hardware Information	4
2.1 Dimensions	5
2.2 Jumpers and Connectors.....	6
2.3 List of Jumpers and Switches	7
2.3.1 CFD Voltage 3.3V/ 5V Selection (JP1).....	7
2.3.2 Clear CMOS (JP2)	7
2.3.3 AT/ATX Power Type Selection (JP3).....	8
2.3.4 LCD Clock and Power Selection (JP4).....	8
2.3.5 Inverter Voltage Selection (JP5)	8
2.4 List of Connectors.....	9
2.4.1 Digital I/O (CN1).....	10
2.4.2 Fan Connector (CN2)	11
2.4.3 Audio Input/ Output/ CD-in/ MIC (CN3).....	11
2.4.4 LCD Inverter Power Connector (CN4).....	11
2.4.5 TFT LCD Connector (CN5)	12
2.4.6 +5VSB Power Connector (CN6).....	13
2.4.7 AT Power 5V, 12V Connector (CN7)	14
2.4.8 LVDS Connector (CN9, 10).....	14
2.4.9 PS/2 Keyboard/Mouse Connector (CN11)	15
2.4.10 Internal Keyboard Connector (CN12)	15
2.4.11 RS-232 Serial Port Header (COM1/ COM3/ COM4)	16
2.4.12 RS-232/422/485 Serial Port Header (COM2)	16
2.4.13 Front Panel Connector 1 (FP1)	16
2.4.14 Front Panel Connector 2 (FP2).....	17

2.4.15	IrDA Connector (IR1)	17
2.4.16	LPT Port Connector (LPT1)	17
2.4.17	USB2.0 Header (USB1/ USB2/ USB3)	18
2.5	Function Block Diagram	19
Chapter 3	- Award BIOS Setup	20
3.1	System Test and Initialization	21
3.2	Award BIOS Setup	22
3.3	Standard CMOS Features	24
3.4	Advanced BIOS Features	27
3.5	Advanced Chipset Features	33
3.6	Integrated Peripherals	36
3.7	Power Management Setup	40
3.8	PnP/PCI Configurations	43
3.9	PC Health Status	45
3.10	Frequency/Voltage Control	47
Chapter 4	- Drivers Installation	48
4.1	Drivers Download and Installation	49
Appendix A	- Watchdog Timer	50
A.1	Programming the Watchdog Timer	51
A.2	Watchdog Timer Initial Program	55
Appendix B	- I/O Information	60
B.1	I/O Address Map	61
B.2	Memory Address Map	62
B.3	IRQ Mapping Chart	63
B.4	DMA Channel Assignments	63

Chapter 1

Product Specifications

1.1 Specifications

System

Form Factor	PICMG 1.0 Half-Size Pure ISA CPU Card
Bus Interface	ISA
CPU	AMD Geode™ LX 800
Memory Type	Onboard 128 MB DDR 400
Chipset	AMD Geode™ CS 5536
BIOS	Award Plug & Play FWH BIOS – 8MB ROM
Wake on LAN	No
Watchdog Timer	255 Levels
Power Requirement	ATX 2.1
Power Consumption (Typical)	AMD LX800, DDR400 128MB 0.19A at +12V, 1.51A at +5V, 9.83W
Power Supply Type	+5V, +12V operation, AT mode
Dimensions (L x W)	7.3" x 4.8" (185mm x 122mm)
Operating Temperature	32°F ~ 140°F (0°C ~ 60°C)
Storage Temperature	-40°F ~ 176°F (-40°C ~ 80°C)
Operating Humidity	0% ~ 90% relative humidity, non-condensing
MTBF (Hours)	85,000
Certification	CE/FCC, Class A

Display

VGA/LCD Controller	AMD Geode™ LX 800
Video Output	1600 x 1200@32bpp at 100 MHz for VGA 1600 x 1200@24bpp for LCD
Backlight Inverter Supply	5V, 12V

I/O

Ethernet	10/100 Mbps LAN x1 or 10/100/1000 Mbps LAN x1 (optional)
Audio	AC97 Codec
USB Port	USB2.0 x 4
Serial Port	COM x 4 (Internal Pin Header x 4) COM1, COM3, COM4: RS-232 COM2: RS-232/422/485
Parallel Port	1 (Support SPP/EPP/ECP mode)
HDD Interface	IDE x 1
FDD Interface	Standard FDD port x 1, support up to 1 floppy device
SSD	CompactFlash™ Type II x 1
Expansion Slot	ISA, PC/104
DIO	8-bit Programmable (4-in/4-out)
TPM	—

Chapter 2

Hardware Information

2.1 Dimensions

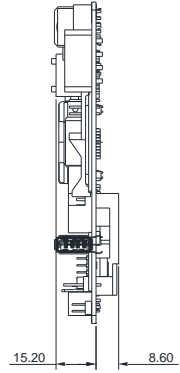
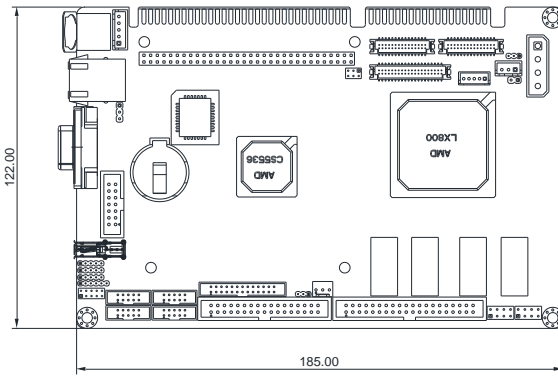

2.2 Jumpers and Connectors

Component Side

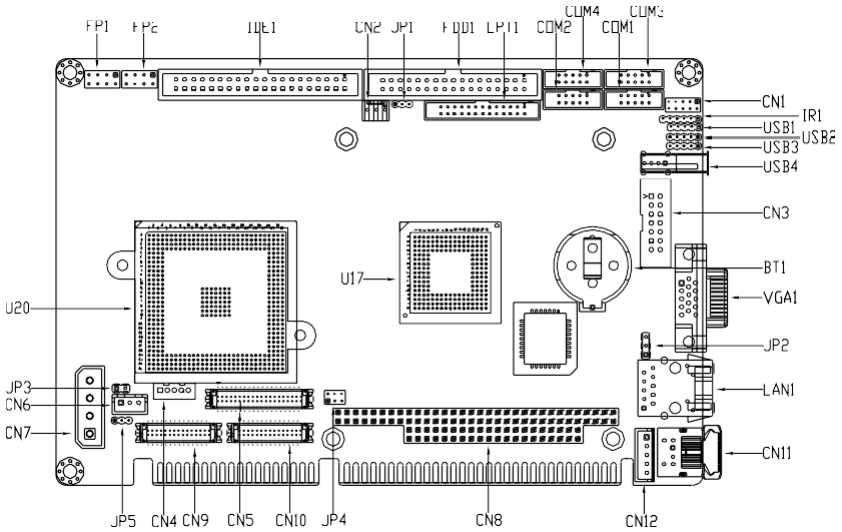

Solder Side

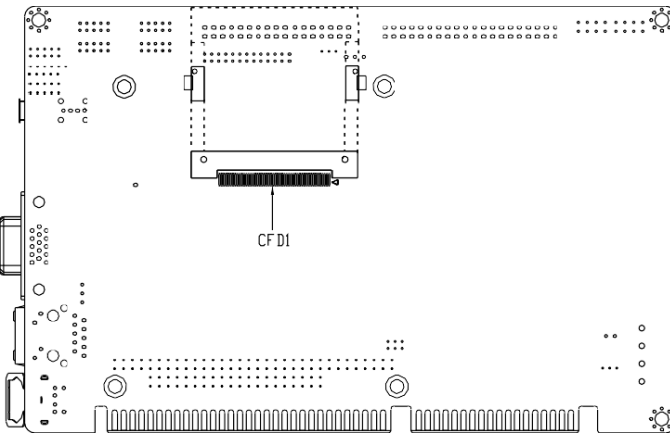

2.3 List of Jumpers and Switches

Please refer to the table below for all of the board's jumpers that you can configure for your application

Label	Function
JP1	CFD Voltage 3.3V/ 5V Selection
JP2	Clear CMOS
JP3	AT/ATX Power Type Selection
JP4	LCD Clock and Power Selection
JP5	Inverter Voltage Selection

2.3.1 CFD Voltage 3.3V/ 5V Selection (JP1)

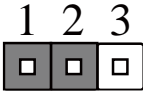

3.3V (Default)



5V

2.3.2 Clear CMOS (JP2)

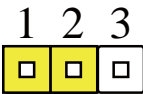

Normal (Default)

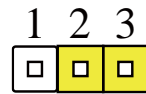

Clear CMOS

2.3.3 AT/ATX Power Type Selection (JP3)

Setting	Function
1-2 Closed	ATX Power Supply (Default)
1-2 Open	AT Power Supply

Note: Only AT Function without Backplanes.

2.3.4 LCD Clock and Power Selection (JP4)

LCD Clock Selection

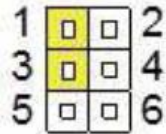

Normal (Default)

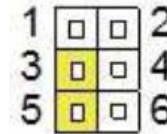

Inverse

LCD Power Selection

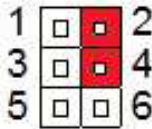

+5Vlcd

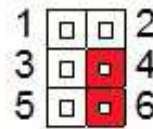

+3Vlcd (Default)

Note: To prevent damage to your system, do not use any other configuration for JP4 than those shown above.

2.3.5 Inverter Voltage Selection (JP5)

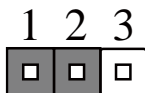

+12V

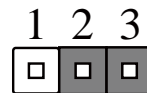

+5V (Default)

2.4 List of Connectors

Please refer to the table below for all of the board's connectors that you can configure for your application

Label	Function
CFD1	CompactFlash Type II Slot (always master)
CN1	Digital I/O
CN2	Fan Connector
CN3	Audio Input/Output/CD-in/MIC
CN4	LCD Inverter Power Connector
CN5	TFT LCD Connector
CN6	+5VSB Power Connector
CN7	AT Power 5V, 12V Connector
CN8	PC/104 ISA Interface
CN9	LVDS1 Connector
CN10	LVDS2 Connector
CN11	PS/2 Keyboard/Mouse Connector
CN12	Internal Keyboard Connector
COM1	RS-232 Serial Port Header
COM2	RS-232/422/485 Serial Port Header
COM3	RS-232 Serial Port Header
COM4	RS-232 Serial Port Header
DIMM1	DDR2 SODIMM Slot (optional)
FDD1	Floppy Drive Connector
FP1	Front Panel Connector 1
FP2	Front Panel Connector 2
IDE1	EIDE Connector (supports one IDE device only)
IR1	IrDA Connector

Label	Function
LAN1	10/100 or 100/1000 Base-TX Ethernet Connector
LPT1	LPT Port Connector
USB1	USB2.0 Header
USB2	USB2.0 Header
USB3	USB2.0 Header
USB4	USB2.0 Type A Connector
VGA1	VGA Display Connector

2.4.1 Digital I/O (CN1)

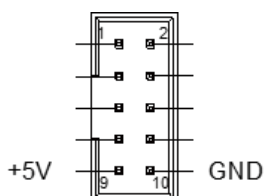

Pin	Signal	Pin	Signal
1	IN0	2	IN1
3	IN2	4	IN3
5	OUT0	6	OUT1
7	OUT2	8	OUT3
9	+5V	10	GND

2.4.2 Fan Connector (CN2)

Pin	Signal
1	GND
2	+5V
3	Speed Sensor

2.4.3 Audio Input/ Output/ CD-in/ MIC (CN3)

Pin	Signal	Pin	Signal
1	MIC	2	MIC_Vcc
3	Audio Ground	4	CD_GND
5	LINE_IN L	6	CD_L
7	LINE_IN R	8	CD_GND
9	Audio Ground	10	CD_R
11	LINE_OUT L	12	LINE_OUT R
13	Audio Ground	14	Audio Ground

2.4.4 LCD Inverter Power Connector (CN4)

Pin	Signal
1	12V/ 5V
2	GND
3	VCON
4	GND
5	BKL_EN

Note: Pin 1 Voltage can be selected by Inverter Voltage Selection (JP5). See Ch 2.3.5.

2.4.5 TFT LCD Connector (CN5)

For 24-bit TFT LCD			
Pin	Signal	Pin	Signal
1	+5VLCD	2	+5VLCD
3	GND	4	GND
5	+3.3VLCD	6	+3.3VLCD
7	BKL_EN	8	GND
9	B0	10	B1
11	B2	12	B3
13	B4	14	B5
15	B6	16	B7
17	G0	18	G1
19	G2	20	G3
21	G4	22	G5
23	G6	24	G7
25	R0	26	R1
27	R2	28	R3
29	R4	30	R5
31	R6	32	R7
33	GND	34	GND
35	LCD_CLK	36	LCD_VS
37	LCD_DE	38	LCD_HS
39	NC	40	TP

For 18-bit TFT LCD			
Pin	Signal	Pin	Signal
1	+5VLCD	2	+5VLCD
3	GND	4	GND

For 18-bit TFT LCD			
Pin	Signal	Pin	Signal
5	+3.3VLCD	6	+3.3VLCD
7	BKL_EN	8	GND
9	NC	10	NC
11	B0	12	B1
13	B2	14	B3
15	B4	16	B5
17	NC	18	NC
19	G0	20	G1
21	G2	22	G3
23	G4	24	G5
25	NC	26	NC
27	R0	28	R1
29	R2	30	R3
31	R4	32	R5
33	GND	34	GND
35	LCD_CLK	36	LCD_VS
37	LCD_DE	38	LCD_HS
39	NC	40	TP

2.4.6 +5VSB Power Connector (CN6)

Pin	Signal
1	PS_ON#
2	+5V
3	+5VSB

2.4.7 AT Power 5V, 12V Connector (CN7)

Pin	Signal
1	+5V
2	GND
3	GND
4	+12V

2.4.8 LVDS Connector (CN9, 10)

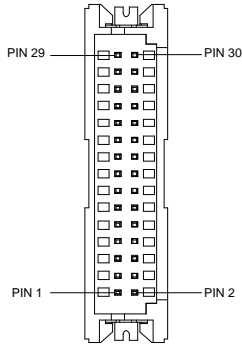

Pin	Signal	Pin	Signal
1	BKL_EN	2	NC
3	VLCD	4	GND
5	LVDS_CLK#	6	LVDS_CLK
7	VLCD	8	GND
9	TX0#	10	TX0
11	TX1#	12	TX1
13	TX2#	14	TX2
15	TX3#	16	TX3
17	NC	18	NC

Pin	Signal	Pin	Signal
19	NC	20	NC
21	NC	22	NC
23	NC	24	NC
25	NC	26	NC
27	VLCD	28	GND
29	NC	30	NC

2.4.9 PS/2 Keyboard/Mouse Connector (CN11)

Pin	Signal	Pin	Signal
1	KB_DATA	4	+5V
2	MS-DATA	5	KB_CLK
3	GND	6	MS_CLK

2.4.10 Internal Keyboard Connector (CN12)

Pin	Signal
1	KB_CLK
2	KB_DATA
3	NC
4	GND
5	+5V

2.4.11 RS-232 Serial Port Header (COM1/ COM3/ COM4)

Pin	Signal	Pin	Signal
1	DCD	2	RXD
3	TXD	4	DTR
5	GND	6	DSR
7	RTS	8	CTS
9	RI	10	NC

2.4.12 RS-232/422/485 Serial Port Header (COM2)

Pin	Signal	Pin	Signal
1	DCD (422TXD-/485DATA-)	2	RXD (422RXD+)
3	TXD (422TXD+/485DATA+)	4	DTR (422RXD-)
5	GND	6	DSR
7	RTS	8	CTS
9	RI	10	NC

2.4.13 Front Panel Connector 1 (FP1)

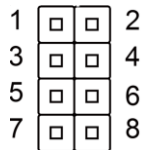

Pin	Signal	Pin	Signal
1	Power On Button (+)	2	Reset Switch (+)
3	Power On Button (-)	4	Reset Switch (-)
5	IDE LED (+)	6	Power LED (+)
7	IDE LED (-)	8	Power LED (-)

2.4.14 Front Panel Connector 2 (FP2)

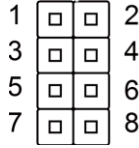

Pin	Signal	Pin	Signal
1	External Speaker (+)	2	Key Board Lock (+)
3	NC	4	GND
5	Internal Buzzer (-)	6	I2C Bus SMB Clock
7	External Speaker (-)	8	I2C Bus SMB Data

2.4.15 IrDA Connector (IR1)

Pin	Signal	Pin	Signal
1	+5V	4	GND
2	NC	5	IRTX
3	IRRX	6	NC

2.4.16 LPT Port Connector (LPT1)

Pin	Signal	Pin	Signal
1	#STROBE	2	#AFD
3	DATA0	4	#ERROR
5	DATA1	6	#INIT
7	DATA2	8	#SLIN
9	DATA3	10	GND
11	DATA4	12	GND
13	DATA5	14	GND

Pin	Signal	Pin	Signal
15	DATA6	16	GND
17	DATA7	18	GND
19	#ACK	20	GND
21	BUSY	22	GND
23	PE	24	GND
25	SELECT	26	GND

2.4.17 USB2.0 Header (USB1/ USB2/ USB3)

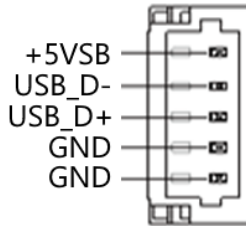

Pin	Signal
1	+5V
2	USBD1-
3	USBD1+
4	GND
5	GND

2.5 Function Block Diagram

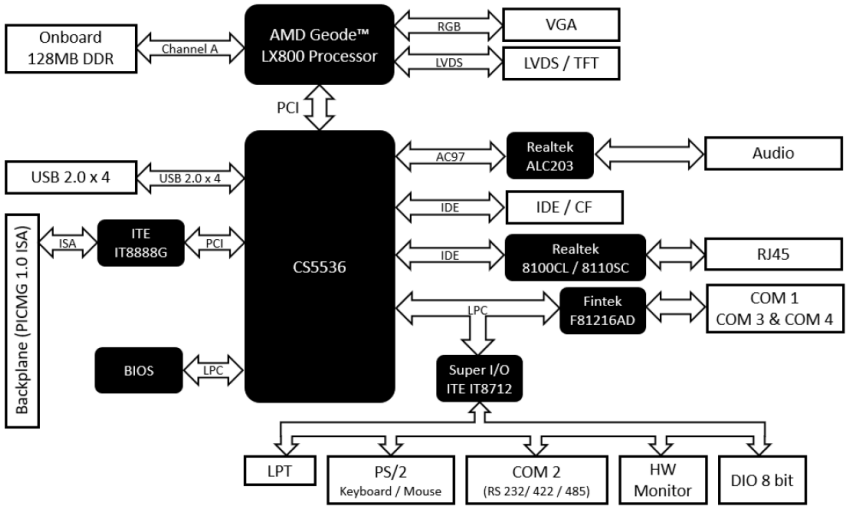

Chapter 3

Award BIOS Setup

3.1 System Test and Initialization

The board uses certain routines to test and initialize board hardware. If the routines encounter an error during the tests, you will either hear a few short beeps or see an error message on the screen. There are two kinds of errors: fatal and non-fatal. The system can usually continue the boot up sequence with non-fatal errors, usually with a message to press <F1> to resume startup.

System configuration verification routines check the current system configuration against values stored in the CMOS memory. If a system configuration is not found or if the values do not match, an error message will be displayed. The BIOS setup will need to be run to set the configuration information in memory.

There are three situations in which you will need to setup system configuration:

- You are starting your system for the first time.
- You have changed the hardware attached to your system.
- The CMOS memory has lost power and the configuration information has been erased.

The HSB-8001-A11 CMOS memory uses a backup battery for data retention. The battery must be replaced if it runs out of power.

3.2 Award BIOS Setup

The Award BIOS ROM has a built-in Setup program that allows users to modify the basic system configuration. This information is stored in the battery-backed CMOS RAM so it retains the Setup information when the power is turned off.

To enter Setup, power on the system and press immediately.

Once the BIOS Setup loads, a list of menus available will be displayed. Each menu provides the user with specific functions as summarized:

Standard CMOS Features – Basic system configuration (date, time, IDE, etc.).

Advanced BIOS Features – Set the advanced features of the system.

Advanced Chipset Features – Set and change the values in the chipset registers and optimize system performance.

Integrated Peripherals – Specify settings for integrated peripherals. (Primary slave, secondary slave, keyboard, mouse etc.).

Power Management Setup – Specify settings for power management (HDD power down, power on by ring, etc.).

PnP/PCI Configurations – This menu will appear if your system supports PnP/PCI.

PC Health Status – Displays system status information.

Frequency/Voltage Control – Display (monitor) frequency and voltage control.

Load Fail-Safe Defaults – Load BIOS default values for minimal/ stable performance for system operation.

Load Optimized Defaults – Load BIOS default factory settings for optimal system performance. While Award has designed the custom BIOS to maximize performance, the factory has the right to change these defaults to meet their needs.

Set Supervisor/User Password – Set supervisor and user passwords.

Save and Exit Setup – Save CMOS value changes to CMOS and exit setup.

Exit Without Saving – Abandon all CMOS value changes and exit setup.

The following sections provide detailed descriptions of each menu, the functions and settings which can be configured by the user.

3.3 Standard CMOS Features

Date and Time Configuration

The BIOS determines the day of the week from the other date information. This field is for information only. Press the left or right arrow key to move to the desired field (date, month, year). Press the PgUp/- or PgDn/+ key to change the setting, or type the desired value into the field. The time format is based on the 24-hour military-time clock. For example, 1 p.m. is 13:00:00 hours. Press the left or right arrow key to move to the desired field. Press the PgUp/- or PgDn/+ key to increment the setting, or type the desired value into the field.

IDE Channel 0/1 Master/Slave

IDE HDD Auto-Detection

The BIOS supports up to two IDE drives. This section does not show information about other IDE devices, such as a CD-ROM drive, or other hard drive types, such as SCSI drives.

NOTE: We recommend that you select type AUTO for all drives. The BIOS can automatically detect the specifications and optimal operating mode of almost all IDE hard drives. When you select AUTO for a hard drive, the BIOS will detect its specifications.

IDE Channel 0/1 Master/Slave

If you do not want to select "AUTO", other methods of selecting the drive type are available:

1. NONE: No drive type to be selected.
2. Manual: This will allow you to manually set the drive type you are using in your system. (See as below)

Access Mode [Default: Auto]

Auto: The BIOS automatically determines the optimal mode.

CHS: This allows the user to enter their own hardware values.

Large: For drives that do not support LBA and have more than 1024 cylinders.

LBA (Logical Block Addressing): During drive access, the IDE controller transforms the data address described by sector, head, and cylinder number into a physical block address, significantly improving data transfer rates for drives with greater than 1024 cylinders.

Here is a brief explanation of drive specifications:

Capacity: Disk drive capacity (approximate). Note that this size is usually slightly greater than the size of a formatted disk given by a disk-checking program.

Cylinder: Number of cylinders.

Head: Number of heads.

Precomp: Write pre-compensation cylinder.

Landing Zone: Landing zone.

Sector: Number of sectors.

Drive A [Default: 1.44M, 3.5 in]

Drive B [Default: None]

Select the correct specifications for the diskette drive(s) installed in the computer.

None – No diskette drive installed

360K, 5.25 in – 5-1/4 inch PC-type standard drive; 360 kilobyte capacity

1.2M, 5.25 in – 5-1/4 inch AT-type high-density drive; 1.2 megabyte capacity

720K, 3.5 in – 3-1/2 inch double-sided drive; 720 kilobyte capacity

1.44M, 3.5 in – 3-1/2 inch double-sided drive; 1.44 megabyte capacity

2.88M, 3.5 in – 3-1/2 inch double-sided drive; 2.88 megabyte capacity

Video

Halt On [Default: All, But Keyboard]

During the power-on-self-test (POST), the computer stops if the BIOS detects a hardware error. You can tell BIOS to ignore certain errors during POST and continue the boot-up process.

Memory [Default: AutoDetect]

You cannot change any values in the Memory fields; they are only for your information. RAM is counted in kilobytes (KB: approximately one thousand bytes) and megabytes (MB: approximately one million bytes). RAM is the computer's working memory, where the computer stores programs and data currently being used, so they are accessible to the CPU. Modern personal computers may contain up to 64 MB, 128 MB, or more.

Base Memory [Default: AutoDetect]

Typically 640 KB. Also called conventional memory. The DOS operating system and conventional applications use this area.

Extended Memory [Default: AutoDetect]

Above the 1-MB boundary. Early IBM personal computers could not use memory above 1 MB, but current PCs and their software can use extended memory.

Total Memory [Default: AutoDetect]

The fields show the total installed random-access memory (RAM).

3.4 Advanced BIOS Features

CPU Feature [Default: Autodetect]

Items will only be enabled when current CPU is supported Thermal Monitor feature.

Delay Prior to Thermal [Default: 16 Min]	The Delay Prior To Thermal BIOS feature controls the activation of the Thermal Monitor's automatic mode. It allows you to determine when the Pentium 4's Thermal Monitor should be activated in automatic mode after the system boots. For example, with the default value of 16 Minutes, the BIOS activates the Thermal Monitor in automatic mode 16 minutes after the system starts booting
Thermal Management [Default: Auto Detect]	Set up to support CPU Thermal Monitor 2 (TM2) or not.
TM2 Bus Ratio [Default: 0]	Set up TM2 Bus Ratio.
TM2 Bus VID [Default: 0.8375]	Set up TM2 Bus VID
Limit CPUID MaxVal [Default: Disabled]	Enabled / Disabled CPUID MaxVal. Only enabled if shown and use older OS like NT4.
NX BIOS Control [Default: Enabled]	Enabled / Disabled NX BIOS Control.

Removable Device Priority [Default: Auto Detect]

Select Removable Boot Device Priority

Hard Disk Boot Priority [Default: Auto Detect]

BIOS will display a list of bootable Hard Disk installed on the system. Select boot sequence for onboard Hard Disk, Add-in cards, SCSI, RAID, etc.

Use <↑> or <↓> to select a device, then press<+> to move it up, or <-> to move it down the list.

Press <ESC> to exit this level of menu.

CD-ROM Boot Priority [Default: Auto Detect]

Select CD-ROM Boot Device Priority

Virus Warning [Default: Disabled]

When enabled, you receive a warning message if a program (specifically, a virus) attempts to write to the boot sector or the partition table of the hard disk drive. You should then run an anti-virus program. Keep in mind that this feature protects only the boot sector, not the entire hard drive.

***NOTE:** Many disk diagnostic programs that access the boot sector table can trigger the virus-warning message. If you plan to run such a program, we recommend that you first disable the virus warning.*

CPU L1&L2 Cache [Default: Enabled]

Enable/Disable CPU L1&L2 Cache. Set to "Enabled" for faster system performance.

CPU L3 Cache [Default: Enabled]

Enable/Disable CPU L3 Cache. Set to "Enabled" for faster system performance.

Hyper-Threading Technology [Default: Enabled]

System will detect automatically and show up when you install the Intel® Pentium® 4 processor with HT Technology. Set to "Enabled" for faster system performance.

Quick Power On Self Test [Default: Enabled]

Select Enabled to reduce the amount of time required to run the power-on-self-test (POST). A quick POST skips certain steps.

USB Floppy Disk Type [Default: Auto]

Auto – By USB Device

Floppy – Emulation to Floppy Mode

HDD – Emulation to HDD mode

First Boot Device/Second Boot Device/Third Boot Device

[Default: First: Hard Disk, Second: Floppy, Third: CDROM]

Floppy – Select the boot device priority by Floppy.

LS120 – Select the boot device priority by LS120.

Hard Disk – Select the boot device priority by Hard Disk.

CDROM – Select the boot device priority by CDROM.

ZIP – Select the boot device priority by ZIP.

USB-FDD – Select the boot device priority by USB-FDD.

USB-ZIP – Select the boot device priority by USB-ZIP.

USB-CDROM – Select the boot device priority by USB-CDROM.

USB-HDD – Select the boot device priority by USB-HDD.

LAN – Select the boot device priority by LAN.

Disabled – Select the boot device priority by Disabled.

Boot Other Device [Default: Enabled]

Set to "Enabled" if you wish the system to boot to other devices if no bootable image found in First/Second/Third Boot device.

Swap Floppy Drive [Default: Disabled]

This field is effective only in systems with two floppy drives. Selecting enabled assigns physical drive B to logical drive A, and physical drive A to logical drive B.

Boot Up Floppy Seek [Default: Enabled]

When Enabled, the BIOS tests (seeks) floppy drives to determine whether they have 40 or 80 tracks. Only 360-KB floppy drives have 40 tracks; drives with 720 KB, 1.2 MB, and 1.44 MB capacity all have 80 tracks. Because very few modern PCs have 40-track floppy drives, we recommend you to choose "Disabled" to save time.

Boot Up NumLock Status [Default: On]

Toggle between On or Off to control the state of the NumLock key when the system boots. When toggled On, the numeric keypad generates numbers instead of controlling cursor operations.

Gate A20 Option [Default: Fast]

Gate A20 refers to the way the system addresses memory above 1 MB (extended memory). When set to Fast, the system chipset controls Gate A20. When set to Normal, a pin in the keyboard controller controls Gate A20. Setting Gate A20 to Fast improves system speed, particularly with OS/2 and Windows.

Typematic Rate Setting [Default: Disabled]

Keystrokes repeat at a rate determined by the keyboard controller. When enabled, the typematic rate and typematic delay can be selected.

Typematic Rate (Char/Sec) [Default: 6]

When the typematic rate setting is enabled, you can select a typematic rate (the rate at which character repeats when you hold down a key) of 6, 8, 10, 12, 15, 20, 24, 30.

Typematic Delay (Msec) [Default: 250]

When the typematic rate setting is enabled, you can select a typematic delay (the delay before key strokes begin to repeat) of 250, 500, 750 or 1000 milliseconds.

Security Option [Default: Setup]

If you have set a password, select whether the password is required every time the System boots, or only when you enter Setup.

APIC Mode [Default: Enabled]

Enable/Disable Advanced Programmable interrupt controller. This option allows system to have Intel's new PIC standard supporting more interrupt lines for onboard devices.

Note: *This option should be only enabled when system is running on ACPI power management mode.*

MPS Version Control for OS [Default: 1.4]

Multi-Processor Specification Support. Choose 1.4 if not sure.

OS Select for DRAM > 64MB [Default: Non-OS2]

Select the operating system that is running with greater than 64MB or RAM on the system. Set this option to OS2 only if OS2 Operating System is installed.

Report No FDD For Win 95 [Default: Yes]

Select "Yes" to release IRQ6 when the system contains no floppy drive, for compatibility with Windows 95 logo certification. In the Integrated Peripherals screen, select Disabled for the Onboard FDD Controller field.

Video BIOS Shadow [Default: Enabled]

C8000-CBFFF Shadow [Default: Disabled]

CC000-CFFFF Shadow [Default: Disabled]

D0000-D3FFF Shadow [Default: Disabled]

D4000-D7FFF Shadow [Default: Disabled]

D8000-DBFFF Shadow [Default: Disabled]

DC000-DFFFF Shadow [Default: Disabled]

Software that resides in a read only memory (ROM) chip on a device is called firmware. The Award BIOS permits shadowing of firmware such as the system BIOS, video BIOS, and similar operating instructions that come with some expansion peripherals such as a SCSI adaptor. Shadowing copies firmware from ROM into system RAM, where the CPU can read it through the 16-bit or 32-bit DRAM bus. Firmware not shadowed must be read by the system through the 8-bit X-bus. Shadowing improves the performance of the system BIOS and similar ROM firmware for expansion peripherals. But it also reduces the amount of high memory (640 KB to 1 MB) available for loading device drivers, etc. Enable shadowing into each section of memory separately. Many system designers hardwire shadowing of the system BIOS and eliminate a System BIOS Shadow option. Video BIOS shadows into memory are C0000-C7FFF. The remaining areas shown on the BIOS Features Setup screen may be occupied by other expansion card firmware. If an expansion peripheral in your system contains ROM-based firmware, you need to know the address range the ROM occupies to shadow it into the correct area of RAM.

Small Logo (EPA) Show [Default: Enabled]

If you want to show your logo, please enable it.

3.5 Advanced Chipset Features

DRAM Timing Selectable [Default: By SPD]

When select to "By SPD", the DRAM timing parameters are set according to DRAM SPD (Serial Presence Detect). When disabled, one can manually set the DRAM timing parameters through the sub items below. Set to "By SPD" if not sure.

CAS Latency Time: [Default: 2]

Controls the latency between the SDRAM Read command and the time data actually becomes available.

Active to Precharge Delay: [Default: 8]

Delay between DRAM Activate Command to Precharge Command

DRAM RAS# to CAS# Delay [Default: 4]

Controls the latency between the DDR SDRAM active command and the read/write command.

DRAM RAS# Precharge [Default: 3]

Controls the idle clocks after issuing a precharge command to the DDR SDRAM.

DRAM Data Integrity Mode [Default: Non-ECC]

Select Parity or ECC (error-correcting code), according to the type of installed DRAM.

Memory Frequency For [Default: Auto]

Allows you to set the DDR operating frequency.

System BIOS Cacheable [Default: Enabled]

Selecting Enabled allows caching of the system BIOS ROM at F0000h-FFFFFh, resulting in better system performance. However, if any program writes to this memory area, a system error may result.

Video BIOS Cacheable [Default: Disabled]

Selecting Enabled allows caching of the video BIOS ROM at F0000h-FFFFFh, resulting in better video performance. However, if any program writes to this memory area, a system error may result.

Memory Hole At 15M-16M [Default: Disabled]

Enable this function to allow ISA ROM to map to 15-16M and support Legacy ISA devices. If you don't utilize legacy ISA devices in your system, you are recommended to disable this function to enhance graphic performance.

AGP Aperture Size (MB) [Default: 64]

Aperture size will ensure that all writes posted in the global write buffer to the graphics aperture are retired to DRAM before initiating any CPU-PCI cycle. This can be used to ensure synchronization between the CPU and AGP master.

** VGA Setting **

On-Chip VGA [Default: Enabled]

Enable/Disable the on-chip VGA.

On-Chip Frame Buffer Size [Default: 32M]

Determine video frame buffer size.

Boot Display [Default: LCD + CRT]

This option is used with various visual display peripherals. This function allows the end user to select the type of visual display peripheral they are incorporated with the AAEON single board computer.

Panel Type [Default: Panel #1]

When your display devices include LCD panel, you have to select the type of panel you are incorporating with your single board computer. Consult your panel manual for detail information.

TV Format [Default: NTSC]

Choose the format for TV.

3.6 Integrated Peripherals

OnChip IDE Device

OnChip Primary/ Secondary PCI IDE [Default: Enabled]	The integrated peripheral controller contains an IDE interface with support for two IDE channels. Select Enabled to activate each channel separately.
IDE Primary / Secondary Master / Slave PIO [Default: Auto]	The four IDE PIO (Programmable Input/Output) fields let you set a PIO mode (0-1) for each of the two IDE devices and the two storage devices that the onboard IDE interface supports. Modes 0 through 4 provide successively increased performance. In Auto mode, the system automatically determines the best mode for each device.
IDE Primary / Secondary Master / Slave UDMA [Default: Auto]	Ultra DMA33 implementation is possible only if your IDE hard drive supports it and the operating environment includes a DMA driver. If both your hard drive and IDE cable support Ultra DMA 33 select Auto to enable BIOS support.
IDD HDD Block Mode [Default: Enabled]	When enable this feature, the BIOS will automatically detect if your hard disk supports block transfers and set the proper block transfer settings for it.
OnChip Serial ATA [Default: Disabled]	Disabled: Disable this function. Auto: BIOS will auto detect. (Default value) Combined: Set On-Chip SATA mode to Combined, you can use up to 4 HDDs on the motherboard; 2 for SATA and the other for PATA IDE. Enhanced: Set On-Chip SATA mode to Enhanced, the motherboard allows up to 6 HDDs to use. SATA Only: Set On-Chip SATA to SATA only.
SATA mode [Default: IDE]	Set up SATA Hard Drive to IDE or RAID mode

Table continues on next page...

Serial ATA Port Mode [Default: Primary Master]	Set up Serial ATA Port mode to Primary / Secondary, Master / Slave or SATA0 / SATA1 according to "Combined / Enhanced / SATA Only" selected on "OnChip Serial ATA" option.
--	--

Onboard Device

USB Controller [Default: Enabled]	Enable / Disable USB Controller.
USB 2.0 Controller [Default: Enabled]	Enable / Disable USB 2.0 Controller. High speed mode will turn on when high speed device is attached.
USB Keyboard Support [Default: Disabled]	Select Enabled if a USB keyboard is installed on the system.
USB Mouse Support [Default: Disabled]	Select Enabled if a USB Mouse is installed on the system.
AC97 Audio [Default: Auto]	Auto Detect / Disable Onboard AC97 Device.
Init Display First [Default: PCI Slot]	You can select AGP or PCI slot to initialize it as the primary display before initializing any other display device on the system.
OnBoard LAN [Default: Enabled]	The default setting for this item is "Enabled". If you don't need to use onboard LAN function, just configure it as "Disabled" without any efforts on jumper setting.

SuperIO Device

Note: Normally, the boards' I/O chips will occupy a certain portion of memory space. For each I/O device the computer provides an I/O address. The more devices attached the more address needed to organize the memory storage areas. If all the I/O devices were running through the same address, your devices would come to a near halt. Also, the corresponding interrupt needs to be selected.

OnBoard FDC Controller [Default: Enabled]	Select Enabled if your system has a floppy disk controller (FDC) installed on the system board and you wish to use it. If you install an add-in FDC or the system has no floppy drive, select Disabled in this field.
OnBoard Serial Port 1 / Serial Port 2 1: [Default: 3F8/IRQ4] 2: [Default: 2F8/IRQ3]	Auto: BIOS will automatically setup the port address. 3F8/IRQ4: Enable onboard Serial port and address is 3F8, IRQ set to 4. (Default value) 2F8/IRQ3: Enable onboard Serial port and address is 2F8, IRQ set to 3. 3E8/IRQ4: Enable onboard Serial port and address is 3E8, IRQ set to 4. 2E8/IRQ3: Enable onboard Serial port and address is 2E8, IRQ set to 3. Disabled: Disable onboard Serial port.
COM2 RS232/422/485 Type [Default: RS232]	Select COM2 type if hardware supports 422/485.
UART Mode Select [Default: Normal]	If you don't disable Onboard Serial Port 2, you will have to select an operating mode for the second serial port: Normal: RS-232C serial port IrDA: IrDA-compliant serial infrared port ASKIR: Amplitude shift keyed infrared port
UR2 Duplex Mode [Default: Half]	Select the value required by the IR device connected to the IR port. Full-duplex mode permits simultaneous two-direction transmission. Half-duplex mode permits transmission in one direction only at a time.

Use IR Pins [Default: IR-Rx2Tx2]	Choose type of IR Pins.
Onboard Parallel Port [Default: 378/IRQ7]	Select a logical LPT port address and corresponding interrupt for the physical parallel port
Parallel Port Mode [Default: SPP]	Select Parallel port mode: SPP Using Parallel port as Standard Parallel Port. EPP Using Parallel port as Enhanced Parallel Port. ECP Using Parallel port as Extended Capabilities Port. ECP+EPP Using Parallel port as ECP & EPP mode.
EPP Mode Select [Default: EPP1.7]	You can use this feature to choose which version of EPP to use. For better performance, use EPP 1.9. If you are facing connection issues, try to set it to EPP 1.7.
ECP Mode Use DMA [Default: 3]	Select a DMA channel for the Parallel port.

Other Device

Expansion Slot Application [Default: PCI]	ISA – Supports full ISA compatible functions. PCI – Supports up to six master devices on PCI.
---	--

3.7 Power Management Setup

Power-Supply Type [Default: ATX]

Choose System Power Supply Type. ATX or AT depends on the Hardware Specification.

ACPI Function [Default: Enabled]

Enable / Disable ACPI function.

Power Management [Default: Min Saving]

Select Max Saving mode or Min Saving mode or define desired Suspend Mode, HDD Power Down functions by User Define.

Video Off Method [Default: DPMS]

This determines the manner in which the monitor is blanked. V/H SYNC + Blank: This selection will cause the system to turn off the vertical and horizontal synchronization ports and write blanks to the video buffer. DPMS: Initial display power management signaling. Blank Screen: This option only writes blanks to the video buffer.

Video Off In Suspend [Default: Yes]

Enable / Disable Video off in suspend mode.

Suspend Type [Default: Stop Grant]

Select suspend type to Stop Grant or Power On suspend.

Modem Use IRQ [Default: 3]

Name the interrupt request (IRQ) line assigned to the modem (if any) on your system. Activity of the selected IRQ always awakens the system.

Suspend Mode [Default: Disabled]

Disable this function or select 1 min, 2 min, 4 min, 8 min, 12 min, 20min, 30 min, 40 min, 1 hour.

HDD Power Down [Default: Disabled]

Disable this function or select from 1 to 15 minutes.

Soft-Off by PWR-BTTN [Default: Instant-Off]

If you select "Instant -Off", pushing the on/off button will instantly shut down the system. If you select " Delay 4 sec", you have to push the on/off button lasting for 4 seconds to shut down the system. In this mode, one touch on the on/off button won't shut down the system but place it in a very low-power-usage state, with only enough circuitry receiving power to detect power button activity or Resume by Ring activity.

CPU THRM-Throttling [Default: 50.0%]

Allow to select CPU duty cycle in throttle mode.

Wake-Up by PCI card [Default: Disabled]

Allow to turn on the system through a PCI LAN or modem card.

Power On by Ring [Default: Enabled]

Allow to turn on the system by Modem Ring.

Resume by Alarm [Default: Disabled]

You can set "Resume by Alarm" item to enabled and key in Date/Time to power on system.

Disabled: Disable this function. (Default value)

Enabled: Enable alarm function to power up system, if RTC Alarm Lead To Power On is Enabled.

Date (of Month) Alarm: Everyday, 1~31

Time (hh: mm: ss) Alarm: (0~23): (0~59): (0~59)

3.8 PnP/PCI Configurations

PNP OS Installed [Default: No]

Select Yes if the system operating environment is Plug and Play aware, for example Windows 95. Select No if you need the BIOS to configure non-boot devices.

Reset Configuration Data [Default: Disabled]

Normally, you leave this field disabled. Select enabled to reset Extended System Configuration Data (ESCD) when you exit Setup if you have installed a new add-on and the system reconfiguration has caused such a serious conflict that the operating system cannot boot.

Resource Controlled By [Default: Auto (ESCD)]

The Award Plug and Play BIOS has the capacity to automatically configure the entire Plug and Play compatible devices. However, this capability means absolutely nothing unless you are using a Plug and Play operating system such as Windows 95. If you set this field to Manual, please choose specific resources by going into each of the sub menu that follows this field (a sub menu is preceded by a ">")

IRQ Resource [Default: PCI/ISA PnP]

When resources are controlled manually, assign each system interrupt a type, depending on the type of device using the interrupt. There are two types for choice: Legacy ISA and PCI/ISA PnP. Legacy ISA: Devices compliant with the original PC AT bus specification, requiring a specific interrupt (such as IRQ4 for serial port 1) PCI/ISA PnP: Devices compliant with the Plug and Play standard, whether designed for PCI or ISA bus architecture.

DMA Resources [Default: PCI/ISA PnP]

When resources are controlled manually, assign each DMA channel a type, depending on the type of device using the DMA channel.

Legacy ISA	Devices compliant with the original PC AT bus specification, requiring a specific DMA channel
PCI/ISA PnP	Devices compliant with the Plug and Play standard, whether designed for PCI or ISA bus architecture.

PCI/VGA Palette Snoop [Default: Disabled]

The palette snooping feature informs the PCI devices that an ISA graphics device is installed in the system so that the later can function correctly.

** PCI Express relative items **

Maximum Payload Size [Default: 4096]

Determine maximum payload size of PCI express interface.

3.9 PC Health Status

CPU Warning Temperature [Default: 70]

Select the combination of lower and upper limits for the CPU temperature. If the CPU temperature extends beyond either limit, any warning mechanism programmed into your system will be activated.

Shutdown Temperature [Default: Disable]

The shutdown temperature for the computer shuts down by itself.

CPU Temperature

Current CPU Temperature.

CPU Fan Speed

Current CPU fan speed.

System Temperature

Current system temperature.

System Fan Speed

Current system fan speed.

Vcore

Current Vcore voltage value.

+1.5V

Current onboard 1.5V voltage value.

+3.3V

Current onboard 3.3V voltage value.

+5V

Current onboard 5V voltage value.

+12V

Current onboard 12V voltage value.

-12V

Current onboard -12V voltage value.

-5V

Current onboard -5V voltage value.

VBAT(V)

Current onboard VBAT voltage value.

5VSB(V)

Current onboard 5VSB voltage value.

3.10 Frequency/Voltage Control

CPU Clock Ratio [Default: Auto detect]

This option will not be shown or not be available if you are using a CPU with the locked ratio.

This setup option will automatically assign by CPU detection.

For C-Stepping P4: 8X, 10X~24X

For Northwood CPU: 12X~24X

The option will display "Locked" and read only if the CPU ratio is not changeable.

Auto Detect PCI Clk [Default: Enabled]

This item allows you to enable/disable auto detect PCI clock.

Spread Spectrum [Default: Disabled]

When the system clock generates pulses, the extreme value of the pulse generates excess EMI. Enabling pulse spectrum spread modulation changes the extreme pulse spikes to flat curves thus reducing EMI. This benefit may in some cases be outweighed by problems with timing-critical devices, such as a clock-sensitive SCSI device.

CPU Clock [Default: Auto detect]

100MHz ~ 355MHz Set CPU Host Clock from 100MHz to 355MHz.

If you use FSB400 Pentium 4 processor, "CPU Clock" should set to 100MHz. If you use FSB533 Pentium 4 processor, "CPU Clock" should set to 133MHz. If you use FSB800 Pentium 4 Processor, "CPU Clock" should set to 200MHz.

Chapter 4

Drivers Installation

4.1 Drivers Download and Installation

Drivers for the HSB-800I-A11 can be downloaded from the product page on the AAEON website by following this link:

<https://www.aaeon.com/en/p/half-size-sbc-hsb-800i>

Download the driver(s) you need and follow the steps below, to install them.

The downloadable drivers are executable installers. Simply double click each driver to run the installation wizard and follow the steps on your screen. Install each driver in the following order:

Step 1 – LX Graphics Driver

Step 2 – AES Driver

Step 3 – PCI to ISA Bridge Driver

Step 4 – LAN Driver

Step 5 – Audio Driver

Note: Drivers are compatible with Windows XP only. If you are running another operating system, you may be required to use other drivers or that operating system's own drivers. If you require any support, please contact an AAEON representative or visit the support page at AAEON.com

Appendix A

Watchdog Timer

A.1 Programming the Watchdog Timer

HSB-800I-A11 utilizes the ITE 8712 chipset as its watchdog timer controller. (K version)
Below are the procedures to complete its configuration. The AAION initial watchdog timer program is also attached, which you can use to develop a customized program to fit your application.

Configuring Sequence Description

After hardware reset or power-on reset, the ITE 8712 enters normal mode with all logical devices disabled except KBC.

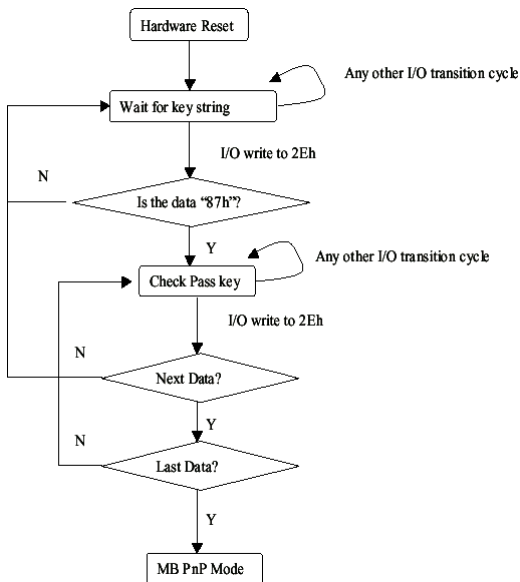

There are three steps to complete the configuration setup: (1) Enter the MB PnP Mode; (2) Modify the data of configuration registers; (3) Exit the MB PnP Mode. Undesired results may occur if the MB PnP Mode is not exited normally.

Step 1 – Enter the MB PnP Mode

To enter the MB PnP Mode, four special I/O write operations need to be performed during Wait for Key state. To ensure the initial state of the key-check logic, it is necessary to perform four write operations to the Special Address port (2EH). Two different enter keys are provided to select configuration ports (2Eh/2Fh) of the next step.

	Address Port	Data Port
87h, 01h, 55h, 55h:	2Eh	2Fh

Step 2 – Modify the Data of the Registers

All configuration registers can be accessed after entering the MB PnP Mode. Before accessing a selected register, the content of Index 07h must be changed to the LDN to which the register belongs, except some Global registers.

Step 3 – Exit the MB PnP Mode

Set bit 1 of the configure control register (Index=02h) to 1 to exit the MB PnP Mode.

Watchdog Timer Configuration Registers

LDN	Index	R/W	Reset	Configuration Register or Action
All	02H	W	N/A	Configuration Control
07H	71H	R/W	00H	WatchDog Timer Control Register
07H	72H	R/W	00H	WatchDog Timer Configuration Register
07H	73H	R/W	00H	WatchDog Timer Time-out Value (LSB) Register
07H	74H	R/W	00H	WatchDog Timer Time-out Value (MSB) Register

Configuration Control (Index=02h)

This register is write only. Its values are not sticky; a hardware reset will automatically clear the bits, and does not require the software to clear them.

Bit	Description
7-2	Reserved
1	Returns to the Wait for Key state. This bit is used when the configuration sequence is completed.
0	Resets all logical devices and restores configuration registers to their power-on states.

WatchDog Timer Control Register (Index=71h, Default=00h)

Bit	Description
7	WDT is reset upon a CIR interrupt
6	WDT is reset upon a KBC (Mouse) interrupt
5	WDT is reset upon a KBC (Keyboard) interrupt
4	WDT is reset upon a read or a write to the Game port base address
3-2	Reserved
1	Force Time-out. This bit is self-clearing
0	WDT status 1: WDT value reaches 0 0: WDT value is not 0

WatchDog Timer Configuration Register (Index=72h, Default=00h)

Bit	Description
7	WDT Time-out value select 1: Second 0: Minute
6	WDT output through KRST (pulse) enable
5	WDT Time-out value Extra select 1: 4s. 0: Determine by WDT Time-out value select (bit7 of this register)
4	WDT output through PWROK1/PWROK2 (pulse) enable
3	Select the interrupt level note for WDT

WatchDog Timer Time-out Value (LSB) Register (Index=73h, Default=00h)

Bit	Description
7-0	WDT Time-out value 7-0

WatchDog Timer Time-out Value (MSB) Register (Index=74h, Default=00h)

Bit	Description
7-0	WDT Time-out value 7-0

A.2 Watchdog Timer Initial Program

```
*****
Main:
.MODEL SMALL
.CODE

CALL Enter_Configuration_mode CALL Check_Chip
mov cl, 7
call Set_Logic_Device
;time setting
mov cl, 10 ; 10 Sec dec al
*****
```

Watch_Dog_Setting:

```
;Timer setting mov al, cl mov cl, 73h
call Superio_Set_Reg
;Clear by keyboard or mouse interrupt mov al, 0f0h
mov cl, 71h
call Superio_Set_Reg
;unit is second. mov al, 0C0H mov cl, 72h
call Superio_Set_Reg
; game port enable mov cl, 9
call Set_Logic_Device
```

Initial_OK:

```
CALL Exit_Configuration_mode MOV AH,4Ch
INT 21h
```

```
Enter_Configuration_Mode PROC NEAR MOV SI,WORD PTR CS:[Offset
Cfg_Port]
```

```
MOV DX,02Eh MOV CX,04h
```

Init_1:

```
MOV AL,BYTE PTR CS:[SI] OUT DX,AL
INC SI
LOOP Init_1 RET
```

```
Enter_Configuration_Mode ENDP
```

```
Exit_Configuration_Mode PROC NEAR MOV AX,0202h
CALL Write_Configuration_Data RET
Exit_Configuration_Mode ENDP
```

```
Check_Chip PROC NEAR
```

```
MOV AL,20h
CALL Read_Configuration_Data CMP AL,87h
JNE Not_Initial
```

```
MOV AL,21h
CALL Read_Configuration_Data
```

```
CMP AL,12h
JNE Not_Initial
```

```
Need_Initial:
```

```
STC RET
```

```
Not_Initial:
```

```
CLC RET
```

```
Check_Chip ENDP Read_Configuration_Data PROC NEAR MOV DX,WORD PTR
CS:[Cfg_Port+04h] OUT DX,AL
MOV DX,WORD PTR CS:[Cfg_Port+06h] IN AL,DX
```

RET

Read_Configuration_Data ENDP

Write_Configuration_Data PROC NEAR MOV DX,WORD PTR

CS:[Cfg_Port+04h] OUT DX,AL

XCHG AL,AH

MOV DX,WORD PTR CS:[Cfg_Port+06h] OUT DX,AL

RET

Write_Configuration_Data ENDP

Superio_Set_Reg proc near push ax

MOV DX,WORD PTR CS:[Cfg_Port+04h]

mov al,cl out dx,al pop ax inc dx out dx,al ret

Superio_Set_Reg endp.Set_Logic_Device proc near

Set_Logic_Device proc near push ax

push cx xchg al,cl mov cl,07h

call Superio_Set_Reg pop cx

pop ax ret

Set_Logic_Device endp

;Select 02Eh->Index Port, 02Fh->Data Port

Cfg_Port DB 087h,001h,055h,055h

DW 02Eh,02Fh

END Main

Note: Interrupt level mapping

0Fh-Dh: not valid 0Ch: IRQ12

.

.

03h: IRQ3

02h: not valid 01h: IRQ1

00h: no interrupt selected

Appendix B

I/O Information

B.1 I/O Address Map

NONO-F502DB7138

- Direct memory access (DMA)
- Input/output (IO)
 - [00000000 - 0000000F] Direct memory access controller
 - [00000000 - 00000CF7] PCI bus
 - [00000010 - 0000001F] Motherboard resources
 - [00000020 - 00000021] Programmable interrupt controller
 - [00000022 - 0000002D] Motherboard resources
 - [00000030 - 0000003F] Motherboard resources
 - [00000040 - 00000043] System timer
 - [00000044 - 0000005F] Motherboard resources
 - [00000060 - 00000060] Standard 101/102-Key or Microsoft Natural PS/2 Keyboard
 - [00000061 - 00000061] System speaker
 - [00000062 - 00000063] Motherboard resources
 - [00000064 - 00000064] Standard 101/102-Key or Microsoft Natural PS/2 Keyboard
 - [00000065 - 0000006F] Motherboard resources
 - [00000070 - 00000073] System CMOS/real time clock
 - [00000074 - 0000007F] Motherboard resources
 - [00000080 - 00000090] Direct memory access controller
 - [00000091 - 00000093] Motherboard resources
 - [00000094 - 0000009F] Direct memory access controller
 - [000000A0 - 000000A1] Programmable interrupt controller
 - [000000A2 - 000000BF] Motherboard resources
 - [000000C0 - 000000DF] Direct memory access controller
 - [000000E0 - 000000EF] Motherboard resources
 - [000000F0 - 000000FF] Numeric data processor
 - [00000170 - 00000177] Secondary IDE Channel
 - [000001F0 - 000001F7] Primary IDE Channel
 - [00000274 - 00000277] ISAPNP Read Data Port
 - [00000279 - 00000279] ISAPNP Read Data Port
 - [000002F8 - 000002FF] Communications Port (COM2)
 - [00000376 - 00000376] Secondary IDE Channel
 - [00000378 - 0000037F] Printer Port (LPT1)
 - [00000380 - 000003BA] Advanced Micro Devices Win 2K/XP Graphics Driver
 - [000003C0 - 000003DF] Advanced Micro Devices Win 2K/XP Graphics Driver
 - [000003F0 - 000003F5] Standard floppy disk controller
 - [000003F6 - 000003F6] Primary IDE Channel
 - [000003F7 - 000003F7] Standard floppy disk controller
 - [000003F8 - 000003FF] Communications Port (COM1)
 - [000004D0 - 000004D1] Motherboard resources
 - [000004E8 - 000004EF] Communications Port (COM4)
 - [000004F8 - 000004FF] Communications Port (COM3)
 - [00000800 - 00000805] Motherboard resources
 - [00000A79 - 00000A79] ISAPNP Read Data Port
 - [00000D00 - 0000AC17] PCI bus
 - [0000AC20 - 0000FFFF] PCI bus
 - [0000FC00 - 0000FCFF] Realtek RTL8139/810x Family Fast Ethernet NIC
 - [0000FE00 - 0000FE7F] Geode WDM Audio Driver for Samba
 - [0000FF00 - 0000FF0F] Standard Dual Channel PCI IDE Controller
- Interrupt request (IRQ)
- Memory

B.2 Memory Address Map

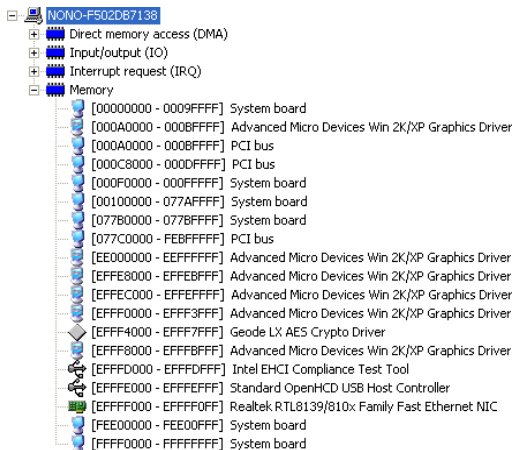

B.3 IRQ Mapping Chart

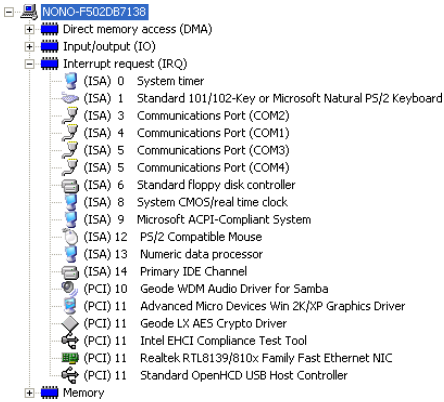

B.4 DMA Channel Assignments

