

# QBiX-Pro-EHLA6412H-A2

---

QBiX-Pro Industrial Embedded System  
Quick Start Guide

## Copyright Notice

---

This document is copyrighted, 2022. All rights are reserved. The original manufacturer reserves the right to make improvements to the products described in this manual at any time without notice.

No part of this manual may be reproduced, copied, translated, or transmitted in any form or by any means without the prior written permission of the original manufacturer. Information provided in this manual is intended to be accurate and reliable. However, the original manufacturer assumes no responsibility for its use, or for any infringements upon the rights of third parties that may result from its use.

The material in this document is for product information only and is subject to change without notice. While reasonable efforts have been made in the preparation of this document to assure its accuracy, GIGAIPC assumes no liabilities resulting from errors or omissions in this document, or from the use of the information contained herein.

GIGAIPC reserves the right to make changes in the product design without notice to its users.

## Acknowledgement

---

All other products' name or trademarks are properties of their respective owners.

- Microsoft Windows is a registered trademark of Microsoft Corp.
- Intel, Pentium, Celeron, and Xeon are registered trademarks of Intel Corporation
- Core, Atom are trademarks of Intel Corporation
- ITE is a trademark of Integrated Technology Express, Inc.
- IBM, PC/AT, PS/2, and VGA are trademarks of International Business Machines Corporation.

All other product names or trademarks are properties of their respective owners.

# Packing List

---

Before setting up your product, please make sure the following items have been shipped:

Item	Quantity
System kit	1
Screw I Head For 2.5" HDD M3x8L (25KSG-130081-K1R)	4
Thermal Pad for Memory (25ST3-200086-T5R)	1
SATA Cable (25CRI-150001-S9R)	1
Power Cord (May vary based on local distribution)	1
PSU ADP 19V 65W 100-240VAC (25EP1-100651-A3S)	1

If any of these items are missing or damaged, please contact your distributor or sales representative immediately.

## About this Document

---

This User's Manual contains all the essential information, such as detailed descriptions and explanations on the product's hardware and software features (if any), its specifications, dimensions, jumper/connector settings/definitions, and driver installation instructions (if any), to facilitate users in setting up their product.

Users may refer to the [GIGAIPC.com](http://GIGAIPC.com) for the latest version of this document.

## Safety Precautions

---

Please read the following safety instructions carefully. It is advised that you keep this manual for future references

1. All cautions and warnings on the device should be noted.
2. Make sure the power source matches the power rating of the device.
3. Position the power cord so that people cannot step on it. Do not place anything over the power cord.
4. Always completely disconnect the power before working on the system's hardware.
5. No connections should be made when the system is powered as a sudden rush of power may damage sensitive electronic components.
6. If the device is not to be used for a long time, disconnect it from the power supply to avoid damage by transient over-voltage.
7. Always disconnect this device from any AC supply before cleaning.
8. While cleaning, use a damp cloth instead of liquid or spray detergents.
9. Make sure the device is installed near a power outlet and is easily accessible.
10. Keep this device away from humidity.
11. Place the device on a solid surface during installation to prevent falls
12. Do not cover the openings on the device to ensure optimal heat dissipation.

13. Watch out for high temperatures when the system is running.
14. Do not touch the heat sink or heat spreader when the system is running
15. Never pour any liquid into the openings. This could cause fire or electric shock.
16. As most electronic components are sensitive to static electrical charge, be sure to ground yourself to prevent static charge when installing the internal components. Use a grounding wrist strap and contain all electronic components in any static-shielded containers.
17. If any of the following situations arises, please the contact our service personnel:
  - i. Damaged power cord or plug
  - ii. Liquid intrusion to the device
  - iii. Exposure to moisture
  - iv. Device is not working as expected or in a manner as described in this manual
  - v. The device is dropped or damaged
  - vi. Any obvious signs of damage displayed on the device
- 18. DO NOT LEAVE THIS DEVICE IN AN UNCONTROLLED ENVIRONMENT WITH TEMPERATURES BEYOND THE DEVICE'S PERMITTED STORAGE TEMPERATURES (SEE CHAPTER 1) TO PREVENT DAMAGE.**

## FCC Statement

---

### **Warning!**



This device complies with Part 15 FCC Rules. Operation is subject to the following two conditions: (1) this device may not cause harmful interference, and (2) this device must accept any interference received including interference that may cause undesired operation.

### **Caution:**

*There is a danger of explosion if the battery is incorrectly replaced. Replace only with the same or equivalent type recommended by the manufacturer. Dispose of used batteries according to the manufacturer's instructions and your local government's recycling or disposal directives.*

### **Attention:**

*Il y a un risque d'explosion si la batterie est remplacée de façon incorrecte. Ne la remplacer qu'avec le même modèle ou équivalent recommandé par le constructeur. Recycler les batteries usées en accord avec les instructions du fabricant et les directives gouvernementales de recyclage.*

## High Temperature Warning

---

(1) This equipment is intended to be used in Restrict Access Location. The access can only be gained by Skilled person or by Instructed person who have been instructed about the metal chassis of the equipment is so hot that Skilled person have to pay special attention or take special protection.

Only authorized by well trained professional person can access the restrict access location.

(2) External metal parts are hot!! Before touching it, special attention or protection is necessary

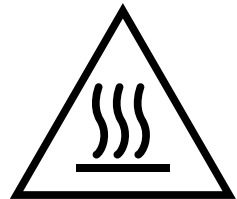



## Table Contents

<b>QBiX-Pro Industrial Embedded System</b>	<b>1</b>
<b>Quick Start Guide</b>	
Copyright Notice .....	2
Acknowledgement .....	3
Packing List.....	4
About this Document.....	5
Safety Precautions .....	6
FCC Statement.....	8
High Temperature Warning .....	8
<b>Chapter 1 - Product Specifications</b>	<b>12</b>
1.1 Specifications .....	14
<b>Chapter 2 – QBiX-Pro-EHLA6412H-A2</b>	<b>16</b>
<b>Industrial Embedded System Kit</b>	
2.1 Dimension .....	17
2.2 Getting Familiar with Your Unit.....	18
2.3 A) M.2 SSD Installation: How to safely install the M.2 2280 SSD .....	20
2.4 B) Memory Installation: DDR4 SO-DIMM .....	21
2.5 C) Mini PCIe Card Installation: How to safely install the Mini PCIe Card .....	22
2.6 Antenna Installation (Antenna inclusion may vary based on local distribution) .....	23
2.7 Cable Pin-define .....	24
2.8 Support .....	25

2.9	Safety and Regulatory Information.....	26
-----	--	----

## **Chapter 3 – Hardware Information** **27**

3.1	Jumpers and Connectors .....	28
3.2.1	FAN (FAN connector) .....	31
3.2.2	DC_IN (DC IN 1x4pin power connector) .....	32
3.2.3	AT_CN (AT/ATX mode select jumper).....	33
3.2.4	BKL_CN (Backlight Control connector) .....	34
3.2.5	JCOM1 (RI# pin RI#/5V/12V Select jumper for COM1 Port) .....	35
3.2.6	COM1, COM2, COM3, COM4 (Serial port header) .....	36
3.2.7	SPKR (Speaker out connector) .....	37
3.2.8	FP_AUDIO (Front panel audio header).....	38
3.2.9	SODIMMA, SODIMMB (DDR4 SO-DIMM sockets) .....	39
3.2.10	SYS_PANEL (Front panel header) .....	40
3.2.11	M2M (M.2 Slot, 2280 M-key).....	41
3.2.12	SATAPW (SATA power connector).....	42
3.2.13	SATAIII (SATA 6Gb/s Connector) .....	43
3.2.14	FUSB20 (USB 2.0 header) .....	44
3.2.15	GPIO_CNT (General Purpose input/output header) ...	45
3.2.16	LVDS (LVDS connector).....	46
3.2.17	LSW (LVDS resolution jumper) .....	47
3.2.18	SIM_CARD (3G/4G SIM Slot) .....	48
3.2.19	MPCIE (Mini PCIe slot).....	49
3.2.20	BUZZER (Buzzer header).....	50
3.2.21	BATTERY .....	51

3.2.22	LAN1, LAN2 (LAN connector).....	52
3.2.23	HDMI (HDMI connector) .....	53
3.2.24	USB31_1, USB31_2 (USB 3.2 Gen 1 connector).....	54

## Chapter 4 – BIOS 55

4.1	Introduction .....	56
4.2	The Main Menu.....	57
4.3	Advanced .....	58
4.3.1	TPM Configuration.....	59
4.3.2	IT8786 Super IO Configuration .....	61
4.3.3	Hardware Monitor .....	62
4.3.4	S5 RTC Wake Settings .....	63
4.3.5	CPU Configuration .....	64
4.3.6	SATA Configuration .....	65
4.3.7	Network Stack Configuration.....	66
4.3.8	NVMe Configuration.....	67
4.3.9	Offboard SATA Controller Configuration .....	68
4.3.10	Digital IO Port Configuration .....	69
4.4	Chipset .....	70
4.5	Security .....	71
4.6	Boot.....	74
4.7	Save & Exit .....	75

# Chapter 1

---

## Chapter 1 - Product Specifications



## 1.1 Specifications

System	QBiX-Pro-EHLA6412H-A2
Dimension	178W x 125D x 52.7H (mm)
CPU	Intel® Celeron® J6412 Processor 10nm, 4 cores, 4 threads, up to 2.60 GHz TDP 10W
Memory	2 x DDR4 SO-DIMM sockets, Max. Capacity 32 GB Support Dual Channel DDR4 3200 MHz memory modules
Ethernet	2 x GbE LAN Ports (Intel® I210AT)
Graphic support	Integrated Graphics Processor - Intel® UHD Graphics for 10th Gen Intel® Processors: 2 x HDMI 2.0 port, supporting a maximum resolution of 4096x2160 @60Hz  (2 independent display outputs)
Audio	Realtek® Audio Codec
Storage	1 x 2.5" HDD/SSD (SATA 6Gb/s)
Expansion Slots	1 x 2280 M.2 M-Key (PCIe x2, SATA 6Gb/s) 1 x Full-size mini PCIe with SIM slot
Front I/O	2 x RJ45 LAN Ports 4 x USB 3.2 Gen 1 2 x HDMI 1 x Power button with LED 1 x Headphone Jack
Rear I/O	2 x USB 2.0 1 x COM Port (RS-232/422/485 & RI/5V/12V) 1 x COM Port (RS-232/422/485) 1 x COM Port (RS-232) 1 x GPIO (8 bits) 1 x Screw Type DC Jack
Side I/O	2 x External Antenna Holes (Optional)
TPM	—
Power	+12V~36VDC (Adapter 19V/65W)

System	QBiX-Pro-EHLA6412H-A2
Operation temperature	Operating temperature: 0°C to 50°C Operating humidity: 0-90% (non-condensing) Non-operating temperature: -40°C to 85°C Non-operating humidity: 0%-95% (non-condensing) Use wide temperature range memory and storage
Vibration During Operation	Operation: IEC 60068-2-64, 3 Grms, random, 5 ~ 500 Hz, 1 hr / Per Axis, With SSD/M.2 2280 Non-operation: IEC 60068-2-6, 2 G, Sine, 10 ~ 500 Hz, 1 Oct/ min, 1 hr / Per Axis
Shock During Operation	Operation: IEC 60068-2-27, 50 G, half sine, 11 ms duration, With SSD
Packaging Content	Carton size: 505 x 333 x 231 (mm) Packing Capacity: 5pcs  Single Box size: 313 x 191 x 95 (mm)  Including: Screw I Head For 2.5" HDD M3x8L x 4 (P/N: 25KSG-130081-K1R) Thermal Pad for Memory x 1 (P/N: 25ST3-200086-T5R) SATA Cable x 1 (P/N: 25CRI-150001-S9R) Power Cord : Optional (by region) PSU ADP 19V 65W 100-240VAC x 1 (P/N: 25EP1-100651-A3S)
Mounting	Wall mount P/N: 25HB2-CGAA20-CHR x 1 (Optional) VESA 75/100 P/N: 25HB1-TPL021-S8R x 1 + 25KSD-000002-C0R x 1 (Screw) (Optional)
Order Information	System : 6BQP6412AMR-SI (Box packing)

## Chapter 2

---

Chapter 2 – QBiX-Pro-EHLA6412H-A2  
Industrial Embedded System Kit



## 2.1 Dimension

---

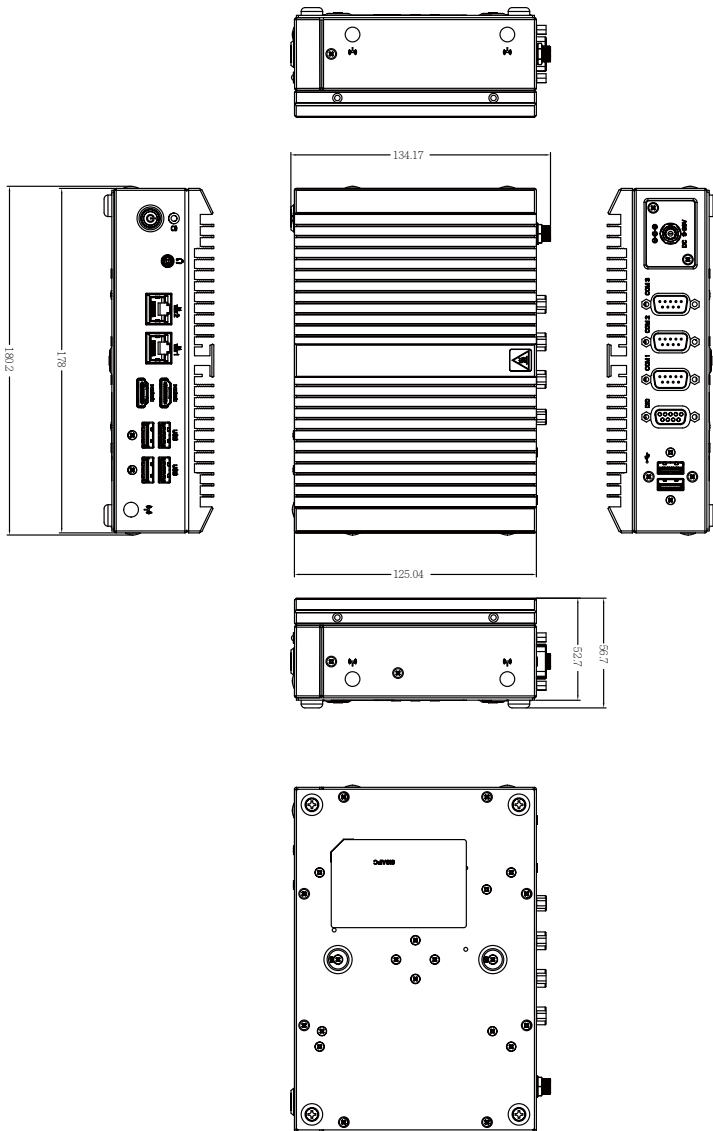

## 2.2 Getting Familiar with Your Unit

### [Front Side]

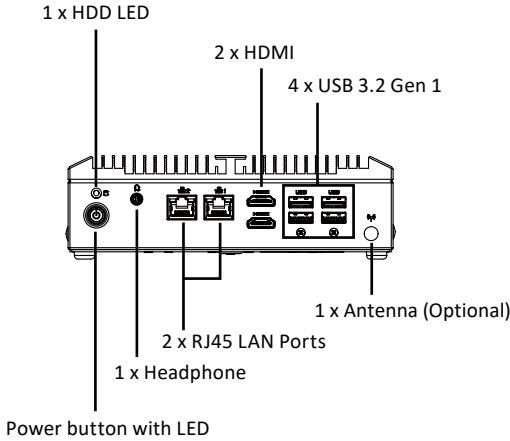

### [Left Side]

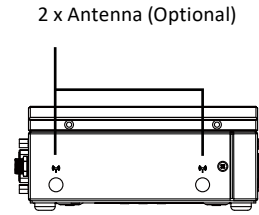

### [Rear Side]

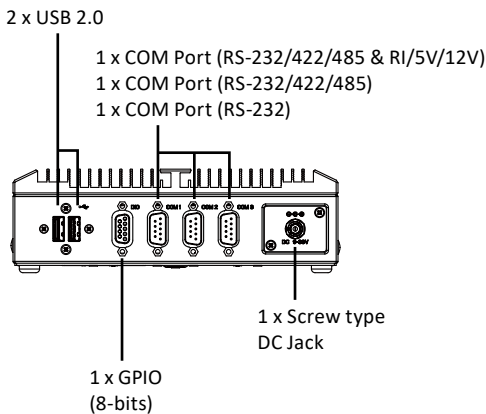

### [Right Side]

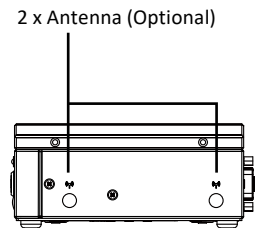

# [Install]

- \* Before opening the case, make sure to unplug the power cord.
- \* Before Connecting the power, make sure to fasten the case securely.

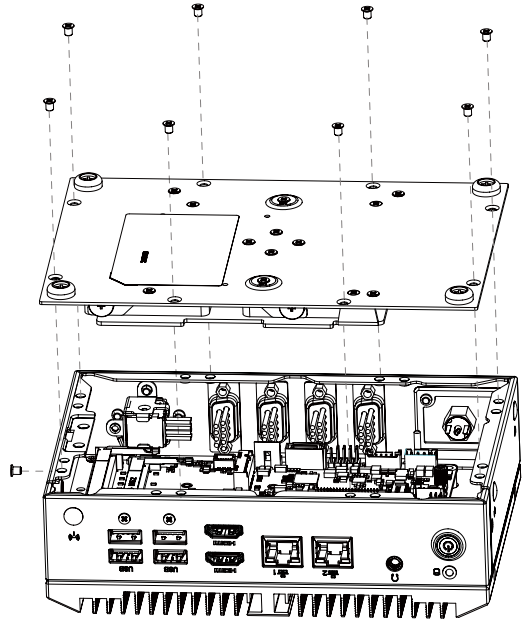

## [Bottom PCB Side]

Information	
A	2 x DDR4 SO-DIMM sockets, Max. Capacity 32 GB
B	1 x M.2 slot, 2280 M-key

Information	
C	1 x Min PCIe slot (PCIe x1 + USB2.0) with SIM Slot
D	support 2.5" Hard drive/SSD

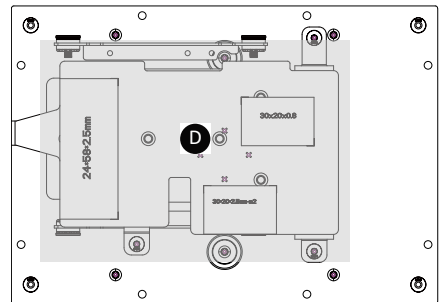
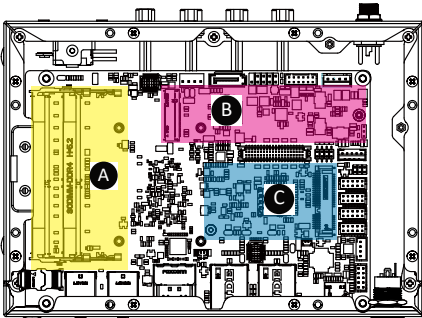

## 2.3 A) M.2 SSD Installation: How to safely install the M.2 2280 SSD

**1**

Remove the screw from the screw hole (Location : MSO2)

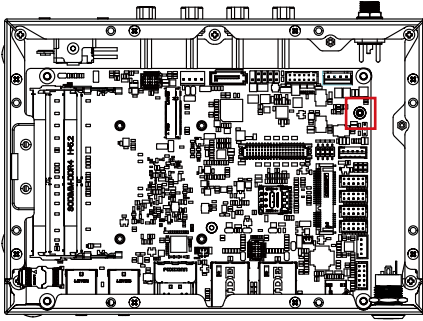
**2**

Carefully insert the M.2 SSD into the slot, and secure with the screw.

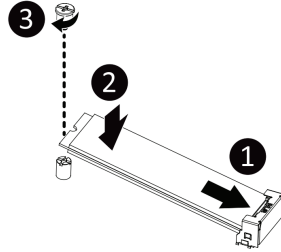

## 2.4 B) Memory Installation: DDR4 SO-DIMM

---

①

Carefully insert SO-DIMM memory modules.

小心地由下至上將 SO-DIMM 記憶體安裝於記憶體插槽。

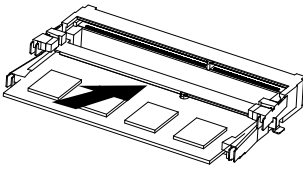

②

Push down until the modules click into place.

當記憶體固定於插槽後，再輕輕下壓至定點。

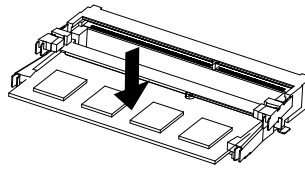

③

Carefully insert SO-DIMM memory modules.

安裝下層記憶體後，重覆前述動作安裝上層記憶體。

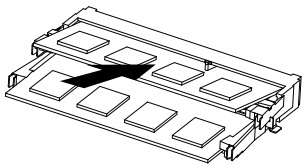

④

Push down until the modules click into place.

當記憶體固定於插槽後，再輕輕下壓至定點。

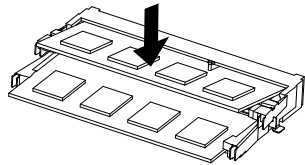

## 2.5 C) Mini PCIe Card Installation: How to safely install the Mini PCIe Card

**1**

Remove the screw from the screw hole (Location : MSO1)

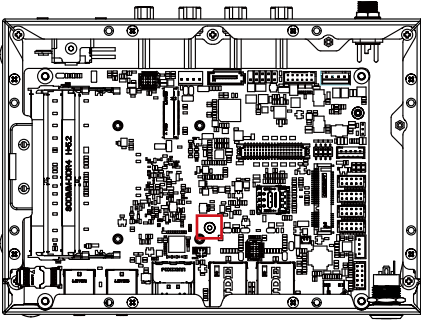
**2**

Carefully insert the Mini PCIe Card into the slot.

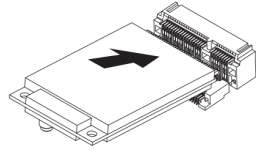
**3**

Secure the Mini PCIe Card with screw.

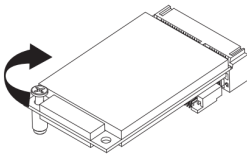

## 2.6 Antenna Installation (Antenna inclusion may vary based on local distribution)

1

Carefully insert the antennas into the connectors.

小心地將天線插入天線插孔中。

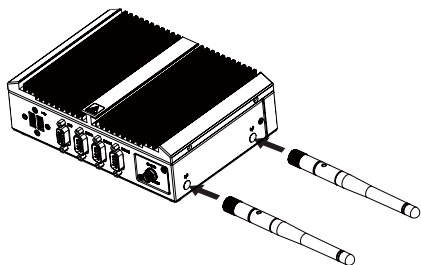

2

Turn the antennas clockwise until they are completely secure on the connectors.

握住天線接頭底端，按順時針方向將天線旋入插孔中牢牢固定。

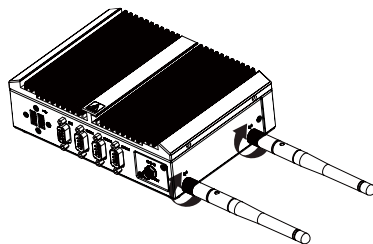

3

Flip up the antenna heads so that they are perpendicular to the machine.

栓緊後請將天線拉起朝上呈垂直狀。

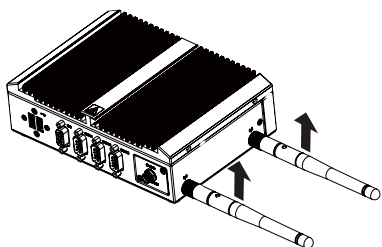

## 2.7 Cable Pin-define

### 1. DB9 COM (25CF8-180620-S9R)

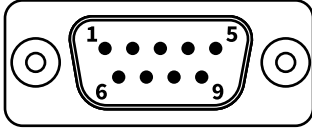

DB9 Pin Define

DB9 Pin	RS-232	RS-422 Full Duplex	RS-485 Half Duplex
1	DCD	TXD-	D-
2	RXD	TXD+	D+
3	TXD	RXD+	-
4	DTR	RXD-	-
5	GND		
6	DSR	-	-
7	RTS	-	-
8	CTS	-	-
9	RI	-	-

### 2. DBP DIO (25CR5-150606-S9R)

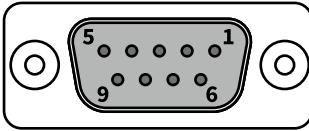

DBP DIO Pin	Pin Name
1	GPIO-output_1
2	GPIO-input_1
3	GPIO-output_2
4	GPIO-input_2
5	GPIO-output_3
6	GPIO-input_3
7	GPIO-output_4
8	GPIO-input_4
9	5V



## 2.8 Support

---

- For a list of tested memory, M.2, 2.5'' SSD, wireless adapters and OS supported, go to: <http://www.gigaipc.com>
- To download the latest drivers and BIOS updates, go to: <http://www.gigaipc.com>
- For product support, go to: <http://www.gigaipc.com>

## 2.9 Safety and Regulatory Information

---

Risk of explosion if the battery is replaced with an incorrect type. Batteries should be recycled where possible.

Disposal of used Batteries must be in accordance with local environmental regulations.

Failure to use the included Power Adapter may violate regulatory compliance and may expose the user to safety hazards.

**HDMI™**  
HIGH DEFINITION MULTIMEDIA INTERFACE



At the end of its serviceable life, this product should not be treated as household or general waste. It should be handed over to the applicable collection point for the recycling of electrical and electronic equipment, or returned to the supplier for disposal.

# Chapter 3

---

## Chapter 3 – Hardware Information

# 3.1 Jumpers and Connectors

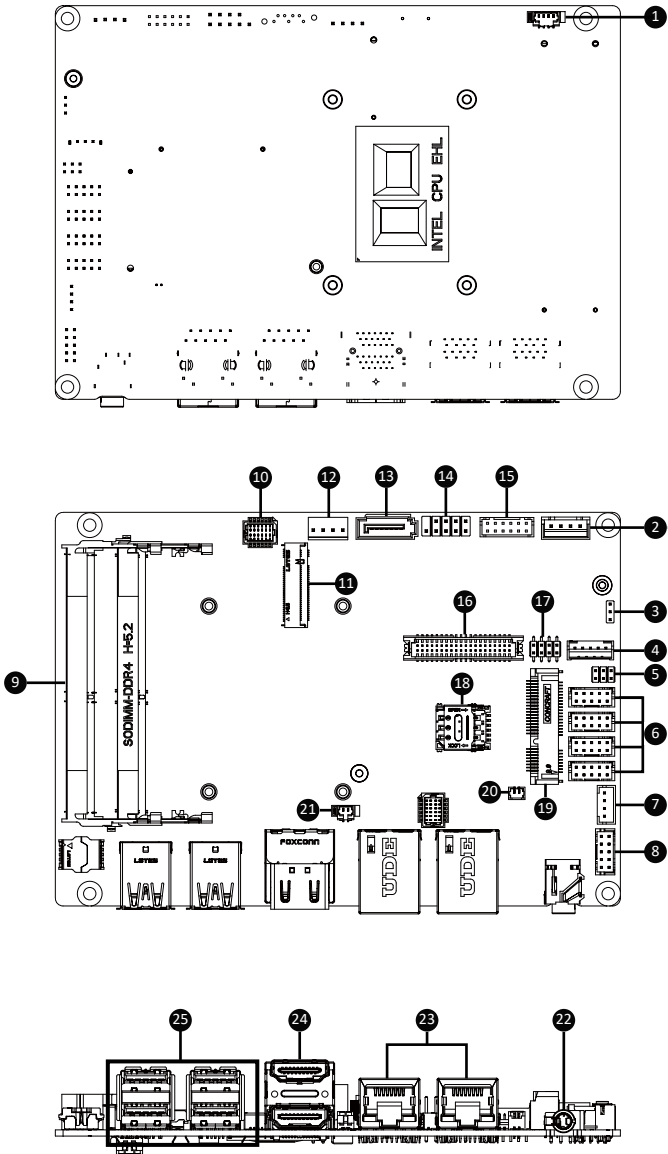

No	Code	Description
1	FAN	FAN connector
2	DC_IN	DC IN 1x4pin power connector
3	AT_CN	AT/ATX mode select jumper
4	BKL_CN	Backlight Control connector
5	JCOM1	RI# pin RI#/5V/12V Select jumper for COM1 port
6	COM1 COM2 COM3 COM4	Serial port header COM1 : RS-232/422/485 & RI/5V/12V COM2 : RS-232/422/485 COM3, COM4 : RS-232
7	SPKR	Speaker out connector
8	FP_AUDIO	Front panel audio header
9	SODIMMA SODIMMB	DDR4 SO-DIMM sockets x 2
10	SYS_PANEL	Front panel header
11	M2M	M.2 slot, 2280 M-key
12	SATAPW	SATA power connector
13	SATAIII	SATA 6Gb/s connector
14	FUSB20	USB 2.0 header
15	GPIO_CNT	General Purpose input/output header
16	LVDS	LVDS connector
17	LSW	LVDS resolution jumper
18	SIM_CARD	3G/4G Sim Slot
19	MPCIE	Mini-PCIe slot
20	BUZZER	Buzzer header
21	BATTERY	Battery cable connector

No	Code	Description
22	AUDIO	Line out connector
23	LAN1, LAN2	LAN connector
24	HDMI	HDMI connector
25	USB31_1, USB31_2	USB 3.2 Gen 1 connector x 4

## 3.2.1 FAN (FAN connector)

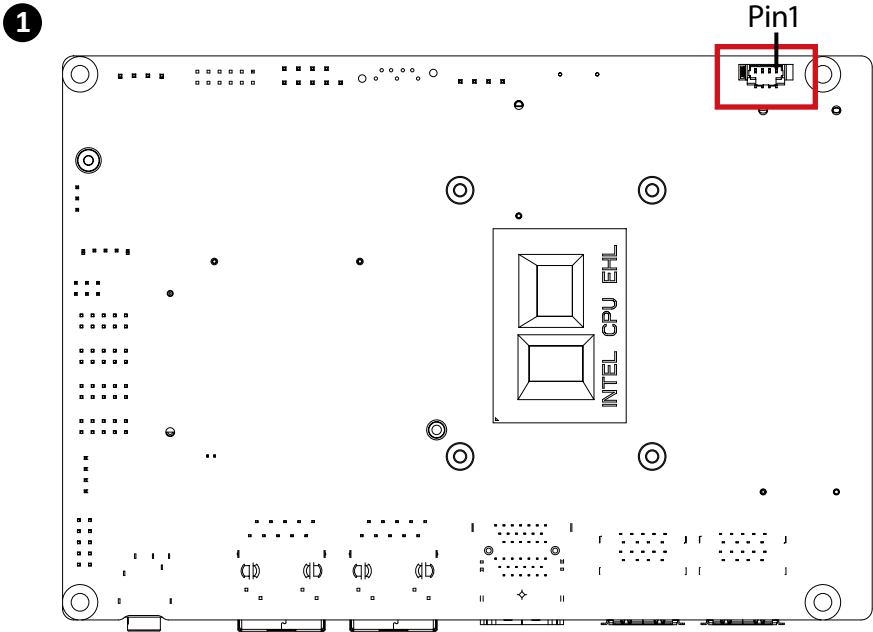

### CPU/System FAN

4 3 2 1

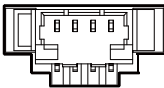

### Connector PN

85205-0470N

A1250WV-S-04PC

### Vendor

ACES

JOINT-TECH

### Pin No.

### Definition

1

GND

2

12V

3

Detect

4

Speed Control

### 3.2.2 DC\_IN (DC IN 1x4pin power connector)

2

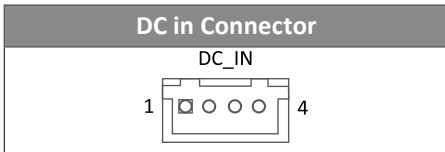
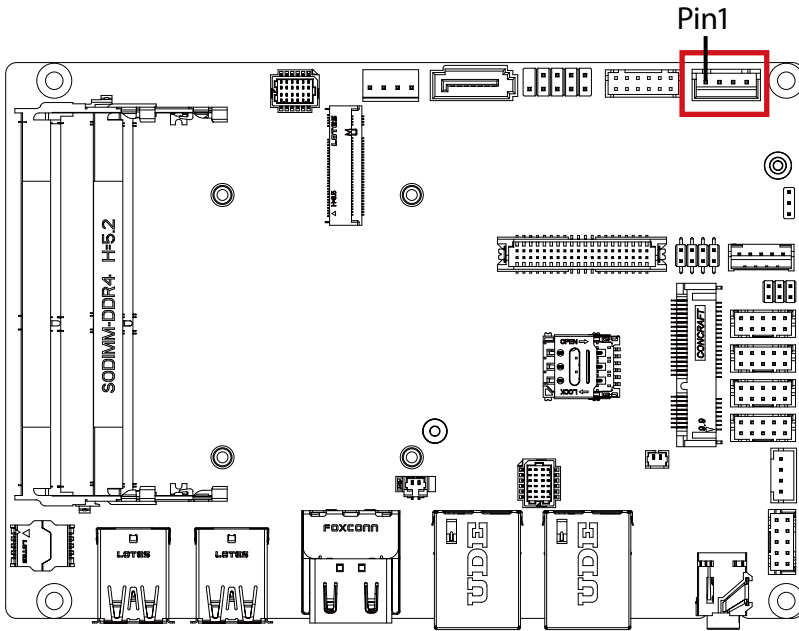

Connector PN	Vendor
753-81-04TW00	PINREX

Pin No.	Definition
1	GND
2	Power in
3	Power in
4	GND



## 3.2.3 AT\_CN (AT/ATX mode select jumper)

3

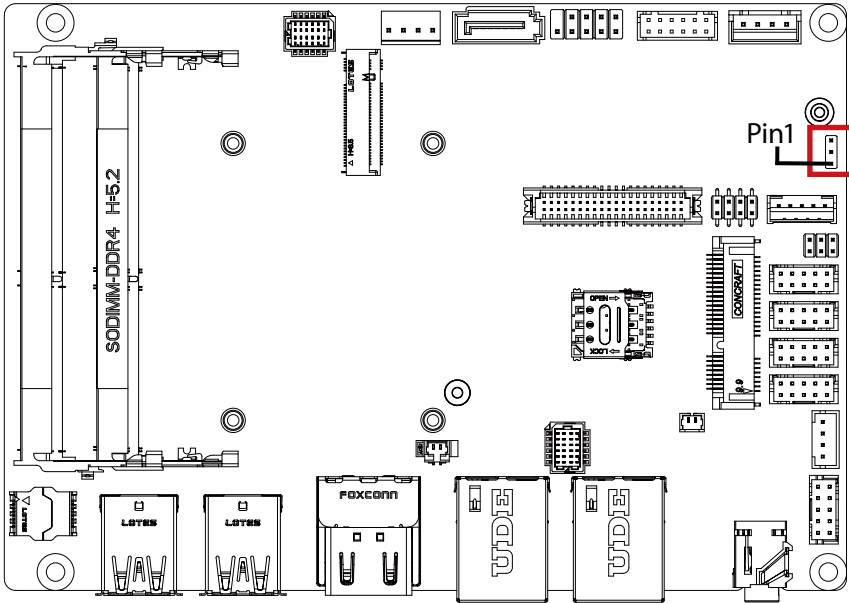

### AT/ATX mode select jumper



1-2 Close : AT mode.

2-3 Close : ATX mode.  
(Default setting)

### Connector PN

220-96-03GB01

PH03N2-7BAN000

### Vendor

PINREX

HORNGTONG

### Pin No.

### Definition

1	AT MODE
2	Detect
3	ATX MODE

### 3.2.4 BKL\_CN (Backlight Control connector)

4

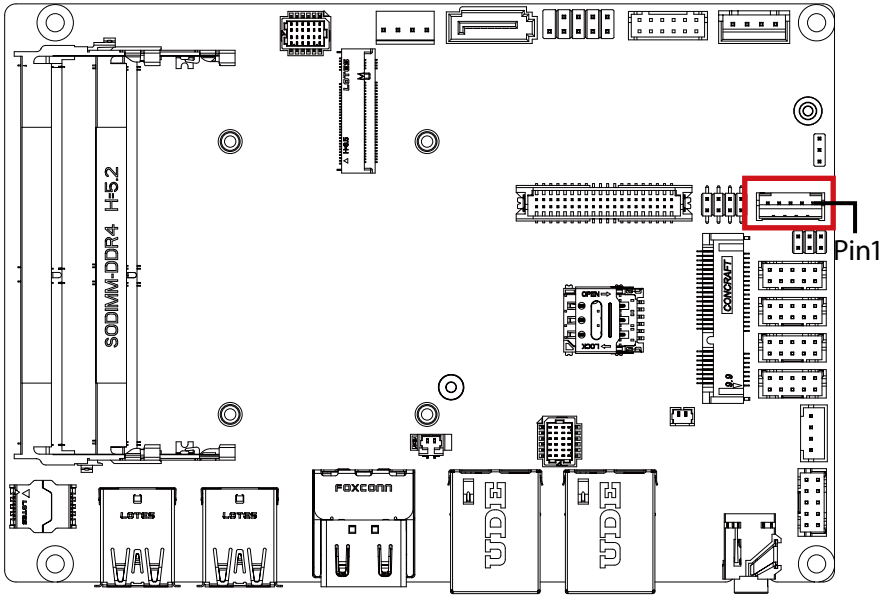

**Backlight Control connector**



**Connector PN**

721-81-05TW00

A2001WV-05P146

**Vendor**

PINREX

JOINT-TECH

**Pin No.**

**Definition**

1	5V
2	PWM
3	Backlight Enable
4	GND
5	12V

## 3.2.5 JCOM1 (RI# pin RI#/5V/12V Select jumper for COM1 Port)

5

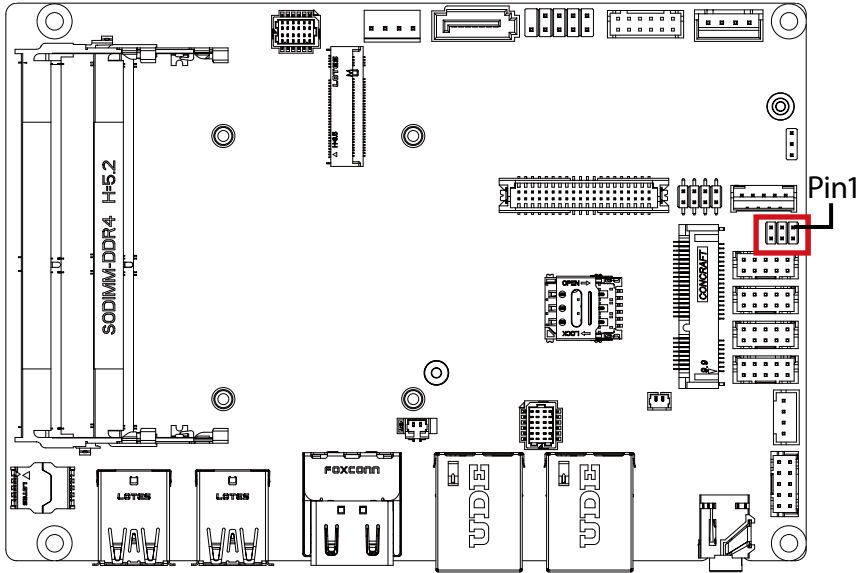

JCOM1 Jumper Select	
	1-2 Close: 5V (Power COM)
	3-4 Close: RI (Stand COM)
	5-6 Close: 12V (Power COM)

Connector PN	Vendor
220-97-03GB01	PINREX
PH06N53BAZ000	HORNGTONG

### 3.2.6 COM1, COM2, COM3, COM4 (Serial port header)

6

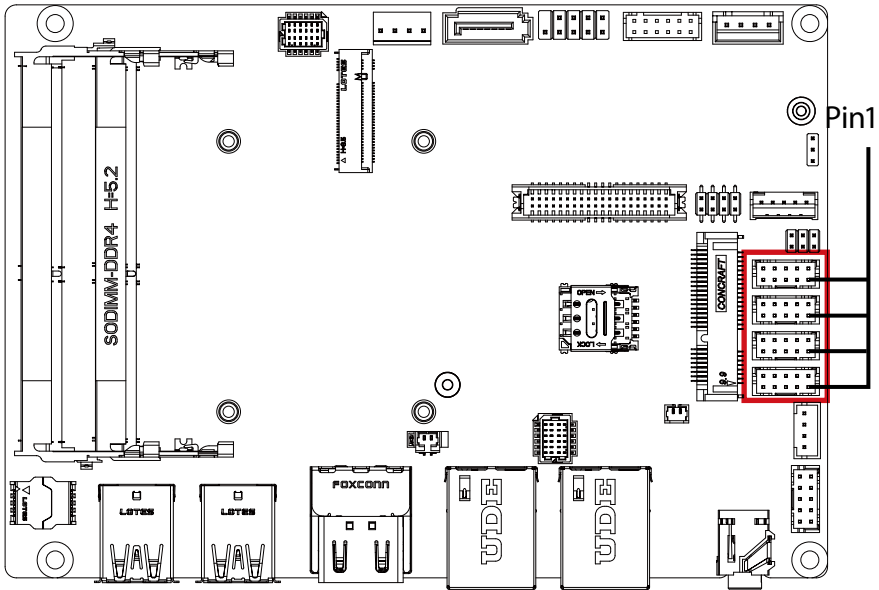

Serial Port Cable Connector

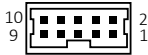

Pin No.	RS-232	RS-422 Full Duplex	RS-485 Half Duplex
1	RXD	TXD+	D+
2	DCD	TXD-	D-
3	DTR	RXD-	-
4	TXD	RXD+	-
5	DSR	-	-
6	GND	-	-
7	CTS	-	-
8	RTS	-	-
9	No Connect	-	-
10	RI/5V/12V	-	-

Connector PN

725-81-10TW00

A2004WV-2X05P46

Vendor

PINREX

JOINT-TECH

**Note :**

COM1 : Support RS-232/422/485 & RI/5V/12V  
For RI/5V/12V jumper setting, please see P. 29

COM2 : Support RS-232/422/485

COM3, COM4 : Support RS-232 only

## 3.2.7 SPKR (Speaker out connector)

7

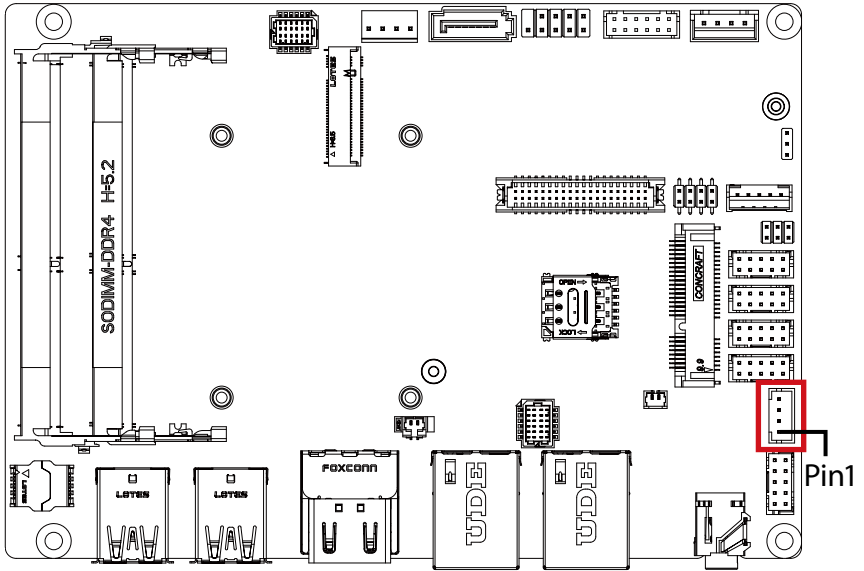

Speaker out connector



Connector PN

721-81-045W00

A2001WV-04P146

Vendor

PINREX

JOINT-TECH

Pin No.

Definition

1	Speaker Out L+
2	Speaker Out L-
3	Speaker Out R-
4	Speaker Out R+

### 3.2.8 FP\_AUDIO (Front panel audio header)

8

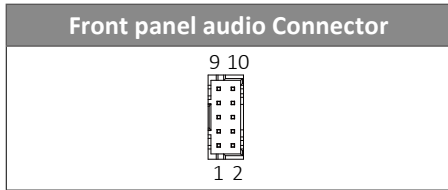
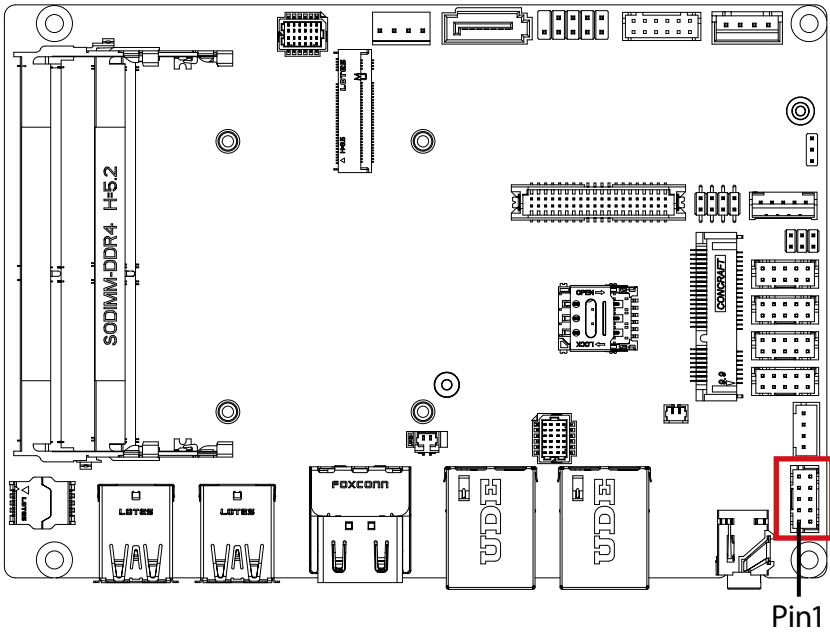

Connector PN	Vendor
725-81-10TW00	PINREX
A2004WV-2X05P46	JOINT-TECH

Pin No.	Definition
1	MIC-LEFT
2	GND
3	MIC-RIGHT
4	Detect
5	LINE-RIGHT
6	GND
7	JACKSENCE Detect
8	NC
9	LINE-LEFT
10	GND

## 3.2.9 SODIMMA, SODIMMB (DDR4 SO-DIMM sockets)

9

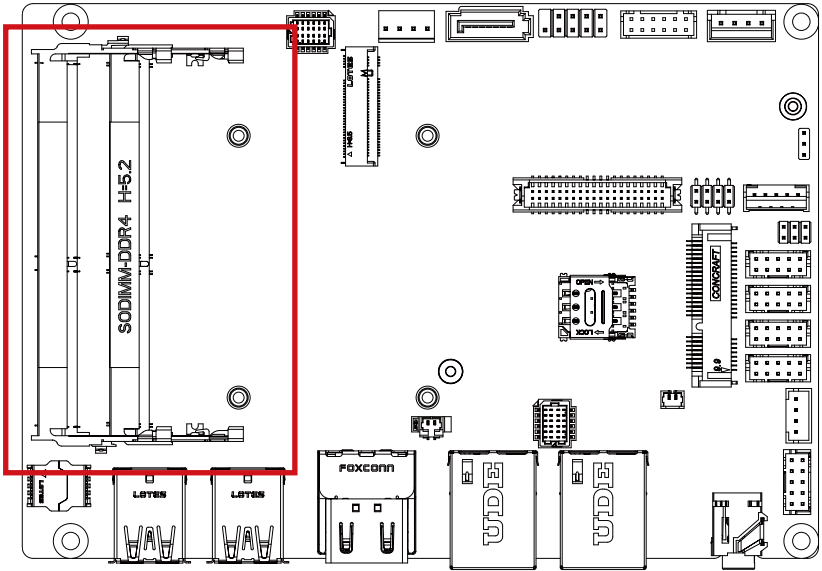

### 3.2.10 SYS\_PANEL (Front panel header)

10

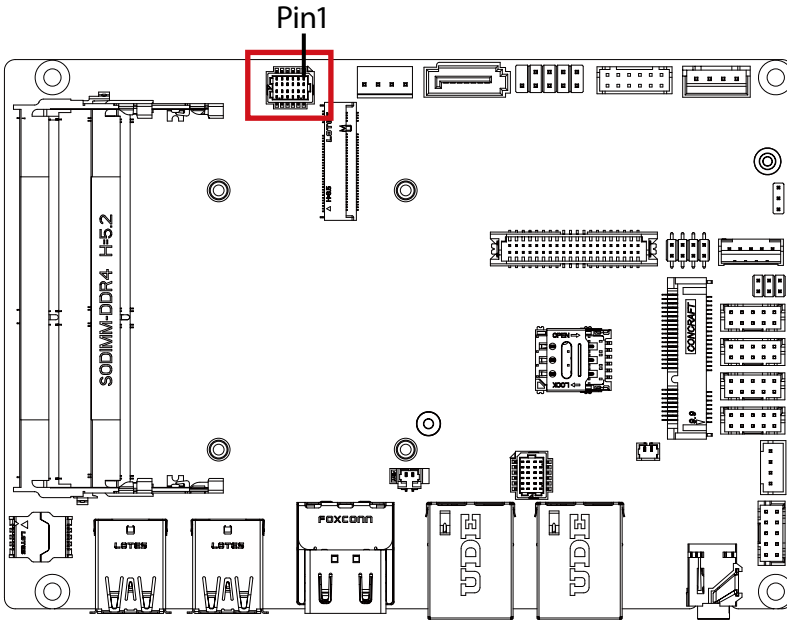

System Panel Header



Pin No.	Definition
10	No Connect
11	No Connect
12	No Connect

Pin No.	Definition
1	HD-p
2	MPD-p
3	HD-n
4	MPD-n
5	GND
6	POWER-ON
7	Reset Button
8	GND
9	No Connect

Connector PN	Vendor
87216-1206-06	ACES



## 3.2.11 M2M (M.2 Slot, 2280 M-key)

11

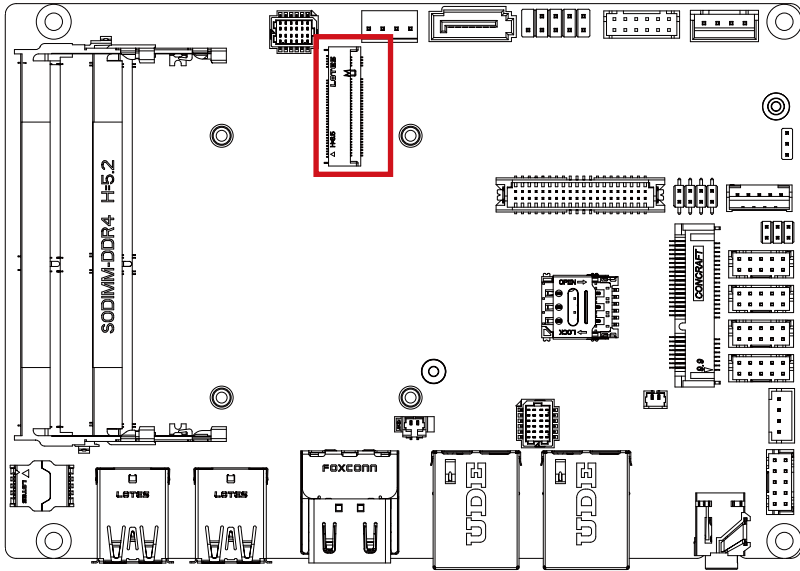

M.2 M Key Connector

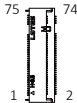

Pin No.	Definition	Pin No.	Definition
1	GND	2	3.3V
3	GND	4	3.3V
5	NC	6	NC
7	NC	8	NC
9	GND	10	SSD LED
11	NC	12	3.3V
13	NC	14	3.3V
15	GND	16	3.3V
17	NC	18	3.3V
19	NC	20	NC
21	GND	22	NC
23	NC	24	NC
25	NC	26	NC
27	GND	28	NC
29	PCIE1 RXn	30	NC
31	PCIE1 RXp	32	NC
33	GND	34	NC

Pin No.	Definition	Pin No.	Definition
35	PCIE1 TXn	36	NC
37	PCIE1 TXp	38	NC
39	GND	40	NC
41	PCIE0 RXn/SATA RXp	42	NC
43	PCIE0 RXp/SATA RXn	44	NC
45	GND	46	NC
47	PCIE0 TXn/SATA TXn	48	NC
49	PCIE0 TXp/SATA TXp	50	PCI Reset
51	GND	52	PCIE Clock Request
53	PCIE Clock n	54	NC
55	PCIE Clock p	56	NC
57	GND	58	NC

Pin No.	Definition	Pin No.	Definition
67	NC	68	NC
69	Detect	70	3.3V
71	GND	72	3.3V
73	GND	74	3.3V
75	GND		

Connector PN	Vendor
80159-8521	BELLWETHER

### 3.2.12 SATAPW (SATA power connector)

12

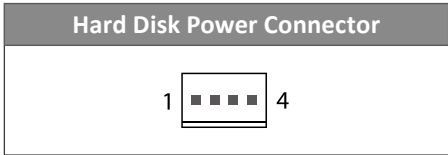
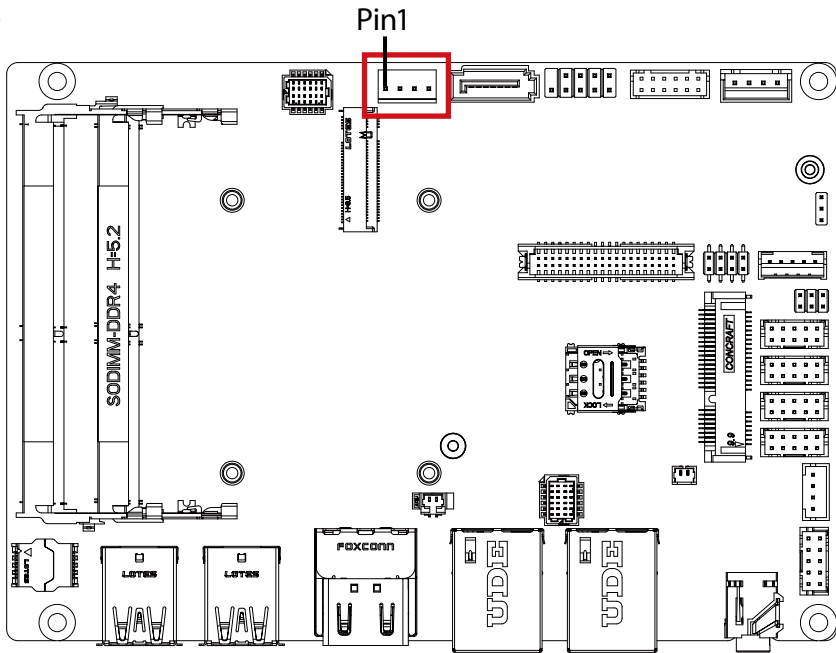

Connector PN	Vendor
743-51-04TW03	PINREX
WF04Q2-3BJQ00	HORNGTONG

Pin No.	Definition
1	12V
2	GND
3	GND
4	5V

## 3.2.13 SATAIII (SATA 6Gb/s Connector)

13

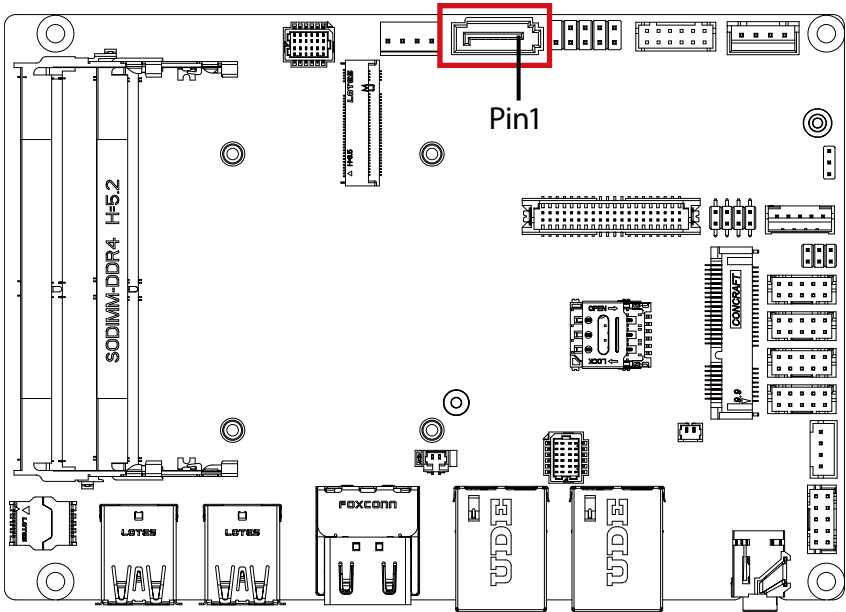

SATA 6GB/s Connector



SATAIII

Connector PN	Vendor
WAT3M-07A1G3BU4W	WINWIN
ABA-SAT-054-S15	LOTES

Pin No.	Definition
1	GND
2	TXp
3	TXn
4	GND
5	RXn
6	RXp
7	GND

### 3.2.14 FUSB20 (USB 2.0 header)

14

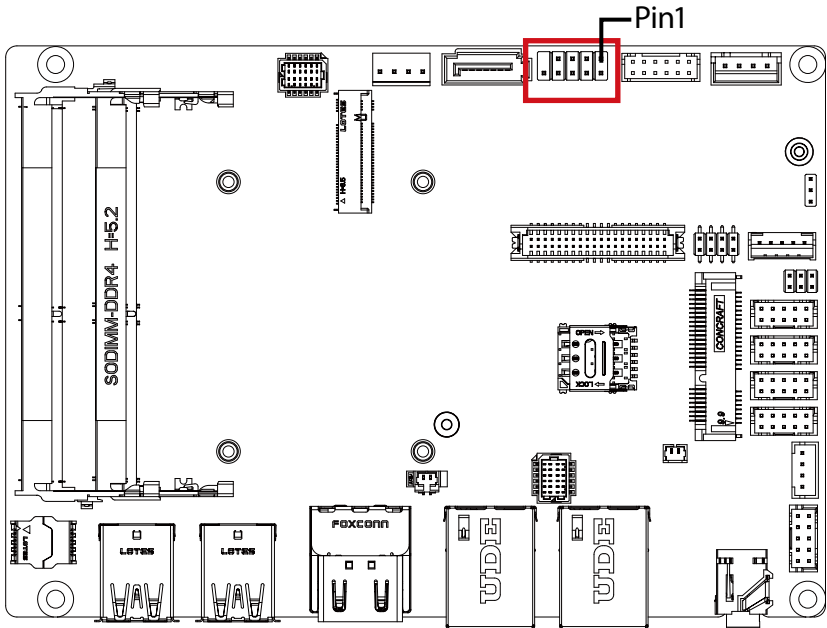

USB 2.0 Header	
9	1
10	2

Connector PN	Vendor
210-92-05GB04	PINREX
PH10R53BAZ009	HORNGTONG

Pin No.	Definition
1	5V
2	5V
3	D2n
4	D1n
5	D2p
6	D1p
7	GND
8	GND
9	No Pin
10	No Connect

## 3.2.15 GPIO\_CNT (General Purpose input/output header)

15

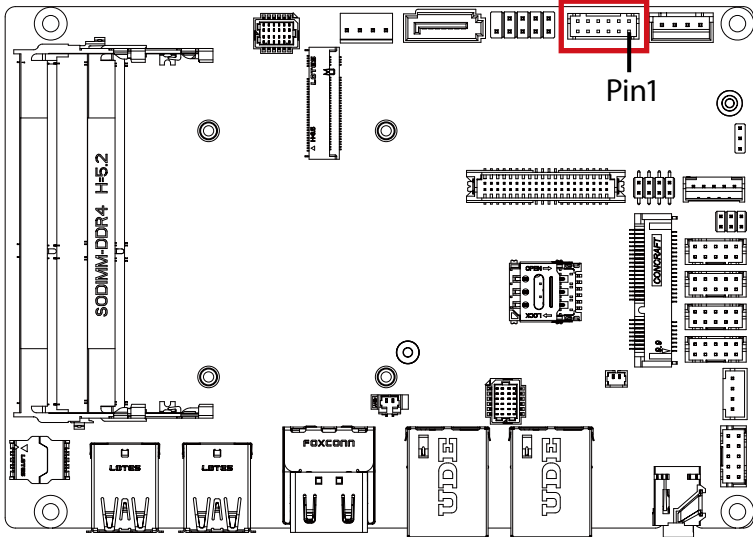

**GPIO Connector**

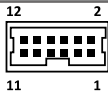

**Connector PN**

725-81-12TW00

A2004WV-2X06P46

**Vendor**

PINREX

JOINT-TECH

**Pin No. Definition**

Pin No.	Definition
1	GPIO-output_1
2	GPIO-input_1
3	GPIO-output_2
4	GPIO-input_2
5	GPIO-output_3
6	GPIO-input_3
7	GPIO-output_4
8	GPIO-input_4
9	SMBus Clock
10	SMBus DATA
11	5V
12	GND

### 3.2.16 LVDS (LVDS connector)

16

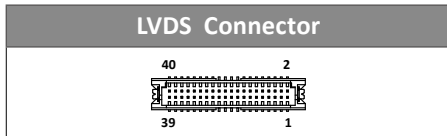
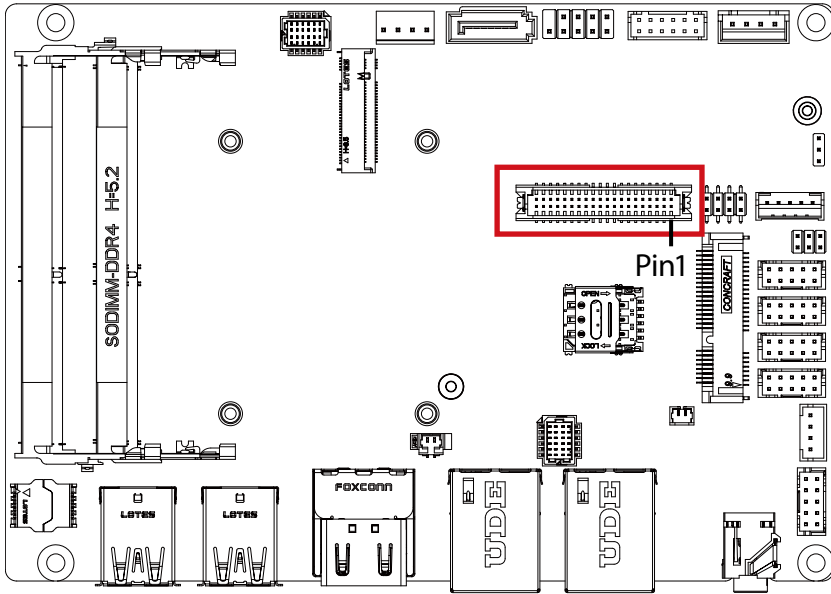

Pin No.	Definition	Pin No.	Definition
17	A3-	37	GND
18	A2-	38	GND
19	GND	39	12V
20	GND	40	12V

Pin No.	Definition	Pin No.	Definition
1	3.3V	21	A5+
2	5V	22	A4+
3	3.3V	23	A5-
4	5V	24	A4-
5	SPECO	25	GND
6	SPEDO	26	GND
7	GND	27	A7+
8	GND	28	A6+
9	A1+	29	A7-
10	A0+	30	A6-
11	A1-	31	GND
12	A0-	32	GND
13	GND	33	CLK2+
14	GND	34	CLK1+
15	A3+	35	CLK2-
16	A2+	36	CLK1-

For each model support LVDS function.  
 But below model no need to add.  
 A0~A3 is odd channel 0~3, A4~A7 is even channel.









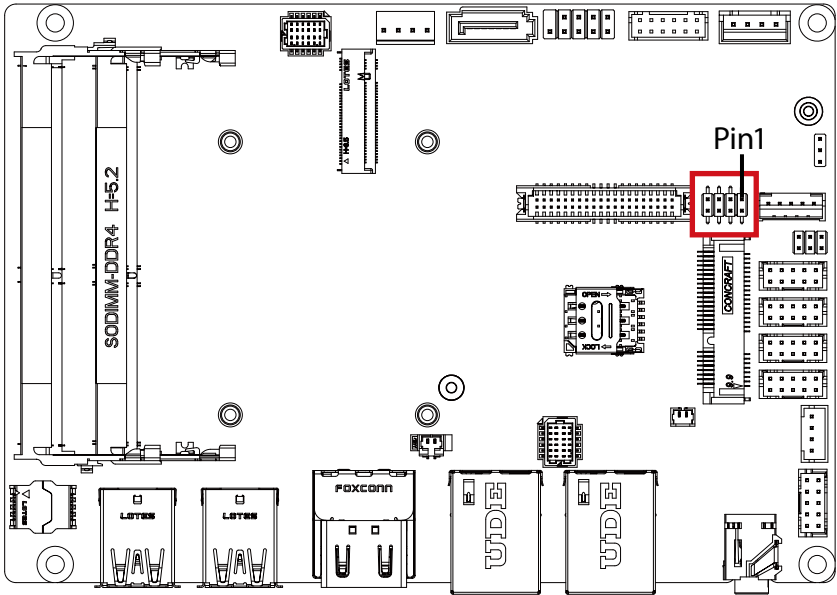







Connector PN	Vendor
712-76-40GWEO	PINREX
A1252WV-SF-2X20PD01	JOINT-TECH

**Note: \*The LVDS output connector of the unit is only intended to be connected to an UL/IEC/EN approval equipment with fire enclosure.**

## 3.2.17 LSW (LVDS resolution jumper)

17



LVDS Resolution Jumper			
Jumper Setting	Resolution	Jumper Setting	Resolution
	800 x 600 18bit (default)		1366 x 768 24bit
	1024 x 768 18bit		1440 x 900 24bit
	1024 x 768 24bit		1400 x 1050 24bit
	1024 x 600 18bit		1600 x 900 24bit
	1280 x 800 18bit		1680 x 1050 24bit
	1280 x 960 18bit		1600 x 1200 24bit
	1280 x 1024 24bit		1920 x 1080 24bit
	1366 x 768 18bit		1920 x 1200 24bit

Connector PN	Vendor
222-97-04GBE1	PINREX

### 3.2.18 SIM\_CARD (3G/4G SIM Slot)

18

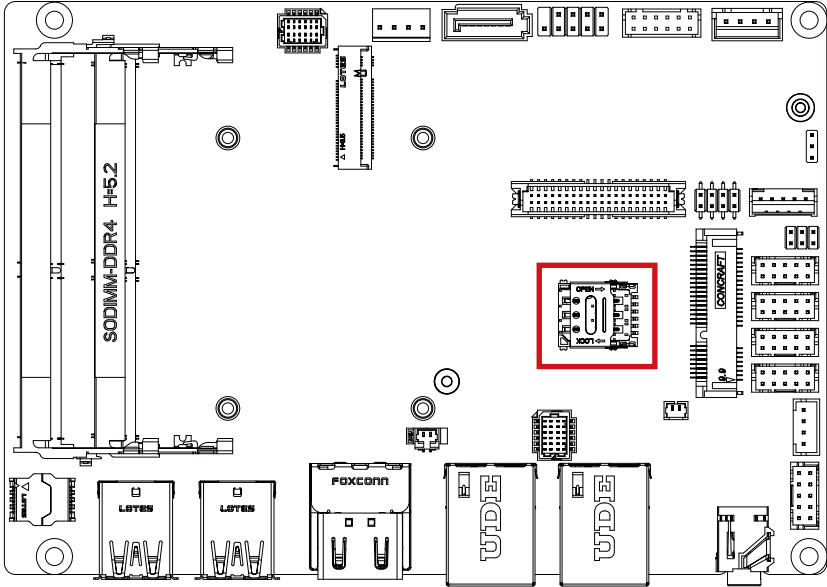



## 3.2.19 MPCIE (Mini PCIe slot)

19

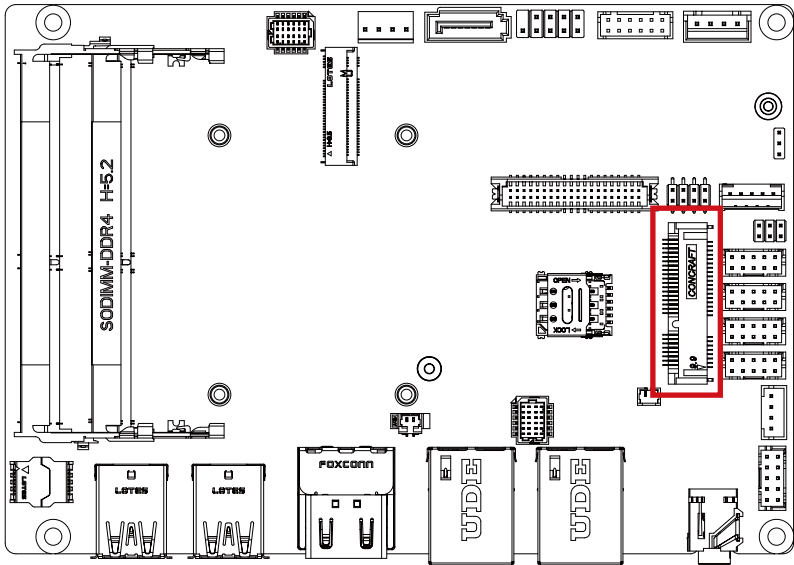

Mini PCIe Connector

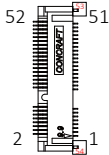

Pin No.	Definition	Pin No.	Definition
1	PCIE WAKE	2	3.3V
3	NC	4	GND
5	NC	6	NC
7	PCIE Clock Request	8	SIM VCC
9	GND	10	SIM DATA
11	PCIE Clock n	12	SIM Clock
13	PCIE Clock p	14	SIM Reset
15	GND	16	UIM VPP3
17	NC	18	GND
19	NC	20	WLAN_DISABLE
21	GND	22	Reset
23	PCIE RXn	24	3.3V
25	PCIE RXp	26	GND
27	GND	28	NC
29	GND	30	SMB Clock

Pin No.	Definition	Pin No.	Definition
31	PCIE TXn	32	SMB DATA
33	PCIE TXp	34	GND
35	GND	36	USB Dn
37	GND	38	USB Dp
39	3.3V	40	GND
41	3.3V	42	NC
43	GND	44	NC
45	NC	46	NC
47	NC	48	NC
49	NC	50	GND
51	NC	52	3.3V
53	GND	54	GND

Connector PN	Vendor
ASOB221-S99Q-7H	FOXCONN

## 3.2.20 BUZZER (Buzzer header)

20

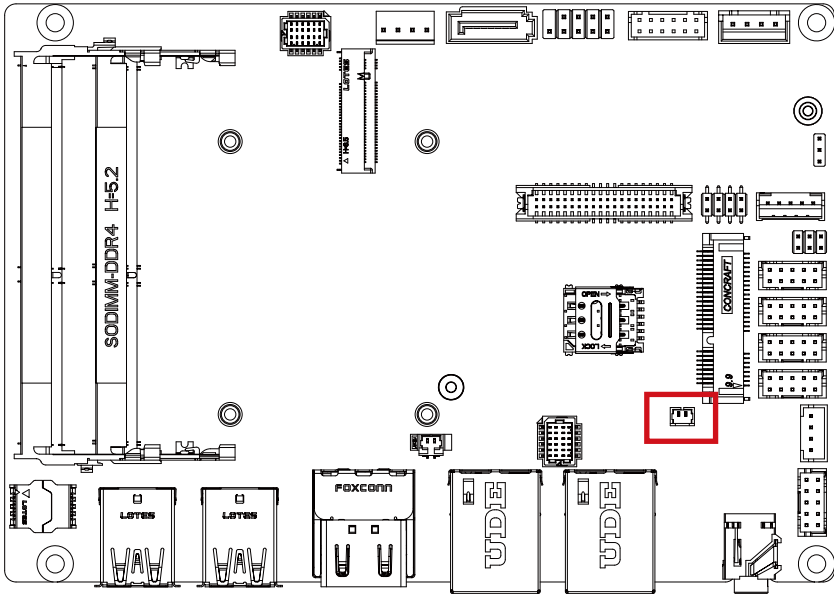

Buzzer header

Connector PN	Vendor
712-71-02TW01	PINREX
A1250WV-02P	JOINT-TECH

Pin No.	Definition
1	Buzzer
2	5V

## 3.2.21 BATTERY

21

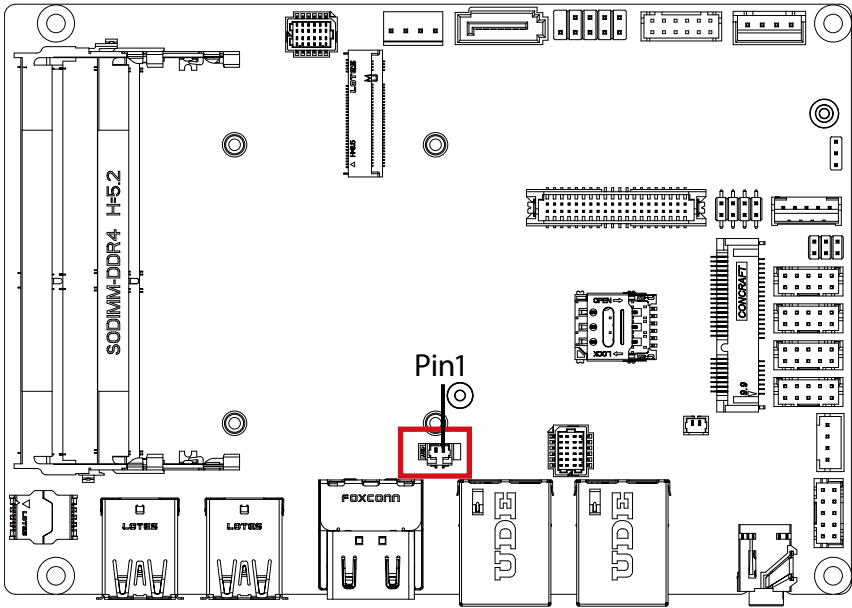

Battery Cable Connector

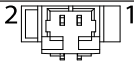

Connector PN

85205-0270L

A1250WV-S-02PC

Vendor

ACES

JOINT-TECH

Pin No.

Definition

1

3V

2

GND

## 3.2.22 LAN1, LAN2 (LAN connector)

23

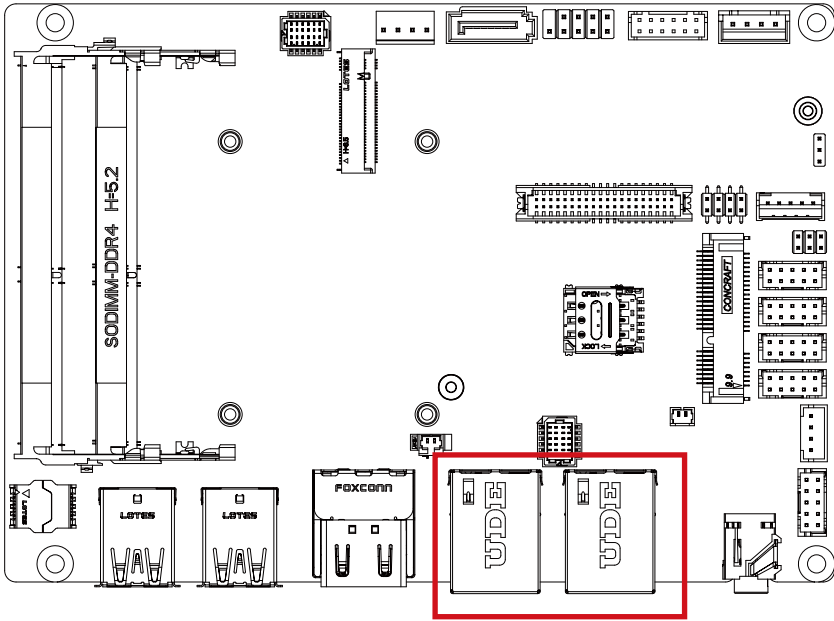

### LAN Connector



Status	Description
Orange On	1Gbps data rate
Green On	100Mbps data rate
Off	10Mbps data rate

Pin No.	Definition
1	TX1+
2	TX1-
3	TX2+
6	TX2-
4	TX3+
5	TX3-
7	TX4+
8	TX4-

## 3.2.23 HDMI (HDMI connector)

24

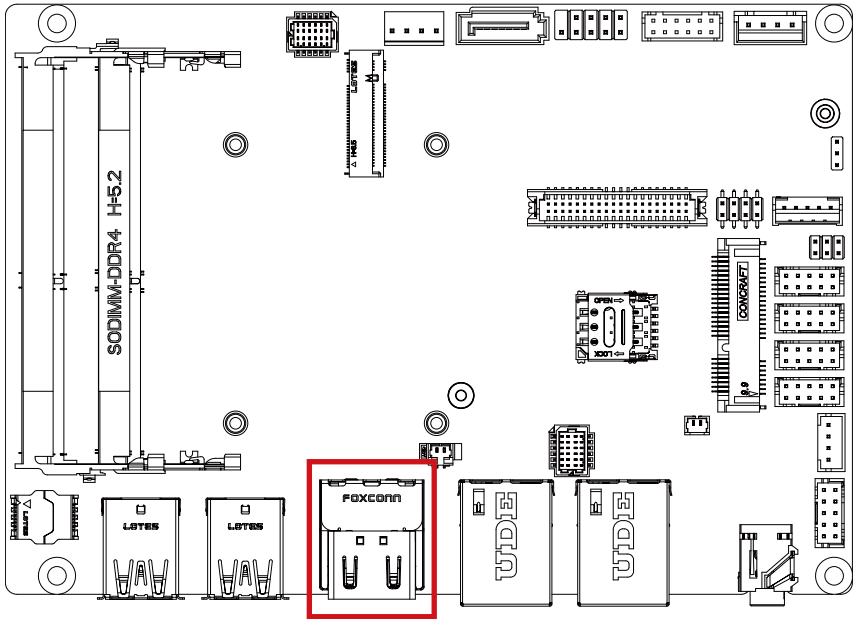

HDMI Connector

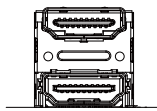

Pin No.	Definition	Pin No.	Definition
1	TX2p	20	TX2p
2	GND	21	GND
3	TX2n	22	TX2n
4	TX1p	23	TX1p
5	GND	24	GND
6	TX1n	25	TX1n
7	TX0p	26	TX0p
8	GND	27	GND
9	TX0n	28	TX0n
10	CLKp	29	CLKp
11	GND	30	GND

Pin No.	Definition	Pin No.	Definition
12	CLKn	31	CLKn
13	NC	32	NC
14	NA	33	NA
15	DDC Clock	34	DDC Clock
16	DDC Data	35	DDC Data
17	GND	36	GND
18	5V	37	5V
19	Hot Plug Detect	38	Hot Plug Detect

### 3.2.24 USB31\_1, USB31\_2 (USB 3.2 Gen 1 connector)

25

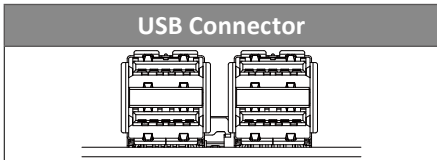
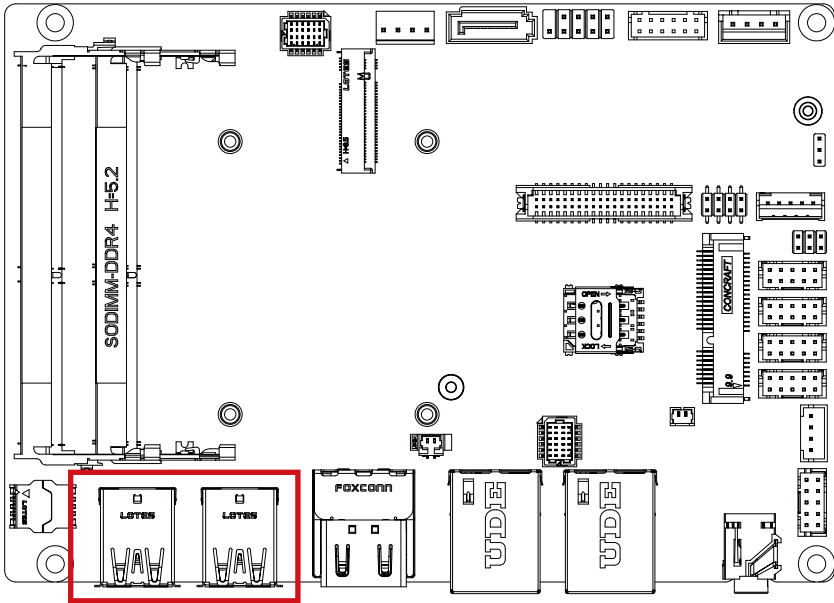

Pin No.	Definition
1	5V
2	D1n
3	D1p
4	GND
5	USB3_RX1n
6	USB3_RX1p
7	GND
8	USB3_TX1n
9	USB3_TX1p
10	5V

Pin No.	Definition
11	D0n
12	D0p
13	GND
14	USB3_RX2n
15	USB3_RX2p
16	GND
17	USB3_TX2n
18	USB3_TX2p

# Chapter 4

---

## Chapter 4 – BIOS

## 4.1 Introduction

BIOS (Basic input/output system) provides hardware detailed information and boot-up options, which include firmware to control, set-up and test all hardware settings. Therefore, BIOS is the communication bridge between OS/application software and hardware.

### 4.1.1 How to Entering into BIOS menu

Once the system is power on, press the <DEL> key as soon as possible to access into BIOS Setup program.

### 4.1.2 Function Keys to setup in BIOS Setup program

Function keys	Description
→←	Select Screen
↑↓	Select Item
Enter	Execute command or enter the submenu
+	Increase the numeric value or make changes
—	Decrease the numeric value or make changes
F1	General Help
F2	Previous Values
F3	Load Optimized Defaults Settings
F4	Save changes & Exit the BIOS Setup program
ESC	Exit the BIOS Setup program



## 4.2 The Main Menu

The main menu shows the basic system information. Use arrow keys to move among the items.

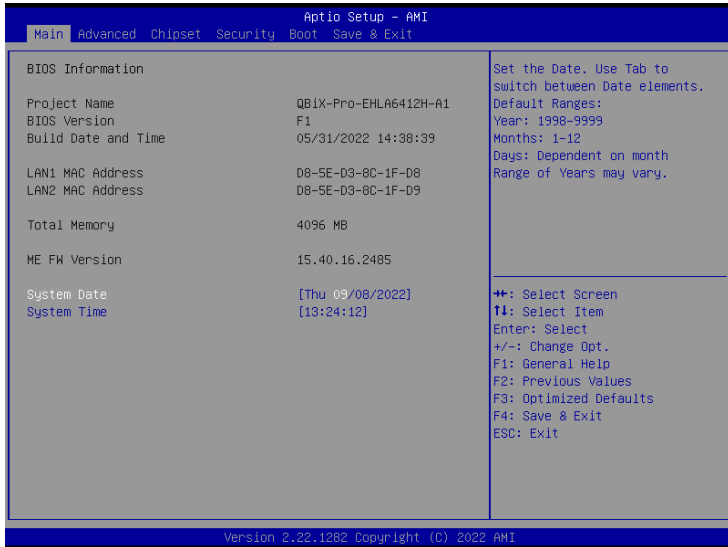

Items	Description
<b>Project Name</b>	<b>Shows Project name information</b>
<b>BIOS Version</b>	<b>Shows the BIOS version of the system</b>
<b>Build Date and Time</b>	<b>Shows the Build Date and Time when the BIOS was created.</b>
<b>LAN1 MAC Address</b>	<b>Shows LAN1 MAC Address information</b>
<b>LAN2 MAC Address</b>	<b>Shows LAN2 MAC Address information</b>
<b>Total Memory</b>	<b>Shows the total memory size of the installed memory</b>
<b>ME FW version</b>	<b>Shows ME firmware version</b>
<b>System Date</b>	<b>Set the Date for the system (Format : Week - Month - Day - Year)</b>
<b>System Time</b>	<b>Set the time for the system (Format : Hour - Minute - Second)</b>

## 4.3 Advanced

The Advanced menu is to configure the functions of hardware settings through submenu. Use arrow keys to move among the items, and press <Enter> to access into the related submenu.

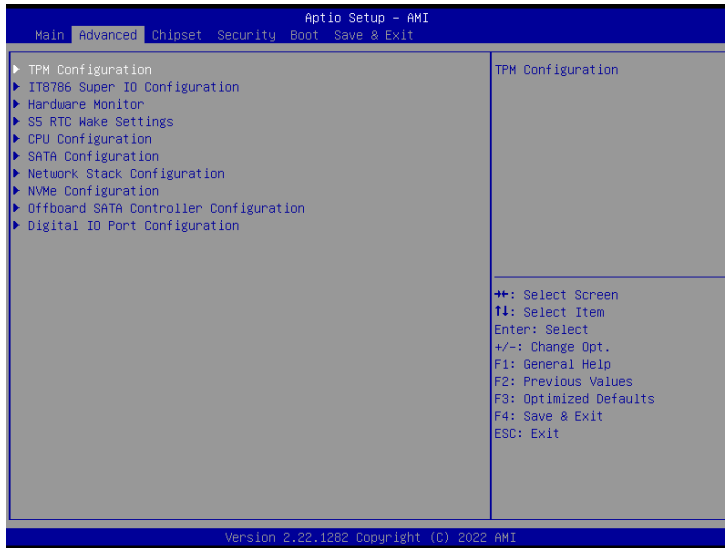

## 4.3.1 TPM Configuration

Use TPM Configuration submenu to choose TPM interface.

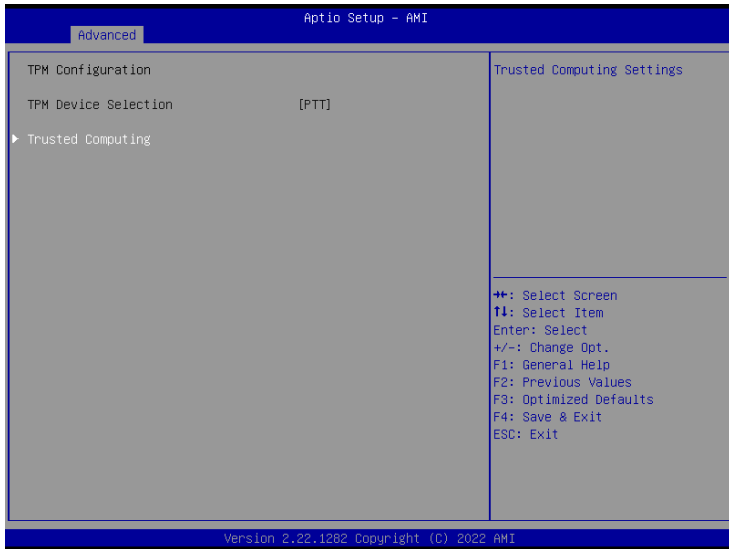

Item	Description
<b>TPM Device Selection</b>	<b>PTT : Internal TPM (Default setting)</b>

Trusted Computing : Shows TPM information, and TPM module configuration setting.

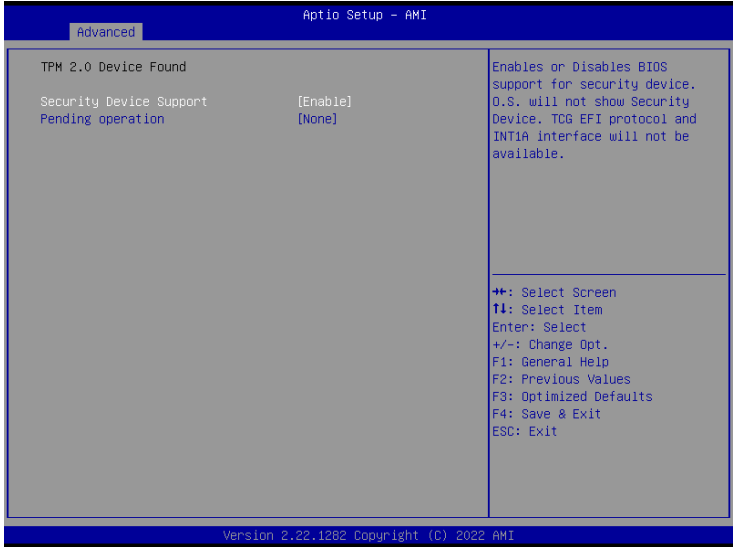

Item	Description
<b>Security Device support</b>	<b>Enabled : Enables TPM feature (Default setting)</b> <b>Disabled : Disables TPM feature</b>
Item	Description
<b>Pending operation</b>	<b>None : No execution will be conducted (Default setting)</b> <b>TPM clear : Set to clear data on TPM</b>

## 4.3.2 IT8786 Super IO Configuration

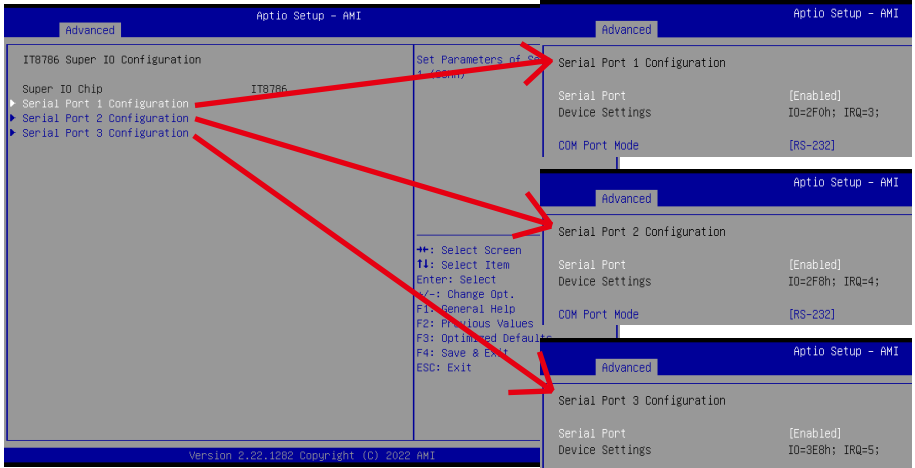

Item	Description
<b>Super IO Chip</b>	Shows Super I/O chip model
<b>Serial Port 1 Configuration</b>	Press [Enter] to configure advanced items : Serial Port : <b>Enabled : Enables allows you to configure the serial port settings</b> <b>Disabled : if Disabled, displays no configuration for the serial port</b>
<b>Serial Port 2 Configuration</b>	Device settings : Display the specified Serial Port base I/O address and IRQ  COM Port Mode : Choose RS-232, RS-422, or RS-485 feature
<b>Serial Port 3 Configuration</b>	Press [Enter] to configure advanced items : Serial Port : <b>Enabled : Enables allows you to configure the serial port settings</b> <b>Disabled : if Disabled, displays no configuration for the serial port</b>  Device settings : Display the specified Serial Port base I/O address and IRQ

### 4.3.3 Hardware Monitor

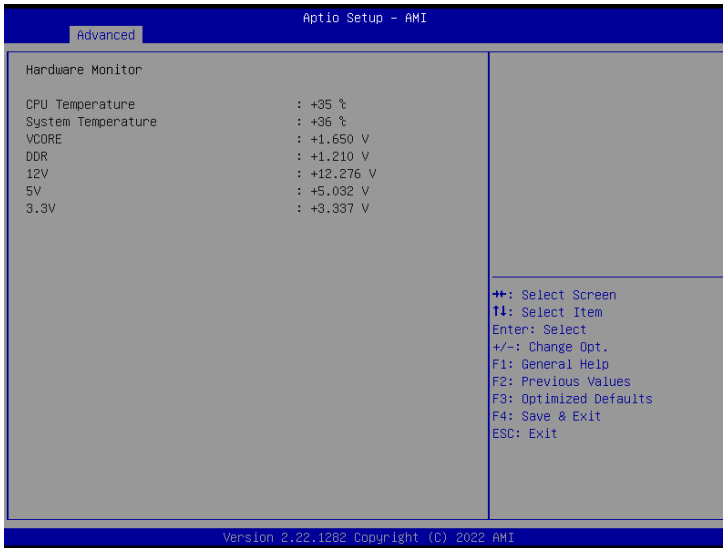

Item	Description
<b>CPU Temperature</b>	Shows current CPU temperature
<b>System temperature</b>	Shows current system temperature

### 4.3.4 S5 RTC Wake Settings



Item	Description
<p><b>Wake system from S5</b></p>	<p>Enable or Disable System to wake on a specific time.  <b>Disabled : Disables system to wake on a specific time (Default setting)</b>  <b>Fixed Time : Enables system to wake on a specific time (Format : hr : min : sec)</b></p>

### 4.3.5 CPU Configuration

This submenu shows detailed CPU informations.



Item	Description
<b>Intel Virtualization Technology</b>	Virtualization enhanced by Intel® Virtualization Technology will allow a platform to run multiple operating systems and applications in independent partitions. With virtualization, one computer system can function as multiple virtual systems. <b>Enabled : Enables Intel Virtualization Technology (Default setting)</b> <b>Disabled : Disables Intel Virtualization Technology</b>
<b>EIST</b>	According to System loading, Enhanced Intel SpeedStep Technology (EIST) will automatically adjust the CPU voltage and core frequency to decrease heat and power consumption for power saving. <b>Enabled : Enables EIST Technology (Default setting)</b> <b>Disabled : Disables EIST Technology</b>
<b>Turbo Mode</b>	<b>Enabled : Enables Turbo Mode (Default setting)</b> <b>Disabled : Disables Turbo Mode</b>
<b>CPU C states</b>	Command CPU to enter into low power consumption mode when CPU is under idle mode. <b>Enabled : Enables C states (Default setting)</b> <b>Disabled : Disables C states</b>
<b>CPU P states</b>	CPU will adjust frequency depends on it's loading. <b>Enabled : Enables CPU P states function (Default setting)</b> <b>Disabled : Disables CPU P states function</b>



### 4.3.6 SATA Configuration

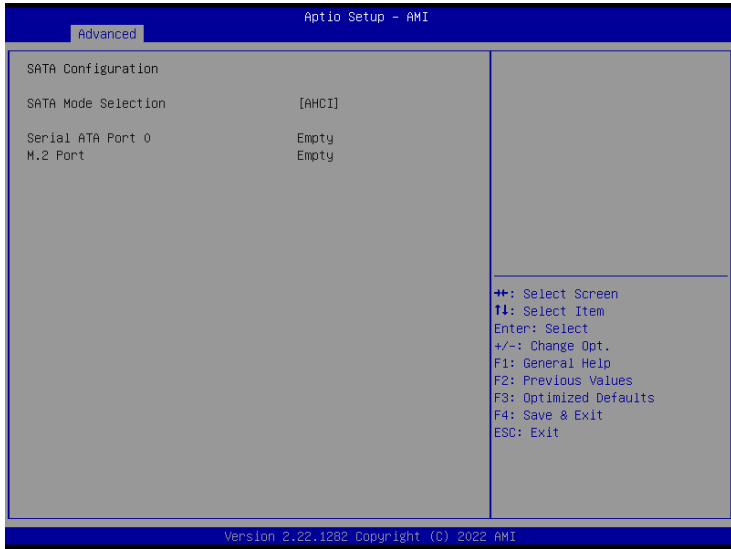

Item	Description
<b>SATA Mode Selection</b>	<b>AHCI</b> : Configures the SATA controllers to AHCI mode. (Default setting)
<b>Serial ATA Port 0</b>	shows 2.5" SATA HDD/SSD information
<b>M.2 Port</b>	shows M.2 SATA interface SSD information

### 4.3.7 Network Stack Configuration

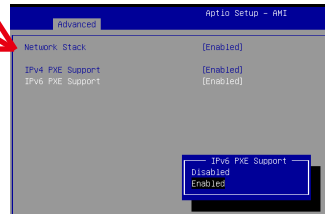
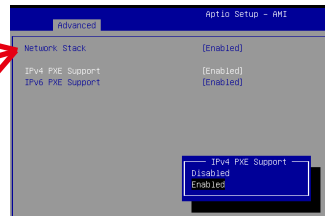
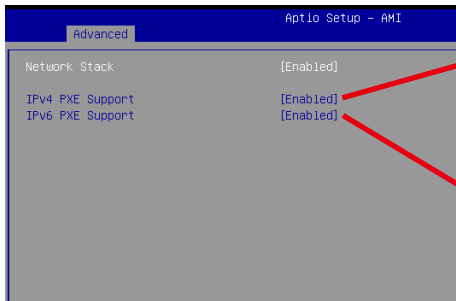
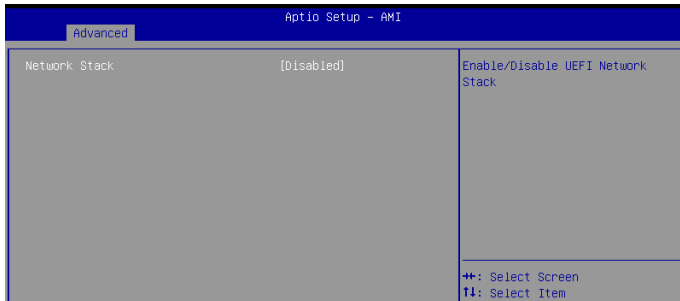

Item	Description
<b>Network Stack</b>	When system is power on, install LAN driver under UEFI mode <b>Disabled : Disables UEFI Network Stack (Default setting)</b> <b>Enabled : Enables UEFI Network Stack</b>
<b>Ipv4 PXE Support</b>	When Network stack is enabled : <b>Disabled : Disables Ipv4 PXE Support</b> <b>Enabled : Enables Ipv4 PXE Support</b>
<b>Ipv6 PXE Support</b>	When Network stack is enabled : <b>Disabled : Disables Ipv6 PXE Support</b> <b>Enabled : Enables Ipv6 PXE Support</b>

### 4.3.8 NVMe Configuration

NVMe Configuration shows information when your M.2 NVMe PCIe SSD is installed.

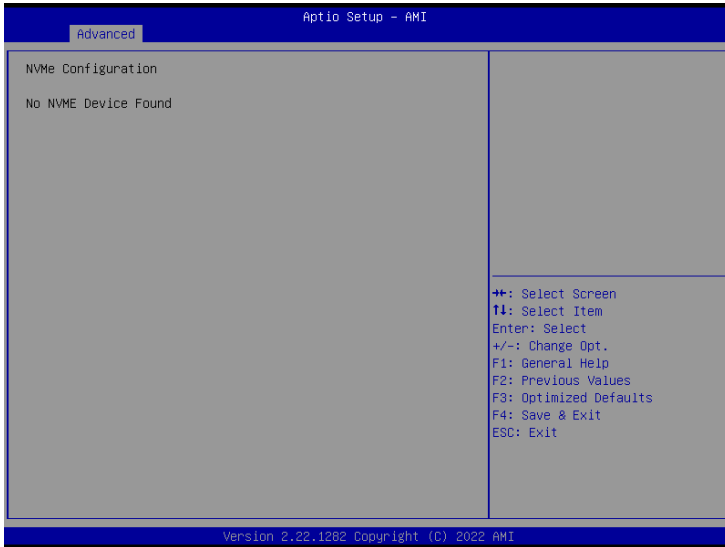

## 4.3.9 Offboard SATA Controller Configuration

---

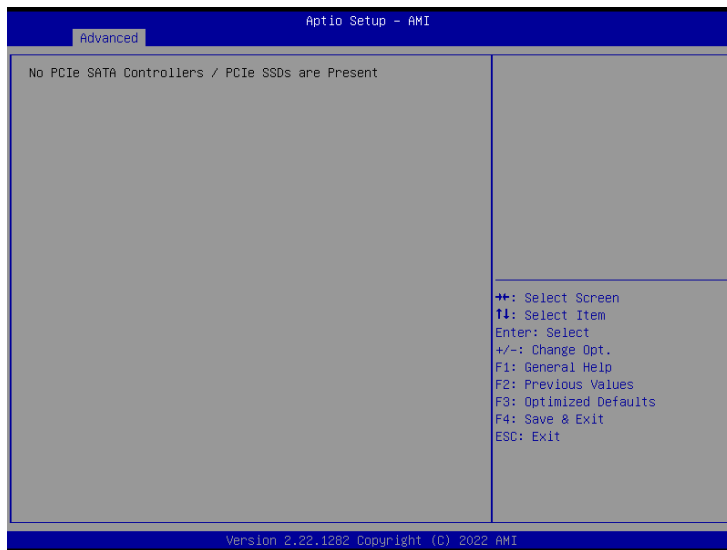

## 4.3.10 Digital IO Port Configuration

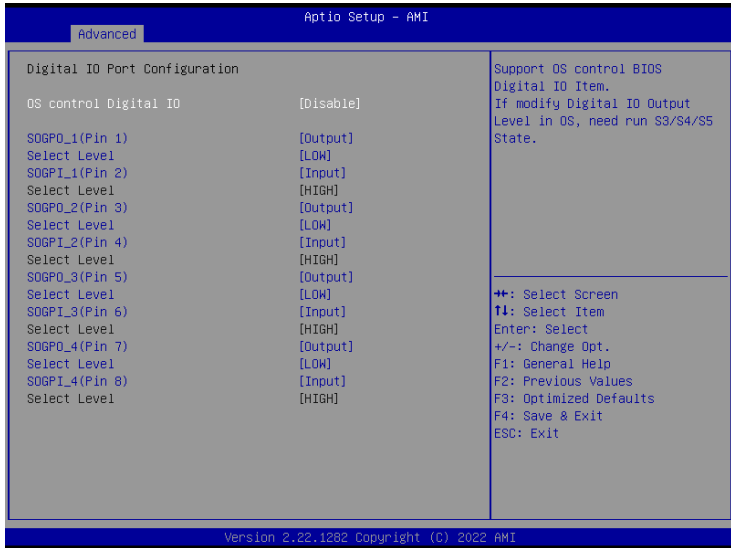

Item	Description
OS control Digital IO	<p><b>Disabled</b> : If Digital IO Output value/level is modified in OS, they will not be memorized and kept. (Default setting)</p> <p><b>Enabled</b> : If Digital IO Output value/level is modified in OS, they will be memorized and kept.</p>
<p>SOGPO_1 (Pin 1)</p> <p>SOGPI_1 (Pin 2)</p> <p>SOGPO_2 (Pin 3)</p> <p>SOGPI_2 (Pin 4)</p> <p>SOGPO_3 (Pin 5)</p> <p>SOGPI_3 (Pin 6)</p> <p>SOGPO_4 (Pin 7)</p> <p>SOGPI_4 (Pin 8)</p>	Configure Digital IO Input or Output values for each pin.

## 4.4 Chipset

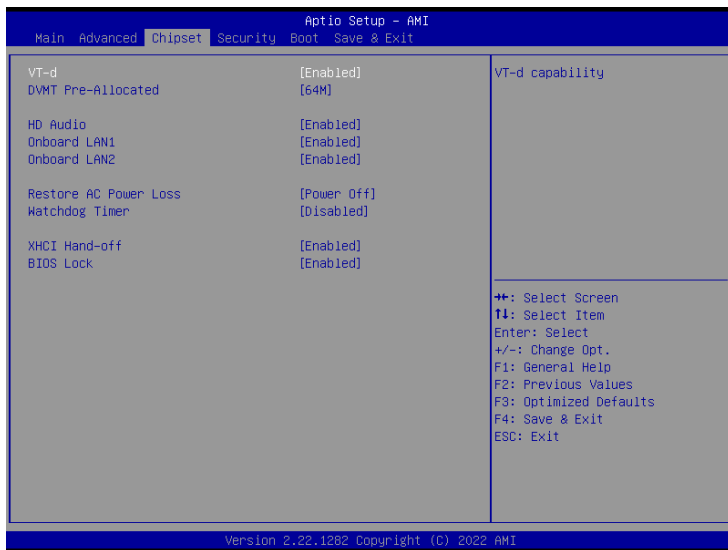

Item	Description
VT-d	<b>Enabled : Enables VT-d function (Default setting)</b> <b>Disabled : Disables VT-d function</b>
DVMT Pre-Allocated	Use DVMT Pre-Allocated to set the amount of system memory which is installed to the integrated graphics processor <b>Option items : 32M , 64M(Default setting) , 128M , 256M</b>
HD Audio	Enable/Disable onboard audio controller <b>Enabled : Enables onboard audio controller (Default setting)</b> <b>Disabled : Disables onboard audio controller</b>
Onboard LAN1 Onboard LAN2	Enable/Disable onboard LAN controller <b>Enabled : Enables onboard LAN controller (Default setting)</b> <b>Disabled : Disables onboard LAN controller</b>
Restore AC Power Loss	To set which option the system should returns if a sudden power loss occurred <b>Power off : Do not power on when the power is back (Default setting)</b> <b>Power on : System power on when the power is back</b> <b>Last state : Restore the system to the state before power loss occurs</b>
Watchdog Timer	Enable/Disable Watchdog Timer function <b>Enabled : Enables Watchdog Timer function</b> <b>Disabled : Disabled Watchdog Timer function (Default setting)</b>
XHCI Hand-off	Enable/Disable XHCI Hand-off function <b>Enabled : Enables XHCI Hand-off function (Default setting)</b> <b>Disabled : Disables XHCI Hand-off function</b>
BIOS Lock	Enable/Disable BIOS Lock function <b>Enabled : Enables BIOS Lock function (Default setting)</b> <b>Disabled : Disabled BIOS Lock funtion</b>

## 4.5 Security

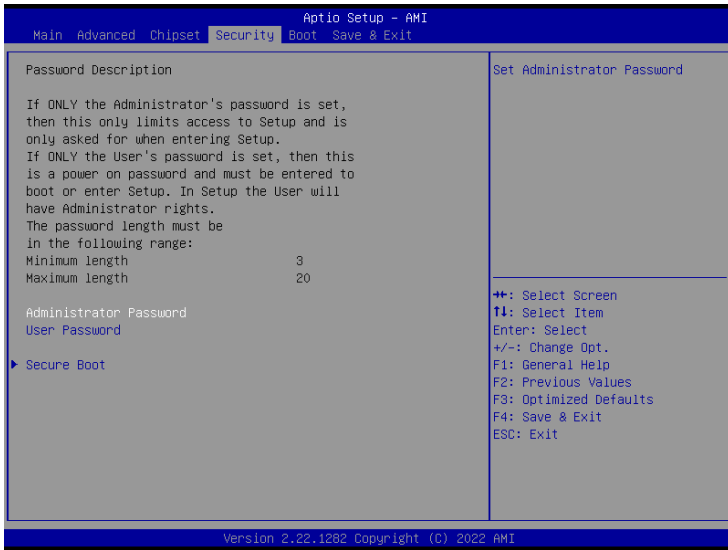

Item	Description
<b>Administrator Password</b>	To set up Administrator's password <b>Minimum length : 3</b> <b>Maximum length : 20</b>
<b>User Password</b>	To set up User's password <b>Minimum length : 3</b> <b>Maximum length : 20</b>
<b>Secure Boot</b>	Press <Enter> to configure the advanced items



Item	Description
<b>Secure Boot</b>	Secure Boot requires all the applications that are running during the booting process to be pre-signed with valid digital certificates <b>Enabled : Enables Secure Boot function</b> <b>Disabled : Disables Secure Boot function (Default setting)</b>
<b>Secure Boot Mode</b>	<b>Standard : Standard mode</b> <b>Custom : Custom mode (Default setting)</b>
<b>Restore Factory Keys</b>	To restore factory settings <b>Yes : Agree to restore factory settings</b> <b>No : Cancel to restore factory settings</b>
<b>Reset To Setup Mode</b>	<b>Yes : Agree to setup mode</b> <b>No : Cancel to setup mode</b>
<b>Key Management</b>	Enables expert users to modify Secure boot policy variables without full authentication Press <Enter> to configure the advanced items



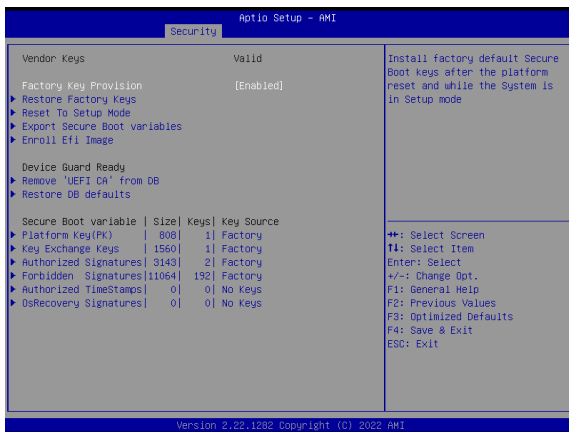

Item	Description
<b>Factory Key Provision</b>	Install factory default Secure Boot keys after the platform reset and while the system is in Setup mode <b>Enabled : Enables Factory Key Provision (Default setting)</b> <b>Disabled : Disables Factory Key Provision</b>
<b>Restore Factory Keys</b>	To restore factory settings <b>Yes : Agree to restore factory settings</b> <b>No : Cancel to restore factory settings</b>
<b>Reset To Setup Mode</b>	<b>Yes : Agree to setup mode</b> <b>No : Cancel to setup mode</b>
<b>Export Secure Boot variables</b>	Copy NVRAM content of Secure Boot variables to files in a root folder on a file system device
<b>Enroll Efi Image</b>	Allow the image to run in Secure Boot mode
<b>Remove 'UEFI CA' from DB</b>	To remove 'UEFI CA' from database <b>Yes : Agree to remove 'UEFI CA' from database</b> <b>No : Cancel to remove 'UEFI CA' from database</b>
<b>Restore DB defaults</b>	Restore DB variables to factory defaults <b>Yes : Agree to restore DB defaults</b> <b>No : Cancel to restore DB defaults</b>

Item	Description
<b>Platform Key (PK)</b>	These items allows you to enroll factory defaults or load Certificates from a file.
<b>Key Exchange Keys</b>	
<b>Authorized Signatures</b>	
<b>Forbidden Signatures</b>	
<b>Authorized TimeStamps</b>	
<b>OsRecovery Signatures</b>	

## 4.6 Boot

This Boot menu allows you to set/change system boot options

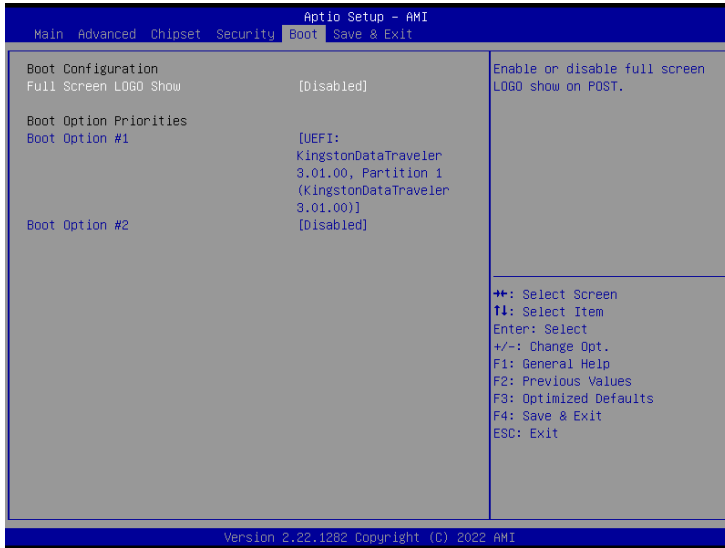

Item	Description
<b>Full Screen LOGO Show</b>	Enable/Disable full screen LOGO show on POST screen <b>Enabled : Enables Full screen LOGO Show on POST screen</b> <b>Disabled : Disables Full screen LOGO Show on POST screen (Default setting)</b>
<b>Boot Option #1</b> <b>Boot Option #2</b>	Shows the information of the storage that be installed in the system <b>Choose/set the boot priority</b>

## 4.7 Save & Exit

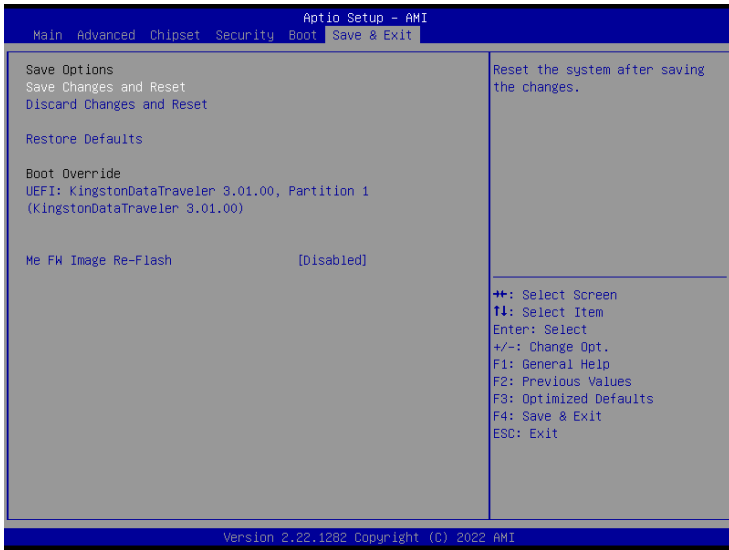

Item	Description
<b>Save Changes and Reset</b>	After configuring all the options that you wish to change, choose this option to save all the changes and reboot the system <b>Yes : Agree to save and reset</b> <b>No : Cancel to save and reset</b>
<b>Discard Changes and Reset</b>	Choose this option to reboot the system without saving any changes <b>Yes : Agree to discard changes and reset</b> <b>No : Cancel to discard changes and reset</b>
<b>Restore Defaults</b>	Restore/Load default values for all the setup options <b>Yes : Agree to load optimized defaults</b> <b>No : Cancel to load optimized defaults</b>
<b>Me FW Image Re-Flash</b>	Enable/Disable Me FW image re-flash function <b>Enabled : Enables Me FW image re-flash function</b> <b>Disabled : Disables Me FW image re-flash function (Default setting)</b>