

# SeaLINK User Manual

## User Manual | Ethernet Serial Server Family



**SEALEVEL**<sup>®</sup>

# Contents

CONTENTS.....	2
INTRODUCTION .....	3
BEFORE YOU GET STARTED .....	5
HARDWARE DESCRIPTION .....	7
HARDWARE CONFIGURATION.....	14
SEALINK REDIRECTOR OVERVIEW.....	20
SEALINK SOFTWARE INSTALLATION .....	23
RAW DATA SOCKETS .....	36
ONBOARD WEB SERVER CONFIGURATION .....	39
APPLICATION REQUIREMENTS.....	49
CONNECTOR PIN ASSIGNMENTS .....	52
4103 DIGITAL I/O.....	56
APPENDIX A - TECHNICAL NOTES.....	57
APPENDIX B – TROUBLESHOOTING.....	62
APPENDIX C – HOW TO GET ASSISTANCE.....	73
APPENDIX D – SILK SCREENS.....	74
APPENDIX E – COMPLIANCE NOTICES.....	77
WARRANTY .....	78
.....	

# Introduction

SeaLINK Ethernet serial servers offer the easiest way to network enable RS-232, RS-422, and RS-485 serial devices. Powered by a 32-bit embedded microprocessor, SeaLINK products reliably communicate over multiple ports at rates up to 230.4 Kbps. All SeaLINK devices use industry-standard TCP/IP protocol (RFC-2217) and allow any host to access serial ports as virtual COM ports. Serial tunneling is also supported, allowing two native serial devices to communicate over a network.

## System Requirements

### Minimum Computer Requirements

- Intel-compatible PC with Pentium-class processor
- Windows XP SP1 (32-bit or 64-bit) or newer Windows based OS
- 20MB storage available

### Network requirements

- An Ethernet network connection from the computer running the SeaLINK software to the SeaLINK Ethernet serial server
- Firewalls in the network path must allow TCP connections to the server on the port numbers (sockets) on which the SeaLINK device provides the serial devices

## QuickStart Guide

A printed QuickStart Guide is included with your Sealevel SeaLINK Ethernet serial server and includes simplified instructions for installing and configuring SeaLINK software and hardware. A copy of the QuickStart Guide can also be downloaded from the product page of the Sealevel web site. Locate your part number on the Sealevel website ([www.sealevel.com](http://www.sealevel.com)) and click the link in the product text to download the Ethernet QuickStart Guide.

Detailed installation and configuration instructions are also covered in the [SeaLINK Software Installation](#) section of this manual.

## Sealevel Ethernet Serial Server Product Family

This manual covers the installation and operation of these devices:

Product	Part No.	Operation
SeaLINK.232	(P/N 4101)	- 1 Port RS-232 Serial Server
SeaLINK.485	(P/N 4102)	- 1 Port RS-422/485 Serial Server
SeaLINK.Ultra	(P/N 4103)	- 1 Port Optically Isolated RS-232/422/485 Serial Server with Optically Isolated Digital Input and Reed Relay Output
SeaLINK.Multi	(P/N 4104)	- 1 Port RS-232/422/485 Serial Server
SeaLINK+2.232	(P/N 4201)	- 2 Port RS-232 Serial Server
SeaLINK+2.485	(P/N 4202)	- 2 Port RS-422/485 Serial Server
SeaLINK+2.Multi	(P/N 4203)	- 2 Port RS-232/422/485 Serial Server
SeaLINK+4.232	(P/N 4401)	- 4 Port RS-232 Serial Server
SeaLINK+4.422	(P/N 4402)	- 4 Port RS-422/485 Serial Server
SeaLINK+4.Ultra	(P/N 4403)	- 4 Port RS-232/422/485 Serial Server
SeaLINK+8.232	(P/N 4801)	- 8 Port RS-232 Serial Server
SeaLINK+8.422	(P/N 4802)	- 8 Port RS-422/485 Serial Server
SeaLINK+8.Ultra	(P/N 4803)	- 8 Port RS-232/422/485 Serial Server
SeaLINK+16.232	(P/N 4161)	- 16 Port RS-232 Serial Server
SeaLINK+16.422	(P/N 4162)	- 16 Port RS-422/485 Serial Server
SeaLINK+16.Ultra	(P/N 4163)	- 16 Port RS-232/422/485 Serial Server

# Before You Get Started

## What's Included

All Ethernet serial servers ship with the following items. If any of these items are missing or damaged, please contact Sealevel for a replacement.

- Ethernet Serial Server – (see part numbers on previous page)
- Power Supply – (described below)
- Ethernet Patch Cable – Item# **CA246**, 7' Ethernet patch cable (blue)
- Ethernet Crossover Cable – Item# **CA251**, 7' Ethernet crossover cable (yellow)
- Serial Loopback – (described below)
- Printed QuickStart Guide

## Power Supplies

The following power supplies are included with the corresponding Ethernet serial server listed below. Replacement power supplies can be purchased from the Sealevel website.

- Item# **TR101** – 5VDC/120VAC @ 3A power adapter  
Ships with 4401, 4402, 4403, 4801, 4802, and 4803  
Optional International Power Supply: Item #TR103
- Item# **TR104** – 12VDC/120VAC @ 500mA power adapter  
Ship with 4103 only  
Optional International Power Supplies: Item #TR105, Item #TR106
- Item# **TR107** – 5VDC/120VAC @ 1A power adapter  
Ships with 4101, 4102, 4104, 4201, 4202, and 4203
- Item# **TR125** – 12VDC/120VAC @ 1A power adapter (Includes locking barrel connector)  
Ships with 4161, 4162, and 4163

## Loopback Adapters

All Ethernet serial servers with DB9M connectors include a 9-pin serial loopback adapter, Item# **LB101**. Only the data pins are looped back on the **LB101**.

For Ethernet serial servers with RJ45 connectors, the following loopback adapters are included:

- Item# **LB117** (Red) – RS-232 loopback plug, ships with 4161 and 4163
- Item# **LB118** (Yellow) – RS-422 loopback cable, ships with 4162 and 4163
- Item# **LB119** (Green) – RS-485 loopback cable, ships with 4162 and 4163

## Advisory Conventions



### Warning

The highest level of importance is used to stress a condition where damage could result to the product, or the user could suffer serious injury.



### Important

The middle level of importance is used to highlight information that might not seem obvious or a situation that could cause the product to fail.



### Note

The lowest level of importance is used to provide background information, additional tips, or other non-critical facts that will not affect the use of the product.

## Optional Items

Depending upon your application, you are likely to find one or more of the following items useful for interfacing the Ethernet serial servers to real-world signals.

All items can be purchased from our website ([www.sealevel.com](http://www.sealevel.com)) or by calling 864-843-4343. For applicable accessories, pin out diagrams are located on the website.

PART NO.	DESCRIPTION
<b>CA127</b>	DB9 female to DB9 male serial extension cable. Extends a DB9 serial connection by 72".
<b>CA177</b>	DB9 female to DB25 males modem cable, 72" in length. A standard RS-232 modem cable provides a convenient connection to serial peripherals with DB25 connectors. Connects to the host system via a DB9 connector.
<b>CA246</b>	Standard CAT5e UTP patch cable, 7' in length (blue).
<b>CA247</b>	Standard CAT5e UTP patch cable, 10' in length (blue).
<b>CA251</b>	Standard CAT5e UTP crossover cable, 7' in length (yellow).
<b>RJ9P8</b>	A modular adapter with an RJ45 female connector and a DB9 male connector. Ships unassembled and can be easily configured without tools for virtually any pin out.
<b>DB116</b>	A modular adapter with an RJ45 female connector and a DB9 male connector preconfigured for RS-232 pin out. Use standard network patch cables to connect RJ45 equipped serial servers to RS-232 serial peripherals with standard DB9 connectors.
<b>TB05</b>	A terminal block with a DB9 female connector breaking out to 9 screw terminals. Simplifies field wiring of RS-422/485 networks with differing pin out configurations.
<b>TBRJ45</b>	A terminal block with an RJ45 female connector breaking out to 9 screw terminals. Converts field wiring to an RJ45 connection. Simplifies remote RS-422/485 wiring to RJ45 equipped serial servers.
<b>DR103</b>	DIN-rail mounting clip for the 4103 Ethernet serial server.
<b>DR104</b>	DIN-rail mounting clips for 4-port and 8-port Ethernet serial servers.

Additional accessories are available at [Accessories - Computing and I/O Accessories - Sealevel](#).

# Hardware Description

## Common Product Features

- Ethernet 10/100BaseT (auto sense)
- Appears as virtual COM port to host machine
- Data rates to 230.4K bps
- Hot-swappable

## Specifications

### Environmental Specifications

Specification	Operating	Storage
Operating Range	0°C – 70°C (32°F – 158°F)	-50° – 105° C (-58°F – 221° F)
Humidity Range	10 to 90% R.H. Non-Condensing	10 to 90% R.H. Non-Condensing

### Manufacturing

All Sealevel Systems Printed Circuit boards are built to UL 94V0 rating and are 100% electrically tested. These printed circuit boards are solder mask over bare copper or solder mask over tin nickel.

# SeaLINK 1-Port Devices

## SeaLINK.232 (Item# 4101) Features

- RS-232 serial server with DB-9M connector
- All modem control signals implemented

## SeaLINK.485 (Item# 4102) Features

- RS-422/485 serial server with DB-9M connector
- Configurable for RS-422 or RS-485
- Automatic RS-485 enable/disable

## SeaLINK.Multi (Item# 4104) Features

- RS-232/422/485 serial server with DB-9M connector
- Configurable for RS-232, RS-422 or RS-485
- Automatic RS-485 enable/disable

## Power Requirements

- +5VDC @ 500mA
- 2.1mm x 5.5mm center positive

## Dimensions

Board Length *	5.0 inches (127 mm)
Board Width	4.17 inches (106 mm)
Board Height	1.14 inches (29 mm)

\* Length Includes Non-Removable Ears





# SeaLINK 1-Port Isolated

## SeaLINK.Ultra (Item# 4103) Features

- RS-232/422/485 serial server with DB-9M connector
- Configurable for RS-232, RS-422 or RS-485
- Automatic RS-485 enable/disable
- Serial port is optically isolated
- Optically isolated digital input for monitoring +5V to +30V
- Reed relay output: 60VDC @ 500mA max

## Power Requirements

- +9-30VDC @ 3.25W Minimum
- Removable 6-position terminal block

## Dimensions

Board Length	4.45 inches (113 mm)
Board Length including terminal block	4.84 inches (123 mm)
Board Width	4.17 inches (106 mm)
Board Height	1.14 inches (29 mm)



# SeaLINK 2-Port Devices

## SeaLINK+2.232 (Item# 4201) Features

- RS-232 serial server with DB-9M connectors
- All modem control signals implemented

## SeaLINK+2.485 (Item# 4202) Features

- RS-422/485 serial server with DB-9M connectors
- Each port configurable for RS-422 or RS-485
- Automatic RS-485 enable/disable

## SeaLINK+2.Multi (Item# 4203) Features

- RS-232/422/485 serial server with DB-9M connectors
- Each port configurable for RS-232, RS-422 or RS-485
- Automatic RS-485 enable/disable

## Power Requirements

- +5VDC @ 500mA
- 2.1mm x 5.5mm center positive

## Dimensions

Board Length *	5.0 inches (127 mm)
Board Width	4.17 inches (106 mm)
Board Height	1.14 inches (29 mm)

\* Length Includes Non-Removable Ears



# SeaLINK 4-Port Devices

## SeaLINK+4.232 (Item# 4401) Features

- RS-232 serial server with DB-9M connectors
- All modem control signals implemented

## SeaLINK+4.422 (Item# 4402) Features

- RS-422/485 serial server with DB-9M connectors
- Each port configurable for RS-422 or RS-485
- Automatic RS-485 enable/disable

## SeaLINK+4.Ultra (Item# 4403) Features

- RS-232/422/485 serial server with DB-9M connectors
- Each port configurable for RS-232, RS-422 or RS-485
- Automatic RS-485 enable/disable

## Power Requirements

- +5VDC @ 1A
- 2.1mm x 5.5mm center positive

## Dimensions

Board Length	8.62 inches (219 mm)
Board Width	6.10 inches (155 mm)
Board Height	2.00 inches (51 mm)



# SeaLINK 8-Port Devices

## SeaLINK+8.232 (Item# 4801) Features

- RS-232 serial server with DB-9M connectors
- All modem control signals implemented

## SeaLINK+8.422 (Item# 4802) Features

- RS-422/485 serial server with DB-9M connectors
- Each port configurable for RS-422 or RS-485
- Automatic RS-485 enable/disable

## SeaLINK+8.Ultra (Item# 4803) Features

- RS-232/422/485 serial server with DB-9M connectors
- Each port configurable for RS-232, RS-422 or RS-485
- Automatic RS-485 enable/disable

## Power Requirements

- +5VDC @ 1A
- 2.1mm x 5.5mm center positive

## Dimensions

Board Length	8.62 inches (219 mm)
Board Width	6.10 inches (155 mm)
Board Height	2.00 inches (51 mm)



# SeaLINK 16-Port Devices

## SeaLINK+16.232 (Item# 4161) Features

- RS-232 serial server with RJ45 connectors
- Transmit/Receive LEDs on each RJ45 port
- Standard 19" rack enclosure

## SeaLINK+16.422 (Item# 4162) Features

- RS-422/485 serial server with RJ45 connectors
- Each port configurable for RS-422 or RS-485
- Automatic RS-485 enable/disable
- Transmit/Receive LEDs on each RJ45 port
- Standard 19" rack enclosure

## SeaLINK+16.Ultra (Item# 4163) Features

- RS-232/422/485 serial server with RJ45 connectors
- Each port configurable for RS-232, RS-422 or RS-485
- Automatic RS-485 enable/disable
- Transmit/Receive LEDs on each RJ45 port
- Standard 19" rack enclosure

## Power Requirements

- +9-30VDC @ 10W Minimum
- 2.5mm x 5.5mm center positive, locking

## Dimensions

Board Length *	16.75 inches (219 mm)
Board Width	7.00 inches (155 mm)
Board Height	1.75 inches (51 mm)

\* Length excludes removable ears.



# Hardware Configuration

SeaLINK devices supporting RS-422/485 need to be properly configured prior to installation. The configuration requirements for each device are outlined below.



The following devices **do not require** any hardware settings, and the enclosures should not be opened. All configuration settings can be made through the SeaLINK driver and/or the device's onboard web page (detailed in the section titled "[Onboard Web Server Configuration](#)").

- 4101 – 1-port RS-232 serial server
- 4201 – 2-port RS-232 serial server
- 4401 – 4-port RS-232 serial server
- 4801 – 8-port RS-232 serial server
- 4161 – 16-port RS-232 serial server
- 4162 – 16-port RS-422/485 serial server
- 4163 – 16-port RS-232/422/485 serial server

## Single and Dual Port Serial Servers

SeaLINK one and two port multi-interface devices are configured by setting dipswitches inside the enclosure. **The hardware default is RS-422 mode.** This section covers the configuration of the following serial servers:

- 4102 – 1-port RS-422/485 serial server
- 4104 – 1-port RS-232/422/485 serial server
- 4202 – 2-port RS-422/485 serial server
- 4203 – 2-port RS-232/422/485 serial server



The configuration setting for the 4103 are covered in the next section.

## Dipswitches

Switch	Label	Function
1	M1	On for RS-422/485, Off for RS-232
2	M0	On for RS-485, Off for RS-232/422
3	L	Link TX- to RX- for RS-485 two wire operation
4	L	Link TX+ to RX+ for RS-485 two wire operation
5	T	Adds or removes the 120Ω termination
6	PD	Adds or removes the 1KΩ pull-down resistor in the RS-422/485 receiver circuit (Receive data only).
7	PU1	Adds or removes the 1KΩ pull-up resistor in the RS-422/485 receiver circuit (Receive data only)
8	PU2	Adds or removes the 4.7KΩ pull-up resistor in the RS-422/485 CTS circuit (compensates for RS-232 biasing)

## Dipswitches, Continued

Dipswitches on the PCB provide SeaLINK devices the ability to communicate with RS-232, RS-422 or RS-485 devices. These switches are also used to set RS-485 enable modes and termination options. The 4102 and 4104 have a single dipswitch labeled (S2). On the 4202 and 4203, there are two dipswitches labeled (S2) and (S3).

To access the dipswitches, you will need to remove the PCB from the metal housing. On the end of the device with the DB9 connector, remove the two black machine screws and set them aside. Make sure you are properly grounded before proceeding. Gently slide the PCB out of the housing. The dipswitches are located on the PCB adjacent to the DB9 connector.

RS-485 is ideal for multi-drop or network environments. RS-485 requires a tri-state driver that will allow the electrical presence of the driver to be removed from the line. The driver is in a tri-state (i.e., high-impedance) condition when this occurs. One of the unique features of SeaLINK devices is the ability to be RS-485 compatible without the need for special software or drivers (RS-485 auto-enable).

Typically, each end of the RS-485 bus must have a line-terminating resistor (RS-422 terminates the receive end only). A  $120\Omega$  resistor (silk-screen 'T') is across each RS-422/485 input in addition to a  $1K\Omega$  pull-up (silk-screen 'PU1') and a  $1K\Omega$  pull-down (silk-screen 'PD') combination that biases the receiver inputs. The SeaLINK device has RS-232 transceivers with built-in biasing, even when disabled. This is compensated for by adding a  $4.7K\Omega$  pull-up (silk-screen 'PU2') to the CTS circuit. Only the ends of an RS-485 network should have a  $120\Omega$  terminating resistor.

To add the termination/bias resistors, select the 'On' position; to remove it, select the 'Off' position. If multiple adapters are configured in an RS-485 network, only the boards on each end should have switches T, PD, PU1, and PU2 'On'.

## Example Settings

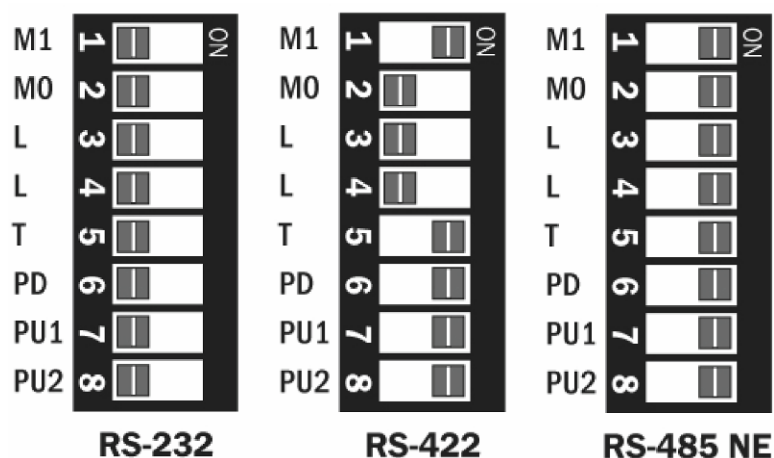



## Optically Isolated Single Port Serial Server (4103)

The SeaLINK 4103 electrical interface is configured by setting dipswitches inside the enclosure. The hardware default is RS-422 mode. This section covers the configuration of the following serial server:

### ■ 4103 – Optically Isolated 1-port RS-232/422/485 serial server



To access the optically isolated serial port, optically isolated digital input and reed relay output, please refer to the [Modbus TCP](#) section of this manual.

## Dip Switch (SW1)

Switch	Label	Function
1	1	On for RS-232, Off for RS-422/485
2	2	On for RS-485, Off for RS-232/422
3	3	On for RS-422/485, Off for RS-232
4	T	Adds or removes the 120Ω termination
5	P	Adds or removes the 1KΩ pull-down resistor in the RS-422/485 receiver circuit (Receive data only)
6	P	Adds or removes the 1KΩ pull-up resistor in the RS-422/485 receiver circuit (Receive data only)
7	L	Connects the TX+ to RX+ for RS-485 two wire operation
8	L	Connects the TX- to RX- for RS-485 two wire operation
9	E	On for No Echo, Off for Echo
10	-	Not Used

A dipswitch labeled (SW1) on the PCB provides the 4103 with the ability to communicate with RS-232, RS-422 or RS-485 devices. The switch is also used to set RS-485 enable modes and termination options. To access the dipswitch, you will need to remove the PCB from the metal housing. On the end of the device with the RJ45 jack and DB9 connector, remove the two black machine screws and set aside. Make sure you are properly grounded before proceeding. Gently slide the PCB out of the housing. The dipswitch is located just behind the DB9 connector.

RS-485 is ideal for multi-drop or network environments. RS-485 requires a tri-state driver that will allow the electrical presence of the driver to be removed from the line. The driver is in a tri-state or high impedance condition when this occurs. One of the unique features of the 4103 is the ability to be RS-485 compatible without the need for special software or drivers (RS-485 auto-enable).

Typically, each end of the RS-485 bus must have a line-terminating resistor (RS-422 terminates the receive end only). A 120Ω resistor (silk-screen 'T') is across each RS-422/485 input in addition to a 1KΩ pull-up (silk-screen 'P') and a 1KΩ pull down (silk-screen 'P') combination that biases the receiver inputs.



To add the termination/bias resistors, select the 'On' position; to remove it, select the 'Off' position. If multiple adapters are configured in an RS-485 network, only the boards on each end should have switches T, P & P 'On'.

The last option that is configurable via SW1 is the 'Echo' option (silk-screen 'E'). Two-wire RS-485 connects the TX± to the RX±. Every time a character is transmitted it is also received. This can be beneficial if the software can handle echoing (i.e., using received characters to throttle the transmitter), or it can confuse the system if the software does not. Switch 9 is used to control the RS-485 enable/disable functions for the receiver circuit. To select the 'No Echo' mode set switch 9 to 'On'. The following shows example switch settings.

## Example Settings



## 4-Port and 8-Port Serial Servers

SeaLINK four and eight port multi-interface devices are primarily configured using the web interface, but may require dipswitch configuration for some use cases, described in the following 'Dipswitches' section. The web interface is used to configure the electrical interface (232/422/485), network settings, and more. See the 'Onboard Web Server Configuration' section of the manual for an overview. The hardware default is RS-422 mode. This section covers the configuration of the following serial servers:

- **4402 – 4-port RS-422/485 serial server**
- **4403 – 4-port RS-232/422/485 serial server**
- **4802 – 8-port RS-422/485 serial server**
- **4803 – 8-port RS-232/422/485 serial server**

## Dipswitches

Switch	Label	Function
1	EN	Adds or removes the 4.7K $\Omega$ pull-up resistor in the RS-422/485 CTS circuit (Compensates for RS-232 biasing)
2	T	Adds or removes the 120 $\Omega$ termination
3	PD	Adds or removes the 1K $\Omega$ pull-down resistor in the RS-422/485 receiver circuit (Receive data only)
4	PU	Adds or removes the 1K $\Omega$ pull-up resistor in the RS-422/485 receiver circuit (Receive data only)
5	EN	Adds or removes the 4.7K $\Omega$ pull-up resistor in the RS-422/485 CTS circuit (Compensates for RS-232 biasing)
6	T	Adds or removes the 120 $\Omega$ termination
7	PD	Adds or removes the 1K $\Omega$ pull-down resistor in the RS-422/485 receiver circuit (Receive data only)
8	PU	Adds or removes the 1K $\Omega$ pull-up resistor in the RS-422/485 receiver circuit (Receive data only)



All switches should be OFF for RS-232

## 4-Port and 8-Port Serial Servers, Continued

Dipswitches on the PCB are used to set termination and biasing options. These settings are only applicable to RS-422 and RS-485 modes and may cause communication issues if enabled in RS-232 mode. The 4402 and 4403 have a pair of dipswitches labeled (S3) and (S4). On the 4802 and 4803, four sets of dipswitches, labeled (S1 – S4), are used to set configuration options.

To access the dipswitches, you will need to open the metal housing. On each side of the device, remove two black machine screws (four total) and set aside. Make sure you are properly grounded before proceeding. Remove the cover to access the PCB. The dipswitches are located on the PCB behind each pair of DB9 connectors.

RS-485 is ideal for multi-drop or network environments. RS-485 requires a tri-state driver that will allow the electrical presence of the driver to be removed from the line. The driver is in a tri-state or high impedance condition when this occurs. One of the unique features of the SeaLINK device is the ability to be RS-485 compatible without the need for special software or drivers.

Typically, each end of the RS-485 bus must have a line-terminating resistor (RS-422 terminates the receive end only). A 120Ω resistor (silk-screen 'T') is across each RS-422/485 input in addition to a 1KΩ pull-up (silk-screen 'PU') and a 1KΩ pull down (silk-screen 'PD') combination that biases the receiver inputs.

To add the termination/bias resistors, select the 'On' position, and to remove it, select the 'Off' position. If multiple adapters are configured in an RS-485 network, only the boards on each end should have switches T, PD, & PU 'On'.

### Example Settings

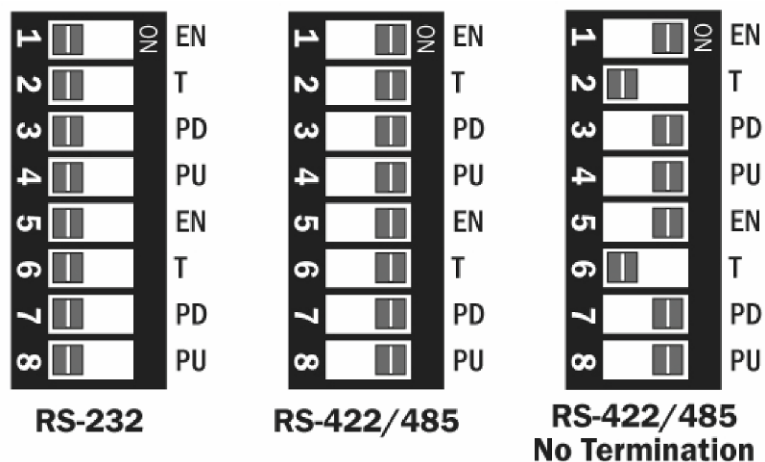

# SeaLINK Redirector Overview

## Virtual COM Port Basics

SeaLINK software is a serial COM port redirector that creates virtual COM ports and provides access to serial devices connected to a SeaLINK Ethernet serial server. SeaLINK allows you to configure Microsoft Windows applications to communicate with networked serial devices as easily as if they were physically installed in or directly connected to the PC.

This means that your serial device applications can communicate with serial devices connected to SeaLINK Ethernet serial servers without software changes. Since the virtual COM ports work like standard Windows COM ports, your application software sees no difference between a local serial device, and one connected to a SeaLINK Ethernet serial server.

The redirector (SeaLINK software) connects to the SeaLINK device (Ethernet serial server) when an application opens the COM port and disconnects from the SeaLINK device when the COM port is closed. The redirector uses TCP network connections to the SeaLINK device to gain access to the connected serial devices.

The SeaLINK redirector can create up to 256 virtual COM ports, from COM1 to COM256. Applications on the local computer can open virtual COM ports to use multiple networked serial devices at the same time. The redirector handles each active virtual COM port as a separate TCP connection to the SeaLINK device.



Some legacy applications are only able to use COM ports in the range of COM1 to COM4, which limits the number of virtual COM ports they can use.

## Application Compatibility

Using a SeaLINK Ethernet serial server adds a network connection and the SeaLINK device to the data path between an application and the serial device it is using. For most applications, these differences are negligible. The SeaLINK software and SeaLINK device both support the COM Port Control protocol (IETF RFC 2217), which is designed to provide the best possible duplication of the behavior of a local COM port. The software uses this network protocol to relay additional control and signal information to the SeaLINK device.

SeaLINK software and devices fully support applications that need to control (at run-time) the baud rate, parity, framing, and status signals of serial devices connected to the virtual COM ports. Serial port settings can also be configured on the SeaLINK Ethernet serial server's internal web page. Configuration settings on the SeaLINK device can allow applications to change serial settings or override them.

# Introduction to Shared COM Ports

## Local COM ports on Windows-based PCs

Most serial devices in use are directly connected to the PC serial port via a cable. This common "local device" configuration can be illustrated as follows:

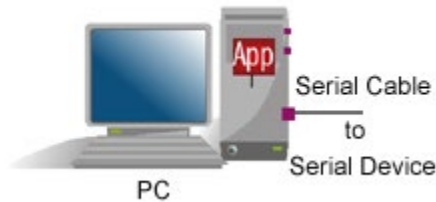

This picture shows a serial device physically connected to the PC via a serial cable. The Windows operating system provides Windows COM ports that applications use for input, output, and control operations that "reach" through the serial cable to the device.

## Serial Servers

If a PC is running more than one or two applications that use a serial device, you can quickly run out of places to attach them. Fortunately, you can employ an Ethernet serial server that provides a pool of virtual COM ports for client computers on the network to access. The serial server is situated between the desktop PCs and the remote serial devices and appears to the network like this:

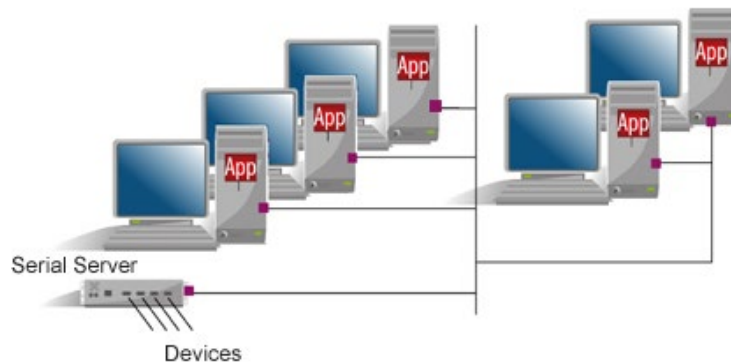

## SeaLINK COM Ports

SeaLINK software is an add-on package for Windows that adds virtual COM ports to the Windows operating system. These COM ports can look and work like conventional COM ports, but they are accessed on the serial server instead of the local PC.

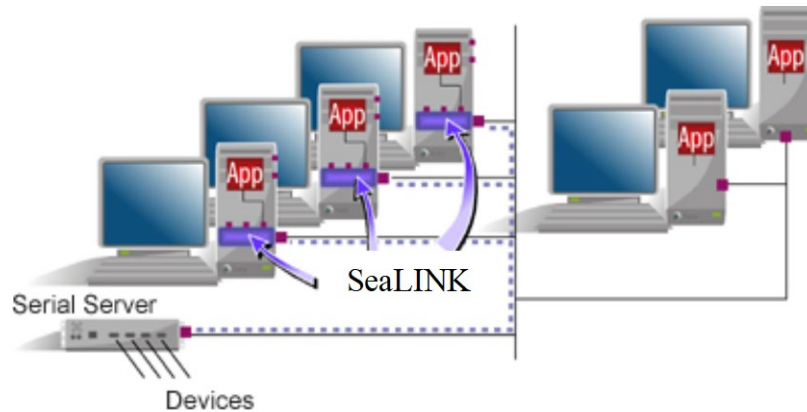

The pieces fit together in the following way:

You configure the serial server to provide one or more serial devices for access by client computers.

For each of its virtual COM ports, SeaLINK uses the IP address of the serial server on the network and the "port number" (socket) on the serial server that provides the COM port.

When the application opens the SeaLINK virtual COM port, it actually sees a device on the serial server. Connections are established just as if the device were connected directly to the PC rather than over the network.

## Benefits of Shared COM Ports

There are two primary benefits to a serial server-based approach:

- 1. Economical.**  
By using a serial server to share serial devices, you eliminate the separate serial lines and devices that would otherwise be attached to individual PCs. Monitoring the serial devices becomes easier and more cost effective.
- 2. Centralized Maintenance.**  
Serial servers concentrate all of the hardware required for serial device communications into one location, typically a server room. This makes it easier to setup, access, and service the devices.

Although the serial server solves many of the hardware issues surrounding shared serial resources, it does not tackle a primary software requirement: setting up the Windows COM ports that most Windows communications software requires. This is where SeaLINK software comes into the picture.

# SeaLINK Software Installation

This section provides instructions on how to install and configure the SeaLINK client. Experienced users will likely find sufficient information in the printed QuickStart guide included with the device.

## Pre-Installation Checklist

Before installing the SeaLINK client on your PC, you or an administrator should first prepare your serial server for operation. The checklist below helps to ensure that both your PC and serial server are ready for SeaLINK.

- ✓ You are using an Intel-compatible PC with 32-bit or 64-bit (x64) processor running:
  - Windows 10\*, Windows 7, Windows Vista, Windows XP (SP1 or SP2), Windows XP 64-bit Edition, Windows Server 2003, Windows Server 2003 64-bit Edition, or Windows Server 2022\*
- ✓ Your PC has at least 20 megabytes of local disk storage for a complete installation of SeaLINK software and documentation. The SeaLINK installation program will place several small files in the Windows system folder. All other files will be located in the installation directory that you designate during installation.
- ✓ Your PC is networked to a SeaLINK serial server on a TCP/IP network and configured for the proper communication protocol (RFC2217 or Raw TCP Socket)



The Microsoft Windows operating systems include Microsoft's TCP/IP networking software, and SeaLINK is tested only with this software. If the Microsoft TCP/IP networking software is missing or has been replaced, SeaLINK may not function properly.



SeaLINK 5.1.0 was released prior to Windows 10. To our knowledge, this has not impacted the functionality of SeaLINK on Windows 10 and Windows Server 2022. We deem SeaLINK to be compatible with Windows 10.

## Windows Operating Systems



Do not install the Adapter in the machine until the software had been fully installed.



Only users running Windows 7 or newer should utilize these instructions for accessing and installing the appropriate driver via Sealevel's website. If you are utilizing an operating system prior to Windows 7, please contact Sealevel by calling 864.843.4343 or emailing [support@sealevel.com](mailto:support@sealevel.com) to receive access to the proper driver download and installation instructions.

---

1. Start Windows and log in as a user with Administrator privileges and quit all Windows applications that use COM ports.
2. Locate, select, and install the correct SeaLINK software from the [Sealevel software driver database](#).
3. Select the **Part Number** for your device from the listing. If you cannot locate the device that you are installing, skip to #5 below and download the SeaLINK software before installing the hardware.
4. Click the 'Install Drivers' button.
5. The setup file will automatically detect the operating environment and install the proper components.

The [SeaLINK software can also be downloaded from Sealevel's website](#). Sealevel's SeaLINK enhanced serial driver makes using the features of our asynchronous serial products easy. In addition to being completely compatible with the Microsoft Windows Serial Driver, SeaLINK also makes use of advanced UART features of our board-based adapters without requiring changes to your software application.

- a) A screen may appear with the declaration: "The publisher cannot be determined due to the problems below: Authenticode signature not found." Please select the 'Yes' button and proceed with the installation. This declaration simply means that the Operating System is not aware of the driver being loaded. It will not cause any harm to your system.
- b) During setup the user may specify installation directories and other preferred configurations. This program also adds entries to the system registry that are necessary for specifying the operating parameters for each driver. An uninstall option is also included to remove all registry/INI file entries from the system, which can be accessed from [Control Panel → Add and Remove Programs](#) ([Control Panel → Programs and Features](#) on Windows Vista and later).
- c) Once SeaLINK has completed installation, a window titled "Select Ports" opens. Select a port number, such as 256. SeaLINK requires at least one port be available, so it can be removed later once other ports are available. Click 'OK' to complete installation.



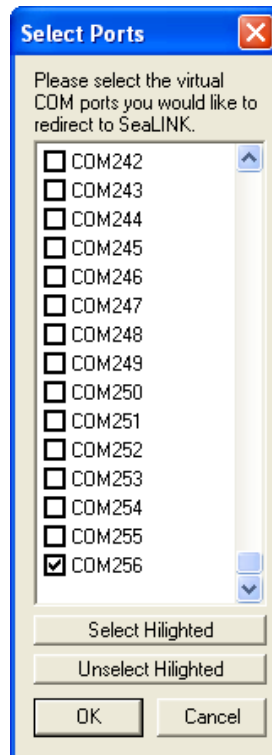

- d) Continue with the following section for instructions on creating and configuring SeaLINK virtual COM ports. The connection with the device can be tested by selecting the desired port and clicking on the '
- e) To confirm that the SeaLINK driver has been successfully installed, click on the 'Start' button, and then select 'All Programs'. You should see the 'SeaLINK' program folder listed.

## Create and Configure SeaLINK Virtual COM Ports in Windows

SeaLINK creates virtual COM ports that Windows applications will use to communicate with remote serial devices on the serial server. SeaLINK virtual COM ports follow the same naming/numbering convention as Windows COM ports. In this step, you tell SeaLINK which serial ports to create as virtual COM ports.

1. Launch the 'SeaLINK Configuration' utility (Start → Programs → Sealevel Systems → SeaLINK → SeaLINK Configuration). COM ports that have already been created will appear in the list on the left. Select a COM port from the list to view and edit the details of the port.

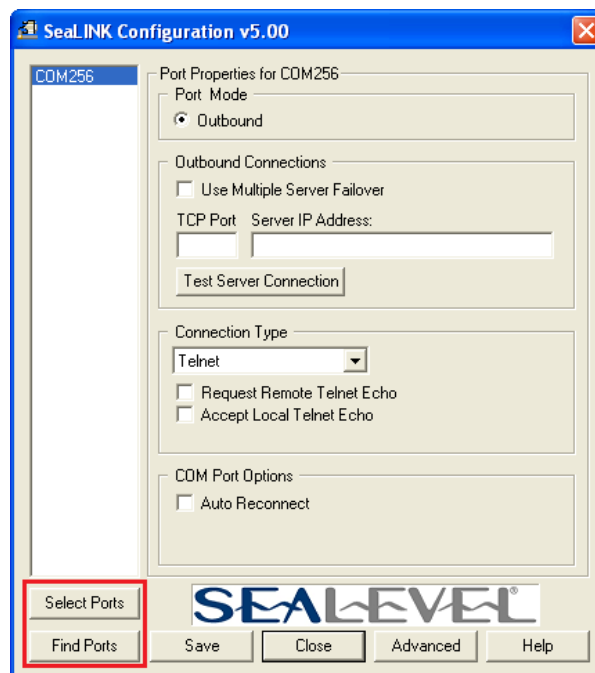

2. To add additional ports to the list or remove ports from the list, click on either the 'Select Ports' button or the 'Find Ports' button. To manually create and remove ports, use the 'Select Ports' button. To perform device discovery and use a wizard to add and remove ports, use the 'Find Ports' button. It is recommended to use the 'Find Ports' feature.
3. The 'Find Ports' button will display the following window. At the top will be a list of devices found on your network. Selecting a device will allow you to create and remove ports on the lower portion of the window. It will also allow you to view and edit settings of the device through the device's web-page by clicking the 'Device Settings' button. The 'Search' button will refresh the list of devices.

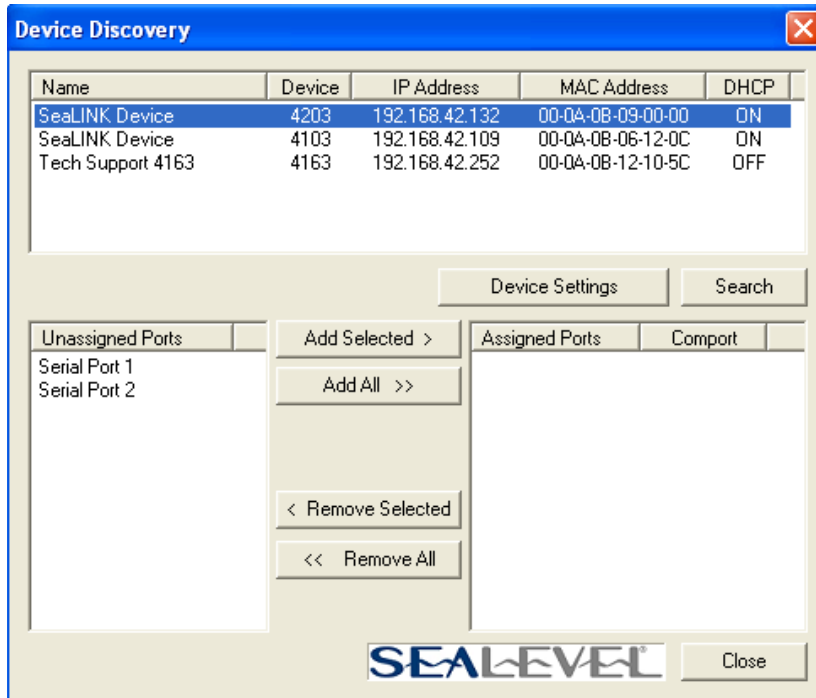

- When you have selected the ports you wish to add, clicking on one of the 'Add' buttons will provide a drop-down list of available COM port numbers on the system. Select the first port number you wish to use, then click 'OK'. Selecting both Serial Port 1 and Serial Port 2 above or clicking 'Add All' will create 2 COM ports. Selecting COM10 from the drop-down list for example, will create the ports at COM10 and COM11 respectively.

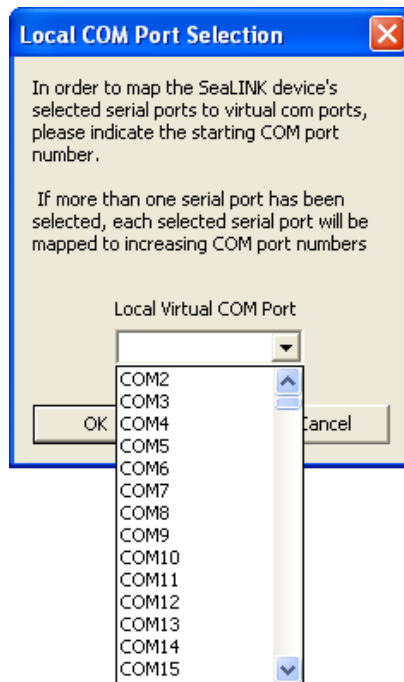

5. The changes you have made will be reflected on the main window.

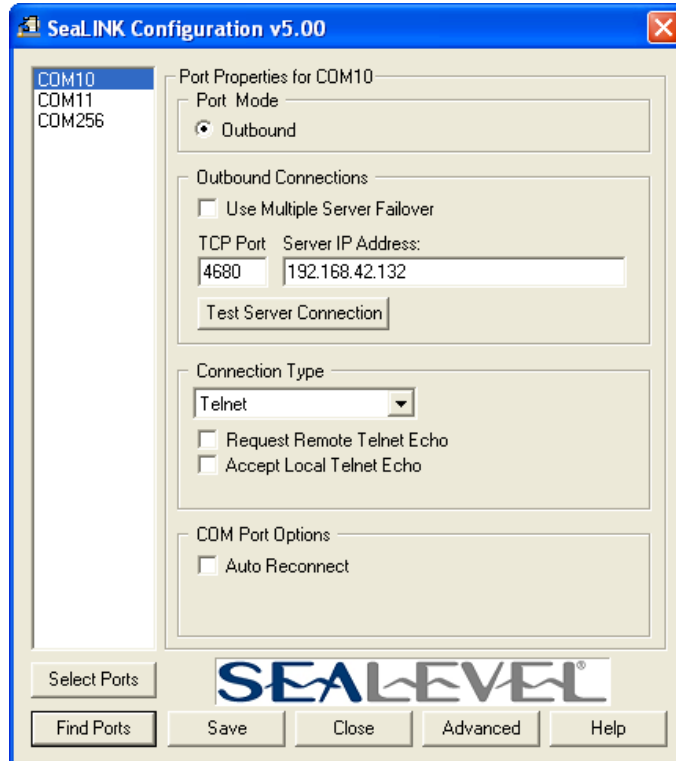

- The connection with the device can be tested by selecting the desired port and clicking on the 'Test Server Connection' button, then clicking 'Start' on the window that appears.



Some legacy applications cannot display COM ports higher than COM4. If you will be using a legacy application, consider selecting ports in the COM 1-4 range. You may need to disable these COM ports in the system BIOS to make them available to SeaLINK

## WinSSD Utility

To verify operation of your virtual COM ports, Sealevel provides the WinSSD utility. WinSSD is part of the SeaLINK software suite and is included with the installation.

### Using WinSSD

1. SeaLINK devices purchased from Sealevel ship with a serial loopback adapter (See the **Before You Get Started** section of this manual for loopback part numbers and descriptions).
2. Plug the loopback adapter into the first serial port on your SeaLINK device.
3. Launch **WinSSD** utility (Start → Programs → Sealevel Systems → WinSSD).
4. In the WinSSD window, under the 'Port Information' tab, click the arrows or type in the COM: number you created with the **SeaLINK Configuration** utility.
5. Click on the 'Settings' button and verify the COM port settings.
6. Click on the 'Loopback' tab and click the 'Start' button in WinSSD.
7. Click on the 'Help' button on each tab of the WinSSD utility for additional instructions.
8. A successful test confirms that your Sealevel device is communicating properly. Repeat the test for each additional serial port on your device; otherwise click the 'Exit' button to close the WinSSD utility.
9. Proceed with **Additional SeaLINK Configuration Options** on the following page or continue with the **Onboard Web Server Configuration** section of this manual for additional device settings.
10. If you experience any configuration or testing problems with SeaLINK or WinSSD, refer to the **Troubleshooting** section at the end of this manual.



WinSSD can also be found on the Sealevel's website: [WinSSD Diagnostic Utility Software](#)

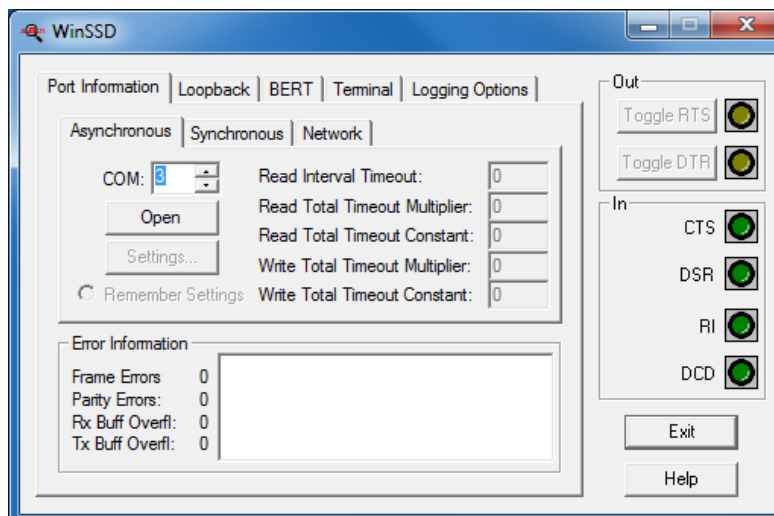

## Multiple Server Failover

SeaLINK has a feature called Multiple Server Failover. If a device becomes unreachable for a certain period of time, SeaLINK will use an alternate device to attempt to resume communications. This is configurable on a per-port basis. To use Multiple Server Failover, check the box as shown below.

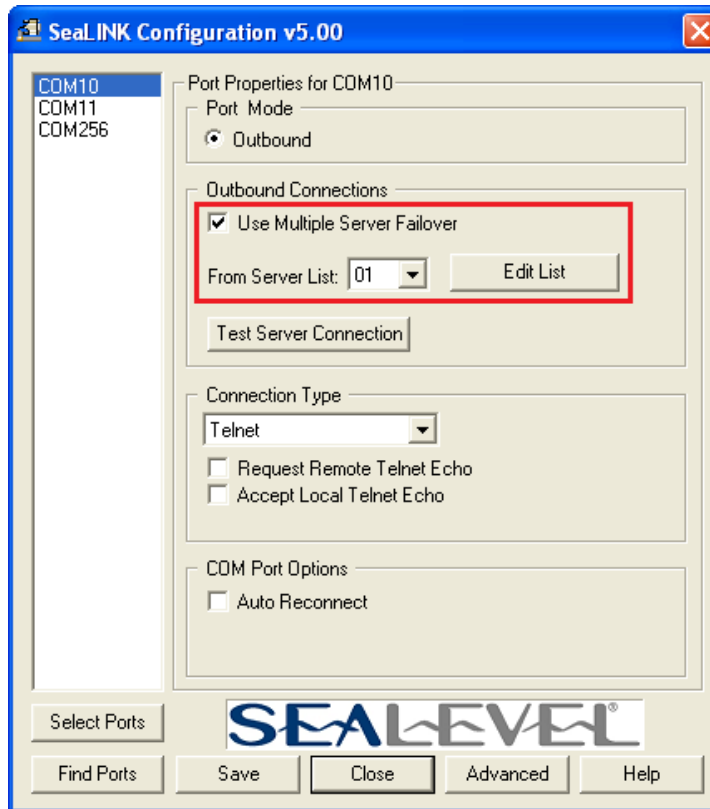

Choose a server list from the dropdown, then click 'Edit List' to set up the list. Currently, this feature requires manual configuration of IP Addresses and Port numbers.

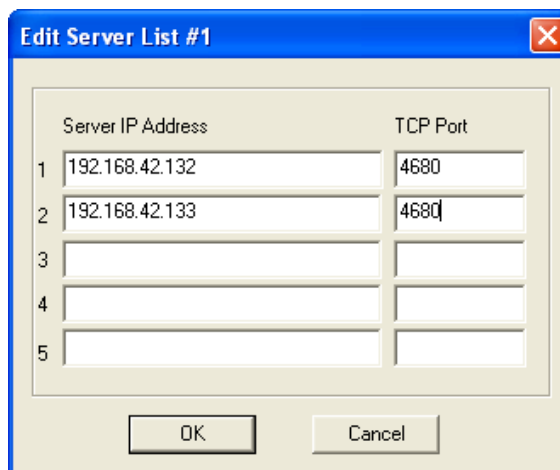

## Advanced Driver Configuration Options

Additional settings for COM ports can be handled in SeaLINK Configuration by clicking the 'Advanced' button on the main window. A number of settings will be available from this window.

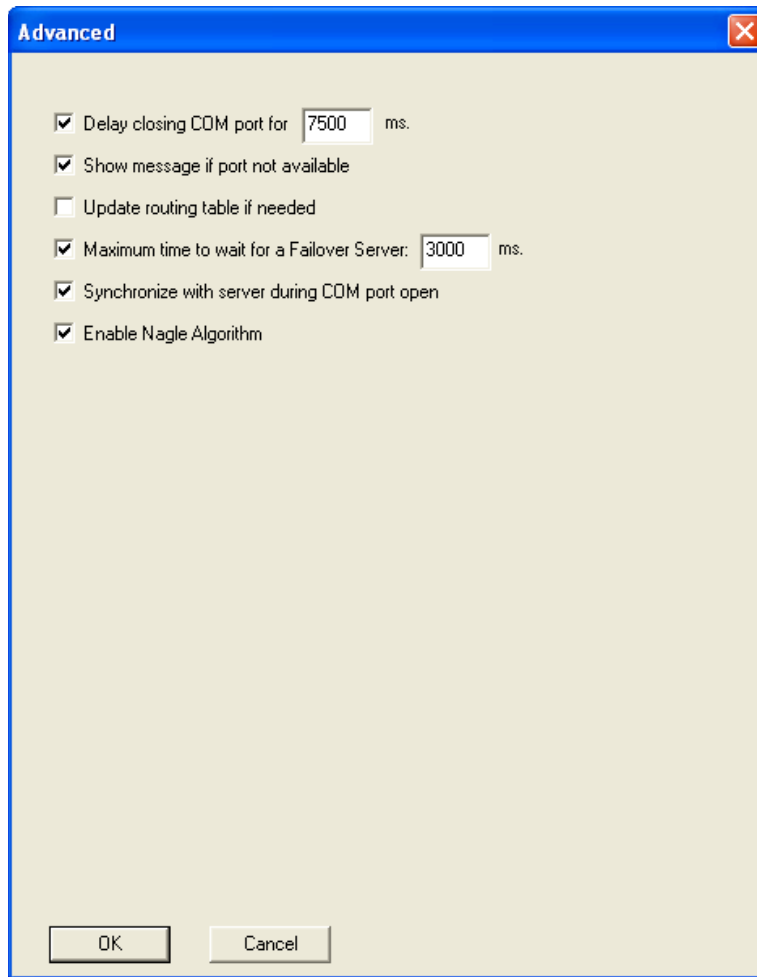

### Delay Closing COM Port

A common Windows programming technique is to hand off a COM port from one process to another. The underlying assumption is that the second process can open COMxx and be connected to exactly the same device. The **'Delay closing COM port'** option causes the redirector to extend its connection to the server (and access to the device) for a designated interval that begins when the virtual COM port is closed by the application.

#### Enabled (default, 7500 milliseconds):

- When the virtual COM port is closed, the SeaLINK driver maintains its connection to the server for the specified number of milliseconds.
- If the virtual COM port is opened (by any application) before the interval ends, it immediately has access to the same modem or serial device as the prior user of the virtual COM port.

## Disabled

- When the virtual COM port is closed, the redirector immediately closes the network connection to the server.
- The SeaLINK drivers can automatically maintain its IP route to a server on a different subnet by modifying the IP routing table. The **'Update routing table if needed'** box controls this option.

## Enabled (default)

- When a virtual COM port is opened, if server is not on the same subnet as the local computer, the driver inserts into the IP routing table a host route to the server, if such a route does not already exist.
- As virtual COM ports are closed, the driver removes the host route it added, since that route is no longer needed.

## Disabled

- The driver does not update the IP routing table.

If failover servers are used, check the **'Maximum time to wait for a Failover Server'** box, and specify the delay period.

Some applications require that the COM port open operation should "synchronize" with the server by waiting until the server provides the serial device and returning a failure from the COM port open function otherwise.



### Enabled (default for Windows XP/Vista/7/10)

The redirector defers the return from the COM port open until all of the following occur between the redirector and the server:

- The redirector-server network connection succeeds.
- SSL/TLS negotiation succeeds (if used).
- Telnet (with COM Port Control if possible) is negotiated.
- Server login succeeds (if used).

### Disabled (Default for 98/95/Me/NT)

- The redirector immediately returns from the COM port open with a success status.

The Nagle algorithm is a method employed by the Windows TCP/IP stack to coalesce small TCP/IP packets. This can affect the packetization and arrival time of data between the redirector and the server. 'Enable Nagle Algorithm' toggles this option.

### Enabled (default)

- The TCP/IP stack operates under its default setting (Nagle enabled).

### Disabled

- The redirector disables the use of the Nagle algorithm in the TCP/IP stack.



Each of the 'Advanced' settings affects all SeaLINK COM ports. These settings are not configurable per individual COM ports.

## Uninstalling SeaLINK Software

The SeaLINK uninstall procedure automatically shuts down SeaLINK if necessary, removes all SeaLINK files from your hard drive, and removes all SeaLINK virtual COM ports from your PC. Follow these easy steps:

- Run Add/Remove Programs in the Control Panel (Programs and Features in Windows Vista or 7).
- Select '**SeaLINK Version X.Y.Z**' from the list of installed software.
- Click the Add/Remove button to start the uninstall wizard.
- In the 'Select Uninstall Method' dialog, choose the default, **Automatic**.
- Click **Next**, and then click **Finish**.
- Restart your computer to complete the uninstall process.

## Linux Installation

SeaLINK for Linux has been archived and should not be considered for new applications. It will not work on any kernel version newer than 2.6. Existing users who require ***a driver for legacy systems*** can download a copy from the [Linux Archives](#).

New users or users migrating legacy systems to an updated kernel are encouraged to contact Sealevel Systems' Technical Support at (864) 843-4343 or [support@sealevel.com](mailto:support@sealevel.com) to discuss alternatives to SeaLINK on Linux. Our technical support is free and available from 8:00 AM - 5:00 PM Eastern Time, Monday through Friday.

## Create Virtual COM Ports in Linux

The virtual COM port driver in Linux is configured by the `/etc/sealink.conf` file.

You may either manually edit the `sealink.conf` file or you can use the provided SeaLINK Configuration command line utility to detect SeaLINK devices and add them to the `sealink.conf` file.

The SeaLINK Configuration utility `'sealinkcfg'` is installed to the `'/usr/bin/'` directory and should be accessible for all users. Adding virtual COM ports to the system requires root privileges. `# sealinkcfg`

The SeaLINK Configuration utility will present a list of SeaLINK devices detected on the local network when it is run. Choose the device you wish to use and install it using the `'i hub'` option.

Save changes to the driver configuration `'s'` and exit the utility.

Now the driver must be told about the new configuration changes. A script has been provided to make this an easy task. Simply execute `# sealink restart` to change the driver's configuration.

- SeaLINK virtual COM ports should now be accessible through `'/dev/ttySL'` device special files just like standard serial ports.



SeaLINK for Linux has been archived and is no longer recommended for new installations. See [Linux Installation](#) for more information. The information above is preserved for reference only.

# Raw Data Sockets

Raw Data Sockets are probably the easiest way for a software developer to control a serial port but provide the least control from a software standpoint. You simply configure the device to operate in Raw Data mode via the device's webpage, open a socket to the device on the Raw Data TCP port corresponding to the serial port you want, and stream data back and forth. The data will not be inspected or modified in any way.

This method provides the least control because serial port functions such as baud rate and modem control signals cannot be monitored or changed programmatically. However, Raw Data is platform-independent and requires no software installation. If your purposes do not require dynamic serial port control, Raw Data may be the most efficient choice for you.

- **Configuration**
  - Since Raw Data does not allow for programmatic changing of serial port controls, the serial ports must be configured before use via the onboard web server (see the [Web Configuration section](#)). From the [Port Settings page](#), configure the ports to the desired settings and click Submit at the bottom of the page. The serial ports will automatically be set to these defaults when opened Selection).
- **Usage Details**
  - To access a serial port using Raw Data mode, open a TCP socket to the device's IP address on port 4760, which corresponds to the serial port on the device. [Sealevel's WinSSD utility](#) can be used to verify proper communication as described on the following page.

Device Serial Port	TCP Port Number (Socket)
1	4760
2	4761
3	4762
4	4763
5	4764
6	4765
7	4766
8	4767
9	4768
10	4769
11	4770
12	4771
13	4772
14	4773
15	4774
16	4775



Only one client can open each serial port at a time. All further socket requests to a TCP port will be denied.

## Using WinSSD

1. SeaLINK devices purchased from Sealevel ship with a serial loopback adapter (See the **Before You Get Started** section of this manual for loopback part numbers and descriptions).
2. Plug the loopback adapter into the first serial port on your SeaLINK device.
3. Launch **WinSSD** utility (Start → Programs → Sealevel Systems → WinSSD).
4. In the WinSSD window, under the “Port Information” tab, click the “Network” tab.
5. Type in the IP Address of the SeaLINK device as discovered by the SeaLINK Configuration utility.
6. Select the 4760 for the first serial port.
7. Click the “Open” button.
8. Click on the “Loopback” tab and click the “Start” button in WinSSD.
9. Click on the “Help” button on each tab of the WinSSD utility for additional instructions.
10. A successful test confirms that your Sealevel device is communicating properly. Repeat the test for each additional serial port on your device; otherwise click the “Exit” button to close the WinSSD utility.
11. If you experience any configuration or testing problems with SeaLINK or WinSSD, refer to the **Troubleshooting** section at the end of this manual.



[WinSSD Diagnostic Utility Software](#) is available as a standalone utility and can be found on Sealevel’s website: [Software: WinSSD Diagnostic Utility - Windows - Sealevel](#).

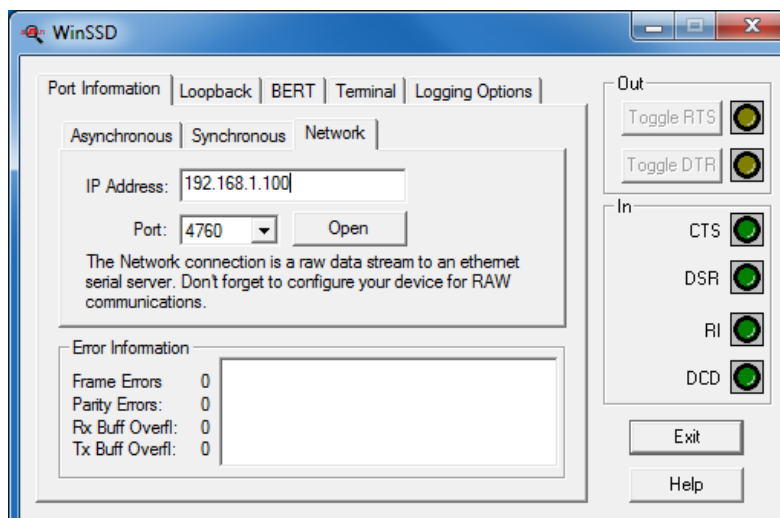

When opening a connection to the device in Telnet mode, SeaLINK must authenticate the device. Depending on your system and network, this can take up to a few seconds. If rapid opening and closing of ports is required, Raw TCP mode should be used because it does not require authentication.

## Device Configuration

### Locating the Device and Assigning an IP Address

Before the SeaLINK device can be used, it must be assigned an IP address valid to your network. When first powered up, the device will attempt to automatically find an IP address using DHCP. The Link LED, if present on your model, will flash if unit was not able to locate a DHCP server. In this case, you will need to connect the device to a valid DHCP server and assign a static IP address through the web interface. The configuration utility is useful for locating devices to determine the IP address. The method depends on your operating system, so see the appropriate section below.

### Device Configuration with Windows

Windows device configuration is performed through the 'SeaLINK Configuration' utility (Start → Programs → Sealevel Systems → SeaLINK → SeaLINK Configuration) provided with the software installation. When started, the utility will display all devices on the local network (the utility cannot see devices on the other side of a router). If your device is not listed, verify that it is connected to the network (see the [Troubleshooting section](#)). To assign a static IP address, select your device in the list, click 'Device Settings'. This will open your default web browser to the web configuration page of the selected device. Navigate to the [Administration Page](#) on the left, then click 'Static' under "Network Settings" and enter your desired network settings. Click Submit when complete. The device will automatically reboot to apply the new network configuration.

### Device Configuration with Linux

Linux device configuration is performed through the 'SeaLINK Configuration' utility (/usr/bin/sealinkcfg) provided with the software package. When started, the command line utility will display all devices on the local network (the utility cannot see devices on the other side of a router). If your device is not listed, verify that it is connected to the network (see the [Troubleshooting section](#)). This utility is primarily used to configure the virtual COM port driver and detect SeaLINK devices. You can set the IP Address, Gateway, Network Mask, and Device Name through the onboard web server, discussed in the following sections.



SeaLINK for Linux has been archived and is no longer recommended for new installations. See [Linux Installation](#) for more information. The information above is preserved for reference only.

# Onboard Web Server Configuration

Once the SeaLINK device has been assigned an IP address, you can configure it through the onboard web server. You may open a web browser (Internet Explorer, Firefox, Chrome, Safari, etc.) and type 'http://xxx.xxx.xxx.xxx' into the URL field, where 'xxx.xxx.xxx.xxx' is the IP address of the SeaLINK device.

The configuration utility 'SeaLINK Configuration' (Start → Programs → Sealevel Systems → SeaLINK Configuration, then click on 'Find Ports') can be used to determine the IP address. The web interface provides three separate pages selectable by tabs on the left side of the screen. A Summary page lists various details about the device, a Port Settings page allows you to configure aspects of each serial port, and an [Administration page](#) lets you change the network and security settings. Some options or settings may not be available depending on the model SeaLINK device you are using.

## Summary Page

The Summary page lists the name of the SeaLINK device and part number. A user defined device name is shown in parenthesis and can be set on the Administration page. A brief description of the SeaLINK device capabilities is shown and the Product Specifications and Settings section follows.

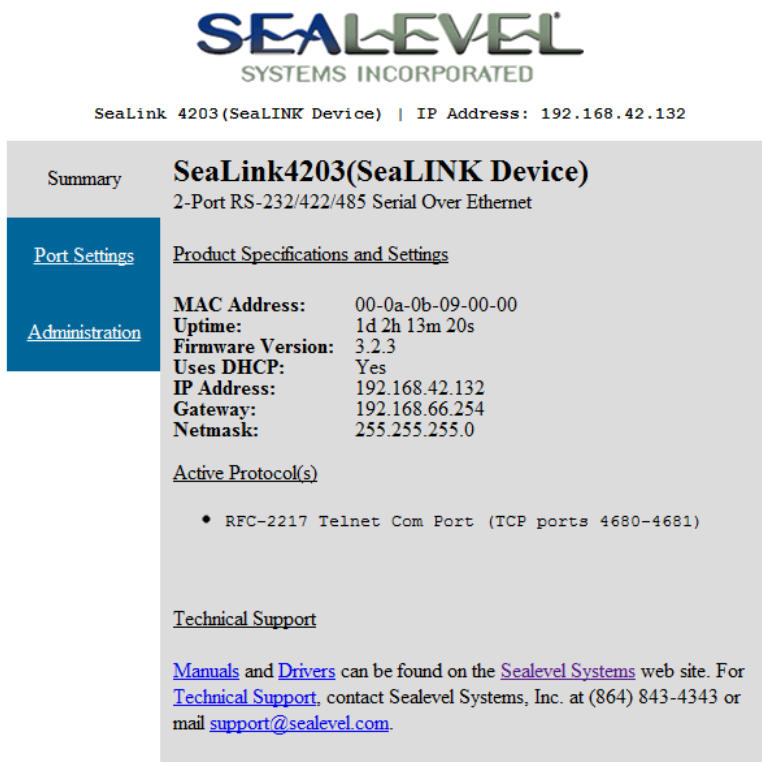

The screenshot displays the web interface for a SeaLINK device. At the top, the logo for SEALEVEL SYSTEMS INCORPORATED is shown. Below the logo, the device name and IP address are listed: SeaLink 4203 (SeaLINK Device) | IP Address: 192.168.42.132. The main content area is divided into three tabs: Summary, Port Settings, and Administration. The Summary tab is active, showing the following information:

**SeaLink4203(SeaLINK Device)**  
2-Port RS-232/422/485 Serial Over Ethernet

**Product Specifications and Settings**

MAC Address:	00-0a-0b-09-00-00
Uptime:	1d 2h 13m 20s
Firmware Version:	3.2.3
Uses DHCP:	Yes
IP Address:	192.168.42.132
Gateway:	192.168.66.254
Netmask:	255.255.255.0

**Active Protocol(s)**

- RFC-2217 Telnet Com Port (TCP ports 4680-4681)

**Technical Support**

[Manuals](#) and [Drivers](#) can be found on the [Sealevel Systems](#) web site. For [Technical Support](#), contact Sealevel Systems, Inc. at (864) 843-4343 or mail [support@sealevel.com](mailto:support@sealevel.com).

## Product Specifications and Settings

The following is a list of settings that are displayed on the Summary page.

**MAC Address** – The hardware address of the SeaLINK device. This is assigned at the factory.

**Uptime** – Displays the amount of time (in days, hours, minutes, seconds) the SeaLINK device has been running since the last power interruption or device reboot.

**Firmware Version** – The version number of the firmware installed.

**Uses DHCP** – Displays 'Yes' if using DHCP set IP Address and 'No' if using a static IP Address. Default is 'Yes'.

**IP Address** – Address number set by the DHCP server or set by the user on the Administration page.

**Gateway** – Default is '(not set)'. A Gateway is a point of entry to and from an Ethernet network; a node that translates between two different networks or network segments

**Netmask** – Default is '(not set)'. The Netmask (Network Mask) is used by the TCP/IP protocol to decide how the network is divided into sub-networks and is used to identify the local portion of an Ethernet network.

## Supported Protocols

RFC-2217 Telnet COM Port (TCP Ports 4680-4695) – the protocols used by the SeaLINK Windows virtual COM port driver.

Unformatted Streamed Data (TCP Ports 4760-4775) – the protocol used for socket based communications. When a port is opened, all data sent over Ethernet is transmitted to COM port(s) and all data received from COM port(s) is transmitted back over network.

SeaLINK Custom Protocol (TCP Port 4560) – the protocol used by the SeaLINK Linux virtual com port driver.

As they are added to the firmware, support for other protocols may be listed.



SeaLINK for Linux has been archived and is no longer recommended for new installations. See [Linux Installation](#) for more information. The information above is preserved for reference only.



## Port Settings Page

The Port Settings page allows you to configure each serial port individually. If you are using a virtual serial port protocol such as SeaLINK software, application programs may change these settings dynamically after opening the ports. If you want to prevent programs from changing these settings, click the “Always use defaults” checkbox and submit changes. This can be useful if you specify a custom baud rate that is not available from your operating system. The ‘Port Settings’ are explained in detail on the following page.



SeaLink 4203 (SeaLINK Device) | IP Address: 192.168.42.132

<a href="#">Summary</a>	<b>Port 1 Defaults</b>
<a href="#">Port Settings</a>	Baud Rate: <input type="text" value="57600"/> Parity: <input type="text" value="None"/>
<a href="#">Administration</a>	Data Bits: <input type="text" value="8"/> Flow Control: <input type="text" value="None"/>
	Stop Bits: <input type="text" value="1"/> RS Mode: <input type="text" value="RS 232"/>
	Protocol: <input type="text" value="Ignored"/>
	<input type="checkbox"/> Always use defaults (do not allow programs to change settings)
	<input type="checkbox"/> Connect to <input type="text" value="0"/> . <input type="text" value="0"/> . <input type="text" value="0"/> . <input type="text" value="0"/> : <input type="text" value="0"/>
	<b>Port 2 Defaults</b>
	Baud Rate: <input type="text" value="57600"/> Parity: <input type="text" value="None"/>
	Data Bits: <input type="text" value="8"/> Flow Control: <input type="text" value="None"/>
	Stop Bits: <input type="text" value="1"/> RS Mode: <input type="text" value="RS 232"/>
	Protocol: <input type="text" value="Ignored"/>
	<input type="checkbox"/> Always use defaults (do not allow programs to change settings)
	<input type="checkbox"/> Connect to <input type="text" value="0"/> . <input type="text" value="0"/> . <input type="text" value="0"/> . <input type="text" value="0"/> : <input type="text" value="0"/>
	<input type="button" value="Submit"/>

## Port 'x' Defaults

The following is a list of settings that are displayed on the Port Settings page. Default settings are in brackets:

- **Baud Rate** – [57600] Text box

You can enter any number from 1 to 921600, but Windows limits the maximum baud rate to 230400. It may not be possible to hit the exact desired baud rate, however the 16C950 compatible UART will attempt to set it as closely as possible and will be within the acceptable 2% range. Enter any valid baud rate and click Submit. The page will refresh and display the nearest calculated baud rate.

- **Data Bits** – 5, 6, 7, [8], 9 ([See Appendix A](#))

- **Stop Bits** – [1], 1.5, 2

- **Parity** – [none], even, odd, mark (forced 1), space (forced 0)

- **Flow Control** – [none], Software (Xon/Xoff), Hardware (RTS/CTS)

- **RS Mode** – [No Default], RS 232, RS 422, RS 485 (no echo), RS 485 (echo)

This is used to configure the electrical interface on 4, 8 and 16 port units. For single and dual port units, 'RS Mode' will instead display the current electrical interface settings of the hardware dipswitches. On multi-interface products, each port is individually configurable.

- **Protocol** – [Ignored], Modbus RTU

Enable if communicating with Modbus serial COM devices. When enabled, the SeaLINK device won't transmit until a full Modbus packet has been received, which helps keep Modbus packets intact.

- **Termination** – [Terminated], Non-Terminated

For SeaLINK devices with software selectable termination (currently 4162 and 4163) using RS-422 or RS-485 mode and no hardware termination jumpers, this dropdown list can enable/disable line termination.

**Input Alias** – [None], DCD, DSR, RING

For the SeaLINK 4103, this sets the modem signal that the input is aliased to. Refer to the 4103 Digital I/O section of this manual for more information.

**Relay Alias** – [None], DTR.

For the SeaLINK 4103, this sets the modem signal the relay is aliased to. Refer to the 4103 Digital I/O section of this manual for more information.

**'Always use defaults'** – Checkbox

When using a virtual serial port protocol (SeaLINK software), application programs may change the port settings dynamically after opening the ports. To prevent programs from changing these settings, click the "Always use defaults" checkbox and submit. This can be useful if you specify a custom baud rate that is not available from your operating system. Applications can still attempt changes, but the SeaLINK device will ignore them.

### Connect to xxx . xxx . xxx . xxx : xxxx – Checkbox & IP/Port Address

To enable serial tunneling, click the checkbox and fill out the IP address and TCP port number (socket) of the serial server you wish to connect to. When the serial server detects serial data present on the serial port and no connection is active, the serial server will connect to the IP address specified on the webpage and send the data. SeaLINK devices support bidirectional serial tunneling.

The TCP port number is the socket assigned to the COM port you are setting up and the numbers range from 4680 to 4695. The first device's serial port is always port 4680 (regardless of virtual COM port mapping) and the numbers increment by one, with the 16<sup>th</sup> serial port always being TCP port (socket) 4696.

For example, if you have a serial device connected to the 4<sup>th</sup> serial port of a SeaLINK 4401 (four port device) that you want to set up to serial-tunnel to a SeaLINK 4101 (single port device). On the webpage of the 4401, you type the IP address of the 4101 with a TCP port number (socket) of 4680. If the serial data is bidirectional, you will also set up serial tunneling on the 4101. On the webpage of the 4101 you will type in the IP address of the 4401. Since you are connecting to the 4<sup>th</sup> serial port, you will use TCP port number 4683. The table below illustrates the TCP port numbers (sockets) assigned to the SeaLINK device serial ports.

Device Serial Port	TCP Port Number (Socket)
1	4680
2	4681
3	4682
4	4683
5	4684
6	4685
7	4686
8	4687
9	4688
10	4689
11	4690
12	4691
13	4692
14	4693
15	4694
16	4695

## Administration Page

The Administration page is where you can set general SeaLINK device settings. You can set the device name, IP address, Gateway, network mask, timeouts, etc. You can set a password to prevent unauthorized access to the SeaLINK device, thus avoiding accidental configuration changes.



SeaLink 4203 (SeaLINK Device) | IP Address: 192.168.42.132

<a href="#">Summary</a>	<b>General Settings</b>
<a href="#">Port Settings</a>	Name: <input type="text" value="SeaLINK Device"/>
<a href="#">Administration</a>	Advertise (blink link LED): <input type="radio"/> On <input checked="" type="radio"/> Off
	Nagle's Algorithm: <input checked="" type="radio"/> Enable <input type="radio"/> Disable
	Connection Protocol: <input type="text" value="RFC-2217"/> (Force Reboot)
	<b>Timeouts</b>
	Allow new connection if existing has been idle <input type="text" value="30"/> seconds.
	Retry dropped active connections after <input type="text" value="10"/> seconds.
	Drop active connections after <input type="text" value="10"/> seconds of inactivity.
	<b>Network Settings</b> (force reboot on submit)
	Addressing: <input checked="" type="radio"/> DHCP <input type="radio"/> Static
	IP Address: <input type="text" value="192.168.42.132"/>
	Gateway: <input type="text" value="192.168.66.254"/>
	Netmask: <input type="text" value="255.255.255.0"/>
	<b>Security Settings</b>
	New Password: <input type="text"/>
	Confirm New Password: <input type="text"/>
	<b>Firmware Settings</b> (force reboot on submit)
	Flash Upgrade File: <input type="button" value="Choose File"/> No file chosen
	<input type="button" value="Submit"/> <input type="checkbox"/> Reboot

## General Settings

- **Name** – Text box

This is the user's assignable name of the SeaLINK device, useful for giving the device a meaningful name (i.e., location, connected equipment, etc.)

- **Advertise (blink link LED)** – On or [Off]

Set to 'On' and submit. The LINK LED will blink until it is disabled again. This option only works on 4-port and 8-port SeaLINK devices. The 1-port, 2-port, and 16-port SeaLINK devices do not have a LINK LED.

- **Nagle's Algorithm** – [Enable] or Disable

Referred to as "Nagling", which is a method (IETF RFC 896) to reduce the number of small packets transmitted over an Ethernet network. Devices that support Nagling will buffer data until 1500 bytes have been received or 200ms has passed. Disable if serial COM devices are timing out due to latency delays. You may have to disable Nagling at the host or network level to further reduce host or network latency.

**Note:** Disabling Nagle's Algorithm **will** increase packet traffic.

- **Connection Protocol** – [RFC-2217],Raw Data, SeaLINK

Sets the connection protocol for all serial ports on the SeaLINK device. RFC-2217 supports COM port control signals such as DTR, CTS, DCD, etc. and is required for connections made via the Windows SeaLINK virtual COM port software. Raw has no protocol associated with it and accepts standard TCP/IP socket connections. The custom SeaLINK protocol is required for connections made via the Linux SeaLINK virtual COM port software.



SeaLINK for Linux has been archived and is no longer recommended for new installations. See [Linux Installation](#) for more information. The information above is preserved for reference only.

## Timeouts

- Allow new connection if existing has been idle 'x' seconds: – [30]

SeaLINK devices automatically prevent multiple users from opening the same serial port at the same time. If a serial port is in use (open), all other socket connection requests are refused. Certain events (i.e., a system crash) may break the serial connection without the SeaLINK device receiving notification that the connection has ended. No further connections can be made to that port unless the device is reset. By setting this option, after 'x' seconds of **inactivity**, the SeaLINK device will allow an incoming connection to override the existing connection.

- Retry dropped active connections every 'x' seconds: – [10]

Setting a timeout period prevents an active connection, via serial tunneling, from trying to connect repeatedly to the assigned IP address (i.e., if the timeout is set to 10 seconds, the failed serial tunnel connection will not be attempted again until 10 seconds have passed). This helps reduce network overhead where multiple serial devices may share the same network.

## Timeouts, Continued

- Drop active connections after 'x' seconds of inactivity: – [10]  
Active connections, via serial tunneling, are made when the SeaLINK device receives serial data and are closed when the receiving device closes the connection. This setting will automatically disconnect the serial connection after 'x' seconds of serial data **inactivity**.

## Network Settings

(Force reboot on Submit) – changes will be reflected on Submit but will not take effect until SeaLINK device has been rebooted. The SeaLINK device defaults to DHCP and will attempt to obtain an IP Address from a DHCP server. If an IP address cannot be obtained from a valid DHCP server, you can set the device to a static IP address. You can also assign a Gateway and Network Mask, if required.

- **Addressing** – [DHCP] or Static
- **IP Address** – Text box
- **Gateway** – Text box
- **Netmask** – Text box

## Firmware Settings

This section may be used to update the SeaLINK device firmware through the web interface. It is recommended to use an uninterruptible power supply (UPS) during the firmware update process. Sudden power loss during a firmware update could lead to invalid data being written to the device's static memory. Invalid data will have unpredictable results on the stability of your SeaLINK device and may require a return to Sealevel for repair.



All new firmware update files are located on the Sealevel website at <https://www.sealevel.com/support/how-to-update-sealink-ethernet-serial-firmware/>

## Security Settings

You can assign a password to the SeaLINK device to prevent unauthorized configuration changes via the web interface. Once a password has been set, a new field appears next to the Submit button. You must enter the correct password and press the Submit button before the SeaLINK device will accept new changes. The password does not prevent the user from viewing the onboard web pages by default. If you forget your password, a default password of xxxx is always available, where xxxx is the last 4 lowercase hexadecimal digits of the MAC Address of the device.

Three security levels are available once a password has been set, configurable by the radio buttons shown below.

**Security Settings**

Require Password:  Yes  Edit  No (clears password)

Login Timeout (s):

New Password:

Confirm New Password:

**Firmware Settings** (force reboot on submit)

Flash Upgrade File:  No file chosen

---

Password:    Reboot

- **Require Password** – Radio Buttons determining the security level on the device.
  - **Yes:** Under this security level, a password is required to view as well as edit settings.
  - **Edit:** Anyone with the IP address of the device can view settings, but only users with the password can edit settings. This is the security level the device defaults to once a password has been set.
  - **No:** A password will no longer be required to view or edit settings on the device.
- **Login Timeout** – Under the highest security level, “Yes,” this is the inactivity timeout in seconds of the password information. When this time has elapsed without any activity, the user will have to log back in before settings can be viewed. Valid range is 15 to 99 seconds.
- **New Password** – Text Box where a new password is entered, if desired.
- **Confirm New Password** – Text Box where the confirmation of the new password is entered.
- **Password** – Text Box where the password must be entered before settings can be changed when under security level “Edit.”

## Resetting to Factory Defaults

If you have forgotten your password or need to reset the device to the factory defaults, manually browse to "http://xxx.xxx.xxx.xxx/debug.htm" (where xxx.xxx.xxx.xxx is the IP Address of the SeaLINK device) and click the button marked "Reset to Factory Defaults." If you are prompted for a username and password, the username is "debug" and the password is the MAC address of the unit with no spaces or dashes. The MAC address can be found either on the summary page or on the bottom of the SeaLINK device. You may or may not be prompted for these fields, depending on the firmware version of your device.

The configuration utility 'SeaLINK Configuration' (Start → Programs → Sealevel Software → SeaLINK → SeaLINK Configuration) can also be used to determine the MAC address number.



The screenshot displays the SeaLINK configuration utility interface. At the top, the logo for SEALEVEL SYSTEMS INCORPORATED is shown. Below the logo, the text reads "SeaLink 4803 (SeaLINK Example) | IP Address: 192.168.42.80". The interface features a blue sidebar on the left with three menu items: "Summary", "Port Settings", and "Administration". The main content area is light gray and contains a "Debug Threshold" dropdown menu set to "None", a "Submit" button, and a "Reset to Factory Defaults" button.



The Debug Threshold settings on this page have no meaning to the end user and are only used for factory testing and diagnostics. This setting should be left set to 'None'.



# Application Requirements

## Check Application Requirements

Nearly all Windows applications can use SeaLINK virtual COM ports and remote serial devices instead of direct-connected devices. Applications with special requirements will usually work after properly configuring SeaLINK software and hardware.

Most Windows applications perform only common read/write operations. Some applications, however, require COM port control. SeaLINK serial servers support COM Port Control, thus offering the degree of control that most of these special applications require. Typically, the applications are one of three types:

1. Fax applications, which require very close interaction with the modem that only COM Port Control can provide.
2. Custom applications that must set specific baud rates and framing. A common workaround is to manually make these settings on the serial server.
3. Custom applications, such as some data collection programs that connect to remote equipment, which requires serial line status signals.

## Create Modem Devices

Windows modem devices allow Windows applications to more easily use different types of modems. Windows Dial-Up Networking, Windows HyperTerminal and many other applications can and sometimes must use Windows modem devices. If your application needs a specific modem device, as opposed to a COM port, follow the instructions here to create a modem device for the remote modem on the server.

When you create a Windows modem device, you use Windows 'Add Hardware' wizard for modems found in the Windows Control Panel. You will need to answer two basic questions:

What modem driver should be used for the remote modem?

What SeaLINK COM port reaches the remote modem? When prompted by the wizard, choose the appropriate COM port from the list presented.

## Choosing the Right Modem Definition (Modem Driver)

A common problem in using remote modems is a mismatch between the Windows modem driver and the modem that is actually connected to the serial server. This results from choosing the wrong modem driver when creating a Windows modem device. Windows may already contain a modem definition for your modem, especially if it is an external modem. You can also obtain the correct driver from the modem manufacturer's website. It is very important that you use the correct modem driver before you create the Windows modem device. If the wrong driver is installed for a COM port, SeaLINK will not work.

## Creating a Windows Modem Device

All versions of Windows include a hardware wizard that simplifies the process of creating a modem device for a standard modem on a serial server. This wizard is accessed through the Windows Control Panel. Because the wizard is implemented slightly different in each Windows version, the following instructions are generalized for all versions of Windows. Refer to your Windows documentation if additional details are needed.

1. Determine the make and model of the modem(s) on the serial server.
2. Verify that the manufacturer of any modems connected to the serial server has provided a modem driver file. If the original INF file cannot be located, check the support pages on the manufacturer's web site.



Windows includes a number of INF files for popular modems. The hardware wizard will list these during the process of creating the modem device. **Standard modems and generic drivers should be avoided.**

3. Open the Windows Control Panel and click on the 'Modems' file or icon.
4. Click 'Add' to begin adding a new modem.
5. If Windows offers to detect the modem, check the box that prevents automatic detection. You need to manually select the modem manufacturer and model from a list.
6. Select the SeaLINK virtual COM port that will access the modem to complete the process.



The Windows typically lets you install the same driver for multiple ports in one step, thus saving time.

7. Windows should now indicate that the modem has been successfully set up and show which COM port SeaLINK is using. You may need to click on a 'Properties' button to see this information.
8. After installing the driver, it is highly recommended that you reboot your PC.

## Application Settings & Examples

The final step in configuring an application is to change the application settings to use either a SeaLINK COM port directly or the Windows modem device that refers to the remote modem on the serial server. The general procedure is:

1. Find the 'Settings', 'Preferences', 'Options' command setting in the application that allows you to specify the COM port or modem device to be used by the program.
2. Choose the SeaLINK COM port, or the modem device that uses the SeaLINK COM port, to access the remote modem.



Some older Windows applications do not recognize COM ports higher than COM4, including some versions of Windows HyperTerminal. If you need to use such an application, consider creating COM ports in the COM1 – COM4 range. You may need to disable COM ports in your system BIOS to make them available to the SeaLINK software.

# Connector Pin Assignments

## Connector Pin Assignments - DB9

The following pin out diagrams cover all Ethernet serial servers with a DB9 connector, excluding the 4103, which is covered on the following page.

### RS-232 (DB9 Male)

This pin out covers the following products:

4101, 4104, 4201, 4203, 4401, 4403, 4801, and 4803

Pin #	Signal	Name	Mode
1	DCD	Data Carrier Detect	Input
2	RX	Receive Data	Input
3	TX	Transmit Data	Output
4	DTR	Data Terminal Ready	Output
5	GND	Ground	
6	DSR	Data Set Ready	Input
7	RTS	Request To Send	Output
8	CTS	Clear To Send	Input
9	RI	Ring Indicator	Input



Please terminate any control signals that are not going to be used. The most common way to do this is connect RTS to CTS and RI. Also, connect DCD to DTR and DSR. Terminating these pins, if not used, will help ensure you get the best performance from your adapter.

### RS-422/485 (DB9 Male)

This pin out covers the following products:

4102, 4104, 4202, 4203, 4402, 4403, 4802 and 4803

Pin #	Signal	Name	Mode
1	RX+	Receive Data Positive	Input
2	RX-	Receive Data Negative	Input
3	TX-	Transmit Data Negative	Output
4	TX+	Transmit Data Positive	Output
5	GND	Ground	
6	RTS+	Request To Send Positive	Output
7	RTS-	Request To Send Negative	Output
8	CTS-	Clear To Send Negative	Input
9	CTS+	Clear To Send Positive	Input



Please terminate any control signals that are not going to be used. The most common way to do this is connect RTS to CTS (connect positive to positive and negative to negative). Terminating these pins, if not used, will help ensure you get the best performance from your adapter.

## Connector Pin Assignments - 4103

### RS-232 (DB9 Male)

This pin out covers the 4103 only.

Pin #	Signal	Name	Mode
2	RX	Receive Data	Input
3	TX	Transmit Data	Output
5	GND	Ground	
7	RTS	Request To Send	Output
8	CTS	Clear To Send	Input

### RS-422/485 (DB9 Male)

This pin out covers the 4103 only.

Pin #	Signal	Name	Mode
1	RX+	Receive Data Positive	Input
2	RX-	Receive Data Negative	Input
3	TX-	Transmit Data Negative	Output
4	TX+	Transmit Data Positive	Output
5	GND	Ground	
6	RTS+	Request To Send Positive	Output
7	RTS-	Request To Send Negative	Output
8	CTS-	Clear To Send Negative	Input
9	CTS+	Clear To Send Positive	Input



Please terminate any control signals that are not going to be used. The most common way to do this is connect RTS to CTS (connect positive to positive and negative to negative). Terminating these pins, if not used, will help ensure you get the best performance from your adapter.

### Relay / Input Connections

This pin out covers the removable terminal block on the 4103 only. Refer to the 4103 Digital I/O section for information on using the input and relay.

Pin #	Signal	Name
1	V+	9-30 VDC Input
2	V-	Supply Power Ground
3	Relay 2	Relay Contact 2
4	Relay 1	Relay Contact 1
5	Input 2	Optically Isolated Serial Port, and Optically Isolated Digital Input
6	Input 1	Optically Isolated Serial Port, and Optically Isolated Digital Input

# Connector Pin Assignments – RJ45

## RS-232 (RJ45 Female)

This pin out covers the 4161 and 4163.

Pin #	Signal	Name	Mode
1	RTS	Request To Send	Output
2	DTR	Data Terminal Ready	Output
3	GND	Ground	
4	TX	Transmit Data	Output
5	RX	Receive Data	Input
6	DCD	Data Carrier Detect	Input
7	DSR	Data Set Ready	Input
8	CTS	Clear To Send	Input

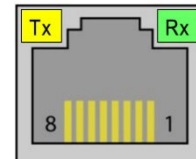

Please terminate any control signals that are not going to be used. The most common way to do this is connect RTS to CTS. Also, connect DCD to DTR and DSR. Terminating these pins, if not used, will help ensure you get the best performance from your adapter.

## Optional Accessories

Sealevel offers a modular adapter (item# RJ9P8) with an RJ45 female connector and a DB9 male connector. This modular adapter ships unassembled and provides an easy method for converting the RJ45 connector on the serial server to a standard DB9 connector. The modular adapter can be connected to any serial peripheral device with a DB9 connector, which allows standard network patch cables to be used to connect the serial device to the serial server. The RS-232 pin out is shown in the table below, or you can order one preconfigured (item# **DB116**).

RJ45	Signal	DB9M	Wire
1	RTS	7	Blue
2	DTR	4	Orange
3	GND	5	Black
4	TX	3	Red
5	RX	2	Green
6	DCD	1	Yellow
7	DSR	6	Brown
8	CTS	8	White



## RS-422/485 (RJ45 Female)

This pin out covers the 4162 and 4163.

Pin #	RS-422	RS-485	Name	Mode
1	TX+	Data+	Transmit Data +	Output
3	GND	GND	Ground	
4	TX-	Data-	Transmit Data -	Output
5	RX+		Receive Data +	Input
8	RX-		Receive Data -	Input

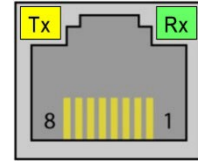

## Optional Accessories

Sealevel offers a modular adapter (item# **RJ9P8**) with an RJ45 female connector and a DB9 male connector. This modular adapter ships unassembled and provides an easy method for converting the RJ45 connector on the serial server to a standard DB9 connector. The modular adapter can be connected to any serial peripheral device with a DB9 connector, which allows standard network patch cables to be used to connect the serial device to the serial server. The Sealevel implementation of RS-422 is shown in the table below.

RJ45	Signal	DB9M	Wire
1	TX+	4	Blue
2	No Connect		Orange
3	GND	5	Black
4	TX-	3	Red
5	RX+	1	Green
6	No Connect		Yellow
7	No Connect		Brown
8	RX-	2	White



For field wiring of RS-485 signals, Sealevel recommends the RJ45 terminal block (item# **TBRJ45**). The RJ45 terminal block provides an RJ45 female connector breaking out to screw terminals. All accessories are available from the Sealevel website.

RJ45	Signal	Terminals
1	TX+	1
2	No Connect	
3	GND	3
4	TX-	4
5	RX+	5
6	No Connect	
7	No Connect	
8	RX-	8



# 4103 Digital I/O

## Relay and Input Configuration

The 4103 has a single Reed relay output and a single optically isolated digital sensor input for general purpose I/O. These functions are available either via a Modbus TCP interface or as 'aliased' modem control signals. These functions are configured in software via the onboard web server configuration interface section of this manual. Refer to the following sections for Modbus TCP communication syntax and aliased modem control signals.

## Aliased Modem Control Signals

Modem control signals provide one the easiest and most convenient methods of controlling the relay output and optically isolated digital input. In order to alias a modem control signal, open the onboard web page for the 4103, and choose the Port Settings tab. Choose a signal option for both the input alias and the relay alias.

For example, in order to control the relay output using the DTR modem control signal, select DTR under the relay alias option and click 'Apply'. Now, in order to toggle the relay output, open a virtual COM connection to the serial port and toggle the DTR signal. Refer to the Onboard Web Server section of this manual for instructions on configuring the device via the onboard web server.

## Modbus TCP

Modbus is a standard field bus protocol designed to make reading and writing I/O device-independent. Modbus TCP is a variant of the Modbus protocol that uses TCP/IP as its communication medium. Per the Modbus TCP specification, each I/O point on a device is mapped to an address that can be specified within Modbus commands. The mapped address is relative to the type of I/O.

The SeaLINK 4103 responds to zero-indexed Modbus TCP requests and has one relay output (readable/writeable bit) mapped as a coil at address 0, and one optically isolated digital input (readable bit) mapped as a discrete input at address 0.

The 4103 responds to slave address 1 and accepts Modbus TCP connections on the standard Modbus TCP port 502.

Supported Modbus commands	
READ_COILS	(0x01)
READ_DISCRETE_INPUTS	(0x02)
WRITE_SINGLE_COIL	(0x05)
WRITE_MULTIPLE_COILS	(0x0f)
READ_DEVICE_IDENTIFICATION	(0x2b)



Some Modbus/TCP software is one-based, meaning that address ranges begin with 1 instead of 0. For more information on Modbus/TCP or Modbus protocols, visit

<http://www.modbus.org>.



# Appendix A - Technical Notes

## 9-bit Serial Framing

Many Industrial Multi-drop protocols make use of 9-bit data framing. The Oxford 16C950, which is the UART used in SeaLINK devices, natively supports this mode of operation. When the SeaLINK UARTs are configured to use 9-bit data framing, two bytes of data are required for each communication. The first data byte contains the desired address in the least significant bit. The second byte is the data to be transmitted.

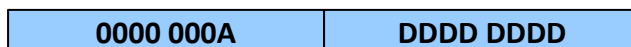

For example, if you wish to transmit the data byte 0xAB with a low address bit, the write buffer would contain two characters. The first byte would be 0x00, and the second byte would be 0xAB. (buffer[0] = 0x00; buffer[1] = 0xAB)

Received data is returned the same way. If a port receives a 9-bit data frame with 0xBA data and the address bit high, the read buffer will contain the bytes 0x01 and 0xBA.

## Windows Virtual COM Driver

The Windows Virtual COM Driver provided with SeaLINK devices does not directly support 9-bit data framing but can be used in this mode regardless. To achieve 9-bit data framing follow these instructions.

NOTE: If the virtual COM port driver is configured to use a data size less than 8 bits, the driver will mask off extra bits.

1. Open the SeaLINK device's web administration page. (see Onboard Web Server Config section)
2. Go to the "Port Settings" tab.
3. Select 9 data bits as the frame size.
4. Check the "Always use defaults" box.
5. Scroll to the bottom of the page and click the "Submit" button.
6. When opening the virtual COM port, choose a data size of 8 bits.

## Raw Mode

When a SeaLINK device is configured for Raw Mode protocol, there are no commands supported for changing UART parameters. The UART must be configured via the web administration page prior to opening the corresponding TCP port. Once the UART is configured for 9-bit data framing in Raw Mode, two bytes of data, formatted as described above, are required for each transmission.

## SeaLINK as the Software Cable

Correctly determining the source of a SeaLINK problem can be elusive, but there are clues to speed up this process. For example, when troubleshooting a local device, there are only three things to consider: the device itself, the COM port and cable, and the PC application software. When SeaLINK and SeaLINK serial servers enter the picture, the number of

potential error sources increases significantly. This can make it more difficult to determine why a particular application is not working properly.

## The Software Cable Concept

SeaLINK has one simple function: to pass data between a remote TCP/IP connection and a virtual COM port on a client PC. The analogy of a "software cable" is appropriate, as SeaLINK's primary mission is to pass data between the PC and the device.

This important point it is worth repeating: all SeaLINK serves to do is pass data between the PC and the device.

When you suspect problems lie with SeaLINK configuration, first consider whether the types of problems that are occurring would happen if a faulty device cable were suspected on a local device.

## SeaLINK and the TCP/IP Routing Table

To allow Microsoft's Dial-Up Networking to function with remote modems regardless of LAN topology, SeaLINK may need to manipulate the client PC's routing table. Depending upon several factors – including the number of network cards present in the PC, the entries in the routing table, and the location of the serial server – there may be situations where SeaLINK is unable to correctly configure the routing table.

SeaLINK automatically reads the routing table on startup and will determine if it needs to insert additional routes. For each COM port, it reads the IP address of the specified serial server, and will insert a route if both of the following are true:

1. The SeaLINK serial server's IP address is not on the same subnet as the PC.
2. The route to the server's address is handled via a "default" route. A default route is one with a network address of 0.0.0.0.

## What SeaLINK Does

If SeaLINK determines that an additional route is necessary, then it needs to calculate the correct information for that route. SeaLINK builds this route using the first default route found in the routing table. It builds a "specific" route using the IP address of the server and a network mask of 255.255.255.255. It uses the same gateway address as is used in the default route.

For example, consider the following (abbreviated) routing table:

Network Address	Netmask	Gateway	Interface	Metric
0.0.0.0	0.0.0.0	10.0.0.1	10.0.0.47	1
10.0.0.0	255.255.255.0	10.0.0.47	10.0.0.47	1
10.0.0.47	255.255.255.255	127.0.0.1	127.0.0.1	1

This example is for a PC with an address of 10.0.0.47, on a class C subnet (a netmask of 255.255.255.0). Only addresses 10.0.0.1 through 10.0.0.254 are accessible in this subnet, which is specified in the second route listed. The first route is the default route, which specifies that all other address outside the range of the 10.0.0.x subnet be delivered via the gateway at 10.0.0.1.

Now suppose that the SeaLINK serial server's IP address is 10.2.2.55, which is not on the client PC's subnet. SeaLINK will take the gateway address of the default route, a netmask of 255.255.255.255, the IP address of the PC, and add a new route so that the routing table will now read:

Network Address	Netmask	Gateway	Interface	Metric
0.0.0.0	0.0.0.0	10.0.0.1	10.0.0.47	1
10.0.0.0	255.255.255.0	10.0.0.47	10.0.0.47	1
10.2.2.55	255.255.255.255	10.0.0.1	10.0.0.47	1
10.0.0.47	255.255.255.255	127.0.0.1	127.0.0.1	1

The new route specifies that the address 10.2.2.55 can be reached via the 10.0.0.1 gateway and singles out that address over and above the other addresses reachable via the default route. This guarantees that the server will be accessible even if the default route changes.

## Why SeaLINK Does This

At first glance this additional route appears to be redundant. It is, after all, specifying the gateway address that is already listed in the default route. So, why bother?

The issue is that Dial-Up Networking sessions also manipulate the routing table. Consider this hypothetical Dial-Up Networking session to an ISP. Once dialed-in, the ISP will assign the calling PC an IP address of 10.23.0.135 and specify that a default route use the gateway at 10.23.0.1 (presumably this gateway knows how to route packets to the rest of the Internet). What happens next is that the routing table gets a new default route added, so the top two entries in the routing table look like this:

Network Address	Netmask	Gateway	Interface	Metric
0.0.0.0	0.0.0.0	10.23.0.1	10.23.0.135	1
0.0.0.0	0.0.0.0	10.0.0.1	10.0.0.47	2

The crux of the problem is this: with the above routing table, all packets outside the range 10.0.0.1 to 10.0.0.254 will be routed via 10.23.0.1 to the ISP – not to the gateway on the LAN. **This includes the serial server, which is at 10.2.2.55!** Dial-Up Networking has, in effect, sawed off the limb it is sitting on by updating the routing table such that the server is no longer accessible to the PC.

Dial-Up Networking doesn't have this problem with a local modem because the modem can always send and receive data to the PC regardless of the state of the routing table. Modems on servers, however, can be cut off from the PC if the routing table suddenly makes them inaccessible. By adding the specific route to the 10.2.2.55 address, the server is guaranteed to be always accessible, because the server is not dependent upon the default route.

## Problem #1: Multiple Default Routes

SeaLINK can run into problems when the PC's routing table contains more than one default route. The two most common situations where this occurs are:

1. The PC is "multi-homed," meaning it has more than one network card, each of which connects to a different subnet on the LAN.
2. The PC has been configured to have redundant default routes, with one intended to act as the backup for the other.

The problem is that SeaLINK needs to determine which gateway address to use for the additional routes (see above), and with multiple default routes it is forced to guess which gateway is the correct one. In lieu of more information, SeaLINK will always use the gateway address from the first default route in the routing table. In either case listed above, this means that SeaLINK may have guessed wrong.

In the first case, the serial server may not in fact be accessible via the network card chosen for the gateway. In the second case, sometimes the backup gateway address is not online. In either situation, you will see connection errors occur in the Configuration Wizard even when you have specified a correct IP address.

There are two solutions to this problem:

- Avoid using default routes when at all possible. Unless your LAN can also route to the Internet, using a default route to route to other subnets is somewhat misleading. If the routing table is adjusted to specify the other subnets directly rather than using a default route, then the problem goes away.
- Manually add a static route to the routing table that specifies which gateway to use for the serial server. In NT/2000/XP this is done with the "-p" option to the route command, and on Windows 98/Me it can be done with a batch file in the startup folder.

## Problem #2: No Route Command

SeaLINK performs all of the routing table inspection and manipulation using the Microsoft-supplied "route" command that ships with all Windows installations. If this command has been deleted or moved, or if you are using another vendor's TCP/IP stack, SeaLINK may run into problems attempting to run the route command.

# Appendix B – Troubleshooting

In most cases, installing SeaLINK is easy and straightforward. All SeaLINK needs to know is an IP Address and TCP Port Number (socket). The Configuration Wizard can usually determine the rest of its settings automatically.

If a problem arises somewhere between the PC running SeaLINK and the serial server, SeaLINK will usually indicate that a problem has occurred. Sometimes pinpointing the exact cause takes a little more work. Experience shows that most problems are related to the configuration of the application or the serial server, not with SeaLINK software.

The [WinSSD diagnostic utility](#) is supplied by Sealevel Systems and will be useful in troubleshooting procedures. Using WinSSD and following these simple steps can eliminate most common problems, usually without the need to call Technical Support.

- Verify that the Power LED is lit and remains on.
- Verify that the Link LED remains on to determine that the 10/100 Base-T connections and the polarity are correct. If the Link LED is lit, you have a valid Link condition.
- Verify that the Ethernet LED remains on to determine that the 10/100 Base-T connections and the polarity are correct. If the Ethernet LED is lit, you have a working Ethernet connection
- Verify that the correct cable is being used (i.e., 'Straight-thru' for switch/hub connection and 'cross over' for direct connection to NIC), and that all cables are connected securely.
- Verify that the Ethernet Hub, Switch, and any other network devices between the network server and the SeaLINK device are powered up and operating.
- Ensure that the serial server and Client are in the same sub-net (Broadcast Domain) and not behind a router or bridge.
- Ensure that the IP address in the Client is the same as the IP address of the Server. If using DHCP this address is subject to change after a Server reboot.
- To isolate the unit from the network, use a 'crossover' Ethernet cable to connect the unit directly to the NIC card in the server.
- Reboot the serial server by disconnecting from power for 10 seconds and reconnecting.
- Verify that the application software, SeaLINK device, and serial devices are all configured for the same baud rate, bit rate, parity, etc.
- Ensure that SeaLINK software is correctly loaded.
- Remove and reload SeaLINK software.
- Update the firmware (Firmware files, if available, and directions for updating can be found at the following link): [How To Update SeaLINK Ethernet Serial Firmware - Sealevel](#)
- In the case of COM ports becoming unresponsive in Windows, if a reboot of the system is not an option, load a command prompt under Administrator privileges. Enter the following commands to restart the SeaLINK drivers:

```
net stop netserial
```

```
net start netserial
```

## Pinpointing the Problem

When trouble arises, the first challenge (and often the most difficult part of the problem) is to determine where a configuration issue is occurring. The following procedure is recommended:

1. **Make sure the IP Address and Port Number for the SeaLINK serial server are correct.** SeaLINK will not be able to connect to the remote devices unless it is configured with the proper information.
2. **Run the Configuration Wizard to verify the IP Address and Port Number.** If the Configuration Wizard does not run successfully, then SeaLINK will not be able to function using the specified IP Address and Port Number. There are many reasons why a Configuration Wizard session may fail. The most common reason is the following:
  - Entering the incorrect IP port number in the SeaLINK Manager window.



A common mistake is to assume the TCP/IP port number is the "device number" on the server. These numbers should be in the range of 4680 to 4696. If unsure of what TCP port range to use, check the Summary tab on the local webpage of the device.



If more information is necessary, see the [Wizard Status and Error Messages](#) section of this manual.

3. **Verify the make and model of Windows Modem Device installed.** Many applications (such as Windows HyperTerminal and Dial-Up Networking) require a Windows modem device to automatically dial. If the installed device driver on the local PC does not match the modem(s) in the serial server, then dialing will not succeed even when the Configuration Wizard *does* succeed.
4. **Verify the Application Requirements.** Certain applications require COM Port Control. See the **Applications Settings** section to see if this may be a requirement for you.
5. **If the application still fails, collect trace data and look for problems.** In the event you need to contact Sealevel Systems support group, one of the first things you may be asked for is a trace file collected during the application failure. It is helpful to be familiar with the procedure for doing this in advance. Because reading trace data is fairly self-explanatory, many users can pinpoint the cause of certain problems from this information. See the trace window discussion for details.

## Problems Relating to Windows Modem Devices (as applicable)

It is very important to ensure that the Windows Modem Devices installed on the local PC match the modems provided by the server. A common symptom of this problem is that the Configuration Wizard succeeds, but then programs such as Windows HyperTerminal and Dial-Up Network fail to dial successfully. Many users mistakenly believe that this is a problem caused by SeaLINK, when in fact SeaLINK is simply a conduit for data between Windows and the modem, where the real configuration problem may be.

The **SeaLINK as the Software Modem Cable** overview section of this manual discusses this problem and how SeaLINK fits into a typical Windows installation.

Try raising the baud rate setting from its default setting (often 19200 or 38400) to 115200 baud. ISDN modems in particular are susceptible to this problem. Try this remedy if dialing fails even after you have verified that the installed modem is in fact correct.

## Other Problem Causes

**The Modem Group (or "hunt group" or "rotary") is configured improperly or contains bad modems.** A symptom of this problem is that not every connection access succeeds. Connections may require one or two tries, and then the Configuration Wizard succeeds. This problem is caused by the device group containing bad entries (such as non-existent ports); malfunctioning devices; devices that are turned off; or devices with faulty connections to the telephone network. Try detecting this problem by repeatedly running the Configuration Wizard. If any Wizard session fails to detect a modem, then investigate the serial server configuration settings.

**The serial server does not support faxing.** For faxing to work, the modems themselves must be capable of fax.

**The fax software is not configured for Class 2 or 2.0 fax.** Because of the tight timing constraints of Class 1 faxing, it is only possible to use a faxmodem in the Class 2 or 2.0 fax mode. This is not a limitation of SeaLINK, but rather a limitation of using networked modems for fax.

**The client program is not set to use the right modem and/or COM port.** It is surprisingly easy to forget to set all client applications to access the SeaLINK virtual COM port for remote device use.

**Incorrect dial-up networking username or password.** If the dial-up networking connection runs into trouble, first check the username and password that you are providing for the connection.

**The Windows "route" command is missing or moved.** SeaLINK uses the "route" utility in Windows to manage the PC's routing table. If the route.exe file is missing from the Windows system (or system32) directory, SeaLINK will not function properly. See the TCP/IP routing table section for more information.



## Wizard Status & Error Messages

When you first run the Configuration Wizard for a SeaLINK COM port, the Wizard answers two important questions:

**Can SeaLINK communicate with the serial server?** The Wizard attempts to establish communications (using a Windows Winsock socket) with the server, and then detects the protocols supported by the server.

**Is a remote device available?** As it works, the Wizard indicates its progress in the Status panel and then provides more details of its interchange with the server in the Log panel.

## Status Panel Error Conditions

The following errors are detected by the Wizard and displayed in the Status Panel:

1. **Server connection failure.** The Wizard window here shows a simple communication problem. In this case, the Wizard indicates that cannot connect to the IP address and port number set for this SeaLINK COM port.
2. **Normal progress messages.** When the Wizard's work proceeds normally, the messages summarize the interaction with the server. These messages include:
  - Connected to Server
  - COM Port Control Support Detected
  - Telnet Protocol Detected
  - Server signature: [server name]
  - Modem Detected
  - Session Completed
3. **Communications error messages.** If the Wizard encounters a problem with the server, the Status panel will contain one of the following messages:
  - Cannot connect to [server IP address]
  - Error sending data.

If such errors appear:

1. If the Restored Failed Connections feature is enabled, the "cannot connect" to server message is never displayed. SeaLINK will continually retry the connection every 15 seconds.
2. Verify that your serial server is at the IP address you expect.
3. Verify your server configuration is providing devices for access at the port number you expect.



In many cases the Port Number is determined when the port server is configured. There is no “correct” value that works for every type of port server.

4. **Modem detection error messages.** If the “test for presence of a modem” box is checked in the Configuration Wizard, then a Wizard session will first establish communications with the server. Next, the Wizard attempts to issue simple “AT” commands to a modem and analyze the responses. If the Wizard does not see output that matches expected modem behavior, it will report a modem detection problem with the Status panel containing one of the following messages:

- Could not elicit AT/OK response from modem
- Modem jabbering – may need to be reset
- Unexpected data received from modem
- Internal modem detection error

The most likely causes of such errors are:

1. An external modem is powered off or the data cable is disconnected.
2. A modem is not currently available in a modem pool.
3. Non-modem device connected to server.

## Log Panel Error Conditions

If the Status panel indicates an error, the Log panel will display one or more messages that provide more details. These messages include:

- Bad IP address
- Server disconnected prematurely
- Internal error

The Log panel can also contain error messages showing error codes that sometimes relate to specific causes. They include:

1. **CONNREFUSED**

Most likely cause: The IP port number is incorrect, or the serial server is not properly configured to accept connections at that port number.

2. **NETUNREACH, TIMEDOUT, or HOSTUNREACH**

Most likely cause: The IP address number is incorrect.

3. **NAMETOOLONG, AFNOSUPPORT**

Most likely cause: The IP address as entered is a malformed hostname.

4. **ADDRNOTAVAIL**

The specified address is not available.

5. **NETDOWN**

The network has failed, or the specified IP address is incorrect.

6. **CONNABORTED, CONNRESET, NOTCONN, SHUTDOWN, EDISCONN**

The server has disconnected from the network. This may be caused either by a server failure, an incorrect IP address and/or Port number, or by an incorrectly configured server.

7. **All errors containing Internal error, contact tech support**

These messages indicate serious errors conditions that require the attention of your company's technical support resource.

## NetSerial Monitor

The included NetSerial Monitor program helps to solve difficult configuration problems. This program lets you monitor all interactions between the client application and the remote device. The window works by recording the interactions on-screen in which can be saved to a file that can be examined off-line or sent to others for analysis. NetSerial Monitor is available by right clicking on the NetSerial system tray icon.

The 'Status' tab shows the current connection state of each COM port.

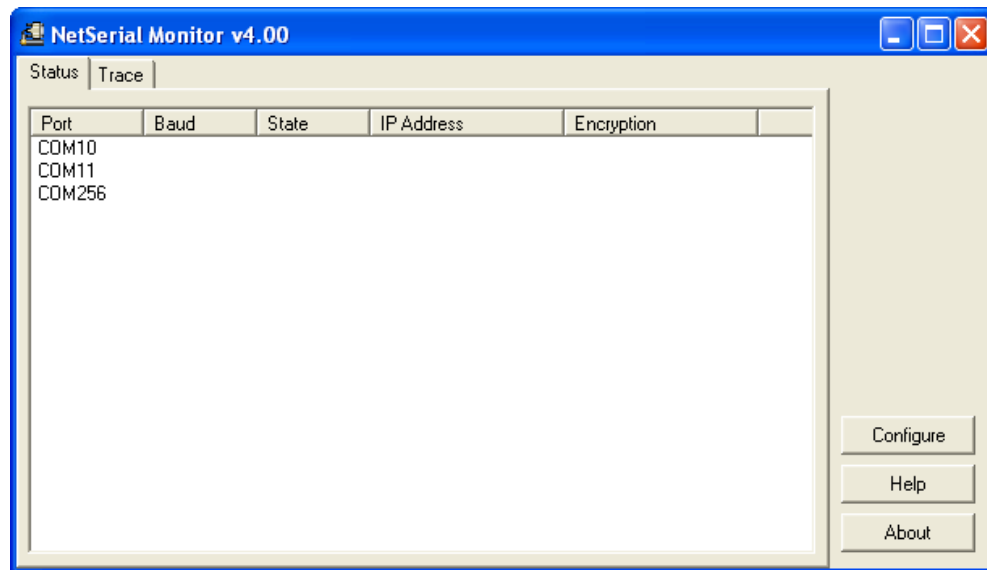

Selecting the 'Trace' tab displays the trace window. To begin tracing, check the **Enable Trace** box to the right of this window.

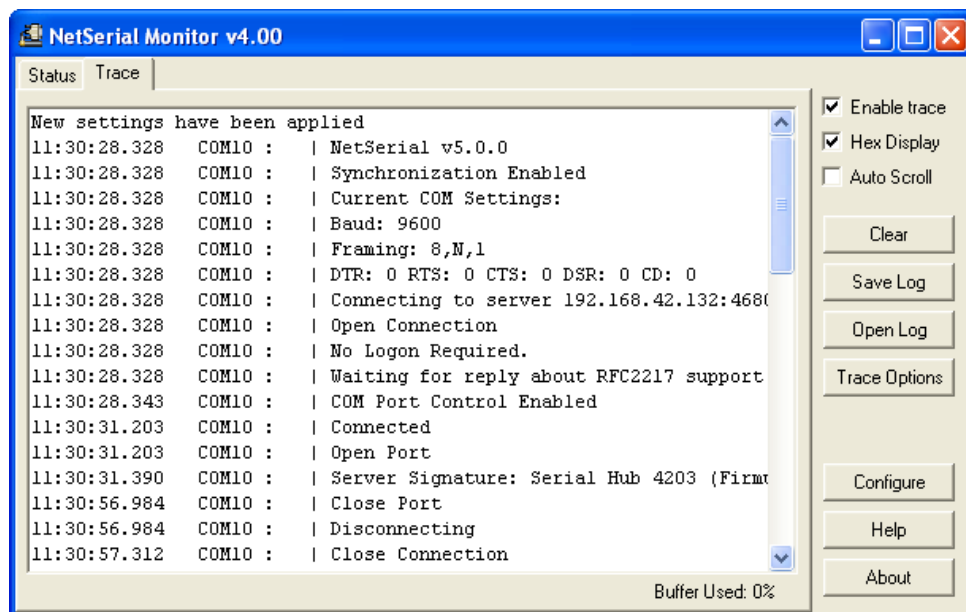

## Using Tracing

To collect trace data, follow these four steps:

1. Be sure you are logged in as administrator.
2. Enable tracing as described above.
3. Recreate the problem condition that you are debugging.
4. Allow the Trace Window to show and record the history of communications activity between SeaLINK and the serial server.

To save the trace data for future review, use the 'Save Log' button. Give the file a name and directory destination. NetSerial Monitor then saves trace data in a \*.log text file format.

If a support representative requests a log file during the course of a support incident, it will be necessary to email the file as an attachment to the regular message.

## Overview of the Trace Window

In addition to the Trace Window's primary data screen, the window provides the following user options:

- **Clear button.** This clears any data captured from a previous trace session.
- **Enable Trace box.** Check this box to begin recording data in a new trace session. Be sure to check this before attempting to make a connection.
- **Hex Display check box.** Check this box to toggle the recorded data between the default ASCII text and hexadecimal format.



Do not send a Hex trace to Sealevel Systems support team unless requested.

- **Auto Scroll box.** Check this box to allow the display to automatically scroll forward as new session data arrives in real-time in the data screen.



This is useful for analyzing a SeaLINK session as it is underway.

The Trace Window displays a series of events, one event per line. Every event is tagged with the current time (shown in hour:minute:second.millisecond format), and the COM port where the event occurred.

There are three types of events:

1. **Transmit events.** Shown in blue and preceded by "»", these indicate that the application software transmitted data to the COM port. The remainder of the line shows the data transmitted, either in ASCII or hexadecimal format, depending upon the current display mode.
2. **Receive events.** Shown in red and preceded by "«", these indicate that the application software received data from the COM port. The remainder of the line shows the data received, either in ASCII or hexadecimal format, depending upon the current display mode.
3. **Control events.** Shown in black and preceded by "|", these indicate non-data events. These events can include the setting of session parameters (such as Telnet); opening and closing a port; connecting to the serial server; setting a device control or status line (DTR, DSR, DCD, etc.); and the configuration of baud rate and framing parameters.

## Independent Diagnostics

Various Windows utilities and administration commands can be used to help debug problems relating to SeaLINK or the configuration of the serial server. This section discusses use of the following diagnostic tools and procedures:

- Using **ping** to check the network
- Using **route** to check the routing table
- Using **telnet** to check remote modems

### DOS Prompt Command Diagnostics

#### 1. Using "ping" to check the network.

Ensure that the PC is connected to the server using the Microsoft TCP/IP networking software supplied with Windows. Open a DOS command prompt window and type in the **ping** command, using the server's network address or domain name in place of the xxx.xxx.xxx.xxx:

```
C:\ ping xxx.xxx.xxx.xxx
```

```
<>
```

The output should indicate that ping has reached the server. If not, SeaLINK will not be able to use the server until the problem is resolved. Contact your system administrator for help.

#### 2. Using "route" to check the routing table.

SeaLINK uses the **route** command to read, and sometimes add to, the PC's routing information during SeaLINK operation. This is a part of SeaLINK's support for accessing servers that are not on the same subnet as the PC. In this case, SeaLINK needs to calculate a static route to be added to the routing table. If there is more than one default route, SeaLINK may not be able to determine a correct static route to the server and will display a warning dialog. Follow this process:

- Check the PC's route table for multiple default routes. Open a DOS command prompt and use the **route print** command:

```
C:\ route print ...
```

(multiple lines of output showing the routes in effect)

The output will indicate whether there is only one default route. In the command's output, the default routes appear at the top and show a Network Address value of 0.0.0.0. If the PC has more than one default route, SeaLINK may not be able to access a server that is not on the same subnet.

- In Windows XP, NT and 2000, make sure you are logged into an account with administrator privileges. Use the Windows NT User Manager or check with your system administrator if you are not sure of the status of your current account.

### 3. Using "telnet" to check remote devices.

Type the **telnet** command from the DOS prompt to establish a connection to one of the ports on the server. This, in turn, opens a Telnet window session.

- In the example that follows, the server is at IP address 192.168.1.100 and is configured to provide TCP/IP port number 4680. Replace the address and port number values with those that apply to your server.



The Ethernet Serial Server must be configured for RFC-2217 mode to connect using telnet.



You can run the telnet command from a DOS prompt, or by using the Run command in the Start menu. If your server has a name on your network, you may be able to use the server's name instead of the numeric address.

- telnet 192.168.1.100 4680
- Check the results of the telnet command. If you see any errors or output to the telnet window, review the error conditions discussed below.
- With a telnet window session open, you can manually check the remote device, in this case a modem, by typing the **AT** command. Then check for the "OK" response from the modem.

AT <--- typed by you

OK <--- response from the modem

The OK response indicates that the server has provided access to a modem that supports AT commands and issues text responses. If you do not see an OK in response to your AT command, then:

1. Ensure that a modem is connected to the server. If it is an external modem, check for power and good cable connections.
2. If the initial telnet command produces the error message "connection refused," then:
  - Fall back to the ping diagnostic described above.
  - Check the SeaLINK serial server configuration to verify that it is waiting for a connection on the expected IP port number.

If the initial telnet command results in output to the telnet window, then:

- If the output is asking for a number to dial, the SeaLINK server has not been configured to provide a modem directly for dial-out. Consult the documentation for instructions regarding dial-out ports.

If the AT command does not echo to the DOS prompt window, then:

- Verify that your port server does have a modem attached to the dial-out port that you are accessing. AT commands are processed by both internal and external modems.
- The modem may be configured to disable echo of AT commands. With the telnet window session open, you can type the **ATE1** command to turn on local echo.

If the OK response does not appear, or another response appears, then:

- The modem may not be operational. Consult the instructions provided with the modem for diagnostic procedures to determine whether the modem is working properly.
- The modem may be configured to provide numeric responses instead of text responses to AT commands. Most Windows applications, including Dial-Up Networking, require text responses. With the telnet window session open, you can type **ATV1** to turn on text messages.

## Verifying the creation of SeaLINK COM ports in Windows 98/Me/NT

If you are running Windows 98, ME, or NT, you can verify the presence of SeaLINK ports from any system port list. To see a complete list of COM ports, including those used by SeaLINK, use the following procedure:

1. Run System in the Control Panel.
2. Select the Device Manager tab.
3. Expand the Ports (COM & LPT) entry.
4. The SeaLINK (COMx) entries should correspond to those checked in the Select Ports Window.



Later versions of Windows will not show the ports in this way, but the ports will be available as choices when installing modems or other devices.



# Appendix C – How To Get Assistance

Begin by reading through the Trouble Shooting Guide in Appendix A. If assistance is still needed, please see below.

When calling for technical assistance, please have your user manual and current serial server settings ready. If possible, please have the computer and serial server ready to run diagnostics.

Sealevel Systems provides an FAQ section on its web site. Please refer to this to answer many common questions. This section can be found at <https://www.sealevel.com/support/category/faqs/>

Sealevel Systems maintains a web page on the Internet. Our home page address is [www.sealevel.com](http://www.sealevel.com). The latest software updates, and newest manuals are available via our web site.

Technical support is available Monday to Friday from 8:00 A.M. to 5:00 P.M. eastern time, excluding national US holidays. Technical support can be reached at (864) 843-4343 or [support@sealevel.com](mailto:support@sealevel.com).

**RETURN AUTHORIZATION MUST BE OBTAINED FROM SEALEVEL SYSTEMS BEFORE RETURNED MERCHANDISE WILL BE ACCEPTED. AUTHORIZATION CAN BE OBTAINED BY CALLING SEALEVEL SYSTEMS AND REQUESTING A RETURN MERCHANDISE AUTHORIZATION (RMA) NUMBER.**

# Appendix D – Silk Screens

4101, 4102, 4104, 4201, 4202, 4203, PCB

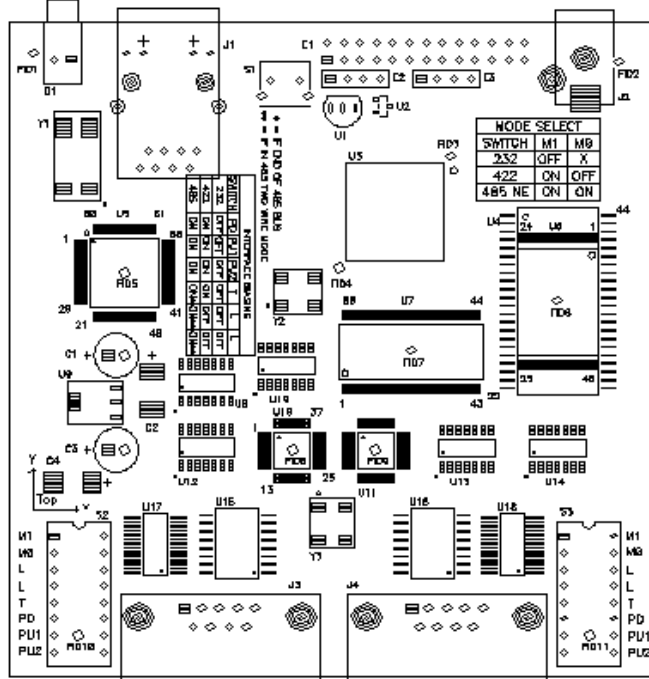

4103 PCB

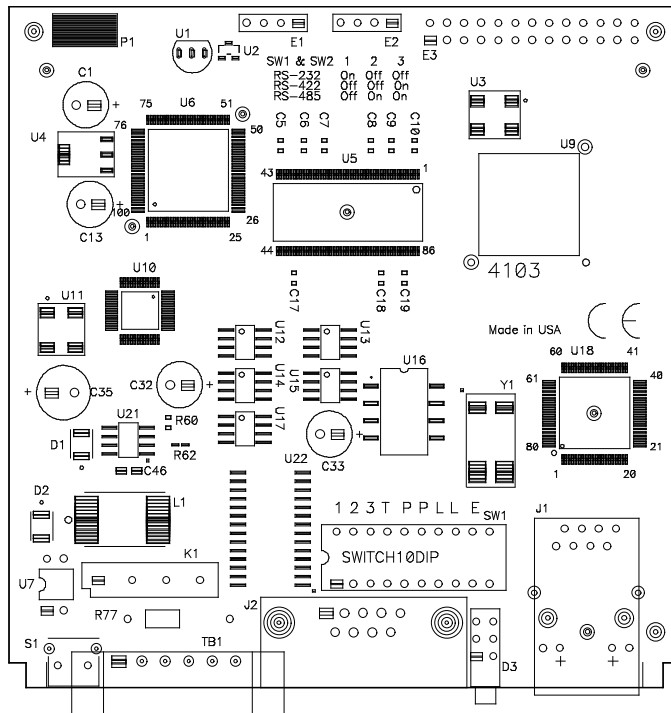

4401, 4402, 4403, 4801, 4802, 4803 PCB

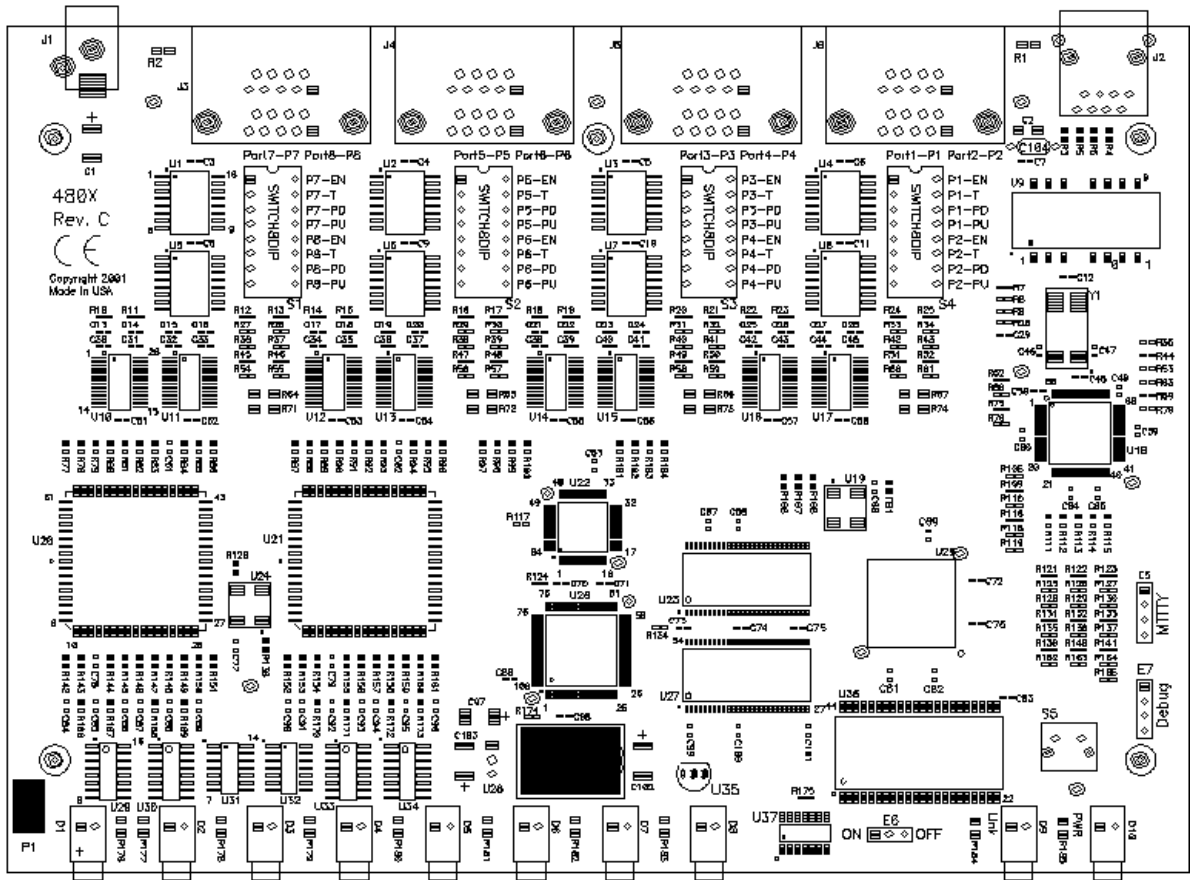



# Appendix E – Compliance Notices

## Federal Communications Commission (FCC) Statement



This equipment has been tested and found to comply with the limits for Class A digital device, pursuant to Part 15 of the FCC Rules. These limits are designed to provide reasonable protection against harmful interference when the equipment is operated in a commercial environment. This equipment generates, uses, and can radiate radio frequency energy and, if not installed and used in accordance with the instruction manual, may cause harmful interference to radio communications. Operation of this equipment in a residential area is likely to cause harmful interference in such case the user will be required to correct the interference at the user's expense.

## EMC Directive Statement



Products bearing the CE Label fulfill the requirements of the EMC directive (89/336/EEC) and of the low-voltage directive (73/23/EEC) issued by the European Commission. To obey these directives, the following European standards must be met:

**EN55022 Class A** - "Limits and methods of measurement of radio interference characteristics of information technology equipment"

**EN55024** - "Information technology equipment Immunity characteristics Limits and methods of measurement".

## United Kingdom Conformity Assessed Statement



Products with UKCA marking are in conformity with the essential requirements of the UK Electromagnetic Compatibility Regulations 2016:

- *Equipment must be designed and manufactured to ensure that the electromagnetic disturbance generated does not exceed the level above which radio and telecommunications equipment cannot operate as intended.*
- *The equipment has a level of immunity to the electromagnetic disturbance to be expected in its intended use which allows it to operate without unacceptable degradation of its intended use.*



This is a Class A Product. In a domestic environment, this product may cause radio interference in which case the user may be required to take adequate measures to prevent or correct the interference.



Always use cabling provided with this product if possible. If no cable is provided or if an alternate cable is required, use high quality shielded cabling to maintain compliance with FCC/EMC directives.

# Warranty

Sealevel's commitment to providing the best I/O solutions is reflected in the Lifetime Warranty that is standard on all Sealevel manufactured I/O products. We are able to offer this warranty due to our control of manufacturing quality and the historically high reliability of our products in the field. Sealevel products are designed and manufactured at its Liberty, South Carolina facility, allowing direct control over product development, production, burn-in and testing. Sealevel achieved ISO-9001:2015 certification in 2018.

## Warranty Policy

Sealevel Systems, Inc. (hereafter "Sealevel") warrants that the Product shall conform to and perform in accordance with published technical specifications and shall be free of defects in materials and workmanship for the warranty period. In the event of failure, Sealevel will repair or replace the product at Sealevel's sole discretion. Failures resulting from misapplication or misuse of the Product, failure to adhere to any specifications or instructions, or failure resulting from neglect, abuse, accidents, or acts of nature are not covered under this warranty.

Warranty service may be obtained by delivering the Product to Sealevel and providing proof of purchase. Customer agrees to ensure the Product or assume the risk of loss or damage in transit, to prepay shipping charges to Sealevel, and to use the original shipping container or equivalent. Warranty is valid only for original purchaser and is not transferable.

This warranty applies to Sealevel manufactured Product. Product purchased through Sealevel but manufactured by a third party will retain the original manufacturer's warranty.

## Non-Warranty Repair/Retest

Products returned due to damage or misuse and Products retested with no problem found are subject to repair/retest charges. A purchase order or credit card number and authorization must be provided in order to obtain an RMA (Return Merchandise Authorization) number prior to returning Product.

## How to obtain an RMA (Return Merchandise Authorization)

If you need to return a product for warranty or non-warranty repair, you must first obtain an RMA number. Please contact Sealevel Systems, Inc. Technical Support for assistance:

Available	Monday – Friday, 8:00AM to 5:00PM EST
Phone	864-843-4343
Email	<a href="mailto:support@sealevel.com">support@sealevel.com</a>

## Trademarks

Sealevel Systems, Incorporated acknowledges that all trademarks referenced in this manual are the service mark, trademark, or registered trademark of the respective company.