

DIO-32.PCLe

User Manual | 8004e

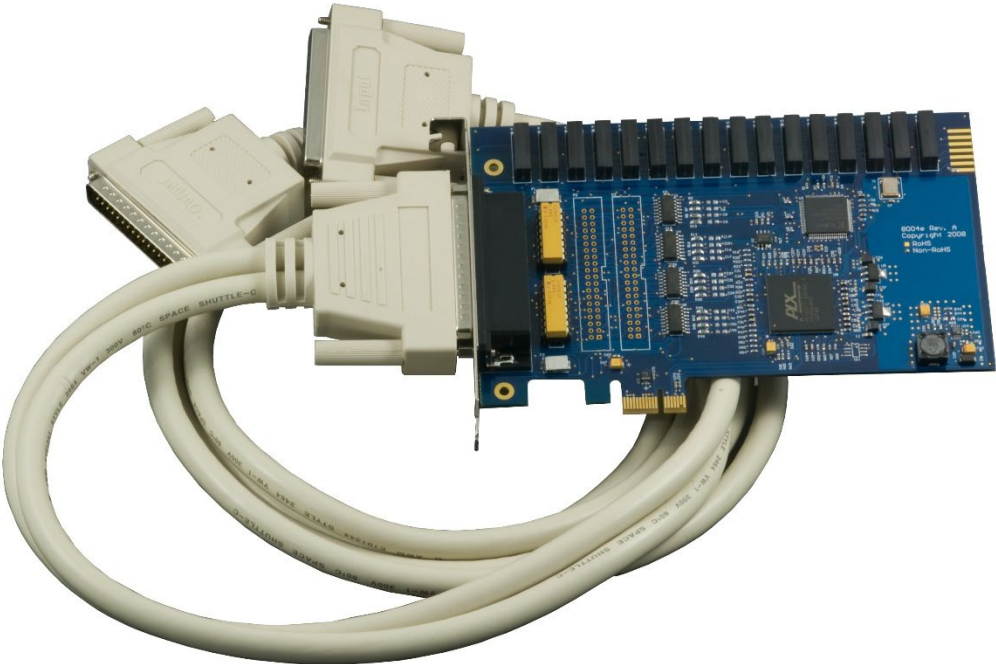

SEALEVEL®

Contents

CONTENTS..... 2

BEFORE YOU GET STARTED 3

INTRODUCTION 4

ELECTRICAL SPECIFICATIONS..... 6

TECHNICAL SPECIFICATIONS..... 7

HARDWARE INSTALLATION 8

PROGRAMMING THE DIO-32.PCI 11

EXAMPLE CIRCUITS 19

SOFTWARE INSTALLATION 20

APPENDIX A – HANDLING INSTRUCTIONS 23

APPENDIX B – TROUBLESHOOTING..... 24

APPENDIX C – HOW TO GET ASSISTANCE..... 27

APPENDIX D – DRAWING..... 28

APPENDIX E – COMPLIANCE NOTICES..... 29

WARRANTY 30

Before You Get Started

What's Included

The 8004e is shipped with the following items. If any of these items are missing or damaged, please contact Sealevel for replacement.

- **8004e - DIO-32.PCie Digital I/O Adapter**
 - **8004e – Board with 3-13V inputs**
 - **8004He – Board with 10-30V inputs**
- **DB78 Male D37 Male and DB37 Female V-cable (Item# CA165)**

Advisory Conventions



Warning

The highest level of importance used to stress a condition where damage could result to the product, or the user could suffer serious injury.



Important

The middle level of importance used to highlight information that might not seem obvious or a situation that could cause the product to fail.



Note

The lowest level of importance used to provide background information, additional tips, or other non-critical facts that will not affect the use of the product.

Introduction

Overview

The DIO-32.PCIe digital I/O interface provides 16 optically isolated inputs and 16 reed relay outputs. The inputs protect the PC and other sensitive equipment from spikes and ground loop current that can be generated in industrial environments, while the outputs provide high quality, long life, low current (10 Watt maximum), dry contact switch closures. Reed relays are well suited for low current applications. The relays are normally open, and close when energized.

The Seal/O Classic software drivers and utilities can be obtained from the Sealevel web site. They make installation and operation easy using Windows 7, Vista, and XP operating systems. The Seal/O API (Application Programmer Interface) provides a variety of useful high-level function calls implemented as a Windows dynamic link library (DLL) and as a Linux kernel module and library. Seal/O also includes sample code and utilities to simplify software development.

The inputs on the 8004e are rated for 3-13V. The inputs on the 8004He are rated for 10-30V.

Features



- PCI Express X1 compliant
- 16 optically isolated inputs
- Socketed dip resistor allows user configurable input range up to +30V
- 16 Reed relay outputs (SPST)
- Highly reliable 10VA Reed relays
- Power (+5V and +12V) and ground provided on DB78 board connector
- Includes 72" cable with DB78 Male connector to DB37 Male and DB37 Female connectors (Item# CA165)
- Seal/O Classic software supports Windows 7, Vista, and XP operating systems
- Software support for Linux available



Optional Items

Depending upon your application, you are likely to find one or more of the following items useful with the 8004e. All items can be purchased from our website (www.sealevel.com) by calling our sales team at (864) 843-4343.

Cables

DB37 Male to DB37 Female Extension Cable (Item# CA112)	
This cable provides a 6' extension to the CA165. It has one DB37 Male connector and one DB37 Female connector.	
DB78 Male to DB78 Female Extension Cable (Item# CA233)	
This cable provides a 6' extension to the DB78 board connector on the 8004e. It has one DB78 Male connector and one DB78 Female connector.	
DB78M to DB37 Female and DB37 Male, for 3093 (Item# CA378)	
The CA378 is designed specifically for customers using the 3093 ISA digital I/O board that need to be upgraded to the 8004e PCIe board while preserving existing infrastructure wiring. The CA378 connects to the 8004e and provides an identical pin out to the 3093.	

Terminal Blocks

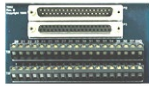
DB37 Terminal Block (Item# TB02)	
Break out serial and digital connectors to screw terminals for easy field connection. The TB02 terminal block is designed with both DB37 male and female connectors for interfacing the inputs or outputs.	

Electrical Specifications

Features

- 2 sets SPST relays with each having 8 relays
- 2 eight bit input ports
- DB-37 Male connector for relay outputs
- DB-37 Female connector for optically isolated inputs
- Highly reliable 10 VA reed relays
- Multiple adapters can reside in same computer

Input Ports

Turn On Current	3mA
Isolator Diode Drop	1.1 VDC
Resistor Power Max	.25 W
Maximum Input Range	3 – 13 VDC/VAC
Maximum Input Current	50 mA

Output Relays

Contact Max Power Rating	10 W
Contact Voltage Maximum	60 VDC (or peak VAC)
Contact Current Maximum	.5A AC/DC RMS
Contact Resistance, Initial	.15 Ω
Contact Speed	
Operate	.5 mS
Release	.5 mS
Bounce	.5 mS
Maximum Operating Speed	600 Hz

Technical Specifications

Physical Dimensions

Board length	6.5 inches (16.5 cm)
Board height	4.2 inches (10.7 cm)

Environmental Specifications

Specification	Operating	Storage
Temperature Range	0° to 70° C (32° to 158° F)	-50° to 105° C (-58° to 221° F)
Humidity Range	10 to 90% R.H. Non-Condensing	10 to 90% R.H. Non-Condensing

Manufacturing

All Sealevel Systems Printed Circuit boards are built to UL 94V0 rating and are 100% electrically tested. These printed circuit boards are solder mask over bare copper or solder mask over tin nickel.

Hardware Installation



Do not install the PCI Express board until the software has been fully installed.

The DIO-32.PCIe does not need to be configured prior to installation.

Once you have installed the Seal/O Classic software, install the board into an available PCI Express slot and boot the computer. The Found New Hardware wizard will appear. The drivers that were installed during the software installation process will automatically be used to configure the adapter.

The following instructions are applicable to the Windows XP operating system and may vary depending on your version of Windows.

1. After the software installation is complete, install the ISO-16.PCIe into an available PCI Express slot and boot the computer.
2. A 'Found New Hardware' alert will appear above the system tray.

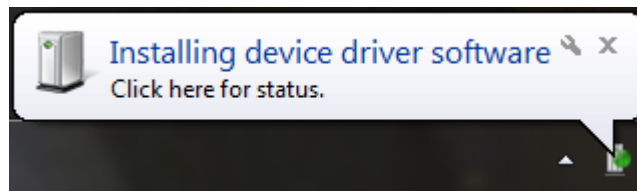

3. When the 'Found New Hardware' alert informs you that your hardware is installed and ready to use, you can proceed with verifying the installation to check functionality if necessary.

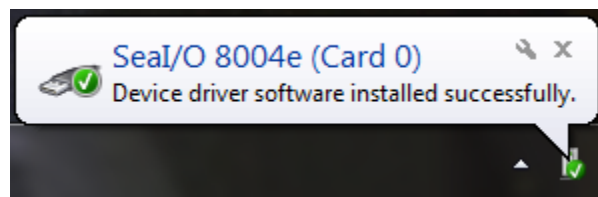

Verifying Installation

To confirm that the digital I/O card has been successfully installed and recognized by your operating system, look in the Windows Device Manager.

To access Device Manager, follow the steps below:

1. Right click on 'My Computer' icon on your desktop or in the Start menu.
2. Click 'Manage' in the fly out menu to launch the 'Computer Management' console window.
3. In the left pane under 'System Tools', click 'Device Manager'.
4. In the right pane near the bottom, expand the 'Seal/O Device' section by clicking the '+' symbol. This shows the parent device is installed correctly.
5. You should see the card assignment listed as 'Seal/O 8004e' with the card number in parentheses. The card number will increment for each additional Seal/O device installed.

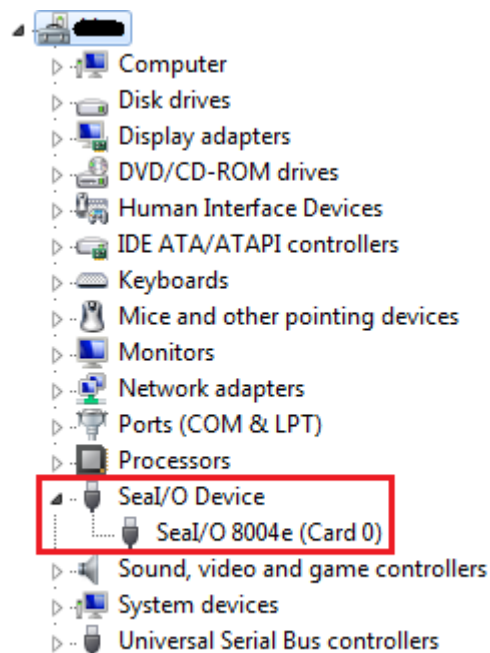

The DIO-32.PCIE is now ready for use.

Digital I/O Interface

The DIO-32.PCIe provides four parallel input/output (I/O) ports. The ports are organized as ports A, B, C, and D. Port A and B are input ports interfaced to optically-isolated inputs, while ports C and D are reed relay output ports. Assuming an I/O address of 4000 Hex the following table shows the Port Addresses.

Base Address	Hex	Decimal	Mode
Port A Address	4000	16384	Optically Isolated Input Port
Port B Address	4001	16385	
Port C Address	4002	16386	Reed Relay Output Port
Port D Address	4003	16387	

Programming the DIO-32.PCI

Sealevel's Seal/O Classic software is provided to assist in the development of reliable applications for the Sealevel Systems family of PCI and PCI Express digital I/O adapters. Included in Sealevel's software are driver functions for use in accessing the I/O as well as helpful samples and utilities.

Programming for Windows

The Seal/O API (Application Programmer Interface) provides a variety of useful high-level function calls implemented in a Windows dynamic link library (DLL). The API is defined in the help file (Start/Programs/SealO/SealO Help) under "Application Programmers Interface." This help file also includes detailed information dealing with installation / removal of the software and information about latency, logic states, and device configuration.

For C language programmers we recommend using the API to access the SeaLINK DIO-32.PCI. If you are programming in Visual Basic, using the ActiveX control included with Seal/O is advised.

Samples and Utilities

A variety of sample programs and utilities (both executable and source code) are included with Seal/O. Further documentation on these samples can be found by selecting "Start/Programs/SealO/Sample Application Description." Information about where the files are physically stored on your system is also included in this same file.

Programming for Linux

Seal/O for Linux consists of two major parts: a kernel module and a library. The kernel module is a simple IO pass-through device, allowing the library to handle the more sophisticated functions provided to Seal/O users. It is provided in a 'tarball' format and can easily be compiled and included in the kernel build.

Input Ports

Ports A and B are 8 bit input ports connected to optically isolated input sensors. Each sensor can be used to interface a voltage input and then sense whether the voltage is on or off. Each sensor is isolated (with respect to a common ground) from every other sensor, and also isolated with respect to the host PC ground. This means that signals such as low-level AC line voltage, e.g. 12 or 24VAC, motor servo voltage, and control relay signals can be 'sensed', or read by the PC, without the risk of damage due to ground loops or ground faults.

Each sensor input pair has a current limiting resistor that is used to limit the input current to the opto-isolator. The opto-isolator has two 'back-to-back' diodes internally. This allows AC or DC signals to be sensed, regardless of polarity. When the applied voltage is high enough to cause the LED in the opto-isolator to turn-on, the output of the opto-isolator goes low (0 volts), and the signal is read as a low logic level (binary 0) by the PC. When the input signal is too low to turn on the opto-isolator, the output goes high, and the port bit is read by the PC as a high logic level (binary 1). While this is true at the hardware level, the Microsoft Windows driver gives the application the ability to use Positive or Negative Logic. This card defaults to Positive Logic and therefore the driver inverts the logic level BEFORE the information is returned to the

application. Therefore, a voltage high enough to cause the LED to turn on will be read by the application as a logic high level.

The input impedance of each isolated input is approximately 560 ohms (factory default). The opto-isolator requires approximately 3mA to turn on. The maximum input current is 50mA. There are two things to consider when selecting the input resistor. The first is to turn on voltage for the circuit to sense, and second is the maximum input voltage. Maximum input voltage must not provide too much power to the input resistor and must also not overdrive the opto-isolator input current specification. The following formulas apply:

$$\text{Turn on Voltage} = \text{diode drop} + (\text{turn on current}) \times (\text{resistance}) \text{ [Ex: } 1.1 + (.003) \times R \text{]}$$

$$\text{Input Current} = ((\text{input voltage}) - 1.1\text{V}) / (\text{resistor value})$$

$$\text{Maximum voltage} = 1.1 + \text{square root of } (.25(\text{resistor value}))$$

The following table shows common input resistors and the ranges associated with each.

Input Resistor	Turn-On	Input Range	Max Input	Max Current
220Ω	1.8V	1.8 – 7.0V	8.5V	27mA
560Ω	2.8V	2.8 – 10.6V	12.9V	20mA
1KΩ	4.1V	4.1 – 13.8V	16.9V	15mA
2.2KΩ	7.7V	7.7 – 20.0V	24.5V	10mA
3.3KΩ	10.0V	10.0 – 24.0V	30.0V	9mA
4.7KΩ	15.2V	15.2 – 28.0V	35.0V	7mA



The turn-off voltage for all resistors is less than 1V. The opto-couplers require a minimum voltage to turn on and this voltage is dependent on the input resistor shown on the table above.

Increasing the input resistor accordingly can increase the maximum input voltage. Because socketed DIP resistors are utilized, they can easily be replaced with a different value. Sealevel can do this, if necessary.



The input circuits are not intended for monitoring 120-volt AC circuits. In addition to being too high a voltage for the circuits, it is dangerous to have that high a voltage on the card.

Input Ports Pin Assignments (DB-37 Female)

Inputs are interfaced via the DB-37 female connector on the supplied CA165 cable.

Port A Bit	Port A Input Pin Pairs	Port B Bit	Port B Input Pin Pairs
0	18,37	0	10,29
1	17,36	1	9, 28
2	16,35	2	8,27
3	15,34	3	7,26
4	14,33	4	6,25
5	13,32	5	5,24
6	12,31	6	4,23
7	11,30	7	3,22
Ground	2,20,21		
+12 Volts	1		
+5 Volts	19		



The CA165 cable input pin out is not compatible with the 3093 ISA digital I/O board. If you are upgrading from the 3093 and wish to preserve existing infrastructure wiring, order the CA378 cable.

Output Ports (Reed Relay)

Reed relays provide very high quality, long life, low current (10 Watt maximum), dry contact switch closures. Reed relays are not suited for high current applications, and can be destroyed by inductive load switching, where a spark occurs across the contacts internally. The relays are normally open, and close when energized.

Output Ports (Reed Relay) Pin Assignments (DB-37 Male)

Outputs are interfaced via the DB-37 male connector on the supplied CA165 cable.

Port C Bit	Relay	Port C Output Pin Pairs	Port D Bit	Relay	Port D Output Pin Pairs
0	K16	2,20	0	K8	10,28
1	K15	3,21	1	K7	11,29
2	K14	4,22	2	K6	12,30
3	K13	5,23	3	K5	13,31
4	K12	6,24	4	K4	14,32
5	K11	7,25	5	K3	15,33
6	K10	8,26	6	K2	16,34
7	K9	9,27	7	K1	17,35
Ground	18,36,37				
+ 5 Volts	19				
+ 12 Volts	1				

DB-78 Female Pin Assignments (Card Edge Connector)

Bit	Port A Pins	Port B Pins	Port C Pins	Port D Pins
0	55,74	47,66	2,20	10,28
1	54,73	46,65	3,21	11,29
2	53,72	45,64	4,22	12,30
3	52,71	44,63	5,23	13,31
4	51,70	43,62	6,24	14,32
5	50,69	42,61	7,25	15,33
6	49,68	41,60	8,26	16,34
7	48,67	40,59	9,27	17,35
GND	39,57,58		18,36,37	
+12V	38		1	
+5V	56		19	

Direct Hardware Control

In systems where the users program has direct access to the hardware (DOS) the tables that follow give the mapping and functions that the DIO-32.PCIe provides.

Function Available	Port	Address Hex	Port Type
RD	A	Base + 0	Optically Isolated Input Port
RD	B	Base + 1	
RD/WR	C	Base + 2	Reed Relay Output Port
RD/WR	D	Base + 3	

RD = Read, RD/WR = Read or Write

Reading the Inputs

The inputs are active Low. If no voltage is applied across one of the differential inputs, it returns a one on that bit. If an AC or DC voltage is applied, it returns a zero on that bit.

Reading the Outputs

The relay ports return the ones complement of the value that is currently being used to drive the relays.

Writing the Outputs

The output ports are the only ports that can be written. The relays on a standard DIO-32.PCIe are normally open. To close a relay a one must be written to the appropriate bit.

Register Description

All ports are set to input after reset or power up.

Address		Mode	D7	D6	D5	D4	D3	D2	D1	D0
Base+0	Input Port A	RD	PAD7	PAD6	PAD5	PAD4	PAD3	PAD2	PAD1	PAD0
Base+1	Input Port B	RD	PBD7	PBD6	PBD5	PBD4	PBD3	PBD2	PBD1	PBD0
Base+2	Output Port C	RD/WR	PCD7	PCD6	PCD5	PCD4	PCD3	PCD2	PCD1	PCD0
Base+3	Output Port D	RD/WR	PDD7	PDD6	PDD5	PDD4	PDD3	PDD2	PDD1	PDD0

Optional 3093 Migration Cable (CA378)

On the 3093 ISA digital I/O board, the input pins #1 and #19 are reversed from the standard CA165 cable that ships standard with the 8004. If you are upgrading from a 3093 ISA board to an 8004 PCI board and wish to preserve existing infrastructure wiring, order the CA378 cable and use it in place of the standard CA165 cable.

CA378 Input Pin Assignments (DB-37 Female)

Inputs are interfaced via the DB-37 female connector on the optional CA378 cable.

Port A Bit	Port A Pins	Port B Bit	Port B Pins
0	18,37	0	10,29
1	17,36	1	9, 28
2	16,35	2	8,27
3	15,34	3	7,26
4	14,33	4	6,25
5	13,32	5	5,24
6	12,31	6	4,23
7	11,30	7	3,22
Ground	2,20,21		
+12 Volts	19		
+5 Volts	1		



The CA378 cable is designed specifically for customers upgrading from a 3093 ISA board to the 8004 PCI board. If you are not upgrading from the 3093 board, use the standard CA165 cable that ships with the 8004 PCI digital I/O board.

CA378 Output Pin Assignments (DB-37 Male)

Outputs are interfaced via the DB-37 male connector on the optional CA378 cable.

Port C Bit	Relay	Port C Pins	Port D Bit	Relay	Port D Pins
0	K16	2,20	0	K8	10,28
1	K15	3,21	1	K7	11,29
2	K14	4,22	2	K6	12,30
3	K13	5,23	3	K5	13,31
4	K12	6,24	4	K4	14,32
5	K11	7,25	5	K3	15,33
6	K10	8,26	6	K2	16,34
7	K9	9,27	7	K1	17,35
Ground	18,36,37				
+ 5 Volts	19				
+ 12 Volts	1				

Example Circuits

INPUT CIRCUIT

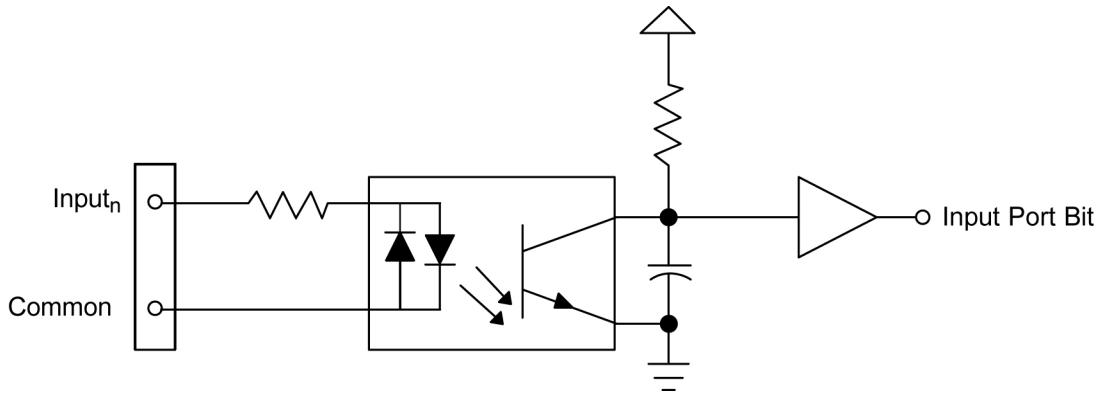

In the above circuit diagram, $Input_n$ is one of the two Input Pair Pins from the table labeled Input Ports Pin Assignments. Common is the other pin listed in the Input Pair Pins entry. The polarity of the pair does not matter.

OUTPUT CIRCUIT

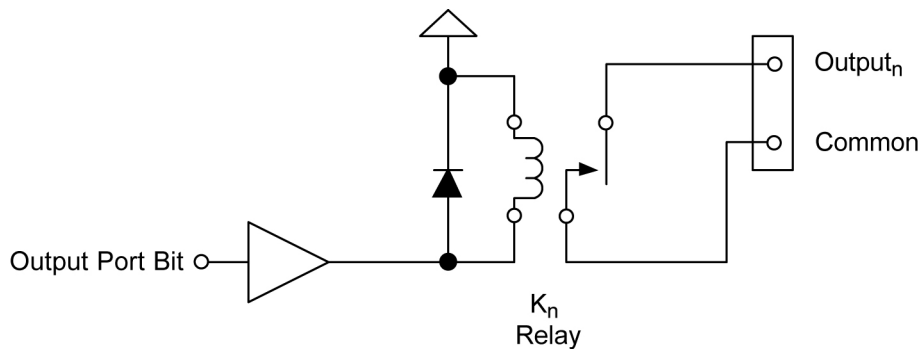

In the above circuit diagram, $Output_n$ is one of the two Output Pair Pins from the table labeled Output Ports Pin Assignments. Common is the other pin listed in Output Pair Pins. Since this is an isolated output, the polarity is not important.

Software Installation

Windows Installation



Do not connect the SeaLINK DIO-32.PCI adapter to the host USB device until the software has been fully installed.



Only users running Windows 7 or newer should utilize these instructions for accessing and installing the appropriate driver via Sealevel's website. If you are utilizing an operating system prior to Windows 7, please contact Sealevel by calling 864.843.4343 or emailing support@sealevel.com to receive access to the legacy driver download and installation instructions.

1. Begin by locating, selecting, and installing the correct software from the [Sealevel software driver database](#).
2. Type in or select the part number (#8004e) for the adapter from the listing.
3. Select "Download Now" for SealO Classic for Windows.
4. The setup files will automatically detect the operating environment and install the proper components. Follow the information presented on the screens that follow.
5. A screen may appear with text similar to: "The publisher cannot be determined due to the problems below: Authenticode signature not found." Please click the 'Yes' button and proceed with the installation. This declaration simply means that the operating system is not aware of the driver being loaded. It will not cause any harm to your system.
6. During setup, the user may specify installation directories and other preferred configurations. This program also adds entries to the system registry that are necessary for specifying the operating parameters for each driver. An uninstall option is also included to remove all registry/INI file entries from the system.

The software is now installed, and you can proceed with the hardware installation.



Do not connect the hardware until the software has been successfully installed.



To install Sealevel software, you must log in as an administrator or have administrator privileges in Windows.

Linux Installation



You MUST have “root” privileges to install the software and drivers.



The syntax is case sensitive.



Users can obtain a README file included in the SealIO Linux package which contains important installation and configuration instructions that makes the Linux installation more user friendly.

1. Login as “root”
2. Select download for the version of SealIO Classic for Linux ([Software: SealIO Classic - Linux - Sealevel.](#))
3. Copy seaio.tar.gz to your home directory by typing:

```
cp seaio.tar.gz ~
```
4. Change to your home directory by typing:

```
cd
```
5. Unzip and Untar the drivers and software by typing:

```
tar -xvzf seaio.tar.gz
```
6. Change to the SealIO directory by typing:

```
cd seaio
```
7. User must download and compile a Linux kernel source.
8. Now compile and prepare the drivers for use by typing:

```
make install
```
9. Using your favorite text editor, edit the /etc/seaio.conf
10. Within the quote marks, insert

```
cardtype=0xYourSealOcardType io=0xCardBaseAddress
```



YourSealOcardType = Model Number of your SealO Card.
CardBaseAddress = What base address you have your SealO card addressed at.

11. Save the file and exit your editor.
12. With the system off and unplugged, install your SealO PCI card.
13. Plug system back in and boot Linux. Login as "**root**".
14. Load the SealO driver by typing:

seaioload

15. The driver has enabled the card and is ready to use.

To set up Linux to automatically load the driver; refer to a Linux manual concerning your specific distribution for help.

For additional software support, please call Sealevel Systems' Technical Support, (864) 843-4343. Our technical support is free and available from 8:00 AM - 5:00 PM Eastern Time, Monday through Friday. For email support contact: support@sealevel.com.

Appendix A – Handling Instructions

ESD Warnings

Electrostatic Discharges (ESD)

A sudden electrostatic discharge can destroy sensitive components. Proper packaging and grounding rules must therefore be observed. Always take the following precautions:

1. Transport boards and cards in electrostatically secure containers or bags.
2. Keep electrostatically sensitive components in their containers until they arrive at an electrostatically protected workplace.
3. Only touch electrostatically sensitive components when you are properly grounded.
4. Store electrostatically sensitive components in protective packaging or on anti-static mats.

Grounding Methods

The following measures help to avoid electrostatic damages to the device:

1. Cover workstations with approved antistatic material. Always wear a wrist strap connected to a properly grounded workplace.
2. Use antistatic mats, heel straps, and/or air ionizers for more protection.
3. Always handle electrostatically sensitive components by their edge or by their casing.
4. Avoid contact with pins, leads, or circuitry.
5. Turn off power and input signals before inserting and removing connectors or connecting test equipment.
6. Keep the work area free of non-conductive materials such as ordinary plastic assembly aids and Styrofoam.
7. Use field service tools such as cutters, screwdrivers, and vacuum cleaners that are conductive.

Appendix B – Troubleshooting

Following these simple steps can eliminate the most common problems.

1. Install software first. After installing the software then proceed to adding the hardware. This places the required installation files in the correct locations.
2. Read this manual thoroughly before attempting to install the adapter in your system.
3. Use Device Manager under Windows to verify proper installation. Refer to the Verifying Hardware section of this manual for instructions.
4. Several utilities with source code are included to verify the functionality of the inputs and outputs and to aid in application development. To test the inputs, you need to supply the turn-on voltage with a minimum of 3mA (maximum input current is 50mA) to trigger an input. Consult the pin out diagrams to test at the card edge connector or at the end of the cable.
5. Use the VCTest to verify the basic I/O functionality of your digital I/O board. The source code is included to simplify application development in the programming language C.

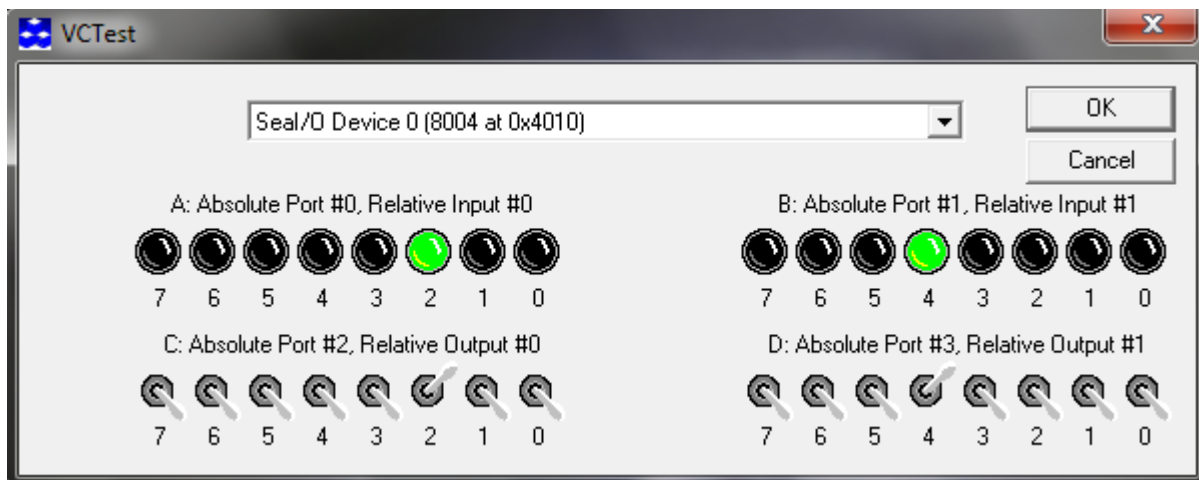

- VBTest is another utility included with Seal/O Classic software. The source code is included to aid with Visual Basic application development.

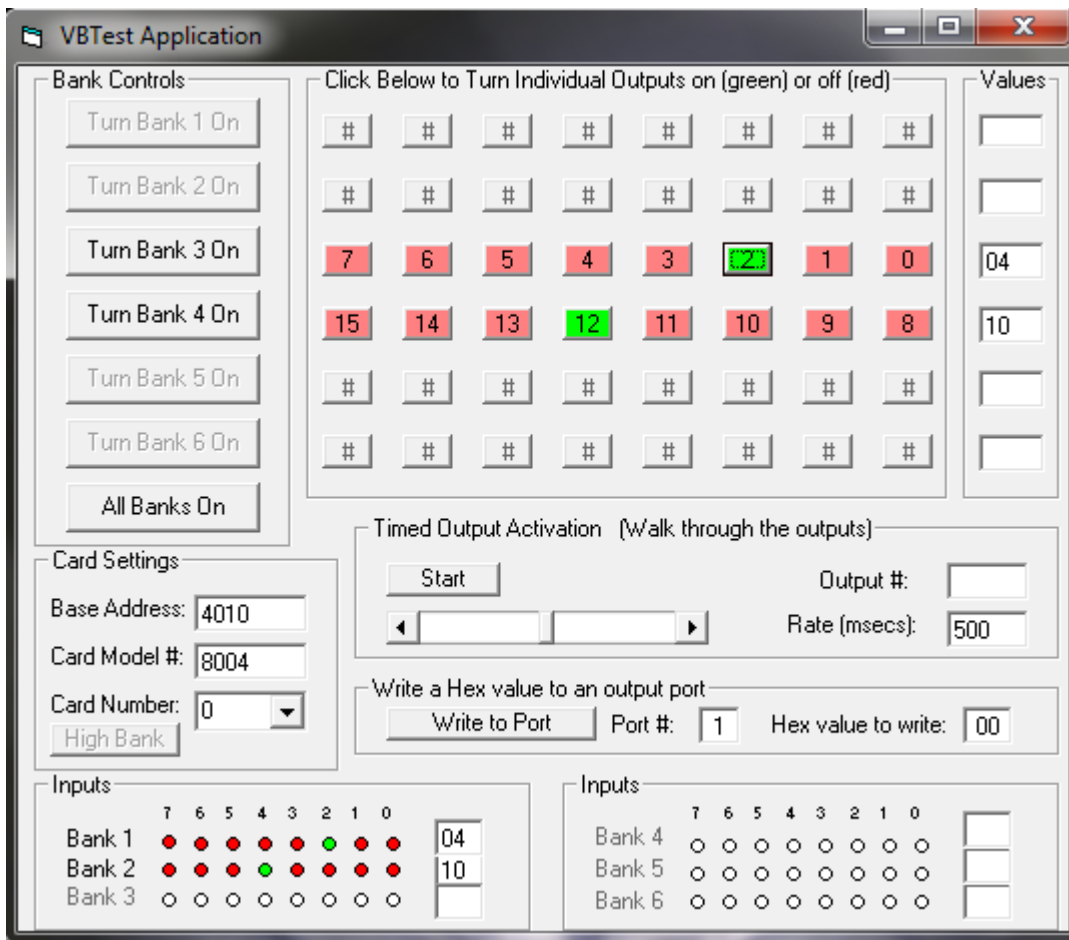

- SealOTST is a command line utility that allows you to test the function calls from the Seal/O Classic API.

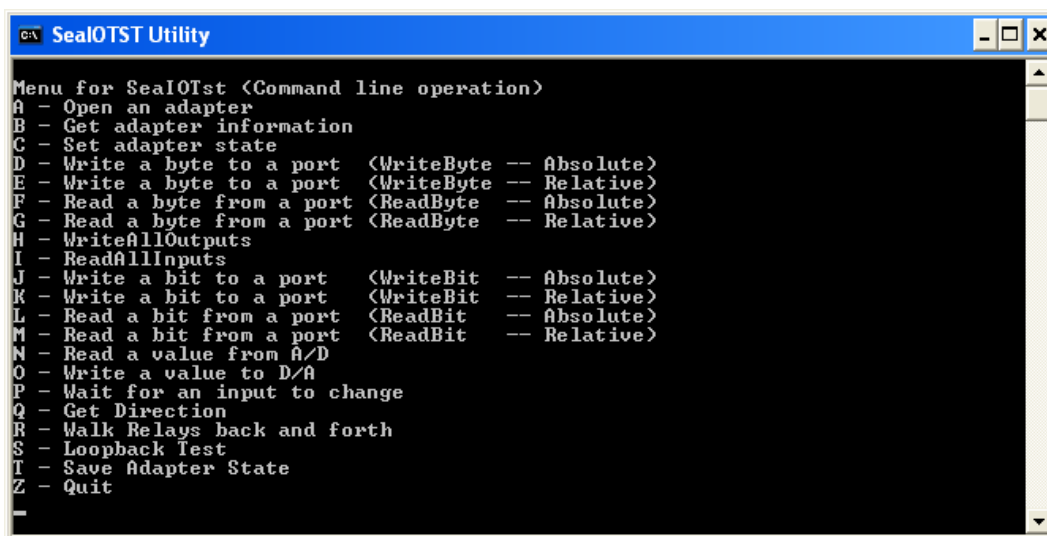



The source code for all utilities is located in the following folder:
C:\Program Files\SeaIO\Samples



The API is documented in the SeaIO help file. Start ▢ All Programs ▢ SeaIO ▢ SeaIO Help. Launch the help file and expand the Programmers Interface section.

If these steps do not solve your problem, please call Sealevel Systems' Technical Support, (864) 843-4343. Our technical support is free and available from 8:00 A.M.- 5:00 P.M. Eastern Time Monday through Friday. For email support contact support@sealevel.com.

Appendix C – How To Get Assistance

Begin by reading through the Troubleshooting Guide in [Appendix B](#). If assistance is still needed, please see below.

When calling for technical assistance, please have your user manual and current adapter settings. If possible, please have the adapter installed in the computer ready to run diagnostics.

Sealevel Systems provides an FAQ section on its web site. Please refer to this to answer many common questions. This section can be found at <http://www.sealevel.com/faq.asp>.

Sealevel Systems maintains a Home page on the Internet. Our home page address is <http://www.sealevel.com>. The latest software updates, and newest manuals are available via our FTP site that can be accessed from our home page.

Technical support is available Monday to Friday from 8:00 A.M. to 5:00 P.M. Eastern Time. Technical support can be reached at (864) 843-4343.

RETURN AUTHORIZATION MUST BE OBTAINED FROM SEALEVEL SYSTEMS BEFORE RETURNED MERCHANDISE WILL BE ACCEPTED. AUTHORIZATION CAN BE OBTAINED BY CALLING SEALEVEL SYSTEMS AND REQUESTING A RETURN MERCHANDISE AUTHORIZATION (RMA) NUMBER.

Appendix D – Drawing

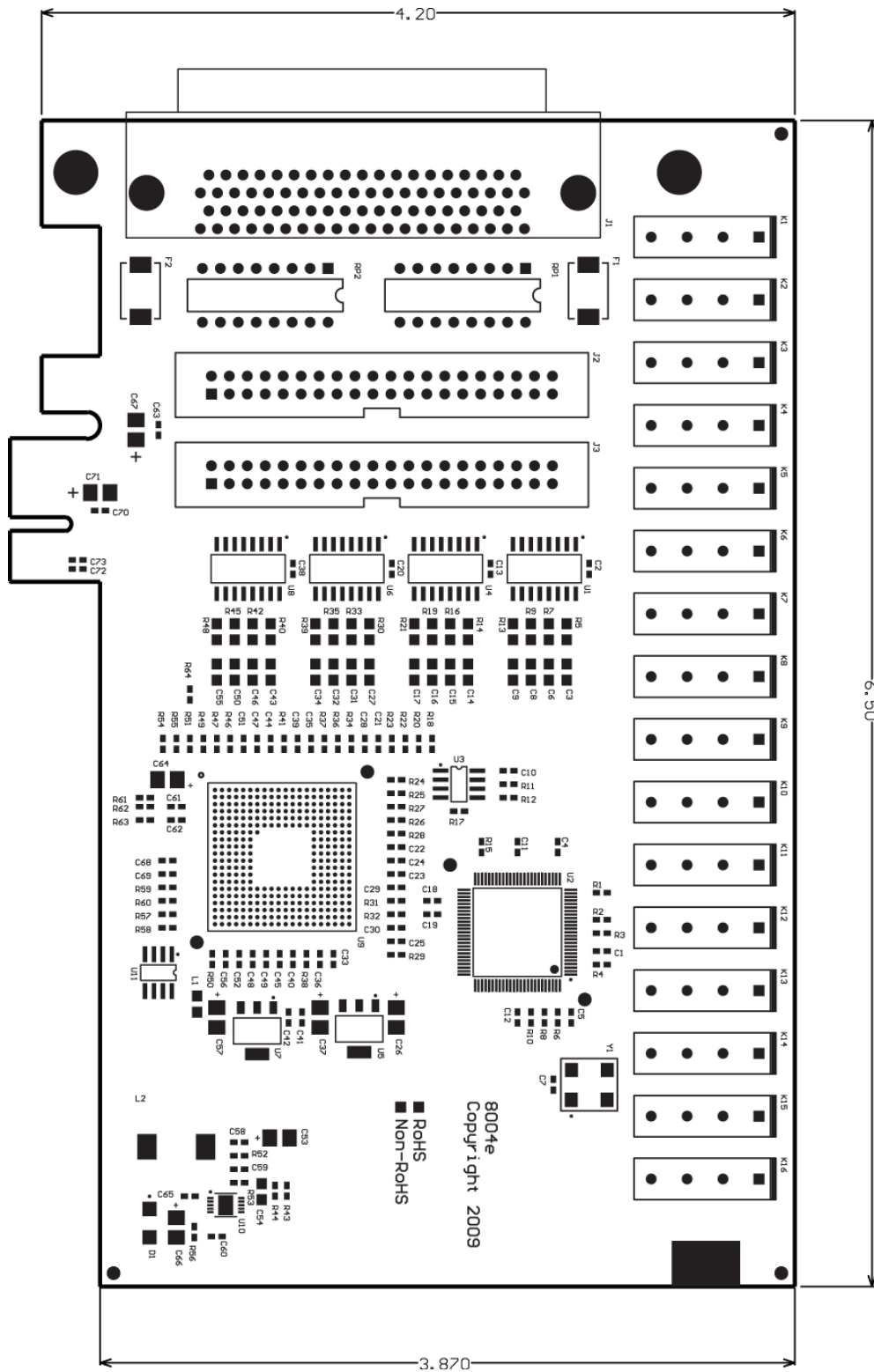

Appendix E – Compliance Notices

Federal Communications Commission (FCC) Statement



This equipment has been tested and found to comply with the limits for a Class A digital device, pursuant to part 15 of the FCC Rules. Operation is subject to the following two conditions: (1) This device may not cause harmful interference, and (2) this device must accept any interference received, including interference that may cause undesired operation.

ISED Canada

- **CAN ICES-003(A) / NMB-003(A)**

EMC Directive Statement



This equipment has been evaluated or tested and found in compliance with the requirements of the following directives issued by the European Commission:

- EMC Directive **2014/30/EU**
- RoHS Directive **2011/65/EU + (EU) 2015/863**

United Kingdom Conformity Assessed Statement



Products with UKCA marking are in conformity with the essential requirements of the UK Electromagnetic Compatibility Regulations 2016:

- *Equipment must be designed and manufactured to ensure that the electromagnetic disturbance generated does not exceed the level above which radio and telecommunications equipment cannot operate as intended.*
- *The equipment has a level of immunity to the electromagnetic disturbance to be expected in its intended use which allows it to operate without unacceptable degradation of its intended use.*



This is a Class A Product. In a domestic environment, this product may cause radio interference in which case the user may be required to take adequate measures to prevent or correct the interference.



Always use the cabling provided with this product if possible. If no cable is provided or if an alternate cable is required, use high quality shielded cabling to maintain compliance with FCC/EMC directives.

Warranty

Sealevel's commitment to providing the best I/O solutions is reflected in the Lifetime Warranty that is standard on all Sealevel manufactured I/O products. We are able to offer this warranty due to our control of manufacturing quality and the historically high reliability of our products in the field. Sealevel products are designed and manufactured at its Liberty, South Carolina facility, allowing direct control over product development, production, burn-in and testing. Sealevel achieved ISO-9001:2015 certification in 2018.

Warranty Policy

Sealevel Systems, Inc. (hereafter "Sealevel") warrants that the Product shall conform to and perform in accordance with published technical specifications and shall be free of defects in materials and workmanship for the warranty period. In the event of failure, Sealevel will repair or replace the product at Sealevel's sole discretion. Failures resulting from misapplication or misuse of the Product, failure to adhere to any specifications or instructions, or failure resulting from neglect, abuse, accidents, or acts of nature are not covered under this warranty.

Warranty service may be obtained by delivering the Product to Sealevel and providing proof of purchase. Customer agrees to ensure the Product or assume the risk of loss or damage in transit, to prepay shipping charges to Sealevel, and to use the original shipping container or equivalent. Warranty is valid only for original purchaser and is not transferable.

This warranty applies to Sealevel manufactured Product. Product purchased through Sealevel but manufactured by a third party will retain the original manufacturer's warranty.

Non-Warranty Repair/Retest

Products returned due to damage or misuse and Products retested with no problem found are subject to repair/retest charges. A purchase order or credit card number and authorization must be provided in order to obtain an RMA (Return Merchandise Authorization) number prior to returning Product.

How to obtain an RMA (Return Merchandise Authorization)

If you need to return a product for warranty or non-warranty repair, you must first obtain an RMA number. Please contact Sealevel Systems, Inc. Technical Support for assistance:

Available	Monday – Friday, 8:00 AM to 5:00 PM EST
Phone	864-843-4343
Email	support@sealevel.com

Trademarks

Sealevel Systems, Incorporated acknowledges that all trademarks referenced in this manual are the service mark, trademark, or registered trademark of the respective company.