

SEADAC LITE

User Manual | SeaDAC Lite

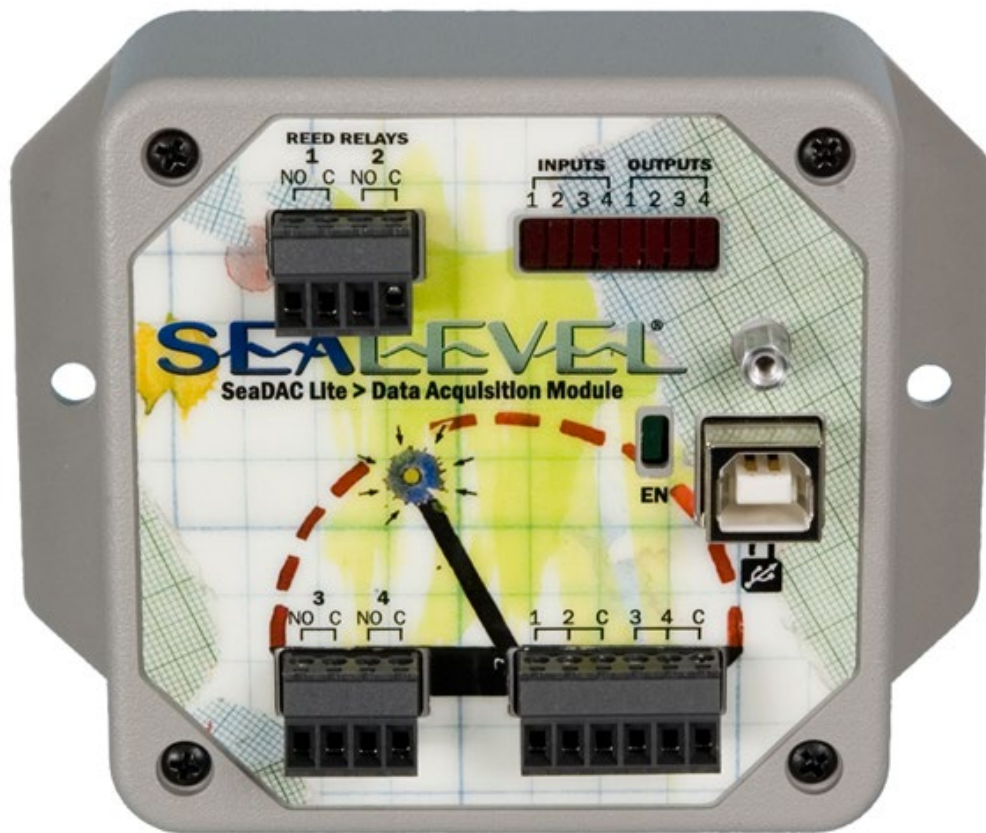

SEALEVEL®

Contents

BEFORE YOU GET STARTED 3

OPTIONAL ITEMS 4

INTRODUCTION 7

HARDWARE DESCRIPTION 10

CONNECTOR PIN ASSIGNMENTS 21

SEALATCH™ USB 25

SEAMAX APPLICATION SUITE 27

SEAMAX SOFTWARE INSTALLATION 28

TECHNICAL SPECIFICATIONS 33

APPENDIX A - HANDLING INSTRUCTIONS 34

APPENDIX B – HOW TO GET ASSISTANCE 35

APPENDIX C – COMPLIANCE NOTICES 36

WARRANTY 38

Before You Get Started

What's Included

All SeaDAC modules are shipped with the following items. If any of these items is missing or damaged, please contact Sealevel for a replacement.

- **SeaDAC Lite Digital Interface Adapter**
- **Item# CA356** – USB Type A to SeaLATCH Type B Cable, 6' in Length



SeaDAC Lite iPorthole and OEM modules do not include an internal USB cable. Order the appropriate internal cable for your system from Sealevel or use Molex connector p/n# 35507-0400 or equivalent.

Advisory Conventions



Warning

The highest level of importance used to stress a condition where damage could result to the product, or the user could suffer serious injury.



Important

The middle level of importance used to highlight information that might not seem obvious or a situation that could cause the product to fail.



Note

The lowest level of importance used to provide background information, additional tips, or other non-critical facts that will not affect the use of the product.



Optional Items

Depending upon your application, you are likely to find one or more of the following items useful for interfacing SeaDAC Lite Modules. All items can be purchased from our website (<http://www.sealevel.com>) or by calling (864) 843-4343. For applicable accessories, pin out diagrams are located on the website.

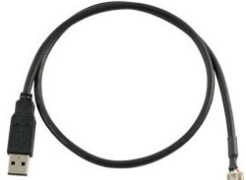

MOUNTING HARDWARE

DIN Rail Mounting Clips (Item# DR105)	
If your device has flanges or mounting ears, you can use the DR105 to make virtually any device DIN rail compatible.	

STANDARD USB CABLES





USB Type A to Sealevel 2mm Molex Connectors (Item# CA342)	
The CA342 is 24" in length and is compatible with Sealevel iPorthole™, SeaDAC Lite OEM, and other Sealevel USB devices with a 1x4 2mm embedded connector. This allows you to connect these USB devices to a standard USB port for testing, debugging and application development.	
USB 3 Meter Extension Cable (Item# CA214)	
The CA214 is a fully rated USB extension cable that adds three meters to any existing USB cable (maximum 5 meters). The CA214 has a Type A male connector on one end and a Type A female connector on the other end.	

EMBEDDED USB CABLES

Internal USB Cable for Sealevel 2mm Molex Connectors (Item# CA382)	
<p>The CA382 is 14" in length and is compatible with Sealevel iPorthole™ and SeaDAC Lite OEM products. Both ends have a 1x4 2mm Molex connector for internal connections to Sealevel embedded USB products.</p>	
Internal USB Cable for 1x4 2mm Box Header Connectors (Item# CA383)	
<p>The CA383 is 14" in length and is compatible with Sealevel iPorthole™ and SeaDAC Lite OEM products. Perfect for adding Sealevel I/O modules to small embedded systems.</p>	
USB Type A to USB Type B Device Cable (Item# CA179)	
<p>The CA179 is a standard six-foot device cable that connects USB peripherals with a Type B connector to the Type A connector on a host PC or hub.</p>	

SEALATCH™ LOCKING USB CABLES

SeaLATCH™ Locking USB Cables	
<p>SeaLATCH locking USB cables provide a secure metal-to-metal connection between a USB device and the cable, preventing the most common point of failure – accidental cable disconnection. SeaLATCH cables are covered in a dedicated section of this manual.</p>	

High Speed 4-Port USB 2.0 Hub (Item# HUB4PH)	
<p>The HUB4PH is a powered 4-port USB 2.0 hub with SeaLATCH locking USB connectors. The hub is perfect for expanding industrial computers with locking USB ports.</p>	
High Speed 7-Port USB 2.0 Hub (Item# HUB7P)	
<p>The HUB7P is a powered 7-port USB 2.0 hub that is perfect for adding high-speed USB ports to industrial computers. A high retention Type B connector prevents accidental cable disconnection.</p>	
Optically Isolated 7-Port USB Hub (Item# HUB7i)	
<p>The HUB7i is an optically isolated USB hub that connects up to seven USB peripherals and protects the host computer from voltages up to 5500 VAC. A high retention Type B connector prevents accidental cable disconnection.</p>	
iPortholes High Speed 4-Port USB 2.0 Hub (Item# HUB4PH-KT)	
<p>The HUB4PH-KT is an internally powered 4-port USB 2.0 hub with SeaLATCH locking USB connectors. Simply design the 3.2" x 3.1" Porthole mounting footprint into your enclosure and easily add four downstream locking USB ports.</p>	
Embedded High Speed 4-Port USB 2.0 Hub (Item# HUB4PH-OEM)	
<p>The HUB4PH-OEM is an internally powered 4-port USB 2.0 hub. It includes a cable that sources +5V power from a standard hard drive connector and is perfect for adding up to four iPorthole modules to your embedded application.</p>	

Introduction

SeaDAC Lite™ USB digital I/O modules provide a low I/O count solution in a small, rugged enclosure. Models are available with optically isolated inputs, Reed or Form C relay and TTL outputs. SeaDAC Lite modules are powered by the USB port, eliminating external power supplies.

SeaDAC Lite modules integrate a SeaLATCH™ USB port that provides a secure metal-to-metal connection and prevents accidental cable disconnection. SeaLATCH connectors are fully compatible with standard USB cables.

For easy software integration, application programs or 3rd party software can use Sealevel's SeaMAX library that includes a variety of helpful diagnostic utilities and sample programs. SeaDAC Lite modules are supported under Windows and Linux operating systems.

For embedded system solutions, SeaDAC Lite modules are available in iPorthole™ versions with the "Intelligent Porthole" family of USB digital I/O products. Simply design the 3.2" x 3.1" Porthole mounting footprint into your enclosure to mix and match iPorthole USB I/O modules for maximum configurability. The Porthole footprint offers a standard method for interfacing real-world I/O connections.

SeaDAC Lite modules are USB 2.0 compatible, USB 1.1 compliant, and are powered by the USB port, eliminating external power supplies. OEM versions without enclosures or Porthole mounting plates are also available.

This manual covers the installation & operation of these SeaDAC Lite modules:

SeaDAC Lite DIO-8	4 Isolated Inputs / 4 Reed Relay Outputs	
	SeaDAC Lite Module	P/N 8111
	iPorthole Module	P/N 8111-KT
	OEM Module	P/N 8111-OEM
SeaDAC Lite PLC-8	4 Isolated Inputs / 4 Form C Relay Outputs	
	SeaDAC Lite Module	P/N 8112
	iPorthole Module	P/N 8112-KT
	OEM Module	P/N 8112-OEM
SeaDAC Lite ISO-4	4 Optically Isolated Inputs	
	SeaDAC Lite Module	P/N 8113
	iPorthole Module	P/N 8113-KT
	OEM Module	P/N 8113-OEM
SeaDAC Lite REL-4	4 Reed Relay Outputs	
	SeaDAC Lite Module	P/N 8114
	iPorthole Module	P/N 8114-KT
	OEM Module	P/N 8114-OEM
SeaDAC Lite REL-4C	4 Form C Relay Outputs	
	SeaDAC Lite Module	P/N 8115
	iPorthole Module	P/N 8115-KT
	OEM Module	P/N 8115-OEM
SeaDAC Lite PIO-32	32 Channel TTL	
	SeaDAC Lite Module	P/N 8126
	iPorthole Module	P/N 8126-KT
	OEM Module	P/N 8126-OEM



Please call for pricing on extended temperature versions and for other available modifications.

Overview

Sealevel SeaDAC Lite modules are available in various I/O configurations, each designed for maximum flexibility and easy field wiring. SeaDAC Lite modules offer system designers a compact, low-cost alternative for interfacing any USB equipped computer with real world signals. SeaDAC Lite modules are designed to work with third party applications via the Sealevel SeaMAX API. For maximum reliability, all SeaDAC Lite modules include Sealevel's innovative SeaLATCH locking USB connector design that prevents accidental cable disconnection.

Industry Segments

SeaDAC modules are perfect for a wide variety of applications and environments including:

- Process Control
- Data Acquisition
- Broadcast Automation
- Security
- Facility Management

Features

- Models Offering Choice of:
- Optically Isolated Inputs
- Reed Relay Outputs
- Form C Relay Outputs
- TTL Interface
- SeaLATCH Locking USB Connector Prevents Cable Disconnection
- Powered by USB Connection
- Status Indicator LEDs for I/O Activity and USB Connection
- Field Removable Terminal Block Connectors
- Optional Spring-Clamp Terminal Blocks Available
- Industry standard 50-pin relay rack connector
- Wide Operating Temperature (0°C to +70°C)
- Extended Temperature Available (-40°C to +85°C)
- Housed in Rugged, Attractive Plastic Enclosure
- Compact Size with Versatile Mounting Capabilities
- Available in iPorthole and OEM versions

Hardware Description

SeaDAC Lite Configurations & Specifications

8111 – 4 Optically Isolated Inputs/4 Reed Relay Outputs

SeaDAC Lite 8111 modules provide 4 optically isolated inputs and 4 dry-contact Reed relay outputs. Inputs can range from 5-30VDC and provide 2500VAC RMS / 3500VDC isolation to ground, while the Reed relays provide long life switch closures that are well suited for low current applications. Each Reed relay has a discrete common and each pair of inputs share a common. Status LEDs display I/O activity and field wiring is simplified via removable 3.5mm terminal blocks compatible with 16-30 AWG wiring.

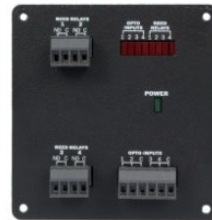

8111-KT iPorthole

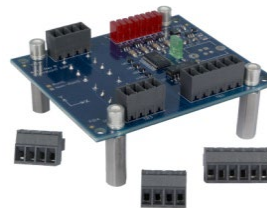

8111-OEM

Inputs	
Type	4 non-polarized optically isolated inputs
Voltage Range	5-30VDC
Isolation	2500VAC RMS / 3500VDC
Input Resistance	6.2K Ohms in series
Response Time	4μs
Outputs	
Type	4 SPST Form A Reed relays
Power	10VA max.
Contact Voltage	60VDC max.
Contact Current	500mA max.
Operate Time	0.5ms max.
Bounce Time	0.5ms max.
Release Time	0.2ms max.

8112 – 4 Optically Isolated Inputs/4 Form C Outputs

The SeaDAC Lite 8112 provides 4 optically isolated inputs and 4 SPDT Form C relay outputs. Inputs can range from 5-30VDC and provide 2500VAC RMS / 3500VDC isolation to ground, while the Form C relays switch up to 60VDC @ 5A or 250VAC @ 6A. Each Form C relay has a discrete common and includes normally-open and normally-closed contact connections. Each pair of inputs shares a common. Status LEDs display I/O activity and field wiring is simplified via 3.5mm field removable terminal blocks compatible with 16-30 AWG wiring.

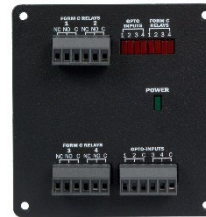

8112-KT iPorthole



8112-OEM

Inputs	
Type	4 non-polarized optically isolated inputs
Voltage Range	5-30VDC
Isolation	2500VAC RMS / 3500VDC
Input Resistance	6.2K Ohms in series
Response Time	4 μ s
Outputs	
Type	4 SPDT Form C relays
Power	DC 240W / AC 600 VA
Contact Voltage	60VDC / 250VAC max. (5VDC min.)
Contact Current (DC)	< 30 VDC @ 5A max. \geq 30 VDC @ 2000mA max. (100mA min.)
Contact Current (AC)	6A max.
Operate Time	10ms max.
Release Time	5ms max.

8113 – 4 Optically Isolated Inputs

SeaDAC Lite 8113 modules provide 4 optically isolated inputs with 2500VAC RMS / 3500VDC external isolation. Ideal for low voltage monitoring applications, inputs can range from 5-30VDC. Status LEDs display I/O activity and connection to real world signals is made via 3.5mm field removable screw terminal connectors compatible with 16-30 AWG wiring.

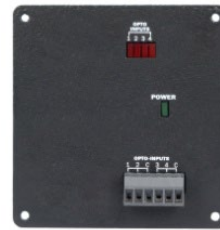

8113-KT iPorthole

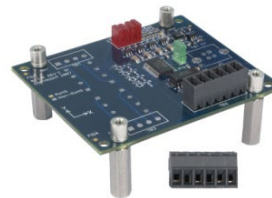

8113-OEM

Inputs	
Type	4 non-polarized optically isolated inputs
Voltage Range	5-30VDC
Isolation	2500VAC RMS / 3500VDC
Input Resistance	6.2K Ohms in series
Response Time	4 μ s

8114 – 4 Reed Relay Outputs

The SeaDAC Lite 8114 provides 4 SPST Form A dry-contact Reed relays. Reed relays offer long life performance, fast response time, and are well suited to low current devices. Each relay output has a discrete common. Status LEDs display I/O activity and field wiring is simplified via field removable 3.5mm screw terminal blocks compatible with 16-30 AWG wiring.

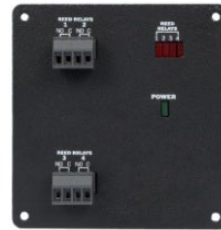

8114-KT iPorthole

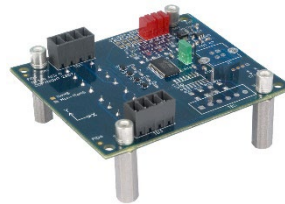

8114-OEM

Outputs	
Type	4 SPST Form A Reed relays
Power	DC 30W / AC 10VA Max.
Contact Voltage	60VDC max.
Contact Current	500mA max.
Operate Time	0.5ms max.
Bounce Time	0.5ms max.
Release Time	0.2ms max.

8115 – 4 Form C Relay Outputs

Control and monitor a variety of devices with the SeaDAC Lite 8115. The module's 4 channels of highly-reliable SPDT Form C relay outputs are rated for up to 60VDC @ 5A or 250VAC @ 6A. Each Form C relay has a discrete common and includes normally-open and normally-closed contact connections. Status LEDs display I/O activity and field wiring is simplified via 3.5mm field removable terminal blocks compatible with 16-30 AWG wiring.

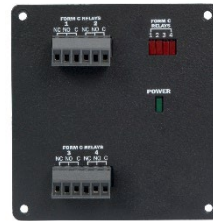

8115-KT iPorthole



8115-OEM

Outputs	
Type	4 SPDT Form C relays
Power	DC 210W / AC 1200 VA Max.
Contact Voltage	60VDC / 250VAC max. (5VDC min.)
Contact Current (DC)	<30 VDC @ 5A max. >30 VDC @ 700mA max. (100mA min.)
Contact Current (AC)	6A max.
Operate Time	10ms max.
Release Time	5ms max.

8126 – 32 Channel TTL

The SeaDAC Lite 8126 provides 32 channels of buffered drive digital I/O. The module addresses the 32 channels of I/O as four eight-bit ports, each programmable as input or output. Use a standard 50-pin IDC ribbon cable to connect an industry standard relay rack for PC based control and automation of equipment including sensors, switches, security control systems, and other industrial automation systems. A status LED lights when the 8126 is successfully communicating with a USB port.



8126-KT iPorthole



8126-OEM

Power Requirements	
Max Output Power	+5VDC @ 350mA
Inputs	
Logic High	Min 2VDC
Logic Low	Max 0.8VDC
Outputs *	
Logic Low	Max 0.5VDC @ 64mA
Logic High	Min 2VDC @ 32mA

8126 – Optional Items

Depending upon your application, you are likely to find one or more of the following items useful for interfacing the 8126 to real-world signals. All items can be purchased from our website (<http://www.sealevel.com>) or by calling +1 864-843-4343.

TTL applications

Terminal Block Kit (Item# KT107)	
<p>Kit includes the TB07 screw terminal block and CA167 ribbon cable for connecting the 8126's 50-pin header connector to your I/O. 6" Snap track and DIN rail clips are included for DIN rail mounting.</p>	
Terminal Block – 50-Pin Header to 40 Screw Terminals (Item# TB07)	
<p>The TB07 allows you to break out digital TTL signals, +5 volts, and ground to screw terminals for easy field connection of switches, discrete solid state relays, sensors, etc. Two four-position screw terminals interface +5V and Ground.</p>	
IDC 50 to IDC 50 Pin 40" Ribbon Cable (Item# CA167)	
<p>Interfaces the 8126's 50-pin header connector</p>	
Simulation/Debug Module (Item# TA01)	
<p>Module allows monitoring status of output pins and controlling state of input pins. An LED corresponding to each port bit illuminates to indicate state. Eight position DIP-switches are used to generate input status changes.</p>	

High-Current, High-Voltage Applications

Discrete 8-Position Relay Rack (Item# PB8HS)	
<p>The PB8HS relay rack can be used with up to eight discrete I/O modules, including input modules, output relays, override relays, watchdog timers, and mechanical relays.</p>	
Discrete 16-Position Relay Rack (Item# PB16HS)	
<p>The PB16HS relay rack can be used with up to sixteen discrete I/O modules, including input modules, output relays, override relays, watchdog timers, and mechanical relays.</p>	
Discrete 24-Position Relay Rack (Item# PB24HS)	
<p>The A24H relay rack can be used with up to twenty-four discrete I/O modules, including input modules, output relays, override relays, watchdog timers, and mechanical relays.</p>	
IDC 50 to IDC 50 Pin Ribbon Cable (Item# CA167)	
<p>40" cable connects the 8126 to solid-state relay racks equipped with a 50-pin header interface.</p>	
IDC 50 to IDC 50 Pin Ribbon Cable (Item# CA135)	
<p>40" cable connects the 8126 to solid-state relay racks equipped with a 50-pin edge connector.</p>	
Solid-State Relay Racks: Quad six position relay rack (Item# PB24HQ)	
<p>Relay rack can accept up to six QSSRs for a total of 24 channels. Features a 50-pin header connector for easy interface via 50-conductor ribbon cables.</p>	

For high-current, high-voltage applications, continued

Solid-State Relay Racks: Quad four position relay rack (Item# PB16HQ)	
<p>Relay rack can accept up to four QSSRs for a total of 16 channels. Features a 50-pin header connector for easy interface via 50-conductor ribbon cables.</p>	
Quad Solid-State Relay Modules: AC Input (Item# IA5Q)	
<p>Provides 4 channels of discrete I/O interface to monitor AC inputs up to 140V @ 10mA.</p>	
Quad Solid-State Relay Modules: DC Input (Item# IB5Q)	
<p>Provides 4 channels of discrete I/O interface to monitor DC inputs from 3.3V to 32V.</p>	
Quad Solid-State Relay Modules: DC Input (Item# OA5Q)	
<p>AC Output (Item# OA5Q) – Provides 4 channels of discrete I/O interface to control AC outputs up to 140V @ 3A.</p>	
Quad Solid-State Relay Modules: DC Output (Item# OB5Q)	
<p>Provides 4 channels of discrete I/O interface to control DC outputs up to 60V @ 3A.</p>	

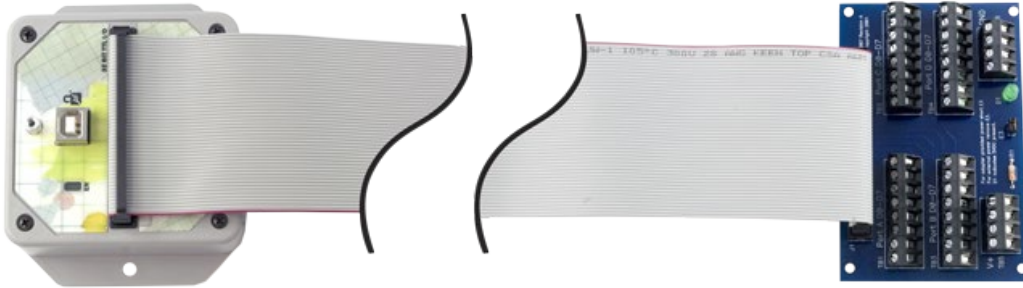

SeaDAC Lite 8126 connected to Terminal Block (TB07)

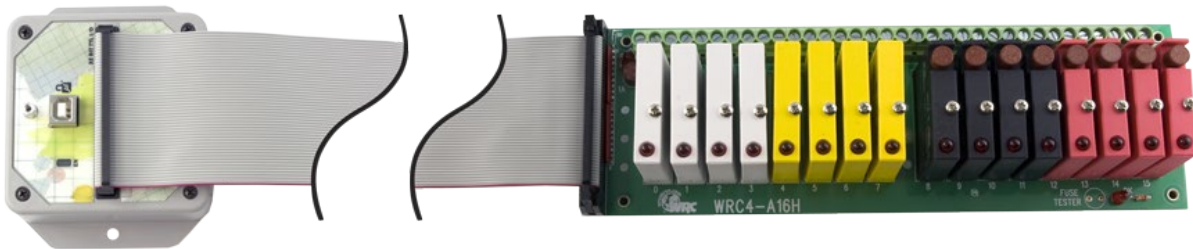

SeaDAC Lite 8126 connected to Discrete Relay Rack (PB1 GHS)

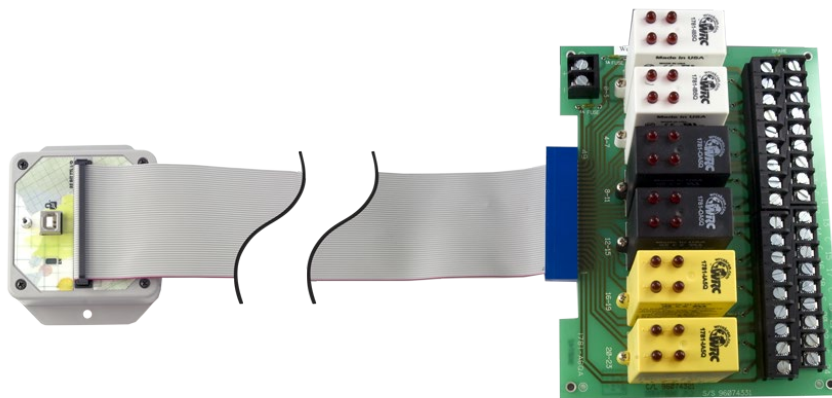

SeaDAC Lite 8126 connected to Solid State Relay Rack (PB24HQ)

SeaDAC Lite Power Requirements

Sealevel SeaDAC Lite modules are powered by the USB host interface and require 5VDC @ 500mA to be available on the USB port. Most computers and powered USB hubs are capable of meeting this requirement, while passive USB hubs and some laptops running on batteries may not. Check the product manual that shipped with your system or hub if you are uncertain. Sealevel technical support may also be able to help.

The maximum power requirements for each SeaDAC Lite device are shown below.

Item#	Description	mA
8111	4 Isolated Inputs / 4 Reed Relay Outputs	300
8112	4 Isolated Inputs / 4 Form C Relay Outputs	500
8113	4 Optically Isolated Inputs	100
8114	4 Reed Relay Outputs	200
8115	4 Form C Relay Outputs	400
8126	32 TTL Channels	500

Connector Pin Assignments

Pin Outs – SeaDAC Lite 8111 - 8115 Modules

Depending on model, you can control and monitor up to 4 optically isolated inputs and 4 Reed or Form C relay outputs. Each Reed or Form C relay has a discrete common (ground) and each pair of inputs share a common. Reed relays can switch up to 60VDC @ 500mA, while Form C relays can switch up to 60VDC @ 5A or 250VAC @ 6A. The non-polarized input voltage range is 5-30VDC and features 2500VAC RMS / 3500VDC optical isolation to protect the host computer from damaging voltage transients and ground loops commonly found in industrial environments.

Field wiring is simplified via 3.5mm removable screw terminal blocks with optional spring clamp terminal blocks also available. The removable terminal blocks are compatible with 16-30 AWG field wiring.

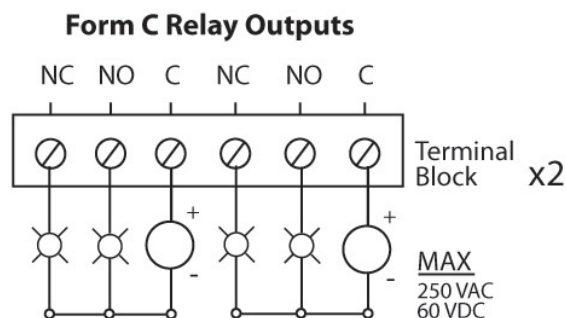
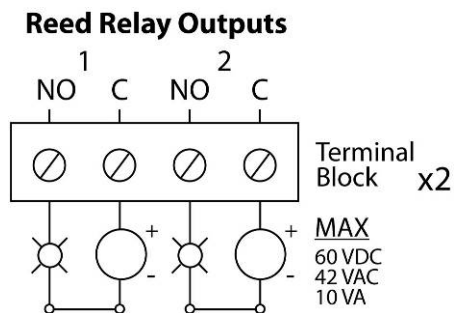
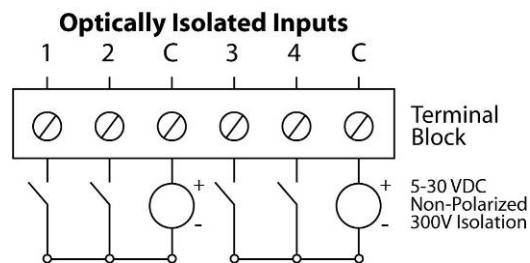

Pin Out – SeaDAC Lite 8126 TTL Module

The 8126 addresses the 32 channels of buffered drive digital I/O as four eight-bit ports, each programmable as input or output. The I/O channels are accessed via an industry standard 50-pin header connector. Use a standard 50-pin IDC ribbon cable to connect an industry standard relay rack, terminal block (Item# TB07), or relay rack simulation module (Item# TA01). Each channel can sink up to 64mA or source up to 32mA. All channels combined cannot exceed a total output of 350mA.



Relay racks with less than 32 channels expect all even pins to be commons. When using relay racks with less than 32 channels, set Port D as an input to avoid shorting the outputs to ground through the relay rack.

8126 – 50-Pin Header Connector

The 8126 has the following pin out which is compatible with a wide variety of industry standard solid-state relay racks.

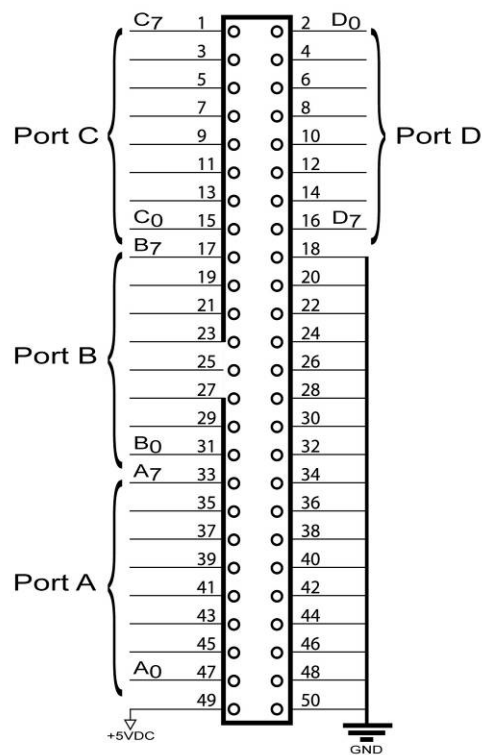

8126 TTL Logic & Example Circuits

The 8126 uses 74ABT245 octal bidirectional transceivers to provide TTL input/output capabilities. Each bit is pulled to +5V through a 10K Ω pull-up resistor to ensure each bit is at a known state when not driven. If an input is not connected to ground, it will read as a one (1) due to the 10K Ω pull-up resistors on each port.

Input Circuit Schematic

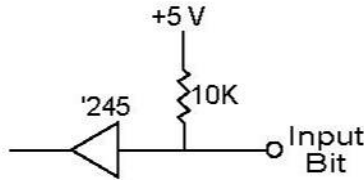

TTL Input

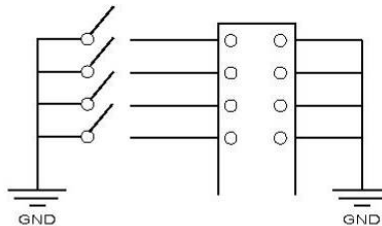

Solid State Relay Input

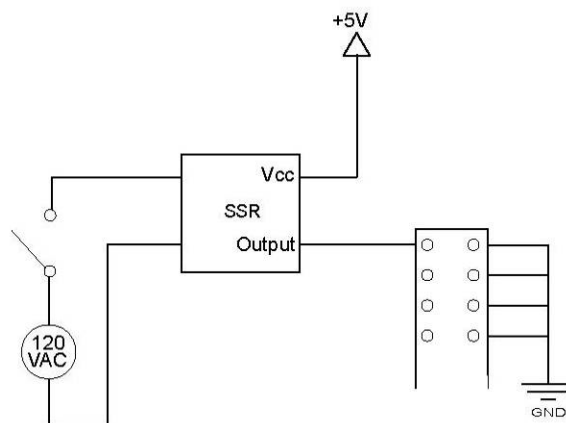

Output Circuit Schematic

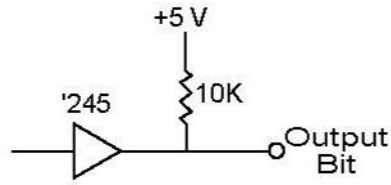

TTL Output

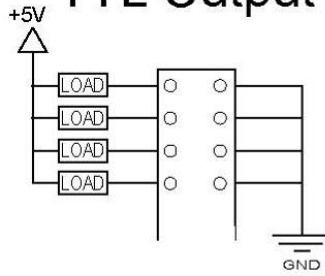

Solid State Relay Output

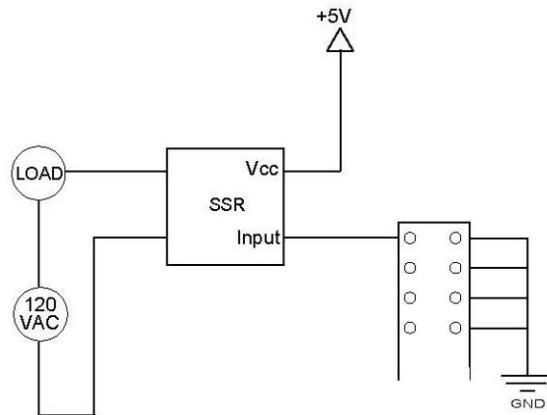





SeaLATCH™ USB

SeaDAC Lite USB digital I/O modules integrate the SeaLATCH USB port, which is fully compatible with standard USB cables. When used with the included USB cable (Item# CA356) with a SeaLATCH USB type B connector, the metal thumbscrew provides a secure connection to the device and prevents accidental cable disconnection.



SeaLATCH Locking USB Cables

SeaLATCH USB Connectors	
<p>SeaLATCH locking USB cables integrate a small thumbscrew into each USB connector. SeaLATCH USB cables are fully interchangeable with standard USB cables. The thumbscrew provides a secure metal-to-metal connection preventing accidental disconnection. SeaLATCH USB cables are available in three configurations.</p>	 <p>SeaLATCH USB Connectors Type B Type A</p>
USB Type A to SeaLATCH USB Type B Device Cable (Item# CA356)	
<p>The CA356 is a 72" USB cable with a SeaLATCH type B connector and a standard USB type A connector. This cable provides a secure connection between Sealevel products with a SeaLATCH type B port and legacy USB type A ports. The CA356 is included with Sealevel devices with a SeaLATCH type B port.</p>	 <p>CA356</p>
SeaLATCH USB Type A to SeaLATCH USB Type B Device Cable (Item# CA332)	
<p>The CA332 is a 72" cable with both SeaLATCH type A and B connectors. This cable secures both ends of the cable to devices with SeaLATCH USB ports and offers complete protection against accidental cable disconnection.</p>	 <p>CA332</p>
SeaLATCH USB Type A to USB Type B Device Cable (Item# CA355)	
<p>The CA355 is a 72" cable with a standard USB type B and a SeaLATCH type A connector. This cable provides a secure connection between legacy USB devices and Sealevel products with a SeaLATCH type A port, such as the isolated USB hub (Item# 270U).</p>	 <p>CA355</p>

SeaMAX Application Suite

SeaMAX Overview

The SeaMAX Suite is a collection of software libraries, and configuration and diagnostic utilities that facilitates rapid application development for Seal/O, SeaDAC, and SeaDAC Lite modules. The following libraries and utilities are included in the SeaMAX Suite:

- MaxSSD Configuration & Diagnostics utility
- Ethernet Configuration utility
- SeaMAX API

Sealevel digital and analog I/O modules supported by SeaMAX software are designed to work with third party applications via the SeaMAX API. To help simplify application development, the complete API documentation and code samples are automatically installed with the SeaMAX Suite and can be found in Windows by clicking Start → All Programs → Sealevel SeaMAX → Documentation.



SeaDAC Lite modules do not support Modbus commands.

SeaMAX Software Installation

For Windows 2000/XP/Vista™ Operating Systems

Begin by downloading and installing the **SeaMAX Software Suite** software from the Sealevel website at <https://www.sealevel.com/support/software-seamax-windows/>. Software drivers are also available on the product webpage or at the [Sealevel software driver database](#). Proceed with configuring your Sealevel I/O module using the MaxSSD utility detailed on the following pages.



Do not connect the I/O module to the host until the software is installed.



Only users running Windows 7 or newer should utilize these instructions for accessing and installing the appropriate driver via Sealevel's website. If you are utilizing an operating system prior to Windows 7, please contact Sealevel by calling 864.843.4343 or emailing support@sealevel.com to receive access to the proper driver download and installation instructions.

1. Download the [SeaMAX software](#) and launch the installation.
2. Select 'Install Software'.
3. Select the Part Number for your device from the listing.
4. The setup file will automatically detect the operating environment and install the proper components. Follow the information presented on the installation screens that follow.
5. A screen may appear with the declaration: "The publisher cannot be determined due to the problems below: Authenticode signature not found." Please select the 'Yes' button and proceed with the installation. This declaration simply means that the Operating System is not aware of the driver being loaded. It will not cause any harm to your system.
6. During setup, you may specify installation directories and other preferred configurations. This program also adds entries to the system registry that are necessary for specifying the operating parameters for each driver. An uninstall option is included to remove the driver and all registry/INI file entries from your system.

Other Operating Systems

Refer to the appropriate section of the Serial Utilities Software.

LINUX INSTALLATION

Refer to [Linux Archives - Sealevel](#). This link contains valuable information on installing your serial adapter in the various Linux releases. Also included is a series of files explaining proper Linux syntax and typical Linux serial implementations.

For additional software support, please call Sealevel Systems' Technical Support, (864) 843-4343. Our technical support is free and available from 8:00AM-5PM Eastern Time, Monday through Friday. For email support contact: <mailto:support@sealevel.com>.

MaxSSD Configuration & Diagnostics Utility

The Sealevel Systems configuration utility, MaxSSD, is designed to simplify the installation, configuration, and diagnostics of Sealevel I/O modules. MaxSSD is a Microsoft Windows application and has been tested with Windows 2000, XP, and Vista.

Host PC Configuration Tab

The first time you run the MaxSSD utility (Start → All Programs → Sealevel SeaMAX → MaxSSD) it will default to the “Host PC Configuration” tab. This tab allows the user to choose the initial communication settings for the connected I/O device.

To communicate with a SeaDAC Lite module, select “SeaDAC Lite” from the “COM Port” dropdown box. MAXSSD will search for any SeaDAC Lite modules connected to a USB port and display them in a frame (as shown below). A new “Digital I/O” tab will appear. If more than one SeaDAC Lite module is connected, select the one you want to test from the list and click the “Digital I/O tab”. You can use this new tab to test the functionality of inputs and relay outputs. The “Digital I/O” tab is covered in detail on subsequent pages.

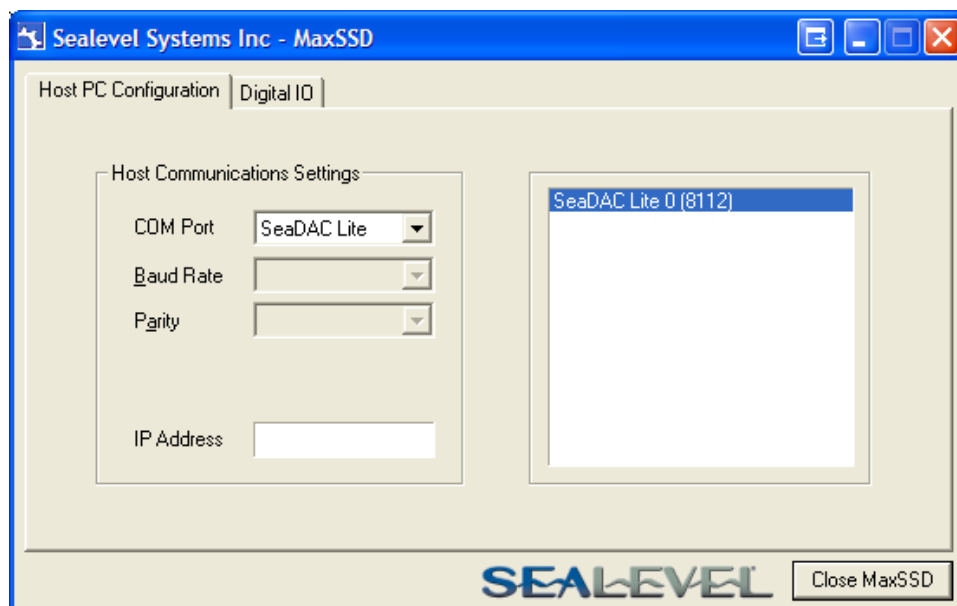

Digital I/O Tab

The “Digital IO” tab of MaxSSD is displayed when using Sealevel I/O devices featuring discrete inputs and outputs. It displays the device’s current input and/or output status in an intuitive and usable manner.

When displaying SeaDAC Lite modules, the “Digital IO” tab displays inputs and outputs in groupings (or banks) of four. Therefore, a SeaDAC Lite module with four inputs and four outputs would show only one bank of inputs and one bank of outputs.

When banks of inputs are displayed, the status LEDs update on each of the banks automatically. This allows you to actively monitor external signals.

With a bank of outputs, the output coils can be set using the buttons below each output LED. As each coil is set, the SeaDAC Lite module is read. The corresponding status LED in the “Digital IO” window indicates the state of the coil. In the example below, a SeaDAC Lite module with four inputs and four Form C relays is shown, with the state of the relays showing either normally-open (NO) or normally-closed (NC).

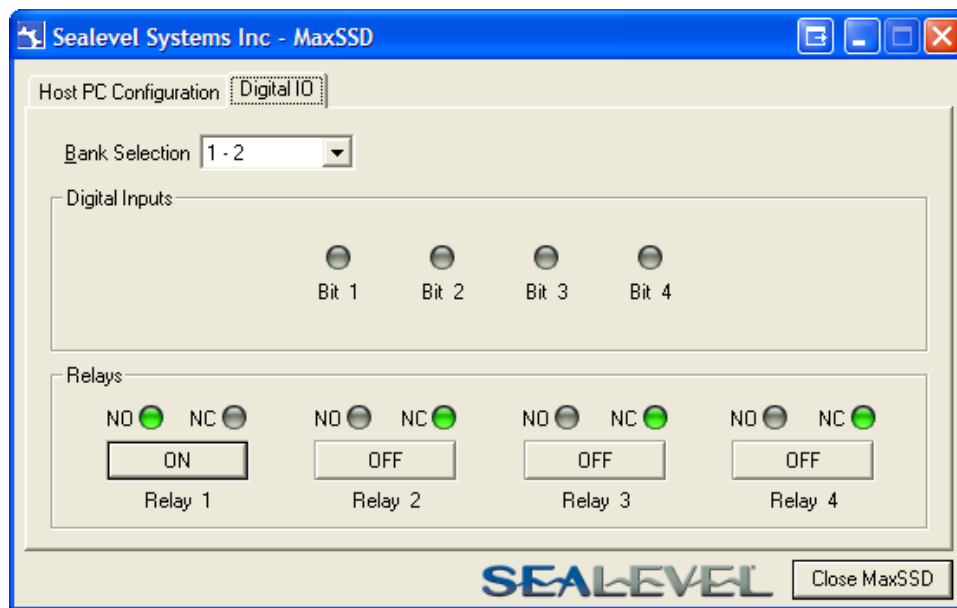

The “SeaIO Configuration” tab does not appear in MaxSSD when using SeaDAC Lite modules since they have no configurable communication settings.

Programmable I/O Tab

The “Programmable IO” tab of MaxSSD is displayed when using Sealevel I/O devices featuring programmable inputs or outputs. This tab allows for bank configuration, input/output configuration, as well as bit-level presets.

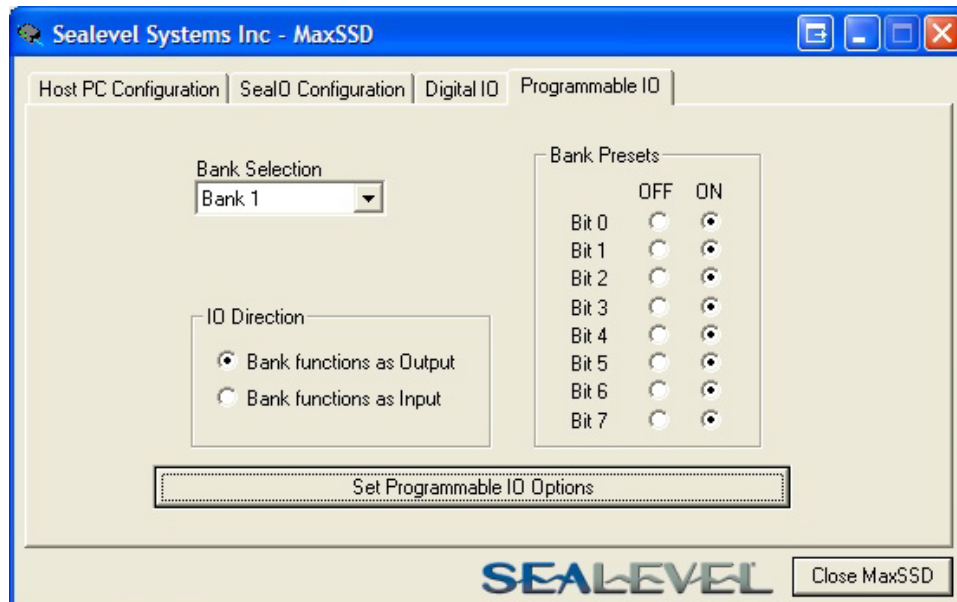

Each bank of programmable I/O can be set as either an 8-bit group of inputs or outputs. By selecting “Bank 1” from the drop-box, clicking the “Bank functions as Input” radio button, and then clicking the “Set Programmable IO Options” button, the first 8 PIO bits on the device will now function as inputs. For ease of configuration, an “All Banks of IO” option is available to configure all of the I/O at one time. Inputs have no preset mode; therefore, the preset options are disabled for any bank of inputs. Outputs; however, have bit-addressable presets. These presets are used whenever the device is powered up or the bank direction changes from input to output.

N The output presets will not lock the outputs into a specified on or off state. They only set the state of the outputs on a power on or bank direction change.

Technical Specifications

Environmental Specifications

Specification	Operating	Storage
Temperature Range	0° to 70° C (32° to 158° F)	-50° to 105° C (-58° to 221° F)
Extended Temperature (Call for Pricing)	-40° to 85° C (40° to 185° F)	-50° to 105° C (-58° to 221° F)
Humidity Range	10 to 90% R.H. Non-Condensing	10 to 90% R.H. Non-Condensing

Dimensions

	Length	Width	Height
SeaDAC Lite Modules	4.3" (109mm)	3.4" (86mm)	1.3" (32mm)
iPorthole Modules	3.2" (81mm)	3.1" (79mm)	0.8" (21mm)
OEM Modules	2.9" (74mm)	2.5" (64mm)	0.8" (21mm)

Manufacturing

All Sealevel Systems, Inc. printed circuit boards are built to UL 94V0 rating and are 100% electrically tested. These printed circuit boards are solder mask over bare copper or solder mask over tin nickel.

Appendix A - Handling Instructions

ESD Warnings

Electrostatic Discharges (ESD)

A sudden electrostatic discharge can destroy sensitive components. Proper packaging and grounding rules must therefore be observed. Always take the following precautions:

- Transport boards and cards in electrostatically secure containers or bags.
- Keep electrostatically sensitive components in their containers, until they arrive at an electrostatically protected workplace.
- Only touch electrostatically sensitive components when you are properly grounded.
- Store electrostatically sensitive components in protective packaging or on anti-static mats.

Grounding Methods

The following measures help to avoid electrostatic damages to the device:

- Cover workstations with approved antistatic material. Always wear a wrist strap connected to workplace as well as properly grounded tools and equipment.
- Use antistatic mats, heel straps, or air ionizers for more protection.
- Always handle electrostatically sensitive components by their edge or by their casing.
- Avoid contact with pins, leads, or circuitry.
- Turn off power and input signals before inserting and removing connectors or connecting test equipment.
- Keep work area free of non-conductive materials such as ordinary plastic assembly aids and Styrofoam.
- Use field service tools such as cutters, screwdrivers, and vacuum cleaners which are conductive.
- Always place drives and boards PCB-assembly-side down on the foam.

Appendix B – How To Get Assistance

Please refer to: [Appendix A](#) – Troubleshooting Guide prior to calling Technical Support.

Begin by reading through the Trouble Shooting Guide in Appendix A. If assistance is still needed, please see below.

When calling for technical assistance, please have your user manual and current adapter settings. If possible, please have the adapter installed in a computer ready to run diagnostics.

Sealevel Systems provides an FAQ section on its web site. Please refer to this to answer many common questions. This section can be found at <http://www.sealevel.com/faq.asp>.

Sealevel Systems maintains a web page on the Internet. Our home page address is www.sealevel.com. The latest software updates, and newest manuals are available via our web site.

Technical support is available Monday to Friday from 8:00 A.M. to 5:00 P.M. Eastern Time. Technical support can be reached at (864) 843-4343.

RETURN AUTHORIZATION MUST BE OBTAINED FROM SEALEVEL SYSTEMS BEFORE RETURNED MERCHANDISE WILL BE ACCEPTED. AUTHORIZATION CAN BE OBTAINED BY CALLING SEALEVEL SYSTEMS AND REQUESTING A RETURN MERCHANDISE AUTHORIZATION (RMA) NUMBER.

Appendix C – Compliance Notices

Federal Communications Commission (FCC) Statement



This equipment has been tested and found to comply with the limits for Class A digital device, pursuant to Part 15 of the FCC Rules. These limits are designed to provide reasonable protection against harmful interference when the equipment is operated in a commercial environment. This equipment generates, uses, and can radiate radio frequency energy and, if not installed and used in accordance with the instruction manual, may cause harmful interference to radio communications. Operation of this equipment in a residential area is likely to cause harmful interference in such case the user will be required to correct the interference at the user's expense.

EMC Directive Statement



Products bearing the CE Label fulfill the requirements of the EMC directive (89/336/EEC) and of the low-voltage directive (73/23/EEC) issued by the European Commission. To obey these directives, the following European standards must be met:

- **EN55022 Class A** - "Limits and methods of measurement of radio interference characteristics of information technology equipment"
- **EN55024** – "Information technology equipment Immunity characteristics Limits and methods of measurement".

United Kingdom Conformity Assessed Statement



Products with UKCA marking are in conformity with the essential requirements of the UK Electromagnetic Compatibility Regulations 2016:

- *Equipment must be designed and manufactured to ensure that the electromagnetic disturbance generated does not exceed the level above which radio and telecommunications equipment cannot operate as intended.*
- *The equipment has a level of immunity to the electromagnetic disturbance to be expected in its intended use which allows it to operate without unacceptable degradation of its intended use.*



This is a Class A Product. In a domestic environment, this product may cause radio interference in which case the user may be required to take adequate measures to prevent or correct the interference.



Always use cabling provided with this product if possible. If no cable is provided or if an alternate cable is required, use high quality shielded cabling to maintain compliance with FCC/EMC directives.

Warranty

Sealevel's commitment to providing the best I/O solutions is reflected in the Lifetime Warranty that is standard on all Sealevel manufactured I/O products. We are able to offer this warranty due to our control of manufacturing quality and the historically high reliability of our products in the field. Sealevel products are designed and manufactured at its Liberty, South Carolina facility, allowing direct control over product development, production, burn-in and testing. Sealevel achieved ISO-9001:2015 certification in 2018.

Warranty Policy

Sealevel Systems, Inc. (hereafter "Sealevel") warrants that the Product shall conform to and perform in accordance with published technical specifications and shall be free of defects in materials and workmanship for the warranty period. In the event of failure, Sealevel will repair or replace the product at Sealevel's sole discretion. Failures resulting from misapplication or misuse of the Product, failure to adhere to any specifications or instructions, or failure resulting from neglect, abuse, accidents, or acts of nature are not covered under this warranty.

Warranty service may be obtained by delivering the Product to Sealevel and providing proof of purchase. Customer agrees to ensure the Product or assume the risk of loss or damage in transit, to prepay shipping charges to Sealevel, and to use the original shipping container or equivalent. Warranty is valid only for original purchaser and is not transferable.

This warranty applies to Sealevel manufactured Product. Product purchased through Sealevel but manufactured by a third party will retain the original manufacturer's warranty.

Non-Warranty Repair/Retest

Products returned due to damage or misuse and Products retested with no problem found are subject to repair/retest charges. A purchase order or credit card number and authorization must be provided in order to obtain an RMA (Return Merchandise Authorization) number prior to returning Product.

How to obtain an RMA (Return Merchandise Authorization)

If you need to return a product for warranty or non-warranty repair, you must first obtain an RMA number. Please contact Sealevel Systems, Inc. Technical Support for assistance:

Available	Monday – Friday, 8:00AM to 5:00PM EST
Phone	864-843-4343
Email	support@sealevel.com

Trademarks

Sealevel Systems, Incorporated acknowledges that all trademarks referenced in this manual are the service mark, trademark, or registered trademark of the respective company.