

eI/O Modules

User Manual | eI/O



SEALEVEL®

Contents

CONTENTS.....2

BEFORE YOU GET STARTED3

INTRODUCTION4

EI/O HARDWARE DESCRIPTION9

POWER OPTIONS.....21

SEAMAX APPLICATION SUITE22

HARDWARE CONFIGURATION.....31

MOUNTING OPTIONS.....39

APPENDIX A – HANDLING INSTRUCTIONS40

APPENDIX B– HOW TO GET ASSISTANCE.....41

APPENDIX C – COMPLIANCE NOTICES42

WARRANTY42

Before You Get Started

Advisory Conventions



Warning

The highest level of importance used to stress a condition where damage could result to the product, or the user could suffer serious injury.



Important

The middle level of importance used to highlight information that might not seem obvious or a situation that could cause the product to fail.



Note

The lowest level of importance used to provide background information, additional tips, or other non-critical facts that will not affect the use of the product.

Introduction

Sealevel eI/O™ modules offer powerful data acquisition solutions that are perfect for a wide range of applications and environments with easy interfacing to computers, controllers, and PLCs. eI/O modules are available in various digital and analog I/O configurations. Each eI/O model is designed for maximum flexibility and easy field wiring.

For easy software integration, application programs or 3rd party software can use the Sealevel SeaMAX™ library or industry standard Modbus TCP (Ethernet) protocol.

Industry Segments



eI/O modules are perfect for a wide variety of applications and environments including:

- Process Control
- Data Acquisition
- Broadcast Automation
- Security
- Facility Management

Features

- Supports Industry Standard Modbus TCP Protocol
- Models Offering Choice of:
 - Optically Isolated Inputs
 - Form A Reed Relay Outputs
 - High Current Form C Relay Outputs
 - Solid State Relay Outputs
 - Single Ended and Differential Analog Inputs
 - Status Indicator LEDs for Communication and power
- Field Removable Terminal Block Connectors
- Power Input via Terminal Block or Power over Ethernet
- Compact Size – 4.5" (L) x 3.5" (W) x 1.3" (H)
- Din Rail or Table Mount

eI/O Products In this Manual

Ethernet 10/100 BaseT	
	<p> eI/O 110E – 4 Optically Isolated Inputs/4 Form A Reed Relay Outputs eI/O 120E – 4 Optically Isolated Inputs/4 Form C Relay Outputs eI/O 130E – 4 Optically Isolated Inputs eI/O 140E – 4 Form A Reed Relay Outputs eI/O 150E – 4 Form C Relay Outputs eI/O 160E – 32 Channel TTL Interface eI/O 170E – 8 Analog Inputs/2 Optically Isolated Inputs/2 Solid State Relay Outputs </p>
Power Over Ethernet	
	<p> eI/O 110PoE – 4 Optically Isolated Inputs/4 Form A Reed Relay Outputs eI/O 120PoE – 4 Optically Isolated Inputs/4 Form C Outputs eI/O 130PoE – 4 Optically Isolated Inputs eI/O 140PoE – 4 Form A Reed Relay Outputs eI/O 150PoE – 4 Form C Relay Outputs eI/O 160PoE – 32 Channel TTL Interface eI/O 170PoE – 8 Analog Inputs/2 Optically Isolated Inputs/2 Solid State Relay Outputs </p>



Optional Items

Depending on the interface type, your eI/O module may include additional accessories. Included accessories are listed below. All items can be purchased from our website (www.sealevel.com) by calling our sales team at (864) 843-4343.

POWER OVER ETHERNET SERIES

Power Over Ethernet Switch	
<p>Connect up to four eI/O modules without power cables with the Sealevel unmanaged five port Ethernet switch.</p>	

POWER SUPPLIES US OPTIONS

eI/O 120VAC to 12VDC @ 500mA Wall Mount Power Supply (Part# TR104)	
<p>The TR104 is a wall wart style power supply capable of powering a single eI/O module at 120VAC input and 12VDC output at 500mA. Other power supply options are available for driving multiple eI/O modules on a DIN rail.</p>	
100-240VAC to 24VDC @ 300mA DIN Rail Power Supply (Part# PS101)	
<p>The PS101 is an AC/DC DIN rail mount power supply that accepts 100-240VAC input and outputs 24VDC at up to 300mA (7.5W).</p>	

100-240VAC to 24VDC @ 2.1A DIN Rail Power Supply (Part# PS103)

The PS103 is an AC/DC DIN rail mount power supply that accepts 100-240VAC input and outputs 24VDC at up to 2.1A (50W).



INTERNATIONAL OPTIONS

eI/O 230VAC to 12VDC @ 500mA Wall Mount Power Supply (Part# TR105)

The TR105 is a wall wart style power supply for European countries and is rated for 230VAC input and 12VDC output at 500mA.





eI/O 240VAC to 12VDC @ 500mA Wall Mount Power Supply (Part# TR106)

The TR106 is a wall wart style power supply for the United Kingdom, Hong Kong, Singapore, and Malaysia. The TR106 is rated for 240VAC input and 12VDC output at 500mA.



CABLES

CAT5 Patch Cable (Part# CA246)	
Standard 7' CAT5 UTP Patch Cable (RJ45).	
CAT5 Patch Cable, 10' in Length (Part# CA247)	
10' Blue Ethernet Patch Cable. Can be used to connect el/O Ethernet modules to a hub or switch.	

eI/O Hardware Description

eI/O Standard and Power over Ethernet Modules

eI/O modules are powered in one of two ways

- 9-30 VDC $\overline{\text{---}}$ 5W MAX power input
(600mA MAX @ 9V; 420mA MAX @ 12V; 210mA MAX @ 24V)



- 802.3af-2003 Power over Ethernet



eI/O Module Common Features

All eI/O modules include the same power connector on the side of the unit. All models use the same style of 3.5mm pitch screw terminals on front for connection to field devices.

Status LEDs are also included on the front of all eI/O modules to indicate the following information:

- **Power (Green)** – Lights when power is applied to the module.
- **Act (Green)** – Light blinks when Modbus/TCP activity is present or when new firmware is being downloaded.



eI/O Configurations & Specifications

110 SERIES – 4 OPTICALLY ISOLATED INPUTS/4 FORM A REED RELAY OUTPUTS

eI/O-110 modules provide 4 optically isolated inputs and 4 Form A Reed Relay outputs. Inputs can range from 5-30VDC, while the Form A Reed Relays provide long life switch closures that are well suited for low current applications. Each pair of inputs shares a common and field wiring is simplified via 3.5mm field removable terminal blocks.



5-30VDC Power Input Version Shown

Inputs	
Type	4 non-polarized optically isolated inputs
Voltage Range	5-30VDC non-polarized
Isolation	2500VAC RMS / 3500VDC
Input Resistance	6.2K Ohms in series
Outputs	
Type	4 SPST Form A Reed Relays
Contact Max Power	10W
Switching Voltage Max DC / Peak AC Resistive	60VDC / 42VAC
Switching Current Max DC / Peak AC Resistive	500mA
Relay Max Operate Time, including Bounce*	1ms
Relay Max Release Time*	0.2ms

Optically Isolated Inputs

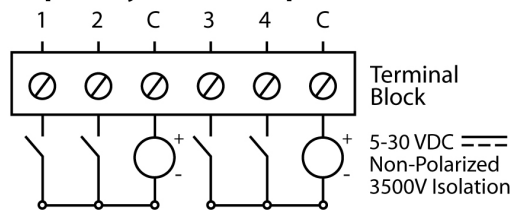

Reed Relay Outputs

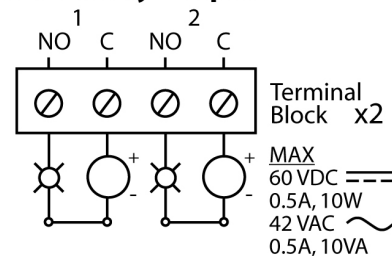

Do not connect protective earthing or protective bonding conductor wiring of any equipment to relay contact outputs. *Minimum hardware requirements

120 SERIES – 4 OPTICALLY ISOLATED INPUTS/4 FORM C OUTPUTS

The ei/O-120 provides 4 optically isolated inputs and 4 SPDT Form C relay outputs. Inputs can range from 5-30VDC, while the high current Form C relays switch up to 60VDC, or 200VAC. Each Form C relay has a discrete common and includes normally-open and normally-closed contact connections. Each pair of inputs shares a common and field wiring is simplified via 3.5mm field removable terminal blocks.



Power over Ethernet Option Shown

Inputs	
Type	4 non-polarized optically isolated inputs
Voltage Range	5-30VDC non-polarized
Isolation	2500VAC RMS / 3500VDC
Input Resistance	6.2K Ohms in series
Outputs	
Type	4 SPDT Form C relays
Power	DC 240W / AC 300VA
Contact Voltage	60VDC / 200VAC max. (5VDC min.)
Contact Current (DC)	≤30 VDC @ 5A max. >30 VDC @ 2000mA max. (100mA min.)
Contact Current (AC)	6A max.

Optically Isolated Inputs

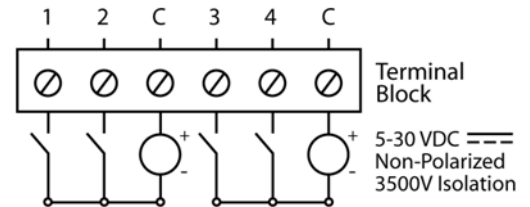

Form C Relay Outputs

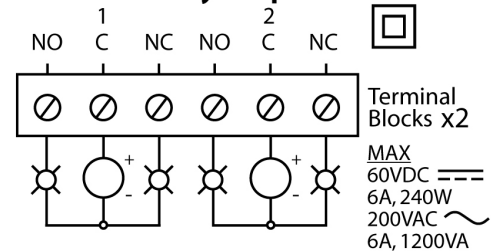

Do not connect protective earthing or protective bonding conductor wiring of any equipment to relay contact outputs.

130 SERIES – 4 OPTICALLY ISOLATED INPUTS

el/O-130 modules provide 4 optically isolated inputs with 2500VAC RMS / 3500VDC external isolation and high channel-to-channel isolation. Each pair of inputs shares a common and field wiring is simplified via 3.5mm field removable terminal blocks.



5-30VDC Power Input Version Shown

Inputs	
Type	4 non-polarized optically isolated inputs
Voltage Range	5-30VDC non-polarized
Isolation	2500VAC RMS / 3500VDC
Input Resistance	6.2K Ohms in series

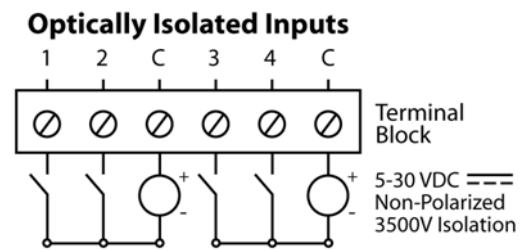

140 SERIES – 4 FORM A REED RELAY OUTPUTS

The ei/O-140 provides 4 SPST Form A dry-contact Form A Reed Relays. Form A Reed Relays offer long life performance and fast response time. Field wiring is simplified via 3.5mm field removable terminal blocks.



Power over Ethernet Option Shown

Outputs	
Type	4 SPST Form A Reed Relays
Contact Max Power	10W
Switching Voltage Max DC / Peak AC Resistive	60VDC / 42VAC
Switching Current Max DC / Peak AC Resistive	500mA
Relay Max Operate Time, including Bounce*	1ms
Relay Max Release Time*	0.2ms

Reed Relay Outputs

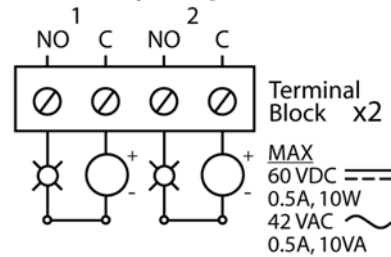

Do not connect protective earthing or protective bonding conductor wiring of any equipment to relay contact outputs.

*Minimum hardware requirements

150 SERIES – 4 FORM C RELAY OUTPUTS

The eI/O-150 provides 4 SPDT Form C relay outputs. The high current Form C relays switch up to 60VDC, or 200VAC. Each Form C relay has a discrete common and includes normally-open and normally-closed contact connections. Field wiring is simplified via 3.5mm field removable terminal blocks.



5-30VDC Power Input Version Shown

Outputs	
Type	4 SPDT Form C relays
Power	DC 240W / AC 300VA
Contact Voltage	60VDC / 200VAC max. (5VDC min.)
Contact Current (DC)	≤30 VDC @ 5A max. >30 VDC @ 2000mA max. (100mA min.)
Contact Current (AC)	6A max.

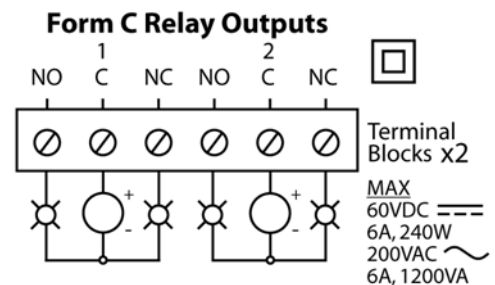

Do not connect protective earthing or protective bonding conductor wiring of any equipment to relay contact outputs.

160 SERIES – 32 CHANNEL TTL DIGITAL INTERFACE

Control and monitor up to 32 channels of buffered drive digital I/O with the eI/O-160. The module addresses the 32 channels of I/O as four eight-bit ports, each programmable as input or output. Use a standard 50-pin IDC ribbon cable to connect an industry standard relay rack for PC based control and automation of equipment including sensors, switches, security control systems, and other industrial automation systems. The eI/O-160 50 pin digital interface is pin compatible with the Sealevel SeaDAC Lite 8126 and will accept 8126 accessories.



Power Requirements	
Max Output Power	+5VDC @ 350mA
Inputs	
Logic High	Min 2VDC
Logic Low	Max 0.8VDC
Outputs *	
Logic High	Max 0.5VDC @ 64mA
Logic Low	Min 2VDC @ 32mA

N The eI/O-160 is designed to work with industry standard solid-state relay racks that expect negative logic to operate. The eI/O-160 itself uses positive logic for inputs and outputs.

The eI/O-160 addresses the 32 channels of buffered drive digital I/O as four eight-bit ports. Each port is programmable as input or output. The I/O channels are accessed via an industry standard 50-pin header connector. Use a standard 50-pin 0.100" pitch IDC ribbon cable to connect to an industry standard relay rack, terminal block (Item# TB07), or relay rack simulation module (Item# TA01). Each channel can sink up to 64mA or source up to 32mA. All channels combined cannot exceed a total output of 350mA.

N Relay racks with less than 32 channels and the TA01 simulation module expect all even pins to be commons. When using the TA01 or relay racks with less than 32 channels, set Port D as an input to avoid shorting the outputs to ground through the relay rack.

N Relay modules vary in their performance and characteristics. Discrete output modules available from typically draw 10mA each but may draw 27mA in a worst case scenario. This actual current draw and the number of modules used will determine how many can be powered by the +5V on pin 49 of the 160E/POE. Contact your relay vendor to determine the actual current requirements.



Many relay racks allow the modules to be powered by an external power supply. This can allow more higher powered devices to be used. In this case, a jumper on the relay rack must be disconnected so the external power supply does not back power the 160E/POE via pin 49. Contact the manufacturer of the relay rack to determine how this jumper can be disconnected.

50-PIN HEADER CONNECTOR

The eI/O-160 has the following pin out which is compatible with a wide variety of industry standard solid-state relay racks.

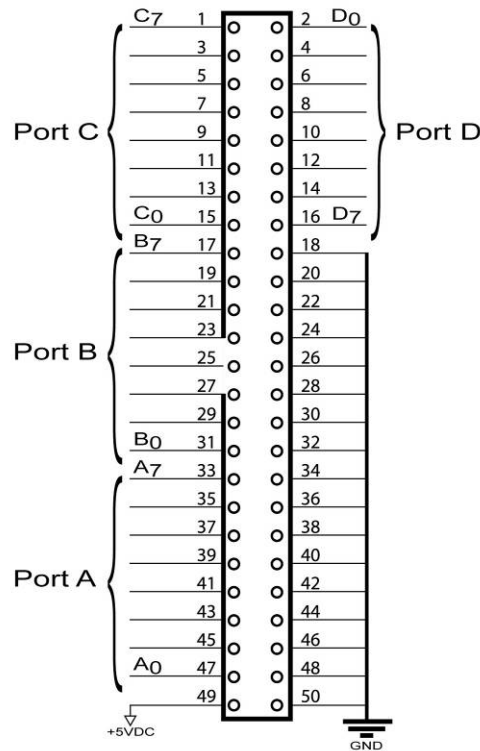

TTL LOGIC & EXAMPLE CIRCUITS

The eI/O-160 uses 74ABT245B octal bidirectional transceivers to provide TTL input/output capabilities. Each bit is pulled to +5V through a 10K Ω pull-up resistor to insure each bit is at a known state when not driven. If an input is not connected to ground, it will read as a one (1) due to the 10K Ω pull-up resistors on each port.

Input Circuit Schematic

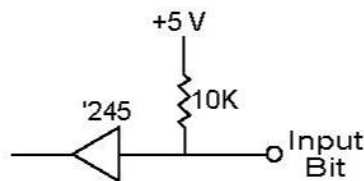

TTL Input

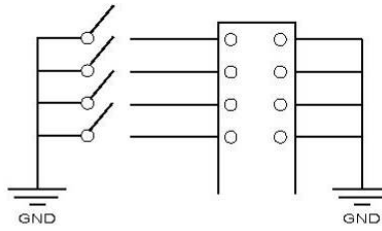

Output Circuit Schematic

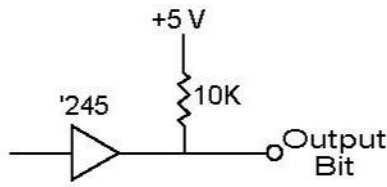

TTL Output

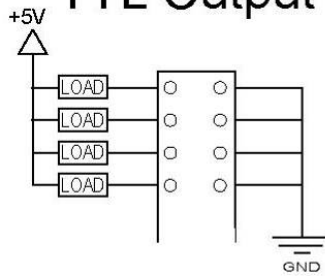

Solid State Relay Output

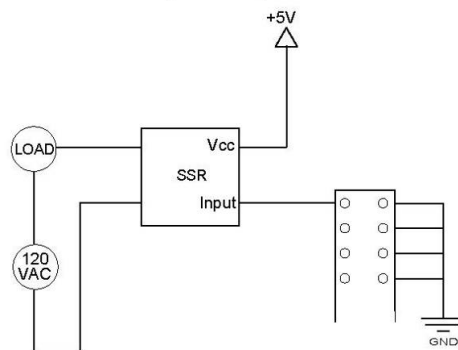

170 SERIES – 8 ANALOG INPUTS / 2 OPTICALLY ISOLATED DIGITAL INPUTS/ 2 SOLID STATE RELAY OUTPUTS

The ei/O-170 provides 8 analog inputs 2 optically isolated digital inputs and 2 SPST Form A solid state relay outputs. Analog inputs can be configured via software as 8 single ended inputs or 4 differential inputs. Voltage ranges are software configurable as 0-5V, 0-10V, -5V to 5V and -10V to 10V to provide optimal accuracy depending on application. Digital inputs are pre-biased internally and current limited so a connection to ground is all that is necessary to activate the input. The inputs also provide 1000V isolation to digital ground. Solid state relays can switch up to 60VDC at 2.5A.



Power over Ethernet Option Shown

Analog Inputs	
	8 single ended or 4 differential
	0V-5V, 0V-10V, -5V-5V, -10V-10V
	12bit
	100kΩ

The analog inputs can operate as 8 single ended inputs or 4 differential inputs. See wiring diagrams below for terminal numbering and channel pairing.

Eight 12-Bit Single-Ended A/D Inputs

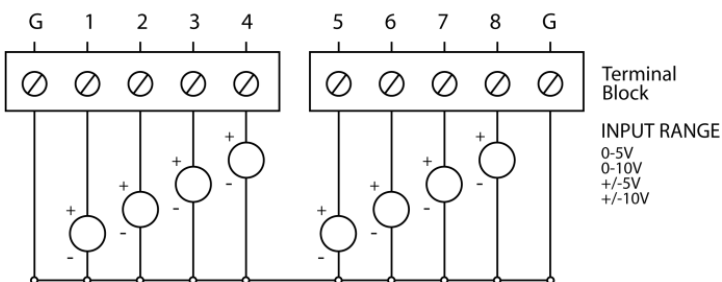

Four 12-Bit Differential A/D Inputs

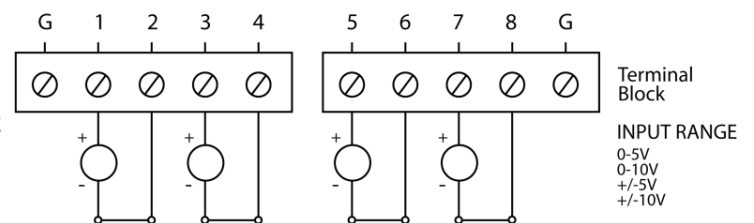

170 Description (cont)

Relay Outputs	
Type	2 SPST solid state relays
Power	DC 150W
Contact Voltage	60VDC max
Contact Current (DC)	2.5A max.
Digital Inputs	
Type	2 Dry Contact Sensing
Isolation	1000VDC
Source Current	12mA max

Solid-State Relay Outputs

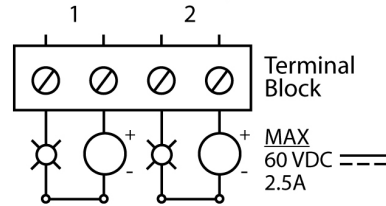

Optically Isolated Inputs

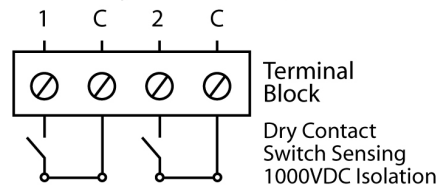

The optically isolated digital inputs featured on the 170 are designed unlike the opto-inputs found on many other Sealevel products. The 170 provides a voltage to the opto input, which is current limited with a 330 ohm resistor. Connecting either of the inputs to a common pin will cause current to flow through the opto-isolator, activating the input.

The inputs were designed this way, so the end-user does not need to provide a voltage source. A simple external contact closure is all that is required to trigger the input.



Two common pins are provided with the optically isolated inputs for convenience; however, both common pins of the inputs are electrically equivalent on the board.

The diagram below shows how the inputs are intended to be used.

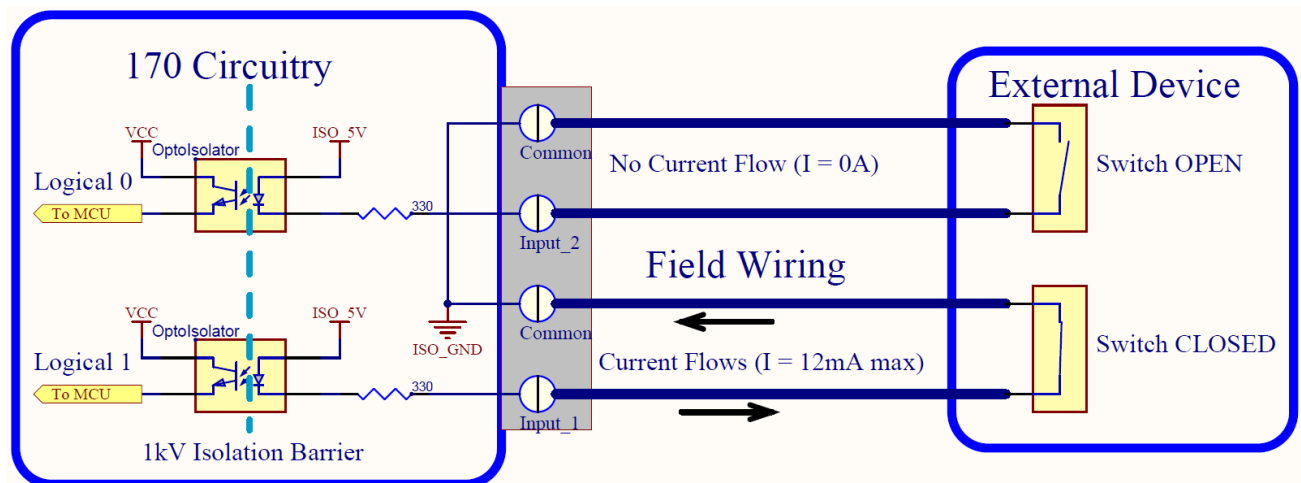

Power Options

eI/O Power Connection

eI/O standard units are powered from a 9-30VDC  source using the screw terminals on the side of the unit. Sealevel offers several power supply choices to make connection easy (see the Optional Items section in the beginning of this document).

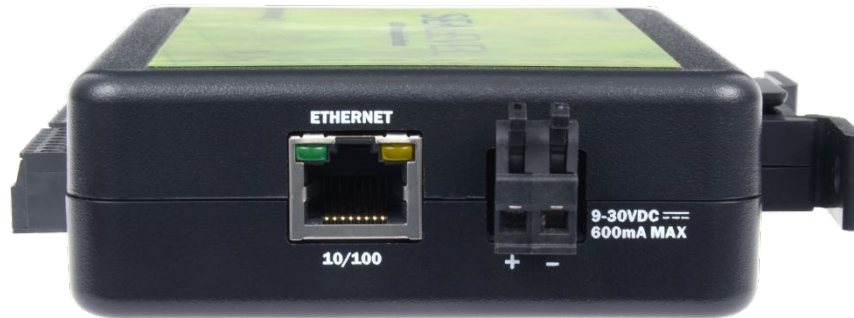

DC supply wiring must be made in accordance to all local and national electrical codes. In particular, DC supply wiring must include overcurrent protection which limits the maximum fault current to 8A.

The eI/O PoE units are Class 0 (IEEE 802.3af-2003) Power over Ethernet devices. This allows power and data to be transferred over a single CAT5 cable and eliminates the need for an external power supply. With PoE, power can be supplied by power sourcing equipment including PoE switches (midspans) and injectors.

eI/O Max Power Requirements

	Standard Series	Power Over Ethernet Series
eI/O-110	2.5W	2.5W
eI/O-120	5W	5W
eI/O-130	2W	2W
eI/O-140	2.2W	2.2W
eI/O-150	5W	5W
eI/O-160	7.2W	8W
eI/O-170	3W	3.5W

SeaMAX Application Suite

SeaMAX Overview

The SeaMAX Suite is a collection of configuration/diagnostic utilities and software libraries that enable rapid application development. The SeaMAX API, included in the SeaMAX Suite, provides a common API for Sealevel eI/O, Seal/O and SeaDAC data acquisition modules. SeaMAX is designed to simplify application development by requiring little knowledge of the underlying communication protocols of these devices and replacing low-level programming. SeaMAX is available in an unmanaged library and a wrapper library that provides an interface to the API from managed code.

The following libraries and utilities are included in the SeaMAX Suite:

- MaxSSD Configuration & Diagnostics utility
- Ethernet Config utility
- SeaMAX API
- SeaMAX .NET API

The SeaMAX API documentation, installed with SeaMAX, explains the usage and API references, including function calls and enumerations. Sealevel digital and analog I/O modules supported by SeaMAX software are designed to work with third party applications via the SeaMAX API. To help simplify application development, the complete API documentation and code samples are automatically installed with the SeaMAX Suite and can be found in Windows by clicking Start → All Programs → Sealevel Systems → SeaMAX → Documentation. For convenience, Sealevel offers a PDF version of the [SeaMAX manual](#) on our website. Example code is also included for several popular languages and compilers.

Please contact Sealevel technical support with any questions regarding SeaMAX documentation:

Phone: (864) 843-4343

Email: support@sealevel.com

Communicating Via Modbus

Sealevel eI/O modules are designed to integrate seamlessly into existing Modbus/TCP networks. The supported command set will vary depending on the eI/O model number used. Specialized diagnostic commands and other RTU specific codes are not supported. An overview of the Modbus specification for TCP connections is covered in detail in the interactive documentation located on the Sealevel website at <http://www.sealevel.com/software/SeaMAX>.

The official Modbus specification can be found at <http://www.modbus.org>.

SeaMAX Software Installation

Proceed with downloading the SeaMAX Software Suite from www.sealevel.com. Software drivers are also available on the product webpage.



To install Sealevel Systems software, you must log in as an administrator or have administrator privileges in Windows.



Only users running Windows 7 or newer should utilize these instructions for accessing and installing the appropriate driver via Sealevel's website. If you are utilizing an operating system prior to Windows 7, please contact Sealevel by calling 864.843.4343 or emailing support@sealevel.com to receive access to the proper driver download and installation instructions.

Instructions for Software Installation

1. To obtain the most current software software package from Sealevel's website, download from here:
 - [SeaMAX for Windows](#)
 - [SeaMAX for Linux](#)
2. Choose the link for the target operating system and click on the 'Download File' link to download the current version.
3. Once downloaded, if you are using Windows 7 or newer operating systems, *right* click on the installer executable and choose 'Run as Administrator'. If you are using an operating system prior to Windows 7, double click on the executable to launch the InstallShield and initiate the driver installation.
4. The setup files will automatically detect the operating environment and install the proper components. Follow the information presented on the screens that follow.
5. A screen may appear with text similar to: "The publisher cannot be determined due to the problems below: Authenticode signature not found." Please click the 'Yes' button and proceed with the installation. This declaration simply means that the operating system is not aware of the driver being loaded. It will not cause any harm to your system.
6. During setup, the user may specify installation directories and other preferred configurations. This program also adds entries to the system registry that are necessary for specifying the operating parameters for each driver. An uninstall option is also included to remove all registry/INI file entries from the system.
7. The software is now installed, and you can proceed with the hardware installation.

Upgrading to the current EIO software (SeaMAX)

Before upgrading your SeaMAX software, you first need to uninstall the previous version. Follow these steps to uninstall the software.

1. Download the current SeaMAX software using the instructions from the *Downloaded Software Installation* section above. Please take note of the destination directory to which it will save.

MaxSSD Configuration & Diagnostics Utility

The Sealevel Systems configuration utility, MaxSSD, is designed to simplify the installation, configuration, and diagnostics of Sealevel eI/O and Sea I/O modules. MaxSSD is a Microsoft Windows application and has been tested with Windows 2000, XP, Vista, and Windows 7.

HOST PC CONFIGURATION TAB

When you run the MaxSSD utility (Start → All Programs → Sealevel Systems → SeaMAX → MaxSSD Configuration Utility) it will default to the “Host PC Configuration” tab. This tab allows the user to choose the initial communication settings for the connected I/O device. The “COM Port” dropdown box allows the selection of a serial COM port (from COM1 to COM256), and Ethernet (for Ethernet and Wireless Sealevel I/O modules).

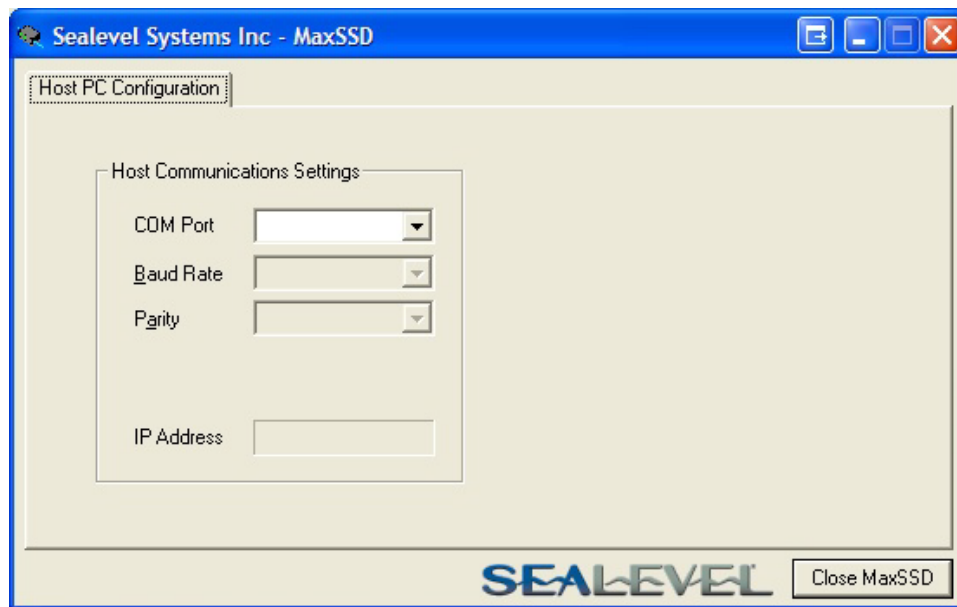

To communicate with an eI/O module, select “ETHERNET” from the “COM Port” dropdown box. When Ethernet is selected, MaxSSD searches for any Seal/O Ethernet or Wireless modules on the network and displays their IP addresses in the “Available Ethernet Devices” list box (not shown). When an IP address is selected from the list box, a socket is opened to the Seal/O module, and it is ready for communication.

If your eI/O module is set to a different subnet, you will need to type in the IP address into the IP Address field displayed in MaxSSD and press Enter. MaxSSD will try to open port 502 on that address. When the connection succeeds, it will display the “SealO Configuration” tab.

N If no IP address is shown and your eI/O module is on the same subnet as the MaxSSD computer, review the previous Hardware Configuration section or proceed to the Troubleshooting section at the end of this manual.

SEAL/O CONFIGURATION TAB

Once the host computer is configured correctly, the “Seal/O Configuration” tab becomes available. Before communicating with an eI/O module, the configuration utility must determine if there is an I/O module, and if so, what type of module it is. This is the purpose of the Get operation.

N The eI/O modules will respond to any Slave ID, so just use the default.

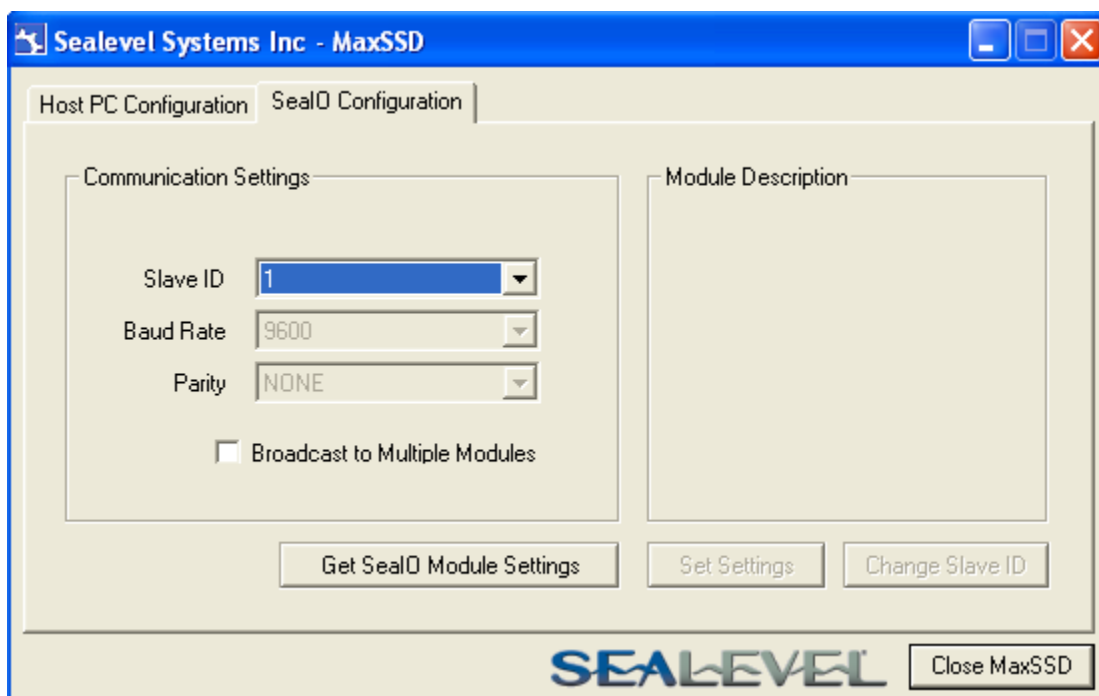

Click the “Get SealO Module Settings” button. After a short delay, the information for that I/O module should be displayed. If no information appears, verify that the host settings are correct and make changes if necessary.

After the Get command is executed, the “Module Description” frame will display the model type, description, firmware version number, interface, and I/O type. In the example shown, the module found at slave ID 1 is an eI/O 170 module with a PoE (Modbus TCP) interface.

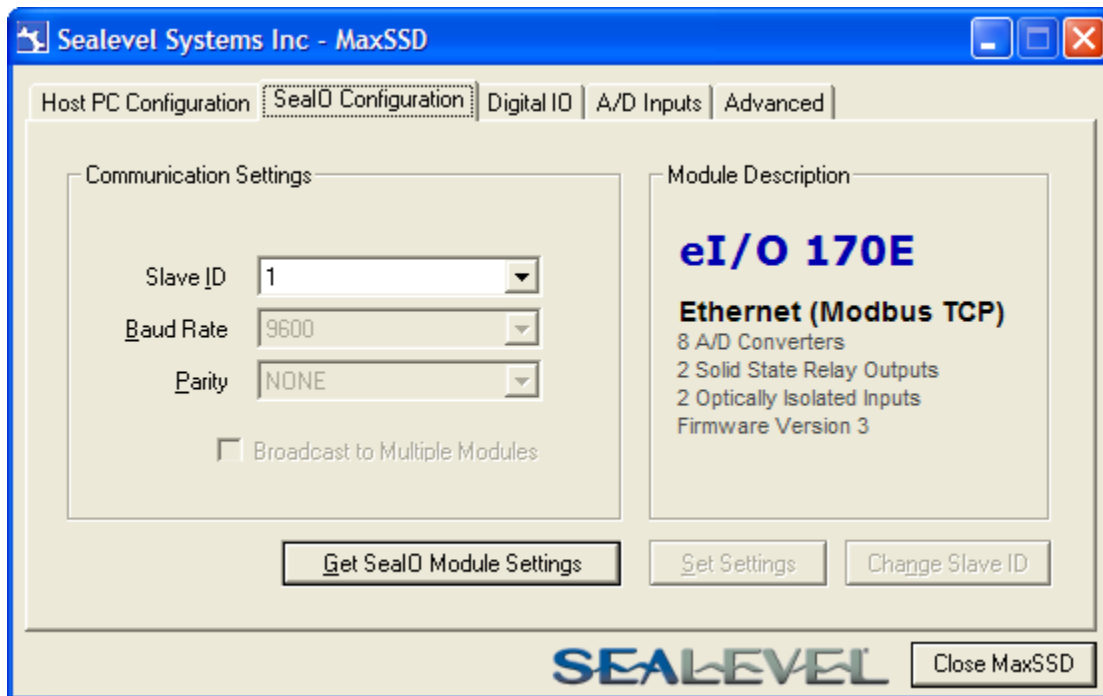

After a successful Get operation, additional tabs may be displayed in MaxSSD, depending on the device model found. These tabs display device I/O and allow easy configurations for all SeaMAX supported devices.

DIGITAL I/O TAB

The 'Digital IO' tab of MaxSSD is displayed when using Sealevel I/O devices featuring discrete inputs and outputs. It displays the device's current input and/or output status in an intuitive and usable manner.

When banks of inputs are displayed, the status LEDs update on each of the banks automatically. This allows you to actively monitor external signals.

With a bank of outputs, the output coils can be set using the buttons below each output LED. As each coil is set, the I/O module is read. The corresponding status LED in the 'Digital IO' tab indicates the state of the coil. In the example below, an eI/O module with 4 optically isolated inputs and 4 Form C relays is shown.

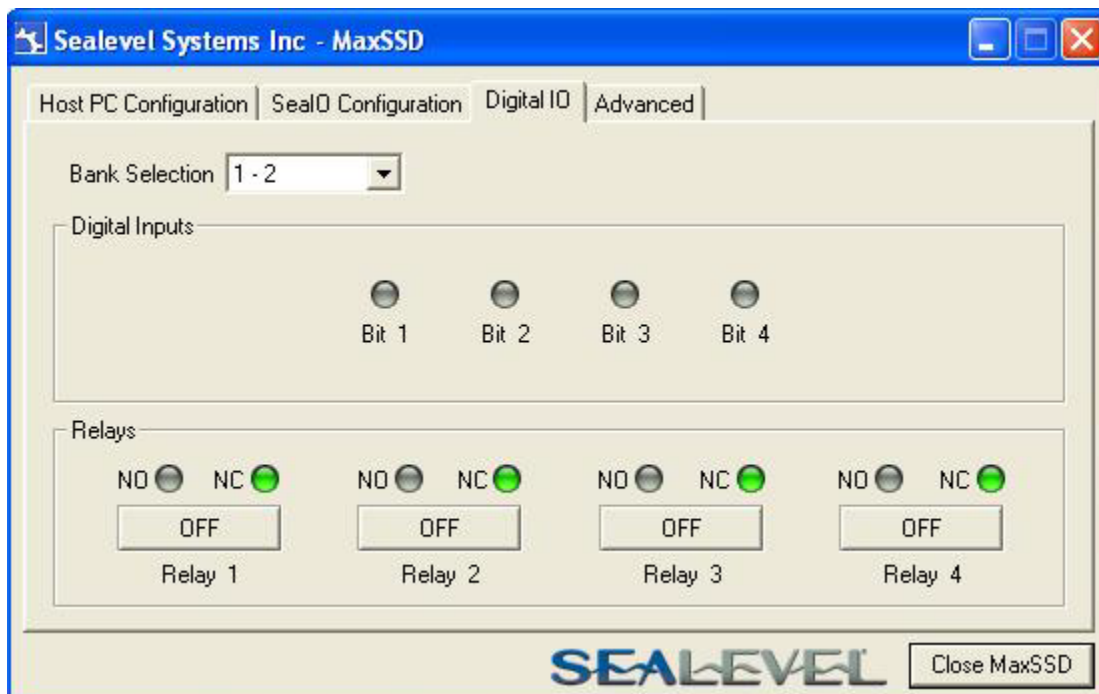

A/D INPUTS TAB

The “A/D Inputs” tab displays the current state of the analog-to-digital channels for Sealevel I/O devices that feature A/D inputs. Settings are provided for both device wide and per-channel configuration.

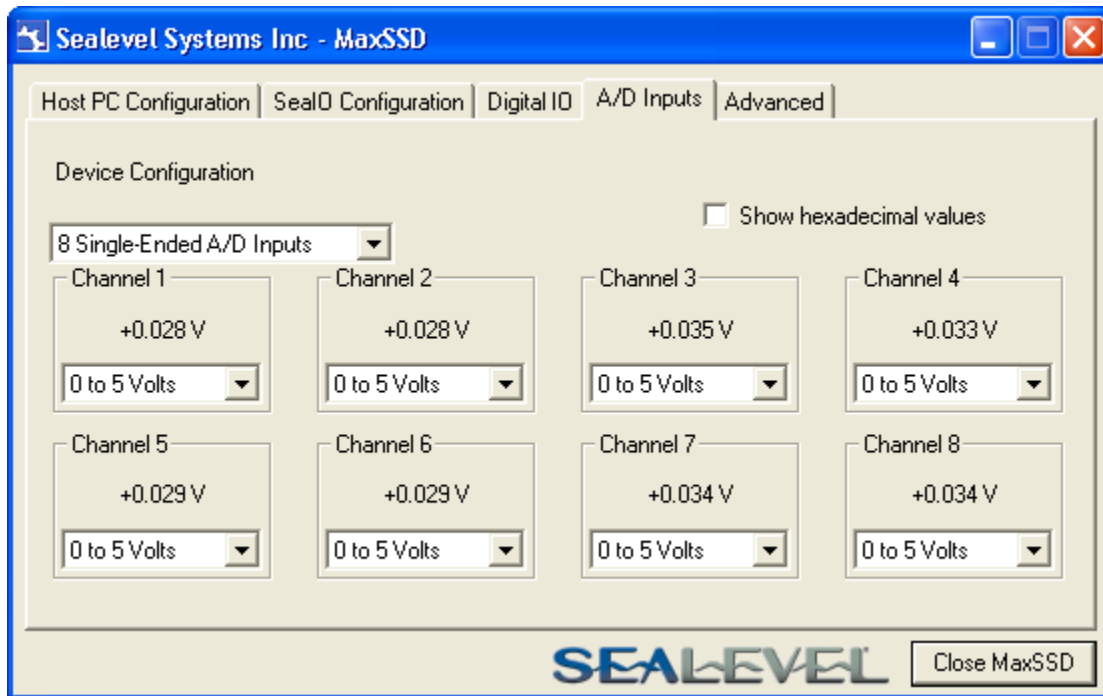

The “Device Configuration” selection drop-box adjusts the arrangement and function of the A/D input channels. Input channels are displayed as banks (groups of up to eight). Each channel is range configurable via the voltage range dropdown list. Both the channel voltage range and device-wide configuration are set on a dropdown list. There is no need to save your settings – they are automatically saved to the device as you select the various configuration options.

“Show Hexadecimal Values” checkbox – Displays the values returned by the A/D converter as a hexadecimal value without converting the values to engineering units (i.e., Amps or Volts).

CONVERTING A/D VALUES

To properly use the values returned from the eI/O-170 module’s A/D channels, the application program must convert the returned values to engineering units (voltage).

The conversion formulas will vary depending on how the I/O module is configured. The formulas and their uses are covered in detail in the interactive documentation located on the Sealevel website at <http://www.sealevel.com/software/SeaMAX/>. For ease of use, SeaMAX functions to convert A/D values have been provided. Use of these functions is also detailed in the SeaMAX Software Manual.

TROUBLESHOOTING SEAMAX

Following these simple steps can eliminate most common problems.

1. Read this manual thoroughly before attempting to install the device in your system.
2. Uninstall any previous versions of the SeaMAX software before installing any new versions.
3. Confirm that all screw terminal connections are correct and secure and that the correct cables are being used, including network cables (crossover vs. patch cables).
4. Use the MaxSSD utility, included in the SeaMAX software suite, to verify proper installation. MaxSSD is designed to simplify the installation, configuration, and diagnostics of Sealevel Seal/O modules.
5. Refer to the Troubleshooting Ethernet eI/O Modules and Factory Resetting Ethernet eI/O modules sections on the following page for additional steps regarding eI/O modules.
6. If these steps do not solve your problem, please contact Sealevel Technical Support. Our technical support is free and available from 8:00 AM – 5:00 PM EST, Monday through Friday. You can contact Technical Support via email at support@sealevel.com or by phone at +1 (864) 843-4343.

TROUBLESHOOTING ETHERNET eI/O MODULES

Problem: The eI/O module starts up with a strange IP address (i.e., 192.168.42.253).

All eI/O modules are shipped with the static IP address 192.168.42.253. To change, connect the module directly to a PC using the supplied network cable and set the PC's network settings to place both the eI/O module and PC on the same subnet. Adjust the eI/O module's IP address and subnet mask using the Ethernet Config utility (Start → All Programs → Sealevel Systems → SeaMAX → Ethernet Configuration Tool) installed with SeaMAX. Then restore the PC's network settings.

Problem: The eI/O module is visible in Ethernet Config, but the network settings cannot be changed.

The eI/O module is most likely on a different subnet than the PC. The PC's IP address and Netmask must be altered to place both the eI/O module and the PC within the same subnet. Contact your network administrator for assistance.

Problem: The eI/O module does not show up in Ethernet Config.

eI/O modules are discovered via a UDP broadcast. Verify that any firewall software, such as Windows Firewall, ZoneAlarm, etc., or router settings that would hinder UDP transmissions are disabled.

It is also possible that the eI/O module may not be discovered if the PC and module are on separate subnets. This may occur if the module's IP address is configured outside the range of the PC's subnet. It can also occur during a failed DHCP discovery. In either case, the "Recover Module" button in Ethernet Config utility may be used to recover the device. Refer to the Hardware Configuration section of this manual for more information.

FACTORY RESETTING ETHERNET eI/O MODULES

If the unwanted behavior persists, the entire configuration of an eI/O module can be reset to its original factory state so that it resumes the original shipping behavior and configuration.

1. Disconnect power to the module. For PoE models this is the RJ-45 network connection.
2. If your eI/O model's reset button is accessed from inside, unscrew the four screws on the bottom and lift the module's top off from the side opposite the Power LED.
3. Press and hold the reset button next to the RJ-45 network port.
4. While continuing to hold the reset button, reconnect power to the module and wait 10 seconds. If you release the button early, disconnect power and try again from step 3. If you have a non-PoE model, using a switched power strip to control the power connection to the module may make this step easier.
5. Release the button.

If these steps do not solve your problem, please call Sealevel Systems' Technical Support, (864) 843-4343. Our technical support is free and available from 8:00 A.M.- 5:00 P.M. Eastern Time Monday through Friday. For email support contact support@sealevel.com.

Hardware Configuration

Configuring Ethernet

All eI/O modules are shipped configured to static IP address 192.168.42.253. If this IP address will not work on your network or it is already used, you can change the IP address using the Ethernet Config utility. Verify that SeaMAX software has been installed successfully and that an eI/O module is connected directly to your computer using the network cable supplied with your module. Next you need to configure the network adapter. Specifics details of this configuration vary with operating systems, but in general you need to change the IP address of the network adaptor to which your eI/O module is connected. The IP address of the adaptor should be 192.168.42.254 (the last octet can be anything but 253).

Start the Ethernet Config utility (Start → All Programs → Sealevel Systems → SeaMAX → Ethernet Configuration Tool) installed with SeaMAX.

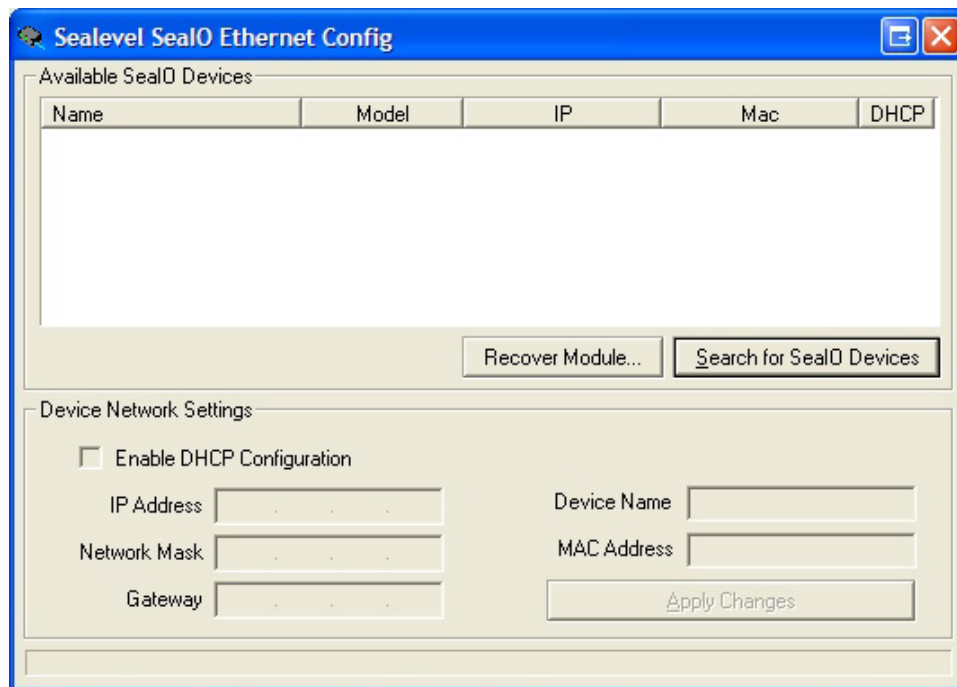

Click on the “Search for Seal/O Devices” button and the ‘Available Seal/O Devices’ pane should refresh with any Ethernet or Wireless Seal/O and any eI/O modules that are connected to any network(s) attached to your computer. Select one of the devices in the list by clicking on it. You can update the network settings for that device in the Device Network Settings pane and then confirm these changes by clicking the “Apply Changes” button. The device list should refresh, indicating that your changes were successful. Checking the “Enable DHCP Configuration” box will configure the device to get an IP address from the DHCP server for your network once the device is connected to that network. Once connect, refresh the device list using the ‘Search for SealIO Devices’ button to get the device’s IP address.

If an eI/O module has been configured to DHCP mode, when you connect it to the network, the status LEDs on the front of the module will blink while it searches for a DHCP server. Once it receives an IP address, the status LEDs will remain on.

Now start MaxSSD (Start → All Programs → Sealevel Systems → SeaMAX → MaxSSD Configuration Utility) and choose the correct IP address to communicate with the eI/O module. Ensure a successful Get operation (refer to the MaxSSD section of this manual for more information).

RESETTING AN ETHERNET eI/O MODULE

An eI/O module may become no longer visible in the module list in the Ethernet Config utility if the eI/O module has been configured to use a different subnet than the host computer.

In other cases, the eI/O module does not appear in the module list due to a DHCP discovery failure. In either case, clicking on the “Recover Module” button (see image on previous page) in the Ethernet Config utility will bring up the “Module Reset” window shown below.

Module Reset

Before recovery, please ensure that the module is connected to the PC via a cross-over Ethernet cable or hub. Then use the drop down box to select the network interface the device is connected to.

Enter the module's MAC address (found on the bottom box label) below with dashed-octet format: XX:XX:XX:XX:XX:XX.

Network Interface
Network: 192.168.66.10

MAC Address
[Input field]

Network Settings
 Enable DHCP Configuration
IP Address: [Input field]
Network Mask: [Input field]
Gateway: [Input field]

Buttons: Cancel, Recover Module...

Before recovery begins, make certain that the PC and eI/O module are on the same network segment – they should be connected directly using the included Ethernet cable (blue or yellow), through a hub, or through a non-routing switch. The PoE series of eI/O modules ship with an Ethernet patch cable (blue). The other eI/O models ship with a crossover cable (yellow). If the correct type of cable is used, most PC network cards should support a direct connection with the eI/O module.

Next, select the IP Address of the network card your eI/O module is connected to from the dropdown labeled “Network Interface.”



If IP address of that network card should be in the same subnet with (but not identical to) the IP address that the reset will give the eI/O module. If this is untrue, or the IP address of the network card is within one number of the eI/O module’s current IP address, reconfigure the card to another IP address before you proceed. Once the card is reconfigured, click “Cancel” in the reset window and click “Recover Module” again. You can now select the card’s new IP address under “Network Interface”. After the module is configured, you can restore the network card to its original IP address.

Enter the MAC address found on the label on the bottom of the eI/O enclosure. A MAC address is made up of six pairs of hexadecimal digits separated by dashes (i.e., xx-xx-xx-xx-xx-xx). The label on your device may or may not include the dashes. While entering the MAC address, the indicator to the right of the field will turn red if the MAC address entered is invalid. Once a MAC address is successfully entered, the indicator light will turn green, and the “Network Settings” options will be enabled.

Contact your network administrator if you are unsure of the proper network settings to choose. If a DHCP server is available, select the “Enable DHCP Configuration” checkbox. Otherwise, complete the network settings and click the “Recover Module” button to complete the configuration changes.

Advanced Features

ADVANCED FEATURE CAPABILITY

Modules with version “2” or higher support several Advanced Features. You may determine the version of your SealO device using the MODBUS command FUNC_SEAMAX_GET_EXTENDED_INFO (0x66), using the SeaMAX method SM_GetDeviceConfig(), or by viewing the Module Description in MaxSSD, shown below.

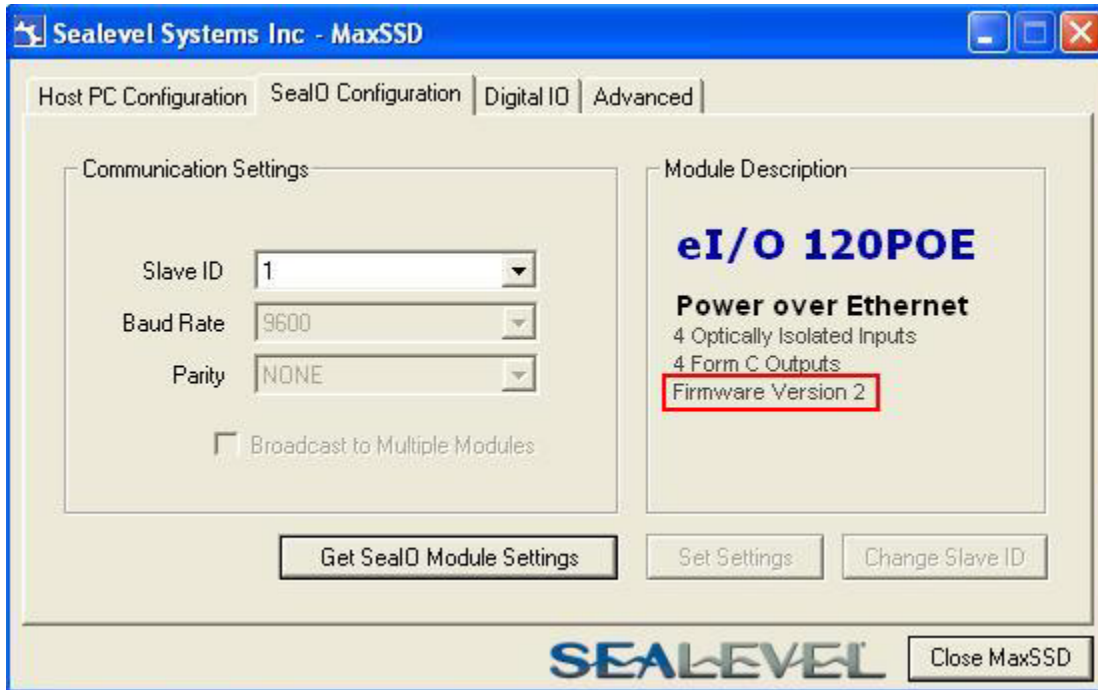

FIRMWARE UPGRADING

In the event that a newer version of the firmware is available, it is possible to upgrade the firmware in the unit. This can be done through the same port that is used to do normal communications with the unit. The unit must be directly connected to the programming computer.



The following should only be performed if you (1) really feel the update is required and (2) you feel confident in your ability to perform the update. Once the firmware has been erased, you must either be able to re-program it locally or send it back to Sealevel Systems, Inc. for reprogramming.

Exercise caution when performing a firmware upgrade to ensure that the process does not get interrupted until it is completed. Once the firmware has been erased, you must either be able to re-program it locally or send it back to Sealevel Systems, Inc. for reprogramming.

This firmware upgrade will be a file with a name similar to your eI/O model number with an extension of “.hex”. As an example, if you have an eI/O 120 style module, the programming file name would be “120.hex”. Please contact Tech Support to receive the latest version of the firmware.

The device’s firmware can be upgraded in one of two ways. The preferred method is through the MaxSSD Configuration Utility the command prompt. The second is using a command prompt procedure.

UPGRADING FIRMWARE VIA THE MAXSSD CONFIGURATION UTILITY

To upgrade your firmware through MaxSSD, connect to your device normally, and then go to the “Advanced” tab. At this point, you can use the “...” button to browse for the *.hex file you wish to update your device with.

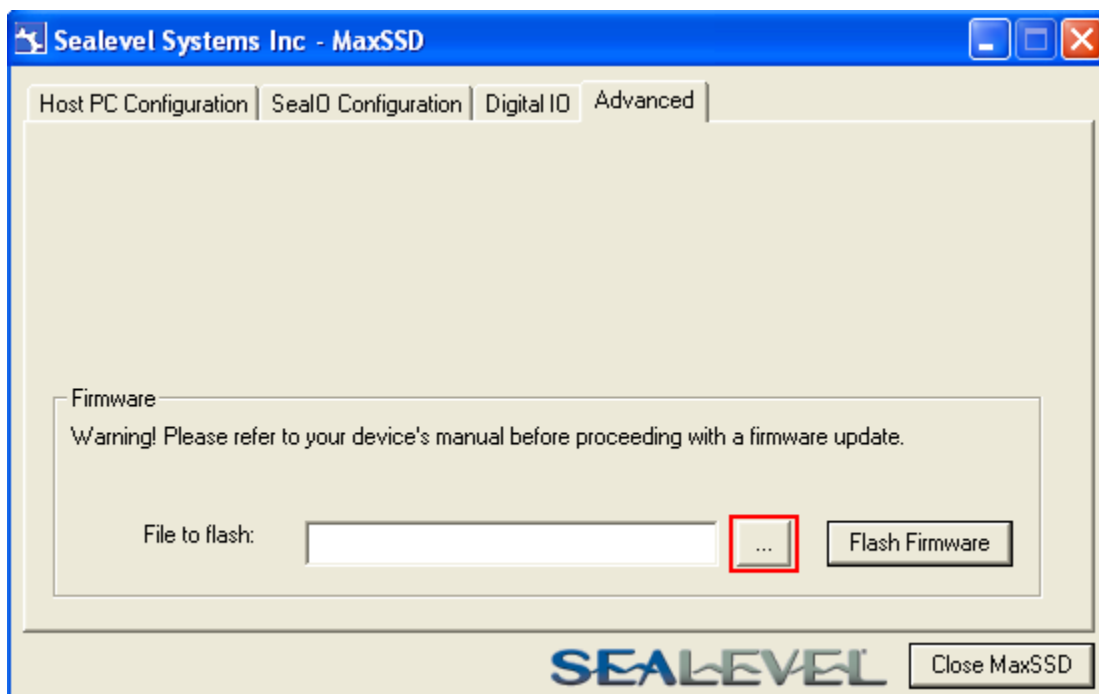

Once the proper file has been selected, click on the “Flash Firmware” button.

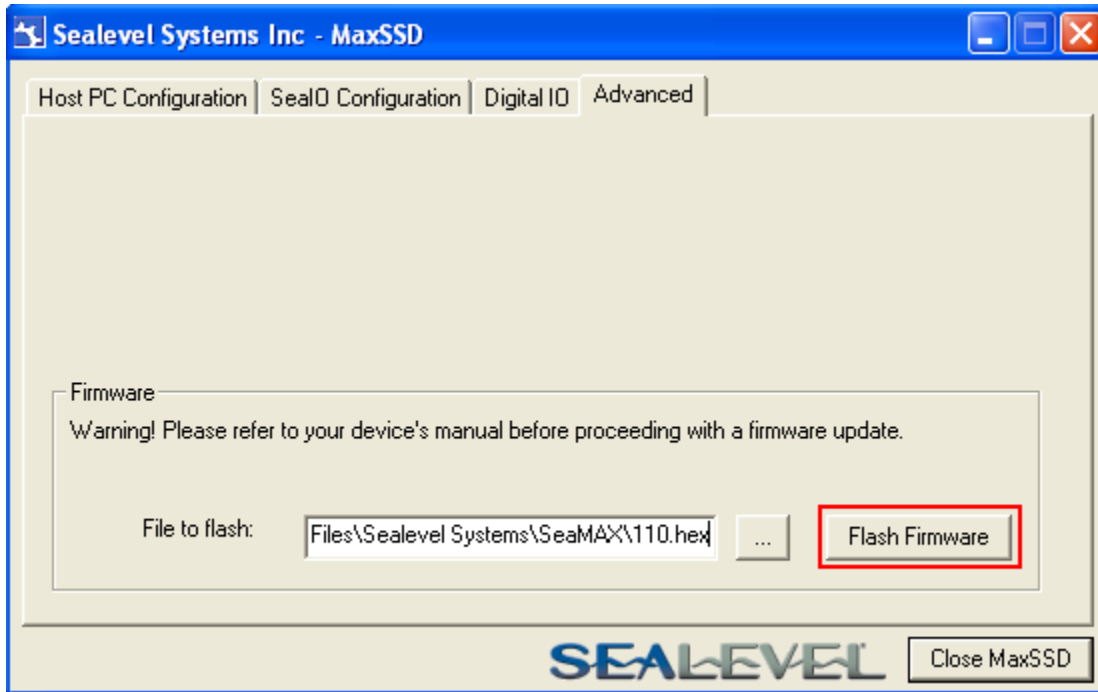

At this point, SeaMAX will give you a warning dialog. If you click “OK” then MaxSSD will attempt to flash your device with new firmware. If you click on the “Cancel” button, no changes will be made.

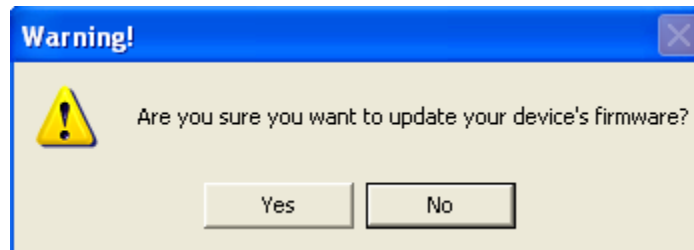

Clicking “OK” will result in IOCU.exe being run in a terminal window. Once the unit has received the download request it will turn on the ACT light. Once the download starts, the ACT light will flash rapidly as data is downloaded. Once the download is complete, the ACT light will remain on while the device is reprogramming itself. The unit will then reboot itself to reload the new firmware. At this point, the ACT light will turn off, and the terminal window will close. MaxSSD will return you to the Host PC Configuration tab.

UPGRADING FIRMWARE VIA COMMAND PROMPT PROCEDURE

To execute IOCU.exe from a command prompt, Click on Start, then click Run and type "cmd" (without the quotation marks) and hit ENTER. You will then see a command prompt (i.e. c:\documents and settings\name>). Once you are at the command prompt, browse to your SeaMAX folder. The default location is "C:\Program Files\Sealevel Systems\SeaMAX\" (or "C:\Program Files (x86)\Sealevel Systems\SeaMAX" on 64-bit systems). Your *.hex file should be saved to this folder as well. If your operating system requires administrator permissions for this action and you cannot provide them, another folder outside the Program Files folder can be used, but a full path to the file will be required in the following step.

Type

Cd "C:\Program Files\Sealevel Systems\SeaMAX\" and then press Enter

When the command calls for iii.iii.iii.iii you substitute the unit's IP address. Please do not enter the numbers with a leading zero. Therefore, if your IP address is 192.168.42.11, you will enter 192.168.42.11 and not 192.168.042.011. The command for this is therefore:

iocu /i=192.168.42.11 /a=247 120.hex

Once the unit has received the download request it will turn on the ACT light. Once the download starts, the ACT light will flash rapidly as data is downloaded. Once the download is complete, the ACT light will remain on while the device is reprogramming itself. The unit will then reboot itself to reload the new firmware. At this point, the ACT light will turn off.

Connector Pin Outs

eI/O ETHERNET PINOUT

eI/O Ethernet connector is used for both data and power in the PoE series of modules. Both DC on spares (Mode B) and mixed DC and data (Mode A) Power over Ethernet 802.3af-2003 configurations are acceptable for the eI/O. The eI/O PoE series modules are class 0 power over Ethernet devices.

ETHERNET / POE (CONNECTOR – RJ-45)

Pin	Signal	PoE Mode A	PoE Mode B
1	TX+	TX+/DC+	TX+
2	TX-	TX-/DC+	TX-
3	RX+	RX+/DC-	RX+
4	N/A	N/A	DC+
5	N/A	N/A	DC+
6	RX-	RX-/DC-	RX-
7	N/A	N/A	DC-
8	N/A	N/A	DC-

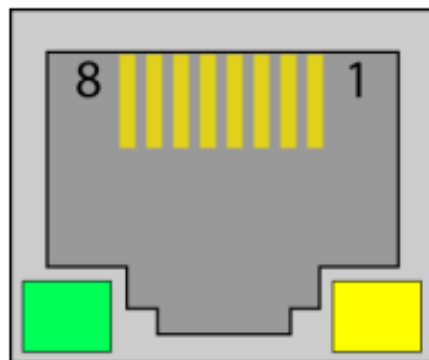

This module is not intended to be directly connected to wiring outside a building.

Mounting Options

DIN Rail Mounting

eI/O modules ship ready for mounting on DIN rail. A small, rugged plastic (shown below) is included that snaps onto 35mm DIN rail. This offers a clean installation by locating the I/O modules near the industrial control equipment on the DIN rail. Additionally, 3.5mm removable screw terminals allow for an easy and reliable connection method.



Wall/Panel Mounting

As an alternative to DIN rail, the versatile plastic clip includes mounting holes that allow eI/O modules to be mounted to walls, under counters, or inside panels. The plastic clip can be permanently mounted to a surface while still allowing the eI/O module to be easily removed for service or configuration changes.



Table/Desktop Mounting

eI/O modules are perfect for table or desktop use. The units ship with four rubber feet that help prevent the devices from sliding due to vibration and help protect surfaces from scratches. The small enclosures take up very little space.



Appendix A – Handling Instructions



Safety Instructions

- Read these instructions completely. Keep these instructions.
- Do not use or install this apparatus near water. Clean only with a dry cloth.
- This apparatus is not intended for outdoor use. It is intended for indoor use only.
- This apparatus is not intended for use in hazardous (classified) locations.
- This apparatus has no user serviceable parts inside.
- Install this apparatus in accordance to all local and national electrical wiring codes.

ESD Warnings

ELECTROSTATIC DISCHARGES (ESD)

A sudden electrostatic discharge can destroy sensitive components. Proper packaging and grounding rules must therefore be observed. Always take the following precautions:

- Transport boards and cards in electrostatically secure containers or bags.
- Keep electrostatically sensitive components in their containers, until they arrive at an electrostatically protected workplace.
- Only touch electrostatically sensitive components when you are properly grounded.
- Store electrostatically sensitive components in protective packaging or on anti-static mats.

-

GROUNDING METHODS

The following measures help to avoid electrostatic damages to the device:

- Cover workstations with approved antistatic material. Always wear a wrist strap connected to workplace as well as properly grounded tools and equipment.
- Use antistatic mats, heel straps, or air ionizers for more protection.
- Always handle electrostatically sensitive components by their edge or by their casing.
- Avoid contact with pins, leads, or circuitry.
- Turn off power and input signals before inserting and removing connectors or connecting test equipment.
- Keep work area free of non-conductive materials such as ordinary plastic assembly aids and Styrofoam.
- Use field service tools such as cutters, screwdrivers, and vacuum cleaners which are conductive.
- Always place drives and boards PCB-assembly-side down on the foam.

Appendix B– How To Get Assistance

When calling for technical assistance, please have your user manual and current adapter settings. If possible, please have the adapter installed in a computer ready to run diagnostics.

Sealevel Systems provides an FAQ section on its web site. Please refer to this to answer many common questions. This section can be found at <http://www.sealevel.com/faq.asp>.

Sealevel Systems maintains a web page on the Internet. Our home page address is www.sealevel.com. The latest software updates, and newest manuals are available via our web site.

Technical support is available Monday to Friday from 8:00 AM to 5:00 PM Eastern time. Technical support can be reached at (864) 843-4343.

RETURN AUTHORIZATION MUST BE OBTAINED FROM SEALEVEL SYSTEMS BEFORE RETURNED MERCHANDISE WILL BE ACCEPTED. AUTHORIZATION CAN BE OBTAINED BY CALLING SEALEVEL SYSTEMS AND REQUESTING A RETURN MERCHANDISE AUTHORIZATION (RMA) NUMBER.

Appendix C – Compliance Notices

Federal Communications Commission (FCC) Statement



This equipment has been tested and found to comply with the limits for Class A digital device, pursuant to Part 15 of the FCC Rules. These limits are designed to provide reasonable protection against harmful interference when the equipment is operated in a commercial environment. This equipment generates, uses, and can radiate radio frequency energy and, if not installed and used in accordance with the instruction manual, may cause harmful interference to radio communications. Operation of this equipment in a residential area is likely to cause harmful interference in such case the user will be required to correct the interference at the user's expense.

EMC Directive Statement



Products bearing the CE Label fulfill the requirements of the EMC directive (89/336/EEC) and of the low-voltage directive (73/23/EEC) issued by the European Commission. To obey these directives, the following European standards must be met:

- **EN55022 Class A** - "Limits and methods of measurement of radio interference characteristics of information technology equipment"
- **EN55024** – "Information technology equipment Immunity characteristics Limits and methods of measurement".

United Kingdom Conformity Assessed Statement



Products with UKCA marking are in conformity with the essential requirements of the UK Electromagnetic Compatibility Regulations 2016:

- *Equipment must be designed and manufactured to ensure that the electromagnetic disturbance generated does not exceed the level above which radio and telecommunications equipment cannot operate as intended.*
- *The equipment has a level of immunity to the electromagnetic disturbance to be expected in its intended use which allows it to operate without unacceptable degradation of its intended use.*



This is a Class A Product. In a domestic environment, this product may cause radio interference in which case the user may be required to take adequate measures to prevent or correct the interference.



Always use cabling provided with this product if possible. If no cable is provided or if an alternate cable is required, use high quality shielded cabling to maintain compliance with FCC/EMC directives.

Warranty

Sealevel's commitment to providing the best I/O solutions is reflected in the Lifetime Warranty that is standard on all Sealevel manufactured I/O products. We are able to offer this warranty due to our control of manufacturing quality and the historically high reliability of our products in the field. Sealevel products are designed and manufactured at its Liberty, South Carolina facility, allowing direct control over product development, production, burn-in and testing. Sealevel achieved ISO-9001:2015 certification in 2018.

Warranty Policy

Sealevel Systems, Inc. (hereafter "Sealevel") warrants that the Product shall conform to and perform in accordance with published technical specifications and shall be free of defects in materials and workmanship for the warranty period. In the event of failure, Sealevel will repair or replace the product at Sealevel's sole discretion. Failures resulting from misapplication or misuse of the Product, failure to adhere to any specifications or instructions, or failure resulting from neglect, abuse, accidents, or acts of nature are not covered under this warranty.

Warranty service may be obtained by delivering the Product to Sealevel and providing proof of purchase. Customer agrees to ensure the Product or assume the risk of loss or damage in transit, to prepay shipping charges to Sealevel, and to use the original shipping container or equivalent. Warranty is valid only for original purchaser and is not transferable.

This warranty applies to Sealevel manufactured Product. Product purchased through Sealevel but manufactured by a third party will retain the original manufacturer's warranty.

Non-Warranty Repair/Retest

Products returned due to damage or misuse and Products retested with no problem found are subject to repair/retest charges. A purchase order or credit card number and authorization must be provided in order to obtain an RMA (Return Merchandise Authorization) number prior to returning Product.

How to obtain an RMA (Return Merchandise Authorization)

If you need to return a product for warranty or non-warranty repair, you must first obtain an RMA number. Please contact Sealevel Systems, Inc. Technical Support for assistance:

Available	Monday – Friday, 8:00AM to 5:00PM EST
Phone	864-843-4343
Email	support@sealevel.com

Trademarks

Sealevel Systems, Incorporated acknowledges that all trademarks referenced in this manual are the service mark, trademark, or registered trademark of the respective company.