

USB to 1-Port RS-422 DB9

Serial Interface Adapter

User Manual | 2106



SEALEVEL[®]

Contents

CONTENTS	2
BEFORE YOU GET STARTED.....	4
PRODUCT DESCRIPTION.....	5
FEATURES	5
OPTIONAL ITEMS.....	6
PRODUCT FAMILY	8
ELECTRICAL SPECIFICATIONS.....	12
CONNECTOR PIN OUT	12
LINE TERMINATION & BIASING	12
TECHNICAL SPECIFICATIONS.....	13
TEMPERATURE RANGE.....	13
POWER REQUIREMENTS.....	13
MANUFACTURING	13
HARDWARE CONFIGURATION	14
RUGGEDIZED OVERMOLD ENCLOSURE.....	14
DB9M SERIAL CONNECTOR.....	14
ATTACHED USB CABLE	14
SOFTWARE INSTALLATION INSTRUCTIONS.....	15
SOFTWARE INSTALLATION	15
UPGRADING TO THE CURRENT SEACOM DRIVER.....	16
HARDWARE INSTALLATION	16
VERIFYING INSTALLATION	20
UNINSTALL & UPGRADE INSTRUCTIONS	21
REMOVE HARDWARE USING DEVICE MANAGER.....	21
REMOVE SOFTWARE USING CONTROL PANEL.....	23
APPENDIX A – HANDLING INSTRUCTIONS.....	25

ESD WARNINGS.....	25
ELECTROSTATIC DISCHARGES (ESD)	25
GROUNDING METHODS	25
APPENDIX B – TROUBLESHOOTING.....	26
TROUBLESHOOTING/VERIFICATION FOR ASYNCHRONOUS SERIAL PRODUCTS.....	26
APPENDIX C – RS-422 ELECTRICAL INTERFACE.....	30
APPENDIX D – ASYNCHRONOUS COMMUNICATIONS.....	31
APPENDIX E – CABLE DRAWING.....	32
APPENDIX F – HOW TO GET ASSISTANCE	33
WARRANTY	34
WARRANTY POLICY	34
NON-WARRANTY REPAIR/RETEST.....	34
HOW TO OBTAIN AN RMA (RETURN MERCHANDISE AUTHORIZATION).....	34

Before You Get Started

What's Included

The SeaLINK+422 is shipped with the following items. If any of these items are missing or damaged, contact Sealevel Systems.

- **SeaLINK +422 USB to RS-422 cable**

Advisory Conventions



Warning

The highest level of importance used to stress a condition where damage could result to the product, or the user could suffer serious injury.



Important

The middle level of importance used to highlight information that might not seem obvious or a situation that could cause the product to fail.



Note

The lowest level of importance used to provide background information, additional tips, or other non-critical facts that will not affect the use of the product.

Product Description

The Sealevel Systems SeaLINK+422 serial interface adapter provides the PC with a single USB to RS-422 asynchronous serial port providing a versatile interface for common RS-422 needs. The SeaLINK+422 connects to a PC's external USB port, so it does not require opening the computer case. Resources such as IRQs and I/O addresses are also not utilized.

The SeaLINK® USB to RS-422 serial adapter utilizes Sealevel's expertise in military-grade designs by incorporating a ruggedized, overmolded enclosure design. This improves the reliability and durability in industrial and mobile applications.

The 2106 features programmable baud rate and data formats with 128-byte transmit and 384-byte receive buffers. The USB serial adapter is compatible with all standard PC baud rates (300 baud and above) and supports high-speed communication to 921.6K bps. The 2106 is powered by a host system USB port.

Sealevel SeaCOM USB software drivers and utilities make installation and operation easy using Windows and Linux operating systems. After installing the software, simply plug the 2106 into an available USB port and the serial port is recognized as a standard COM port by the host system enabling compatibility with legacy software.

The overall adapter is 60 inches long and fully shielded to protect the 2106 from RF and EMI interference that is common in mobile and industrial environments. Standard operating temperature range is 0 - +70°C, and extended temperature range (-40 - +85°C) is optional.

Features



- Compliant with RoHS and WEEE directives
- High speed UART with 128-byte Tx FIFO and 384-byte Rx FIFO
- Data rates from 300 bps to 921.6K bps
- Rugged construction using molded connectors
- Powered by USB connection
- Sealevel software supports Windows 98SE/ME/2000/XP/Vista/Windows 7 and Linux operating systems
- DB-9M connector
- Hot-pluggable device
- Does not require opening the case
- No system resources are required (i.e., I/O ports or IRQs)





Optional Items

Depending upon your application, you are likely to find one or more of the following items useful with the SeaLINK+422. All items can be purchased from our website (www.sealevel.com) by calling our sales team at (864) 843-4343.

Cables & Converters

DB9 Female to DB9 Female RS-422 207M SMPTE Cable (Part# CA190)	
The CA190 connects any Sealevel DB9 RS-422 device to a Sony (or compatible) 207M (SMPTE) 9 Pin connector.	
DB9 Female (RS-422) to DB9 Female (Opto 22 Optomux) Converter (Part# DB103)	
The DB103 is designed to convert a Sealevel DB9 male RS-422 connector to a DB9 female pinout compatible with AC24AT and AC422AT Opto 22 ISA bus cards. This allows Optomux devices to be controlled from any Sealevel RS-422 board with a DB9 male connector.	

Hubs

High Speed USB 2.0 4-Port Hub (Part# Hub4)	
<p>This 4-port hub allows you to connect more USB devices to a computer such as Sealevel USB serial and digital I/O devices, as well as digital cameras, scanners, mice, and keyboards. Includes the hub, an AC power supply, and a six-foot USB cable.</p>	
High Speed USB 2.0 7-Port Hub (Part# Hub7)	
<p>This 7-port hub allows you to connect more USB devices to a computer such as Sealevel USB serial and digital I/O devices, as well as digital cameras, scanners, mice, and keyboards. Includes the hub, an AC power supply, and a six-foot USB cable.</p>	
Optically Isolated 7-Port USB Hub (Part# Hub7i)	
<p>Sealevel's HUB7i is an optically isolated USB hub that connects up to seven USB peripherals and protects the host computer from voltages up to 5500 VAC. The HUB7i includes an industrial grade wall-mount power supply that provides up to 4000 VAC isolation. Supported in Windows, Linux, and other USB aware operating systems, the HUB7i requires no separate drivers and is easy to install. Simply</p>	

Terminal Blocks

Terminal Block - DB9 Female to 5 Screw Terminals (RS-422/485) (Part# TB34)	
<p>The TB34 terminal block adapter offers a simple solution for connecting RS-422 and RS-485 field wiring to a serial port. The terminal block is compatible with 2-wire and 4-wire RS-485 networks and matches the RS-422/485 pin-out on Sealevel serial devices with DB9 male connectors. A pair of thumbscrews secures the adapter to the serial port and prevents accidental disconnection. The TB34 is compact and allows multiple adapters to be used on multi-port serial devices, such as Sealevel USB serial adapters, Ethernet serial servers and other Sealevel serial devices with two or more ports.</p>	
Terminal Block - DB9 Female to 9 Screw Terminals (Part# TB05)	
<p>The TB05 terminal block breaks out a DB9 connector to 9 screw terminals to simplify field wiring of serial connections. It is ideal for RS-422 and RS-485 networks, yet it will work with any DB9 serial connection, including RS-232. The TB05 includes holes for board or panel mounting. The TB05 is designed to connect directly to Sealevel DB9 serial cards or any cable with a DB9M connector.</p>	
Terminal Block Kit - TB05 + CA127 Cable (Part# KT105)	
<p>The KT105 terminal block kit breaks out a DB9 connector to 9 screw terminals to simplify field wiring of serial connections. It is ideal for RS-422 and RS-485 networks, yet it will work with any DB9 serial connection, including RS-232. The KT105 includes one DB9 terminal block (Item# TB05) and one DB9M to DB9F 72 extension cable (Item# CA127). The TB05 includes holes for board or panel mounting. The TB05 is designed to connect directly to Sealevel DB9 serial cards or any cable with a DB9M connector.</p>	

Product Family

Whether you require one serial port or 16, SeaLINK USB serial adapters will have you quickly communicating with RS-232, RS-422, and RS-485 peripherals. Unlike traditional UART-based devices, SeaLINK USB products use a state-machine architecture that reduces host processor overhead for faster, more reliable communications. Sealevel's SeaCOM software drivers and utilities make installation and operation easy using Windows and Linux operating systems.

Part #	Description
2105R	USB to 1-Port RS-232 DB9 Serial Interface Adapter
2106	USB to 1-Port RS-422 DB9 Serial Interface Adapter
2113	USB to 1-Port RS-232, RS-422, RS-485 DB9 Serial Interface Adapter
2123	USB to 1-Port RS-232, RS-422, RS-485 (Software Configurable) DB9 Serial Interface Adapter
2101	USB to 1-Port RS-232 DB25 Serial Interface Adapter
2102	USB to 1-Port RS 422, RS-485, RS-530 DB25 Serial Interface Adapter
2103	USB to 1-Port Isolated RS-232 DB25 Serial Interface Adapter
2104	USB to 1-Port RS 422, RS-485, RS-530 DB25 Serial Interface Adapter
2108	Embedded USB to 1-Port RS-232 DB9 Serial Interface Adapter with Low Profile PC Bracket
2128	Embedded USB to 1-Port RS-232, RS-422, RS-485 (Software Configurable) DB9 Serial Interface Adapter with PC Bracket
2213	USB to 2-Port Isolated RS-232, RS-422, RS-485 DB9 Serial Interface Adapter
2223	USB to 2-Port RS-232, RS-422, RS-485 (Software Configurable) DB9 Serial Interface Adapter
2201	USB to 2-Port RS-232 DB9 Serial Interface Adapter
2202	USB to 2-Port RS-422, RS-485 DB9 Serial Interface Adapter
2203	USB to 2-Port RS-232, RS-422, RS-485 DB9 Serial Interface Adapter
2208	Embedded USB to 2-Port RS-232 DB9 Serial Interface Adapter with Standard Size PC Bracket
2228	Embedded USB to 2-Port RS-232, RS-422, RS-485 (Software Configurable) DB9 Serial Interface Adapter with PC Bracket
2401	USB to 4-Port RS-232 DB9 Serial Interface Adapter
2402	USB to 4-Port RS-422, RS-485 DB9 Serial Interface Adapter
2403	USB to 4-Port RS-232, RS-422, RS-485 DB9 Serial Interface Adapter
2404	USB to 4-Port RS-232 RJ45 Serial Interface Adapter
2407	USB to 4-Port RS-232, RS-485 RJ45 VersaCom Serial Interface Adapter

2423	USB to 4-Port RS-232, RS-422, RS-485 (Software Configurable) DB9 Serial Interface Adapter
2433	USB to 4-Port RS-232, RS-422, RS-485 (Software Configurable) DB9 Serial Interface Adapter
641U	USB to RS-232 RJ45 Serial Interface Adapter
647U	USB to RS-232, RS-485 RJ45 VersaCom Serial Interface Adapter
2801	USB to 8-Port RS-232 DB9 Serial Interface Adapter
2802	USB to 8-Port RS-422, RS-485 DB9 Serial Interface Adapter
2803	USB to 8-Port RS-232, RS-422, RS-485 DB9 Serial Interface Adapter
2804	USB to 8-Port RS-232 RJ45 Serial Interface Adapter
2807	USB to 8-Port RS-232, RS-485, RJ45 VersaCom Serial Interface Adapter
2823	USB to 8-Port RS-232, RS-422, RS-485 (Software Configurable) DB9 Serial Interface Adapter
2833	USB to 8-Port RS-232, RS-422, RS-485 DB9 Serial Interface Adapter
681U	USB to RS-232 RJ45 Serial Interface Adapter
687U	USB to RS-232, RS-485 RJ45 VersaCom Serial Interface Adapter
2161	USB to 16-Port RS-232 RJ45 Serial Interface Adapter
2167	USB to 16-Port RS-232, RS-485 RJ45 VersaCom Serial Interface Adapter
2108S	Embedded USB to 1-Port RS-232 DB9 Serial Interface Adapter with Standard Size PC Bracket
2123-OEM	USB to 1-Port RS-232, RS-422, RS-485 (Software Configurable) DB9 Serial Interface Adapter
2223-KT	USB to 2-Port RS-232, RS-422, RS-485 (Software Configurable) DB9 Serial Interface Adapter
2223-OEM	USB to 2-Port RS-232, RS-422, RS-485 (Software Configurable) DB9 Serial Interface Adapter
641U-OEM	USB to RS-232 RJ4 Serial Interface Adapter
647U-OEM	USB to RS-232, RS-485 RJ45 VersaCom Serial Interface Adapter
681U-OEM	USB to RS-232 RJ45 Serial Interface Adapter
687U-OEM	USB to RS-232, RS-485 RJ45 VersaCom Serial Interface Adapter
2106-RoHS	RoHS Compliant USB to 1-Port RS-422 DB9 Serial Interface Adapter

2102-RoHS	RoHS Compliant USB to 1-Port RS-422, RS-485, RS-530 DB25 Serial Interface Adapter
2201-RoHS	RoHS Compliant USB to 2-Port RS-232 DB9 Serial Interface Adapter
2203-RoHS	RoHS Compliant USB to 2-Port RS-232, RS-422, RS-485 DB9 Serial Interface Adapter
2401-RoHS	RoHS Compliant USB to 4-Port RS-232 DB9 Serial Interface Adapter
2403-RoHS	RoHS Compliant USB to 4-Port RS-232, RS-422, RS-485 DB9 Serial Interface Adapter
2801-RoHS	RoHS Compliant USB to 8-Port RS-232 DB9 Serial Interface Adapter
2404-RoHS	RoHS Compliant USB to RS-232 RJ45 Serial Interface Adapter for Powering 5VDC Serial Peripherals
2402-DC12	RoHS Compliant USB to RS-232 RJ45 Serial Interface Adapter for Powering 12VDC Serial Peripherals
2404-DC24	USB to RS-232 RJ45 Serial Interface Adapter for Powering 24VDC Serial Peripherals
2407-DC05	USB to 4-Port RS-232, RS-485 RJ45 VersaCom Serial Interface Adapter for Powering 5VDC Serial Peripherals
2407-DC12	USB to 4-Port RS-232, RS-485 RJ45 VersaCom Serial Interface Adapter for Powering 12VDC Serial Peripherals
2407-DC24	USB to 4-Port RS-232, RS-485 RJ45 VersaCom Serial Interface Adapter for Powering 24VDC Serial Peripherals
2804-DC05	USB to 8-Port RS-232 RJ45 Serial Interface Adapter for Powering 5VDC Serial Peripherals
2804-DC12	USB to 8-Port RS-232 RJ45 Serial Interface Adapter for Powering 12VDC Serial Peripherals
2804-DC24	USB to 8-Port RS-232 RJ45 Serial Interface Adapter for Powering 24VDC Serial Peripherals
2807-DC05	USB to 8-Port RS-232, RS-485 RJ45 VersaCom Serial Interface Adapter for Powering 5VDC Serial Peripherals
2807-DC12	USB to 8-Port RS-232, RS-485 RJ45 VersaCom Serial Interface Adapter for Powering 12VDC Serial Peripherals
2807-DC24	USB to 8-Port RS-232, RS-485 RJ45 VersaCom Serial Interface Adapter for Powering 24VDC Serial Peripherals

Electrical Specifications

The SeaLINK+422: utilizes a USB UART. This chip features programmable baud rate, data format, 128-byte dual port TX buffer, and 384-byte dual port RX buffer. The RS-422 transceiver supports data rates from 300 baud up to 921.6K baud.

Connector Pin Out

RS-422 (DB-9 MALE)

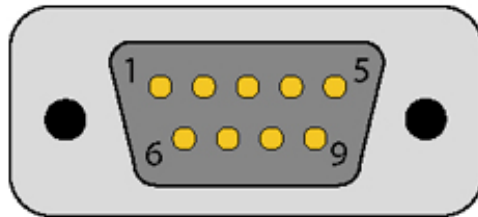

Pin	Signal	Name	Mode
1	RX+	Receive Positive	Input
2	RX-	Receive Negative	Input
3	TX-	Transmit Negative	Output
4	TX+	Transmit Positive	Output
5	GND	Ground	
6, 7, 8, 9	NC	No Contact	

For two wire (half duplex) RS-485, connect the (+) communication wire to pins 1 and 4. Also connect the (-) wire to pins 2 and 3. Connect the communication ground to pin 5.

Line Termination & Biasing

The inputs have appropriate biasing to keep them in the proper state and are always present. A 1K ohm pull-down resistor is connected to RX- and a 1K pull-up resistor is connected to RX+. A 120-ohm terminating resistor is connected between RX+ and RX-.

Technical Specifications

Temperature Range

Specification	Operating	Storage
Temperature Range	-0° to 70° C (32° to 158° F)	-50° to 105° C (-58° to 221° F)
Humidity Range	10 to 90% R.H. Non-Condensing	10 to 90% R.H. Non-Condensing

Power Requirements

Supply line	+5 VDC
Rating	70 mA

Manufacturing

All Sealevel Systems Printed Circuit boards are built to UL 94V0 rating and are 100% electrically tested. These printed circuit boards are solder mask over bare copper or solder mask over tin nickel.

Hardware Configuration

Ruggedized Overmold Enclosure

The 2106 is built for harsh conditions and features a military-grade, ruggedized, overmolded enclosure. This improves the reliability and durability in industrial and mobile applications.

DB9M Serial Connector

The 2106 includes a DB9 male serial connector on one end of the device. The pin assignments for this connector are detailed in the previous Electrical Specifications section.

Attached USB Cable

The attached cable has a clear jacket over a braided shield. The cable is approximately 44" overall with a USB Type A connector, which is compatible with any available USB port on a host computer or USB hub. Self-powered hubs can be used as long as they provide a minimum of 100mA to each USB port. The 2106 is compatible with USB 2.0 ports and is USB 1.1 compliant.



Software Installation Instructions

Software Installation

Windows Installation



Do not connect the device to a USB port until the software has been fully installed.



To install Sealevel Systems Software, you must log in as an administrator or have administrator privileges in Windows.



Only users running Windows 7 or newer should utilize these instructions for accessing and installing the appropriate driver via Sealevel's website. If you are utilizing an operating system prior to Windows 7, please contact Sealevel by calling 864.843.4343 or emailing support@sealevel.com to receive access to the proper driver download and installation instructions.

1. Begin by locating, selecting, and installing the correct software from the [Sealevel software driver database](#).
2. Type in or select the part number (#2106) for the adapter from the listing.
3. Select "Download Now" for SeaCOM for Windows.
4. The setup files will automatically detect the operating environment and install the proper components. Follow the information presented on the screens that follow.
5. A screen may appear with text similar to: "The publisher cannot be determined due to the problems below: Authenticode signature not found." Please click the 'Yes' button and proceed with the installation. This declaration simply means that the operating system is not aware of the driver being loaded. It will not cause any harm to your system.
6. During setup, the user may specify installation directories and other preferred configurations. This program also adds entries to the system registry that are necessary for specifying the operating parameters for each driver. An uninstall option is also included to remove all registry/INI file entries from the system.
7. The software is now installed, and you can proceed with the hardware installation.

For additional software support, please call Sealevel Systems' Technical Support, (864) 843-4343. Our technical support is free and available from 8:00 AM - 5:00 PM Eastern Time, Monday through Friday. For email support contact: support@sealevel.com.



Windows NT is not USB aware and thus cannot support this device.

Upgrading to the current SeaCOM driver

1. Download the current driver using the Instructions from the *Downloaded Software Installation* section above. Please take note of the destination directory it will save to.
2. *Uninstall* the currently loaded driver SeaCOM driver found in the Control Panel. Prior to Windows Vista SeaCOM will be populated in 'Add/Remove Programs' list. In Vista and newer OSs it will be found in the 'Programs and Features' list.
3. Navigate to the Device Manager and remove the Sealevel adapter by *right* clicking on the line item choosing 'Uninstall'. Depending on your product, it can be found under either 'Multiport Serial adapters' or 'Universal Serial Bus controllers'.
4. Single port ISA cards and PCMCIA cards will need to be uninstalled under 'Ports (COM & LPT)'.



If you are upgrading from a previous driver version, you should remove the associated Device Manager hardware entries and reinstall the adapter after installing the SeaCOM software.

Hardware Installation

The SeaLINK+422 can be connected to any Upstream Type "A" USB port at the PC host or an Upstream Hub. Since it is hot pluggable, there is no need to power down your computer prior to installation. The SeaLINK+422 requires no user hardware configuration. Once you have installed the software simply plug the USB connector into an available USB port. The drivers that were installed during setup will automatically be used to configure the adapter. In Windows XP and previous OS versions, you should see one or more "Found New Hardware" windows, indicating the actual device being created and enumerated. See below. In Vista and newer operating systems, the enumeration occurs automatically without user interaction.

Windows XP (Example below)



Once the device has been connected, the Found New Hardware wizard will appear twice – first for the USB Part, and then for the serial port that you are installing.

The following instructions are applicable to the Windows XP operating system and may vary depending on your version of Windows.

1. After the software installation is complete, plug the 2106 into an available USB port on the computer or USB hub.

2. A 'Found New Hardware' alert will appear above the system tray.



3. The 'Found New Hardware Wizard' will appear.
4. Choose 'No, not this time' and click 'Next' to proceed.



5. Choose 'Install the software automatically' and click 'Next'.

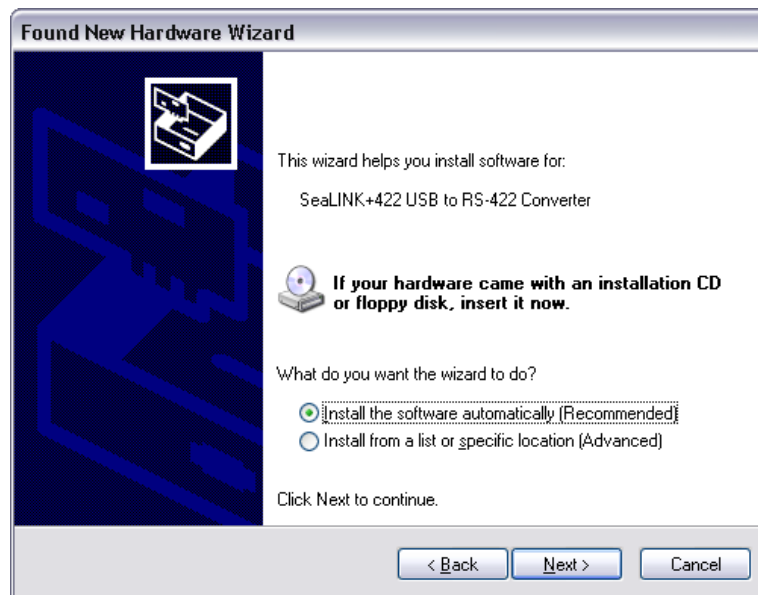

6. The 'Hardware Wizard' will search for the proper drivers; however, it may be interrupted by a message stating that the hardware has not passed Windows certification. Click 'Continue Anyway'.



All SeaCOM software and drivers have been fully tested by Sealevel. Clicking 'Continue anyway' will not harm your system.

7. The appropriate drivers for your SeaLINK device and version of Windows will be installed as shown.

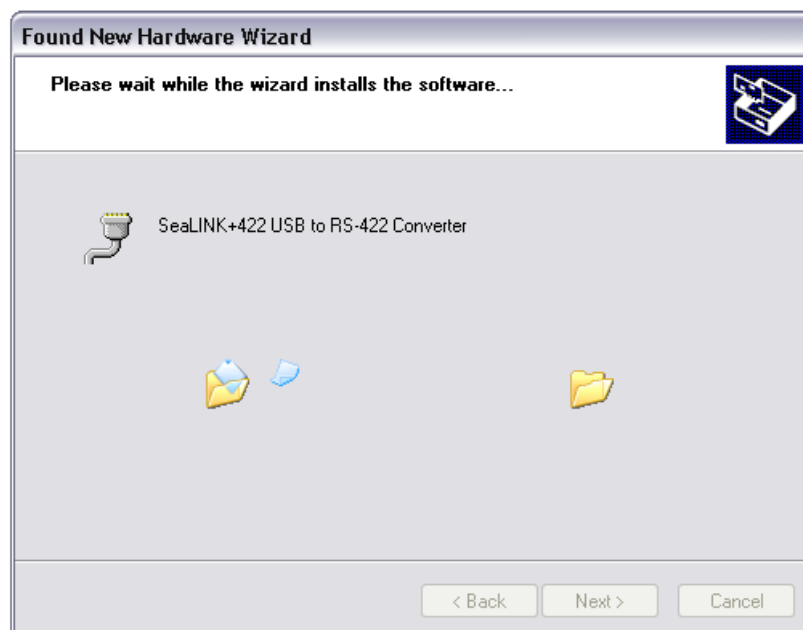

8. Click 'Finish' to complete the installation of your hardware.



The 'Found New Hardware Wizard' appears a second time; repeat steps 4-8.

9. When the 'Found New Hardware' alert informs you that your hardware is installed and ready to use, you can proceed with verifying the installation to check functionality and/or locate the COM port assignments, if necessary.



Verifying Installation

To confirm that the serial port has been successfully installed, look in Device Manager under 'Ports (COM & LPT)' and the COM assignment will be included with the associated COM number in parentheses.

To access Device Manager, follow the steps below:

1. Right click on 'My Computer' icon on your desktop or in the Start menu.
2. Click 'Manage' in the fly out menu to launch the 'Computer Management' console window.
3. In the left pane under 'System Tools', click 'Device Manager'.
4. In right pane near the bottom, expand the 'Ports (COM & LPT)' section by clicking the '+' symbol.
5. You should now see the COM assignment with the associated COM number in parentheses.



Your system will assign the next available COM number, which will vary by computer (COM4 as shown in this example).

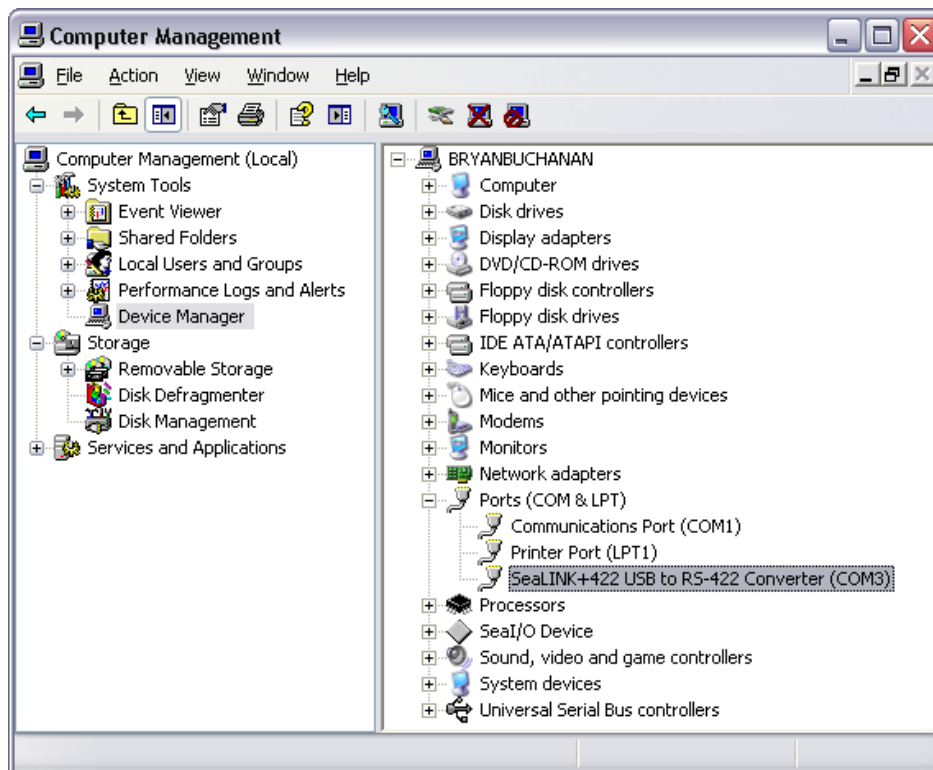

Uninstall & Upgrade Instructions

The SeaCOM software program adds entries to the system registry that are necessary for specifying the operating parameters for your device. To completely remove the hardware and associated software, follow the steps in the order that they appear.

To upgrade to the latest version of SeaCOM, follow the instructions to uninstall the hardware and software, followed by the upgrade instructions.



Start with the hardware connected to a USB port. Do not unplug it until instructed to do so.

Remove Hardware Using Device Manager

To access Device Manager, follow the steps below:

1. Right click on 'My Computer' icon on your desktop or in the Start menu.
2. Click 'Manage' in the fly out menu to launch the 'Computer Management' console window.
3. In the left pane under 'System Tools', click 'Device Manager'.
4. In right pane near the bottom, expand the 'Universal Serial Bus controllers' section by clicking the '+' symbol.
5. Locate the SeaLINK device in the listing, highlighted below.

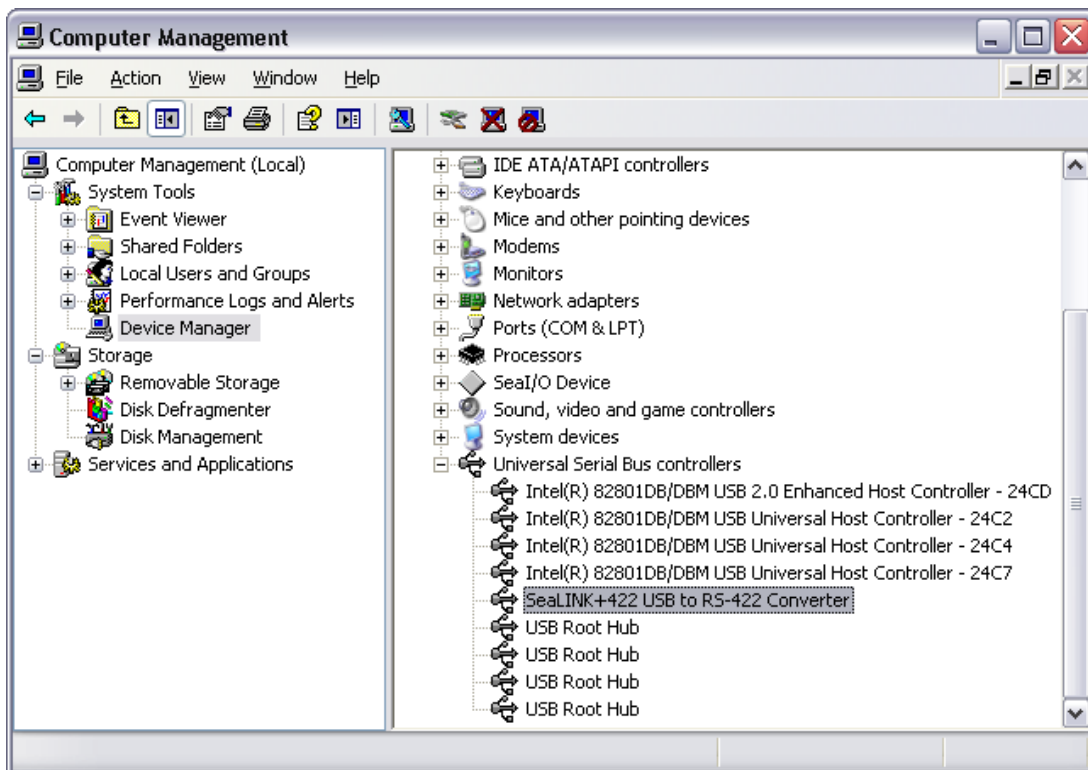

6. Right click on the entry for the SeaLINK device and click 'Uninstall' in the fly out menu.

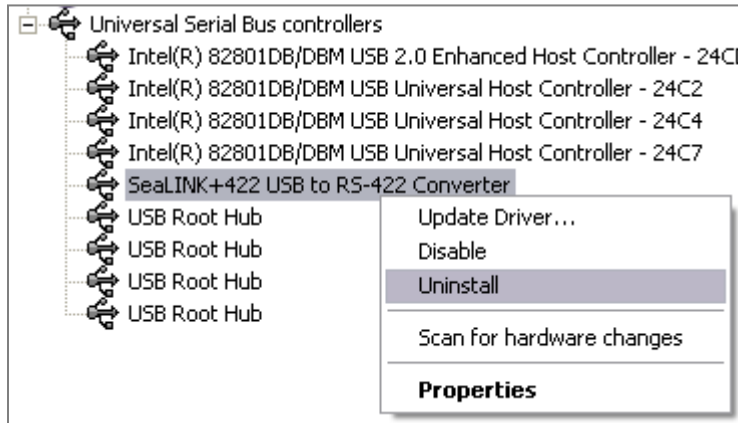

7. Confirm that you want to uninstall the SeaLINK device by clicking the 'OK' button. This will remove the hardware and all registry entries from your computer. Keep the device plugged in.



8. The window will refresh and the entry for the SeaLINK device will no longer appear. Proceed with removing the software on the following pages.

Remove Software Using Control Panel

Make sure you have first removed the hardware using the instructions on the previous page before removing the software, otherwise remnants of the configuration settings will be left on your system. Keep the SeaLINK device plugged in until the software has been completely uninstalled.

1. Access the Control Panel by clicking the 'Start' button, and then 'Control Panel'.
2. In the Control Panel window, double-click the 'Add or Remove Programs' icon (In Windows Vista, double-click on 'Programs and Features').
3. The Add or Remove Programs window will list all currently installed software on your system. Once the 'Currently installed programs' list populates, locate, and select the entry for 'SeaCOM'.
4. Click the 'Remove' button.

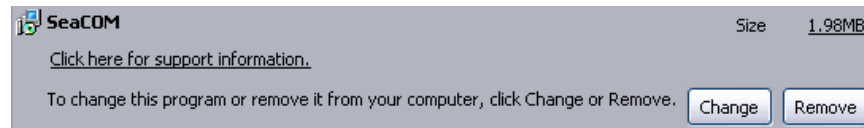

5. The 'SeaCOM – InstallShield Wizard' window will appear along with a dialog box asking you to confirm. Click the 'Yes' button to continue.



6. When the removal process completes, click the 'Finish' button to close the window. A dialog box appears to confirm the removal success. Click the 'Ok' button on the dialog box.
7. If you are upgrading software, leave the SeaLINK device plugged in and follow the instructions in the 'UPGRADING TO THE CURRENT SEACOM DRIVER' section above.

Appendix A – Handling Instructions

ESD Warnings

ELECTROSTATIC DISCHARGES (ESD)

A sudden electrostatic discharge can destroy sensitive components. Proper packaging and grounding rules must therefore be observed. Always take the following precautions.

- Transport boards and cards in electrostatically secure containers or bags.
- Keep electrostatically sensitive components in their containers, until they arrive at an electrostatically protected workplace.
- Only touch electrostatically sensitive components when you are properly grounded.
- Store electrostatically sensitive components in protective packaging or on anti-static mats.

GROUNDING METHODS

The following measures help to avoid electrostatic damage to the device:

- Cover workstations with approved antistatic material. Always wear a wrist strap connected to workstation as well as properly grounded tools and equipment.
- Use antistatic mats, heel straps, or air ionizers for more protection.
- Always handle electrostatically sensitive components by their edge or by their casing.
- Avoid contact with pins, leads, or circuitry.
- This is a hot pluggable item – it can be connected and disconnected with power applied to PC. We do not recommend having input signals during this process.
- Keep work area free of non-conductive materials such as ordinary plastic assembly aids and Styrofoam.
- Use field service tools such as cutters, screwdrivers, and vacuum cleaners, which are conductive.

Appendix B – Troubleshooting

The adapter should provide years of trouble-free service. However, in the event that it appears to be functioning incorrectly, the following tips can eliminate most common problems without the need to call Technical Support.

Ensure that the Sealevel Systems SeaCOM software has been installed on the machine, so that the necessary files are in place to complete the installation. To confirm installation, click on the Windows 'Start' button and then select 'All Programs'. You should see the 'SeaCOM' program folder listed.

Check to make sure that USB support is enabled and functioning properly in the operating system. The presence of the 'Universal Serial Bus controllers' listing in Device Manager will confirm that USB support is enabled in Windows 98, ME, 2000, XP, Vista™ and Windows 7 operating systems.

Locate the COM ports for your device in Device Manager (described under '[Verifying Installation](#)' in the Installation and Configuration section of this manual).

Troubleshooting/Verification for Asynchronous Serial Products

1. Once you have confirmed that the serial adapter COM ports are listed in Device Manager, use the [Sealevel WinSSD utility](#) to verify communications. Detailed help is included in the WinSSD utility.
2. Set the adapters Electrical Interface for either RS-232 or RS-422.
3. If you have a loopback plug, put it on the adapter connector. If you do not have a loopback plug, you can use female jumper wires to make the connection to verify the functionality.
4. RS-232 requires pins 2 (Receive) & 3 (Transmit) to be jumpered as shown in this graphic:

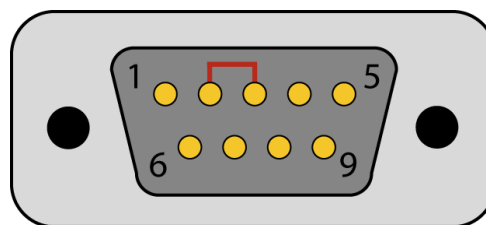

- RS-422 requires pins 1 & 4 (Receive + and Transmit +) and also pins 2 & 3 (Receive - and Transmit -) to be jumpered as shown in this graphic:

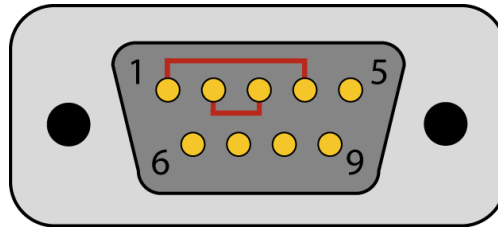

- To test communications, launch the WinSSD utility in the SeaCOM folder in the 'Start' menu.
- On the 'Port Information' tab, select the associated COM port and click the 'Open' button.
- This will first open the COM port. From this tab the port can also be closed (See image below). Click the 'Settings' button to open the COM Port Properties dialog box. This will allow the Port Settings to be altered.

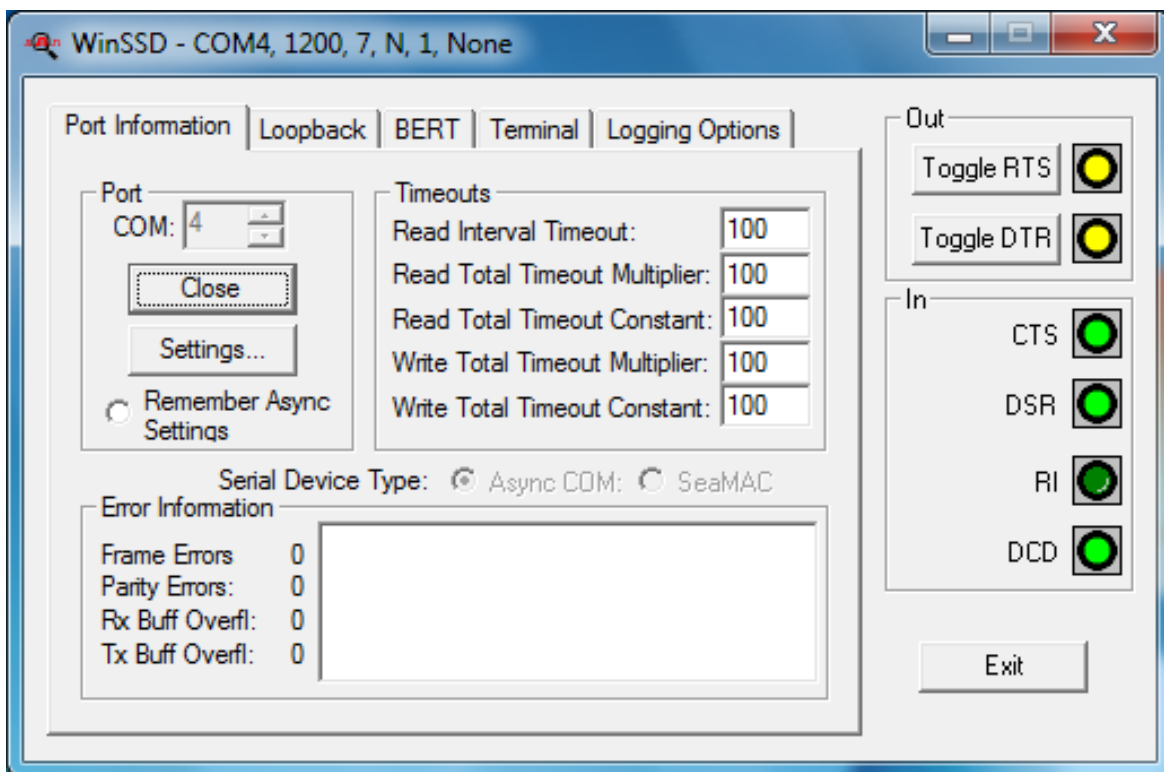

- Change your parameters to 9600 bits per second, 8 data bits, no parity, 1 stop bit, and no flow control, as pictured below.

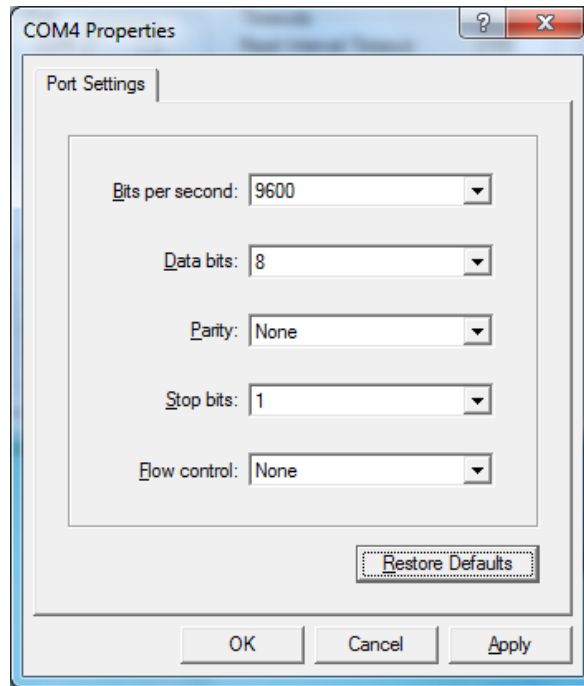

- Click 'Apply' and 'OK'.
- In the main WinSSD window, click on the 'BERT' tab (Bit Error Rate test).
- Click on the 'Start' button.

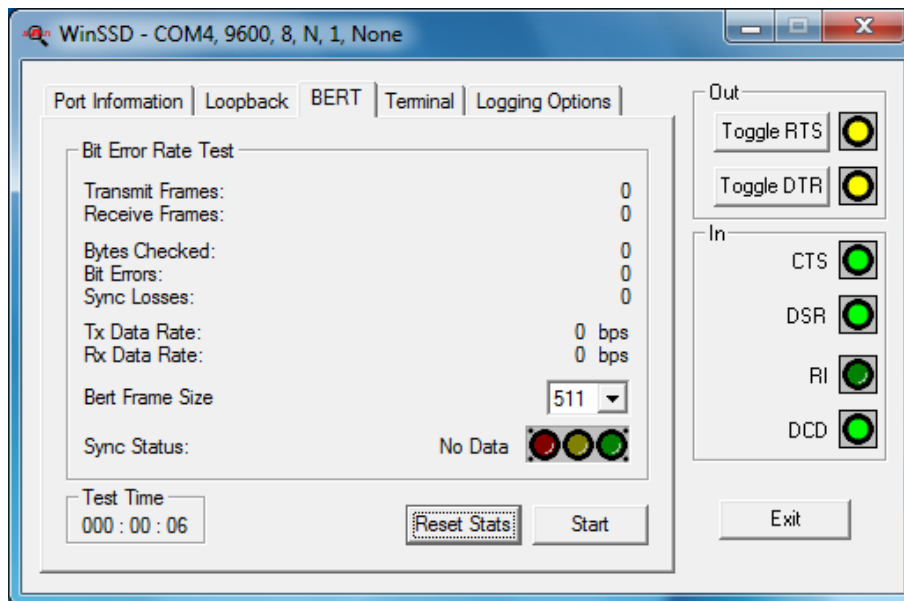

13. If the COM port is properly working, the Sync Status green light will glow, and the Transmit Frames and Receive Frames will increase. The Tx and Rx Data Rates will show the calculated data rate.

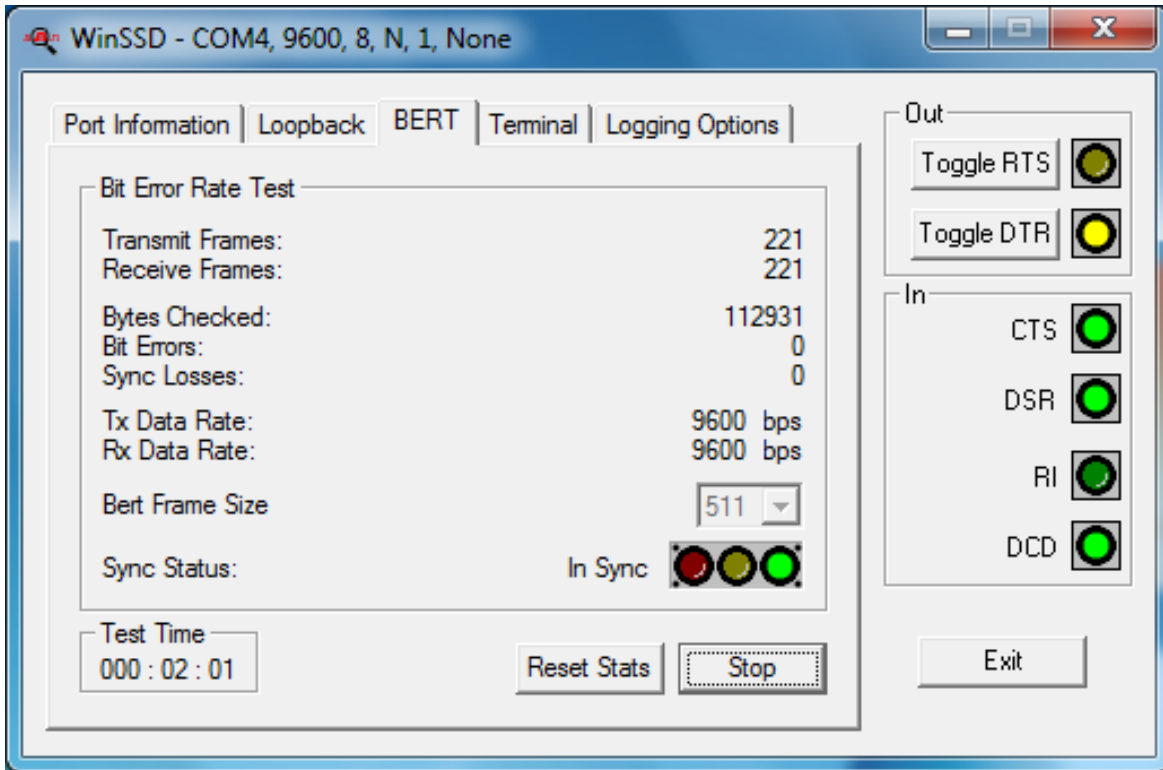

14. This verifies that the adapter is working properly. You can continue testing this port with different configurations or proceed with testing other ports, if necessary.

If these steps do not solve your problem, please call Sealevel Systems' Technical Support, (864) 843-4343. Our technical support is free and available from 8:00 AM to 5:00 PM Eastern Time Monday through Friday. For email support contact support@sealevel.com.

Appendix C – RS-422 Electrical Interface

The RS-422 specification defines the electrical characteristics of balanced voltage digital interface circuits. RS-422 is a differential interface that defines voltage levels and driver/receiver electrical specifications. On a differential interface, logic levels are defined by the difference in voltage between a pair of outputs or inputs. In contrast, a single ended interface, for example RS-232, defines the logic levels as the difference in voltage between a single signal and a common ground connection. Differential interfaces are typically more immune to noise or voltage spikes that may occur on the communication lines. Differential interfaces also have greater drive capabilities that allow for longer cable lengths. RS-422 is rated up to 10 Megabits per second and can have cabling 4000 feet long. RS-422 also defines driver and receiver electrical characteristics that will allow 1 driver and up to 32 receivers on the line at once. RS-422 signal levels range from 0 to +5 volts. RS-422 does not define a physical connector.

Appendix D – Asynchronous Communications

Serial data communications implies that individual bits of a character are transmitted consecutively to a receiver that assembles the bits back into a character. Data rate, error checking, handshaking, and character framing (start/stop bits) are pre-defined and must correspond at both the transmitting and receiving ends.

Asynchronous communications is the standard means of serial data communication for PC compatibles and PS/2 computers. The original PC was equipped with a communication or COM: port that was designed around an 8250 Universal Asynchronous Receiver Transmitter (UART). This device allows asynchronous serial data to be transferred through a simple and straightforward programming interface. A starting bit followed by a pre-defined number of data bits (5, 6, 7, or 8) defines character boundaries for asynchronous communications. The end of the character is defined by the transmission of a pre-defined number of stop bits (usually 1, 1.5 or 2). An extra bit used for error detection is often appended before the stop bits.

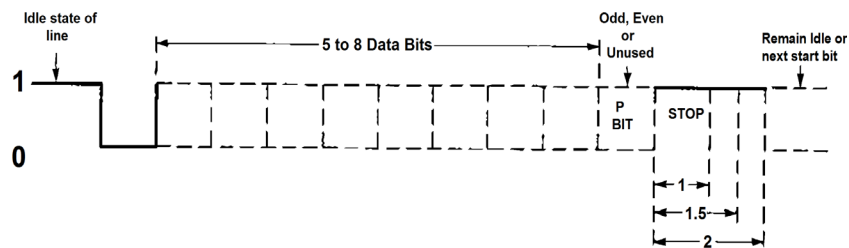

This special bit is called the parity bit. Parity is a simple method of determining if a data bit has been lost or corrupted during transmission. There are several methods for implementing a parity check to guard against data corruption. Common methods are called (E)ven Parity or (O)dd Parity. Sometimes parity is not used to detect errors on the data stream. This is referred to as (N)o parity. Because each bit in asynchronous communications is sent consecutively, it is easy to generalize asynchronous communications by stating that each character is wrapped (framed) by pre-defined bits to mark the beginning and end of the serial transmission of the character. The data rate and communication parameters for asynchronous communications have to be the same at both the transmitting and receiving ends. The communication parameters are baud rate, parity, number of data bits per character, and stop bits (i.e., 9600, N, 8, 1).

Appendix E – Cable Drawing

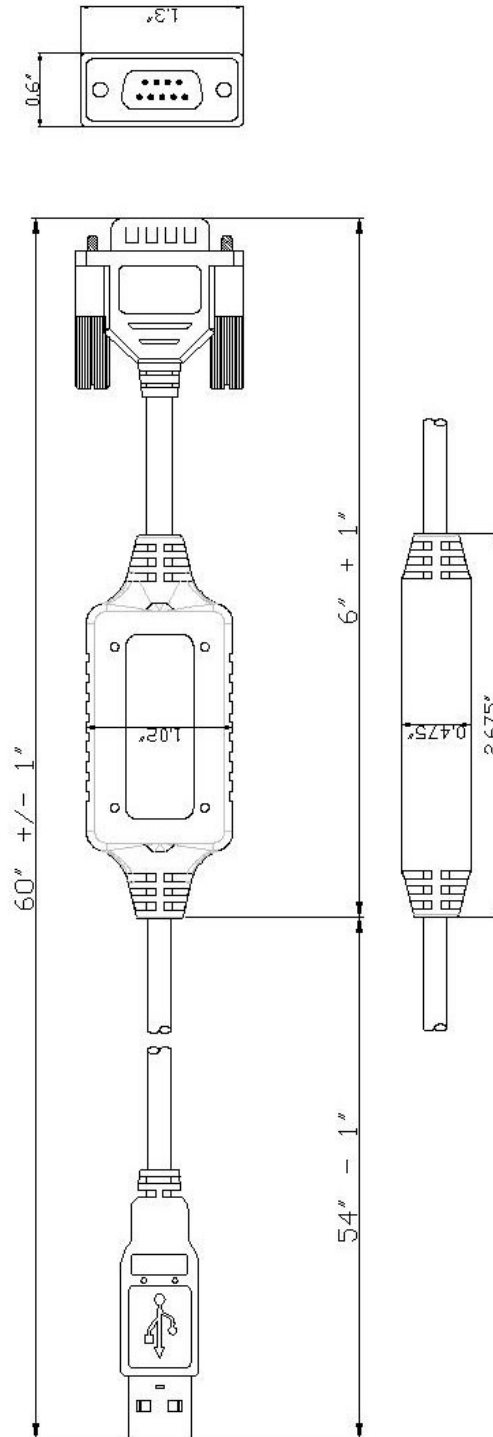

Appendix F – How To Get Assistance

Begin by reading the Troubleshooting Guide in [Appendix A](#). If assistance is still needed, please see below.

When calling for technical assistance, please have your user manual and current adapter settings. If possible, please have the adapter installed in a computer ready to run diagnostics.

Sealevel Systems provides an FAQ section on its web site. Please refer to this to answer many common questions. This section can be found at <http://www.sealevel.com/faq.asp>.

Sealevel Systems maintains a Home page on the Internet. Our home page address is <http://www.sealevel.com>. The latest software updates, and newest manuals are available via our FTP site that can be accessed from our home page.

Technical support is available Monday to Friday from 8:00 AM to 5:00 PM eastern time. Technical support can be reached at (864) 843-4343.

RETURN AUTHORIZATION MUST BE OBTAINED FROM SEALEVEL SYSTEMS BEFORE RETURNED MERCHANDISE WILL BE ACCEPTED. AUTHORIZATION CAN BE OBTAINED BY CALLING SEALEVEL SYSTEMS AND REQUESTING A RETURN MERCHANDISE AUTHORIZATION (RMA) NUMBER.

Warranty

Sealevel's commitment to providing the best I/O solutions is reflected in the Lifetime Warranty that is standard on all Sealevel manufactured I/O products. We are able to offer this warranty due to our control of manufacturing quality and the historically high reliability of our products in the field. Sealevel products are designed and manufactured at its Liberty, South Carolina facility, allowing direct control over product development, production, burn-in and testing. Sealevel achieved ISO-9001:2015 certification in 2018.

Warranty Policy

Sealevel Systems, Inc. (hereafter "Sealevel") warrants that the Product shall conform to and perform in accordance with published technical specifications and shall be free of defects in materials and workmanship for the warranty period. In the event of failure, Sealevel will repair or replace the product at Sealevel's sole discretion. Failures resulting from misapplication or misuse of the Product, failure to adhere to any specifications or instructions, or failure resulting from neglect, abuse, accidents, or acts of nature are not covered under this warranty.

Warranty service may be obtained by delivering the Product to Sealevel and providing proof of purchase. Customer agrees to ensure the Product or assume the risk of loss or damage in transit, to prepay shipping charges to Sealevel, and to use the original shipping container or equivalent. Warranty is valid only for original purchaser and is not transferable.

This warranty applies to Sealevel manufactured Product. Product purchased through Sealevel but manufactured by a third party will retain the original manufacturer's warranty.

Non-Warranty Repair/Retest

Products returned due to damage or misuse and Products retested with no problem found are subject to repair/retest charges. A purchase order or credit card number and authorization must be provided in order to obtain an RMA (Return Merchandise Authorization) number prior to returning Product.

How to obtain an RMA (Return Merchandise Authorization)

If you need to return a product for warranty or non-warranty repair, you must first obtain an RMA number. Please contact Sealevel Systems, Inc. Technical Support for assistance:

Available	Monday – Friday, 8:00AM to 5:00PM EST
Phone	864-843-4343
Email	support@sealevel.com

Trademarks

Sealevel Systems, Incorporated acknowledges that all trademarks referenced in this manual are the service mark, trademark, or registered trademark of the respective company.