



**MODEL:**

# **TANGO-7010 Series**

**Embedded System Support 12th Gen. Intel® CPU, DDR4 DIMM, Triple 2.5GbE LAN, Dual HDMI, DP, Four USB, 12V DC, RoHS**

## **User Manual**

# Revisions

---

Date	Version	Changes
July 18, 2023	1.00	Initial release

# Copyright

---

## **COPYRIGHT NOTICE**

The information in this document is subject to change without prior notice in order to improve reliability, design and function and does not represent a commitment on the part of the manufacturer.

In no event will the manufacturer be liable for direct, indirect, special, incidental, or consequential damages arising out of the use or inability to use the product or documentation, even if advised of the possibility of such damages.

This document contains proprietary information protected by copyright. All rights are reserved. No part of this manual may be reproduced by any mechanical, electronic, or other means in any form without prior written permission of the manufacturer.

## **TRADEMARKS**

All registered trademarks and product names mentioned herein are used for identification purposes only and may be trademarks and/or registered trademarks of their respective owners.

# Manual Conventions

---



## WARNING

Warnings appear where overlooked details may cause damage to the equipment or result in personal injury. Warnings should be taken seriously.



## CAUTION

Cautionary messages should be heeded to help reduce the chance of losing data or damaging the product.



## NOTE

These messages inform the reader of essential but non-critical information. These messages should be read carefully as any directions or instructions contained therein can help avoid making mistakes.



## HOT SURFACE

This symbol indicates a hot surface that should not be touched without taking care.

# Table of Contents

<b>1 INTRODUCTION.....</b>	<b>1</b>
1.1 OVERVIEW.....	2
1.2 FEATURES.....	3
1.3 FRONT PANEL.....	3
1.4 REAR PANEL.....	4
1.5 LEFT SIDE PANEL.....	4
1.6 TECHNICAL SPECIFICATIONS.....	5
1.7 PHYSICAL DIMENSIONS.....	7
<b>2 UNPACKING.....</b>	<b>8</b>
2.1 ANTI-STATIC PRECAUTIONS.....	9
2.2 UNPACKING PRECAUTIONS.....	9
2.3 UNPACKING CHECKLIST.....	10
<b>3 INSTALLATION.....</b>	<b>12</b>
3.1 INSTALLATION PRECAUTIONS.....	13
3.2 BACK COVER REMOVAL.....	14
3.3 STORAGE INSTALLATION.....	14
3.3.1 Tool-Less HDD/SSD Installation.....	15
3.3.2 M.2 SSD Installation.....	18
3.4 BACK COVER INSTALLATION.....	20
3.5 EXTERNAL PERIPHERAL INTERFACE CONNECTORS.....	21
3.5.1 HDMI Connection.....	21
3.5.2 LAN Connection.....	22
3.5.3 RS-232/422/485 Serial Port Connection.....	23
3.6 POWERING ON/OFF THE SYSTEM.....	24
3.7 POWER INPUT.....	24
3.8 AVAILABLE DRIVERS.....	26
3.8.1 Driver Download.....	26
<b>4 SYSTEM MOTHERBOARD.....</b>	<b>28</b>

## TANGO-7010 Embedded System

4.1 OVERVIEW.....	29
4.1.1 Layout .....	29
4.2 INTERNAL PERIPHERAL CONNECTORS .....	31
4.2.1 RTC Battery Connector (BAT1).....	32
4.2.2 CPU Fan Connector (CPU_FAN1).....	34
4.2.3 System Debug Connector (DBG_PORT1).....	35
4.2.4 EC Debug Connector (EC_DEBUG1).....	36
4.2.5 EC Flash Connector (EC_FLASH1).....	37
4.2.6 SATA Connector (SATA1).....	38
4.2.7 AT/ATX Power Mode Switch (J_ATX_AT1).....	39
4.2.8 BIOS Programming Connector (JSP11) .....	41
4.2.9 Clear CMOS Button (J_CMOS1).....	42
4.2.10 Flash Override Jumper (ME_FLASH1).....	43
4.2.11 Buzzer Connector .....	44
4.2.12 M.2 E-key Slot.....	45
4.2.13 M.2 M-key Slot.....	47
4.2.14 HDD LED Connector .....	49
4.2.15 LAN LED Connector.....	50
4.2.16 PMBUS Connector.....	51
4.3 EXTERNAL INTERFACE PANEL CONNECTORS .....	53
4.3.1 External HDMI 1.4 Connectors (HDMI1, HDMI_DP2).....	53
4.3.2 External DP Connectors (HDMI_DP2).....	54
4.3.3 External 2.5GbE LAN Connectors (LAN1, LAN2, LAN3).....	54
4.3.4 External RS-232/422/485 Serial Port Connector (COM2).....	55
4.3.5 External RS-232 Serial Port Connector (COM1).....	56
4.3.6 External USB 3.2 GEN2 Type-A Connectors (USB1, USB2).....	56
4.3.7 External USB 3.2 GEN1 Type-A Connectors (USB3, USB4).....	57
<b>5 BIOS.....</b>	<b>58</b>
1.1 INTRODUCTION .....	59
5.1.1 Starting Setup.....	59
5.1.2 Using Setup .....	60
5.1.2.1 Keyboard Navigation .....	60
5.1.2.2 Touch Navigation .....	61
5.1.3 Getting Help.....	62

## TANGO-7010 Embedded System

5.1.4	Unable to Reboot after Configuration Changes .....	62
5.1.5	BIOS Menu Bar.....	62
1.2	MAIN .....	63
1.3	ADVANCED.....	66
5.3.1	CPU Configuration .....	68
5.3.2	Trusted Computing.....	73
5.3.3	IT5571 Super IO Configuration.....	74
5.3.4	IT5571 H/W Monitor.....	77
5.3.4.1	Smart Fan Mode Configuration .....	78
5.3.5	HDMI CEC Configuration.....	80
5.3.6	RTC Wake Settings .....	82
5.3.7	Serial Port Console Redirection .....	83
5.3.7.1	Console Redirection Settings .....	84
5.3.8	AMI Graphic Output Protocol Policy.....	87
5.3.9	Network Stack Configuration.....	88
5.3.10	NVMe Configuration.....	89
5.4	CHIPSET .....	90
5.4.1	System Agent (SA) Configuration .....	91
5.4.1.1	Memory Configuration.....	92
5.4.1.2	Graphics Configuration.....	93
5.4.1.3	PCI Express Configuration .....	94
5.4.2	PCH-IO Configuration .....	96
5.4.2.1	PCI Express Configuration .....	98
5.4.2.2	SATA Configuration.....	100
5.5	SECURITY.....	101
5.6	BOOT.....	103
5.6.1	Boot Configuration .....	103
5.6.2	Boot Option Priorities.....	103
5.7	SAVE & EXIT .....	104

# List of Figures

Figure 1-1: TANGO-7010 Series .....	2
Figure 1-2: Front Panel .....	3
Figure 1-3: Rear Panel.....	4
Figure 1-4: Left Side Panel .....	4
Figure 1-5: Physical Dimensions .....	7
Figure 3-1: Remove the Cover.....	14
Figure 3-2: Open the HDD bracket .....	15
Figure 3-3: Install hard drive .....	16
Figure 3-4: Lock bracket with screws.....	16
Figure 3-5: Connect the SATA cable .....	17
Figure 3-6: The M.2 Module Locations .....	18
Figure 3-7: Removing the M.2 Module Retention Screw .....	18
Figure 3-8: Inserting the M.2 Module into the Slot at an Angle.....	19
Figure 3-9: Securing the M.2 Module.....	19
Figure 3-10: Back Cover Installation .....	20
Figure 3-11: HDMI Connection .....	21
Figure 3-12: LAN Connection .....	22
Figure 3-13: DB-9 Serial Port Connector .....	23
Figure 3-14: Serial Device Connection .....	23
Figure 3-15: Power Button.....	24
Figure 3-16: Power Connector .....	25
Figure 3-17: IEI Resource Download Center.....	26
Figure 4-1: Connector and Jumper Locations.....	30
Figure 4-2: Battery Connector Location.....	33
Figure 4-3: CPU Fan Connector Location .....	34
Figure 4-4: System Debug Connector Location .....	35
Figure 4-5: EC Debug Connector Location .....	36
Figure 4-6: EC Flash Connector Location.....	37
Figure 4-7: SATA Connector Location .....	38
Figure 4-8: AT/ATX Power Mode Switch Locations .....	40



## TANGO-7010 Embedded System

Figure 4-9: BIOS Programming Connector Location.....	41
Figure 4-10: Clear CMOS Button Location.....	42
Figure 4-11: Flash Descriptor Override Setting Jumper Locations .....	43
Figure 4-12: Buzzer Connector Location .....	44
Figure 4-13: M.2 E-key Slot Location.....	45
Figure 4-14: M.2 M-key Slot Location .....	48
Figure 4-15: HDD LED Connector Location .....	50
Figure 4-16: LAN LED Connector Location .....	51
Figure 4-17: PMBUS Connector Location .....	52
Figure 4-18: HDMI Connector .....	54
Figure 4-19: DP Connector .....	54
Figure 4-20: LAN Connectors.....	55
Figure 4-21: RS-232/422/485 Serial Port Connectors.....	56
Figure 4-22: USB 3.2 GEN2 Port Location .....	57
Figure 4-23: USB 3.2 GEN1 Port Location .....	57
Figure 5-1: BIOS Starting Menu .....	59
Figure 5-2: BIOS On-screen Navigation Keys .....	61

# List of Tables

Table 1-1: Technical Specifications .....	6
Table 3-1: RJ-45 Ethernet Connector LEDs .....	22
Table 3-2: RS-232 (COM1) & RS-232/422/485 (COM2) Connector Pinouts .....	23
Table 4-1: Peripheral Interface Connectors .....	31
Table 4-2: Battery Connector Pinouts .....	33
Table 4-3: CPU Fan Connector Pinouts .....	34
Table 4-4: System Debug Connector Pinouts .....	35
Table 4-5: EC Debug Connector Pinouts .....	37
Table 4-6: EC Flash Connector Pinouts .....	38
Table 4-7: SATA Connector Pinouts .....	39
Table 4-8: AT/ATX Power Mode Switch Pinouts .....	40
Table 4-9: BIOS Programming Connector Pinouts .....	41
Table 4-10: Clear CMOS Button Pinouts .....	42
Table 4-11: Flash Descriptor Security Override Jumper Pinouts .....	43
Table 4-12: Buzzer Connector Pinouts .....	44
Table 4-13: M.2 E-Key Slot Pinouts .....	46
Table 4-14: M.2 M-key Slot Pinouts .....	49
Table 4-15: HDD LED Connector Pinouts .....	50
Table 4-16: LAN LED Connector Pinouts .....	51
Table 4-17: PMBUS Connector Pinouts .....	52
Table 4-18: Rear Panel Connectors .....	53
Table 4-19: HDMI Connector Pinouts .....	53
Table 4-20: DP Connector Pinouts .....	54
Table 4-21: LAN Connectors Pinouts .....	55
Table 4-22: LAN Connectors LEDs .....	55
Table 4-23: RS-232/422/485 Serial Port Connector Pinouts .....	55
Table 4-24: RS-232 Serial Port Connector Pinouts .....	56
Table 4-25: USB 3.2 GEN2 Connectors Pinouts .....	56
Table 4-26: USB 3.2 GEN1 Type-A Connectors Pinouts .....	57
Table 5-1: BIOS Navigation Keys .....	60

## TANGO-7010 Embedded System

Table 5-2: BIOS Options and Configured USB Ports.....97

Chapter

**1**

# Introduction

---

## 1.1 Overview



**Figure 1-1: TANGO-7010 Series**

The TANGO-7010 Series is an embedded system with 12<sup>th</sup> Gen Intel® Core™ i9/i7/i5/i3 processor and two DDR4 DIMM (8GB DDR4 pre-installed). It is equipped with three 2.5 GbE LAN ports, two USB 3.2 Gen2 (10Gb/s) ports, two USB 3.2 Gen1 (5Gb/s) ports, one RS-232 port and one RS-232/422/485 port.

The TANGO-7010 Series has two HDMI 2.0b & one DP1.4 ports supporting up to 4k@60Hz resolution, and includes one M.2 2230 A-key slot (pre-installed WIFI module) and two M.2 2280 M-key slot for expansions.

## 1.2 Features

The TANGO-7010 Series features are listed below:

- 12<sup>th</sup> Intel® Core™ i Processors
- Smart Fan system
- Triple 2.5GbE LAN
- One 2.5" HDD/SSD SATA 6Gb/s bay (supports up to 9.5 mm SSD)
- Built-in Wi-Fi 6E & Bluetooth 5.2 module (internal antenna)

## 1.3 Front Panel

The front panel of the TANGO-7010 Series has the following features (See Figure 1-2):

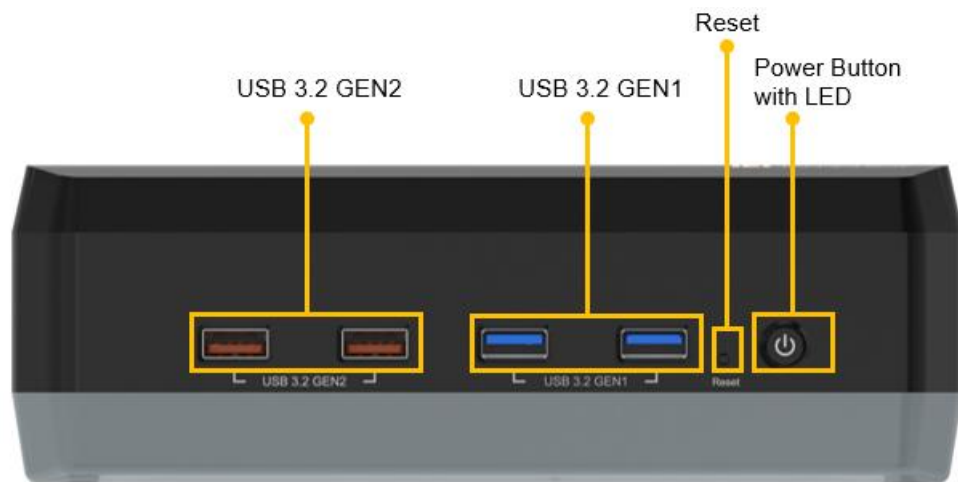

Figure 1-2: Front Panel

## 1.4 Rear Panel

The rear panel of the TANGO-7010 Series is shown below (See Figure 1-3).

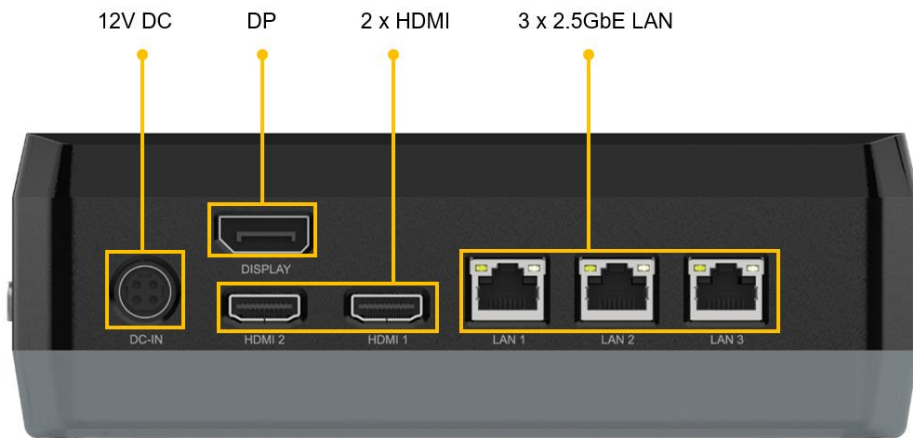

Figure 1-3: Rear Panel

## 1.5 Left Side Panel

The left side panel of the TANGO-7010 Series is shown below (See Figure 1-4).

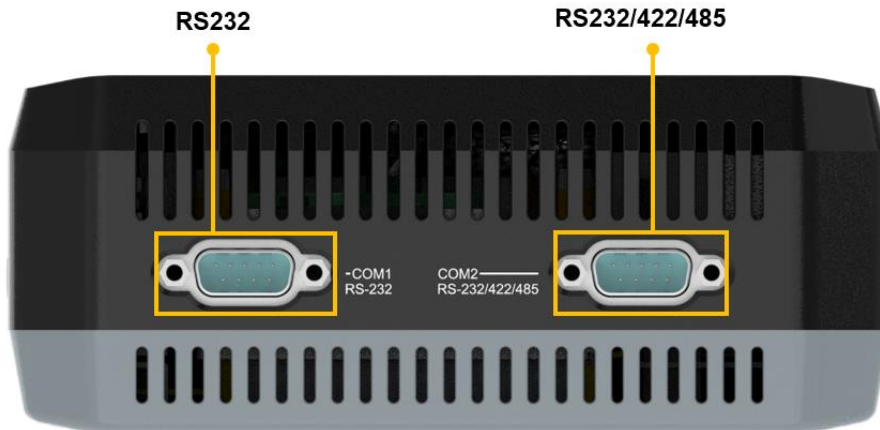

Figure 1-4: Left Side Panel

## 1.6 Technical Specifications

The TANGO-7010 Series technical specifications are listed in Table 1-1

Model Name		TANGO-7010-i9AWC-R10	TANGO-7010-i7AWC-R10	TANGO-7010-i5AWC-R10	TANGO-7010-i3AWC-R10
Chassis	Color	Black C & grey (Pantone 430C)			
	Dimension( WxDxH)(mm)	192.09*158*64 mm			
	System Fan	Fan			
	Chassis Construction	ABS Plastic + Aluminum			
Processor	CPU	Intel® Core™ i9-12900TE 1.1 GHz (up to 4.8 GHz, 16-core, TDP 35W)	Intel® Core™ i7-12700TE 1.4 GHz (up to 4.6 GHz, 12-core, TDP 35W)	Intel® Core™ i5-12500TE 1.9 GHz (up to 4.3 GHz, 6-core, TDP 35W)	Intel® Core™ i3-12100TE 2.1 GHz (up to 4 GHz, quad core, TDP 35W)
	Chipset	H610			
Memory	System Memory	2 x SO-DIMM 3200MHz DDR4,8GB pre-installed up to 64GB			
Storage	SATA	1 x 2.5" SATA 6Gb/s HDD/SSD bay (support 9.5mm SSD)			
I/O Interfaces	USB	2 x USB3.2 Gen 2 2 x USB3.2 Gen 1			
	Ethernet	3 x 2.5GbE by Intel® I225V controller			
	Display	2 x HDMI 2.0B Support CEC (up to 4k@ 60Hz) 1 x DP 1.4 (up to 4k@ 60Hz)			
	COM	1 x RS-232 (DB9) 1 x RS-232/422/485 with AFC (DB9)			
	Wireless	Intel AX210 Wi-Fi 6E & Bluetooth 5.2 Module built-in 2T2R antenna			
	TPM2.0	Support Intel PTT			
Expansions	M.2	1 x 2230 A-key (PCIe1/USB2.0) (preinstalled WIFI Module) 1 x 2280 M-key (PCIe Gen4 x4) 1 x 2280 M-key (PCIe Gen3 x4)			
Power	Power Input	DC JACK: 12 VDC			
	Power Consumption	12V@2.95A (Intel®Core™ i7-12700TE with 8GB memory)			
Reliability	Mounting	VESA 75/100			



	Operating Temperature	0°C ~ 40°C with air flow (SSD), 10% ~ 95%, non-condensing
	Storage Temperature	-10°C ~ 60°C with air flow (SSD), 10% ~ 90%, non-condensing
	Operating Shock	Half-sine wave shock 5G, 11ms, 100 shocks per axis (SSD)
	Operation Vibration	10-500 Hz, 1.04 Grms, random, 1 hr/axis (SSD)
	Weight (Net/Gross)	1.29 / 2.34kg
	Safety / EMC	CE, RED, FCC, UKCA
	Watchdog timer	Programmable 1~255 sec/min
Others	Switch	1 x Power Button (with LED), 1 x Reset Button
OS	Supported OS	Microsoft® Windows® 10/11, Linux

**Table 1-1: Technical Specifications**

## 1.7 Physical Dimensions

The physical dimensions of the TANGO-7010 are shown in **Figure1-5**.

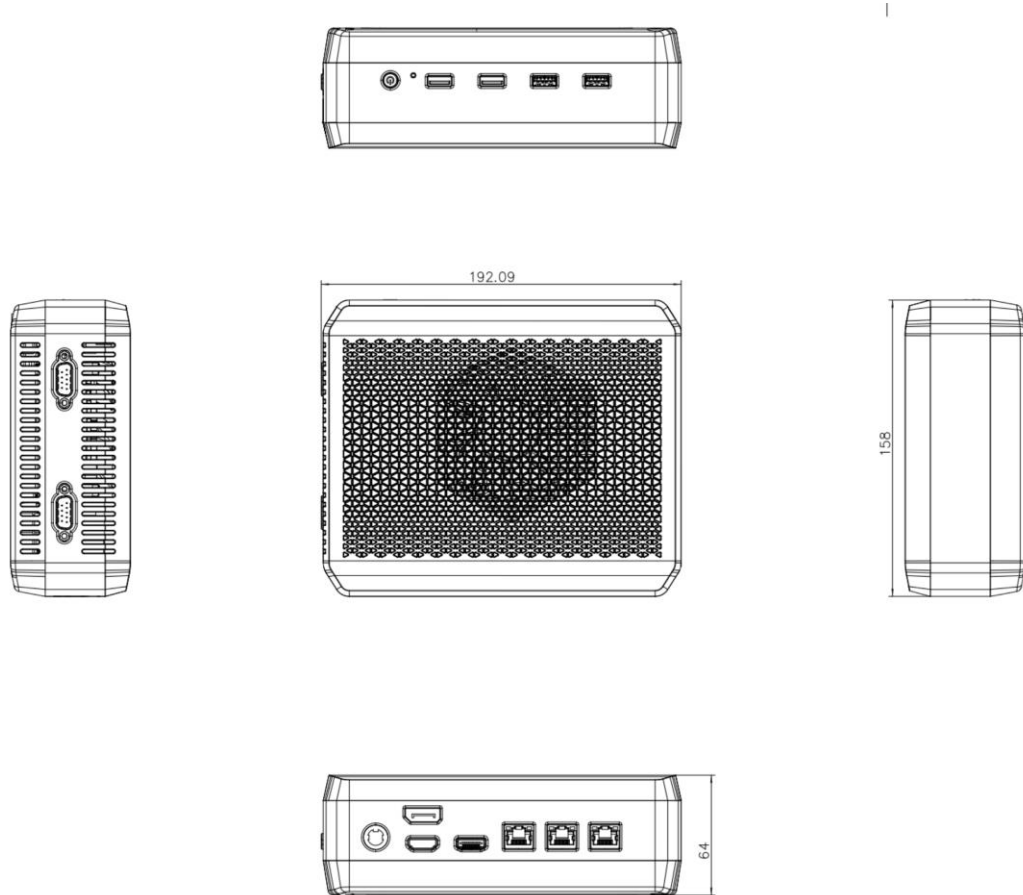

**Figure1-5: Physical Dimensions**

Chapter

**2**

# Unpacking

---

## 2.1 Anti-static Precautions

---



### WARNING:

Failure to take ESD precautions during installation may result in permanent damage to the TANGO-7010 Series and severe injury to the user.

---

Electrostatic discharge (ESD) can cause serious damage to electronic components, including the TANGO-7010 Series. Dry climates are especially susceptible to ESD. It is therefore critical that whenever the TANGO-7010 Series or any other electrical component is handled, the following anti-static precautions are strictly adhered to.

- **Wear an anti-static wristband:** Wearing a simple anti-static wristband can help to prevent ESD from damaging the board.
- **Self-grounding:** Before handling the board touch any grounded conducting material. During the time the board is handled, frequently touch any conducting materials that are connected to the ground.
- **Use an anti-static pad:** When configuring the TANGO-7010 Series, place it on an anti-static pad. This reduces the possibility of ESD damaging the TANGO-7010 Series.

## 2.2 Unpacking Precautions

When the TANGO-7010 Series is unpacked, please do the following:

- Follow the anti-static precautions outlined in **Section 2.1**.
- Make sure the packing box is facing upwards so the TANGO-7010 Series does not fall out of the box.
- Make sure all the components shown in **Section 2.2** are present.





## 2.3 Unpacking Checklist





**NOTE:**

If some of the components listed in the checklist below are missing, please do not proceed with the installation. Contact the IEI reseller or vendor you purchased the TANGO-7010 Series from or contact an IEI sales representative directly. To contact an IEI sales representative, please send an email to [sales@ieiworld.com](mailto:sales@ieiworld.com).

The TANGO-7010 Series is shipped with the following components:

Quantity	Item and Part Number	Image
<b>Standard</b>		
1	TANGO-7010 Series	
1	VESA mounting kit	
1	Mounting screw pack	
1	Power cord	

Quantity	Item and Part Number	Image
<b>Standard</b>		
1	Power adapter (P/N: 63040-380060-101-RS)	
1	Screw driver	

**Table 2-1: Packing List**

Chapter

**3**

# Installation

---

### 3.1 Installation Precautions

During installation, be aware of the precautions below:

- **Read the user manual:** The user manual provides a complete description of the TANGO-7010 Series, installation instructions and configuration options.
- **DANGER! Disconnect Power:** Power to the TANGO-7010 Series must be disconnected during the installation process, or before any attempt is made to access the rear panel. Electric shock and personal injury might occur if the rear panel of the TANGO-7010 Series is opened while the power cord is still connected to an electrical outlet.
- **Qualified Personnel:** The TANGO-7010 Series must be installed and operated only by trained and qualified personnel. Maintenance, upgrades, or repairs may only be carried out by qualified personnel who are familiar with the associated dangers.
- **Air Circulation:** Make sure there is sufficient air circulation when installing the TANGO-7010 Series. The cooling vents of TANGO-7010 Series must not be obstructed by any objects. Leave at least 5 cm of clearance around the TANGO-7010 Series to prevent overheating.
- **Grounding:** The TANGO-7010 Series should be properly grounded. The voltage feeds must not be overloaded. Adjust the cabling and provide external overcharge protection per the electrical values indicated on the label attached to the back of the TANGO-7010 Series.



## 3.2 Back Cover Removal

Before installing or maintaining the internal components, the back cover must be removed from the TANGO-7010. Follow the steps below to complete the task.

**Step 1:** Turn the TANGO-7010 over and loosen the 4 screws on the back cover (the screws cannot be removed).

**Step 2:** Take off the back cover (See Figure 3-1).

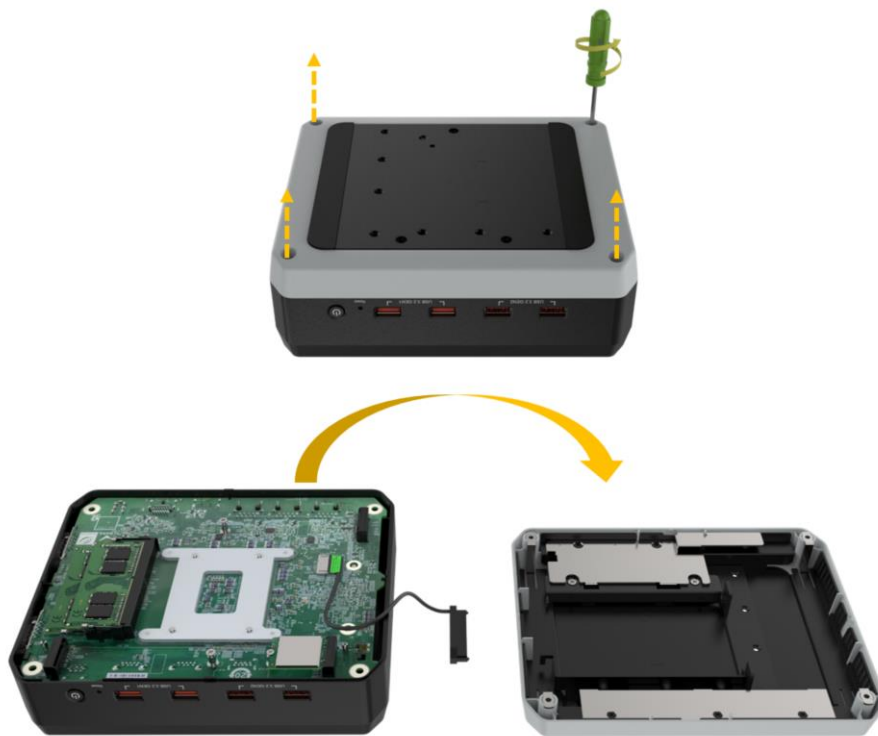

Figure 3-1: Remove the Cover

## 3.3 Storage Installation

The TANGO-7010 supports two types of storage, one via M.2 2280 M-key slot and one via 2.5" SATA drive bay.

### 3.3.1 Tool-Less HDD/SSD Installation

The TANGO-7010 Series allow installation of one 2.5" HDD/SSD. Follow the steps below to complete the task.

**Step 1:** Remove the 2 hard disk bracket screws and push out the hard disk bracket in parallel.

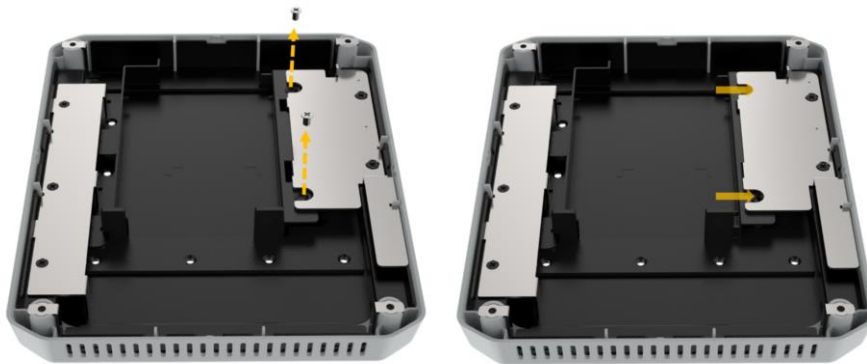

**Figure 3-2: Open the HDD bracket**

**Step 2:** Insert one side of the hard disk by aligning the two screw holes with the two positioning studs on the chassis. After clipping into place, push the other side down.

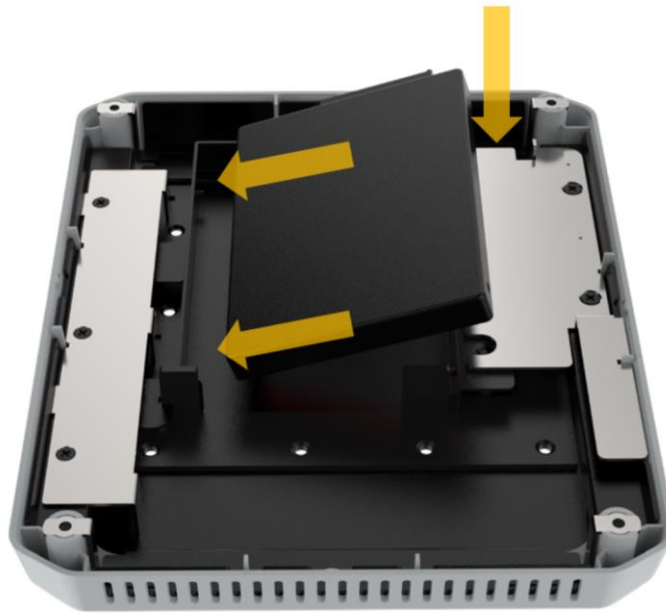

**Figure 3-3: Install hard drive**

**Step 3:** Push the hard disk bracket back to secure the hard disk, and lock it with 2 retention screws.



**Figure 3-4: Lock bracket with screws**

**Step 4:** Connect the SATA cable to an HDD/SSD and re-install the back cover.

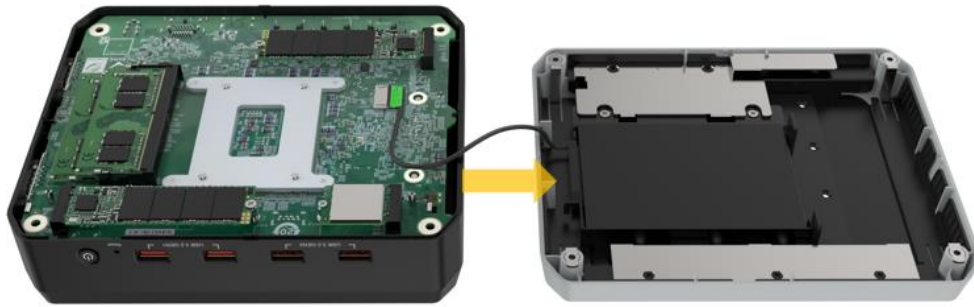
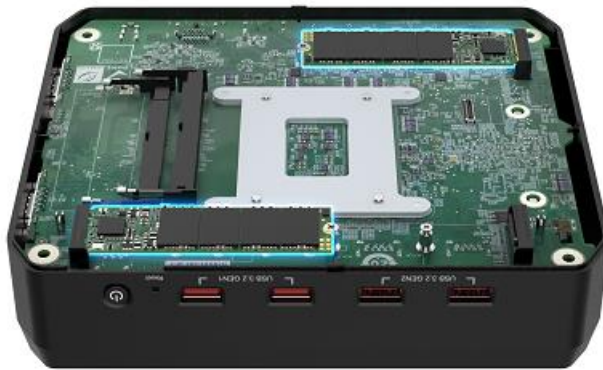

**Figure 3-5: Connect the SATA cable**

### 3.3.2 M.2 SSD Installation

The TANGO-7010 Series allows installation of two M.2 2280 M-key card. Follow the steps below to complete the task.

**Step 1:** Locate the M.2 2280 M-key slot. (See **Figure 3-6**)



**Figure 3-6: The M.2 Module Locations**

**Step 2:** Remove the on-board retention screw as shown below (See **Figure 3-7**).

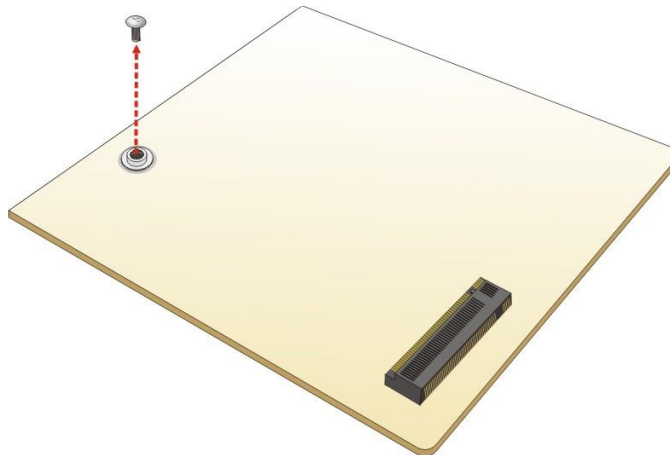

**Figure 3-7: Removing the M.2 Module Retention Screw**

**Step 3:** Line up the notch on the module with the notch on the slot. Slide the M.2 module into the socket at an angle of about 20° (**Figure 3-8**).

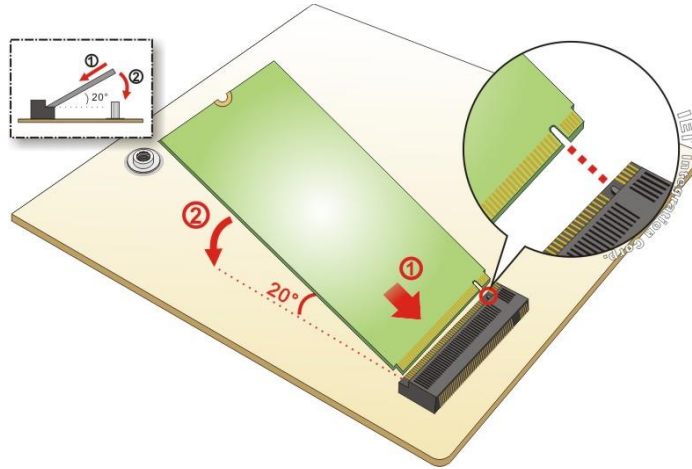

**Figure 3-8: Inserting the M.2 Module into the Slot at an Angle**

**Step 4:** Secure the M.2 module with the previously removed retention screw

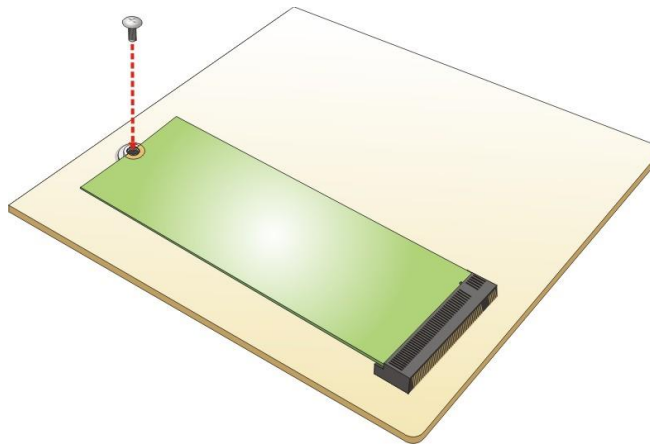

**Figure 3-9: Securing the M.2 Module**

### 3.4 Back Cover Installation

Install the back cover and fasten the 4 screws to secure it (See Figure 3-10).

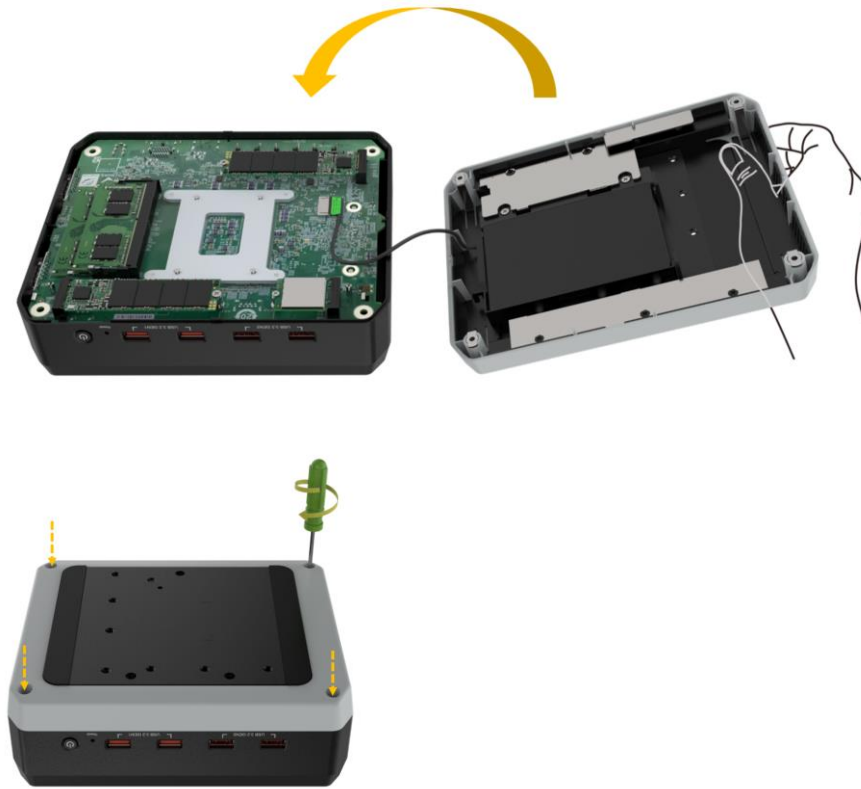

Figure 3-10: Back Cover Installation

## 3.5 External Peripheral Interface Connectors

### 3.5.1 HDMI Connection

To connect the HDMI devices, please plug in HDMI connector in the right direction as shown below:

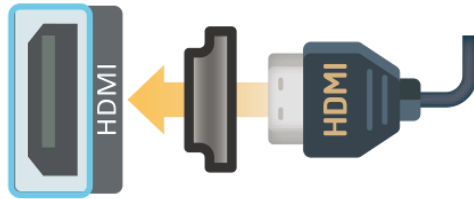

Figure 3-11: HDMI Connection



### 3.5.2 LAN Connection

The LAN connectors allow connection to an external network.

**Step 1:** Locate the RJ-45 connectors. The locations of the RJ-45 connectors are shown in **Chapter 1**.

**Step 2:** Align the connectors. Align the RJ-45 connector on the LAN cable with one of the RJ-45 connectors on the **TANGO-7010 Series**. (See **Figure 3-12**).

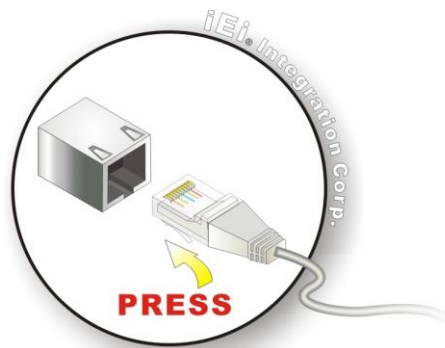

**Figure 3-12: LAN Connection**

**Step 3:** Insert the LAN cable RJ-45 connector. Once aligned, gently insert the LAN cable RJ-45 connector into the on-board RJ-45 connector.

The RJ-45 Ethernet connector has two status LEDs, one green and one yellow. The green LED indicates activity on the port and the yellow LED indicates the port is linked. See **Table 3-1**

Activity/Link LED		Speed LED	
STATUS	DESCRIPTION	STATUS	DESCRIPTION
Off	No link	Off	100 Mbps connection
Yellow	Linked	Orange	1 Gbp connection
Blinking	TX/RX activity	Green	2.5 Gbps connection

**Table 3-1: RJ-45 Ethernet Connector LEDs**

### 3.5.3 RS-232/422/485 Serial Port Connection

The system has one RS-232/422/485 port & one RS-232 serial port. The pinouts for the serial ports are listed in the table below (See Table 3-2).

PIN NO.	RS232	RS422	RS485
1	DCD#	TX-	TX-
2	RXD	TX+	TX+
3	TXD	RX+	
4	DTR#	RX-	
5	GND		
6	DSR#		
7	RTS#		
8	CTS#		
9	RI#		

Table 3-2: RS-232 (COM1) & RS-232/422/485 (COM2) Connector Pinouts

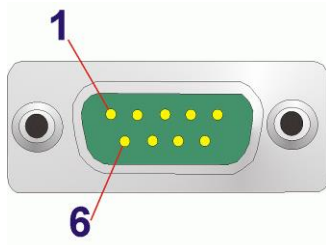

Figure 3-13: DB-9 Serial Port Connector

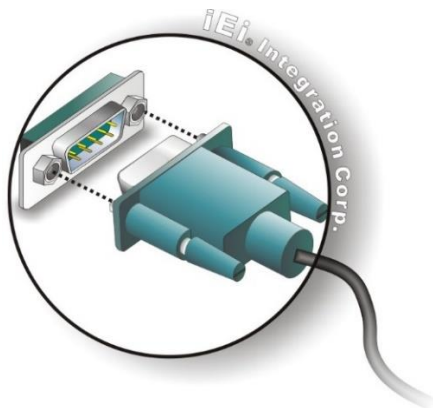

Figure 3-14: Serial Device Connection

### 3.6 Powering On/Off the System



#### WARNING:

Make sure a power supply with the correct input voltage is being fed into the system. Incorrect voltages applied to the system may cause damage to the internal electronic components and may also cause injury to the user.

- **Power on** the system: press the power button for 3 seconds
- **Power off** the system: press the power button for 6 seconds
- The power of this system can be less than 250w-20A.



Figure 3-15: Power Button

### 3.7 Power Input

The power connector is a 4-pin DC jack connector on the rear panel that can directly connect to a power adapter. The supported power input voltage is 12 VDC.

Power Input : DC Jack 12V



Figure 3-16: Power Connector

## 3.8 Available Drivers

All the drivers for the TANGO-7010 Series are available on IEI Resource Download Center (<https://download.ieiworld.com>). Type TANGO-7010 Series and press Enter to find all the relevant software, utilities, and documentation.

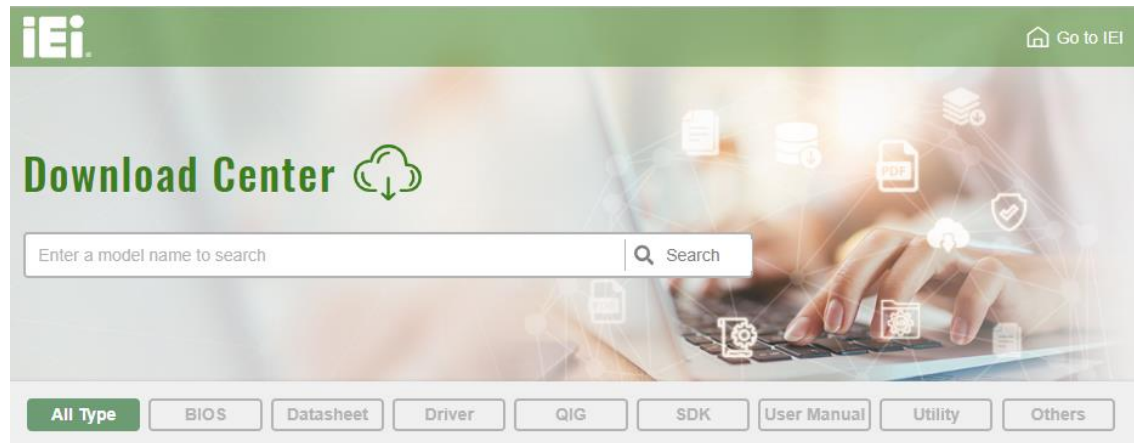
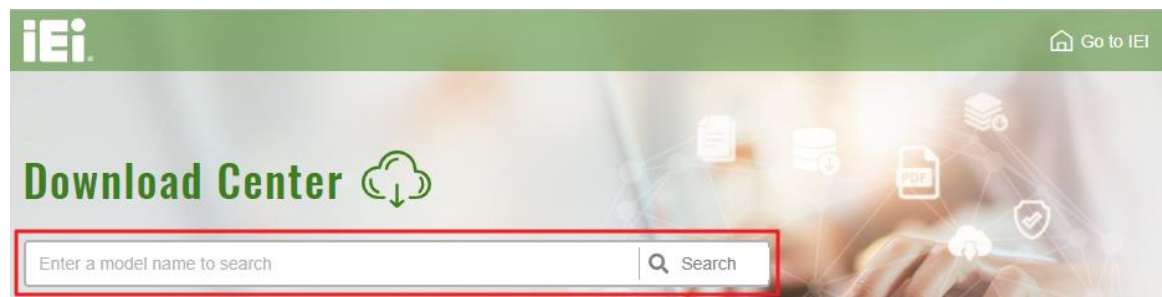

Figure 3-17: IEI Resource Download Center

### 3.8.1 Driver Download

To download drivers from IEI Resource Download Center, follow the steps below.

**Step 1:** Go to <https://download.ieiworld.com>. Type TANGO-7010 Series and press Enter.



**Step 4:** All product-related software, utilities, and documentation will be listed. You can choose **Driver** to filter the result.

[All Type](#)
[BIOS](#)
[Datasheet](#)
[Driver](#)
[QIG](#)
[SDK](#)
[User Manual](#)
[Utility](#)
[Others](#)

**WAFER-BT-i1** [Product Info](#)

[Embedded Computer](#) ▶ [Single Board Computer](#) ▶ [Embedded Board](#)  
 3.5" SBC with Intel® 22nm Atom™/Celeron® on-board SoC

Driver

File Name	Published	Version	File Checksum
<a href="#">7B000-001033-RS V2.3.iso (2.23 GB)</a>	2017/10/03	2.30	3B2DB1F792779A93A8F50DDBC3943E30

**Step 5:** Click the driver file name on the page and you will be prompted with the following window. You can download the entire ISO file ( ), or click the small arrow to find an individual driver and click the file name to download ( ).

7B000-001168-RS\_V1.4.iso

1 [Click here to download entire ISO file. \(2.99 GB\)](#)

\* Download individual file \*

2 Docs

- 1.Chipset
- 10.1.1.12.zip (2.7 MB)
- 2.VGA
- 3.Audio
- 4.Lan
- 5.USB 3.0
- 6.Serial IO
- 7.TXE
- 8.Manual



**NOTE:**

To install software from the downloaded ISO image file in Windows 10 (or later), double-click the ISO file to mount it as a virtual drive to view its content.

Chapter

**4**

# System Motherboard

---

## 4.1 Overview

This chapter details all the jumpers and connectors of the system motherboard.

### 4.1.1 Layout

The figures below show all the connectors and jumpers of the system motherboard.

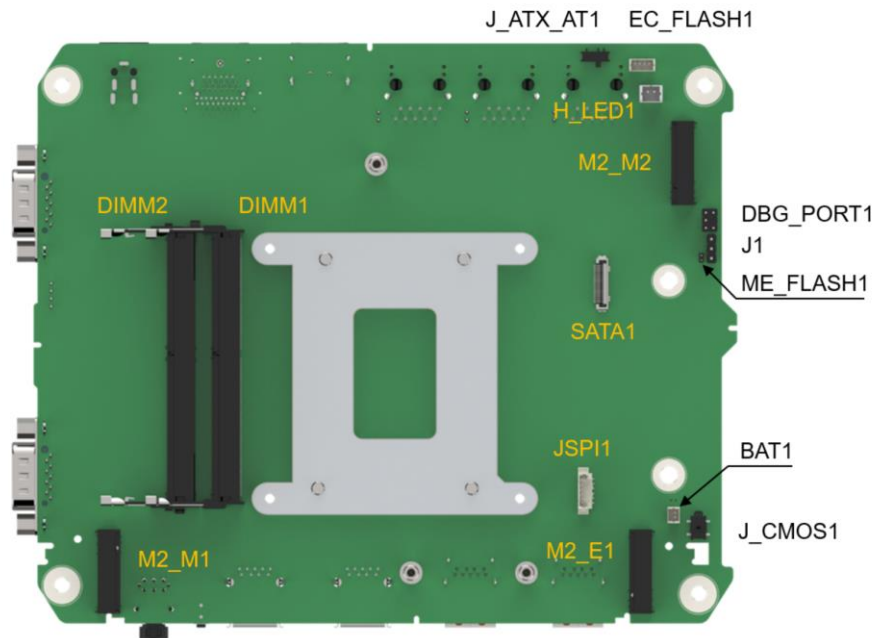



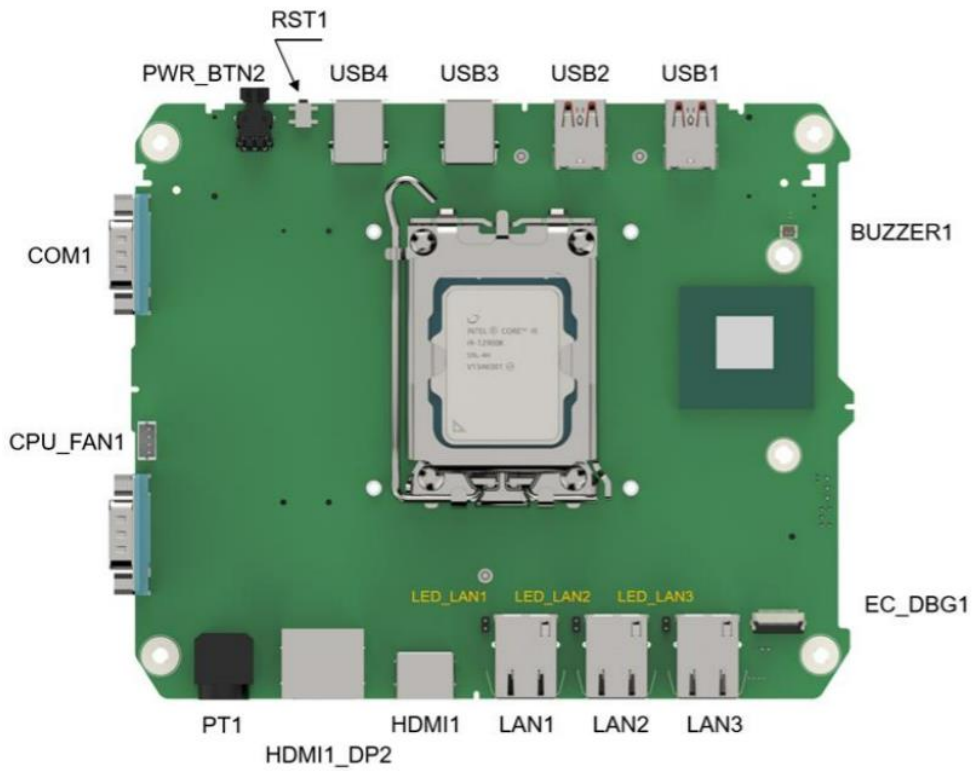

Figure 4-1: Connector and Jumper Locations

## 4.2 Internal Peripheral Connectors

The table below shows a list of the internal peripheral interface connectors on the system motherboard. Pinouts of these connectors can be found in the following sections.

Connector	Type	Label
Battery Connector	2-pin wafer	BAT1
CPU Fan Connector	4-pin wafer	CPU_FAN1
System Debug Connector	6-pin header	DBG_PORT1
EC Debug Connector	20-pin FPC connector	EC_DBG1
EC Flash Connector	4-pin wafer	EC_FLASH1
M.2 A key Slot	2230 A-key slot	M2_E1
M.2 M key Slot	2280 M-key slot	M2_M1, M2_M2
LAN LED Connector	2-pin header	LED_LAN1, LED_LAN2, LED_LAN3
SATA Connector	20-pin Wire to Board	SATA1
AT/ATX Power Mode Switch	3-pin switch	J_ATX_AT1
BIOS Programming Connector	6-pin wafer	JSPI1
Clear CMOS Button	Push button	J_CMOS1
Buzzer Connector	2-pin wafer	BUZZER1
PMBUS Connector	3-pin header	J1
HDD Act Connector	2-pin wafer	H_LED1
Flash Override Jumper	2-pin header	ME_FLASH1

**Table 4-1: Peripheral Interface Connectors**

#### 4.2.1 RTC Battery Connector (BAT1)

---

**CAUTION:**

Risk of explosion if battery is replaced by an incorrect type. Only certified engineers should replace the on-board battery.

Dispose of used batteries according to instructions and local regulations.

---

**NOTE:**

It is recommended to attach the RTC battery onto the system chassis in which the TANGO-7010 Series is installed.

---

<b>CN Label:</b>	<b>BAT1</b>
<b>CN Type:</b>	2-pin wafer, p=1.25 mm
<b>CN Location:</b>	See <b>Figure 4-2</b>
<b>CN Pinouts:</b>	See <b>Table 4-2</b>

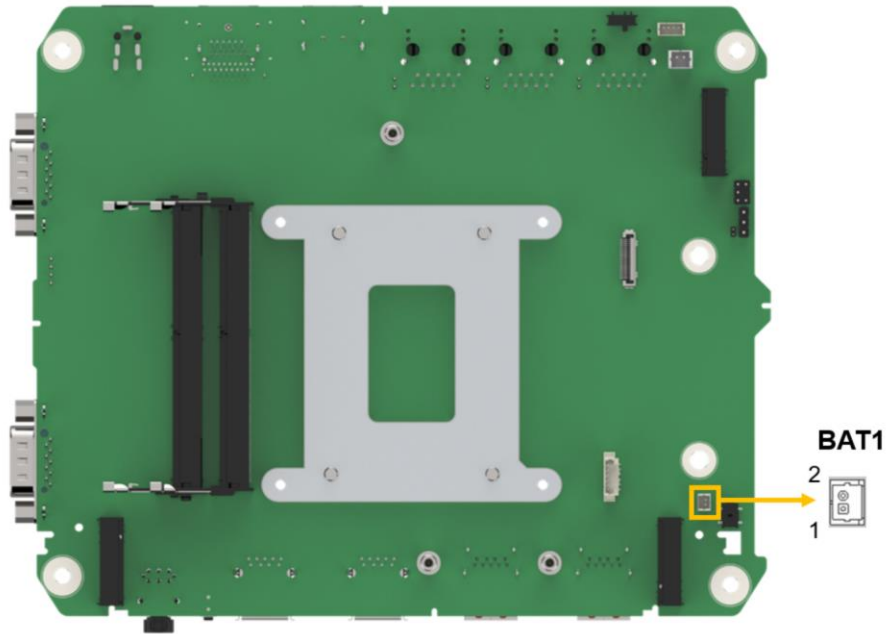

Figure 4-2: Battery Connector Location

PIN NO.	DESCRIPTION	PIN NO.	DESCRIPTION
1	VBATT(+3V)	2	GND

Table 4-2: Battery Connector Pinouts

### 4.2.2 CPU Fan Connector (CPU\_FAN1)

- CN Label:** CPU\_FAN1
- CN Type:** 4-pin wafer, p=2.00 mm
- CN Location:** See Figure 4-3
- CN Pinouts:** See Table 4-3

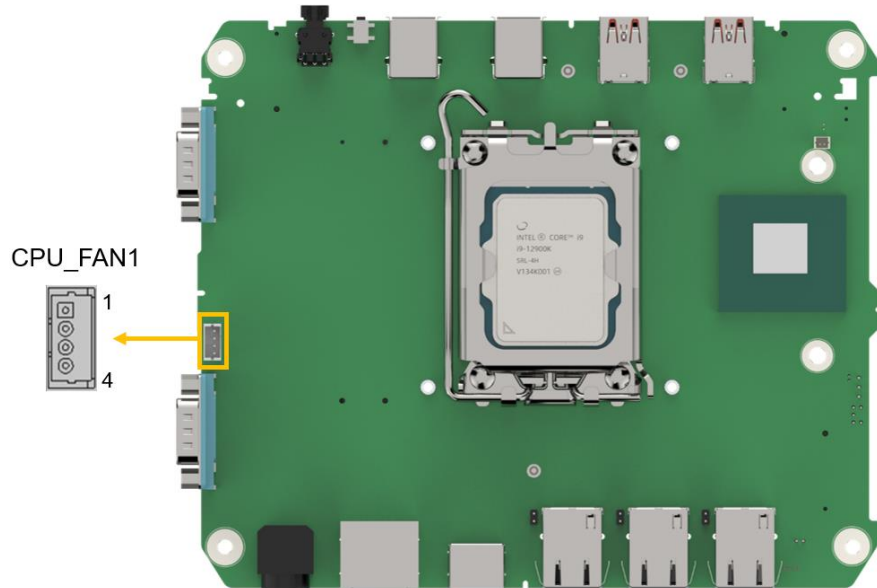

Figure 4-3: CPU Fan Connector Location

PIN NO.	DESCRIPTION	PIN NO.	DESCRIPTION
1	GND	2	VCC12V
3	FANIO	4	PWM

Table 4-3: CPU Fan Connector Pinouts

### 4.2.3 System Debug Connector (DBG\_PORT1)

- CN Label:** DBG\_PORT1
- CN Type:** 6-pin header, p=2.00 mm
- CN Location:** See Figure 4-4
- CN Pinouts:** See Table 4-4

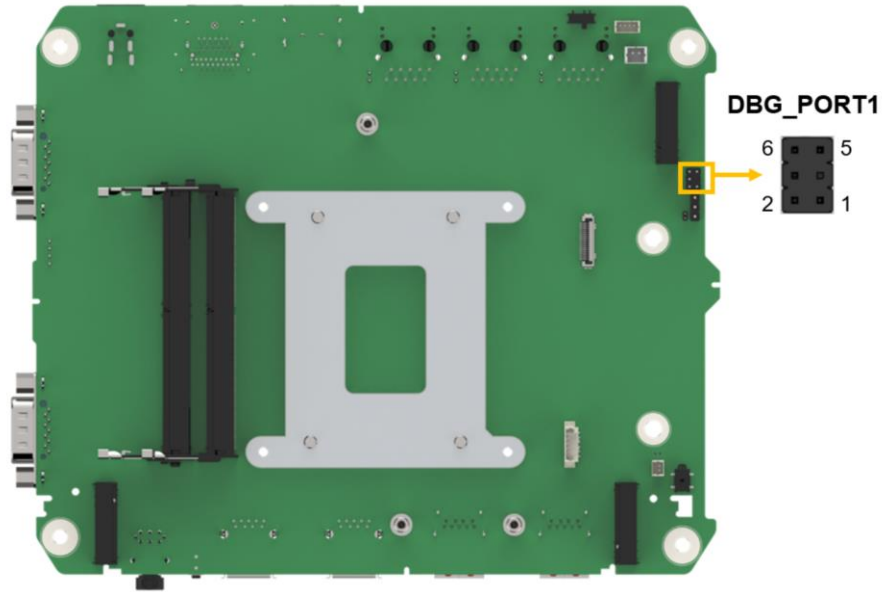

**Figure 4-4: System Debug Connector Location**

PIN NO.	DESCRIPTION	PIN NO.	DESCRIPTION
1	VCC	2	SMCLK_EC
3	NC	4	SMDAT_EC
5	GND	6	RST#

**Table 4-4: System Debug Connector Pinouts**

#### 4.2.4 EC Debug Connector (EC\_DEBUG1)

- CN Label:** EC\_DEBUG1
- CN Type:** FPC, p=0.5 mm
- CN Location:** See Figure 4-5
- CN Pinouts:** See Table 4-5

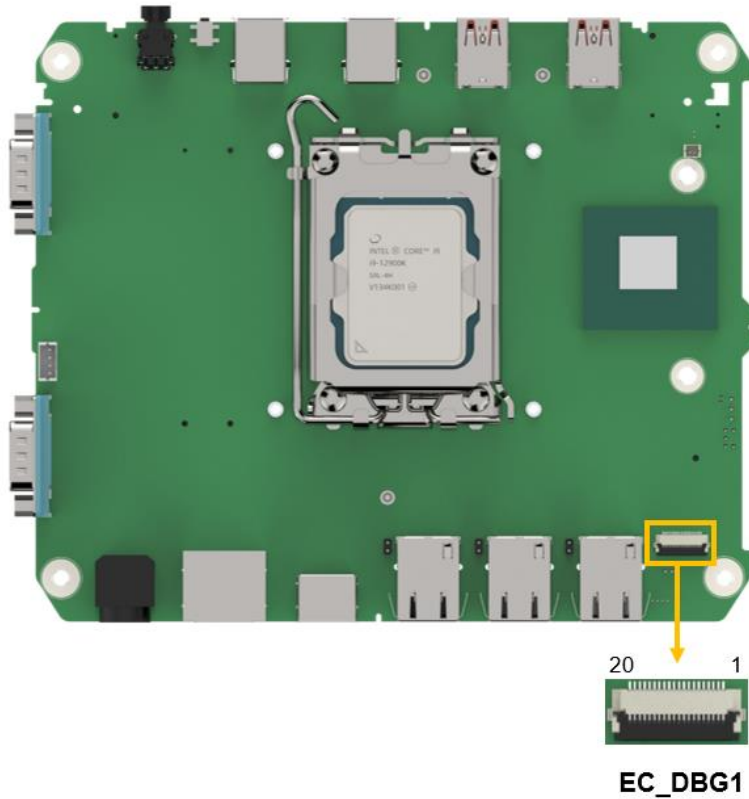

Figure 4-5: EC Debug Connector Location

PIN NO.	DESCRIPTION	PIN NO.	DESCRIPTION
1	KSI0	11	KSO9
2	KSO0	12	KSO10
3	KSO1	13	KSO12
4	KSO2	14	KSI1
5	KSO3	15	KSO11
6	KSO4	16	KSI2

7	KSO5	17	KSI3
8	KSO6	18	GND
9	KSO7	19	GND
10	KSO8	20	GND

**Table 4-5: EC Debug Connector Pinouts**

#### 4.2.5 EC Flash Connector (EC\_FLASH1)

- CN Label:** EC\_FLASH1
- CN Type:** 4-pin header, p=1.25 mm
- CN Location:** See Figure 4-6
- CN Pinouts:** See Table 4-6

The 4-pin Flash EC ROM connector is used to flash the EC internal ROM.

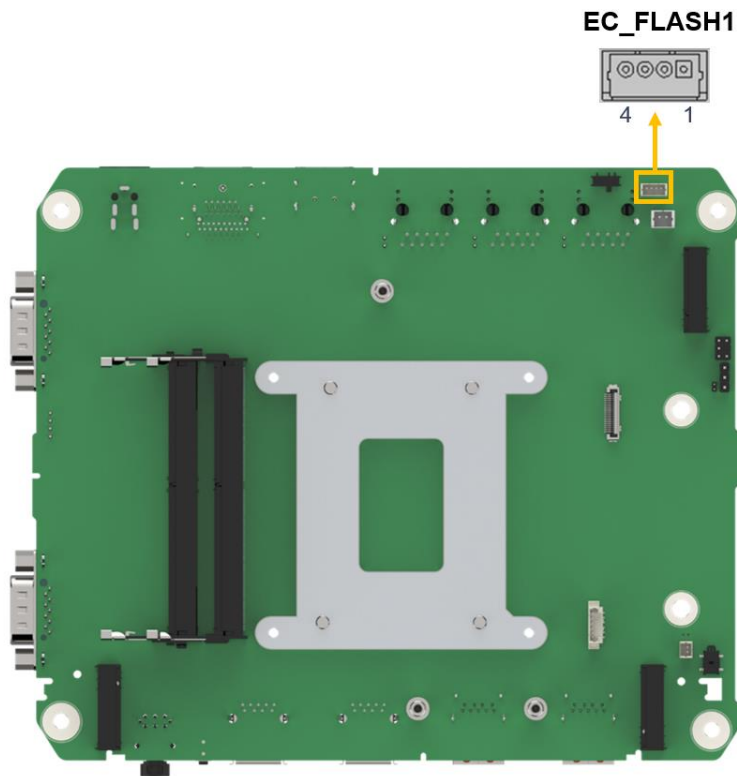

**Figure 4-6: EC Flash Connector Location**



PIN NO.	DESCRIPTION	PIN NO.	DESCRIPTION
1	GND	2	EC_FLASH_DAT
3	EC_FLASH_CLK	4	NC

**Table 4-6: EC Flash Connector Pinouts**

#### 4.2.6 SATA Connector (SATA1)

- CN Label:** SATA1
- CN Type:** 20-pin iSATA connector
- CN Location:** See **Figure 4-7**
- CN Pinouts:** See **Table 4-7**

The SATA 6Gb/s drive connector is connected to a SATA 6Gb/s drive. The SATA 6Gb/s drive transfers data at speeds as high as 6Gb/s.

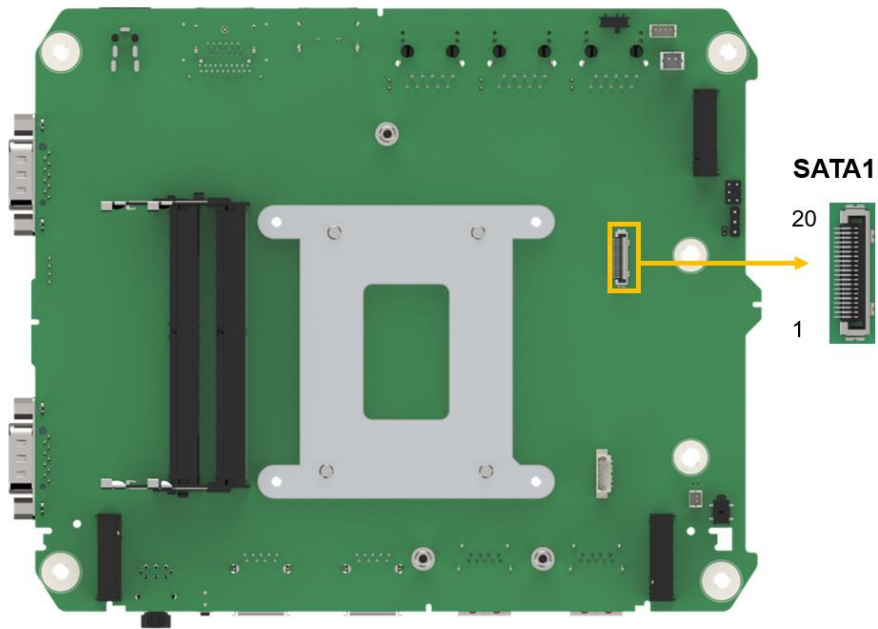

**Figure 4-7: SATA Connector Location**

PIN NO.	DESCRIPTION	PIN NO.	DESCRIPTION
1	GND	11	VCC1
2	GND	12	NC2

3	GND	13	NC1
4	GND	14	GND
5	GND	15	SATA_RXP0_C
6	NC3	16	SATA_RXN0_C
7	VCC5	17	GND
8	VCC4	18	SATA_TXN0_C
9	VCC3	19	SATA_TXP0_C
10	VCC2	20	GND

**Table 4-7: SATA Connector Pinouts**

#### 4.2.7 AT/ATX Power Mode Switch (J\_ATX\_AT1)

- CN Label:** J\_ATX\_AT1
- CN Type:** 3-pin switch
- CN Location:** See **Figure 4-8**
- CN Pinouts:** See **Table 4-8**

The AT/ATX power mode selection is made through the AT/ATX power mode switch which is shown in Figure 4-8.

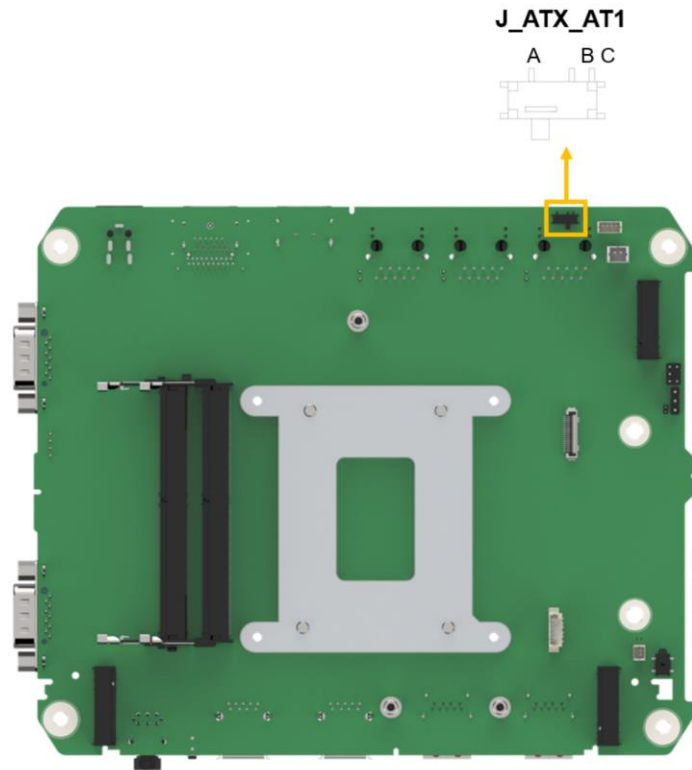

Figure 4-8: AT/ATX Power Mode Switch Locations

PIN NO.	DESCRIPTION
A-B	ATX Power Mode (default)
B-C	AT Power Mode

Table 4-8: AT/ATX Power Mode Switch Pinouts

#### 4.2.8 BIOS Programming Connector (JSPI1)

- CN Label:** JSPI1
- CN Type:** 6-pin wafer, p=1.25 mm
- CN Location:** See **Figure 4-9**
- CN Pinouts:** See **Table 4-9**

The 6-pin Flash SPI ROM connector is used to flash the BIOS.

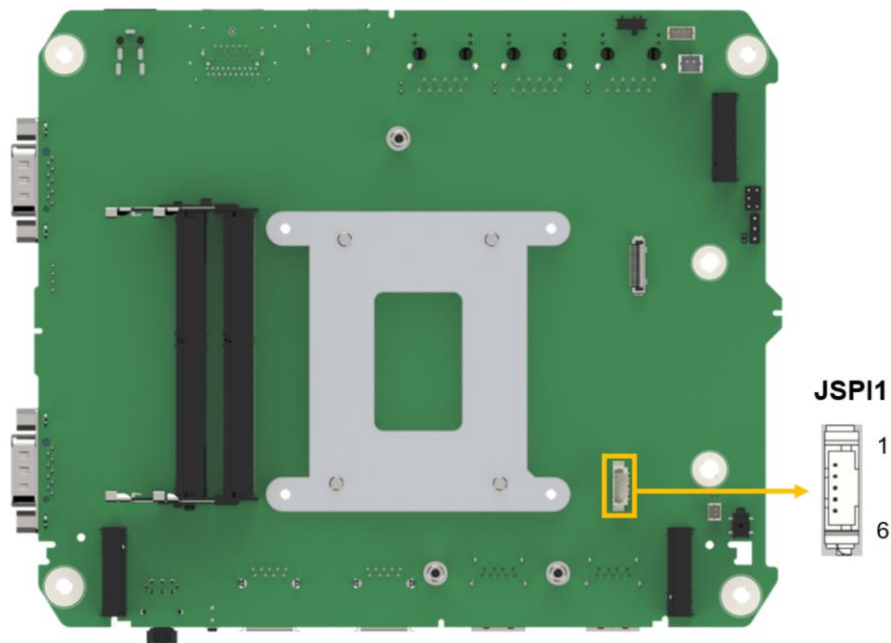

**Figure 4-9: BIOS Programming Connector Location**

PIN NO.	DESCRIPTION	PIN NO.	DESCRIPTION
1	+V3.3M_SPI_CON	2	SPI_CS#0_N
3	SPI_SO_N	4	SPI_CLK_N
5	SPI_SI_N	6	GND

**Table 4-9: BIOS Programming Connector Pinouts**

### 4.2.9 Clear CMOS Button (J\_CMOS1)

- CN Label:** J\_CMOS1
- CN Type:** Button
- CN Location:** See **Figure 4-10**
- CN Pinouts:** See **Table 4-10**

To clear the CMOS Setup (for example if you have forgotten the password, you should clear the CMOS and then reset the password), you should disconnect the RTC battery and press the button for about 3 seconds. This will set back to normal operation mode.

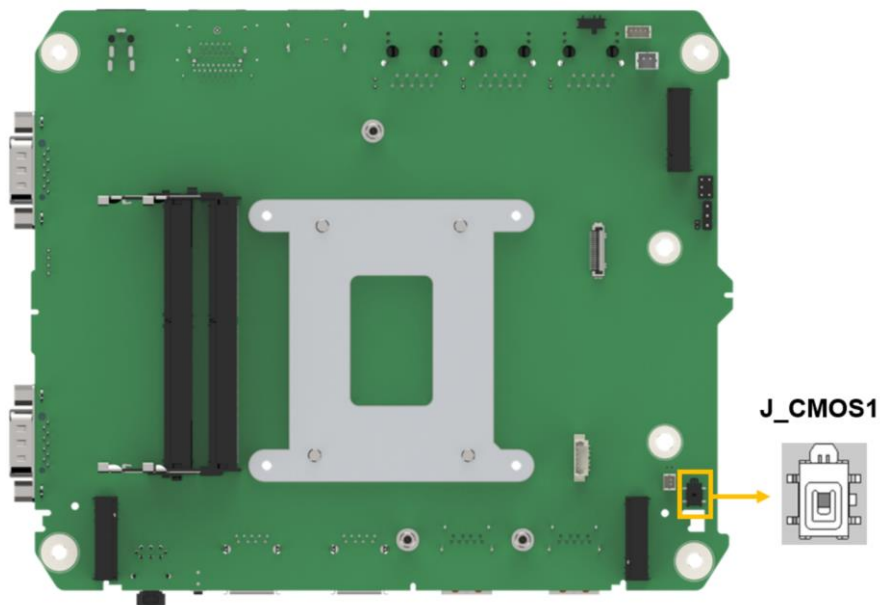

**Figure 4-10: Clear CMOS Button Location**

PIN NO.	DESCRIPTION
NC	Keep CMOS Setup (Normal Operation)
Press button	Clear CMOS Setup

**Table 4-10: Clear CMOS Button Pinouts**

#### 4.2.10 Flash Override Jumper (ME\_FLASH1)

- CN Label:** ME\_FLASH1
- CN Type:** 2-pin header, P=2.00mm
- CN Location:** See **Figure 4-11**
- CN Pinouts:** See **Table 4-11**

The ME\_FLASH1 connector is used for Flash Descriptor Security Override.

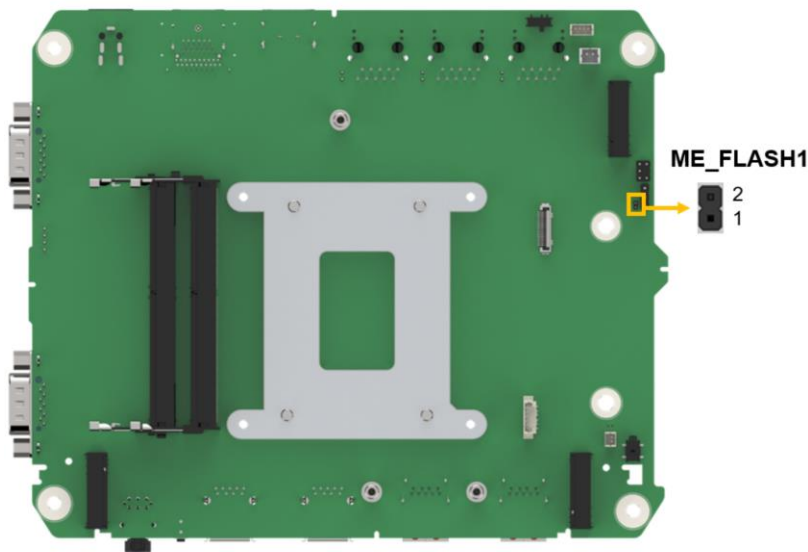

**Figure 4-11: Flash Descriptor Override Setting Jumper Locations**

PIN NO.	DESCRIPTION
NC (default)*	Disabled-Default
Short 1-2	Override

**Table 4-11: Flash Descriptor Security Override Jumper Pinouts**

### 4.2.11 Buzzer Connector

- CN Label:** BUZZER1
- CN Type:** 2-pin wafer, p=1.25mm
- CN Location:** See **Figure 4-12**
- CN Pinouts:** See **Table 4-12**

The buzzer connector is connected with the buzzer to give a beep warning when the motherboard goes wrong.

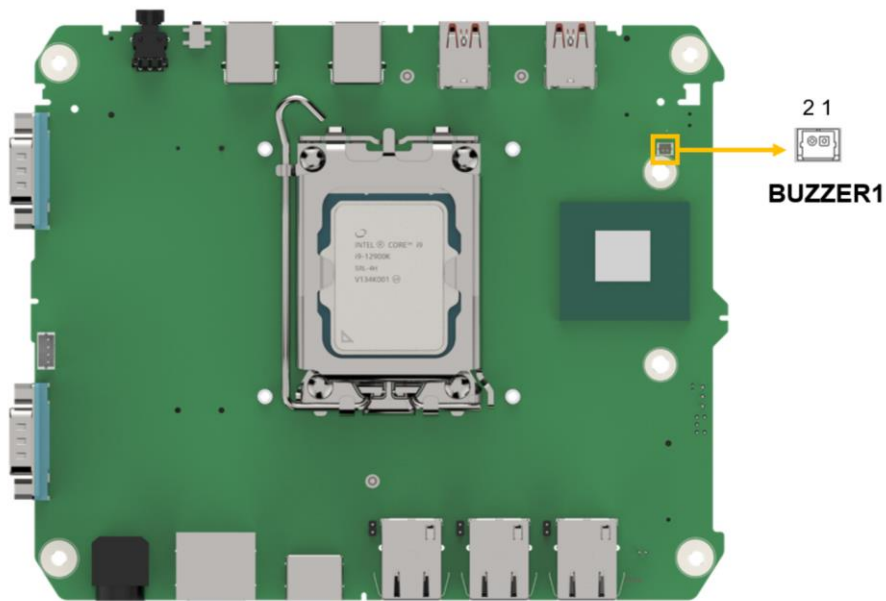

**Figure 4-12: Buzzer Connector Location**

Pin	Description
1	+5V
2	PC_BEEP_N

**Table 4-12: Buzzer Connector Pinouts**

#### 4.2.12 M.2 E-key Slot

- CN Label:** M2\_E1
- CN Type:** M.2 E-key slot
- CN Location:** See **Figure 4-13**
- CN Pinouts:** See **Table 4-13**

The M.2 slot is keyed in the E position and accepts 2230 size of M.2 modules. The M.2 slot supports PCIe Gen3 x1 and USB 2.0 signals.

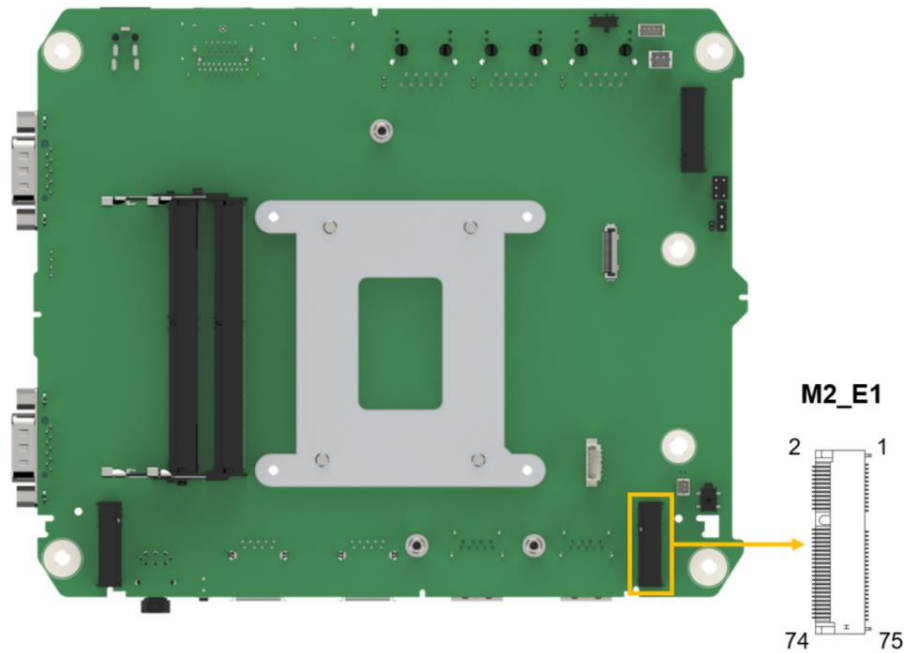

**Figure 4-13: M.2 E-key Slot Location**

Pin	Description	Pin	Description
1	GND	2	+V3.3A
3	USB+	4	+V3.3A
5	USB-	6	NC
7	GND	8	M.2_BT_PCMCLK
9	CNV_WR_1_DN	10	M.2_BT_PCMFRM_CRF_R
11	CNV_WR_1_DP	12	M.2_BT_PCMIN
13	GND	14	M.2_BT_PCOUT_CLKRE



Pin	Description	Pin	Description
15	CNV_WR_0_DN	16	NC
17	CNV_WR_0_DP	18	GND
19	GND	20	UART_BT_WAKE_N
21	CNV_WR_CLK_DN	22	CNV_BRI_RSP
23	CNV_WR_CLK_DP	24	Module Key
25	Module Key	26	Module Key
27	Module Key	28	Module Key
29	Module Key	30	Module Key
31	Module Key	32	CNV_RGI_DT
33	Module Key	34	CNV_RGI_RSP
35	PCIE_TX1+	36	CNV_BRI_DT_R
37	PCIE_TX1-	38	MLK_RST_N
39	GND	40	MLK_DATA
41	PCIE_RX1+	42	MLK_CLK
43	PCIE_RX1-	44	CNV_PA_BLANKING
45	GND	46	CNV_MFUART2_TXD
47	CLK_PCIE1+	48	CNV_MFUART2_RXD
49	CLK_PCIE1-	50	PMC_SUS_CLK
51	GND	52	PLT_SLOT_RST_N
53	SRCCLKREQB_3_N	54	BT_RF_KILL_N
55	EC_WAKE_N	56	WFI_RF_KILL_N
57	GND	58	NC
59	CNV_WT_1_DN	60	NC
61	CNV_WT_1_DP	62	NC
63	GND	64	GND
65	CNV_WT_0_DN	66	NC
67	CNV_WT_0_DP	68	NC
69	GND	70	NC
71	CNV_WT_CLK_DN	72	+V3.3A
73	CNV_WT_CLK_DP	74	+V3.3A
75	GND		

**Table 4-13: M.2 E-Key Slot Pinouts**

### 4.2.13 M.2 M-key Slot

- CN Label:** M2\_M1, M2\_M2
- CN Type:** M.2 M-key slot
- CN Location:** See Figure 4-14
- CN Pinouts:** See Table 4-14

The M.2 M key (M2\_M1 2280) slot with PCIe Gen4 x4 supports NVMe storage.

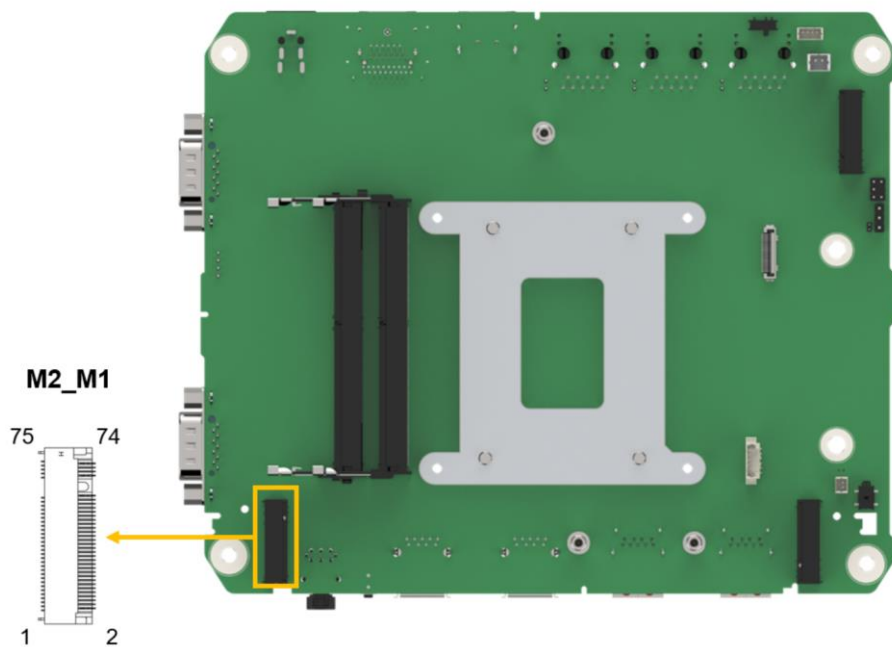

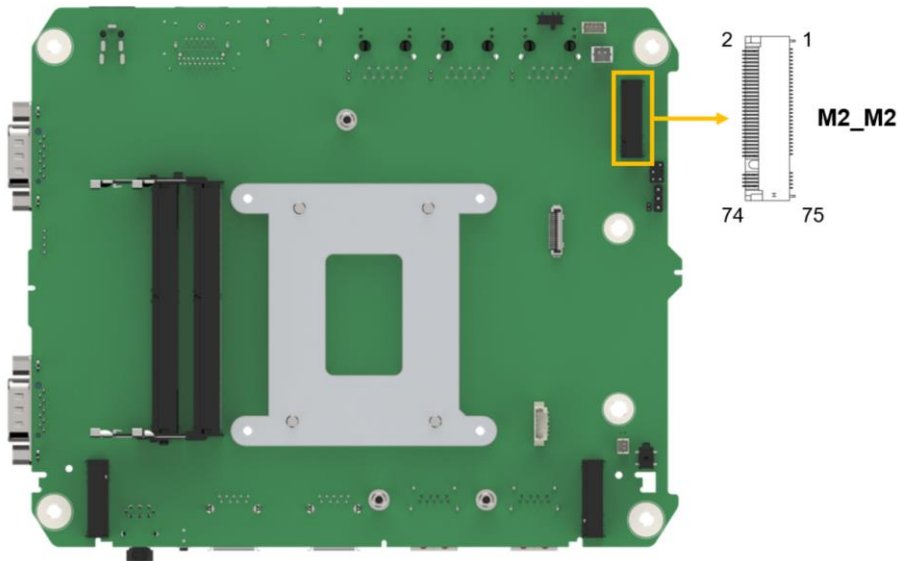

Figure 4-14: M.2 M-key Slot Location

PIN NO.	DESCRIPTION	PIN NO.	DESCRIPTION
1	GND	2	+3.3V
3	GND	4	+3.3V
5	PCIE_3_RX_DN	6	N/C
7	PCIE_3_RX_DP	8	N/C
9	GND	10	NGFF1_ACT_N
11	PCIE_3_TX_DN	12	+3.3V
13	PCIE_3_TX_DP	14	+3.3V
15	GND	16	+3.3V
17	PCIE_2_RX_DN	18	+3.3V
19	PCIE_2_RX_DP	20	N/C
21	GND	22	N/C
23	PCIE_2_TX_DN	24	N/C
25	PCIE_2_TX_DP	26	N/C
27	GND	28	N/C
29	PCIE_1_RX_DN	30	N/C
31	PCIE_1_RX_DP	32	N/C
33	GND	34	N/C

35	PCIE_1_TX_DN	36	N/C
37	PCIE_1_TX_DP	38	M_2_SSD_SLP
39	GND	40	SMB_CLK_M2
41	PCIE_0_RX_DN	42	SMB_DATA_M2
43	PCIE_0_RX_DP	44	N/C
45	GND	46	N/C
47	PCIE_0_TX_DN	48	N/C
49	PCIE_0_TX_DP	50	PLT_SLOT_RST_N
51	GND	52	SRCCLKREQB_1_N
53	REFCLKN	54	N/C
55	REFCLKP	56	N/C
57	GND	58	N/C
59	Module Key	60	Module Key
61	Module Key	62	Module Key
63	Module Key	64	Module Key
65	Module Key	66	Module Key
67	N/C	68	N/C
69	N/C	70	+3.3V
71	GND	72	+3.3V
73	GND	74	+3.3V
75	GND		

**Table 4-14: M.2 M-key Slot Pinouts**

#### 4.2.14 HDD LED Connector

- CN Label:** H\_LED1
- CN Type:** 2-pin wafer, p=2.00 mm
- CN Location:** See **Figure 4-15**
- CN Pinouts:** See **Table 4-15**

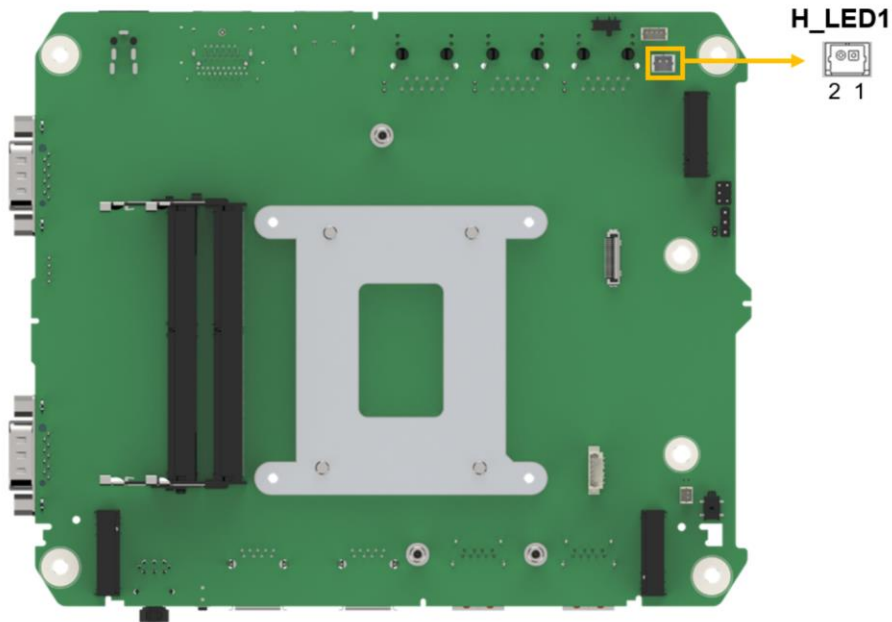

**Figure 4-15: HDD LED Connector Location**

PIN NO.	DESCRIPTION	PIN NO.	DESCRIPTION
1	+V5S	2	HD_LED_N

**Table 4-15: HDD LED Connector Pinouts**

#### 4.2.15 LAN LED Connector

**CN Label:** LED\_LAN1, LED\_LAN2, LED\_LAN3

**CN Type:** 2-pin header, p=2.00mm

**CN Location:** See **Figure 4-16**

**CN Pinouts:** See **Table 4-16**

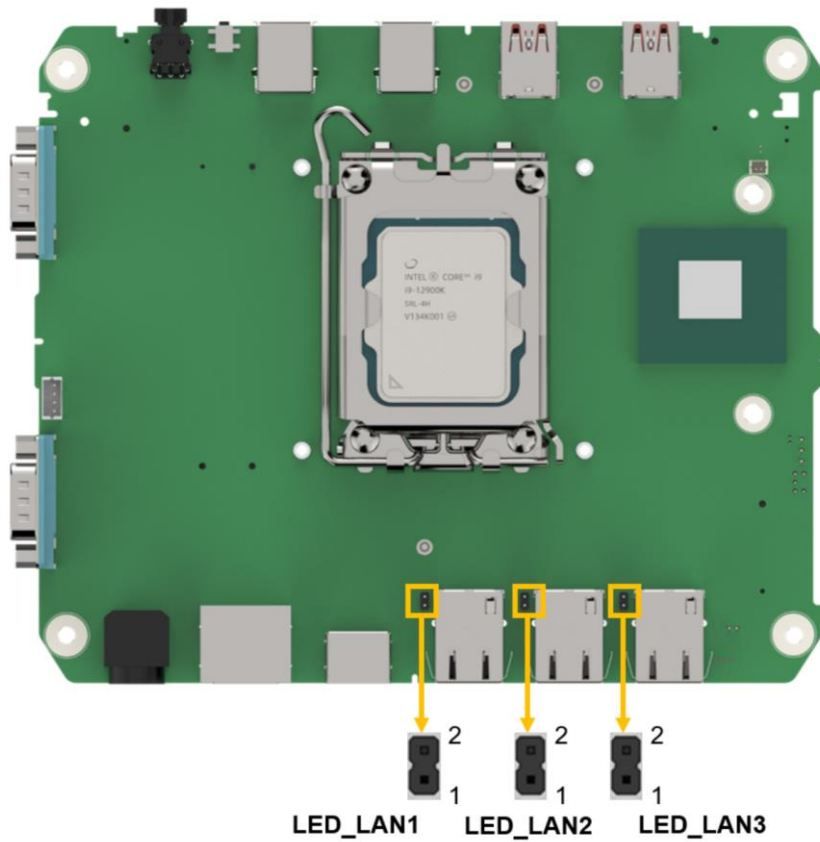

Figure 4-16: LAN LED Connector Location

PIN NO.	DESCRIPTION	PIN NO.	DESCRIPTION
1	+3.3V	2	LAN1_LED_LNK#_ACT

Table 4-16: LAN LED Connector Pinouts

#### 4.2.16 PMBUS Connector

- CN Label:** J1
- CN Type:** 3-pin header, p=2.54mm
- CN Location:** See Figure 4-17
- CN Pinouts:** See Table 4-17

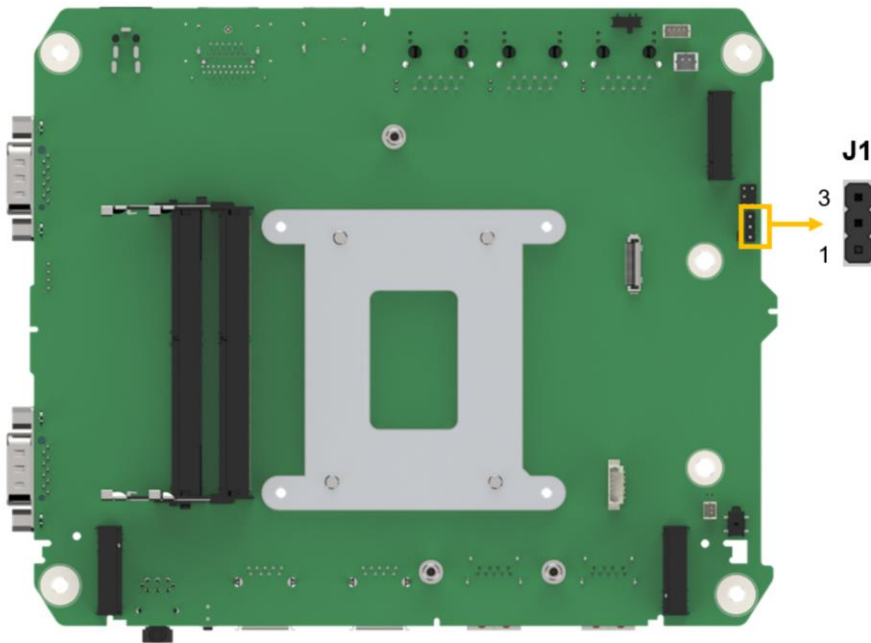

**Figure 4-17: PMBUS Connector Location**

PIN NO.	DESCRIPTION	PIN NO.	DESCRIPTION
1	PM_SCL	2	PM_SDA
3	GND		

**Table 4-17: PMBUS Connector Pinouts**

## 4.3 External Interface Panel Connectors

The table below shows a list of the external interface panel connectors on the system motherboard. Pinouts of these connectors can be found in the following sections.

Connector	Type	Label
HDMI Connectors	HDMI 1.4b	HDMI1, HDMI_DP2
DP Connectors	DP 1.2	HDMI_DP2
LAN 2.5GbE Connectors	RJ45	LAN1, LAN2, LAN3
Power Input Connector	2-pin DC jack	PT1
Power Button	8-pin electronic switch	PWR_BTN2
Reset Button	4-pin electronic switch	RST1
RS-232/422/485 Connector	DB9	COM1
RS-232 Connector	DB9	COM2
USB 3.2 Gen 2 Connectors	USB 3.2 Gen2 Type-A	USB1, USB2
USB 3.2 Gen1 Connectors	USB 3.2 Gen1 Type-A	USB3, USB4

**Table 4-18: Rear Panel Connectors**

### 4.3.1 External HDMI 1.4 Connectors (HDMI1, HDMI\_DP2)

PIN NO.	DESCRIPTION	PIN NO.	DESCRIPTION
1	HDMI_DATA2	11	GND
2	GND	12	HDMI_CLK#
3	HDMI_DATA2#	13	N/C
4	HDMI_DATA1	14	N/C
5	GND	15	HDMI_SCL
6	HDMI_DATA1#	16	HDMI_SDA
7	HDMI_DATA0	17	GND
8	GND	18	+5V
9	HDMI_DATA0#	19	HDMI_HPD
10	HDMI_CLK		

**Table 4-19: HDMI Connector Pinouts**



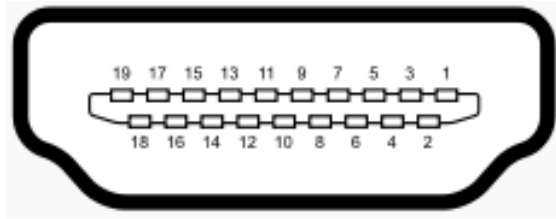

Figure 4-18: HDMI Connector

#### 4.3.2 External DP Connectors (HDMI\_DP2)

PIN NO.	DESCRIPTION	PIN NO.	DESCRIPTION
1	LANE0P	11	GND
2	GND	12	LANE3N
3	LANE0N	13	AUX_CTRL_DET_D
4	LANE1P	14	GND
5	GND	15	DPB_AUX_CTRL_P2
6	LANE1N	16	GND
7	LANE2P	17	DPB_AUX_CTRL_N2
8	GND	18	HPD
9	LANE2N	19	GND
10	LANE3P	20	+3.3V

Table 4-20: DP Connector Pinouts

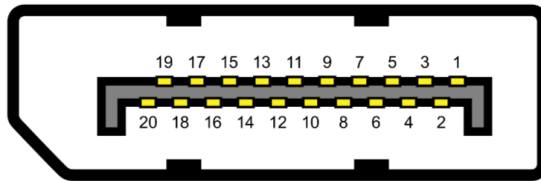

Figure 4-19: DP Connector

#### 4.3.3 External 2.5GbE LAN Connectors (LAN1, LAN2, LAN3)

PIN NO.	DESCRIPTION	PIN NO.	DESCRIPTION
1	MDIA3-	5	MDIA1+
2	MDIA3+	6	MDIA2+

3	MDIA2-	7	MDIA0-
4	MDIA1-	8	MDIA0+

**Table 4-21: LAN Connectors Pinouts**

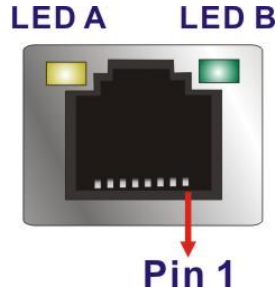

**Figure 4-20: LAN Connectors**

LED.	DESCRIPTION	PIN NO.	DESCRIPTION
Off	No link	Off	100 Mbps connection
Yellow	Linked	Orange	1 Gbp connection
Blinking	TX/RX activity	Green	2.5 Gbps connection

**Table 4-22: LAN Connectors LEDs**

#### 4.3.4 External RS-232/422/485 Serial Port Connector (COM2)

Mode	RS-232	RS-422	RS-485
PIN NO.	DESCRIPTION	DESCRIPTION	DESCRIPTION
1	DCD#	TX-	TX-
2	RXD	TX+	TX+
3	TXD	RX+	
4	DTR#	RX-	
5	GND		
6	DSR#		
7	RTS#		
8	CTS#		
9	RI#		

**Table 4-23: RS-232/422/485 Serial Port Connector Pinouts**

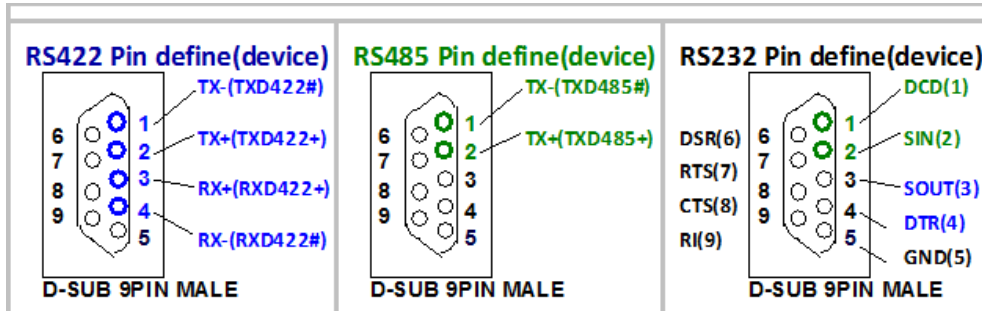

Figure 4-21: RS-232/422/485 Serial Port Connectors

#### 4.3.5 External RS-232 Serial Port Connector (COM1)

PIN NO.	DESCRIPTION	PIN NO.	DESCRIPTION
1	DCD	6	DSR
2	SIN	7	RTS
3	SOUT	8	CTS
4	DTR	9	RI
5	GND		

Table 4-24: RS-232 Serial Port Connector Pinouts

#### 4.3.6 External USB 3.2 GEN2 Type-A Connectors (USB1, USB2)

PIN	DESCRIPTION	PIN	DESCRIPTION
1	VCC	10	VCC
2	USB_DATA0-	11	USB_DATA1-
3	USB_DATA0+	12	USB_DATA1+
4	GND	13	GND
5	USB3_RX0-	14	USB3_RX1-
6	USB3_RX0+	15	USB3_RX1+
7	GND	16	GND
8	USB3_TX0-	17	USB3_TX1-
9	USB3_TX0+	18	USB3_TX1+

Table 4-25: USB 3.2 GEN2 Connectors Pinouts

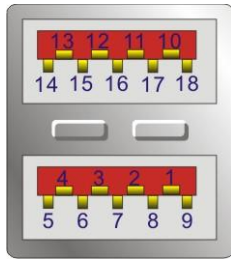

Figure 4-22: USB 3.2 GEN2 Port Location

#### 4.3.7 External USB 3.2 GEN1 Type-A Connectors (USB3, USB4)

PIN	DESCRIPTION	PIN	DESCRIPTION
1	VCC	10	VCC
2	USB_DATA0-	11	USB_DATA1-
3	USB_DATA0+	12	USB_DATA1+
4	GND	13	GND
5	USB3_RX0-	14	USB3_RX1-
6	USB3_RX0+	15	USB3_RX1+
7	GND	16	GND
8	USB3_TX0-	17	USB3_TX1-
9	USB3_TX0+	18	USB3_TX1+

Table 4-26: USB 3.2 GEN1 Type-A Connectors Pinouts

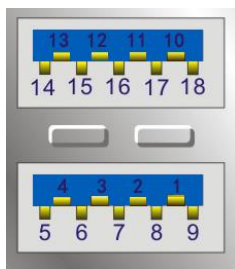

Figure 4-23: USB 3.2 GEN1 Port Location

Chapter

**5**

# **BIOS**

---

## 1.1 Introduction

The BIOS is programmed onto the BIOS chip. The BIOS setup program allows changes to certain system settings. This chapter outlines the options that can be changed.



### NOTE:

Some of the BIOS options may vary throughout the life cycle of the product and are subject to change without prior notice.

### 5.1.1 Starting Setup

The UEFI BIOS is activated when the computer is turned on. The setup program can be activated in one of two ways.

1. **Using keyboard:** Press the **DEL** or **F2** as soon as the system is turned on.
2. **Using touchscreen:** Press the **Setup** button on the upper right corner of the BIOS Starting Menu.

If the message disappears before the **DEL** or **F2** key is pressed, restart the computer and try again, then the BIOS Starting Menu will appear. Select "Setup" and press Enter to get into the BIOS Setup.

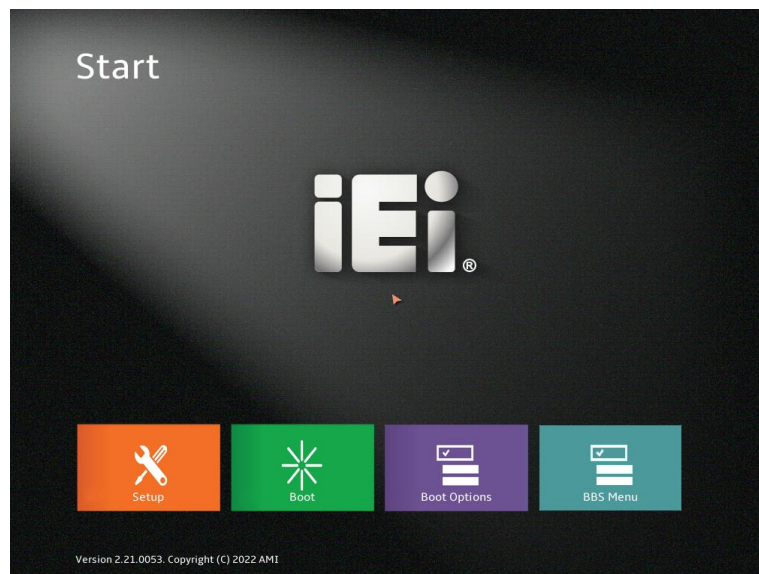

Figure 5-1: BIOS Starting Menu

## 5.1.2 Using Setup

The BIOS Setup menu can be navigated by using a keyboard or a touchscreen

### 5.1.2.1 Keyboard Navigation

Key	Function
Up arrow	Move to previous item
Down arrow	Move to next item
Left arrow	Move to the item on the left-hand side
Right arrow	Move to the item on the right-hand side
+	Increase the numeric value or make changes
-	Decrease the numeric value or make changes
Page Up	Move to the previous page
Page Dn	Move to the next page
Esc	Main Menu – Quit and not save changes into CMOS Status Page Setup Menu and Option Page Setup Menu -- Exit current page and return to Main Menu
F1	General help, only for Status Page Setup Menu and Option Page Setup Menu
F2	Load previous values
F3	Load optimized defaults
F4	Save changes and Exit BIOS
<K>	Scroll help area upwards
<M>	Scroll help area downwards

**Table 5-1: BIOS Navigation Keys**

### 5.1.2.2 Touch Navigation

For touchscreen navigation, use the on-screen navigation keys shown below.

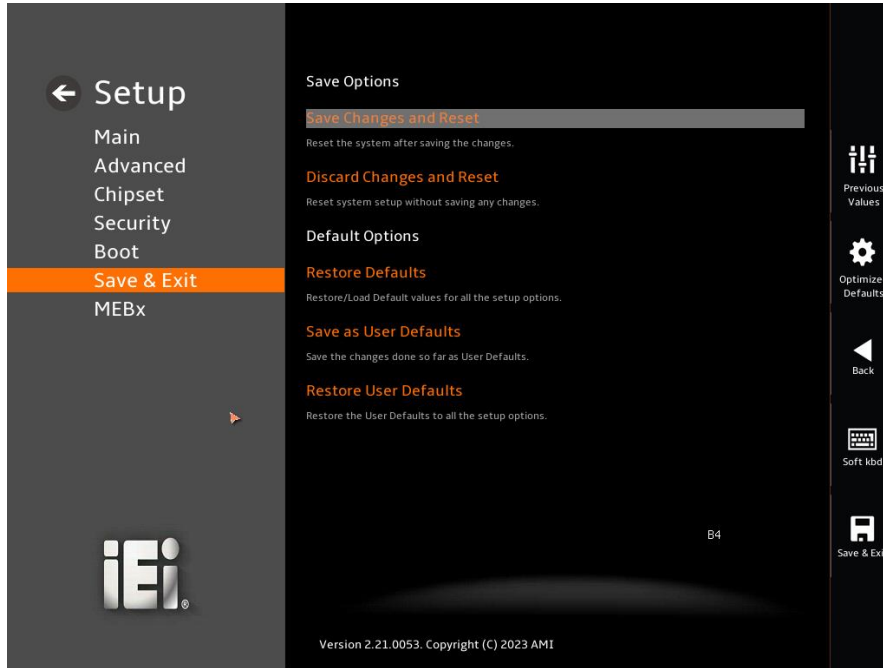

On-screen Button	Function
Previous Values	Load the last value you set.
Optimized Defaults	Load the factory default values in order to achieve the best performance.
Back	Return to the previous menu.
Soft kbd	Display the on-screen keyboard.
Save & Exit	Save the changes made to the BIOS options and reset the system.

**Figure 5-2: BIOS On-screen Navigation Keys**



### 5.1.3 Getting Help

When **F1** is pressed a small help window describing the appropriate keys to use and the possible selections for the highlighted item appears. To exit the Help Window, press the **Esc** key.

### 5.1.4 Unable to Reboot after Configuration Changes

If the computer cannot boot after changes to the system configuration is made, CMOS defaults. Use the clear CMOS button described in **Chapter 4**.

### 5.1.5 BIOS Menu Bar

The **menu bar** on top of the BIOS screen has the following main items:

- Main – Changes the basic system configuration.
- Advanced – Changes the advanced system settings.
- Chipset – Changes the chipset settings.
- Security – Sets User and Supervisor Passwords.
- Boot – Changes the system boot configuration.
- Save & Exit – Selects exit options and loads default settings
- MEBx – Support Intel AMT function

The following sections completely describe the configuration options found in the menu items at the top of the BIOS screen and listed above.

## 1.2 Main

The **Main** BIOS menu (**BIOS Menu 1 & BIOS Menu 2**) appears when the **BIOS Setup** program is entered. The **Main** menu gives an overview of the basic system information.

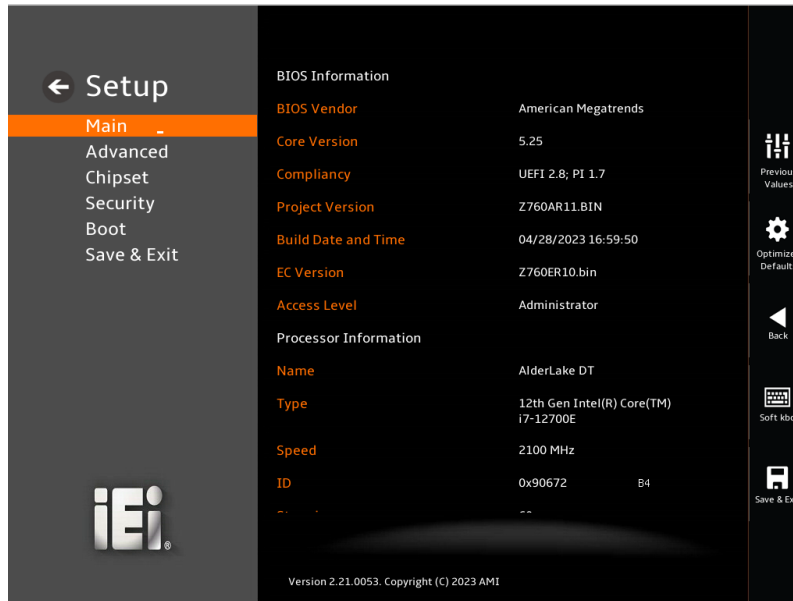

### BIOS Menu 1: Main (1/2)

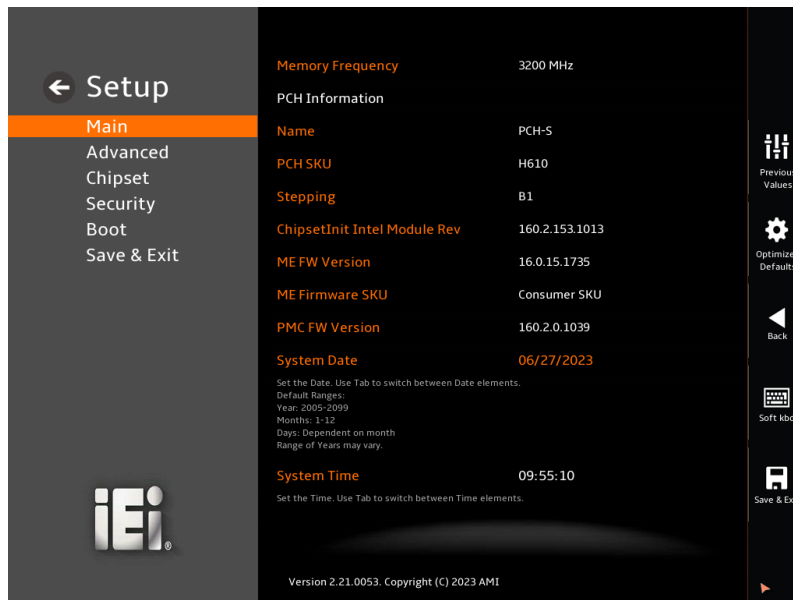

### BIOS Menu 2: Main (2/2)

## → BIOS Information

The **BIOS Information** lists a brief summary of the BIOS. The fields in **BIOS Information** cannot be changed. The items shown in the system overview include:

- **BIOS Vendor:** Installed BIOS vendor
- **Core Version:** Current BIOS version
- **Compliance:** Current UEFI & PI version
- **Project Version:** the board version
- **Build Date and Time:** Date and time when the current BIOS version was created
- **EC Version:** Current EC version

## → Processor Information

The **Processor Information** lists a brief summary of the Processor. The fields in **Processor Information** cannot be changed. The items shown in the system overview include:

- **Name:** Displays the Processor Details
- **Type:** Displays the Processor Type
- **Speed:** Displays the Processor Speed
- **ID:** Displays the Processor ID
- **Stepping:** Displays the Processor Stepping
- **Number of Efficient-cores:** Displays number of CPU efficient-cores
- **Number of Processors:** Displays number of CPU cores
- **Microcode Revision:** CPU Microcode Revision
- **IGFX GOP Version:** Displays the IGFX GOP Version
- **Total Memory:** Total Memory in the System
- **Memory Frequency:** Displays the Frequency of Memory

## → PCH Information

The **PCH Information** lists a brief summary of the PCH. The fields in **PCH Information** cannot be changed. The items shown in the system overview include:

- **Name:** Displays the PCH Name
- **PCH SKU:** Displays the PCH SKU

- **Stepping:** Displays the PCH Stepping
- **Production Type:** Displays the Production Type
- **Dual Output Fast Read support:** Displays the Processor Details
- **Read ID/Status Clock Freq:** Displays the Read ID and Read Status Clock Frequency
- **ME FW Version:** Displays the ME Firmware Version
- **ME Firmware SKU:** Displays the ME Firmware SKU
- **PMC FW Version:** Displays the PMC Firmware Version

The System Overview field also has two user configurable fields:

→ **System Date [xx/xx/xx]**

Use the **System Date** option to set the system date. Manually enter the day, month and year.

→ **System Time [xx:xx:xx]**

Use the **System Time** option to set the system time. Manually enter the hours, minutes and seconds.

## 1.3 Advanced

Use the Advanced menu (**BIOS Menu 3 & BIOS Menu 4**) to configure the CPU and peripheral devices through the following sub-menus:



### WARNING!

Setting the wrong values in the sections below may cause the system to malfunction. Make sure that the settings made are compatible with the hardware.

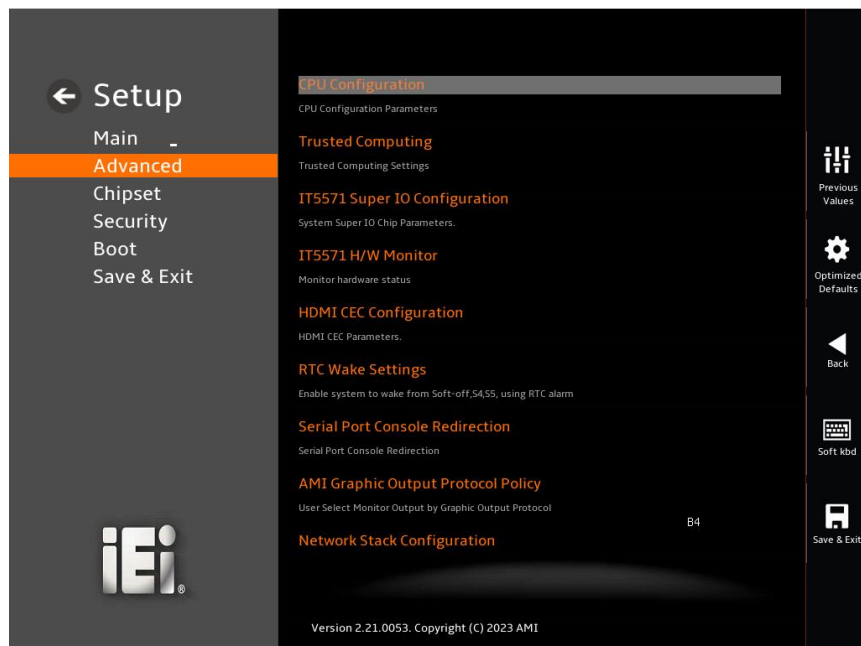

**BIOS Menu 3: Advanced(1/2)**

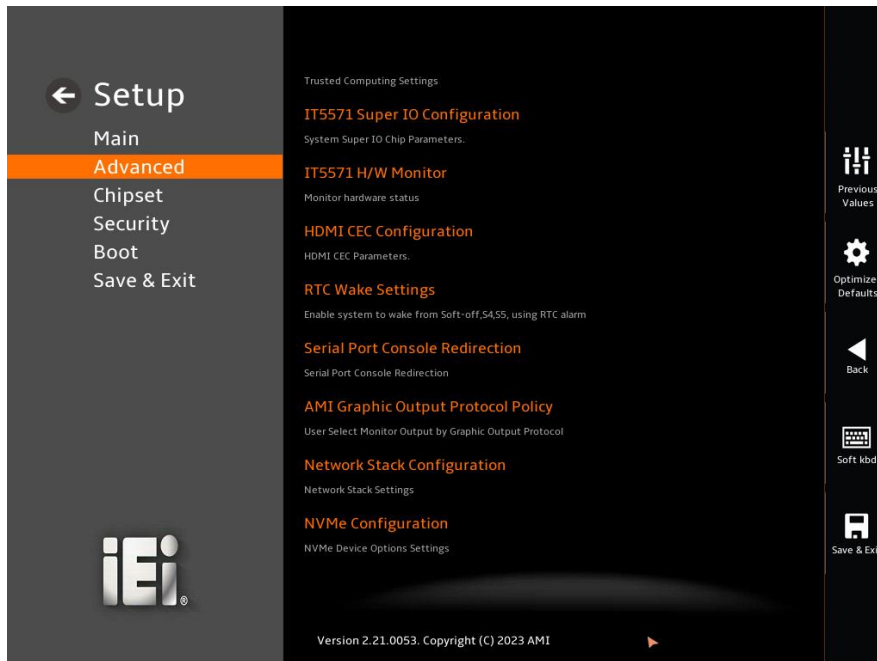

BIOS Menu 4: Advanced (2/2)

### 5.3.1 CPU Configuration

Use the **CPU Configuration** menu (**BIOS Menu 5 & BIOS Menu 6 & BIOS Menu 7**) to view detailed CPU specifications or enable the Intel Virtualization Technology.



**BIOS Menu 5: CPU Configuration (1/3)**



**BIOS Menu 6: CPU Configuration (2/3)**

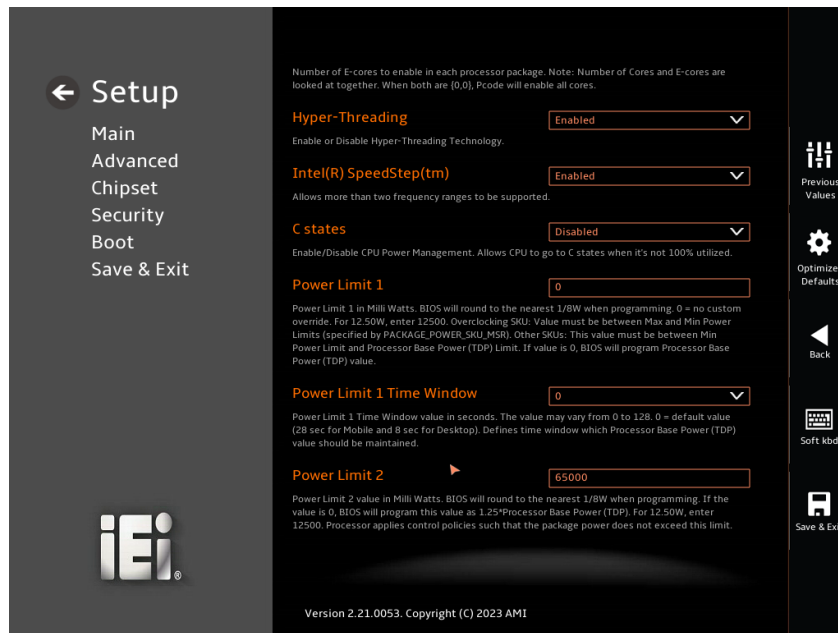

**BIOS Menu 7: CPU Configuration (3/3)**

➔ **Performance-core Information**

The **Performance-core Information** displays the P-core Information.



- ➔ **L1 Data Cache** 48 KB x 4
- ➔ **L1 Instruction Cache** 32 KB x 4
- ➔ **L2 Cache** 1280 KB x 4
- ➔ **L3 Cache** 18 MB

➔ **Efficient-core Information**

The **Efficient-core Information** displays the E-core Information.

- ➔ **L1 Data Cache** 32 KB x 8
- ➔ **L1 Instruction Cache** 64 KB x 8
- ➔ **L2 Cache** 2048 KB x 2
- ➔ **L3 Cache** 18 MB

➔ **Intel (VMX) Virtualization Technology [Enabled]**

Use the **Intel (VMX) Virtualization Technology** option to enable or disable virtualization on the system. When enabled, a VMM can utilize the additional hardware capabilities provided by Vanderpool Technology.

- ➔ **Disabled** Disables Intel Virtualization Technology.
- ➔ **Enabled** **DEFAULT** Enables Intel Virtualization Technology.

➔ **Active Performance-cores [All]**

Use the **Active Processor Cores** BIOS option to enable numbers of P-cores in the processor package.

- ➔ **All** **DEFAULT** Enable all cores in the processor package.
- ➔ **1** Enable one core in the processor package.
- ➔ **2** Enable two cores in the processor package.
- ➔ **3** Enable three cores in the processor package.

→ **Active Efficient-cores [All]**

Use the **Active Processor Cores** BIOS option to enable numbers of E-cores in the processor package.

- **All**                      **DEFAULT**              Enable all cores in the processor package.
- **7**    Enable seven cores in the processor package.
- **6**    Enable six cores in the processor package.
- **5**    Enable five cores in the processor package.
- **4**    Enable four cores in the processor package.
- **3**    Enable three cores in the processor package.
- **2**    Enable two cores in the processor package.
- **1**    Enable one core in the processor package.

→ **Hyper-Threading [Enabled]**

Use the **Hyper-Threading** option to enable or disable the **Hyper-Threading** Technology.

- **Disabled**                                      Disables Hyper-Threading Technology
- **Enabled**                                      **DEFAULT**              Enables Hyper-Threading Technology

→ **Intel(R) SpeedStep(tm) [Enabled]**

Use the Intel(R) SpeedStep(tm) option to enable more than two frequency ranges to be supported.

- **Disabled**                                      Disables more than two frequency ranges
- **Enabled**                                      **DEFAULT**              Enables more than two frequency ranges

→ **C states [Disabled]**

Use C states option to enable or disable CPU Power Management. Allows CPU to go to **C states** when it's not 100% utilized

- |   |                 |                |   |
|---|-----------------|----------------|---|
| → | <b>Disabled</b> | <b>DEFAULT</b> | Disables CPU to go to C states when it's not 100% utilized. |
| → | <b>Enabled</b>  |                | Enables CPU to go to C states when it's not 100% utilized.  |

→ **Power Limit 1 [0]**

Use the + or – key to change the **Power Limit 1** value. BIOS will program the default values for Limit 1 and Power Limit 1 Time Window. For 12.50W, enter 12500.

→ **Power Limit 1 Time Window [0]**

Use the **Power Limit 1 Time Window** option to select the PL1 time duration. The value may vary from 0 to 128. For 0 is the default value

→ **Power Limit 2 [65000]**

Use the + or – key to change the **Power Limit 2** value. BIOS will round to the nearest 1/8W when programming. 0 = no custom override. For 12.50W, enter 12500.

### 5.3.2 Trusted Computing

Use the **Trusted Computing** menu (**BIOS Menu 8**) to configure settings related to the Trusted Computing Group (TCG) Trusted Platform Module (TPM).



#### BIOS Menu 8: Trusted Computing

##### ➔ Security Device Support [Enable]

Use the **Security Device Support** option to configure support for the TPM.

- ➔ **Disable**                                      TPM support is disabled.
- ➔ **Enable**                                      **DEFAULT**      TPM support is enabled.

##### ➔ Pending Operation [None]

Use the **Pending Operation** option to schedule an operation for the security device.

- ➔ **None**                                      **DEFAULT**      TPM information is previous
- ➔ **TPM Clear**                                      TPM information is cleared

### 5.3.3 IT5571 Super IO Configuration

Use the **IT5571 Super IO Configuration** menu (**BIOS Menu 9**) to set or change the configurations for the serial ports.

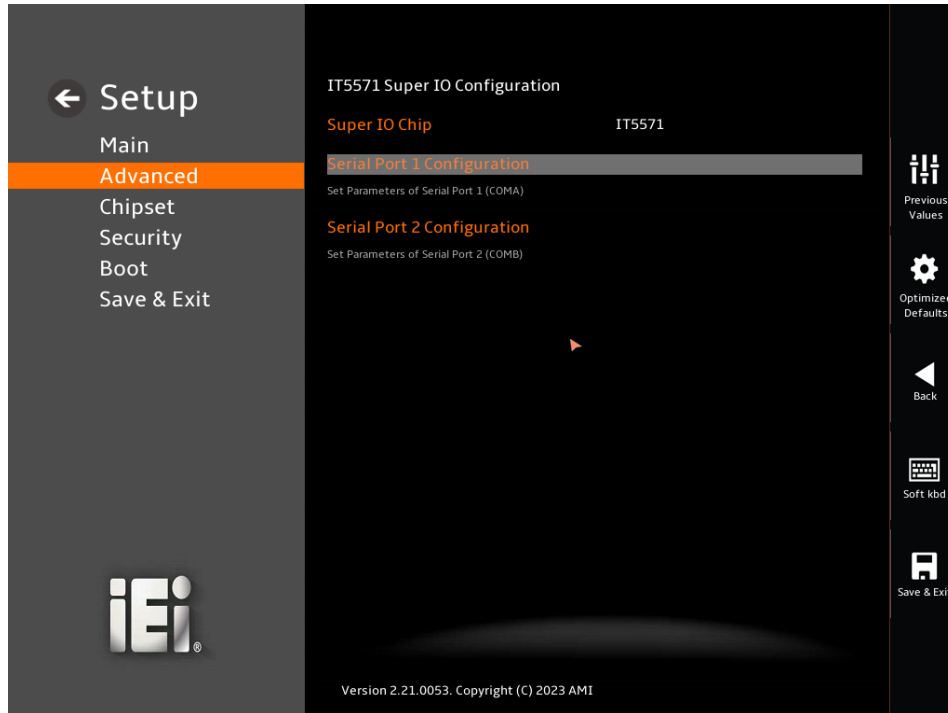

**BIOS Menu 9: IT5571 Super IO Configuration**

### 5.3.3.1 Serial Port 1 Configuration

Use the **Serial Port 1 Configuration** menu (**BIOS Menu 10**) to configure the serial port 1.

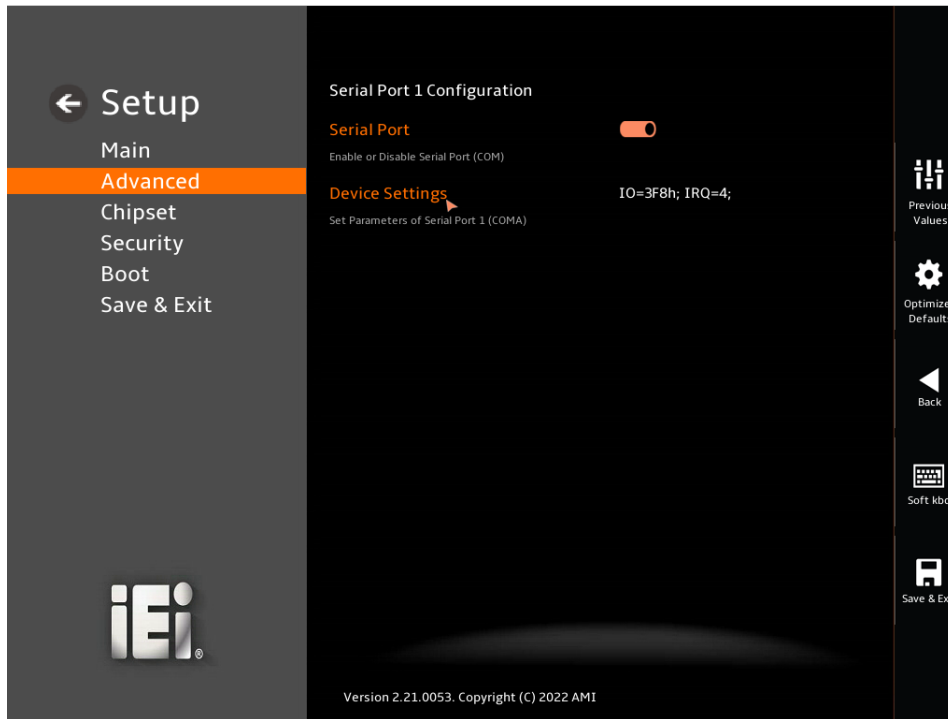

**BIOS Menu 10: Serial Port 1 Configuration Menu**

#### ➔ Serial Port [Enabled]

Use the **Serial Port** option to enable or disable the serial port.

- ➔ **Disabled**                      Disable the serial port
- ➔ **Enabled      DEFAULT**      Enable the serial port

#### ➔ Device Settings

The **Device Settings** option shows the serial port IO port address and interrupt address.

- ➔ **IO=3F8h;**                      Serial Port I/O port address is 3F8h and the interrupt  
**IRQ=4**                              address is IRQ4

### 5.3.3.2 Serial Port 2 Configuration

Use the **Serial Port 2 Configuration** menu (**BIOS Menu 11**) to configure the serial port 2

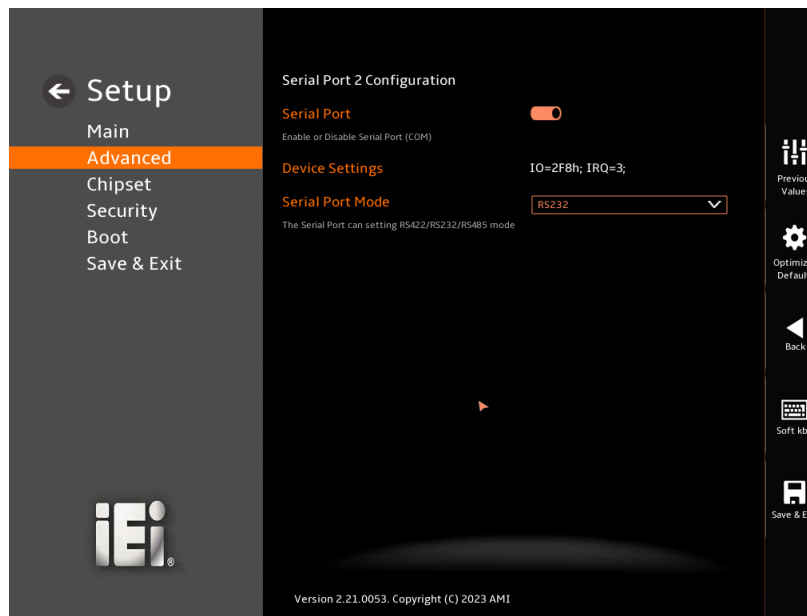

**BIOS Menu 11: Serial Port 2 Configuration Menu**

#### ➔ Serial Port [Enabled]

Use the **Serial Port** option to enable or disable the serial port.

- ➔ **Disabled**                      Disable the serial port
- ➔ **Enabled**      **DEFAULT**      Enable the serial port

#### ➔ Device Settings

The **Device Settings** option shows the serial port IO port address and interrupt address.

- ➔ **IO=2F8h;**                      Serial Port I/O port address is 2F8h and the interrupt  
**IRQ=3**                              address is IRQ3

### 5.3.4 IT5571 H/W Monitor

The **IT5571 H/W Monitor** menu (**BIOS Menu 12**) contains the smart fan mode configuration submenu and shows the state of H/W real-time operating temperature, fan speeds and system voltages.



**BIOS Menu 12: IT5571 H/W Monitor**

#### → PC Health Status

The following system parameters and values are shown. The system parameters that are monitored are:

- CPU Temperature
- System Temperatures
- CPU\_FAN1 Speed
- CPU\_CORE
  - +12V
  - +5VSB
  - +3.3V
  - +3.3VSB



### 5.3.4.1 Smart Fan Mode Configuration

Use the **Smart Fan Mode Configuration** submenu (**BIOS Menu 13**) to configure the CPU/system fan start/off temperature and control mode.

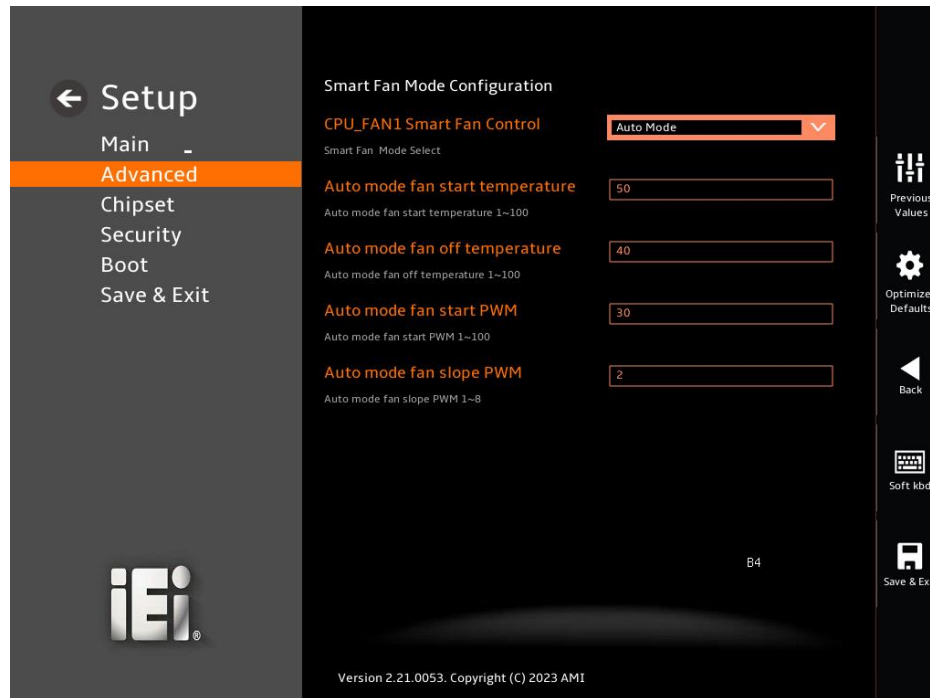

#### BIOS Menu 13: Smart Fan Mode Configuration

##### → CPU\_FAN1 Smart Fan Control [Auto Mode]

Use the **CPU\_FAN Smart Fan Control** option to configure the CPU Smart Fan.

- **Manual Mode**                      The fan spins at the speed set in Manual Mode settings.
- **Auto Mode**                      **DEFAULT**      The fan adjusts its speed using Auto Mode settings.

##### → Auto mode fan start Temperature [50]

Use the **Auto mode fan start Temperature** option to shows the temperature exceeds 50 degrees, it will open. Use the Number key to change the value or enter a decimal number between 1 and 100

→ **Auto mode fan off Temperature [40]**

Use the **Auto mode fan off Temperature** option to show the temperature drops below 40 degrees, it will turn off. Use the Number key to change the value or enter a decimal number between 1 and 100

→ **Auto mode fan start PWM [30]**

Use the **Auto mode fan slope PWM** option to select the linear rate at which the PWM mode increases with respect to an increase in temperature. Use the Number key to change the value or enter a decimal number between 1 and 100

→ **Auto mode fan slope PWM [2]**

Use the **Auto mode fan slope PWM** option to select the linear rate at which the PWM mode increases with respect to an increase in temperature. Use the Number key to change the value or enter a decimal number between 1 and 8

### 5.3.5 HDMI CEC Configuration

Use the **HDMI CEC Configuration** submenu (**BIOS Menu 14**) to configure the HDMI CEC function. With CEC enabled, the user only needs to power-up the TANGO-7010 Series, and the TV connected with it will also turn on and automatically display audio and video content delivered by the device.

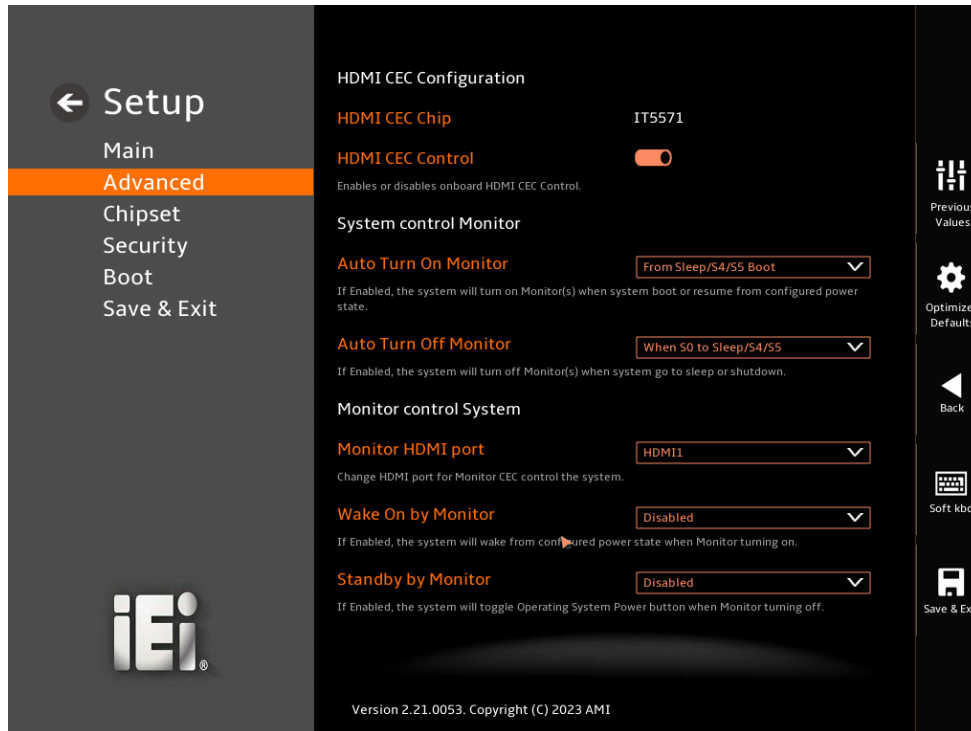

#### BIOS Menu 14: HDMI CEC Configuration

➔ **HDMI CEC Configuration**

- ➔ **HDMI CEC Chip** IT5571
- ➔ **HDMI CEC Control** Enables or Disables onboard HDMI CEC Control, enable default

➔ **System Control Monitor [Auto Mode]**

Use the **System Control Monitor** option to configure whether the system will turn on/off monitor(s) when system boot or resume from configured power state

- ➔ **Auto Turn On Monitor**      If Enabled, from sleep/S4/S5 Boot, the system will turn on Monitor
- ➔ **Auto Turn Off Monitor**      If Enabled, When S0 to sleep/S4/S5, the system will turn off Monitor
  
- ➔ **Monitor Control System**
  - ➔ **Monitor HDMI port**      Change HDMI port for Monitor CEC control the system
  - ➔ **Wake on by Monitor**      If Enabled, the system will wake from configured power state when Monitor turning on. Disabled by default
  - ➔ **Standby by Monitor**      If Enabled, the system will toggle Operating System Power button when Monitor turning off. Disabled by default

### 5.3.6 RTC Wake Settings

Use the **RTC Wake Settings** menu (**BIOS Menu 15**) to enable or disable System wake on alarm event.

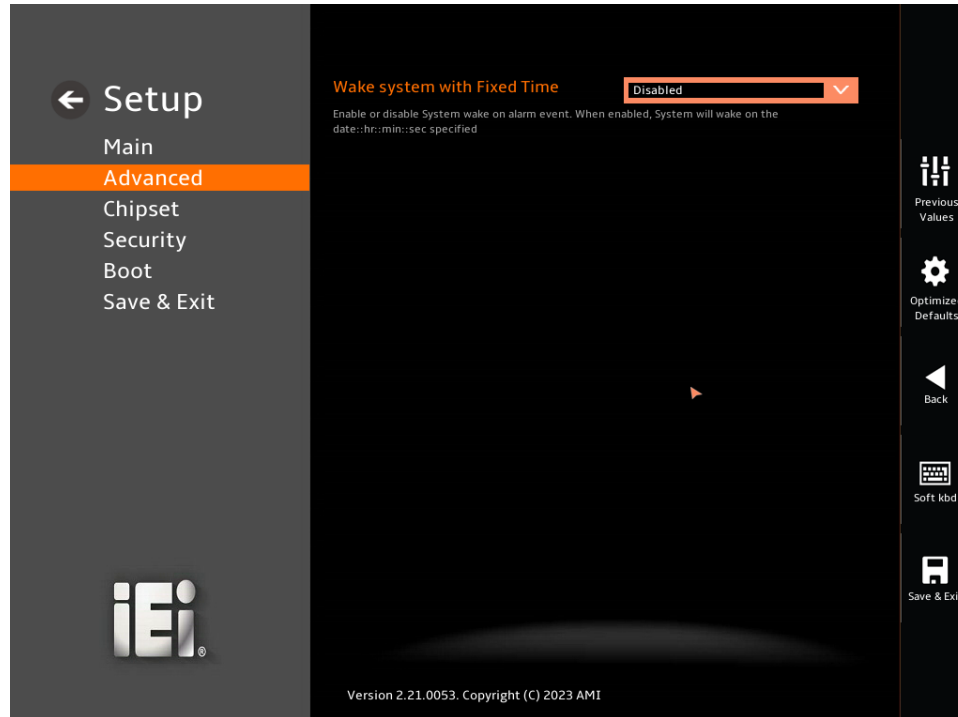

#### BIOS Menu 15: RTC Wake Settings

- ➔ **Disabled**      **DEFAULT**      Disable System wake on alarm event.
- ➔ **Enabled**                System will wake on the date::hr::min::sec specified.

### 5.3.7 Serial Port Console Redirection

The **Serial Port Console Redirection** menu (**BIOS Menu 16**) allows the console redirection options to be configured. Console Redirection allows users to maintain a system remotely by re-directing keyboard input and text output through the serial port.

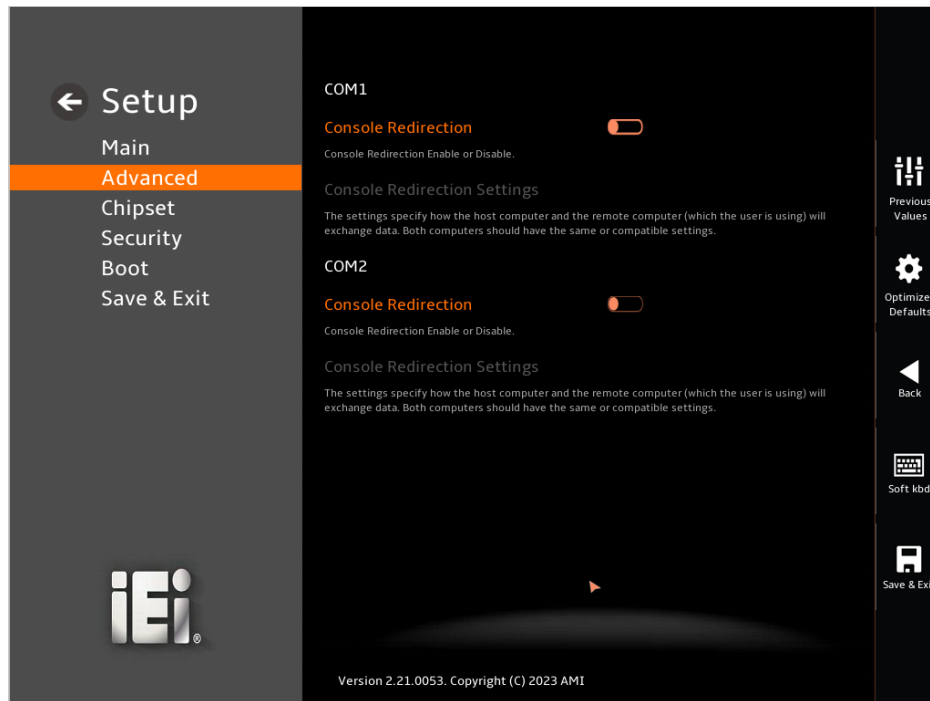

**BIOS Menu 16: Serial Port Console Redirection**

➔ **Console Redirection [Disabled]**

Use **Console Redirection** option to enable or disable the console redirection function.

- ➔ **Disabled**      **DEFAULT**      Disabled the console redirection function
- ➔ **Enabled**                      Enabled the console redirection function

The **Console Redirection Settings** submenu will be available when the **Console Redirection** option is enabled.

### 5.3.7.1 Console Redirection Settings

The following options are available in the **Console Redirection Settings** submenu (**BIOS Menu 17**) when the **COM Console Redirection** (form COM1 to COM2) option is enabled.

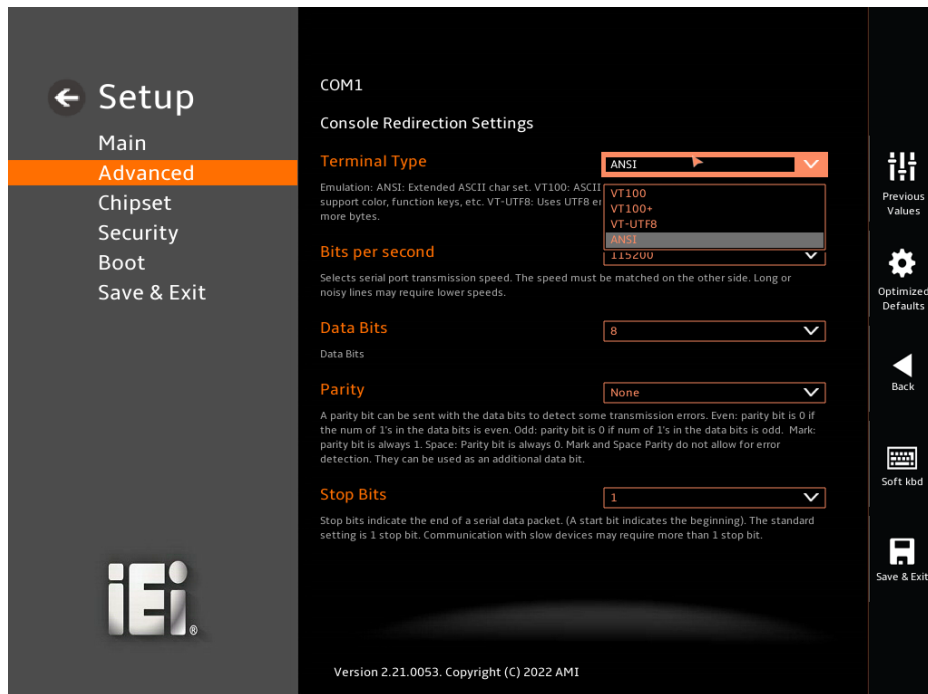

#### BIOS Menu 17: COM Console Redirection Settings

##### → Terminal Type [ANSI]

Use the **Terminal Type** option to specify the remote terminal type.

- **VT100**                                      The target terminal type is VT100
- **VT100+**                                    The target terminal type is VT100+
- **VT-UTF8**                                    The target terminal type is VT-UTF8
- **ANSI**                                        **DEFAULT**                                    The target terminal type is ANSI

##### → Bits per second [115200]

Use the **Bits per second** option to specify the serial port transmission speed. The speed must match on the other side. Long or noisy lines may require lower speeds.

- **9600** Sets the serial port transmission speed at 9600.
- **19200** Sets the serial port transmission speed at 19200.
- **57600** Sets the serial port transmission speed at 57600.
- **115200**      **DEFAULT** Sets the serial port transmission speed at 115200.

#### → **Data Bits [8]**

Use the **Data Bits** option to specify the number of data bits.

- **7** Sets the data bits at 7.
- **8**      **DEFAULT** Sets the data bits at 8.

#### → **Parity [None]**

Use the **Parity** option to specify the parity bit that can be sent with the data bits for detecting the transmission errors.

- **None**      **DEFAULT** No parity bit is sent with the data bits.
- **Even** The parity bit is 0 if the number of ones in the data bits is even.
- **Odd** The parity bit is 0 if the number of ones in the data bits is odd.
- **Mark** The parity bit is always 1. This option does not allow for error detection.
- **Space** The parity bit is always 0. This option does not allow for error detection.

#### → **Stop Bits [1]**

Use the **Stop Bits** option to specify the number of stop bits used to indicate the end of a serial data packet. Communication with slow devices may require more than 1 stop bit.

- **1**      **DEFAULT** Sets the number of stop bits at 1.



→ 2

Sets the number of stop bits at 2.

### 5.3.8 AMI Graphic Output Protocol Policy

Use the **AMI Graphic Output Protocol Policy (BIOS Menu 18)** menu to select output interface HDMI3 is Active

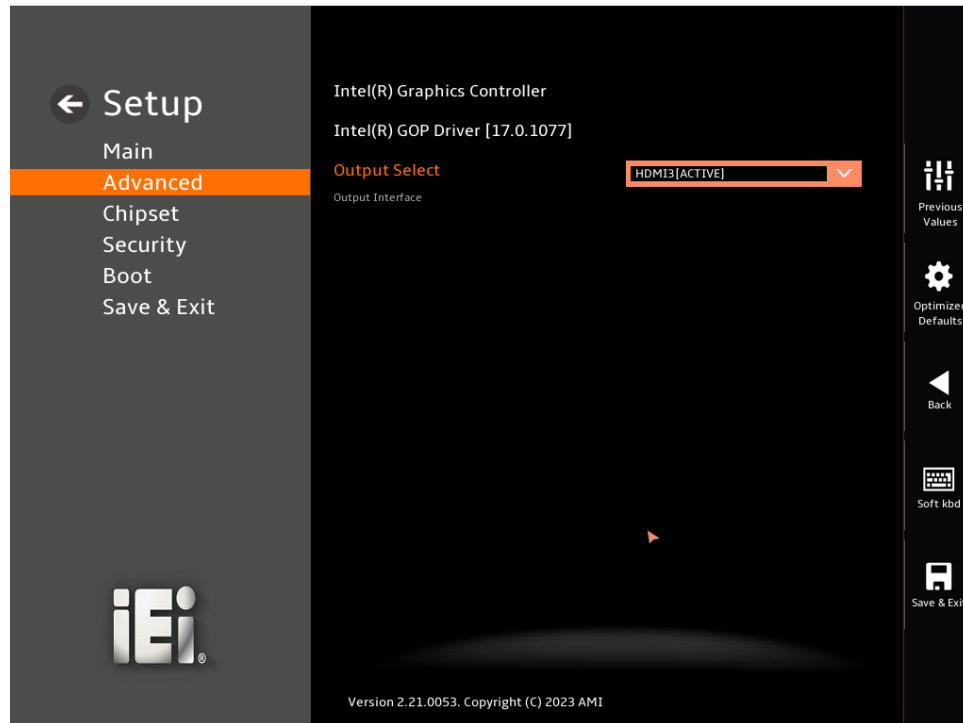

**BIOS Menu 18: AMI Graphic Output Protocol Policy**

### 5.3.9 Network Stack Configuration

Use the **Network Stack Configuration (BIOS Menu 19)** menu to configure the UEFI Network Stack



#### BIOS Menu 19: Network Stack Configuration

The UEFI Network Stack is disabled by default. When enabled, the following options will be available for configuration.

- ➔ **IPv4 PXE Support**      Enable/Disable IPv4 PXE boot support. If disabled, IPv4 PXE boot support will not be available.
- ➔ **IPv6 PXE Support**      Enable/Disable IPv6 PXE boot support. If disabled, IPv6 PXE boot support will not be available.

### 5.3.10 NVMe Configuration

Use the **NVMe Configuration (BIOS Menu 20)** menu to display the NVMe controller and device information.

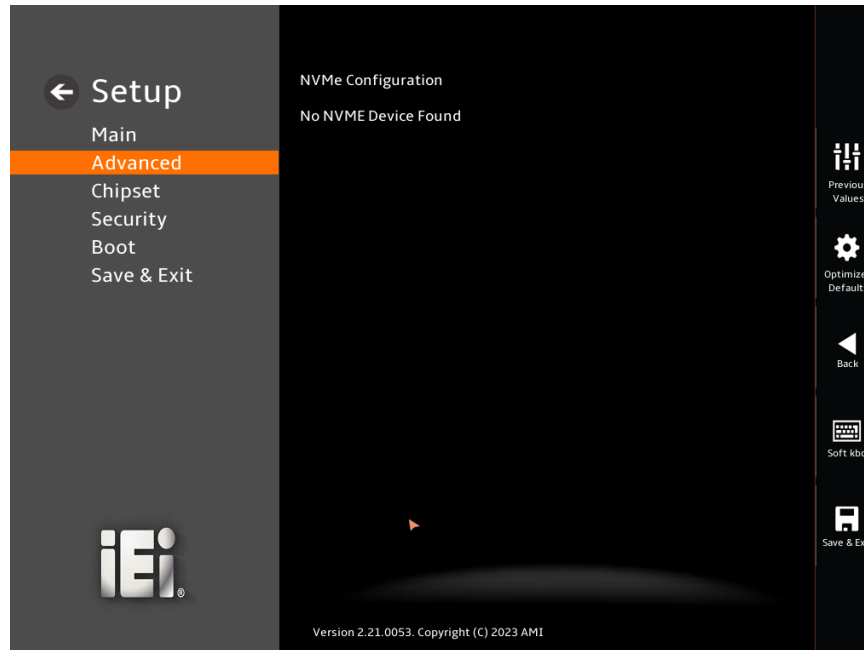

**BIOS Menu 20: NVMe Configuration**

## 5.4 Chipset

Use the **Chipset** menu (**BIOS Menu 21**) to access the PCH IO and System Agent (SA) configuration menus.



### WARNING!

Setting the wrong values for the Chipset BIOS selections in the Chipset BIOS menu may cause the system to malfunction.

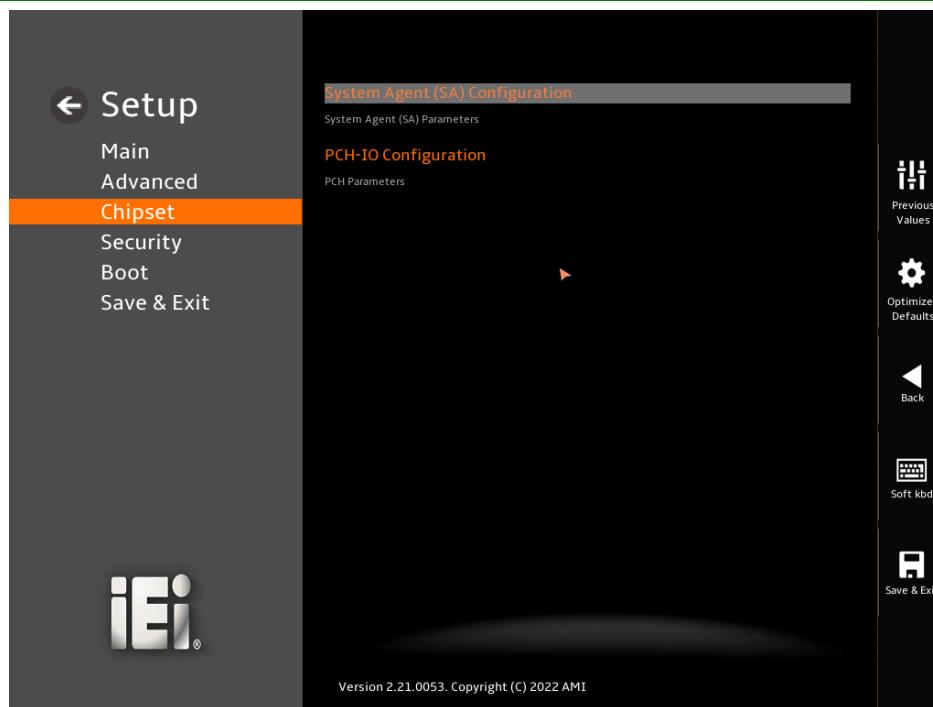

**BIOS Menu 21: Chipset**

### 5.4.1 System Agent (SA) Configuration

Use the **System Agent (SA) Configuration** menu (**BIOS Menu 22**) to configure the System Agent (SA) parameters.

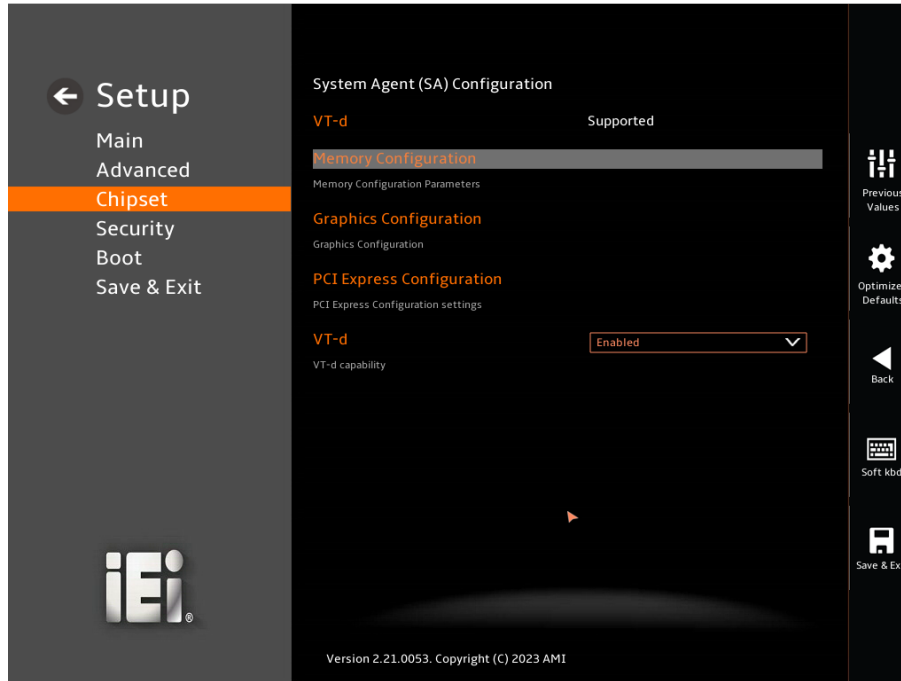

**BIOS Menu 22: System Agent (SA) Configuration**

→ **VT-d [Enabled]**

Use the **VT-d** option to enable or disable the VT-d capability.

- **Disabled**                      Disable the VT-d capability
- **Enabled**                      **DEFAULT**              Enable the VT-d capability

### 5.4.1.1 Memory Configuration

Use the **Memory Configuration** submenu (**BIOS Menu 23**) to view memory information.



**BIOS Menu 23: Memory Configuration**

### 5.4.1.2 Graphics Configuration

Use the **Graphics Configuration (BIOS Menu 24)** menu to see the video device connected to the system.

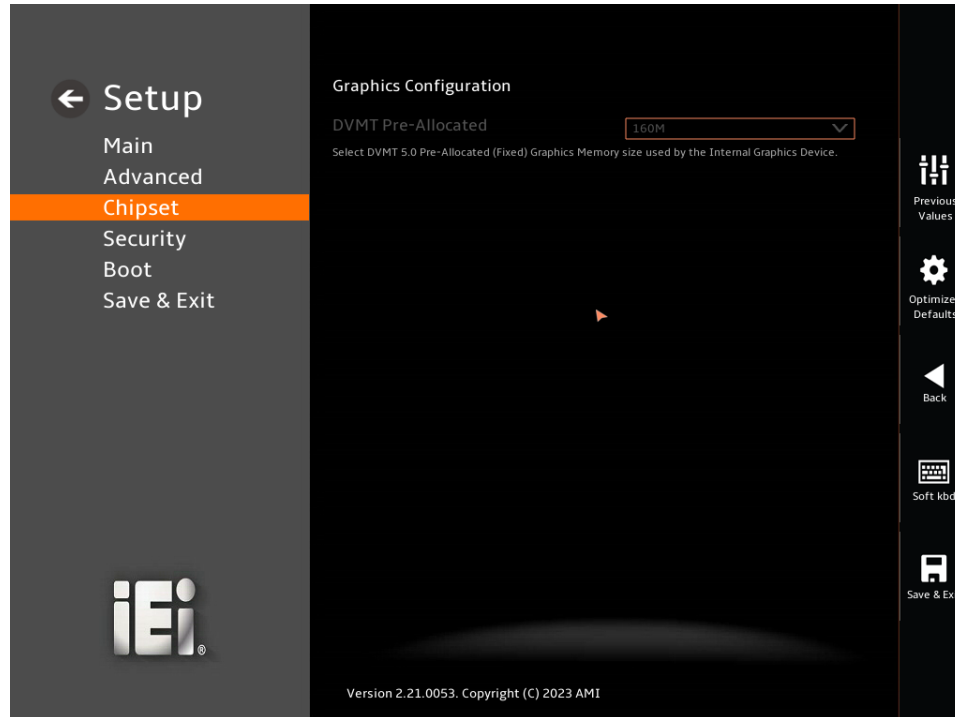

**BIOS Menu 24: Graphics Configuration**





➔ **Gen4**

Configure PCIe Speed to Gen4.

## 5.4.2 PCH-IO Configuration

Use the **PCI-IO Configuration** menu (**BIOS Menu 26**) to configure the PCH Parameters

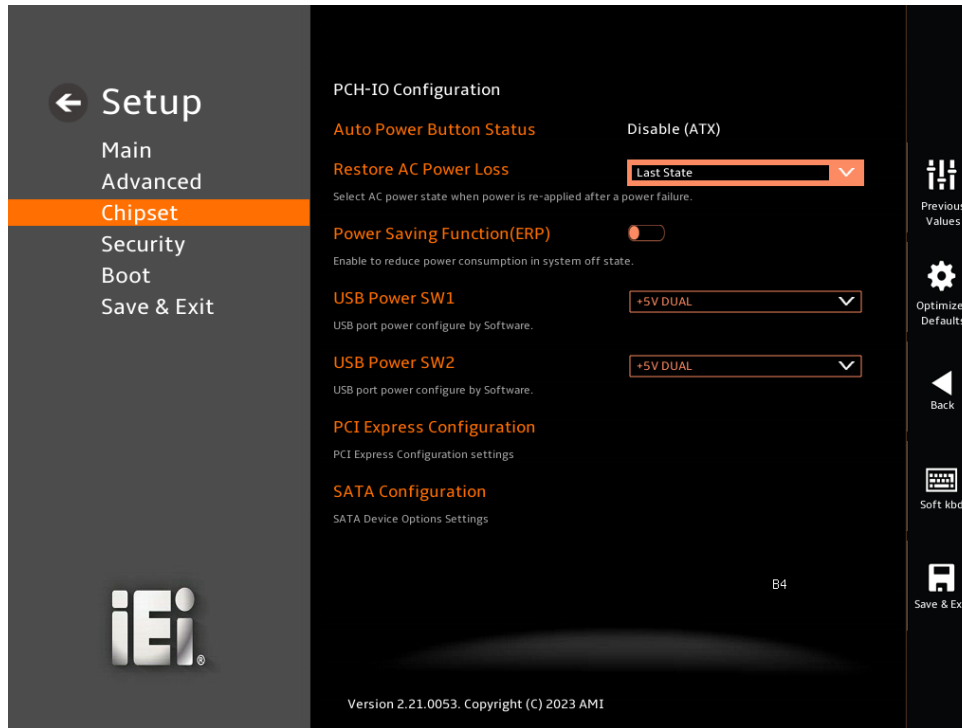

### BIOS Menu 26: PCI-IO Configuration

#### → Auto Power Button Status [Disabled(ATX)]

The **Auto Power Button Status** BIOS option to show the power mode state is ATX

#### → Restore AC Power Loss [Last State]

Use the **Restore AC Power Loss** BIOS option to specify what state the system returns to if there is a sudden loss of power to the system when the power mode is ATX.

- **Power Off**                      The system remains turned off
- **Power On**                        The system turns on
- **Last State**    **DEFAULT**      The system returns to its previous state. If it was on, it turns itself on. If it was off, it remains off.

➔ **Power Saving Function (EUP) [Disabled]**

Use the **Power Saving Function (EUP)** BIOS option to enable or disable the power saving function.

- ➔ **Disabled**      **DEFAULT**      Power saving function is disabled.
- ➔ **Enabled**                      Power saving function is enabled. It will reduce power consumption when the system is off.

➔ **USB Power SW1 [+5V DUAL]**

Use the **USB Power SW1** BIOS option to configure the USB power source for the corresponding USB connectors (**Table 5-2**).

- ➔ **+5V DUAL**      **DEFAULT**      Sets the USB power source to +5V dual
- ➔ **+5V**                              Sets the USB power source to +5V

➔ **USB Power SW2 [+5V DUAL]**

Use the **USB Power SW2** BIOS option to configure the USB power source for the corresponding USB connectors (**Table 5-2**).

- ➔ **+5V DUAL**      **DEFAULT**      Sets the USB power source to +5V dual
- ➔ **+5V**                              Sets the USB power source to +5V

BIOS Options	Configured USB Ports
USB Power SW1	USB1 external USB 3.2 Gen1 ports USB2 external USB 3.2 Gen1 ports
USB Power SW2	USB3 external USB 3.2 Gen2 ports USB4 external USB 3.2 Gen2 ports

**Table 5-2: BIOS Options and Configured USB Ports**

### 5.4.2.1 PCI Express Configuration

Use the **PCI Express Configuration** submenu (**BIOS Menu 27**) to configure the PCI Express slots.

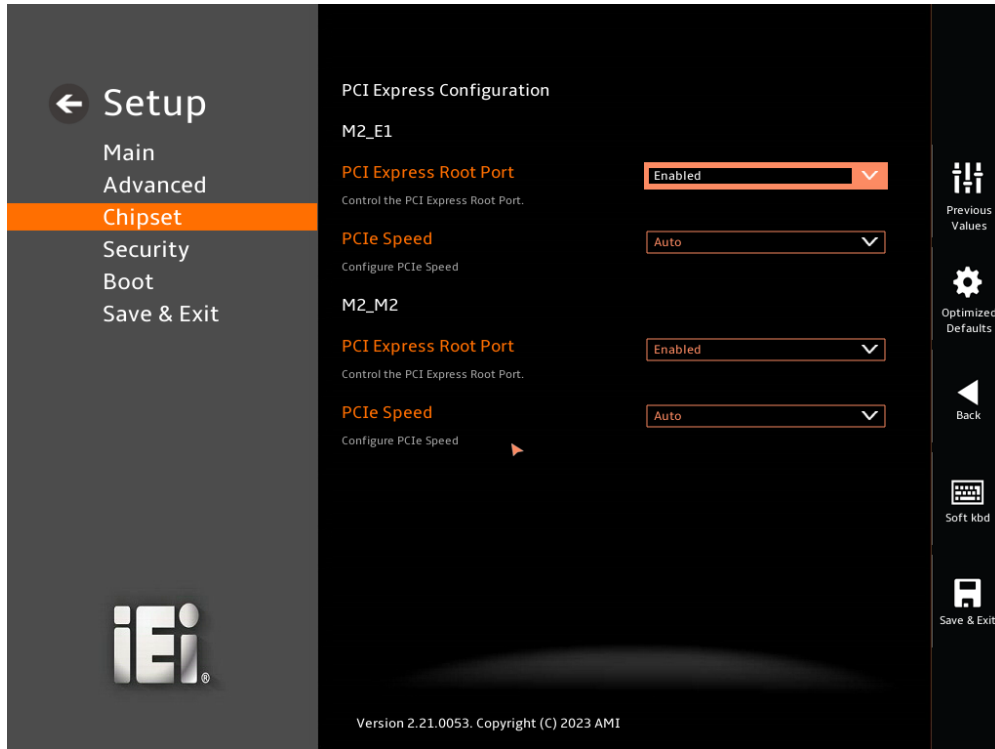

#### BIOS Menu 27: PCI Express Configuration

##### ➔ PCIe Express Root Port [Enabled]

Use the **M2\_E1** and **M2\_M1** submenu to configure the PCI Root Port Settings.

- ➔ **Disabled** Not Control the PCI Express Root Port
- ➔ **Enabled** **DEFAULT** Control the PCI Express Root Port

##### ➔ PCIe Speed [Auto]

Use the **PCIe Speed** option to specify the PCI Express port speed. Configuration options are listed below.

- ➔ **Auto** **DEFAULT** Auto mode.
- ➔ **Gen1** Configure PCIe Speed to Gen1.
- ➔ **Gen2** Configure PCIe Speed to Gen2.

➔ **Gen3**

Configure PCIe Speed to Gen3.

### 5.4.2.2 SATA Configuration

Use the **SATA Configuration** menu (**BIOS Menu 28**) to change or set the configuration of the SATA devices installed in the system.

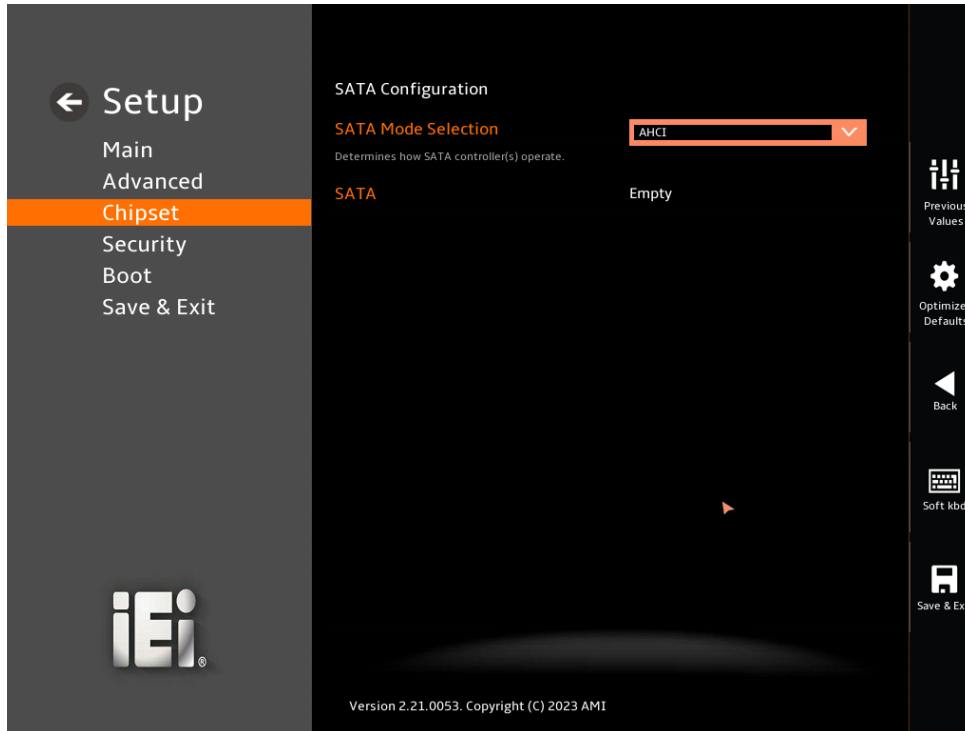

#### BIOS Menu 28: SATA Configuration

##### → SATA Mode Selection [AHCI]

Use the **SATA Mode Selection** option to determine how the SATA devices operate.

- **AHCI**      **DEFAULT**      Configures SATA devices as AHCI device.

## 5.5 Security

Use the **Security** menu (**BIOS Menu 29 & BIOS Menu 30**) to set system and user passwords.



**BIOS Menu 29: Security (1/2)**

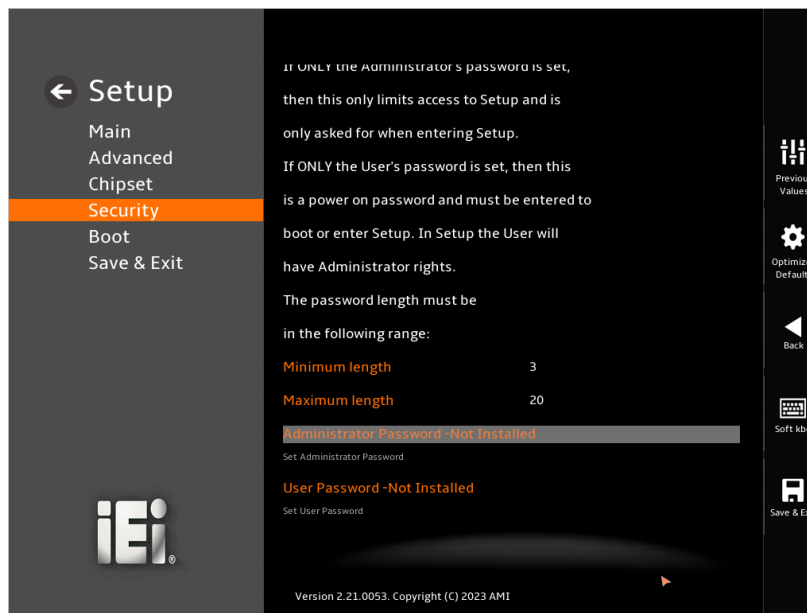

**BIOS Menu 30: Security (2/2)**



→ **Administrator Password**

Use the **Administrator Password** to set or change an administrator password.

→ **User Password**

Use the **User Password** to set or change a user password.

## 5.6 Boot

Use the **Boot** menu (**BIOS Menu 31**) to configure system boot options.

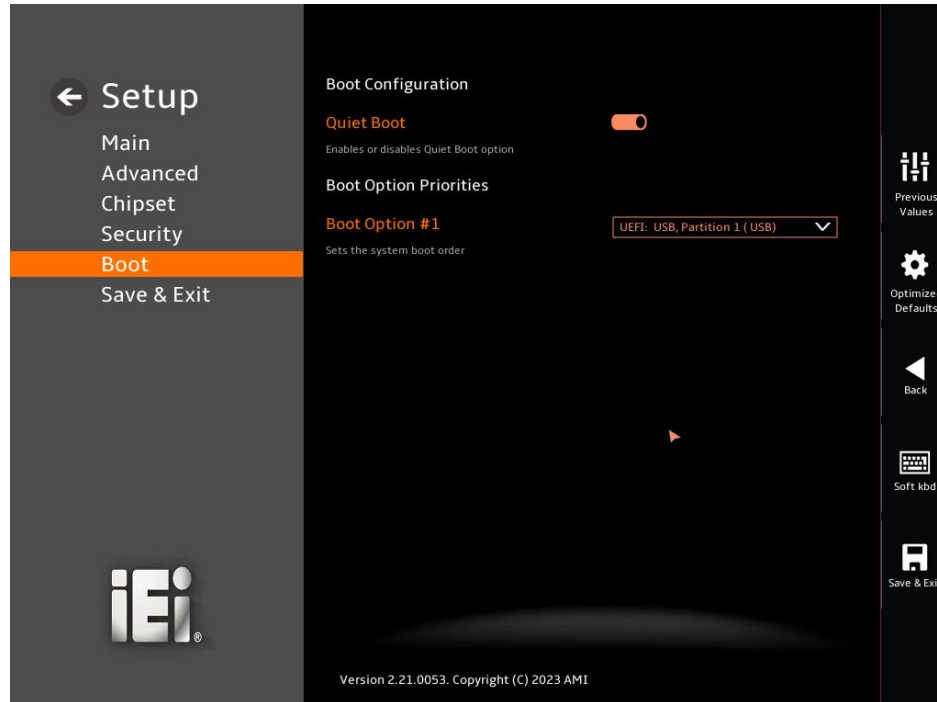

**BIOS Menu 31: Boot**

### 5.6.1 Boot Configuration

#### → Quiet Boot [Enabled]

Use the **Quiet Boot** BIOS option to select the screen display when the system boots.

- **Disabled** Normal POST messages displayed
- **Enabled**     **DEFAULT**     OEM Logo displayed instead of POST messages

### 5.6.2 Boot Option Priorities

#### → Quiet Option #1 [UEFI: USB, Partition 1(USB)]

- **Disabled**
- **Enabled**     **DEFAULT**     **UEFI: USB, Partition 1(USB)**

## 5.7 Save & Exit

Use the **Save & Exit** menu (**BIOS Menu 32**) to load default BIOS values, optimal failsafe values and to save configuration changes.



**BIOS Menu 32: Save & Exit**

### → Save Changes and Reset

Use the **Save Changes and Reset** option to save the changes made to the BIOS options and reset the system.

### → Discard Changes and Reset

Use the **Discard Changes and Reset** option to exit the system without saving the changes made to the BIOS configuration setup program.

### → Restore Defaults

Use the **Restore Defaults** option to load the optimal default values for each of the parameters on the Setup menus. **F3 key can be used for this operation.**

→ **Save as User Defaults**

Use the **Save as User Defaults** option to save the changes done so far as user defaults.

→ **Restore User Defaults**

Use the **Restore User Defaults** option to restore the user defaults to all the setup

Appendix

**A**

# **Regulatory Compliance**

---

## DECLARATION OF CONFORMITY



This equipment has been tested and found to comply with specifications for CE marking. If the user modifies and/or installs other devices in the equipment, the CE conformity declaration may no longer apply.

## FCC WARNING



This equipment complies with Part 15 of the FCC Rules. Operation is subject to the following two conditions:

- This device may not cause harmful interference, and
- This device must accept any interference received, including interference that may cause undesired operation.

This equipment has been tested and found to comply with the limits for a Class A digital device, pursuant to part 15 of the FCC Rules. These limits are designed to provide reasonable protection against harmful interference when the equipment is operated in a commercial environment. This equipment generates, uses, and can radiate radio frequency energy and, if not installed and used in accordance with the instruction manual, may cause harmful interference to radio communications. Operation of this equipment in a residential area is likely to cause harmful interference in which case the user will be required to correct the interference at his own expense.

Appendix

**B**

# Product Disposal

---

**CAUTION:**

Risk of explosion if battery is replaced by an incorrect type. Only certified engineers should replace the on-board battery.

Dispose of used batteries according to instructions and local regulations.

---

Outside the European Union—If you wish to dispose of used electrical and electronic products outside the European Union, please contact your local authority so as to comply with the correct disposal method.

Within the European Union—The device that produces less waste and is easier to recycle is classified as electronic device in terms of the European Directive 2012/19/EU (WEEE), and must not be disposed of as domestic garbage.

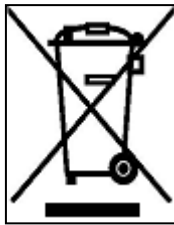

EU-wide legislation, as implemented in each Member State, requires that waste electrical and electronic products carrying the mark (left) must be disposed of separately from normal household waste. This includes monitors and electrical accessories, such as signal cables or power cords.

When you need to dispose of your device, please follow the guidance of your local authority, or ask the shop where you purchased the product. The mark on electrical and electronic products only applies to the current European Union Member States.

Please follow the national guidelines for electrical and electronic product disposal.



Appendix

**C**

# Error Beep Code

---

## C.1 PEI Beep Codes

Number of Beeps	Description
1	Memory not Installed
1	Memory was installed twice (InstallPeiMemory routine in PEI Core called twice)
2	Recovery started
3	DXE IPL was not found
3	DXE Core Firmware Volume was not found
4	Recovery failed
4	S3 Resume failed
7	Reset PPI is not available

## C.2 DXE Beep Codes

Number of Beeps	Description
1	Invalid password
4	Some of the Architectural Protocols are not available
5	No Console Output Devices are found
5	No Console Input Devices are found
6	Flash update is failed
7	Reset protocol is not available
8	Platform PCI resource requirements cannot be met



### NOTE:

If you have any question, please contact IEI for further assistance.

Appendix

**D**

# **Hazardous Materials Disclosure**

---

## D.1 RoHS II Directive (2015/863/EU)

The details provided in this appendix are to ensure that the product is compliant with the RoHS II Directive (2015/863/EU). The table below acknowledges the presences of small quantities of certain substances in the product, and is applicable to RoHS II Directive (2015/863/EU).

Please refer to the following table.

Part Name	Toxic or Hazardous Substances and Elements									
	Lead (Pb)	Mercury (Hg)	Cadmium (Cd)	Hexavalent Chromium (CR(VI))	Polybrominated Biphenyls (PBBs)	Polybrominated Diphenyl Ethers (PBDEs)	Bis(2-ethylhexyl) phthalate (DEHP)	Butyl benzyl phthalate (BBP)	Dibutyl phthalate (DBP)	Diisobutyl phthalate (DIBP)
Housing	O	O	O	O	O	O	O	O	O	O
Printed Circuit Board	O	O	O	O	O	O	O	O	O	O
Metal Fasteners	O	O	O	O	O	O	O	O	O	O
Cable Assembly	O	O	O	O	O	O	O	O	O	O
Fan Assembly	O	O	O	O	O	O	O	O	O	O
Power Supply Assemblies	O	O	O	O	O	O	O	O	O	O
Battery	O	O	O	O	O	O	O	O	O	O

O: This toxic or hazardous substance is contained in all of the homogeneous materials for the part is below the limit requirement in Directive (EU) 2015/863.

X: This toxic or hazardous substance is contained in at least one of the homogeneous materials for this part is above the limit requirement in Directive (EU) 2015/863.

## D.2 China RoHS

此附件旨在确保本产品符合中国 RoHS 标准。以下表格标示此产品中某有毒物质的含量符合中国 RoHS 标准规定的限量要求。

本产品上会附有“环境友好使用期限”的标签，此期限是估算这些物质“不会有泄漏或突变”的年限。本产品可能包含有较短的环境友好使用期限的可替换元件，像是电池或灯管，这些元件将会单独标示出来。

部件名称	有毒有害物质或元素					
	铅 (Pb)	汞 (Hg)	镉 (Cd)	六价铬 (CR(VI))	多溴联苯 (PBB)	多溴二苯醚 (PBDE)
壳体	○	○	○	○	○	○
印刷电路板	○	○	○	○	○	○
金属螺帽	○	○	○	○	○	○
电缆组装	○	○	○	○	○	○
风扇组装	○	○	○	○	○	○
电力供应组装	○	○	○	○	○	○
电池	○	○	○	○	○	○

○: 表示该有毒有害物质在该部件所有物质材料中的含量均在 SJ/T11364-2014 與 GB/T26572-2011 标准规定的限量要求以下。X: 表示该有毒有害物质至少在该部件的某一均质材料中的含量超出 SJ/T11364-2014 與 GB/T26572-2011 标准规定的限量要求。