

Neosys Technology Inc.

Nuvo-7531 Series

User Manual

Revision 1.0

Table of Contents

Table of Contents	2
Legal Information	4
Contact Information	5
Declaration of Conformity	5
Copyright Notice	6
Safety Precautions	7
Hot Surface Warning	7
Battery Warning	7
Service and Maintenance	8
ESD Precautions	8
Restricted Access Location	8
About This Manual	9

1 Introduction

1.1 Product Specifications.....	11
1.1.1 Nuvo-7531 Specifications	11
1.2 Dimension	13
1.2.1 Top View of Nuvo-7531 Series	13
1.2.2 Front View of Nuvo-7531 Series	13
1.2.3 Back View of Nuvo-7531 Series	14
1.2.4 Side View of Nuvo-7531 Series	14
1.3 Dimension with Fan Kit.....	15
1.3.1 Top View with Fan Kit.....	15
1.3.2 Front View with Fan Kit	16
1.3.3 Back View with Fan Kit.....	16
1.3.4 Side View with Fan Kit	16

2 System Overview

2.1 Nuvo-7531 Series Packing List	17
2.2 Front Panel I/O	18
2.2.1 Power Button	19
2.2.2 Reset Button	19
2.2.3 System Status LED	20
2.2.4 Ethernet Port.....	21
2.2.5 DVI-I/ VGA Port.....	22
2.2.6 USB3.1 Gen1 Ports	23
2.2.7 2.5" HDD/ SSD Hot-swappable Tray	23
2.2.8 CMOS Reset Button	24
2.2 Rear Panel I/O	25
2.3.1 3-pin Terminal Block DC Input.....	26
2.3.2 COM Ports 1 & 2.....	27
2.3.3 On/ Off Ctrl & Status Output.....	28
2.3.4 USB2.0 Ports	29
2.3.5 DisplayPort.....	30
2.3.6 4-Pole 3.5mm Microphone-in/ Speaker-out Jack	31
2.3.7 DIO Port.....	32
2.4 Internal I/O Functions.....	33
2.4.1 M.2 2280 (SATA Signal Only) Slot for SSD	33
2.4.2 Single DRAM SO-DIMM Slot	35
2.4.3 mini-PCIe Slot.....	36
2.4.4 Ignition Rotary Switch (Nuvo-7531-IGN Only)	38
2.4.5 SATA Port.....	39

3 System Installation

3.1 Disassembling the System	41
---	-----------

3.2	Installing Internal Components	44
3.2.1	CPU Installation	44
3.2.2	DDR4 SO-DIMM Installation	48
3.2.3	M.2 2280 SSD Installation	51
3.2.4	mini-PCIe Module Installation	53
3.2.5	External Hot-swappable 2.5" HDD/ SSD Installation.....	56
3.3	Installing the System Enclosure	58
3.4	FAN Kit Installation	60
3.5	Mounting Nuvo-7531 Series	63
3.5.1	Wall-mounting Nuvo-7531 Series	63
3.5.2	Installing DIN-Rail Mounting Kit (Optional).....	64
3.6	Powering On the System	65
3.6.1	Powering On Using the Power Button.....	65
3.6.2	Powering On Using Wake-on-LAN.....	66
3.7	Ignition Power Control (Nuvo-7531-IGN Only)	68
3.7.1	Principles of Ignition Power Control	68
3.7.2	Additional Features of Ignition Power Control	69
3.7.3	Wiring Ignition Signal	70
3.7.4	Configure your Windows system.....	71
3.7.5	Operation Modes of Ignition Power Control	72
4	System Configuration	
4.1	BIOS Settings	74
4.1.1	COM1 & COM2 Configuration.....	75
4.1.2	COM Port Slew Rate.....	76
4.1.3	COM Port High Speed Mode	77
4.1.4	Power On After Power Failure Option	78
4.1.5	Power & Performance (CPU SKU Power Configuration)	79
4.1.6	Wake on LAN Option	80
4.1.7	Boot Menu	81
4.1.8	Boot Type (Legacy/ UEFI).....	82
4.1.9	Add Boot Options.....	83
4.1.10	Watchdog Timer for Booting.....	84
4.1.11	Legacy/ UEFI Boot Device.....	85
5	OS Support and Driver Installation	
5.1	Operating System Compatibility	86
5.2	Driver Installation	87
5.2.1	Install Drivers Automatically	87
5.2.2	Install Drivers Manually.....	88
5.3	Driver Installation for Watchdog Timer Control	89
Appendix A Using WDT & DIO		
Watchdog Timer	90	
Installing WDT_DIO Library	90	
WDT and DIO Library Installation	91	
WDT Functions	93	
InitWDT	93	
SetWDT	93	
StartWDT	94	
ResetWDT	94	
StopWDT	94	
DIO Functions	95	
InitDIO.....	95	
DIReadLine	95	
DIReadPort	95	
DOWriteLine.....	96	
DOWritePort.....	96	

Legal Information

All Neosys Technology Inc. products shall be subject to the latest Standard Warranty Policy

Neosys Technology Inc. may modify, update or upgrade the software, firmware or any accompanying user documentation without any prior notice. Neosys Technology Inc. will provide access to these new software, firmware or documentation releases from download sections of our website or through our service partners.

Before installing any software, applications or components provided by a third party, customer should ensure that they are compatible and interoperable with Neosys Technology Inc. product by checking in advance with Neosys Technology Inc.. Customer is solely responsible for ensuring the compatibility and interoperability of the third party's products. Customer is further solely responsible for ensuring its systems, software, and data are adequately backed up as a precaution against possible failures, alternation, or loss.

For questions in regards to hardware/ software compatibility, customers should contact Neosys Technology Inc. sales representative or technical support.

To the extent permitted by applicable laws, Neosys Technology Inc. shall NOT be responsible for any interoperability or compatibility issues that may arise when (1) products, software, or options not certified and supported; (2) configurations not certified and supported are used; (3) parts intended for one system is installed in another system of different make or model.

Contact Information

Headquarters
(Taipei, Taiwan)

Neosys Technology Inc.
15F, No.868-3, Zhongzheng Rd., Zhonghe Dist., New Taipei City, 23586, Taiwan
Tel: +886-2-2223-6182 Fax: +886-2-2223-6183 [Email](#), [Website](#)

Americas
(Illinois, USA)

Neosys Technology America, Inc.
3384 Commercial Avenue, Northbrook, IL 60062, USA
Tel: +1-847-656-3298 [Email](#), [Website](#)

China

Neosys Technology China Co., Ltd.
Room 429 /431, Building 32, Guiping Road 680, Shanghai, 200233, China
Tel: +86-2161155366 [Email](#), [Website](#)

Declaration of Conformity

FCC

This equipment has been tested and found to comply with the limits for a Class A digital device, pursuant to part 15 of the FCC Rules. These limits are designed to provide reasonable protection against harmful interference when the equipment is operated in a commercial environment. This equipment generates, uses, and can radiate radio frequency energy and, if not installed and used in accordance with the instruction manual, may cause harmful interference to radio communications. Operation of this equipment in a residential area is likely to cause harmful interference in which case the user will be required to correct the interference at own expense.

CE

The product(s) described in this manual complies with all applicable European Union (CE) directives if it has a CE marking. For computer systems to remain CE compliant, only CE-compliant parts may be used. Maintaining CE compliance also requires proper cable and cabling techniques.

Copyright Notice

All rights reserved. This publication may not be reproduced, transmitted, transcribed, stored in a retrieval system, or translated into any language or computer language, in any form or by any means, electronic, mechanical, magnetic, optical, chemical, manual or otherwise, without the prior written consent of Neosys Technology, Inc.

Disclaimer

This manual is intended to be used as an informative guide only and is subject to change without prior notice. It does not represent commitment from Neosys Technology Inc. Neosys Technology Inc. shall not be liable for any direct, indirect, special, incidental, or consequential damages arising from the use of the product or documentation, nor for any infringement on third party rights.

Patents and Trademarks

Neosys, the Neosys logo, Expansion Cassette, MezIO™ are registered patents and trademarks of Neosys Technology, Inc.

Windows is a registered trademark of Microsoft Corporation.

Intel®, Core™ are registered trademarks of Intel Corporation

NVIDIA®, GeForce® are registered trademarks of NVIDIA Corporation

All other names, brands, products or services are trademarks or registered trademarks of their respective owners.

Safety Precautions

Read these instructions carefully before you install, operate, or transport the system.

- Install the system or DIN rail associated with, at a sturdy location
- Install the power socket outlet near the system where it is easily accessible
- Secure each system module(s) using its retaining screws
- Place power cords and other connection cables away from foot traffic. Do not place items over power cords and make sure they do not rest against data cables
- Shutdown, disconnect all cables from the system and ground yourself before touching internal modules
- Ensure that the correct power range is being used before powering the device
- Should a module fail, arrange for a replacement as soon as possible to minimize down-time
- By means of a power cord connected to a socket-outlet with earthing connection
- This product is intended to be supplied by a Listed Power Adapter or DC power source, rated 24Vdc, 16A, Tma 60 degree C and 5000m altitude during operation. If further assistance is required, please contact Neousys Technology
- If the system is not going to be used for a long time, disconnect it from mains (power socket) to avoid transient over-voltage

Hot Surface Warning



HOT SURFACE. DO NOT TOUCH. "ATTENTION: Surface chaude. Ne pas toucher."

WARNING!

Components/ parts inside the equipment may be hot to touch!
Please wait one-half hour after switching off before handling parts.

Battery Warning

Caution!



- Batteries are at risk of exploding if incorrectly installed
- Do not attempt to recharge, force open, or heat the battery
- Replace the battery only with the same or equivalent type recommended by the manufacturer

Service and Maintenance

- ONLY qualified personnel should service the system
- Shutdown the system, disconnect the power cord and all other connections before servicing the system
- When replacing/ installing additional components (expansion card, memory module, etc.), insert them as gently as possible while assuring proper connector engagement

ESD Precautions

- Handle add-on module, motherboard by their retention screws or the module's frame/ heat sink. Avoid touching the PCB circuit board or add-on module connector pins
- Use a grounded wrist strap and an anti-static work pad to discharge static electricity when installing or maintaining the system
- Avoid dust, debris, carpets, plastic, vinyl and styrofoam in your work area
- Do not remove any module or component from its anti-static bag before installation

Restricted Access Location

The controller is intended for installation only in certain environments where both of the following conditions apply:

- Access can only be gained by **QUALIFIED SERVICE PERSONNEL** who have been instructed on the reasons for restrictions applied to the location and any precautions that shall be taken
- Access is through the use of a **TOOL**, lock and key, or other means of security, and is controlled by the authority responsible for the location

About This Manual

This guide introduces Neosys Nuvo-7531 series systems. They are compact fanless embedded controllers with Intel® 9th/8th Gen Core™ i7/ i5/ i3 processor.

The guide also demonstrates the system's basic installation procedures.

Revision History

Version	Date	Description
1.0	Jul. 2020	Initial release

1 Introduction

Nuvo-7531 is one of the most compact fanless embedded controller supporting Intel® 9th/ 8th-Gen Core™ CPUs. Measuring just 212 x 165 x 63 mm, it comfortably fits into confined spaces. Despite its compact size, Nuvo-7531 does not compromise on performance. Based on Intel® 9th/ 8th- Gen Core™ 65W/ 35W CPUs, it can deliver more than 50% extra performance compared to the previous generation. Nuvo-7531 is a compact and powerful fanless embedded controller for a variety of industrial applications.



The Nuvo-7531 has abundant I/O functions. It features four GbE ports and four USB3.1 ports for multiple GbE and USB cameras. There is a hot-swappable HDD tray for you to hot-swap the storage drive without turning off the system or dismantle the chassis. There are three mPCIe slots to install WIFI or 3G/ 4G for wireless communication needs. In addition, Nuvo-7531 is also equipped with 8x DIO, 2x COM ports and dual display outputs for your application needs.

For a compact embedded controller, Nuvo-7531 delivers amazing computing power and provides rich I/O functions. It is suitable for a variety of industrial applications, especially when space is limited. Nuvo-7531 is a little giant in the world of rugged embedded controllers.

1.1 Product Specifications

1.1.1 Nuvo-7531 Specifications

System Core	
Processor	Supporting Intel® 9 th / 8 th Gen Core™ CPU (LGA1151 socket) - Intel® Core™ i7-8700/ i7-8700T/ i7-9700E/ i7-9700TE - Intel® Core™ i5-8500/ i5-8500T/ i5-9500E/ i5-9500TE - Intel® Core™ i3-8100/ i3-8100T/ i3-9100E/ i3-9100TE
Chipset	Intel® H310 platform controller hub
Graphics	Integrated Intel® UHD graphics 630
Memory	Up to 32 GB DDR4 2666/ 2400 SDRAM (one SODIMM slot)
I/O Interface	
Ethernet	4x Gigabit Ethernet ports by I219 and 3x I210
USB	4x USB 3.1 Gen1 (5 Gbps) ports 2x USB 2.0 ports
Video Port (Integrated Graphics)	1x DVI-I connector for DVI/ VGA output, supporting 1920 x 1200 resolution 1x DisplayPort connector, supporting 4096 x 2304 resolution
Serial Port	2x software-programmable RS-232/ 422/ 485 ports (COM1/ COM2)
Audio	1x 3.5 mm jack for mic-in and speaker-out
Isolated DIO	4-CH isolated DI and 4-CH isolated DO
Storage Interface	
SATA HDD	1x hot-swappable 2.5" HDD/ SSD tray
M.2	1x M.2 2280 SATA interface
Internal Expansion Bus	
Mini PCI Express	3x full-size mini PCI Express sockets with internal SIM sockets
Power Supply	
DC Input	1x 3-pin pluggable terminal block for 8~35V DC input with optional ignition power control
Remote Ctrl & Status Output	1x 10-pin (2x5) pin header for remote on/off control and status LED output
Power Consumption	With i5-8500T (35W mode): 58W (Max.) @ 24V With i7-9700E (65W mode): 100W (Max.) @ 24V
Mechanical	
Dimension	212mm (W) x 165 mm (D) x 63 mm (H)
Weight	2.5 kg
Mounting	Wall-mount mounting bracket or optional DIN-Rail mounting

Environmental	
Operating Temperature	with 35W CPU -25°C ~ 60°C */** with 65W CPU, optional fan kit is required -25°C ~ 60°C */**
Storage Temperature	-40°C ~85°C
Humidity	10%~90% , non-condensing
Vibration	Operating, MIL-STD-810G, Method 514.6, Category 4
Shock	Operating, MIL-STD-810G, Method 516.6, Procedure I, Table 516.6-II
EMC	CE/FCC Class A, according to EN 55032 & EN 55024

* For sub-zero operating temperature, a wide temperature HDD or Solid State Disk (SSD) is required.

** For i7 CPUs, thermal throttling may occur when sustained full-loading applied at 60°C ambient temperature.

1.2 Dimension

 **NOTE**

All measurements are in millimeters (mm).

1.2.1 Top View of Nuvo-7531 Series

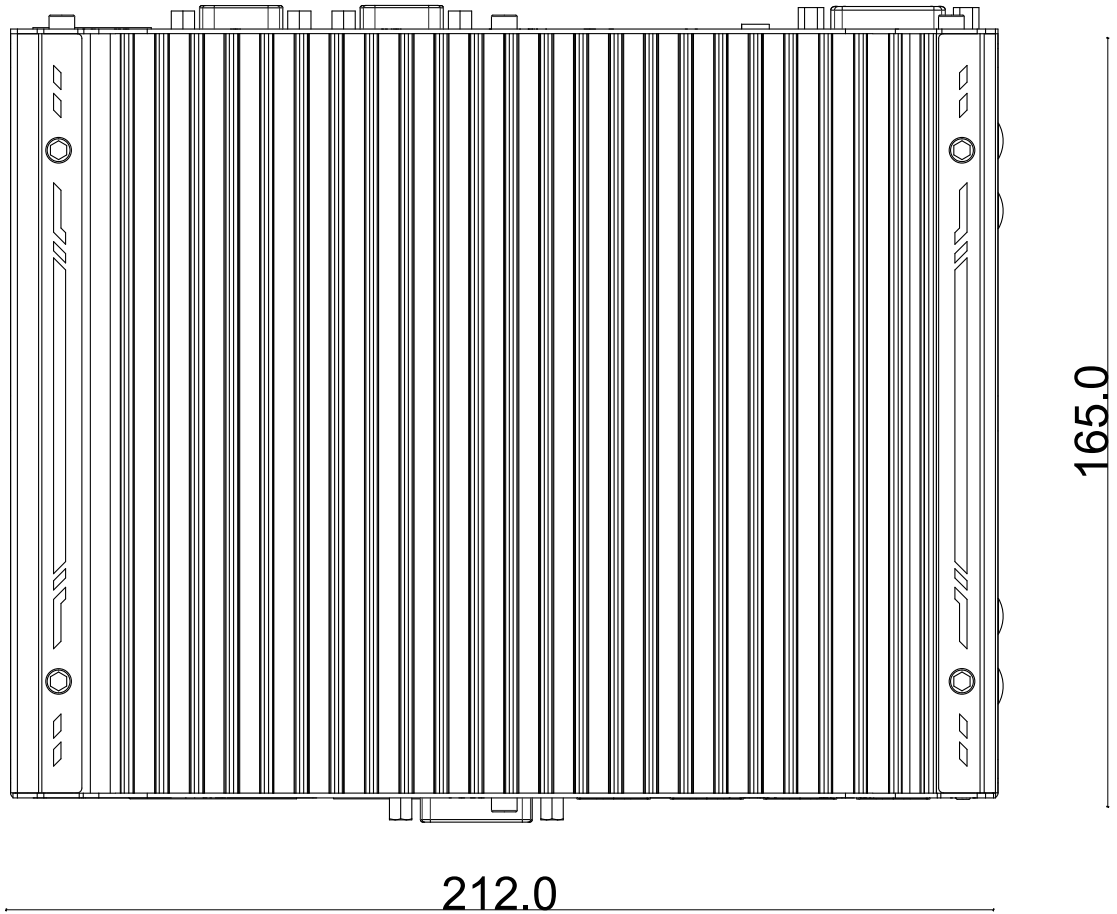

1.2.2 Front View of Nuvo-7531 Series

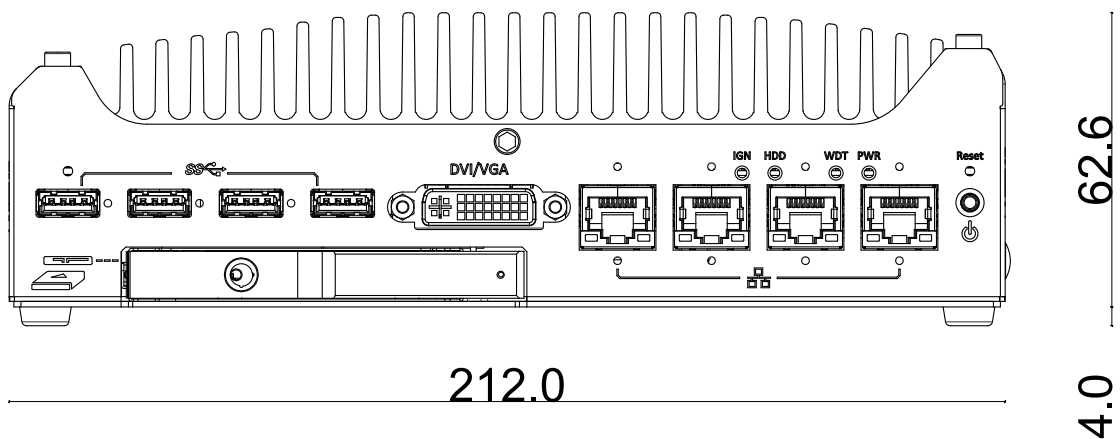

1.2.3 Back View of Nuvo-7531 Series

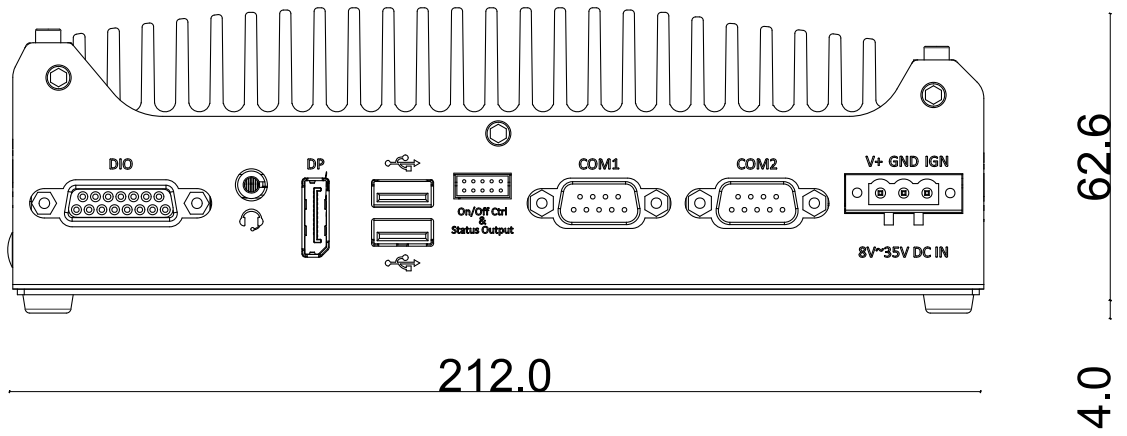

1.2.4 Side View of Nuvo-7531 Series

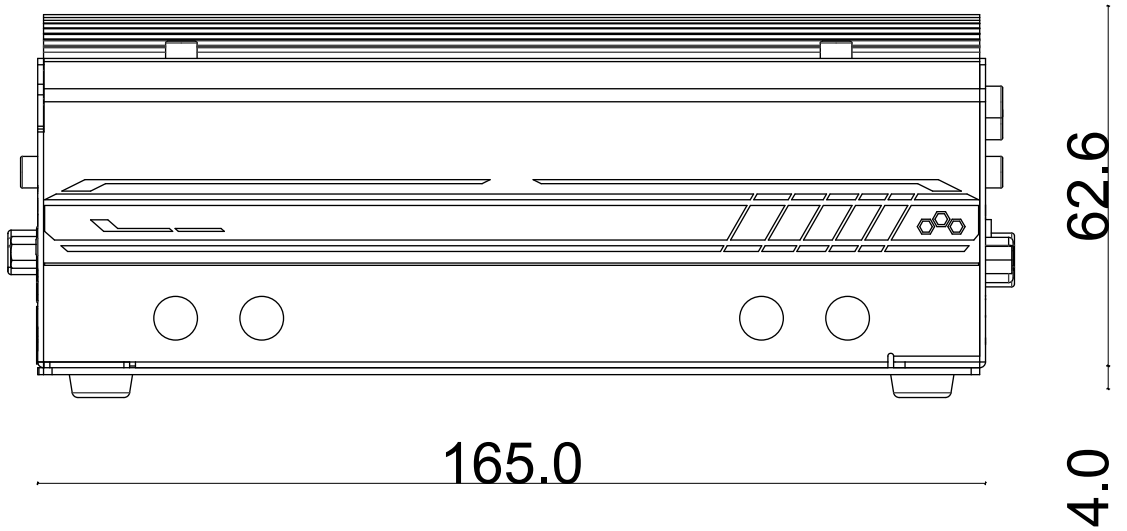

1.3.2 Front View with Fan Kit

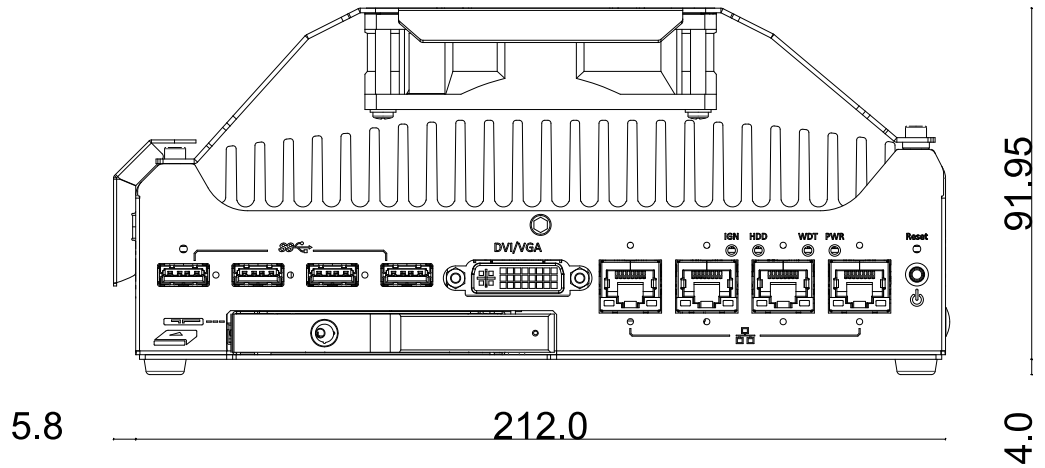

1.3.3 Back View with Fan Kit

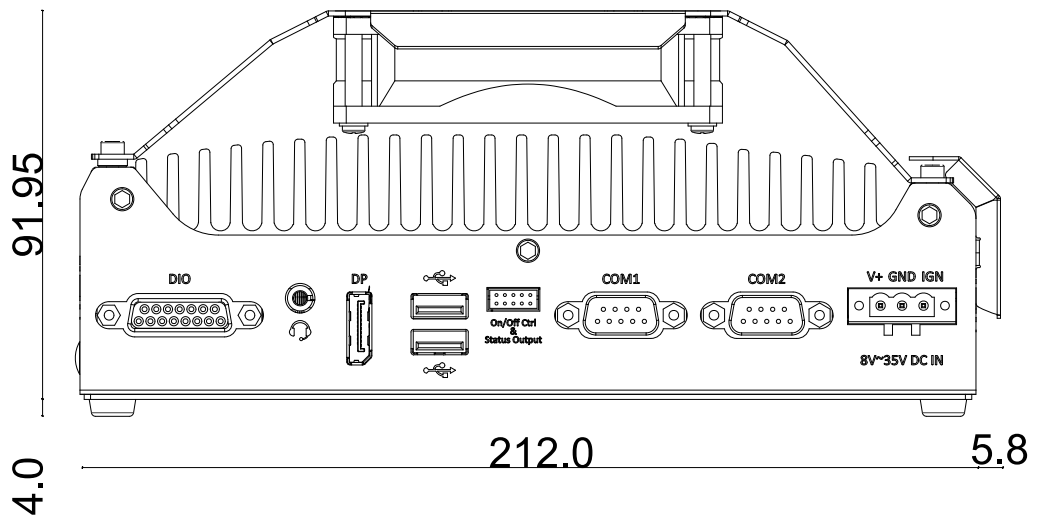

1.3.4 Side View with Fan Kit

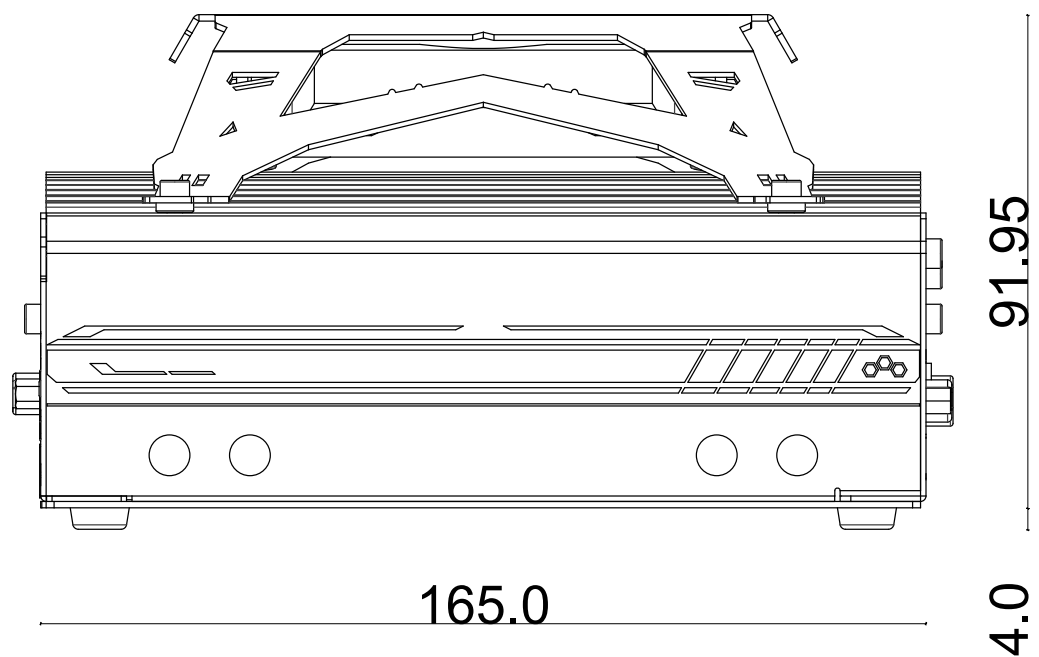

2 System Overview

Upon receiving and unpacking your Nuvo-7531, please check immediately if the package contains all the items listed in the following table. If any item(s) are missing or damaged, please contact your local dealer or Neosys Technology.

2.1 Nuvo-7531 Series Packing List

System Pack	Nuvo-7531	Qty
1	Nuvo-7531 (If you ordered CPU/ RAM/ HDD, please verify these items)	1
2	Accessory box, which contains <ul style="list-style-type: none"> ● CPU bracket ● HDD/ SSD PORON ● Neosys drivers & utilities DVD ● 3-pin power terminal block ● Screw pack ● DVI-I to VGA adapter 	1 4 1 1 4 1

2.2 Front Panel I/O

The Nuvo-7531 I/O panel features four gigabit Ethernet ports, four USB3.1 Gen1 ports, one DVI/ VGA connector and a 2.5" hot-swappable tray.

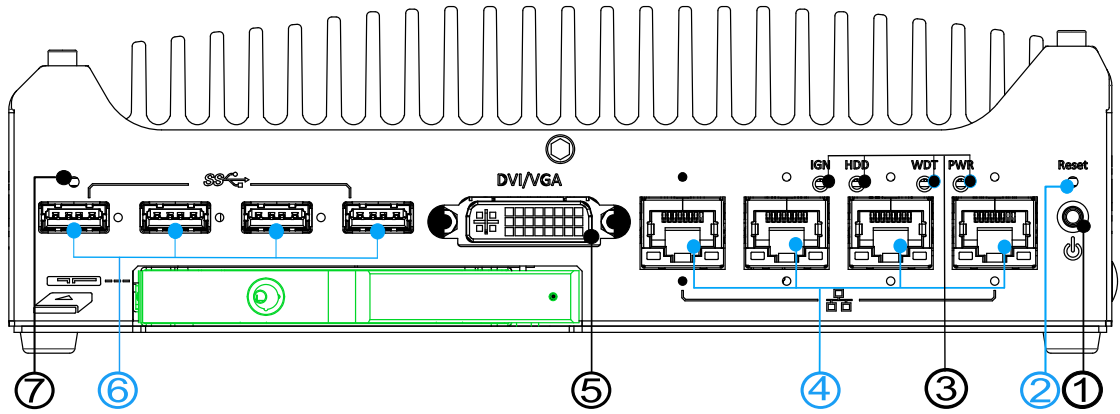

No.	Item	Description
1	Power button	Use this button to turn on or shutdown the system.
2	Reset button	Use this button to manually reset the system.
3	System status LEDs	Four system LEDs, power (PWR), watchdog timer (WDT), hard disk drive (HDD) and ignition (IGN).
4	Ethernet port	The Ethernet ports support 10/ 100/ 1000Mbps network connections.
5	DVI-I/ VGA port	DVI-I output supports resolution up to 1920x1200 and is compatible with other digital connections via an adapter.
6	USB 3.1 Gen1 port	USB 3.0 port supports up to 5 Gbit/s data transfer bandwidth.
7	CMOS reset	Use this button to manually reset the CMOS.
	Area in green	2.5" HDD/ SSD hot swappable tray

2.2.1 Power Button

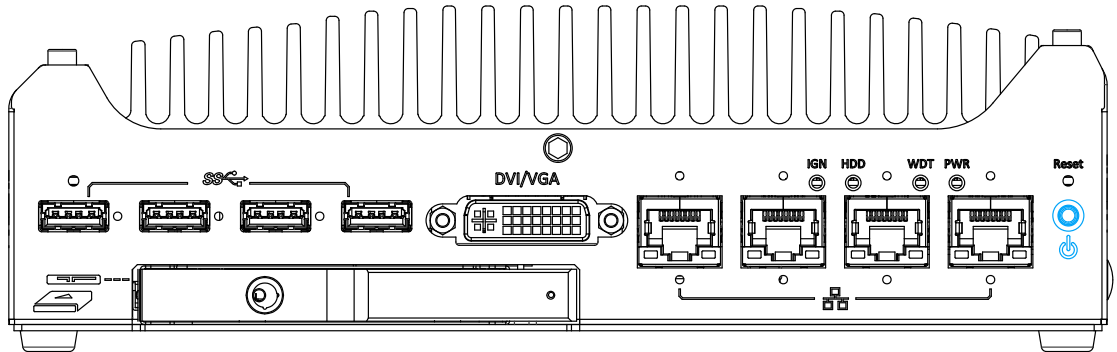

The power button is a non-latched switch for ATX mode on/off operation. Press to turn on the system, PWR LED should light up and to turn off, you can either issue a shutdown command in the OS, or just press the power button. In case of system halts, you can press and hold the power button for 5 seconds to force-shutdown the system. Please note that there is a 5 seconds interval between two on/off operations (i.e. once turning off the system, you will need to wait for 5 seconds to initiate another power-on operation).

2.2.2 Reset Button

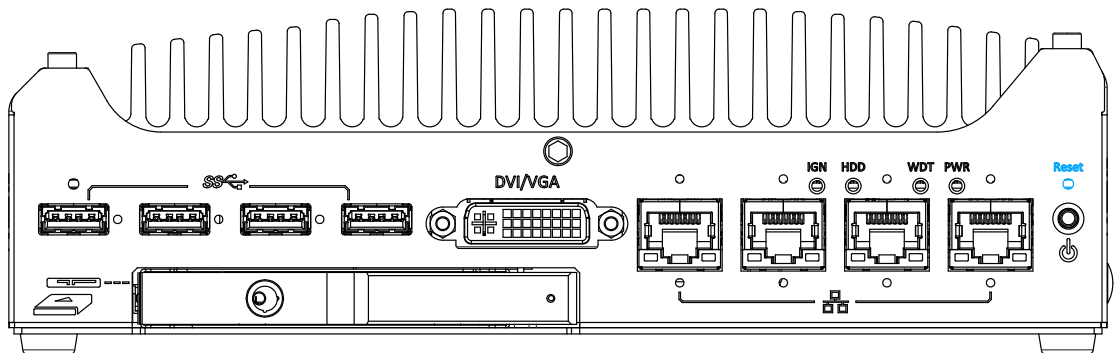

The reset button can be used to manually reset the system in case of abnormal condition. To avoid unexpected operation, the reset button is hidden behind the front panel. You need to use a pin-like object to push the reset button.

2.2.3 System Status LED

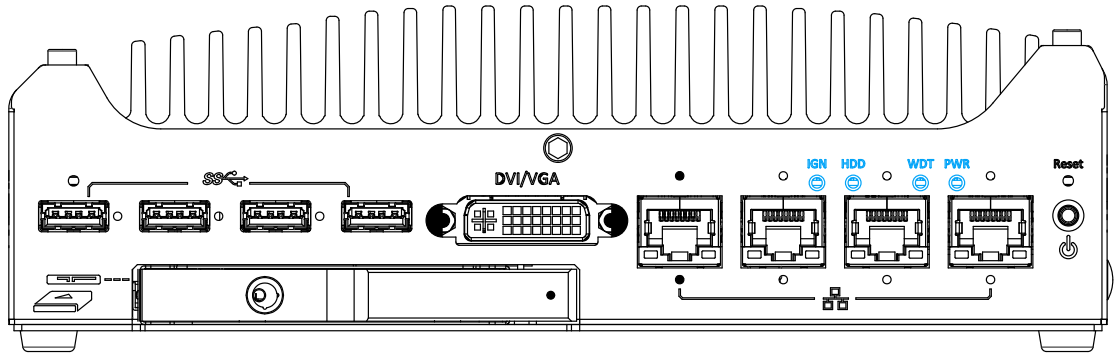

There are four LED indicators on the I/O panel: PWR, WDT, HDD and IGN. The descriptions of these LEDs are listed in the following table.

Indicator	Color	Description
PWR	Green	Power indicator, lighted-up when system is on.
WDT	Yellow	Watchdog timer LED, flashing when watchdog timer is started.
HDD	Red	Hard drive indicator, flashing when SATA HDD is active.
IGN	Green	Power indicator, lid when system is on

2.2.4 Ethernet Port

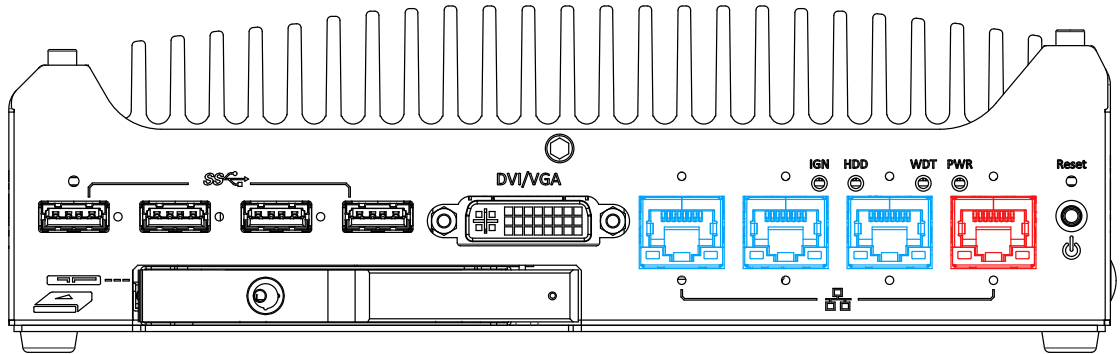

The system offers four GbE ports with screw-lock mechanism. The GbE port marked in **red** is implemented with Intel® I219-LM while the ones marked in blue and are implemented with Intel® I210-IT controllers. Each port has one dedicated PCI Express link for maximum performance. When an Ethernet connection is established, the LED indicators on the RJ45 connector represents the following connection statuses:

Active/Link LED

LED Color	Status	Description
Yellow	Off	Ethernet port is disconnected
	On	Ethernet port is connected and no data transmission
	Flashing	Ethernet port is connected and data is transmitting/receiving

Speed LED

LED Color	Status	Description
Green or Orange	Off	10 Mbps
	Green	100 Mbps
	Orange	1000 Mbps

The port implemented using Intel® I219-LM (in **red**) supports Wake-on-LAN function. Drivers may be required to utilize the GbE port in Windows environment.

2.2.5 DVI-I/ VGA Port

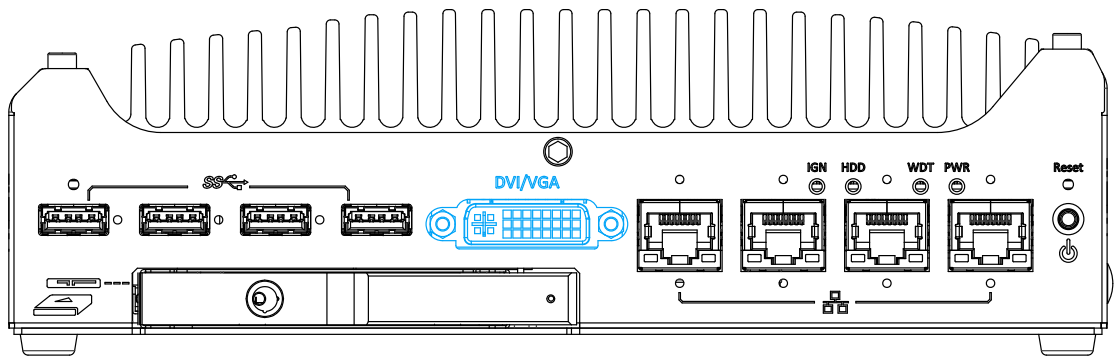

The system features a DVI-I connector on its front panel that is also compatible with VGA signals. The DVI and VGA outputs are directly driven by integrated Intel HD graphics engine and support up to 1920 x 1200 resolution.

For VGA monitor, Neosys offers a specialized DVI-to-VGA adapter as an accessory shipped with the system. This adapter supports VGA DDC signals and thus eliminates compatibility issues with VGA monitors. Or you can use a DVI-I to VGA+DVI-D Y-cable to support two independent display outputs



DVI to VGA adapter



Optional DVI to VGA+DVI Y-cable



NOTE

Please make sure your VGA cable includes SDA and SCL (DDC clock and data) signals for correct communication with monitor to get resolution/timing information. A cable without SDA/SCL can cause blank screen on your VGA monitor due to incorrect resolution/timing output.

2.2.6 USB3.1 Gen1 Ports

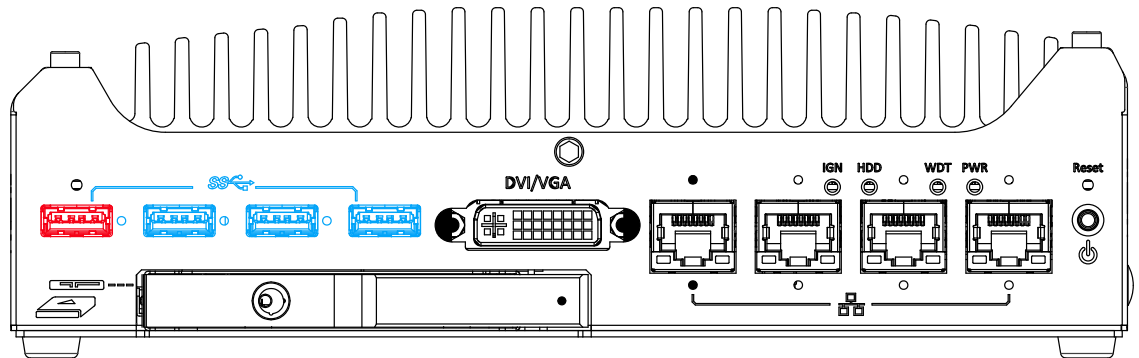

The system offers four USB 3.1 Gen1 (SuperSpeed USB) ports on its front panel with screw-lock mechanism. They are backward compatible with USB 2.0, USB 1.1 and USB 1.0 devices. Legacy USB support is also provided so you can use USB keyboard/mouse in DOS environment while USB 3.1 Gen1 driver is supported natively in Windows 10. The screw-lock mechanism is limited to the three ports on the right (indicated in blue) and due to the width of the USB connector with screw-lock, only two of them (from right to left, 1st and 3rd USB port) may be connected, using the screw-lock, at the same time.

2.2.7 2.5" HDD/ SSD Hot-swappable Tray

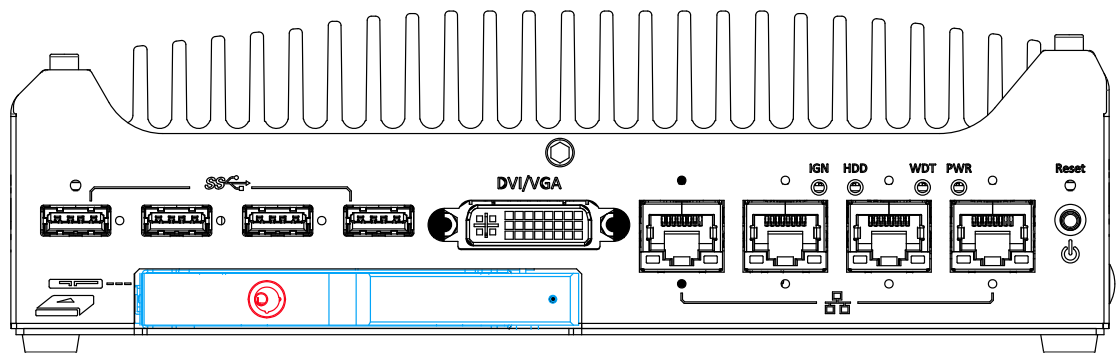

The system features an external hot-swappable 2.5" hot-swappable tray that supports a 7mm or 9.5mm 2.5" HDD/ SSD. The 7mm HDD/ SSD will need attach PORON materials supplied to make up for the thickness difference. Designed for easy access, the HDD tray is secured by a lock (indicated in red).

2.2.8 CMOS Reset Button

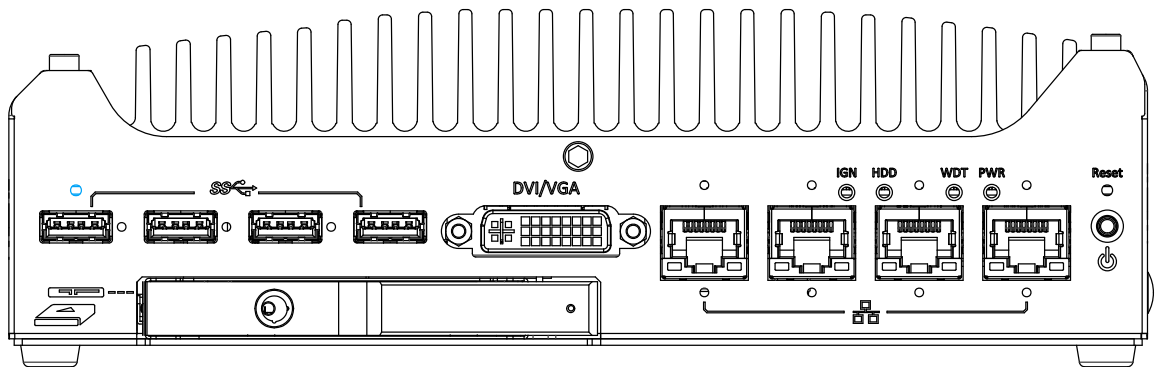

The CMOS Reset button is used to manually reset the motherboard BIOS in case of system halt or malfunction. To avoid unexpected operation, it is purposely placed behind the panel. To reset, please use the tip of a pen, press and hold for at least 5 seconds to reset the BIOS.



NOTE

Depending on the design of your screw-lock USB connector, the CMOS reset button may be obstructed if it is connected in the USB port below.

2.2 Rear Panel I/O

On the rear panel of the system, you will find a 3-pin terminal block for DC input, two configurable COM ports, on/ off control status output header, USB2.0 ports for legacy USB devices, a DisplayPort, a 4-pole female 3.5mm headphone (speaker)/ microphone jack and a digital input/ output DB15 connector.

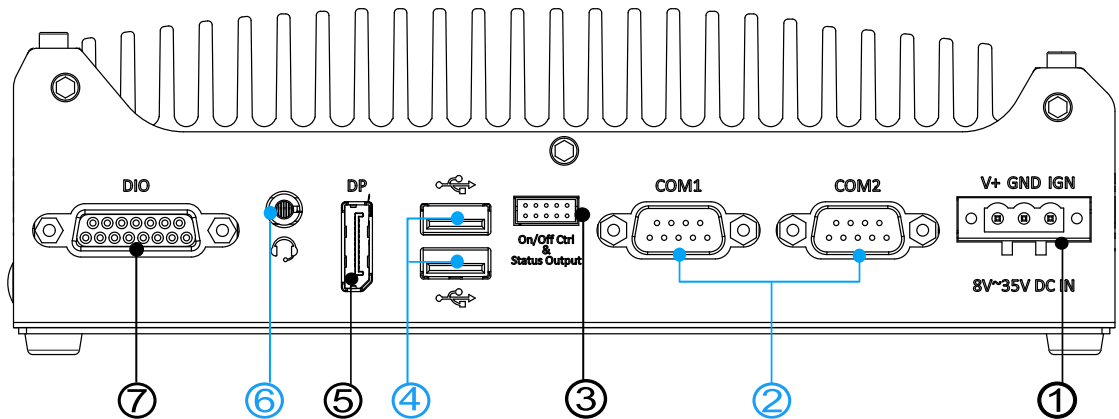

No.	Item	Description
1	3-pin terminal block (DC/ ignition input)	Compatible with DC power input from 8~35V, the terminal block is also used for ignition signal input.
2	COM ports	There are 2 COM ports for communicating with external devices.
3	On/ off control & status output	Allows for external switch extension when the system is placed inside a cabinet.
4	USB 2.0 ports	The USB 2.0 ports are backward with USB 1.1 / 1.0.
5	DisplayPort	Support display resolutions up to 4096 x 2304. Compatible with HDMI/ DVI via respective adapter cable (resolution may vary).
6	3.5mm 4-pole speaker/ microphone jack	The 4-pole 3.5mm jack accepts microphone voice input and headphone speaker sound output.
7	DIO port	The port provides four DI and four DO via DB15 female connector

2.3.1 3-pin Terminal Block DC Input

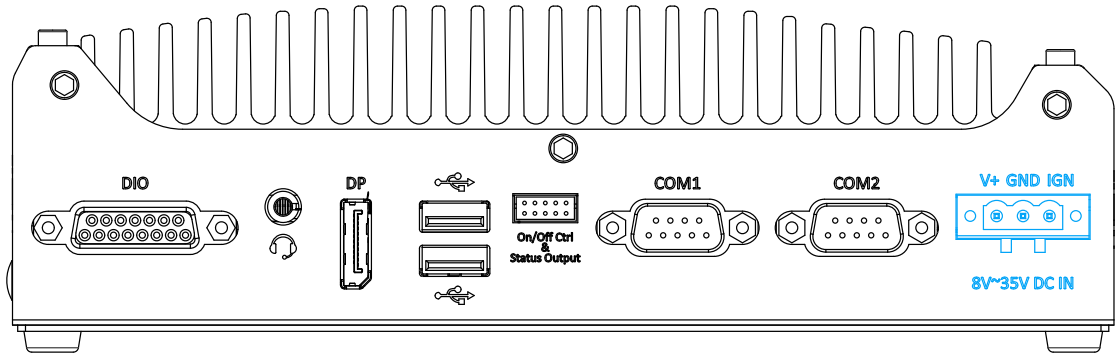

The system accepts a wide range of DC power input from 8 to 35V via a 3-pin pluggable terminal block, which is fit for field usage where DC power is usually provided. The screw clamping mechanism on the terminal block offers connection reliability when wiring DC power.

For Nuo-7531-IGN systems, in addition to DC power input, this terminal block can also accept ignition signal input (IGN).

2.3.2 COM Ports 1 & 2

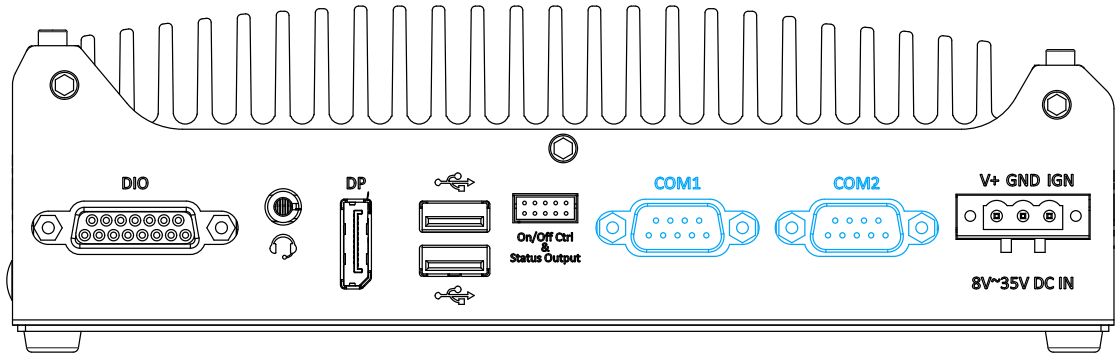

The system provides two COM ports for communicating with external devices. These COM ports are implemented using industrial-grade ITE8786 Super IO chip (-40 to 85°C) and provide up to 115200 bps baud rate.

COM1 and COM2 are software-configurable RS-232/422/485 ports. The operation mode of COM1 and COM2 can be set in BIOS setup utility. The following table describes the pin definition of COM ports.

COM Port Pin Definition

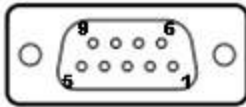

COM1 & COM2			
Pin#	RS-232 Mode	RS-422 Mode	RS-485 Mode (Two-wire 485)
1	DCD		
2	RX	422 TXD+	485 TXD+/RXD+
3	TX	422 RXD+	
4	DTR	422 RXD-	
5	GND	GND	GND
6	DSR		
7	RTS		
8	CTS	422 TXD-	485 TXD-/RXD-
9	RI		

2.3.3 On/ Off Ctrl & Status Output

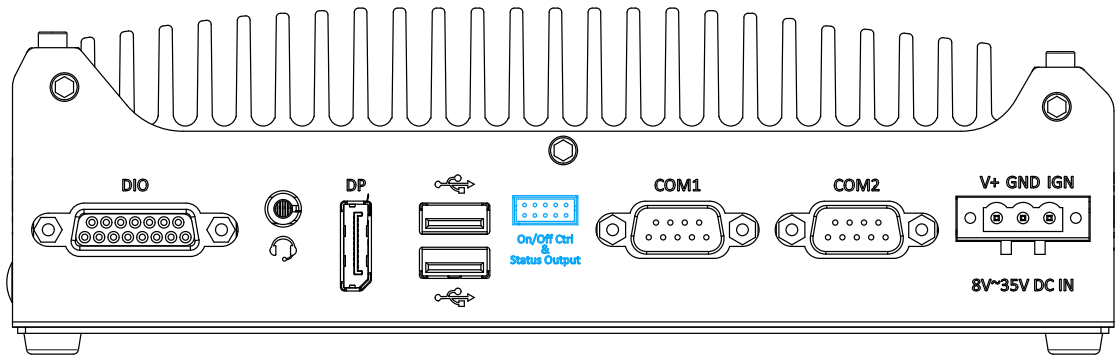

The “On/ Off Control Ctrl & Status Output” connection allows for external switch and LED indicator extension. It is useful when the system is placed in a cabinet or a not easily accessed location. This function is provided via a 2x5 2.0mm pitch wafer connector.

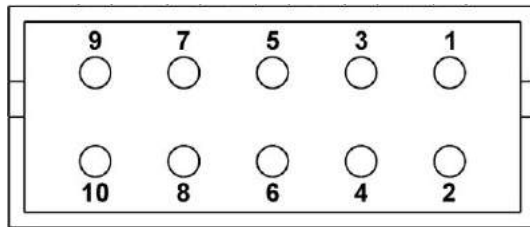

Pin#	Definition	Description
1	Ctrl+	[Input] Remote on/off control, connecting to an external switch to turn on/off the system (polarity is negligible).
2	Ctrl-	
3	Power+	[Output] System power indicator, on if system is turned on, off if system is turned off.
4	Power-	
5	HDD+	[Output] Hard drive indicator, flashing when SATA hard drive is active.
6	HDD-	
7	Standby Power+	[Output] Standby power indicator, lighting up when DC power is applied and system is in S5 (standby) mode.
8	Standby Power-	
9	WDT+	[Output] Watchdog timer indicator, flashing when watchdog timer is started.
10	WDT-	



NOTE

Please make sure the polarity is correct when you connect the external LED indicator to the Status LED Output.

2.3.4 USB2.0 Ports

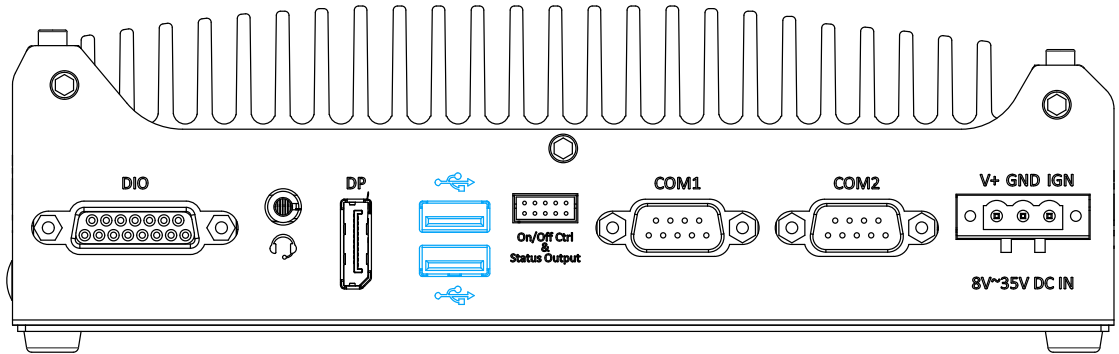

The system has two USB 2.0 ports. They are implemented by native xHCI (eXtensible Host Controller Interface) controller in H310 chipset and are compatible with USB 2.0, USB 1.1 and USB 1.0 devices. Legacy USB support is also provided so you can use USB keyboard/mouse in DOS environment.

2.3.5 DisplayPort

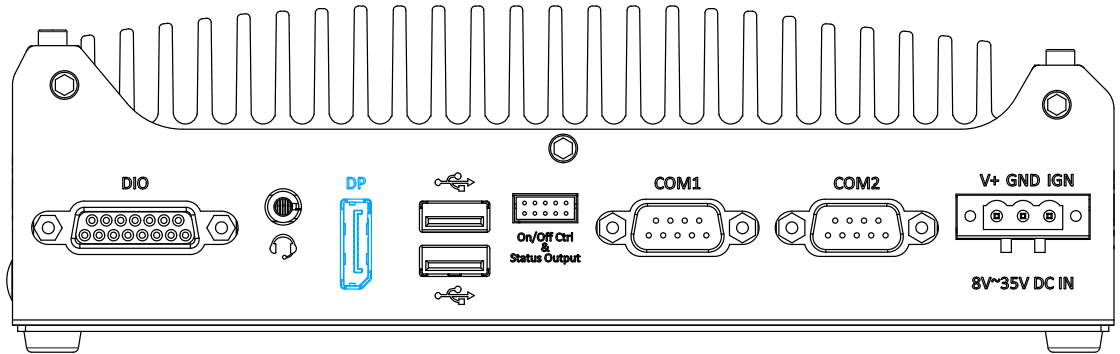

The system has a DisplayPort (DP) output which is a digital display interface that mainly connect video source and carry audio to a display device. When connecting a DP, it can deliver up to 4K UHD (4096 x 2304) in resolution. The system is designed to support passive DP adapter/ cable. You can connect to other display devices using DP-to-HDMI cable or DP-to-DVI cable.



DP-to-HDMI



DP-to-DVI

The system supports dual independent display outputs by connecting display devices to DVI and DisplayPort connection. To support dual display outputs and achieve best DisplayPort output resolution in Windows, you need to install corresponding graphics drivers. Please refer to section [Driver Installation](#) for details.

2.3.6 4-Pole 3.5mm Microphone-in/ Speaker-out Jack

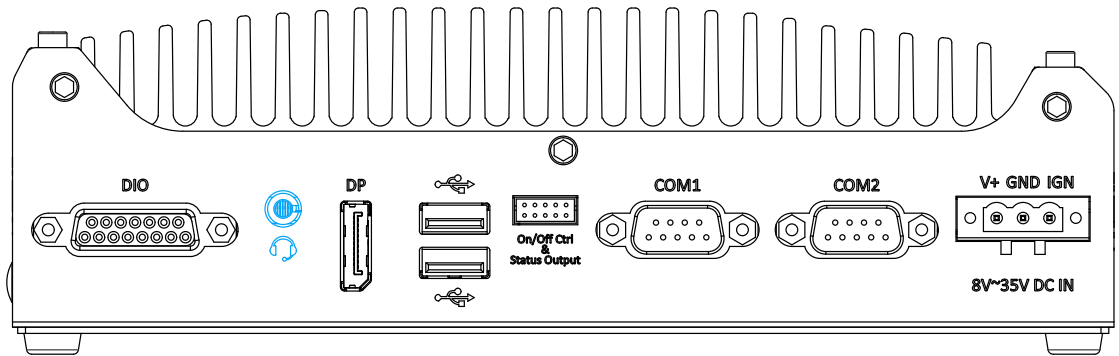

There is a female 4-pole  audio jack for headphone (speaker) output and microphone input. To utilize the audio function in Windows, you need to install corresponding drivers. Please refer to the section, [Driver Installation](#).

2.3.7 DIO Port

The digital input (DI) and digital output (DO) function provides four digital input and four digital output on the rear panel of the system via DB15 female connector.

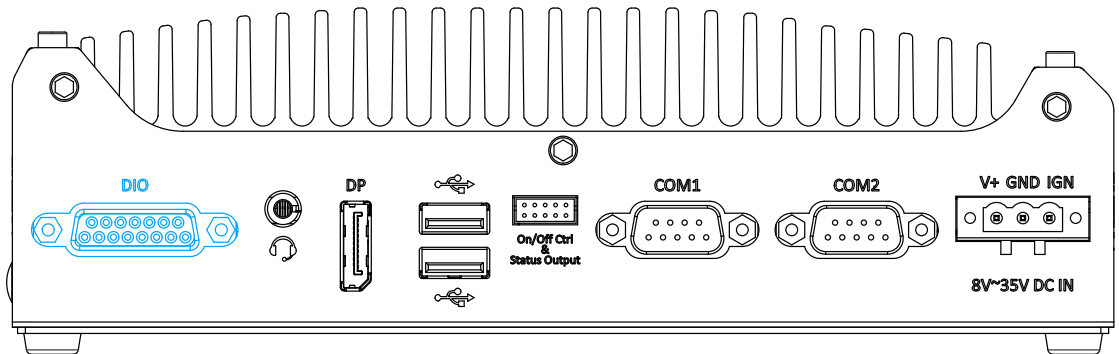

Isolated Digital Input

No. of Channel	4-CH Isolated Digital Input Channels
Logic Level	Logic High: 5 to 24V Logic Low: 0 to 1.5V
Isolated Voltage	2500 Vrms
Input Resistance	1kΩ
Operation Mode	Polling

Isolated Digital Output

No. of Channel	4-CH Isolated Digital Output Channels
Sink Current (per channel)	500 mA
Isolated Voltage	1500 Vrms
Operation Mode	Polling

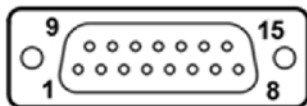

Pin Definition

Pin#	Pin Definition	Pin#	Pin Definition
1	DI_0	9	DI_GND
2	DI_1	10	DI_2
3	DI_GND	11	DI_3
4	DO_GND	12	DO_GND
5	DO_0	13	DO_2
6	DO_1	14	DO_3
7	DO_GND	15	-
8	VDD		

* When using DO0 ~ DO3, DOGND is the ground should be used.

2.4 Internal I/O Functions

In addition to I/O connectors on the front panel, the system also provides internal on-board expansion slots. In this section, we'll illustrate these internal I/O functions.

2.4.1 M.2 2280 (SATA Signal Only) Slot for SSD

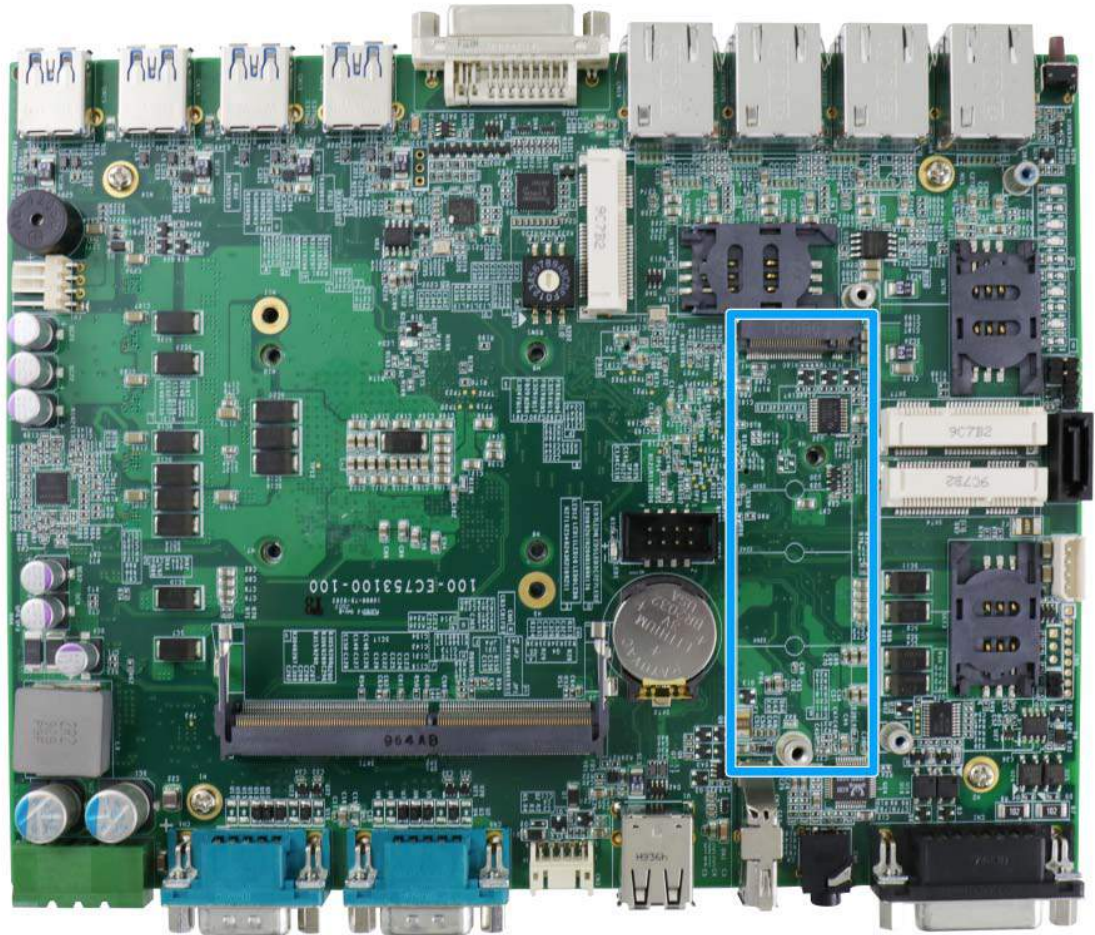

The system has an M.2 2280 slot (SATA signal only) for you to install an M.2 SATA SSD for faster access over traditional hard disk drives.



NOTE

The M.2 slot is only compatible with SATA signal M.2 SSD only.

M.2 2280M Key Pin Definition

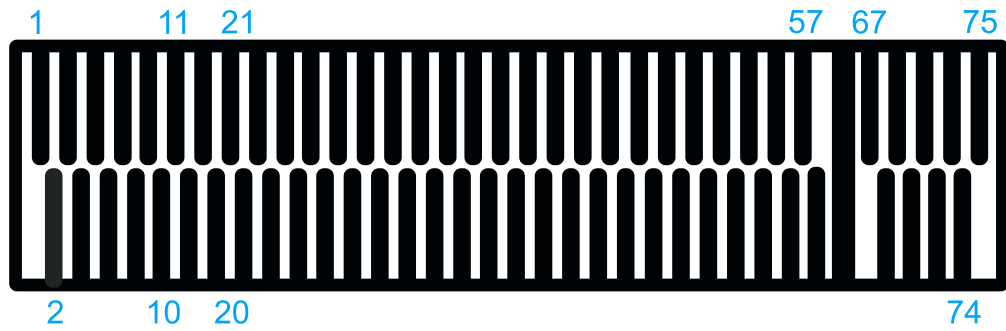

Pin #	Signal	Pin #	Signal
1		2	+3V3
3	GND	4	+3V3
5	GND	6	-
7		8	-
9	GND	10	DAS/DSS N
11		12	+3V3
13		14	+3V3
15	GND	16	+3V3
17		18	+3V3
19		20	-
21	GND	22	-
23		24	-
25		26	-
27	GND	28	-
29		30	-
31		32	-
33	GND	34	-
35		36	-
37		38	-
39	GND	40	-
41	SATA-B+	42	-
43	SATA-B-	44	-
45	GND	46	-
47	SATA-A-	48	-
49	SATA-A+	50	
51	GND	52	-
53		54	-
55		56	-
57	GND	58	-
Mechanical Key			
67	-	68	
69		70	+3V3
71	GND	72	+3V3
73	GND	74	+3V3
75	GND		

2.4.2 Single DRAM SO-DIMM Slot

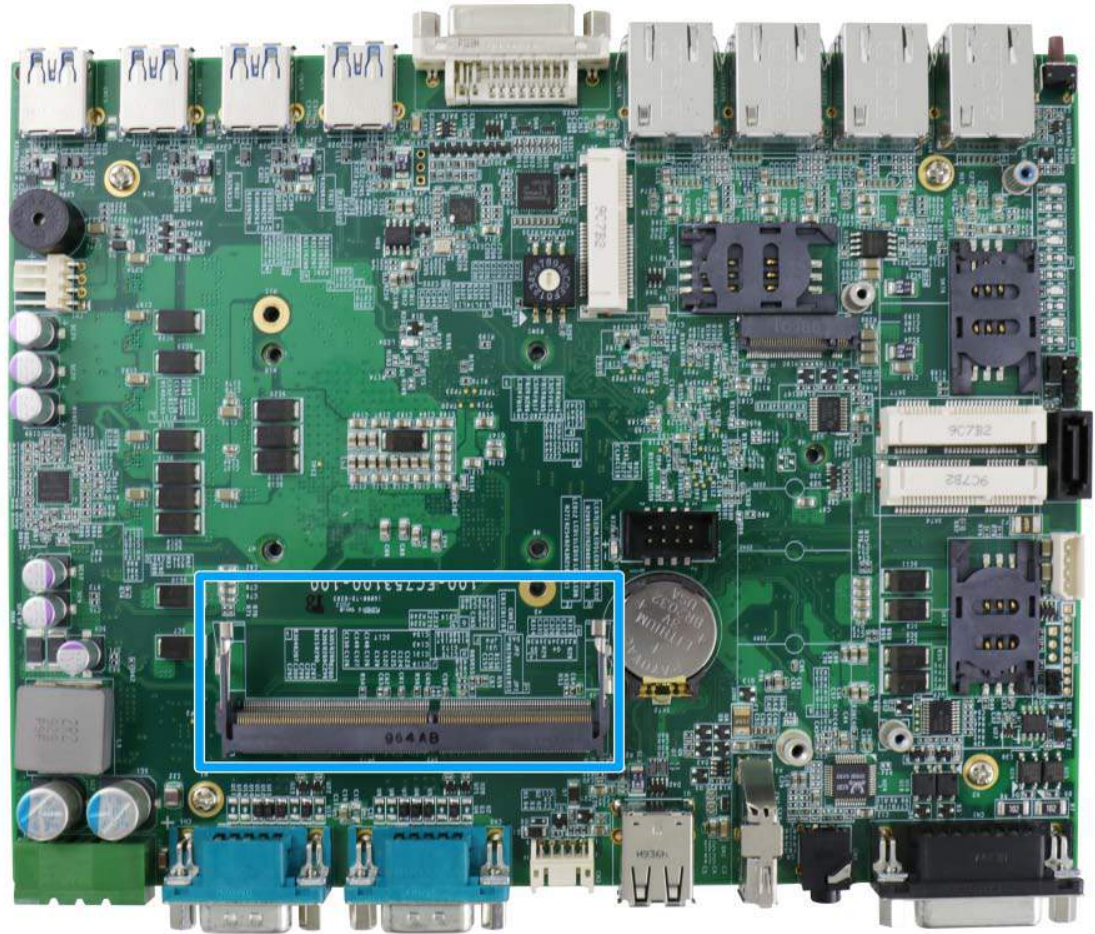

The system motherboard supports one 260-pin SODIMM socket for installing one DDR4-2666/ 2400 memory module up to 32GB capacity.

2.4.3 mini-PCle Slot

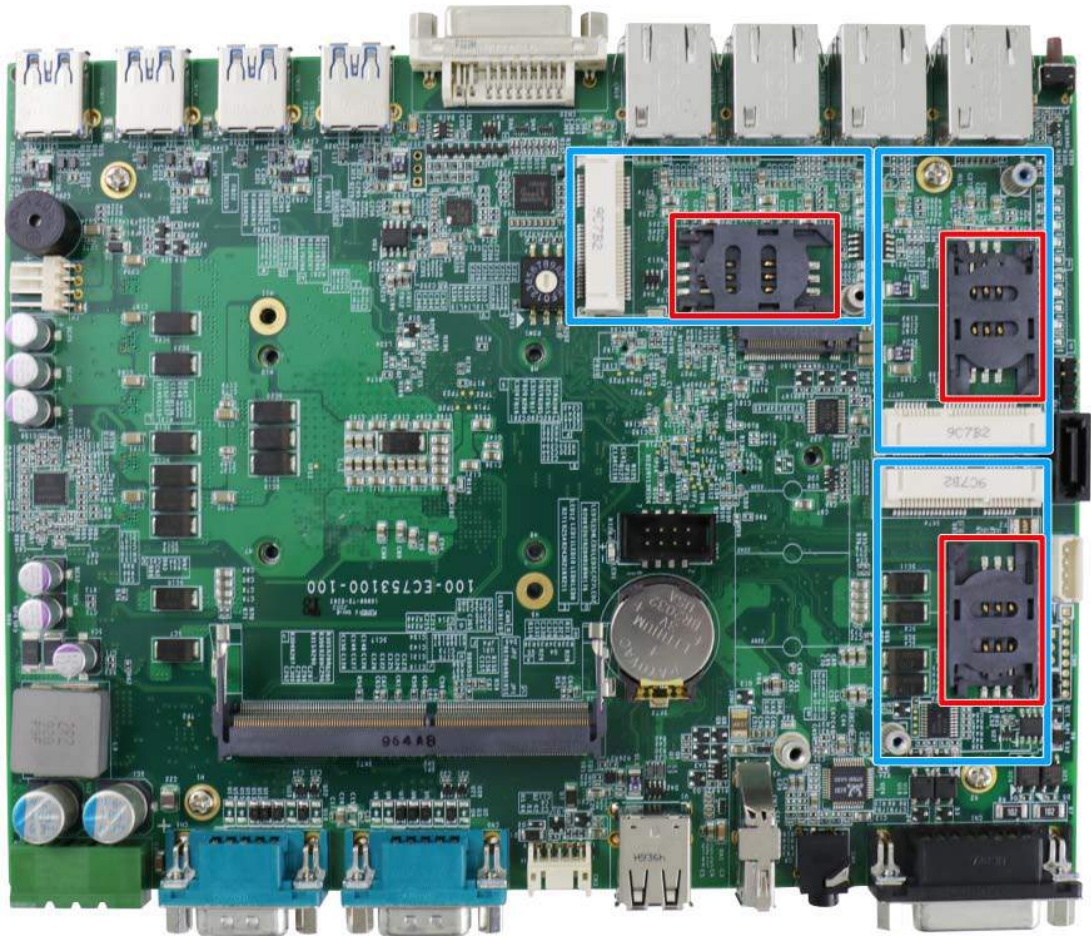

The system has three mini-PCle sockets and there are plenty of off-the-shelf mini-PCle modules with versatile capabilities. By installing a mini-PCle module, your system can have expanded features such as WIFI, GPS, CAN bus, analog frame grabber, etc.

For SMA antenna installation, there are dedicated openings located on the side of the chassis.



mini-PCle slot definition

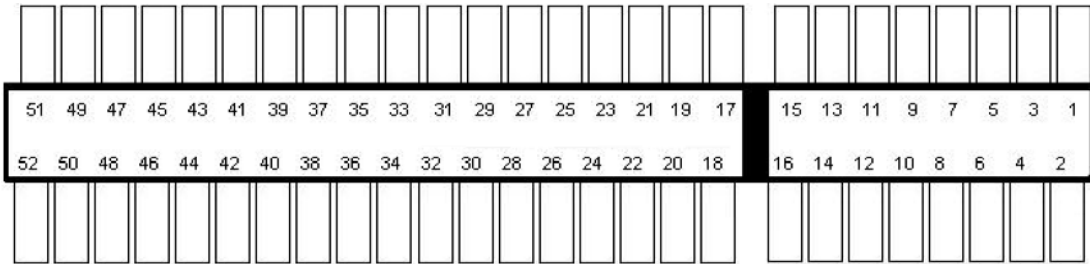

Pin #	Signal	Pin #	Signal
1	WAKE#	2	+3.3Vaux
3	COEX1	4	GND
5	COEX2	6	+1.5V
7	CLKREQ#	8	UIM PWR
9	GND	10	UIM DATA
11	REFCLK-	12	UIM CLK
13	REFCLK+	14	UIM RESET
15	GND	16	UIM VPP
Mechanical Key			
17	Reserved* (UIM C8)	18	GND
19	Reserved* (UIM C4)	20	W DISABLE#
21	GND	22	PERST#
23	PERn0	24	+3.3Vaux
25	PERp0	26	GND
27	GND	28	+1.5V
29	GND	30	SMB CLK
31	PETn0	32	SMB DATA
33	PETp0	34	GND
35	GND	36	USB D-
37	GND	38	USB D+
39	+3.3Vaux	40	GND
41	+3.3Vaux	42	LED WWAN#
43	GND	44	LED WLAN#
45	Reserved	46	LED WPAN#
47	Reserved	48	+1.5V
49	Reserved	50	GND
51	Reserved	52	+3.3Vaux

2.4.4 Ignition Rotary Switch (Nuvo-7531-IGN Only)

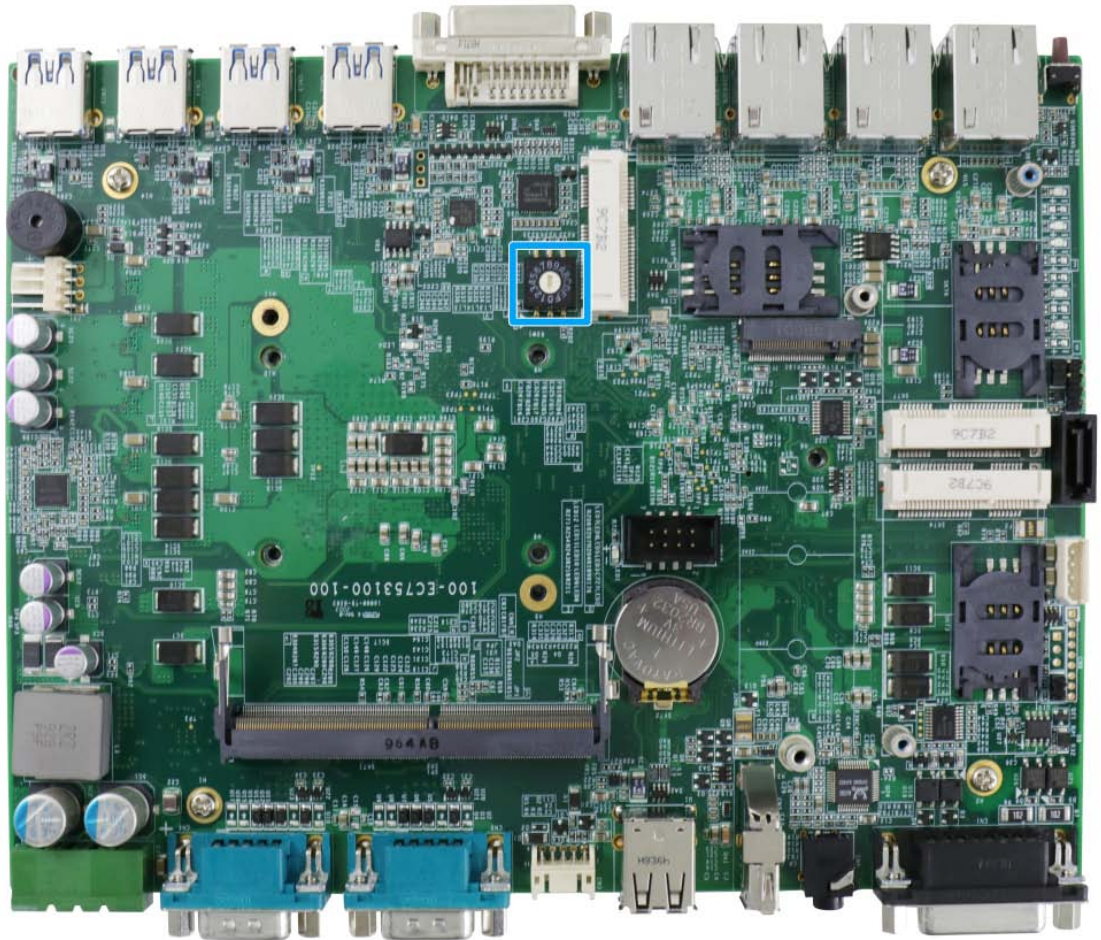

The ignition power control switch features multiple modes for pre and post ignition settings. Please refer to the section [Ignition Power Control](#) for details.

2.4.5 SATA Port

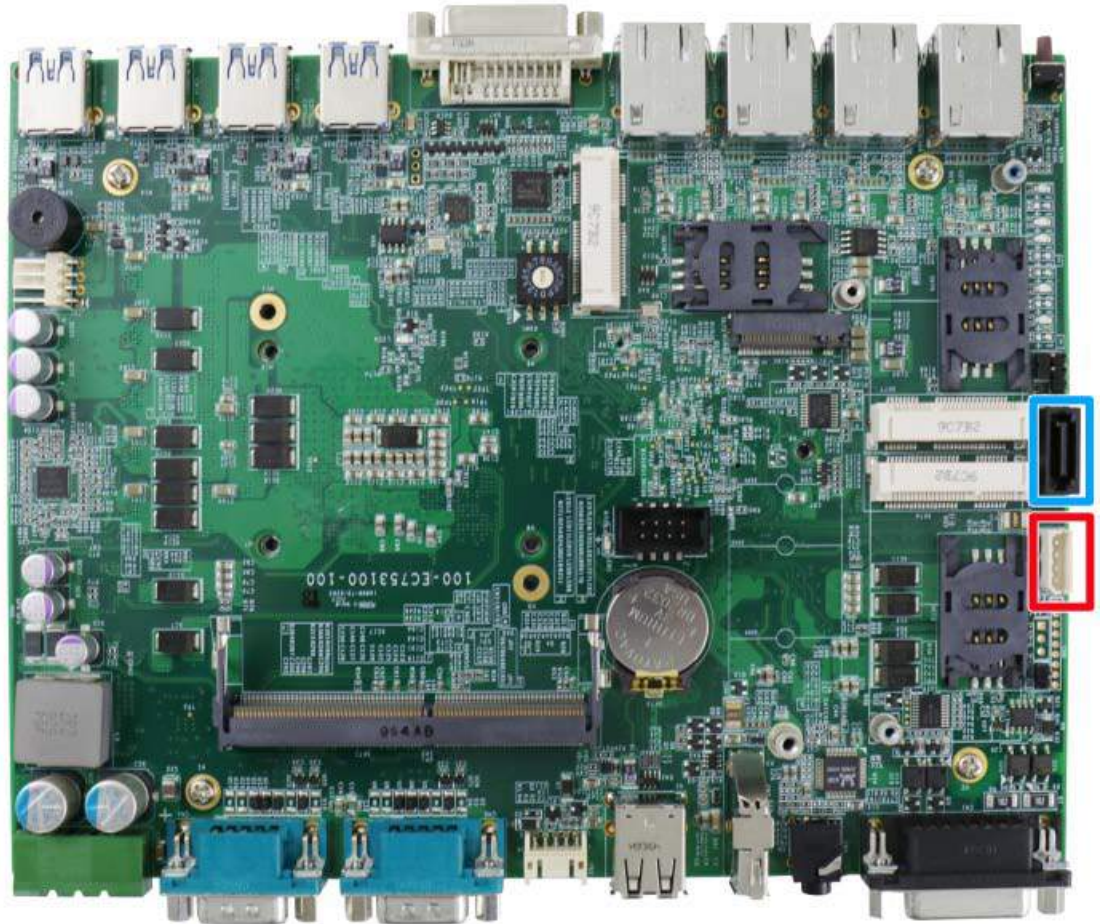

The system provides one SATA port which support Gen3, 6 Gb/s SATA signals. The SATA port is composed of a 7-pin SATA connector (indicated in blue) and a 4-pin power connector (indicated in red). This SATA and power connector should be pre-connected to the external 2.5" hot-swappable tray.

3 System Installation

Before disassembling the system enclosure and installing components and modules, please make sure you have done the following:

- It is recommended that only qualified service personnel should install and service this product to avoid injury or damage to the system.
- Please observe all ESD procedures at all times to avoid damaging the equipment.
- Before disassembling your system, please make sure the system has powered off, all cables and antennae (power, video, data, etc.) are disconnected.
- Place the system on a flat and sturdy surface (remove from mounts or out of server cabinets) before proceeding with the installation/ replacement procedure.

3.1 Disassembling the System

To access system internal components, the system needs to be disassembled. To disassemble the system enclosure, please refer to the procedures below:

1. Turn the system upside-down on a steady surface. Remove the screws indicated and separate the bottom panel from the system's enclosure.



- Remove the screw indicated on the rear I/O panel.



- Remove the screws indicated on the front I/O panel.



- Remove the screws from the top of the heatsink and separate the motherboard/ heatsink from the enclosure.

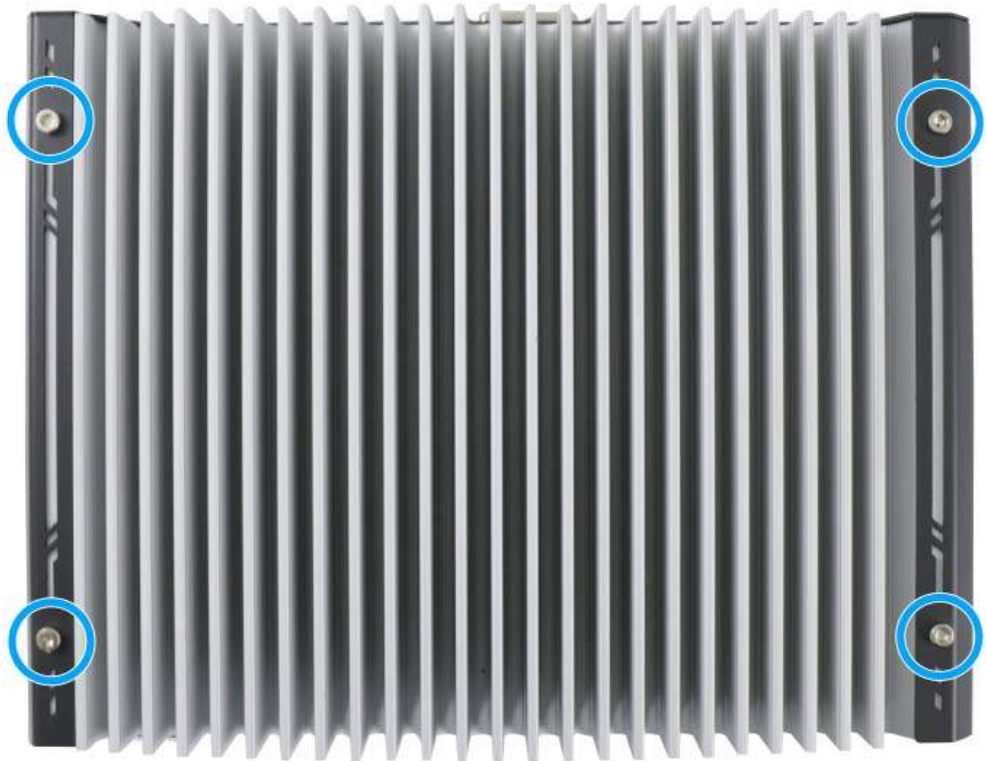

5. Turn the motherboard/ heatsink around to gain access to internal components and expansions.

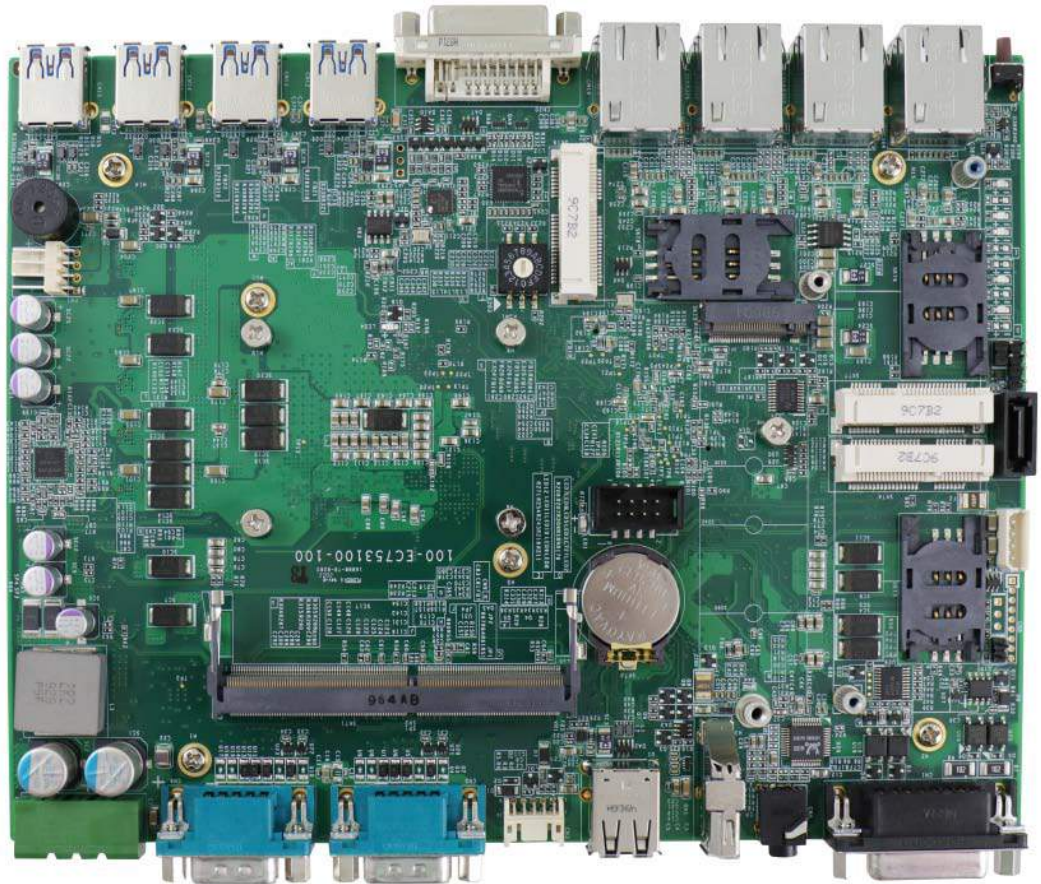

3.2 Installing Internal Components

3.2.1 CPU Installation

1. **DO NOT** remove the CPU from its container / tray before it is ready to be installed.
2. With the enclosure panels removed, to access the CPU socket, please do the following:
 - i. If you are installing a CPU for the first time, remove the four (4) screws indicated in **blue**.
 - ii. If you see the seven (7) screws indicated in **red**, the system may already have a CPU installed. To gain access to the CPU socket, you will also need to remove the seven (7) screws indicated in **red**.

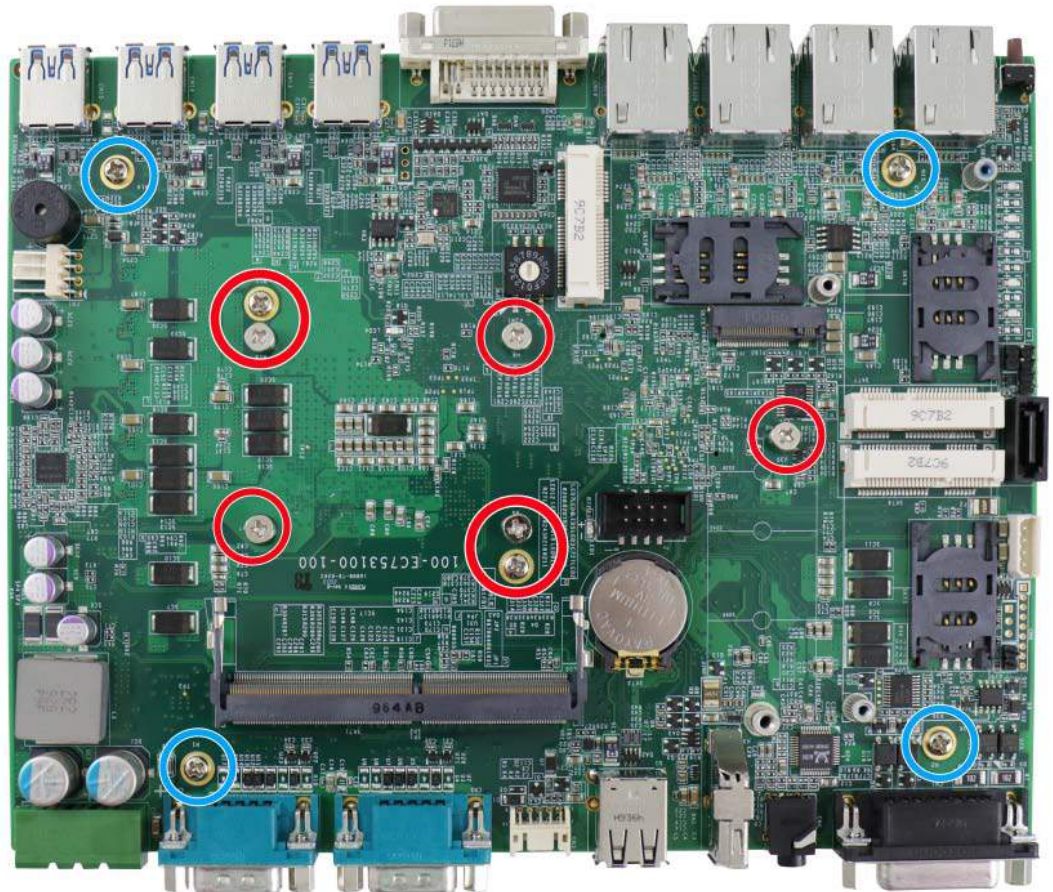

3. Between the motherboard and the heatsink, you'll see the CPU socket protective cover, place finger tips underneath the sign "REMOVE" for leverage and gently lift the cover.

 **WARNING**

*With the protective cover removed, please be careful when handling the motherboard.
DO NOT touch the pins in the LGA socket!*

4. Remove the CPU from its container/ tray. Match the two notches on the side to the protrusions in the socket, gently lower the CPU into the socket.



5. Locate the CPU retention bracket from the accessory box. Place the retention bracket on the CPU and hold it in place.



6. Turn the motherboard around and secure the bracket by tightening two M3 P-head screws.

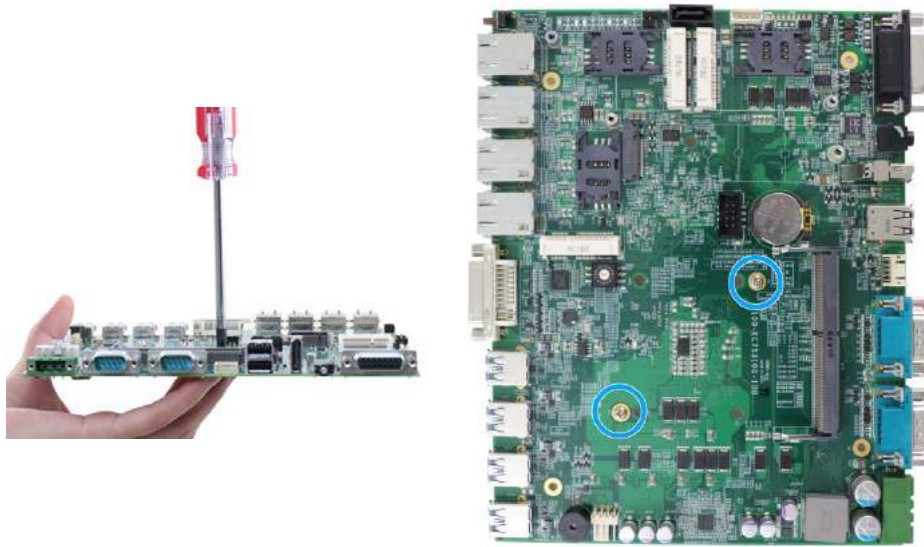

Hold CPU bracket firmly and turn the motherboard around

Secure two M3 P-head screws

7. Remove the CPU's thermal pad protective film on the heatsink.

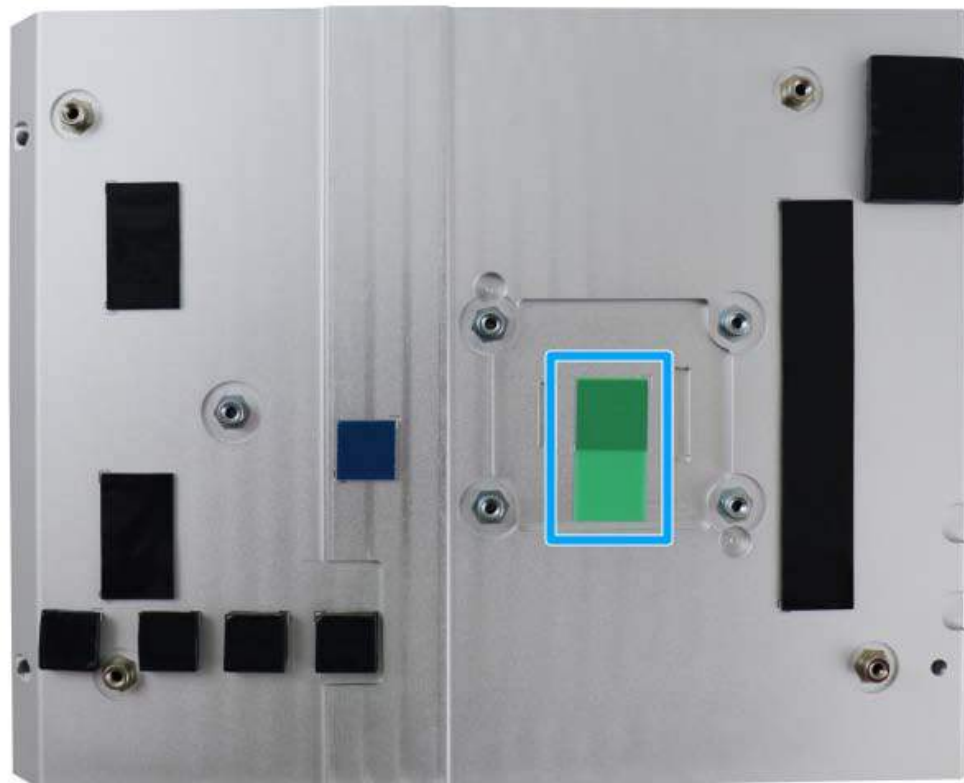

8. With the four motherboard standoffs aligned, gently lower the motherboard onto the heatsink.

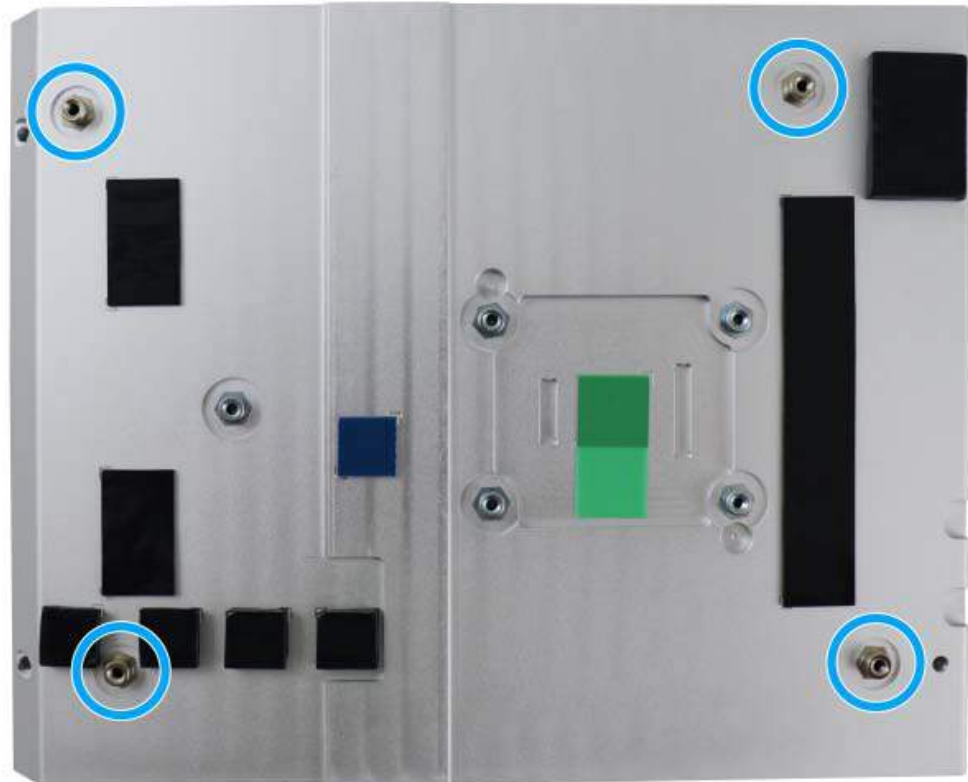

9. Secure the four (4) M3 P-head motherboard screws (indicated in blue) and from the accessory box, five (5) M3 spring screws (indicated in red). Gradually tighten the five screws in the following order for even pressure.

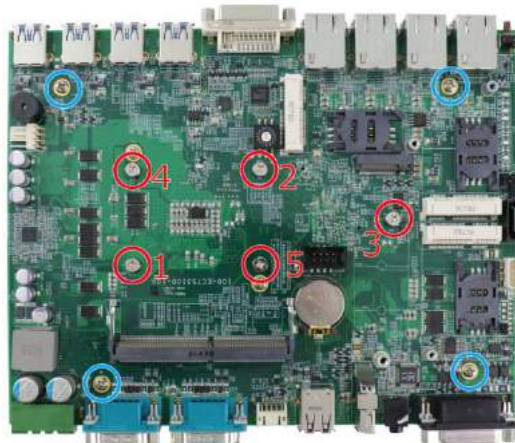

Securing the motherboard



Secure five CPU/ heatsink spring screws in order

10. [Reinstall the system enclosure](#) and panel when done.

If you need to install other components, please refer to respective sections.

3.2.2 DDR4 SO-DIMM Installation

There is a single memory SO-DIMM slot on the motherboard that supports up to 32GB DDR4-2666/ 2400. Please follow the procedures below to replace or install the memory modules.

1. Please refer to the section “[Disassembling the System](#)”, you may not need to completely dismantle the system to gain access to the memory module slots.
2. Locate the SODIMM memory module slot on the motherboard.

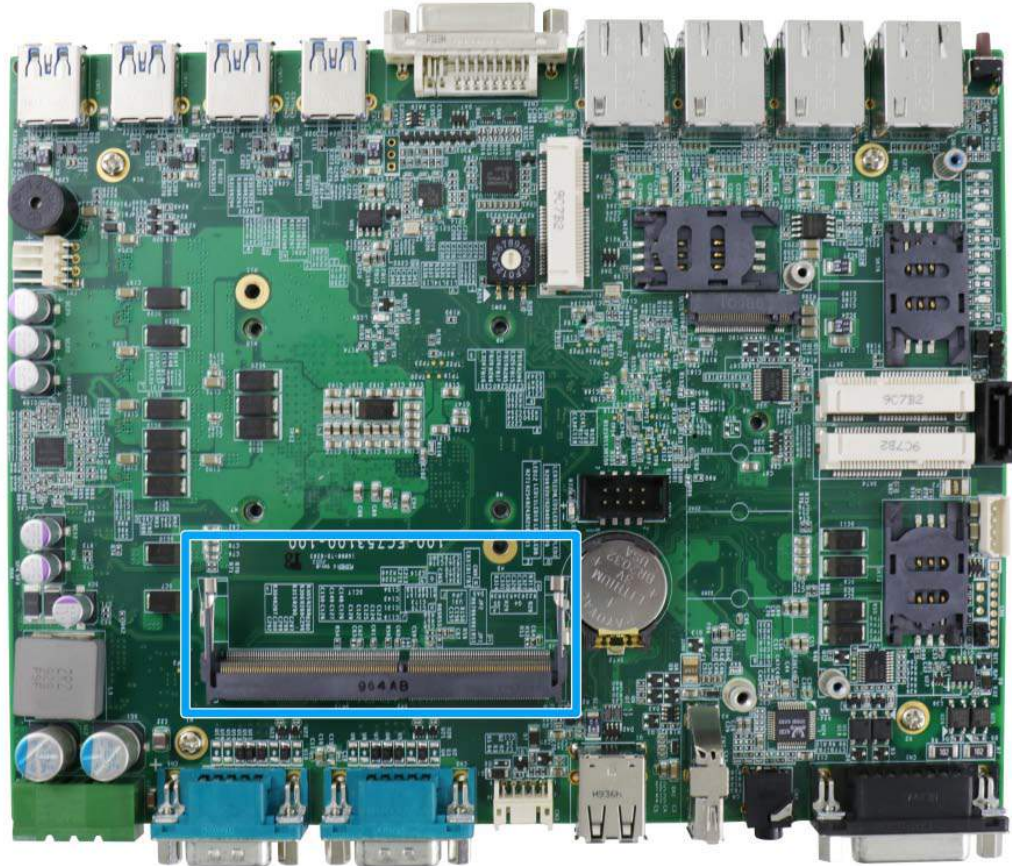

3. To install the memory module, insert gold fingers of the module into the slot at 45 degree angle, push down on the edge of the module and the clips on the side should clip the module into position.



4. Push the memory module down until it is clipped-in.

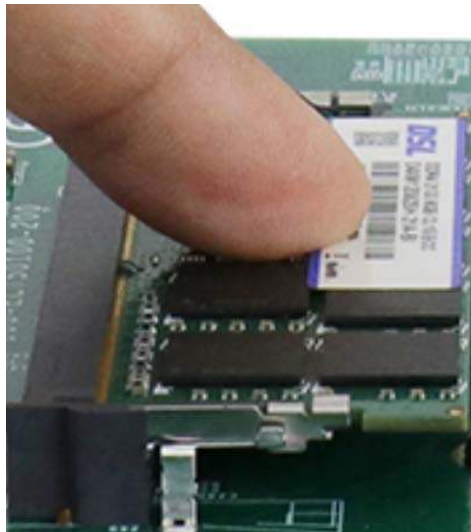

5. If you are installing the DRAM module for the first time, please remove the thermal pad protective film attached to the bottom of the hot-swappable tray enclosure.

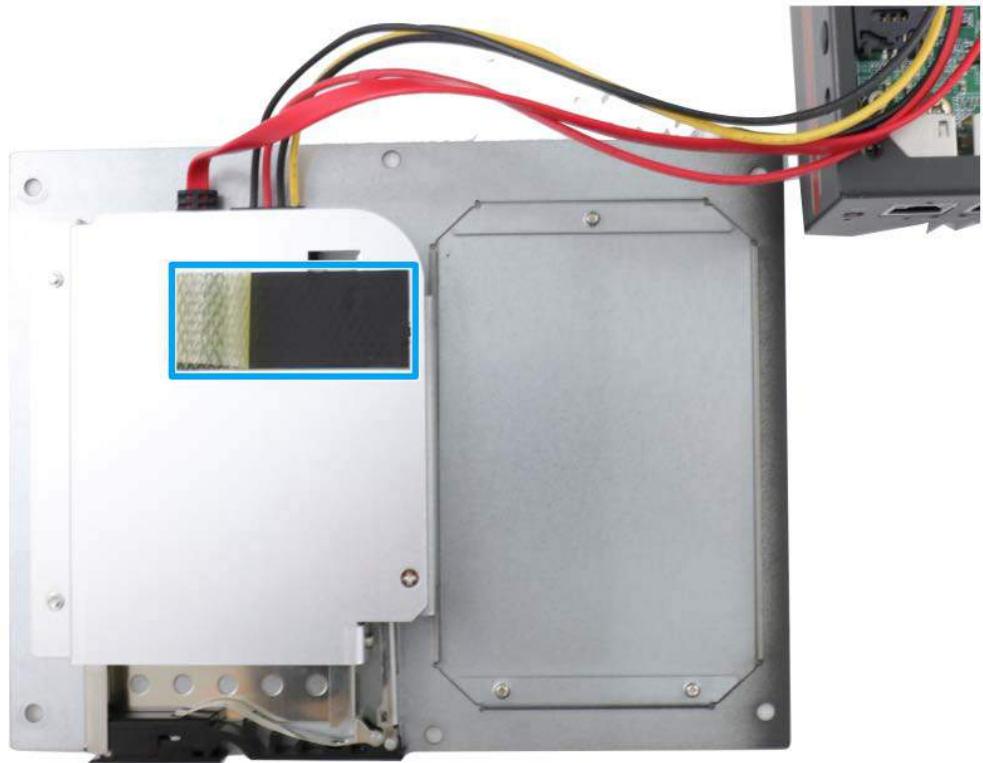

6. [Reinstall the system enclosure](#) and panel when done.

If you need to install other components, please refer to respective sections.

3.2.3 M.2 2280 SSD Installation

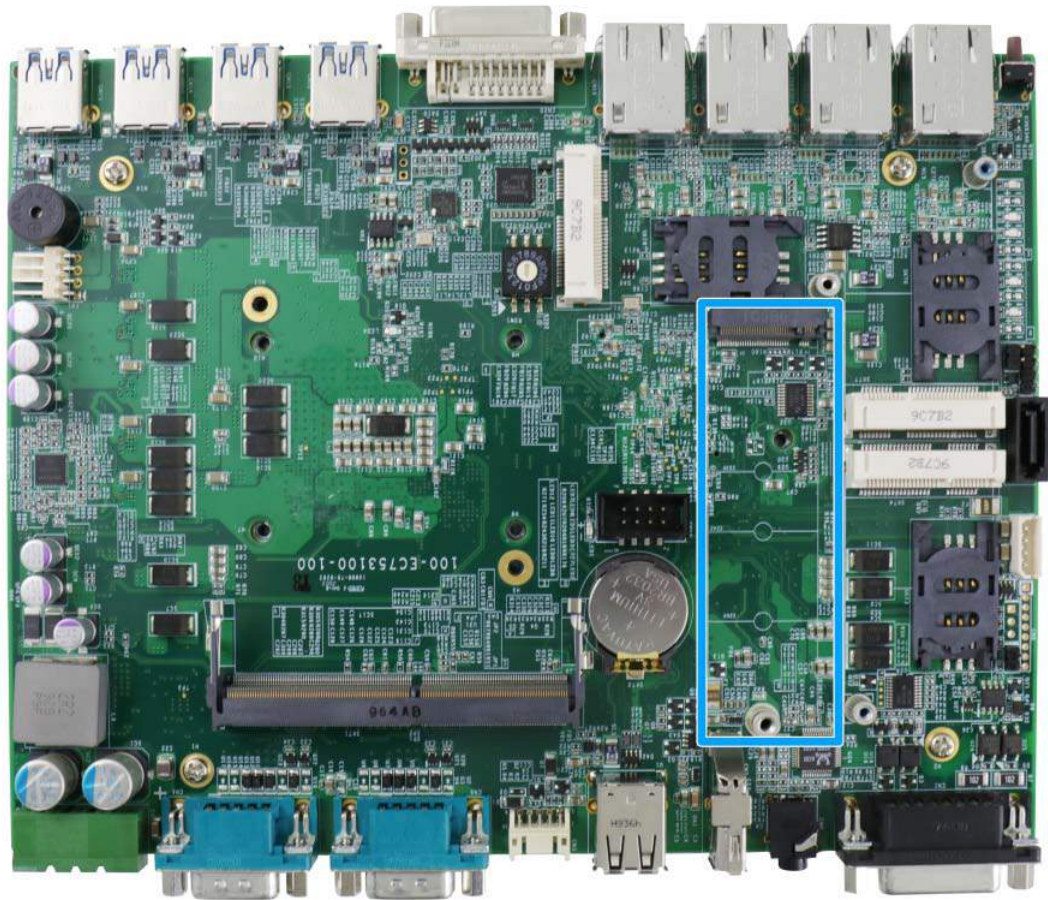

The system has an SATA signal M.2 2280 slot for you to install an M.2 2280 SATA SSD. For installation, please refer to the following instructions.

1. The M.2 slot can be accessed via the trapdoor located at the bottom of the enclosure by removing the screws indicated.



Remove screws indicated



M.2 slot in red, SSD in blue

2. Alternatively, you can refer to the section "[Disassembling the System](#)" to gain access to the M.2 slot.
3. Insert the module on a 45 degree angle.



4. Gently press down and secure the module with an M3 P-head screw.



5. [Reinstall the system enclosure](#) or the trapdoor when done.
6. If you need to install other components, please refer to respective sections.

3.2.4 mini-PCle Module Installation

The system has three mini-PCle slots. To install a mini-PCle module, please refer to the following instructions.

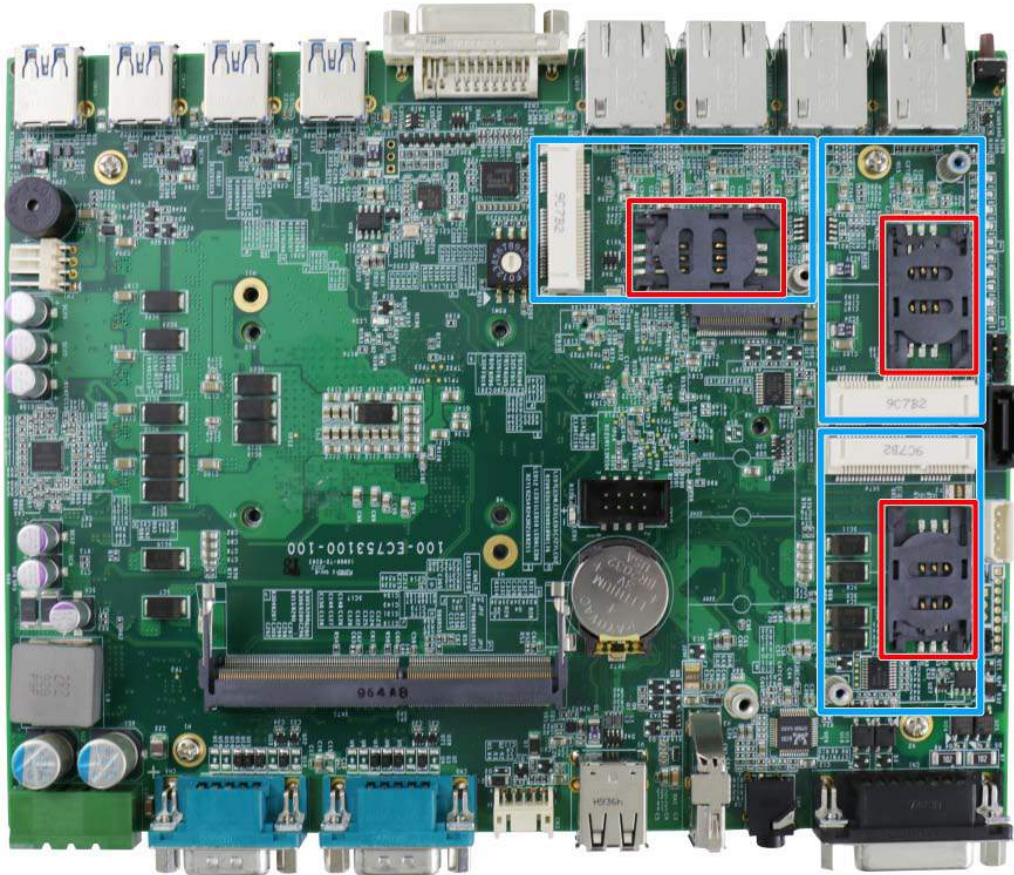

1. The mini-PCle slots can be accessed via the trapdoor located at the bottom of the enclosure by removing the screws indicated.



Remove screws indicated



mini-PCle slot in **red**

mini-PCle module in **blue**

2. Alternatively, you can refer to the section "[Disassembling the System](#)" to gain access to the mini-PCIe slot.
3. Insert the corresponding SIM card before you install the mini-PCIe module.

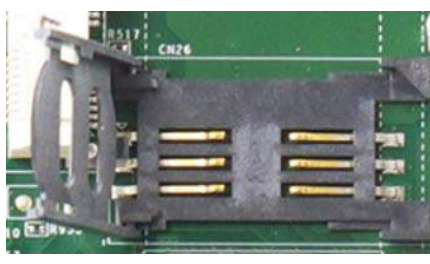

Slide and lift SIM card holder



Insert SIM card with pins facing up



Secure the SIM card by sliding the holder

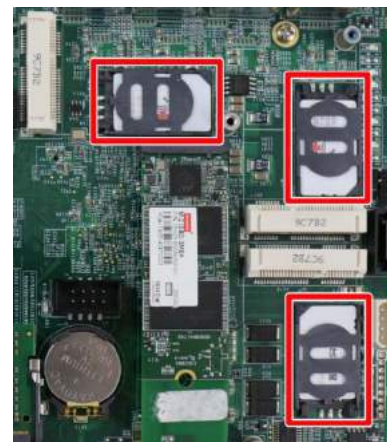

SIM cards installed

4. Insert the mPCIe module on a 45 degree angle into the mPCIe slot and secure the module.



Insert on 45 degree angle

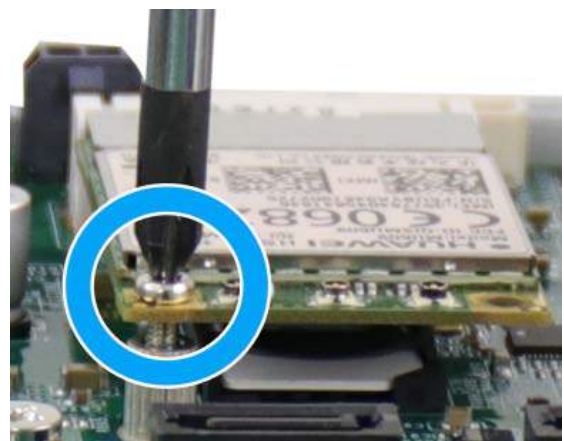

Secure the module

5. Clip on the IPEZ-to-SMA cable to the module and secure the antenna to the side panel.
Please refer to the module's manual for clip-on connection.
6. Secure antenna to side panel

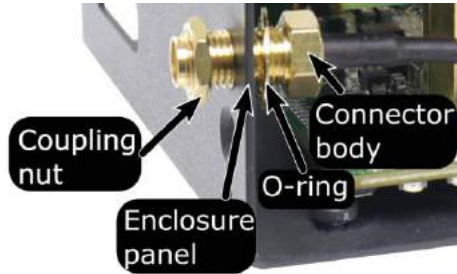

Secure on side panel



Antenna installation

7. [Reinstall the system enclosure](#), panel and external antenna.

If you need to install other components, please refer to respective sections.

3.2.5 External Hot-swappable 2.5” HDD/ SSD Installation



The system has one SATA port (**blue**) and one four pin power connector (**red**). The SATA and power cables should already be connected on the motherboard so users only need to install the 2.5” SATA HDDs/ SSDs to the front hot-swappable tray.

If you previously disconnected the SATA and power cables, please reconnect them before continuing this procedure.

1. Please refer to the section [“Disassembling the System”](#) to gain access to SATA port.
2. The SATA and power cable should already be connected to the hot-swappable tray situated on the bottom enclosure panel.

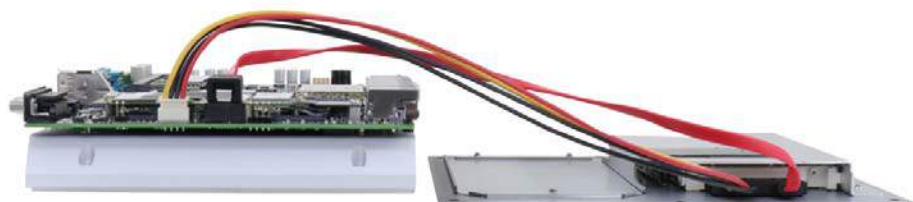

SATA/ power cables connected

3. Pull the lever on the 2.5" external hot-swappable slot to swing open the cover



4. If you are installing a 7mm thickness HDD/ SSD, please attach the PORON materials supplied, at the corners of the non-label side, on the HDD/ SSD. With the label side facing upward, insert the SATA connector side of the 2.5" HDD/ SSD into the slot first. You may feel resistance when the SATA connectors meet, push it in firmly until the 2.5" HDD/ SSD is fully inserted into the slot.



Attach PORON on corners, on label side Insert HDD/ SSD into tray

5. Push the lever into the 2.5" slot until it snaps into position. A key is provided (in accessory box) to lock the external slot.



Key in accessory box

2.5" HDD/ SSD slot lock

6. [Reinstall the system enclosure](#) and panel when done.

If you need to install other components, please refer to respective sections.

3.3 Installing the System Enclosure

To reinstall the system enclosure, please follow the steps below:

1. Slide the motherboard and heatsink back into the U-shaped enclosure and secure it with four screws on top of the heatsink.

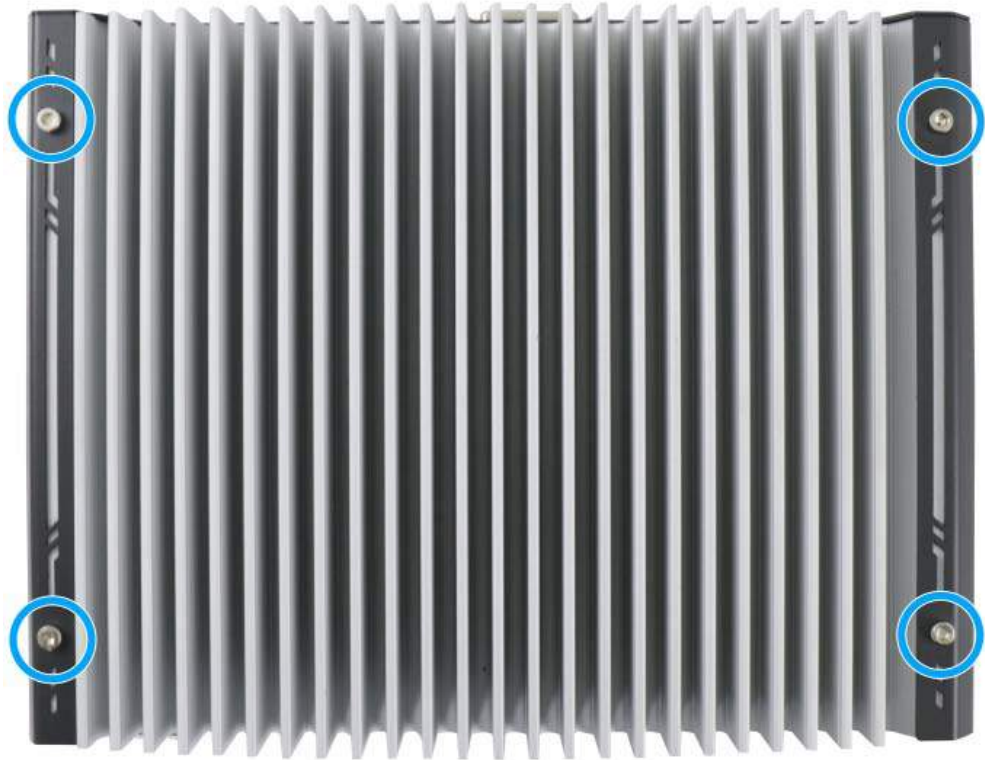

2. Secure the screw on the front I/O panel to the heatsink.



- Secure the three screws on the read I/O panel to the heatsink.



- Secure the six screws at the bottom to complete enclosure installation process.



3.4 FAN Kit Installation

The fan kit is applicable when you install a 65W CPU into the system. Please refer to the following procedure on how to install the fan kit onto the system.

1. Place the fan on top of the system's heatsink and secure it with the hex-bolt screws indicated in blue and beware of the orientation of the fan as the fan's power cable must be within reach of 4-pin fan power connector.



NOTE

With front panel (the panel with DVI-I/ Ethernet/ USB, etc.) facing you, the fan's power connector should be on the left, just around the corner from USB ports.

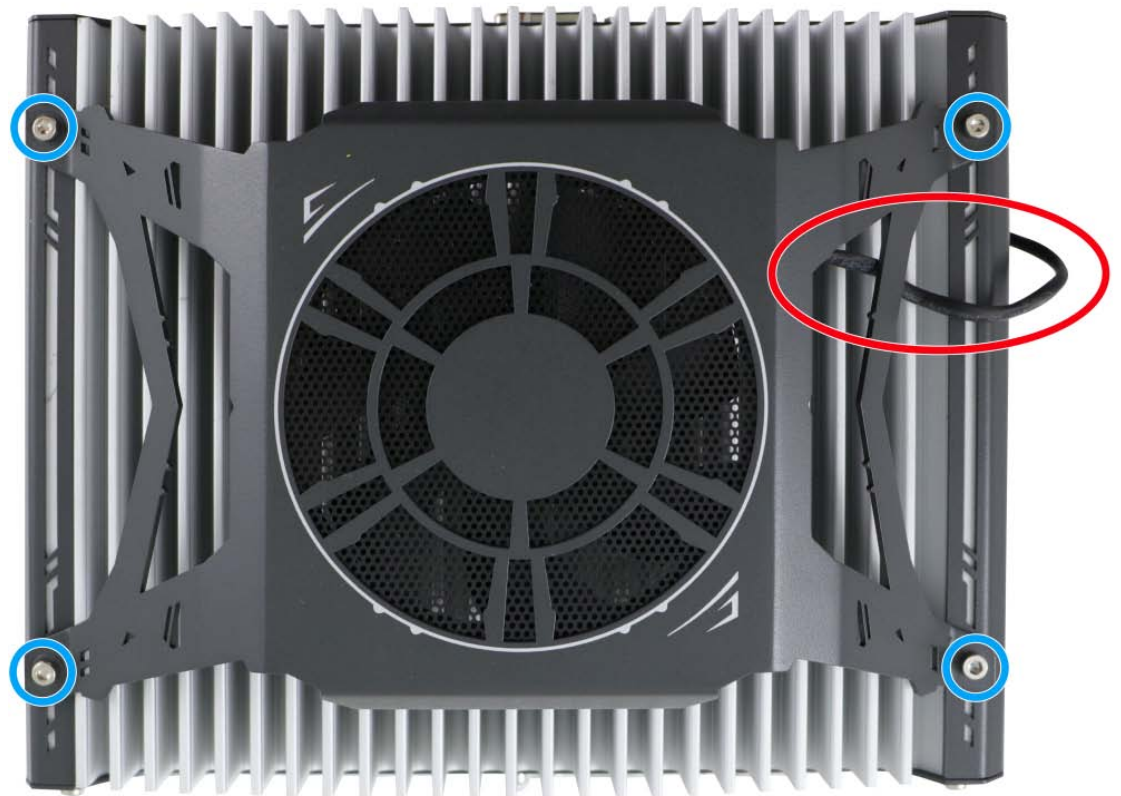

2. With the fan secure, around the corner of USB ports, locate the fan power connector's cover plate, use a small Phillips screwdriver, gently insert it into the gap and bend it outwards to remove it.

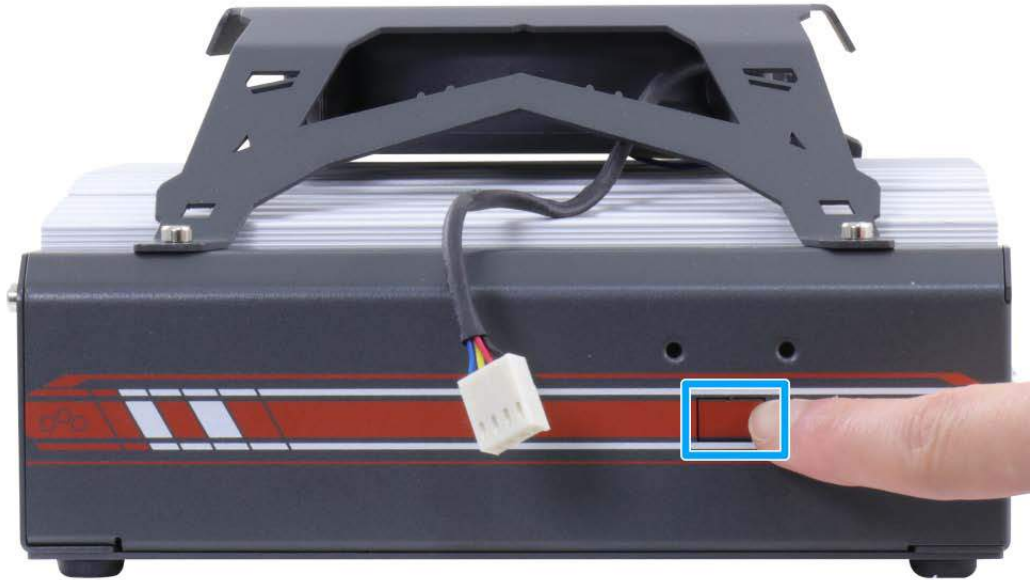

3. Connect the 4-pin fan's power cable to the 4-pin fan power connector.



4. Once the power cable is connected, place the supplied cable cover (in the accessory box) over the cable and secure it with the screws indicated to complete the installation.

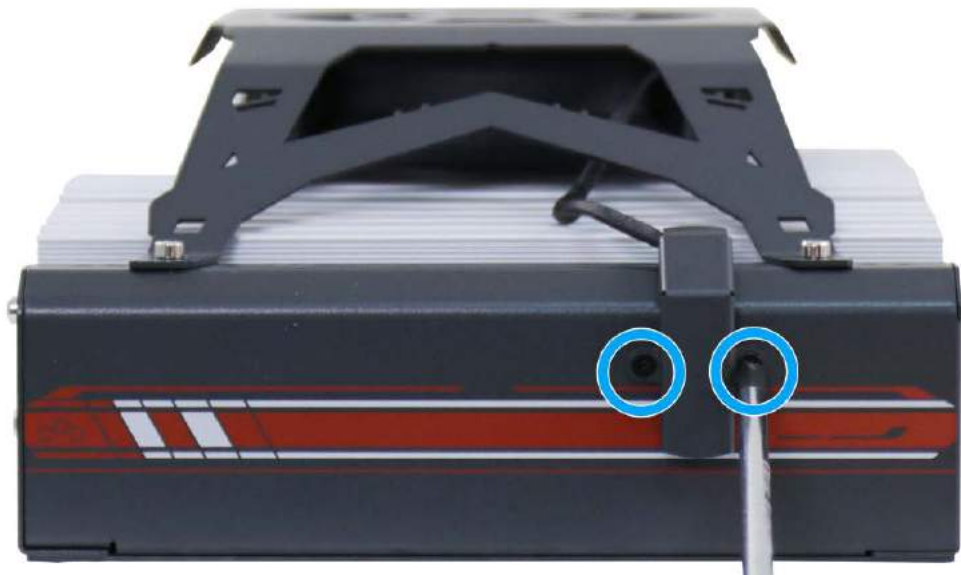

Here's an exploded view of the fan kit.

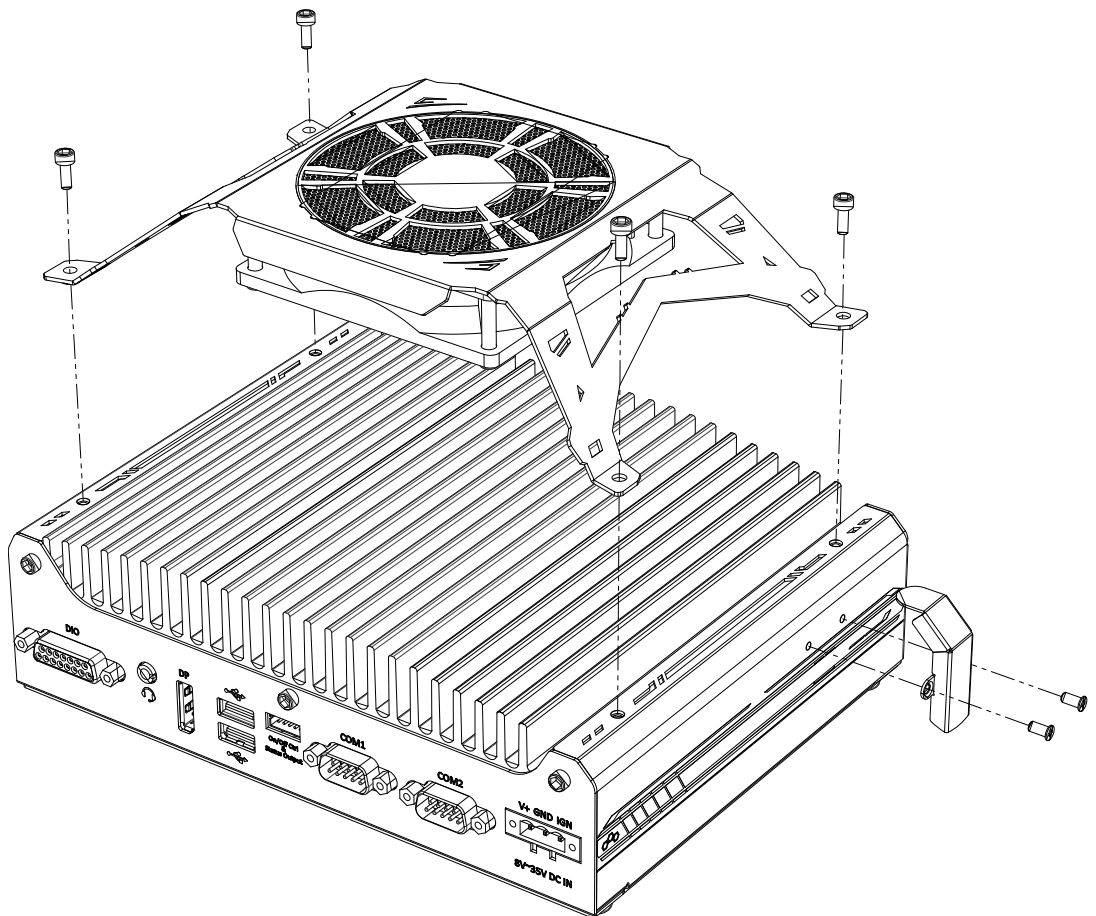

3.5 Mounting Nuvo-7531 Series

Neosys provides versatile mounting methods for Nuvo-7531 series systems. You can use built-in wall-mounting brackets to mount it on the wall. Neosys also offers optional DIN-rail mounting kit to mount it on a DIN-rail. To mount your Nuvo-7531 controller, please refer to the instructions listed below.

3.5.1 Wall-mounting Nuvo-7531 Series

Nuvo-7531 systems have built-in wall-mounting brackets as the standard mounting option. Please follow steps below to mount your Nuvo-7531 controller on a flat surface.

1. Take out the two wall mount brackets from the accessory box and four M4 screws to secure the brackets onto the enclosure.

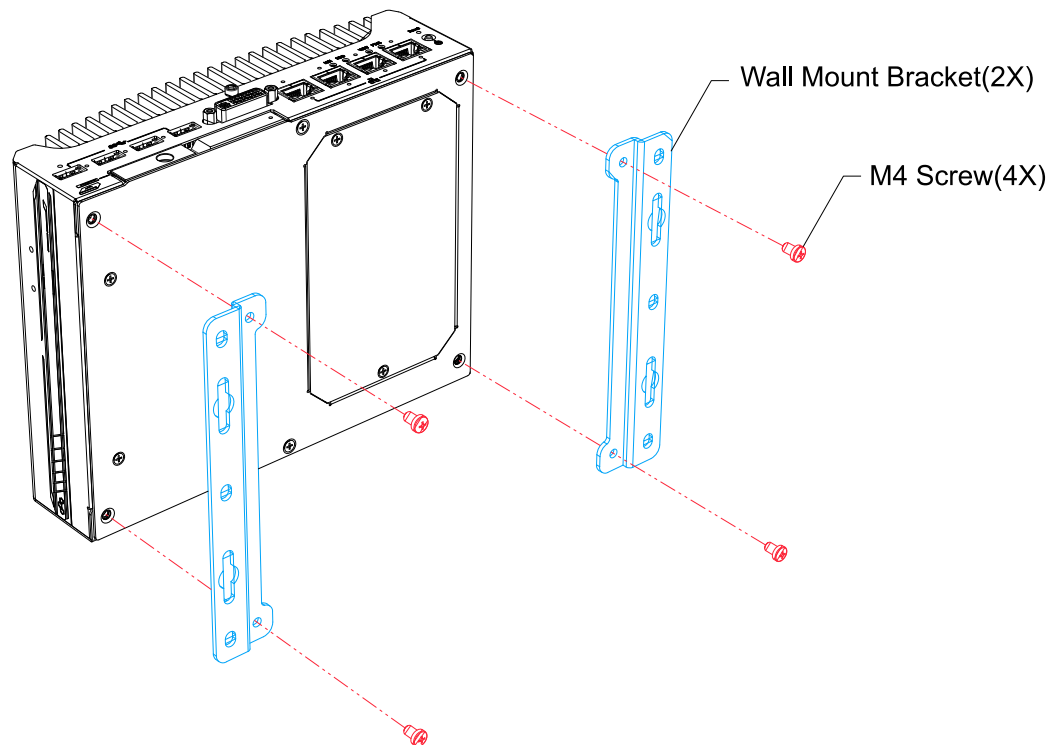

2. Find a sturdy flat surface and secure the system.

3.5.2 Installing DIN-Rail Mounting Kit (Optional)

The kit includes a bracket (in blue) and a DIN-rail mounting clip (in red). You should fix the clip to the bracket using four M4 flat-head screws first (in green), and then fix the bracket assembly to the Nuvo-7531 controller with another four M4 screws. This option can be useful if you want to deploy it inside an equipment cabinet where DIN-rail is available.

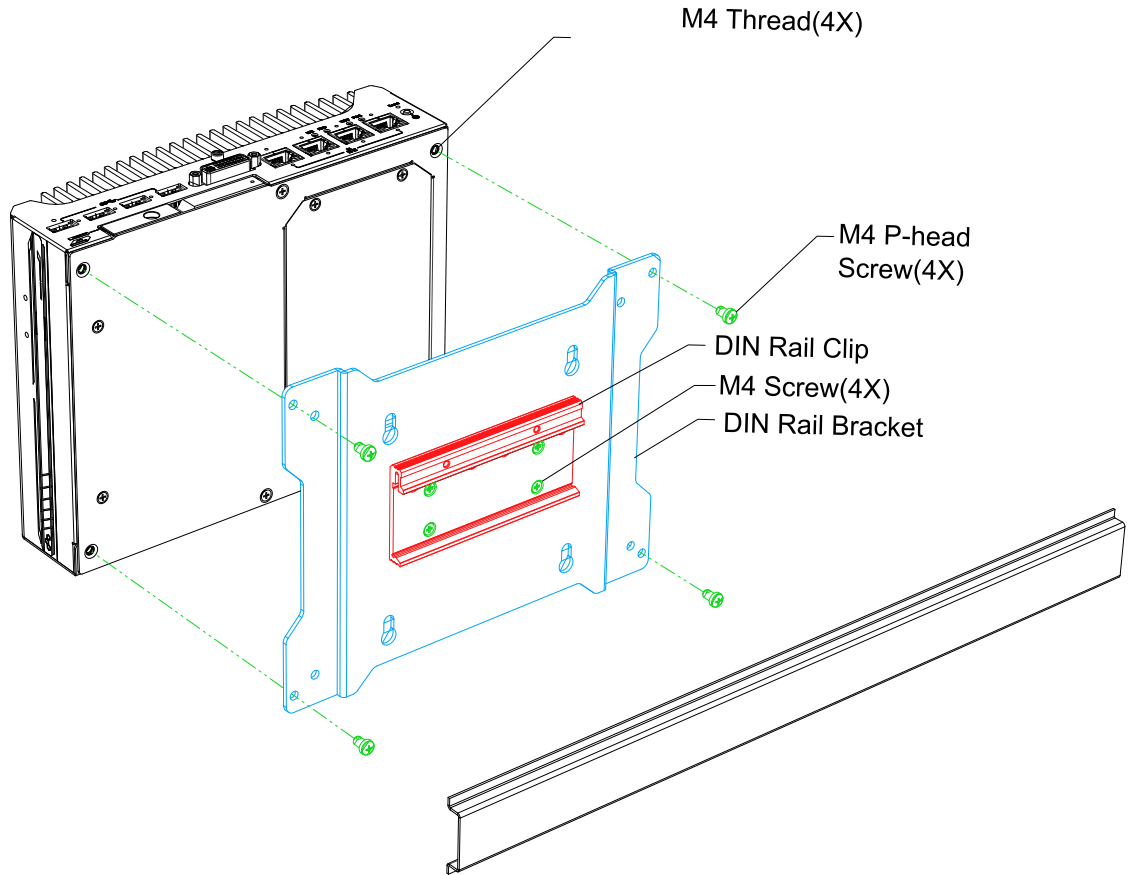

3.6 Powering On the System

There are three methods to power on the system

- Pressing the power button
- Sending a LAN packet via Ethernet (Wake-on-LAN)
- Powering on via ignition control (for Nuvo-7531-IGN only, please refer to [Ignition Control](#) section)

3.6.1 Powering On Using the Power Button

This is the simplest way to turn on your system. The power button is a non-latched switch and behaves as the ATX-mode on/off control. With DC power connected, pushing the power button will turn on the system and the PWR LED indicator will light up. Pushing the button when system is on will turn off the system. If your operating system supports ATX power mode (i.e. Microsoft Windows or Linux), pushing the power button while the system is in operation will result in a pre-defined system behavior, such as shutdown or hibernation.

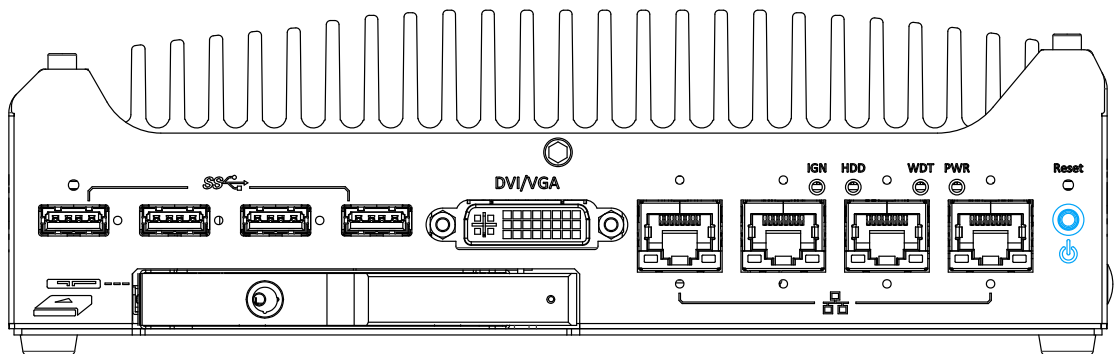

3.6.2 Powering On Using Wake-on-LAN

Wake-on-LAN (WOL) is a mechanism to wake up a computer system from a S5 (system off with standby power) state via issuing a magic packet. The system's Wake-on-LAN compatible GbE port is shown below.

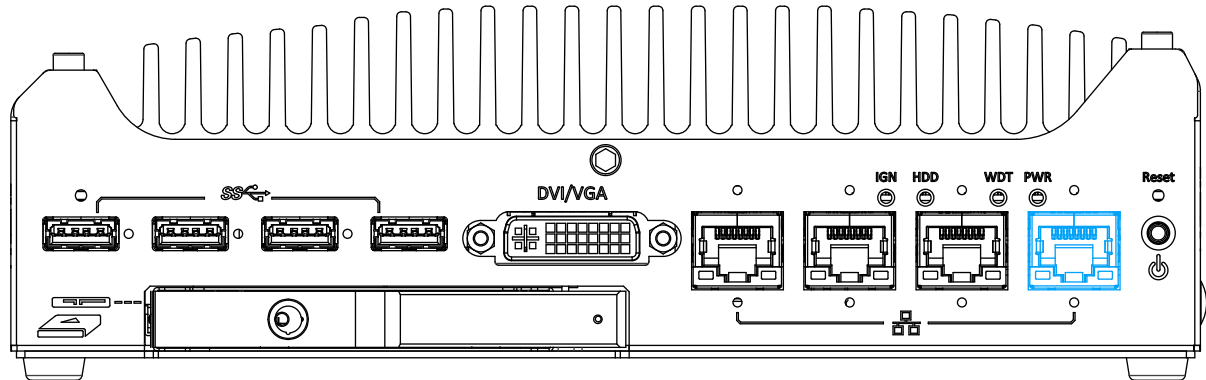

 **NOTE**

Please make sure the Intel chipset and Ethernet driver has been properly installed prior to setting up WOL function.

To enable WOL function, please set up WOL settings in the BIOS and in the operating system by follow the steps described below.

1. When the system boots up, press F2 to enter BIOS setup utility.
2. Go to the **[Power]>[Wake On LAN]** and set it to **[Enabled]**.
3. Press F10 to **“Save changes and exit BIOS”** and allow the system boot into the operating system.
4. Once booted into the Windows system, press **“Windows key + E”**, right-click on **“Network>Properties>Change adapter settings”**. Locate and double-click on the adapter Intel® I219 Gigabit Network Connection, click on **Configure**.
5. Click on the **Power Management**

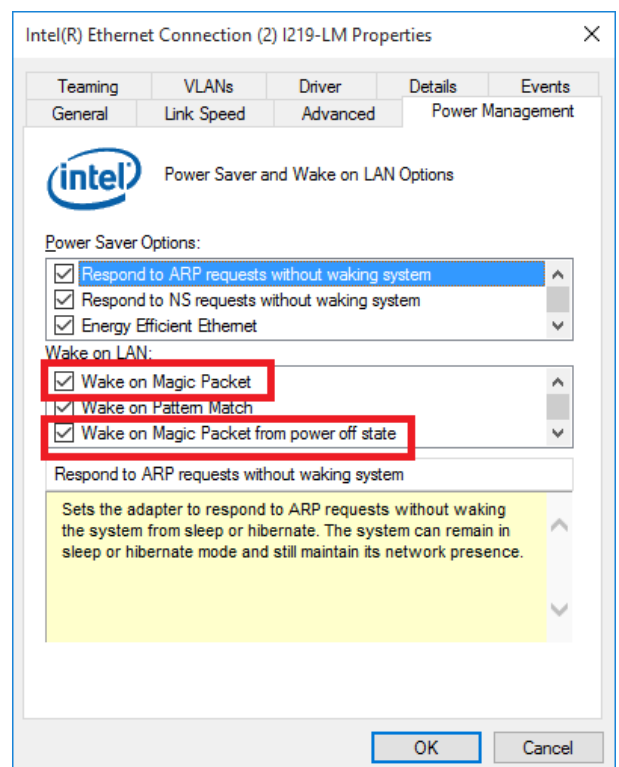

tab and check the following options. Click on OK when done.

Magic Packet

The magic packet is a broadcast frame containing anywhere within its payload 6 bytes of all 255 (FF FF FF FF FF FF in hexadecimal), followed by sixteen repetitions of the target computer's 48-bit MAC address.

For example, NIC's 48-bit MAC Address is 78h D0h 04h 0Ah 0Bh 0Ch

```

DESTINATION SOURCE MISC
FF FF FF FF FF FF
78 D0 04 0A 0B 0C 78 D0 04 0A 0B 0C
78 D0 04 0A 0B 0C 78 D0 04 0A 0B 0C
78 D0 04 0A 0B 0C 78 D0 04 0A 0B 0C
78 D0 04 0A 0B 0C 78 D0 04 0A 0B 0C
78 D0 04 0A 0B 0C 78 D0 04 0A 0B 0C
78 D0 04 0A 0B 0C 78 D0 04 0A 0B 0C
78 D0 04 0A 0B 0C 78 D0 04 0A 0B 0C
78 D0 04 0A 0B 0C 78 D0 04 0A 0B 0C
MISC    CRC
    
```

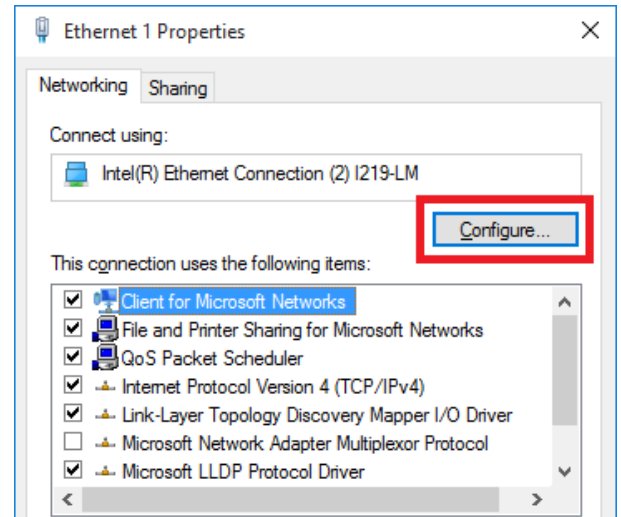

There are some free tools available on Internet that can be used to send a magic packet. Please refer to the following link to understand more about [Magic Packet](#).

3.7 Ignition Power Control (Nuvo-7531-IGN Only)

The ignition power control module for in-vehicle applications is a MCU-based implementation that monitors the ignition signal and reacts to turn on/off the system according to predefined on/off delay. Its built-in algorithm supports other features such as ultra-low power standby, battery-low protection, system hard-off, etc. In this section, we'll illustrate the principle of ignition power control and operation modes.

3.7.1 Principles of Ignition Power Control

The basic concept of ignition power control module is to control the timing correlation between ignition signal and system power status. A typical timing correlation is described in following diagram.

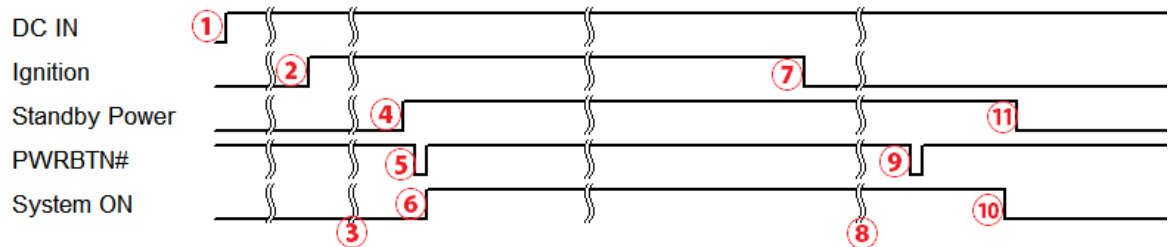

1. When DC power is supplied to the system, MCU starts to periodically detect ignition signal. Note that only MCU is working at this moment and the overall power consumption is less than 2 mW.
2. Ignition signal is active (both 12VDC and 24VDC ignition signals are accepted).
3. MCU starts to count a pre-defined power-on delay.
4. Once power-on delay expired, MCU turns on necessary standby power for the system (3.3VSB & 5VSB).
5. A PWRBTN# pulse is then issued to turn on the system (equivalent to one pressing the power button on the front panel).
6. The system is booting and becomes operational.
7. After a period of time, the ignition signal becomes inactive.
8. MCU starts to count a pre-defined power-off delay.
9. Once power-off delay expired, another PWRBTN# pulse is issued to perform a soft-off for the system (ex. a normal shutdown process for Windows system).
10. The system is completely shut down.
11. As MCU detects system is off, it turns off the standby power for the system, and operates in low power mode again (< 2mW power consumption).

3.7.2 Additional Features of Ignition Power Control

In addition to the typical timing correlation, the ignition power control module offers additional features to provide additional reliability for in-vehicle applications.

1. Low battery detection

The ignition power control module continuously monitors the voltage of DC input when the system is operational. If input voltage is less than 9V (for 12VDC input) or less than 18V (for 24VDC input) over a 60-second duration, it will shut down the system automatically.

2. Guarded power-on/ power-off delay duration

If ignition signal goes inactive during the power-on delay duration, the ignition power control module will cancel the power-on delay process and go back to idle status. Likewise if ignition signal goes active during the power-off delay duration, the ignition power control module will cancel the power-off delay process and keep the system running.

3. System hard-off

In some cases, system may fail to shutdown via a soft-off operation due to system/ application halts. The ignition power control module offers a mechanism called “hard-off” to handle this unexpected condition. By detecting the system status, it can determine whether the system is shutting down normally. If not, the ignition power control module will force cut-off the system power 10 minutes after the power-off delay duration.

4. Smart off-delay

The ignition power control module offers two modes (mode 13 & mode 14) which have very long power-off delay duration for applications require additional off-line time to process after the vehicle has stopped. In these two modes, the ignition power control module will automatically detect the system status during the power-off delay duration. If the system has shutdown (by the application software) prior to power-off delay expiring, it will cut off the system power immediately to prevent further battery consumption.

3.7.3 Wiring Ignition Signal

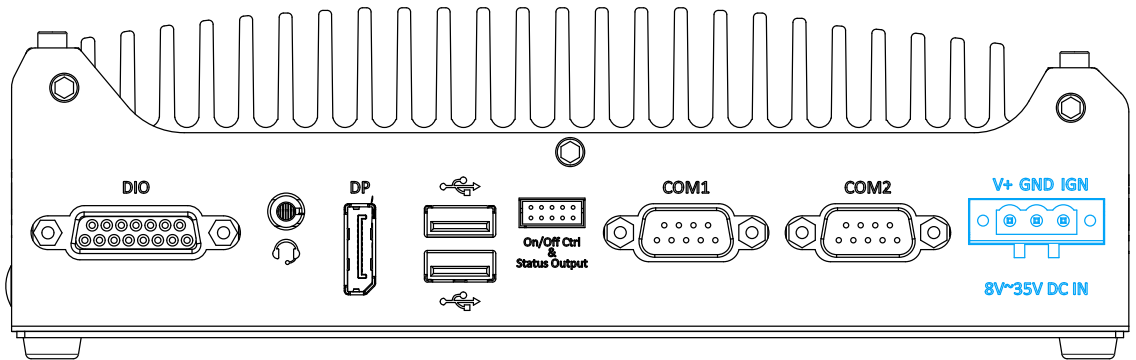

To have ignition power control for in-vehicle usage, you need to supply IGN signal to the system. The IGN input is located on the 3-pin pluggable terminal block (shared with DC power input). Below is the typical wiring configuration for in-vehicle applications.

1. Connect car Battery+ line (12V for sedan, 24V for bus/truck) to V+.
2. Connect car Batter-/ GND line to GND.
3. Connect ACC line to IGN.



WARNING

Please make sure your DC power source and IGN signal share the same ground.

IGN input accepts 8~35VDC. Supply a voltage higher than 35VDC may damage the system.

3.7.4 Configure your Windows system

When applying ignition power control to your system, please make sure you've configured your Windows system to initiate a shutdown process when pressing the power button. By default, Windows 7/ 8/ 10 goes to sleep (S3) mode when power button is pressed. As sleep (S3) is not a complete shutdown behavior, the ignition control function does not recognize the finish of a normal shut down process and thus users will encounter a system hard-off (power cut-off after 10 minutes). Please configure "When I press the power button" to "Shut down" in your Windows system settings.

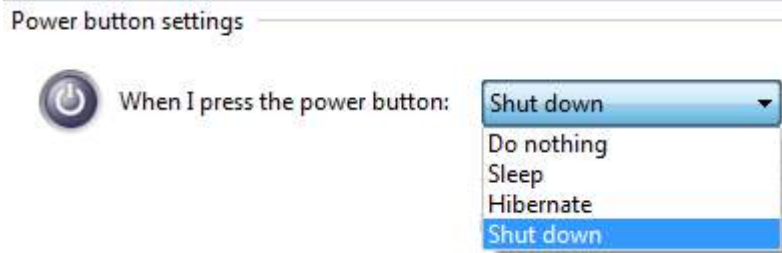

3.7.5 Operation Modes of Ignition Power Control

You can use the rotary switch to configure the operation mode. The system offers 16 (0~15) operation modes with different power-on/power-off delay configurations.

The ignition control rotary switch can be located on the motherboard. Please refer to the “Disassembling the enclosure” section on how to remove the bottom panel and gaining access to the rotary switch.

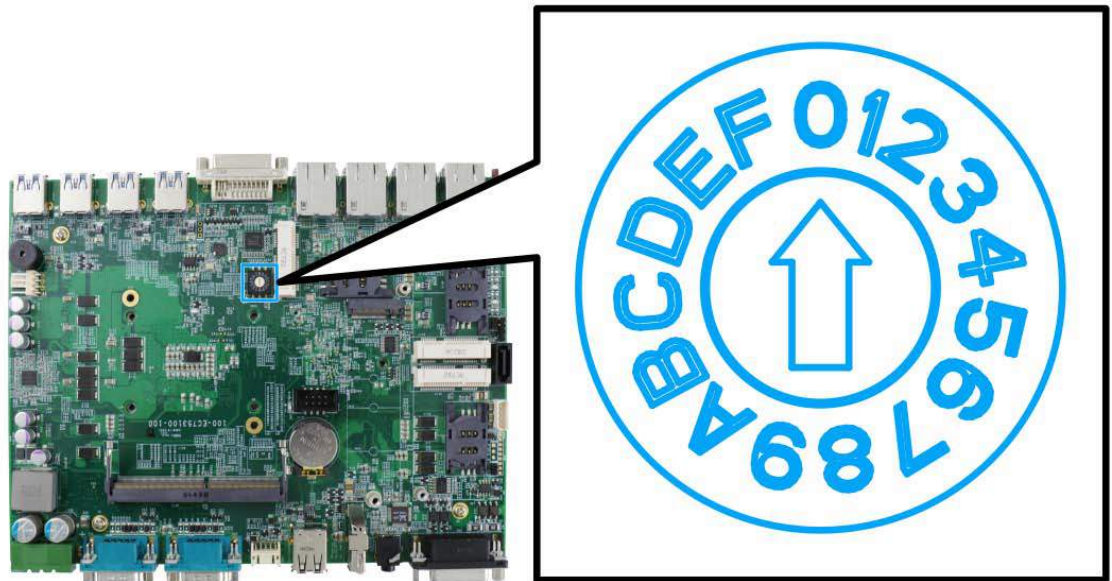

- **Mode 0**

Mode 0 is the ATX mode without power-on and power-off delay. User can only use the power button on the front panel to turn on or turn off the system.

Mode	Power-on Delay	Power-off Delay	Hard-off Timeout
0	N/A	N/A	N/A

- **Mode 1**

Mode 1 is AT mode without power-on and power-off delay. The system automatically turns on when DC power is applied. A retry mechanism is designed to repeat the power-on cycle if the system fails to boot up.

Mode	Power-on Delay	Power-off Delay	Hard-off Timeout
1	N/A	N/A	N/A

- **Mode 2**

Mode 2 is designed to have a very minor power on/ off delay of 160ms for applications that requires the system to start up almost at the same as the rest of the equipment it is working in collaboration with.

Mode	Power-on Delay	Power-off Delay	Hard-off Timeout
2	160ms	160ms	10 minutes

- **Mode 3 ~ Mode 12**

Mode 3 ~ Mode 12 have various power-on delay and power-off delay. Each mode supports a hard-off timeout of 10 minutes.

Mode	Power-on Delay	Power-off Delay	Hard-off Timeout
3	10 seconds	10 seconds	10 minutes
4	10 seconds	1 minute	10 minutes
5	10 seconds	5 minutes	10 minutes
6	30 seconds	1 minute	10 minutes
7	30 seconds	5 minutes	10 minutes
8	30 seconds	10 minutes	10 minutes
9	3 minutes	1 minute	10 minutes
10 (A)	3 minutes	10 minutes	10 minutes
11 (B)	3 minutes	30 minutes	10 minutes
12 (C)	10 minutes	30 minutes	10 minutes

- **Mode 13 (D) / Mode 14 (E)**

Mode 13 and Mode 14 are ignition power control modes with very long power-off delay. Both modes support the feature of “smart off-delay”, which automatically detect system status during power-off delay duration and cut off system power if system is off in prior to power-off delay expired.

Mode	Power-on Delay	Power-off Delay	Hard-off Timeout
13 (D)	30 seconds	2 hours	10 minutes
14 (E)	3 minutes	2 hours	10 minutes

- **Mode 15 (F)**

Reserved

4 System Configuration

4.1 BIOS Settings

The system is shipped with factory-default BIOS settings meticulously programmed for optimum performance and compatibility. In this section, we'll illustrate some of BIOS settings you may need to modify. Please always make sure you understand the effect of change before you proceed with any modification. If you are unsure of the function you are changing, it is recommended to change one setting at a time to see its effect(s).

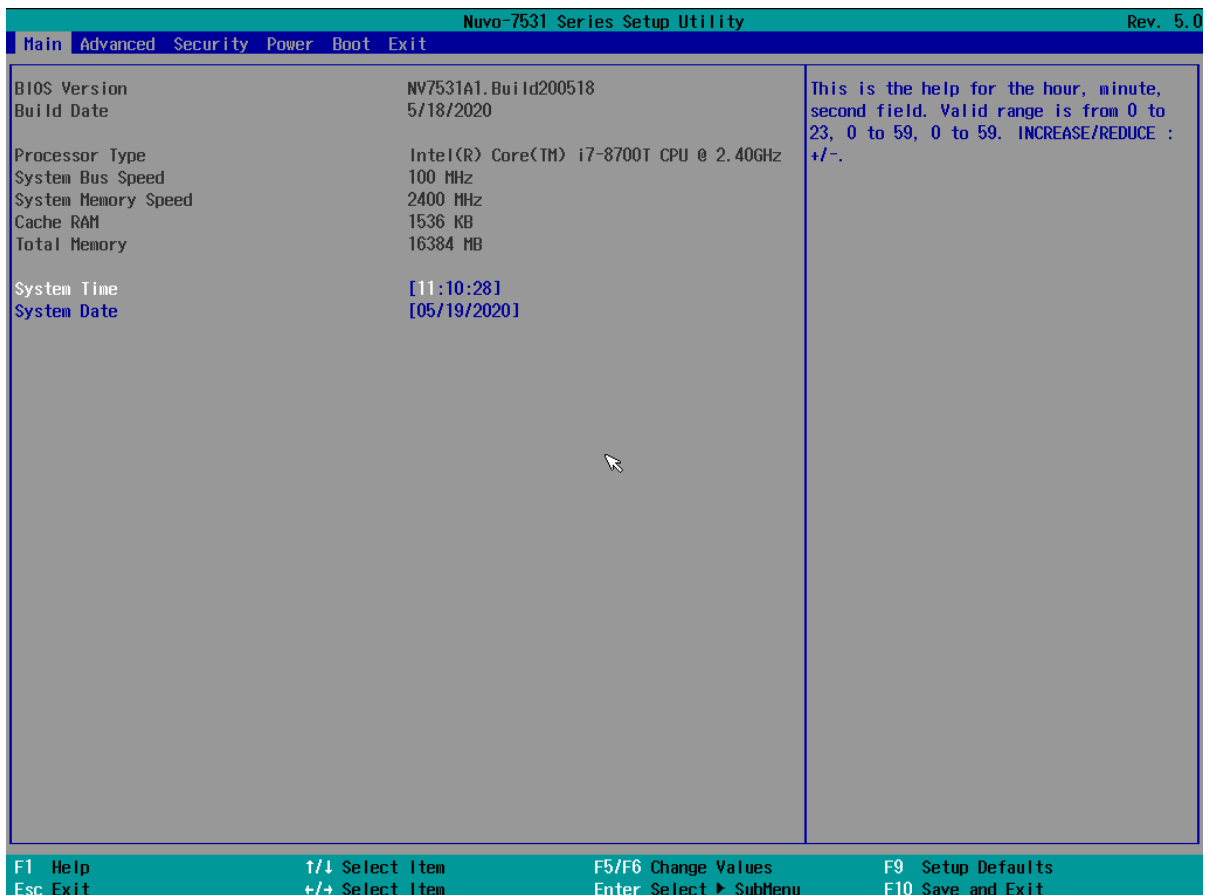

NOTE

Not all BIOS settings will be discussed in this section. If there is a particular BIOS setting you are after but is not discussed in this section, please contact Neousys Technical Support staff.

4.1.1 COM1 & COM2 Configuration

The system's [COM1/ COM2](#) ports support RS-232 (full-duplex), RS-422 (full-duplex) and RS-485 (half-duplex) mode. You can set the COM1 operating mode via BIOS settings.

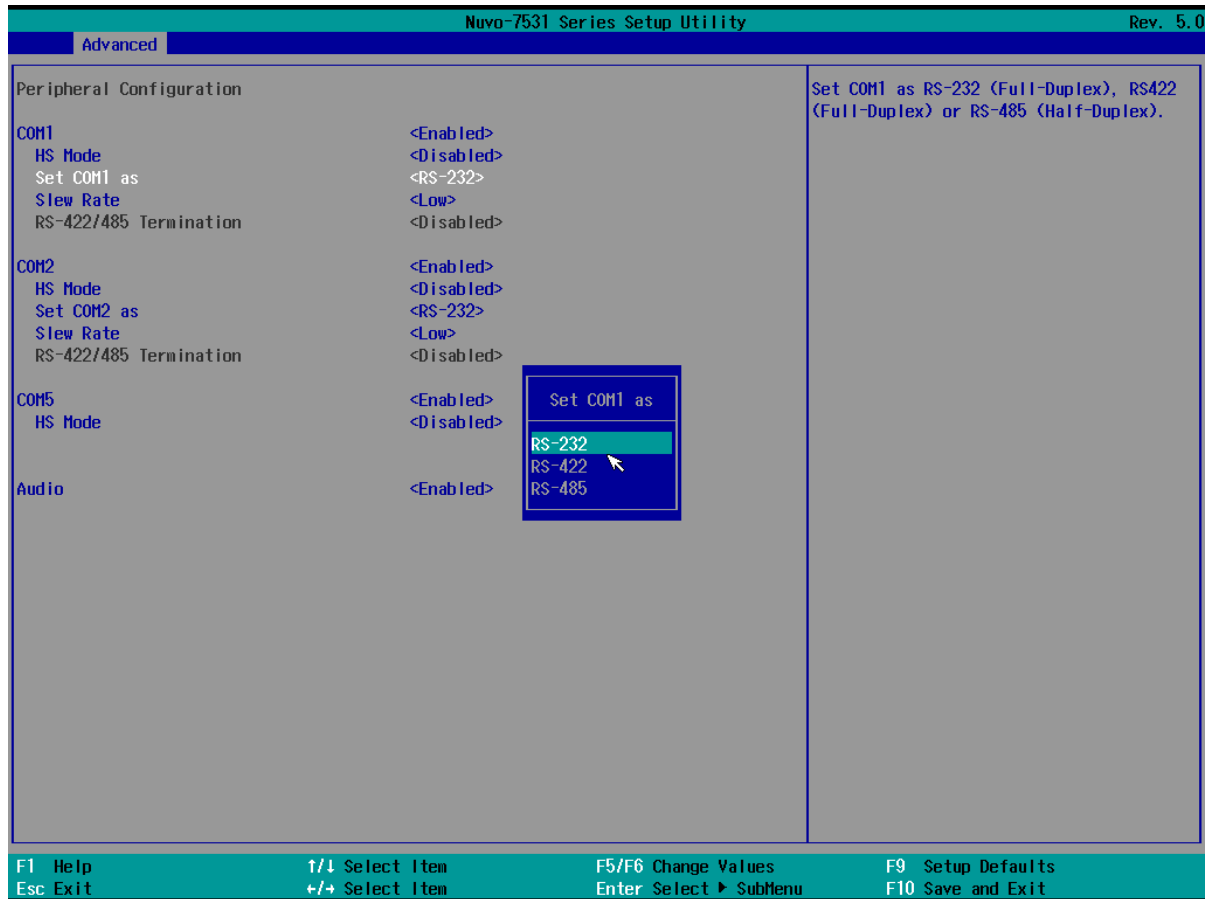

To set COM port operating mode:

1. Press **F2** when the system boots up to enter the BIOS setup utility.
2. Go to **[Advanced] → [Peripheral Configuration]**.
3. Set the **[Set COM1 Mode as]** option to the desired mode.
4. Once set, press **F10** to save setting and exit.

4.1.2 COM Port Slew Rate

Another option in BIOS called “*Slew Rate*” defines how sharp the rising/falling edge is for the output signal of COM1. For long-distance RS-422/ 485 transmission, you may set the “*Slew Rate*” option as “High” to improve signal quality. For RS-422/485 communication, the “*RS-422/ 485 Termination*” option determines whether to enable/disable internal termination of RS-422/ 485 transceiver according to your wiring configuration (e.g. with or without external termination).

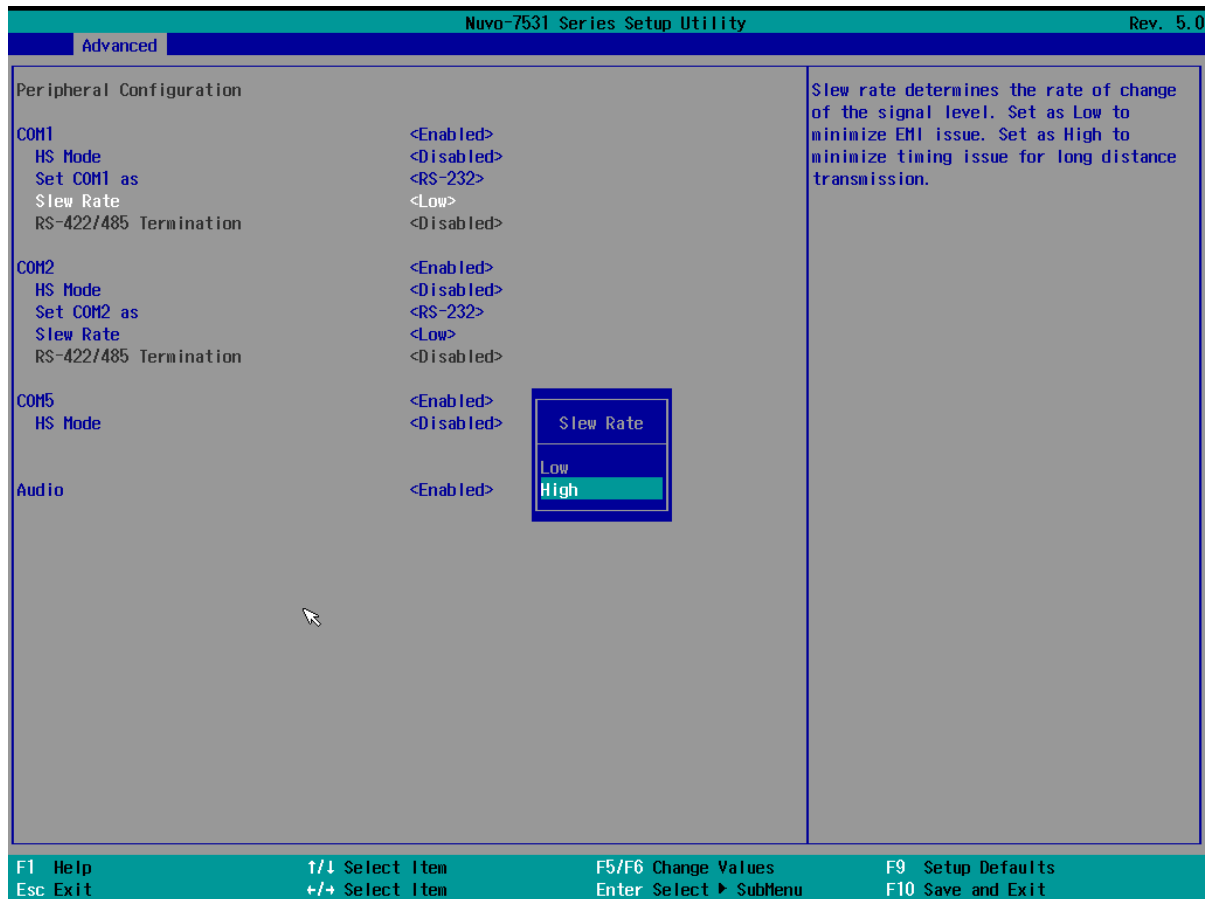

To set COM port Slew rate:

1. Press **F2** when the system boots up to enter the BIOS setup utility.
2. Go to **[Advanced]** → **[Peripheral Configuration]**.
3. Select and highlight the COM port > **[Slew Rate]**.
4. Set it to the desired mode **[Low]** or **[High]** and press Enter.
5. Once set, press **F10** to save setting and exit.

4.1.3 COM Port High Speed Mode

The high speed mode of each COM port effectively allows for the port's baud rate generator to operate at 8x the speed with an effective baud rate of 921,600 bps (115,200 x 8). Please refer to the following instructions on how to enable the high speed mode for your COM port (COM1 used as an example).

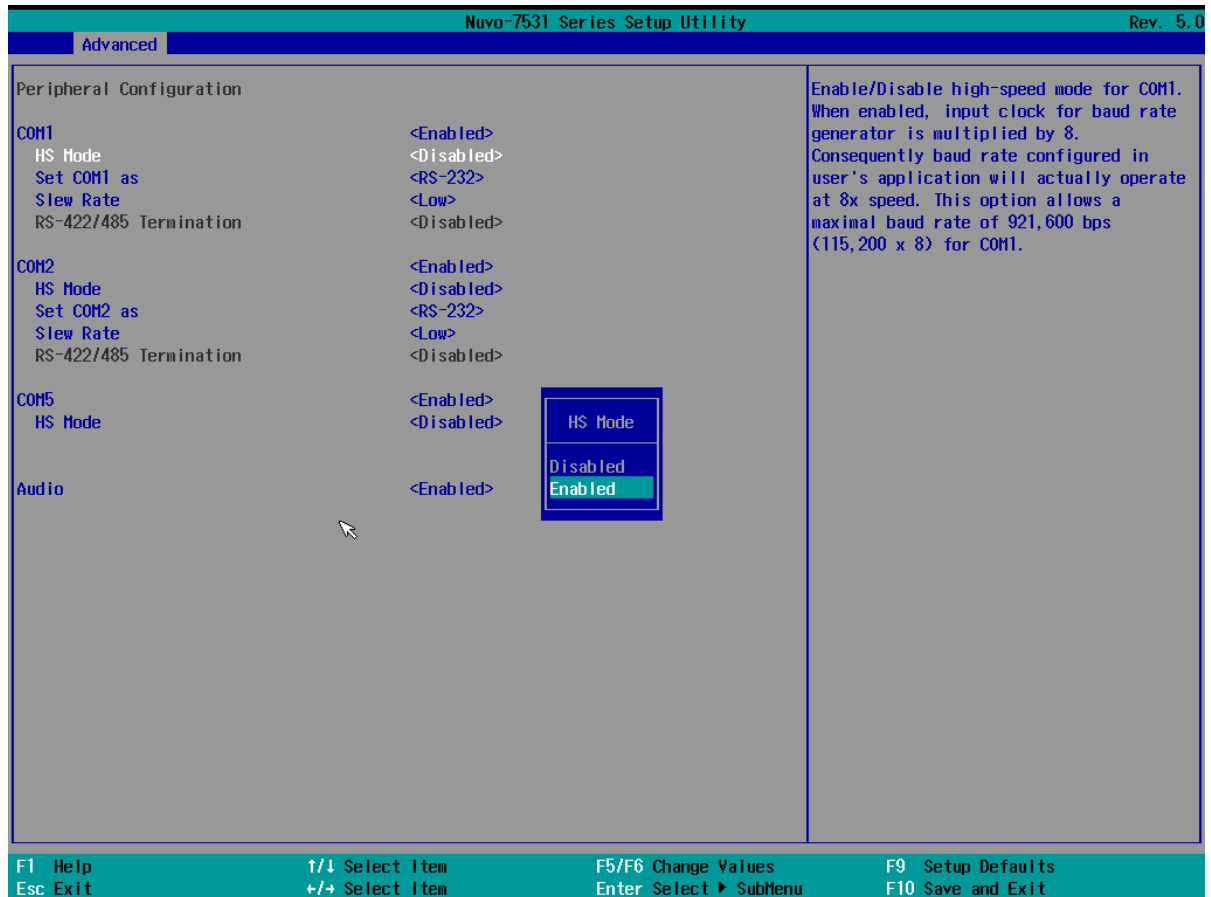

To set COM port high speed mode:

1. Press **F2** when the system boots up to enter the BIOS setup utility.
2. Go to **[Advanced] > [Peripheral Configuration]**.
3. Enable or set the **[Set COM1 Mode as]** option to the desired mode.
4. Highlight **[HS Mode]** and press ENTER to bring up options, highlight **[Enable]** and press ENTER.
5. Once set, press **F10** to save setting and exit.

4.1.4 Power On After Power Failure Option

This option defines the behavior of system when DC power is supplied.

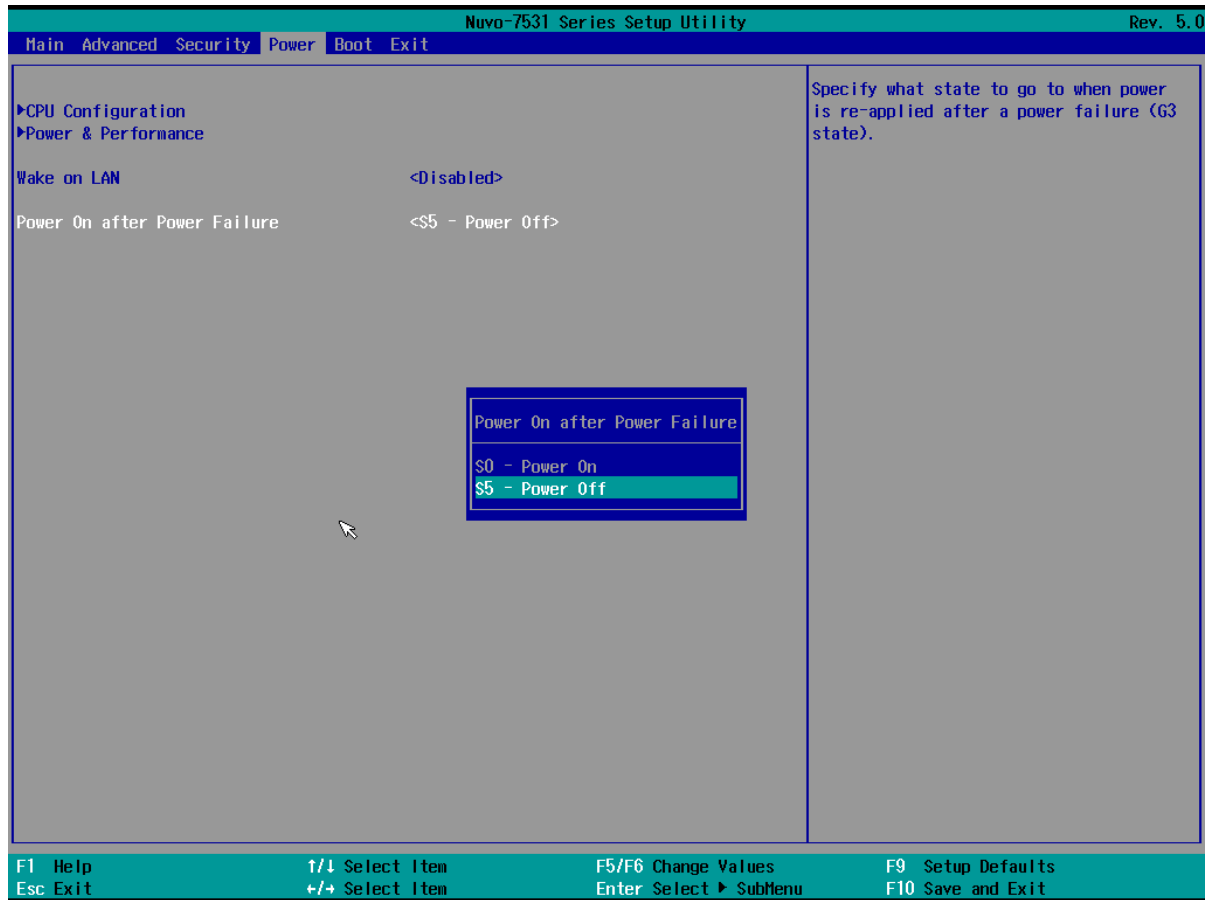

Value	Description
S0 – Power On	System is powered on when DC power is supplied.
S5 – Power Off	System is kept in off state when DC power is supplied.

To set “Power On after Power Failure” option:

1. When system boots up, press F2 to enter BIOS setup utility.
2. Go to **[Power] > [Power On after Power Failure]**.
3. Scroll down to highlight **[Power On after Power Failure]**, press Enter to bring up setting options, S0 – Power On or S5 – Power Off, and press Enter to select the setting.
4. Press F10 to “Exit Saving Changes”.

4.1.5 Power & Performance (CPU SKU Power Configuration)

The system supports various Intel 9th/8th-Gen LGA1151 CPUs. A unique feature, “**SKU Power Config**” is implemented in BIOS to allow users to specify user-defined SKU power limit. Although the system is designed to have best thermal performance with CPUs of 35W TDP, you can install a 65W CPU with the fan kit installed. Alternatively, you can install a 65W CPU and limit its SKU power (to 35W) to obtain more computing power. This feature gives you the flexibility of CPU selection and great balance between computing power and operating temperature range.

To configure the CPU SKU power limit:

1. When the system boots up, press F2 to enter BIOS setup utility.
2. Go to **[Power]** → **[Power & Performance]**.

Select a proper value of SKU power limit for **[SKU Power Config]** option.

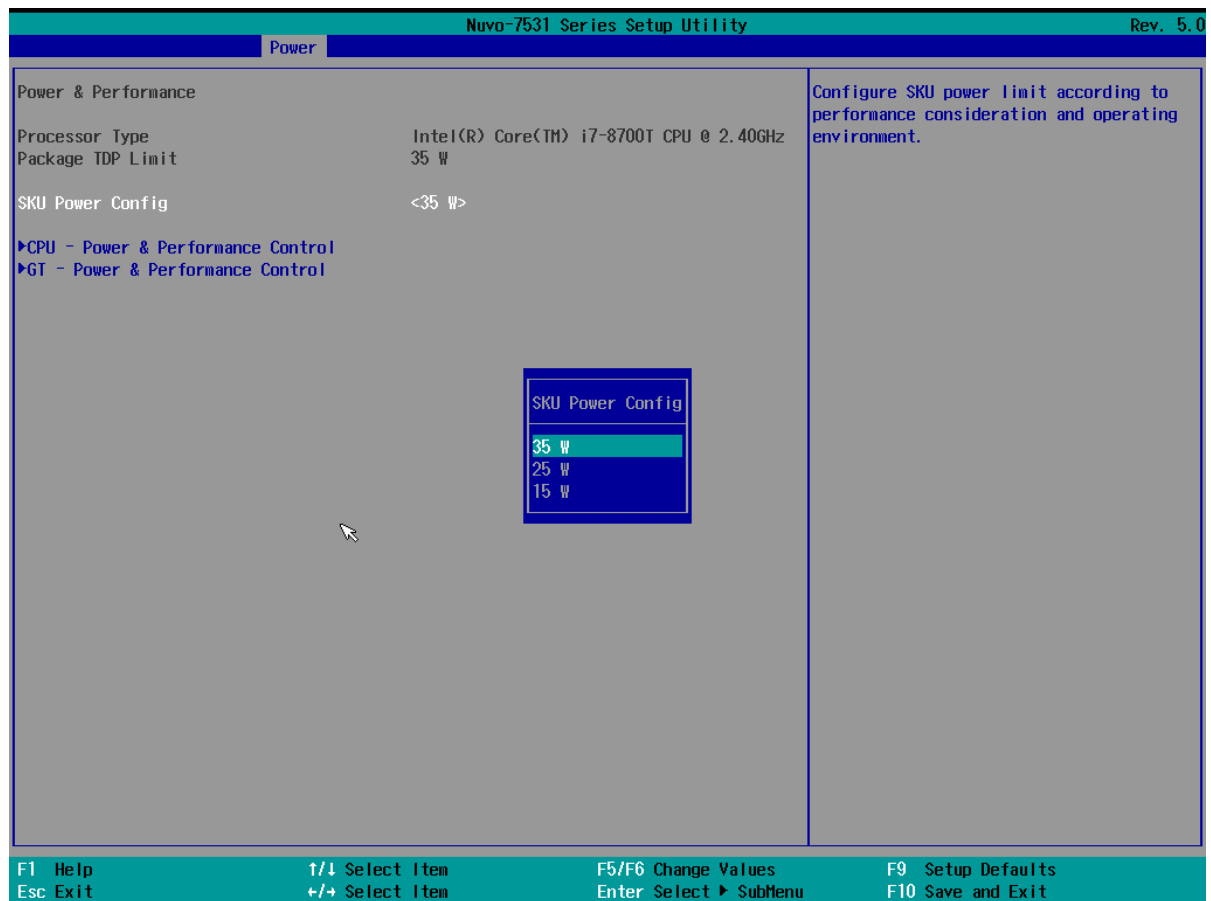

4.1.6 Wake on LAN Option

Wake-on-LAN (WOL) is a mechanism which allows you to turn on your system via Ethernet connection. To utilize Wake-on-LAN function, you have to enable this option first in BIOS settings. Please refer to “Powering On Using Wake-on-LAN” to set up the system.

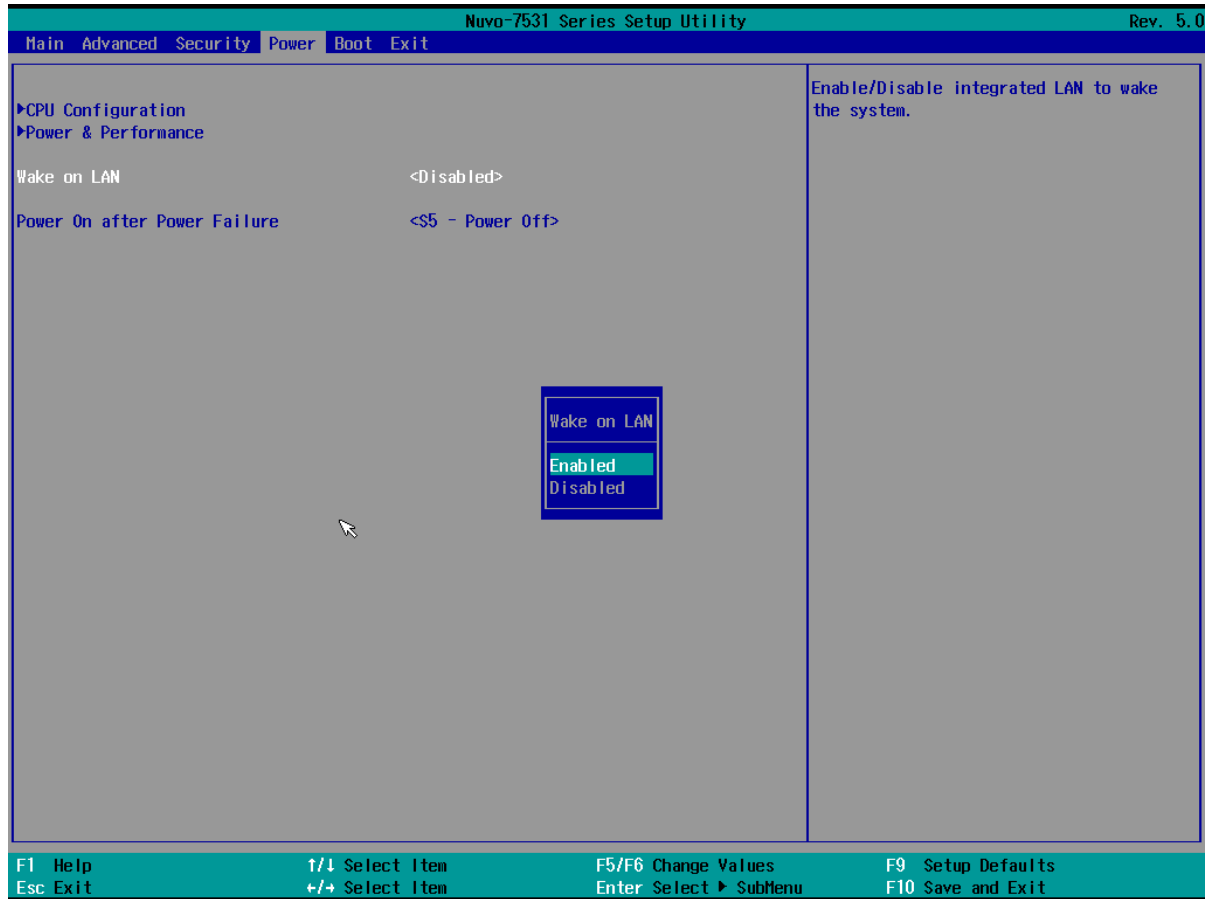

To enable/disable “Wake on LAN” option:

1. When system boots up, press F2 to enter BIOS setup utility.
2. Go to **[Power] > [Wake on LAN]**.
3. Press Enter to bring up setting options, scroll to the setting you desire and press Enter to set.
4. Press F10 to “Exit Saving Changes”.

4.1.7 Boot Menu

The Boot menu in BIOS allows you to specify the system’s boot characteristics by setting bootable device components (boot media) and method. Or, you may press F12 upon system start up and select a device you wish boot from.

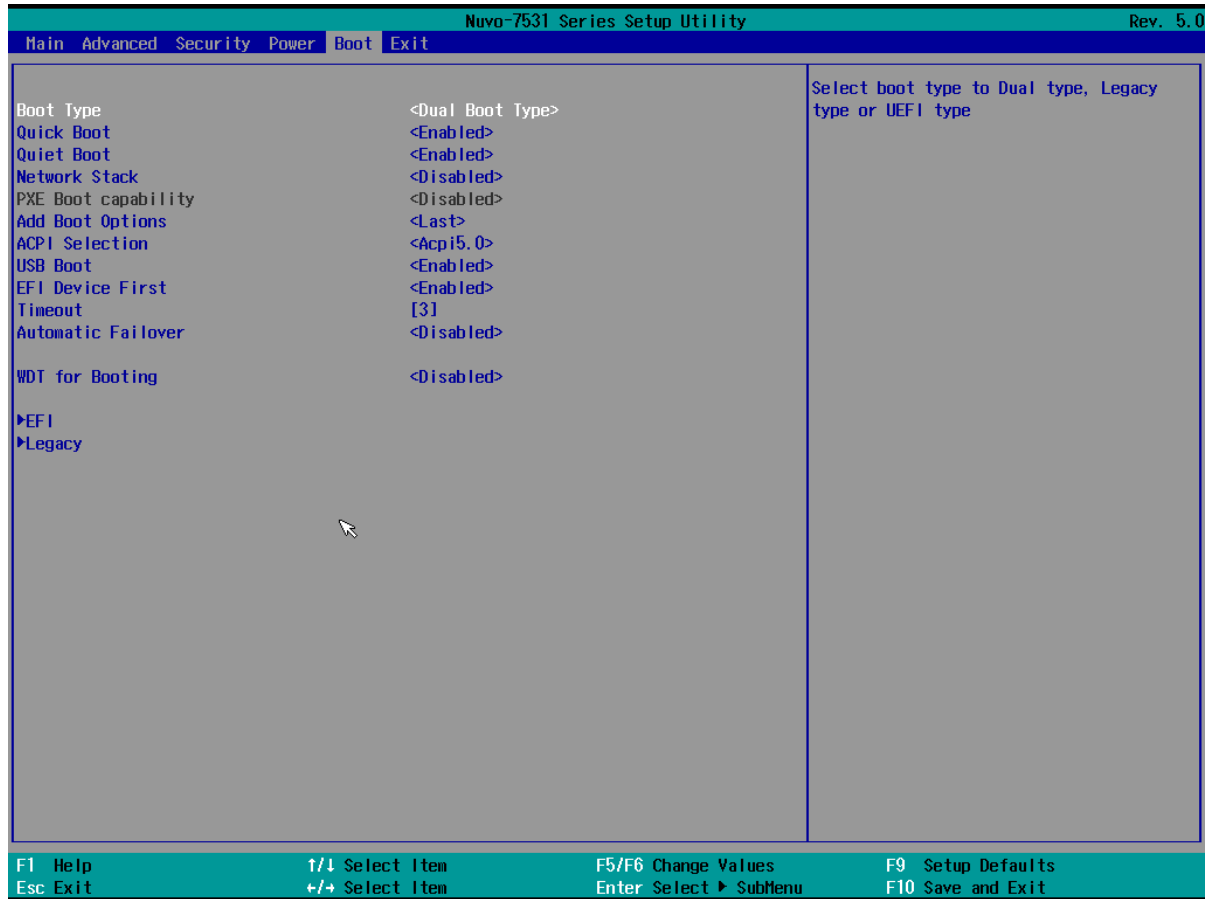

4.1.8 Boot Type (Legacy/ UEFI)

The system supports both Legacy and Unified Extensible Firmware Interface (UEFI) boot modes. UEFI is a specification proposed by Intel to define a software interface between operating system and platform firmware. Most modern operating systems, such as Windows 7/8/10 and Linux support both Legacy and UEFI boot modes. The Legacy boot mode uses MBR partition for disk and VBIOS for video initialization, the UEFI boot mode uses GPT partition which supports greater than 2TB partition size and GOP driver for faster video initialization.

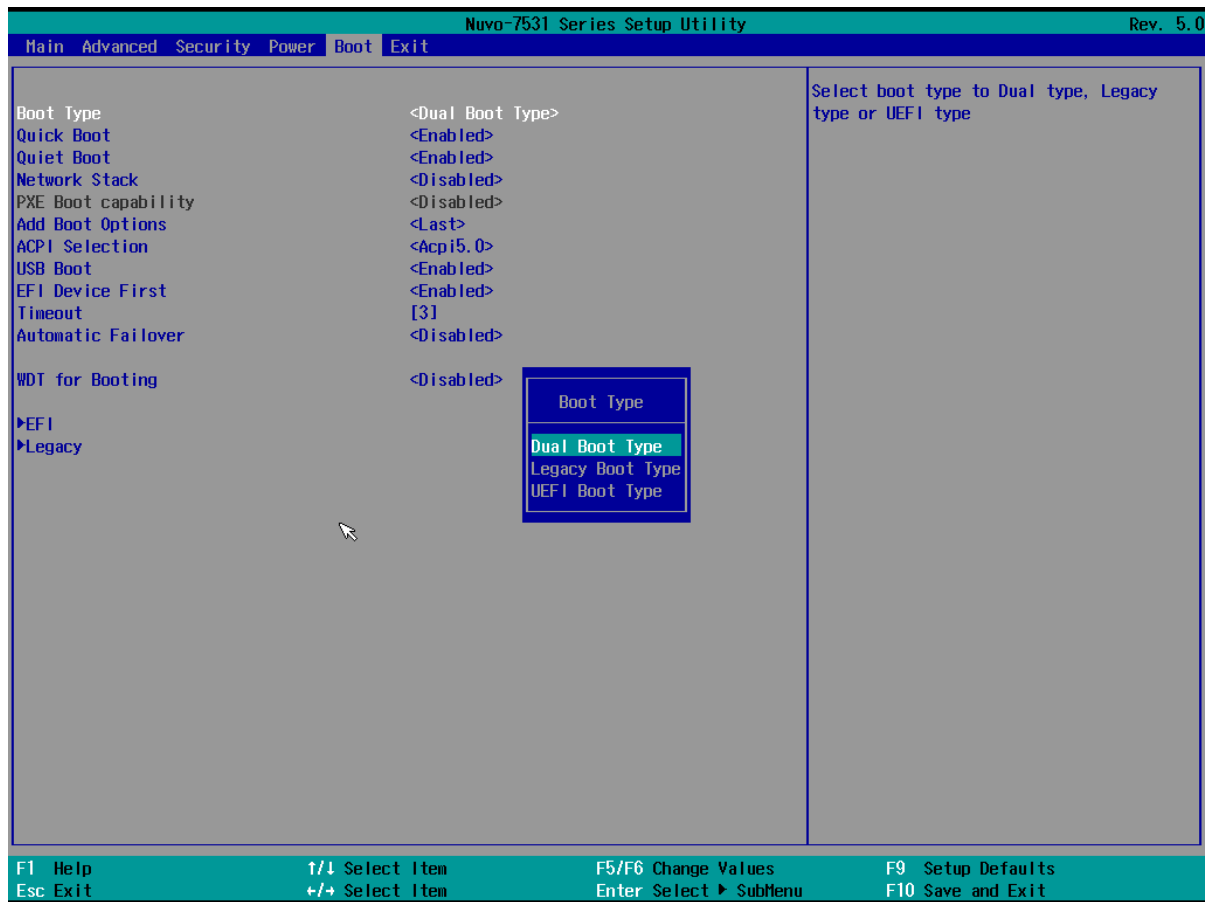

It is recommended that:

- If you need greater than 2TB disk partition, you shall choose UEFI boot mode and install operating system accordingly.
- Choose Legacy boot mode if the installed HDD/ SSD capacities are under 2TB

To configure Boot Type:

1. When system boots up, press F2 to enter BIOS setup utility.
2. Go to **[Boot] > [Boot Type]**, press Enter to bring up options, Dual Boot (Legacy+UEFI), Legacy Boot Type, UEFI Boot Type.
3. Highlight your selection and press Enter.
4. Press F10 to “Exit Saving Changes”.

4.1.9 Add Boot Options

The Add Boot Options dedicates the boot sequence order of a newly added device (eg. USB flash drive). The setting allows you to set the newly added device to boot first or as the last device on the list.

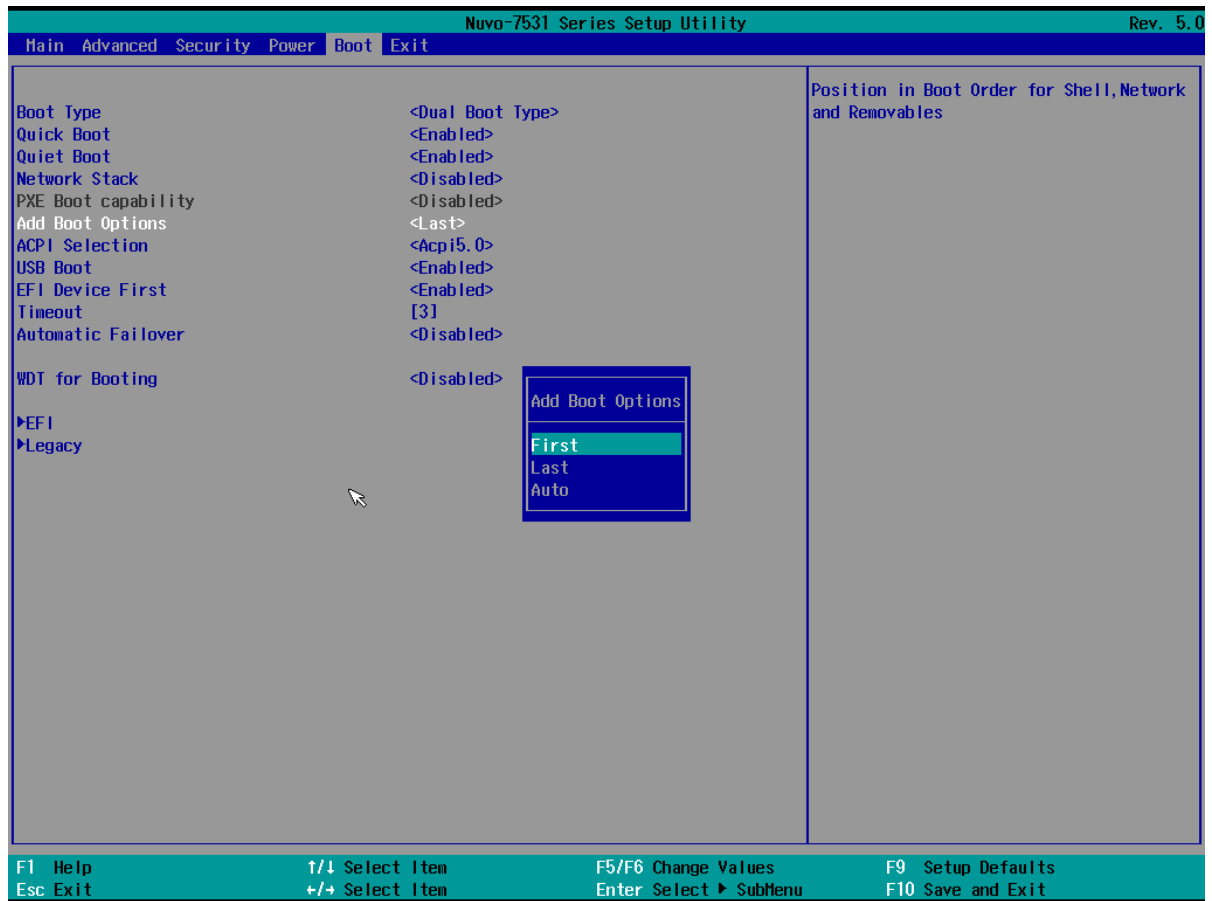

To set Add Boot Options:

1. When system boots up, press F2 to enter BIOS setup utility.
2. Go to [Boot] > [Add Boot Option], press Enter to bring up options, First or Last.
3. Highlight your selection and press Enter, press F10 to “Exit Saving Changes”.

4.1.10 Watchdog Timer for Booting

The Watchdog timer setting in the BIOS ensures a successful system boot by specifying a timeout value. If the Watchdog timer is not stopped and expires, the BIOS will issues a reset command to initiate another boot process. There are two options in BIOS menu, “**Automatically after POST**” and “**Manually after Entering OS**”. When “**Automatically after POST**” is selected, the BIOS automatically stop the watchdog timer after POST (Power-On Self Test) OK. When “**Manually after Entering OS**” is selected, it’s user’s liability to stop the watchdog timer when entering OS. This guarantees the system can always boot into OS, otherwise another booting process will be initiated.

For information about programming watchdog timer, please refer to **Appendix A Watchdog Timer & Isolated DIO**.

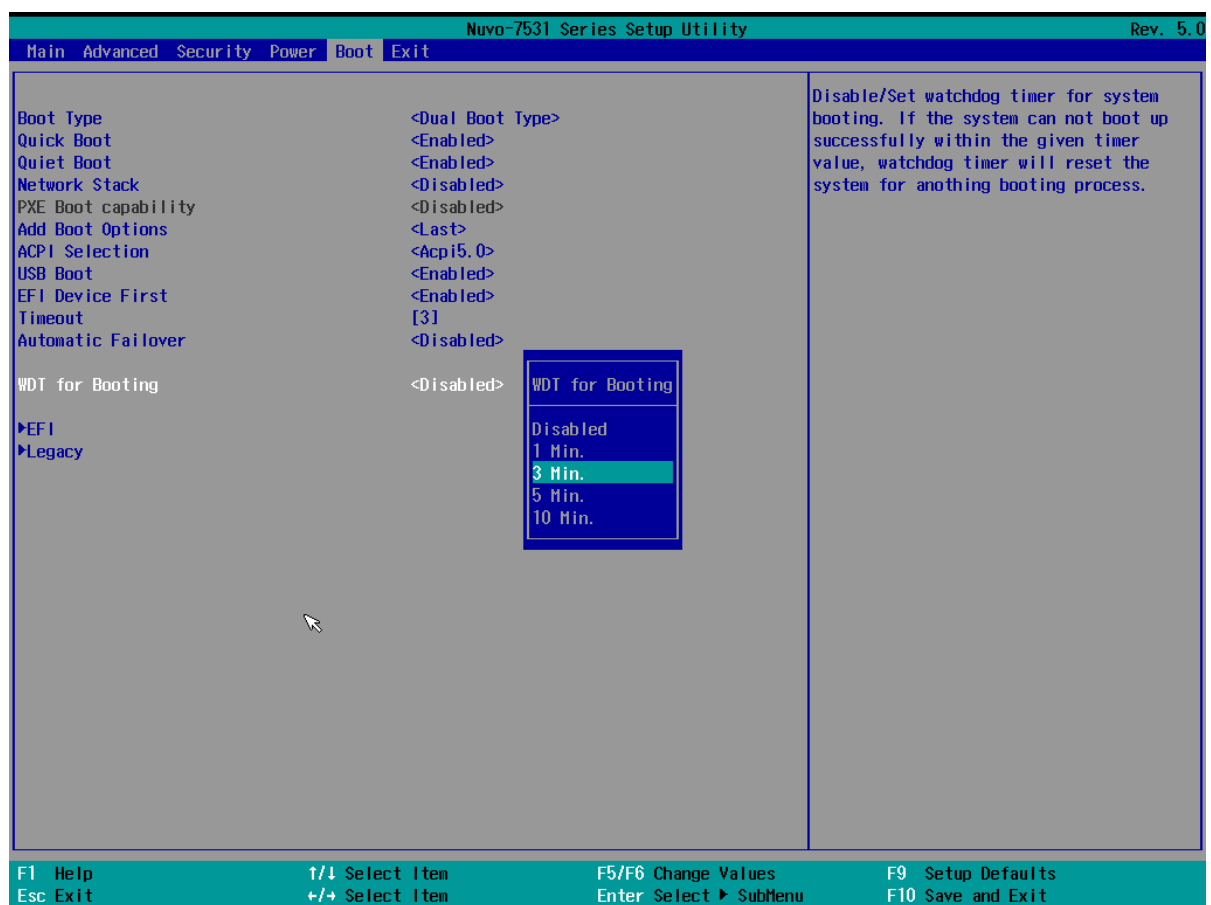

To set the watchdog timer for boot in BIOS:

1. When system boots up, press F2 to enter BIOS setup utility.
2. Go to **[Boot]** menu.
3. Disable or select timeout value for **[WDT for Booting]** option.
4. Once you give a timeout value, the **[WDT Stop Option]** option appears. You can select “*Automatically after POST*” or “*Manually after Entering OS*”.
5. Press F10 to “Exit Saving Changes.

4.1.11 Legacy/ UEFI Boot Device

When you wish to set a designated boot device, you may set it as the first device to boot in Legacy or UEFI Boot Device setting. Or if you wish to manually select a boot device, you may do so by pressing F12 when the system boots up.

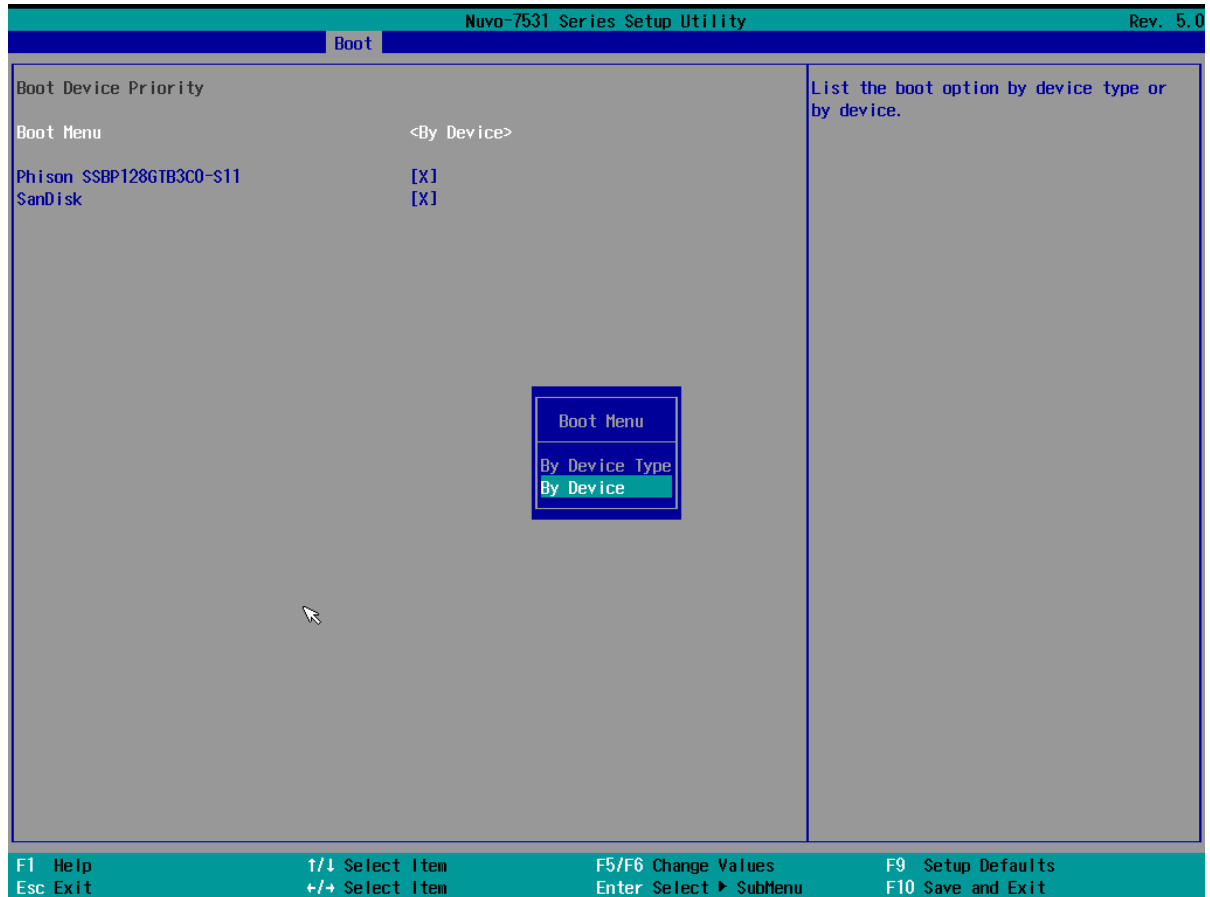

To set boot order for devices in UEFI Boot Device:

1. When system boots up, press F2 to enter BIOS setup utility
2. Go to **[Boot] > [UEFI Boot Device]**
3. Highlight the device you wish to make boot order changes to and press F5/ F6 or +/- to change device boot order.

To select boot order for devices in Legacy Boot Device:

1. When system boots up, press F2 to enter BIOS setup utility
2. Go to **[Boot] > [Legacy Boot Device]**, you can choose the type of device to list by selecting **"By Device or By Device Type"**.
3. Highlight the device you wish to make boot order changes to and press F5/ F6 or +/- to change device boot order.

5 OS Support and Driver Installation

5.1 Operating System Compatibility

The system supports most operating system developed for Intel® x86 architecture. The following list contains the operating systems which have been tested by Neosys Technology.

- Microsoft Window 10 (x64)
- Fedora 29**
- Ubuntu 16.04.5 LTS** & Ubuntu18.04.0 LTS**



NOTE

For other Linux OS, Linux kernel should upgrade to 4.15.18.

**For Linux system, user may need to manually compile and install the driver for Intel graphics or I210 GbE controller if the driver is not embedded in kernel. You can visit Intel website for further information.*

***For distributions, graphics driver and RAID function may not be completely implemented in its kernel. You may encounter restrictions when using these features, such as triple independent display and RAID. For optimum operation, it is the users' responsibility to manually check for new drivers and upgrades!*

Neosys may remove or update operating system compatibility without prior notice. Please contact us if your operating system of choice is not on the list.

5.2 Driver Installation

The system comes with a “Drivers & Utilities” DVD that offers “one-click” driver installation process or you can choose to install driver manually.

5.2.1 Install Drivers Automatically

The system comes with a “Drivers & Utilities” DVD that offers “one-click” driver installation process. It automatically detects your Windows operating system and installs all necessary drivers for you system with a single click.

To install drivers automatically, please refer to the following procedures.

1. Insert the “Drivers & Utilities” DVD into a USB DVD-drive connect to your system. A setup utility launches and the following dialog appears.



2. Click on “**Automatic Driver Installation**” and the setup utility will automatically detect your Windows operating system and install all necessary drivers. The installation process takes about 6~8 minutes depending on your Windows version. Once driver installation is done, the setup utility reboots your Windows and you may begin using your system.

5.2.2 Install Drivers Manually

You can also manually install each driver for the system. Please note when installing drivers manually, you need to install the drivers in the following sequence mentioned below.

Windows 10 (x64)

The recommended driver installation sequence is

1. Chipset driver (x:\Driver_Pool\Chipset_CFL\Win_10_64\SetupChipset.exe)
2. Graphics driver (x:\Driver_Pool\Graphics_CFL_SKL_APL\Win_10_64\igxpinstall.exe)
3. Audio driver (x:\Driver_Pool\Audio_ALC262\Win_ALL_64\Setup.exe)
4. LAN driver
(x:\Driver_Pool\GbE_I210_I350\Win_10_64_CFL\APPS\PROSETDX\Winx64\DxSetup.exe)
5. ME driver (x:\Driver_Pool\ME_CFL\Win_10_64\SetupME.exe)

5.3 Driver Installation for Watchdog Timer Control

Neosys provides a driver package which contain function APIs for Watchdog Timer control function. You should install the driver package (WDT_DIO_Setup.exe) in prior to use these functions. Please note that you must install WDT_DIO_Setup_v2.3.0.0 or later versions.

Windows 10 (x64)

Please execute the driver setup program in the following directory.

x:\Driver_Pool\WDT_DIO\Win7_8_64\WDT_DIO_Setup_v2.3.0.x (x64).exe

Windows 10 (WOW64)

Please execute the driver setup program in the following directory.

x:\Driver_Pool\WDT_DIO\Win7_8_WOW64\WDT_DIO_Setup_v2.3.0.x (wow64).exe

Appendix A Using WDT & DIO

Watchdog Timer

The watchdog timer (WDT) function ensures reliable system operation. The WDT is a hardware mechanism to reset the system if the watchdog timer expires. Users can start the WDT and keep resetting the timer to make sure the system or program is running. Otherwise, the system shall be reset.

In this section, we'll illustrate how to use the function library provided by Neosys to program the WDT functions. Currently, WDT driver library supports Windows 7/ 8.1/ 10 32-bit and 64-bit versions. For other OS support, please contact Neosys Technology for further information.

Installing WDT_DIO Library

The WDT_DIO function library is delivered in the form of a setup package named **WDT_DIO_Setup.exe**. Prior to programming WDT, you should execute the setup program and install the WDT library. Please use the following WDT_DIO_Setup packages according to your operating systems and application.

- For Windows 10 64-bit OS with 64-bit application (x64 mode), please install WDT_DIO_Setup_v2.3.0.0(x64).exe or later version.
- For Windows 10 64-bit OS with 32-bit application (WOW64 mode), please install WDT_DIO_Setup_v2.3.0.0 (wow64).exe or later version.

WDT and DIO Library Installation

To setup WDT & DIO Library, please follow instructions below.

1. Execute **WDT_DIO_Setup.2.3.0.xexe**. and the following dialog appears.

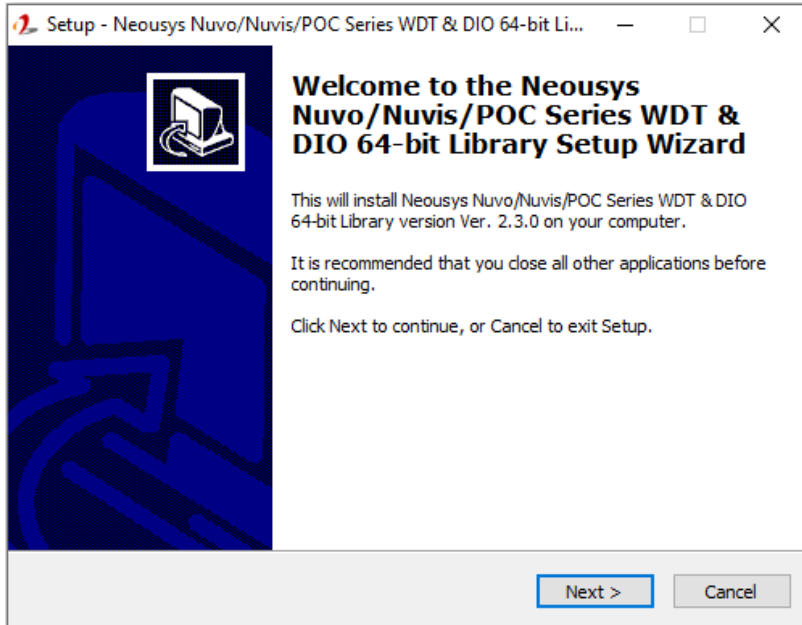

2. Click "Next >" and specify the directory of installing related files. The default directory is *C:\Neosys\WDT_DIO*.

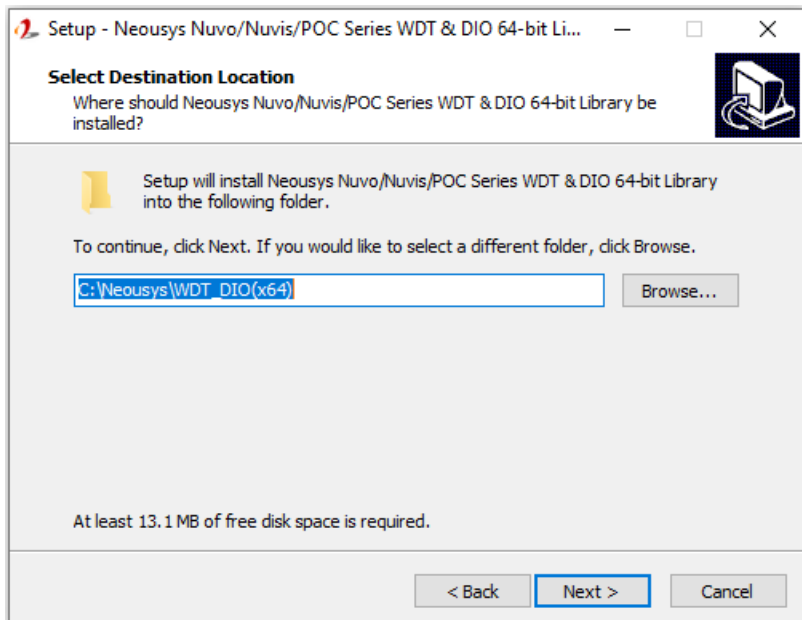

- Once the installation has finished, a dialog will appear to prompt you to reboot the system. The WDT & DIO library will take effect after the system has rebooted.

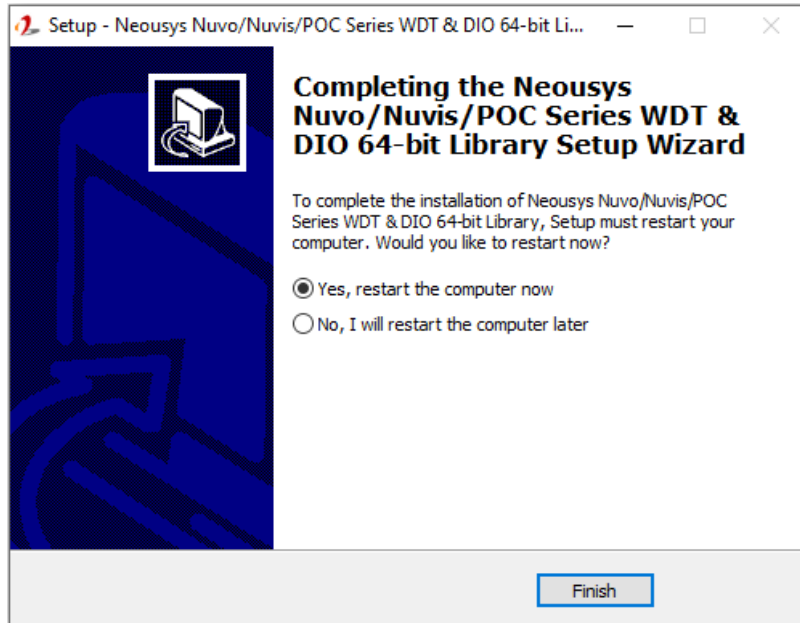

- When programming your WDT or DIO program, the related files are located in

Header File:	\Include
Library File:	\Lib
Function	\Manual
Reference:	
Sample Code:	\Sample\ WDT_Demo (Demo for Watchdog Timer) \Sample\ DIO_Demo (Demo for Polling I/O)

WDT Functions

InitWDT

Syntax	BOOL InitWDT(void);
Description:	Initialize the WDT function. You should always invoke InitWDT() before set or start watchdog timer.
Parameter	None
Return Value	TRUE: Successfully initialized FALSE: Failed to initialize
Usage	BOOL bRet = InitWDT()

SetWDT

Syntax	BOOL SetWDT(WORD tick, BYTE unit);
Description	Set timeout value and unit for watchdog timer. When InitWDT() is invoked, a default timeout value of 255 seconds is assigned.
Parameter	tick WORD value (1 ~ 65535) to indicate timeout ticks. unit BYTE value (0 or 1) to indicate unit of timeout ticks. 0 : unit is minute 1: unit is second
Return Value	If value of unit is correct (0 or 1), this function returns TRUE, otherwise FALSE.
Usage	WORD tick=255; BYTE unit=1; //unit is second. BOOL bRet = SetWDT(tick, unit); //timeout value is 255 seconds

StartWDT

Syntax	BOOL StartWDT(void);
Description	Starts WDT countdown. Once started, the WDT LED indicator will begin blinking. If ResetWDT() or StopWDT is not invoked before WDT countdowns to 0, the WDT expires and the system resets.
Parameter	None
Return Value	If the timeout value is given in correct format (WDT started), this function returns TRUE, otherwise FALSE
Usage	BOOL bRet = StartWDT()

ResetWDT

Syntax	BOOL ResetWDT(void);
Description	Reset the timeout value to the value given by SetWDT().If ResetWDT() or StopWDT is not invoked before WDT countdowns to 0, the WDT expires and the system resets.
Parameter	None
Return Value	Always returns TRUE
Usage	BOOL bRet = ResetWDT()

StopWDT

Syntax	BOOL StopWDT(void);
Description	Stops the countdown of WDT. When WDT has stopped, the WDT LED indicator stops blinking.
Parameter	None
Return Value	Always returns TRUE
Usage	BOOL bRet = StopWDT()

DIO Functions

InitDIO

Syntax	BOOL InitDIO(void);
Description	Initialize the DIO function. You should always invoke InitDIO() before write/read any DIO port/channel.
Parameter	None
Return Value	Returns TRUE if initialization successes, FALSE if initialization failed.
Usage	BOOL bRet = InitWDT();

DIReadLine

Syntax	BOOL DIReadLine(BYTE ch);
Description	Read a single channel of isolated digital input.
Parameter	ch BYTE value specifies the DI channel to be read. <i>Ch</i> should be a value of 0 ~ 7.
Return Value	The status (TRUE or FALSE) of the specified DI channel.
Usage	BYTE ch=3; //DI channel #3 BOOL DIChValue = DIReadLine(ch); //read DI channel #3

DIReadPort

Syntax	WORD DIReadPort(void);
Description	Read the entire isolated digital input port (8 channels).
Parameter	None
Return Value	A WORD value (0~255) indicates the status of DI port (8 DI channels).
Usage	WORD DIPortValue = DIReadPort ();

DOWriteLine

Syntax	void DOWriteLine(BYTE ch, BOOL value);
Description	Write a single channel of isolated digital output.
Parameter	<p>ch BYTE value specifies the DO channel to be written. <i>Ch</i> should be a value of 0 ~ 7.</p> <p>value BOOL value (TRUE or FALSE) specifies the status of DO channel.</p>
Return Value	None
Usage	<pre> BYTE ch=3; //DI channel #3 BOOL DOChValue=TRUE; DOWriteLine(ch, DOChValue); //write DO channel #3 as TRUE </pre>

DOWritePort

Syntax	void DOWritePort(WORD value);
Description	Write the entire isolated digital output port (8 channels).
Parameter	<p>value WORD value specifies the status of the DO port. <i>Value</i> should be a value of 0~255.</p>
Return Value	None
Usage	<pre> WORD DOPortValue=0XFF; //11111111b DOWritePort(DOPortValue); //write DO port as 11111111b </pre>