

**MODEL:**  
**IMBA-ADL-Q670**

**ATX Motherboard Supports LGA1700 12th/13th Gen. Intel® Core® i9/i7/i5/i3, Pentium® and Celeron® Processor, DDR4, Triple Independent Display, Dual 2.5GbE LAN, M.2, USB 3.2, SATA 6Gb/s, IPMI, Audio and RoHS**

# User Manual

# Revision

---

Date	Version	Changes
July 21, 2023	1.00	Initial release

# Copyright

---

## **COPYRIGHT NOTICE**

The information in this document is subject to change without prior notice in order to improve reliability, design and function and does not represent a commitment on the part of the manufacturer.

In no event will the manufacturer be liable for direct, indirect, special, incidental, or consequential damages arising out of the use or inability to use the product or documentation, even if advised of the possibility of such damages.

This document contains proprietary information protected by copyright. All rights are reserved. No part of this manual may be reproduced by any mechanical, electronic, or other means in any form without prior written permission of the manufacturer.

## **TRADEMARKS**

All registered trademarks and product names mentioned herein are used for identification purposes only and may be trademarks and/or registered trademarks of their respective owners.

# Manual Conventions

---



## **WARNING**

Warnings appear where overlooked details may cause damage to the equipment or result in personal injury. Warnings should be taken seriously.



## **CAUTION**

Cautionary messages should be heeded to help reduce the chance of losing data or damaging the product.



## **NOTE**

These messages inform the reader of essential but non-critical information. These messages should be read carefully as any directions or instructions contained therein can help avoid making mistakes.

# Table of Contents

<b>1 INTRODUCTION.....</b>	<b>15</b>
1.1 INTRODUCTION.....	16
1.2 FEATURES.....	17
1.3 CONNECTORS .....	18
1.4 DIMENSIONS.....	19
1.5 DATA FLOW .....	20
1.6 TECHNICAL SPECIFICATIONS .....	21
<b>2 PACKING LIST.....</b>	<b>24</b>
2.1 ANTI-STATIC PRECAUTIONS.....	25
2.2 UNPACKING PRECAUTIONS.....	25
2.3 PACKING LIST .....	26
2.4 OPTIONAL ITEMS .....	27
<b>3 CONNECTORS .....</b>	<b>29</b>
3.1 PERIPHERAL INTERFACE CONNECTORS.....	30
3.1.1 <i>IMBA-ADL-Q670 Layout</i> .....	30
3.1.2 <i>Peripheral Interface Connectors</i> .....	31
3.1.3 <i>External Interface Panel Connectors</i> .....	32
3.2 INTERNAL PERIPHERAL CONNECTORS .....	33
3.2.1 <i>CPU 12V Power Connector</i> .....	33
3.2.2 <i>ATX Power Connector</i> .....	34
3.2.3 <i>Battery Connector</i> .....	35
3.2.4 <i>Chassis Intrusion Connector</i> .....	37
3.2.5 <i>AT/ATX Power Mode Setting</i> .....	38
3.2.6 <i>Digital I/O Connector</i> .....	39
3.2.7 <i>EC Debug Connector</i> .....	40
3.2.8 <i>Clear CMOS Button</i> .....	41
3.2.9 <i>Fan Connector (CPU)</i> .....	42
3.2.10 <i>Fan Connectors (System)</i> .....	43
3.2.11 <i>Audio Connector for iEi AC-KIT-888S kit</i> .....	44

3.2.12 Front Panel Connector .....	45
3.2.13 I <sup>2</sup> C Connector .....	46
3.2.14 SMBus Connector .....	47
3.2.15 LAN Link LED connector.....	48
3.2.16 Internal USB 2.0 connectors.....	49
3.2.17 Internal USB 3.2 Gen 1 connector.....	50
3.2.18 M.2 M-key Slot.....	51
3.2.19 IEI iDPM slot.....	53
3.2.20 IPMI (Intelligent Platform Management Interface) slot.....	55
3.2.21 PCI Slot.....	56
3.2.22 PCIe x1 Slots.....	57
3.2.23 PCIe x4 Slots.....	58
3.2.24 PCIe x16 slots .....	59
3.2.25 Onboard Power Button .....	60
3.2.26 DDR4 DIMM sockets.....	61
3.2.27 SATA 6Gb/s Connectors.....	62
3.2.28 RS-232 Serial Port Connectors.....	63
3.2.29 Flash SPI ROM Connector .....	64
<b>3.3 EXTERNAL PERIPHERAL INTERFACE CONNECTOR PANEL .....</b>	<b>65</b>
3.3.1 External dual RS-232/422/485 connector.....	65
3.3.2 External HDMI and DP combo connector .....	66
3.3.3 External 2.5GbE RJ-45 and dual USB 3.2 Gen 1 combo connector .....	68
3.3.4 External 2.5GbE RJ-45 and dual USB 3.2 Gen 2 combo connector .....	69
3.3.5 External RJ-45 for IPMI and dual USB 3.2 Gen 2 combo connector .....	71
<b>4 INSTALLATION .....</b>	<b>73</b>
4.1 ANTI-STATIC PRECAUTIONS.....	74
4.2 INTERNAL PERIPHERAL DEVICE CONNECTIONS.....	74
4.2.1 SATA Drive Connection .....	74
4.3 INSTALLATION CONSIDERATIONS.....	77
4.4 SOCKET LGA1700 CPU INSTALLATION.....	78
4.5 SOCKET LGA1700 COOLING KIT INSTALLATION .....	82
4.6 DIMM INSTALLATION .....	84
4.7 M.2 MODULE INSTALLATION.....	85
4.8 SOFTWARE INSTALLATION .....	88

## IMBA-ADL-Q670

4.9 DRIVER DOWNLOAD .....	88
<b>5 BIOS .....</b>	<b>90</b>
5.1 INTRODUCTION.....	91
5.1.1 Starting Setup.....	91
5.1.2 Using Setup .....	92
5.1.2.1 Keyboard Navigation .....	92
5.1.2.2 Touch Navigation .....	93
5.1.3 Getting Help.....	94
5.1.4 Unable to Reboot after Configuration Changes .....	94
5.1.5 BIOS Menu Bar.....	94
5.2 MAIN.....	95
5.3 ADVANCED.....	98
5.3.1 CPU Configuration .....	99
5.3.2 Trusted Computing.....	103
5.3.3 RTC Wake Settings .....	104
5.3.4 F81966 Super IO Configuration .....	106
5.3.4.1 Serial Port 1 Configuration .....	107
5.3.4.2 Serial Port 2 Configuration .....	108
5.3.4.3 Serial Port 3 Configuration .....	109
5.3.4.4 Serial Port 4 Configuration .....	110
5.3.4.5 Serial Port 5 Configuration .....	111
5.3.4.6 Serial Port 6 Configuration .....	112
5.3.5 EC KB9068 H/W Monitor.....	113
5.3.5.1 Smart Fan Mode Configuration .....	115
5.3.6 Serial Port Console Redirection .....	119
5.3.6.1 Console Redirection Settings .....	120
5.3.7 NVMe Configuration.....	123
5.4 CHIPSET .....	124
5.4.1 System Agent (SA) Configuration .....	125
5.4.1.1 Memory Configuration .....	126
5.4.1.2 Graphics Configuration.....	127
5.4.1.3 VMD Configuration.....	130
5.4.1.4 PEG Port Configuration.....	131
5.4.2 PCH-IO Configuration .....	132

5.4.2.1 PCI Express Configuration .....	135
5.4.2.1.2 PCIe Root Port Setting.....	136
5.4.2.2 SATA Configuration.....	137
5.4.2.3 HD Audio Configuration.....	138
5.5 SECURITY.....	139
5.6 BOOT.....	141
5.6.1 <i>Boot Configuration</i> .....	141
5.6.2 <i>Boot Option Priorities</i> .....	142
5.7 SAVE & EXIT .....	143
<b>A REGULATORY COMPLIANCE .....</b>	<b>145</b>
<b>B PRODUCT DISPOSAL .....</b>	<b>147</b>
<b>C BIOS OPTIONS .....</b>	<b>149</b>
<b>D WATCHDOG TIMER .....</b>	<b>153</b>
<b>E ERROR BEEP CODE.....</b>	<b>156</b>
E.1 PEI BEEP CODES.....	157
E.2 DXE BEEP CODES .....	157
<b>F HAZARDOUS MATERIALS DISCLOSURE.....</b>	<b>158</b>
F.1 RoHS II DIRECTIVE (2015/863/EU) .....	159
F.2 CHINA RoHS.....	160



# List of Figures

Figure 1-1: IMBA-ADL-Q670 .....	16
Figure 1-2: Connectors .....	18
Figure 1-3: IMBA-ADL-Q670 Dimensions (mm) .....	19
Figure 1-4: Data Flow Diagram .....	20
Figure 3-1: Peripheral Interface Connectors .....	30
Figure 3-2: CPU 12V Power Connector Location .....	33
Figure 3-3: ATX Power Connector Location .....	34
Figure 3-4: Battery Connector Location .....	36
Figure 3-5: Chassis Intrusion Connector Location .....	37
Figure 3-6: AT/ATX Power Mode Switch Location .....	38
Figure 3-7: Digital I/O Connector Location .....	39
Figure 3-8: EC Debug Connector Location .....	40
Figure 3-9: Clear CMOS Jumper Location .....	41
Figure 3-10: CPU Fan Connector Location .....	42
Figure 3-11: System Fan Connector Locations .....	43
Figure 3-12: Audio Connector Location .....	44
Figure 3-13: Front Panel Connector Location .....	45
Figure 3-14: I <sup>2</sup> C Connector Location .....	46
Figure 3-15: SMBus Connector Location .....	47
Figure 3-16: LAN LED Connector Locations .....	48
Figure 3-17: Internal USB 2.0 Connector Location .....	49
Figure 3-18: Internal USB 3.2 Gen 1 Connector Location .....	50
Figure 3-19: M.2 M-key Slot Location .....	51
Figure 3-20: iDPM Slot Location .....	53
Figure 3-21: IPMI Slot Location .....	55
Figure 3-22: PCI Slot Location .....	56
Figure 3-23: PCIe x1 Slot Locations .....	57
Figure 3-24: PCIe x4 Slot Locations .....	58
Figure 3-25: PCIe x16 Slot Location .....	59
Figure 3-26: Power Button Location .....	60
Figure 3-27: DDR4 DIMM Sockets Location .....	61

Figure 3-28: SATA 6Gb/s Connector Locations .....	62
Figure 3-29: RS-232 Connector Location .....	63
Figure 3-30: Flash SPI ROM Connector Location .....	64
Figure 3-31: External Peripheral Interface Connector .....	65
Figure 3-32: DB-9 RS-232/422/485 Pinouts .....	66
Figure 3-33: External DP Connector Pinouts.....	66
Figure 3-34: External HDMI Connector Location.....	67
Figure 3-35: USB 3.2 and RJ45 Connector .....	68
Figure 3-36: USB 3.2 and RJ45 Connector .....	69
Figure 3-37: USB 3.2 and RJ45 Connector .....	71
Figure 4-1: SATA Drive Cable Connection.....	75
Figure 4-2: SATA Power Drive Connection.....	76
Figure 4-3: Disengage the CPU Socket Load Lever.....	79
Figure 4-4: Remove Protective Cover.....	80
Figure 4-5: Insert the Socket LGA1700 CPU.....	81
Figure 4-6: Close the Socket LGA1700.....	82
Figure 4-7: Cooling Kit Support Bracket .....	83
Figure 4-8: DIMM Installation.....	84
Figure 4-9: Inserting the M.2 Module into the Slot at an Angle.....	85
Figure 4-10: Securing the M.2 Module.....	86
Figure 4-11: Press the Retainer.....	86
Figure 4-12: Aligning the M.2 Module with the Retainer.....	87
Figure 4-13: Securing the M.2 Module.....	87
Figure 4-14: IEI Resource Download Center.....	88
Figure 5-1: BIOS Starting Menu .....	91

# List of Tables

Table 1-1: IMBA-ADL-Q670 Specifications .....	23
Table 2-1: Packing List.....	26
Table 2-2: Optional Items .....	28
Table 3-1: Peripheral Interface Connectors .....	32
Table 3-2: Rear Panel Connectors .....	32
Table 3-3: CPU 12V Power Connector Pinouts.....	33
Table 3-4: ATX Power Connector Pinouts.....	35
Table 3-5: Battery Connector Pinouts .....	36
Table 3-6: Chassis Intrusion Connector Pinouts .....	37
Table 3-7: AT/ATX Power Mode Switch Settings.....	38
Table 3-8: Digital I/O Connector Pinouts.....	39
Table 3-9: EC Debug Connector Pinouts .....	40
Table 3-10: Clear CMOS Jumper Pinouts.....	41
Table 3-11: CPU Fan Connector Pinouts.....	42
Table 3-12: System Fan Connector Pinouts .....	43
Table 3-13: Audio Connector Pinouts .....	44
Table 3-14: Front Panel Connector Pinouts.....	45
Table 3-15: I <sup>2</sup> C Connector Pinouts.....	46
Table 3-16: SMBus Connector Pinouts .....	47
Table 3-17: LAN1 LED Connector (JLAN_LED1) Pinouts.....	48
Table 3-18: LAN2 LED Connector (JLAN_LED 2) Pinouts.....	48
Table 3-19: Internal USB 2.0 Connector Pinouts.....	49
Table 3-20: Internal USB 3.2 Gen 1 Connector Pinouts.....	51
Table 3-21: M.2 M-key Connector Pinouts .....	52
Table 3-22: iDPM Connector Pinouts.....	54
Table 3-23: SATA 6Gb/s Connector Pinouts.....	62
Table 3-24: RS-232 Connector Pinouts .....	63
Table 3-25: Flash SPI ROM Connector Pinouts.....	64
Table 3-26: External RS-232/422/485 Connector Pinouts.....	66
Table 3-27: External DP Connector Pinouts .....	67
Table 3-28: External HDMI Connector Pinouts .....	67

<b>Table 3-29: USB 3.2 Port Pinouts</b> .....	<b>68</b>
<b>Table 3-30: Dual RJ45 Pinouts</b> .....	<b>69</b>
<b>Table 3-31: USB 3.2 Port Pinouts</b> .....	<b>70</b>
<b>Table 3-32: RJ-45 for IPMI Pinouts</b> .....	<b>70</b>
<b>Table 3-33: USB 3.2 Port Pinouts</b> .....	<b>71</b>
<b>Table 3-34: Dual RJ45 Pinouts</b> .....	<b>72</b>
<b>Table 5-1: BIOS Navigation Keys</b> .....	<b>92</b>
<b>Table 5-2: BIOS On-screen Navigation Keys</b> .....	<b>93</b>

# BIOS Menus

BIOS Menu 1: Main (1/3).....	95
BIOS Menu 2: Main (2/3).....	95
BIOS Menu 3: Main (3/3).....	96
BIOS Menu 4: Advanced .....	98
BIOS Menu 5: CPU Configuration (1/3).....	99
BIOS Menu 6: CPU Configuration (2/3).....	100
BIOS Menu 7: CPU Configuration (3/3).....	100
BIOS Menu 8: PCH-FW Configuration .....	103
BIOS Menu 9: RTC Wake Settings (1/2).....	104
BIOS Menu 10: RTC Wake Settings (2/2).....	105
BIOS Menu 11: F81966 Super IO Configuration .....	106
BIOS Menu 12: Serial Port 1 Configuration Menu .....	107
BIOS Menu 13: Serial Port 2 Configuration Menu .....	108
BIOS Menu 14: Serial Port 3 Configuration Menu .....	109
BIOS Menu 15: Serial Port 4 Configuration Menu .....	110
BIOS Menu 16: Serial Port 5 Configuration Menu .....	111
BIOS Menu 17: Serial Port 6 Configuration Menu .....	112
BIOS Menu 18: EC KB9068 H/W Monitor (1/2) .....	113
BIOS Menu 19: EC KB9068 H/W Monitor (2/2) .....	114
BIOS Menu 20: Smart Fan Mode Configuration (1/2).....	115
BIOS Menu 21: Smart Fan Mode Configuration (2/2).....	116
BIOS Menu 22: Serial Port Console Redirection (1/3).....	119
BIOS Menu 23: Serial Port Console Redirection (2/3).....	119
BIOS Menu 24: Serial Port Console Redirection (3/3).....	120
BIOS Menu 25: COM Console Redirection Settings .....	121
BIOS Menu 26: NVMe Configuration.....	123
BIOS Menu 27: Chipset .....	124
BIOS Menu 28: System Agent (SA) Configuration .....	125
BIOS Menu 29: Memory Configuration.....	126
BIOS Menu 30: Graphics Configuration .....	127
BIOS Menu 31: LCD Control .....	129

<b>BIOS Menu 32: VMD Configuration.....</b>	<b>130</b>
<b>BIOS Menu 33: PEG Port Configuration.....</b>	<b>131</b>
<b>BIOS Menu 34: PCH-IO Configuration (1/2) .....</b>	<b>132</b>
<b>BIOS Menu 35: PCH-IO Configuration (2/2) .....</b>	<b>133</b>
<b>BIOS Menu 36: PCI Express Configuration .....</b>	<b>135</b>
<b>BIOS Menu 37: PCIe Slot Configuration Submenu .....</b>	<b>136</b>
<b>BIOS Menu 38: SATA Configuration .....</b>	<b>137</b>
<b>BIOS Menu 39: HD Audio Configuration .....</b>	<b>138</b>
<b>BIOS Menu 40: Security (1/2).....</b>	<b>139</b>
<b>BIOS Menu 41: Security (2/2).....</b>	<b>140</b>
<b>BIOS Menu 42: Boot .....</b>	<b>141</b>
<b>BIOS Menu 43: Save &amp; Exit.....</b>	<b>143</b>

Chapter

1

# Introduction

---

## 1.1 Introduction



**Figure 1-1: IMBA-ADL-Q670**

The IMBA-ADL-Q670 is a microATX motherboard. It accepts a Socket LGA1700 Intel® 12/13th Core® i9/i7/i5/i3, Pentium® or Celeron® processor and supports four 288-pin 3200MHz dual-channel unbuffered DDR4 SDRAM DIMM slots supporting up to 128 GB memory. The Intel® Q670/Q670E chipset supports four SATA 6Gb/s drives. Moreover, the IMBA-ADL-Q670 includes DP, HDMI and IEI iDPM for triple independent display.

The IMBA-ADL-Q670 provides two 2.5GbE interfaces through the Intel® I225V controllers. Expansion and I/O include one PCI slot, two PCIe x1 slot, three PCIe x4 slots, one PCIe x16 slot, two M.2 slots, six COM ports, four USB 3.2 Gen 2, four USB 3.2 Gen1, and four USB 2.0.



## IMBA-ADL-Q670

### 1.2 Features

Some of the IMBA-ADL-Q670 motherboard features are listed below:

- LGA1700 12th/13th Generation Intel® Core® i9/i7/i5/i3, Celeron® and Pentium® processors (up to 125W TDP)
- Four 288-pin 3200MHz dual-channel unbuffered DDR4 SDRAM DIMM slots supporting up to 128 GB memory
- One 2.5GbE I225LM controller and one 2.5GbE I225V controller
- Triple independent display by VGA, HDMI and IEI iDPM
- Four SATA 6Gb/s connectors
- Four USB 3.2 Gen 2 ports, four USB 3.2 Gen 1 ports and four USB 2.0
- One M.2 M-key slot for SSD; one M.2 M-key slot with PCIe x4 signal
- 1 x PCIe Gen4 x16 slot
- 2 x PCIe Gen4 x4 open-end slot
- 1 x PCIe Gen3 x1 slot
- 1 x PCI slot
- Six serial ports
- TPM 2.0 security function supported by PTT
- RoHS compliant

### 1.3 Connectors

The connectors on the IMBA-ADL-Q670 are shown in the figure below.

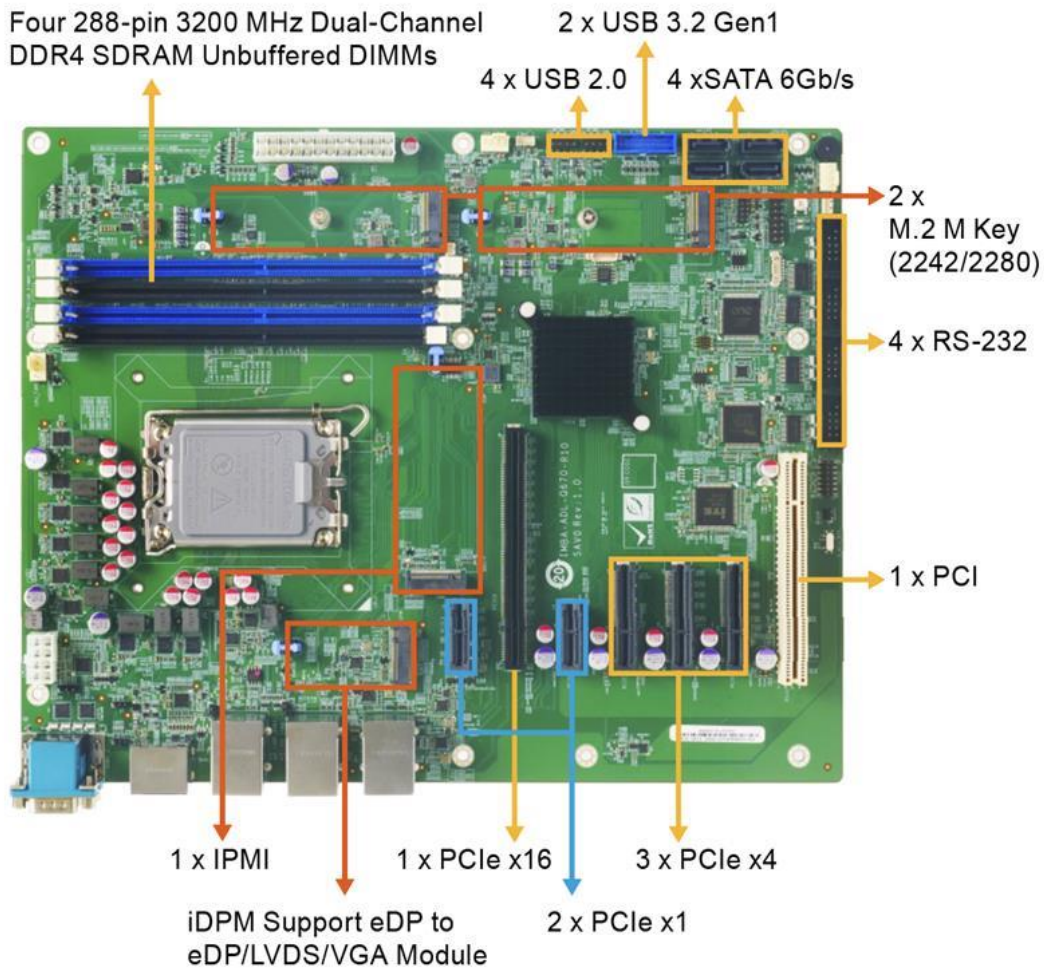

**Figure 1-2: Connectors**

IMBA-ADL-Q670

1.4 Dimensions

The main dimensions of the IMBA-ADL-Q670 are shown in the diagram below.

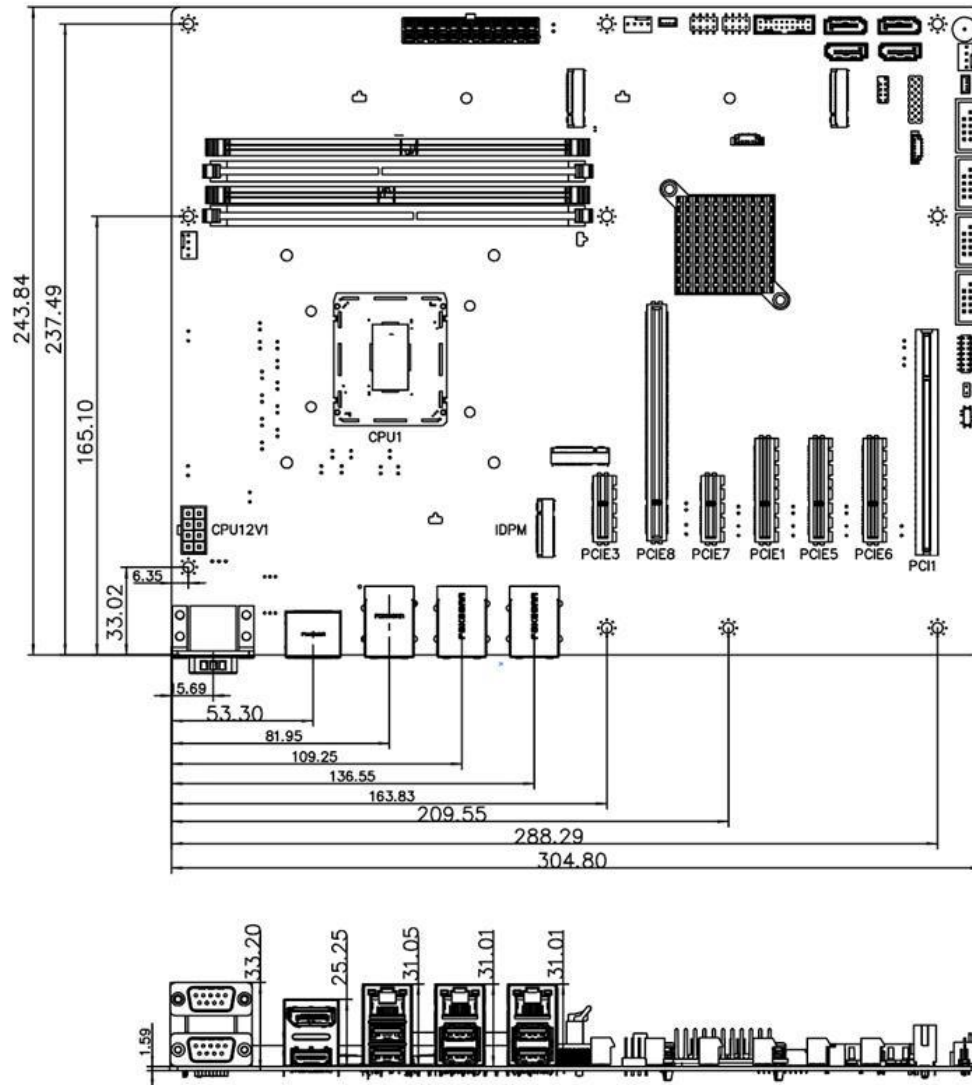

Figure 1-3: IMBA-ADL-Q670 Dimensions (mm)

## 1.5 Data Flow

Figure 1-4 shows the data flow between the system chipset, the CPU and other components installed on the motherboard.

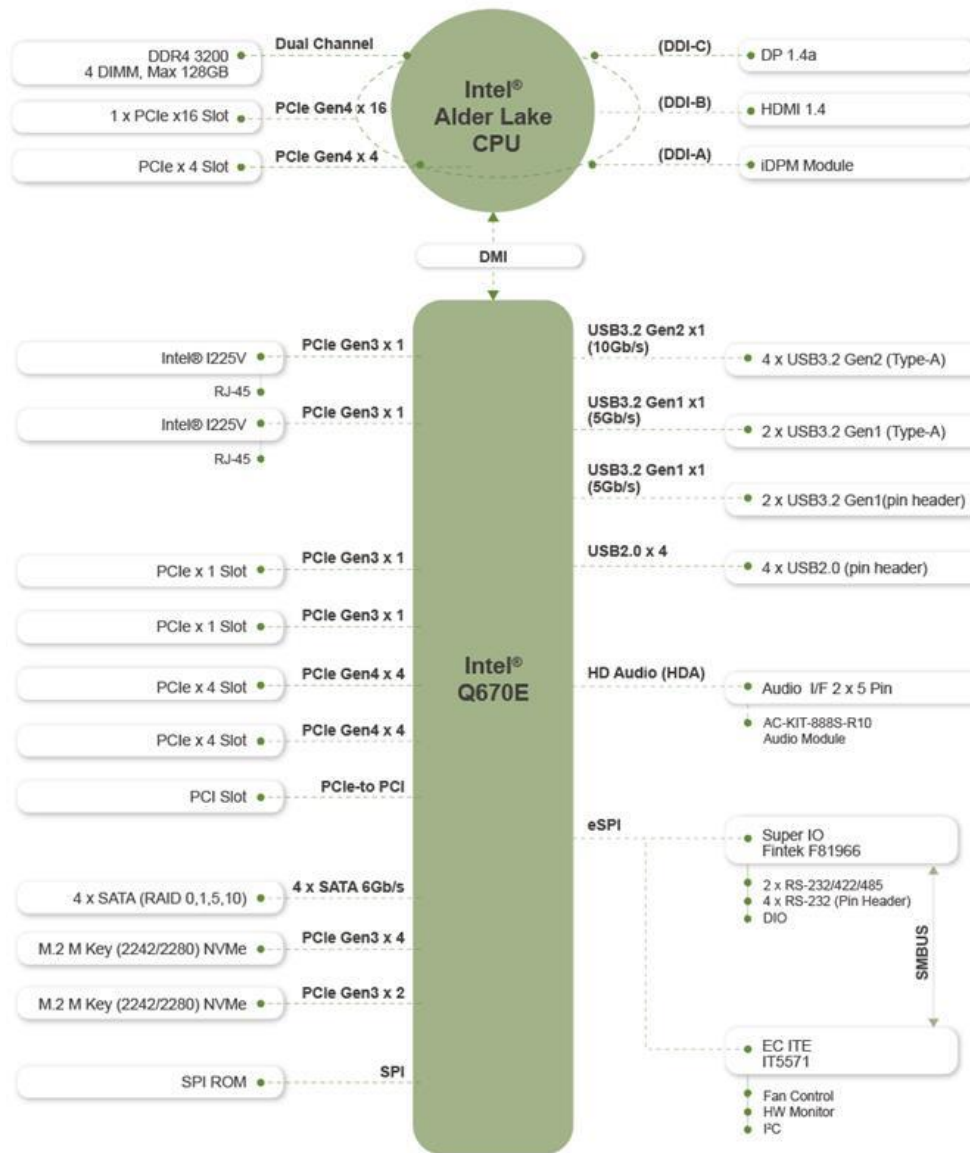

Figure 1-4: Data Flow Diagram

## IMBA-ADL-Q670

### 1.6 Technical Specifications

The IMBA-ADL-Q670 technical specifications are listed below.

Specification/Model	IMBA-ADL-Q670
<b>Form Factor</b>	ATX
<b>CPU Supported</b>	LGA1700 12th/13th Generation Intel® Core™ i9/i7/i5/i3, Celeron® and Pentium® processors (up to 125W TDP)
<b>Chipset</b>	Intel® Q670/Q670E
<b>Memory</b>	Four 288-pin 3200MHz dual-channel unbuffered DDR4 SDRAM DIMM slots supporting up to 128 GB memory
<b>Graphics Engine</b>	New Intel® Xe Graphics architecture with SRIOV, Genlock
<b>Display Output</b>	Triple independent display 1 x DP (up to 4096 x 2304 @ 60Hz) 1 x HDMI (up to 4096 x 2304 @ 30Hz) 1 x IEI iDPM eDP/ LVDS/ VGA module
<b>Ethernet Controllers</b>	<b>LAN1:</b> 2.5GbE RJ-45 port via Intel® I225LM controller <b>LAN2:</b> 2.5GbE RJ-45 port via Intel® I225V controller
<b>Audio</b>	1 x iAUDIO supports IEI AC-KIT-888S Audio Kit
<b>BIOS</b>	AMI UEFI BIOS
<b>Watchdog Timer</b>	Software programmable supports 1~255 sec. system reset
<b>Expansions</b>	1 x PCIe Gen4 x16 slot 3 x PCIe Gen4 x4 open-end slot 2 x PCIe Gen3 x1 slot 1 x PCI slot 1 x M.2 M key (2242/2280, PCIe x4), NVMe supported 1 x M.2 M key (2242/2280, PCIe x2 for SSD), NVMe supported
<b>I/O Interface Connectors</b>	
<b>Audio Connectors</b>	One internal audio connector (10-pin header)
<b>Chassis Intrusion</b>	One 2-pin header

<b>Specification/Model</b>	<b>IMBA-ADL-Q670</b>
<b>Digital I/O</b>	12-bit digital I/O
<b>Ethernet</b>	Two RJ-45 GbE ports
<b>Fan</b>	1 x CPU fan connector (1x4 pin) 2 x System fan connector (1x4 pin)
<b>Front Panel</b>	One 14-pin header (power LED, HDD LED, speaker, power button, reset button)
<b>I<sup>2</sup>C</b>	One 4-pin wafer connector
<b>TPM</b>	Intel® PTT (TPM 2.0)
<b>IPMI:</b>	Support intelligent platform management
<b>LAN LED</b>	Two 2-pin headers for LAN1 LED and LAN2 LED
<b>Serial ATA</b>	Four SATA 6Gb/s connectors (support RAID 0, 1, 5, 10)
<b>Serial Ports</b>	2 x RS-232/422/485 (RS-485 support AFC) 4 x RS-232 (2x5 pin, p=2.54)
<b>SMBus</b>	One 4-pin wafer connector
<b>USB Ports</b>	4 x USB 3.2 Gen 2 (Type-A) (10Gb/s) 2 x USB 3.2 Gen 1 (Type-A) (5Gb/s) 4 x USB 2.0 (2x4 pin, p=2.54) 2 x USB 3.2 Gen 1 (5Gb/s) (2x10 pin, p=2.00, wafer)
<b>Environmental and Power Specifications</b>	
<b>Power Supply</b>	AT/ATX power supply
<b>Power Consumption</b>	3.3V@1.04A, 5V@10.38A, 12V@5.76A, 5VSB@0.39A (Intel® Core™ i9-12900E CPU with 8 GB 3200 MHz DDR4 memory, EuP mode enabled)
<b>Operating Temperature</b>	0°C ~ 60°C
<b>Storage Temperature</b>	-30°C ~ 70°C
<b>Operating Humidity</b>	5% ~ 95% (non-condensing)
<b>Physical Specifications</b>	

## IMBA-ADL-Q670

<b>Specification/Model</b>	<b>IMBA-ADL-Q670</b>
<b>Dimensions</b>	244 mm x 305 mm
<b>Weight (GW/NW)</b>	1200g / 700g

**Table 1-1: IMBA-ADL-Q670 Specifications**

**Chapter**

**2**

# **Packing List**

---



## 2.1 Anti-static Precautions

---



### WARNING!

Static electricity can destroy certain electronics. Make sure to follow the ESD precautions to prevent damage to the product, and injury to the user.

---

Make sure to adhere to the following guidelines:

- **Wear an anti-static wristband:** Wearing an anti-static wristband can prevent electrostatic discharge.
- **Self-grounding:** Touch a grounded conductor every few minutes to discharge any excess static buildup.
- **Use an anti-static pad:** When configuring any circuit board, place it on an anti-static mat.
- **Only handle the edges of the PCB:** Don't touch the surface of the motherboard. Hold the motherboard by the edges when handling.

## 2.2 Unpacking Precautions

When the IMBA-ADL-Q670 is unpacked, please do the following:

- Follow the anti-static guidelines above.
- Make sure the packing box is facing upwards when opening.
- Make sure all the packing list items are present.



## 2.3 Packing List



**NOTE:**

If any of the components listed in the checklist below are missing, do not proceed with the installation. Contact the IEI reseller or vendor the IMBA-ADL-Q670 was purchased from or contact an IEI sales representative directly by sending an email to [sales@ieiworld.com](mailto:sales@ieiworld.com).

The IMBA-ADL-Q670 is shipped with the following components:

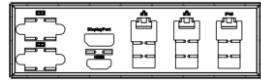
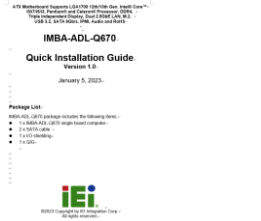





Quantity	Item and Part Number	Image
1	IMBA-ADL-Q670 single board computer	
2	SATA cable	
1	I/O shielding	
1	Quick installation guide	

**Table 2-1: Packing List**

## IMBA-ADL-Q670

### 2.4 Optional Items

The following are optional components which may be separately purchased:

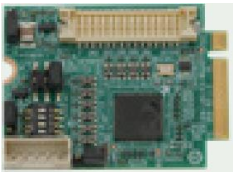
Item and Part Number	Image
Dual port USB cable with bracket, 300mm, P=2.54 (P/N: 19800-003100-100-RS)	
USB 3.0 cable 450mm with bracket (P/N: 19800-010500-200-RS)	
RS-232/422/485 cable, 230mm, P=2.54 (P/N: 32205-000702-200-RS)	
SATA power cable (P/N: 32102-000100-200-RS)	
Realtek ALC888S 7.1 Channel HD Audio board, RoHS (P/N: AC-KIT-888S-R10)	
eDP to eDP converter board (for IEI iDPM connector) (P/N: iDPM-eDP-R10)	
eDP to LVDS converter board (for IEI iDPM connector) (P/N: iDPM-LVDS-R10)	

Item and Part Number	Image
eDP to VGA converter board (for IEI iDPM connector) (P/N: iDPM-VGA-R10)	
Cooler module (P/N: 19100-000326-00-RS)	
Cooler module (P/N: 19100-000323-00-RS)	
Cooler module (P/N: 19100-000319-00-RS)	
Cooler module (P/N: 19100-000327-00-RS)	
Cooler module (P/N: 19100-000328-00-RS)	

**Table 2-2: Optional Items**

Chapter

3

# Connectors

---

### 3.1 Peripheral Interface Connectors

This chapter details all the peripheral interface connectors.

#### 3.1.1 IMBA-ADL-Q670 Layout

The figures below show all the peripheral interface connectors.

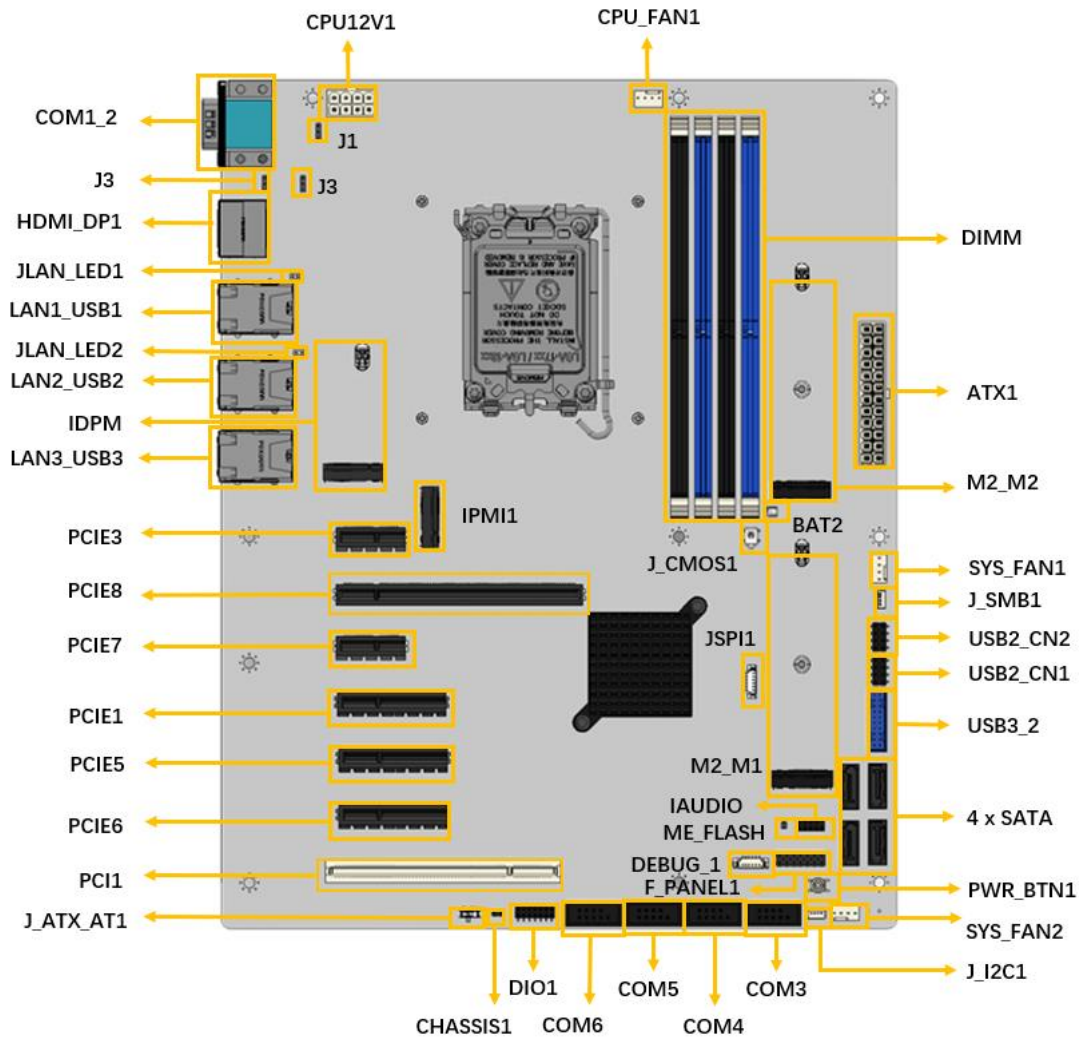

**Figure 3-1: Peripheral Interface Connectors**

### 3.1.2 Peripheral Interface Connectors

The table below lists all the connectors on the board.

Connector	Type	Label
AT/ATX power mode setting	3-pin switch	J_ATX_AT1
Clear CMOS jumper	Button	J_CMOS1
Audio connector for IEI AC-KIT-888S kit	10-pin header	IAUDIO
ATX power connector	24-pin connector	ATX1
ATX CPU 12V power connector	8-pin Molex power connector	CPU12V1
RTC battery connector	2-pin header	BAT2
Chassis intrusion connector	2-pin header	CHASSIS1
DDR4 DIMM slots	288-pin socket	CHA_DIMM0, CHA_DIMM1, CHB_DIMM0, CHB_DIMM1
Digital I/O connector	14-pin header	DIO1
EC debug connector	6-pin header	DEBUG_1
Fan connectors	4-pin header	CPU_FAN1, SYS_FAN1, SYS_FAN2
Front panel connector	14-pin header	F_PANEL1
I2C connector	4-pin wafer	J_I2C1
LAN1 link LED connector	2-pin header	JLAN_LED1
LAN2 link LED connector	2-pin header	JLAN_LED2
RS-232 serial port connectors	10-pin header	COM3, COM4, COM5, COM6
SATA 6Gb/s connectors	8-pin SATA connector	SATA1, SATA2, SATA3, SATA4

Connector	Type	Label
SMBus connector	4-pin wafer	J_SMB1
Flash SPI ROM connector	6-pin header	JSPI1
Internal USB 2.0 connectors	8-pin header	USB2_CN1, USB2_CN2
Internal USB 3.2 Gen 1 connector	20-pin box header	USB3_2
M.2 M key slots	M-key slot	M2_M1, M2_M2
IEI iDPM slot	IDPM slot	IDPM
IPMI (Intelligent Platform Management Interface) slot	IPMI slot	IPMI1
PCI slot	PCI slot	PCI1
PCIe x1 slots	PCIe x1 Slot	PCIE3, PCIE7
PCIe x4 slots	PCIe x4 slot	PCIE1, PCIE5, PCIE6
PCIe x16 slot	PCIe x16 slot	PCIE8
Onboard power button	Push button	PWR_BTN1

**Table 3-1: Peripheral Interface Connectors**

### 3.1.3 External Interface Panel Connectors

The table below lists the connectors on the external I/O panel.

Connector	Type	Label
External dual RS-232/422/485 connector	DB-9	COM1_2
External HDMI and DP combo connector	HDMI, DP	HDMI_DP1
External 2.5GbE RJ-45 and dual USB 3.2	USB 3.2, RJ45	LAN1_USB1
Gen 1 combo connector	USB 3.2, RJ45	LAN2_USB2
External 2.5GbE RJ-45 and dual USB 3.2	USB 3.2, RJ45	LAN3_USB3

**Table 3-2: Rear Panel Connectors**



IMBA-ADL-Q670

### 3.2 Internal Peripheral Connectors

The section describes all of the connectors on the IMBA-ADL-Q670.

#### 3.2.1 CPU 12V Power Connector

- CN Label:** CPU12V1
- CN Type:** 8-pin Molex power connector, p=4.2mm
- CN Location:** See Figure 3-2
- CN Pinouts:** See Table 3-3

This connector provides power to the CPU.

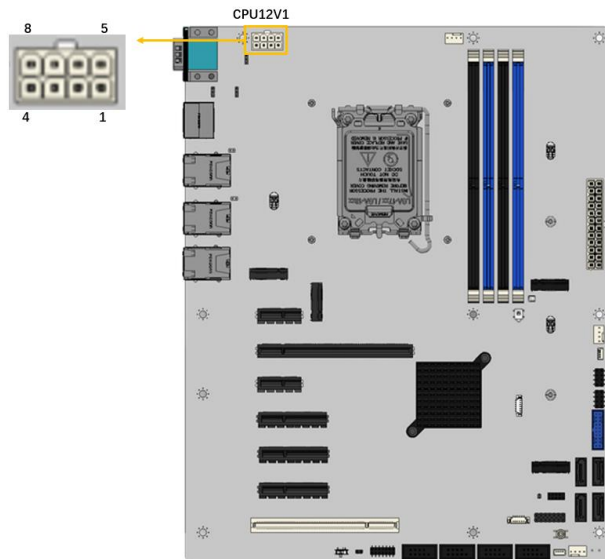

Figure 3-2: CPU 12V Power Connector Location

PIN NO.	DESCRIPTION	PIN NO.	DESCRIPTION
1	GND	5	+12V
2	GND	6	+12V
3	GND	7	+12V
4	GND	8	+12V

Table 3-3: CPU 12V Power Connector Pinouts

### 3.2.2 ATX Power Connector

- CN Label:** ATX1
- CN Type:** 24-pin connector, p=4.2 mm
- CN Location:** See Figure 3-3
- CN Pinouts:** See Table 3-4

The ATX power connector connects to an ATX power supply.

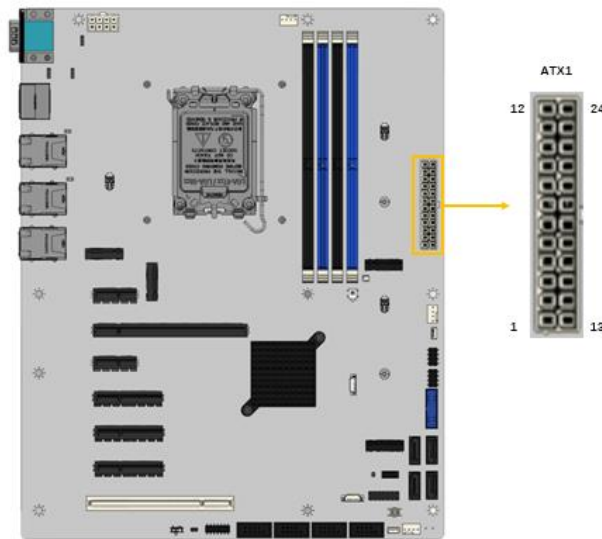

**Figure 3-3: ATX Power Connector Location**

Pin	Description	Pin	Description
1	+3.3V	13	+3.3V
2	+3.3V	14	-12V
3	GND	15	GND
4	+5V	16	PS_ON
5	GND	17	GND
6	+5V	18	GND
7	GND	19	GND
8	Power good	20	-5V
9	5VSB	21	+5V
10	+12V	22	+5V

## IMBA-ADL-Q670

Pin	Description	Pin	Description
11	+12V	23	+5V
12	+3.3V	24	GND

Table 3-4: ATX Power Connector Pinouts

### 3.2.3 Battery Connector

**CAUTION:**

Risk of explosion if battery is replaced by an incorrect type. Only certified engineers should replace the on-board battery.

Dispose of used batteries according to instructions and local regulations.

**NOTE:**

It is recommended to attach the RTC battery onto the system chassis in which the IMBA-ADL-Q670 is installed.

- CN Label:**            **BAT2**
- CN Type:**            2-pin header
- CN Location:**      See **Figure 3-4**
- CN Pinouts:**        See **Table 3-5**

A system battery is placed in the battery holder. The battery provides power to the system clock to retain the time when power is turned off.

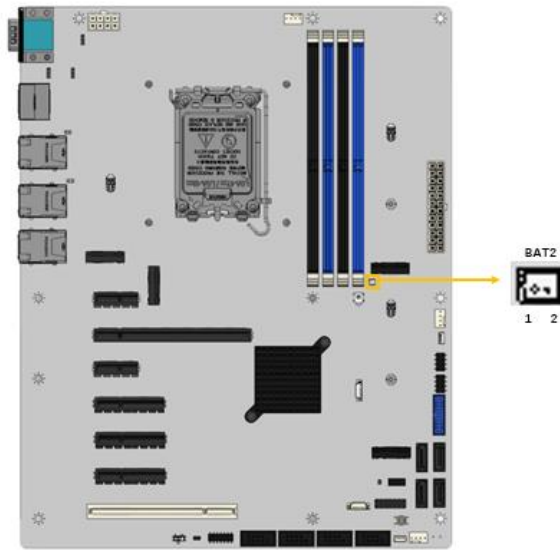

**Figure 3-4: Battery Connector Location**

Pin	Description	Pin	Description
1	VBATT	2	GND

**Table 3-5: Battery Connector Pinouts**

IMBA-ADL-Q670

3.2.4 Chassis Intrusion Connector

- CN Label:** CHASSIS1
- CN Type:** 2-pin header, p=2.54 mm
- CN Location:** See Figure 3-5
- CN Pinouts:** See Table 3-6

The chassis intrusion connector is for a chassis intrusion detection sensor or switch that detects if a chassis component is removed or replaced.

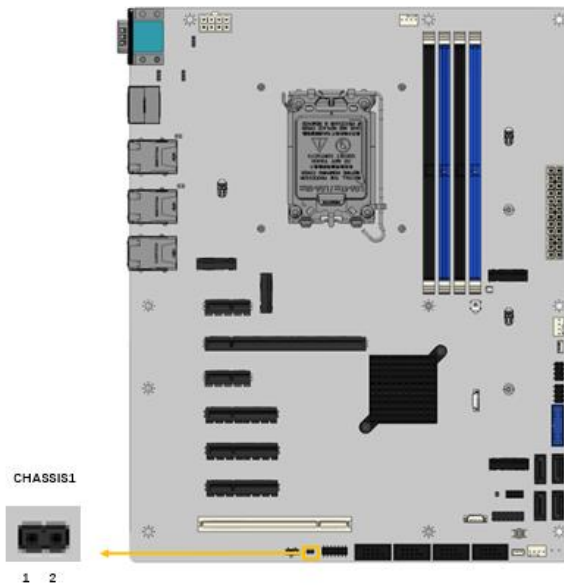

Figure 3-5: Chassis Intrusion Connector Location

Pin	Description	Pin	Description
1	CASEOPEN_N	2	GND

Table 3-6: Chassis Intrusion Connector Pinouts

### 3.2.5 AT/ATX Power Mode Setting

- CN Label:** J\_ATX\_AT1
- CN Type:** 3-pin switch
- CN Location:** See Figure 3-6
- CN Pinouts:** See Table 3-7

The AT/ATX power mode selection is made through the AT/ATX power mode switch.

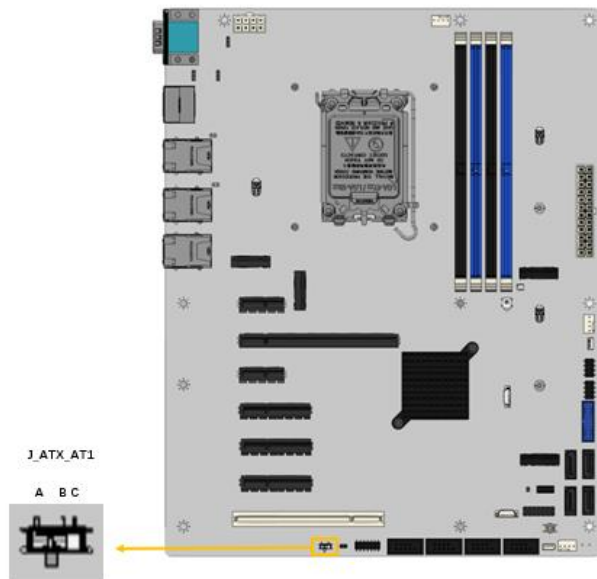

**Figure 3-6: AT/ATX Power Mode Switch Location**

Pin	Description	Pin	Description
Short A - B	ATX Power Mode (default)	Short B - C	AT Power Mode

**Table 3-7: AT/ATX Power Mode Switch Settings**

IMBA-ADL-Q670

3.2.6 Digital I/O Connector

- CN Label:** DIO1
- CN Type:** 14-pin header, p=2.0 mm
- CN Location:** See Figure 3-7
- CN Pinouts:** See Table 3-8

The Digital I/O connector provides programmable input and output for external devices.

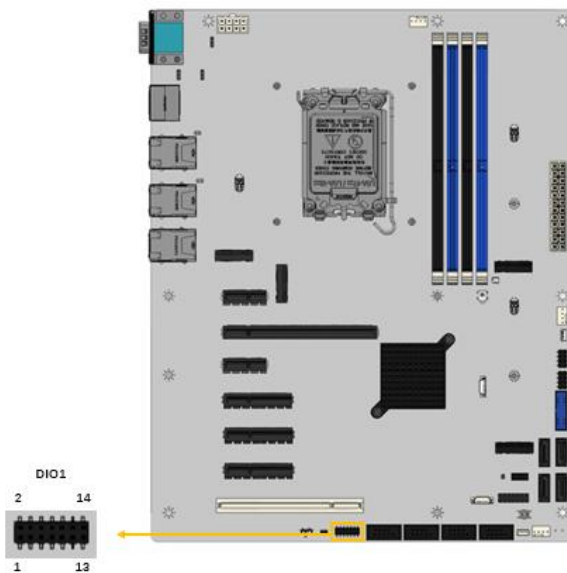

Figure 3-7: Digital I/O Connector Location

Pin	Description	Pin	Description
1	GND	2	VCC
3	Output 5	4	Output 4
5	Output 3	6	Output 2
7	Output 1	8	Output 0
9	Input 5	10	Input 4
11	Input 3	12	Input 2
13	Input 1	14	Input 0

Table 3-8: Digital I/O Connector Pinouts

### 3.2.7 EC Debug Connector

- CN Label:**        **DEBUG\_1**
- CN Type:**        6-pin header
- CN Location:**    See **Figure 3-8**
- CN Pinouts:**     See **Table 3-9**

The EC debug connector is used for EC debug.

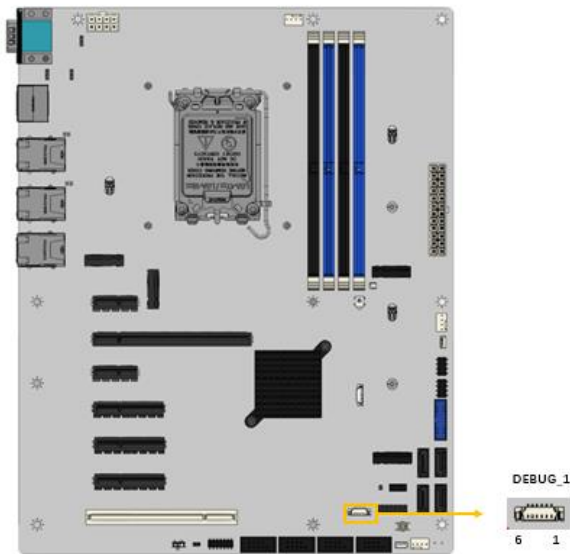

**Figure 3-8: EC Debug Connector Location**

Pin	Description	Pin	Description
1	NC	4	EDICK
2	EDICS	5	EDIDI
3	EDIDO	6	GND

**Table 3-9: EC Debug Connector Pinouts**



**IMBA-ADL-Q670**

**3.2.8 Clear CMOS Button**

- CN Label:** J\_CMOS1
- CN Type:** Button
- CN Location:** See Figure 3-9
- CN Pinouts:** See Table 3-10

The J\_CMOS1 is used to Clear CMOS Setup.

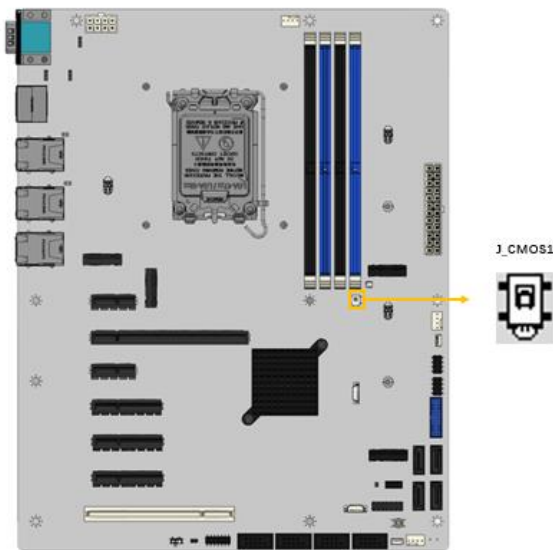

**Figure 3-9: Clear CMOS Jumper Location**

Pin	Description
NC	Keep CMOS Setup (Normal Operation)
Press	Clear CMOS Setup

**Table 3-10: Clear CMOS Jumper Pinouts**

### 3.2.9 Fan Connector (CPU)

- CN Label:** CPU\_FAN1
- CN Type:** 4-pin header, p=2.54 mm
- CN Location:** See **Figure 3-10**
- CN Pinouts:** See **Table 3-11**

The fan connector attaches to a CPU cooling fan.

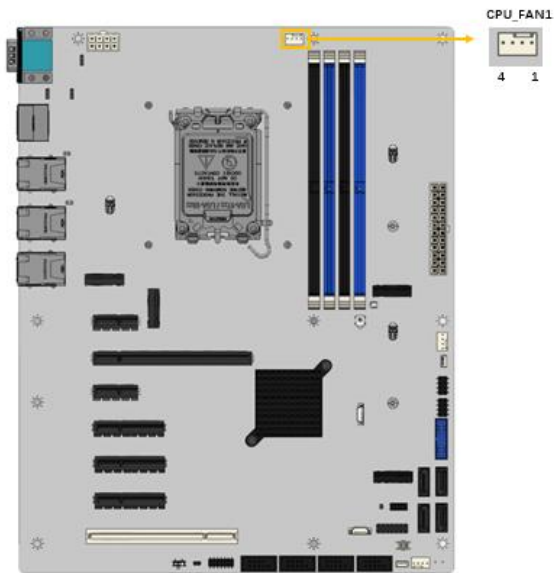

**Figure 3-10: CPU Fan Connector Location**

Pin	Description	Pin	Description
1	GND	2	+12V
3	FANIO	4	PWM (+5V)

**Table 3-11: CPU Fan Connector Pinouts**

**IMBA-ADL-Q670**

**3.2.10 Fan Connectors (System)**

- CN Label:** SYS\_FAN1, SYS\_FAN2
- CN Type:** 4-pin header, p=2.54 mm
- CN Location:** See Figure 3-11
- CN Pinouts:** See Table 3-12

Fan connector attaches to a system cooling fan. The fan connector provides smart fan function.

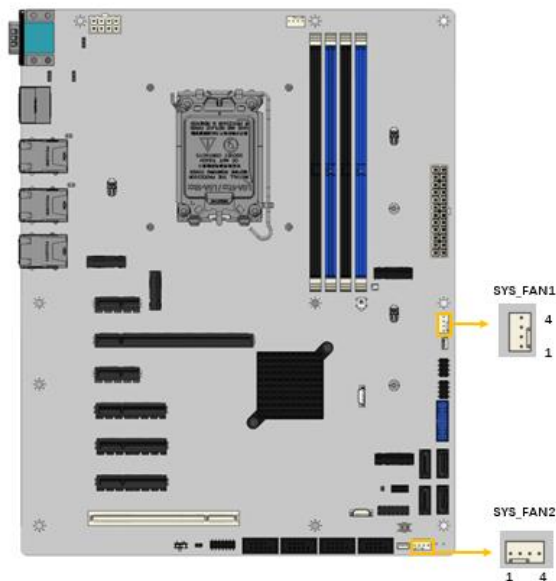

**Figure 3-11: System Fan Connector Locations**

Pin	Description	Pin	Description
1	GND	2	+12V
3	FANIO	4	PWM (+5V)

**Table 3-12: System Fan Connector Pinouts**

**3.2.11 Audio Connector for iEi AC-KIT-888S kit**

- CN Label:** IAUDIO
- CN Type:** 10-pin header, p=2.54 mm
- CN Location:** See **Figure 3-12**
- CN Pinouts:** See **Table 3-13**

This connector connects to speakers, a microphone and an audio input.

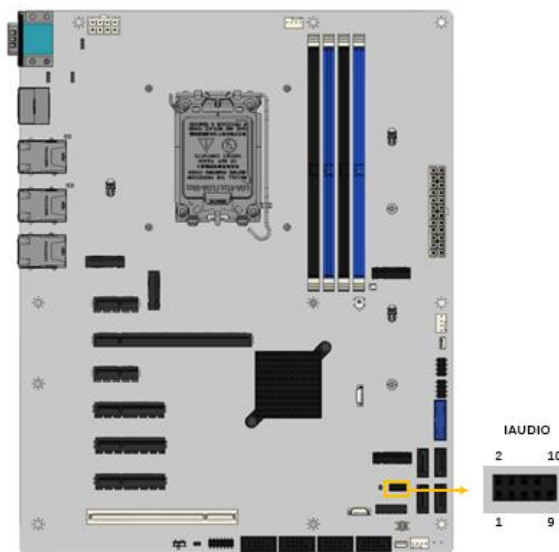

**Figure 3-12: Audio Connector Location**

Pin	Description	Pin	Description
1	HDA_SYNC_R	2	HDA_BCLK_R
3	HDA_SDO_R	4	HDA_PCBEPC
5	HDA_SDI_0_R	6	HDA_RST_R
7	+5V	8	GND
9	+12V	10	GND

**Table 3-13: Audio Connector Pinouts**

IMBA-ADL-Q670

3.2.12 Front Panel Connector

- CN Label:** F\_PANEL1
- CN Type:** 14-pin header, p=2.54 mm
- CN Location:** See Figure 3-13
- CN Pinouts:** See Table 3-14

The front panel connector connects to the indicator LEDs and buttons on the computer's front panel.

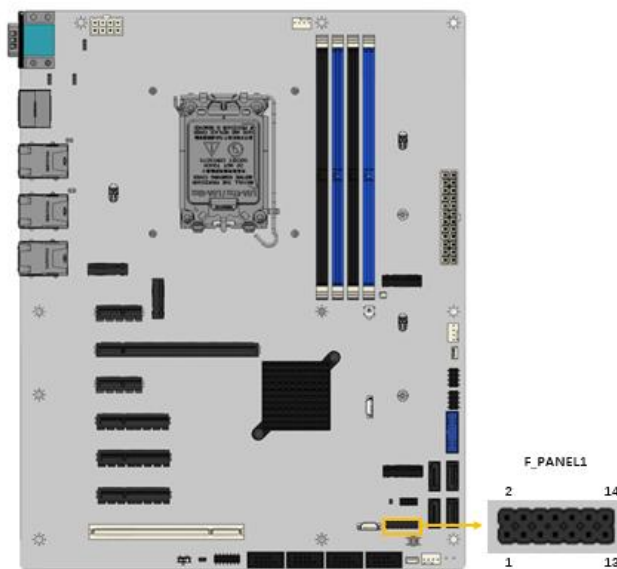

Figure 3-13: Front Panel Connector Location

Function	Pin	Description	Pin	Description	
PWR LED	1	PWR_LED+	2	SPKR+	SPKR
	3	NC	4	NC	
	5	PWR_LED-	6	NC	
PWR BTN	7	PWR_BTN+	8	SPKR-	
	9	PWR_BTN-	10	NC	
HDD LED	11	HDD_LED+	12	Reset+	RESET
	13	HDD_LED-	14	Reset-	

Table 3-14: Front Panel Connector Pinouts

### 3.2.13 I<sup>2</sup>C Connector

- CN Label:** J\_I2C1
- CN Type:** 4-pin wafer, p=1.25 mm
- CN Location:** See **Figure 3-14**
- CN Pinouts:** See **Table 3-15**

The I<sup>2</sup>C connector is used to connect I<sup>2</sup>C-bus devices to the mainboard.



**Figure 3-14: I<sup>2</sup>C Connector Location**

Pin	Description	Pin	Description
1	GND	3	I2C_CLK
2	I2C_DATA	4	+5V

**Table 3-15: I<sup>2</sup>C Connector Pinouts**

**IMBA-ADL-Q670**

**3.2.14 SMBus Connector**

- CN Label:** J\_SMB1
- CN Type:** 4-pin wafer, p=1.25 mm
- CN Location:** See Figure 3-15
- CN Pinouts:** See Table 3-16

The SMBus (System Management Bus) connector provides low-speed system management communications.

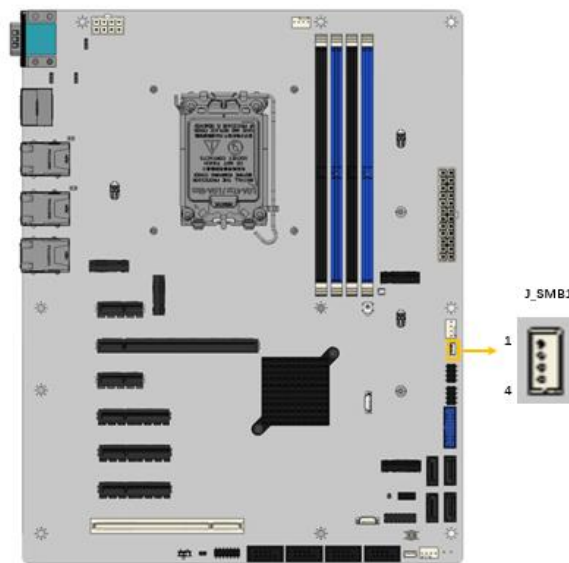

**Figure 3-15: SMBus Connector Location**

Pin	Description
1	GND
2	SMB_DATA
3	SMB_CLK
4	+5V

**Table 3-16: SMBus Connector Pinouts**

### 3.2.15 LAN Link LED connector

- CN Label:** JLAN\_LED1, JLAN\_LED2
- CN Type:** 2-pin header, p=2.00 mm
- CN Location:** See **Figure 3-16**
- CN Pinouts:** See **Table 3-17** and **Table 3-18**

The LAN LED connectors are used to connect to the LAN LED indicators on the chassis to indicate users the link activities of the two LAN ports.

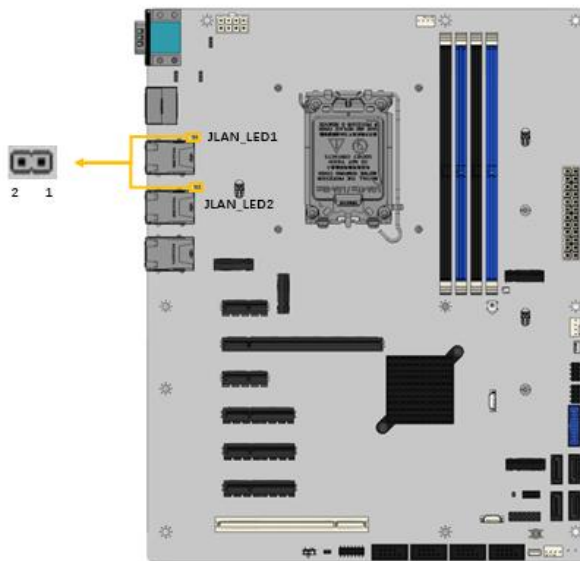

**Figure 3-16: LAN LED Connector Locations**

Pin	Description
1	+3.3V
2	I225_LINK_ACT_N_1

**Table 3-17: LAN1 LED Connector (JLAN\_LED1) Pinouts**

Pin	Description
1	+3.3V
2	I225_LINK_ACT_N_2

**Table 3-18: LAN2 LED Connector (JLAN\_LED 2) Pinouts**



**IMBA-ADL-Q670**

**3.2.16 Internal USB 2.0 connectors**

- CN Label:** USB2\_CN1, USB2\_CN2
- CN Type:** 8-pin header, p=2.54 mm
- CN Location:** See Figure 3-17
- CN Pinouts:** See Table 3-19

The Internal USB 2.0 connectors connect to USB 2.0 devices.

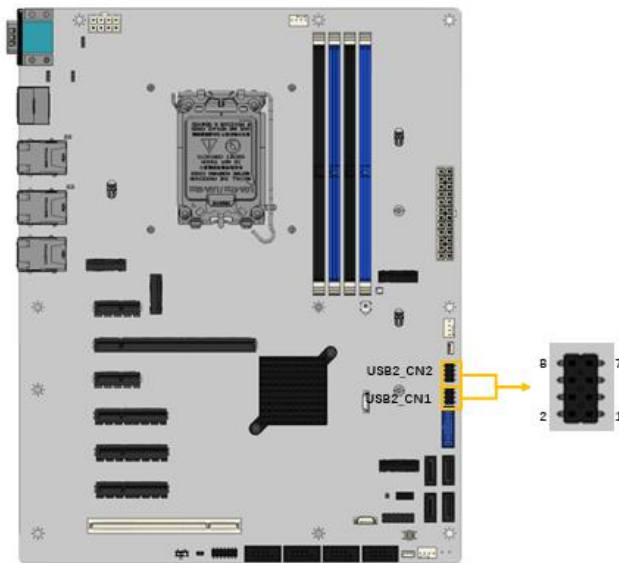

**Figure 3-17: Internal USB 2.0 Connector Location**

Pin	Description	Pin	Description
1	VCC	2	GND
3	USB_DATA-	4	USB_DATA+
5	USB_DATA+	6	USB_DATA-
7	GND	8	VCC

**Table 3-19: Internal USB 2.0 Connector Pinouts**

### 3.2.17 Internal USB 3.2 Gen 1 connector

- CN Label:** USB3\_2
- CN Type:** 20-pin box header, p=2.00 mm
- CN Location:** See Figure 3-18
- CN Pinouts:** See Table 3-20

The Internal USB 2.0 connectors connect to USB 2.0 devices.

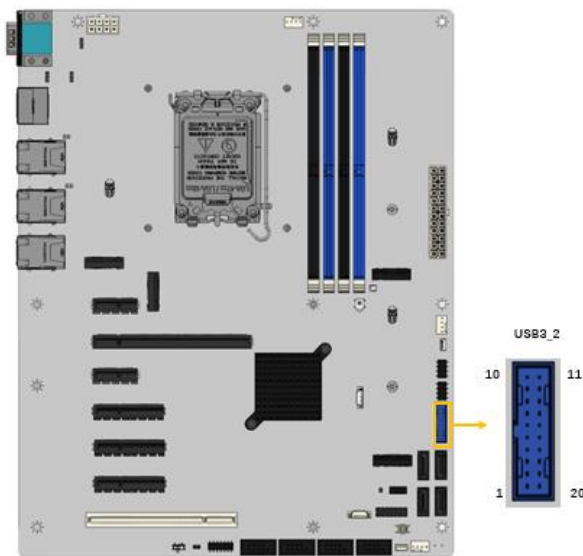

**Figure 3-18: Internal USB 3.2 Gen 1 Connector Location**

Pin	Description	Pin	Description
1	+5V	11	USB2_4_P
2	USB3_RX3_N	12	USB2_4_N
3	USB3_RX3_P	13	GND
4	GND	14	USB3_TX4_P
5	USB3_TX3_N	15	USB3_TX4_N
6	USB3_TX3_P	16	GND
7	GND	17	USB3_RX4_P
8	USB2_3_N	18	USB3_RX4_N
9	USB2_3_P	19	+5V
10	N/C		

IMBA-ADL-Q670

Table 3-20: Internal USB 3.2 Gen 1 Connector Pinouts

3.2.18 M.2 M-key Slot

- CN Label:** M2\_M1, M2\_M2
- CN Type:** M-key slot
- CN Location:** See Figure 3-19
- CN Pinouts:** See Table 3-21

The M.2 2242/2280 slot is keyed in the M position.

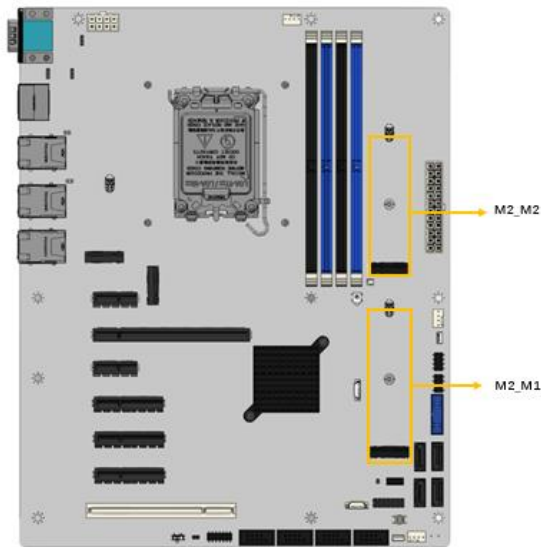

Figure 3-19: M.2 M-key Slot Location

Pin	Description	Pin	Description
1	GND	2	+3.3V
3	GND	4	+3.3V
5	N/C	6	N/C
7	N/C	8	N/C
9	GND	10	NGFF2_ACT_N
11	N/C	12	+3.3V
13	N/C	14	+3.3V

Pin	Description	Pin	Description
15	GND	16	+3.3V
17	N/C	18	+3.3V
19	N/C	20	N/C
21	GND	22	N/C
23	N/C	24	N/C
25	N/C	26	N/C
27	GND	28	N/C
29	PCIE_18_RX_DN	30	N/C
31	PCIE_18_RX_DP	32	N/C
33	GND	34	N/C
35	PCIE_18_TX_DN18	36	N/C
37	PCIE_18_TX_DP18	38	M_2_SATA_SLP
39	GND	40	N/C
41	PCIE_17_RX_DN	42	N/C
43	PCIE_17_RX_DP	44	N/C
45	GND	46	N/C
47	PCIE_17_TX_DN17	48	N/C
49	PCIE_17_TX_DP17	50	PERST_N
51	GND	52	SRCCLKREQB_15_N
53	PCIE_SRC15_DN	54	NC
55	PCIE_SRC15_DP	56	N/C
57	GND	58	N/C
59	N/C	60	N/C
61	N/C	62	N/C
63	N/C	64	N/C
65	N/C	66	N/C
67	N/C	68	NC
69	N/C	70	+3.3V
71	GND	72	+3.3V
73	GND	74	+3.3V
75	GND		

**Table 3-21: M.2 M-key Connector Pinouts**

**IMBA-ADL-Q670**

**3.2.19 IEI iDPM slot**

- CN Label:** IDPM
- CN Type:** IDPM slot
- CN Location:** See **Figure 3-19**
- CN Pinouts:** See **Table 3-21**

The iDPM slot is only for IEI eDP/LVDS/VGA module

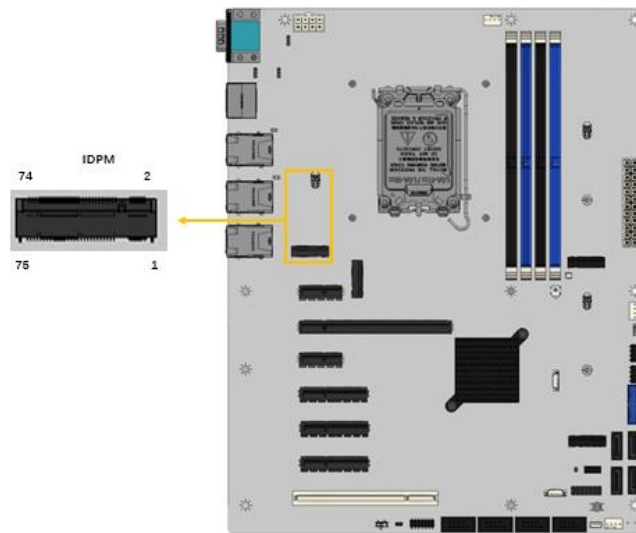

**Figure 3-20: iDPM Slot Location**

<b>Pin</b>	<b>Description</b>	<b>Pin</b>	<b>Description</b>
1	GND	2	+3.3V
3	GND	4	+3.3V
5	N/C	6	N/C
7	N/C	8	N/C
9	GND	10	NGFF2_ACT_N
11	N/C	12	+3.3V
13	N/C	14	+3.3V
15	GND	16	+3.3V
17	N/C	18	+3.3V
19	N/C	20	N/C

Pin	Description	Pin	Description
21	GND	22	N/C
23	N/C	24	N/C
25	N/C	26	N/C
27	GND	28	N/C
29	PCIE_18_RX_DN	30	N/C
31	PCIE_18_RX_DP	32	N/C
33	GND	34	N/C
35	PCIE_18_TX_DN18	36	N/C
37	PCIE_18_TX_DP18	38	M_2_SATA_SLP
39	GND	40	N/C
41	PCIE_17_RX_DN	42	N/C
43	PCIE_17_RX_DP	44	N/C
45	GND	46	N/C
47	PCIE_17_TX_DN17	48	N/C
49	PCIE_17_TX_DP17	50	PERST_N
51	GND	52	SRCCLKREQB_15_N
53	PCIE_SRC15_DN	54	NC
55	PCIE_SRC15_DP	56	N/C
57	GND	58	N/C
59	N/C	60	N/C
61	N/C	62	N/C
63	N/C	64	N/C
65	N/C	66	N/C
67	N/C	68	NC
69	N/C	70	+3.3V
71	GND	72	+3.3V
73	GND	74	+3.3V
75	GND		

Table 3-22: iDPM Connector Pinouts

## IMBA-ADL-Q670

### 3.2.20 IPMI (Intelligent Platform Management Interface) slot

<b>CN Label:</b>	<b>IPMI1</b>
<b>CN Type:</b>	IPMI slot
<b>CN Location:</b>	See <b>Figure 3-19</b>
<b>CN Pinouts:</b>	See <b>Table 3-21</b>

The iDPM slot is an Intelligent Platform Management Interface.

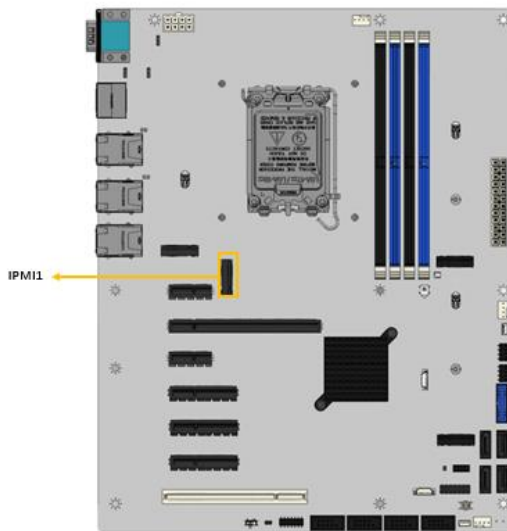
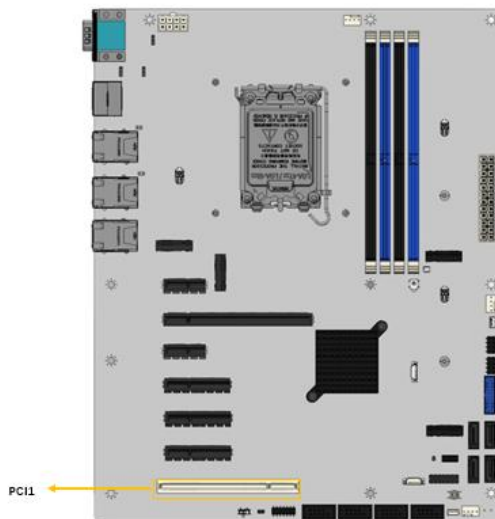

**Figure 3-21: IPMI Slot Location**

### 3.2.21 PCI Slot

- CN Label:** PCI1
- CN Type:** PCI Slot
- CN Location:** See **Figure 3-23**

The PCI slot enables a PCI expansion module to be connected to the board.



**Figure 3-22: PCI Slot Location**



## IMBA-ADL-Q670

### 3.2.22 PCIe x1 Slots

<b>CN Label:</b>	<b>PCIE3, PCIE7</b>
<b>CN Type:</b>	PCIe x1 Slot
<b>CN Location:</b>	See <b>Figure 3-23</b>

The PCIe x1 slot enables a PCIe x1 expansion module to be connected to the board.

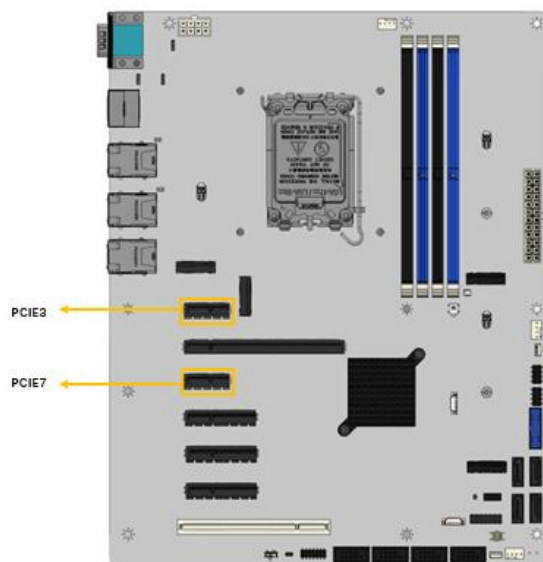

**Figure 3-23: PCIe x1 Slot Locations**

### 3.2.23 PCIe x4 Slots

**CN Label:** PCIE1, PCIE5, PCIE6

**CN Type:** PCIe x4 slot

**CN Location:** See **Figure 3-24**

The PCIe x4 expansion card slots are for PCIe x4 expansion cards.

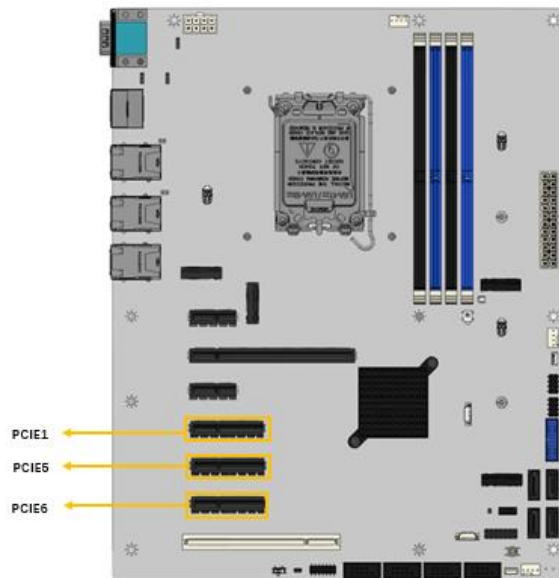

**Figure 3-24: PCIe x4 Slot Locations**

## IMBA-ADL-Q670

### 3.2.24 PCIe x16 slots

- CN Label:** PCIE8
- CN Type:** PCIe x16 slot
- CN Location:** See Figure 3-25

The PCIe x16 expansion card slots are for PCIe x16 expansion cards.

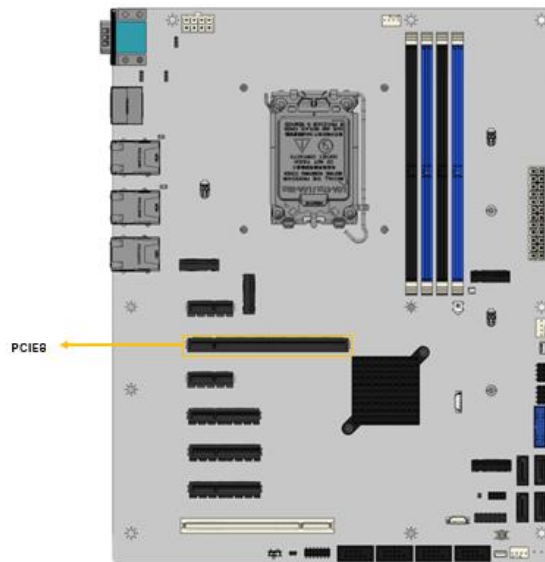
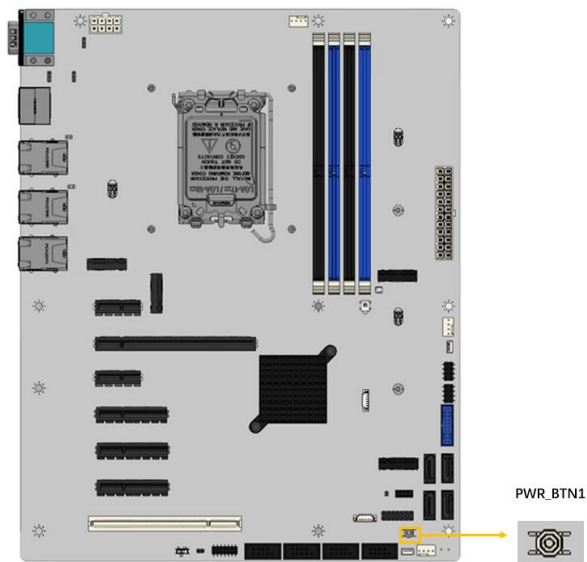

Figure 3-25: PCIe x16 Slot Location

### 3.2.25 Onboard Power Button

- CN Label:** PWR\_BTN1
- CN Type:** Push button
- CN Location:** See **Figure 3-26**

The on-board power button controls system power.



**Figure 3-26: Power Button Location**

## IMBA-ADL-Q670

### 3.2.26 DDR4 DIMM sockets

**CN Label:** CHA\_DIMM0, CHA\_DIMM1, CHB\_DIMM0, CHB\_DIMM1

**CN Type:** 288-pin socket

**CN Location:** See Figure 3-27

The DIMM slots are for DDR4 DIMM memory modules

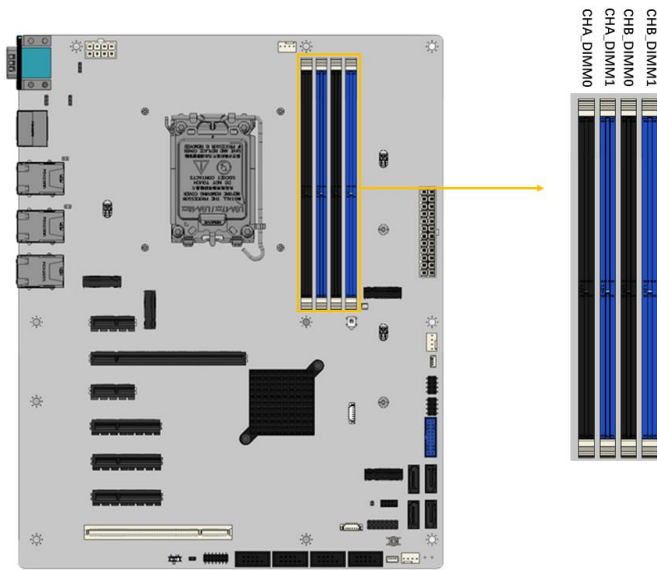
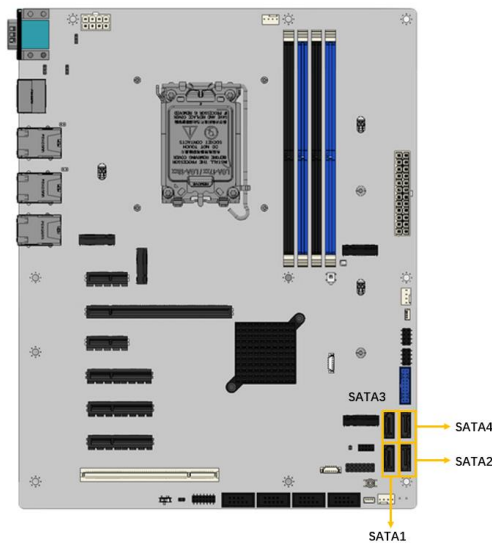

Figure 3-27: DDR4 DIMM Sockets Location

### 3.2.27 SATA 6Gb/s Connectors

- CN Label:** SATA1, SATA2, SATA3, SATA4
- CN Type:** 8-pin SATA connector
- CN Location:** See Figure 3-28
- CN Pinouts:** See Table 3-23

The SATA drive connectors can be connected to SATA drives and support up to 6Gb/s data transfer rate.



**Figure 3-28: SATA 6Gb/s Connector Locations**

Pin	Description
1	GND
2	SATA_TX+
3	SATA_TX-
4	GND
5	SATA_RX-
6	SATA RX+
7	GND
8	N/C

**Table 3-23: SATA 6Gb/s Connector Pinouts**

IMBA-ADL-Q670

3.2.28 RS-232 Serial Port Connectors

- CN Label:** COM3-6
- CN Type:** 10-pin header, p=2.54 mm
- CN Location:** See Figure 3-29
- CN Pinouts:** See Table 3-24

Each of these connectors provides RS-232 communications.

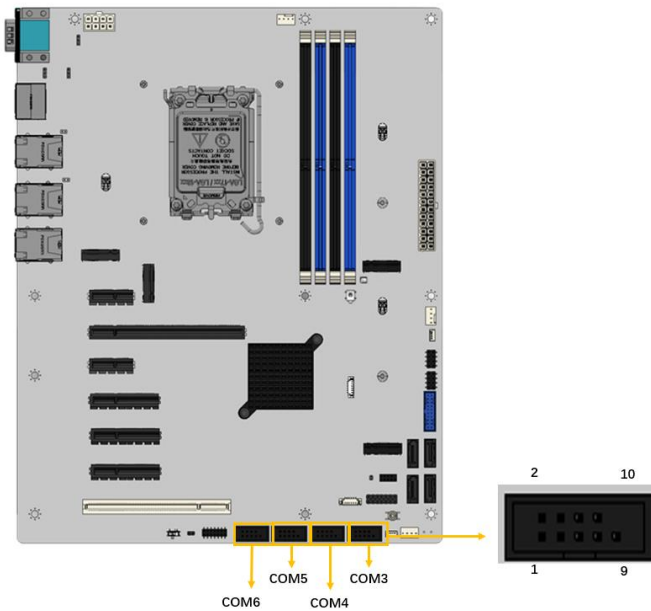

Figure 3-29: RS-232 Connector Location

Pin	Description	Pin	Description
1	DCD	2	DSR
3	RXD	4	RTS
5	TXD	6	CTS
7	DTR	8	RI
9	GND	10	NC

Table 3-24: RS-232 Connector Pinouts

### 3.2.29 Flash SPI ROM Connector

- CN Label:** JSPI1
- CN Type:** 6-pin header, p=1.25 mm
- CN Location:** See **Figure 3-30**
- CN Pinouts:** See **Table 3-25**

The Flash SPI ROM connector is used to flash the SPI ROM.

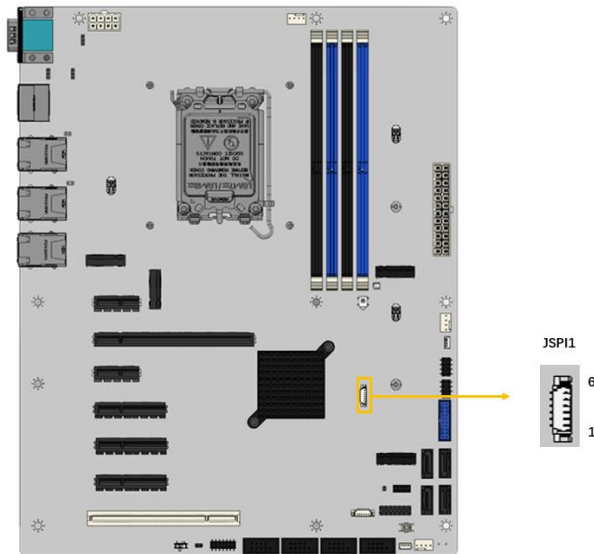

**Figure 3-30: Flash SPI ROM Connector Location**

Pin	Description	Pin	Description
1	+3.3V	4	SPI_CLK
2	SPI_CS#	5	SPI_SI
3	SPI_SO	6	GND

**Table 3-25: Flash SPI ROM Connector Pinouts**



### 3.3 External Peripheral Interface Connector Panel

The figure below shows the external peripheral interface connector (EPIC) panel. The EPIC panel consists of the following:

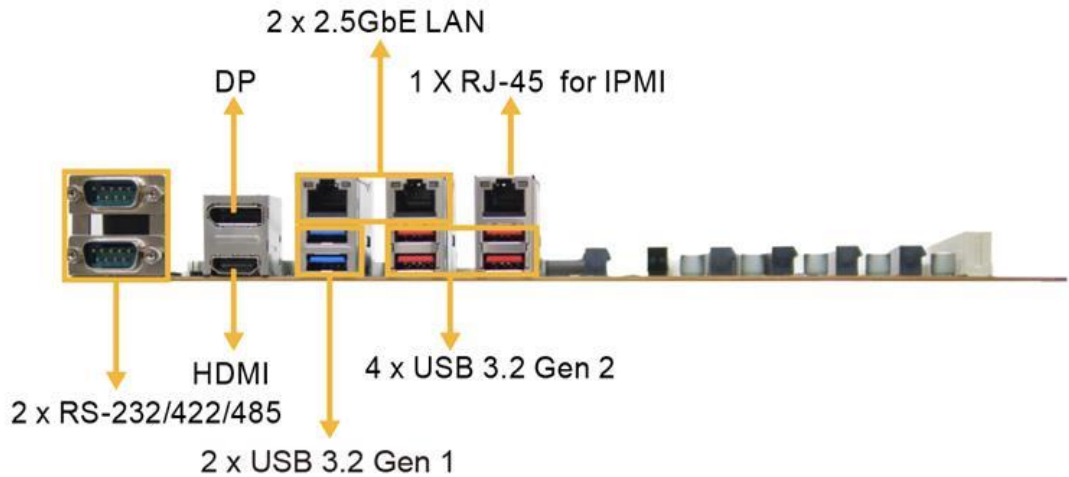

Figure 3-31: External Peripheral Interface Connector

#### 3.3.1 External dual RS-232/422/485 connector

- CN Label:** COM1\_2
- CN Type:** DB-9
- CN Location:** See Figure 3-26
- CN Pinouts:** See Table 3-28

The COM connector connects to a serial device that supports RS-232/422/485 communication.

	RS-232	RS-422	RS-485
1	DCD	TXD422-	TXD485-
2	RXD	TXD422+	TXD485+
3	TXD	RXD422+	--
4	DTR	RXD422-	--
5	GND	--	--
6	DSR	--	--
7	RTS	--	--

8	CTS	--	--
9	RI	--	--

**Table 3-26: External RS-232/422/485 Connector Pinouts**

Use the optional RS-232/422/485 cable to connect to a serial device. The pinouts of the DB-9 connector are listed below.

RS-232 Pinouts	RS-422 Pinouts	RS-485 Pinouts
<p>DSR(6) 6 RTS(7) 7 CTS(8) 8 RI(9) 9</p> <p>1 DCD(1) 2 SIN(2) 3 SOUT(3) 4 DTR(4) 5 GND(5)</p> <p>D-SUB 9PIN MALE MODE 01</p>	<p>6 7 8 9</p> <p>1 TX- (TXD485#) 2 TX+ (TXD485+) 3 RX+ (RXD485+) 4 RX- (RXD485#) 5</p> <p>D-SUB 9PIN MALE MODE 00</p>	<p>6 7 8 9</p> <p>1 TX- (TXD485#) 2 TX+ (TXD485+) 3 4 5</p> <p>D-SUB 9PIN MALE MODE 10/11</p>

**Figure 3-32: DB-9 RS-232/422/485 Pinouts**

### 3.3.2 External HDMI and DP combo connector

- CN Label:** HDMI\_DP1
- CN Type:** HDMI, DP
- CN Location:** See **Figure 3-33**, **Figure 3-34**
- CN Pinouts:** See **Table 3-27**, **Table 3-28**

The external DP connector on the IMBA-ADL-Q670.

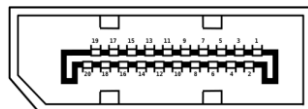

**Figure 3-33: External DP Connector Pinouts**

## IMBA-ADL-Q670

Pin	Description	Pin	Description
1	LANE0P	11	GND
2	GND	12	LANE3N
3	LANE0N	13	AUX_CTRL_DET_C
4	LANE1P	14	GND
5	GND	15	AUXP
6	LANE1N	16	GND
7	LANE2P	17	AUXN
8	GND	18	HPD
9	LANE2N	19	GND
10	LANE3P	20	+5V

**Table 3-27: External DP Connector Pinouts**

The external HDMI connector on the IMBA-ADL-Q670.

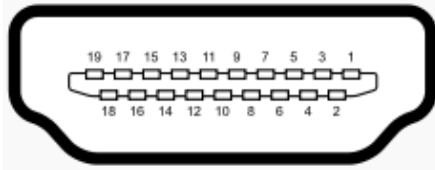

**Figure 3-34: External HDMI Connector Location**

Pin	Description	Pin	Description
21	HDMI_DATA2	31	GND
22	GND	32	HDMI_CLK#
23	HDMI_DATA2#	33	N/C
24	HDMI_DATA1	34	N/C
25	GND	35	HDMI_SCL
26	HDMI_DATA1#	36	HDMI_SDA
27	HDMI_DATA0	37	GND
28	GND	38	+5V
29	HDMI_DATA0#	39	HDMI_HPD
30	HDMI_CLK		

**Table 3-28: External HDMI Connector Pinouts**

**3.3.3 External 2.5GbE RJ-45 and dual USB 3.2 Gen 1 combo connector**

- CN Label:** LAN1\_USB1,
- CN Type:** USB 3.2, RJ45
- CN Location:** See **Figure 3-35**
- CN Pinouts:** See **Table 3-29** and **Table 3-30**

The external dual USB 3.2 Gen 1 connector and 2.5GbE RJ-45 Connector on the IMBA-ADL-Q670.



**Figure 3-35: USB 3.2 and RJ45 Connector**

The USB 3.2 connector.

<b>Pin</b>	<b>Description</b>	<b>Pin</b>	<b>Description</b>
1	VCC	10	VCC
2	USB_DATA-	11	USB_DATA-
3	USB_DATA+	12	USB_DATA+
4	GND	13	GND
5	USB3_RX-	14	USB3_RX-
6	USB3_RX+	15	USB3_RX+
7	GND	16	GND
8	USB3_TX-	17	USB3_TX-
9	USB3_TX+	18	USB3_TX+

**Table 3-29: USB 3.2 Port Pinouts**

**IMBA-ADL-Q670**

The dual 2.5GbE RJ-45 connector.

<b>PIN</b>	<b>DESCRIPTION</b>	<b>PIN</b>	<b>DESCRIPTION</b>
20	LAN1_MDI0P	24	LAN1_MDI2P
21	LAN1_MDI0N	25	LAN1_MDI2N
22	LAN1_MDI1P	26	LAN1_MDI3P
23	LAN1_MDI1N	27	LAN1_MDI3N

**Table 3-30: Dual RJ45 Pinouts**

**3.3.4 External 2.5GbE RJ-45 and dual USB 3.2 Gen 2 combo connector**

- CN Label:** LAN2\_USB2,
- CN Type:** USB 3.2, RJ45
- CN Location:** See **Figure 3-35**
- CN Pinouts:** See **Table 3-29** and **Table 3-30**

The external dual USB 3.2 Gen 2 connector and 2.5GbE RJ-45 Connector on the IMBA-ADL-Q670.



**Figure 3-36: USB 3.2 and RJ45 Connector**

The USB 3.2 connector.

<b>Pin</b>	<b>Description</b>	<b>Pin</b>	<b>Description</b>
1	VCC	10	VCC
2	USB_DATA-	11	USB_DATA-

Pin	Description	Pin	Description
3	USB_DATA+	12	USB_DATA+
4	GND	13	GND
5	USB3_RX-	14	USB3_RX-
6	USB3_RX+	15	USB3_RX+
7	GND	16	GND
8	USB3_TX-	17	USB3_TX-
9	USB3_TX+	18	USB3_TX+

**Table 3-31: USB 3.2 Port Pinouts**

The dual 2.5GbE RJ-45 connector.

Pin	Description	Pin	Description
19	GND	30	IPMI_LED_ATC_N
20	I225_MDIO_P_2	31	IPMI_LINK_LED_1G_N
21	IPMI_MDIO_N	32	IPMI_LINK_LED_100M_N
22	IPMI_MDI1_P	G1	LAN3_GND
23	IPMI_MDI1_N	G2	LAN3_GND
24	IPMI_MDI2_P	G3	LAN3_GND
25	IPMI_MDI2_N	G4	LAN3_GND
26	IPMI_MDI3_P	G5	LAN3_GND
27	IPMI_MDI3_N	G6	LAN3_GND
28	GND	G7	LAN3_GND
29	+3.3V	G8	LAN3_GND

**Table 3-32: RJ-45 for IPMI Pinouts**

## IMBA-ADL-Q670

### 3.3.5 External RJ-45 for IPMI and dual USB 3.2 Gen 2 combo connector

- CN Label:** LAN3\_USB3,
- CN Type:** USB 3.2, RJ45
- CN Location:** See **Figure 3-35**
- CN Pinouts:** See **Table 3-29** and **Table 3-30**

The external RJ-45 for IPMI and dual USB 3.2 Gen 2 combo connector on the IMBA-ADL-Q670.



**Figure 3-37: USB 3.2 and RJ45 Connector**

The USB 3.2 connector.

Pin	Description	Pin	Description
1	+5V	10	+5V
2	USB2_3_N	11	USB2_4_N
3	USB2_3_P	12	USB2_4_P
4	GND	13	GND
5	USB3_RX3_N	14	USB3_RX4_N
6	USB3_RX3_P	15	USB3_RX4_P
7	GND	16	GND
8	USB3_TX3_N	17	USB3_TX4_N
9	USB3_TX3_P	18	USB3_TX4_P

**Table 3-33: USB 3.2 Port Pinouts**

The dual 2.5GbE RJ-45 connector.

<b>PIN</b>	<b>DESCRIPTION</b>	<b>PIN</b>	<b>DESCRIPTION</b>
20	LAN1_MDI0P	24	LAN1_MDI2P
21	LAN1_MDI0N	25	LAN1_MDI2N
22	LAN1_MDI1P	26	LAN1_MDI3P
23	LAN1_MDI1N	27	LAN1_MDI3N

**Table 3-34: Dual RJ45 Pinouts**



Chapter

4

# Installation

---

## 4.1 Anti-static Precautions

---



### WARNING:

Failure to take ESD precautions during the installation of the IMBA-ADL-Q670 may result in permanent damage to the IMBA-ADL-Q670 and severe injury to the user.

---

Electrostatic discharge (ESD) can cause serious damage to electronic components, including the IMBA-ADL-Q670. Dry climates are especially susceptible to ESD. It is therefore critical that whenever the IMBA-ADL-Q670 or any other electrical component is handled, the following anti-static precautions are strictly adhered to.

- **Wear an anti-static wristband:** Wearing a simple anti-static wristband can help to prevent ESD from damaging the board.
- **Self-grounding:** Before handling the board touch any grounded conducting material. During the time the board is handled, frequently touch any conducting materials that are connected to the ground.
- **Use an anti-static pad:** When configuring the IMBA-ADL-Q670, place it on an anti-static pad. This reduces the possibility of ESD damaging the IMBA-ADL-Q670.
- **Only handle the edges of the PCB:** When handling the PCB, hold the PCB by the edges.

## 4.2 Internal Peripheral Device Connections

This section outlines the installation of peripheral devices to the onboard connectors.

### 4.2.1 SATA Drive Connection

The IMBA-ADL-Q670 is shipped with two SATA drive cables. To connect the SATA drives to the connectors, please follow the steps below.

**Step 1: Locate the connectors.** The locations of the SATA drive connectors are shown in **Chapter 3**.

## IMBA-ADL-Q670

**Step 2:** **Insert the cable connector.** Insert the cable connector into the on-board SATA drive connector until it clips into place. See **Figure 4-1**.

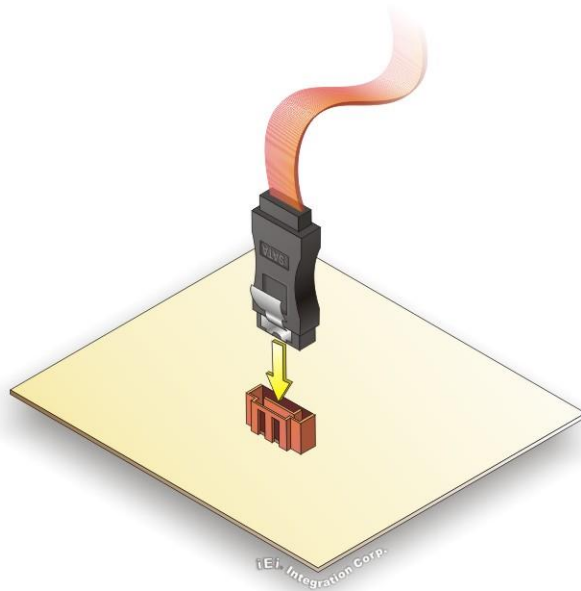

**Figure 4-1: SATA Drive Cable Connection**

**Step 3:** **Connect the cable to the SATA disk.** Connect the connector on the other end of the cable to the connector at the back of the SATA drive. See **Figure 4-2**.

**Step 4:** **Connect the SATA power cable.** Connect the SATA power connector to the back of the SATA drive. See **Figure 4-2**.

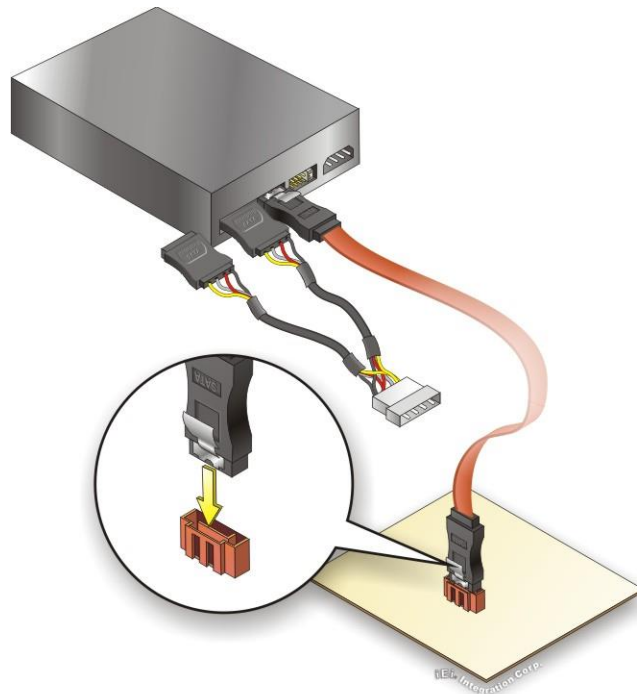

**Figure 4-2: SATA Power Drive Connection**

The SATA power cable can be bought from IEI. See Optional Items in Section 2.4.

### 4.3 Installation Considerations

---

**NOTE:**

The following installation notices and installation considerations should be read and understood before installation. All installation notices must be strictly adhered to. Failing to adhere to these precautions may lead to severe damage and injury to the person performing the installation.

---

---

**WARNING:**

The installation instructions described in this manual should be carefully followed in order to prevent damage to the components and injury to the user.

---

Before and during the installation please **DO** the following:

- Read the user manual:
  - The user manual provides a complete description of the IMBA-ADL-Q670 installation instructions and configuration options.
- Wear an electrostatic discharge cuff (ESD):
  - Electronic components are easily damaged by ESD. Wearing an ESD cuff removes ESD from the body and helps prevent ESD damage.
- Place the IMBA-ADL-Q670 on an anti-static pad:
  - When installing or configuring the motherboard, place it on an anti-static pad. This helps to prevent potential ESD damage.
- Turn all power to the IMBA-ADL-Q670 off:
  - When working with the IMBA-ADL-Q670, make sure that it is disconnected from all power supplies and that no electricity is being fed into the system.

Before and during the installation of the IMBA-ADL-Q670, **DO NOT:**

- Remove any of the stickers on the PCB board. These stickers are required for warranty validation.
- Use the product before verifying all the cables and power connectors are properly connected.
- Allow screws to come in contact with the PCB circuit, connector pins, or its components.

## 4.4 Socket LGA1700 CPU Installation

---



### WARNING:

CPUs are expensive and sensitive components. When installing the CPU please be careful not to damage it in anyway. Make sure the CPU is installed properly and ensure the correct cooling kit is properly installed.

DO NOT touch the pins at the bottom of the CPU. When handling the CPU, only hold it on the sides.

---

To install the CPU, follow the steps below.

- Step 1:** Disengage the load lever by pressing the lever down and slightly outward to clear the retention tab. Fully open the lever. See **Figure 4-3**.

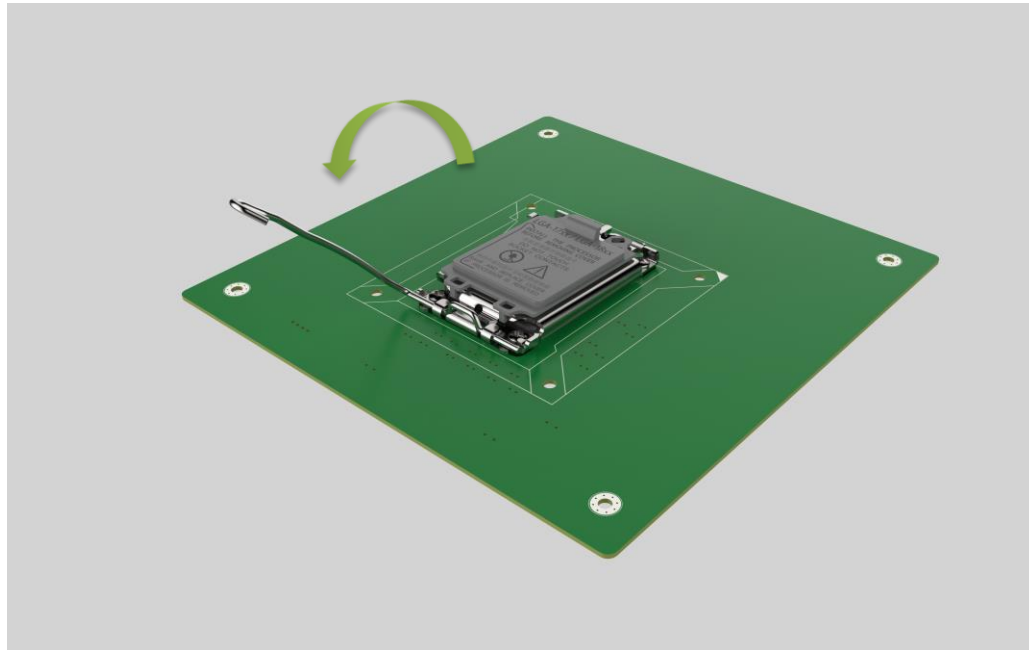

**Figure 4-3: Disengage the CPU Socket Load Lever**

- Step 2:** Open the socket and remove the protective cover. The black protective cover can be removed by pulling up on the tab labeled "Remove". See **Figure 4-4**.

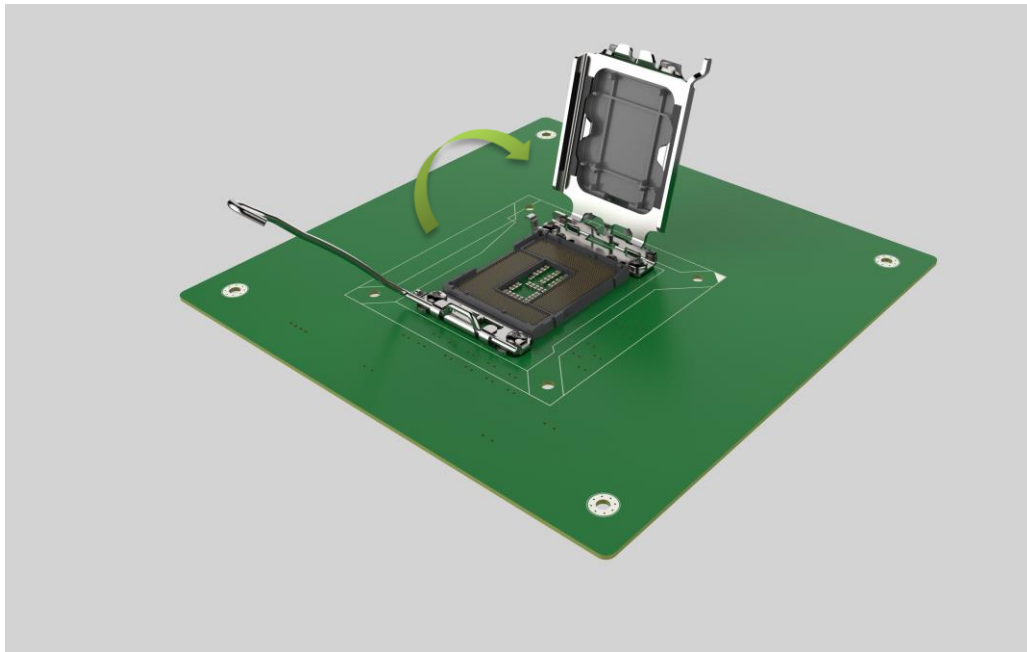

Figure 4-4: Remove Protective Cover

- Step 3:** **Inspect the CPU socket.** Make sure there are no bent pins and make sure the socket contacts are free of foreign material. If any debris is found, remove it with compressed air.
- Step 4:** **Orientate the CPU properly.** The contact array should be facing the CPU socket.



**WARNING:**

DO NOT touch the pins at the bottom of the CPU. When handling the CPU, only hold it on the sides.

- 
- Step 5:** **Correctly position the CPU.** Match the Pin 1 mark with the cut edge on the CPU socket.
- Step 6:** **Align the CPU pins.** Locate pin 1 and the two orientation notches on the CPU. Carefully match the two orientation notches on the CPU with the socket alignment keys.



## IMBA-ADL-Q670

**Step 7: Insert the CPU.** Gently insert the CPU into the socket. If the CPU pins are properly aligned, the CPU should slide into the CPU socket smoothly. See **Figure 4-5**.

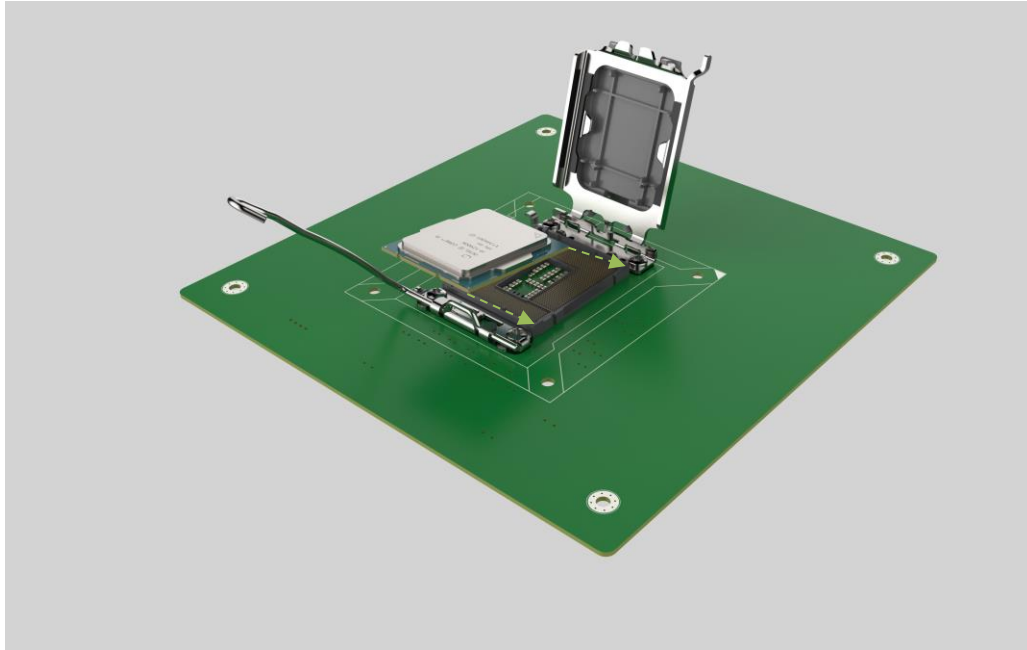

**Figure 4-5: Insert the Socket LGA1700 CPU**

**Step 8: Close the CPU socket.** Close the load plate and pull the load lever back a little to have the load plate be able to secure to the knob. Engage the load lever by pushing it back to its original position (**Figure 4-6**). There will be some resistance, but will not require extreme pressure.

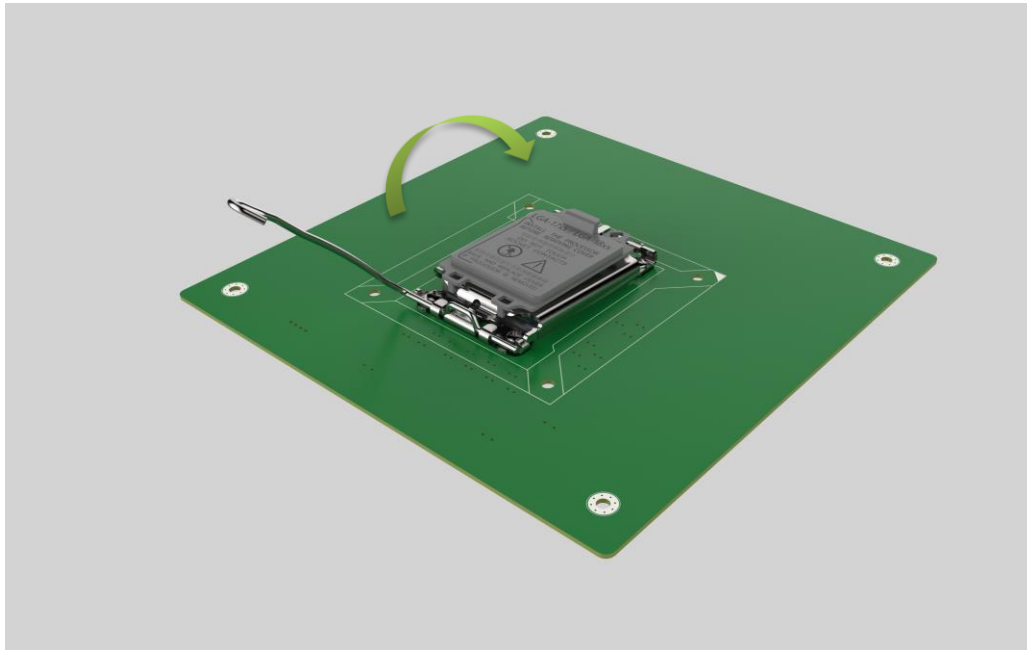

Figure 4-6: Close the Socket LGA1700

**Step 9:** Connect the 12 V power to the board. Connect the 12 V power from the power supply to the board.

## 4.5 Socket LGA1700 Cooling Kit Installation



**WARNING:**

**DO NOT** attempt to install a push-pin cooling fan.

The pre-installed support bracket prevents the board from bending and is **ONLY** compatible with captive screw type cooling fans.

---

The cooling kit can be bought from IEI. The cooling kit has a heat sink and fan.

## IMBA-ADL-Q670

**WARNING:**

Do not wipe off (accidentally or otherwise) the pre-sprayed layer of thermal paste on the bottom of the heat sink. The thermal paste between the CPU and the heat sink is important for optimum heat dissipation.

To install the cooling kit, follow the instructions below.

**Step 1:** A cooling kit bracket is pre-installed on the rear of the motherboard. See **Figure 4-7**.

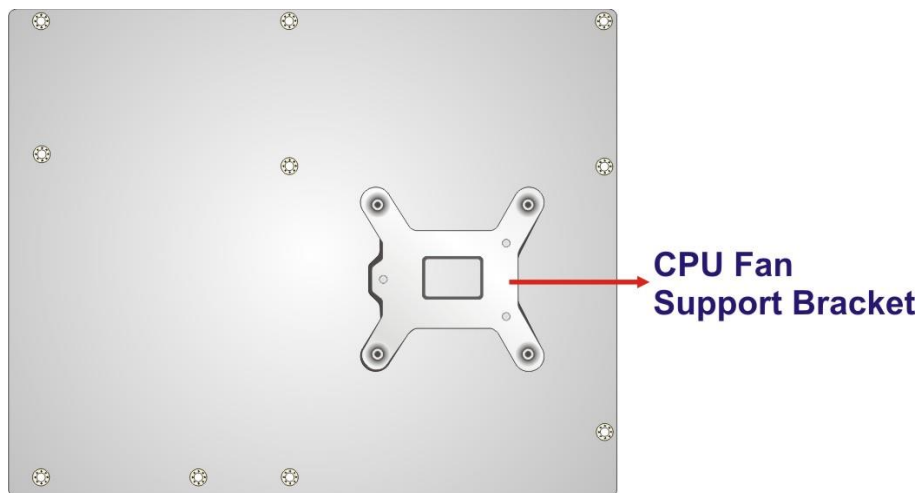

**Figure 4-7: Cooling Kit Support Bracket**

- Step 2:** Place the cooling kit onto the socket LGA1700 CPU. Make sure the CPU cable can be properly routed when the cooling kit is installed.
- Step 3:** Mount the cooling kit. Gently place the cooling kit on top of the CPU. Make sure the four threaded screws on the corners of the cooling kit properly pass through the holes of the cooling kit bracket.

**Step 4: Tighten the screws.** Use a screwdriver to tighten the four screws. In a diagonal pattern, tighten each screw a few turns then move to the next one, until they are all secured. Do not overtighten the screws.

**Step 5: Connect the fan cable.** Connect the cooling kit fan cable to the CPU fan connector on the IMBA-ADL-Q670. Carefully route the cable and avoid heat generating chips and fan blades.

## 4.6 DIMM Installation

To install a DIMM, please follow the steps below and refer to **Figure 4-8**.

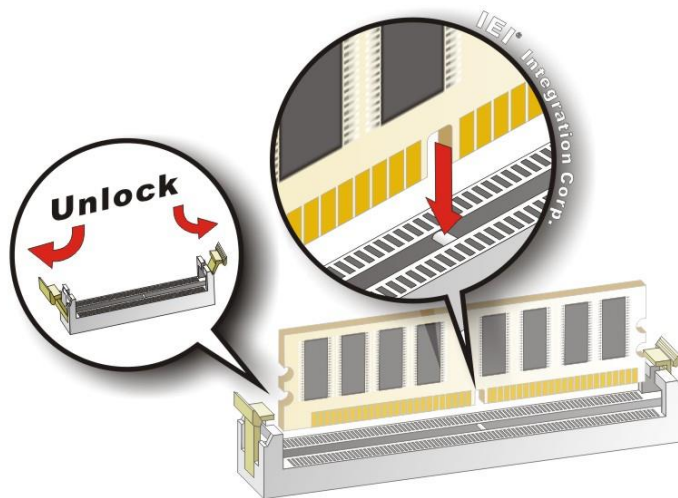

**Figure 4-8: DIMM Installation**

**Step 1: Open the DIMM socket handles.** Open the two handles outwards as far as they can. See **Figure 4-8**.

**Step 2: Align the DIMM with the socket.** Align the DIMM so the notch on the memory lines up with the notch on the memory socket. See **Figure 4-8**.

**Step 3: Insert the DIMM.** Once aligned, press down until the DIMM is properly seated. Clip the two handles into place. See **Figure 4-8**.

**Step 4: Removing a DIMM.** To remove a DIMM, push both handles outward. The memory module is ejected by a mechanism in the socket.

**CAUTION:**

For quad channel configuration, install four identical memory modules that feature the same capacity, timings, voltage, number of ranks and the same brand.

## 4.7 M.2 Module Installation

The IMBA-ADL-Q670 provide two ways to install the M.2 expansion card. One is using screw, and the other is using the retainer. Please follow the steps below.

### Mode One: Using screw

- Step 1:** Locate the M.2 module slot. See **Chapter 3**.
- Step 2:** Remove the retention screw secured on the motherboard.
- Step 3:** Line up the notch on the module with the notch on the slot. Slide the M.2 module into the socket at an angle of about 20° (**Figure 4-9**).

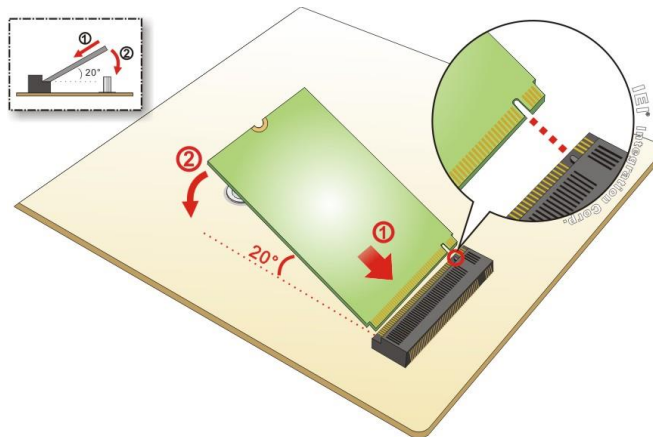

**Figure 4-9: Inserting the M.2 Module into the Slot at an Angle**

- Step 4:** Secure the M.2 module with the previously removed retention screw (**Figure 4-10**).

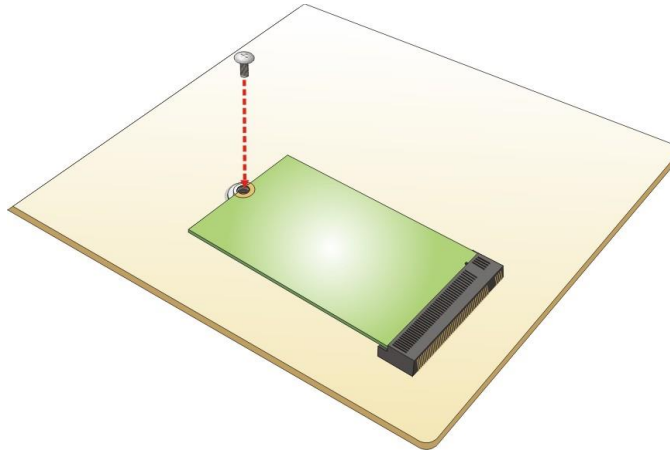

**Figure 4-10: Securing the M.2 Module**

**Mode Two: Using the Retainer**

**Step 1:** Press the retainer down as shown below. (See **Figure 4-11**)

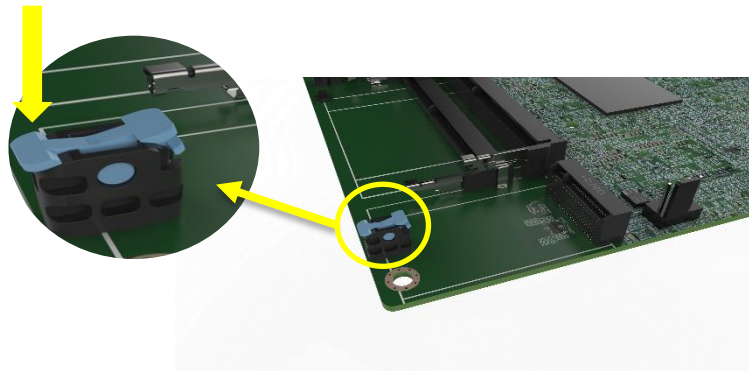

**Figure 4-11: Press the Retainer**

## IMBA-ADL-Q670

**Step 2:** Line up the notch on the M.2 module with the notch on the slot. Slide the M.2 module into the socket at an angle of about 20°. (See **Figure 4-9**)

**Step 3:** Align the notch on the end of the M.2 module with the clip of the retainer. (See

**Figure 4-12**)

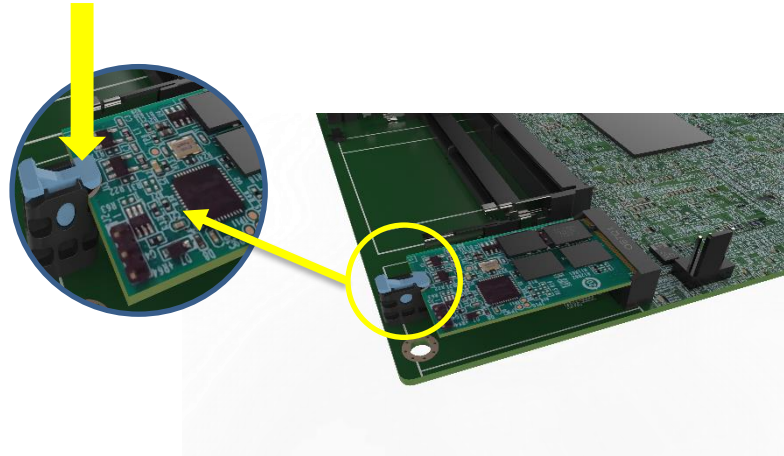

**Figure 4-12: Aligning the M.2 Module with the Retainer**

**Step 4:** Press the M.2 module down until it is secured into place by the retainer. (See **Figure 4-13**)

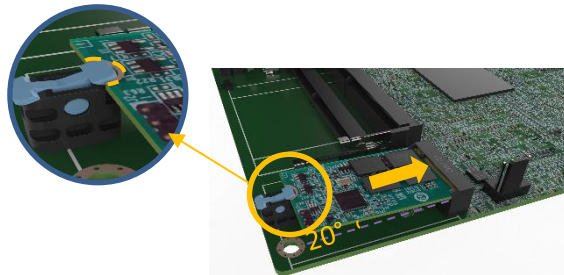

**Figure 4-13: Securing the M.2 Module**

**Step 5:** If you want to remove the M.2 module, you should press the retainer down as described in Step 1 to release the M.2 module. (See **Figure 4-11**)

## 4.8 Software Installation

All the drivers for the IMBA-ADL-Q670 are available on IEI Resource Download Center (<https://download.ieiworld.com>). Type IMBA-ADL-Q670 and press Enter to find all the relevant software, utilities, and documentation.

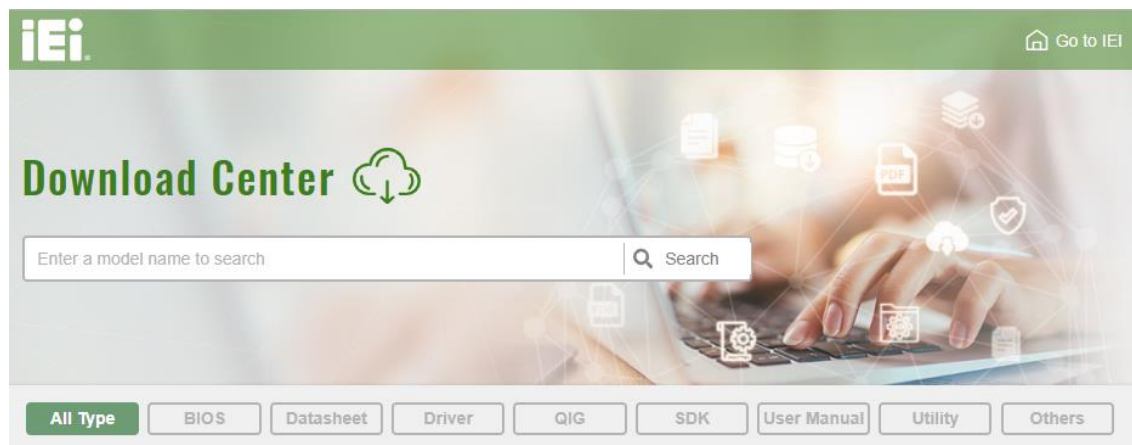
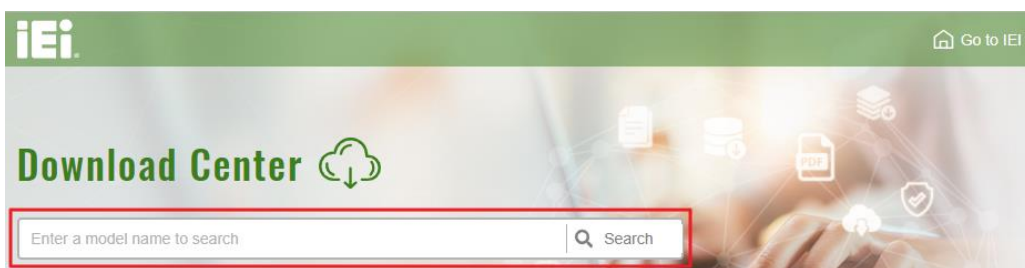

Figure 4-14: IEI Resource Download Center

## 4.9 Driver Download

To download drivers from IEI Resource Download Center, follow the steps below.

**Step 1:** Go to <https://download.ieiworld.com>. Type IMBA-ADL-Q670 and press Enter.



**Step 2:** All product-related software, utilities, and documentation will be listed. You can choose **Driver** to filter the result.



## IMBA-ADL-Q670

[All Type](#)
[BIOS](#)
[Datasheet](#)
[Driver](#)
[QIG](#)
[SDK](#)
[User Manual](#)
[Utility](#)
[Others](#)

**WAFER-BT-i1** Product Info ▶

[Embedded Computer](#) ▶ [Single Board Computer](#) ▶ [Embedded Board](#)  
 3.5" SBC with Intel® 22nm Atom™/Celeron® on-board SoC

**Driver**

File Name	Published	Version	File Checksum
<a href="#">7B000-001033-RS V2.3.iso (2.23 GB)</a>	2017/10/03	2.30	3B2DB1F792779A93A8F50DDBC3943E30

**Step 3:** Click the driver file name on the page and you will be prompted with the following window. You can download the entire ISO file (❶), or click the small arrow to find an individual driver and click the file name to download (❷).

7B000-001168-RS\_V1.4.iso

❶ [Click here to download entire ISO file. \(2.99 GB\)](#)

\* Download individual file \*

- Docs
  - 1.Chipset
    - ❷ 10.1.1.12.zip (2.7 MB)
    - 2.VGA
    - 3.Audio
    - 4.Lan
    - 5.USB 3.0
    - 6.Serial IO
    - 7.TXE
    - 8.Manual



### NOTE:

To install software from the downloaded ISO image file in Windows 8, 8.1 or 10, double-click the ISO file to mount it as a virtual drive to view its content. On Windows 7 system, an additional tool (such as Virtual CD-ROM Control Panel from Microsoft) is needed to mount the file.

Chapter

**5**

# **BIOS**

---

## 5.1 Introduction

The BIOS is programmed onto the BIOS chip. The BIOS setup program allows changes to certain system settings. This chapter outlines the options that can be changed.



### NOTE:

Some of the BIOS options may vary throughout the life cycle of the product and are subject to change without prior notice.

### 5.1.1 Starting Setup

The UEFI BIOS is activated when the computer is turned on. The setup program can be activated in one of two ways.

1. **Using keyboard:** Press the **DEL** or **F2** as soon as the system is turned on.
2. **Using touchscreen:** Press the **Setup** button on the upper right corner of the BIOS Starting Menu.

If the message disappears before the **DEL** or **F2** key is pressed, restart the computer and try again, then the BIOS Starting Menu will appear. Select "Setup" and press Enter to get into the BIOS Setup.

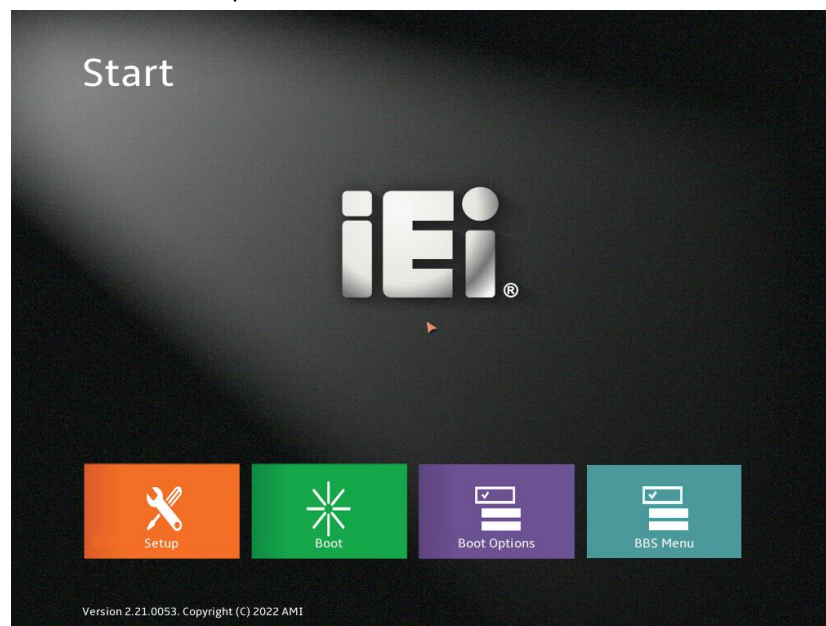

Figure 5-1: BIOS Starting Menu

## 5.1.2 Using Setup

The BIOS Setup menu can be navigated by using a keyboard or a touchscreen.

### 5.1.2.1 Keyboard Navigation

For keyboard navigation, use the navigation keys shown in **Table 5-1**.

Key	Function
Up arrow	Move to previous item
Down arrow	Move to next item
Left arrow	Move to the item on the left hand side
Right arrow	Move to the item on the right hand side
+	Increase the numeric value or make changes
-	Decrease the numeric value or make changes
Page Up	Move to the previous page
Page Dn	Move to the next page
Esc	Main Menu – Quit and not save changes into CMOS Status Page Setup Menu and Option Page Setup Menu -- Exit current page and return to Main Menu
F1	General help, only for Status Page Setup Menu and Option Page Setup Menu
F2	Load previous values
F3	Load optimized defaults
F4	Save changes and Exit BIOS
<K>	Scroll help area upwards
<M>	Scroll help area downwards

**Table 5-1: BIOS Navigation Keys**

### 5.1.2.2 Touch Navigation

For touchscreen navigation, use the on-screen navigation keys shown below.

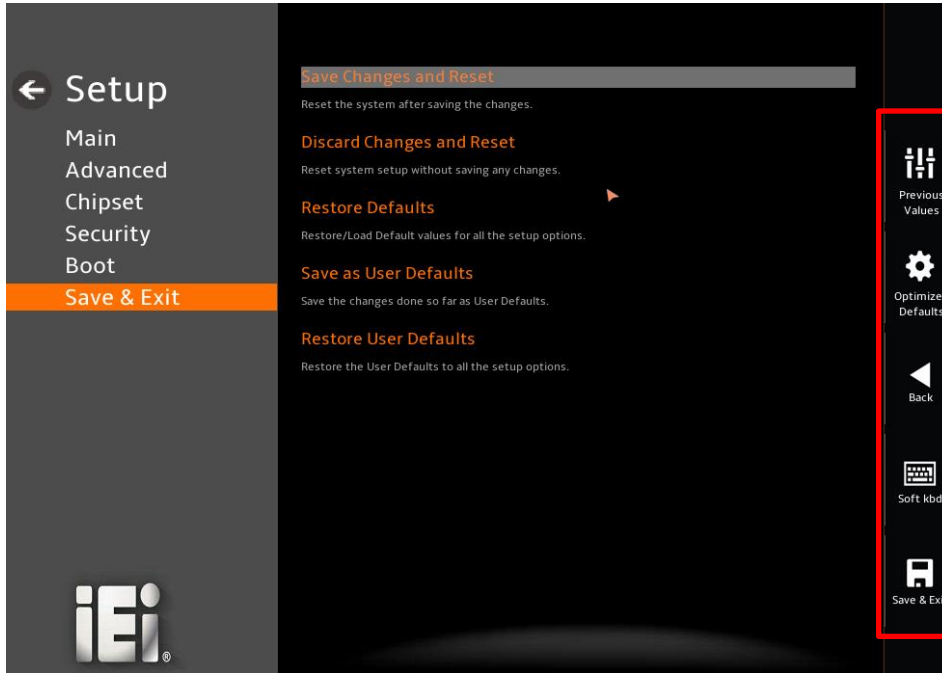

On-screen Button	Function
Previous Values	Load the last value you set.
Optimized Defaults	Load the factory default values in order to achieve the best performance.
Back	Return to the previous menu.
Soft kbd	Display the on-screen keyboard.
Save & Exit	Save the changes made to the BIOS options and reset the system.

Table 5-2: BIOS On-screen Navigation Keys

### 5.1.3 Getting Help

When **F1** is pressed a small help window describing the appropriate keys to use and the possible selections for the highlighted item appears. To exit the Help Window, press the **Esc** key.

### 5.1.4 Unable to Reboot after Configuration Changes

If the computer cannot boot after changes to the system configuration is made, CMOS defaults. Use the clear CMOS button described in **Chapter 4**.

### 5.1.5 BIOS Menu Bar

The **menu bar** on top of the BIOS screen has the following main items:

- Main – Changes the basic system configuration.
- Advanced – Changes the advanced system settings.
- Chipset – Changes the chipset settings.
- Security – Sets User and Supervisor Passwords.
- Boot – Changes the system boot configuration.
- Save & Exit – Selects exit options and loads default settings

The following sections completely describe the configuration options found in the menu items at the top of the BIOS screen and listed above.

## IMBA-ADL-Q670

### 5.2 Main

The **Main** BIOS menu (**BIOS Menu 2**) appears when the **BIOS Setup** program is entered. The **Main** menu gives an overview of the basic system information.

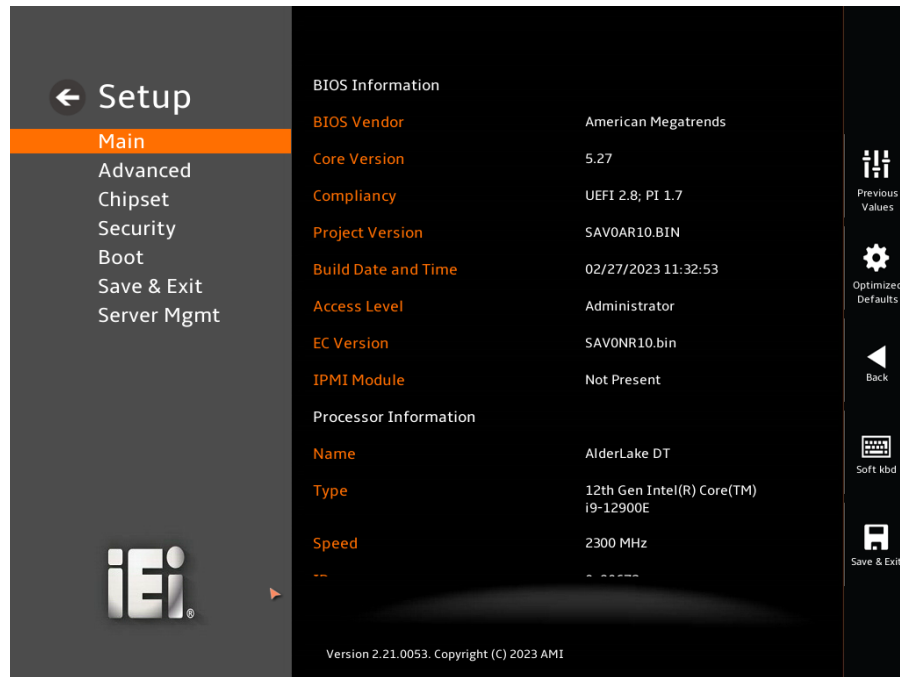

#### BIOS Menu 1: Main (1/3)

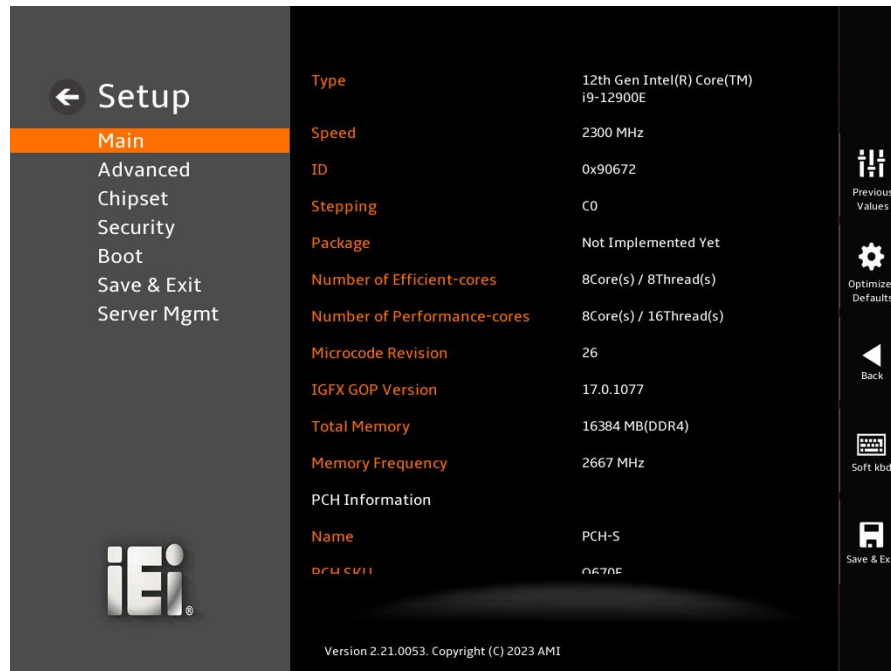

#### BIOS Menu 2: Main (2/3)

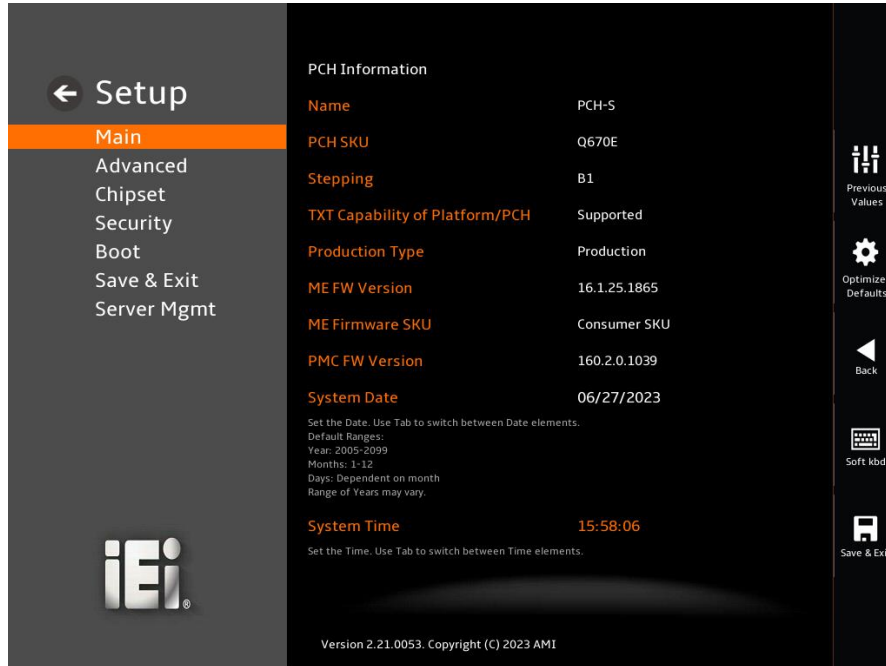

**BIOS Menu 3: Main (3/3)**

➔ **BIOS Information**

The **BIOS Information** lists a brief summary of the BIOS. The fields in **BIOS Information** cannot be changed. The items shown in the system overview include:

- **BIOS Vendor:** Installed BIOS vendor
- **Core Version:** Current BIOS version
- **Compliance:** Current UEFI & PI version
- **Project Version:** the board version
- **Build Date and Time:** Date the current BIOS version was made
- **EC Version:** Current EC version

➔ **Processor Information**

The **Processor Information** lists a brief summary of the Processor. The fields in **Processor Information** cannot be changed. The items shown in the system overview include:

- **Name:** Displays the Processor Details
- **Type:** Displays the Processor Type
- **Speed:** Displays the Processor Speed



## IMBA-ADL-Q670

- **ID:** Displays the Processor ID

### → PCH Information

The **PCH Information** lists a brief summary of the PCH. The fields in **PCH Information** cannot be changed. The items shown in the system overview include:

- **Name:** Displays the PCH Name
- **PCH SKU:** Displays the PCH SKU
- **Stepping:** Displays the PCH Stepping
- **TXT Capability of Platform/PCH:** Displays the TXT Capability
- **Production Type:** Displays the Production Type
- **ME FW Version:** Displays the ME Firmware Version
- **ME Firmware SKU:** Displays the ME Firmware SKU
- **PMC FW Version:** Displays the PMC Firmware Version

### → System Date [xx/xx/xx]

Use the **System Date** option to set the system date. Manually enter the day, month and year.

### → System Time [xx:xx:xx]

Use the **System Time** option to set the system time. Manually enter the hours, minutes and seconds.

### 5.3 Advanced

Use the **Advanced** menu (**BIOS Menu 4**) to configure the CPU and peripheral devices through the following sub-menus:



#### WARNING!

Setting the wrong values in the sections below may cause the system to malfunction. Make sure that the settings made are compatible with the hardware.

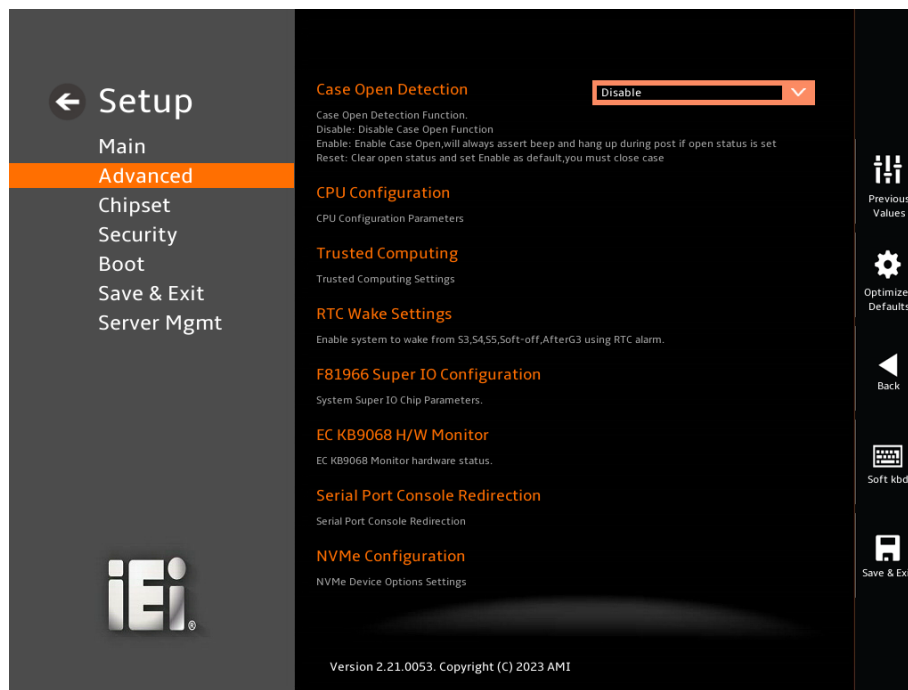

**BIOS Menu 4: Advanced**

### 5.3.1 CPU Configuration

Use the **CPU Configuration** menu (**BIOS Menu 5**) to view detailed CPU specifications or enable the Intel Virtualization Technology.



#### BIOS Menu 5: CPU Configuration (1/3)



**BIOS Menu 6: CPU Configuration (2/3)**

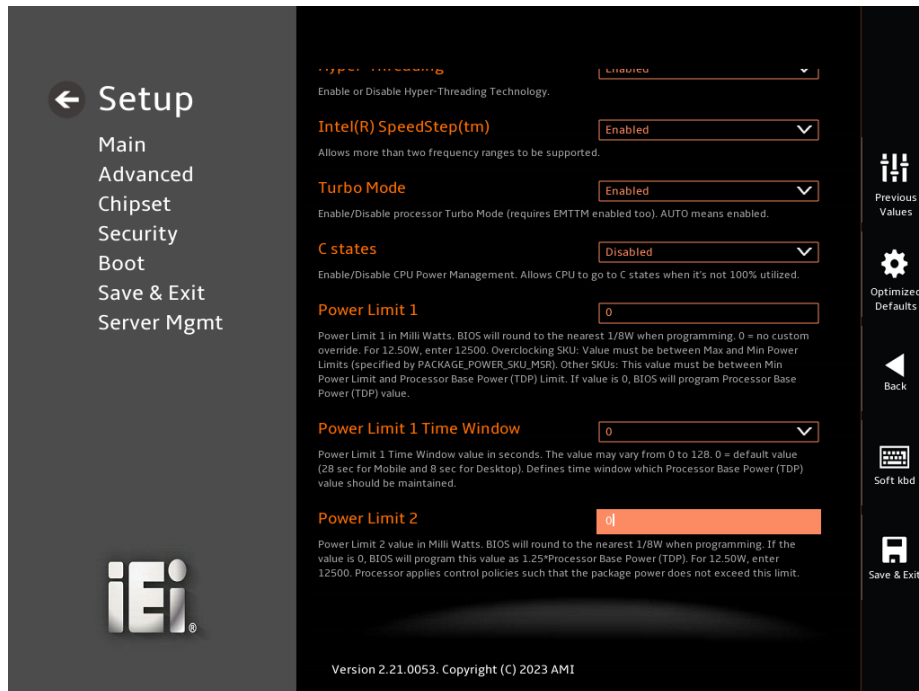

**BIOS Menu 7: CPU Configuration (3/3)**

➔ **Intel (VMX) Virtualization Technology [Enabled]**

## IMBA-ADL-Q670

Use the **Intel (VMX) Virtualization Technology** option to enable or disable virtualization on the system. When combined with third party software, Intel® Virtualization technology allows several OSs to run on the same system at the same time.

- ➔ **Disabled** Disables Intel Virtualization Technology.
- ➔ **Enabled** **DEFAULT** Enables Intel Virtualization Technology.

➔ **Active Performance Cores [All]**

Use the **Active Performance Cores** BIOS option to enable numbers of P-cores in the processor package.

- ➔ **All** **DEFAULT** Enable all P-cores in the processor package.
- ➔ **1** Enable one P-core in the processor package.

➔ **Active Efficient Cores [All]**

Use the **Active Efficient Cores** BIOS option to enable numbers of E-cores in the processor package.

- ➔ **All** **DEFAULT** Enable all E-cores in the processor package.
- ➔ **0** Enable zero E-core in the processor package.
- ➔ **1** Enable one E-cores in the processor package.
- ➔ **2** Enable two E-cores in the processor package.
- ➔ **3** Enable three E-cores in the processor package.
- ➔ **4** Enable four E-cores in the processor package.
- ➔ **5** Enable five E-cores in the processor package.
- ➔ **6** Enable six E-cores in the processor package.
- ➔ **7** Enable seven E-cores in the processor package.

➔ **Hyper-Threading [Enabled]**

Use the **Hyper-Threading** option to enable or disable the **Hyper-Threading** Technology.

- ➔ **Disabled** Disables Hyper-Threading Technology

→ **Enabled**      **DEFAULT**      Enables Hyper-Threading Technology

→ **Intel(R) SpeedStep(tm) [Enabled]**

Use the **Intel(R) SpeedStep(tm)** option to enable or disable the Intel® SpeedStep Technology which allows more than two frequency ranges to be supported.

→ **Disabled**      Disables Intel® SpeedStep Technology

→ **Enabled**      **DEFAULT**      Enables Intel® SpeedStep Technology

→ **Turbo Mode [Enabled]**

Use the **Turbo Mode** option to enable or disable Turbo Mode which requires Intel Speed Step or Intel Speed Shift to be available and enabled.

→ **Disabled**      Disables Turbo Mode Technology

→ **Enabled**      **DEFAULT**      Enables Turbo Mode Technology

→ **C states [Disabled]**

Use the **C states** option to enable or disable CPU power management which allows CPU to go to C states when it is not 100% utilized.

→ **Disabled**      **DEFAULT**      Disables CPU power management

→ **Enabled**      Enables CPU power management

→ **Power Limit 1 [0]**

Use the + or – key to change the **Power Limit 1** value. BIOS will program the default values for Limit 1 and Power Limit 1 Time Window. For 12.50W, enter 12500.

→ **Power Limit 1 Time Window [0]**

Use the **Power Limit 1 Time Window** option to select the PL1 time duration. The value may vary from 0 to 128. For 0 is the default value

## IMBA-ADL-Q670

### → Power Limit 2 [0]

Use the + or – key to change the **Power Limit 2** value. BIOS will round to the nearest 1/8W when programming. 0 = no custom override. For 12.50W, enter 12500.

## 5.3.2 Trusted Computing

Use the **Trusted Computing** menu (**BIOS Menu 8**) to configure settings related to the Trusted Computing Group (TCG) Trusted Platform Module (TPM).

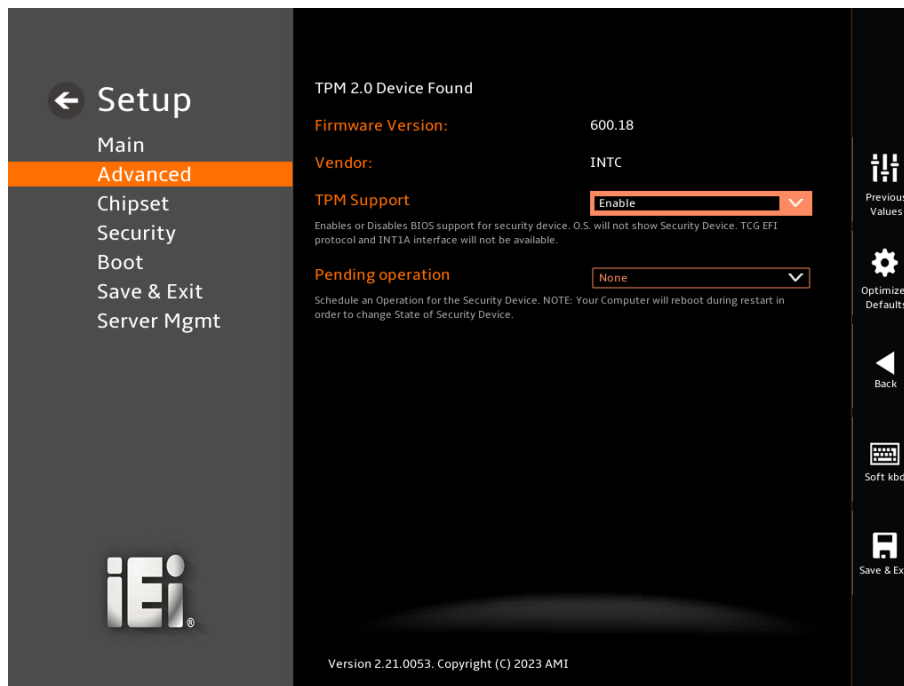

### BIOS Menu 8: PCH-FW Configuration

#### → TPM Support [Enable]

Use the **TPM Support** option to enable or disable BIOS support for security device.

- **Disable**    TPM support is disabled.
- **Enable**    DEFAULT          TPM support is enabled.

→ Pending Operation [None]

Use the **Pending Operation** option to schedule an operation for the security device.

- **None**                      **DEFAULT**                      TPM information is previous.S
- **TPM Clear**                                      TPM information is cleared

### 5.3.3 RTC Wake Settings

The **RTC Wake Settings** menu (**BIOS Menu 9**) configures RTC wake event.

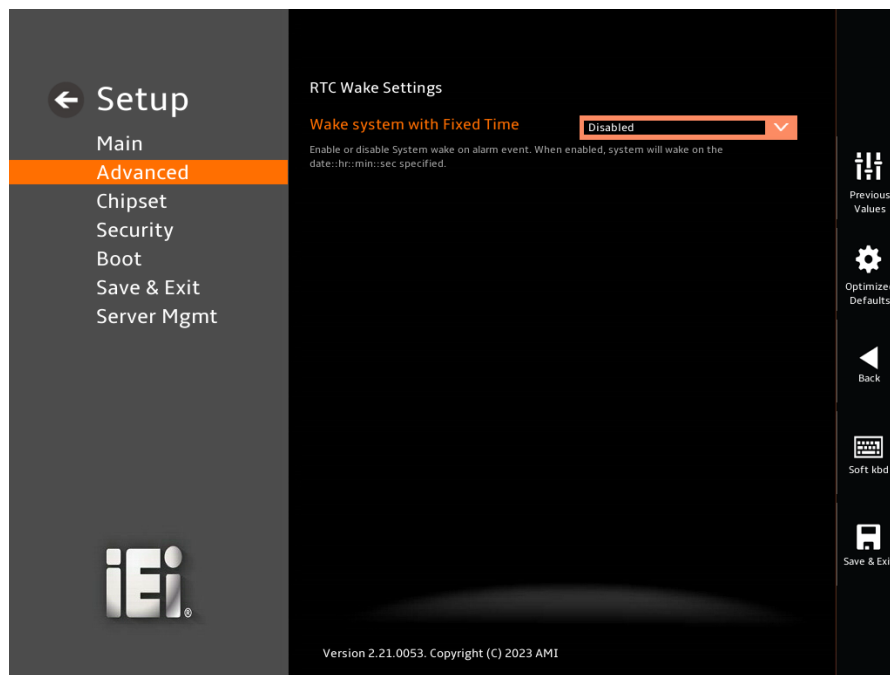

**BIOS Menu 9: RTC Wake Settings (1/2)**



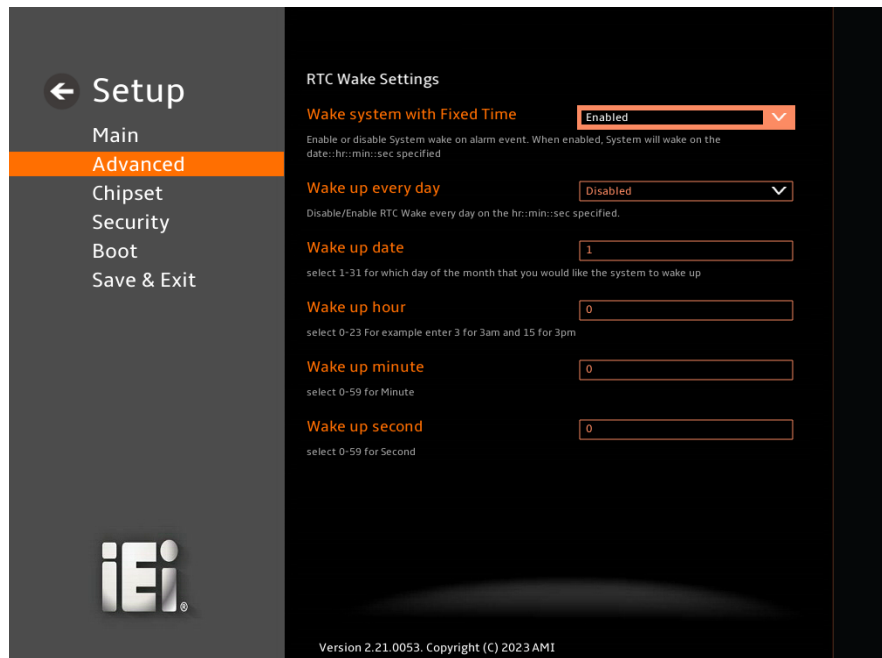

### BIOS Menu 10: RTC Wake Settings (2/2)

#### → Wake system with Fixed Time [Enabled]

Use the **Wake system with Fixed Time** option to enable or disable the system wake on alarm event.

- **Disabled**      The real time clock (RTC) cannot generate a wake event
- **Enabled**      **DEFAULT**      If selected, the **Wake up every day** option appears allowing you to enable to disable the system to wake every day at the specified time. Besides, the following options appear with values that can be selected:
  - Wake up date
  - Wake up hour
  - Wake up minute
  - Wake up second

After setting the alarm, the computer turns itself on from a suspend state when the alarm goes off.

### 5.3.4 F81966 Super IO Configuration

Use the **F81966 Super IO Configuration** menu (**BIOS Menu 11**) to set or change the configurations for serial ports.

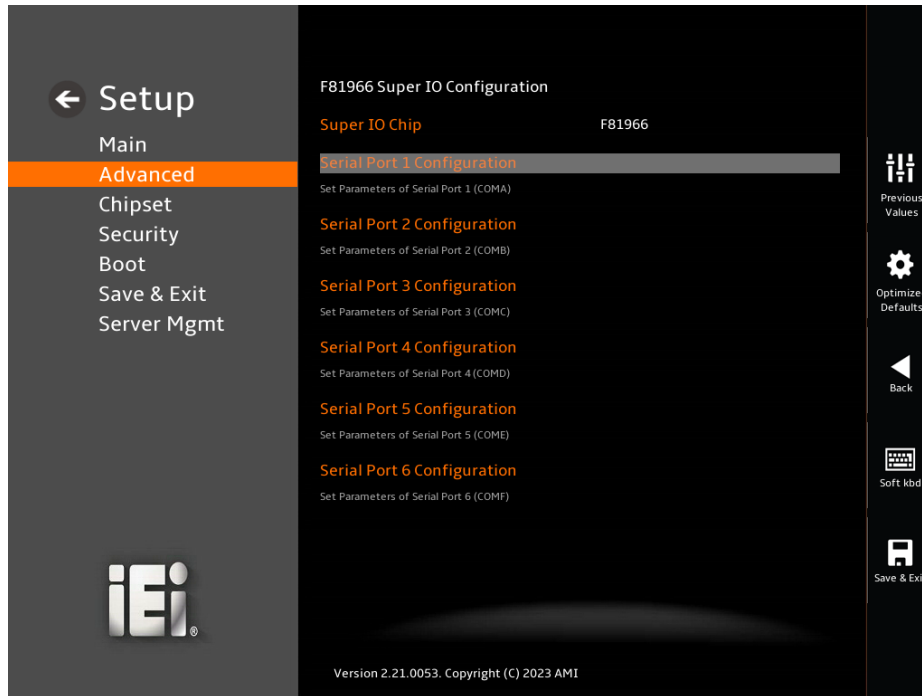

**BIOS Menu 11: F81966 Super IO Configuration**

## IMBA-ADL-Q670

## 5.3.4.1 Serial Port 1 Configuration

Use the **Serial Port 1 Configuration** menu (**BIOS Menu 12**) to configure the serial port.

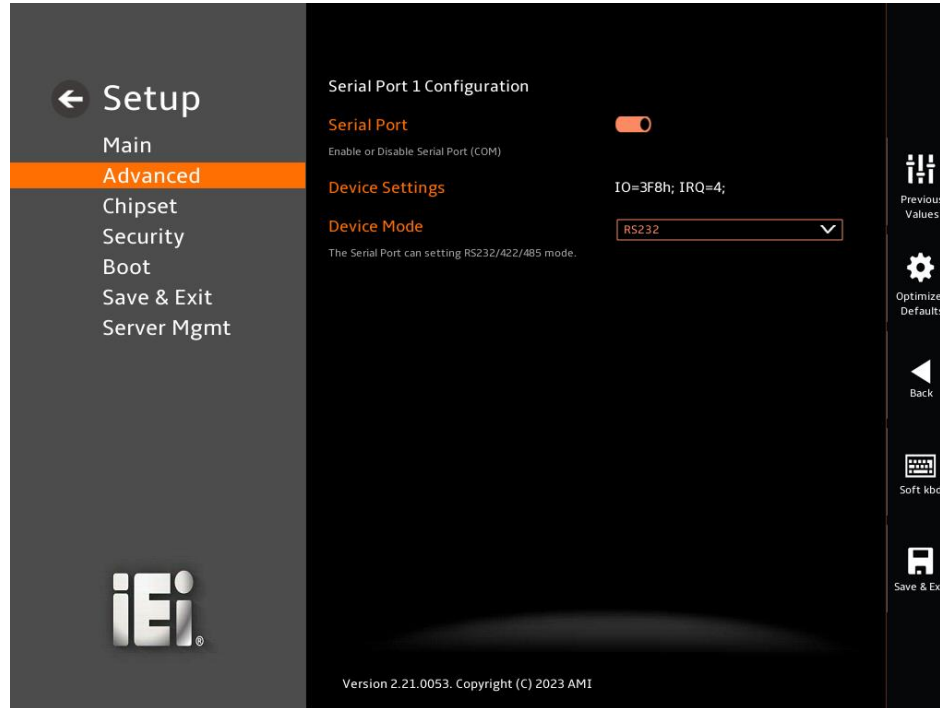

## BIOS Menu 12: Serial Port 1 Configuration Menu

## → Serial Port [Enabled]

Use the **Serial Port** option to enable or disable the serial port.

- **Disabled**                      Disable the serial port
- **Enabled**                      **DEFAULT**              Enable the serial port

## → Device Settings

The **Device Settings** option shows the serial port IO port address and interrupt address.

- **IO=3F8h;**                      Serial Port I/O port address is 3F8h and the  
**IRQ=4**                              interrupt address is IRQ4

## → Device Mode [RS232]

Use the **Device Mode** option to change the serial port mode.



## IMBA-ADL-Q670

→ **IO=2F8h;** Serial Port I/O port address is 2F8h and the interrupt  
**IRQ=3** address is IRQ3

### → Device Mode [RS232]

Use the **Device Mode** option to change the serial port mode.

→ <b>RS232</b>	<b>DEFAULT</b>	The serial port mode is RS-232
<b>RS422 with Register</b>		The serial port mode is RS-422
<b>RS485 with Register</b>		The serial port mode is RS-485

### 5.3.4.3 Serial Port 3 Configuration

Use the **Serial Port 3 Configuration** menu (**BIOS Menu 14**) to configure the serial port.

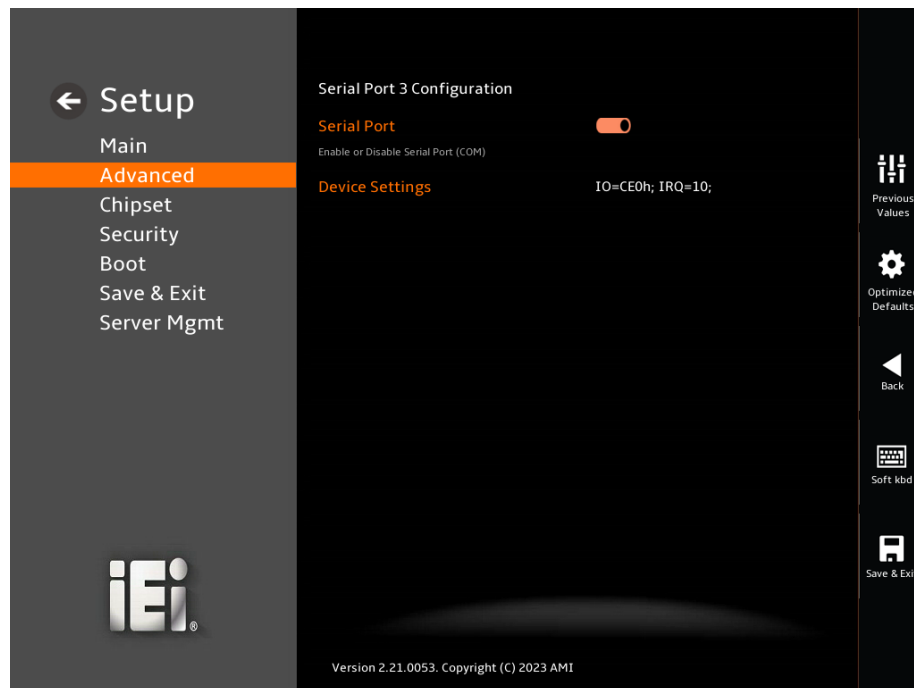

#### BIOS Menu 14: Serial Port 3 Configuration Menu

### → Serial Port [Enabled]

Use the **Serial Port** option to enable or disable the serial port.

→ **Disabled** Disable the serial port

➔ **Enabled**      **DEFAULT**      Enable the serial port

➔ **Device Settings**

The **Device Settings** option shows the serial port IO port address and interrupt address.

➔ **IO=CE0h;**                      Serial Port I/O port address is CE0h and the interrupt  
**IRQ=10**                              address is IRQ10

**5.3.4.4 Serial Port 4 Configuration**

Use the **Serial Port 4 Configuration** menu (**BIOS Menu 15**) to configure the serial port.

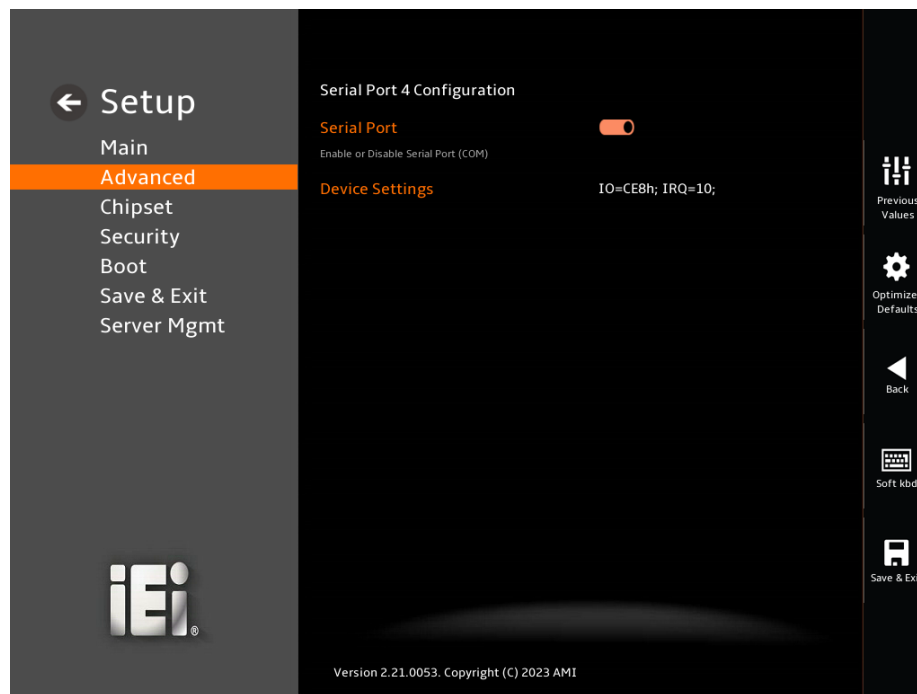

**BIOS Menu 15: Serial Port 4 Configuration Menu**

➔ **Serial Port [Enabled]**

Use the **Serial Port** option to enable or disable the serial port.

➔ **Disabled**                      Disable the serial port

➔ **Enabled**      **DEFAULT**      Enable the serial port

## IMBA-ADL-Q670

### → Device Settings

The **Device Settings** option shows the serial port IO port address and interrupt address.

- **IO=CE8h;**                      Serial Port I/O port address is CE8h and the interrupt
- IRQ=10**                      address is IRQ10

### 5.3.4.5 Serial Port 5 Configuration

Use the **Serial Port 5 Configuration** menu (**BIOS Menu 16**) to configure the serial port.

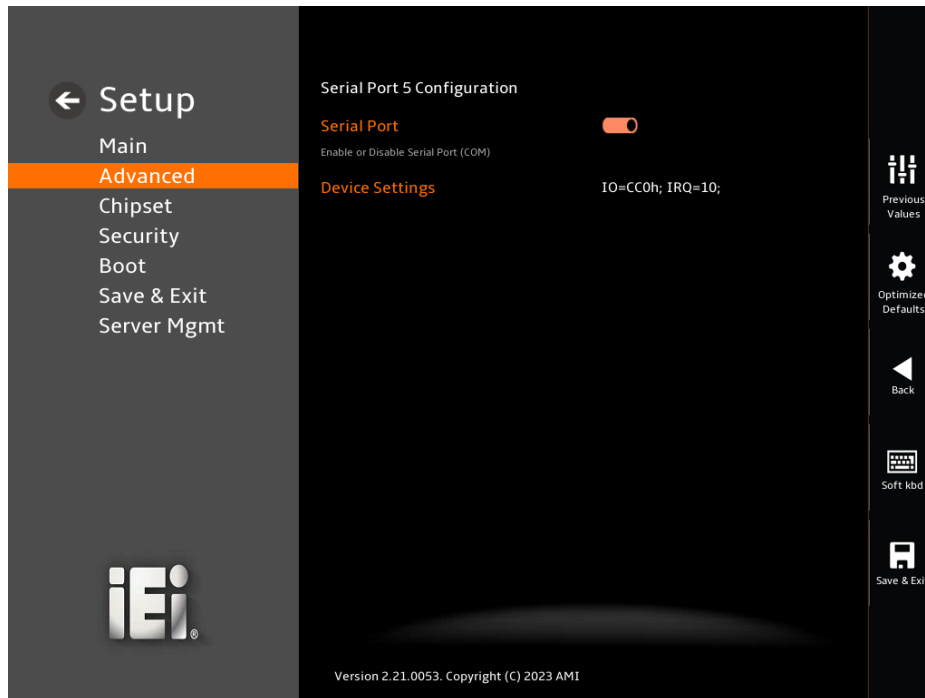

#### BIOS Menu 16: Serial Port 5 Configuration Menu

### → Serial Port [Enabled]

Use the **Serial Port** option to enable or disable the serial port.

- **Disabled**                      Disable the serial port
- **Enabled**                      **DEFAULT**                      Enable the serial port

### → Device Settings

The **Device Settings** option shows the serial port IO port address and interrupt address.

- ➔ **IO=CC0h;**                      Serial Port I/O port address is CC0h and the interrupt address is IRQ10
- IRQ=10**

### 5.3.4.6 Serial Port 6 Configuration

Use the **Serial Port 6 Configuration** menu (**BIOS Menu 17**) to configure the serial port.

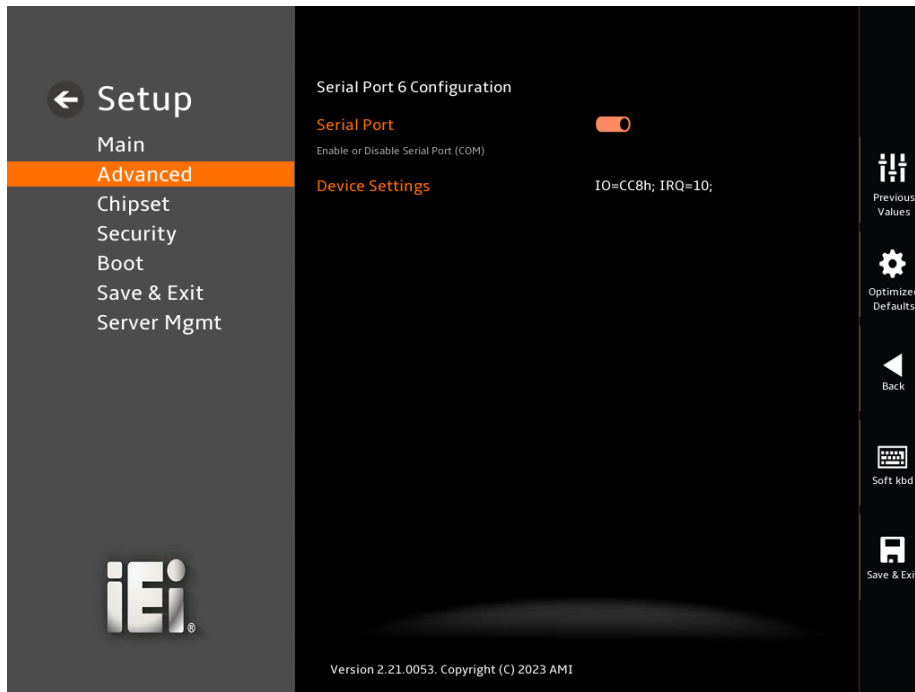

#### BIOS Menu 17: Serial Port 6 Configuration Menu

##### ➔ **Serial Port [Enabled]**

Use the **Serial Port** option to enable or disable the serial port.

- ➔ **Disabled**                      Disable the serial port
- ➔ **Enabled**      **DEFAULT**      Enable the serial port

##### ➔ **Device Settings**

The **Device Settings** option shows the serial port IO port address and interrupt address.

- ➔ **IO=CC8h;**                      Serial Port I/O port address is CC8h and the interrupt address is IRQ10
- IRQ=10**



## IMBA-ADL-Q670

### 5.3.5 EC KB9068 H/W Monitor

The **EC KB9068 H/W Monitor** menu (**BIOS Menu 18**) contains the smart fan mode configuration submenu and shows the state of H/W real-time operating temperature, fan speeds and system voltages.



**BIOS Menu 18: EC KB9068 H/W Monitor (1/2)**

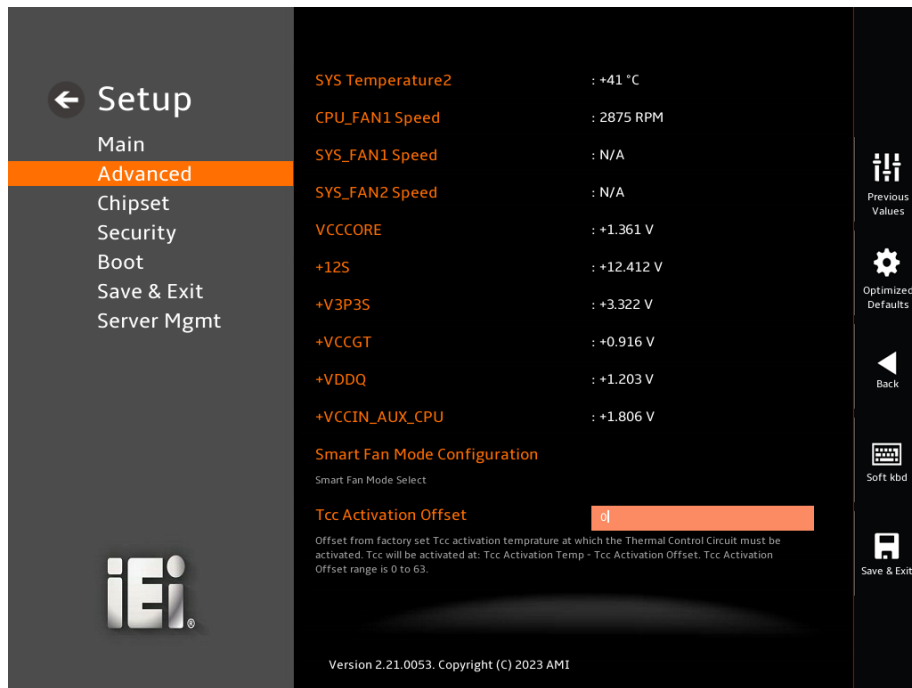

**BIOS Menu 19: EC KB9068 H/W Monitor (2/2)**

**→ PC Health Status**

The following system parameters and values are shown. The system parameters that are monitored are:

- System Temperatures:
  - CPU Temperature
  - System Temperature1
  - System Temperature2
- Fan Speeds:
  - CPU\_Fan1 Speed
  - SYS\_Fan1 Speed
  - SYS\_Fan2 Speed
- Voltages:
  - VCCCORE
  - +12S
  - +V3P3S
  - +VCCGT

## IMBA-ADL-Q670

- +VDDQ
- +VCCIN\_AUX\_CPU

### 5.3.5.1 Smart Fan Mode Configuration

Use the **Smart Fan Mode Configuration** submenu (**BIOS Menu 20**) to configure the CPU/system fan start/off temperature and control mode.

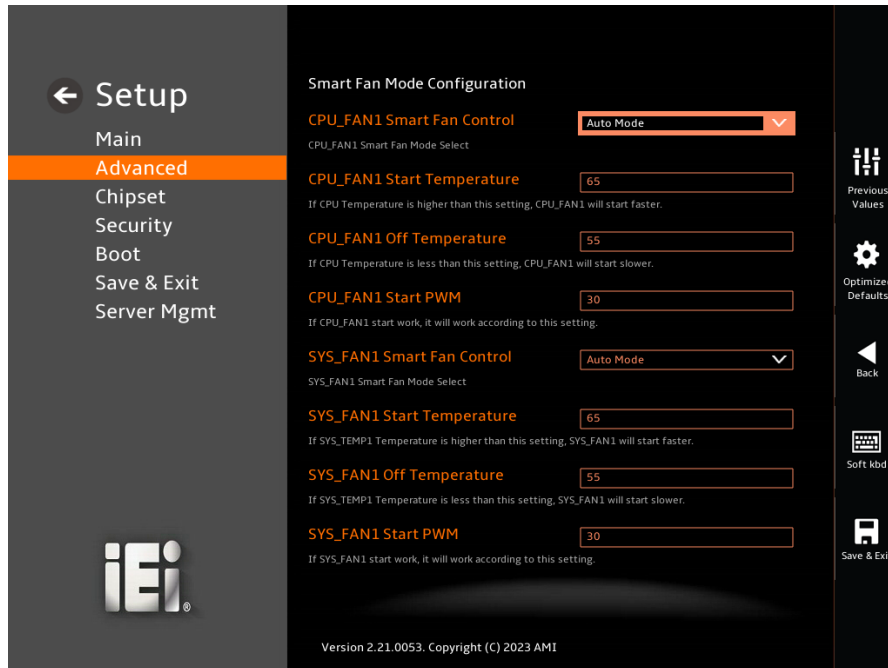

**BIOS Menu 20: Smart Fan Mode Configuration (1/2)**

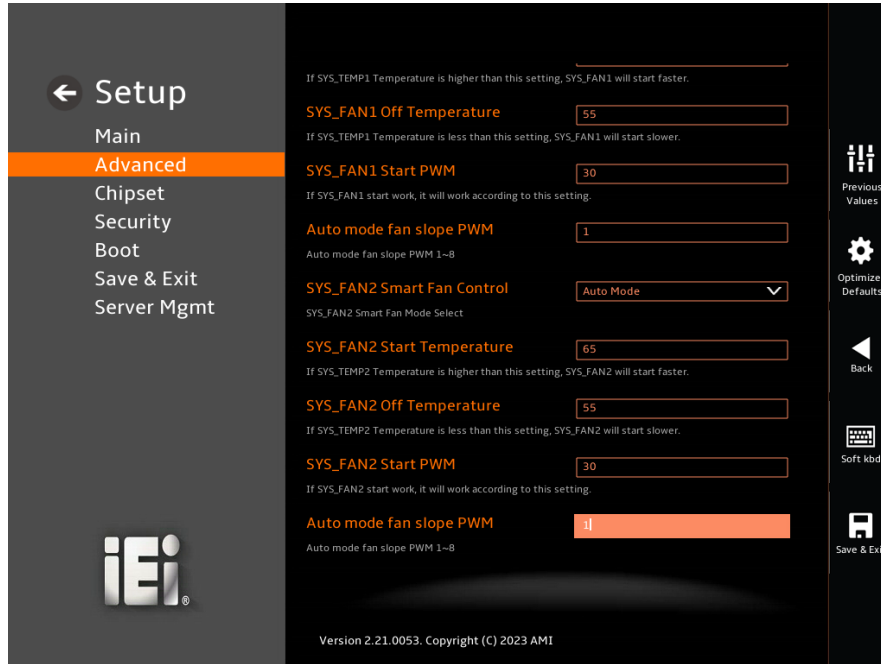

**BIOS Menu 21: Smart Fan Mode Configuration (2/2)**

➔ **CPU\_FAN1 Smart Fan Control [Auto Mode]**

Use the **CPU\_FAN1 Smart Fan Control** option to configure the CPU Smart Fan.

- ➔ **Manual Mode**                      The fan spins at the speed set in Manual Mode settings.
- ➔ **Auto Mode**                      **DEFAULT**      The fan adjusts its speed using Auto Mode settings.

➔ **CPU\_FAN1 Start Temperature**

If the CPU temperature is between **fan off** and **fan start**, the fan speed change to **fan start PWM**. To set a value, Use the + or – key to change the value or enter a decimal number between 1 and 100.

➔ **CPU\_FAN1 Off Temperature**

If the CPU temperature is lower than the value set this option, the fan speed change to be lowest. To set a value, Use the + or – key to change the value or enter a decimal number between 1 and 100.

**IMBA-ADL-Q670****→ CPU\_FAN1 Start PWM**

Use the **CPU\_FAN1 Start PWM** option to set the PWM start value. Use the + or – key to change the value or enter a decimal number between 1 and 100.

**→ SYS\_FAN1 Smart Fan Control [Auto Mode]**

Use the **SYS\_FAN1 Smart Fan Control** option to configure the System Smart Fan.

- Manual Mode**                      The fan spins at the speed set in Manual Mode settings.
- Auto Mode                      DEFAULT**      The fan adjusts its speed using Auto Mode settings.

**→ SYS\_FAN1 Start Temperature**

If the System temperature is between **fan off** and **fan start**, the fan speed change to **fan start PWM**. To set a value, Use the + or – key to change the value or enter a decimal number between 1 and 100.

**→ SYS\_FAN1 Off Temperature**

If the System temperature is lower than the value set this option, the fan speed change to be lowest. To set a value, Use the + or – key to change the value or enter a decimal number between 1 and 100.

**→ SYS\_FAN1 Start PWM**

Use the **SYS\_Fan1 Start PWM** option to set the PWM start value. Use the + or – key to change the value or enter a decimal number between 1 and 100.

**→ Auto mode fan slope PWM [1]**

Use the **Auto mode fan slope PWM** option to set the auto mode fan slope 1-8.

**→ SYS\_FAN2 Smart Fan Control [Auto Mode]**

Use the **SYS\_FAN2Smart Fan Control** option to configure the System Smart Fan.

- ➔ **Manual Mode**                      The fan spins at the speed set in Manual Mode settings.
- ➔ **Auto Mode**                      **DEFAULT**                      The fan adjusts its speed using Auto Mode settings.

➔ **SYS\_FAN2 Start Temperature**

If the System temperature is between **fan off** and **fan start**, the fan speed change to **fan start PWM**. To set a value, Use the + or – key to change the value or enter a decimal number between 1 and 100.

➔ **SYS\_FAN2 Off Temperature**

If the System temperature is lower than the value set this option, the fan speed change to be lowest. To set a value, Use the + or – key to change the value or enter a decimal number between 1 and 100.

➔ **SYS\_FAN2 Start PWM**

Use the **SYS\_Fan2 Start PWM** option to set the PWM start value. Use the + or – key to change the value or enter a decimal number between 1 and 100.

### 5.3.6 Serial Port Console Redirection

The **Serial Port Console Redirection** menu (**BIOS Menu 22**) allows the console redirection options to be configured. Console Redirection allows users to maintain a system remotely by re-directing keyboard input and text output through the serial port.

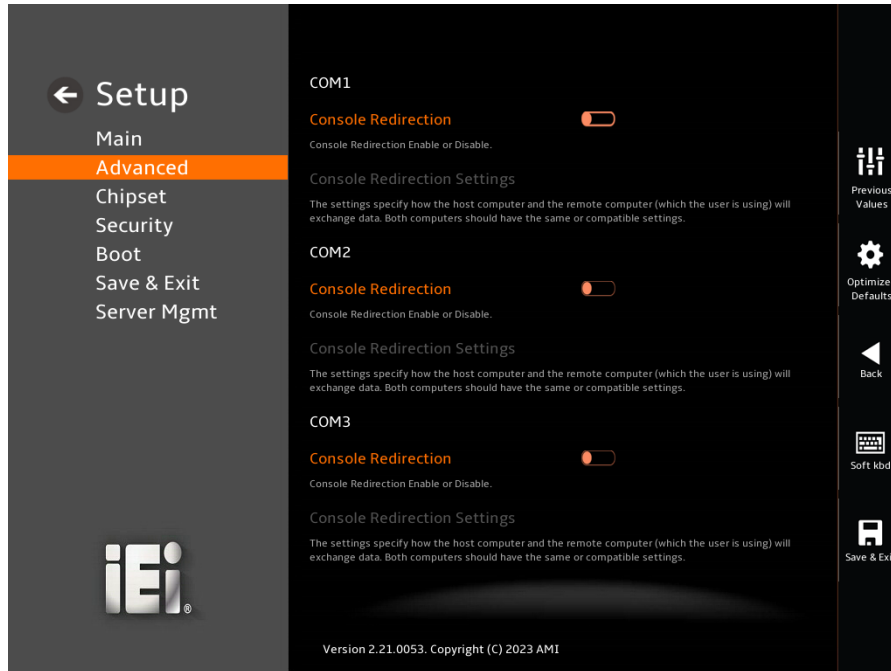

**BIOS Menu 22: Serial Port Console Redirection (1/3)**

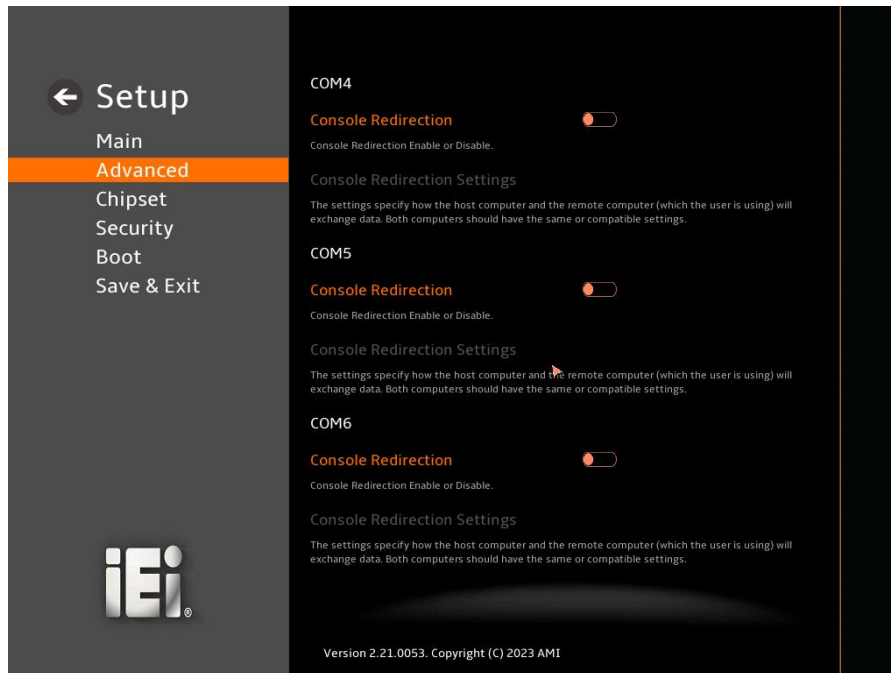

**BIOS Menu 23: Serial Port Console Redirection (2/3)**

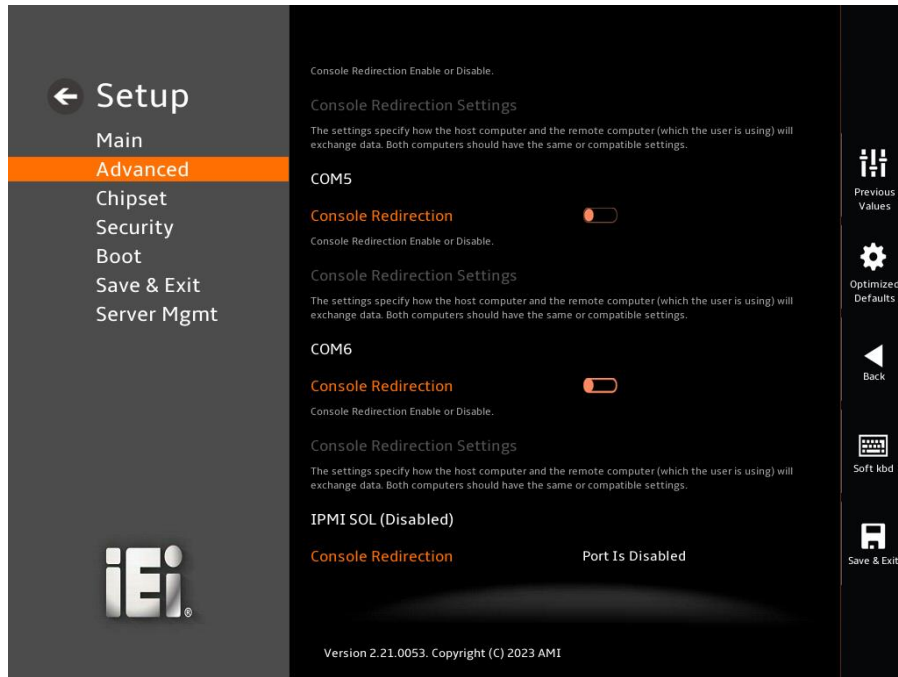

**BIOS Menu 24: Serial Port Console Redirection (3/3)**

➔ **Console Redirection [Disabled]**

Use **Console Redirection** option to enable or disable the console redirection function.

- ➔ **Disabled**    **DEFAULT**    Disabled the console redirection function
- ➔ **Enabled**                    Enabled the console redirection function

The **Console Redirection Settings** submenu will be available when the **Console Redirection** option is enabled.

**5.3.6.1 Console Redirection Settings**

The following options are available in the **Console Redirection Settings** submenu (**BIOS Menu 25**) when the **COM Console Redirection** (for COM1 to COM6) option is enabled.



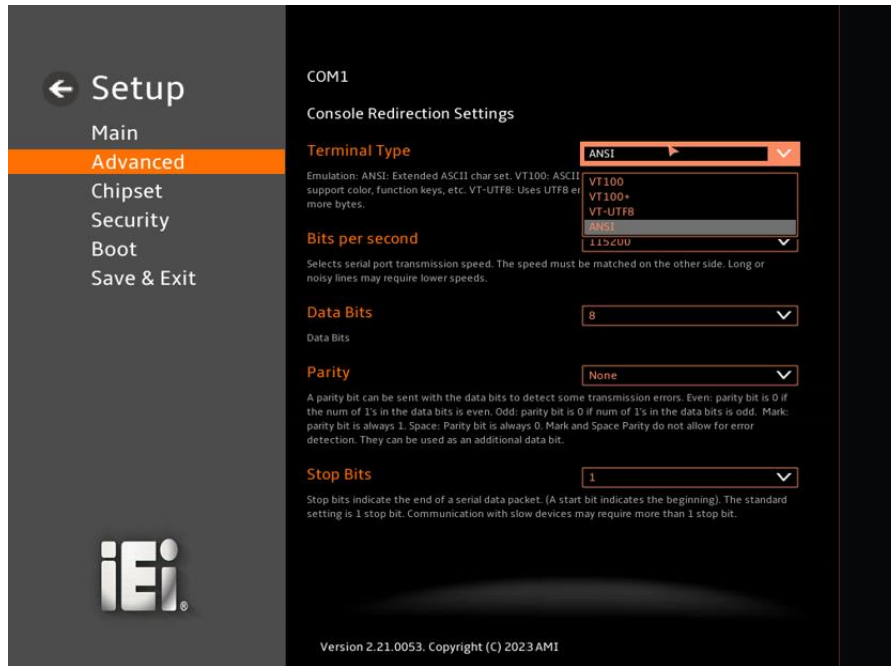

**BIOS Menu 25: COM Console Redirection Settings**

➔ **Terminal Type [ANSI]**

Use the **Terminal Type** option to specify the remote terminal type.

- ➔ **VT100**                      The target terminal type is VT100
- ➔ **VT100+**                      The target terminal type is VT100+
- ➔ **VT-UTF8**                      The target terminal type is VT-UTF8
- ➔ **ANSI**                      **DEFAULT**                      The target terminal type is ANSI

➔ **Bits per second [115200]**

Use the **Bits per second** option to specify the serial port transmission speed. The speed must match on the other side. Long or noisy lines may require lower speeds.

- ➔ **9600**                      Sets the serial port transmission speed at 9600.
- ➔ **19200**                      Sets the serial port transmission speed at 19200.
- ➔ **38400**                      Sets the serial port transmission speed at 38400.

- **57600** Sets the serial port transmission speed at 57600.
- **115200**      **DEFAULT** Sets the serial port transmission speed at 115200.

→ **Data Bits [8]**

Use the **Data Bits** option to specify the number of data bits.

- **7** Sets the data bits at 7.
- **8**      **DEFAULT** Sets the data bits at 8.

→ **Parity [None]**

Use the **Parity** option to specify the parity bit that can be sent with the data bits for detecting the transmission errors.

- **None**      **DEFAULT** No parity bit is sent with the data bits.
- **Even** The parity bit is 0 if the number of ones in the data bits is even.
- **Odd** The parity bit is 0 if the number of ones in the data bits is odd.
- **Mark** The parity bit is always 1. This option does not allow for error detection.
- **Space** The parity bit is always 0. This option does not allow for error detection.

→ **Stop Bits [1]**

Use the **Stop Bits** option to specify the number of stop bits used to indicate the end of a serial data packet. Communication with slow devices may require more than 1 stop bit.

- **1**      **DEFAULT** Sets the number of stop bits at 1.
- **2** Sets the number of stop bits at 2.

### 5.3.7 NVMe Configuration

Use the **NVMe Configuration (BIOS Menu 26)** menu to display the NVMe controller and device information.



**BIOS Menu 26: NVMe Configuration**

## 5.4 Chipset

Use the **Chipset** menu (**BIOS Menu 27**) to access the PCH IO and System Agent (SA) configuration menus.



### **WARNING!**

Setting the wrong values for the Chipset BIOS selections in the Chipset BIOS menu may cause the system to malfunction.



**BIOS Menu 27: Chipset**

### 5.4.1 System Agent (SA) Configuration

Use the **System Agent (SA) Configuration** menu (**BIOS Menu 28**) to configure the System Agent (SA) parameters.



#### BIOS Menu 28: System Agent (SA) Configuration

##### → VT-d [Enabled]

Use the **VT-d** option to enable or disable the VT-d capability.

- **Disabled**                      Disable the VT-d capability
- **Enabled**                      **DEFAULT**              Enable the VT-d capability

### 5.4.1.1 Memory Configuration

Use the **Memory Configuration** submenu (**BIOS Menu 29**) to view memory information.



**BIOS Menu 29: Memory Configuration**

### 5.4.1.2 Graphics Configuration

Use the **Graphics Configuration (BIOS Menu 30)** menu to configure the video device connected to the system.

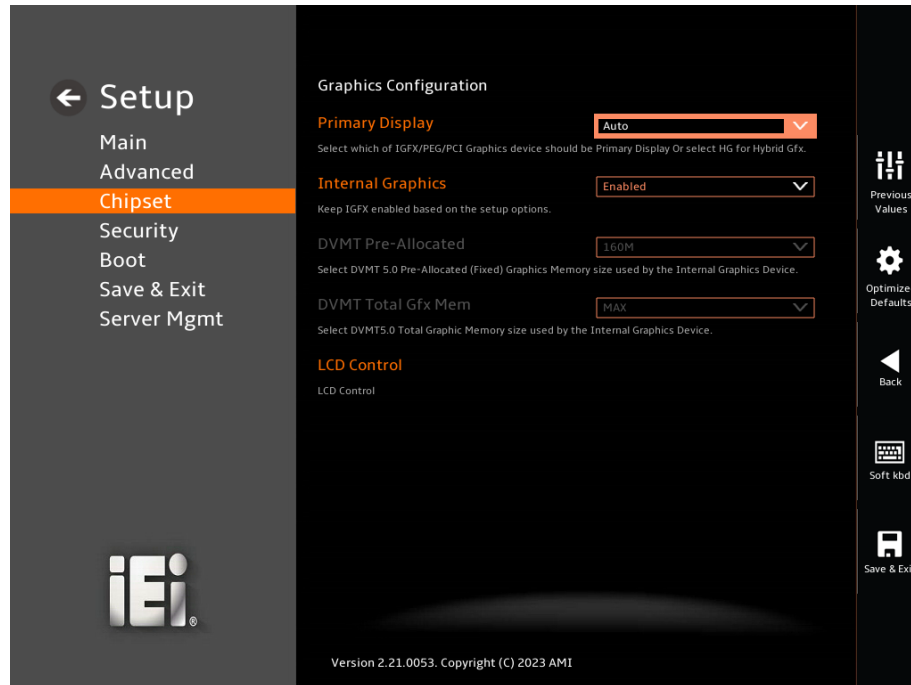

#### BIOS Menu 30: Graphics Configuration

##### → Primary Display [Auto]

Use the **Primary Display** option to select the primary graphics controller the system uses. The following options are available:

- Auto                   **Default**
- IGFX
- PEG
- PCI
- SG

##### → Internal Graphics [Enabled]

Use the **Internal Graphics** option to configure whether to keep IGFX enabled. If user wants to support dual display by internal graphics and external graphics, this Internal

Graphics option should be set to Enabled and the above Primary Display option should be set to IGFX.

- ➔ **Auto** Auto mode
- ➔ **Disabled** Disables IGFX.
- ➔ **Enabled** **Default** Enables IGFX.

➔ **DVMT Pre-Allocated [160M]**

Use the **DVMT Pre-Allocated** option to set the amount of system memory allocated to the integrated graphics processor when the system boots. The system memory allocated can then only be used as graphics memory, and is no longer available to applications or the operating system. Configuration options are listed below:

- 80M
- 160M **Default**

➔ **DVMT Total Gfx Mem [MAX]**

Use the **DVMT Total Gfx Mem** option to select DVMT5.0 total graphic memory size used by the internal graphic device. The following options are available:

- 128M
- 256M
- MAX **Default**



# IMBA-ADL-Q670

## → LCD Control



BIOS Menu 31: LCD Control

### 5.4.1.3 VMD Configuration

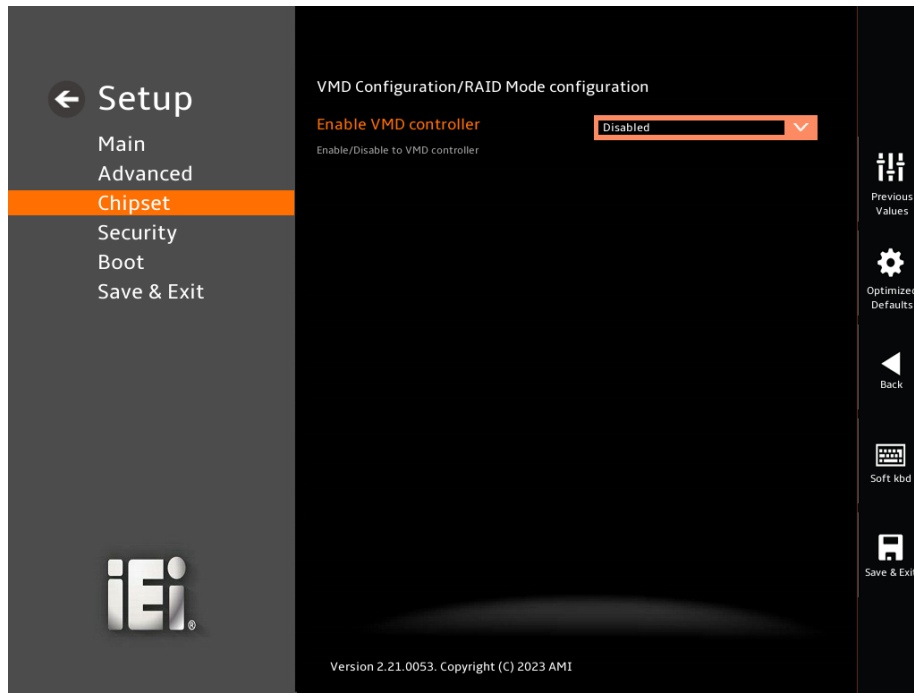

#### BIOS Menu 32: VMD Configuration

➔ **Enable VMD controller [Disabled]**

Use the **Enable VMD controller** option to enable or disable VMD controller.

- ➔ **Disabled**                      **Default**                      Disable VMD controller.
- ➔ **Enabled**    Enable VMD controller.

### 5.4.1.4 PEG Port Configuration

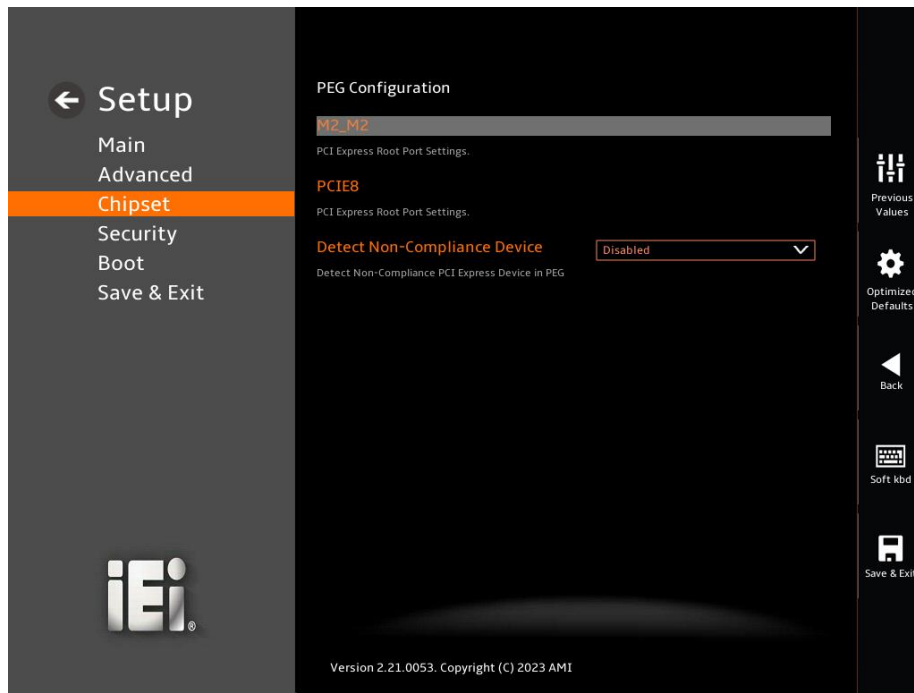

#### BIOS Menu 33: PEG Port Configuration

##### → Detect Non-Compliance Device [Disabled]

Use the **Detect Non-Compliance Device** option to detect non-compliance PCIe device in PEG.

- **Disabled**      **DEFAULT**      Do not detect non-compliance PCIe device in PEG
- **Enabled**           Detect non-compliance PCIe device in PEG

### 5.4.2 PCH-IO Configuration

Use the **PCH-IO Configuration** menu (**BIOS Menu 34**) to configure the PCH parameters.



**BIOS Menu 34: PCH-IO Configuration (1/2)**



→ **Power Saving Function (EUP) [Disabled]**

Use the **Power Saving Function (EUP)** BIOS option to enable or disable the power saving function.

- **Disabled**      **DEFAULT**      Power saving function is disabled.
- **Enabled**                      Power saving function is enabled. It will reduce power consumption when the system is off.

→ **USB Power state [S0/S3/S4/S5 ON]**

Use the **USB Power state option** to enable or disable the USB Power.

- **S0/S3/S4/S5 ON**      **DEFAULT**      USB Power is on.
- **S3/S4/S5 OFF**                      USB Power is off.

### 5.4.2.1 PCI Express Configuration

Use the **PCI Express Configuration** submenu (**BIOS Menu 36**) to configure the PCI Express slots.



**BIOS Menu 36: PCI Express Configuration**

### 5.4.2.1.2 PCIe Root Port Setting

Use the **M2\_M1, PCIE7, PCIE3, M2\_M2, PCI1, IPMI, PCIE6, PCIE5** submenu (**BIOS Menu 37**) to configure the PCIe Root Port Setting.



#### BIOS Menu 37: PCIe Slot Configuration Submenu

##### ➔ PCIe Speed [Auto]

Use the **PCIe Speed** option to specify the PCI Express port speed. Configuration options are listed below.

- ➔ **Auto**                      **DEFAULT**                      Auto mode.
- ➔ **Gen1**    Configure PCIe Speed to Gen1.
- ➔ **Gen2**    Configure PCIe Speed to Gen2.
- ➔ **Gen3**    Configure PCIe Speed to Gen3.

##### ➔ Detect Non-Compliance Device [Disabled]

Use the **Detect Non-Compliance Device** option to configure whether to detect if a non-compliance PCI Express device is connected to the PCI Express port.



## IMBA-ADL-Q670

- ➔ **Disabled**                      **DEFAULT**      Do not detect if a non-compliance PCI Express device is connected to the PCI Express port.
- ➔ **Enabled**                              Detect if a non-compliance PCI Express device is connected to the PCI Express port.

### 5.4.2.2 SATA Configuration

Use the **SATA Configuration** menu (**BIOS Menu 38**) to change and/or set the configuration of the SATA devices installed in the system.

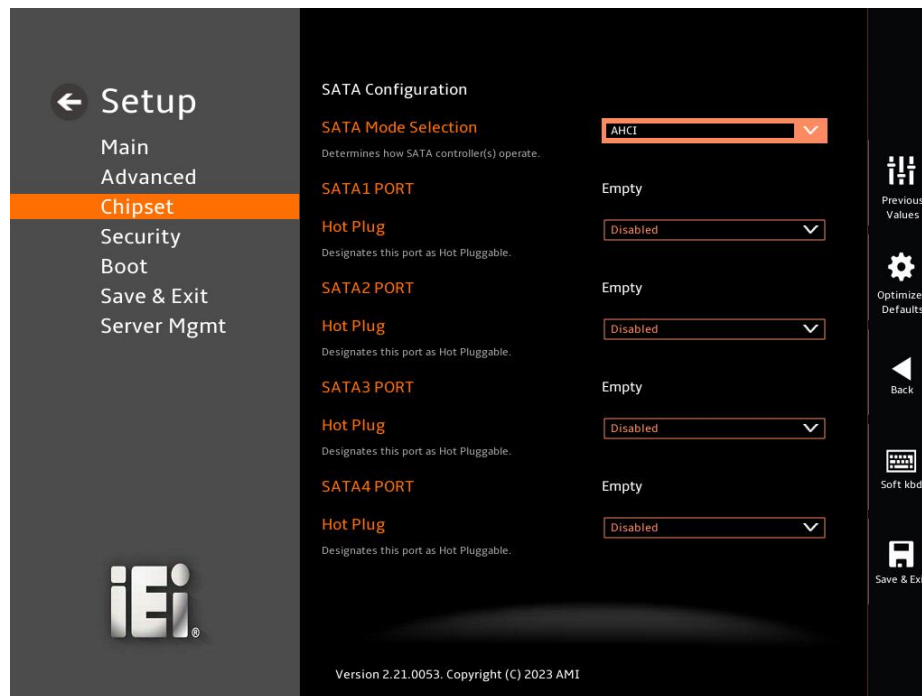

### BIOS Menu 38: SATA Configuration

#### ➔ **SATA Mode Selection [AHCI]**

Use the **SATA Mode Selection** option to determine how the SATA devices operate.

- ➔ **AHCI**                                      **DEFAULT**      Configures SATA devices as AHCI device.
- ➔ **Intel RST Premium With Intel Optane System Acceleration**                              Configures SATA devices to the Intel RST Premium With Intel Optane System Acceleration mode.

➔ **Hot Plug [Disabled]**

Use the **Hot Plug** option to designate the correspondent port as hot-pluggable.

- ➔ **Disabled**      **DEFAULT**      Disables the hot-pluggable function of the SATA port.
- ➔ **Enabled**                      Designates the SATA port as hot-pluggable.

**5.4.2.3 HD Audio Configuration**

Use the **HD Audio Configuration** menu (**BIOS Menu 39**) to configure the PCH Azalia settings.

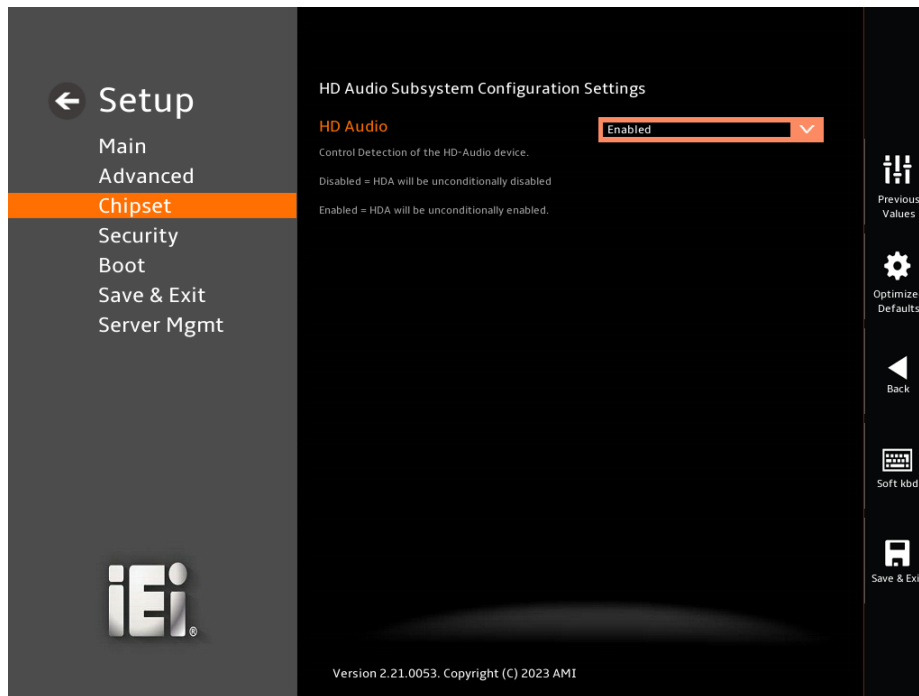

**BIOS Menu 39: HD Audio Configuration**

➔ **HD Audio [Enabled]**

Use the **HD Audio** option to enable or disable the High Definition Audio controller.

- ➔ **Disabled**                      The onboard High Definition Audio controller is disabled.
- ➔ **Enabled**      **DEFAULT**      The onboard High Definition Audio controller is enabled.

## 5.5 Security

Use the **Security** menu (**BIOS Menu 41**) to set system and user passwords.



**BIOS Menu 40: Security (1/2)**



**BIOS Menu 41: Security (2/2)**

**➔ Administrator Password**

Use the **Administrator Password** to set or change an administrator password.

**➔ User Password**

Use the **User Password** to set or change a user password.

## IMBA-ADL-Q670

## 5.6 Boot

Use the **Boot** menu (**BIOS Menu 42**) to configure system boot options.

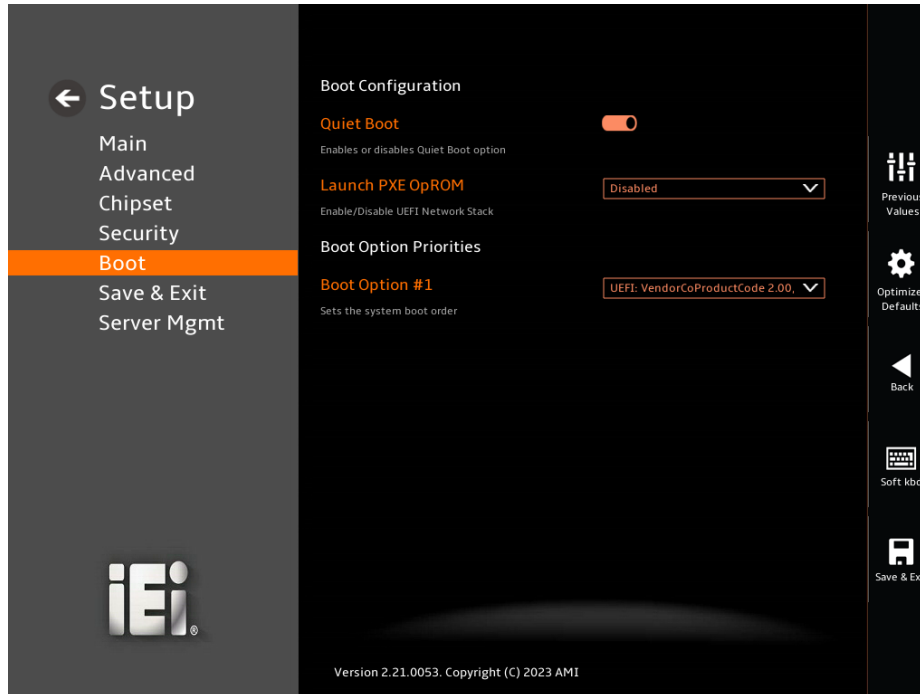

## BIOS Menu 42: Boot

## 5.6.1 Boot Configuration

## → Quiet Boot [Enabled]

Use the **Quiet Boot** BIOS option to select the screen display when the system boots.

- **Disabled** Normal POST messages displayed
- **Enabled** **DEFAULT** OEM Logo displayed instead of POST messages

## → Launch PXE OpROM [Disabled]

Use the **Launch PXE OpROM** option to enable or disable boot option for legacy network devices.

- **Disabled** **DEFAULT** Ignore all PXE Option ROMs

→ **Enabled** Load PXE Option ROMs.

→ **Option ROM Messages [Force BIOS]**

Use the **Option ROM Messages** option to set the Option ROM display mode.

→ **Force BIOS** **DEFAULT** Sets display mode to force BIOS.

→ **Keep Current** Sets display mode to current.

### 5.6.2 Boot Option Priorities

Use the Boot Option # N to choose the system boots from the peripherals you selected. The following Boot Options are listed as an example.

→ **Boot Option #1**

Sets the system boot order **ADATA SP580** as the first priority.

→ **Windows Boot Manager (P1: ADATA SSD SP580 240GB)**

→ **Disabled**

→ **Boot Option #2**

Sets the system boot order **USB Partition 1** as the second priority.

→ **UEFI: USB, Partition 1**

→ **Disabled**

## 5.7 Save & Exit

Use the **Save & Exit** menu (**BIOS Menu 43**) to load default BIOS values, optimal failsafe values and to save configuration changes.

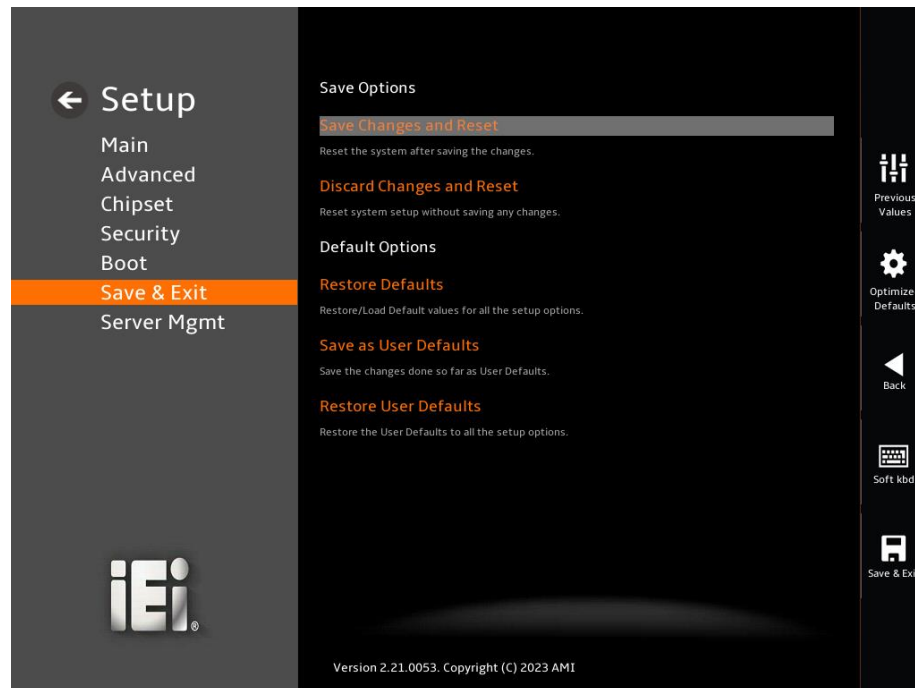

### BIOS Menu 43: Save & Exit

#### → Save Changes and Reset

Use the **Save Changes and Reset** option to save the changes made to the BIOS options and reset the system.

#### → Discard Changes and Reset

Use the **Discard Changes and Reset** option to exit the system without saving the changes made to the BIOS configuration setup program.

#### → Restore Defaults

Use the **Restore Defaults** option to load the optimal default values for each of the parameters on the Setup menus. **F3 key can be used for this operation.**

→ **Save as User Defaults**

Use the **Save as User Defaults** option to save the changes done so far as user defaults.

→ **Restore User Defaults**

Use the **Restore User Defaults** option to restore the user defaults to all the setup options.



Appendix

**A**

# Regulatory Compliance

---

**DECLARATION OF CONFORMITY**

This equipment has been tested and found to comply with specifications for CE marking. If the user modifies and/or installs other devices in the equipment, the CE conformity declaration may no longer apply.

**FCC WARNING**

This equipment complies with Part 15 of the FCC Rules. Operation is subject to the following two conditions:

- This device may not cause harmful interference, and
- This device must accept any interference received, including interference that may cause undesired operation.

This equipment has been tested and found to comply with the limits for a Class A digital device, pursuant to part 15 of the FCC Rules. These limits are designed to provide reasonable protection against harmful interference when the equipment is operated in a commercial environment. This equipment generates, uses, and can radiate radio frequency energy and, if not installed and used in accordance with the instruction manual, may cause harmful interference to radio communications.

Operation of this equipment in a residential area is likely to cause harmful interference in which case the user will be required to correct the interference at his own expense.

Appendix

**B**

# Product Disposal

---

**CAUTION:**

Risk of explosion if battery is replaced by an incorrect type. Only certified engineers should replace the on-board battery.

Dispose of used batteries according to instructions and local regulations.

- Outside the European Union–If you wish to dispose of used electrical and electronic products outside the European Union, please contact your local authority so as to comply with the correct disposal method.
- Within the European Union–The device that produces less waste and is easier to recycle is classified as electronic device in terms of the European Directive 2012/19/EU (WEEE), and must not be disposed of as domestic garbage.

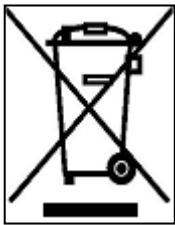

EU-wide legislation, as implemented in each Member State, requires that waste electrical and electronic products carrying the mark (left) must be disposed of separately from normal household waste. This includes monitors and electrical accessories, such as signal cables or power cords. When you need to dispose of your device, please follow the guidance of your local authority, or ask the shop where you purchased the product. The mark on electrical and electronic products only applies to the current European Union Member States.

Please follow the national guidelines for electrical and electronic product disposal.

Appendix

C

# BIOS Options

---

Below is a list of BIOS configuration options in the BIOS chapter.

- ➔ BIOS Information .....96
- ➔ Processor Information.....96
- ➔ PCH Information.....97
- ➔ System Date [xx/xx/xx] .....97
- ➔ System Time [xx:xx:xx] .....97
- ➔ Intel (VMX) Virtualization Technology [Enabled] .....100
- ➔ Active Performance Cores [All] .....101
- ➔ Active Efficient Cores [All] .....101
- ➔ Hyper-Threading [Enabled] .....101
- ➔ Intel(R) SpeedStep(tm) [Enabled] .....102
- ➔ Turbo Mode [Enabled] .....102
- ➔ C states [Disabled] .....102
- ➔ Power Limit 1 [0] .....102
- ➔ Power Limit 1 Time Window [0] .....102
- ➔ Power Limit 2 [0] .....103
- ➔ TPM Support [Enable] .....103
- ➔ Pending Operation [None] .....104
- ➔ Wake system with Fixed Time [Enabled] .....105
- ➔ Serial Port [Enabled] .....107
- ➔ Device Settings .....107
- ➔ Device Mode [RS232] .....107
- ➔ Serial Port [Enabled] .....108
- ➔ Device Settings .....108
- ➔ Device Mode [RS232] .....109
- ➔ Serial Port [Enabled] .....109
- ➔ Device Settings .....110
- ➔ Serial Port [Enabled] .....110
- ➔ Device Settings .....111
- ➔ Serial Port [Enabled] .....111
- ➔ Device Settings .....111
- ➔ Serial Port [Enabled] .....112
- ➔ Device Settings .....112
- ➔ PC Health Status .....114

## IMBA-ADL-Q670

➔ CPU_FAN1 Smart Fan Control [Auto Mode] .....	116
➔ CPU_FAN1 Start Temperature .....	116
➔ CPU_FAN1 Off Temperature .....	116
➔ CPU_FAN1 Start PWM .....	117
➔ SYS_FAN1 Smart Fan Control [Auto Mode].....	117
➔ SYS_FAN1 Start Temperature .....	117
➔ SYS_FAN1 Off Temperature .....	117
➔ SYS_FAN1 Start PWM .....	117
➔ Auto mode fan slope PWM [1] .....	117
➔ SYS_FAN2 Smart Fan Control [Auto Mode].....	117
➔ SYS_FAN2 Start Temperature .....	118
➔ SYS_FAN2 Off Temperature .....	118
➔ SYS_FAN2 Start PWM .....	118
➔ Console Redirection [Disabled].....	120
➔ Terminal Type [ANSI].....	121
➔ Bits per second [115200].....	121
➔ Data Bits [8] .....	122
➔ Parity [None].....	122
➔ Stop Bits [1].....	122
➔ VT-d [Enabled].....	125
➔ Primary Display [Auto] .....	127
➔ Internal Graphics [Enabled] .....	127
➔ DVMT Pre-Allocated [160M] .....	128
➔ DVMT Total Gfx Mem [MAX].....	128
➔ Enable VMD controller [Disabled] .....	130
➔ Detect Non-Compliance Device [Disabled] .....	131
➔ Auto Power Button Function [Disabled (ATX)].....	133
➔ Restore AC Power Loss [Last State] .....	133
➔ Power Saving Function (EUP) [Disabled].....	134
➔ USB Power state [S0/S3/S4/S5 ON].....	134
➔ PCIe Speed [Auto].....	136
➔ Detect Non-Compliance Device [Disabled] .....	136
➔ SATA Mode Selection [AHCI].....	137
➔ Hot Plug [Disabled] .....	138
➔ HD Audio [Enabled] .....	138

→ Administrator Password .....	140
→ User Password .....	140
→ Quiet Boot [Enabled] .....	141
→ Launch PXE OpROM [Disabled] .....	141
→ Option ROM Messages [Force BIOS].....	142
→ Boot Option #1 .....	142
→ Boot Option #2 .....	142
→ Save Changes and Reset .....	143
→ Discard Changes and Reset .....	143
→ Restore Defaults .....	143
→ Save as User Defaults .....	144
→ Restore User Defaults .....	144



Appendix

D

# Watchdog Timer

---



**NOTE:**

The following discussion applies to DOS environment. Contact IEI support or visit the IEI website for specific drivers for other operating systems.

The Watchdog Timer is provided to ensure that standalone systems can always recover from catastrophic conditions that cause the CPU to crash. This condition may have occurred by external EMIs or a software bug. When the CPU stops working correctly, Watchdog Timer either performs a hardware reset (cold boot) or a Non-Maskable Interrupt (NMI) to bring the system back to a known state.

A BIOS function call (INT 15H) is used to control the Watchdog Timer.

INT 15H:

<b>AH – 6FH Sub-function:</b>	
AL – 2:	Sets the Watchdog Timer’s period.
BL:	Time-out value (Its unit-second is dependent on the item “Watchdog Timer unit select” in CMOS setup).

**Table D-1: AH-6FH Sub-function**

Call sub-function 2 to set the time-out period of Watchdog Timer first. If the time-out value is not zero, the Watchdog Timer starts counting down. When the timer value reaches zero, the system resets. To ensure that this reset condition does not occur, calling sub-function 2 must periodically refresh the Watchdog Timer. However, the watchdog timer is disabled if the time-out value is set to zero.

A tolerance of at least 10% must be maintained to avoid unknown routines within the operating system (DOS), such as disk I/O that can be very time-consuming.

**NOTE:**

When exiting a program it is necessary to disable the Watchdog Timer, otherwise the system resets.

**EXAMPLE PROGRAM:**

**; INITIAL TIMER PERIOD COUNTER**

;

**W\_LOOP:**

;

```

MOV      AX, 6F02H      ;setting the time-out value
MOV      BL, 30         ;time-out value is 48 seconds
INT      15H

```

;

**; ADD THE APPLICATION PROGRAM HERE**

;

```

CMP      EXIT_AP, 1     ;is the application over?
JNE      W_LOOP        ;No, restart the application

```

```

MOV      AX, 6F02H     ;disable Watchdog Timer
MOV      BL, 0        ;
INT      15H

```

;

**; EXIT ;**

Appendix

**E**

# Error Beep Code

---

## E.1 PEI Beep Codes

Number of Beeps	Description
1	Memory not Installed
1	Memory was installed twice (InstallPeiMemory routine in PEI Core called twice)
2	Recovery started
3	DXE IPL was not found
3	DXE Core Firmware Volume was not found
4	Recovery failed
4	S3 Resume failed
7	Reset PPI is not available

## E.2 DXE Beep Codes

Number of Beeps	Description
1	Invalid password
4	Some of the Architectural Protocols are not available
5	No Console Output Devices are found
5	No Console Input Devices are found
6	Flash update is failed
7	Reset protocol is not available
8	Platform PCI resource requirements cannot be met



**NOTE:**

If you have any question, please contact IEI for further assistance.

Appendix

**F**

# Hazardous Materials Disclosure

---

## F.1 RoHS II Directive (2015/863/EU)

The details provided in this appendix are to ensure that the product is compliant with the RoHS II Directive (2015/863/EU). The table below acknowledges the presences of small quantities of certain substances in the product, and is applicable to RoHS II Directive (2015/863/EU).

Please refer to the following table.

Part Name	Toxic or Hazardous Substances and Elements									
	Lead (Pb)	Mercury (Hg)	Cadmium (Cd)	Hexavalent Chromium (CR(VI))	Polybrominated Biphenyls (PBB)	Polybrominated Diphenyl Ethers (PBDE)	Bis(2-ethylhexyl) phthalate (DEHP)	Butyl benzyl phthalate (BBP)	Dibutyl phthalate (DBP)	Diisobutyl phthalate (DIBP)
Housing	O	O	O	O	O	O	O	O	O	O
Printed Circuit Board	O	O	O	O	O	O	O	O	O	O
Metal Fasteners	O	O	O	O	O	O	O	O	O	O
Cable Assembly	O	O	O	O	O	O	O	O	O	O
Fan Assembly	O	O	O	O	O	O	O	O	O	O
Power Supply Assemblies	O	O	O	O	O	O	O	O	O	O
Battery	O	O	O	O	O	O	O	O	O	O
<p>O: This toxic or hazardous substance is contained in all of the homogeneous materials for the part is below the limit requirement in Directive (EU) 2015/863.</p> <p>X: This toxic or hazardous substance is contained in at least one of the homogeneous materials for this part is above the limit requirement in Directive (EU) 2015/863.</p>										

## F.2 China RoHS

此附件旨在确保本产品符合中国 RoHS 标准。以下表格标示此产品中某有毒物质的含量符合中国 RoHS 标准规定的限量要求。

本产品上会附有“环境友好使用期限”的标签，此期限是估算这些物质“不会有泄漏或突变”的年限。本产品可能包含有较短的环境友好使用期限的可替换元件，像是电池或灯管，这些元件将会单独标示出来。

部件名称	有毒有害物质或元素					
	铅 (Pb)	汞 (Hg)	镉 (Cd)	六价铬 (CR(VI))	多溴联苯 (PBB)	多溴二苯醚 (PBDE)
壳体	○	○	○	○	○	○
印刷电路板	○	○	○	○	○	○
金属螺帽	○	○	○	○	○	○
电缆组装	○	○	○	○	○	○
风扇组装	○	○	○	○	○	○
电力供应组装	○	○	○	○	○	○
电池	○	○	○	○	○	○
<p>O: 表示该有毒有害物质在该部件所有物质材料中的含量均在 SJ/T11364-2014 與 GB/T26572-2011 标准规定的限量要求以下。</p> <p>X: 表示该有毒有害物质至少在该部件的某一均质材料中的含量超出 SJ/T11364-2014 與 GB/T26572-2011 标准规定的限量要求。</p>						