

MODEL:
KINO-DQM170

Mini-ITX SBC Supports 6th GEN Intel[®] Core[™] i7/i5/i3 or Celeron[®] CPU with Intel[®] QM170, HDMI 2.0, HDMI 1.4, Dual PCIe GbE, PCIe Mini, PCIe x16, M.2, SATA 6Gb/s, USB 3.0, HD Audio, and RoHS

User Manual

Revision

Date	Version	Changes
September 1, 2016	1.00	Initial release



Safety Instructions

- en** Warning! Read the user manual before connecting the system to the power source.
- de** Vorsicht! Bitte lesen Sie die Bedienungsanleitung, bevor Sie das System an eine Stromquelle anschließen.
- fr** Attention! Avant de brancher le système à la source d'alimentation, consultez le mode d'emploi.
- it** Avvertenza! Consultare il manuale utente prima di collegare il sistema all'alimentatore.
- es** Atención! Lea atentamente este manual del usuario antes de operar la fuente de alimentación.
- zh** 警告！在將系統連接到電源之前，請仔細閱讀使用手冊。
- cn** 警告！在將系統連接到電源之前，請仔細閱讀使用手冊。
-

- en** Warning! To prevent the system from overheating, do not operate it in an area that exceeds the maximum operating temperature described in the user manual.
- de** Vorsicht! Um eine Überhitzung des Systems zu vermeiden, betreiben Sie es ausschließlich im zulässigen Betriebstemperaturbereich. Dieser ist in der Bedienungsanleitung vermerkt.
- fr** Attention! Pour éviter la surchauffe du système, ne l'utilisez pas dans une zone dont la température dépasse les limites décrits dans le mode d'emploi.
- it** Avvertenza! Per evitare che il sistema si surriscaldi, non utilizzarlo in aree che superino la temperatura massima d'esercizio descritta nel manuale utente.
- es** Atención! Para evitar el excesivo calentamiento del sistema, no opere en las condiciones de temperatura superior a lo recomendado en este manual del usuario.
- zh** 警告！為防止系統過熱，不要在超過使用手冊上記載的產品工作溫度範圍之外操作此系統。
- cn** 警告！為防止系統過熱，不要在超過使用手冊上記載的產品工作溫度範圍之外操作此系統。
-

- en** Warning! Use only the adapter and power cord approved for this system. Use of another type of adapter may risk fire or explosion. Please refer to the user manual for the power adapter specifications.
- de** Vorsicht! Nur zugelassene Netzteile und Netzkabel dürfen verwendet werden. Die Benutzung von anderen Netzteilen kann einen Brand oder eine Explosion zur Folge haben. Prüfen Sie die jeweiligen Spezifikationen in der Bedienungsanleitung.
- fr** Attention! Utilisez exclusivement le câble d'alimentation et l'adaptateur homologués pour ce système. L'utilisation d'un autre type d'adaptateur risquerait de provoquer un incendie ou une explosion. Veuillez référer au mode d'emploi pour les spécifications de l'adaptateur d'alimentation.
- it** Avvertenza! Utilizzare solo l'adattatore e il cavo di alimentazione approvati per questo sistema. L'uso di un altro tipo di adattatore può causare rischio d'incendio o esplosione. Si prega di fare riferimento al manuale utente per le specifiche sull'alimentazione.
- es** Atención! Utilice solamente el adaptador de corriente alterna (CA) con Marcas Conformidad otorgadas. Cualquier otro adaptador no otorgado aumenta el riesgo de explosión o incendio. Por favor consulte el manual del usuario para las especificaciones del adaptador de alimentación.
- zh** 警告！只能使用經過認證、適用於本系統的電源變壓器與電源線。使用不適用的電源變壓器將可能導致火災或爆炸。電源變壓器規格請參考使用手冊。
- cn** 警告！只能使用经过认证，适用于本系统的电源适配器与电源线。使用不适用的电源适配器将可能导致火灾或爆炸。电源适配器规格请参考使用手冊。
-

- en** Warning! Ultimate disposal of this product should be handled according to all national laws and regulations.
- de** Vorsicht! Die Entsorgung dieses Produkts sollte gemäß allen Bestimmungen und Gesetzen des Landes erfolgen.
- fr** Attention! La mise au rebut ou le recyclage de ce produit sont généralement soumis aux lois et/ou directives de respect de l'environnement. Renseignez-vous auprès de l'organisme compétent.
- it** Avvertenza! Lo smaltimento di questo prodotto deve essere eseguito secondo le leggi e i regolamenti locali.
- es** Atención! La disposición final de residuos de este producto se debe cumplir con las normativas y leyes del país.
- zh** 警告！本產品的廢棄處理應根據該國家的法律和規章進行。
- cn** 警告！本产品的废弃处理应根据该国家的法律和规章进行。
-

Copyright

COPYRIGHT NOTICE

The information in this document is subject to change without prior notice in order to improve reliability, design and function and does not represent a commitment on the part of the manufacturer.

In no event will the manufacturer be liable for direct, indirect, special, incidental, or consequential damages arising out of the use or inability to use the product or documentation, even if advised of the possibility of such damages.

This document contains proprietary information protected by copyright. All rights are reserved. No part of this manual may be reproduced by any mechanical, electronic, or other means in any form without prior written permission of the manufacturer.

TRADEMARKS

All registered trademarks and product names mentioned herein are used for identification purposes only and may be trademarks and/or registered trademarks of their respective owners.

Manual Conventions



WARNING

Warnings appear where overlooked details may cause damage to the equipment or result in personal injury. Warnings should be taken seriously.



CAUTION

Cautionary messages should be heeded to help reduce the chance of losing data or damaging the product.



NOTE

These messages inform the reader of essential but non-critical information. These messages should be read carefully as any directions or instructions contained therein can help avoid making mistakes.



HOT SURFACE

This symbol indicates a hot surface that should not be touched without taking care.

Table of Contents

1 INTRODUCTION.....	1
1.1 INTRODUCTION.....	2
1.2 MODEL VARIATIONS	3
1.3 FEATURES.....	3
1.4 CONNECTORS	4
1.5 DIMENSIONS.....	5
1.6 DATA FLOW	7
1.7 TECHNICAL SPECIFICATIONS	8
2 UNPACKING	11
2.1 ANTI-STATIC PRECAUTIONS	12
2.2 UNPACKING PRECAUTIONS.....	12
2.3 PACKING LIST.....	13
2.4 OPTIONAL ITEMS	14
3 CONNECTORS	15
3.1 PERIPHERAL INTERFACE CONNECTORS.....	16
3.1.1 KINO-DQM170 Layout	16
3.1.2 Peripheral Interface Connectors	17
3.1.3 External Interface Panel Connectors.....	18
3.2 INTERNAL PERIPHERAL CONNECTORS	19
3.2.1 ATX Power Connector	19
3.2.2 Audio Connector	20
3.2.3 Battery Connector.....	21
3.2.4 Chassis Intrusion Connector.....	22
3.2.5 Digital I/O Connector	23
3.2.6 Fan Connectors.....	24
3.2.7 Front Panel Connector	25
3.2.8 I ² C Connector	26
3.2.9 Keyboard/Mouse Connector	27
3.2.10 LAN LED Connectors	28

3.2.11 LVDS Connector.....	29
3.2.12 LVDS Backlight Connector.....	30
3.2.13 M.2 Module Slot.....	31
3.2.14 PCI Express x16 Slot.....	33
3.2.15 PCIe Mini Card Slot, Full-size	33
3.2.16 PCIe Mini Card Slot, Half-size	35
3.2.17 Power Button	37
3.2.18 RS-232 Serial Port Connectors.....	37
3.2.19 RS-232/422/485 Serial Port Connectors	38
3.2.20 SATA 6Gb/s Drive Connectors.....	40
3.2.21 SATA Power Connectors	41
3.2.22 SMBus Connector	42
3.2.23 SPI Flash Connector, BIOS.....	43
3.2.24 SPI Flash Connector, EC	44
3.2.25 USB 2.0 Connectors.....	45
3.3 EXTERNAL INTERFACE CONNECTORS	46
3.3.1 Audio Connector	46
3.3.2 Ethernet and USB 3.0 Connectors	47
3.3.3 HDMI Connectors.....	48
3.3.4 Power Connector (12 V, Power Adapter)	49
3.3.5 Serial Port Connector (COM1)	50
4 INSTALLATION	51
4.1 ANTI-STATIC PRECAUTIONS	52
4.2 INSTALLATION CONSIDERATIONS.....	52
4.3 SO-DIMM INSTALLATION	54
4.4 M.2 MODULE INSTALLATION.....	55
4.5 FULL-SIZE PCIe MINI CARD INSTALLATION	56
4.6 HALF-SIZE PCIe MINI CARD INSTALLATION.....	57
4.7 SYSTEM CONFIGURATION.....	59
4.7.1 AT/ATX Mode Select Switch.....	59
4.7.2 Clear CMOS Button.....	60
4.7.3 Flash Descriptor Security Override Jumper.....	61
4.7.4 LVDS Resolution Selection	62
4.7.5 LVDS Backlight Mode Selection	63

KINO-DQM170 Industrial Motherboard

4.7.6 LVDS Voltage Selection.....	63
4.7.7 USB Power Selection.....	64
4.8 CHASSIS INSTALLATION.....	65
4.8.1 Airflow.....	65
4.8.2 Motherboard Installation.....	65
4.9 INTERNAL PERIPHERAL DEVICE CONNECTIONS.....	65
4.9.1 SATA Drive Connection.....	65
4.10 INTEL® AMT SETUP PROCEDURE.....	67
4.11 WINDOWS 7 INSTALLATION–USB 3.0 CREATOR UTILITY.....	68
5 BIOS.....	69
5.1 INTRODUCTION.....	70
5.1.1 Starting Setup.....	70
5.1.2 Using Setup.....	70
5.1.3 Getting Help.....	71
5.1.4 Unable to Reboot after Configuration Changes.....	71
5.1.5 BIOS Menu Bar.....	71
5.2 MAIN.....	72
5.3 ADVANCED.....	73
5.3.1 ACPI Settings.....	74
5.3.2 AMT Configuration.....	75
5.3.3 Super IO Configuration.....	76
5.3.3.1 Serial Port n Configuration.....	77
5.3.3.1.1 Serial Port 1 Configuration.....	77
5.3.3.1.2 Serial Port 2 Configuration.....	78
5.3.3.1.3 Serial Port 3 Configuration.....	79
5.3.3.1.4 Serial Port 4 Configuration.....	80
5.3.3.1.5 Serial Port 5 Configuration.....	81
5.3.3.1.6 Serial Port 6 Configuration.....	82
5.3.4 iWDD H/W Monitor.....	83
5.3.4.1 Smart Fan Mode Configuration.....	85
5.3.5 RTC Wake Settings.....	88
5.3.6 Serial Port Console Redirection.....	89
5.3.6.1 Legacy Console Redirection Settings.....	90
5.3.6.2 Console Redirection Settings.....	91

5.3.7 CPU Configuration.....	93
5.3.8 SATA Configuration	95
5.3.9 NVMe Configuration.....	97
5.3.10 USB Configuration.....	98
5.3.11 IEI Feature	99
5.4 CHIPSET	100
5.4.1 System Agent (SA) Configuration	100
5.4.1.1 Graphics Configuration.....	101
5.4.1.1.1 LCD Control	104
5.4.1.2 PEG Port Configuration.....	105
5.4.1.3 Memory Configuration	106
5.4.2 PCH-IO Configuration	107
5.4.2.1 PCI Express Configuration	109
5.4.2.2 HD Audio Configuration.....	110
5.5 SECURITY.....	111
5.6 BOOT.....	112
5.7 SAVE & EXIT	114
6 SOFTWARE DRIVERS	116
6.1 SOFTWARE INSTALLATION	117
6.2 AVAILABLE SOFTWARE DRIVERS	118
A REGULATORY COMPLIANCE	119
B PRODUCT DISPOSAL	121
C BIOS MENU OPTIONS.....	123
D TERMINOLOGY	127
E DIGITAL I/O INTERFACE.....	132
F WATCHDOG TIMER.....	135
G HAZARDOUS MATERIALS DISCLOSURE	138

List of Figures

Figure 1-1: KINO-DQM170 Industrial Motherboard	2
Figure 1-2: Connectors	4
Figure 1-3: Dimensions (mm).....	5
Figure 1-4: KINO-DQM170 Height Dimensions 1 (mm).....	6
Figure 1-5: KINO-DQM170 Height Dimensions 2 (mm).....	6
Figure 1-6: Data Flow Diagram.....	7
Figure 3-1: Connector and Jumper Locations (Front Side)	16
Figure 3-2: +12V DC-IN Power Connector Location.....	19
Figure 3-3: Audio Connector Location	20
Figure 3-4: Battery Connector Location.....	21
Figure 3-5: Chassis Intrusion Connector Location.....	22
Figure 3-6: Digital I/O Connector Location	23
Figure 3-7: Fan Connector Locations.....	24
Figure 3-8: Front Panel Connector Location	25
Figure 3-9: I ² C Connector Location	26
Figure 3-10: Keyboard/Mouse Connector Location.....	27
Figure 3-11: LAN LED Connector Locations	28
Figure 3-12: LVDS Connector Location.....	29
Figure 3-13: LVDS Backlight Inverter Connector	30
Figure 3-14: M.2 Slot Location	31
Figure 3-15: PCIe x16 Slot Location	33
Figure 3-16: Full-size PCIe Mini Card Slot Location	34
Figure 3-17: Half-size PCIe Mini Card Slot Location.....	35
Figure 3-18: Power Button Location.....	37
Figure 3-19: RS-232 Connector Locations.....	38
Figure 3-20: RS-232/422/485 Connector Locations.....	39
Figure 3-21: SATA 6Gb/s Drive Connector Locations	40
Figure 3-22: SATA Power Connector Locations	41
Figure 3-23: SMBus Connector Location.....	42
Figure 3-24: SPI Flash Connector Location.....	43
Figure 3-25: SPI Flash Connector Location.....	44

Figure 3-26: USB Connector Locations.....	45
Figure 3-27: External Interface Connectors.....	46
Figure 3-28: Audio Jacks	46
Figure 3-29: Ethernet Connector.....	47
Figure 3-30: HDMI Connector	49
Figure 3-31: 4-pin Power Mini-DIN Connection	49
Figure 3-32: Serial Port Pinouts	50
Figure 4-1: SO-DIMM Installation	54
Figure 4-2: Inserting the M.2 Module into the Slot at an Angle	55
Figure 4-3: Securing the M.2 Module.....	55
Figure 4-4: Removing the Retention Screw	56
Figure 4-5: Inserting the Full-size PCIe Mini Card into the Slot at an Angle	56
Figure 4-6: Securing the Full-size PCIe Mini Card	57
Figure 4-7: Removing Retention Screw	57
Figure 4-8: Inserting the Half-size PCIe Mini Card into the Slot at an Angle.....	58
Figure 4-9: Securing the Half-size PCIe Mini Card	58
Figure 4-10: AT/ATX Mode Select Switch Location	59
Figure 4-11: Clear CMOS Button Location.....	60
Figure 4-12: Flash Descriptor Security Override Jumper Location	61
Figure 4-13: LVDS Resolution Selection Jumper Location.....	62
Figure 4-14: LVDS Backlight Mode Select Jumper Location	63
Figure 4-15: LVDS Voltage Jumper Location	64
Figure 4-16: SATA Drive Cable Connection.....	66

List of Tables

Table 1-1: Model Variations	3
Table 1-2: Technical Specifications.....	10
Table 3-1: Peripheral Interface Connectors	18
Table 3-2: Rear Panel Connectors	18
Table 3-3: +12V DC-IN Power Connector Pinouts	19
Table 3-4: Audio Connector Pinouts	20
Table 3-5: Battery Connector Pinouts	21
Table 3-6: Chassis Intrusion Connector Pinouts	22
Table 3-7: Digital I/O Connector Pinouts.....	23
Table 3-8: Fan Connector Pinouts	24
Table 3-9: Front Panel Connector Pinouts.....	25
Table 3-10: I ² C Connector Pinouts.....	26
Table 3-11: Keyboard/Mouse Connector Pinouts	27
Table 3-12: LAN LED Connector Pinouts	28
Table 3-13: LVDS Connector Pinouts.....	30
Table 3-14: Backlight Inverter Connector Pinouts	30
Table 3-15: M.2 Slot Pinouts.....	32
Table 3-16: Full-size PCIe Mini Card Slot Pinouts.....	35
Table 3-17: Half-size PCIe Mini Card Slot Pinouts	36
Table 3-18: RS-232 Connector Pinouts	38
Table 3-19: RS-232/422/485 Connector Pinouts	39
Table 3-20: RS-232/422/485 DB-9 Serial Port Pinouts.....	39
Table 3-21: SATA Power Connector Pinouts.....	41
Table 3-22: SMBus Connector Pinouts	42
Table 3-23: SPI Flash Connector Pinouts	43
Table 3-24: SPI Flash Connector Pinouts	44
Table 3-25: USB Connector Pinouts.....	45
Table 3-26: LAN1 Pinouts	47
Table 3-27: Connector LEDs.....	47
Table 3-28: External USB 3.0 Port Pinouts	48
Table 3-29: HDMI Connector Pinouts	49

Table 3-30: Serial Port Pinouts.....	50
Table 4-1: AT/ATX Mode Select Switch Settings.....	59
Table 4-2: Flash Descriptor Security Override Jumper Settings.....	61
Table 4-3: LVDS Resolution Selection Jumper Settings	62
Table 4-4: LVDS Backlight Mode Select Jumper Settings.....	63
Table 4-5: LVDS Voltage Jumper Settings.....	63
Table 4-6: BIOS Options and Configured USB Ports.....	64
Table 4-7: USB Power Source Setup	64
Table 5-1: BIOS Options and Configured USB Ports.....	108

List of BIOS Menus

BIOS Menu 1: Main	72
BIOS Menu 2: Advanced	73
BIOS Menu 3: ACPI Settings	74
BIOS Menu 4: AMT Configuration.....	75
BIOS Menu 5: Super IO Configuration.....	76
BIOS Menu 6: Serial Port n Configuration	77
BIOS Menu 7: iWDD H/W Monitor	83
BIOS Menu 8: Smart Fan Mode Configuration	85
BIOS Menu 9: RTC Wake Settings	88
BIOS Menu 10: Serial Port Console Redirection	89
BIOS Menu 11: Legacy Console Redirection Settings	90
BIOS Menu 12: Console Redirection Settings.....	91
BIOS Menu 13: CPU Configuration	93
BIOS Menu 14: SATA Configuration	95
BIOS Menu 15: NVMe Configuration.....	97
BIOS Menu 16: USB Configuration	98
BIOS Menu 17: IEI Feature	99
BIOS Menu 18: Chipset	100
BIOS Menu 19: System Agent (SA) Configuration	100
BIOS Menu 20: Graphics Configuration	101
BIOS Menu 21: LCD Control	104
BIOS Menu 22: PEG Port Configuration.....	105
BIOS Menu 23: Memory Configuration.....	106
BIOS Menu 24: PCH-IO Configuration	107
BIOS Menu 25: PCI Express Configuration	109
BIOS Menu 26: HD Audio Configuration	110
BIOS Menu 27: Security	111
BIOS Menu 28: Boot	112
BIOS Menu 29: Exit.....	114

Chapter

1

Introduction

1.1 Introduction

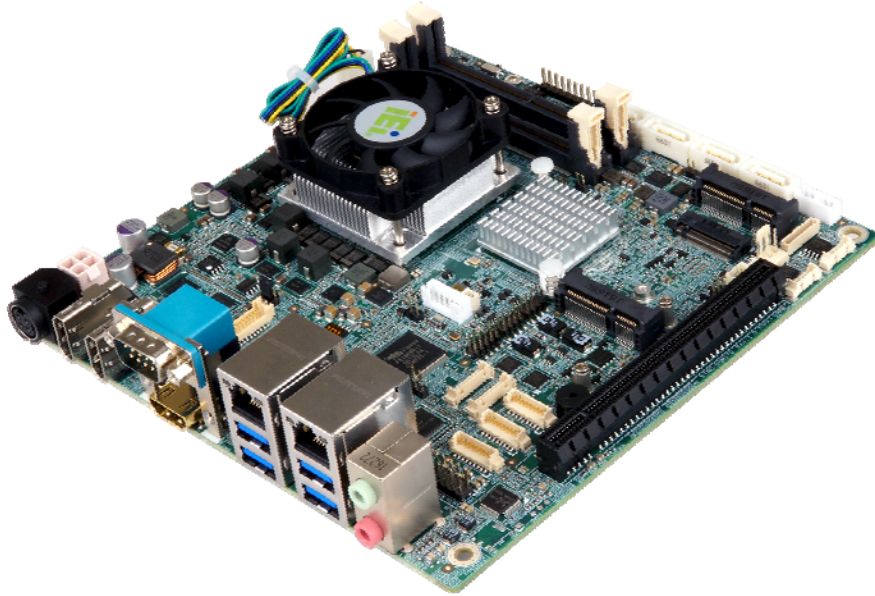

Figure 1-1: KINO-DQM170 Industrial Motherboard

The KINO-DQM170 series is a Mini-ITX form factor industrial motherboard with 6th generation Intel® Core™ i7/i5/i3 or Celeron® processor. It also equipped with two 260-pin 2133 MHz dual-channel DDR4 SDRAM SO-DIMM slots supporting up to 32 GB of memory.

The KINO-DQM170 series includes an HDMI 2.0 port, two HDMI 1.4 ports and a LVDS connector for triple independent display.

Expansions include one full-size PCIe Mini slot supporting mSATA modules, one half-size PCIe Mini slot, one M.2 A-key slot and one PCIe x16 slot. I/O include four USB 3.0 connectors on the rear panel plus two internal USB 2.0 connectors supporting four USB 2.0 devices, and four SATA 6Gb/s connectors. Serial device connectivity is provided by one external RS-232 port, three internal RS-232 connectors and two internal RS-232/422/485 connectors. Two RJ-45 GbE connectors provide the system with smooth connections to an external LAN.

KINO-DQM170 Industrial Motherboard

1.2 Model Variations

There are four models of the KINO-DQM170 series. The model variations are listed in **Table 1-1**.

Model	On-board Processor			
	Name	Speed	Cache	Max TDP
KINO-DQM170-i7	Intel® Core™ i7-6820EQ processor	3.5 GHz	8 MB	45 W
KINO-DQM170-i5	Intel® Core™ i5-6440EQ processor	3.4 GHz	6 MB	45 W
KINO-DQM170-i3E	Intel® Core™ i3-6102E processor	1.9 GHz	3 MB	25 W
KINO-DQM170-CE	Intel® Celeron® processor G3902E	1.6 GHz	2 MB	25 W

Table 1-1: Model Variations

1.3 Features

Some of the KINO-DQM170 motherboard features are listed below:

- Mini-ITX motherboard supports 6th generation Intel® Core™ i7/i5/i3 or Celeron® processor
- Two 2133 MHz DDR4 SO-DIMM slots support up to 32 GB of memory
- Triple independent display via HDMI 2.0, HDMI 1.4 and LVDS interface
- Supports HDMI 2.0 (4096x2160 @ 60 Hz)
- Dual Intel® GbE port supporting Intel® AMT 11.0
- Supports M.2 2230 modules with A-key edge connector
- One full-size PCIe Mini card slot supports mSATA module
- PCIe x16 slot for expansion
- Four SATA 6Gb/s connectors with 5V power output
- Four USB 3.0 external connectors
- Four RS-232 connectors and two RS-232/422/485 connectors
- IEI One Key Recovery solution allows you to create rapid OS backup and recovery

1.4 Connectors

The connectors on the KINO-DQM170 are shown in the figures below.

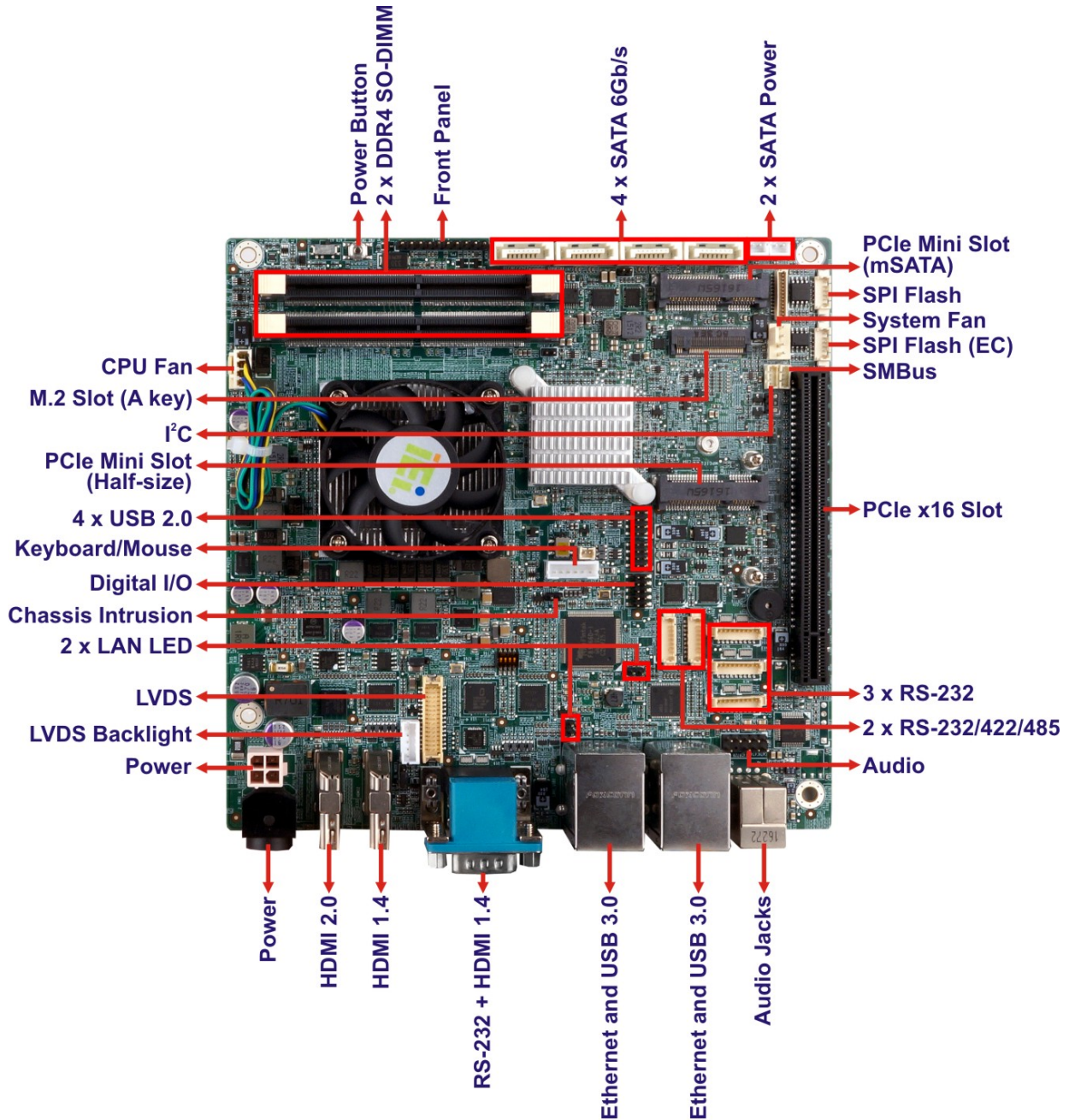

Figure 1-2: Connectors

KINO-DQM170 Industrial Motherboard

1.5 Dimensions

The dimensions of the board are listed below:

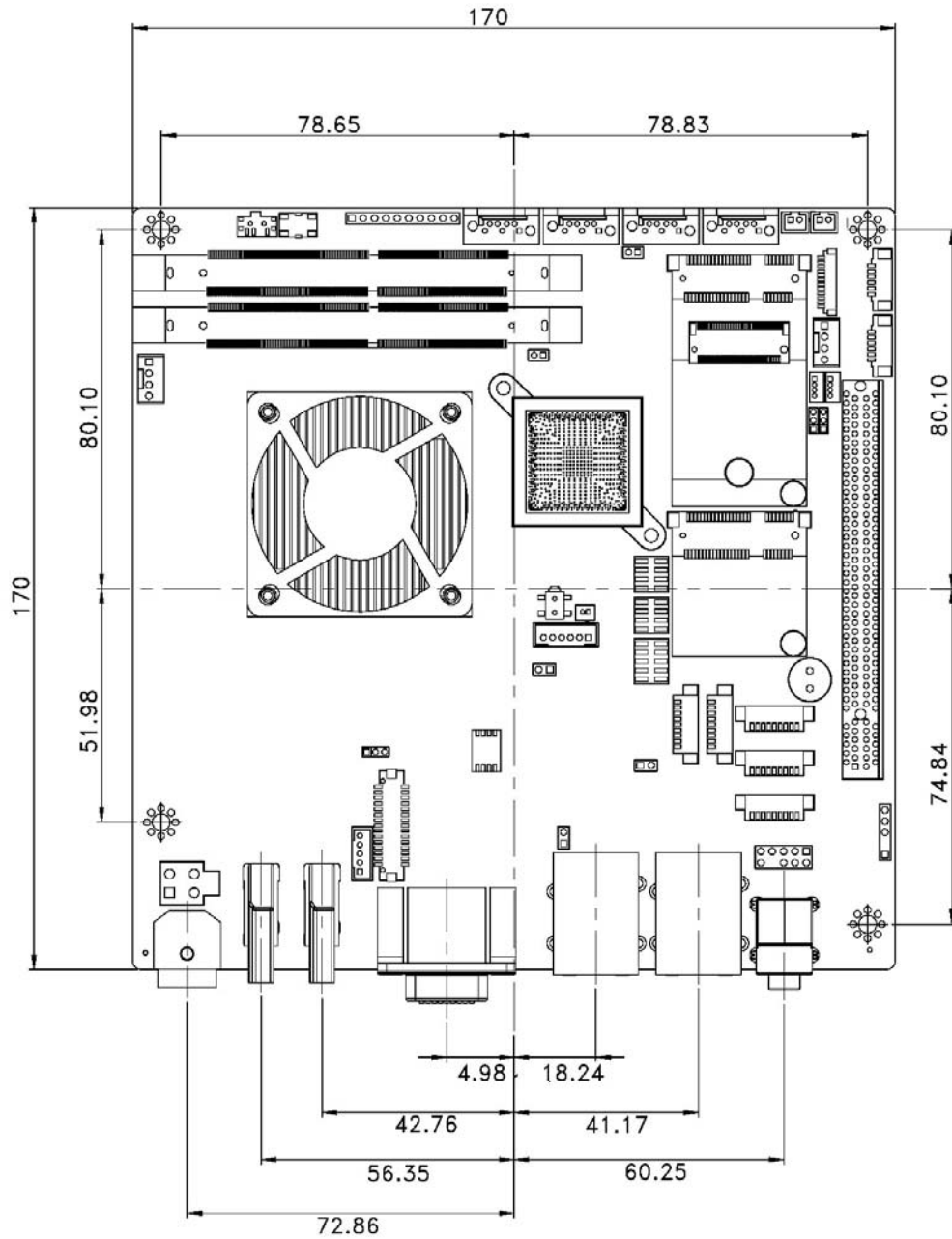

Figure 1-3: Dimensions (mm)

The height of the KINO-DQM170 series varies depending on the cooler module installed on the board. **Figure 1-4** shows the height dimensions of the following models:

- KINO-DQM170-i3E
- KINO-DQM170-CE

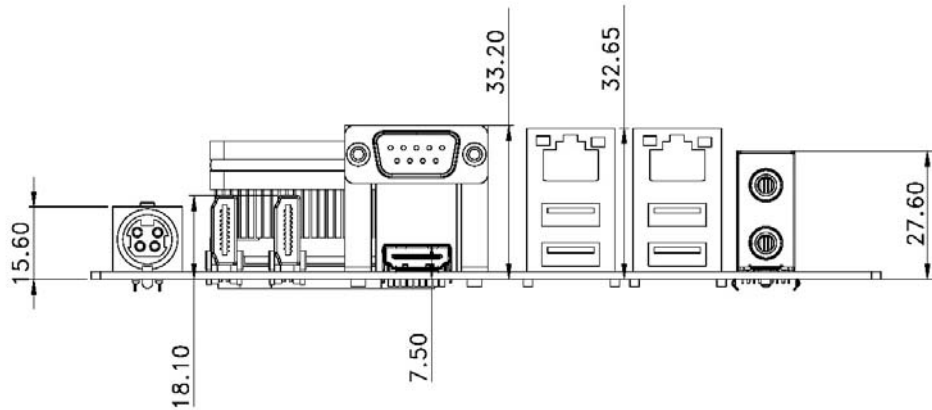

Figure 1-4: KINO-DQM170 Height Dimensions 1 (mm)

Figure 1-5 shows the height dimensions of the following models:

- KINO-DQM170-i7
- KINO-DQM170-i5

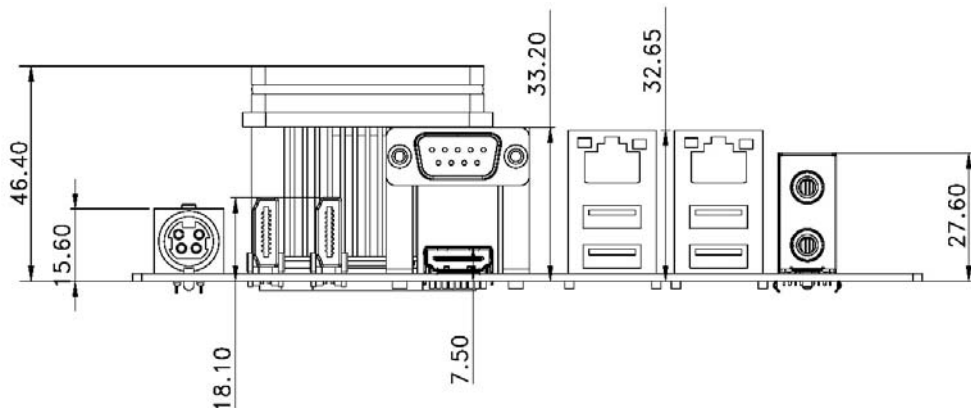

Figure 1-5: KINO-DQM170 Height Dimensions 2 (mm)

KINO-DQM170 Industrial Motherboard

1.6 Data Flow

Figure 1-6 shows the data flow between the system chipset, the CPU and other components installed on the motherboard.

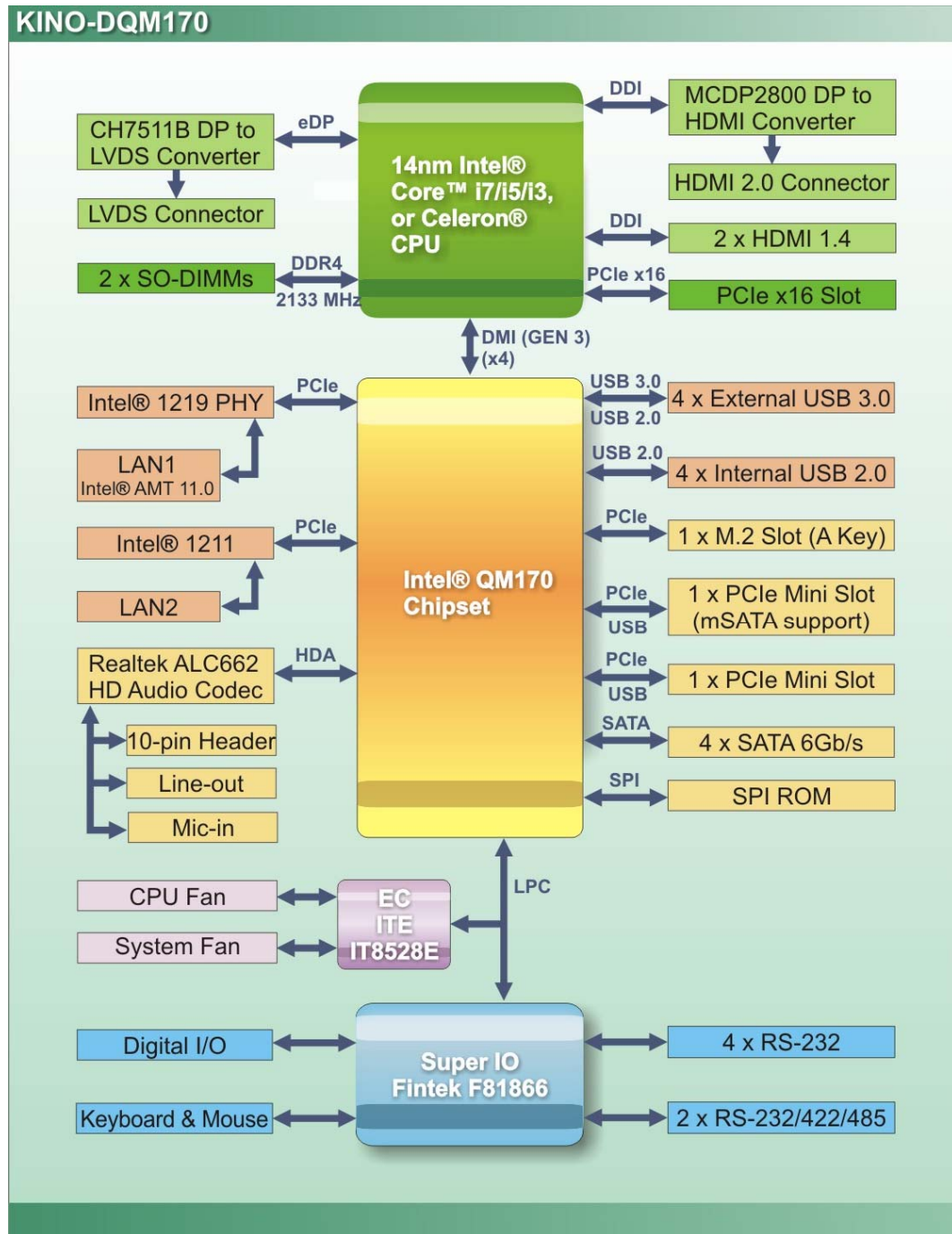

Figure 1-6: Data Flow Diagram

1.7 Technical Specifications

KINO-DQM170 technical specifications are listed below.

Specification	KINO-DQM170
Form Factor	Mini-ITX
CPU	Intel® Core™ i7-6820EQ processor (3.5 GHz, quad-core, 8 MB cache, 45 W TDP) Intel® Core™ i5-6440EQ processor (3.4 GHz, quad-core, 6 MB cache, 45 W TDP) Intel® Core™ i3-6102E processor (1.9 GHz, dual-core, 3 MB cache, 25 W TDP) Intel® Celeron® processor G3902E (1.6 GHz, dual-core, 2 MB cache, 25 W TDP)
Chipset	Intel® QM170
BIOS	AMI BIOS
Memory	Two 260-pin 2133 MHz dual-channel DDR4 SO-DIMM slots (system max. 32 GB)
Graphics	9 th generation Intel® HD Graphics with 16 low-power execution units, supporting DX11, DX12, OpenCL 2.x, OpenGL 4.3/4.4 and ES 2.0
Display Output	Triple independent display 1 x HDMI 2.0 by MCDP2800-BB DP to HDMI converter (up to 4096x2160 @ 60 Hz) 2 x HDMI 1.4 (up to 4096x2160 @ 24 Hz) 1 x 18/24-bit dual-channel LVDS by CH7511B DP to LVDS converter (up to 1920x1200 @ 60 Hz)
Ethernet	LAN1: Intel® I219-LM PHY with Intel® AMT 11.0 support LAN2: Intel® I211 PCIe GbE controller with NCSI support
Super IO	Fintek F81866D-I
Embedded Controller	ITE IT8528E/FX

KINO-DQM170 Industrial Motherboard

Specification	KINO-DQM170
Audio	Realtek ALC662 HD Audio codec
Watchdog Timer	Software programmable support 1~255 sec. system reset
I/O Interface	
Audio Connector	2 x Audio jacks (line-out, mic-in) 1 x Audio connector by 10-pin (2x5) header
Digital I/O	8-bit digital I/O by 10-pin (2x5) header
Ethernet	2 x RJ-45 GbE port
Keyboard/Mouse	1 x Keyboard and mouse connector by 6-pin (1x6) wafer
Serial Ports	1 x RS-232 on rear I/O 3 x RS-232 by 9-pin (1x9) wafer 2 x RS-232/422/485 by 9-pin (1x9) wafer
USB Ports	4 x USB 3.0 on rear I/O 4 x USB 2.0 by 8-pin (2x4) header
Front Panel	1 x Front panel connector by 10-pin (1x10) header (supports power LED, HDD LED, power button and reset button)
LAN LED	2 x LAN link LED connector by 2-pin header
SMBus	1 x SMBus connector by 4-pin (1x4) wafer
I²C	1 x I ² C connector by 4-pin (1x4) wafer
Chassis Intrusion	1 x Chassis intrusion connector by 2-pin header
Storage	4 x SATA 6Gb/s port (with 5V output)
Expansion	1 x Full-size PCIe Mini card slot (with mSATA support) 1 x Half-size PCIe Mini card slot 1 x M.2 2230 module slot (A key) 1 x PCIe x16 slot
Fan	1 x CPU smart fan connector by 4-pin (1x4) wafer 1 x System fan connector by 4-pin (1x4) wafer
Environmental and Power Specifications	

Specification	KINO-DQM170
Power Supply	12 V DC
Power Consumption	12 V @ 5.08 A (Intel® Core™ i7-6820EQ CPU with 16 GB (two 8 GB) 2133 MHz DDR4 memory)
Cooler Module	19100-000219-00-RS for i7/i5 models (45W) 19100-000203-00-RS for i3/Celeron models (25W)
Operating Temperature	-20°C ~ 60°C
Storage Temperature	-30°C ~ 70°C
Humidity	5% ~ 95%, non-condensing
Physical Specifications	
Dimensions	170 mm x 170 mm
Weight GW/NW	900 g / 450 g

Table 1-2: Technical Specifications

Chapter

2

Unpacking

2.1 Anti-static Precautions



WARNING!

Static electricity can destroy certain electronics. Make sure to follow the ESD precautions to prevent damage to the product, and injury to the user.

Make sure to adhere to the following guidelines:

- **Wear an anti-static wristband:** Wearing an anti-static wristband can prevent electrostatic discharge.
- **Self-grounding:** Touch a grounded conductor every few minutes to discharge any excess static buildup.
- **Use an anti-static pad:** When configuring any circuit board, place it on an anti-static mat.
- **Only handle the edges of the PCB:** Don't touch the surface of the motherboard. Hold the motherboard by the edges when handling.

2.2 Unpacking Precautions

When the KINO-DQM170 is unpacked, please do the following:

- Follow the antistatic guidelines above.
- Make sure the packing box is facing upwards when opening.
- Make sure all the packing list items are present.

KINO-DQM170 Industrial Motherboard







2.3 Packing List



NOTE:





If any of the components listed in the checklist below are missing, do not proceed with the installation. Contact the IEI reseller or vendor the KINO-DQM170 was purchased from or contact an IEI sales representative directly by sending an email to sales@ieiworld.com.

The KINO-DQM170 is shipped with the following components:

Quantity	Item and Part Number	Image
1	KINO-DQM170 industrial motherboard	
2	SATA and power cable, 150 mm	
1	I/O shielding	
1	Utility CD	
1	One Key Recovery CD	
1	Quick Installation Guide	

2.4 Optional Items

The following are optional components which may be separately purchased:

Item and Part Number	Image
KB/MS PS/2 Y-cable (P/N: 32000-023800-RS)	
SATA cable, 500 mm (P/N: 32000-062800-RS)	
Dual USB cable (wo bracket), 210 mm, p=2.0 (P/N: 32000-070301-RS)	
Dual USB cable (wo bracket, double layer), 220 mm, p=2.0 (P/N: 32000-023407-RS)	
RS-232 cable, 100 mm, p=1.25 (P/N : 32005-000900-200-RS)	

Chapter

3

Connectors

3.1 Peripheral Interface Connectors

This chapter details all the jumpers and connectors.

3.1.1 KINO-DQM170 Layout

The figures below show all the connectors and jumpers.

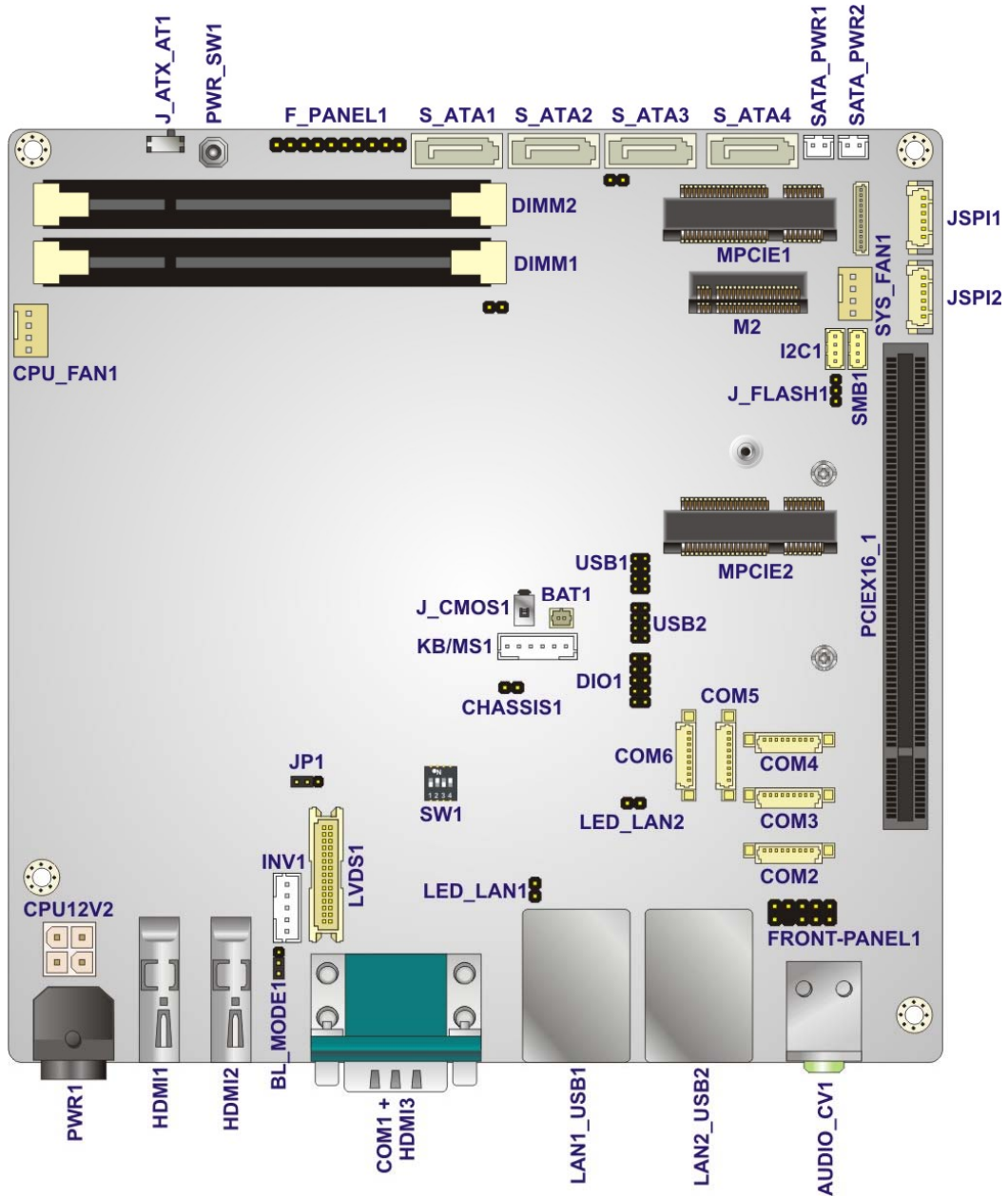

Figure 3-1: Connector and Jumper Locations (Front Side)

KINO-DQM170 Industrial Motherboard

3.1.2 Peripheral Interface Connectors

The table below lists all the connectors on the board.

Connector	Type	Label
ATX power connector	4-pin Molex	CPU12V2
Audio connector	10-pin header	FRONT-PANEL1
Battery connector	2-pin wafer	BAT1
Chassis intrusion connector	2-pin header	CHASSIS1
Debug connector	12-pin wafer	DBG_PORT1
Digital I/O connector	10-pin header	DIO1
Fan connector, CPU	4-pin wafer	CPU_FAN1
Fan connector, system	4-pin wafer	SYS_FAN1
Front panel connector	10-pin header	F_PANEL1
I ² C connector	4-pin wafer	I2C1
Keyboard/mouse connector	6-pin wafer	KB/MS1
LAN link LED connectors	2-pin header	LED_LAN1, LED_LAN2
LVDS connector	30-pin crimp	LVDS1
LVDS backlight connector	5-pin wafer	INV1
M.2 slot	A key slot	M2
Memory slot	260-pin DDR4 SO-DIMM	DIMM1, DIMM2
PCIe Mini card slot (full-size)	Full-size PCIe Mini slot	MPCIE1
PCIe Mini card slot (half-size)	Half-size PCIe Mini slot	MPCIE2
Power button (on board)	Push button	PWR_SW1
RS-232 connectors	9-pin wafer	COM2, COM3, COM4
RS-232/422/485 connectors	9-pin wafer	COM5, COM6
SATA 6Gb/s drive connectors	7-pin SATA connector	S_ATA1, S_ATA2,

		S_ATA3, S_ATA4
SATA power connectors	2-pin wafer	SATA_PWR1, SATA_PWR2
SMBus connector	4-pin wafer	SMB1
SPI flash connector, BIOS	6-pin wafer	JSPI1
SPI flash connector, EC	6-pin wafer	JSPI2
USB 2.0 connectors	8-pin header	USB1, USB2

Table 3-1: Peripheral Interface Connectors

3.1.3 External Interface Panel Connectors

The table below lists the connectors on the external I/O panel.

Connector	Type	Label
Audio jacks	Audio jacks	AUDIO_CV1
Ethernet and USB 3.0 connectors	RJ-45 and USB 3.0 combo connector	LAN1_USB1, LAN2_USB2
HDMI 2.0 connector	HDMI 2.0 connector	HDMI1
HDMI 1.4 connectors	HDMI 1.4 connector	HDMI2, HDMI3
Power connector	4-pin DIN	PWR1
RS-232 serial port	D-sub 9	COM1

Table 3-2: Rear Panel Connectors

KINO-DQM170 Industrial Motherboard

3.2 Internal Peripheral Connectors

The section describes all of the connectors on the KINO-DQM170.

3.2.1 ATX Power Connector

- CN Label:** CPU12V2
- CN Type:** 4-pin Molex, p=4.2 mm
- CN Location:** See **Figure 3-2**
- CN Pinouts:** See **Table 3-3**

The connector supports the +12V power supply.

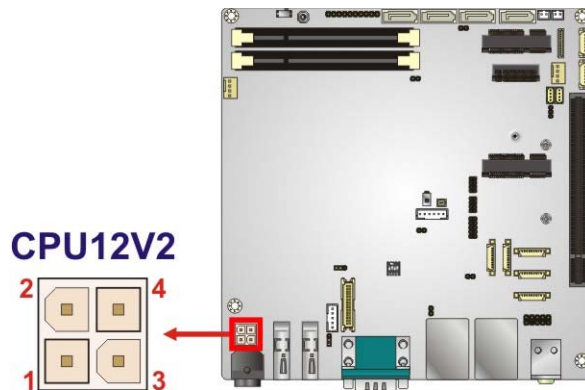

Figure 3-2: +12V DC-IN Power Connector Location

Pin	Description	Pin	Description
1	GND	2	GND
3	+12V	4	+12V

Table 3-3: +12V DC-IN Power Connector Pinouts

3.2.2 Audio Connector

- CN Label:** FRONT-PANEL1
- CN Type:** 10-pin header, p=2.54 mm
- CN Location:** See **Figure 3-3**
- CN Pinouts:** See **Table 3-4**

The audio connector is connected to external audio devices including speakers and microphones for the input and output of audio signals to and from the system.

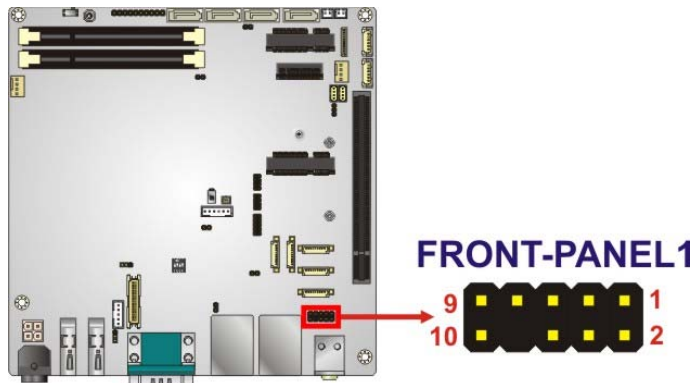

Figure 3-3: Audio Connector Location

Pin	Description	Pin	Description
1	LMIC2-L	2	AUD_GND
3	LMIC2-R	4	PRESENCE#
5	LLINE2-R	6	MIC2-JD
7	FRONT-IO	8	NC
9	LLINE2-L	10	LINE2-JD

Table 3-4: Audio Connector Pinouts

KINO-DQM170 Industrial Motherboard

3.2.3 Battery Connector



CAUTION:

Risk of explosion if battery is replaced by an incorrect type. Only certified engineers should replace the on-board battery.

Dispose of used batteries according to instructions and local regulations.

- CN Label:** **BAT1**
- CN Type:** 2-pin wafer, p=1.25 mm
- CN Location:** See **Figure 3-4**
- CN Pinouts:** See **Table 3-5**

The battery connector is connected to the system battery. The battery provides power to the system clock to retain the time when power is turned off.

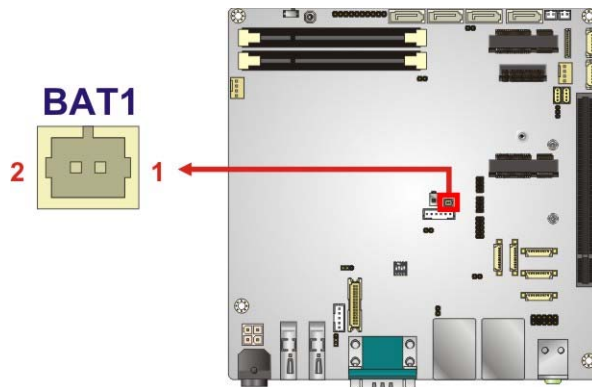

Figure 3-4: Battery Connector Location

PIN NO.	DESCRIPTION
1	VBAT+
2	GND

Table 3-5: Battery Connector Pinouts

3.2.4 Chassis Intrusion Connector

- CN Label:** CHASSIS1
- CN Type:** 2-pin header, p=2.54 mm
- CN Location:** See **Figure 3-5**
- CN Pinouts:** See **Table 3-6**

The chassis intrusion connector is for a chassis intrusion detection sensor or switch that detects if a chassis component is removed or replaced.

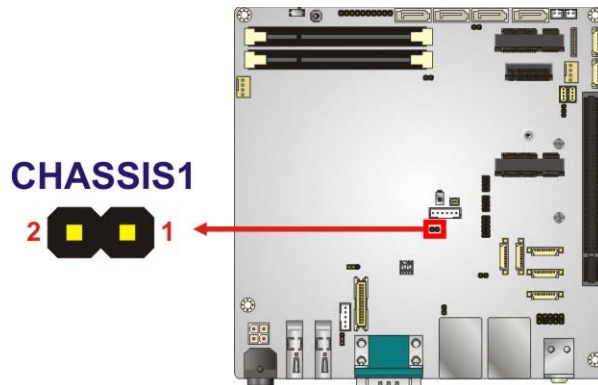

Figure 3-5: Chassis Intrusion Connector Location

Pin	Description
1	+3.3VSB
2	Chassis open

Table 3-6: Chassis Intrusion Connector Pinouts

KINO-DQM170 Industrial Motherboard

3.2.5 Digital I/O Connector

- CN Label:** DIO1
- CN Type:** 10-pin header, p=2.00 mm
- CN Location:** See **Figure 3-6**
- CN Pinouts:** See **Table 3-7**

The 8-bit digital I/O connector provides programmable input and output for external devices.

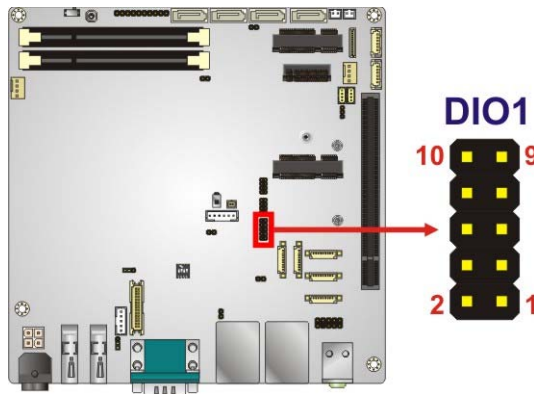

Figure 3-6: Digital I/O Connector Location

PIN NO.	DESCRIPTION	PIN NO.	DESCRIPTION
1	GND	2	VCC
3	DOUT3	4	DOUT2
5	DOUT1	6	DOUT0
7	DIN3	8	DIN2
9	DIN1	10	DIN0

Table 3-7: Digital I/O Connector Pinouts

3.2.6 Fan Connectors

CN Label: CPU_FAN1, SYS_FAN1

CN Type: 4-pin wafer, p=2.54 mm

CN Location: See **Figure 3-7**

CN Pinouts: See **Table 3-8**

The fan connector attaches to a cooling fan.

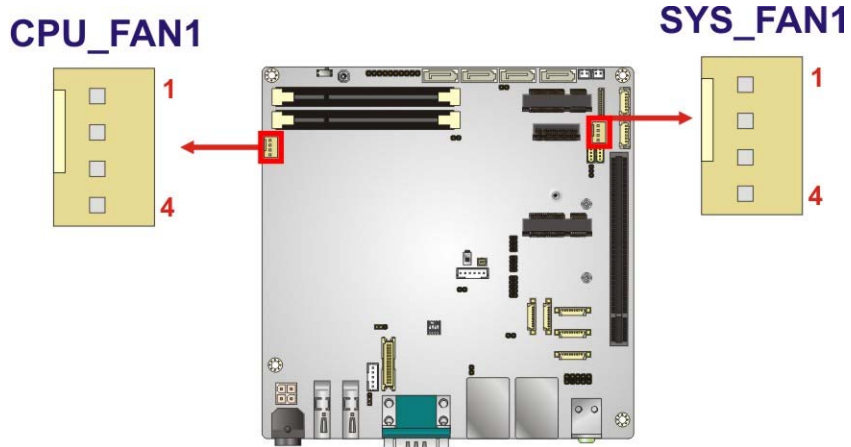

Figure 3-7: Fan Connector Locations

Pin	Description
1	GND
2	+12V
3	FANIO
4	PWM

Table 3-8: Fan Connector Pinouts

KINO-DQM170 Industrial Motherboard

3.2.7 Front Panel Connector

- CN Label:** F_PANEL1
- CN Type:** 10-pin header, p=2.54 mm
- CN Location:** See **Figure 3-8**
- CN Pinouts:** See **Table 3-9**

The front panel connector connects to the indicator LEDs and buttons on the computer's front panel.

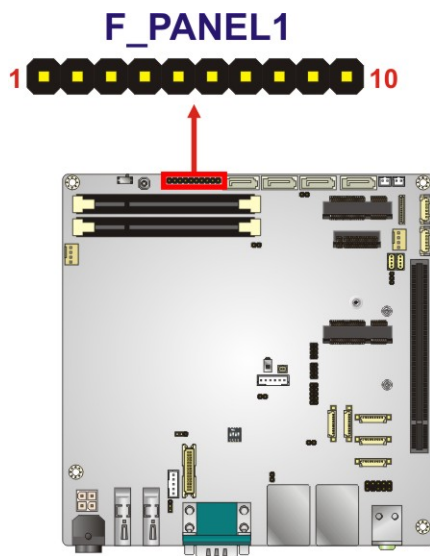

Figure 3-8: Front Panel Connector Location

Function	Pin	Description	Function	Pin	Description
	1	NC		6	PWR_LED+
Power Button	2	PWR_BTN+	Power LED	7	PWR_LED+
	3	PWR_BTN-		8	PWR_LED-
HDD LED	4	HDD_LED+	Reset	9	RESET+
	5	HDD_LED-		10	RESET-

Table 3-9: Front Panel Connector Pinouts

3.2.8 I²C Connector

- CN Label:** I2C1
- CN Type:** 4-pin wafer, p=1.25 mm
- CN Location:** See **Figure 3-9**
- CN Pinouts:** See **Table 3-10**

The I²C connector is used to connect I²C-bus devices to the motherboard.

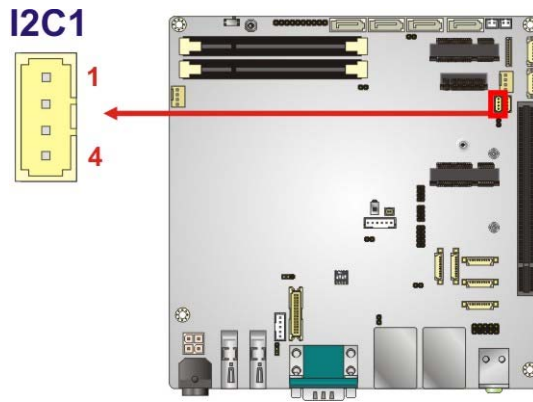

Figure 3-9: I²C Connector Location

Pin	Description
1	GND
2	I2C_DAT
3	I2C_CLK
4	+5V

Table 3-10: I²C Connector Pinouts

KINO-DQM170 Industrial Motherboard

3.2.9 Keyboard/Mouse Connector

- CN Label:** KB/MS1
- CN Type:** 6-pin wafer, p=2.00 mm
- CN Location:** See **Figure 3-10**
- CN Pinouts:** See **Table 3-11**

The keyboard/mouse connector connects to a PS/2 Y-cable that can be connected to a PS/2 keyboard and mouse.

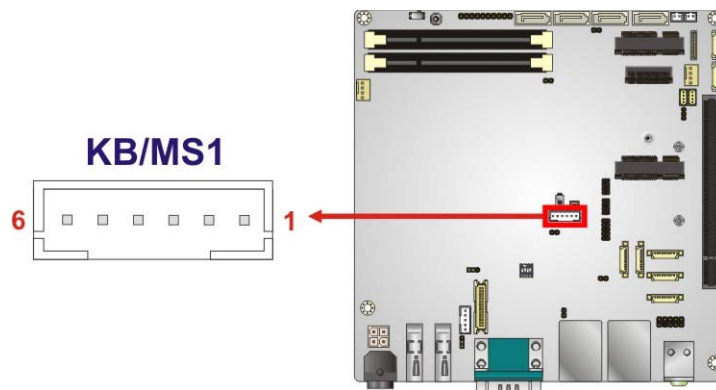

Figure 3-10: Keyboard/Mouse Connector Location

Pin	Description
1	VCC5_KBMS
2	Mouse Data
3	Mouse Clock
4	Keyboard Data
5	Keyboard Clock
6	GND

Table 3-11: Keyboard/Mouse Connector Pinouts

3.2.10 LAN LED Connectors

- CN Label:** LED_LAN1, LED_LAN2
- CN Type:** 2-pin header, p=2.54 mm
- CN Location:** See **Figure 3-11**
- CN Pinouts:** See **Table 3-12**

The LAN LED connectors connect to the LAN link LEDs on the system.

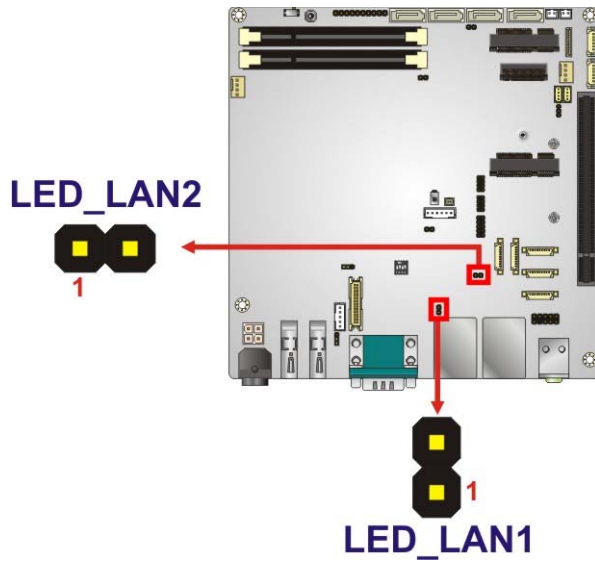

Figure 3-11: LAN LED Connector Locations

Pin	Description
1	+3.3V
2	LAN_LED_LINK#_ACT

Table 3-12: LAN LED Connector Pinouts

KINO-DQM170 Industrial Motherboard

3.2.11 LVDS Connector

- CN Label:** LVDS1
- CN Type:** 30-pin crimp, p=1.25 mm
- CN Location:** See **Figure 3-12**
- CN Pinouts:** See **Table 3-13**

The LVDS connector is for an LCD panel connected to the board.

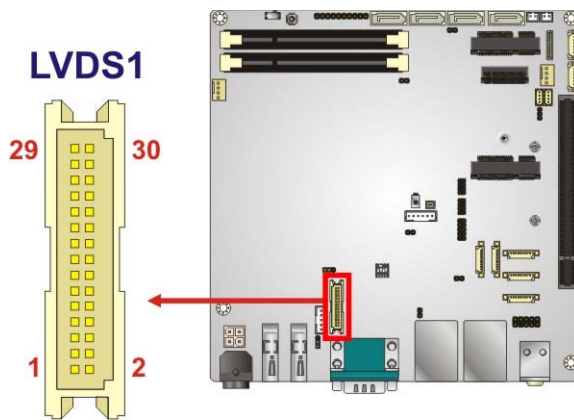

Figure 3-12: LVDS Connector Location

Pin	Description	Pin	Description
1	GND	2	GND
3	LVDS_A_TX0-P	4	LVDS_A_TX0-N
5	LVDS_A_TX1-P	6	LVDS_A_TX1-N
7	LVDS_A_TX2-P	8	LVDS_A_TX2-N
9	LVDS_A_TXCLK-P	10	LVDS_A_TXCLK-N
11	LVDS_A_TX3-P	12	LVDS_A_TX3-N
13	GND	14	GND
15	LVDS_B_TX0-P	16	LVDS_B_TX0-N
17	LVDS_B_TX1-P	18	LVDS_B_TX1-N
19	LVDS_B_TX2-P	20	LVDS_B_TX2-N
21	LVDS_B_TXCLK-P	22	LVDS_B_TXCLK-N
23	LVDS_B_TX3-P	24	LVDS_B_TX3-N
25	GND	26	GND

Pin	Description	Pin	Description
27	+LCD Vcc	28	+LCD Vcc
29	+LCD Vcc	30	+LCD Vcc

Table 3-13: LVDS Connector Pinouts

3.2.12 LVDS Backlight Connector

- CN Label:** INV1
- CN Type:** 5-pin wafer, p=2.00 mm
- CN Location:** See **Figure 3-13**
- CN Pinouts:** See **Table 3-14**

The backlight inverter connectors provide power to LCD panels.

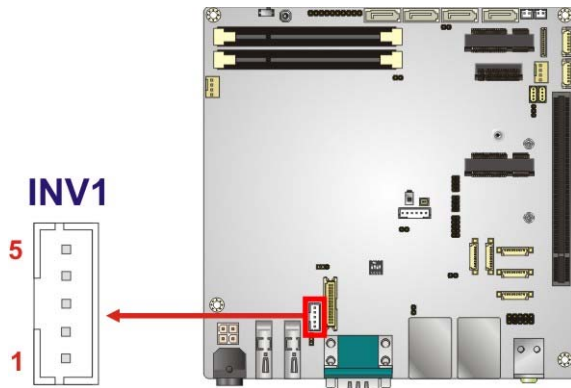

Figure 3-13: LVDS Backlight Inverter Connector

Pin	Description
1	BRIGHTNESS
2	GROUND
3	+12VS_LCD_BKL
4	GROUND
5	BACKLIGHT ENABLE

Table 3-14: Backlight Inverter Connector Pinouts

KINO-DQM170 Industrial Motherboard

3.2.13 M.2 Module Slot

- CN Label:** M2
- CN Type:** M.2 A-key slot
- CN Location:** See **Figure 3-14**
- CN Pinouts:** See **Table 3-15**

The M.2 slot is for installing M.2 2230 modules with A-key edge connector.

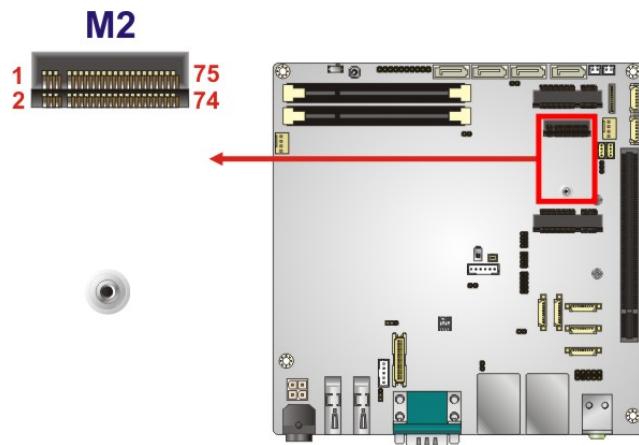

Figure 3-14: M.2 Slot Location

Pin	Description	Pin	Description
1	GND	2	+3.3V
3	USB_D+	4	+3.3V
5	USB_D-	6	NC
7	GND	8	Connector Key
9	Connector Key	10	Connector Key
11	Connector Key	12	Connector Key
13	Connector Key	14	Connector Key
15	Connector Key	16	NC
17	NC	18	GND
19	NC	20	NC
21	NC	22	NC

Pin	Description	Pin	Description
23	GND	24	GND
25	NC	26	NC
27	NC	28	NC
29	GND	30	GND
31	NC	32	NC
33	GND	34	NC
35	PCIE_TXP11_M2	36	GND
37	PCIE_TXN11_M2	38	NC
39	GND	40	NC
41	PCIE_RXP11_M2	42	NC
43	PCIE_RXN11_M2	44	NC
45	GND	46	NC
47	CK_M2_100M_DP	48	NC
49	CK_M2_100M_DN	50	NC
51	GND	52	PLT_GATED_RST#
53	NC	54	+3.3V
55	NC	56	W_DISABLE# (ACTIVE LOW)
57	GND	58	NC
59	PCIE_TXP10_M2	60	NC
61	PCIE_TXN10_M2	62	NC
63	GND	64	NC
65	PCIE_RXP10_M2	66	NC
67	PCIE_RXN10_M2	68	NC
69	GND	70	NC
71	CK_M2_100M_D10P	72	+3.3V
73	CK_M2_100M_D10N	74	+3.3V
75	GND		

Table 3-15: M.2 Slot Pinouts

KINO-DQM170 Industrial Motherboard

3.2.14 PCI Express x16 Slot

CN Label:	PCIEX16_1
CN Type:	PCIe x16 slot
CN Location:	See Figure 3-15

The PCIe x16 expansion card slot is for PCIe x16 cards.

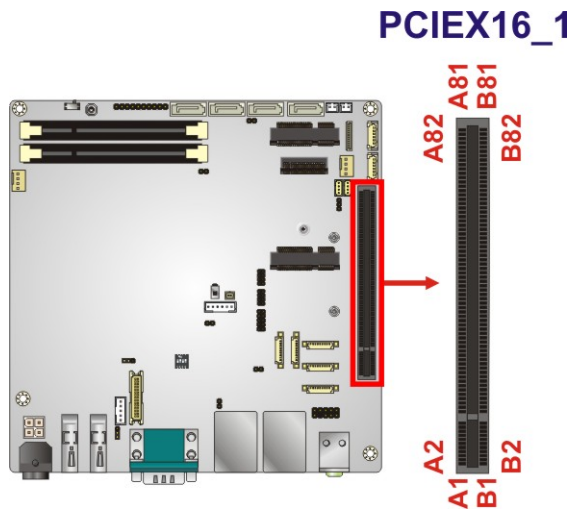

Figure 3-15: PCIe x16 Slot Location

3.2.15 PCIe Mini Card Slot, Full-size

CN Label:	MPCIE1
CN Type:	Full-size PCIe Mini card slot
CN Location:	See Figure 3-16
CN Pinouts:	See Table 3-16

The PCIe Mini card slot supports PCIe Mini cards with USB interface, including mSATA modules.

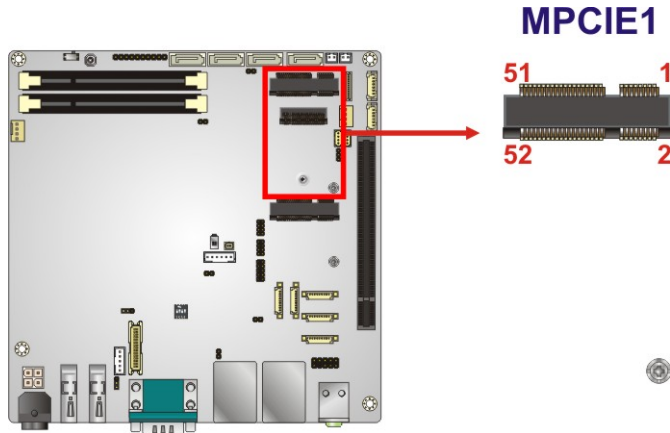

Figure 3-16: Full-size PCIe Mini Card Slot Location

Pin	Description	Pin	Description
1	PCIE_WAKE#	2	+3.3V
3	N/C	4	GND
5	N/C	6	1.5V
7	N/C	8	N/C
9	GND	10	N/C
11	CLK-	12	N/C
13	CLK+	14	N/C
15	GND	16	N/C
17	PCIRST#	18	GND
19	N/C	20	+3.3V
21	GND	22	PCIRST#
23	PERN(SATA_RX+)	24	3VDual
25	PERP(SATA_RX-)	26	GND
27	GND	28	1.5V
29	GND	30	SMBCLK
31	PETN(SATA_TX-)	32	SMBDATA
33	PETP(SATA_TX+)	34	GND
35	GND	36	USB D-
37	N/C	38	USB D+
39	N/C	40	GND
41	N/C	42	N/C

KINO-DQM170 Industrial Motherboard

Pin	Description	Pin	Description
43	SATA_DET_R_N	44	N/C
45	N/C	46	N/C
47	N/C	48	1.5V
49	N/C	50	GND
51	MSATA_SEL#	52	+3.3V

Table 3-16: Full-size PCIe Mini Card Slot Pinouts

3.2.16 PCIe Mini Card Slot, Half-size

- CN Label:** MPCIE2
- CN Type:** Half-size PCIe Mini card slot
- CN Location:** See **Figure 3-17**
- CN Pinouts:** See **Table 3-17**

The PCIe Mini card slot supports PCIe Mini cards with USB interface.

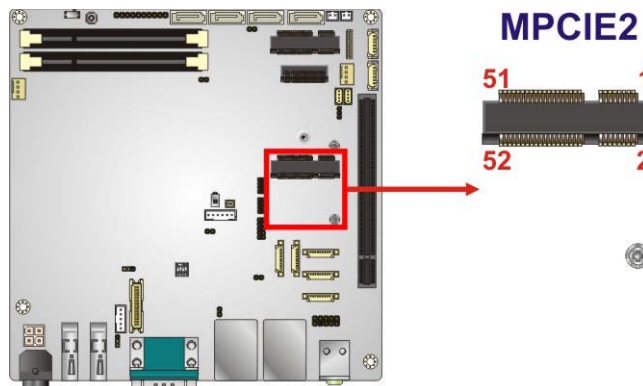

Figure 3-17: Half-size PCIe Mini Card Slot Location

Pin	Description	Pin	Description
1	PCIE_WAKE#	2	+3.3V
3	N/C	4	GND
5	N/C	6	1.5V
7	N/C	8	N/C
9	GND	10	N/C

Pin	Description	Pin	Description
11	PCIE_CLK#	12	N/C
13	PCIE_CLK	14	N/C
15	GND	16	N/C
17	PLTRST_N	18	GND
19	N/C	20	+3.3V
21	GND	22	PLTRST_N
23	PCIE_RX+	24	+3.3V
25	PCIE_RX-	26	GND
27	GND	28	1.5V
29	GND	30	SMB_CLK
31	PCIE_TX+	32	SMB_DATA
33	PCIE_TX-	34	GND
35	GND	36	USB_DATA-
37	GND	38	USB_DATA+
39	+3.3V	40	GND
41	+3.3V	42	N/C
43	+3.3V	44	N/C
45	CLINK_CLK	46	N/C
47	CLINK_DATA	48	1.5V
49	CLINK_RST#	50	GND
51	N/C	52	+3.3V

Table 3-17: Half-size PCIe Mini Card Slot Pinouts

KINO-DQM170 Industrial Motherboard

3.2.17 Power Button

CN Label:	PWR_SW1
CN Type:	Push button
CN Location:	See Figure 3-18

The on-board power button controls system power.

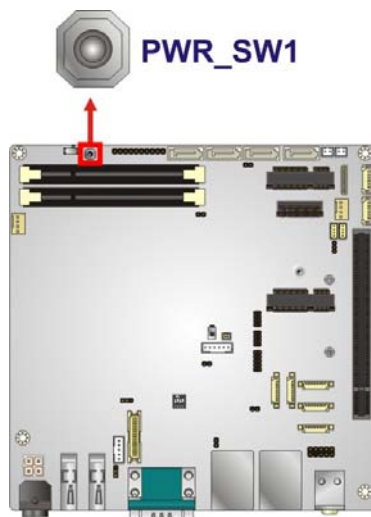

Figure 3-18: Power Button Location

3.2.18 RS-232 Serial Port Connectors

CN Label:	COM2, COM3, COM4
CN Type:	9-pin wafer, p=1.25 mm
CN Location:	See Figure 3-19
CN Pinouts:	See Table 3-18

The serial connector provides RS-232 connection.

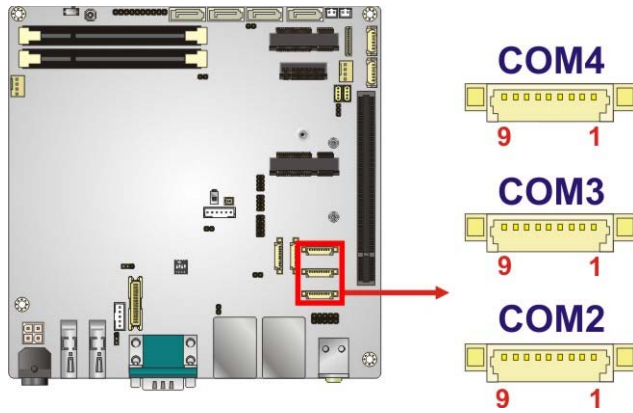

Figure 3-19: RS-232 Connector Locations

Pin	Description	Pin	Description
1	DCD	2	DSR
3	SIN	4	RTS
5	SOUT	6	CTS
7	DTR	8	RI
9	GND		

Table 3-18: RS-232 Connector Pinouts

3.2.19 RS-232/422/485 Serial Port Connectors

- CN Label:** COM5, COM6
- CN Type:** 9-pin wafer, p=1.25 mm
- CN Location:** See **Figure 3-20**
- CN Pinouts:** See **Table 3-19**

This connector provides RS-232, RS-422 or RS-485 communications. The default mode is set to RS-232 in BIOS. To configure the connector as RS-422 or RS-485, please refer to **Section 5.3.3.1.5 (COM5)** and **Section 5.3.3.1.6 (COM6)**.

KINO-DQM170 Industrial Motherboard

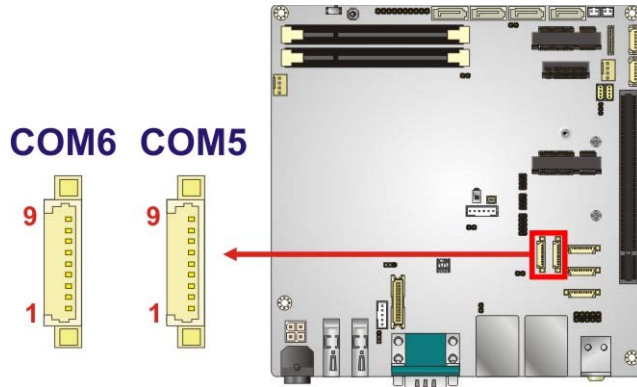

Figure 3-20: RS-232/422/485 Connector Locations

Pin	Description	Pin	Description
1	DCD	2	DSR
3	SIN	4	RTS
5	SOUT	6	CTS
7	DTR	8	RI
9	GND		

Table 3-19: RS-232/422/485 Connector Pinouts

Use the optional RS-232/422/485 cable to connect to a serial device. The pinouts of the DB-9 connector are listed below.

PIN NO.	RS-232	RS-422	RS-485
1	DCD	TXD422-	TXD485-
2	RXD	TXD422+	TXD485+
3	TXD	RXD422+	--
4	DTR	RXD422-	--
5	GND	--	--
6	DSR	--	--
7	RTS	--	--
8	CTS	--	--
9	RI	--	--

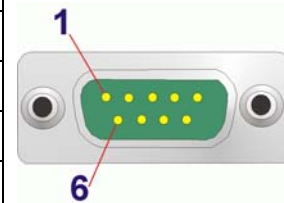

Table 3-20: RS-232/422/485 DB-9 Serial Port Pinouts

3.2.20 SATA 6Gb/s Drive Connectors

CN Label: S_ATA1, S_ATA2, S_ATA3, S_ATA4

CN Type: 7-pin SATA connector

CN Location: See **Figure 3-21**

The SATA 6Gb/s drive connector is connected to a SATA 6Gb/s drive. The SATA 6Gb/s drive transfers data at speeds as high as 6Gb/s.

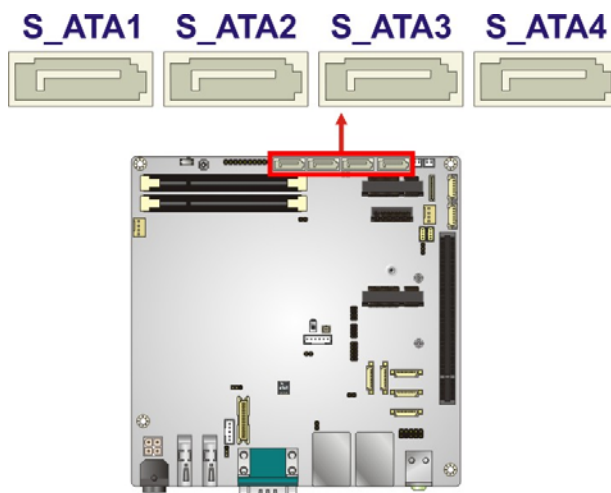

Figure 3-21: SATA 6Gb/s Drive Connector Locations

KINO-DQM170 Industrial Motherboard

3.2.21 SATA Power Connectors

CN Label: SATA_PWR1, SATA_PWR2

CN Type: 2-pin wafer, p=2.00 mm

CN Location: See Figure 3-22

CN Pinouts: See Table 3-21

Use the SATA Power Connector to connect to SATA device power connections.

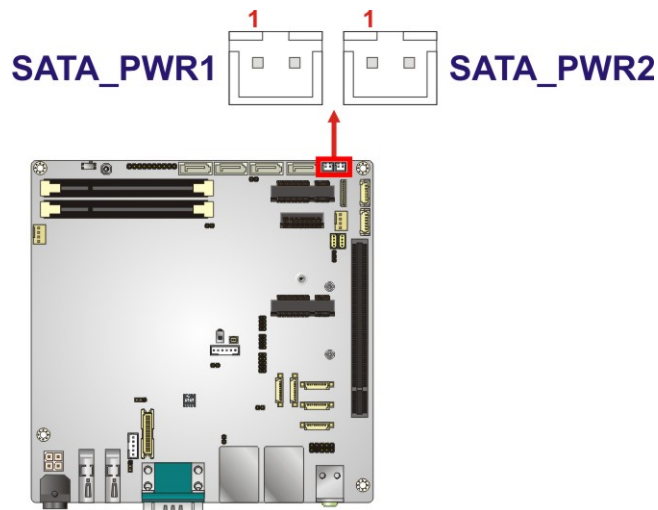

Figure 3-22: SATA Power Connector Locations

Pin	Description
1	+5V (support 1A)
2	GND

Table 3-21: SATA Power Connector Pinouts

3.2.22 SMBus Connector

- CN Label:** SMB1
- CN Type:** 4-pin wafer, p=1.25 mm
- CN Location:** See **Figure 3-23**
- CN Pinouts:** See **Table 3-22**

The SMBus (System Management Bus) connector provides low-speed system management communications.

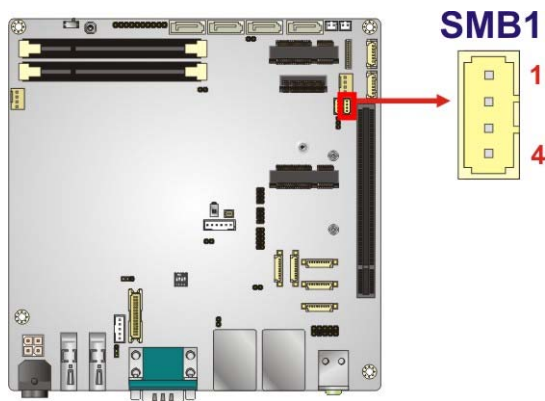

Figure 3-23: SMBus Connector Location

Pin	Description
1	GND
2	SMB_DATA
3	SMB_CLK
4	+5V

Table 3-22: SMBus Connector Pinouts

KINO-DQM170 Industrial Motherboard

3.2.23 SPI Flash Connector, BIOS

- CN Label:** JSPI1
- CN Type:** 6-pin wafer, p=1.25 mm
- CN Location:** See **Figure 3-24**
- CN Pinouts:** See **Table 3-23**

The 6-pin SPI Flash connector is used to flash the BIOS.

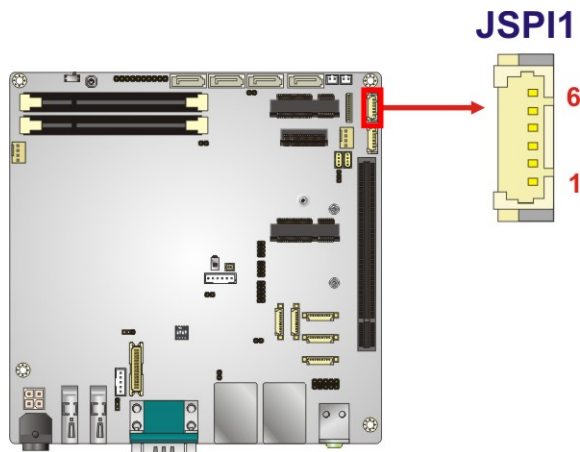

Figure 3-24: SPI Flash Connector Location

Pin	Description
1	+3.3VA
2	SPI_CS
3	SPI_SO_SW
4	SPI_CLK_SW
5	SPI_SI_SW
6	GND

Table 3-23: SPI Flash Connector Pinouts

3.2.24 SPI Flash Connector, EC

- CN Label:** JSPI2
- CN Type:** 6-pin wafer, p=1.25 mm
- CN Location:** See **Figure 3-25**
- CN Pinouts:** See **Table 3-24**

The 6-pin SPI Flash connector is used to flash the embedded controller.

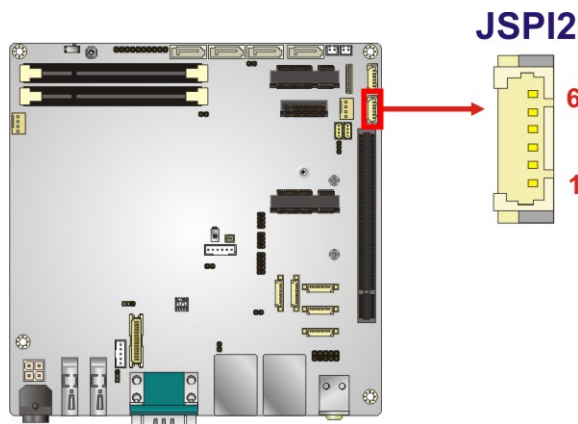

Figure 3-25: SPI Flash Connector Location

Pin	Description
1	+3.3VA
2	SPI_CS#0_CN_EC
3	SPI_SO_SW_EC
4	SPI_CLK_SW_EC
5	SPI_SI_SW_EC
6	GND

Table 3-24: SPI Flash Connector Pinouts

KINO-DQM170 Industrial Motherboard

3.2.25 USB 2.0 Connectors

- CN Label:** USB1, USB2
- CN Type:** 8-pin header, p=2.00 mm
- CN Location:** See **Figure 3-26**
- CN Pinouts:** See **Table 3-25**

The USB connector provides two USB 2.0 ports by dual-port USB cable.

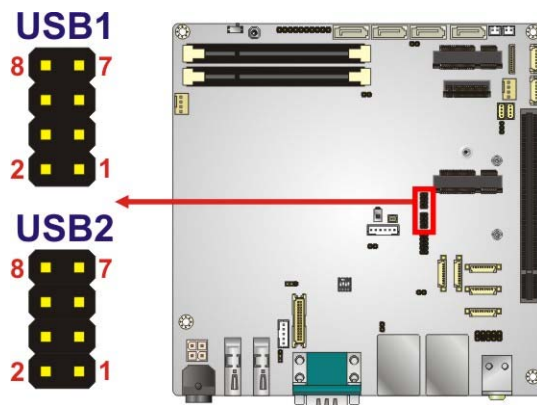

Figure 3-26: USB Connector Locations

Pin	Description	Pin	Description
1	VCC	2	GND
3	USB_DATA-	4	USB_DATA+
5	USB_DATA+	6	USB_DATA-
7	GND	8	VCC

Table 3-25: USB Connector Pinouts

3.3 External Interface Connectors

Figure 3-27 shows the KINO-DQM170 motherboard external interface connectors. The KINO-DQM170 on-board external interface connectors are shown in **Figure 3-27**.

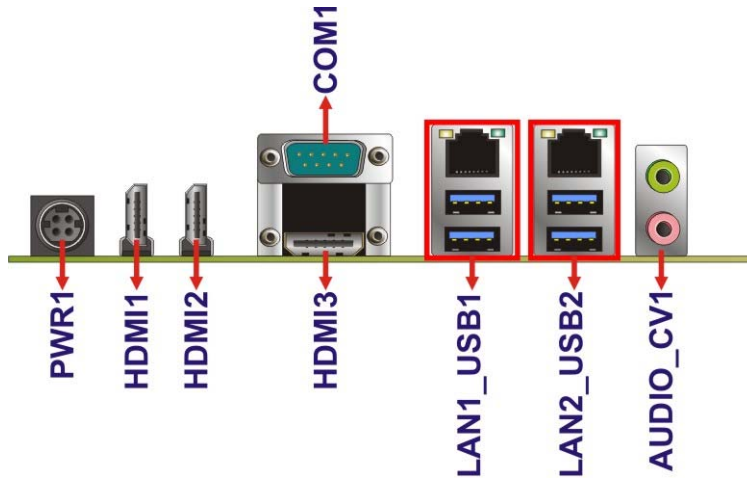

Figure 3-27: External Interface Connectors

3.3.1 Audio Connector

CN Label: AUDIO_CV1
CN Type: Audio jack
CN Location: See **Figure 3-27**

The audio jacks connect to external audio devices.

- **Line Out port (Lime):** Connects to a headphone or a speaker. With multi-channel configurations, this port can also connect to front speakers.
- **Microphone (Pink):** Connects a microphone.



Figure 3-28: Audio Jacks

KINO-DQM170 Industrial Motherboard

3.3.2 Ethernet and USB 3.0 Connectors

- CN Label:** LAN1_USB1, LAN2_USB2
- CN Type:** RJ-45 and USB 3.0 combo connector
- CN Location:** See **Figure 3-27**
- CN Pinouts:** See **Table 3-26** and **Table 3-28**

The LAN connector connects to a local network and supports Intel® AMT 11.0.

Pin	Description	Pin	Description
1	MDIO+	5	MDI2+
2	MDIO-	6	MDI2-
3	MDI1+	7	MDI3+
4	MDI1-	8	MDI3-

Table 3-26: LAN1 Pinouts

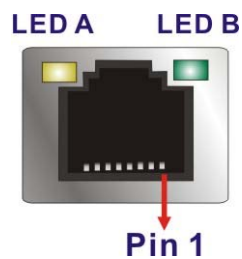

Figure 3-29: Ethernet Connector

LED	Description	LED	Description
A	on: linked blinking: data is being sent/received	B	off: 10 Mb/s green: 100 Mb/s orange: 1000 Mb/s

Table 3-27: Connector LEDs

Each USB 3.0 connector can be connected to a USB device.

Pin	Description
1	VBUS
2	D1-
3	D1+
4	GND1
5	STDA_SSRX1_N
6	STDA_SSRX1_P
7	GND_DRAIN
8	STDA_SSTX1_N
9	STDA_SSTX1_P

Table 3-28: External USB 3.0 Port Pinouts

3.3.3 HDMI Connectors

- CN Label:** HDMI1, HDMI2, HDMI3
- CN Type:** HDMI connector
- CN Location:** See **Figure 3-27**
- CN Pinouts:** See **Table 3-29** and **Figure 3-30**

The HDMI connector connects to a display device with HDMI interface. The HDMI1 is an HDMI 2.0 connector which supports up to 4096x2160 resolution at 60 Hz. The HDMI2 and HDMI3 are HDMI 1.4 connectors which support up to 4096x2160 resolution at 24 Hz.

Pin	Description	Pin	Description
1	HDMI_DATA2	11	GND
2	GND	12	HDMI_CLK#
3	HDMI_DATA2#	13	N/C
4	HDMI_DATA1	14	N/C
5	GND	15	HDMI_SCL
6	HDMI_DATA1#	16	HDMI_SDA
7	HDMI_DATA0	17	GND
8	GND	18	+5V

KINO-DQM170 Industrial Motherboard

Pin	Description	Pin	Description
9	HDMI_DATA0#	19	HDMI_HPD
10	HDMI_CLK+		

Table 3-29: HDMI Connector Pinouts

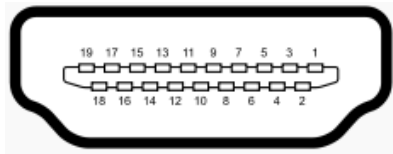

Figure 3-30: HDMI Connector

3.3.4 Power Connector (12 V, Power Adapter)

- CN Label:** PWR1
- CN Type:** 4-pin Mini-DIN
- CN Location:** See **Figure 3-27**
- CN Pinouts:** See **Figure 3-31**

The connector supports a 12V power adapter.

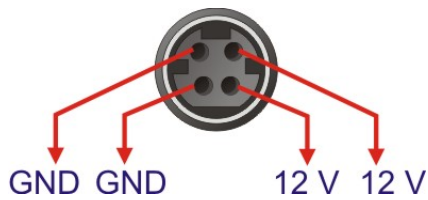

Figure 3-31: 4-pin Power Mini-DIN Connection

3.3.5 Serial Port Connector (COM1)

- CN Label:** COM1
- CN Type:** D-sub 9
- CN Location:** See **Figure 3-27**
- CN Pinouts:** See **Table 3-30**

The serial port connects to a RS-232 serial communications device.

Pin	Description	Pin	Description
1	DATA CARRIER DETECT (DCD1)	6	DATA SET READY (DSR1)
2	RECEIVE DATA (RXD1)	7	REQUEST TO SEND (RTS1)
3	TRANSMIT DATA (TXD1)	8	CLEAR TO SEND (CTS1)
4	DATA TERMINAL READY (DTR1)	9	RING INDICATOR (RI1)
5	GND		

Table 3-30: Serial Port Pinouts

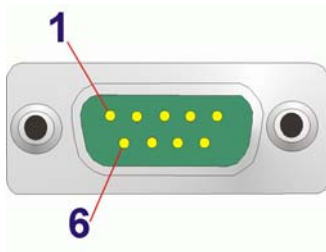

Figure 3-32: Serial Port Pinouts

Chapter

4

Installation

4.1 Anti-static Precautions



WARNING:

Failure to take ESD precautions during the installation of the KINO-DQM170 may result in permanent damage to the KINO-DQM170 and severe injury to the user.

Electrostatic discharge (ESD) can cause serious damage to electronic components, including the KINO-DQM170. Dry climates are especially susceptible to ESD. It is therefore critical that whenever the KINO-DQM170 or any other electrical component is handled, the following anti-static precautions are strictly adhered to.

- **Wear an anti-static wristband:** Wearing a simple anti-static wristband can help to prevent ESD from damaging the board.
- **Self-grounding** Before handling the board, touch any grounded conducting material. During the time the board is handled, frequently touch any conducting materials that are connected to the ground.
- **Use an anti-static pad:** When configuring the KINO-DQM170, place it on an anti-static pad. This reduces the possibility of ESD damaging the KINO-DQM170.
- **Only handle the edges of the PCB:** When handling the PCB, hold the PCB by the edges.

4.2 Installation Considerations



NOTE:

The following installation notices and installation considerations should be read and understood before installation. All installation notices must be strictly adhered to. Failing to adhere to these precautions may lead to severe damage and injury to the person performing the installation.

KINO-DQM170 Industrial Motherboard



WARNING:

The installation instructions described in this manual should be carefully followed in order to prevent damage to the KINO-DQM170, KINO-DQM170 components and injury to the user.

Before and during the installation please **DO** the following:

- Read the user manual:
 - The user manual provides a complete description of the KINO-DQM170 installation instructions and configuration options.
- Wear an electrostatic discharge cuff (ESD):
 - Electronic components are easily damaged by ESD. Wearing an ESD cuff removes ESD from the body and helps prevent ESD damage.
- Place the KINO-DQM170 on an antistatic pad:
 - When installing or configuring the motherboard, place it on an antistatic pad. This helps to prevent potential ESD damage.
- Turn all power to the KINO-DQM170 off:
 - When working with the KINO-DQM170, make sure that it is disconnected from all power supplies and that no electricity is being fed into the system.

Before and during the installation of the KINO-DQM170 **DO NOT**:

- Remove any of the stickers on the PCB board. These stickers are required for warranty validation.
- Use the product before verifying all the cables and power connectors are properly connected.
- Allow screws to come in contact with the PCB circuit, connector pins, or its components.

4.3 SO-DIMM Installation

To install an SO-DIMM, please follow the steps below and refer to **Figure 4-1**.

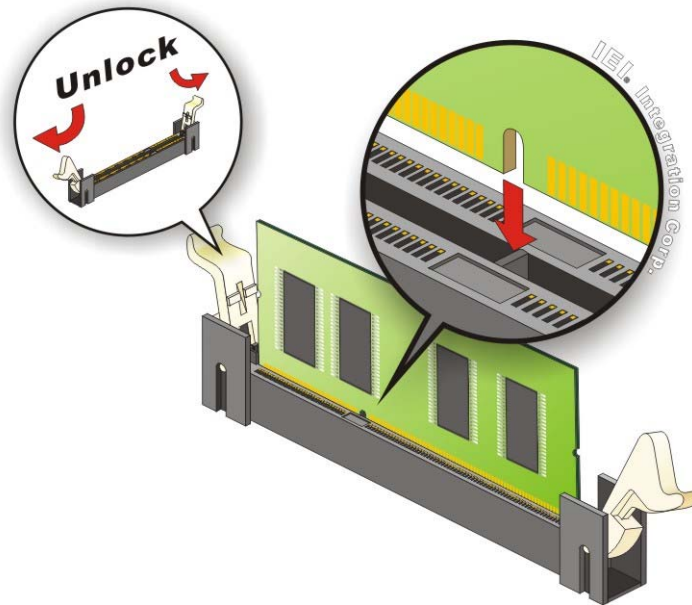

Figure 4-1: SO-DIMM Installation

- Step 1:** Open the SO-DIMM socket handles. Open the two handles outwards as far as they can. See **Figure 4-1**.
- Step 2:** Align the SO-DIMM with the socket. Align the SO-DIMM so the notch on the memory lines up with the notch on the memory socket. See **Figure 4-1**.
- Step 3:** Insert the SO-DIMM. Once aligned, press down until the SO-DIMM is properly seated. Clip the two handles into place. See **Figure 4-1**.
- Step 4:** Removing a SO-DIMM. To remove a SO-DIMM, push both handles outward. The memory module is ejected by a mechanism in the socket.

KINO-DQM170 Industrial Motherboard

4.4 M.2 Module Installation

To install an M.2 module, please follow the steps below.

Step 1: Locate the M.2 module slot. See **Chapter 3**.

Step 2: Line up the notch on the card with the notch on the slot. Slide the PCIe Mini card into the socket at an angle of about 20° (**Figure 4-5**).

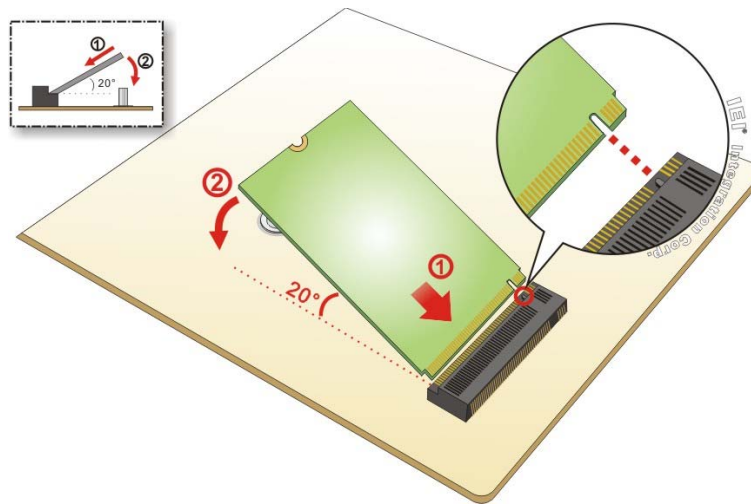

Figure 4-2: Inserting the M.2 Module into the Slot at an Angle

Step 3: Secure the M.2 module with an M2*3 retention screw (**Figure 4-6**).

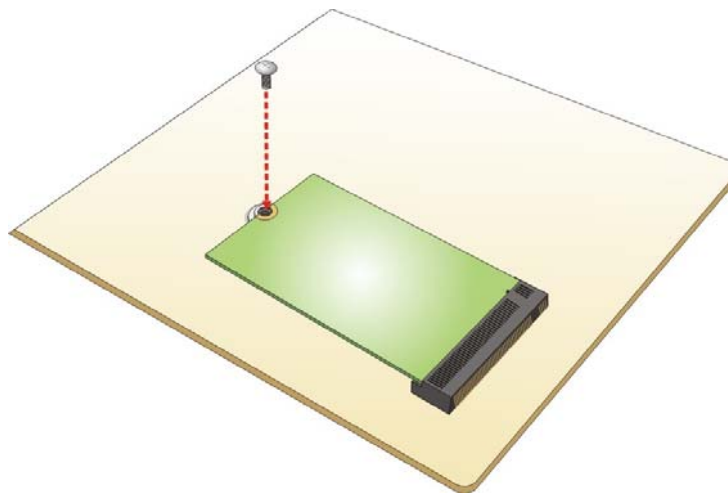

Figure 4-3: Securing the M.2 Module

4.5 Full-size PCIe Mini Card Installation

To install a full-size PCIe Mini card, please follow the steps below.

Step 1: Locate the full-size PCIe Mini card slot. See **Chapter 3**.

Step 2: Remove the retention screw as shown in **Figure 4-4**.

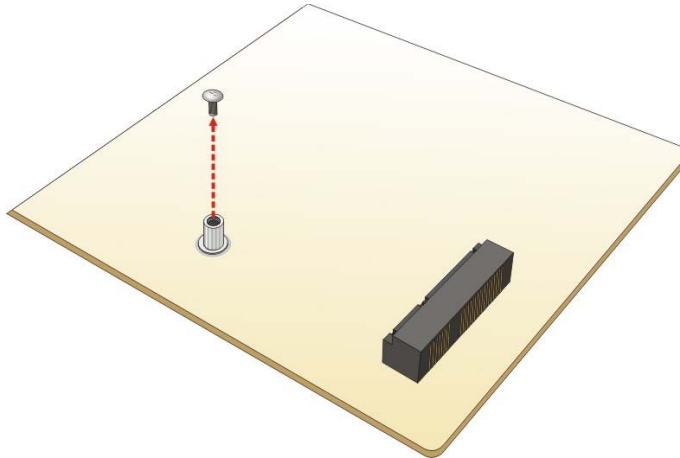

Figure 4-4: Removing the Retention Screw

Step 3: Line up the notch on the card with the notch on the slot. Slide the PCIe Mini card into the socket at an angle of about 20° (**Figure 4-5**).

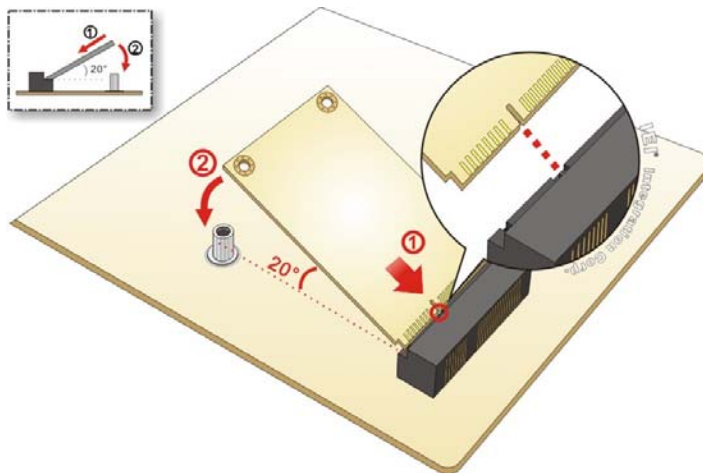

Figure 4-5: Inserting the Full-size PCIe Mini Card into the Slot at an Angle

Step 4: Secure the full-size PCIe Mini card with the retention screw previously removed (**Figure 4-6**).

KINO-DQM170 Industrial Motherboard

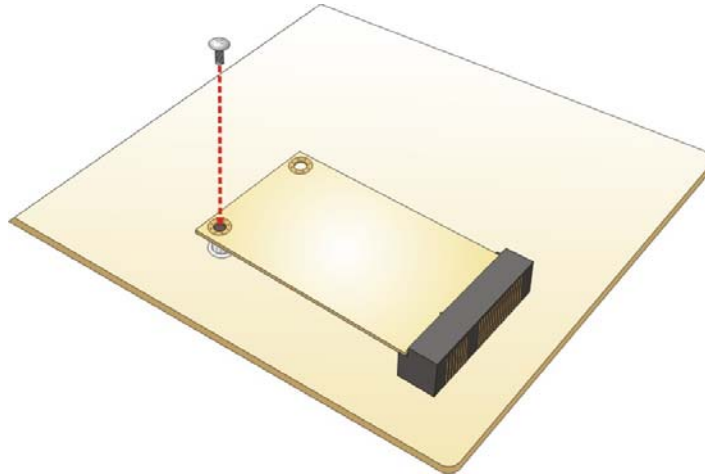

Figure 4-6: Securing the Full-size PCIe Mini Card

4.6 Half-size PCIe Mini Card Installation

To install a half-size PCIe Mini card, please follow the steps below.

Step 1: Locate the half-size PCIe Mini card slot. See Chapter 3.

Step 2: Remove the retention screw. See Figure 4-7.

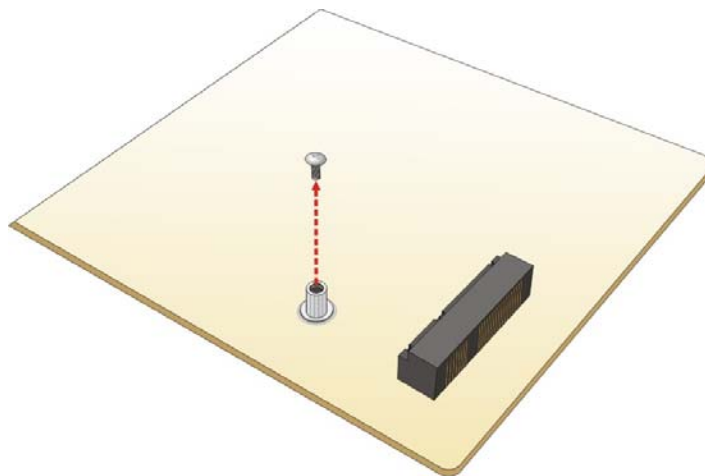

Figure 4-7: Removing Retention Screw

Step 3: Line up the notch on the card with the notch on the slot. Slide the PCIe Mini card into the slot at an angle of about 20° (Figure 4-8).

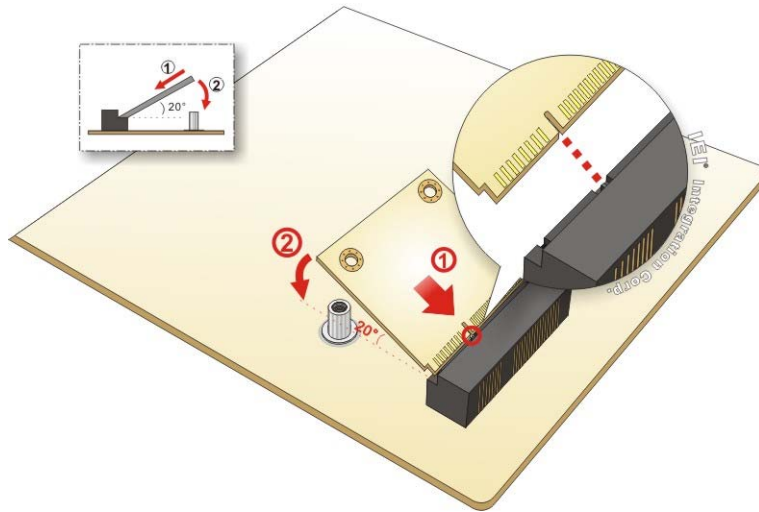

Figure 4-8: Inserting the Half-size PCIe Mini Card into the Slot at an Angle

Step 4: Secure the half-size PCIe Mini card with the retention screw previously removed (Figure 4-9).

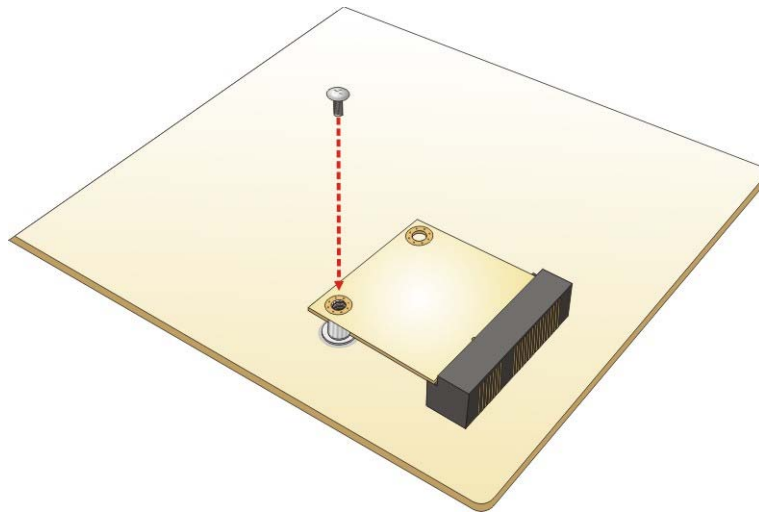

Figure 4-9: Securing the Half-size PCIe Mini Card

KINO-DQM170 Industrial Motherboard

4.7 System Configuration

The system configuration is controlled by buttons, jumpers and switches. The system configuration should be performed before installation.

4.7.1 AT/ATX Mode Select Switch

The AT/ATX mode select switch specifies the systems power mode as AT or ATX. AT/ATX mode select switch settings are shown in **Table 4-1**.

Setting	Description
Short 1-2	ATX Mode (Default)
Short 2-3	AT Mode

Table 4-1: AT/ATX Mode Select Switch Settings

The location of the AT/ATX mode select switch is shown in **Figure 4-10** below.

J_ATX_AT1

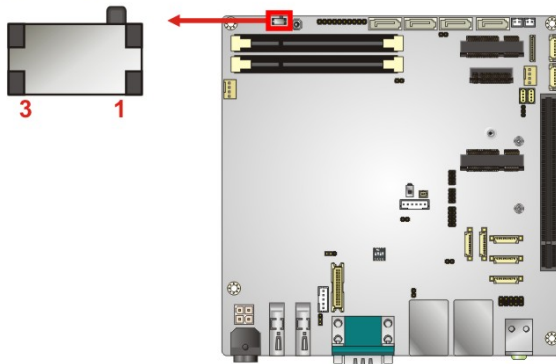

Figure 4-10: AT/ATX Mode Select Switch Location

4.7.2 Clear CMOS Button

If the KINO-DQM170 fails to boot due to improper BIOS settings, press the button for three seconds to clear the CMOS data and reset the system BIOS information. After updating to a new version of BIOS, the user has to follow the steps described below to boot up the system.

Step 1: Unplug the system power cord.

Step 2: Unplug the RTC battery for a while and re-plug it back in.

Step 3: Clear CMOS by pressing the clear CMOS button for three seconds or more.

Step 4: Boot up the system.

The location of the clear CMOS button is shown in **Figure 4-11**

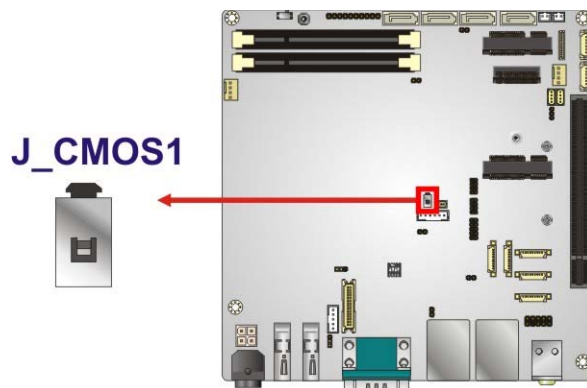

Figure 4-11: Clear CMOS Button Location

KINO-DQM170 Industrial Motherboard

4.7.3 Flash Descriptor Security Override Jumper

The Flash Descriptor Security Override jumper (J_FLASH1, p=2.00 mm) allows users to enable or disable the ME firmware update. Refer to **Figure 4-12** and **Table 4-2** for the jumper location and settings.

Setting	Description
Short 1-2	Disabled (default)
Short 2-3	Enabled

Table 4-2: Flash Descriptor Security Override Jumper Settings

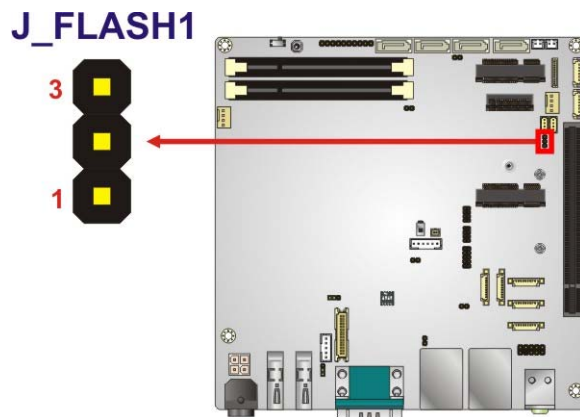

Figure 4-12: Flash Descriptor Security Override Jumper Location

To update the ME firmware, please follow the steps below.

- Step 1:** Before turning on the system power, short pin 2~3 of the Flash Descriptor Security Override jumper.
- Step 2:** Update the BIOS and ME firmware, and then turn off the system power.
- Step 3:** Remove the metal clip on the Flash Descriptor Security Override jumper to its default setting (short 1~2).
- Step 4:** Restart the system. The system will reboot 2 ~ 3 times to complete the ME firmware update.

4.7.4 LVDS Resolution Selection

The DIP switch (SW1) selects the resolution of the LCD panel connected to the LVDS connector.

* ON=0, OFF=1; Single=S, Dual=D

SW1 (4-3-2-1)	Description
0000	800x600 18bit S (default)
0001	1024x768 18bit S
0010	1024x768 24bit S
0011	1280x768 18bit S
0100	1280x800 18bit S
0101	1280x960 18bit S
0110	1280x1024 24bit D
0111	1366x768 18bit S
1000	1366x768 24bit S
1001	1440x960 24bit D
1010	1400x1050 24bit D
1011	1600x900 24bit D
1100	1680x1050 24bit D
1101	1600x1200 24bit D
1110	1920x1080 24bit D
1111	1920x1200 24bit D

Table 4-3: LVDS Resolution Selection Jumper Settings

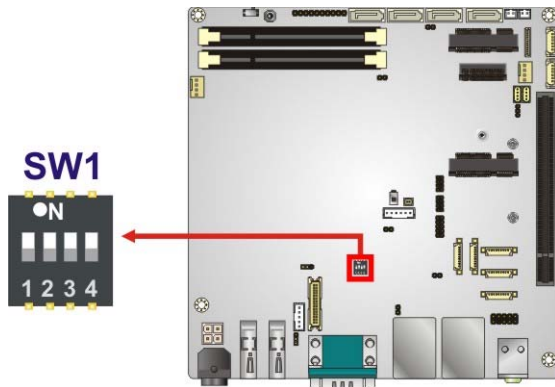

Figure 4-13: LVDS Resolution Selection Jumper Location

KINO-DQM170 Industrial Motherboard

4.7.5 LVDS Backlight Mode Selection

This LVDS backlight mode select jumper (BL_MODE1, p=2.00 mm) selects the LVDS backlight mode.

Pin	Description
Short 1-2	PWM mode (Default)
Short 2-3	DC mode

Table 4-4: LVDS Backlight Mode Select Jumper Settings

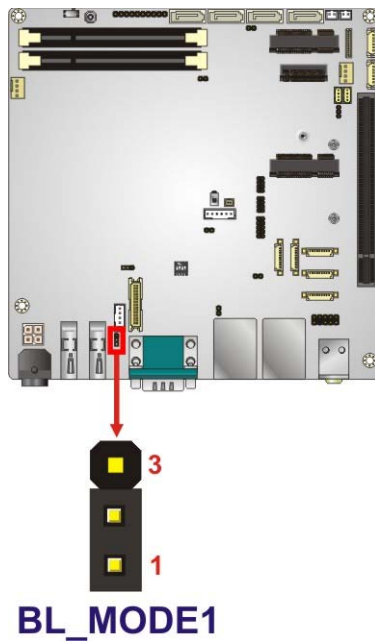

Figure 4-14: LVDS Backlight Mode Select Jumper Location

4.7.6 LVDS Voltage Selection

The LVDS voltage jumper (JP1, p=2.00 mm) selects the voltage of the LVDS connector.

Pin	Description
Short 1-2	+3.3 V (Default)
Short 2-3	+5 V

Table 4-5: LVDS Voltage Jumper Settings

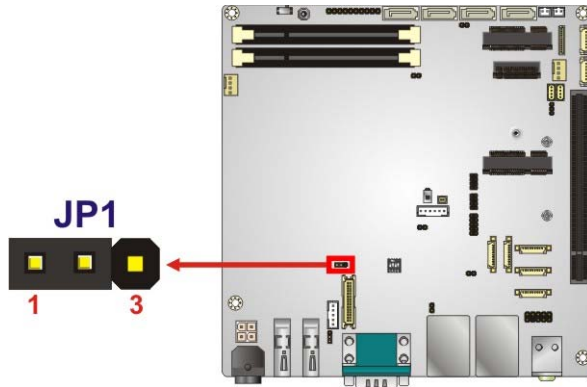

Figure 4-15: LVDS Voltage Jumper Location

4.7.7 USB Power Selection

The USB power selection is made through the BIOS menu in “Chipset → PCH-IO Configuration”. Use the **USB Power SW1** and the **USB Power SW2** BIOS options to configure the correspondent USB ports (see **Table 4-6**) and refer to **Table 4-7** to select the USB power source.

BIOS Options	Configured USB Ports
USB Power SW1	LAN1_USB1 (external USB 3.0 ports) LAN2_USB2 (external USB 3.0 ports)
USB Power SW2	USB1 (internal USB 2.0 ports) USB2 (internal USB 2.0 ports)

Table 4-6: BIOS Options and Configured USB Ports

Options	Description
+5V DUAL	+5V dual (default)
+5V	+5V

Table 4-7: USB Power Source Setup

Please refer to **Section 5.4.2** for BIOS setup.

KINO-DQM170 Industrial Motherboard

4.8 Chassis Installation

4.8.1 Airflow



WARNING:

Airflow is critical for keeping components within recommended operating temperatures. The chassis should have fans and vents as necessary to keep things cool.

The KINO-DQM170 must be installed in a chassis with ventilation holes on the sides allowing airflow to travel through the heat sink surface. In a system with an individual power supply unit, the cooling fan of a power supply can also help generate airflow through the board surface.

4.8.2 Motherboard Installation

To install the KINO-DQM170 motherboard into the chassis please refer to the reference material that came with the chassis.

4.9 Internal Peripheral Device Connections

This section outlines the installation of peripheral devices to the on-board connectors

4.9.1 SATA Drive Connection

The KINO-DQM170 is shipped with two SATA drive cables. To connect the SATA drives to the connectors, please follow the steps below.

Step 1: Locate the connectors. The locations of the SATA drive connectors are shown in **Chapter 3**.

Step 2: Insert the cable connector into the on-board SATA drive connector and the SATA power connector. See **Figure 4-16**.

**NOTE:**

The connector locations in the following diagram are just for reference.
For the exact locations, please see **Section 3.2.20**.

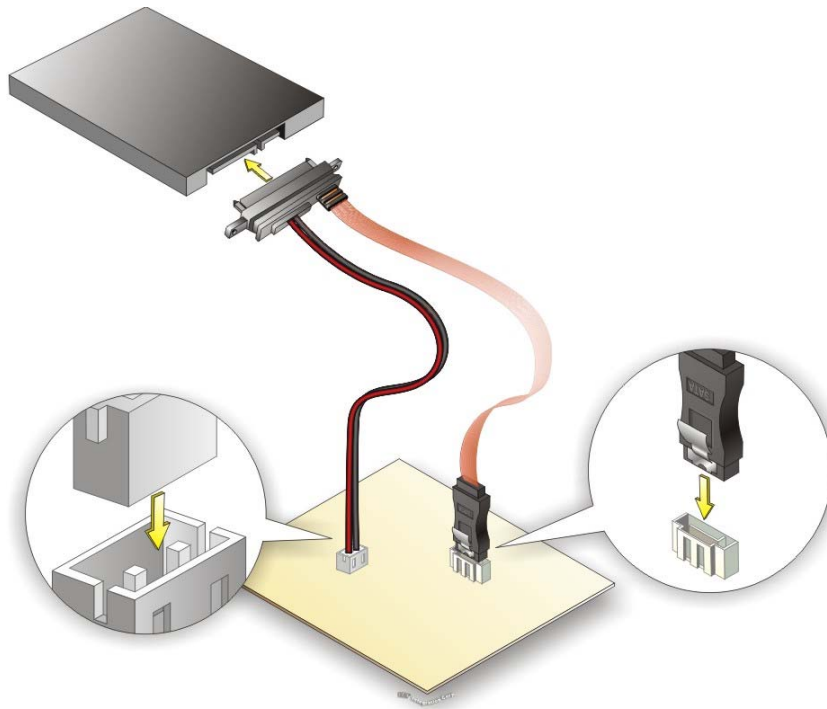

Figure 4-16: SATA Drive Cable Connection

- Step 3:** Connect the connector on the other end of the cable to the connector at the back of the SATA drive. See **Figure 4-16**.
- Step 4:** To remove the SATA cable from the SATA connector, press the clip on the connector at the end of the cable.

KINO-DQM170 Industrial Motherboard

4.10 Intel® AMT Setup Procedure

The KINO-DQM170 is featured with the Intel® Active Management Technology (AMT). To enable the Intel® AMT function, follow the steps below.

- Step 1:** Make sure at least one of the memory sockets is installed with a DDR4 SO-DIMM.
- Step 2:** Connect an Ethernet cable to the RJ-45 connector labeled **LAN1_USB1**.
- Step 3:** The AMI BIOS options regarding the Intel® ME or Intel® AMT must be enabled,
- Step 4:** Properly install the Intel® Management Engine Components drivers from the Intel AMT (ME) directory in the driver CD.
- Step 5:** Configure the Intel® Management Engine BIOS extension (MEBx). To get into the Intel® MEBx settings, press <Ctrl+P> after a single beep during boot-up process. Enter the Intel® current ME password as it requires (the Intel® default password is **admin**).



NOTE:

To change the password, enter a new password following the strong password rule (containing at least one upper case letter, one lower case letter, one digit and one special character, and be at least eight characters).

4.11 Windows 7 Installation – USB 3.0 Creator Utility

Microsoft Windows 7 installation media does not include native driver support for USB 3.0, so during installation, a keyboard/mouse connected to a USB 3.0 port does not respond. The Windows 7 USB 3.0 Creator Utility automates the steps to update a Windows 7 installation image so that it contains USB 3.0 drivers. To install Windows 7 from a USB drive onto the KINO-DQM170, please follow the steps described below.

- Step 1:** Create a USB flash drive installer. Use your Windows 7 DVD or ISO image to create a bootable USB flash drive. Instructions on how to do are found on [Microsoft's website](#).
- Step 2:** Download and unzip the [Windows 7 USB 3.0 Creator utility](#) to a temporary folder on the Admin system.
- Step 3:** Connect the USB device containing the Windows 7 image to the Admin system.
- Step 4:** Right-click the file “Installer_Creator.exe” and select Run as administrator.
- Step 5:** Browse to the root of the USB drive.
- Step 6:** Click “Create Image” to begin the creation process.
- Step 7:** Wait for the process to finish. It can take up to 15 minutes.
- Step 8:** Using the updated installer, proceed with the Windows 7 installation as you normally would.

Chapter

5

BIOS

5.1 Introduction

The BIOS is programmed onto the BIOS chip. The BIOS setup program allows changes to certain system settings. This chapter outlines the options that can be changed.



NOTE:

Some of the BIOS options may vary throughout the life cycle of the product and are subject to change without prior notice.

5.1.1 Starting Setup

The UEFI BIOS is activated when the computer is turned on. The setup program can be activated in one of two ways.

1. Press the **DELETE** or **F2** key as soon as the system is turned on or
2. Press the **DELETE** or **F2** key when the “**Press Del to enter SETUP**” message appears on the screen.

If the message disappears before the **DELETE** or **F2** key is pressed, restart the computer and try again.

5.1.2 Using Setup

Use the arrow keys to highlight items, press **ENTER** to select, use the PageUp and PageDown keys to change entries, press **F1** for help and press **ESC** to quit. Navigation keys are shown in.

Key	Function
Up arrow	Move to previous item
Down arrow	Move to next item
Left arrow	Move to the item on the left hand side
Right arrow	Move to the item on the right hand side
+	Increase the numeric value or make changes

KINO-DQM170 Industrial Motherboard

Key	Function
-	Decrease the numeric value or make changes
F1 key	General help, only for Status Page Setup Menu and Option Page Setup Menu
F2 key	Load previous values.
F3 key	Load optimized defaults
F4 key	Save changes and Exit BIOS
Esc key	Main Menu – Quit and not save changes into CMOS Status Page Setup Menu and Option Page Setup Menu -- Exit current page and return to Main Menu

5.1.3 Getting Help

When **F1** is pressed a small help window describing the appropriate keys to use and the possible selections for the highlighted item appears. To exit the Help Window press **Esc** or the **F1** key again.

5.1.4 Unable to Reboot after Configuration Changes

If the computer cannot boot after changes to the system configuration is made, CMOS defaults. Use the jumper described in **Section 4.7.2**.

5.1.5 BIOS Menu Bar

The **menu bar** on top of the BIOS screen has the following main items:

- Main – Changes the basic system configuration.
- Advanced – Changes the advanced system settings.
- Chipset – Changes the chipset settings.
- Security – Sets User and Supervisor Passwords.
- Boot – Changes the system boot configuration.
- Save & Exit – Selects exit options and loads default settings

The following sections completely describe the configuration options found in the menu items at the top of the BIOS screen and listed above.

5.2 Main

The **Main** BIOS menu (**BIOS Menu 1**) appears when the **BIOS Setup** program is entered.

Aptio Setup Utility - Copyright (C) 2016 American Megatrends, Inc.					
Main	Advanced	Chipset	Security	Boot	Save & Exit
BIOS Information					
BIOS Vendor	American Megatrends		Set the Date. Use Tab to switch between Data elements.		
Core Version	5.11				
Compliancy	UEFI 2.4; PI 1.3				
Project Version	B377AR12.ROM				
Build Date and Time	08/23/2016 17:42:44				
iWDD Vendor	iEi				
iWDD Version	B377ER03.bin				
Processor Information					
Name	SkyLake DT				
Brand String	Intel(R) Xeon(R) CPU E3-1505 v5 @ 2.80GHz				
Frequency	2700 MHz				
Processor ID	506E3				
Stepping	RO/S0/N0				
Number of Processors	4Core(s) / 8Thread(s)				
Microcode Revision	8A				
GT Info	GT2				
Memory RC Version	2.0.0.1				
Total Memory	8192 MB				
Memoery Frequency	2133 MHz				
PCH Information					
Name	SKL PCH-H				
PCH SKU	N/A				
Stepping	31/D1				
LAN PHY Revision	B2				
ME FW Version	11.0.10.1002		-----		
ME Firmware SKU	Corporate SKU		←→: Select Screen		
SPI Clock Frequency			↑ ↓: Select Item		
D0FR Support	Unsupported		EnterSelect		
Read Status Clock Frequency	17 MHz		+/-: Change Opt.		
Write Status Clock Frequency	48 MHz		F1: General Help		
Fast Read Status Clock Frequency	48 MHz		F2: Previous Values		
Access Level	Administrator		F3: Optimized Defaults		
System Date	[Fri 01/01/2010]		F4: Save & Exit		
System Time	[00:18:46]		ESC: Exit		
Version 2.18.1256. Copyright (C) 2016 American Megatrends, Inc.					

BIOS Menu 1: Main

KINO-DQM170 Industrial Motherboard

→ System Date [xx/xx/xx]

Use the **System Date** option to set the system date. Manually enter the day, month and year.

→ System Time [xx:xx:xx]

Use the **System Time** option to set the system time. Manually enter the hours, minutes and seconds.

5.3 Advanced

Use the **Advanced** menu (**BIOS Menu 2**) to configure the CPU and peripheral devices through the following sub-menus:



WARNING!

Setting the wrong values in the sections below may cause the system to malfunction. Make sure that the settings made are compatible with the hardware.

```

Aptio Setup Utility - Copyright (C) 2016 American Megatrends, Inc.
Main  Advanced  Chipset  Security  Boot  Save & Exit
-----
> ACPI Settings                System ACPI Parameters.
> AMT Configuration
> Super IO Configuration
> iWDD H/W Monitor
> RTC Wake Settings
> Serial Port Console Redirection
> CPU Configuration
> SATA Configuration
> NVMe Configuration
> USB Configuration
> iEi Feature

-----
<=>: Select Screen
↑ ↓: Select Item
Enter>Select
F1  General Help
F2  Previous Values
F3  Optimized Defaults
F4  Save
ESC Exit

Version 2.18.1256. Copyright (C) 2016 American Megatrends, Inc.
    
```

BIOS Menu 2: Advanced

5.3.1 ACPI Settings

The **ACPI Settings** menu (**BIOS Menu 3**) configures the Advanced Configuration and Power Interface (ACPI) options.

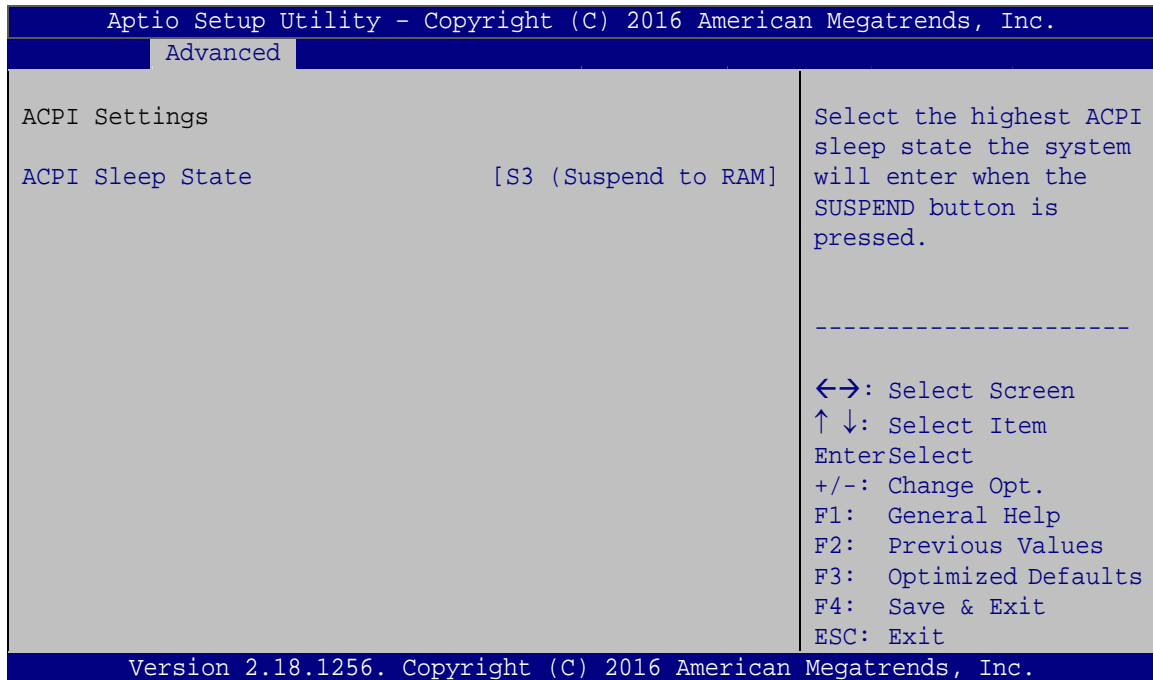

BIOS Menu 3: ACPI Settings

→ **ACPI Sleep State [S3 (Suspend to RAM)]**

Use the **ACPI Sleep State** option to specify the sleep state the system enters when it is not being used.

- **S3 (Suspend to DEFAULT RAM)** The caches are flushed and the CPU is powered off. Power to the RAM is maintained. The computer returns slower to a working state, but more power is saved.

KINO-DQM170 Industrial Motherboard

5.3.2 AMT Configuration

The **AMT Configuration** menu (**BIOS Menu 4**) allows Intel® Active Management Technology (AMT) options to be configured.

```

Aptio Setup Utility - Copyright (C) 2016 American Megatrends, Inc.
  Advanced
-----
Intel AMT                [Enabled]
Un-Configure ME         [Disabled]

Enable/Disable Intel (R)
Active Management
Technology BIOS
Extension.
Note: iAMT H/W is always
enabled.
This option just controls
the BIOS extension
execution.
If enabled, this requires
additional firmware in the
SPI device

-----
<->: Select Screen
↑ ↓: Select Item
Enter>Select
F1   General Help
F2   Previous Values
F3   Optimized Defaults
F4   Save
ESC  Exit

Version 2.18.1256. Copyright (C) 2016 American Megatrends, Inc.
  
```

BIOS Menu 4: AMT Configuration

→ Intel AMT [Enabled]

Use **Intel AMT** option to enable or disable the Intel® AMT function.

- **Disabled** Intel® AMT is disabled
- **Enabled** **DEFAULT** Intel® AMT is enabled

→ Un-configure ME [Disabled]

Use the **Un-configure ME** option to perform ME unconfigure without password operation.

- **Disabled** **DEFAULT** Not perform ME unconfigure

➔ Enabled To perform ME unconfigure

5.3.3 Super IO Configuration

Use the **Super IO Configuration** menu (**BIOS Menu 5**) to set or change the configurations for the serial ports.

```

Aptio Setup Utility - Copyright (C) 2016 American Megatrends, Inc.
  Advanced
F81866 Super IO Configuration
Super IO Chip                      F81866
> Serial Port 1 Configuration
> Serial Port 2 Configuration
> Serial Port 3 Configuration
> Serial Port 4 Configuration
> Serial Port 5 Configuration
> Serial Port 6 Configuration

Set Parameters of Serial
Port 1 (COMA)
-----
<->: Select Screen
↑ ↓: Select Item
EnterSelect
F1  General Help
F2  Previous Values
F3  Optimized
Defaults
F4  Save
ESC Exit

Version 2.18.1256. Copyright (C) 2016 American Megatrends, Inc.
  
```

BIOS Menu 5: Super IO Configuration

KINO-DQM170 Industrial Motherboard

5.3.3.1 Serial Port n Configuration

Use the **Serial Port n Configuration** menu (**BIOS Menu 6**) to configure the serial port n.

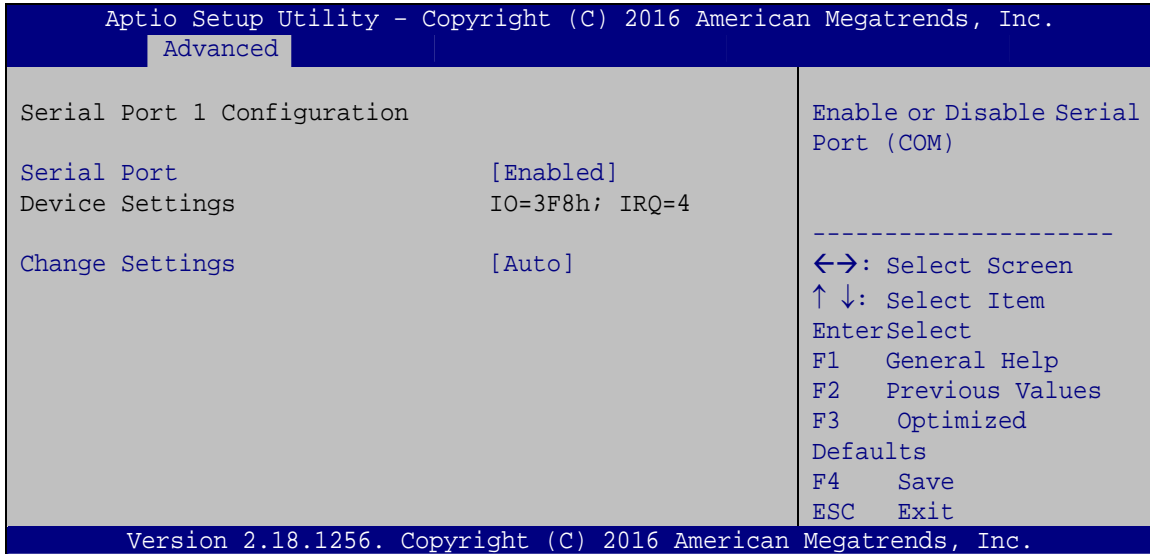

BIOS Menu 6: Serial Port n Configuration

5.3.3.1.1 Serial Port 1 Configuration

→ Serial Port [Enabled]

Use the **Serial Port** option to enable or disable the serial port.

- **Disabled** Disable the serial port
- **Enabled** **DEFAULT** Enable the serial port

→ Change Settings [Auto]

Use the **Change Settings** option to change the serial port IO port address and interrupt address.

- **Auto** **DEFAULT** The serial port IO port address and interrupt address are automatically detected.
- **IO=3F8h; IRQ=4** Serial Port I/O port address is 3F8h and the interrupt address is IRQ4

- | | |
|----------------------------|---|
| → IO=3F8h; IRQ=3,
4, 11 | Serial Port I/O port address is 3F8h and the interrupt address is IRQ3, 4, 11 |
| → IO=2F8h; IRQ=3,
4, 11 | Serial Port I/O port address is 2F8h and the interrupt address is IRQ3, 4, 11 |
| → IO=3E8h; IRQ=3,
4, 11 | Serial Port I/O port address is 3E8h and the interrupt address is IRQ3, 4, 11 |
| → IO=2E8h; IRQ=3,
4, 11 | Serial Port I/O port address is 2E8h and the interrupt address is IRQ3, 4, 11 |

5.3.3.1.2 Serial Port 2 Configuration

→ Serial Port [Enabled]

Use the **Serial Port** option to enable or disable the serial port.

- | | |
|--------------------------|-------------------------|
| → Disabled | Disable the serial port |
| → Enabled DEFAULT | Enable the serial port |

→ Change Settings [Auto]

Use the **Change Settings** option to change the serial port IO port address and interrupt address.

- | | |
|----------------------------|---|
| → Auto DEFAULT | The serial port IO port address and interrupt address are automatically detected. |
| → IO=2F8h; IRQ=3 | Serial Port I/O port address is 2F8h and the interrupt address is IRQ3 |
| → IO=3F8h; IRQ=3,
4, 11 | Serial Port I/O port address is 3F8h and the interrupt address is IRQ3, 4, 11 |
| → IO=2F8h; IRQ=3,
4, 11 | Serial Port I/O port address is 2F8h and the interrupt address is IRQ3, 4, 11 |
| → IO=3E8h; IRQ=3,
4, 11 | Serial Port I/O port address is 3E8h and the interrupt address is IRQ3, 4, 11 |

KINO-DQM170 Industrial Motherboard

- ➔ **IO=2E8h; IRQ=3, 4, 11** Serial Port I/O port address is 2E8h and the interrupt address is IRQ3, 4, 11

5.3.3.1.3 Serial Port 3 Configuration

➔ Serial Port [Enabled]

Use the **Serial Port** option to enable or disable the serial port.

- ➔ **Disabled** Disable the serial port
- ➔ **Enabled DEFAULT** Enable the serial port

➔ Change Settings [Auto]

Use the **Change Settings** option to change the serial port IO port address and interrupt address.

- ➔ **Auto DEFAULT** The serial port IO port address and interrupt address are automatically detected.
- ➔ **IO=3E8h; IRQ=11** Serial Port I/O port address is 3E8h and the interrupt address is IRQ11
- ➔ **IO=3F8h; IRQ=3, 4, 11** Serial Port I/O port address is 3F8h and the interrupt address is IRQ3, 4, 11
- ➔ **IO=2F8h; IRQ=3, 4, 11** Serial Port I/O port address is 2F8h and the interrupt address is IRQ3, 4, 11
- ➔ **IO=3E8h; IRQ=3, 4, 11** Serial Port I/O port address is 3E8h and the interrupt address is IRQ3, 4, 11
- ➔ **IO=2E8h; IRQ=3, 4, 11** Serial Port I/O port address is 2E8h and the interrupt address is IRQ3, 4, 11
- ➔ **IO=2D0h; IRQ=3, 4, 11** Serial Port I/O port address is 2D0h and the interrupt address is IRQ3, 4, 11
- ➔ **IO=2E0h; IRQ=3, 4, 11** Serial Port I/O port address is 2E0h and the interrupt address is IRQ3, 4, 11

5.3.3.1.4 Serial Port 4 Configuration

→ **Serial Port [Enabled]**

Use the **Serial Port** option to enable or disable the serial port.

- **Disabled** Disable the serial port
- **Enabled** **DEFAULT** Enable the serial port

→ **Change Settings [Auto]**

Use the **Change Settings** option to change the serial port IO port address and interrupt address.

- **Auto** **DEFAULT** The serial port IO port address and interrupt address are automatically detected.
- **IO=2E8h; IRQ=11** Serial Port I/O port address is 2E8h and the interrupt address is IRQ11
- **IO=3F8h; IRQ=3, 4, 11** Serial Port I/O port address is 3F8h and the interrupt address is IRQ3, 4, 11
- **IO=2F8h; IRQ=3, 4, 11** Serial Port I/O port address is 2F8h and the interrupt address is IRQ3, 4, 11
- **IO=3E8h; IRQ=3, 4, 11** Serial Port I/O port address is 3E8h and the interrupt address is IRQ3, 4, 11
- **IO=2E8h; IRQ=3, 4, 11** Serial Port I/O port address is 2E8h and the interrupt address is IRQ3, 4, 11
- **IO=2D0h; IRQ=3, 4, 11** Serial Port I/O port address is 2D0h and the interrupt address is IRQ3, 4, 11
- **IO=2E0h; IRQ=3, 4, 11** Serial Port I/O port address is 2E0h and the interrupt address is IRQ3, 4, 11

KINO-DQM170 Industrial Motherboard

5.3.3.1.5 Serial Port 5 Configuration

→ Serial Port [Enabled]

Use the **Serial Port** option to enable or disable the serial port.

- **Disabled** Disable the serial port
- **Enabled** **DEFAULT** Enable the serial port

→ Change Settings [Auto]

Use the **Change Settings** option to change the serial port IO port address and interrupt address.

- **Auto** **DEFAULT** The serial port IO port address and interrupt address are automatically detected.
- **IO=2D0h; IRQ=11** Serial Port I/O port address is 2D0h and the interrupt address is IRQ11
- **IO=3F8h; IRQ=3, 4, 11** Serial Port I/O port address is 3F8h and the interrupt address is IRQ3, 4, 11
- **IO=2F8h; IRQ=3, 4, 11** Serial Port I/O port address is 2F8h and the interrupt address is IRQ3, 4, 11
- **IO=3E8h; IRQ=3, 4, 11** Serial Port I/O port address is 3E8h and the interrupt address is IRQ3, 4, 11
- **IO=2E8h; IRQ=3, 4, 11** Serial Port I/O port address is 2E8h and the interrupt address is IRQ3, 4, 11
- **IO=2D0h; IRQ=3, 4, 11** Serial Port I/O port address is 2D0h and the interrupt address is IRQ3, 4, 11
- **IO=2E0h; IRQ=3, 4, 11** Serial Port I/O port address is 2E0h and the interrupt address is IRQ3, 4, 11

→ Transfer Mode [RS232]

Use the **Transfer Mode** option to select the Serial Port 5 signaling mode.

- RS422 Serial Port 5 signaling mode is RS-422
- RS485 Serial Port 5 signaling mode is RS-485
- RS232 **DEFAULT** Serial Port 5 signaling mode is RS-232

5.3.3.1.6 Serial Port 6 Configuration

→ Serial Port [Enabled]

Use the **Serial Port** option to enable or disable the serial port.

- Disabled Disable the serial port
- Enabled **DEFAULT** Enable the serial port

→ Change Settings [Auto]

Use the **Change Settings** option to change the serial port IO port address and interrupt address.

- **Auto** **DEFAULT** The serial port IO port address and interrupt address are automatically detected.
- IO=2E0h; IRQ=11 Serial Port I/O port address is 2E0h and the interrupt address is IRQ11
- IO=3F8h; IRQ=3, 4, 11 Serial Port I/O port address is 3F8h and the interrupt address is IRQ3, 4, 11
- IO=2F8h; IRQ=3, 4, 11 Serial Port I/O port address is 2F8h and the interrupt address is IRQ3, 4, 11
- IO=3E8h; IRQ=3, 4, 11 Serial Port I/O port address is 3E8h and the interrupt address is IRQ3, 4, 11
- IO=2E8h; IRQ=3, 4, 11 Serial Port I/O port address is 2E8h and the interrupt address is IRQ3, 4, 11

KINO-DQM170 Industrial Motherboard

- ➔ IO=2D0h; IRQ=3, 4, 11 Serial Port I/O port address is 2D0h and the interrupt address is IRQ3, 4, 11
- ➔ IO=2E0h; IRQ=3, 4, 11 Serial Port I/O port address is 2E0h and the interrupt address is IRQ3, 4, 11

➔ Transfer Mode [RS232]

Use the **Transfer Mode** option to select the Serial Port 6 signaling mode.

- ➔ RS422 Serial Port 6 signaling mode is RS-422
- ➔ RS485 Serial Port 6 signaling mode is RS-485
- ➔ RS232 **DEFAULT** Serial Port 6 signaling mode is RS-232

5.3.4 iWDD H/W Monitor

The **iWDD H/W Monitor** menu (**BIOS Menu 7**) contains the fan configuration submenus and displays operating temperature, fan speeds and system voltages.

```

Aptio Setup Utility - Copyright (C) 2016 American Megatrends, Inc.
  Advanced
PC Health Status
CPU temperature           :+29 °C
System temperature       :+29 °C

CPU_FAN1 Speed           :6455 RPM
SYS_FAN1 Speed           :N/A

CPU_CORE                 :+1.041 V
+5V                      :+5.023 V
+12V                     :+12.000 V
+DDR                     :+1.202 V
+5VSB                    :+5.005 V
+3.3V                    :+3.296 V
+3.3VSB                  :+3.259 V

> Smart Fan Mode Configuration

Smart Fan Mode Select

-----
<->: Select Screen
↑ ↓: Select Item
Enter>Select
+ - Change Opt.
F1  General Help
F2  Previous Values
F3  Optimized Defaults
F4  Save & Exit
ESC Exit

Version 2.18.1256. Copyright (C) 2016 American Megatrends, Inc.
  
```

BIOS Menu 7: iWDD H/W Monitor

→ PC Health Status

The following system parameters and values are shown. The system parameters that are monitored are:

- System Temperatures:
 - CPU Temperature
 - System temperature
- Fan Speed:
 - CPU Fan Speed
 - System Fan Speed
- Voltages
 - CPU_CORE
 - +5V
 - +12V
 - +DDR
 - +5VSB
 - +3.3V
 - +3.3VSB

KINO-DQM170 Industrial Motherboard

5.3.4.1 Smart Fan Mode Configuration

Use the **Smart Fan Mode Configuration** submenu (**BIOS Menu 8**) to configure fan temperature and speed settings.

```

Aptio Setup Utility - Copyright (C) 2016 American Megatrends, Inc.
-----
Advanced
-----
Smart Fan Mode Configuration
CPU_FAN1 Smart Fan Control      [Auto Mode]
Auto mode fan start temperature 30
Auto mode fan off temperature  20
Auto mode fan start PWM        40
Auto mode fan slope PWM        1
SYS_FAN1 Smart Fan Control      [Auto Mode]
Auto mode fan start temperature 30
Auto mode fan off temperature  20
Auto mode fan start PWM        40
Auto mode fan slope PWM        1

Smart Fan Mode Select
-----
<=>: Select Screen
↑ ↓: Select Item
EnterSelect
+ - Change Opt.
F1  General Help
F2  Previous Values
F3  Optimized Defaults
F4  Save & Exit
ESC Exit

Version 2.18.1256. Copyright (C) 2016 American Megatrends, Inc.
    
```

BIOS Menu 8: Smart Fan Mode Configuration

→ CPU_FAN1 Smart Fan Control [Auto Mode]

Use the **CPU_FAN1 Smart Fan Control** BIOS option to configure the CPU Smart Fan.

- **Manual Mode** **DEFAULT** The fan spins at the speed set in the Manual Mode option
- **Auto Mode** **DEFAULT** The fan adjusts its speed using these settings:
 - Auto mode fan start temperature
 - Auto mode fan off temperature
 - Auto mode fan start PWM
 - Auto mode fan slope PWM

→ SYS_FAN1 Smart Fan Control [Auto Mode]

Use the **SYS_FAN1 Smart Fan Control** BIOS option to configure the system smart fan.

- Manual Mode** The fan spins at the speed set in the Manual Mode option

- Auto Mode** **DEFAULT** The fan adjusts its speed using these settings:
 - Auto mode fan start temperature
 - Auto mode fan off temperature
 - Auto mode fan start PWM
 - Auto mode fan slope PWM

→ Auto mode fan start temperature [30]



WARNING:

Setting this value too high may cause the fan to rotate at full speed only when the CPU is at a very high temperature and therefore cause the system to be damaged.

The **Auto mode fan start temperature** option can only be set if the **Smart Fan Control** option is set to **Auto Mode**. If the system temperature is between **Start Temperature** and **Off Temperature**, the fan speed change to be **Start PWM**. To set a value, select the **Auto mode fan start temperature** option and enter a decimal number between 1 and 100.

KINO-DQM170 Industrial Motherboard

→ Auto mode fan off temperature [20]



WARNING:

Setting this value too high may cause the fan to speed up only when the CPU is at a very high temperature and therefore cause the system to be damaged.

The **Auto mode fan off temperature** option can only be set if the **Smart Fan control** option is set to **Auto Mode**. If the system temperature is lower than **Auto mode fan off temperature**, the fan speed change to be lowest. To set a value, select the **Auto mode fan off temperature** option and enter a decimal number between 1 and 100.

→ Auto mode fan start PWM [40]

The **Auto mode fan start PWM** option can only be set if the **Smart Fan control** option is set to **Auto Mode**. Use the **Auto mode fan start PWM** option to set the PWM start value. To set a value, select the **Auto mode fan start PWM** option and enter a decimal number between 1 and 100.

→ Auto mode fan slope PWM [1]

The **Auto mode fan slope PWM** option can only be set if the **Smart Fan control** option is set to **Auto Mode**. Use the **Auto mode fan slope PWM** option to select the linear rate at which the PWM mode increases with respect to an increase in temperature. To set a value, select the **Auto mode fan slope PWM** option and enter a decimal number between 1 and 8.

5.3.5 RTC Wake Settings

The **RTC Wake Settings** menu (**BIOS Menu 9**) configures RTC wake event.

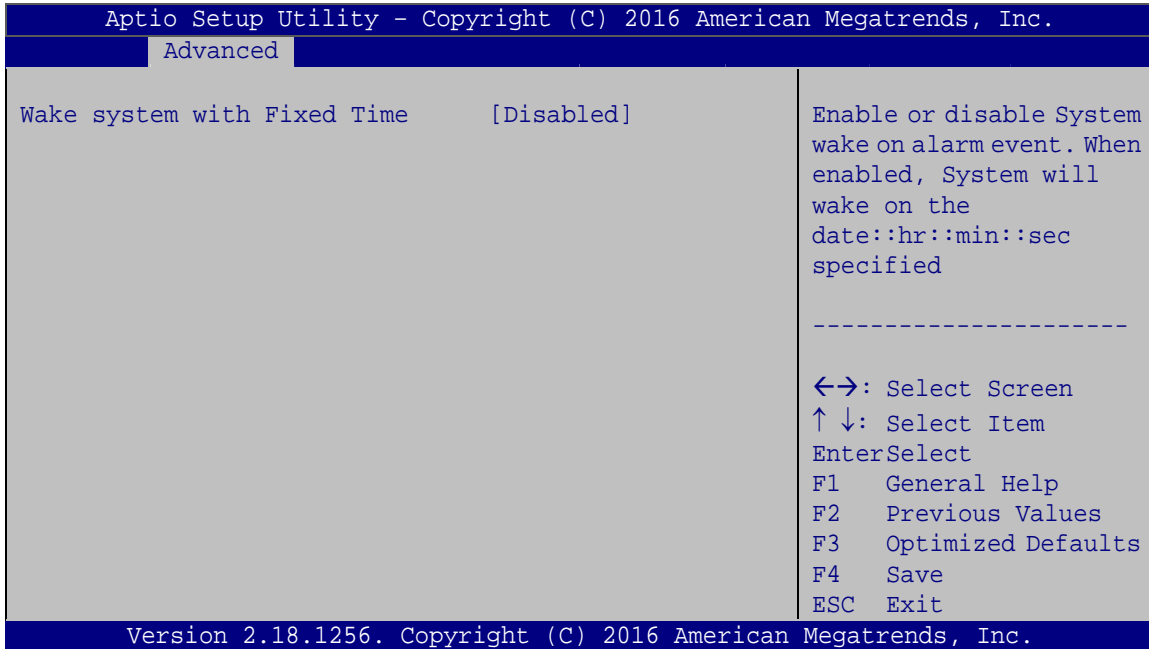

BIOS Menu 9: RTC Wake Settings

→ Wake system with Fixed Time [Disabled]

Use the **Wake system with Fixed Time** option to enable or disable the system wake on alarm event.

- **Disabled** **DEFAULT** The real time clock (RTC) cannot generate a wake event
- **Enabled** If selected, the **Wake up every day** option appears allowing you to enable to disable the system to wake every day at the specified time. Besides, the following options appear with values that can be selected:

Wake system with Fixed Time

Wake up every day

Wake up date

KINO-DQM170 Industrial Motherboard

Wake up hour

Wake up minute

Wake up second

After setting the alarm, the computer turns itself on from a suspend state when the alarm goes off.

5.3.6 Serial Port Console Redirection

The **Serial Port Console Redirection** menu (**BIOS Menu 10**) allows the console redirection options to be configured. Console redirection allows users to maintain a system remotely by re-directing keyboard input and text output through the serial port.

```

Aptio Setup Utility - Copyright (C) 2016 American Megatrends, Inc.
  Advanced
COM1
  Console Redirection          [Disabled]
> Console Redirection Settings  Console Redirection
                                Enable or Disable

COM2
  Console Redirection          [Disabled]
> Console Redirection Settings

COM3
  Console Redirection          [Disabled]
> Console Redirection Settings

COM4
  Console Redirection          [Disabled]
> Console Redirection Settings

COM5
  Console Redirection          [Disabled]
> Console Redirection Settings

COM6
  Console Redirection          [Disabled]
> Console Redirection Settings

COM7(Pci Bus0, Dev0, Func0)(Disabled)
  Console Redirection          Port Is Disabled

Legacy Console Redirection
> Legacy Console Redirection Settings

-----
<=>: Select Screen
↑↓: Select Item
Enter>Select
F1   General Help
F2   Previous Values
F3   Optimized
Defaults
F4   Save
ESC  Exit
Version 2.18.1256. Copyright (C) 2016 American Megatrends, Inc.
  
```

BIOS Menu 10: Serial Port Console Redirection

→ Console Redirection [Disabled]

Use **Console Redirection** option to enable or disable the console redirection function.

- **Disabled** **DEFAULT** Disabled the console redirection function
- **Enabled** Enabled the console redirection function

5.3.6.1 Legacy Console Redirection Settings

The **Legacy Console Redirection Settings** menu (**BIOS Menu 11**) allows the legacy console redirection options to be configured.

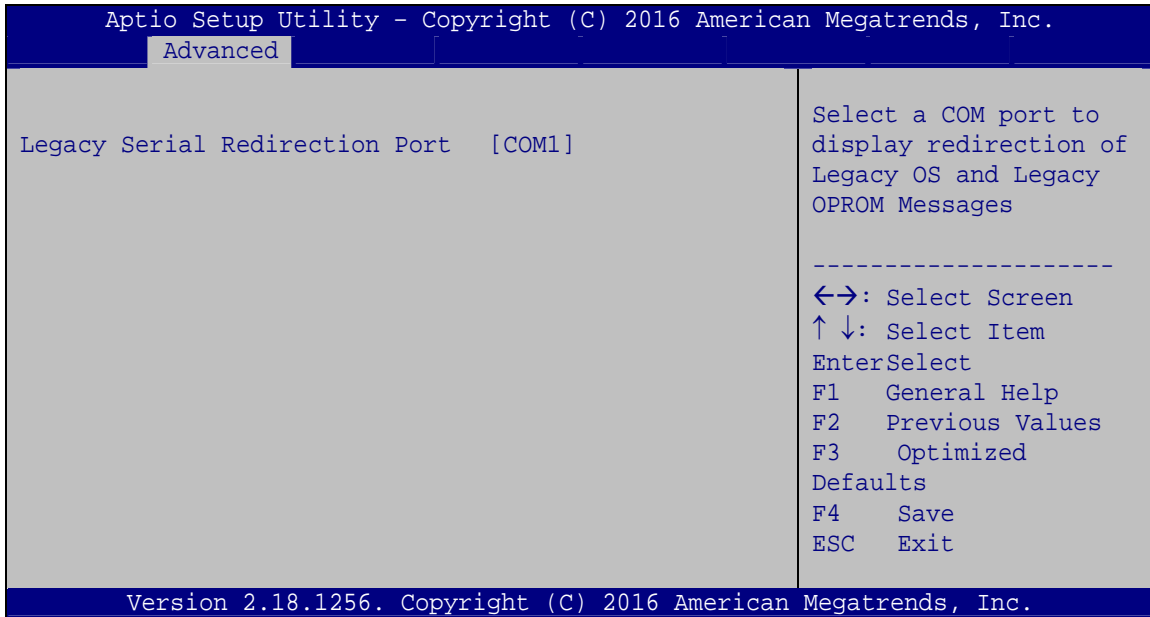

BIOS Menu 11: Legacy Console Redirection Settings

→ Legacy Serial Redirection Port [COM1]

Use the **Legacy Serial Redirection Port** option to specify a COM port to display redirection of legacy OS and legacy OPROM messages. The options include:

- COM1 **DEFAULT**
- COM2
- COM3
- COM4
- COM5

KINO-DQM170 Industrial Motherboard

- COM6
- COM7 (Pci Bus0, Dev0, Func0) (Disabled)

5.3.6.2 Console Redirection Settings

The **Console Redirection Settings** menu (**BIOS Menu 12**) allows the console redirection options to be configured. The option is active when Console Redirection option is enabled.

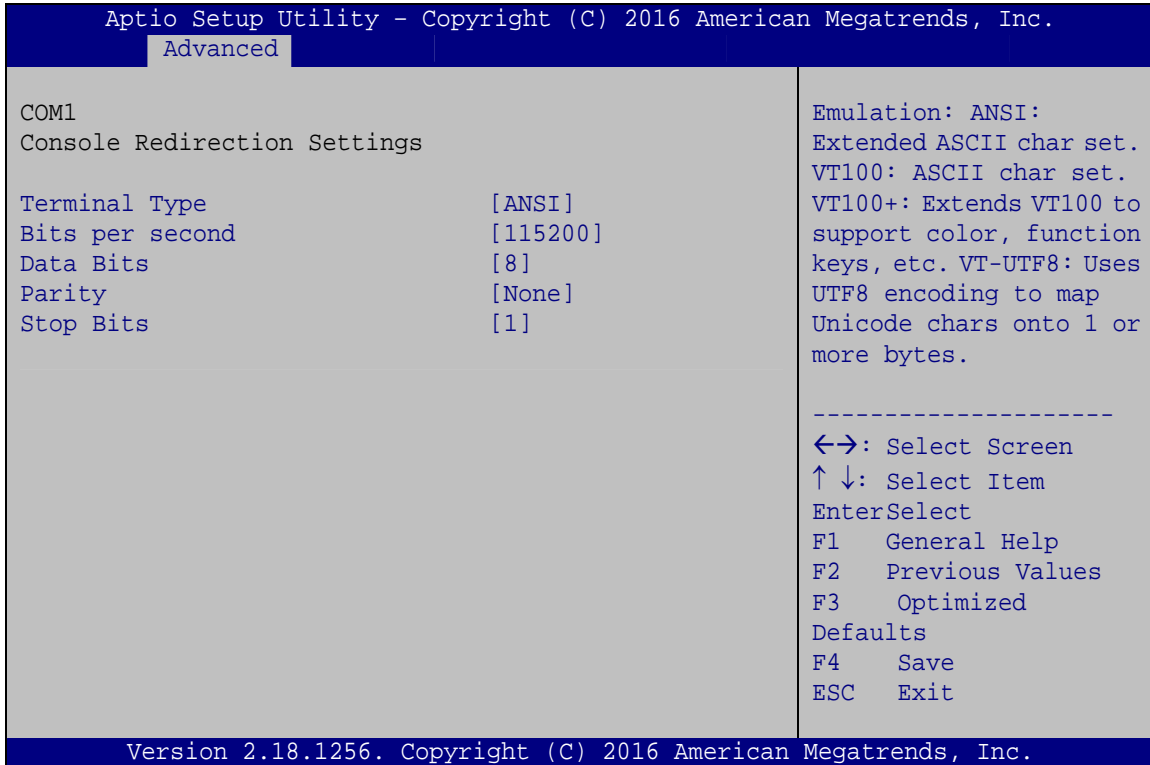

BIOS Menu 12: Console Redirection Settings

→ Terminal Type [ANSI]

Use the **Terminal Type** option to specify the remote terminal type.

- **VT100** The target terminal type is VT100
- **VT100+** The target terminal type is VT100+
- **VT-UTF8** The target terminal type is VT-UTF8
- **ANSI** **DEFAULT** The target terminal type is ANSI

→ Bits per second [115200]

Use the **Bits per second** option to specify the serial port transmission speed. The speed must match the other side. Long or noisy lines may require lower speeds.

- | | | |
|-----------------|----------------|--|
| → 9600 | | Sets the serial port transmission speed at 9600. |
| → 19200 | | Sets the serial port transmission speed at 19200. |
| → 57600 | | Sets the serial port transmission speed at 57600. |
| → 115200 | DEFAULT | Sets the serial port transmission speed at 115200. |

→ Data Bits [8]

Use the **Data Bits** option to specify the number of data bits.

- | | | |
|------------|----------------|--------------------------|
| → 7 | | Sets the data bits at 7. |
| → 8 | DEFAULT | Sets the data bits at 8. |

→ Parity [None]

Use the **Parity** option to specify the parity bit that can be sent with the data bits for detecting the transmission errors.

- | | | |
|----------------|----------------|---|
| → None | DEFAULT | No parity bit is sent with the data bits. |
| → Even | | The parity bit is 0 if the number of ones in the data bits is even. |
| → Odd | | The parity bit is 0 if the number of ones in the data bits is odd. |
| → Mark | | The parity bit is always 1. This option does not provide error detection. |
| → Space | | The parity bit is always 0. This option does not provide error detection. |

KINO-DQM170 Industrial Motherboard

→ Stop Bits [1]

Use the **Stop Bits** option to specify the number of stop bits used to indicate the end of a serial data packet. Communication with slow devices may require more than 1 stop bit.

- 1 **DEFAULT** Sets the number of stop bits at 1.
- 2 Sets the number of stop bits at 2.

5.3.7 CPU Configuration

Use the **CPU Configuration** menu (**BIOS Menu 13**) to view detailed CPU specifications and configure the CPU.

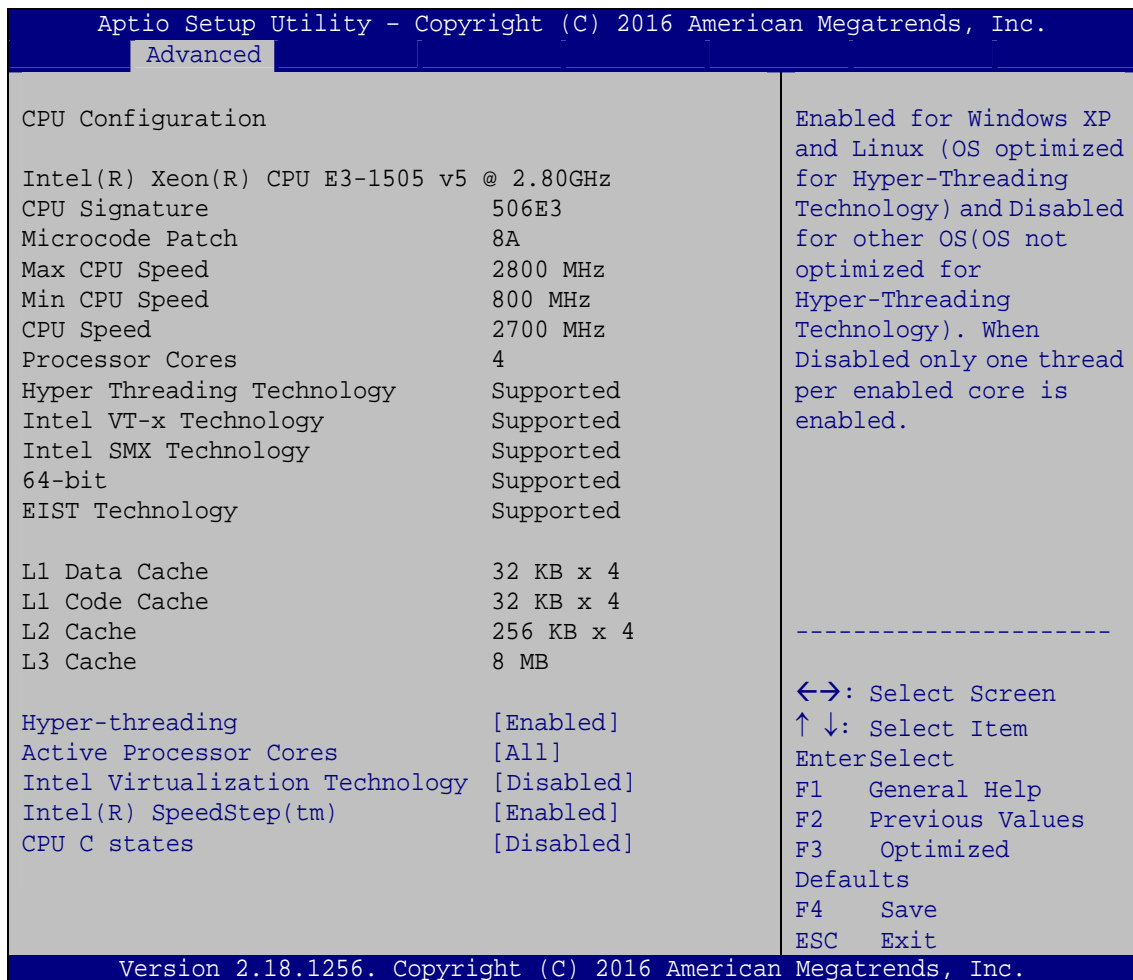

Aptio Setup Utility - Copyright (C) 2016 American Megatrends, Inc.

Advanced

CPU Configuration		Enabled for Windows XP and Linux (OS optimized for Hyper-Threading Technology) and Disabled for other OS(OS not optimized for Hyper-Threading Technology). When Disabled only one thread per enabled core is enabled.
Intel(R) Xeon(R) CPU E3-1505 v5 @ 2.80GHz		
CPU Signature	506E3	
Microcode Patch	8A	
Max CPU Speed	2800 MHz	
Min CPU Speed	800 MHz	
CPU Speed	2700 MHz	
Processor Cores	4	
Hyper Threading Technology	Supported	
Intel VT-x Technology	Supported	
Intel SMX Technology	Supported	
64-bit	Supported	
EIST Technology	Supported	

L1 Data Cache	32 KB x 4	
L1 Code Cache	32 KB x 4	
L2 Cache	256 KB x 4	
L3 Cache	8 MB	
Hyper-threading	[Enabled]	
Active Processor Cores	[All]	
Intel Virtualization Technology	[Disabled]	
Intel(R) SpeedStep(tm)	[Enabled]	
CPU C states	[Disabled]	

←→: Select Screen
↑ ↓: Select Item
Enter>Select
F1 General Help
F2 Previous Values
F3 Optimized
Defaults
F4 Save
ESC Exit

Version 2.18.1256. Copyright (C) 2016 American Megatrends, Inc.

BIOS Menu 13: CPU Configuration

→ Hyper-threading [Enabled]

Use the **Hyper-threading** option to enable or disable the hyper-threading technology.

- **Disabled** Disables hyper-threading technology.
- **Enabled DEFAULT** Enables hyper-threading technology.

→ Active Processor Cores [All]

Use the **Active Processor Cores** BIOS option to enable numbers of cores in the processor package.

- **All DEFAULT** Enable all cores in the processor package.
- **1** Enable one core in the processor package.
- **2** Enable two cores in the processor package.
- **3** Enable three cores in the processor package.

→ Intel® Virtualization Technology [Disabled]

Use the **Intel® Virtualization Technology** option to enable or disable virtualization on the system. When combined with third party software, Intel® Virtualization technology allows several OSs to run on the same system at the same time.

- **Disabled DEFAULT** Disables Intel® Virtualization Technology.
- **Enabled** Enables Intel® Virtualization Technology.

→ Intel® SpeedStep™ [Enabled]

Use the **Intel® SpeedStep™** option to enable or disable the Intel® SpeedStep Technology.

- **Disabled** Disables the Intel® SpeedStep Technology.
- **Enabled DEFAULT** Enables the Intel® SpeedStep Technology.

KINO-DQM170 Industrial Motherboard

→ CPU C State [Disabled]

Use the **CPU C State** option to enable or disable CPU C state.

- **Disabled** **DEFAULT** Disables CPU C state.
- **Enabled** Enables CPU C state.

5.3.8 SATA Configuration

Use the **SATA Configuration** menu (**BIOS Menu 14**) to change and/or set the configuration of the SATA devices installed in the system.

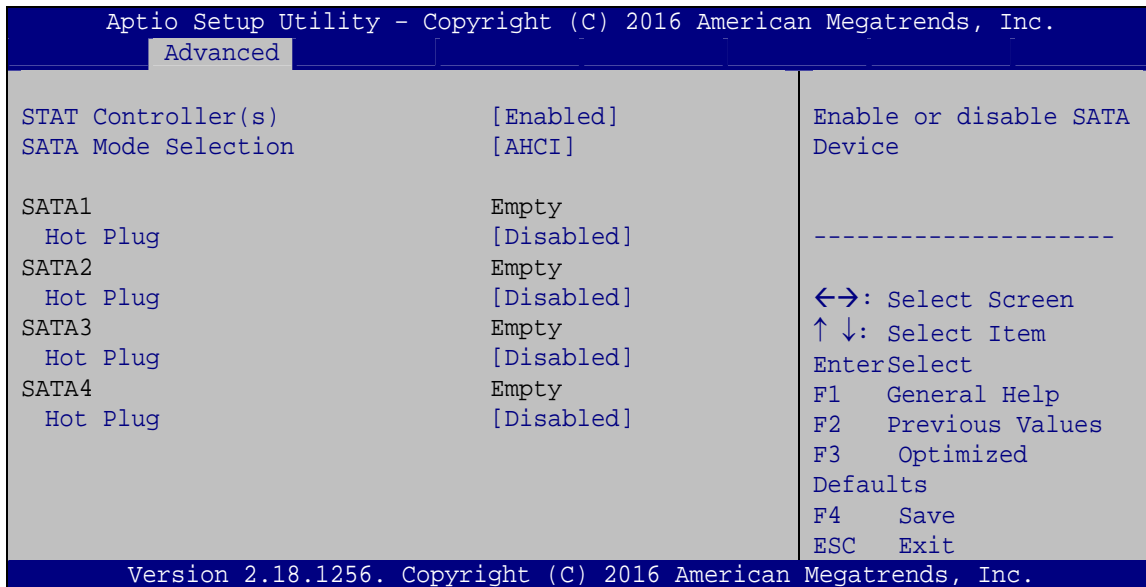

BIOS Menu 14: SATA Configuration

→ STAT Controller(s) [Enabled]

Use the **STAT Controller(s)** option to enable or disable the SATA device.

- **Enabled** **DEFAULT** Enables the SATA device.
- **Disabled** Disables the SATA device.

→ **SATA Mode Selection [AHCI]**

Use the **SATA Mode Selection** option to configure SATA devices as AHCI devices.

- **AHCI** **DEFAULT** Configures SATA devices as AHCI device.
- **RAID** Configures SATA devices as RAID device.



NOTE:

Before accessing the RAID configuration utility, ensure to set the **Option ROM Messages BIOS** option in the **Boot** menu to **Force BIOS**. This is to allow the “Press <CTRL+I> to enter Configuration Utility.....” message to appear during POST. Press Ctrl+I when prompted to enter the RAID configuration utility.

→ **Hot Plug [Disabled]**

Use the **Hot Plug** option to enable or disable the SATA device hot plug.

- **Disabled** **DEFAULT** Disables the SATA device hot plug.
- **Enabled** Enables the SATA device hot plug

KINO-DQM170 Industrial Motherboard

5.3.9 NVMe Configuration

Use the **NVMe Configuration (BIOS Menu 15)** menu to display the NVMe controller and device information.

```
Aptio Setup Utility - Copyright (C) 2016 American Megatrends, Inc.
  Advanced
NVMe controller and Drive information
No NVMe Device Found
-----
-><: Select Screen
↑↓: Select Item
Enter: Select
+/-: Change Opt.
F1: General Help
F2: Previous Values
F3: Optimized Defaults
F4: Save & Exit
ESC: Exit
Version 2.18.1256. Copyright (C) 2016 American Megatrends, Inc.
```

BIOS Menu 15: NVMe Configuration

5.3.10 USB Configuration

Use the **USB Configuration** menu (**BIOS Menu 16**) to read USB configuration information and configure the USB settings.

```

Aptio Setup Utility - Copyright (C) 2016 American Megatrends, Inc.
  Advanced
-----
USB Configuration
USB Controllers:
  1 XHCI
USB Devices:
  1 Keyboard
Legacy USB Support          [Enabled]

-----
<=>: Select Screen
↑ ↓: Select Item
Enter>Select
F1   General Help
F2   Previous Values
F3   Optimized
Defaults
F4   Save
ESC  Exit

Version 2.18.1256. Copyright (C) 2016 American Megatrends, Inc.
  
```

BIOS Menu 16: USB Configuration

➔ USB Devices

The **USB Devices Enabled** field lists the USB devices that are enabled on the system

➔ Legacy USB Support [Enabled]

Use the **Legacy USB Support** BIOS option to enable USB mouse and USB keyboard support. Normally if this option is not enabled, any attached USB mouse or USB keyboard does not become available until a USB compatible operating system is fully booted with all USB drivers loaded. When this option is enabled, any attached USB mouse or USB keyboard can control the system even when there is no USB driver loaded onto the system.

KINO-DQM170 Industrial Motherboard

- ➔ **Enabled** **DEFAULT** Legacy USB support enabled
- ➔ **Disabled** Legacy USB support disabled
- ➔ **Auto** Legacy USB support disabled if no USB devices are connected

5.3.11 IEI Feature

Use the **IEI Feature** menu (**BIOS Menu 17**) to configure One Key Recovery function.

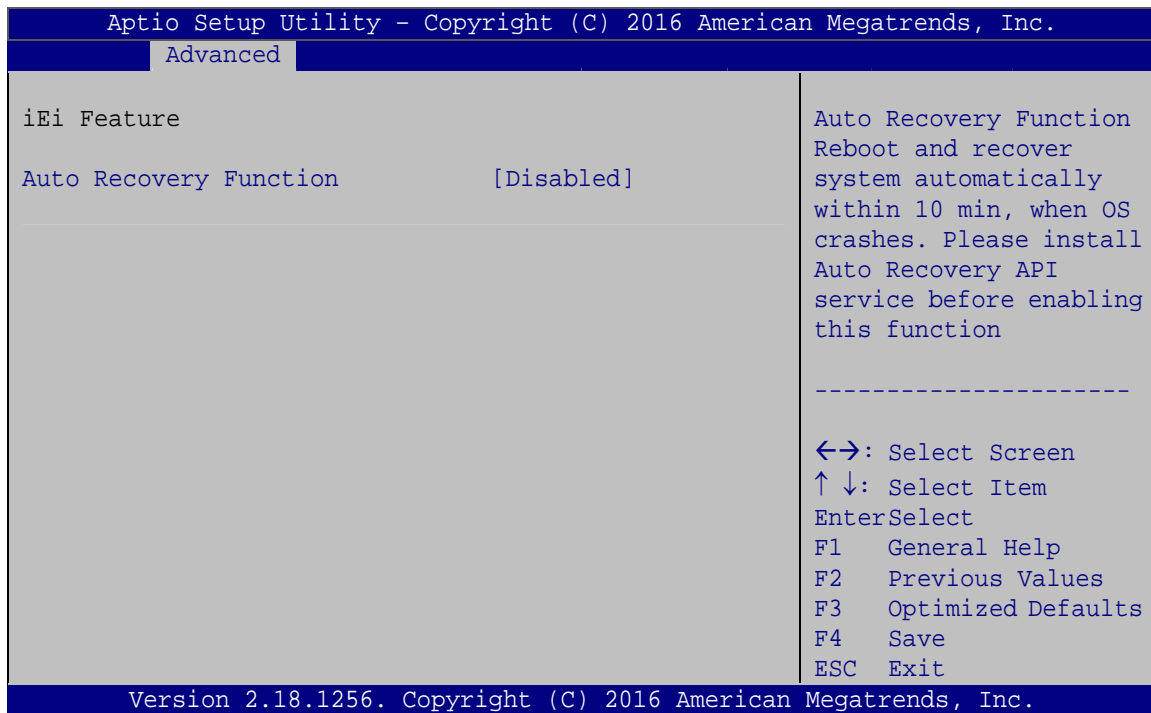

BIOS Menu 17: IEI Feature

➔ **Auto Recovery Function [Disabled]**

Use the **Auto Recovery Function** BIOS option to enable or disable the auto recovery function of the IEI One Key Recovery.

- ➔ **Disabled** **DEFAULT** Auto recovery function disabled
- ➔ **Enabled** Auto recovery function enabled

5.4 Chipset

Use the **Chipset** menu (**BIOS Menu 18**) to configure the system chipset.

```

Aptio Setup Utility - Copyright (C) 2016 American Megatrends, Inc.
Main    Advanced  Chipset    Boot    Security  Save & Exit  Server Mgmt
-----
> System Agent (SA) Configuration
> PCH-IO Configuration

System Agent (SA)
Parameters

-----
<=>: Select Screen
↑↓: Select Item
Enter>Select
+ - Change Opt.
F1  General Help
F2  Previous Values
F3  Optimized Defaults
F4  Save & Exit
ESC Exit

Version 2.18.1256. Copyright (C) 2016 American Megatrends, Inc.
    
```

BIOS Menu 18: Chipset

5.4.1 System Agent (SA) Configuration

Use the **System Agent (SA) Configuration** menu (**BIOS Menu 19**) to configure the System Agent (SA) parameters.

```

Aptio Setup Utility - Copyright (C) 2016 American Megatrends, Inc.
-----
Chipset
-----
VT-d                [Disabled]          VT-d capability

-----
> Graphics Configuration
> PEG Port Configuration
> Memory Configuration

<=>: Select Screen
↑↓: Select Item
Enter>Select
+ - Change Opt.
F1  General Help
F2  Previous Values
F3  Optimized Defaults
F4  Save & Exit
ESC Exit

Version 2.18.1256. Copyright (C) 2016 American Megatrends, Inc.
    
```

BIOS Menu 19: System Agent (SA) Configuration

KINO-DQM170 Industrial Motherboard

→ VT-d [Disabled]

Use the **VT-d** option to enable or disable VT-d support.

→ **Disabled** **DEFAULT** Disable VT-d support.

→ **Enabled** Enable VT-d support.

5.4.1.1 Graphics Configuration

Use the **Graphics Configuration** menu (**BIOS Menu 20**) to configure the graphics settings.

```

Aptio Setup Utility - Copyright (C) 2016 American Megatrends, Inc.
Chipset
Graphics Configuration
Internal Graphics          [Enabled]
Primary Display           [Auto]
DVMT Pre-Allocated        [256M]
DVMT Total Gfx Mem        [MAX]
Primary IGFX Boot Display [VBIOS Default]
> LCD Control

Keep IGFX enabled based on the setup options. If User want to support Dual Display by Internal Graphics & External Graphics. Internal Graphics item should be set to Enabled and Primary Display item should be set to IGFX.

-----
<->: Select Screen
↑↓: Select Item
Enter>Select
+ - Change Opt.
F1  General Help
F2  Previous Values
F3  Optimized Defaults
F4  Save & Exit
ESC Exit

Version 2.18.1256. Copyright (C) 2016 American Megatrends, Inc.
    
```

BIOS Menu 20: Graphics Configuration

→ Internal Graphics [Enabled]

Use the **Internal Graphics** option to enable or disable the internal graphics device.

- **Auto** The internal graphics device is automatically detected and enabled.
- **Disabled** Disable the internal graphics device.
- **Enabled** **DEFAULT** Enable the internal graphics device. The following submenu appear with values that can be selected:

LCD Control (see Section 5.4.1.1.1)

→ Primary Display [Auto]

Use the **Primary Display** option to select the graphics controller used as the primary boot device. Configuration options are listed below:

- Auto **DEFAULT**
- IGFX
- PEG
- PCIE
- SG

→ DVMT Pre-Allocated [256M]

Use the **DVMT Pre-Allocated** option to set the amount of system memory allocated to the integrated graphics processor when the system boots. The system memory allocated can then only be used as graphics memory, and is no longer available to applications or the operating system. Configuration options are listed below:

- 32M
- 64M
- 128M
- 256M **DEFAULT**
- 512M

KINO-DQM170 Industrial Motherboard

→ DVMT Total Gfx Mem [MAX]

Use the **DVMT Total Gfx Mem** option to select DVMT 5.0 total graphic memory size used by the internal graphics device. The following options are available:

- 128M
- 256M
- MAX **DEFAULT**

→ Primary IGFX Boot Display [VBIOS Default]

Use the **Primary IGFX Boot Display** option to select the display device used by the system when it boots.

- VBIOS Default **DEFAULT**
- LVDS
- HDMI1
- HDMI2
- HDMI3

5.4.1.1.1 LCD Control

Use the **LCD Control** submenu (**BIOS Menu 21**) to select a display device which will be activated during POST.

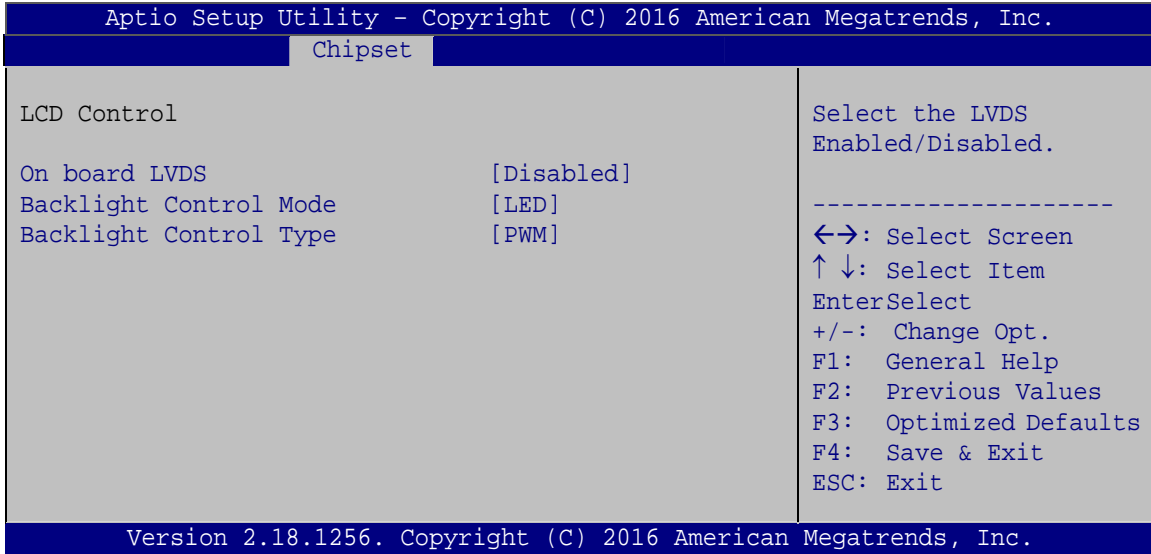

BIOS Menu 21: LCD Control

→ On board LVDS [Disabled]

Use the **On board LVDS** option enables or disables the on-board LVDS connector.

- **Disabled** **DEFAULT** The on-board LVDS connector is disabled.
- **Enabled** The on-board LVDS connector is disabled.

→ Backlight Control Mode [LED]

Use the **Backlight Control Mode** option to specify the backlight control mode. Configuration options are listed below.

- CCFL
- LED **DEFAULT**

KINO-DQM170 Industrial Motherboard

→ Backlight Control Type [PWM]

Use the **Backlight Control Type** option to specify the backlight control type. Configuration options are listed below.

- PWM **DEFAULT**
- DC

5.4.1.2 PEG Port Configuration

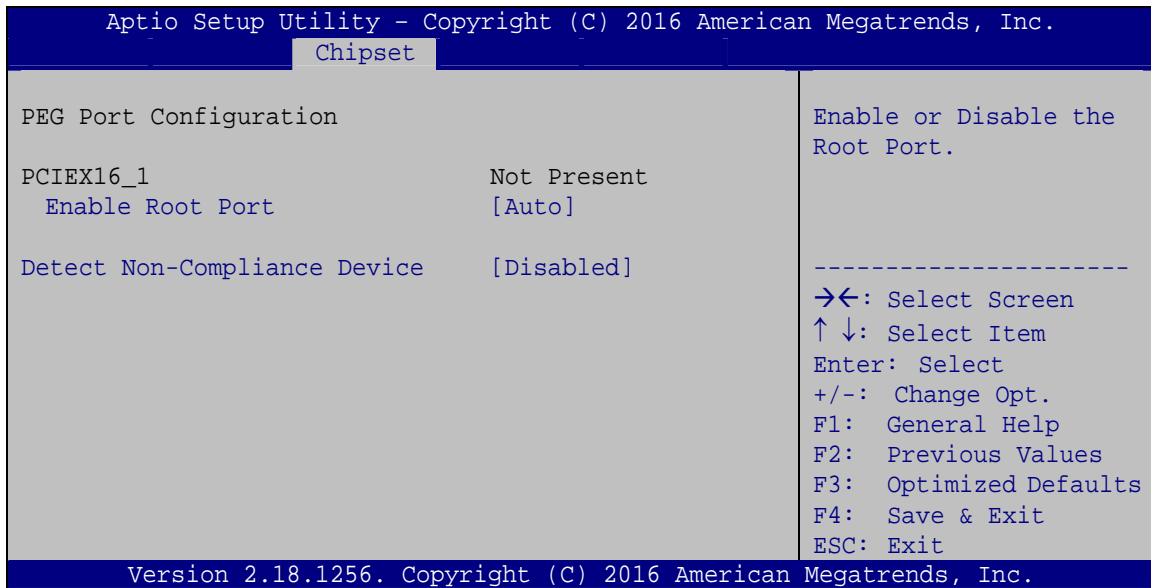

BIOS Menu 22: PEG Port Configuration

→ Enable Root Port [Auto]

Use the **Enable Root Port** option to enable or disable the PCI Express (PEG) controller.

- **Disabled** Disables the PCI Express (PEG) controller.
- **Enabled** Enables the PCI Express (PEG) controller.
- **Auto** **DEFAULT** The PCI Express (PEG) controller is automatically detected.

➔ **Detect Non-Compliance Device [Disabled]**

Use the **Detect Non-Compliance Device** option to enable or disable detecting if a non-compliance PCI Express device is connected to the PCI Express slot.

- ➔ **Disabled** **DEFAULT** Disables to detect if a non-compliance PCI Express device is connected to the PCI Express slot.

- ➔ **Enabled** Enables to detect if a non-compliance PCI Express device is connected to the PCI Express slot.

5.4.1.3 Memory Configuration

Use the **Memory Configuration** submenu (**BIOS Menu 23**) to display the memory information.

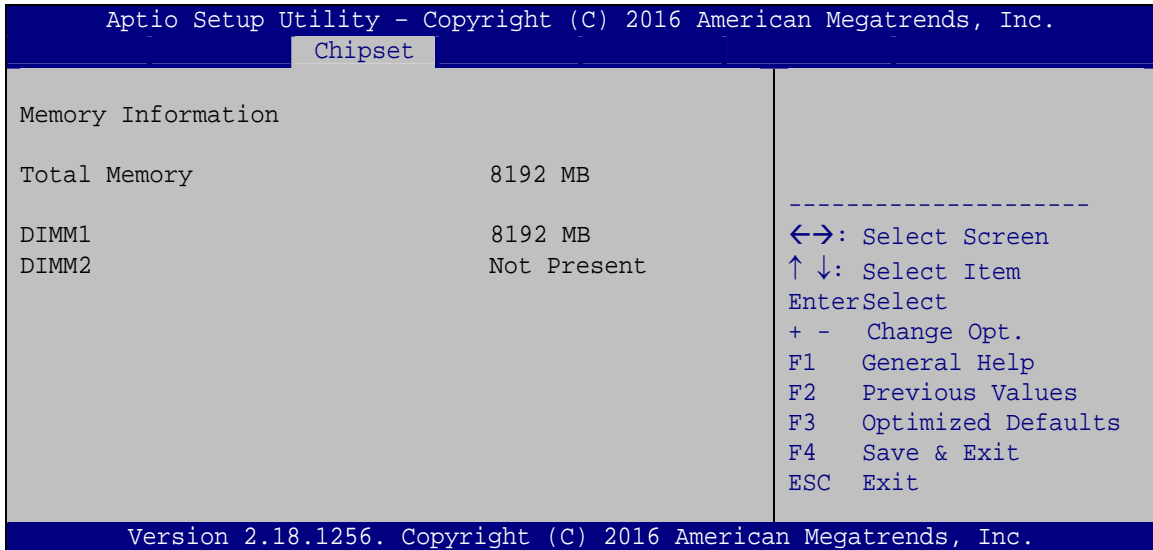

BIOS Menu 23: Memory Configuration

KINO-DQM170 Industrial Motherboard

5.4.2 PCH-IO Configuration

Use the **PCH-IO Configuration** menu (**BIOS Menu 24**) to configure the PCH-IO chipset.

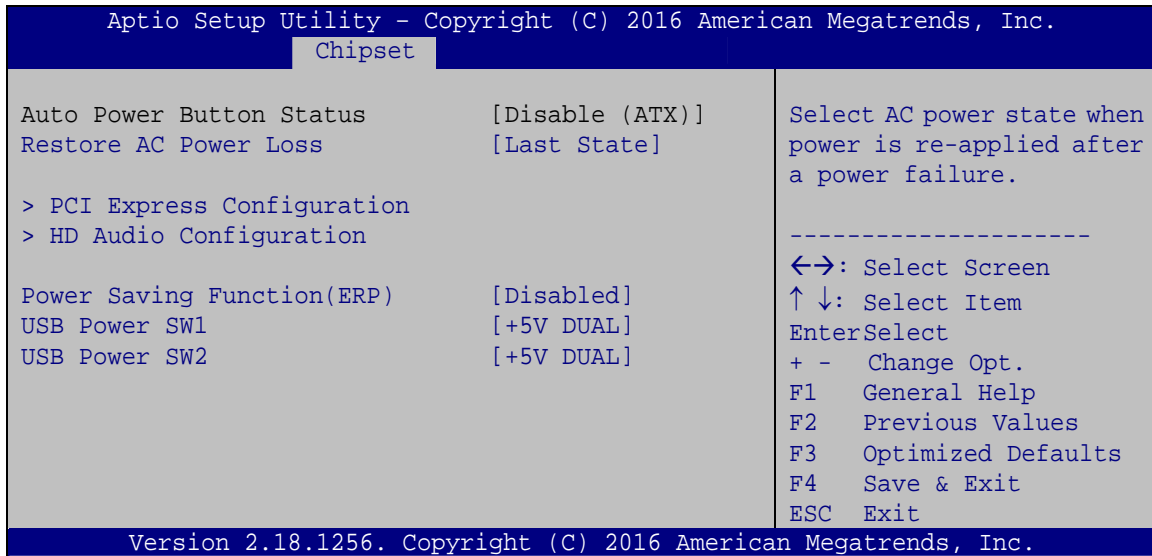

BIOS Menu 24: PCH-IO Configuration

→ Restore AC Power Loss [Last State]

Use the **Restore AC Power** BIOS option to specify what state the system returns to if there is a sudden loss of power to the system.

- **Power Off** The system remains turned off
- **Power On** The system turns on
- **Last State** **DEFAULT** The system returns to its previous state. If it was on, it turns itself on. If it was off, it remains off.

→ Power Saving Function(ERP) [Disabled]

Use the **Power Saving Function(ERP)** BIOS option to enable or disable the power saving function.

- **Disabled** **DEFAULT** Power saving function is disabled.
- **Enabled** Power saving function is enabled. It will reduce power consumption when the system is off.

➔ USB Power SW1 [+5V DUAL]

Use the **USB Power SW1** BIOS option to configure the USB power source for the corresponding USB connectors (**Table 5-1**).

- ➔ **+5V DUAL** **DEFAULT** Sets the USB power source to +5V dual
- ➔ **+5V** Sets the USB power source to +5V

➔ USB Power SW2 [+5V DUAL]

Use the **USB Power SW2** BIOS option to configure the USB power source for the corresponding USB connectors (**Table 5-1**).

- ➔ **+5V DUAL** **DEFAULT** Sets the USB power source to +5V dual
- ➔ **+5V** Sets the USB power source to +5V

BIOS Options	Configured USB Ports
USB Power SW1	LAN1_USB1 (external USB 3.0 ports) LAN2_USB2 (external USB 3.0 ports)
USB Power SW2	USB1 (internal USB 2.0 ports) USB2 (internal USB 2.0 ports)

Table 5-1: BIOS Options and Configured USB Ports

KINO-DQM170 Industrial Motherboard

5.4.2.1 PCI Express Configuration

Use the **PCI Express Configuration** submenu (**BIOS Menu 25**) to configure the PCI Express slots.

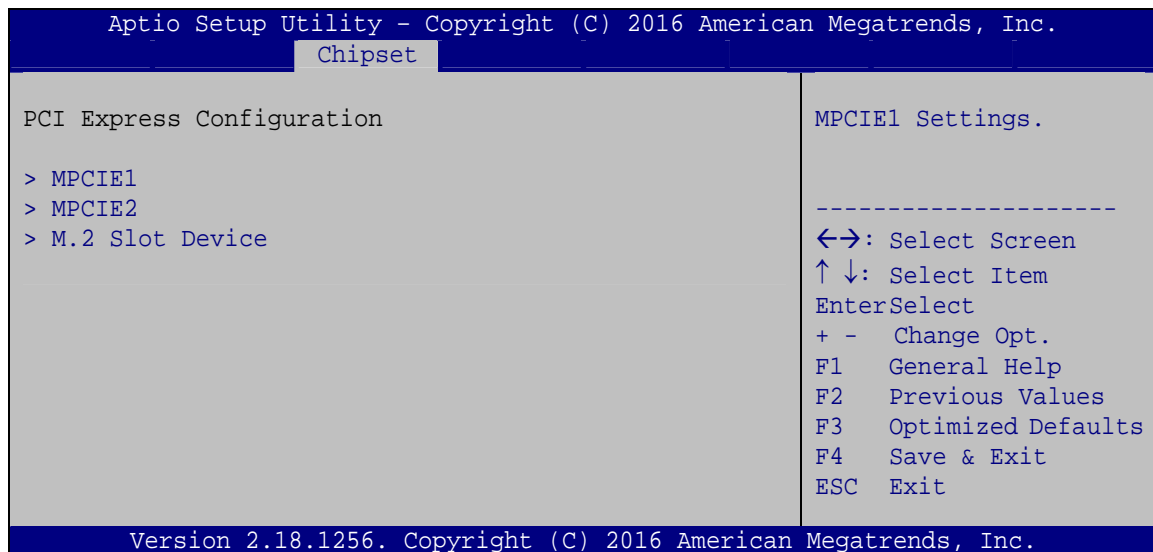
**BIOS Menu 25: PCI Express Configuration**

The **MPCIE1**, **MPCIE2** and **M.2 Slot Device** submenus all contain the following options:

→ **PCIe Speed [Auto]**

Use the **PCIe Speed** option to configure the PCIe interface speed.

- Auto **DEFAULT**
- Gen 1
- Gen 2
- Gen 3

→ **Detect Non-Compliance Device [Disabled]**

Use the **Detect Non-Compliance Device** option to enable or disable detecting if a non-compliance PCI Express device is connected to the PCI Express slot.

- ➔ **Disabled** **DEFAULT** Disables to detect if a non-compliance PCI Express device is connected to the PCI Express slot.
- ➔ **Enabled** Enables to detect if a non-compliance PCI Express device is connected to the PCI Express slot.

5.4.2.2 HD Audio Configuration

Use the **HD Audio Configuration** submenu (**BIOS Menu 26**) to configure the High Definition Audio codec.

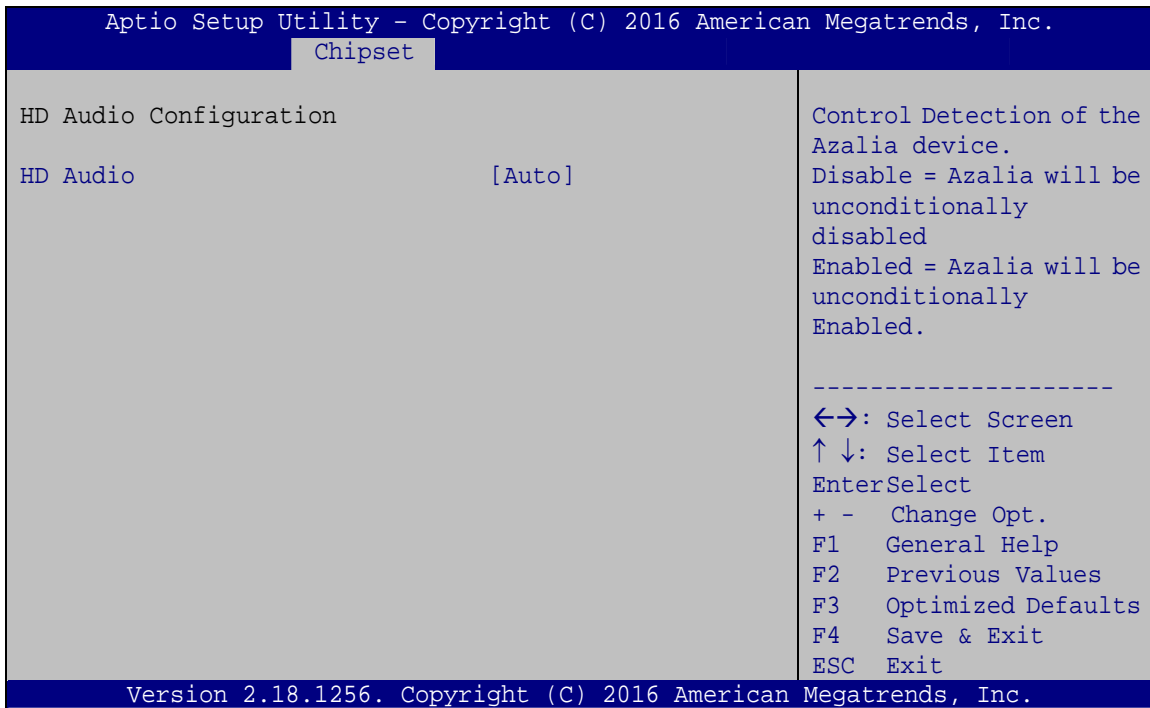

BIOS Menu 26: HD Audio Configuration

➔ HD Audio [Auto]

Use the **HD Audio** BIOS option to enable or disable the High Definition Audio controller.

- ➔ **Disabled** The High Definition Audio controller is disabled.
- ➔ **Enabled** The High Definition Audio controller is enabled.

KINO-DQM170 Industrial Motherboard

- ➔ **Auto** **DEFAULT** The onboard High Definition Audio controller automatically detected and enabled.

5.5 Security

Use the **Security** menu (**BIOS Menu 27**) to set system and user passwords.

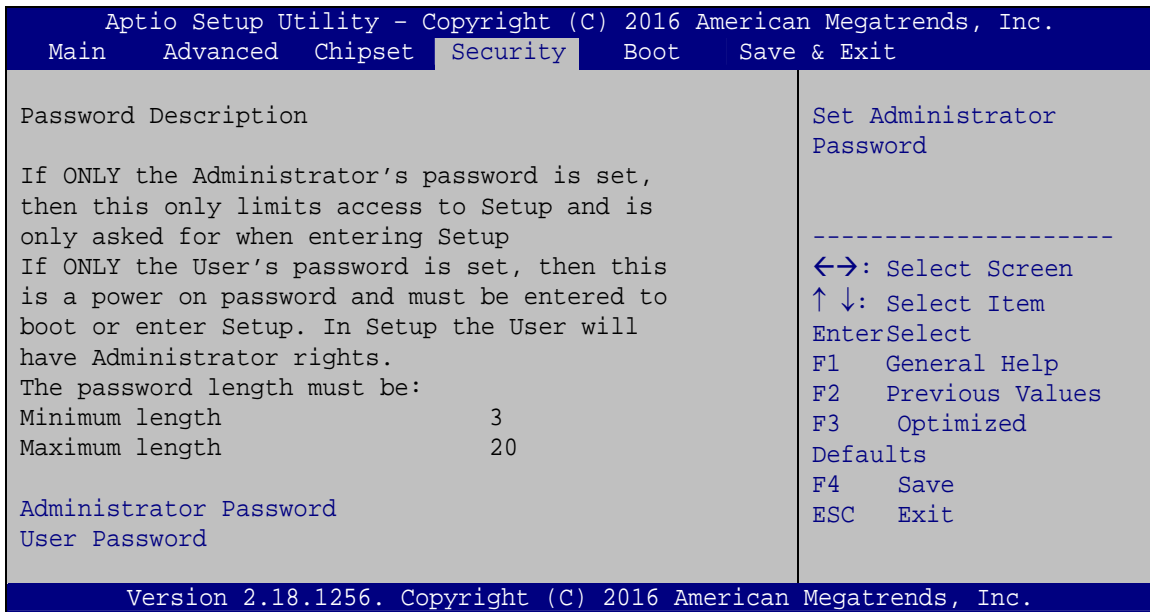

BIOS Menu 27: Security

➔ Administrator Password

Use the **Administrator Password** to set or change a administrator password.

➔ User Password

Use the **User Password** to set or change a user password.

5.6 Boot

Use the **Boot** menu (**BIOS Menu 28**) to configure system boot options.

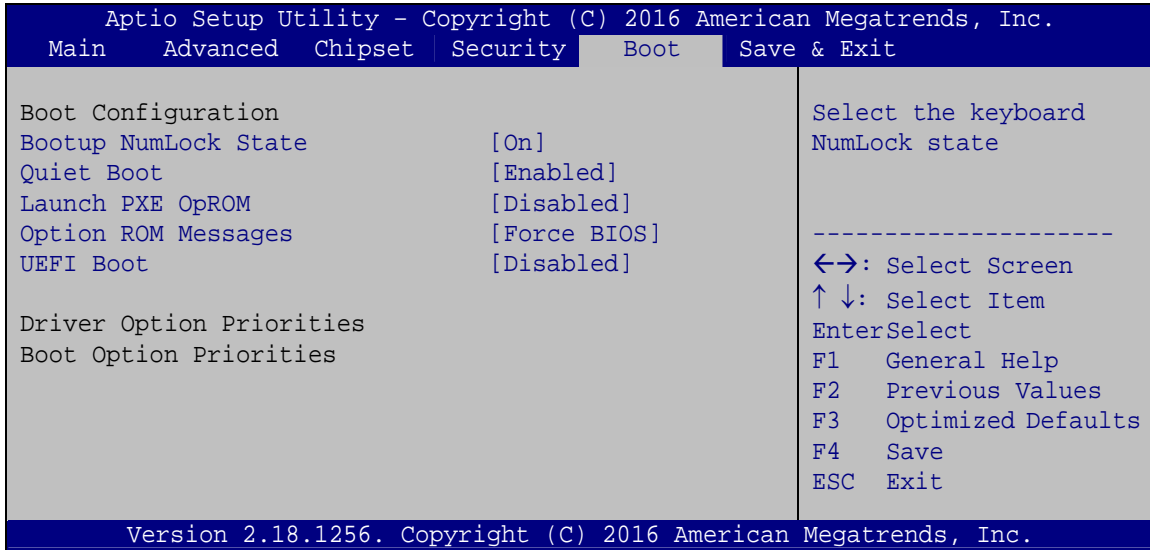

BIOS Menu 28: Boot

→ Bootup NumLock State [On]

Use the **Bootup NumLock State** BIOS option to specify if the number lock setting must be modified during boot up.

- **On** **DEFAULT** Allows the Number Lock on the keyboard to be enabled automatically when the computer system boots up. This allows the immediate use of the 10-key numeric keypad located on the right side of the keyboard. To confirm this, the Number Lock LED light on the keyboard is lit.

- **Off** Does not enable the keyboard Number Lock automatically. To use the 10-keys on the keyboard, press the Number Lock key located on the upper left-hand corner of the 10-key pad. The Number Lock LED on the keyboard lights up when the Number Lock is engaged.

KINO-DQM170 Industrial Motherboard

→ Quiet Boot [Enabled]

Use the **Quiet Boot** BIOS option to select the screen display when the system boots.

- **Disabled** Normal POST messages displayed
- **Enabled** **DEFAULT** OEM Logo displayed instead of POST messages

→ Launch PXE OpROM [Disabled]

Use the **Launch PXE OpROM** option to enable or disable boot option for legacy network devices.

- **Disabled** **DEFAULT** Ignore all PXE Option ROMs
- **Enabled** Load PXE Option ROMs.

→ Option ROM Messages [Force BIOS]

Use the **Option ROM Messages** option to set the Option ROM display mode.

- **Force BIOS** **DEFAULT** Sets display mode to force BIOS.
- **Keep Current** Sets display mode to current.

→ UEFI Boot [Disabled]

Use the **UEFI Boot** option to enable or disable to boot from the UEFI devices.

- **Enabled** Boot from UEFI devices is enabled.
- **Disabled** **DEFAULT** Boot from UEFI devices is disabled.

→ Boot Option Priority

Use the **Boot Option Priority** function to set the system boot sequence from the available devices. The drive sequence also depends on the boot sequence in the individual device section.

5.7 Save & Exit

Use the **Save & Exit** menu (**BIOS Menu 29**) to load default BIOS values, optimal failsafe values and to save configuration changes.

```
Aptio Setup Utility - Copyright (C) 2016 American Megatrends, Inc.
Main   Advanced  Chipset  Security  Boot   Save & Exit
-----
Save Changes and Reset
Discard Changes and Reset

Restore Defaults
Save as User Defaults
Restore User Defaults

Reset the system after
saving the changes.

-----
<-->: Select Screen
↑ ↓: Select Item
Enter>Select
F1   General Help
F2   Previous Values
F3   Optimized
Defaults
F4   Save
ESC  Exit

Version 2.18.1256. Copyright (C) 2016 American Megatrends, Inc.
```

BIOS Menu 29: Exit

→ Save Changes and Reset

Use the **Save Changes and Reset** option to save the changes made to the BIOS options and to exit the BIOS configuration setup program.

→ Discard Changes and Reset

Use the **Discard Changes and Reset** option to exit the system without saving the changes made to the BIOS configuration setup program.

→ Restore Defaults

Use the **Restore Defaults** option to load the optimal default values for each of the parameters on the Setup menus. **F3 key can be used for this operation.**

KINO-DQM170 Industrial Motherboard

→ Save as User Defaults

Use the **Save as User Defaults** option to save the changes done so far as user defaults.

→ Restore User Defaults

Use the **Restore User Defaults** option to restore the user defaults to all the setup options.

Chapter

6

Software Drivers

KINO-DQM170 Industrial Motherboard



NOTE:

The content of the CD may vary throughout the life cycle of the product and is subject to change without prior notice. Visit the IEI website or contact technical support for the latest updates.

6.1 Software Installation

All the drivers for the KINO-DQM170 are on the CD that came with the system. To install the drivers, please follow the steps below.

Step 1: Insert the CD into a CD drive connected to the system.



NOTE:

If the installation program doesn't start automatically:
Click "Start->My Computer->CD Drive->autorun.exe"

Step 2: The driver main menu appears.

Step 3: Click **KINO-DQM170**.

Step 4: A new screen with a list of available drivers appears.

Step 5: Install all of the necessary drivers in the menu.

6.2 Available Software Drivers

All the drivers for the KINO-DQM170 are on the utility CD that came with the system. The utility CD contains drivers for Windows 7, Windows 8 and Windows 10 operating systems. If the drivers are not installed automatically, please install the following drivers manually.

The following drivers can be installed on the **KINO-DQM170**:

- Chipset
- VGA
- LAN
- Audio
- USB 3.0 (for Windows 7 and Windows 8.1 OS)
- Kernel-Mode Driver Framework (for Windows 7 OS only)
- ME (Intel® AMT)
- RST (Intel® Rapid Storage Technology)
- Intel® Serial IO (for Windows 8.1/10 64-bit OS only)



NOTE:

The Intel TXE requires that Microsoft's "Kernel-Mode Driver Framework (KMDF) version 1.11 update for Windows 7" must be installed first on Windows 7 OS. If the KMDF is not installed, either error 37 or error 28 may appear on the Intel TXE device in Device Manager.

Please find the KMDF version 1.11 update for Windows 7 in the TXE driver folder in the driver CD or click the following link to download it.

<http://www.microsoft.com/en-us/download/details.aspx?id=38423>

Appendix

A

Regulatory Compliance

DECLARATION OF CONFORMITY

This equipment has been tested and found to comply with specifications for CE marking. If the user modifies and/or installs other devices in the equipment, the CE conformity declaration may no longer apply.

FCC WARNING

This equipment complies with Part 15 of the FCC Rules. Operation is subject to the following two conditions:

- This device may not cause harmful interference, and
- This device must accept any interference received, including interference that may cause undesired operation.

This equipment has been tested and found to comply with the limits for a Class A digital device, pursuant to part 15 of the FCC Rules. These limits are designed to provide reasonable protection against harmful interference when the equipment is operated in a commercial environment. This equipment generates, uses, and can radiate radio frequency energy and, if not installed and used in accordance with the instruction manual, may cause harmful interference to radio communications. Operation of this equipment in a residential area is likely to cause harmful interference in which case the user will be required to correct the interference at his own expense.

Appendix

B

Product Disposal

**CAUTION:**

Risk of explosion if battery is replaced by an incorrect type. Only certified engineers should replace the on-board battery.

Dispose of used batteries according to instructions and local regulations.

- Outside the European Union – If you wish to dispose of used electrical and electronic products outside the European Union, please contact your local authority so as to comply with the correct disposal method.
- Within the European Union – The device that produces less waste and is easier to recycle is classified as electronic device in terms of the European Directive 2012/19/EU (WEEE), and must not be disposed of as domestic garbage.

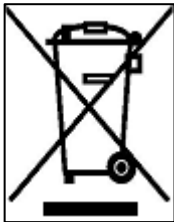

EU-wide legislation, as implemented in each Member State, requires that waste electrical and electronic products carrying the mark (left) must be disposed of separately from normal household waste. This includes monitors and electrical accessories, such as signal cables or power cords. When you need to dispose of your device, please follow the guidance of your local authority, or ask the shop where you purchased the product. The mark on electrical and electronic products only applies to the current European Union Member States.

Please follow the national guidelines for electrical and electronic product disposal.

Appendix

C

BIOS Menu Options

System Date [xx/xx/xx]	73
System Time [xx:xx:xx]	73
ACPI Sleep State [S3 (Suspend to RAM)]	74
Intel AMT [Enabled]	75
Un-configure ME [Disabled]	75
Serial Port [Enabled]	77
Change Settings [Auto]	77
Serial Port [Enabled]	78
Change Settings [Auto]	78
Serial Port [Enabled]	79
Change Settings [Auto]	79
Serial Port [Enabled]	80
Change Settings [Auto]	80
Serial Port [Enabled]	81
Change Settings [Auto]	81
Transfer Mode [RS232]	82
Serial Port [Enabled]	82
Change Settings [Auto]	82
Transfer Mode [RS232]	83
PC Health Status	84
CPU_FAN1 Smart Fan Control [Auto Mode]	85
SYS_FAN1 Smart Fan Control [Auto Mode]	86
Auto mode fan start temperature [30]	86
Auto mode fan off temperature [20]	87
Auto mode fan start PWM [40]	87
Auto mode fan slope PWM [1]	87
Wake system with Fixed Time [Disabled]	88
Console Redirection [Disabled]	90
Legacy Serial Redirection Port [COM1]	90
Terminal Type [ANSI]	91
Bits per second [115200]	92
Data Bits [8]	92
Parity [None]	92
Stop Bits [1]	93

KINO-DQM170 Industrial Motherboard

Hyper-threading [Enabled].....	94
Active Processor Cores [All]	94
Intel® Virtualization Technology [Disabled]	94
Intel® SpeedStep™ [Enabled]	94
CPU C State [Disabled].....	95
STAT Controller(s) [Enabled].....	95
SATA Mode Selection [AHCI].....	96
Hot Plug [Disabled].....	96
USB Devices	98
Legacy USB Support [Enabled].....	98
Auto Recovery Function [Disabled].....	99
VT-d [Disabled].....	101
Internal Graphics [Enabled].....	102
Primary Display [Auto]	102
DVMT Pre-Allocated [256M]	102
DVMT Total Gfx Mem [MAX].....	103
Primary IGFX Boot Display [VBIOS Default]	103
On board LVDS [Disabled].....	104
Backlight Control Mode [LED]	104
Backlight Control Type [PWM]	105
Enable Root Port [Auto]	105
Detect Non-Compliance Device [Disabled]	106
Restore AC Power Loss [Last State]	107
Power Saving Function(ERP) [Disabled].....	107
USB Power SW1 [+5V DUAL].....	108
USB Power SW2 [+5V DUAL].....	108
PCIe Speed [Auto].....	109
Detect Non-Compliance Device [Disabled]	109
HD Audio [Auto].....	110
Administrator Password	111
User Password	111
Bootup NumLock State [On].....	112
Quiet Boot [Enabled]	113
Launch PXE OpROM [Disabled].....	113
Option ROM Messages [Force BIOS].....	113

UEFI Boot [Disabled]	113
Boot Option Priority.....	113
Save Changes and Reset	114
Discard Changes and Reset	114
Restore Defaults	114
Save as User Defaults	115
Restore User Defaults	115

Appendix

D

Terminology

AC '97	Audio Codec 97 (AC'97) refers to a codec standard developed by Intel® in 1997.
ACPI	Advanced Configuration and Power Interface (ACPI) is an OS-directed configuration, power management, and thermal management interface.
AHCI	Advanced Host Controller Interface (AHCI) is a SATA Host controller register-level interface.
ATA	The Advanced Technology Attachment (ATA) interface connects storage devices including hard disks and CD-ROM drives to a computer.
APM	The Advanced Power Management (APM) application program interface (API) enables the inclusion of power management in the BIOS.
ARMD	An ATAPI Removable Media Device (ARMD) is any ATAPI device that supports removable media, besides CD and DVD drives.
ASKIR	Amplitude Shift Keyed Infrared (ASKIR) is a form of modulation that represents a digital signal by varying the amplitude (“volume”) of the signal. A low amplitude signal represents a binary 0, while a high amplitude signal represents a binary 1.
BIOS	The Basic Input/Output System (BIOS) is firmware that is first run when the computer is turned on and can be configured by the end user
CODEC	The Compressor-Decompressor (CODEC) encodes and decodes digital audio data on the system.
CMOS	Complimentary metal-oxide-conductor is a type of integrated circuit used in chips like static RAM and microprocessors.
COM	COM is used to refer to serial ports. Serial ports offer serial communication to expansion devices. The serial port on a personal

KINO-DQM170 Industrial Motherboard

	computer is usually a male DE-9 connector.
DAC	The Digital-to-Analog Converter (DAC) converts digital signals to analog signals.
DDR	Double Data Rate refers to a data bus transferring data on both the rising and falling edges of the clock signal.
DMA	Direct Memory Access (DMA) enables some peripheral devices to bypass the system processor and communicate directly with the system memory.
DIMM	Dual Inline Memory Modules are a type of RAM that offer a 64-bit data bus and have separate electrical contacts on each side of the module.
EHCI	The Enhanced Host Controller Interface (EHCI) specification is a register-level interface description for USB 2.0 Host Controllers.
GbE	Gigabit Ethernet (GbE) is an Ethernet version that transfers data at 1.0 Gbps and complies with the IEEE 802.3-2005 standard.
GPIO	General purpose input
IrDA	Infrared Data Association (IrDA) specify infrared data transmission protocols used to enable electronic devices to wirelessly communicate with each other.
L1 Cache	The Level 1 Cache (L1 Cache) is a small memory cache built into the system processor.
L2 Cache	The Level 2 Cache (L2 Cache) is an external processor memory cache.
LVDS	Low-voltage differential signaling (LVDS) is a dual-wire, high-speed differential electrical signaling system commonly used to connect LCD displays to a computer.
MAC	The Media Access Control (MAC) protocol enables several terminals or network nodes to communicate in a LAN, or other multipoint networks.

PCIe	PCI Express (PCIe) is a communications bus that uses dual data lines for full-duplex (two-way) serial (point-to-point) communications between the SBC components and/or expansion cards and the SBC chipsets. Each line has a 2.5 Gbps data transmission rate and a 250 MBps sustained data transfer rate.
POST	The Power-on Self Test (POST) is the pre-boot actions the system performs when the system is turned-on.
QVGA	Quarter Video Graphics Array (QVGA) refers to a display with a resolution of 320 x 240 pixels.
RAM	Random Access Memory (RAM) is a form of storage used in computer. RAM is volatile memory, so it loses its data when power is lost. RAM has very fast data transfer rates compared to other storage like hard drives.
SATA	Serial ATA (SATA) is a serial communications bus designed for data transfers between storage devices and the computer chipsets. The SATA bus has transfer speeds up to 1.5 Gbps and the SATA 3Gb/s bus has data transfer speeds of up to 3.0 Gbps.
S.M.A.R.T	Self Monitoring Analysis and Reporting Technology (S.M.A.R.T) refers to automatic status checking technology implemented on hard disk drives.
UART	Universal Asynchronous Receiver-transmitter (UART) is responsible for asynchronous communications on the system and manages the system's serial communication (COM) ports.
UHCI	The Universal Host Controller Interface (UHCI) specification is a register-level interface description for USB 1.1 Host Controllers.
USB	The Universal Serial Bus (USB) is an external bus standard for interfacing devices. USB 1.1 supports 12Mbps data transfer rates, while

KINO-DQM170 Industrial Motherboard

USB 2.0 supports 480Mbps data transfer rates.

VGA

The Video Graphics Array (VGA) is a graphics display system developed by IBM.

Appendix

E

Digital I/O Interface

KINO-DQM170 Industrial Motherboard

The DIO connector on the KINO-DQM170 is interfaced to GPIO ports on the Super I/O chipset. The DIO has both 8-bit digital inputs and 8-bit digital outputs. The digital inputs and digital outputs are generally control signals that control the on/off circuit of external devices or TTL devices. Data can be read or written to the selected address to enable the DIO functions.



NOTE:

For further information, please refer to the datasheet for the Super I/O chipset.

The BIOS interrupt call **INT 15H** controls the digital I/O.

INT 15H:

AH – 6FH	
<u>Sub-function:</u>	
AL – 8	: Set the digital port as INPUT
AL	: Digital I/O input value

Assembly Language Sample 1

```
MOV     AX, 6F08H      ; setting the digital port as input
INT     15H           ;
```

AL low byte = value

AH – 6FH	
<u>Sub-function:</u>	
AL – 9	: Set the digital port as OUTPUT
BL	: Digital I/O output value

Assembly Language Sample 2

```

MOV     AX, 6F09H      ; setting the digital port as output
MOV     BL, 09H        ; digital value is 09H
INT     15H            ;
    
```

Digital Output is 1001b

Appendix

F

Watchdog Timer



NOTE:

The following discussion applies to DOS. Contact IEI support or visit the IEI website for drivers for other operating systems.

The Watchdog Timer is a hardware-based timer that attempts to restart the system when it stops working. The system may stop working because of external EMI or software bugs. The Watchdog Timer ensures that standalone systems like ATMs will automatically attempt to restart in the case of system problems.

A BIOS function call (INT 15H) is used to control the Watchdog Timer.

INT 15H:

AH – 6FH Sub-function:	
AL – 2:	Sets the Watchdog Timer’s period.
BL:	Time-out value (Its unit-second is dependent on the item “Watchdog Timer unit select” in CMOS setup).

Table F-1: AH-6FH Sub-function

Call sub-function 2 to set the time-out period of Watchdog Timer first. If the time-out value is not zero, the Watchdog Timer starts counting down. When the timer value reaches zero, the system resets. To ensure that this reset condition does not occur, calling sub-function 2 must periodically refresh the Watchdog Timer. However, the watchdog timer is disabled if the time-out value is set to zero.

A tolerance of at least 10% must be maintained to avoid unknown routines within the operating system (DOS), such as disk I/O that can be very time-consuming.

KINO-DQM170 Industrial Motherboard

**NOTE:**

The Watchdog Timer is activated through software. The software application that activates the Watchdog Timer must also deactivate it when closed. If the Watchdog Timer is not deactivated, the system will automatically restart after the Timer has finished its countdown.

EXAMPLE PROGRAM:

; INITIAL TIMER PERIOD COUNTER

;

W_LOOP:

;

```

MOV      AX, 6F02H      ;setting the time-out value
MOV      BL, 30         ;time-out value is 48 seconds
INT      15H

```

;

; ADD THE APPLICATION PROGRAM HERE

;

```

CMP      EXIT_AP, 1     ;is the application over?
JNE      W_LOOP        ;No, restart the application

```

```

MOV      AX, 6F02H     ;disable Watchdog Timer
MOV      BL, 0        ;
INT      15H

```

;

; EXIT ;

Appendix

G

Hazardous Materials Disclosure

KINO-DQM170 Industrial Motherboard

The details provided in this appendix are to ensure that the product is compliant with the Peoples Republic of China (China) RoHS standards. The table below acknowledges the presences of small quantities of certain materials in the product, and is applicable to China RoHS only.

A label will be placed on each product to indicate the estimated “Environmentally Friendly Use Period” (EFUP). This is an estimate of the number of years that these substances would “not leak out or undergo abrupt change.” This product may contain replaceable sub-assemblies/components which have a shorter EFUP such as batteries and lamps. These components will be separately marked.

Part Name	Toxic or Hazardous Substances and Elements					
	Lead (Pb)	Mercury (Hg)	Cadmium (Cd)	Hexavalent Chromium (CR(VI))	Polybrominated Biphenyls (PBB)	Polybrominated Diphenyl Ethers (PBDE)
Housing	O	O	O	O	O	O
Display	O	O	O	O	O	O
Printed Circuit Board	O	O	O	O	O	O
Metal Fasteners	O	O	O	O	O	O
Cable Assembly	O	O	O	O	O	O
Fan Assembly	O	O	O	O	O	O
Power Supply Assemblies	O	O	O	O	O	O
Battery	O	O	O	O	O	O
<p>O: This toxic or hazardous substance is contained in all of the homogeneous materials for the part is below the limit requirement in SJ/T11363-2006 (now replaced by GB/T 26572-2011).</p> <p>X: This toxic or hazardous substance is contained in at least one of the homogeneous materials for this part is above the limit requirement in SJ/T11363-2006 (now replaced by GB/T 26572-2011).</p>						

此附件旨在确保本产品符合中国 RoHS 标准。以下表格标示此产品中某有毒物质的含量符合中国 RoHS 标准规定的限量要求。

本产品上会附有“环境友好使用期限”的标签，此期限是估算这些物质“不会有泄漏或突变”的年限。本产品可能包含有较短的环境友好使用期限的可替换元件，像是电池或灯管，这些元件将会单独标示出来。

部件名称	有毒有害物质或元素					
	铅 (Pb)	汞 (Hg)	镉 (Cd)	六价铬 (CR(VI))	多溴联苯 (PBB)	多溴二苯醚 (PBDE)
壳体	○	○	○	○	○	○
显示	○	○	○	○	○	○
印刷电路板	○	○	○	○	○	○
金属螺帽	○	○	○	○	○	○
电缆组装	○	○	○	○	○	○
风扇组装	○	○	○	○	○	○
电力供应组装	○	○	○	○	○	○
电池	○	○	○	○	○	○

O: 表示该有毒有害物质在该部件所有物质材料中的含量均在 SJ/T11363-2006 (现由 GB/T 26572-2011 取代)标准规定的限量要求以下。

X: 表示该有毒有害物质至少在该部件的某一均质材料中的含量超出 SJ/T11363-2006 (现由 GB/T 26572-2011 取代)标准规定的限量要求。