

**MODEL:  
IMBA-H112**

**ATX Motherboard Supports 6th Generation LGA1151  
Intel® Core™ i7/i5/i3, Pentium® or Celeron® CPU,  
Intel® H110 Chipset, DDR4, HDMI, VGA, iDP, SATA 6Gb/s,  
USB 3.2 Gen 1, Dual Intel® GbE LAN, HD Audio and RoHS**

## **User Manual**

# Revision

---

Date	Version	Changes
November 8, 2019	1.00	Initial release

# Copyright

---

## **COPYRIGHT NOTICE**

The information in this document is subject to change without prior notice in order to improve reliability, design and function and does not represent a commitment on the part of the manufacturer.

In no event will the manufacturer be liable for direct, indirect, special, incidental, or consequential damages arising out of the use or inability to use the product or documentation, even if advised of the possibility of such damages.

This document contains proprietary information protected by copyright. All rights are reserved. No part of this manual may be reproduced by any mechanical, electronic, or other means in any form without prior written permission of the manufacturer.

## **TRADEMARKS**

All registered trademarks and product names mentioned herein are used for identification purposes only and may be trademarks and/or registered trademarks of their respective owners.

# Manual Conventions

---



## **WARNING**

Warnings appear where overlooked details may cause damage to the equipment or result in personal injury. Warnings should be taken seriously.



## **CAUTION**

Cautionary messages should be heeded to help reduce the chance of losing data or damaging the product.



## **NOTE**

These messages inform the reader of essential but non-critical information. These messages should be read carefully as any directions or instructions contained therein can help avoid making mistakes.



## **HOT SURFACE**

This symbol indicates a hot surface that should not be touched without taking care.

# Table of Contents

<b>1 INTRODUCTION.....</b>	<b>1</b>
1.1 INTRODUCTION.....	2
1.2 FEATURES.....	3
1.3 CONNECTORS .....	4
1.4 DIMENSIONS.....	5
1.5 DATA FLOW .....	6
1.6 TECHNICAL SPECIFICATIONS .....	7
<b>2 PACKING LIST.....</b>	<b>10</b>
2.1 ANTI-STATIC PRECAUTIONS.....	11
2.2 UNPACKING PRECAUTIONS.....	11
2.3 PACKING LIST.....	12
2.4 OPTIONAL ITEMS.....	13
<b>3 CONNECTORS .....</b>	<b>15</b>
3.1 PERIPHERAL INTERFACE CONNECTORS.....	16
3.1.1 <i>IMBA-H112 Layout</i> .....	16
3.1.2 <i>Peripheral Interface Connectors</i> .....	17
3.1.3 <i>External Interface Panel Connectors</i> .....	18
3.2 INTERNAL PERIPHERAL CONNECTORS .....	19
3.2.1 <i>+12V Power Connector</i> .....	19
3.2.2 <i>Additional Power Connector</i> .....	19
3.2.3 <i>ATX Power Connector</i> .....	20
3.2.4 <i>Battery Connector</i> .....	22
3.2.5 <i>Chassis Intrusion Connector</i> .....	23
3.2.6 <i>CRT FW Update Connector</i> .....	24
3.2.7 <i>DDR4 DIMM Slots</i> .....	24
3.2.8 <i>EC Debug Connector</i> .....	25
3.2.9 <i>Fan Connector (CPU)</i> .....	26
3.2.10 <i>Fan Connectors (System)</i> .....	27

3.2.11 Front Panel Audio Connector .....	28
3.2.12 Front Panel Connector .....	29
3.2.13 I <sup>2</sup> C Connector .....	30
3.2.14 Internal DisplayPort Connector .....	31
3.2.15 Keyboard and Mouse Connector .....	32
3.2.16 LAN LED Connectors .....	33
3.2.17 Parallel Port Connector .....	34
3.2.18 PCI Slots .....	35
3.2.19 PCI Express x16 Slot.....	35
3.2.20 PCI Express x4 Slot.....	36
3.2.21 PCIe Mini Slot.....	37
3.2.22 Power Button .....	38
3.2.23 RS-232 Serial Port Connector .....	39
3.2.24 RS-232/422/485 Serial Port Connector .....	40
3.2.25 SATA 6Gb/s Drive Connector .....	41
3.2.26 SMBus Connector .....	43
3.2.27 SPI Flash Connector.....	44
3.2.28 SPI Flash Connector, EC .....	45
3.2.29 USB 2.0 Connector (Type A).....	45
3.2.30 USB 2.0 Connector .....	47
<b>3.3 EXTERNAL PERIPHERAL INTERFACE CONNECTOR PANEL .....</b>	<b>48</b>
3.3.1 Audio Connector .....	48
3.3.2 HDMI Connector .....	49
3.3.3 Ethernet and USB 3.2 Gen 1 Connectors .....	50
3.3.4 Keyboard/Mouse and USB 2.0 Connectors .....	51
3.3.5 Serial Port and VGA Connectors.....	52
<b>4 INSTALLATION .....</b>	<b>54</b>
4.1 ANTI-STATIC PRECAUTIONS.....	55
4.2 INSTALLATION CONSIDERATIONS.....	55
4.3 SOCKET LGA1151 CPU INSTALLATION .....	57
4.4 SOCKET LGA1151 COOLING KIT INSTALLATION .....	60
4.5 DIMM INSTALLATION .....	62
4.6 FULL-SIZE PCIe MINI CARD INSTALLATION .....	63
4.7 HALF-SIZE PCIe MINI CARD INSTALLATION.....	64

## IMBA-H112 ATX Motherboard

4.8 SYSTEM CONFIGURATION.....	66
4.8.1 AT/ATX Power Mode Setting .....	66
4.8.2 Clear CMOS Button.....	67
4.8.3 Flash Descriptor Security Override.....	67
4.8.4 USB Power Selection .....	69
4.9 INTERNAL PERIPHERAL DEVICE CONNECTIONS.....	69
4.9.1 SATA Drive Connection .....	69
4.10 ADDING USB 3.0 DRIVERS TO A WINDOWS 7 INSTALLATION IMAGE .....	71
4.11 DRIVER INSTALLATION.....	73
4.11.1 Driver Download.....	74
<b>5 BIOS.....</b>	<b>76</b>
5.1 INTRODUCTION.....	77
5.1.1 Starting Setup.....	77
5.1.2 Using Setup .....	77
5.1.3 Getting Help.....	78
5.1.4 Unable to Reboot after Configuration Changes .....	78
5.1.5 BIOS Menu Bar.....	78
5.2 MAIN.....	79
5.3 ADVANCED.....	80
5.3.1 CPU Configuration .....	81
5.3.2 ACPI Settings.....	83
5.3.3 F81866 Super IO Configuration .....	84
5.3.3.1 Serial Port 1 ~ 6 Configuration.....	84
5.3.3.2 Serial Port 1 Configuration.....	85
5.3.3.3 Serial Port 2 Configuration.....	85
5.3.3.4 Serial Port 3 Configuration.....	86
5.3.3.5 Parallel Port Configuration.....	89
5.3.4 iWDD H/W Monitor.....	90
5.3.4.1 Smart Fan Mode Configuration .....	91
5.3.5 RTC Wake Settings.....	92
5.3.6 Serial Port Console Redirection .....	94
5.3.6.1 Legacy Console Redirection Settings.....	96
5.3.7 NVMe Configuration.....	97
5.3.8 USB Configuration.....	98

5.3.9 iEi Feature .....	99
5.4 CHIPSET .....	100
5.4.1 System Agent (SA) Configuration .....	101
5.4.1.1 Memory Configuration .....	102
5.4.1.2 Graphics Configuration.....	102
5.4.1.3 PEG Port Configuration.....	104
5.4.2 PCH-IO Configuration .....	106
5.4.2.1 PCI Express Configuration .....	108
5.4.2.2 SATA Configuration.....	110
5.4.2.3 HD Audio Configuration.....	111
5.5 SECURITY.....	112
5.6 BOOT.....	113
5.7 SAVE & EXIT .....	115
<b>A REGULATORY COMPLIANCE .....</b>	<b>116</b>
<b>B PRODUCT DISPOSAL .....</b>	<b>118</b>
<b>C BIOS OPTIONS .....</b>	<b>120</b>
<b>D TERMINOLOGY .....</b>	<b>124</b>
<b>E WATCHDOG TIMER.....</b>	<b>128</b>
<b>F ERROR BEEP CODE .....</b>	<b>131</b>
F.1 PEI BEEP CODES .....	132
F.2 DXE BEEP CODES .....	132
<b>G HAZARDOUS MATERIALS DISCLOSURE .....</b>	<b>133</b>



# List of Figures

Figure 1-1: IMBA-H112 .....	2
Figure 1-2: Connectors .....	4
Figure 1-3: IMBA-H112 Dimensions (mm) .....	5
Figure 1-4: Data Flow Diagram .....	6
Figure 3-1: Peripheral Interface Connectors .....	16
Figure 3-2: +12V Power Connector Pinout Location .....	19
Figure 3-3: Additional Power Connector Location .....	20
Figure 3-4: ATX Power Connector Location .....	21
Figure 3-5: Battery Connector Location .....	22
Figure 3-6: Chassis Intrusion Connector Location .....	23
Figure 3-7: CRT FW Update Connector Location .....	24
Figure 3-8: DDR4 DIMM Slot Locations .....	25
Figure 3-9: EC Debug Connector Location .....	25
Figure 3-10: CPU Fan Connector Location .....	26
Figure 3-11: System Fan Connector Locations .....	27
Figure 3-12: Front Panel Audio Connector Location .....	28
Figure 3-13: Front Panel Connector Location .....	29
Figure 3-14: I <sup>2</sup> C Connector Location .....	30
Figure 3-15: Internal DisplayPort Connector Location .....	31
Figure 3-16: Keyboard and Mouse Connector Location .....	32
Figure 3-17: LAN1 LED Connector Location .....	33
Figure 3-18: Parallel Port Connector Location .....	34
Figure 3-19: PCI Slot Locations .....	35
Figure 3-20: PCIe x16 Slot Location .....	36
Figure 3-21: PCIe x4 Slot Location .....	36
Figure 3-22: PCIe Mini Slot Location .....	37
Figure 3-23: Power Button Location .....	39
Figure 3-24: RS-232 Serial Port Connector Locations .....	39
Figure 3-25: RS-232/422/485 Connector Location .....	40
Figure 3-26: SATA 6Gb/s Drive Connector Location .....	42

Figure 3-27: SMBus Connector Location .....	43
Figure 3-28: SPI Flash Connector Location .....	44
Figure 3-29: SPI EC Flash Connector Location .....	45
Figure 3-30: USB 2.0 Connector (Type A) Pinout Location .....	46
Figure 3-31: USB 2.0 Connector Pinout Locations .....	47
Figure 3-32: External Peripheral Interface Connector .....	48
Figure 3-33: Audio Connector .....	49
Figure 3-34: LAN Connector .....	50
Figure 3-35: Serial Port Connector Pinouts .....	52
Figure 3-36: VGA Connector .....	53
Figure 4-1: Disengage the CPU Socket Load Lever .....	57
Figure 4-2: Remove Protective Cover .....	58
Figure 4-3: Insert the Socket LGA1151 CPU .....	59
Figure 4-4: Close the Socket LGA1151 .....	59
Figure 4-5: Cooling Kit Support Bracket .....	61
Figure 4-6: DIMM Installation .....	62
Figure 4-7: Removing the Retention Screw .....	63
Figure 4-8: Inserting the Full-size PCIe Mini Card into the Slot at an Angle .....	63
Figure 4-9: Securing the Full-size PCIe Mini Card .....	64
Figure 4-10: Installing the Standoff .....	65
Figure 4-11: Inserting the Half-size PCIe Mini Card into the Slot at an Angle .....	65
Figure 4-12: Securing the Half-size PCIe Mini Card .....	66
Figure 4-13: AT/ATX Power Mode Switch Location .....	66
Figure 4-14: Clear CMOS Button Location .....	67
Figure 4-15: Flash Descriptor Security Override Jumper Location .....	68
Figure 4-16: SATA Drive Cable Connection .....	70
Figure 4-17: SATA Power Drive Connection .....	71
Figure 4-18: Windows 7 USB 3.0 Creator Utility .....	72
Figure 4-19: Update Process is Complete .....	73
Figure 4-20: IEl Resource Download Center .....	73

# List of Tables

Table 1-1: IMBA-H112 Specifications .....	9
Table 2-1: Packing List.....	12
Table 2-2: Optional Items .....	14
Table 3-1: Peripheral Interface Connectors .....	18
Table 3-2: Rear Panel Connectors .....	18
Table 3-3: +12V Power Connector Pinouts .....	19
Table 3-4: Additional Power Connector Pinouts .....	20
Table 3-5: ATX Power Connector Pinouts .....	21
Table 3-6: Chassis Intrusion Connector Pinouts .....	23
Table 3-7: CRT FW Update Connector Pinouts .....	24
Table 3-8: EC Debug Connector Pinouts .....	26
Table 3-9: CPU Fan Connector Pinouts.....	27
Table 3-10: System Fan Connector Pinouts .....	27
Table 3-11: Front Panel Audio Connector Pinouts .....	28
Table 3-12: Front Panel Connector Pinouts.....	29
Table 3-13: I <sup>2</sup> C Connector Pinouts.....	30
Table 3-14: Internal DisplayPort Connector Pinouts .....	31
Table 3-15: Keyboard and Mouse Connector Pinouts .....	32
Table 3-16: LAN LED Connector Pinouts .....	33
Table 3-17: Parallel Port Connector Pinouts .....	34
Table 3-18: PCIe Mini Slot Pinouts.....	38
Table 3-19: RS-232 Serial Port Connector Pinouts .....	40
Table 3-20: RS-232/422/485 Connector Pinouts .....	41
Table 3-21: DB-9 RS-232/422/485 Pinouts .....	41
Table 3-22: SATA 6Gb/s Drive Connector Pinouts.....	42
Table 3-23: SMBus Connector Pinouts .....	43
Table 3-24: SPI Flash Connector Pinouts .....	44
Table 3-25: SPI EC Flash Connector Pinouts .....	45
Table 3-26: USB 2.0 Connector (Type A) Pinouts .....	46
Table 3-27: USB 2.0 Connector Pinouts.....	47

Table 3-28: HDMI Connector Pinouts .....	49
Table 3-29: USB 3.2 Gen 1 Port Pinouts .....	50
Table 3-30: LAN Pinouts .....	50
Table 3-31: USB 2.0 Port Pinouts.....	51
Table 3-32: PS/2 Connector Pinouts.....	51
Table 3-33: Serial Port Connector Pinouts .....	52
Table 3-34: VGA Connector Pinouts.....	52
Table 4-1: AT/ATX Power Mode Switch Settings.....	67
Table 4-2: Flash Descriptor Security Override Jumper Settings.....	67
Table 4-3: BIOS Options and Configured USB Ports.....	69
Table 4-4: USB Power Source Setup .....	69
Table 5-1: BIOS Navigation Keys .....	78
Table 5-2: BIOS Options and Configured USB Ports.....	107

# BIOS Menus

BIOS Menu 1: Main .....	79
BIOS Menu 2: Advanced .....	80
BIOS Menu 3: CPU Configuration .....	81
BIOS Menu 4: ACPI Configuration .....	83
BIOS Menu 5: F81866 Super IO Configuration .....	84
BIOS Menu 6: Serial Port 1 ~ 6 Configuration Menu .....	84
BIOS Menu 7: Parallel Port Configuration Menu .....	89
BIOS Menu 8: iWDD H/W Monitor .....	90
BIOS Menu 9: Smart Fan Mode Configuration .....	91
BIOS Menu 10: RTC Wake Settings .....	92
BIOS Menu 11: Serial Port Console Redirection .....	94
BIOS Menu 12: Legacy Console Redirection Settings .....	96
BIOS Menu 13: NVMe Configuration.....	97
BIOS Menu 14: USB Configuration .....	98
BIOS Menu 15: iEi Feature .....	99
BIOS Menu 16: Chipset .....	100
BIOS Menu 17: System Agent (SA) Configuration .....	101
BIOS Menu 18: Memory Configuration.....	102
BIOS Menu 19: Graphics Configuration.....	102
BIOS Menu 20: PEG Port Configuration.....	104
BIOS Menu 21: PEG Port Feature Configuration.....	105
BIOS Menu 22: PCH-IO Configuration .....	106
BIOS Menu 23: PCI Express Configuration .....	108
BIOS Menu 24: MPCIE1 Slot .....	108
BIOS Menu 25: SATA Configuration .....	110
BIOS Menu 26: HD Audio Configuration .....	111
BIOS Menu 27: Security .....	112
BIOS Menu 28: Boot .....	113
BIOS Menu 29: Save & Exit.....	115



Chapter

1

# Introduction

---

## 1.1 Introduction

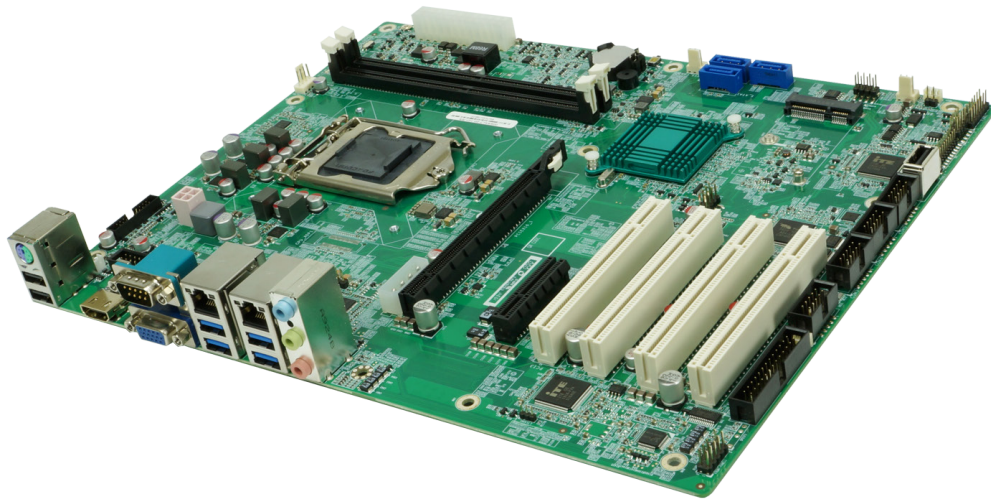

**Figure 1-1: IMBA-H112**

The IMBA-H112 is an ATX motherboard. It accepts a Socket LGA1151 Intel® Core™ i7/i5/i3, Pentium® or Celeron® processor and supports two 288-pin 2133 MHz dual-channel DDR4 DIMMs up to 64 GB.

The IMBA-H112 provides two GbE interfaces through the Intel® I219LM and the Intel® I211 PCIe controllers. The integrated Intel® H110 chipset supports three SATA 6Gb/s drives. In addition, the IMBA-H112 includes HDMI, VGA and iDP interfaces for dual independent display.

Expansion and I/O include four PCI slots, one PCIe x16 slot, one PCIe x4 slot, one PCIe Mini slot with mSATA support, four USB 3.2 Gen 1 (5Gb/s) and two USB 2.0 on the rear panel, two USB 2.0 by pin headers, one USB 2.0 by internal Type A connector, five RS-232 and one RS-232/422/485. High Definition Audio (HDA) support ensures HDA devices can be easily implemented on the IMBA-H112.



## IMBA-H112 ATX Motherboard

### 1.2 Features

Some of the IMBA-H112 motherboard features are listed below:

- ATX form factor
- 6th generation LGA1151 Intel® Core™ i7/i5/i3, Pentium® or Celeron® processor supported
- Intel® H110 chipset
- Two 288-pin 2133 MHz dual-channel unbuffered DDR4 DIMMs support up to 64 GB
- Two Intel® PCIe GbE connectors
- Dual independent display by HDMI, VGA or iDP interfaces
- SATA 6Gb/s and USB 3.2 Gen 1 (5Gb/s) supported
- One PCIe Mini slot with mSATA support
- One PCIe x16 slot and one PCIe x4 slot
- Four PCI slots
- Six COM ports (five RS-232 and one RS-232/422/485)
- High Definition Audio
- RoHS compliant

### 1.3 Connectors

The connectors on the IMBA-H112 are shown in the figure below.

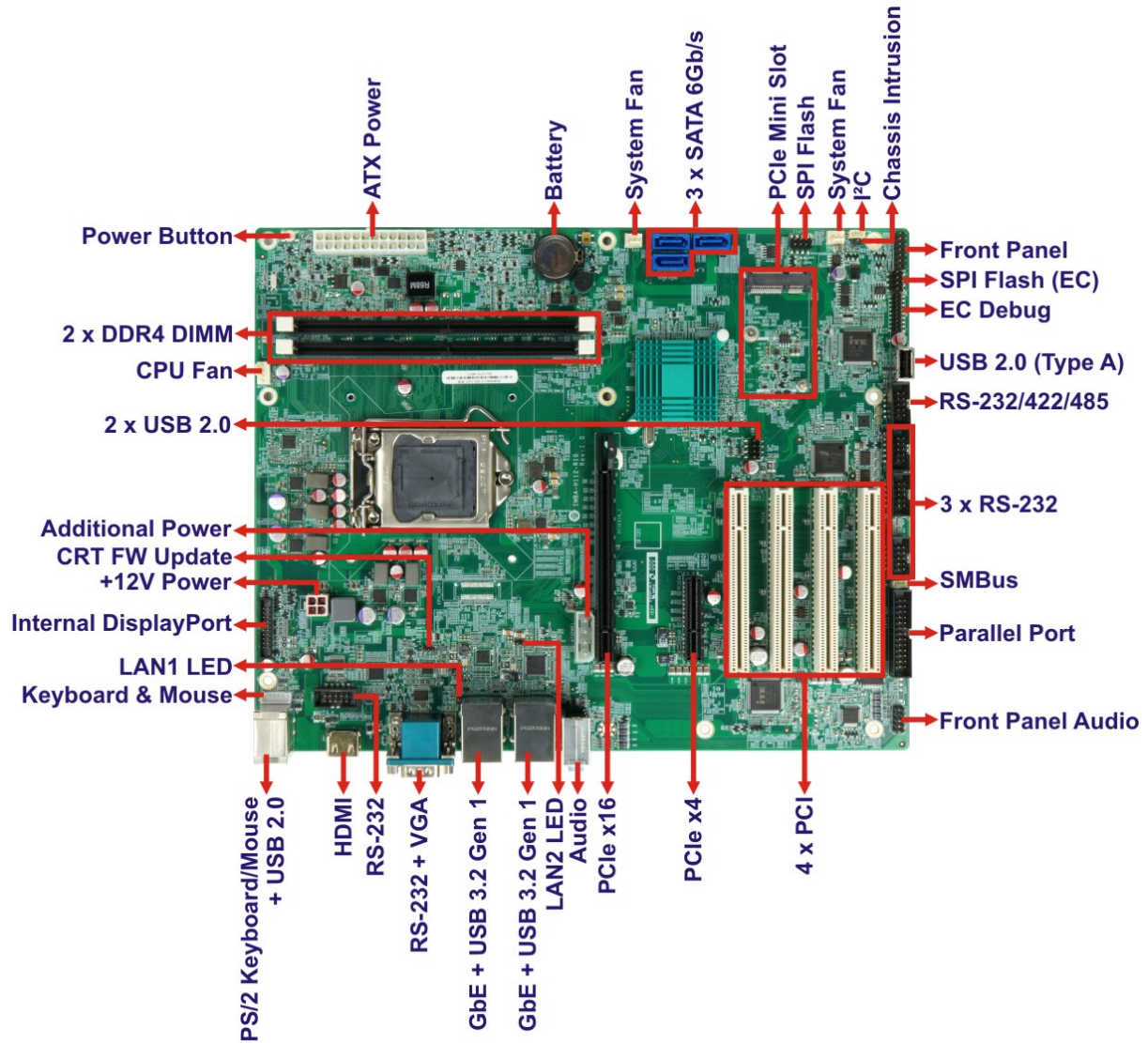

**Figure 1-2: Connectors**

## IMBA-H112 ATX Motherboard

### 1.4 Dimensions

The main dimensions of the IMBA-H112 are shown in the diagram below.

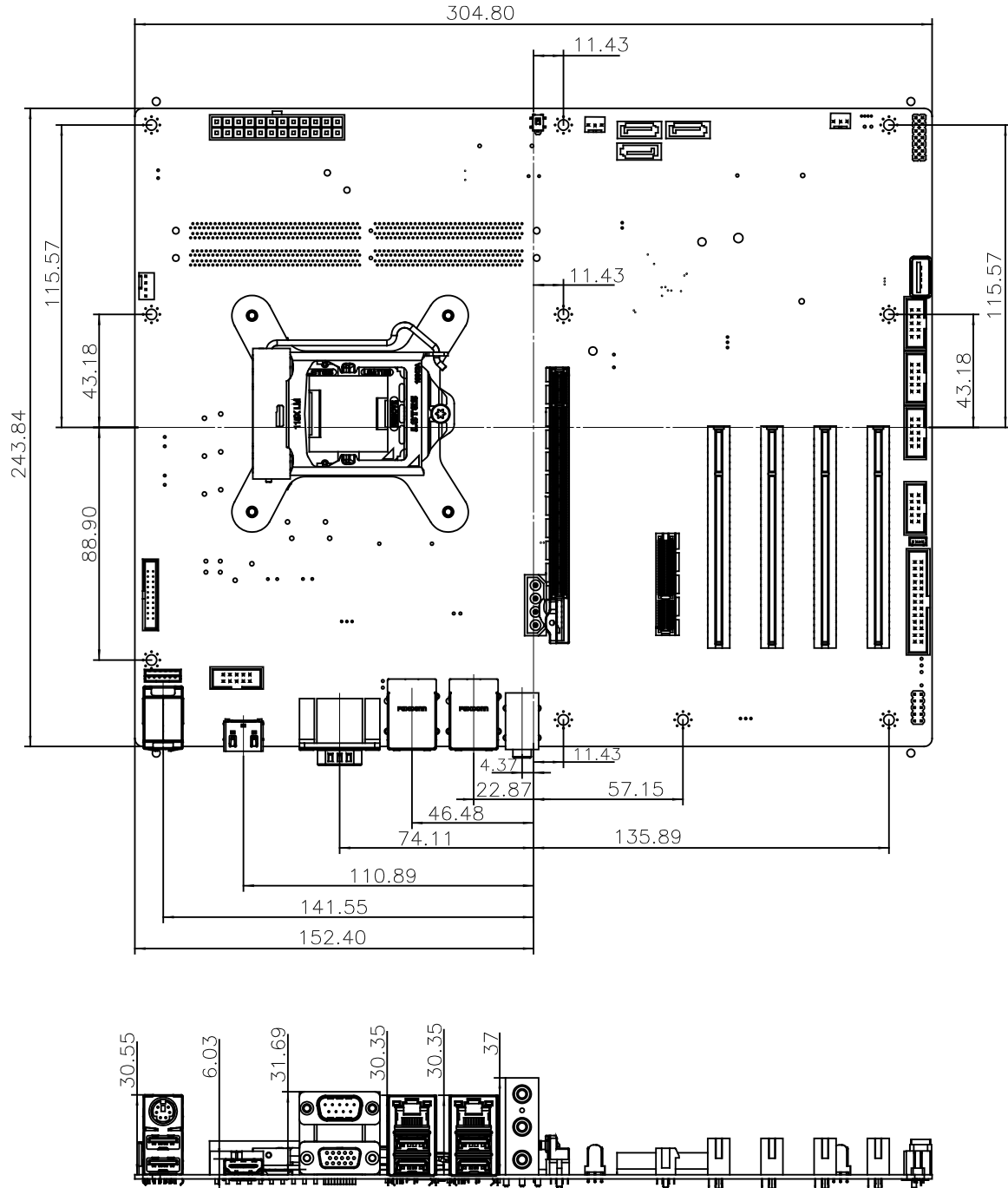

Figure 1-3: IMBA-H112 Dimensions (mm)

### 1.5 Data Flow

Figure 1-4 shows the data flow between the system chipset, the CPU and other components installed on the motherboard.

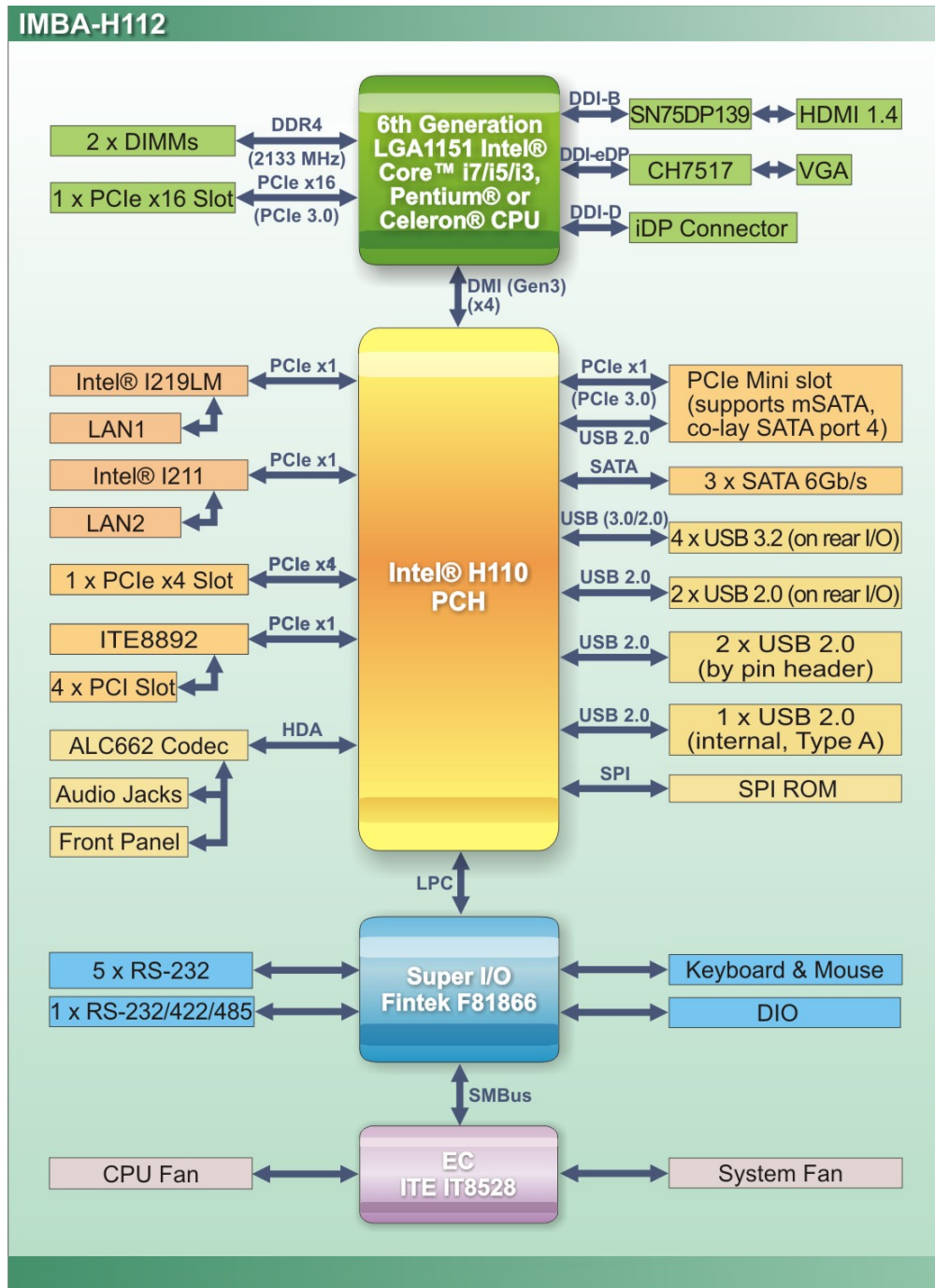

Figure 1-4: Data Flow Diagram

## IMBA-H112 ATX Motherboard

### 1.6 Technical Specifications

The IMBA-H112 technical specifications are listed below.

Specification/Model	IMBA-H112
<b>Form Factor</b>	ATX
<b>CPU Supported</b>	6th generation LGA1151 Intel® Core™ i7/i5/i3, Pentium® or Celeron® CPU
<b>PCH</b>	Intel® H110
<b>Memory</b>	Two 288-pin 2133 MHz dual-channel unbuffered DDR4 SDRAM DIMMs supported (system max. 64 GB)
<b>Graphics Engine</b>	Intel® HD Graphics Gen9 engine with 16 low-power execution units, supporting DX2015, OpenGL 5.x, OpenCL 2.x and ES 2.0
<b>Display Output</b>	Dual independent display One VGA One HDMI 1.4 One iDP interface for HDMI, LVDS, VGA, DVI and DisplayPort
<b>Audio</b>	Realtek ALC662 HD Audio codec supports 5.1 channels
<b>BIOS</b>	AMI UEFI BIOS
<b>Ethernet Controllers</b>	<b>LAN1_USB1:</b> Intel® I219LM <b>LAN2_USB2:</b> Intel® I211
<b>Super I/O Controller</b>	Fintek F81866
<b>Watchdog Timer</b>	Software programmable supports 1~255 sec. system reset
<b>Expansions</b>	One full-size/half-size PCIe Mini card slot (supports mSATA) One PCIe 3.0 x16 slot One PCIe 3.0 x4 slot Four PCI slots
<b>I/O Interface Connectors</b>	
<b>Audio Connectors</b>	Line-in, line-out and mic-in audio jacks on rear panel One internal front panel audio connector (10-pin header)

<b>Chassis Intrusion</b>	One 2-pin header
<b>Ethernet</b>	Two RJ-45 GbE ports
<b>Fan</b>	One 4-pin CPU smart fan connector Two 3-pin system fan connectors
<b>Front Panel</b>	One 14-pin header (power LED, HDD LED, speaker, power button, reset button)
<b>I<sup>2</sup>C</b>	One 4-pin wafer connector
<b>Keyboard and Mouse</b>	One PS/2 keyboard/mouse connector One internal keyboard and mouse connector (6-pin wafer)
<b>LAN LEDs</b>	Two 2-pin headers
<b>Parallel Port</b>	One parallel port via internal 26-pin box header
<b>Serial ATA</b>	Three SATA 6Gb/s connectors (support hot plug)
<b>Serial Ports</b>	One external RS-232 serial port Four RS-232 via internal box headers One RS-232/422/485 via internal box header
<b>SMBus</b>	One 4-pin wafer connector
<b>USB 2.0</b>	One USB 2.0 port by internal Type A connector Two USB 2.0 ports on rear panel Two USB 2.0 ports via internal pin header
<b>USB 3.0</b>	Four USB 3.2 Gen 1 (5Gb/s) ports on rear panel <b>* The Windows® 7 installation media does not include native driver support for USB 3.0. In order to use the USB keyboard or mouse connected to a USB 3.0 port during OS installation, the user has to update the Windows® 7 installation image so that it contains USB 3.0 drivers. Please refer to Section 4.10 for detailed installation procedures.</b>
<b>Environmental and Power Specifications</b>	
<b>Power Supply</b>	AT/ATX power supply
<b>Power Consumption</b>	3.3V@0.48A, 5V@2.06A, 12V@3.35A, 5VSB@0.02A (3.5 GHz Intel® Core™ i5-6500 CPU with 4 GB 2133 MHz DDR4 memory)

## IMBA-H112 ATX Motherboard

<b>Operating Temperature</b>	-20°C ~ 60°C
<b>Storage Temperature</b>	-30°C ~ 70°C
<b>Operating Humidity</b>	5% ~ 95% (non-condensing)
<b>Physical Specifications</b>	
<b>Dimensions</b>	244 mm x 305 mm
<b>Weight (GW/NW)</b>	1200 g/700 g

**Table 1-1: IMBA-H112 Specifications**

Chapter

**2**

# Packing List

---



## IMBA-H112 ATX Motherboard

### 2.1 Anti-static Precautions

---



#### WARNING!

Static electricity can destroy certain electronics. Make sure to follow the ESD precautions to prevent damage to the product, and injury to the user.

---

Make sure to adhere to the following guidelines:

- **Wear an anti-static wristband:** Wearing an anti-static wristband can prevent electrostatic discharge.
- **Self-grounding:** Touch a grounded conductor every few minutes to discharge any excess static buildup.
- **Use an anti-static pad:** When configuring any circuit board, place it on an anti-static mat.
- **Only handle the edges of the PCB:** Don't touch the surface of the motherboard. Hold the motherboard by the edges when handling.

### 2.2 Unpacking Precautions

When the IMBA-H112 is unpacked, please do the following:

- Follow the anti-static guidelines above.
- Make sure the packing box is facing upwards when opening.
- Make sure all the packing list items are present.



## 2.3 Packing List



**NOTE:**

If any of the components listed in the checklist below are missing, do not proceed with the installation. Contact the IEI reseller or vendor the IMBA-H112 was purchased from or contact an IEI sales representative directly by sending an email to [sales@ieiworld.com](mailto:sales@ieiworld.com).

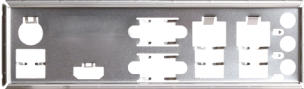
The IMBA-H112 is shipped with the following components:

Quantity	Item and Part Number	Image
1	IMBA-H112 single board computer	
1	I/O shielding	
2	SATA cable	
1	Quick installation guide	





**Table 2-1: Packing List**

## IMBA-H112 ATX Motherboard

### 2.4 Optional Items

The following are optional components which may be separately purchased:

Item and Part Number	Image
LPT cable (P/N: 19800-000049-RS)	
Dual RS-232 cable, 230 mm, P=2.54 (P/N: 19800-000051-RS)	
PS/2 KB/MS Y-cable with bracket, 220 mm (P/N: 19800-000075-RS)	
SATA power cable (P/N: 32102-000100-200-RS)	
LGA1155/LGA1156 cooler kit (1U chassis compatible, 73W) (P/N: CF-1156A-RS-R11)	
LGA1155/LGA1156 cooler kit (1U chassis compatible, 45W) (P/N: CF-1156C-RS)	
LGA1155/LGA1156 cooler kit (1U chassis compatible, 65W) (P/N: CF-1156D-RS)	
LGA1155/LGA1156 cooler kit (95W) (P/N: CF-1156E-R11)	

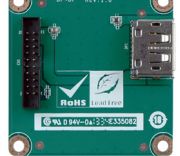
Item and Part Number	Image
DisplayPort to HDMI converter board (for IEI iDP connector) (P/N: DP-HDMI-R10)	
DisplayPort to LVDS converter board (for IEI iDP connector) (P/N: DP-LVDS-R10)	
DisplayPort to VGA converter board (for IEI iDP connector) (P/N: DP-VGA-R10)	
DisplayPort to DVI-D converter board (for IEI iDP connector) (P/N: DP-DVI-R10)	
DisplayPort to DisplayPort converter board (for IEI iDP connector) (P/N: DP-DP-R10)	

**Table 2-2: Optional Items**

Chapter

3

# Connectors

---

### 3.1 Peripheral Interface Connectors

This chapter details all the peripheral interface connectors.

#### 3.1.1 IMBA-H112 Layout

The figure below shows all the peripheral interface connectors.

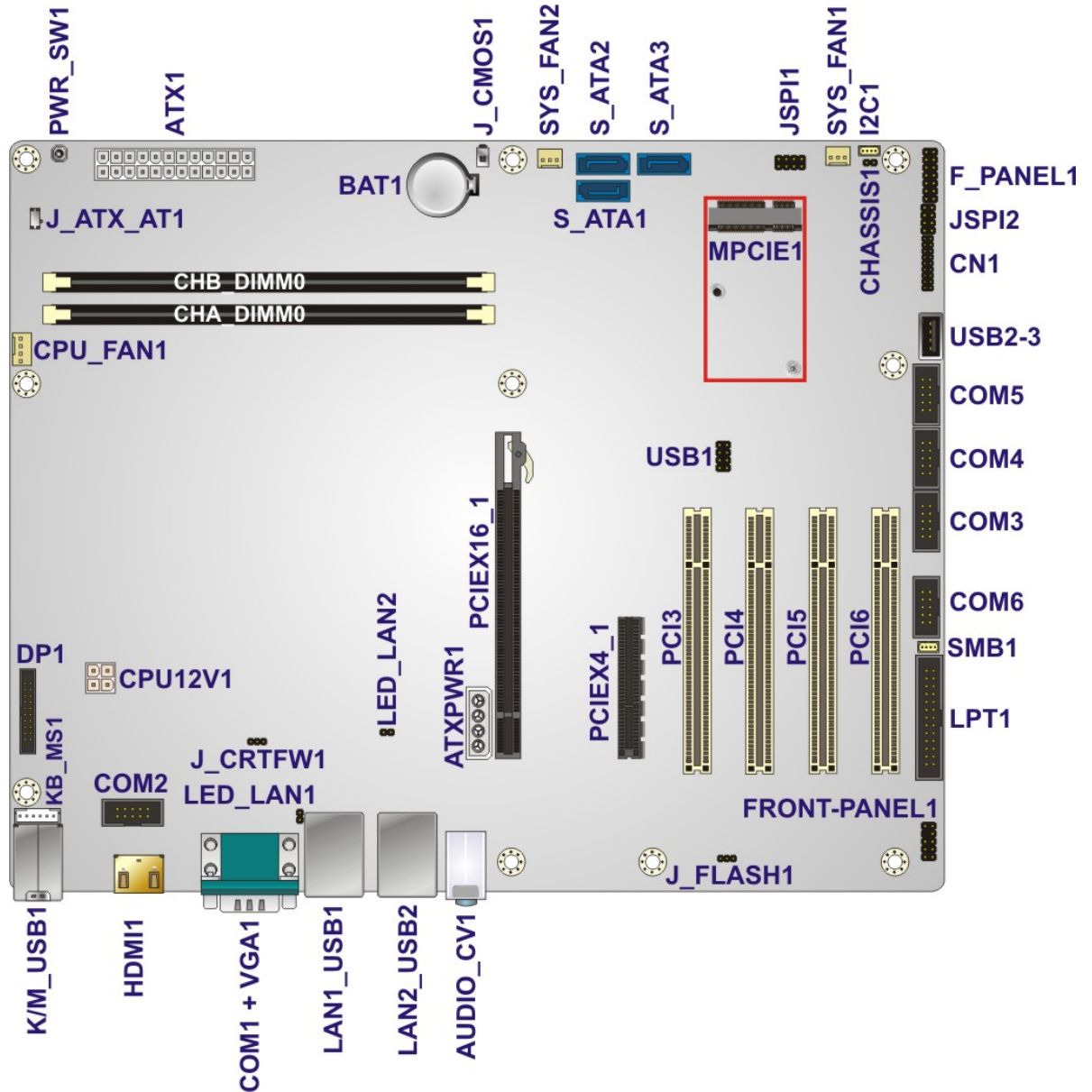

Figure 3-1: Peripheral Interface Connectors

## IMBA-H112 ATX Motherboard

### 3.1.2 Peripheral Interface Connectors

The table below lists all the connectors on the board.

Connector	Type	Label
+12V power connector	4-pin Molex power connector	CPU12V1
Additional power connector	4-pin connector	ATXPWR1
ATX power connector	24-pin connector	ATX1
Battery connector	Battery holder	BAT1
Chassis intrusion connector	2-pin header	CHASSIS1
CRT FW update	3-pin header	J_CRTFW1
DDR4 DIMM sockets	288-pin socket	CHA_DIMM0, CHB_DIMM0
EC debug connector	18-pin header	CN1
Fan connector (CPU)	4-pin wafer	CPU_FAN1
Fan connectors (system)	3-pin wafer	SYS_FAN1, SYS_FAN2
Front panel audio connector	10-pin header	FRONT-PANEL1
Front panel connector	14-pin header	F_PANEL1
I <sup>2</sup> C connector	4-pin wafer	I2C1
Internal DisplayPort connector	20-pin box header	DP1
Keyboard and mouse connector	6-pin wafer	KB_MS1
LAN LED connectors	2-pin header	LED_LAN1, LED_LAN2
Parallel port connector	26-pin box header	LPT1
PCI slots	PCI slot	PCI3, PCI4, PCI5, PCI6
PCIe x16 slot	PCIe x16 slot	PCIEX16_1
PCIe x4 slot	PCIe x4 slot	PCIEX4_1

Connector	Type	Label
PCIe Mini slot	PCIe Mini slot	MPCIE1
Power button	Push button	PWR_SW1
SATA 6Gb/s drive connector	7-pin SATA connector	S_ATA1, S_ATA2, S_ATA3
RS-232 serial ports	10-pin box header	COM2, COM3, COM4, COM6
RS-232/422/485 serial port	10-pin box header	COM5
SMBus connector	4-pin wafer	SMB1
SPI flash connector	8-pin header	JSPI1
SPI flash connector, EC	8-pin header	JSPI2
USB 2.0 connector (Type A)	Type A	USB2-3
USB 2.0 connector	8-pin header	USB1

**Table 3-1: Peripheral Interface Connectors**

### 3.1.3 External Interface Panel Connectors

The table below lists the connectors on the external I/O panel.

Connector	Type	Label
Audio connector	Audio jacks	AUDIO_CV1
Ethernet and USB 3.2 Gen 1 connectors	RJ-45, USB 3.2 Gen 1	LAN1_USB1, LAN2_USB2
Keyboard/mouse and USB 2.0 connectors	PS/2, USB 2.0	K/M_USB1
HDMI connector	HDMI 1.4	HDMI1
Serial port connector	DB-9 male	COM1
VGA connector	DB-15 female	VGA1

**Table 3-2: Rear Panel Connectors**



## IMBA-H112 ATX Motherboard

### 3.2 Internal Peripheral Connectors

The section describes all of the connectors on the IMBA-H112.

#### 3.2.1 +12V Power Connector

- CN Label:** CPU12V1
- CN Type:** 4-pin Molex power connector, p=4.2 mm
- CN Location:** See **Figure 3-2**
- CN Pinouts:** See **Table 3-3**

This connector provides power to the CPU.

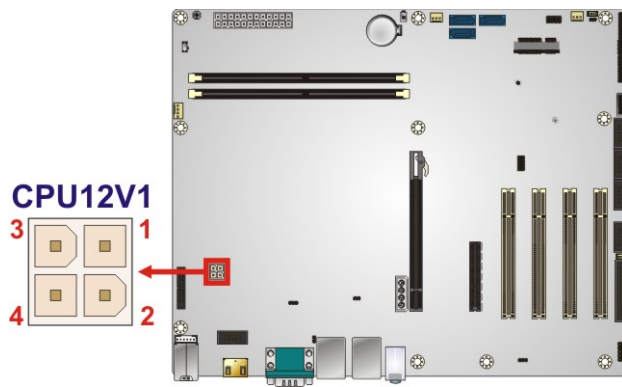

**Figure 3-2: +12V Power Connector Pinout Location**

Pin	Description	Pin	Description
1	GND	2	GND
3	+12V	4	+12V

**Table 3-3: +12V Power Connector Pinouts**

#### 3.2.2 Additional Power Connector

- CN Label:** ATPWR1
- CN Type:** 4-pin connector, p=5.08 mm
- CN Location:** See **Figure 3-3**
- CN Pinouts:** See **Table 3-4**

The additional power connector provides extra +12V and +5V power to the system.

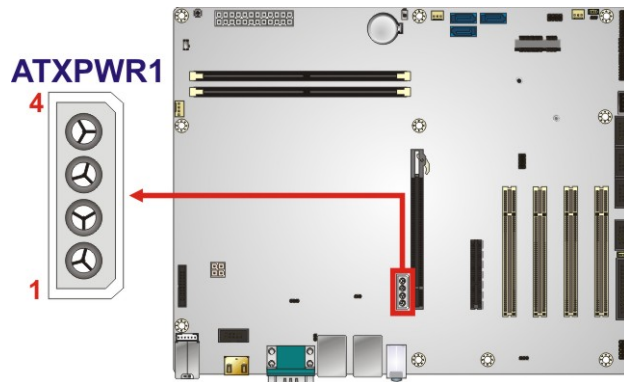

**Figure 3-3: Additional Power Connector Location**

Pin	Description
1	+12V
2	GND
3	GND
4	+5V

**Table 3-4: Additional Power Connector Pinouts**

### 3.2.3 ATX Power Connector

- CN Label:** ATX1
- CN Type:** 24-pin connector, p=4.2 mm
- CN Location:** See **Figure 3-4**
- CN Pinouts:** See **Table 3-5**

The ATX power connector connects to an ATX power supply.

## IMBA-H112 ATX Motherboard

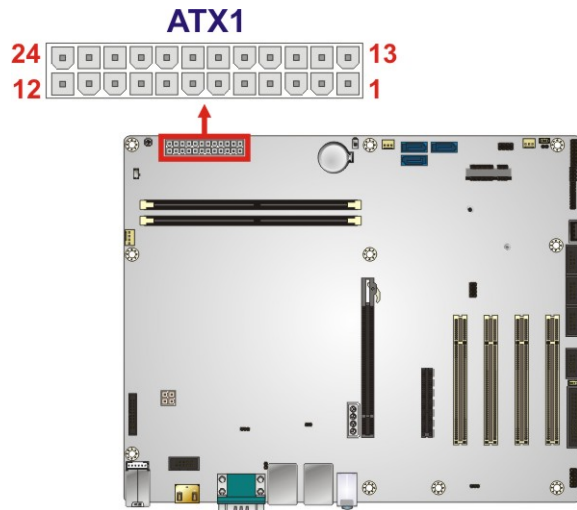

Figure 3-4: ATX Power Connector Location

Pin	Description	Pin	Description
1	+3.3V	13	+3.3V
2	+3.3V	14	-12V
3	GND	15	GND
4	+5V	16	PS_ON
5	GND	17	GND
6	+5V	18	GND
7	GND	19	GND
8	Power good	20	-5V
9	5VSB	21	+5V
10	+12V	22	+5V
11	+12V	23	+5V
12	+3.3V	24	GND

Table 3-5: ATX Power Connector Pinouts

### 3.2.4 Battery Connector

**CAUTION:**

Risk of explosion if battery is replaced by an incorrect type. Only certified engineers should replace the on-board battery.

Dispose of used batteries according to instructions and local regulations.

---

<b>CN Label:</b>	<b>BAT1</b>
<b>CN Type:</b>	Battery holder
<b>CN Location:</b>	See <b>Figure 3-5</b>

A system battery is placed in the battery holder. The battery provides power to the system clock to retain the time when power is turned off.

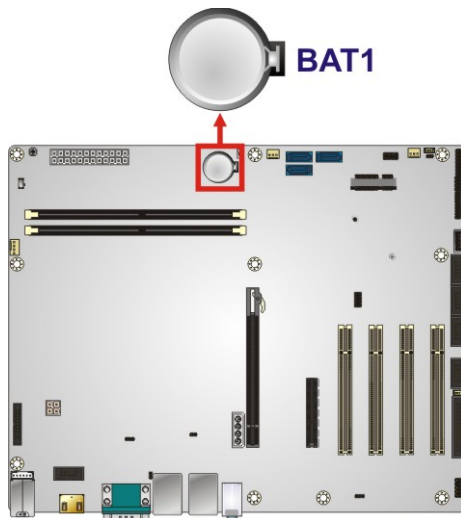

**Figure 3-5: Battery Connector Location**

## IMBA-H112 ATX Motherboard

### 3.2.5 Chassis Intrusion Connector

- CN Label:** CHASSIS1
- CN Type:** 2-pin header, p=2.54 mm
- CN Location:** See **Figure 3-6**
- CN Pinouts:** See **Table 3-6**

The chassis intrusion connector is for a chassis intrusion detection sensor or switch that detects if a chassis component is removed or replaced.



**Figure 3-6: Chassis Intrusion Connector Location**

Pin	Description
1	+VRTC
2	CHASSIS OPEN

**Table 3-6: Chassis Intrusion Connector Pinouts**

### 3.2.6 CRT FW Update Connector

- CN Label:** J\_CRTFW1
- CN Type:** 3-pin header, p=2.00 mm
- CN Location:** See **Figure 3-7**
- CN Pinouts:** See **Table 3-7**

The CRT FW update connector is used to update the CRT firmware.

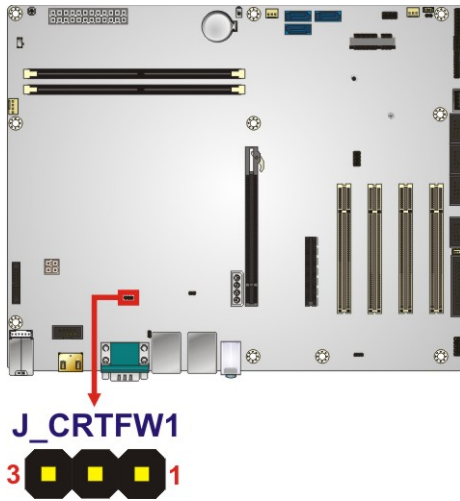

**Figure 3-7: CRT FW Update Connector Location**

Pin	Description
1	SPC
2	SPD
3	GND

**Table 3-7: CRT FW Update Connector Pinouts**

### 3.2.7 DDR4 DIMM Slots

- CN Label:** CHA\_DIMM0, CHB\_DIMM0
- CN Type:** DDR4 DIMM slot
- CN Location:** See **Figure 3-8**

The DIMM slots are for DDR4 DIMM memory modules.

## IMBA-H112 ATX Motherboard

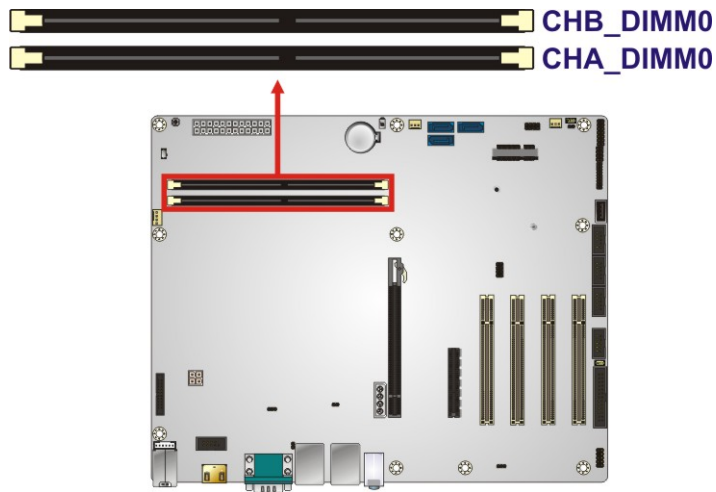

Figure 3-8: DDR4 DIMM Slot Locations

### 3.2.8 EC Debug Connector

<b>CN Label:</b>	<b>CN1</b>
<b>CN Type:</b>	18-pin header, p=2 mm
<b>CN Location:</b>	See <b>Figure 3-9</b>
<b>CN Pinouts:</b>	See <b>Table 3-8</b>

The EC debug connector is used for EC debug.

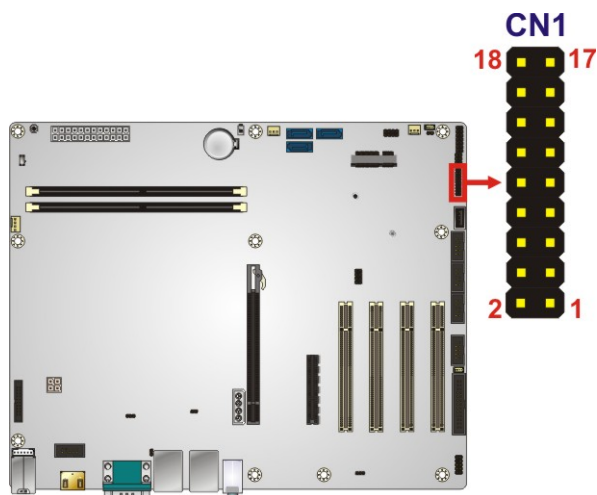

Figure 3-9: EC Debug Connector Location

Pin	Description	Pin	Description
1	EC_EPP_STB#	2	EC_EPP_AFD#
3	EC_EPP_PD0	4	NC
5	EC_EPP_PD1	6	EC_EPP_INIT#
7	EC_EPP_PD2	8	EC_EPP_SLIN#
9	EC_EPP_PD3	10	GND
11	EC_EPP_PD4	12	NC
13	EC_EPP_PD5	14	EC_EPP_BUSY
15	EC_EPP_PD6	16	EC_EPP_KSI5
17	EC_EPP_PD7	18	EC_EPP_KSI4

**Table 3-8: EC Debug Connector Pinouts**

### 3.2.9 Fan Connector (CPU)

- CN Label:** CPU\_FAN1
- CN Type:** 4-pin wafer, p=2.54 mm
- CN Location:** See **Figure 3-10**
- CN Pinouts:** See **Table 3-9**

The fan connector attaches to a CPU cooling fan.

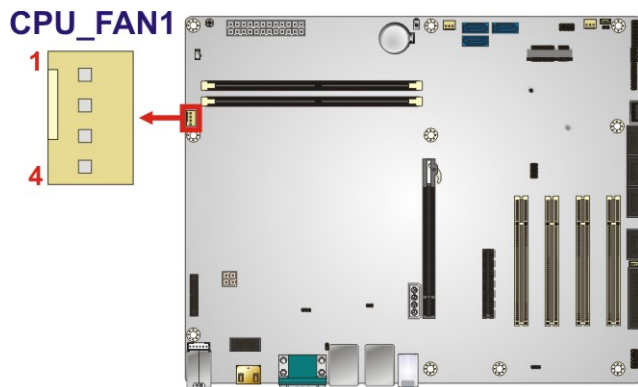

**Figure 3-10: CPU Fan Connector Location**

Pin	Description
1	GND
2	+12V



## IMBA-H112 ATX Motherboard

Pin	Description
3	FANIO
4	PWM

**Table 3-9: CPU Fan Connector Pinouts**

### 3.2.10 Fan Connectors (System)

**CN Label:** SYS\_FAN1, SYS\_FAN2

**CN Type:** 3-pin wafer, p=2.54 mm

**CN Location:** See **Figure 3-11**

**CN Pinouts:** See **Table 3-10**

Each fan connector attaches to a system cooling fan.

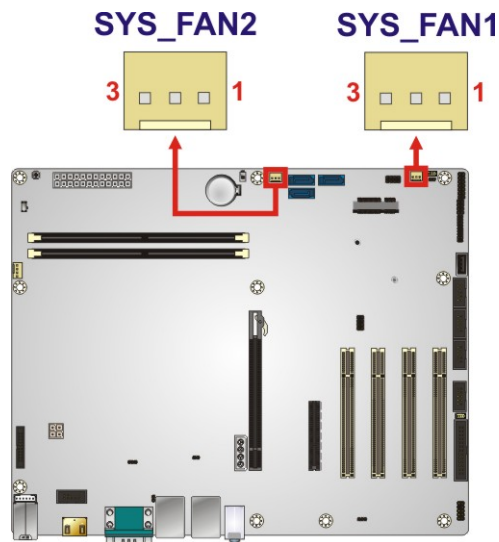

**Figure 3-11: System Fan Connector Locations**

Pin	Description
1	FANIO
2	+12V (PWM)
3	GND

**Table 3-10: System Fan Connector Pinouts**

**3.2.11 Front Panel Audio Connector**

- CN Label:** FRONT-PANEL1
- CN Type:** 10-pin header, p=2.54 mm
- CN Location:** See **Figure 3-12**
- CN Pinouts:** See **Table 3-11**

This connector connects to speakers, a microphone and an audio input.

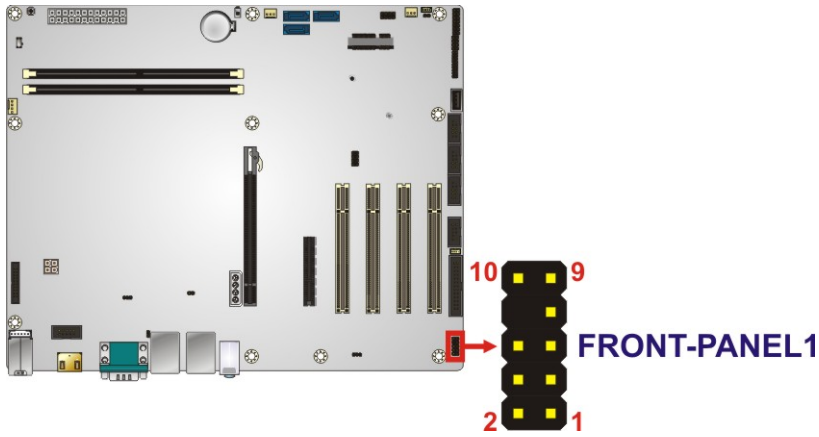

**Figure 3-12: Front Panel Audio Connector Location**

Pin	Description	Pin	Description
1	MIC2-L	2	GND
3	MIC2-R	4	Presence#
5	LINE2-R	6	MIC2-JD
7	FRONT-IO	8	NC
9	LINE2-L	10	LINE2-JD

**Table 3-11: Front Panel Audio Connector Pinouts**

## IMBA-H112 ATX Motherboard

### 3.2.12 Front Panel Connector

- CN Label:** F\_PANEL1
- CN Type:** 14-pin header, p=2.54 mm
- CN Location:** See **Figure 3-13**
- CN Pinouts:** See **Table 3-12**

The front panel connector connects to the indicator LEDs and buttons on the computer's front panel.

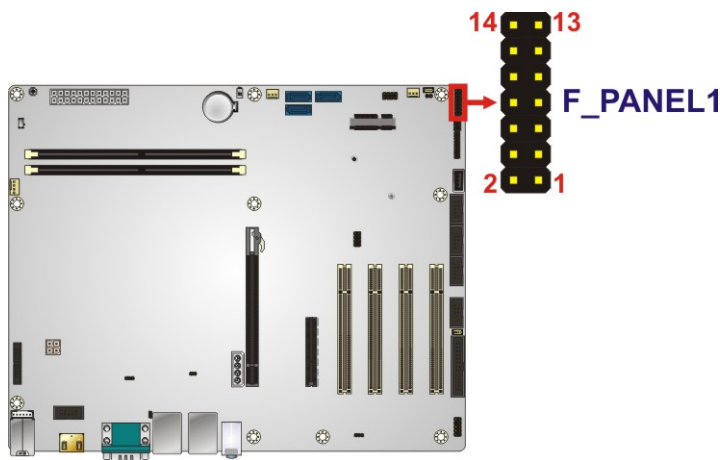

**Figure 3-13: Front Panel Connector Location**

Function	Pin	Description	Function	Pin	Description
Power LED	1	+5V	Speaker	2	BEEP_PWR
	3	NC		4	NC
	5	GND		6	NC
Power Button	7	PWRBTN_SW#		8	PC_BEEP
	9	GND	10	NC	
HDD LED	11	+5V	Reset	12	EXTRST-
	13	SATA_LED#		14	GND

**Table 3-12: Front Panel Connector Pinouts**

### 3.2.13 I<sup>2</sup>C Connector

- CN Label:** I2C1
- CN Type:** 4-pin wafer, p=1.25 mm
- CN Location:** See **Figure 3-14**
- CN Pinouts:** See **Table 3-13**

The I<sup>2</sup>C connector is used to connect I<sup>2</sup>C-bus devices to the mainboard.

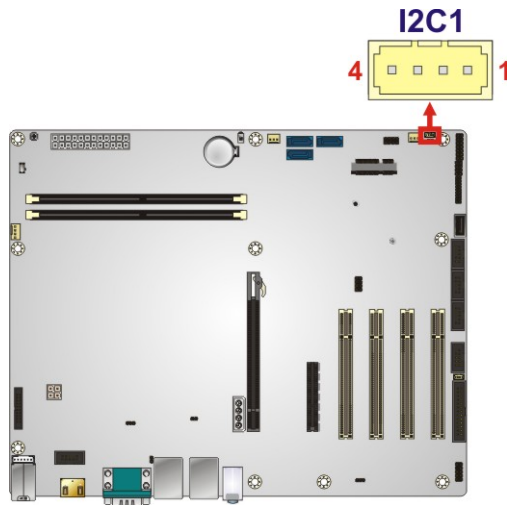

**Figure 3-14: I<sup>2</sup>C Connector Location**

Pin	Description
1	GND
2	I2C_DAT
3	I2C_CLK
4	+5V

**Table 3-13: I<sup>2</sup>C Connector Pinouts**

## IMBA-H112 ATX Motherboard

### 3.2.14 Internal DisplayPort Connector

- CN Label:** DP1
- CN Type:** 20-pin box header, p=2.00 mm
- CN Location:** See **Figure 3-15**
- CN Pinouts:** See **Table 3-14**

The DisplayPort connector supports HDMI, LVDS, VGA, DVI and DisplayPort graphics interfaces.

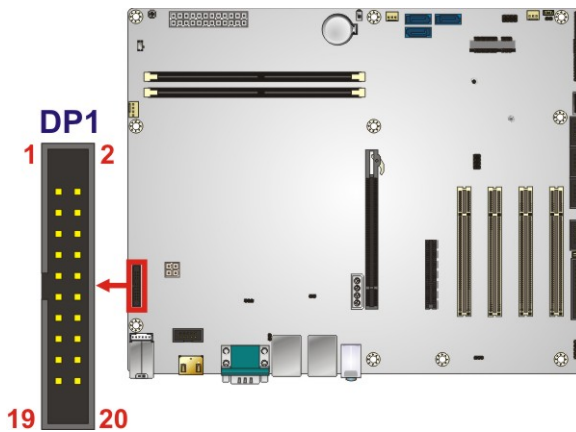

**Figure 3-15: Internal DisplayPort Connector Location**

Pin	Description	Pin	Description
1	HPD	2	AUX_P
3	GND	4	AUX_N
5	AUX_DET	6	GND
7	GND	8	LANE2P
9	LANE3P	10	LANE2N
11	LANE3N	12	GND
13	GND	14	LANE0P
15	LANE1P	16	LANE0N
17	LANE1N	18	VCC3V
19	VCC5V	20	NC

**Table 3-14: Internal DisplayPort Connector Pinouts**

**3.2.15 Keyboard and Mouse Connector**

- CN Label:** KB\_MS1
- CN Type:** 6-pin wafer, p=2 mm
- CN Location:** See **Figure 3-16**
- CN Pinouts:** See **Table 3-15**

The keyboard and mouse connector connects to a PS/2 Y-cable that can be connected to a PS/2 keyboard and mouse.

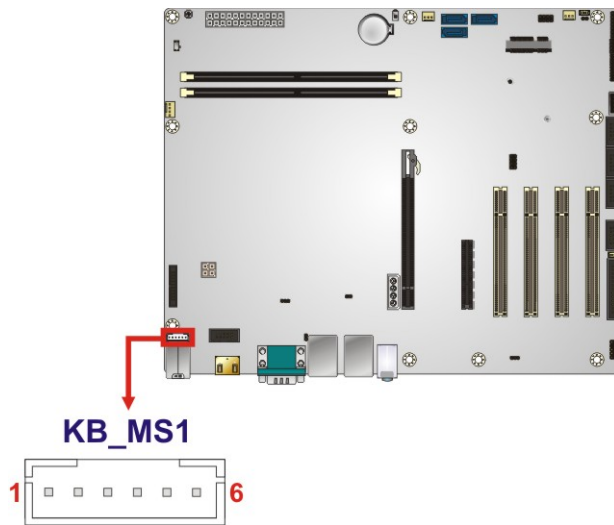

**Figure 3-16: Keyboard and Mouse Connector Location**

Pin	Description
1	VCC
2	Mouse Data
3	Mouse Clock
4	Keyboard Data
5	Keyboard Clock
6	GND

**Table 3-15: Keyboard and Mouse Connector Pinouts**

## IMBA-H112 ATX Motherboard

### 3.2.16 LAN LED Connectors

**CN Label:** LED\_LAN1, LED\_LAN2

**CN Type:** 2-pin header, p=2.54 mm

**CN Location:** See **Figure 3-17**

**CN Pinouts:** See **Table 3-16**

The LAN LED connectors are used to connect to the LAN LED indicators on the chassis to indicate users the link activities of the two LAN ports.

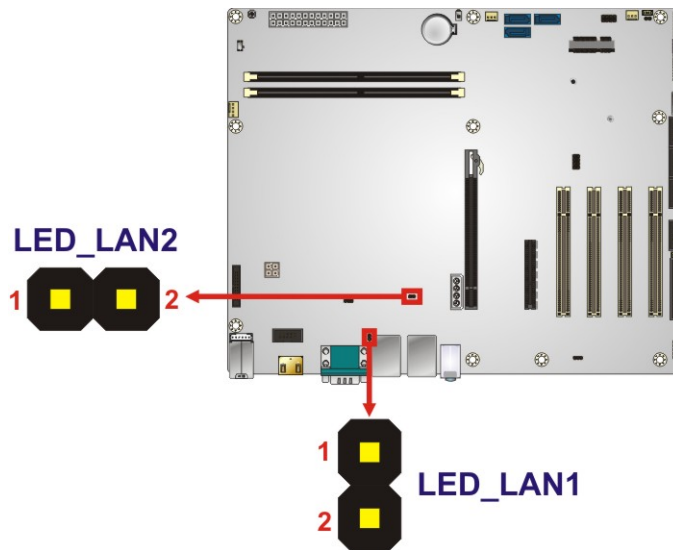

**Figure 3-17: LAN1 LED Connector Location**

Pin	Description
1	+3.3V
2	LAN_LED_LINK#_ACT

**Table 3-16: LAN LED Connector Pinouts**

**3.2.17 Parallel Port Connector**

- CN Label:** LPT1
- CN Type:** 26-pin box header, p=2.54 mm
- CN Location:** See **Figure 3-18**
- CN Pinouts:** See **Table 3-17**

The parallel port connector connects to a parallel port connector interface or some other parallel port device such as a printer.

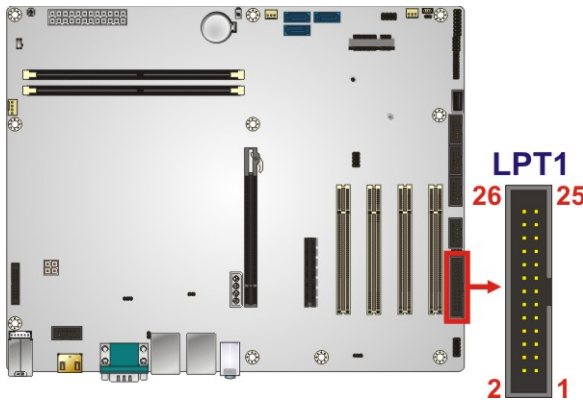

**Figure 3-18: Parallel Port Connector Location**

Pin	Description	Pin	Description
1	RSTROBE#	2	SIO_AFD#
3	RPD0	4	SIO_ERR#
5	RPD1	6	SIO_INIT#
7	RPD2	8	SIO_SLIN#
9	RPD3	10	GND
11	RPD4	12	GND
13	RPD5	14	GND
15	RPD6	16	GND
17	RPD7	18	GND
19	SIO_ACK#	20	GND
21	SIO_BUSY	22	GND
23	SIO_PE	24	GND
25	SIO_SLCT	26	N/C

**Table 3-17: Parallel Port Connector Pinouts**



## IMBA-H112 ATX Motherboard

### 3.2.18 PCI Slots

**CN Label:** PCI3, PCI4, PCI5, PCI6

**CN Type:** PCI Slot

**CN Location:** See **Figure 3-19**

Each PCI slot enables a PCI expansion module to be connected to the board.

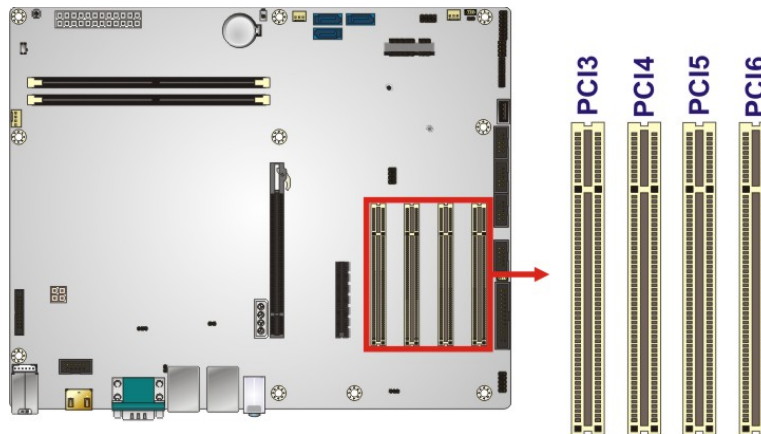

**Figure 3-19: PCI Slot Locations**

### 3.2.19 PCI Express x16 Slot

**CN Label:** PCIEX16\_1

**CN Type:** PCIe x16 slot

**CN Location:** See **Figure 3-20**

The PCIe x16 expansion card slot is for PCIe x16 expansion card.

**PCIEX16\_1**

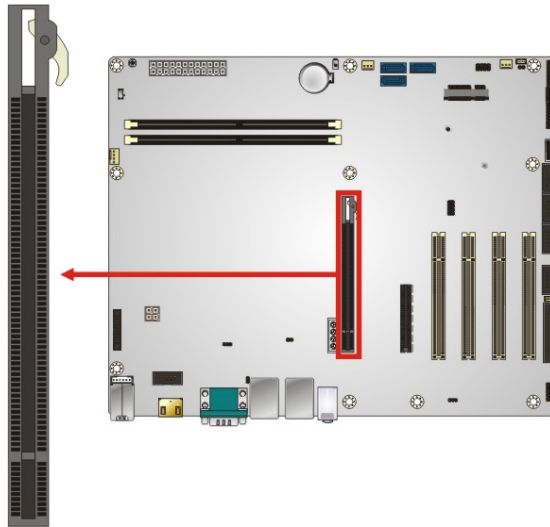
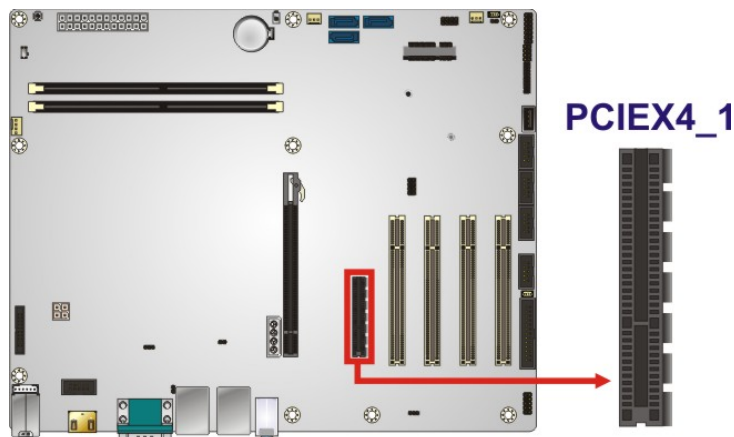

**Figure 3-20: PCIe x16 Slot Location**

### 3.2.20 PCI Express x4 Slot

- CN Label:** PCIEX4\_1
- CN Type:** PCIe x4 slot
- CN Location:** See **Figure 3-20**

The PCIe x4 expansion card slot is for PCIe x4 expansion card.



**Figure 3-21: PCIe x4 Slot Location**

## IMBA-H112 ATX Motherboard

### 3.2.21 PCIe Mini Slot

- CN Label:** MPCIE1
- CN Type:** PCIe Mini slot
- CN Location:** See **Figure 3-22**
- CN Pinouts:** See **Table 3-18**

The PCIe Mini slot is for installing a full-size/half-size PCIe Mini expansion card, including an mSATA card.

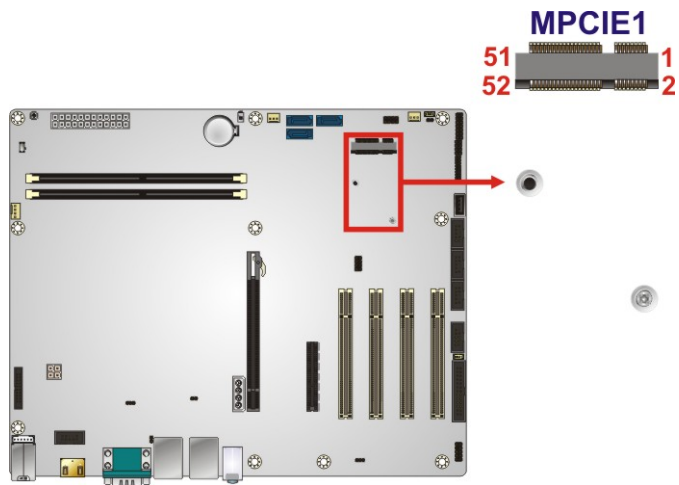

**Figure 3-22: PCIe Mini Slot Location**

Pin	Description	Pin	Description
1	PCIE_WAKE#	2	+3.3V
3	N/C	4	GND
5	N/C	6	1.5V
7	N/C	8	N/C
9	GND	10	N/C
11	MSATA_CLK#	12	N/C
13	MSATA_CLK	14	N/C
15	GND	16	N/C
17	PLTRST_N	18	GND
19	N/C	20	+3.3V
21	GND	22	PLTRST_N
23	SATA_RX-/PCIE_RX-	24	+3.3V

Pin	Description	Pin	Description
25	SATA_RX+/PCIE_RX+	26	GND
27	GND	28	1.5V
29	GND	30	SMB_CLK
31	SATA_TX-/PCIE_TX-	32	SMB_DATA
33	SATA_TX+/PCIE_TX+	34	GND
35	GND	36	USB_DATA-
37	GND	38	USB_DATA+
39	+3.3V	40	GND
41	+3.3V	42	N/C
43	+3.3V	44	N/C
45	CLINK_CLK	46	N/C
47	CLINK_DATA	48	1.5V
49	CLINK_RST#	50	GND
51	MSATA_DET	52	+3.3V

**Table 3-18: PCIe Mini Slot Pinouts**

### 3.2.22 Power Button

- CN Label:** PWR\_SW1
- CN Type:** Push button
- CN Location:** See **Figure 3-23**

The on-board power button controls system power.

## IMBA-H112 ATX Motherboard

**PWR\_SW1**

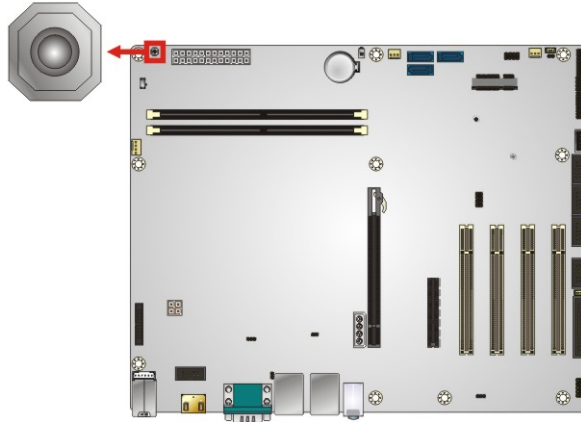

**Figure 3-23: Power Button Location**

### 3.2.23 RS-232 Serial Port Connector

**CN Label:** COM2, COM3, COM4, COM6

**CN Type:** 10-pin box header, p=2.54 mm

**CN Location:** See **Figure 3-24**

**CN Pinouts:** See **Table 3-19**

Each of these connectors provides RS-232 connections.

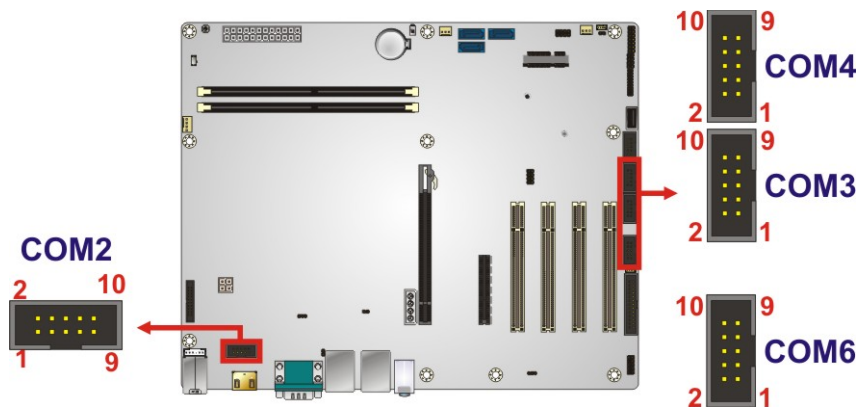

**Figure 3-24: RS-232 Serial Port Connector Locations**

Pin	Description	Pin	Description
1	DCD	2	DSR

Pin	Description	Pin	Description
3	RXD	4	RTS
5	TXD	6	CTS
7	DTR	8	RI
9	GND	10	GND

**Table 3-19: RS-232 Serial Port Connector Pinouts**

### 3.2.24 RS-232/422/485 Serial Port Connector

- CN Label:** COM5
- CN Type:** 10-pin box header, p=2.54 mm
- CN Location:** See **Figure 3-25**
- CN Pinouts:** See **Table 3-20**

Each of these connectors provides RS-232, RS-422 or RS-485 communications.



**NOTE:**

The communication protocol of the serial port is set through the BIOS menu in “Advanced → Super IO Configuration → Serial Port 5 Configuration”. Use the **Transfer Mode** BIOS option to configure the correspondent serial ports (refer to **Sections 5.3.3.4.2** for detailed information).

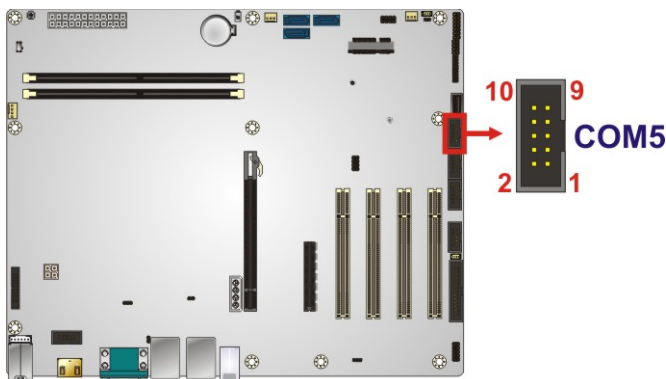

**Figure 3-25: RS-232/422/485 Connector Location**

## IMBA-H112 ATX Motherboard

Pin	Description	Pin	Description
1	DCD	2	DSR
3	RXD	4	RTS
5	TXD	6	CTS
7	DTR	8	RI
9	GND	10	GND

**Table 3-20: RS-232/422/485 Connector Pinouts**

Use an RS-232/422/485 cable to connect to a serial device. The pinouts of the DB-9 connector are listed below.

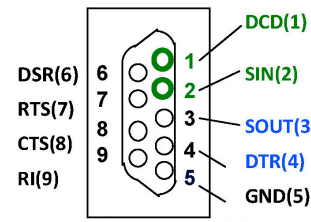
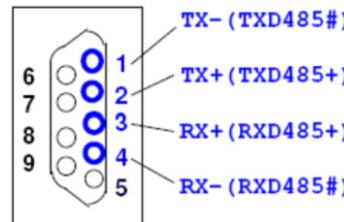
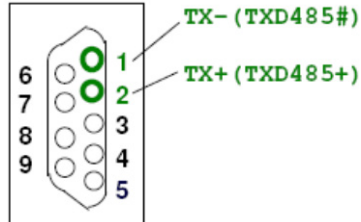
RS-232 Pinouts	RS-422 Pinouts	RS-485 Pinouts
		

**Table 3-21: DB-9 RS-232/422/485 Pinouts**

### 3.2.25 SATA 6Gb/s Drive Connector

**CN Label:** S\_ATA1, S\_ATA2, S\_ATA3

**CN Type:** 7-pin SATA drive connector

**CN Location:** See **Figure 3-26**

**CN Pinouts:** See **Table 3-22**

The SATA drive connectors can be connected to SATA drives and support up to 6Gb/s data transfer rate.

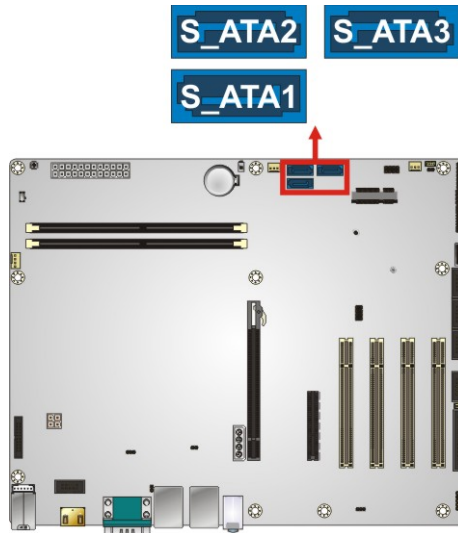

**Figure 3-26: SATA 6Gb/s Drive Connector Location**

<b>Pin</b>	<b>Description</b>
1	GND
2	SATA_TX+
3	SATA_TX-
4	GND
5	SATA_RX-
6	SATA RX+
7	GND

**Table 3-22: SATA 6Gb/s Drive Connector Pinouts**



## IMBA-H112 ATX Motherboard

### 3.2.26 SMBus Connector

- CN Label:** SMB1
- CN Type:** 4-pin wafer, p=1.25 mm
- CN Location:** See **Figure 3-27**
- CN Pinouts:** See **Table 3-23**

The SMBus (System Management Bus) connector provides low-speed system management communications.

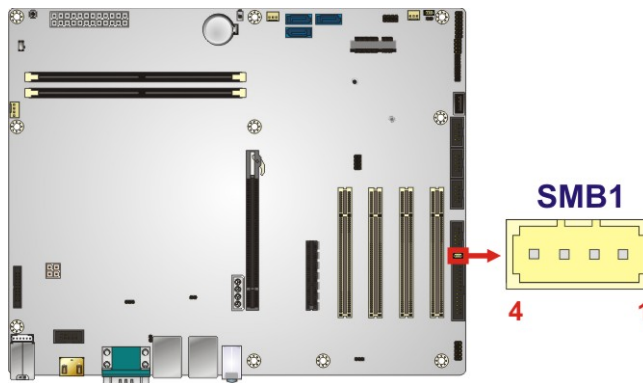

**Figure 3-27: SMBus Connector Location**

Pin	Description
1	GND
2	SMB_DATA
3	SMB_CLK
4	+5V

**Table 3-23: SMBus Connector Pinouts**

**3.2.27 SPI Flash Connector**

- CN Label:** JSPI1
- CN Type:** 8-pin header, p=2.54 mm
- CN Location:** See **Figure 3-28**
- CN Pinouts:** See **Table 3-24**

The SPI flash connector is used to flash the SPI ROM.

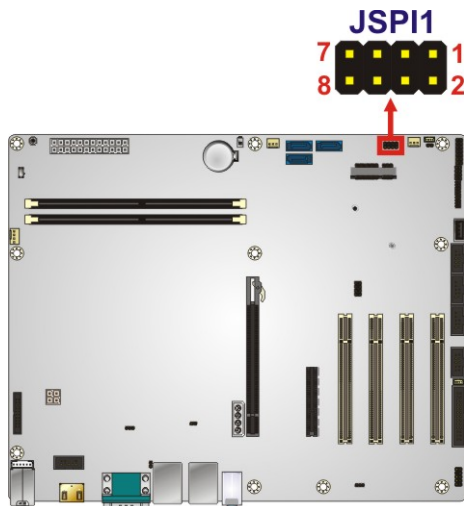

**Figure 3-28: SPI Flash Connector Location**

Pin	Description	Pin	Description
1	+3.3V	2	GND
3	SPI_CS	4	SPI_CLK
5	SPI_SO	6	SPI_SI
7	NC	8	NC

**Table 3-24: SPI Flash Connector Pinouts**

## IMBA-H112 ATX Motherboard

### 3.2.28 SPI Flash Connector, EC

- CN Label:** JSPI2
- CN Type:** 8-pin header, p=2.54 mm
- CN Location:** See **Figure 3-29**
- CN Pinouts:** See **Table 3-25**

The SPI flash connector is used to flash the EC ROM.

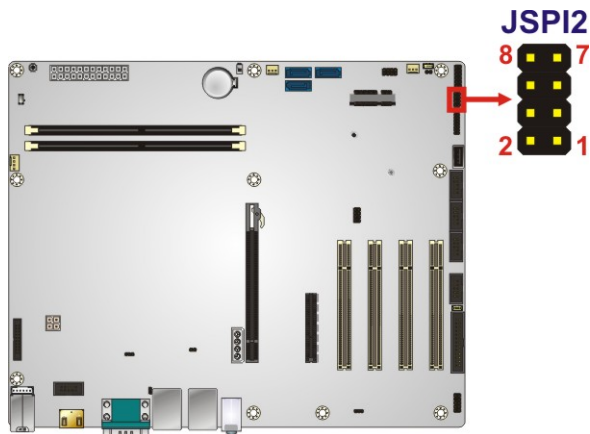

**Figure 3-29: SPI EC Flash Connector Location**

Pin	Description	Pin	Description
1	+3.3V_EC	2	GND
3	SPI_CS_EC	4	SPI_CLK_EC
5	SPI_SO_EC	6	SPI_SI_EC
7	NC	8	NC

**Table 3-25: SPI EC Flash Connector Pinouts**

### 3.2.29 USB 2.0 Connector (Type A)

- CN Label:** USB2-3
- CN Type:** USB Type A
- CN Location:** See **Figure 3-30**
- CN Pinouts:** See **Table 3-26**

The USB Type A connector connects to a USB 2.0/1.1 device.

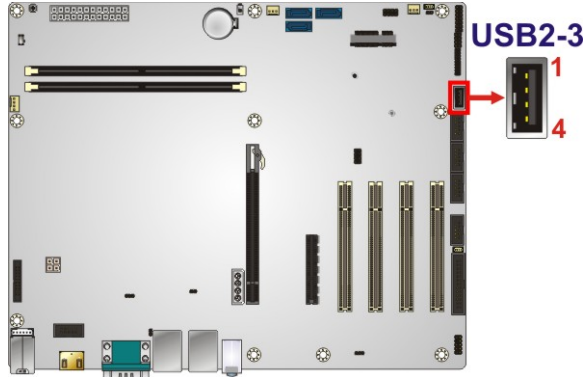

**Figure 3-30: USB 2.0 Connector (Type A) Pinout Location**

<b>Pin</b>	<b>Description</b>
1	VCC
2	DATA-
3	DATA+
4	GROUND

**Table 3-26: USB 2.0 Connector (Type A) Pinouts**

## IMBA-H112 ATX Motherboard

### 3.2.30 USB 2.0 Connector

- CN Label:** USB1
- CN Type:** 8-pin header, p=2.54 mm
- CN Location:** See **Figure 3-31**
- CN Pinouts:** See **Table 3-27**

The USB 2.0 connector connects to USB 2.0 devices. Each pin header provides two USB 2.0 ports.

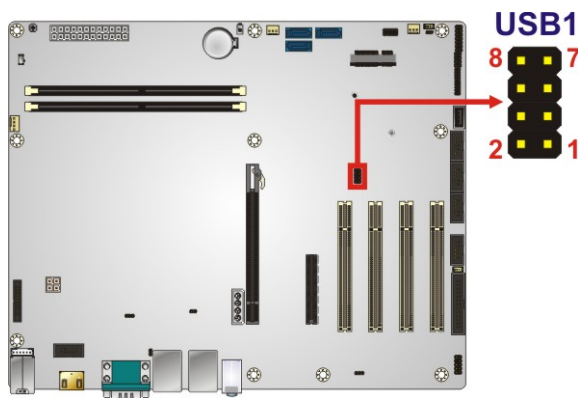

**Figure 3-31: USB 2.0 Connector Pinout Locations**

Pin	Description	Pin	Description
1	VCC	2	GND
3	USB_DATA-	4	USB_DATA+
5	USB_DATA+	6	USB_DATA-
7	GND	8	VCC

**Table 3-27: USB 2.0 Connector Pinouts**

### 3.3 External Peripheral Interface Connector Panel

The figure below shows the external peripheral interface connector (EPIC) panel. The EPIC panel consists of the following:

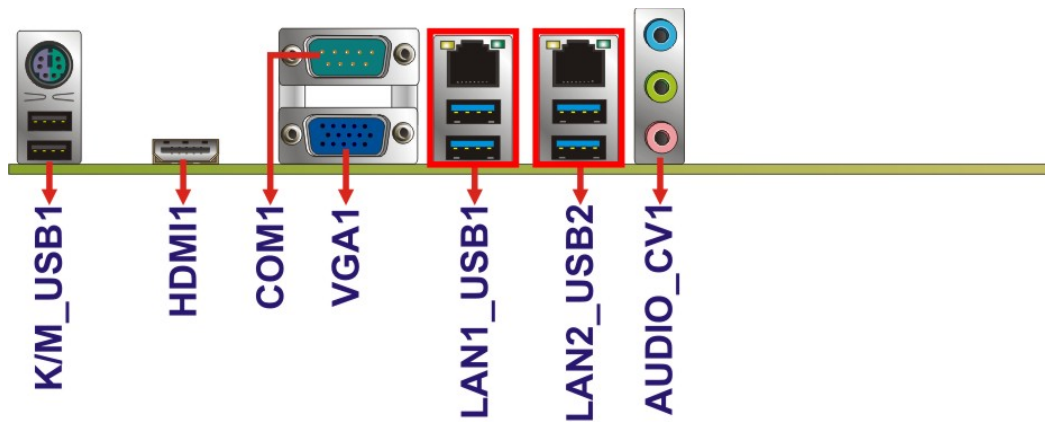

Figure 3-32: External Peripheral Interface Connector

#### 3.3.1 Audio Connector

<b>CN Label:</b>	<b>AUDIO_CV1</b>
<b>CN Type:</b>	Audio jack
<b>CN Location:</b>	See <b>Figure 3-32</b>

The audio jacks connect to external audio devices.

- **Line In port (Light Blue):** Connects a CD-ROM, DVD player, or other audio devices.
- **Line Out port (Lime):** Connects to a headphone or a speaker. With multi-channel configurations, this port can also connect to front speakers.
- **Microphone (Pink):** Connects a microphone.

## IMBA-H112 ATX Motherboard

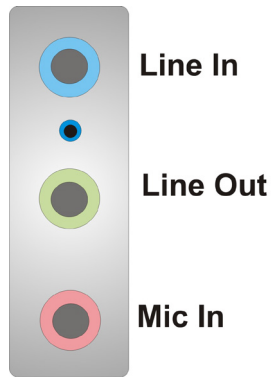

Figure 3-33: Audio Connector

### 3.3.2 HDMI Connector

<b>CN Label:</b>	<b>HDMI1</b>
<b>CN Type:</b>	HDMI 1.4
<b>CN Location:</b>	See <b>Figure 3-32</b>
<b>CN Pinouts:</b>	See <b>Table 3-28</b>

The HDMI connector connects to a display device with HDMI interface.

Pin	Description	Pin	Description
1	HDMI_DATA2	13	NC
2	GND	14	NC
3	HDMI_DATA2#	15	HDMI_SCL
4	HDMI_DATA1	16	HDMI_SDA
5	GND	17	GND
6	HDMI_DATA1#	18	+5V
7	HDMI_DATA0	19	HDMI_HPD
8	GND	20	HDMI_GND
9	HDMI_DATA0#	21	HDMI_GND
10	HDMI_CLK	22	HDMI_GND
11	GND	23	HDMI_GND
12	HDMI_CLK#		

Table 3-28: HDMI Connector Pinouts

**3.3.3 Ethernet and USB 3.2 Gen 1 Connectors**

**CN Label:** LAN1\_USB1, LAN2\_USB2

**CN Type:** RJ-45, USB 3.0

**CN Location:** See **Figure 3-32**

**CN Pinouts:** See **Table 3-29** and **Table 3-30**

There are four external USB 3.2 Gen 1 (5Gb/s) connectors on the IMBA-H112.

Pin	Description	Pin	Description
1	VCC	10	VCC
2	USB_DATA-	11	USB_DATA-
3	USB_DATA+	12	USB_DATA+
4	GND	13	GND
5	USB3_RX-	14	USB3_RX-
6	USB3_RX+	15	USB3_RX+
7	GND	16	GND
8	USB3_TX-	17	USB3_TX-
9	USB3_TX+	18	USB3_TX+

**Table 3-29: USB 3.2 Gen 1 Port Pinouts**

Each LAN connector connects to a local network

Pin	Description	Pin	Description
1	LAN_MDI0P	5	LAN_MDI2P
2	LAN_MDI0N	6	LAN_MDI2N
3	LAN_MDI1P	7	LAN_MDI3P
4	LAN_MDI1N	8	LAN_MDI3N

**Table 3-30: LAN Pinouts**

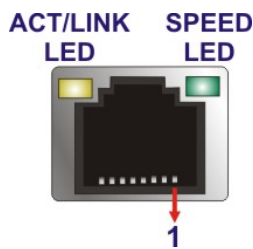

**Figure 3-34: LAN Connector**



## IMBA-H112 ATX Motherboard

### 3.3.4 Keyboard/Mouse and USB 2.0 Connectors

- CN Label:** K/M\_USB1
- CN Type:** PS/2, USB 2.0
- CN Location:** See **Figure 3-32**
- CN Pinouts:** See **Table 3-31** and **Table 3-32**

The USB 2.0 connector can be connected to a USB 2.0/1.1 device.

Pin	Description	Pin	Description
1	VCC	5	VCC
2	USB_DATA-	6	USB_DATA-
3	USB_DATA+	7	USB_DATA+
4	GND	8	GND

**Table 3-31: USB 2.0 Port Pinouts**

The PS/2 port is for connecting a PS/2 mouse or keyboard.

Pin	Description
9	GND
10	Keyboard Data
11	Mouse Data
12	VCC
13	Keyboard Clock
14	Mouse Clock

**Table 3-32: PS/2 Connector Pinouts**

**3.3.5 Serial Port and VGA Connectors**

- CN Label:** COM1, VGA1
- CN Type:** DB-9 male, DB-15 female
- CN Location:** See **Figure 3-32**
- CN Pinouts:** See **Table 3-33** and **Table 3-34**

The serial port connects to a RS-232 serial communications device.

Pin	Description	Pin	Description
1	DATA CARRIER DETECT	6	DATA SET READY
2	RECEIVE DATA	7	REQUEST TO SEND
3	TRANSMIT DATA	8	CLEAR TO SEND
4	DATA TERMINAL READY	9	RING INDICATOR
5	GND		

**Table 3-33: Serial Port Connector Pinouts**

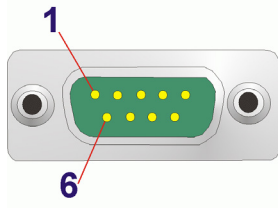

**Figure 3-35: Serial Port Connector Pinouts**

Pin	Description	Pin	Description
1	RED	2	GREEN
3	BLUE	4	NC
5	GND	6	GND
7	GND	8	GND
9	VCC / NC	10	GND
11	NC	12	DDC DAT
13	HSYNC	14	VSYNC
15	DDCCLK		

**Table 3-34: VGA Connector Pinouts**

## IMBA-H112 ATX Motherboard

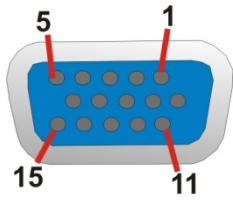

Figure 3-36: VGA Connector

Chapter

4

# Installation

---

## IMBA-H112 ATX Motherboard

### 4.1 Anti-static Precautions

---



#### WARNING:

Failure to take ESD precautions during the installation of the IMBA-H112 may result in permanent damage to the IMBA-H112 and severe injury to the user.

---

Electrostatic discharge (ESD) can cause serious damage to electronic components, including the IMBA-H112. Dry climates are especially susceptible to ESD. It is therefore critical that whenever the IMBA-H112 or any other electrical component is handled, the following anti-static precautions are strictly adhered to.

- **Wear an anti-static wristband:** - Wearing a simple anti-static wristband can help to prevent ESD from damaging the board.
- **Self-grounding:**- Before handling the board touch any grounded conducting material. During the time the board is handled, frequently touch any conducting materials that are connected to the ground.
- **Use an anti-static pad:** When configuring the IMBA-H112, place it on an anti-static pad. This reduces the possibility of ESD damaging the IMBA-H112.
- **Only handle the edges of the PCB:-:** When handling the PCB, hold the PCB by the edges.

### 4.2 Installation Considerations

---



#### NOTE:

The following installation notices and installation considerations should be read and understood before installation. All installation notices must be strictly adhered to. Failing to adhere to these precautions may lead to severe damage and injury to the person performing the installation.

---

**WARNING:**

The installation instructions described in this manual should be carefully followed in order to prevent damage to the components and injury to the user.

Before and during the installation please **DO** the following:

- Read the user manual:
  - The user manual provides a complete description of the IMBA-H112 installation instructions and configuration options.
- Wear an electrostatic discharge cuff (ESD):
  - Electronic components are easily damaged by ESD. Wearing an ESD cuff removes ESD from the body and helps prevent ESD damage.
- Place the IMBA-H112 on an anti-static pad:
  - When installing or configuring the motherboard, place it on an anti-static pad. This helps to prevent potential ESD damage.
- Turn all power to the IMBA-H112 off:
  - When working with the IMBA-H112, make sure that it is disconnected from all power supplies and that no electricity is being fed into the system.

Before and during the installation of the IMBA-H112, **DO NOT**:

- Remove any of the stickers on the PCB board. These stickers are required for warranty validation.
- Use the product before verifying all the cables and power connectors are properly connected.
- Allow screws to come in contact with the PCB circuit, connector pins, or its components.

## IMBA-H112 ATX Motherboard

### 4.3 Socket LGA1151 CPU Installation

---



#### **WARNING:**

CPUs are expensive and sensitive components. When installing the CPU please be careful not to damage it in anyway. Make sure the CPU is installed properly and ensure the correct cooling kit is properly installed.

DO NOT touch the pins at the bottom of the CPU. When handling the CPU, only hold it on the sides.

---

To install the CPU, follow the steps below.

**Step 1:** **Disengage the load lever** by pressing the lever down and slightly outward to clear the retention tab. Fully open the lever. See **Figure 4-1**.

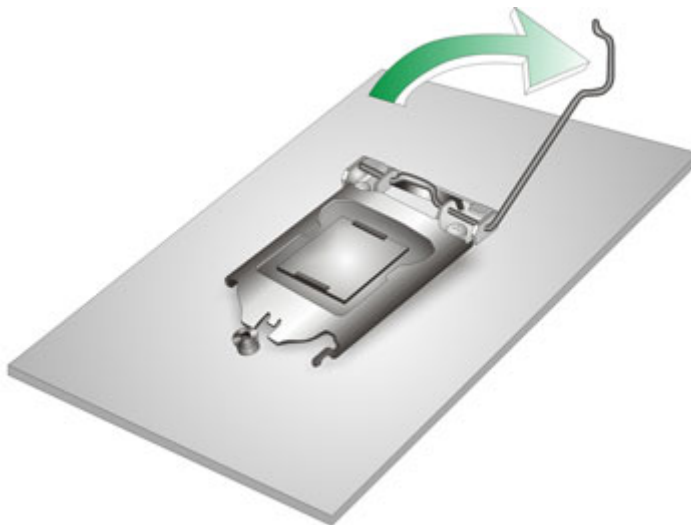

**Figure 4-1: Disengage the CPU Socket Load Lever**

**Step 2:** **Open the socket and remove the protective cover.** The black protective cover can be removed by pulling up on the tab labeled "Remove". See **Figure 4-2**.

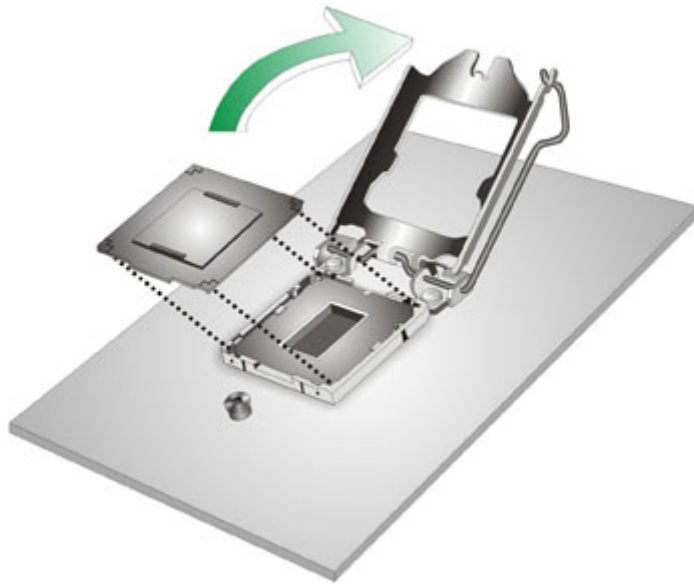

**Figure 4-2: Remove Protective Cover**

- Step 3: Inspect the CPU socket.** Make sure there are no bent pins and make sure the socket contacts are free of foreign material. If any debris is found, remove it with compressed air.
- Step 4: Orientate the CPU properly.** The contact array should be facing the CPU socket.



**WARNING:**

DO NOT touch the pins at the bottom of the CPU. When handling the CPU, only hold it on the sides.

- 
- Step 5: Correctly position the CPU.** Match the Pin 1 mark with the cut edge on the CPU socket.
- Step 6: Align the CPU pins.** Locate pin 1 and the two orientation notches on the CPU. Carefully match the two orientation notches on the CPU with the socket alignment keys.



## IMBA-H112 ATX Motherboard

**Step 7: Insert the CPU.** Gently insert the CPU into the socket. If the CPU pins are properly aligned, the CPU should slide into the CPU socket smoothly. See **Figure 4-3**.

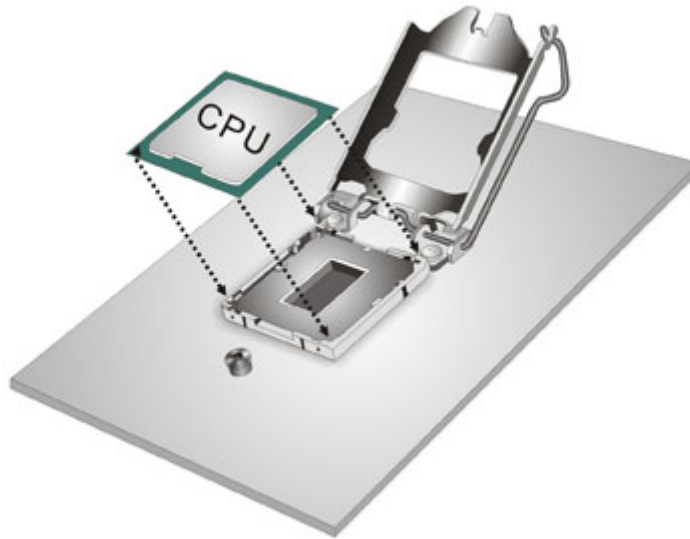

**Figure 4-3: Insert the Socket LGA1151 CPU**

**Step 8: Close the CPU socket.** Close the load plate and pull the load lever back a little to have the load plate be able to secure to the knob. Engage the load lever by pushing it back to its original position (**Figure 4-4**). There will be some resistance, but will not require extreme pressure.

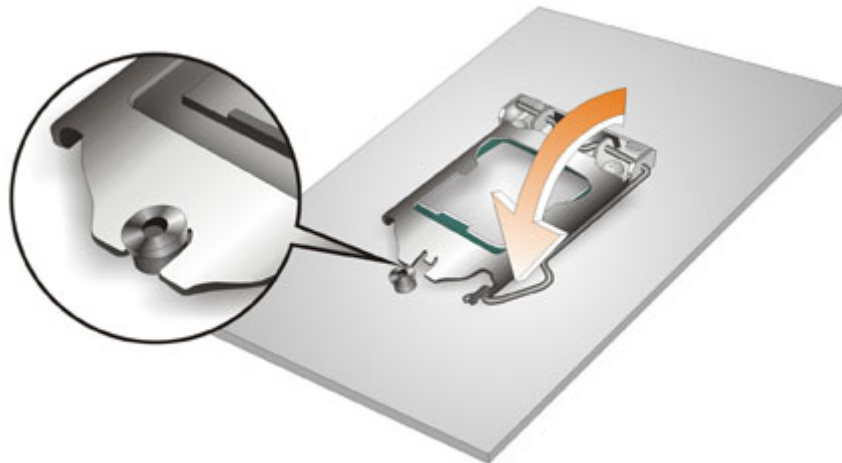

**Figure 4-4: Close the Socket LGA1151**

**Step 9:** Connect the 12 V power to the board. Connect the 12 V power from the power supply to the board.

## 4.4 Socket LGA1151 Cooling Kit Installation

---



### **WARNING:**

**DO NOT** attempt to install a push-pin cooling fan.

The pre-installed support bracket prevents the board from bending and is **ONLY** compatible with captive screw type cooling fans.

---

The cooling kit can be bought from IEI. The cooling kit has a heat sink and fan.

---



### **WARNING:**

Do not wipe off (accidentally or otherwise) the pre-sprayed layer of thermal paste on the bottom of the heat sink. The thermal paste between the CPU and the heat sink is important for optimum heat dissipation.

---

To install the cooling kit, follow the instructions below.

**Step 1:** A cooling kit bracket is pre-installed on the rear of the motherboard. See **Figure 4-5**.

## IMBA-H112 ATX Motherboard

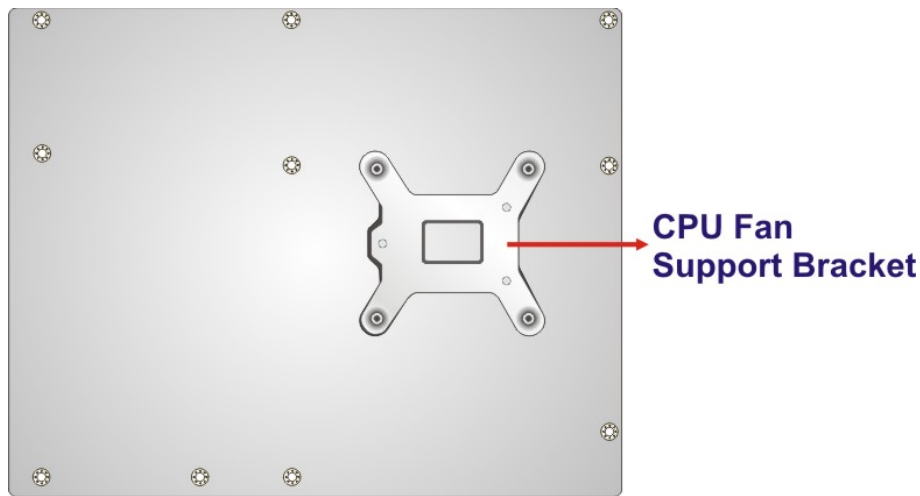

**Figure 4-5: Cooling Kit Support Bracket**

- Step 2:** Place the cooling kit onto the socket LGA1151 CPU. Make sure the CPU cable can be properly routed when the cooling kit is installed.
- Step 3:** Mount the cooling kit. Gently place the cooling kit on top of the CPU. Make sure the four threaded screws on the corners of the cooling kit properly pass through the holes of the cooling kit bracket.
- Step 4:** Tighten the screws. Use a screwdriver to tighten the four screws. In a diagonal pattern, tighten each screw a few turns then move to the next one, until they are all secured. Do not overtighten the screws.
- Step 5:** Connect the fan cable. Connect the cooling kit fan cable to the CPU fan connector on the IMBA-H112. Carefully route the cable and avoid heat generating chips and fan blades.

## 4.5 DIMM Installation



### CAUTION:

For dual channel configuration, always install two identical memory modules that feature the same capacity, timings, voltage, number of ranks and the same brand.

To install a DIMM, please follow the steps below and refer to **Figure 4-6**.

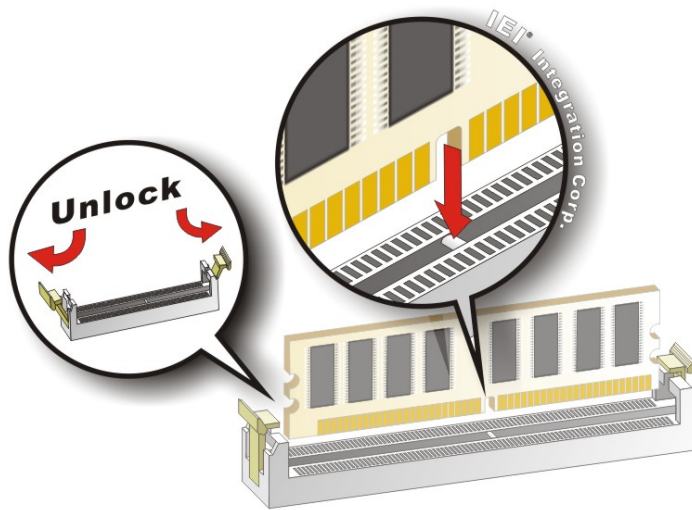

**Figure 4-6: DIMM Installation**

- Step 1: Open the DIMM socket handles.** Open the two handles outwards as far as they can. See **Figure 4-6**.
- Step 2: Align the DIMM with the socket.** Align the DIMM so the notch on the memory lines up with the notch on the memory socket. See **Figure 4-6**.
- Step 3: Insert the DIMM.** Once aligned, press down until the DIMM is properly seated. Clip the two handles into place. See **Figure 4-6**.
- Step 4:** To remove a DIMM, push both handles outward. The memory module is ejected by a mechanism in the socket.

## IMBA-H112 ATX Motherboard

### 4.6 Full-size PCIe Mini Card Installation

The PCIe Mini card slot allows installation of either a full-size or half-size PCIe Mini card. To install a full-size PCIe Mini card, please follow the steps below.

**Step 1:** Locate the PCIe Mini card slot. See **Chapter 3**.

**Step 2:** Remove the retention screw. Remove the retention screw as shown in **Figure 4-7**.

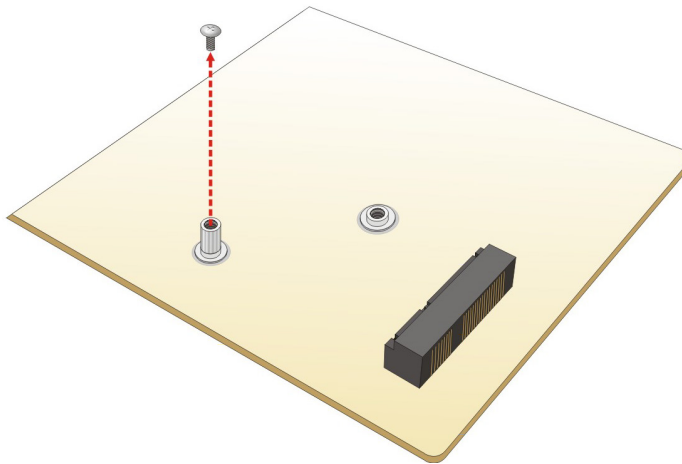

**Figure 4-7: Removing the Retention Screw**

**Step 3:** Insert into the socket at an angle. Line up the notch on the card with the notch on the slot. Slide the PCIe Mini card into the socket at an angle of about 20° (**Figure 4-8**).

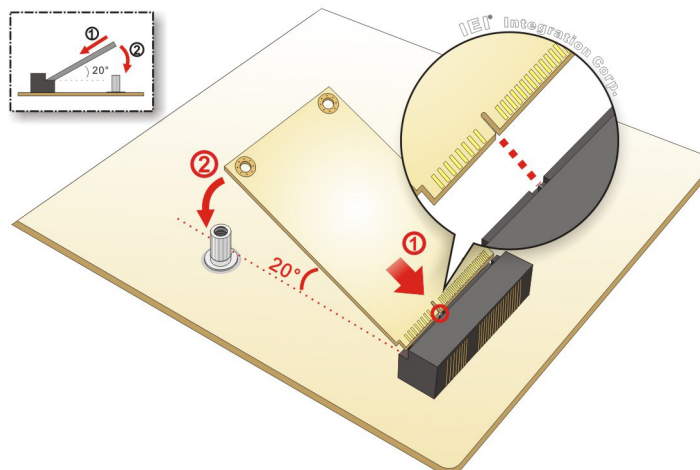

**Figure 4-8: Inserting the Full-size PCIe Mini Card into the Slot at an Angle**

**Step 4:** **Secure the full-size PCIe Mini card.** Secure the full-size PCIe Mini card with the retention screw previously removed (**Figure 4-9**).

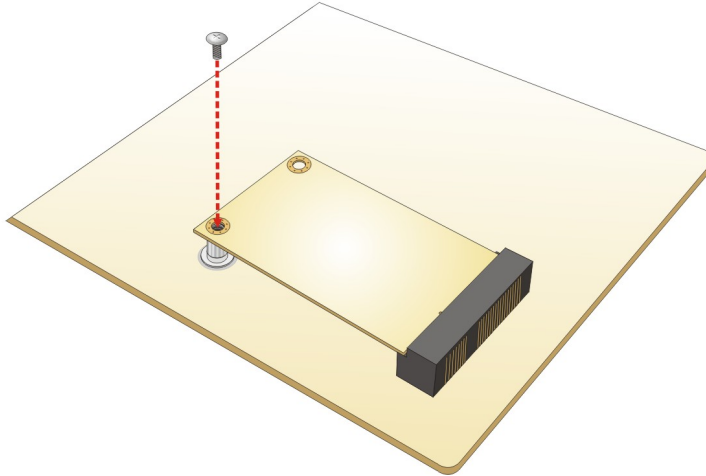

**Figure 4-9: Securing the Full-size PCIe Mini Card**

## 4.7 Half-size PCIe Mini Card Installation

The PCIe Mini card slot allows installation of either a full-size or half-size PCIe Mini card. To install a half-size PCIe Mini card, please follow the steps below.

**Step 1:** **Locate the PCIe Mini card slot.** See **Chapter 3**.

**Step 2:** **Install the standoff to the screw hole for the half-size PCIe Mini card.** Install the supplied standoff to the screw hole for the half-size PCIe Mini card (**Figure 4-10**).

## IMBA-H112 ATX Motherboard

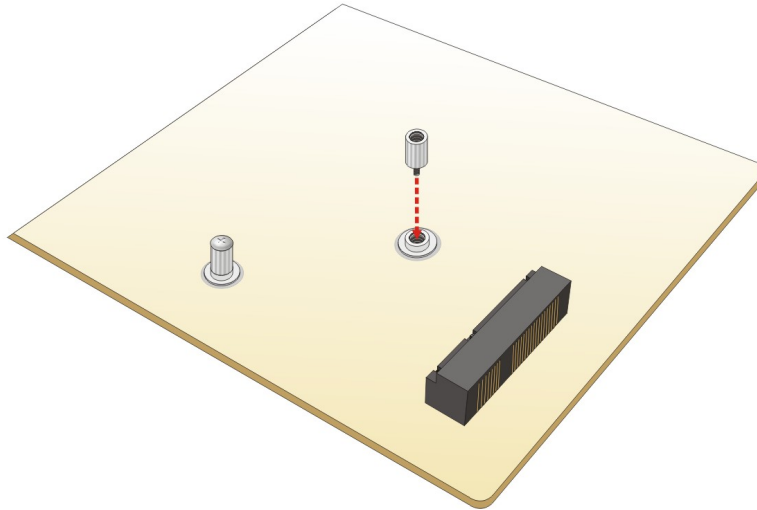

Figure 4-10: Installing the Standoff

**Step 3:** Insert into the socket at an angle. Line up the notch on the card with the notch on the slot. Slide the PCIe Mini card into the slot at an angle of about 20° (Figure 4-11).

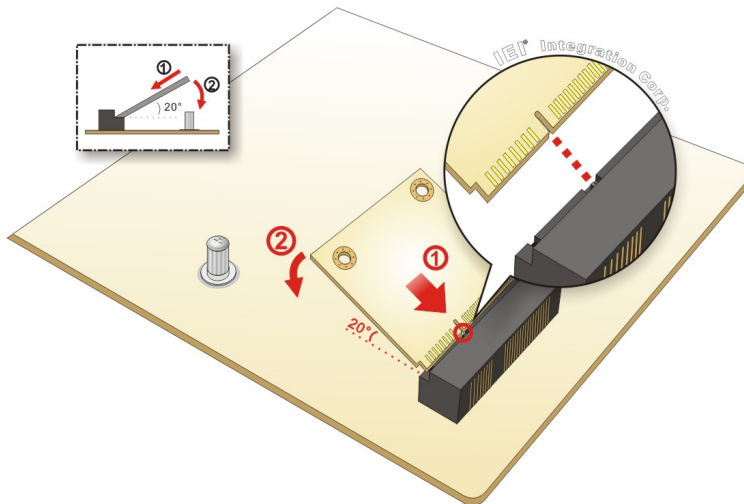
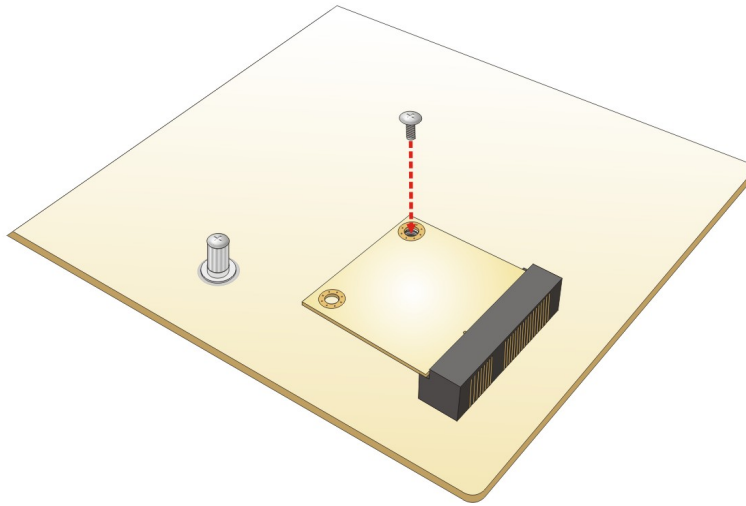

Figure 4-11: Inserting the Half-size PCIe Mini Card into the Slot at an Angle

**Step 4:** Secure the half-size PCIe Mini card. Secure the half-size PCIe Mini card with the supplied retention screw (Figure 4-12).



**Figure 4-12: Securing the Half-size PCIe Mini Card**

## 4.8 System Configuration

The system configuration should be performed before installation.

### 4.8.1 AT/ATX Power Mode Setting

The AT and ATX power mode selection is made through the AT/ATX power mode switch which is shown in **Figure 4-13**.

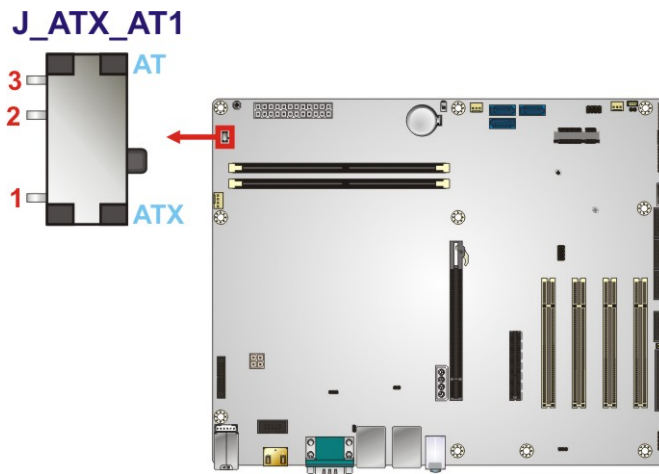

**Figure 4-13: AT/ATX Power Mode Switch Location**



## IMBA-H112 ATX Motherboard

Setting	Description
1-2	ATX power mode (default)
2-3	AT power mode

**Table 4-1: AT/ATX Power Mode Switch Settings**

### 4.8.2 Clear CMOS Button

To reset the BIOS, remove the on-board battery and press the clear CMOS button for three seconds or more. The clear CMOS button location is shown in **Figure 4-14**.

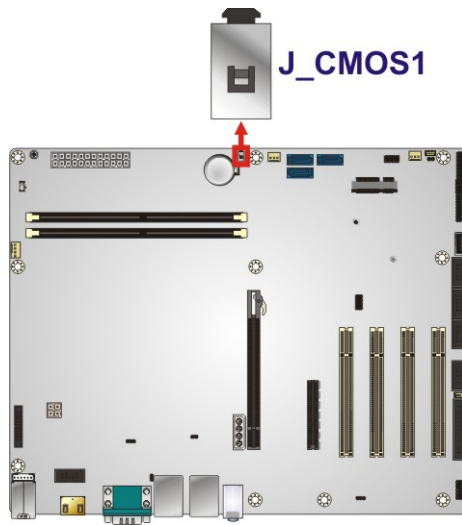

**Figure 4-14: Clear CMOS Button Location**

### 4.8.3 Flash Descriptor Security Override

The Flash Descriptor Security Override jumper (J\_FLASH1) allows to enable or disable the ME firmware update. Refer to **Figure 4-15** and **Table 4-2** for the jumper location and settings.

Setting	Description
Short 1-2	Disabled (default)
Short 2-3	Enabled

**Table 4-2: Flash Descriptor Security Override Jumper Settings**

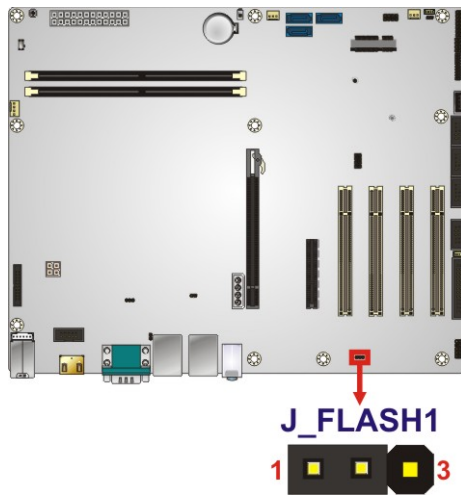

**Figure 4-15: Flash Descriptor Security Override Jumper Location**

To update the ME firmware, please follow the steps below.

- Step 1:** Before turning on the system power, short pin 2-3 of the Flash Descriptor Security Override jumper.
- Step 2:** Update the BIOS and ME firmware, and then turn off the system power.
- Step 3:** Remove the metal clip on the Flash Descriptor Security Override jumper or return to its default setting (short pin 1-2).
- Step 4:** Restart the system. The system will reboot 2 ~ 3 times to complete the ME firmware update.

## IMBA-H112 ATX Motherboard

### 4.8.4 USB Power Selection

The USB power selection is made through the BIOS menu in “Chipset → PCH-IO Configuration”. Use the **USB Power SW1** and the **USB Power SW2** BIOS options to configure the correspondent USB ports (see **Table 4-3**) and refer to **Table 4-4** to select the USB power source.

BIOS Options	Configured USB Ports
USB Power SW1	LAN1_USB1 (external USB 3.0 ports) LAN2_USB2 (external USB 3.0 ports) K/M_USB1 (external USB 2.0 ports)
USB Power SW2	USB1 (internal USB 2.0 ports) USB2-3 (internal USB 2.0 port, Type A)

**Table 4-3: BIOS Options and Configured USB Ports**

Options	Description
+5V DUAL	+5V dual (default)
+5V	+5V

**Table 4-4: USB Power Source Setup**

Please refer to **Section 5.4.2** for detailed information.

## 4.9 Internal Peripheral Device Connections

This section outlines the installation of peripheral devices to the onboard connectors.

### 4.9.1 SATA Drive Connection

The IMBA-H112 is shipped with two SATA drive cables. To connect the SATA drives to the connectors, please follow the steps below.

**Step 1: Locate the connectors.** The locations of the SATA drive connectors are shown in **Chapter 3**.

**Step 2: Insert the cable connector.** Insert the cable connector into the on-board SATA drive connector until it clips into place. See **Figure 4-16**.

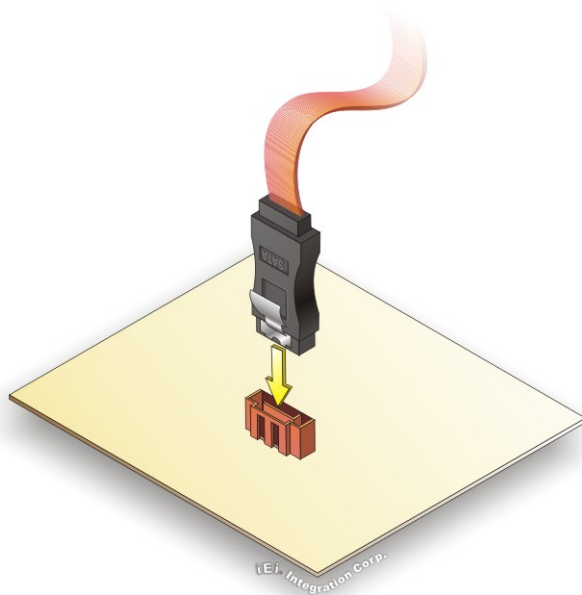

**Figure 4-16: SATA Drive Cable Connection**

- Step 3:** Connect the cable to the SATA disk. Connect the connector on the other end of the cable to the connector at the back of the SATA drive. See **Figure 4-17**.
- Step 4:** Connect the SATA power cable. Connect the SATA power connector to the back of the SATA drive. See **Figure 4-17**.

## IMBA-H112 ATX Motherboard

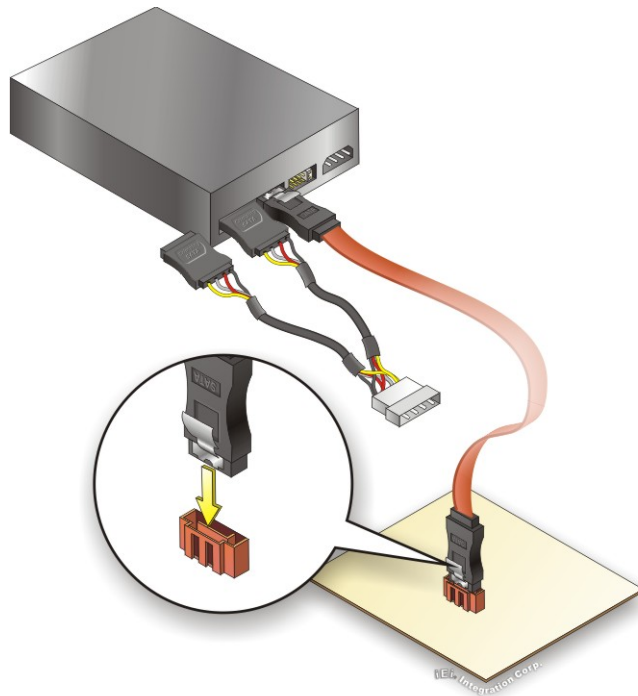

**Figure 4-17: SATA Power Drive Connection**

The SATA power cable can be bought from IEI. See Optional Items in Section 2.4.

### 4.10 Adding USB 3.0 Drivers to a Windows 7 Installation Image

The Windows 7 installation media does not include native driver support for USB 3.0. In order to use the USB keyboard or mouse connected to a USB 3.0 port during OS installation, the user has to update the Windows 7 installation image so that it contains USB 3.0 drivers. Please follow the instructions below to complete the task.

**Step 1:** Prepare a USB flash drive installer.

On a working computer, use your Windows 7 DVD or ISO image to create a bootable USB flash drive.

**Step 2:** Download the Windows 7 USB 3.0 Creator Utility from:

<https://downloadcenter.intel.com/download/25476/Windows-7-USB-3-0-Creator-Utility>.

**Step 3:** Extract the downloaded file to a temporary folder on a computer where the user has logged in as the administrator.

**NOTE:**

The OS version of the computer can be Windows 7, Windows 8.1 or Windows 10.

---

**Step 4:** Connect the USB drive containing the Windows 7 installation image to the computer.

**Step 5:** Right click on **Installer\_Creator.exe** from the extracted files and select **Run as administrator**.

**Step 6:** The Windows 7 USB 3.0 Creator Utility screen appears (**Figure 4-18**). Click  to browse to the root of the USB drive containing the Windows 7 image.

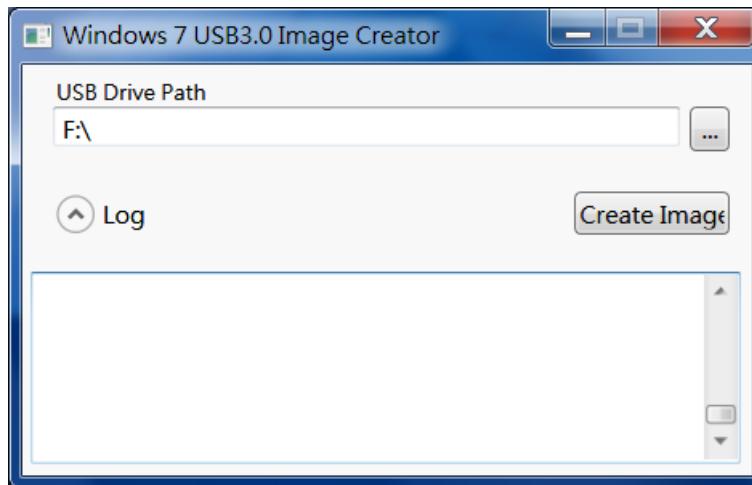
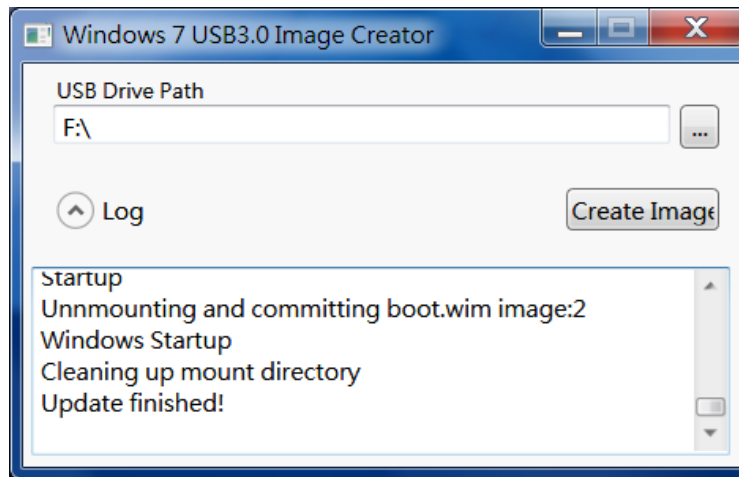

**Figure 4-18: Windows 7 USB 3.0 Creator Utility**

**Step 7:** Click **Create Image** to start the update process.

## IMBA-H112 ATX Motherboard

**Step 8:** Wait for the process to finish. It may take up to 15 minutes.

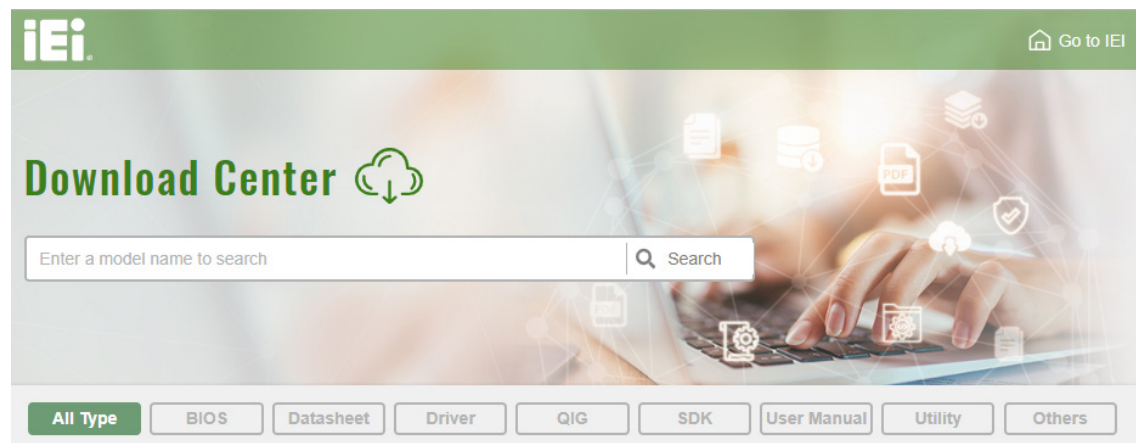

**Figure 4-19: Update Process is Complete**

**Step 9:** Now the user can proceed with the Windows 7 installation using the updated installer.

### 4.11 Driver Installation

All the drivers for the IMBA-H112 are available on IEI Resource Download Center (<https://download.ieiworld.com>). Type IMBA-H112 and press Enter to find all the relevant software, utilities, and documentation.

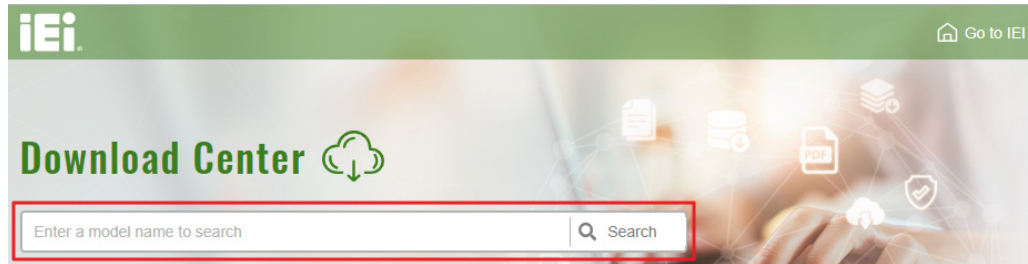

**Figure 4-20: IEI Resource Download Center**

### 4.11.1 Driver Download

To download drivers from IEI Resource Download Center, follow the steps below.

**Step 1:** Go to <https://download.ieiworld.com>. Type IMBA-H112 and press Enter.



**Step 2:** All product-related software, utilities, and documentation will be listed. You can choose **Driver** to filter the result.

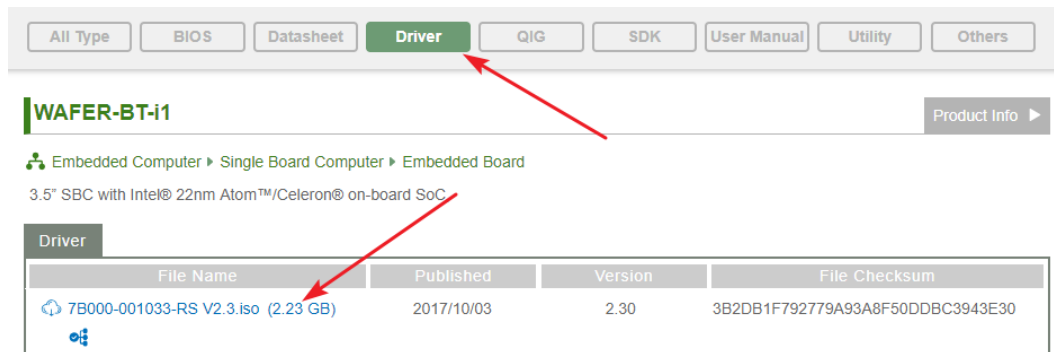

**Step 3:** Click the driver file name on the page and you will be prompted with the following window. You can download the entire ISO file (❶), or click the small arrow to find an individual driver and click the file name to download (❷).



## IMBA-H112 ATX Motherboard

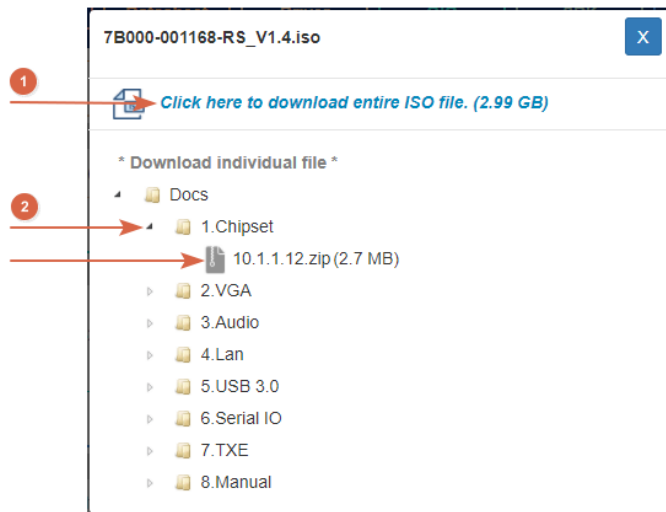

### NOTE:

To install software from the downloaded ISO image file in Windows 8, 8.1 or 10, double-click the ISO file to mount it as a virtual drive to view its content. On Windows 7 system, an additional tool (such as Virtual CD-ROM Control Panel from Microsoft) is needed to mount the file.

Chapter

5

**BIOS**

---

## IMBA-H112 ATX Motherboard

### 5.1 Introduction

The BIOS is programmed onto the BIOS chip. The BIOS setup program allows changes to certain system settings. This chapter outlines the options that can be changed.



#### NOTE:

Some of the BIOS options may vary throughout the life cycle of the product and are subject to change without prior notice.

---

#### 5.1.1 Starting Setup

The UEFI BIOS is activated when the computer is turned on. The setup program can be activated in one of two ways.

1. Press the **DEL** or **F2** key as soon as the system is turned on or
2. Press the **DEL** or **F2** key when the “**Press DEL or F2 to enter SETUP**” message appears on the screen.

If the message disappears before the **DEL** or **F2** key is pressed, restart the computer and try again.

#### 5.1.2 Using Setup

Use the arrow keys to highlight items, press **ENTER** to select, use the PageUp and PageDown keys to change entries, press **F1** for help and press **ESC** to quit. Navigation keys are shown in the following table.

Key	Function
Up arrow	Move to previous item
Down arrow	Move to next item
Left arrow	Move to the item on the left hand side
Right arrow	Move to the item on the right hand side
+	Increase the numeric value or make changes
-	Decrease the numeric value or make changes

Key	Function
Page Up	Move to the previous page
Page Dn	Move to the next page
Esc	Main Menu – Quit and not save changes into CMOS Status Page Setup Menu and Option Page Setup Menu -- Exit current page and return to Main Menu
F1	General help, only for Status Page Setup Menu and Option Page Setup Menu
F2	Load previous values
F3	Load optimized defaults
F4	Save changes and Exit BIOS

**Table 5-1: BIOS Navigation Keys**

### 5.1.3 Getting Help

When **F1** is pressed, a small help window describing the appropriate keys to use and the possible selections for the highlighted item appears. To exit the Help Window, press **Esc**.

### 5.1.4 Unable to Reboot after Configuration Changes

If the computer cannot boot after changes to the system configuration is made, CMOS defaults. Use the clear CMOS button described in **Chapter 4**.

### 5.1.5 BIOS Menu Bar

The **menu bar** on top of the BIOS screen has the following main items:

- Main – Changes the basic system configuration.
- Advanced – Changes the advanced system settings.
- Chipset – Changes the chipset settings.
- Boot – Changes the system boot configuration.
- Security – Sets User and Supervisor Passwords.
- Save & Exit – Selects exit options and loads default settings

The following sections completely describe the configuration options found in the menu items at the top of the BIOS screen and listed above.

## IMBA-H112 ATX Motherboard

### 5.2 Main

The **Main** BIOS menu (**BIOS Menu 1**) appears when the **BIOS Setup** program is entered.

The **Main** menu gives an overview of the basic system information.

```

Aptio Setup Utility - Copyright (C) 2019 American Megatrends, Inc.
Main  Advanced  Chipset  Security  Boot  Save & Exit

BIOS Information
BIOS Vendor                American Megatrends
Core Version                5.12
Compliance                 UEFI 2.5; PI 1.4
Project Version            SAL7AR06.ROM
Build Date and Time        09/11/2019 09:15:10

iWDD Vendor                iEi
iWDD Version               SALER10.bin

Processor Information
Name                       SkyLake DT
Type                       Intel(R) Core(TM)
                           i5-6500TE CPU @ 2.30GHz
Frequency                  2300 MHz
ID                          506E3
Stepping                   R0/S0/N0
Number of Processors       4Core(s) / 4Thread(s)
Microcode Revision         7C
GT Info                    GT2

IGFX VBIOS Version         1049
Memory RC Version          1.5.0.0
Total Memory               8192 MB
Memory Frequency           2400 MHz

PCH Information
Name                       SKL PCH-H
PCH SKU                    H110
Stepping                   D1
LAN PHY Revision           A6 (B2 Stepping)

ME FW Version               11.8.65.3590
ME Firmware SKU            Consumer SKU

SPI Clock Frequency
Dual Output Fast Read support  Not supported
Read ID/Status Clock Freq   17 MHz
Write and Erase Clock Freq  48 MHz
Fast Read Clock Freq        48 MHz

Access Level                Administrator

System Date                 [Thu 10/27/2019]
System Time                 [15:10:27]

-----
-><: Select Screen
↑ ↓: Select Item
Enter: Select
+/-: Change Opt.
F1:  General Help
F2:  Previous Values
F3:  Optimized Defaults
F4:  Save & Exit
ESC: Exit

Version 2.18.1263. Copyright (C) 2019 American Megatrends, Inc.
    
```

**BIOS Menu 1: Main**

The **Main** menu has two user configurable fields:

→ **System Date [xx/xx/xx]**

Use the **System Date** option to set the system date. Manually enter the day, month and year.

→ **System Time [xx:xx:xx]**

Use the **System Time** option to set the system time. Manually enter the hours, minutes and seconds.

### 5.3 Advanced

Use the **Advanced** menu (**BIOS Menu 2**) to configure the CPU and peripheral devices through the following sub-menus:



#### WARNING!

Setting the wrong values in the sections below may cause the system to malfunction. Make sure that the settings made are compatible with the hardware.

```

Aptio Setup Utility - Copyright (C) 2019 American Megatrends, Inc.
Main  Advanced  Chipset  Security  Boot  Save & Exit
-----
> CPU Configuration
> ACPI Settings
> F81866 Super IO Configuration
> iWDD H/M Monitor
> RTC Wake Settings
> Serial Port Console Redirection
> NVMe Configuration
> USB Configuration
> iEi Feature

Trusted Computing
Settings
-----
→←: Select Screen
↑ ↓: Select Item
Enter: Select
+/-: Change Opt.
F1: General Help
F2: Previous Values
F3: Optimized Defaults
F4: Save & Exit
ESC: Exit

Version 2.18.1263. Copyright (C) 2019 American Megatrends, Inc.
    
```

**BIOS Menu 2: Advanced**

## IMBA-H112 ATX Motherboard

### 5.3.1 CPU Configuration

Use the **CPU Configuration** menu (**BIOS Menu 3**) to view detailed CPU specifications or enable the Intel Virtualization Technology.

```

Aptio Setup Utility - Copyright (C) 2019 American Megatrends, Inc.
  Advanced
CPU Configuration
Type                Intel(R) Core(TM)
                   i5-6500TE CPU @
                   2.30GHz
ID                  506E3
Speed               2300 MHz
L1 Data Cache      32 kB x 4
L1 Code Cache      32 kB x 4
L2 Cache           256 kB x 4
L3 Cache           6 MB
L4 Cache           N/A
VMX                 Supported
SMX/TXT            Supported

Intel Virtualization Technology [Disabled]
Active Processor Cores [All]
Hyper-Threading     [Enabled]
Intel(R) SpeedStep(tm) [Enabled]
CPU C states        [Disabled]

When enabled, a VMM can
utilize the additional
hardware capabilities
provided by Vanderpool
Technology.

-----
-><: Select Screen
↑ ↓: Select Item
Enter: Select
+/-: Change Opt.
F1: General Help
F2: Previous Values
F3: Optimized Defaults
F4: Save & Exit
ESC: Exit

Version 2.18.1263. Copyright (C) 2019 American Megatrends, Inc.
  
```

#### BIOS Menu 3: CPU Configuration

##### ➔ Intel Virtualization Technology [Disabled]

Use the **Intel Virtualization Technology** option to enable or disable virtualization on the system. When combined with third party software, Intel® Virtualization technology allows several OSs to run on the same system at the same time.

- ➔ **Disabled**                      **DEFAULT**      Disables Intel Virtualization Technology.
- ➔ **Enabled**    Enables Intel Virtualization Technology.

##### ➔ Active Processor Cores [All]

Use the **Active Processor Cores** BIOS option to enable numbers of cores in the processor package.

- **All**            **DEFAULT**    Enable all cores in the processor package.
- **1**                    Enable one core in the processor package.
- **2**                    Enable two cores in the processor package.
- **3**                    Enable three cores in the processor package.

→ **Hyper-Threading [Enabled]**

Use the **Hyper-Threading** option to enable or disable the Hyper-Threading Technology.

- **Disabled**                            Disables Hyper-Threading Technology
- **Enabled**                    **DEFAULT**    Enables Hyper-Threading Technology

→ **Intel(R) SpeedStep(tm) [Enabled]**

Use the **Intel(R) SpeedStep(tm)** option to enable or disable the Intel® SpeedStep Technology which allows more than two frequency ranges to be supported.

- **Disabled**                            Disables Intel® SpeedStep Technology
- **Enabled**                    **DEFAULT**    Enables Intel® SpeedStep Technology

→ **CPU C states [Disabled]**

Use the **CPU C states** option to enable or disable the CPU C states.

- **Enabled**                            Enables the CPU C states.
- **Disabled**                    **DEFAULT**    Disables the CPU C states.



## IMBA-H112 ATX Motherboard

### 5.3.2 ACPI Settings

The **ACPI Settings** menu (**BIOS Menu 4**) configures the Advanced Configuration and Power Interface (ACPI) options.

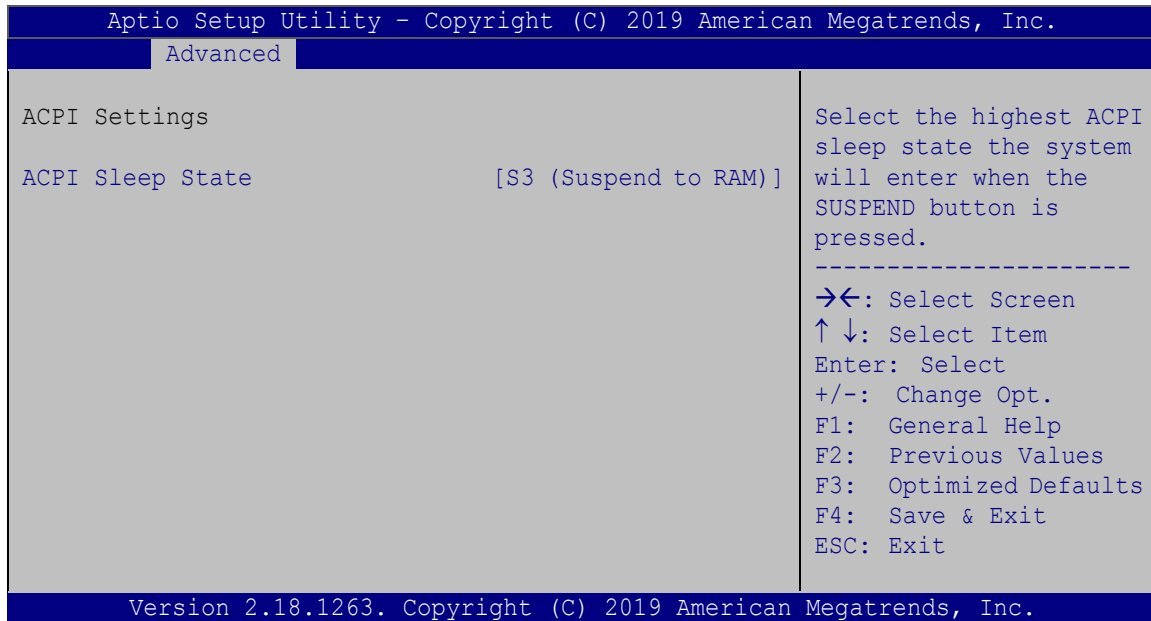

#### BIOS Menu 4: ACPI Configuration

##### → ACPI Sleep State [S3 (Suspend to RAM)]

Use the **ACPI Sleep State** option to specify the sleep state the system enters when it is not being used.

- **S3 (Suspend to RAM)**      **DEFAULT**      The caches are flushed and the CPU is powered off. Power to the RAM is maintained. The computer returns slower to a working state, but more power is saved.

### 5.3.3 F81866 Super IO Configuration

Use the **F81866 Super IO Configuration** menu (**BIOS Menu 5**) to set or change the configurations for the parallel ports and serial ports.

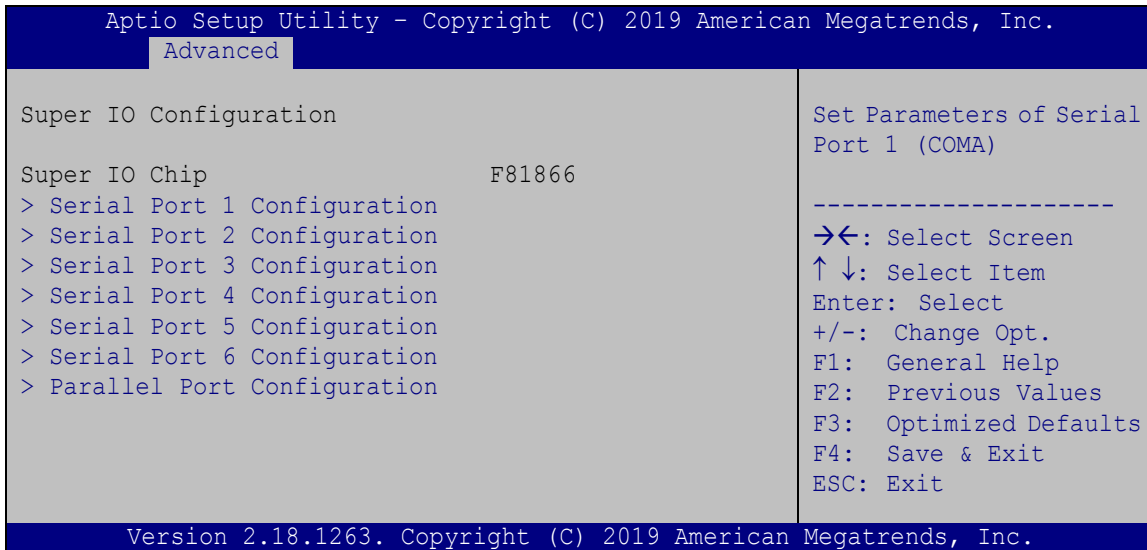

**BIOS Menu 5: F81866 Super IO Configuration**

#### 5.3.3.1 Serial Port 1 ~ 6 Configuration

Use the **Serial Port 1 ~ 6 Configuration** menu (**BIOS Menu 6**) to configure the serial ports.

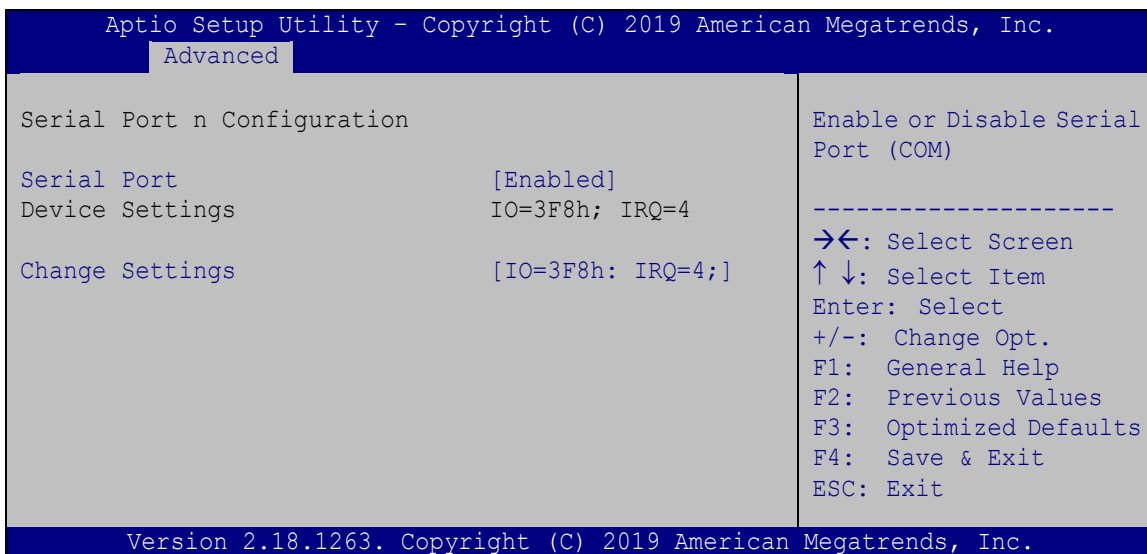

**BIOS Menu 6: Serial Port 1 ~ 6 Configuration Menu**

## IMBA-H112 ATX Motherboard

### 5.3.3.2 Serial Port 1 Configuration

#### → Serial Port [Enabled]

Use the **Serial Port** option to enable or disable the serial port.

- **Disabled**                                      Disable the serial port
- **Enabled**            **DEFAULT**            Enable the serial port

#### → Change Settings [IO=3F8h; IRQ=4;]

Use the **Change Settings** option to change the serial port IO port address and interrupt address.

- **IO=3F8h;      DEFAULT**            Serial Port I/O port address is 3F8h and the interrupt address is IRQ4
- **IO=3F8h;                                      Serial Port I/O port address is 3F8h and the interrupt**  
**IRQ=3, 4, 11**                                      address is IRQ3, 4, 11
- **IO=2F8h;                                      Serial Port I/O port address is 2F8h and the interrupt**  
**IRQ=3, 4, 11**                                      address is IRQ3, 4, 11
- **IO=3E8h;                                      Serial Port I/O port address is 3E8h and the interrupt**  
**IRQ=3, 4, 11**                                      address is IRQ3, 4, 11
- **IO=2E8h;                                      Serial Port I/O port address is 2E8h and the interrupt**  
**IRQ=3, 4, 11**                                      address is IRQ3, 4, 11

### 5.3.3.3 Serial Port 2 Configuration

#### → Serial Port [Enabled]

Use the **Serial Port** option to enable or disable the serial port.

- **Disabled**                                      Disable the serial port
- **Enabled**            **DEFAULT**            Enable the serial port

### → Change Settings [IO=2F8h; IRQ=3;]

Use the **Change Settings** option to change the serial port IO port address and interrupt address.

- **IO=2F8h;      DEFAULT**      Serial Port I/O port address is 2F8h and the interrupt address is IRQ3  
**IRQ=3**
- **IO=3F8h;**                      Serial Port I/O port address is 3F8h and the interrupt address is IRQ3, 4, 11  
**IRQ=3, 4, 11**
- **IO=2F8h;**                      Serial Port I/O port address is 2F8h and the interrupt address is IRQ3, 4, 11  
**IRQ=3, 4, 11**
- **IO=3E8h;**                      Serial Port I/O port address is 3E8h and the interrupt address is IRQ3, 4, 11  
**IRQ=3, 4, 11**
- **IO=2E8h;**                      Serial Port I/O port address is 2E8h and the interrupt address is IRQ3, 4, 11  
**IRQ=3, 4, 11**

### 5.3.3.4 Serial Port 3 Configuration

#### → Serial Port [Enabled]

Use the **Serial Port** option to enable or disable the serial port.

- **Disabled**                      Disable the serial port
- **Enabled      DEFAULT**      Enable the serial port

#### → Change Settings [IO=3E8h; IRQ=11;]

Use the **Change Settings** option to change the serial port IO port address and interrupt address.

- **IO=3E8h;      DEFAULT**      Serial Port I/O port address is 3E8h and the interrupt address is IRQ11  
**IRQ=11**
- **IO=3F8h;**                      Serial Port I/O port address is 3F8h and the interrupt address is IRQ3, 4, 11  
**IRQ=3, 4, 11**

## IMBA-H112 ATX Motherboard

- ➔ **IO=2F8h;**  
**IRQ=3, 4, 11**      Serial Port I/O port address is 2F8h and the interrupt address is IRQ3, 4, 11
- ➔ **IO=3E8h;**  
**IRQ=3, 4, 11**      Serial Port I/O port address is 3E8h and the interrupt address is IRQ3, 4, 11
- ➔ **IO=2E8h;**  
**IRQ=3, 4, 11**      Serial Port I/O port address is 2E8h and the interrupt address is IRQ3, 4, 11

### 5.3.3.4.1 Serial Port 4 Configuration

#### ➔ Serial Port [Enabled]

Use the **Serial Port** option to enable or disable the serial port.

- ➔ **Disabled**      Disable the serial port
- ➔ **Enabled**      **DEFAULT**      Enable the serial port

#### ➔ Change Settings [IO=2E8h; IRQ=11;]

Use the **Change Settings** option to change the serial port IO port address and interrupt address.

- ➔ **IO=2E8h;      DEFAULT**      Serial Port I/O port address is 2E8h and the interrupt address is IRQ11
- ➔ **IO=3F8h;**  
**IRQ=3, 4, 11**      Serial Port I/O port address is 3F8h and the interrupt address is IRQ3, 4, 11
- ➔ **IO=2F8h;**  
**IRQ=3, 4, 11**      Serial Port I/O port address is 2F8h and the interrupt address is IRQ3, 4, 11
- ➔ **IO=3E8h;**  
**IRQ=3, 4, 11**      Serial Port I/O port address is 3E8h and the interrupt address is IRQ3, 4, 11
- ➔ **IO=2E8h;**  
**IRQ=3, 4, 11**      Serial Port I/O port address is 2E8h and the interrupt address is IRQ3, 4, 11

#### 5.3.3.4.2 Serial Port 5 Configuration

##### → Serial Port [Enabled]

Use the **Serial Port** option to enable or disable the serial port.

→ **Disabled** Disable the serial port

→ **Enabled** **DEFAULT** Enable the serial port

##### → Change Settings [IO=2D0h; IRQ=11;]

Use the **Change Settings** option to change the serial port IO port address and interrupt address.

→ **IO=2D0h; DEFAULT** Serial Port I/O port address is 2D0h and the interrupt  
**IRQ=11** address is IRQ11

##### → Transfer Mode [RS232]

The serial port 5 allows setting the data transfer mode to RS-232, RS-422 or RS-485.

#### 5.3.3.4.3 Serial Port 6 Configuration

##### → Serial Port [Enabled]

Use the **Serial Port** option to enable or disable the serial port.

→ **Disabled** Disable the serial port

→ **Enabled** **DEFAULT** Enable the serial port

##### → Change Settings [IO=2E0h; IRQ=11;]

Use the **Change Settings** option to change the serial port IO port address and interrupt address.

→ **IO=2E0h; DEFAULT** Serial Port I/O port address is 2E0h and the interrupt  
**IRQ=11** address is IRQ11

## IMBA-H112 ATX Motherboard

### 5.3.3.5 Parallel Port Configuration

Use the **Parallel Port Configuration** menu (**BIOS Menu 7**) to configure the parallel port.

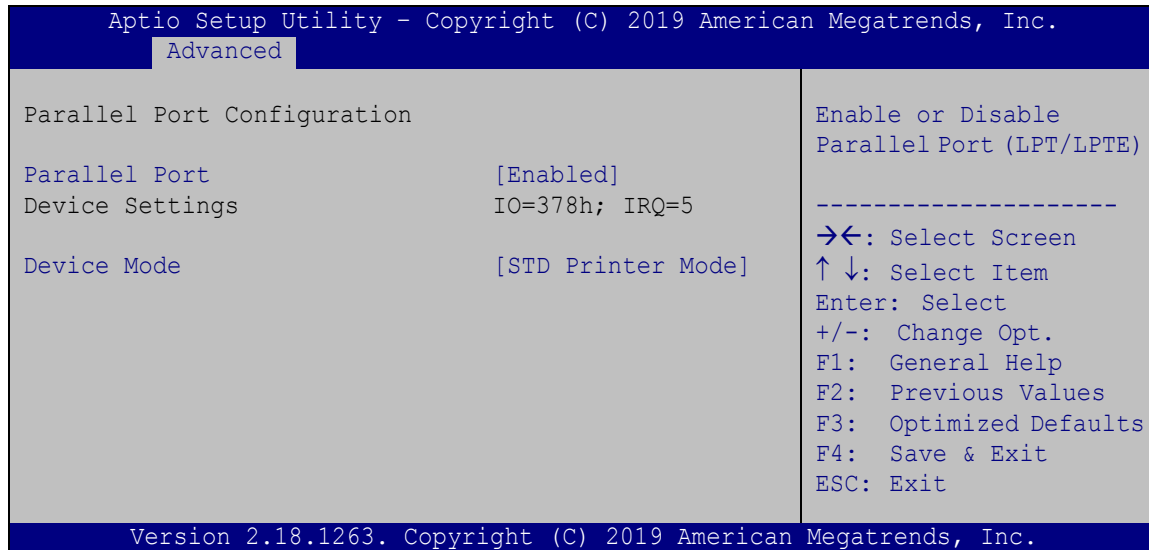

#### BIOS Menu 7: Parallel Port Configuration Menu

##### → Parallel Port [Enabled]

Use the **Parallel Port** option to enable or disable the parallel port.

- **Disabled** Disable the parallel port
- **Enabled** **DEFAULT** Enable the parallel port

##### → Device Mode [STD Printer Mode]

Use the **Device Mode** option to select the mode the parallel port operates in.

Configuration options are listed below.

- STD Printer Mode **Default**
- SPP Mode
- EPP-1.9 and SPP Mode
- EPP-1.7 and SPP Mode
- ECP Mode
- ECP and EPP 1.9 Mode
- ECP and EPP 1.7 Mode

### 5.3.4 iWDD H/W Monitor

The **iWDD H/W Monitor** menu (**BIOS Menu 8**) contains the fan configuration submenu, and displays operating temperature, fan speeds and system voltages.

```

Aptio Setup Utility - Copyright (C) 2019 American Megatrends, Inc.
  Advanced
PC Health Status
CPU temperature           : +40°C
SYS temperature          : +28°C

CPU_FAN1 Speed           : 1368 RPM
SYS_FAN1 Speed           : N/A

CPU_CORE                  : +1.129 V
+5V                       : +5.058 V
+12V                      : +12.032 V
+DDR                      : +1.196 V
+5VSB                     : +5.070 V
+3.3V                     : +3.310 V
+3.3VSB                   : +3.300 V

> Smart Fan Mode Configuration

Smart Fan Mode Select

-----
-><: Select Screen
↑↓: Select Item
Enter: Select
+/-: Change Opt.
F1: General Help
F2: Previous Values
F3: Optimized Defaults
F4: Save & Exit
ESC: Exit

Version 2.18.1263. Copyright (C) 2019 American Megatrends, Inc.
  
```

#### BIOS Menu 8: iWDD H/W Monitor

##### ➔ PC Health Status

The following system parameters and values are shown. The system parameters that are monitored are:

- System Temperatures:
  - CPU Temperature
  - System Temperature
- Fan Speed:
  - CPU Fan Speed
  - System Fan Speed
- Voltages:
  - CPU\_CORE
  - +5V
  - +12V
  - +DDR
  - +5VSB



## IMBA-H112 ATX Motherboard

- +3.3V
- +3.3VSB

### 5.3.4.1 Smart Fan Mode Configuration

Use the **Smart Fan Mode Configuration** submenu (**BIOS Menu 9**) to configure the CPU/system fan temperature and speed settings.

```

Aptio Setup Utility - Copyright (C) 2019 American Megatrends, Inc.
Advanced
Smart Fan Mode Configuration
CPU_FAN1 Smart Fan Control      [Auto Mode]
Auto mode fan start temperature 50
Auto mode fan off temperature  40
Auto mode fan start PWM        30
Auto mode fan slope PWM        1

SYS_FAN1 Smart Fan Control      [Auto Mode]
Auto mode fan start temperature 50
Auto mode fan off temperature  40
Auto mode fan start PWM        30
Auto mode fan slope PWM        1

Smart Fan Mode Select
-----
-><: Select Screen
↑↓: Select Item
Enter: Select
+/-: Change Opt.
F1: General Help
F2: Previous Values
F3: Optimized Defaults
F4: Save & Exit
ESC: Exit

Version 2.18.1263. Copyright (C) 2019 American Megatrends, Inc.
    
```

#### BIOS Menu 9: Smart Fan Mode Configuration

##### → CPU\_FAN1 Smart Fan Control/SYS\_FAN1 Smart Fan Control [Auto Mode]

Use the **CPU\_FAN1 Smart Fan Control/SYS\_FAN1 Smart Fan Control** option to configure the CPU/System Smart Fan.

- **Auto Mode**      **DEFAULT**      The fan adjusts its speed using Auto Mode settings.
- **Manual Mode**                      The fan spins at the speed set in Manual Mode settings.

##### → Auto mode fan start/off temperature

Use the + or – key to change the **Auto mode fan start/off temperature** value. Enter a decimal number between 1 and 100.

→ **Auto mode fan start PWM**

Use the + or – key to change the **Auto mode fan start PWM** value. Enter a decimal number between 1 and 100.

→ **Auto mode fan slope PWM**

Use the + or – key to change the **Auto mode fan slope PWM** value. Enter a decimal number between 1 and 8.

### 5.3.5 RTC Wake Settings

The **RTC Wake Settings** menu (**BIOS Menu 10**) enables the system to wake at the specified time.

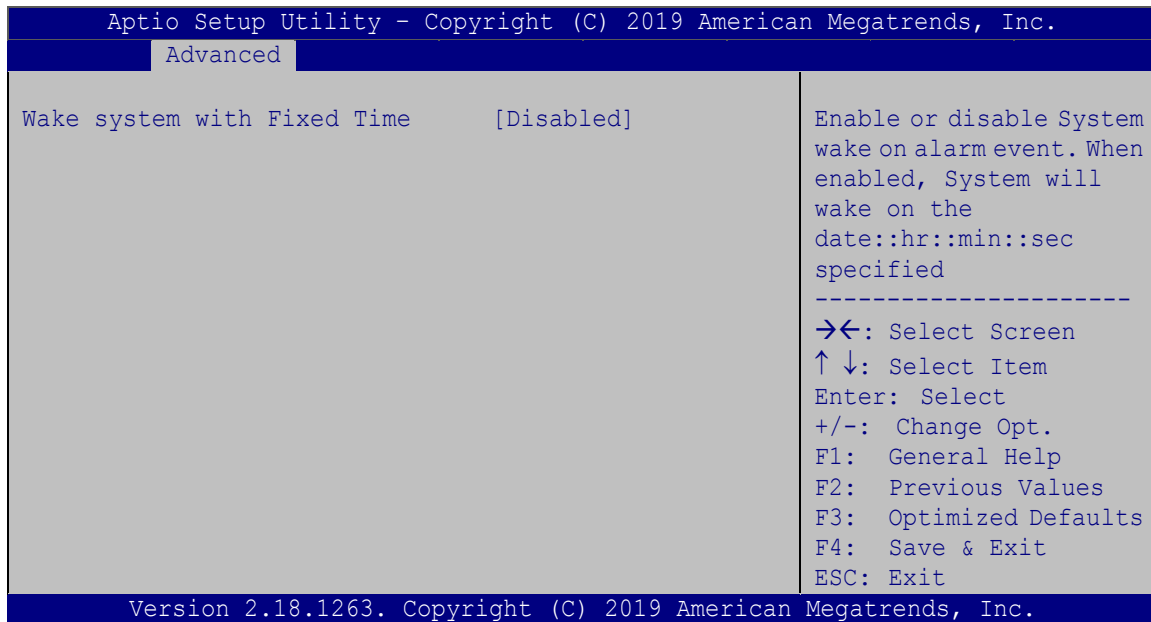

#### BIOS Menu 10: RTC Wake Settings

→ **Wake system with Fixed Time [Disabled]**

Use the **Wake system with Fixed Time** option to enable or disable the system wake on alarm event.

- **Disabled**      **DEFAULT**      The real time clock (RTC) cannot generate a wake event.

## IMBA-H112 ATX Motherboard

→ **Enabled**

If selected, the **Wake up every day** option appears allowing you to enable to disable the system to wake every day at the specified time. Besides, the following options appear with values that can be selected:

Wake up date

Wake up hour

Wake up minute

Wake up second

After setting the alarm, the computer turns itself on from a suspend state when the alarm goes off.

### 5.3.6 Serial Port Console Redirection

The **Serial Port Console Redirection** menu (**BIOS Menu 11**) allows the console redirection options to be configured. Console redirection allows users to maintain a system remotely by re-directing keyboard input and text output through the serial port.

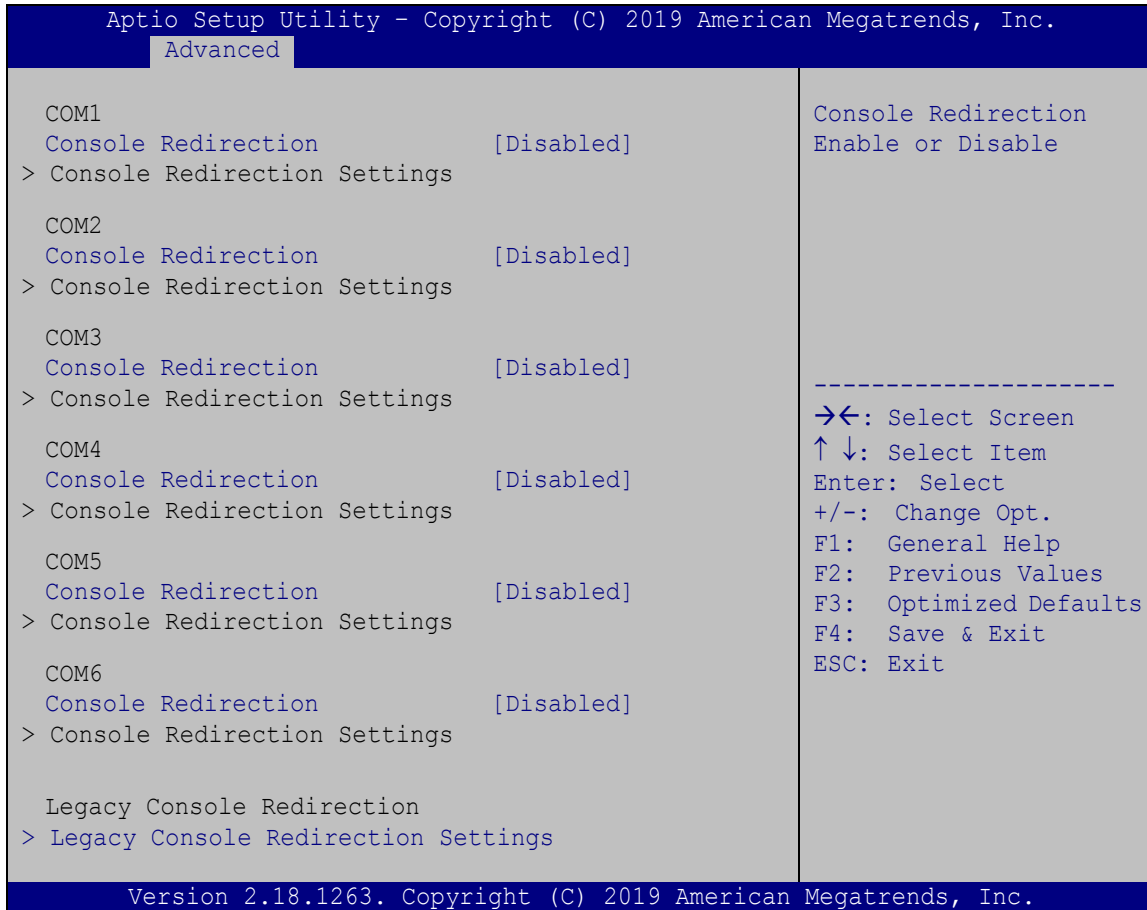

#### BIOS Menu 11: Serial Port Console Redirection

##### → Console Redirection [Disabled]

Use **Console Redirection** option to enable or disable the console redirection function.

- **Disabled**    **DEFAULT**    Disabled the console redirection function
- **Enabled**                    Enabled the console redirection function

The following options are available in the **Console Redirection Settings** submenu when the **Console Redirection** option is enabled.



- ➔ **Odd**                      The parity bit is 0 if the number of ones in the data bits is odd.
- ➔ **Mark**                     The parity bit is always 1. This option does not provide error detection.
- ➔ **Space**                    The parity bit is always 0. This option does not provide error detection.

➔ **Stop Bits [1]**

Use the **Stop Bits** option to specify the number of stop bits used to indicate the end of a serial data packet. Communication with slow devices may require more than 1 stop bit.

- ➔ **1**                      **DEFAULT**              Sets the number of stop bits at 1.
- ➔ **2**                      Sets the number of stop bits at 2.

**5.3.6.1 Legacy Console Redirection Settings**

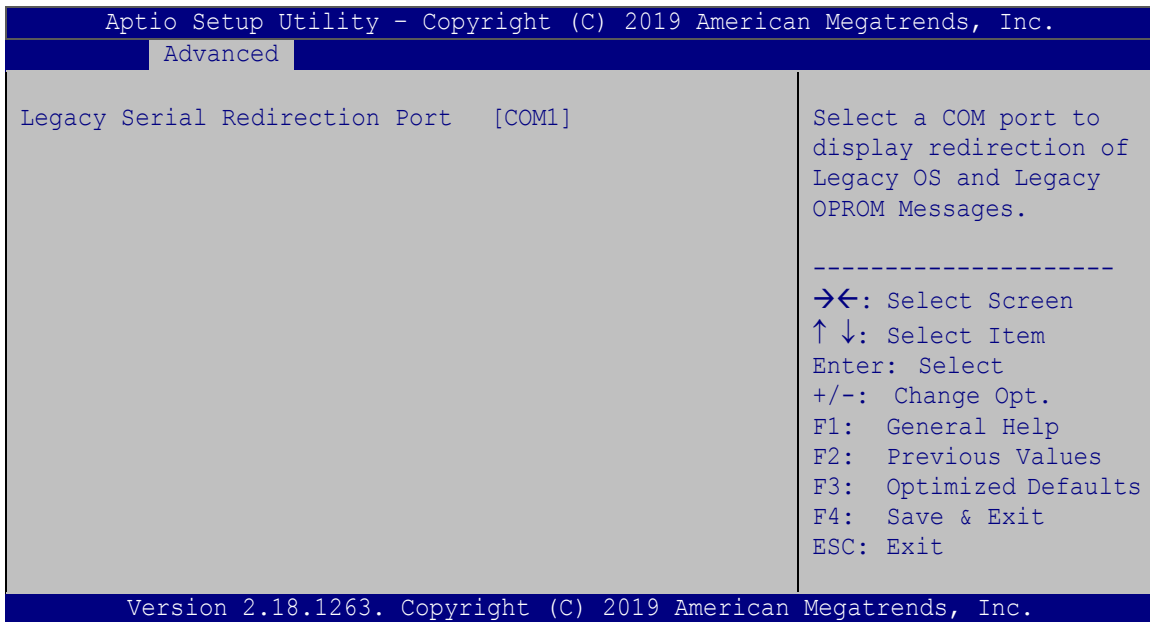

**BIOS Menu 12: Legacy Console Redirection Settings**

## IMBA-H112 ATX Motherboard

### → Legacy Serial Redirection Port [COM1]

Use the Legacy Serial Redirection Port option to select a COM port to display redirection of legacy OS and legacy OPRM messages.

### 5.3.7 NVMe Configuration

Use the **NVMe Configuration (BIOS Menu 13)** menu to display the NVMe controller and device information.

```

Aptio Setup Utility - Copyright (C) 2019 American Megatrends, Inc.
-----
Advanced
-----
NVMe controller and Drive information
No NVMe Device Found

-----
→←: Select Screen
↑↓: Select Item
Enter: Select
+/-: Change Opt.
F1: General Help
F2: Previous Values
F3: Optimized Defaults
F4: Save & Exit
ESC: Exit
-----
Version 2.18.1263. Copyright (C) 2019 American Megatrends, Inc.
    
```

### BIOS Menu 13: NVMe Configuration

### 5.3.8 USB Configuration

Use the **USB Configuration** menu (**BIOS Menu 14**) to read USB configuration information and configure the USB settings.

```

Aptio Setup Utility - Copyright (C) 2019 American Megatrends, Inc.
  Advanced
USB Configuration
USB Controllers:
  1 XHCI
USB Devices:
  1 Keyboard
Legacy USB Support                [Enabled]

Enables Legacy USB support. AUTO option disables legacy support if no USB devices are connected. DISABLE option will keep USB devices available only for EFI applications.
-----
-><: Select Screen
↑ ↓: Select Item
Enter: Select
+/-: Change Opt.
F1: General Help
F2: Previous Values
F3: Optimized Defaults
F4: Save & Exit
ESC: Exit

Version 2.18.1263. Copyright (C) 2019 American Megatrends, Inc.
  
```

#### BIOS Menu 14: USB Configuration

##### ➔ Legacy USB Support [Enabled]

Use the **Legacy USB Support** BIOS option to enable USB mouse and USB keyboard support. Normally if this option is not enabled, any attached USB mouse or USB keyboard does not become available until a USB compatible operating system is fully booted with all USB drivers loaded. When this option is enabled, any attached USB mouse or USB keyboard can control the system even when there is no USB driver loaded onto the system.

- ➔ **Enabled**      **DEFAULT**      Legacy USB support enabled
- ➔ **Disabled**                      Legacy USB support disabled
- ➔ **Auto**                              Legacy USB support disabled if no USB devices are connected



## IMBA-H112 ATX Motherboard

### 5.3.9 iEi Feature

Use the **iEi Feature** menu (**BIOS Menu 15**) to configure One Key Recovery function.

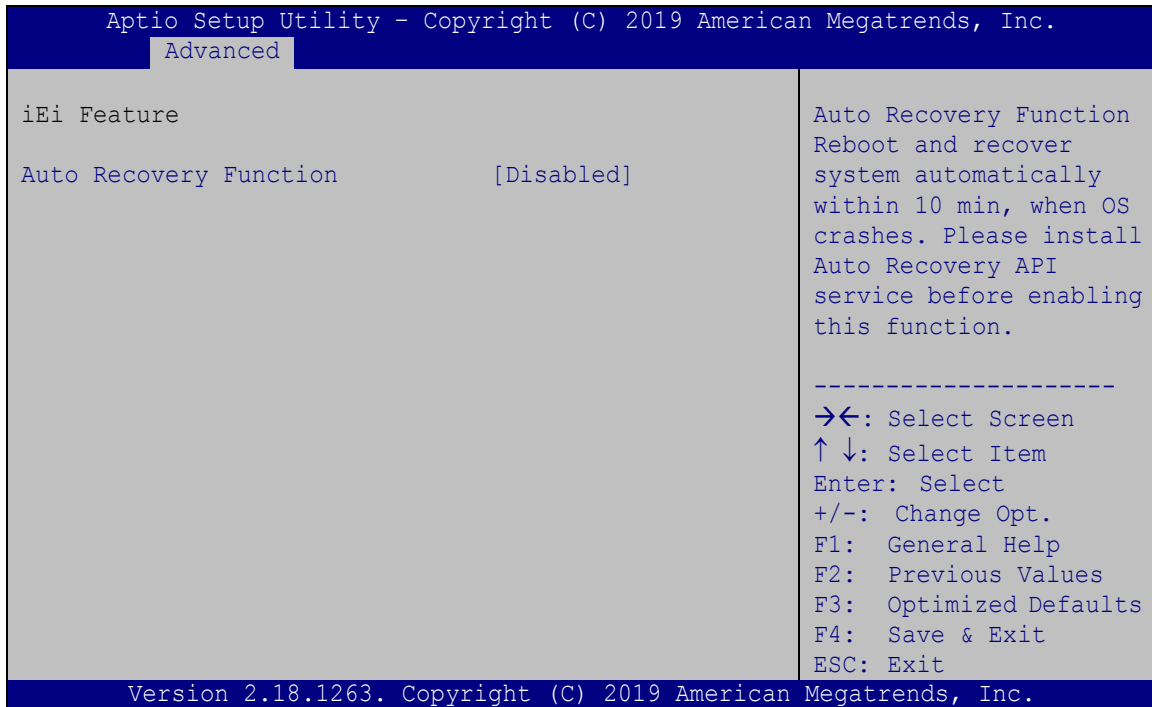

#### BIOS Menu 15: iEi Feature

##### ➔ Auto Recovery Function [Disabled]

Use the **Auto Recovery Function** BIOS option to enable or disable the auto recovery function of the IEI One Key Recovery.

- ➔ **Disabled**     **DEFAULT**     Auto recovery function disabled
- ➔ **Enabled**         Auto recovery function enabled

## 5.4 Chipset

Use the **Chipset** menu (**BIOS Menu 16**) to access the PCH IO and System Agent (SA) configuration menus.



### WARNING!

Setting the wrong values for the Chipset BIOS selections in the Chipset BIOS menu may cause the system to malfunction.

```
Aptio Setup Utility - Copyright (C) 2019 American Megatrends, Inc.
Main   Advanced  Chipset  Security  Boot   Save & Exit
-----
> System Agent (SA) Configuration      System Agent (SA)
> PCH-IO Configuration                Parameters
-----
-><: Select Screen
↑↓: Select Item
Enter: Select
+/-: Change Opt.
F1: General Help
F2: Previous Values
F3: Optimized Defaults
F4: Save & Exit
ESC: Exit

Version 2.18.1263. Copyright (C) 2019 American Megatrends, Inc.
```

**BIOS Menu 16: Chipset**

## IMBA-H112 ATX Motherboard

### 5.4.1 System Agent (SA) Configuration

Use the **System Agent (SA) Configuration** menu (**BIOS Menu 17**) to configure the System Agent (SA) parameters.

```

Aptio Setup Utility - Copyright (C) 2019 American Megatrends, Inc.
Chipset
-----
VT-d                Supported
VT-d                [Disabled]

> Memory Configuration
> Graphics Configuration
> PEG Port Configuration

-----
-><: Select Screen
↑ ↓: Select Item
Enter: Select
+/-: Change Opt.
F1:  General Help
F2:  Previous Values
F3:  Optimized Defaults
F4:  Save & Exit
ESC: Exit

Version 2.18.1263. Copyright (C) 2019 American Megatrends, Inc.
    
```

#### BIOS Menu 17: System Agent (SA) Configuration

##### → VT-d [Disabled]

Use the **VT-d** option to enable or disable VT-d capability.

- **Disabled**                      **DEFAULT**      Disables VT-d capability.
- **Enabled**                              Enables VT-d capability.

### 5.4.1.1 Memory Configuration

Use the **Memory Configuration** submenu (**BIOS Menu 18**) to view memory information.

```

Aptio Setup Utility - Copyright (C) 2019 American Megatrends, Inc.
Chipset
Memory Configuration
CHA_DIMM0#          Populated & Enabled
  Size              8192 MB (DDR4)
  Number of Ranks   1
  Manufacturer      Unknown
CHB_DIMM0#          Not Populated/Disabled
-----
-><: Select Screen
↑↓: Select Item
Enter: Select
+/-: Change Opt.
F1:  General Help
F2:  Previous Values
F3:  Optimized Defaults
F4:  Save & Exit
ESC: Exit
Version 2.18.1263. Copyright (C) 2019 American Megatrends, Inc.
  
```

**BIOS Menu 18: Memory Configuration**

### 5.4.1.2 Graphics Configuration

Use the **Graphics Configuration (BIOS Menu 19)** menu to configure the video device connected to the system.

```

Aptio Setup Utility - Copyright (C) 2019 American Megatrends, Inc.
Chipset
Graphics Configuration
Primary Display      [Auto]
Internal Graphics    [Enabled]
DVMT Pre-Allocated  [32M]
DVMT Total Gfx Mem  [MAX]
Primary IGFX Boot Display [VBIOS Default]
-----
Select which of
IGFX/PEG/PCI Graphics
device should be Primary
Display Or select SG for
Switchable Gfx.
-----
-><: Select Screen
↑↓: Select Item
Enter: Select
+/-: Change Opt.
F1:  General Help
F2:  Previous Values
F3:  Optimized Defaults
F4:  Save & Exit
ESC: Exit
Version 2.18.1263. Copyright (C) 2019 American Megatrends, Inc.
  
```

**BIOS Menu 19: Graphics Configuration**

## IMBA-H112 ATX Motherboard

### → Primary Display [Auto]

Use the **Primary Display** option to select the primary graphics controller the system uses.

The following options are available:

- Auto                      **Default**
- IGFX
- PEG
- PCI

### → Internal Graphics [Enabled]

Use the **Internal Graphics** option to keep IGFX enabled basing on the setup options. The following options are available:

- Auto
- Disabled
- Enabled                      **Default**

### → DVMT Pre-Allocated [32M]

Use the **DVMT Pre-Allocated** option to set the amount of system memory allocated to the integrated graphics processor when the system boots. The system memory allocated can then only be used as graphics memory, and is no longer available to applications or the operating system. Configuration options are listed below:

- 32M                          **Default**
- 64M

### → DVMT Total Gfx Mem [MAX]

Use the **DVMT Total Gfx Mem** option to select DVMT5.0 total graphic memory size used by the internal graphic device. The following options are available:

- 128M
- 256M
- MAX                          **Default**

### → Primary IGFX Boot Display [VBIOS Default]

Use the **Primary IGFX Boot Display** option to select the display device used by the system when it boots. Configuration options are listed below.

- VBIOS Default      **Default**
- CRT
- IDP
- HDMI

### 5.4.1.3 PEG Port Configuration

```

Aptio Setup Utility - Copyright (C) 2019 American Megatrends, Inc.
Chipset
PEG Port Configuration
PEG 0:1:0                x0 Gen1
  Enable Root Port        [Enabled]
  Max Link Speed          [Auto]
> PEG Port Feature Configuration
-----
-><: Select Screen
↑ ↓: Select Item
Enter: Select
+/-: Change Opt.
F1: General Help
F2: Previous Values
F3: Optimize Defaults
F4: Save & Exit
ESC: Exit
Version 2.18.1263. Copyright (C) 2019 American Megatrends, Inc.
  
```

#### BIOS Menu 20: PEG Port Configuration

##### ➔ Enable Root Port [Enabled]

Use the **Enable Root Port** option to enable or disable the PCI Express (PEG) controller.

- ➔ **Disabled**                      Disables the PCI Express (PEG) controller.
- ➔ **Enabled**                      **DEFAULT**      Enables the PCI Express (PEG) controller.

## IMBA-H112 ATX Motherboard

### → Max Link Speed [Auto]

Use the **Max Link Speed** option to select the maximum link speed of the PCI Express slot.

The following options are available:

- Auto                   **Default**
- Gen1
- Gen2
- Gen3

### 5.4.1.3.1 PEG Port Feature Configuration

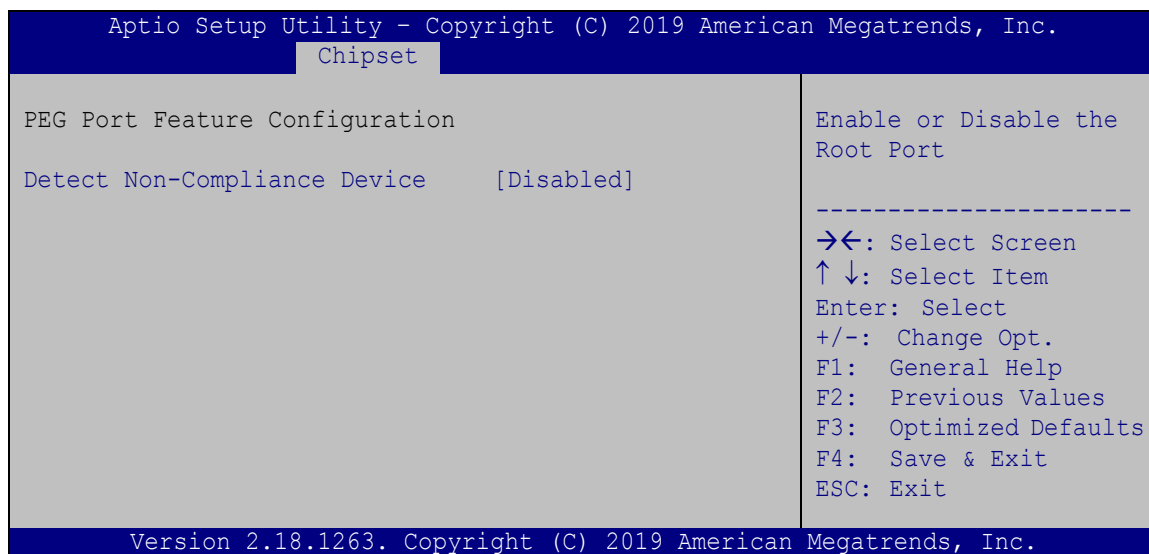

#### BIOS Menu 21: PEG Port Feature Configuration

### → Detect Non-Compliance Device [Disabled]

Use the **Detect Non-Compliance Device** option to enable or disable detecting if a non-compliance PCI Express device is connected to the PCI Express slot.

- **Disabled**                   **DEFAULT**    Disables to detect if a non-compliance PCI Express device is connected to the PCI Express slot.
- **Enabled**                    Enables to detect if a non-compliance PCI Express device is connected to the PCI Express slot.

### 5.4.2 PCH-IO Configuration

Use the **PCH-IO Configuration** menu (**BIOS Menu 22**) to configure the PCH parameters.

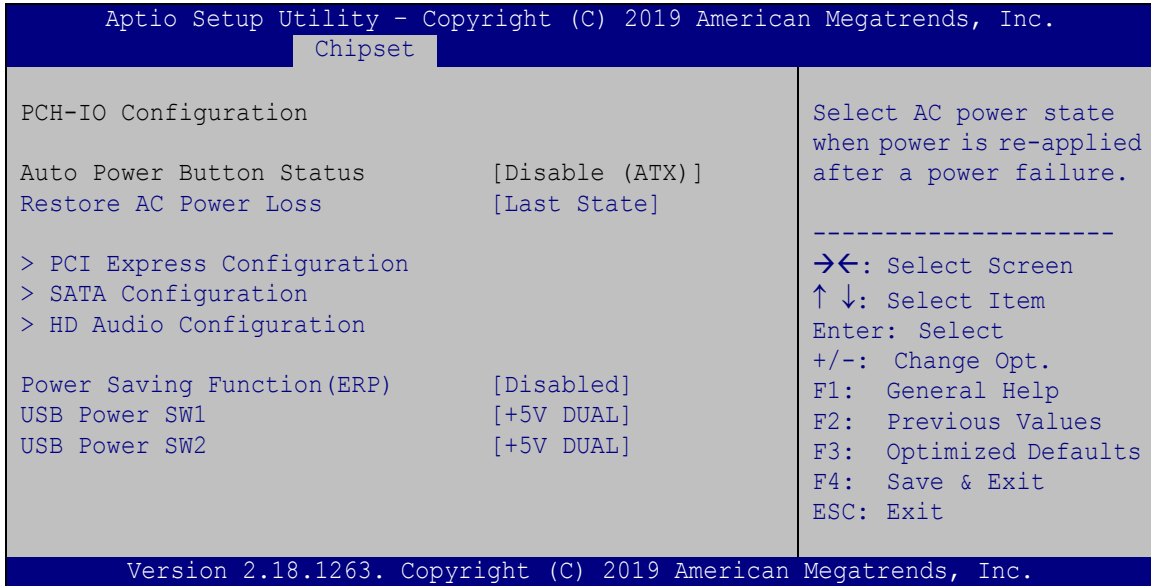

#### BIOS Menu 22: PCH-IO Configuration

##### → Restore AC Power Loss [Last State]

Use the **Restore AC Power Loss** BIOS option to specify what state the system returns to if there is a sudden loss of power to the system.

- **Power Off**                      The system remains turned off.
- **Power On**                        The system turns on.
- **Last State    DEFAULT**        The system returns to its previous state. If it was on, it turns itself on. If it was off, it remains off.

##### → Power Saving Function(ERP) [Disabled]

Use the **Power Saving Function(ERP)** BIOS option to enable or disable the power saving function.

- **Disabled    DEFAULT**        Power saving function is disabled.
- **Enabled**                        Power saving function is enabled. It will reduce power consumption when the system is off.



## IMBA-H112 ATX Motherboard

### → USB Power SW1 [+5V DUAL]

Use the **USB Power SW1** BIOS option to configure whether to provide power to the corresponding USB connectors (**Table 5-2**) when the system is in S3/S4 sleep state. This option is valid only when the above **Power Saving Function (ERP)** BIOS option is disabled.

→ **+5V DUAL**    **DEFAULT**    Power is provided to the external USB connectors when the system is in S3/S4 sleep state

→ **+5V**    Power is not provided to the external USB connectors when the system is in S3/S4 sleep state

### → USB Power SW2 [+5V DUAL]

Use the **USB Power SW2** BIOS option to configure whether to provide power to the corresponding USB connectors (**Table 5-2**) when the system is in S3/S4 sleep state. This option is valid only when the above **Power Saving Function (ERP)** BIOS option is disabled.

→ **+5V DUAL**    **DEFAULT**    Power is provided to the internal USB connectors when the system is in S3/S4 sleep state

→ **+5V**    Power is not provided to the internal USB connectors when the system is in S3/S4 sleep state

BIOS Options	Configured USB Ports
USB Power SW1	LAN1_USB1 (external USB 3.0 ports) LAN2_USB2 (external USB 3.0 ports) K/M_USB1 (external USB 2.0 ports)
USB Power SW2	USB1 (internal USB 2.0 ports) USB2-3 (internal USB 2.0 port, Type A)

**Table 5-2: BIOS Options and Configured USB Ports**

### 5.4.2.1 PCI Express Configuration

Use the **PCI Express Configuration** submenu (**BIOS Menu 23**) to configure the PCIe Mini slot.

```

Aptio Setup Utility - Copyright (C) 2019 American Megatrends, Inc.
  Chipset
PCI Express Configuration
> MPCIE1 Slot
MPCIE1 Slot Settings.
-----
-><: Select Screen
↑↓: Select Item
Enter: Select
+/-: Change Opt.
F1: General Help
F2: Previous Values
F3: Optimized Defaults
F4: Save & Exit
ESC: Exit

Version 2.18.1263. Copyright (C) 2019 American Megatrends, Inc.
  
```

**BIOS Menu 23: PCI Express Configuration**

#### 5.4.2.1.1 MPCIE1 Slot

```

Aptio Setup Utility - Copyright (C) 2019 American Megatrends, Inc.
  Advanced
PCI Express Root Port      [Enabled]      Control the PCI Express
PCIe Speed                 [Auto]         Root Port.
Detect Non-Compliance Device [Disabled]
-----
-><: Select Screen
↑↓: Select Item
Enter: Select
+/-: Change Opt.
F1: General Help
F2: Previous Values
F3: Optimized Defaults
F4: Save & Exit
ESC: Exit

Version 2.18.1263. Copyright (C) 2019 American Megatrends, Inc.
  
```

**BIOS Menu 24: MPCIE1 Slot**

## IMBA-H112 ATX Motherboard

### → PCI Express Root Port [Enabled]

Use the **PCI Express Root Port** option to enable or disable the PCI Express controller.

→ **Enabled**                      **DEFAULT**      Enables the PCI Express controller.

→ **Disabled**                                      Disables the PCI Express controller.

### → PCIe Speed [Auto]

Use this option to select the support type of the PCI Express slots. The following options are available:

- Auto                      **Default**
- Gen1
- Gen2
- Gen3

### → Detect Non-Compliance Device [Disabled]

Use the **Detect Non-Compliance Device** option to enable or disable detecting if a non-compliance PCI Express device is connected to the PCI Express slot.

→ **Disabled**                      **DEFAULT**      Disables to detect if a non-compliance PCI Express device is connected to the PCI Express slot.

→ **Enabled**                                      Enables to detect if a non-compliance PCI Express device is connected to the PCI Express slot.

### 5.4.2.2 SATA Configuration

Use the **SATA Configuration** menu (**BIOS Menu 25**) to change and/or set the configuration of the SATA devices installed in the system.

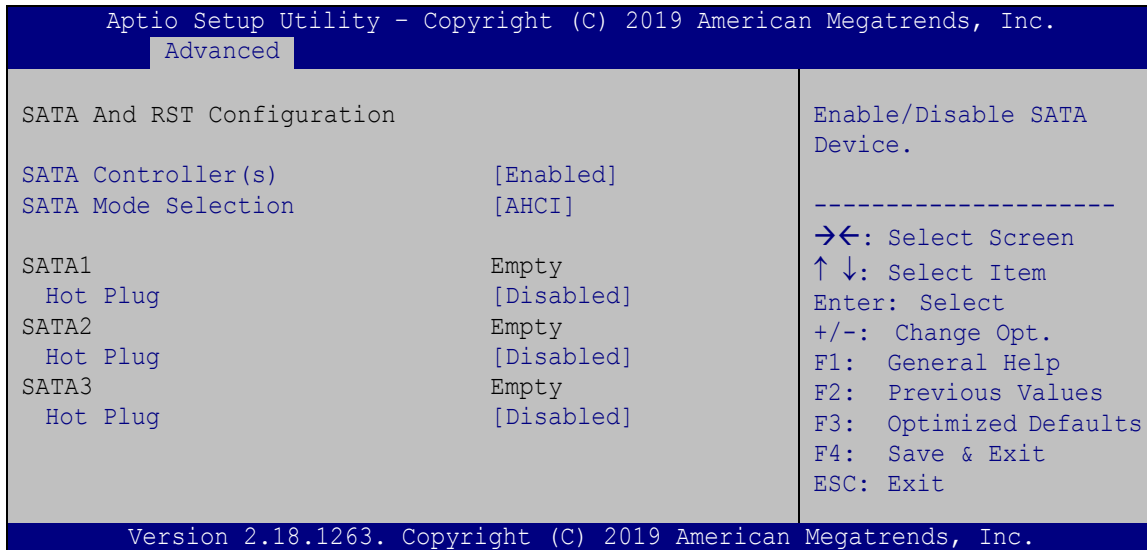

#### BIOS Menu 25: SATA Configuration

##### → SATA Controller(s) [Enabled]

Use the **SATA Controller(s)** option to configure the SATA controller(s).

- **Enabled**      **DEFAULT**      Enables the on-board SATA controller(s).
- **Disabled**                              Disables the on-board SATA controller(s).

##### → SATA Mode Selection [AHCI]

Use the **SATA Mode Selection** option to determine how the SATA devices operate.

- **AHCI**              **DEFAULT**      Configures SATA devices as AHCI device.

##### → Hot Plug [Disabled]

Use the **Hot Plug** option to designate the correspondent SATA port as hot-pluggable.

- **Disabled**      **DEFAULT**      Disables the hot-pluggable function of the SATA port.
- **Enabled**                              Designates the SATA port as hot-pluggable.

## IMBA-H112 ATX Motherboard

### 5.4.2.3 HD Audio Configuration

Use the **HD Audio Configuration** menu (**BIOS Menu 26**) to configure the PCH Azalia settings.

```

Aptio Setup Utility - Copyright (C) 2019 American Megatrends, Inc.
Chipset
HD Audio Subsystem Configuration Settings
HD Audio [Auto]
Control Detection of the HD-Audio device.
Disable = HDA will be unconditionally disabled
Enabled = HDA will be unconditionally enabled
Auto = HDA will be enabled if present, disabled otherwise.
-----
-><: Select Screen
↑↓: Select Item
Enter: Select
+/-: Change Opt.
F1: General Help
F2: Previous Values
F3: Optimized Defaults
F4: Save & Exit
ESC: Exit
Version 2.18.1263. Copyright (C) 2019 American Megatrends, Inc.
    
```

#### BIOS Menu 26: HD Audio Configuration

##### → HD Audio [Auto]

Use the **HD Audio** option to enable or disable the High Definition Audio controller.

- **Disabled**                      The onboard High Definition Audio controller is disabled.
- **Enabled**                        The onboard High Definition Audio controller is enabled.
- **Auto**                      **DEFAULT**      The onboard High Definition Audio controller automatically detected and enabled

## 5.5 Security

Use the **Security** menu (**BIOS Menu 27**) to set system and user passwords.

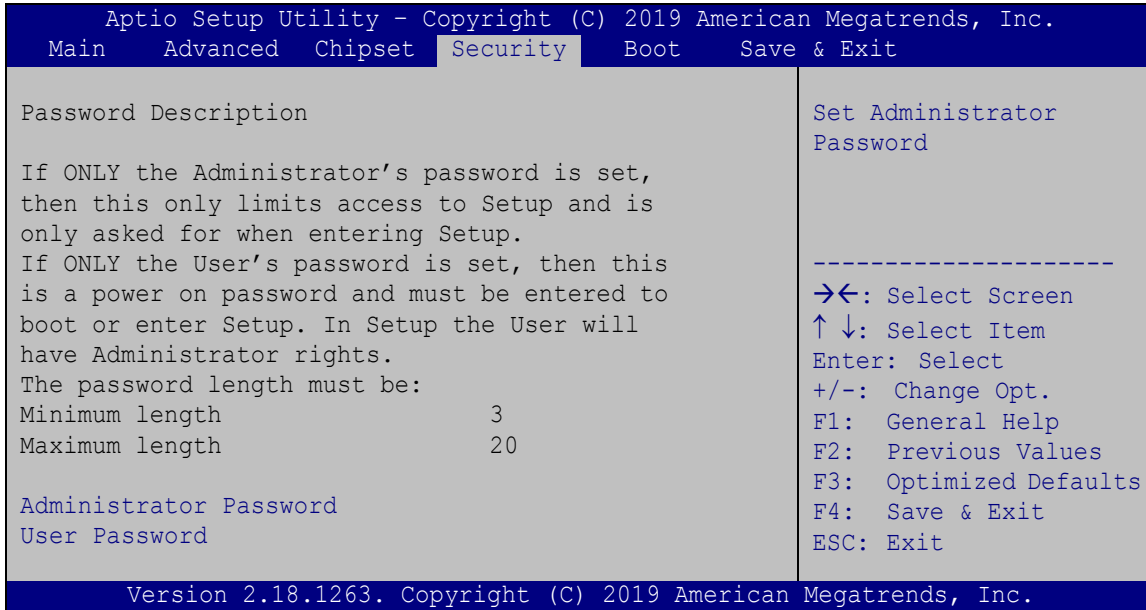

### BIOS Menu 27: Security

#### → Administrator Password

Use the **Administrator Password** to set or change a administrator password.

#### → User Password

Use the **User Password** to set or change a user password.

## IMBA-H112 ATX Motherboard

### 5.6 Boot

Use the **Boot** menu (**BIOS Menu 28**) to configure system boot options.

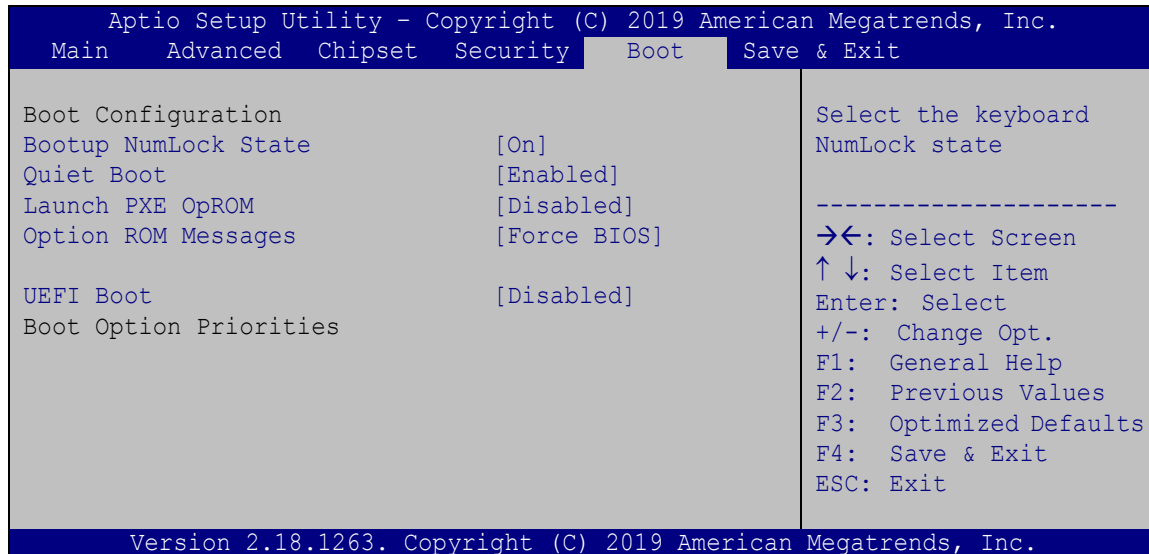

#### BIOS Menu 28: Boot

##### → Bootup NumLock State [On]

Use the **Bootup NumLock State** BIOS option to specify if the number lock setting must be modified during boot up.

- **On**      **DEFAULT**      Allows the Number Lock on the keyboard to be enabled automatically when the computer system boots up. This allows the immediate use of the 10-key numeric keypad located on the right side of the keyboard. To confirm this, the Number Lock LED light on the keyboard is lit.
  
- **Off**      Does not enable the keyboard Number Lock automatically. To use the 10-keys on the keyboard, press the Number Lock key located on the upper left-hand corner of the 10-key pad. The Number Lock LED on the keyboard lights up when the Number Lock is engaged.

→ **Quiet Boot [Enabled]**

Use the **Quiet Boot** BIOS option to select the screen display when the system boots.

- **Disabled** Normal POST messages displayed
- **Enabled** **DEFAULT** OEM Logo displayed instead of POST messages

→ **Launch PXE OpROM [Disabled]**

Use the **Launch PXE OpROM** option to enable or disable boot option for legacy network devices.

- **Disabled** **DEFAULT** Ignore all PXE Option ROMs
- **Enabled** Load PXE Option ROMs.

→ **Option ROM Messages [Force BIOS]**

Use the **Option ROM Messages** option to set the Option ROM display mode.

- **Force BIOS** **DEFAULT** Sets display mode to force BIOS.
- **Keep Current** Sets display mode to current.

→ **UEFI Boot [Disabled]**

Use the **UEFI Boot** option to enable or disable to boot from the UEFI devices.

- **Enabled** Boot from UEFI devices is enabled.
- **Disabled** **DEFAULT** Boot from UEFI devices is disabled.



## IMBA-H112 ATX Motherboard

### 5.7 Save & Exit

Use the **Safe & Exit** menu (**BIOS Menu 29**) to load default BIOS values, optimal failsafe values and to save configuration changes.

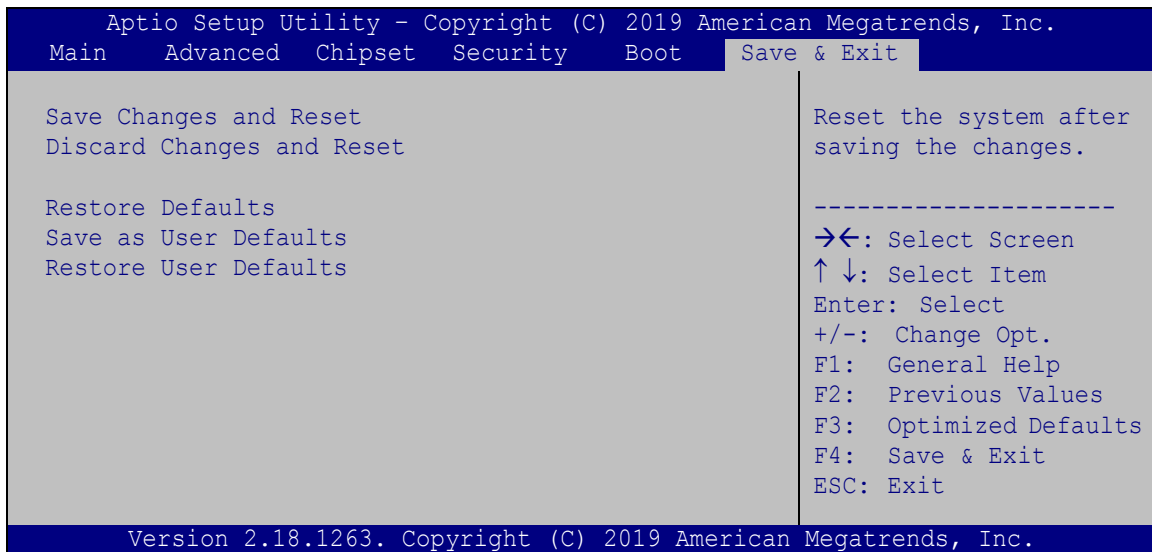

#### BIOS Menu 29: Save & Exit

##### → Save Changes and Reset

Use the **Save Changes and Reset** option to save the changes made to the BIOS options and reset the system.

##### → Discard Changes and Reset

Use the **Discard Changes and Reset** option to exit the system without saving the changes made to the BIOS configuration setup program.

##### → Restore Defaults

Use the **Restore Defaults** option to load the optimal default values for each of the parameters on the Setup menus. **F3 key can be used for this operation.**

##### → Save as User Defaults

Use the **Save as User Defaults** option to save the changes done so far as user defaults.

##### → Restore User Defaults

Use the **Restore User Defaults** option to restore the user defaults to all the setup options.

Appendix

**A**

# Regulatory Compliance

---

## IMBA-H112 ATX Motherboard

### DECLARATION OF CONFORMITY



This equipment has been tested and found to comply with specifications for CE marking. If the user modifies and/or installs other devices in the equipment, the CE conformity declaration may no longer apply.

### FCC WARNING



This equipment complies with Part 15 of the FCC Rules. Operation is subject to the following two conditions:

- This device may not cause harmful interference, and
- This device must accept any interference received, including interference that may cause undesired operation.

This equipment has been tested and found to comply with the limits for a Class A digital device, pursuant to part 15 of the FCC Rules. These limits are designed to provide reasonable protection against harmful interference when the equipment is operated in a commercial environment. This equipment generates, uses, and can radiate radio frequency energy and, if not installed and used in accordance with the instruction manual, may cause harmful interference to radio communications. Operation of this equipment in a residential area is likely to cause harmful interference in which case the user will be required to correct the interference at his own expense.

Appendix

**B**

# Product Disposal

---

## IMBA-H112 ATX Motherboard



### CAUTION:

Risk of explosion if battery is replaced by an incorrect type. Only certified engineers should replace the on-board battery.

Dispose of used batteries according to instructions and local regulations.

- Outside the European Union–If you wish to dispose of used electrical and electronic products outside the European Union, please contact your local authority so as to comply with the correct disposal method.
- Within the European Union–The device that produces less waste and is easier to recycle is classified as electronic device in terms of the European Directive 2012/19/EU (WEEE), and must not be disposed of as domestic garbage.

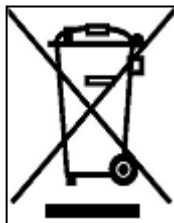

EU-wide legislation, as implemented in each Member State, requires that waste electrical and electronic products carrying the mark (left) must be disposed of separately from normal household waste. This includes monitors and electrical accessories, such as signal cables or power cords. When you need to dispose of your device, please follow the guidance of your local authority, or ask the shop where you purchased the product. The mark on electrical and electronic products only applies to the current European Union Member States.

Please follow the national guidelines for electrical and electronic product disposal.

Appendix

**C**

# BIOS Options

---

## IMBA-H112 ATX Motherboard

Below is a list of BIOS configuration options in the BIOS chapter.

<input type="checkbox"/>	<b>System Date [xx/xx/xx]</b> .....	<b>80</b>
<input type="checkbox"/>	<b>System Time [xx:xx:xx]</b> .....	<b>80</b>
<input type="checkbox"/>	<b>Intel Virtualization Technology [Disabled]</b> .....	<b>81</b>
<input type="checkbox"/>	<b>Active Processor Cores [All]</b> .....	<b>81</b>
<input type="checkbox"/>	<b>Hyper-Threading [Enabled]</b> .....	<b>82</b>
<input type="checkbox"/>	<b>Intel(R) SpeedStep(tm) [Enabled]</b> .....	<b>82</b>
<input type="checkbox"/>	<b>CPU C states [Disabled]</b> .....	<b>82</b>
<input type="checkbox"/>	<b>ACPI Sleep State [S3 (Suspend to RAM)]</b> .....	<b>83</b>
<input type="checkbox"/>	<b>Serial Port [Enabled]</b> .....	<b>85</b>
<input type="checkbox"/>	<b>Change Settings [IO=3F8h; IRQ=4;]</b> .....	<b>85</b>
<input type="checkbox"/>	<b>Serial Port [Enabled]</b> .....	<b>85</b>
<input type="checkbox"/>	<b>Change Settings [IO=2F8h; IRQ=3;]</b> .....	<b>86</b>
<input type="checkbox"/>	<b>Serial Port [Enabled]</b> .....	<b>86</b>
<input type="checkbox"/>	<b>Change Settings [IO=3E8h; IRQ=11;]</b> .....	<b>86</b>
<input type="checkbox"/>	<b>Serial Port [Enabled]</b> .....	<b>87</b>
<input type="checkbox"/>	<b>Change Settings [IO=2E8h; IRQ=11;]</b> .....	<b>87</b>
<input type="checkbox"/>	<b>Serial Port [Enabled]</b> .....	<b>88</b>
<input type="checkbox"/>	<b>Change Settings [IO=2D0h; IRQ=11;]</b> .....	<b>88</b>
<input type="checkbox"/>	<b>Transfer Mode [RS232]</b> .....	<b>88</b>
<input type="checkbox"/>	<b>Serial Port [Enabled]</b> .....	<b>88</b>
<input type="checkbox"/>	<b>Change Settings [IO=2E0h; IRQ=11;]</b> .....	<b>88</b>
<input type="checkbox"/>	<b>Parallel Port [Enabled]</b> .....	<b>89</b>
<input type="checkbox"/>	<b>Device Mode [STD Printer Mode]</b> .....	<b>89</b>
<input type="checkbox"/>	<b>PC Health Status</b> .....	<b>90</b>
<input type="checkbox"/>	<b>CPU_FAN1 Smart Fan Control/SYS_FAN1 Smart Fan Control [Auto Mode]</b> .....	<b>91</b>
<input type="checkbox"/>	<b>Auto mode fan start/off temperature</b> .....	<b>91</b>
<input type="checkbox"/>	<b>Auto mode fan start PWM</b> .....	<b>92</b>
<input type="checkbox"/>	<b>Auto mode fan slope PWM</b> .....	<b>92</b>
<input type="checkbox"/>	<b>Wake system with Fixed Time [Disabled]</b> .....	<b>92</b>
<input type="checkbox"/>	<b>Console Redirection [Disabled]</b> .....	<b>94</b>
<input type="checkbox"/>	<b>Terminal Type [ANSI]</b> .....	<b>95</b>
<input type="checkbox"/>	<b>Bits per second [115200]</b> .....	<b>95</b>
<input type="checkbox"/>	<b>Data Bits [8]</b> .....	<b>95</b>

<input type="checkbox"/>	Parity [None].....	95
<input type="checkbox"/>	Stop Bits [1].....	96
<input type="checkbox"/>	Legacy Serial Redirection Port [COM1].....	97
<input type="checkbox"/>	Legacy USB Support [Enabled].....	98
<input type="checkbox"/>	Auto Recovery Function [Disabled].....	99
<input type="checkbox"/>	VT-d [Disabled].....	101
<input type="checkbox"/>	Primary Display [Auto].....	103
<input type="checkbox"/>	Internal Graphics [Enabled].....	103
<input type="checkbox"/>	DVMT Pre-Allocated [32M].....	103
<input type="checkbox"/>	DVMT Total Gfx Mem [MAX].....	103
<input type="checkbox"/>	Primary IGFX Boot Display [VBIOS Default].....	103
<input type="checkbox"/>	Enable Root Port [Enabled].....	104
<input type="checkbox"/>	Max Link Speed [Auto].....	105
<input type="checkbox"/>	Detect Non-Compliance Device [Disabled].....	105
<input type="checkbox"/>	Restore AC Power Loss [Last State].....	106
<input type="checkbox"/>	Power Saving Function(ERP) [Disabled].....	106
<input type="checkbox"/>	USB Power SW1 [+5V DUAL].....	107
<input type="checkbox"/>	USB Power SW2 [+5V DUAL].....	107
<input type="checkbox"/>	PCI Express Root Port [Enabled].....	109
<input type="checkbox"/>	PCIe Speed [Auto].....	109
<input type="checkbox"/>	Detect Non-Compliance Device [Disabled].....	109
<input type="checkbox"/>	SATA Controller(s) [Enabled].....	110
<input type="checkbox"/>	SATA Mode Selection [AHCI].....	110
<input type="checkbox"/>	Hot Plug [Disabled].....	110
<input type="checkbox"/>	HD Audio [Auto].....	111
<input type="checkbox"/>	Administrator Password.....	112
<input type="checkbox"/>	User Password.....	112
<input type="checkbox"/>	Bootup NumLock State [On].....	113
<input type="checkbox"/>	Quiet Boot [Enabled].....	114
<input type="checkbox"/>	Launch PXE OpROM [Disabled].....	114
<input type="checkbox"/>	Option ROM Messages [Force BIOS].....	114
<input type="checkbox"/>	UEFI Boot [Disabled].....	114
<input type="checkbox"/>	Save Changes and Reset.....	115
<input type="checkbox"/>	Discard Changes and Reset.....	115
<input type="checkbox"/>	Restore Defaults.....	115



## IMBA-H112 ATX Motherboard

- Save as User Defaults .....115
- Restore User Defaults .....115

Appendix

**D**

# Terminology

---

## IMBA-H112 ATX Motherboard

<b>AC '97</b>	Audio Codec 97 (AC'97) refers to a codec standard developed by Intel® in 1997.
<b>ACPI</b>	Advanced Configuration and Power Interface (ACPI) is an OS-directed configuration, power management, and thermal management interface.
<b>AHCI</b>	Advanced Host Controller Interface (AHCI) is a SATA Host controller register-level interface.
<b>ATA</b>	The Advanced Technology Attachment (ATA) interface connects storage devices including hard disks and CD-ROM drives to a computer.
<b>ARMD</b>	An ATAPI Removable Media Device (ARMD) is any ATAPI device that supports removable media, besides CD and DVD drives.
<b>ASKIR</b>	Amplitude Shift Keyed Infrared (ASKIR) is a form of modulation that represents a digital signal by varying the amplitude (“volume”) of the signal. A low amplitude signal represents a binary 0, while a high amplitude signal represents a binary 1.
<b>BIOS</b>	The Basic Input/Output System (BIOS) is firmware that is first run when the computer is turned on and can be configured by the end user
<b>CODEC</b>	The Compressor-Decompressor (CODEC) encodes and decodes digital audio data on the system.
<b>CMOS</b>	Complimentary metal-oxide-conductor is an integrated circuit used in chips like static RAM and microprocessors.
<b>COM</b>	COM refers to serial ports. Serial ports offer serial communication to expansion devices. The serial port on a personal computer is usually a male DB-9 connector.
<b>DAC</b>	The Digital-to-Analog Converter (DAC) converts digital signals to analog signals.
<b>DDR</b>	Double Data Rate refers to a data bus transferring data on both the rising and falling edges of the clock signal.
<b>DMA</b>	Direct Memory Access (DMA) enables some peripheral devices to bypass the system processor and communicate directly with the system memory.

<b>DIMM</b>	Dual Inline Memory Modules are a type of RAM that offer a 64-bit data bus and have separate electrical contacts on each side of the module.
<b>DIO</b>	The digital inputs and digital outputs are general control signals that control the on/off circuit of external devices or TTL devices. Data can be read or written to the selected address to enable the DIO functions.
<b>EHCI</b>	The Enhanced Host Controller Interface (EHCI) specification is a register-level interface description for USB 2.0 Host Controllers.
<b>EIDE</b>	Enhanced IDE (EIDE) is a newer IDE interface standard that has data transfer rates between 4.0 MBps and 16.6 MBps.
<b>EIST</b>	Enhanced Intel® SpeedStep Technology (EIST) allows users to modify the power consumption levels and processor performance through application software. The application software changes the bus-to-core frequency ratio and the processor core voltage.
<b>FSB</b>	The Front Side Bus (FSB) is the bi-directional communication channel between the processor and the Northbridge chipset.
<b>GbE</b>	Gigabit Ethernet (GbE) is an Ethernet version that transfers data at 1.0 Gbps and complies with the IEEE 802.3-2005 standard.
<b>GPIO</b>	General purpose input
<b>HDD</b>	Hard disk drive (HDD) is a type of magnetic, non-volatile computer storage device that stores digitally encoded data.
<b>ICH</b>	The Input/Output Control Hub (ICH) is an Intel® Southbridge chipset.
<b>IrDA</b>	Infrared Data Association (IrDA) specify infrared data transmission protocols used to enable electronic devices to wirelessly communicate with each other.
<b>L1 Cache</b>	The Level 1 Cache (L1 Cache) is a small memory cache built into the system processor.
<b>L2 Cache</b>	The Level 2 Cache (L2 Cache) is an external processor memory cache.
<b>LCD</b>	Liquid crystal display (LCD) is a flat, low-power display device that consists of two polarizing plates with a liquid crystal panel in between.

## IMBA-H112 ATX Motherboard

<b>LVDS</b>	Low-voltage differential signaling (LVDS) is a dual-wire, high-speed differential electrical signaling system commonly used to connect LCD displays to a computer.
<b>POST</b>	The Power-on Self Test (POST) is the pre-boot actions the system performs when the system is turned-on.
<b>RAM</b>	Random Access Memory (RAM) is volatile memory that loses data when power is lost. RAM has very fast data transfer rates compared to other storage like hard drives.
<b>SATA</b>	Serial ATA (SATA) is a serial communications bus designed for data transfers between storage devices and the computer chipsets. The SATA bus has transfer speeds up to 1.5 Gbps and the SATA II bus has data transfer speeds of up to 3.0 Gbps.
<b>S.M.A.R.T</b>	Self Monitoring Analysis and Reporting Technology (S.M.A.R.T) refers to automatic status checking technology implemented on hard disk drives.
<b>UART</b>	Universal Asynchronous Receiver-transmitter (UART) is responsible for asynchronous communications on the system and manages the system's serial communication (COM) ports.
<b>UHCI</b>	The Universal Host Controller Interface (UHCI) specification is a register-level interface description for USB 1.1 Host Controllers.
<b>USB</b>	The Universal Serial Bus (USB) is an external bus standard for interfacing devices. USB 1.1 supports 12Mbps data transfer rates and USB 2.0 supports 480Mbps data transfer rates.
<b>VGA</b>	The Video Graphics Array (VGA) is a graphics display system developed by IBM.

Appendix

**E**

# Watchdog Timer

---

## IMBA-H112 ATX Motherboard



### NOTE:

The following discussion applies to DOS environment. Contact IEI support or visit the IEI website for specific drivers for other operating systems.

The Watchdog Timer is provided to ensure that standalone systems can always recover from catastrophic conditions that cause the CPU to crash. This condition may have occurred by external EMIs or a software bug. When the CPU stops working correctly, Watchdog Timer either performs a hardware reset (cold boot) or a Non-Maskable Interrupt (NMI) to bring the system back to a known state.

A BIOS function call (INT 15H) is used to control the Watchdog Timer.

INT 15H:

AH – 6FH Sub-function:	
AL – 2:	Sets the Watchdog Timer's period.
BL:	Time-out value (Its unit-second is dependent on the item "Watchdog Timer unit select" in CMOS setup).

**Table E-1: AH-6FH Sub-function**

Call sub-function 2 to set the time-out period of Watchdog Timer first. If the time-out value is not zero, the Watchdog Timer starts counting down. When the timer value reaches zero, the system resets. To ensure that this reset condition does not occur, calling sub-function 2 must periodically refresh the Watchdog Timer. However, the watchdog timer is disabled if the time-out value is set to zero.

A tolerance of at least 10% must be maintained to avoid unknown routines within the operating system (DOS), such as disk I/O that can be very time-consuming.

**NOTE:**

When exiting a program it is necessary to disable the Watchdog Timer, otherwise the system resets.

**EXAMPLE PROGRAM:**

**; INITIAL TIMER PERIOD COUNTER**

;

**W\_LOOP:**

;

```
MOV     AX, 6F02H      ;setting the time-out value
MOV     BL, 30         ;time-out value is 48 seconds
INT     15H
```

;

**; ADD THE APPLICATION PROGRAM HERE**

;

```
CMP     EXIT_AP, 1     ;is the application over?
JNE     W_LOOP        ;No, restart the application
```

```
MOV     AX, 6F02H      ;disable Watchdog Timer
MOV     BL, 0          ;
INT     15H
```

;

**; EXIT ;**



Appendix

**F**

# Error Beep Code

---

### F.1 PEI Beep Codes

Number of Beeps	Description
1	Memory not Installed
1	Memory was installed twice (InstallPeiMemory routine in PEI Core called twice)
2	Recovery started
3	DXE IPL was not found
3	DXE Core Firmware Volume was not found
4	Recovery failed
4	S3 Resume failed
7	Reset PPI is not available

### F.2 DXE Beep Codes

Number of Beeps	Description
1	Invalid password
4	Some of the Architectural Protocols are not available
5	No Console Output Devices are found
5	No Console Input Devices are found
6	Flash update is failed
7	Reset protocol is not available
8	Platform PCI resource requirements cannot be met



**NOTE:**

If you have any question, please contact IEI for further assistance.

Appendix

G

# Hazardous Materials Disclosure

---

The details provided in this appendix are to ensure that the product is compliant with the Peoples Republic of China (China) RoHS standards. The table below acknowledges the presences of small quantities of certain materials in the product, and is applicable to China RoHS only.

A label will be placed on each product to indicate the estimated “Environmentally Friendly Use Period” (EFUP). This is an estimate of the number of years that these substances would “not leak out or undergo abrupt change.” This product may contain replaceable sub-assemblies/components which have a shorter EFUP such as batteries and lamps. These components will be separately marked.

Please refer to below table.

Part Name	Toxic or Hazardous Substances and Elements					
	Lead (Pb)	Mercury (Hg)	Cadmium (Cd)	Hexavalent Chromium (CR(VI))	Polybrominated Biphenyls (PBB)	Polybrominated Diphenyl Ethers (PBDE)
Housing	O	O	O	O	O	O
Display	O	O	O	O	O	O
Printed Circuit Board	O	O	O	O	O	O
Metal Fasteners	O	O	O	O	O	O
Cable Assembly	O	O	O	O	O	O
Fan Assembly	O	O	O	O	O	O
Power Supply Assemblies	O	O	O	O	O	O
Battery	O	O	O	O	O	O

O: This toxic or hazardous substance is contained in all of the homogeneous materials for the part is below the limit requirement in SJ/T11363-2006 (now replaced by GB/T 26572-2011).

X: This toxic or hazardous substance is contained in at least one of the homogeneous materials for this part is above the limit requirement in SJ/T11363-2006 (now replaced by GB/T 26572-2011).

## IMBA-H112 ATX Motherboard

此附件旨在确保本产品符合中国 RoHS 标准。以下表格标示此产品中某有毒物质的含量符合中国 RoHS 标准规定的限量要求。

本产品上会附有“环境友好使用期限”的标签，此期限是估算这些物质“不会有泄漏或突变”的年限。本产品可能包含有较短的环境友好使用期限的可替换元件，像是电池或灯管，这些元件将会单独标示出来。

部件名称	有毒有害物质或元素					
	铅 (Pb)	汞 (Hg)	镉 (Cd)	六价铬 (CR(VI))	多溴联苯 (PBB)	多溴二苯 醚 (PBDE)
壳体	○	○	○	○	○	○
显示	○	○	○	○	○	○
印刷电路板	○	○	○	○	○	○
金属螺帽	○	○	○	○	○	○
电缆组装	○	○	○	○	○	○
风扇组装	○	○	○	○	○	○
电力供应组装	○	○	○	○	○	○
电池	○	○	○	○	○	○

○: 表示该有毒有害物质在该部件所有物质材料中的含量均在 SJ/T 11363-2006 (现由 GB/T 26572-2011 取代) 标准规定的限量要求以下。

X: 表示该有毒有害物质至少在该部件的某一均质材料中的含量超出 SJ/T 11363-2006 (现由 GB/T 26572-2011 取代) 标准规定的限量要求。