



MODEL:
FLEX-BX200-Q370

2U AI Box PC with 8th Gen. LGA1151 Intel® Core™ i7/i5/i3 and Pentium® Processor, DDR4, HDMI, USB 3.1, Dual GbE, RS-232, M.2, Four SSD Bays, PCIe 3.0, RoHS Compliant,

User Manual

Revision

Date	Version	Changes
October 4, 2018	1.00	Initial release



Safety Instructions

- en** Warning! Read the user manual before connecting the system to the power source.
- de** Vorsicht! Bitte lesen Sie die Bedienungsanleitung, bevor Sie das System an eine Stromquelle anschließen.
- fr** Attention! Avant de brancher le système à la source d'alimentation, consultez le mode d'emploi.
- it** Avvertenza! Consultare il manuale utente prima di collegare il sistema all'alimentatore.
- es** Atención! Lea atentamente este manual del usuario antes de operar la fuente de alimentación.
- zh** 警告！在將系統連接到電源之前，請仔細閱讀使用手冊。
- cn** 警告！在將系統連接到電源之前，請仔細閱讀使用手冊。
-

- en** Warning! To prevent the system from overheating, do not operate it in an area that exceeds the maximum operating temperature described in the user manual.
- de** Vorsicht! Um eine Überhitzung des Systems zu vermeiden, betreiben Sie es ausschließlich im zulässigen Betriebstemperaturbereich. Dieser ist in der Bedienungsanleitung vermerkt.
- fr** Attention! Pour éviter la surchauffe du système, ne l'utilisez pas dans une zone dont la température dépasse les limites décrits dans le mode d'emploi.
- it** Avvertenza! Per evitare che il sistema si surriscaldi, non utilizzarlo in aree che superino la temperatura massima d'esercizio descritta nel manuale utente.
- es** Atención! Para evitar el excesivo calentamiento del sistema, no opere en las condiciones de temperatura superior a lo recomendado en este manual del usuario.
- zh** 警告！為防止系統過熱，不要在使用手冊上記載的產品工作溫度範圍之外操作此系統。
- cn** 警告！為防止系統過熱，不要在使用手冊上記載的產品工作溫度範圍之外操作此系統。
-

-
- en** Warning! Ultimate disposal of this product should be handled according to all national laws and regulations.
 - de** Vorsicht! Die Entsorgung dieses Produkts sollte gemäß allen Bestimmungen und Gesetzen des Landes erfolgen.
 - fr** Attention! La mise au rebut ou le recyclage de ce produit sont généralement soumis aux lois et/ou directives de respect de l'environnement. Renseignez-vous auprès de l'organisme compétent.
 - it** Avvertenza! Lo smaltimento di questo prodotto deve essere eseguito secondo le leggi e i regolamenti locali.
 - es** Atención! La disposición final de residuos de este producto se debe cumplir con las normativas y leyes del país.
 - zh** 警告！本產品的廢棄處理應根據該國家的法律和規章進行。
 - cn** 警告！本产品的废弃处理应根据该国家的法律和规章进行。
-

Copyright

COPYRIGHT NOTICE

The information in this document is subject to change without prior notice in order to improve reliability, design and function and does not represent a commitment on the part of the manufacturer.

In no event will the manufacturer be liable for direct, indirect, special, incidental, or consequential damages arising out of the use or inability to use the product or documentation, even if advised of the possibility of such damages.

This document contains proprietary information protected by copyright. All rights are reserved. No part of this manual may be reproduced by any mechanical, electronic, or other means in any form without prior written permission of the manufacturer.

TRADEMARKS

All registered trademarks and product names mentioned herein are used for identification purposes only and may be trademarks and/or registered trademarks of their respective owners.

Manual Conventions



WARNING

Warnings appear where overlooked details may cause damage to the equipment or result in personal injury. Warnings should be taken seriously.



CAUTION

Cautionary messages should be heeded to help reduce the chance of losing data or damaging the product.



NOTE

These messages inform the reader of essential but non-critical information. These messages should be read carefully as any directions or instructions contained therein can help avoid making mistakes.

Table of Contents

1 INTRODUCTION.....	1
1.1 OVERVIEW.....	2
1.2 MODEL VARIATIONS.....	3
1.3 FEATURES.....	4
1.4 FRONT PANEL.....	4
1.5 REAR PANEL.....	5
1.6 BOTTOM PANEL.....	5
1.7 TECHNICAL SPECIFICATIONS.....	6
1.8 OPTIONAL PANEL KIT SPECIFICATIONS.....	8
1.8.1 15" ~ 18.5" Specifications.....	8
1.8.1 21.5" ~ 23.8" Specifications.....	9
1.9 DIMENSIONS.....	10
2 UNPACKING.....	11
2.1 UNPACKING.....	12
2.2 PACKING LIST.....	12
2.3 OPTIONAL ITEMS.....	13
3 INSTALLATION.....	15
3.1 ANTI-STATIC PRECAUTIONS.....	16
3.2 INSTALLATION PRECAUTIONS.....	16
3.3 INSTALLATION PROCEDURE.....	17
3.4 SOLID-STATE DRIVE INSTALLATION.....	18
3.5 REMOVING THE TOP COVER.....	20
3.6 SOCKET LGA1151 CPU INSTALLATION (OPTIONAL).....	21
3.6.1 Socket LGA1151 Cooling Kit Installation (Optional).....	24
3.7 DIMM INSTALLATION (OPTIONAL).....	26
3.8 M.2 SSD INSTALLATION (OPTIONAL).....	27
3.9 EXPANSION CARD INSTALLATION (OPTIONAL).....	29
3.10 MOUNTING THE SYSTEM.....	31
3.10.1 Wall Mount.....	31

3.10.2 Rack Mount	33
3.11 CONVERTING TO PANEL PC (OPTIONAL).....	34
3.12 COM PORT CONNECTION.....	40
3.13 POWER-ON PROCEDURE.....	41
3.13.1 Installation Checklist	41
3.13.2 Power-on Procedure	41
3.14 SOFTWARE INSTALLATION	42
3.14.1 Driver Download	42
3.15 RAID CONFIGURATION	44
4 BIOS	47
4.1 INTRODUCTION.....	48
4.1.1 Starting Setup.....	48
4.1.2 Using Setup	48
4.1.3 Getting Help.....	49
4.1.4 BIOS Menu Bar.....	49
4.2 MAIN.....	50
4.3 ADVANCED.....	51
4.3.1 CPU Configuration	53
4.3.2 Thunderbolt Configuration	55
4.3.3 Trusted Computing.....	56
4.3.4 ACPI Settings.....	57
4.3.5 iWDD H/W Monitor.....	58
4.3.5.1 Smart Fan Mode Configuration	59
4.3.6 F81866 Super IO Configuration	61
4.3.6.1 Serial Port n Configuration	62
4.3.7 RTC Wake Settings.....	63
4.3.8 Serial Port Console Redirection	64
4.3.8.1 Legacy Console Redirection Settings	67
4.3.9 USB Configuration.....	68
4.3.10 NVMe Configuration.....	69
4.3.1 IEI QTS	69
4.3.2 IEI Feature.....	70
4.4 CHIPSET	71
4.4.1 System Agent (SA) Configuration	72

FLEX-BX200-Q370

4.4.1.1 Memory Configuration	73
4.4.1.2 Graphics Configuration.....	74
4.4.1.3 PEG Port Configuration.....	76
4.4.2 PCH-IO Configuration	78
4.4.2.1 PCI Express Configuration	80
4.4.2.2 SATA Configuration.....	83
4.4.2.3 HD Audio Configuration.....	85
4.5 SECURITY.....	86
4.6 BOOT.....	87
4.7 SAVE & EXIT	89
5 TROUBLESHOOTING AND MAINTENANCE	90
5.1 FLEX-BX200-Q370 SYSTEM MAINTENANCE OVERVIEW	91
5.2 SYSTEM TROUBLESHOOTING.....	91
5.2.1 The System Doesn't Turn On.....	91
5.2.2 The System Doesn't Boot Up.....	92
5.2.3 More Troubleshooting.....	92
5.3 COMPONENT REPLACEMENT	93
6 INTERFACE CONNECTORS	94
6.1 PERIPHERAL INTERFACE CONNECTORS.....	95
6.2 INTERNAL PERIPHERAL CONNECTORS	96
6.2.1 ATX Power Input Connector (ATX1)	97
6.2.2 Additional Power Connector (ATXPWR1).....	98
6.2.3 Battery Connector (BAT1)	98
6.2.4 Chassis Intrusion Connector (CHASSIS1).....	98
6.2.5 CPU Power Connector (CPU12V1)	98
6.2.6 DIO Connector (DIO1).....	99
6.2.7 EC Debug Port (EC_DBG1).....	99
6.2.8 Fan Connector, CPU (CPU_FAN1).....	99
6.2.9 Fan Connectors, System (SYS_FAN1, SYS_FAN2, SYS_FAN3).....	100
6.2.10 I ² C Connector (I2C1).....	100
6.2.11 Internal DisplayPort Connector (IDP1)	100
6.2.12 LED Connector, HDD (H_LED1).....	101
6.2.13 LED Connector, Power (P_LED1)	101

6.2.14 LVDS Connector (LVDS1).....	101
6.2.15 LVDS Backlight Connector (INV1).....	102
6.2.16 Mini SAS Connector (MINI_SAS1).....	102
6.2.17 Power Button Connector (P_BTN1).....	103
6.2.18 Touch Panel Connector (TS1).....	103
6.2.19 RS-232 Connector (COM2).....	104
6.2.20 RS-422/485 Connector (COM3).....	104
6.2.21 SMBus Connector (SMB1).....	104
6.2.22 SPI Flash Connector (J_SPI1).....	105
6.2.23 SPI Flash (EC) Connector (J_EC1).....	105
6.2.24 Speaker Connector (SPK1).....	105
6.2.25 TPM Connector (TPM1).....	106
6.2.26 USB 2.0 Connectors, Single (JUSB1, JUSB2).....	106
6.2.27 USB 2.0 Connectors, Dual (JUSB3).....	107
6.2.1 USB DOM Connector (USB_DOM1).....	107
6.3 JUMPERS.....	107
6.3.1 Clear CMOS Jumper (J_CMOS1).....	108
6.3.2 ME RTC Register Setting Jumper (ME_RTC1).....	108
A REGULATORY COMPLIANCE	109
B SAFETY PRECAUTIONS	114
B.1 SAFETY PRECAUTIONS.....	115
B.1.1 General Safety Precautions.....	115
B.1.2 Anti-static Precautions	116
B.1.3 Product Disposal.....	117
B.2 MAINTENANCE AND CLEANING PRECAUTIONS	118
B.2.1 Maintenance and Cleaning.....	118
B.2.2 Cleaning Tools.....	118
C BIOS MENU OPTIONS.....	120
C.1 BIOS CONFIGURATION OPTIONS	121
D WATCHDOG TIMER	123
E PANEL KIT DIMENSIONS.....	126
E.1 FLEX-PLKIT-F15	127

FLEX-BX200-Q370

E.2 FLEX-PLKIT-FW15.....	128
E.3 FLEX-PLKIT-F17	129
E.4 FLEX-PLKIT-FW19.....	130
E.5 FLEX-PLKIT-FW22.....	131
E.6 FLEX-PLKIT-FW24.....	132
F HAZARDOUS MATERIALS DISCLOSURE.....	133

List of Figures

Figure 1-1: FLEX-BX200-Q370 Series Box PC	2
Figure 1-2: Front Panel	4
Figure 1-3: Rear Panel.....	5
Figure 1-4: Bottom Panel	5
Figure 1-5: FLEX-BX200-Q370 Dimensions with Mounting Brackets (mm).....	10
Figure 3-1: Unlock HDD Cover	18
Figure 3-2: Drive Tray Removal.....	18
Figure 3-3: SSD Retention Screws.....	19
Figure 3-4: SSD Installation	19
Figure 3-5: Top Cover Retention Screw Removal	20
Figure 3-6: Remove the Top Cover	21
Figure 3-7: Disengage the CPU Socket Load Lever.....	22
Figure 3-8: Remove Protective Cover.....	22
Figure 3-9: Insert the Socket LGA1151 CPU.....	23
Figure 3-10: Close the Socket LGA1151	24
Figure 3-11: DIMM Installation.....	26
Figure 3-12: M.2 Slot Locations	27
Figure 3-13: Removing the M.2 Module Retention Screw	27
Figure 3-14: Inserting the M.2 Module into the Slot at an Angle	28
Figure 3-15: Securing the M.2 Module.....	28
Figure 3-16: PCIe Slot Locations	29
Figure 3-17: Blank Bracket Screw Removal	30
Figure 3-18: Install and Secure Expansion Card.....	30
Figure 3-19: Mounting Bracket Retention Screws	31
Figure 3-20: Mounting Bracket Retention Screws	32
Figure 3-21: Install Rack Mount Bracket	33
Figure 3-22: Mounting Bracket Retention Screws	33
Figure 3-23: RS-232 Connector (COM1, COM2).....	40
Figure 3-24: Power Button.....	41
Figure 3-25: IEI Resource Download Center.....	42
Figure 3-26: RAID Configuration–BIOS Setting.....	45

FLEX-BX200-Q370

Figure 6-1: Main Board Layout Diagram (Front Side).....95

List of Tables

Table 1-1: Model Variations	3
Table 1-2: Technical Specifications.....	7
Table 2-1: Package List.....	13
Table 2-2: Optional Items.....	14
Table 3-1: Panel Resolution and Voltage Jumper Settings.....	39
Table 3-2: RS-232 Connector Pinouts	40
Table 4-1: BIOS Navigation Keys	49
Table 6-1: Peripheral Interface Connectors	97
Table 6-2: ATX Power Input Connector (ATX1) Pinouts.....	97
Table 6-3: Additional Power Connector (ATXPWR1) Pinouts.....	98
Table 6-4: Battery Connector (BAT1) Pinouts	98
Table 6-5: Chassis Intrusion Connector (CHASSIS1) Pinouts.....	98
Table 6-6: CPU Power Connector (CPU12V1).....	98
Table 6-7: DIO Connector (DIO1) Pinouts	99
Table 6-8: EC Debug Port (EC_DBG1) Pinouts.....	99
Table 6-9: CPU Fan Connector (CPU_FAN1) Pinouts.....	99
Table 6-10: System Fan Connectors (SYS_FAN1, SYS_FAN2, SYS_FAN3) Pinouts.....	100
Table 6-11: I ² C Connector (I2C1) Pinouts.....	100
Table 6-12: Internal DisplayPort Connector (IDP1) Pinouts.....	100
Table 6-13: HDD LED Connector (H_LED1) Pinouts	101
Table 6-14: Power LED Connector (P_LED1) Pinouts	101
Table 6-15: LVDS Connector (LVDS1) Pinouts.....	102
Table 6-16: LVDS Backlight Connector (INV1) Pinouts	102
Table 6-17: Mini SAS Connector (MINI_SAS1) Pinouts	103
Table 6-18: Power Button Connector (P_BTN1) Pinouts.....	103
Table 6-19: Touch Panel Connector (TS1) Pinouts	103
Table 6-20: RS-232 Connector (COM2) Pinouts	104
Table 6-21: RS-422/485 Connector (COM3) Pinouts	104
Table 6-22: SMBus Connector (SMB1) Pinouts.....	104
Table 6-23: SPI Flash Connector (J_SPI1) Pinouts.....	105
Table 6-24: SPI Flash (EC) Connector (J_EC1) Pinouts	105

FLEX-BX200-Q370

Table 6-25: Speaker Connector (SPK1) Pinouts.....	105
Table 6-26: TPM Connector (TPM1) Pinouts.....	106
Table 6-27: Single USB 2.0 Connectors (JUSB1, JUSB2) Pinouts	106
Table 6-28: Dual USB 2.0 Connector (JUSB3) Pinouts.....	107
Table 6-29: USB DOM Connector (USB_DOM1) Pinouts.....	107
Table 6-30: Jumpers.....	107
Table 6-31: Clear CMOS Jumper (J_CMOS1) Settings	108
Table 6-32: ME RTC Register Jumper (ME_RTC1) Settings.....	108

List of BIOS Menus

BIOS Menu 1: Main	50
BIOS Menu 2: Advanced	52
BIOS Menu 3: CPU Configuration	53
BIOS Menu 4: Thunderbolt Configuration.....	55
BIOS Menu 5: Trusted Computing	56
BIOS Menu 6: ACPI Configuration	57
BIOS Menu 7: iWDD H/W Monitor	58
BIOS Menu 8: Smart Fan Mode Configuration	59
BIOS Menu 9: F81866 Super IO Configuration	61
BIOS Menu 10: Serial Port n Configuration Menu	62
BIOS Menu 11: RTC Wake Settings	63
BIOS Menu 12: Serial Port Console Redirection	64
BIOS Menu 13: Legacy Console Redirection Settings	67
BIOS Menu 14: USB Configuration	68
BIOS Menu 15: NVMe Configuration.....	69
BIOS Menu 16: IEI QTS	69
BIOS Menu 17: IEI Feature	70
BIOS Menu 18: Chipset	71
BIOS Menu 19: System Agent (SA) Configuration	72
BIOS Menu 20: Memory Configuration.....	73
BIOS Menu 21: Graphics Configuration	74
BIOS Menu 22: PEG Port Configuration.....	76
BIOS Menu 23: PEG Port Feature Configuration.....	77
BIOS Menu 24: PCH-IO Configuration	78
BIOS Menu 25: PCI Express Configuration	80
BIOS Menu 26: PCIe Slot Configuration Submenu	81
BIOS Menu 27: SATA Configuration	83
BIOS Menu 28: HD Audio Configuration	85
BIOS Menu 29: Security	86
BIOS Menu 30: Boot	87

FLEX-BX200-Q370

BIOS Menu 31: Save & Exit.....89

Chapter

1

Introduction

1.1 Overview



Figure 1-1: FLEX-BX200-Q370 Series Box PC

The FLEX-BX200-Q370 box PC is powered by 8th Generation LGA1151 Intel® Core™ i7/i5/i3 and Pentium® Processor. It can be used as an inference computing system for AI applications.

The excellent active cooling method is utilized to effectively transfer heat from the chassis and maintain system performance. By combining with the FLEX-PLKIT LCD touchscreen module, the system can transform into an all-in-one panel PC to achieve high flexibility using its optimized modular design. The FLEX-PLKIT modules ranged from 15" to 24" are compliant with IP65, providing durable protection for a variety of applications.

The FLEX-BX200-Q370 includes four low-profile PCIe slots for various expansions, two of them are PCIe 3.0 x8 slots for adding GPU cards or image processing cards for high-performance Artificial Intelligence computing. Four 2.5" SATA SSD bays with RAID function are protected in a lockable cover to ensure security of data and disks. The system is also equipped with two M.2 M-key (2280) slots to support PCIe SSD and NVMe, providing a variety of storage interfaces for users to choose.

FLEX-BX200-Q370

1.2 Model Variations

There are three models in the FLEX-BX200-Q370 box PC series. The model variations are listed in **Table 1-1** below.

	Processor	Power Supply
FLEX-BX200-Q370/25	N/A	250 W
FLEX-BX200-Q370-P/25	Intel® Pentium® Gold G5400T (2-core, 4M cache, 3.1 GHz, 35W TDP)	250 W
FLEX-BX200-Q370-i3/25	Intel® Core™ i3-8100T (4-core, 6M cache, 3.1 GHz, 35W TDP)	250 W
FLEX-BX200-Q370-i5/25*	Intel® Core™ i5-8500T (6-core, 9M cache, 2.1 GHz, 35W TDP)	250 W
FLEX-BX200-Q370-i7/25*	Intel® Core™ i7-8700T (6-core, 12M cache, 2.4 GHz, 35W TDP)	250 W
FLEX-BX200-Q370/35*	N/A	350 W
FLEX-BX200-Q370-P/35*	Intel® Pentium® Gold G5400T (2-core, 4M cache, 3.1 GHz, 35W TDP)	350 W
FLEX-BX200-Q370-i3/35*	Intel® Core™ i3-8100T (4-core, 6M cache, 3.1 GHz, 35W TDP)	350 W
FLEX-BX200-Q370-i5/35*	Intel® Core™ i5-8500T (6-core, 9M cache, 2.1 GHz, 35W TDP)	350 W
FLEX-BX200-Q370-i7/35*	Intel® Core™ i7-8700T (6-core, 12M cache, 2.4 GHz, 35W TDP)	350 W

**Build to Order*

Table 1-1: Model Variations

1.3 Features

The FLEX-BX200-Q370 has the following features

- 8th generation Intel® Core™ i7/i5/i3 and Pentium® Processor
- Modularized design for flexible utilization
- 2U chassis for 19-inch rack mount
- Support up to 64 GB of 2666 MHz DDR4 memory
- Four PCIe 3.0 slots for expansion
- Four hot-swappable 2.5" SATA HDD/SSD bays
- Two M.2 M-key (2280) slots support NVMe SSD
- Two GbE LAN
- Various I/O interfaces, including six USB 3.0 ports, one RS-232 port, HDMI output, audio line-out and mic-in
- RoHS compliant design

1.4 Front Panel

The front panel of the FLEX-BX200-Q370 has the following button and indicator:

- 1 x Power button with power LED indicator (power on: solid blue)
- 1 x HDD LED indicator (HDD activity: blinking red)



Figure 1-2: Front Panel

FLEX-BX200-Q370

1.5 Rear Panel

An overview of the rear panel is shown in **Figure 1-3**.

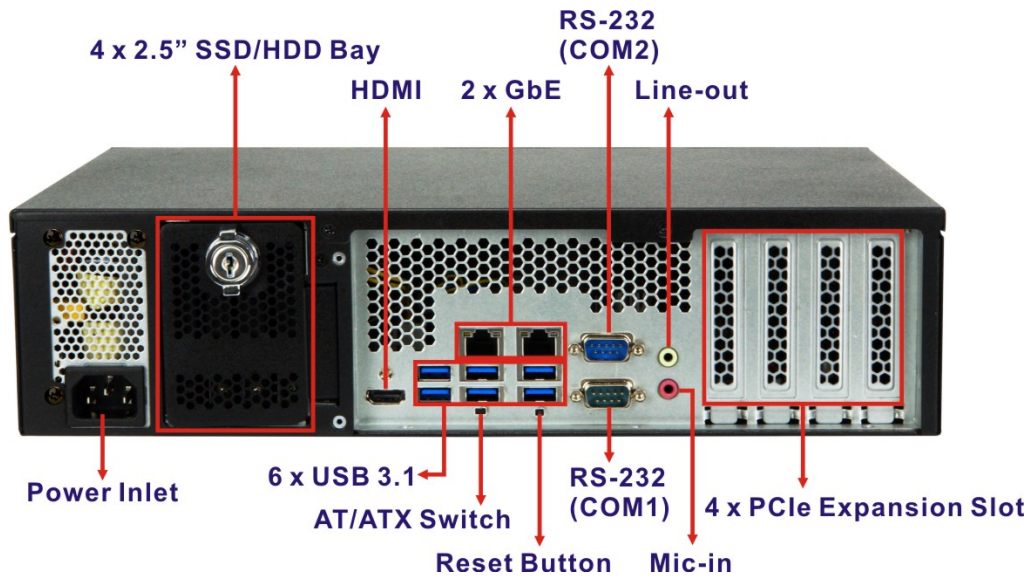

Figure 1-3: Rear Panel

1.6 Bottom Panel

The bottom surface of the FLEX-BX200-Q370 contains four retention screw holes for installing two side mounting brackets. The wiring connection hole is protected by a cover, and allows the display cables from the panel kit to connect to the box PC motherboard.

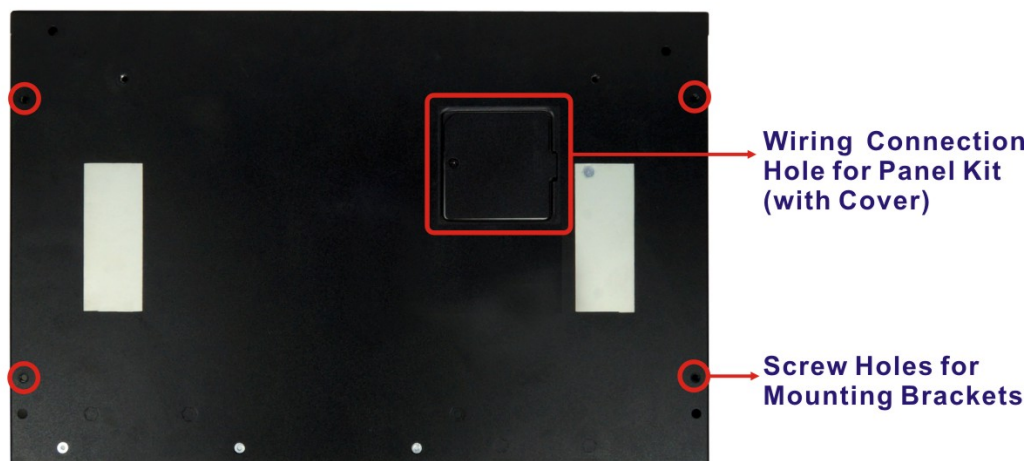

Figure 1-4: Bottom Panel

1.7 Technical Specifications

The specifications for the FLEX-BX200-Q370 box PCs are listed below.

	FLEX-BX200-Q370
CPU	8th Generation LGA1151 Intel® Core™ i7/i5/i3 and Pentium® processor (65W/35W)
Chipset	Intel® Q370
BIOS	AMI UEFI BIOS
Memory	Two 288-pin 2666/2400 MHz dual-channel DDR4 SDRAM DIMM slots (system max. 64 GB)
Graphics Engine	-Intel® HD Graphics Gen 9 Engines with low power 16 execution units, supports DX2015, OpenGL 5.X and OpenCL2.x, ES 2.0
Display Output	1 x HDMI (external) 1 x LVDS (internal) 1 x iDP (internal)
Ethernet	LAN1: Intel® I211AT Ethernet controller LAN2: Intel® I211AT Ethernet controller
Super I/O	Fintek F81866
Embedded Controller	ITE IT8528E
Storage	4 x Hot-swappable SATA 6G/s HDD/SSD bay (support RAID 0/1/5/10) 2 x M.2 M-key (2280, PCIe 3.0 x4), support NVMe SSD
USB	6 x USB 3.1 Gen 1 Type-A (external) 1 x USB DOM for QTS Gateway (internal, 2x4 pin header)
COM	2 x RS-232 (DB-9, COM1 & COM2)
Audio	Realtek ALC662 HD codec 1 x Line out 1 x Mic in
Buttons and Indicators	1 x HDD LED (front panel) 1 x Power button with LED indicator (front panel) 1 x Reset button (rear panel) 1 x AT/ATX mode switch (rear panel)

FLEX-BX200-Q370

Expansions	2 x PCIe 3.0 x16 (x8 mode) 2 x PCIe 3.0 x4 (Max. card size: 68 mm x 167 mm)
Thermal	3 x System fan 1 x CPU fan
Power supply	<p>AC input ATX power supply</p> <p>1. 250 W power supply</p> <ul style="list-style-type: none"> - Input: 115VAC~230VAC, 50/60Hz - Output (max.): 3.3V@12A, 5V@14A, 12V@25A, -12V@0.3A,+5Vsb@3A <p>2. 350 W power supply (Build to Order)</p> <ul style="list-style-type: none"> - Input: 115VAC~264VAC, 50/60Hz - Output (max.): 3.3V@14A, 5V@16A, 12V@29A, -12V@0.3A,+5Vsb@3A -Efficiency: Full load (100%) 87%, Typical load (50%) 90%, Light load (20%) 87%
	Support AT/ATX mode
Chassis Construction	Metal housing
Mounting	Wall mount, rack mount
Color	Black C
Dimensions (LxDxH)	357 mm x 230 mm x 88 mm
Watchdog Timer	Software programmable support 1~255 sec. system reset
Vibration	5~17Hz, 0.1 double amplitude displacement 17~640Hz 1.5G acceleration peak to peak
Shock	10G acceleration part to part (11ms)
Operating Temperature	-20°C ~ 50°C (with SSD and TDP 65W processor) -20°C ~ 40°C (with HDD or add-on cards without fan)
Storage Temperature	-30°C ~ 60°C
Operating Humidity	5% ~95%, non-condensing

Table 1-2: Technical Specifications

1.8 Optional Panel Kit Specifications

By combining with the FLEX-PLKIT LCD panel, the FLEX-BX200-Q370 can transform into an all-in-one panel PC. The specifications for the optional panel kits are listed below.

1.8.1 15" ~ 18.5" Specifications

	FLEX-PLKIT-F15	FLEX-PLKIT-FW15	FLEX-PLKIT-F17	FLEX-PLKIT-FW19
LCD Size	15"	15.6"	17"	18.5"
Max. Resolution	1024 x 768	1366 x 768	1280 x 1024	1366 x 768
Brightness (cd/m²)	450	400	350	400
Contrast Ratio	800:1	500:1	1000:1	1000:1
LCD Color	16.2M	16.2M	16.7M	16.7M
Pixel Pitch (mm)	0.29 x 0.29	0.252 x 0.252	0.26 x 0.26	0.3 x 0.3
Viewing Angle (H/V)	160°/150°	170°/160°	170°/160°	170°/160°
Backlight MTBF	70,000 hrs	50,000 hrs	50,000 hrs	50,000 hrs
Touchscreen Type	5-wire resistive touch window with anti-glare coating / Projected capacitive type with 10-point multi-touch and anti-glare coating			
Touch Controller	Resistive type: Penmount 9000 Projected capacitive type: EETI EXC3000			
Video Interface	LVDS	LVDS	LVDS	LVDS
Dimensions (mm) (W x H x D)	378.5 x 303 x 30	400.1 x 253.3 x 33	408.4 x 341.4 x 31	468.8 x 288.2 x 32.8
Cutout Dimensions	285.6 x 361.1 (mm)	232.3 x 379.1 (mm)	324 x 391 (mm)	257.2 x 447.8 (mm)
Color	PANTONE 296 C	PANTONE 296 C	PANTONE 296 C	PANTONE 296 C
Front Frame	Aluminum	Aluminum	Aluminum	Aluminum
Rear Cover	Sheet Metal	Sheet Metal	Sheet Metal	Sheet Metal
Mounting	Panel mount, Rack mount			
Operating Temp.	-10°C ~ 60°C (with air flow)	-10°C ~ 50°C (with air flow)	-10°C ~ 60°C (with air flow)	
Storage Temp.	-20°C ~ 70°C			
Humidity	10% ~ 95% (non-condensing)			

FLEX-BX200-Q370

1.8.1 21.5" ~ 23.8" Specifications

	FLEX-PLKIT-FW22	FLEX-PLKIT-FW24
LCD Size	21.5"	23.8"
Max. Resolution	1920 x 1080	1920 x 1080
Brightness (cd/m²)	250	250
Contrast Ratio	1000:1	3000:1
LCD Color	16.7M	16.7M
Pixel Pitch (mm)	0.25 x 0.25	0.274 x 0.274
Viewing Angle (H/V)	170°/160°	178°/178°
Backlight MTBF	30,000 hrs	30,000 hrs
Touchscreen Type	Projected capacitive type with 10-point multi-touch and anti-glare coating	
Touch Controller	EETI EXC3000	
Video Interface	LVDS	LVDS
Dimensions (mm)	550.4 (W) x 358.4 (H) x 29.8 (D)	600 (W) x 382 (H) x 31 (D)
Cutout Dimensions	341 x 533 (mm)	359.6 x 577.6 (mm)
Color	PANTONE 296 C	PANTONE 296 C
Front Frame	Aluminum	Aluminum
Rear Cover	Sheet Metal	Sheet Metal
Mounting	Panel mount	
Operating Temp.	-10°C ~ 50°C (with air flow)	
Storage Temp.	-20°C ~ 60°C	
Humidity	10% ~ 95% (non-condensing)	

1.9 Dimensions

The dimensions of the FLEX-BX200-Q370 are listed below and shown in **Figure 1-5**.

See “Appendix E: Panel Kit Dimensions” for the dimensions of the whole FLEX-PLKIT series.

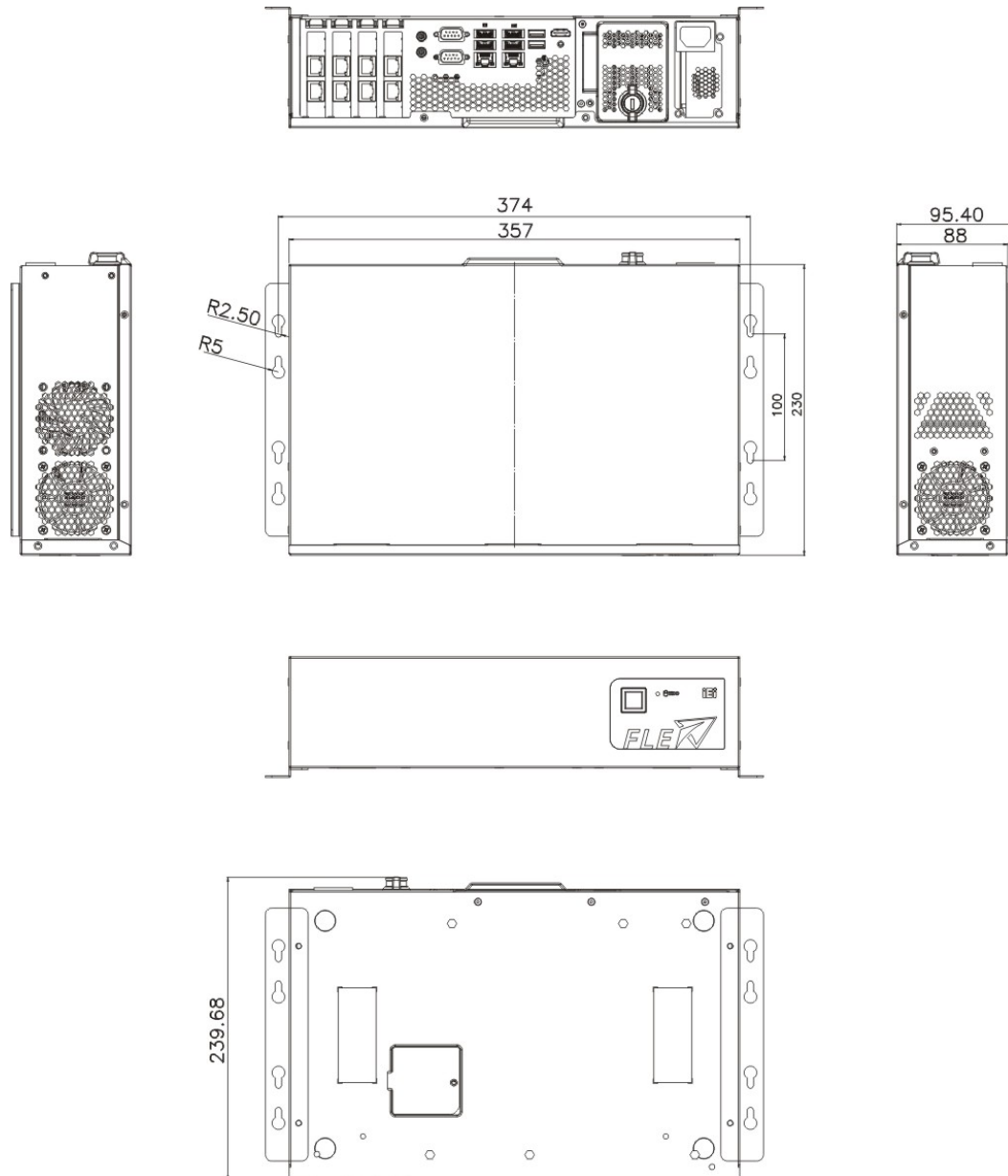

Figure 1-5: FLEX-BX200-Q370 Dimensions with Mounting Brackets (mm)

Chapter

2

Unpacking

2.1 Unpacking

To unpack the box PC, follow the steps below:

- Step 1:** Use box cutters, a knife or a sharp pair of scissors that seals the top side of the external (second) box.
- Step 2:** Open the external (second) box.
- Step 3:** Use box cutters, a knife or a sharp pair of scissors that seals the top side of the internal (first) box.
- Step 4:** Lift the system out of the boxes.
- Step 5:** Remove both polystyrene ends, one from each side.
- Step 6:** Make sure all the components listed in the packing list are present.



2.2 Packing List



NOTE:

If any of the components listed in the checklist below are missing, do not proceed with the installation. Contact the IEI reseller or vendor the FLEX-BX200-Q370 was purchased from or contact an IEI sales representative directly by sending an email to sales@ieiworld.com.

The FLEX-BX200-Q370 box PC is shipped with the following components:

Quantity	Item	Image
1	FLEX-BX200-Q370 box PC	
1	Power cord	

FLEX-BX200-Q370









2	Keys for locking HDD cover	
2	Wall mount bracket	
2	Rack mount bracket	
8	Screws (M4*6) for mounting brackets	
16	Screws (M3*4) for HDD installation	
4	Foot pad	
1	CPU cooler (only for the SKU without CPU)	

Table 2-1: Package List

2.3 Optional Items

The following are optional component(s) which may be separately purchased:

<p>15" touch LCD for FLEX box PC, P-CAP (P/N: FLEX-PLKIT-F15/PC-R10)</p>	
---	--



<p>15.6" touch LCD for FLEX box PC, P-CAP (P/N: FLEX-PLKIT-FW15/PC-R10)</p>	
<p>17" touch LCD for FLEX box PC, P-CAP (P/N: FLEX-PLKIT-F17/PC-R10)</p>	
<p>18.5" touch LCD for FLEX box PC, P-CAP (P/N: FLEX-PLKIT-FW19/PC-R10)</p>	
<p>21.5" touch LCD for FLEX box PC, P-CAP (P/N: FLEX-PLKIT-FW22/PC-R10)</p>	
<p>23.8" touch LCD for FLEX box PC, P-CAP (P/N: FLEX-PLKIT-FW24/PC-R10)</p>	

Table 2-2: Optional Items

Chapter

3

Installation

3.1 Anti-static Precautions

**WARNING:**

Failure to take ESD precautions during the maintenance of the FLEX-BX200-Q370 may result in permanent damage to the FLEX-BX200-Q370 and severe injury to the user.

Electrostatic discharge (ESD) can cause serious damage to electronic components, including the WAFER series motherboard and the power module. (Dry climates are especially susceptible to ESD.) It is therefore critical that whenever the FLEX-BX200-Q370 is opened and any electrical component handled, the following anti-static precautions are strictly adhered to.

- **Wear an anti-static wristband:** Wearing a simple anti-static wristband can help to prevent ESD from damaging the board.
- **Self-grounding:** Before handling the board, touch any grounded conducting material. During the time the board is handled, frequently touch any conducting materials that are connected to the ground.
- **Use an anti-static pad:** When configuring the FLEX-BX200-Q370, place it on an anti-static pad. This reduces the possibility of ESD damaging the FLEX-BX200-Q370.

3.2 Installation Precautions

During installation, be aware of the precautions below:

- **Read the user manual:** The user manual provides a complete description of the FLEX-BX200-Q370, installation instructions and configuration options.
- **DANGER! Disconnect Power:** Power to the FLEX-BX200-Q370 must be disconnected during the installation process. Failing to disconnect the power may cause severe injury to the body and/or damage to the system.
- **Qualified Personnel:** The FLEX-BX200-Q370 must be installed and operated only by trained and qualified personnel. Maintenance, upgrades, or

FLEX-BX200-Q370

repairs may only be carried out by qualified personnel who are familiar with the associated dangers.

- **Air Circulation:** Make sure there is sufficient air circulation when installing the FLEX-BX200-Q370. The FLEX-BX200-Q370's cooling vents must not be obstructed by any objects. Blocking the vents can cause overheating of the FLEX-BX200-Q370. Leave at least 5 cm of clearance around the FLEX-BX200-Q370 to prevent overheating.
- **Grounding:** The FLEX-BX200-Q370 should be properly grounded. The voltage feeds must not be overloaded. Adjust the cabling and provide external overcharge protection per the electrical values indicated on the label attached to the back of the FLEX-BX200-Q370.

3.3 Installation Procedure

To properly install the FLEX-BX200-Q370, the following steps must be followed. Detailed descriptions of these instructions are listed in the sections that follow.

Step 1: Unpacking the FLEX-BX200-Q370 box PC

Step 2: Install SATA SSD

Step 3: Install M.2 SSD (optional)

Step 4: Install expansion cards (optional)

Step 5: Mount the FLEX-BX200-Q370

Step 6: Connect the peripheral devices

Step 7: Power the system up

3.4 Solid-State Drive Installation

Four 2.5" SATA drives can be installed in the FLEX-BX200-Q370. The SATA drives are installed into the removable hard drive trays protected by a lockable cover on the front panel. To install the SSD into the system, please follow the steps below.

Step 1: Unlock the HDD cover on the front panel with the key came with the system.



Figure 3-1: Unlock HDD Cover

Step 2: Open the HDD cover, and you will see four drive trays (**Figure 3-2**). Pull out one of the drive trays.



Figure 3-2: Drive Tray Removal

FLEX-BX200-Q370

Step 3: Place an SSD onto the drive tray and secure the SSD with the bracket by inserting four retention screws (M3*4) into the bottom of the SSD (**Figure 3-3**).

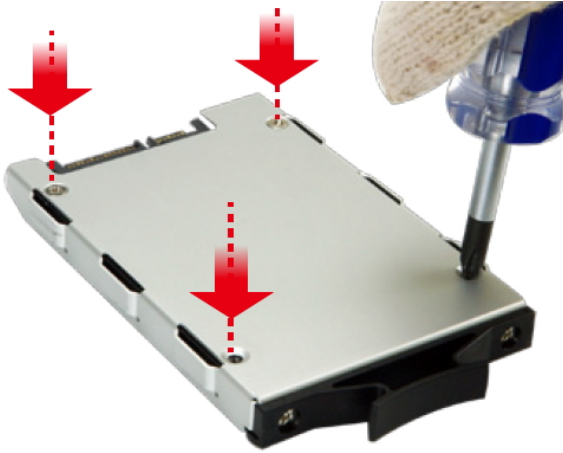

Figure 3-3: SSD Retention Screws

Step 4: Carefully insert the SSD into the slot on the front panel. Make sure the SATA connector on the SSD is securely connected to the SATA connector inside the chassis.



Figure 3-4: SSD Installation

Step 5: Repeat **Step 2 ~ Step 4** described above to install another SSD.

Step 6: Close the HDD cover and lock it with the key.

**NOTE:**

To temporarily close the HDD cover, turn the lock knob 90° counterclockwise by hand to secure the cover.

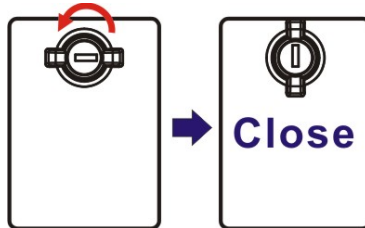

3.5 Removing the Top Cover

**WARNING:**

Before any internal installation procedures are carried out on the system, make sure the system is turned off and cooled down for 15 minutes. Failing to turn off the system before opening it can cause permanent damage to the system and serious or fatal injury to the user.

To access the FLEX-BX200-Q370 internally the top cover must be removed. To remove the top cover, please follow the steps below.

Step 1: Remove the six retention screws, two on the rear and two on each side.



Figure 3-5: Top Cover Retention Screw Removal

FLEX-BX200-Q370

Step 2: Slide the top cover towards the I/O panel until it is disengaged from the locking mechanism. Then, lift the top cover off the chassis. See **Figure 3-6**.



Figure 3-6: Remove the Top Cover

3.6 Socket LGA1151 CPU Installation (Optional)



WARNING:

CPUs are expensive and sensitive components. When installing the CPU please be careful not to damage it in anyway. Make sure the CPU is installed properly and ensure the correct cooling kit is properly installed.

DO NOT touch the pins at the bottom of the CPU. When handling the CPU, only hold it on the sides.

To install the CPU, follow the steps below.

Step 1: Remove the top cover. See Section 3.5 above.

Step 2: **Disengage the load lever** by pressing the lever down and slightly outward to clear the retention tab. Fully open the lever. See **Figure 3-7**.

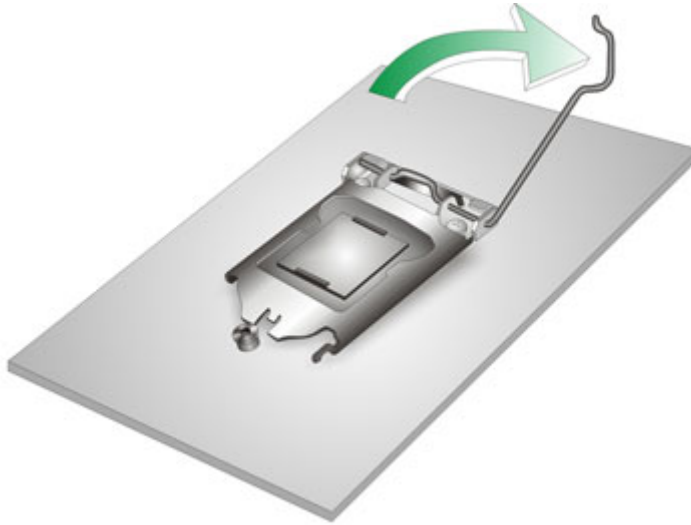

Figure 3-7: Disengage the CPU Socket Load Lever

Step 3: Open the socket and remove the protective cover. The black protective cover can be removed by pulling up on the tab labeled "Remove". See Figure 3-8.

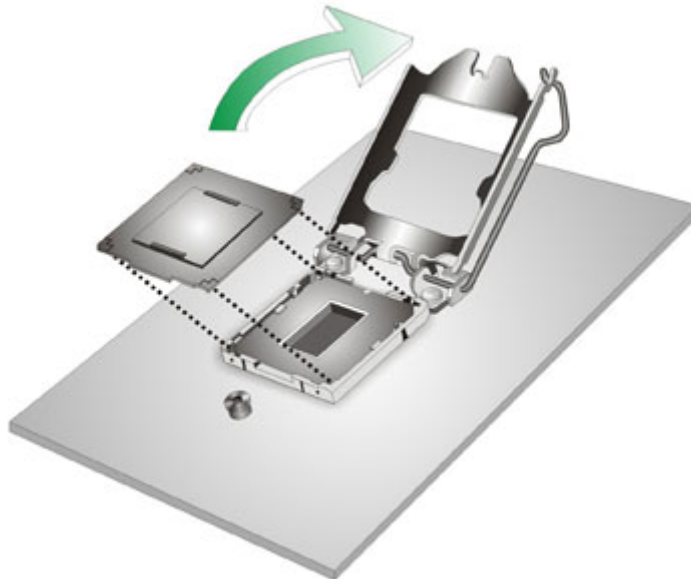

Figure 3-8: Remove Protective Cover

Step 4: **Inspect the CPU socket.** Make sure there are no bent pins and make sure the socket contacts are free of foreign material. If any debris is found, remove it with compressed air.

FLEX-BX200-Q370

Step 5: Orientate the CPU properly. The contact array should be facing the CPU socket.

**WARNING:**

DO NOT touch the pins at the bottom of the CPU. When handling the CPU, only hold it on the sides.

Step 6: Correctly position the CPU. Match the Pin 1 mark with the cut edge on the CPU socket.

Step 7: Align the CPU pins. Locate pin 1 and the two orientation notches on the CPU. Carefully match the two orientation notches on the CPU with the socket alignment keys.

Step 8: Insert the CPU. Gently insert the CPU into the socket. If the CPU pins are properly aligned, the CPU should slide into the CPU socket smoothly. See **Figure 3-9**.

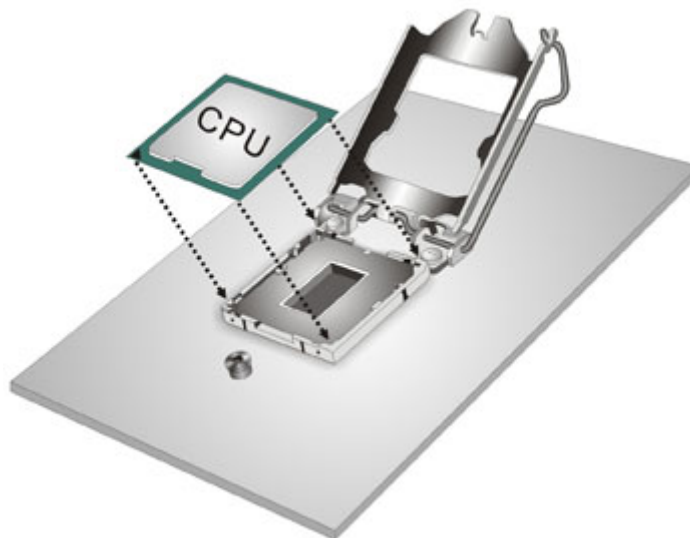

Figure 3-9: Insert the Socket LGA1151 CPU

Step 9: Close the CPU socket. Close the load plate and pull the load lever back a little to have the load plate be able to secure to the knob. Engage the load lever by pushing it back to its original position (**Figure 3-10**). There will be some resistance, but will not require extreme pressure.

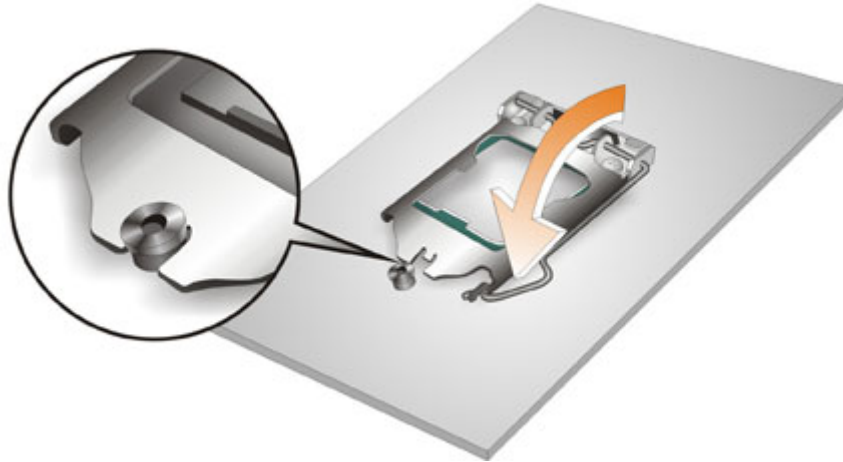

Figure 3-10: Close the Socket LGA1151

Step 10: Connect the 12 V power to the board. Connect the 12 V power from the power supply to the board.

3.6.1 Socket LGA1151 Cooling Kit Installation (Optional)



WARNING:

DO NOT attempt to install a push-pin cooling fan.

The pre-installed support bracket prevents the board from bending and is **ONLY** compatible with captive screw type cooling fans.

The cooling kit can be bought from IEI. The cooling kit has a heat sink and fan.

FLEX-BX200-Q370

**WARNING:**

Do not wipe off (accidentally or otherwise) the pre-sprayed layer of thermal paste on the bottom of the heat sink. The thermal paste between the CPU and the heat sink is important for optimum heat dissipation.

To install the cooling kit, follow the instructions below.

- Step 1:** A cooling kit bracket is pre-installed on the rear of the motherboard.
- Step 2:** **Place the cooling kit onto the socket LGA1151 CPU.** Make sure the CPU cable can be properly routed when the cooling kit is installed.
- Step 3:** **Mount the cooling kit.** Gently place the cooling kit on top of the CPU. Make sure the four threaded screws on the corners of the cooling kit properly pass through the holes of the cooling kit bracket.
- Step 4:** **Tighten the screws.** Use a screwdriver to tighten the four screws. In a diagonal pattern, tighten each screw a few turns then move to the next one, until they are all secured. Do not overtighten the screws.
- Step 5:** **Connect the fan cable.** Connect the cooling kit fan cable to the CPU fan connector on the FLEX-BX200-Q370. Carefully route the cable and avoid heat generating chips and fan blades.

3.7 DIMM Installation (Optional)

To install a DIMM, please follow the steps below and refer to **Figure 3-11**.

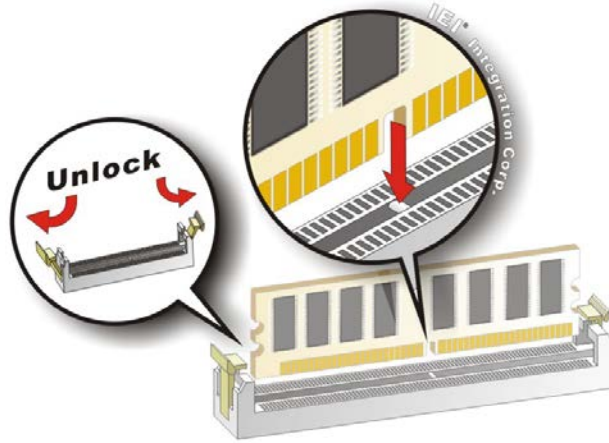

Figure 3-11: DIMM Installation

- Step 1:** Remove the top cover. See Section 3.5 above.
- Step 2:** **Open the DIMM socket handles.** Open the two handles outwards as far as they can. See **Figure 3-11**.
- Step 3:** **Align the DIMM with the socket.** Align the DIMM so the notch on the memory lines up with the notch on the memory socket. See **Figure 3-11**.
- Step 4:** **Insert the DIMM.** Once aligned, press down until the DIMM is properly seated. Clip the two handles into place. See **Figure 3-11**.
- Step 5:** **Removing a DIMM.** To remove a DIMM, push both handles outward. The memory module is ejected by a mechanism in the socket.



CAUTION:

For dual channel configuration, install two identical memory modules that feature the same capacity, timings, voltage, number of ranks and the same brand.

FLEX-BX200-Q370**3.8 M.2 SSD Installation (Optional)**

The two M.2 M-key slots allow installation of M.2 2280 cards. To install an M.2 card, please follow the steps below.

Step 1: Remove the top cover. See Section 3.5 above.

Step 2: Locate the M.2 slot as shown in Figure 3-12.

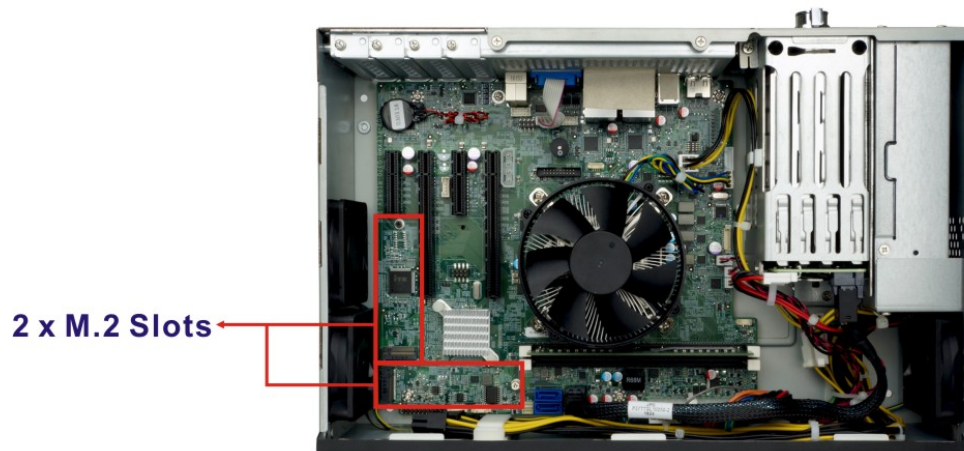

Figure 3-12: M.2 Slot Locations

Step 3: Remove the on-board retention screw as shown in Figure 3-13.

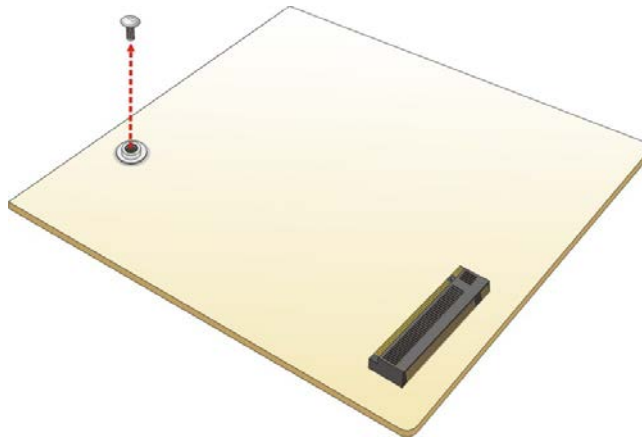

Figure 3-13: Removing the M.2 Module Retention Screw

Step 4: Line up the notch on the module with the notch on the slot. Slide the M.2 module into the socket at an angle of about 20° (**Figure 3-14**).

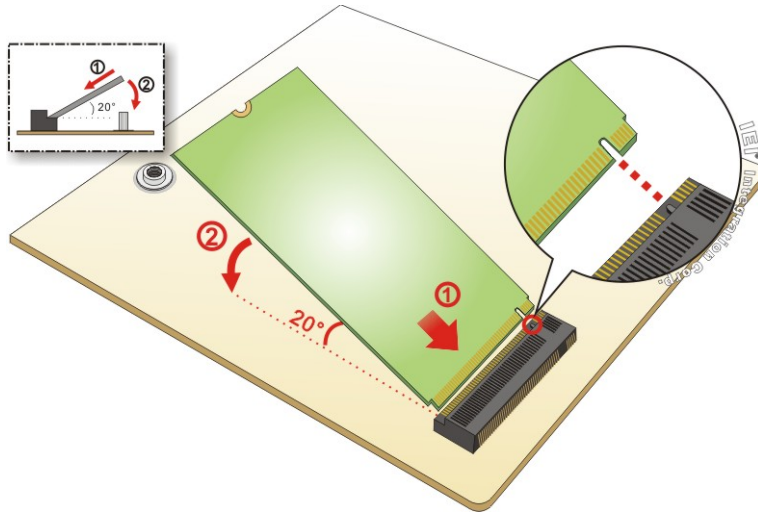

Figure 3-14: Inserting the M.2 Module into the Slot at an Angle

Step 5: Push the M.2 module down and secure it with the previously removed retention screw (**Figure 3-15**).

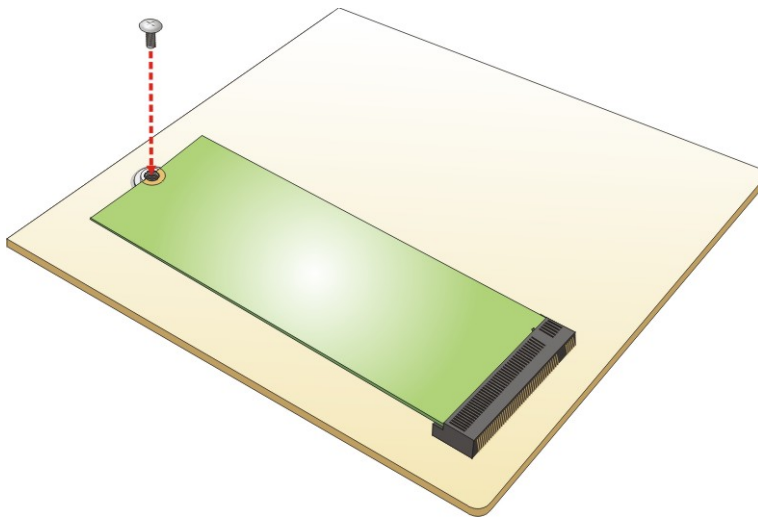

Figure 3-15: Securing the M.2 Module

Step 6: Re-install the top cover and secure it with the six retention screws previously removed.

FLEX-BX200-Q370**3.9 Expansion Card Installation (Optional)**

The FLEX-BX200-Q370 supports multiple PCIe slots which are compatible with standard low-profile add-on cards, including two PCIe 3.0 x16 (x8 mode) and two PCIe 3.0 x4 slots. To install an expansion card, follow the steps below.

Step 1: Remove the top cover. See Section 3.5 above.

Step 2: Locate an empty PCIe slot.

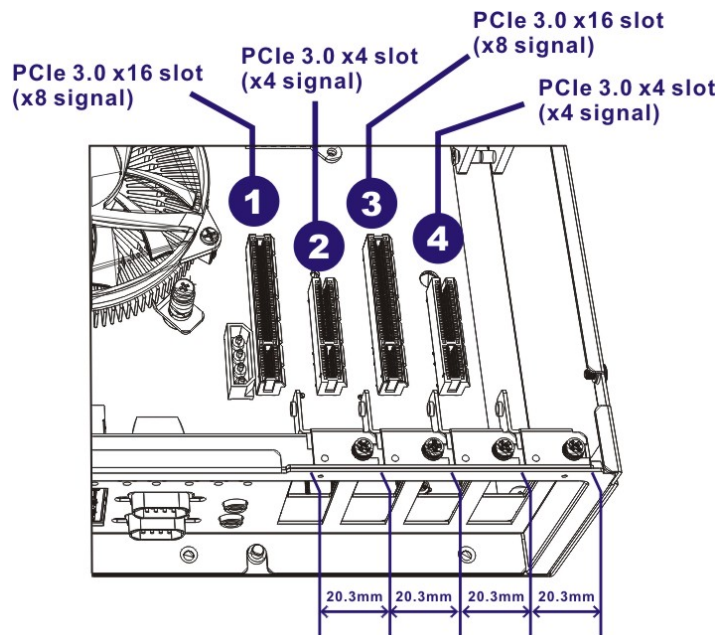

Figure 3-16: PCIe Slot Locations

Step 3: Remove the blank bracket panel on the back of the FLEX-BX200-Q370 that aligns with the empty PCIe slot. Save this bracket screw.

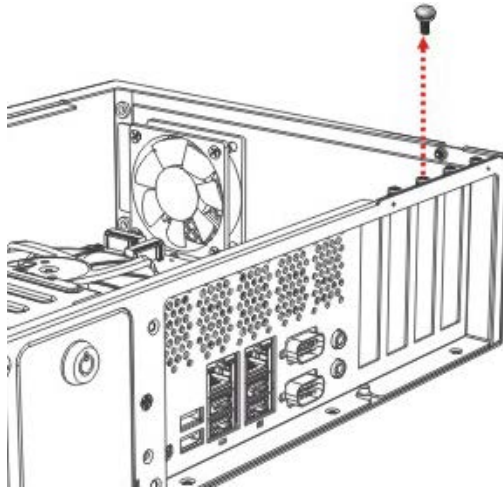

Figure 3-17: Blank Bracket Screw Removal

Step 4: Align the expansion card to a PCIe slot. Press down gently, but firmly, to seat the expansion card correctly in the slot.

Step 5: Install the bracket screw to secure the expansion card to the system chassis.

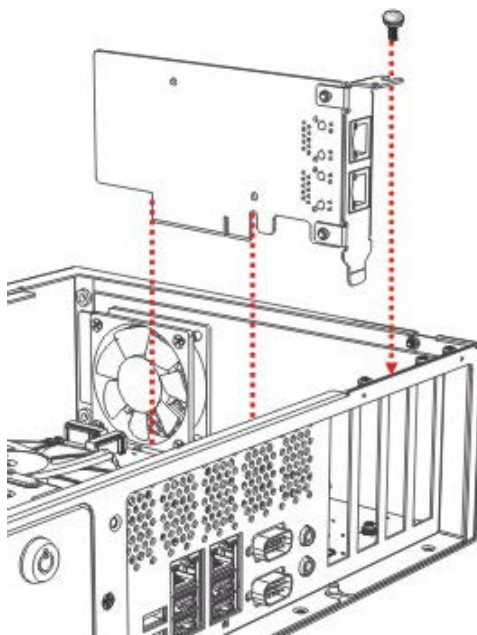

Figure 3-18: Install and Secure Expansion Card

FLEX-BX200-Q370

Step 6: Re-install the top cover and secure it with the six retention screws previously removed.

3.10 Mounting the System

The following sections describe the mounting methods supported by the FLEX-BX200-Q370.

3.10.1 Wall Mount

To mount the box PC onto a wall or some other surface using the two mounting brackets, please follow the steps below.

Step 1: Turn the box PC over.

Step 2: Align the two retention screw holes in each bracket with the retention screw holes on the sides of the bottom surface.

Step 3: Secure the brackets to the system by inserting two retention screws (M4*6) into each bracket (**Figure 3-19**).

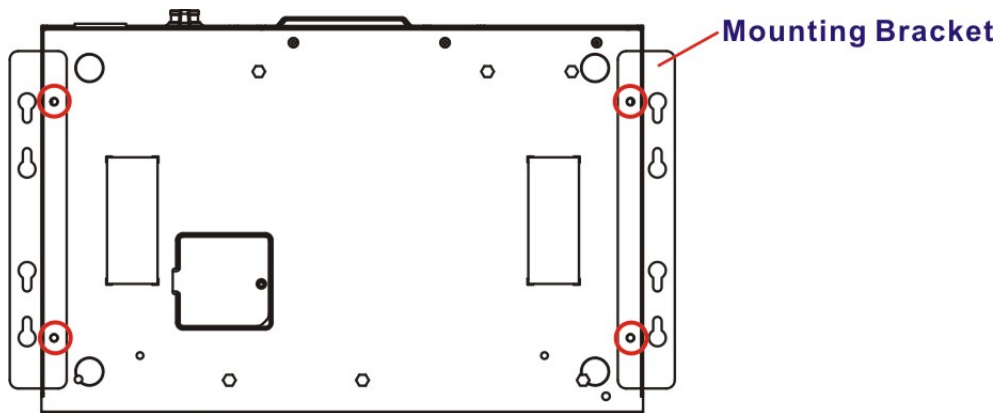

Figure 3-19: Mounting Bracket Retention Screws

Step 4: Drill holes in the intended installation surface according to the bracket dimensions listed below.

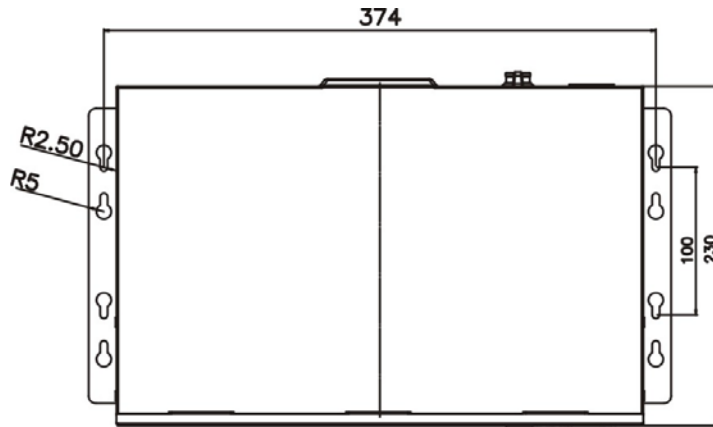

Figure 3-20: Mounting Bracket Retention Screws

- Step 5:** Align the mounting holes in the sides of the mounting brackets with the predrilled holes in the mounting surface.

- Step 6:** Insert retention screws into each bracket to secure the system to the wall.

FLEX-BX200-Q370

3.10.2 Rack Mount

The 2U chassis of the box PC is designed to support 19" rack mount. To mount the box PC onto a rack, please follow the steps below.

- Step 1:** Secure the rack mount brackets to the system by inserting two retention screws (M4*6) into each bracket.

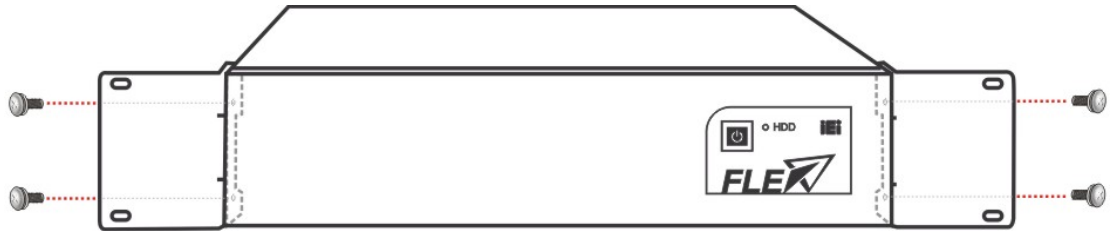

Figure 3-21: Install Rack Mount Bracket

- Step 2:** Slide the box PC with the attached rack mount brackets into a rack.
- Step 3:** Once the box PC has been properly inserted into the rack, secure the front of the rack mount bracket to the front of the rack.

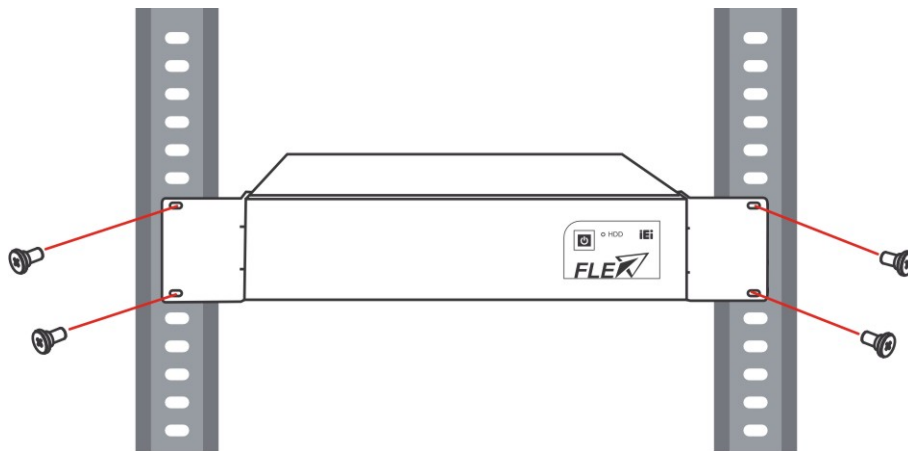
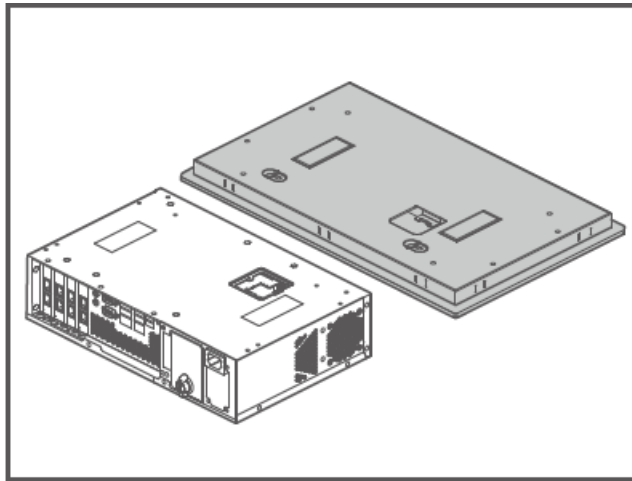

Figure 3-22: Mounting Bracket Retention Screws

3.11 Converting to Panel PC (Optional)

By combining with the FLEX-PLKIT LCD panel, the FLEX-BX200-Q370 can be converted to a panel PC. To install the FLEX-BX200-Q370 box PC onto a FLEX-PLKIT LCD panel, follow the steps below.

Step 1: Face the monitor panel down and place it onto a flat surface. Place the box PC on the side with the bottom panel facing up.



Step 2:

- 1 Loosen the cover retention screw located in the bottom panel of the box PC, and remove the cover to expose the wiring connection hole.
- 2 Fasten two positioning screws onto the box PC as shown in the figure below.

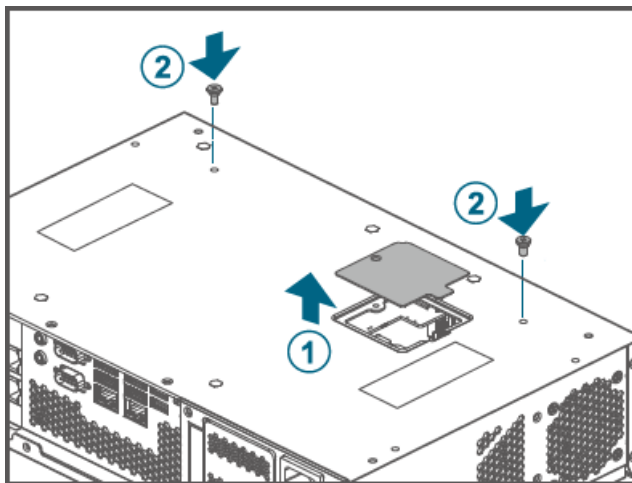

FLEX-BX200-Q370

- Step 3:**
- 1 Turn the box PC over. Remove the six top cover retention screws.
 - 2 Slide the top cover towards the I/O panel, and then lift the top cover off the box PC.

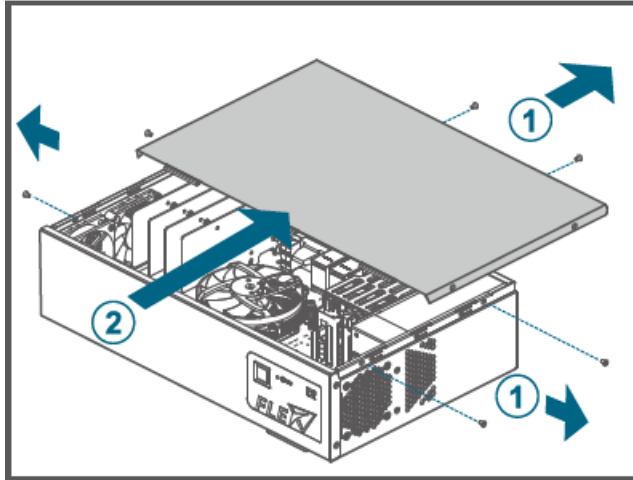

- Step 4:** Gently pull out the three cables from the rear of the panel kit.

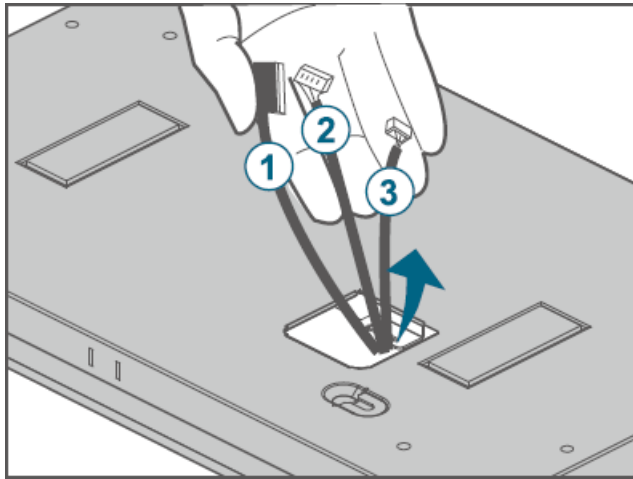

Step 5: Carefully feed the three cables into the box PC through the wiring connection hole on the bottom panel.

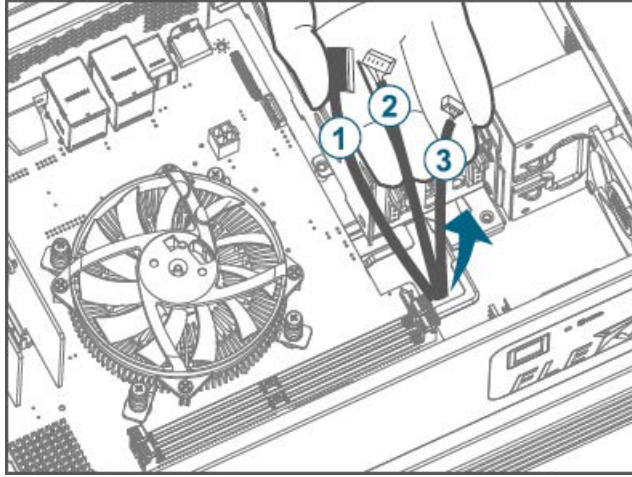

Step 6: Align the two positioning screws (M4*6) fastened on the bottom panel of the box PC with the slotted holes located in the rear panel of the panel kit. Gently place the box PC onto the panel kit, while ensure the screws are inserted into the slotted holes. Push the box PC towards left to lock it into position.

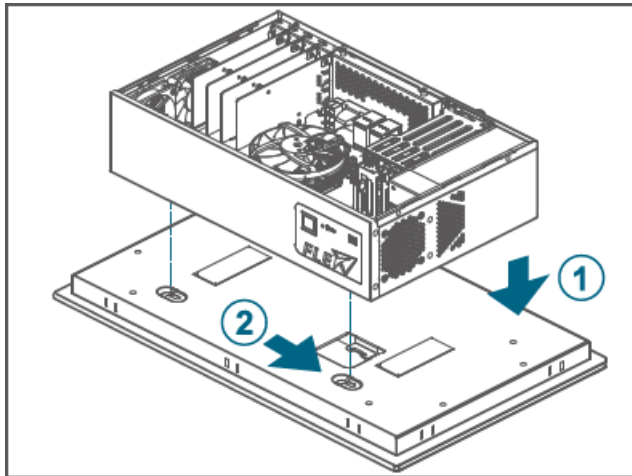

FLEX-BX200-Q370

Step 7: Use four retention screws (M4*7) to secure the box PC with the panel kit.

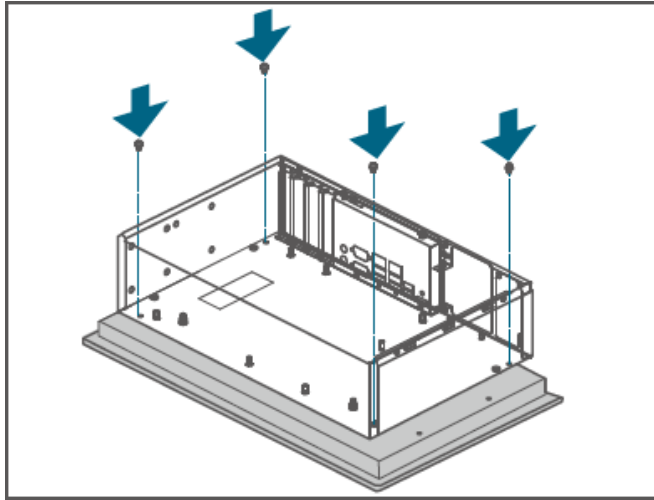

Step 8: Connect the cables to the corresponding connectors on the motherboard.





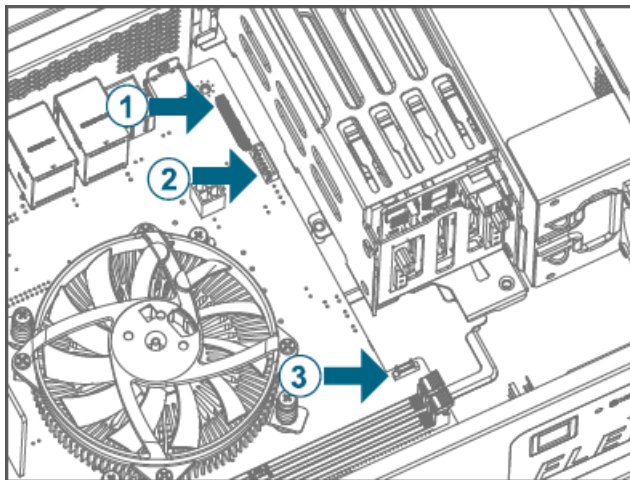



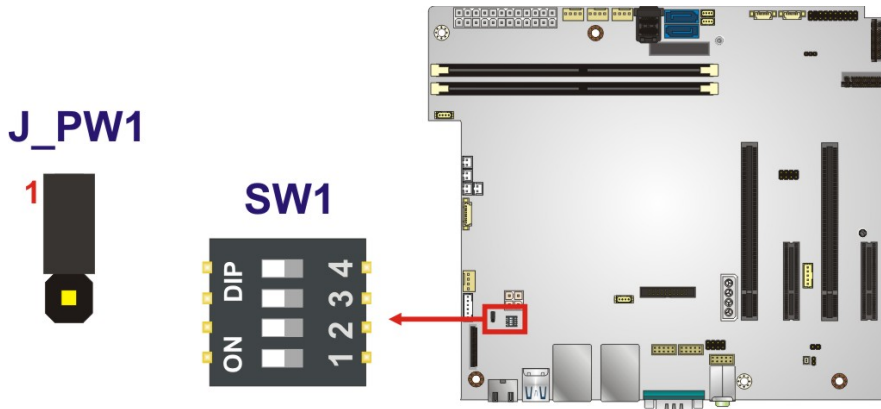

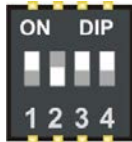
- ❶ LVDS connector (LVDS1, 40-pin)
- ❷ Inverter connector (INV1, 6-pin)
- ❸ Touch connector (JUSB1, 4-pin)

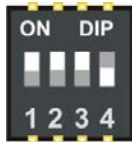
For connector pinouts, see Chapter 6.

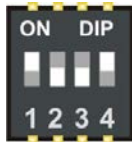

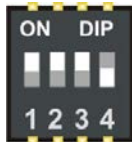
Step 9: Configure jumper and switch in box PC. Locate the panel resolution switch (SW1) and the panel voltage jumper (J_PW1) on the motherboard. Configure the switch and the jumper for the installed panel kit according to the description listed in the following table.

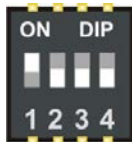

	Panel Resolution (SW1)	Panel Voltage (J_PW1)
FLEX-PLKIT-F15	ON-OFF-ON-ON 	Short 1-2 (+3.3V, default) 
FLEX-PLKIT-FW15	ON-ON-ON-OFF 	Short 2-3 (+5V) 
FLEX-PLKIT-F17	ON-OFF-OFF-ON 	Short 2-3 (+5V) 
FLEX-PLKIT-FW19	ON-ON-ON-OFF 	Short 2-3 (+5V) 
FLEX-PLKIT-FW22	ON-OFF-OFF-OFF 	Short 2-3 (+5V) 

FLEX-BX200-Q370



<p>FLEX-PLKIT-FW24</p>	<p>ON-OFF-OFF-OFF</p> 	<p>Short 2-3 (+5V)</p> 
------------------------	--	--

Table 3-1: Panel Resolution and Voltage Jumper Settings

Step 10: Re-install the top cover of the box PC with the six retention screws previously removed.

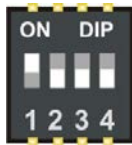

3.12 COM Port Connection

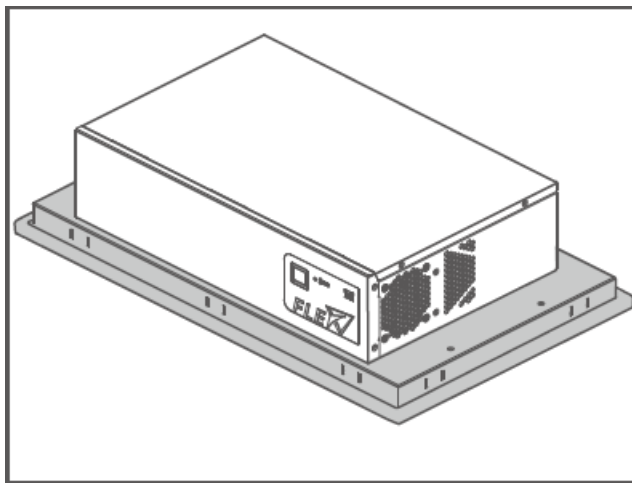
The FLEX-BX200-Q370 has two DB-9 connectors for RS-232 serial port connection. The pinouts for the RS-232 connectors (COM1 and COM2) are listed in the figure and table below.

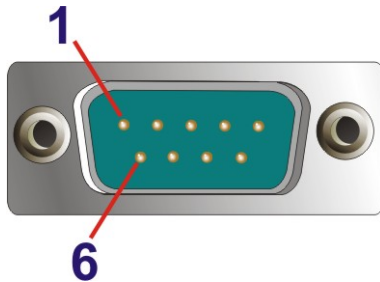

Figure 3-23: RS-232 Connector (COM1, COM2)

PIN NO.	DESCRIPTION
1	DCD
2	RX
3	TX
4	DTR
5	GND
6	DSR
7	RTS
8	CTS
9	RI

Table 3-2: RS-232 Connector Pinouts

FLEX-BX200-Q370

3.13 Power-On Procedure

3.13.1 Installation Checklist

**WARNING:**

Make sure a power supply with the correct input voltage is being fed into the system. Incorrect voltages applied to the system may cause damage to the internal electronic components and may also cause injury to the user.

To power on the box PC please make sure of the following:

- The top cover is installed
- All peripheral devices are connected
- The power cables are plugged in
- The system is securely mounted

3.13.2 Power-on Procedure

To power-on the FLEX-BX200-Q370 please follow the steps below:

Step 1: Connect the power source to the power inlet on the rear panel.

Step 2: Short-press the power button on the front panel to power up the system. The power LED lights on in blue (**Figure 3-24**).

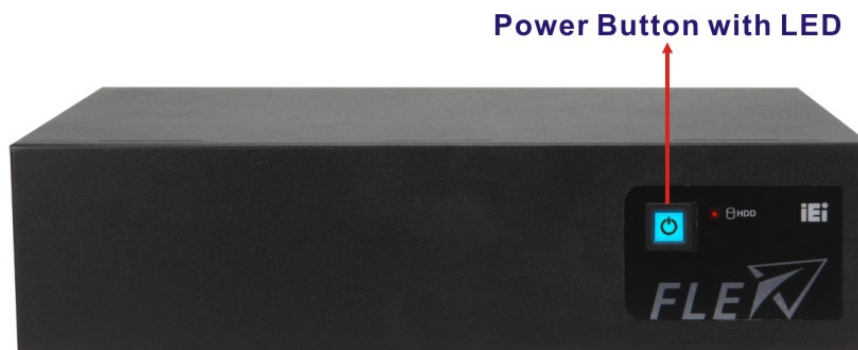

Figure 3-24: Power Button

3.14 Software Installation

All the drivers for the FLEX-BX200-Q370 are available on IEI Resource Download Center (<https://download.ieiworld.com>). Type FLEX-BX200-Q370 and press Enter to find all the relevant software, utilities, and documentation.

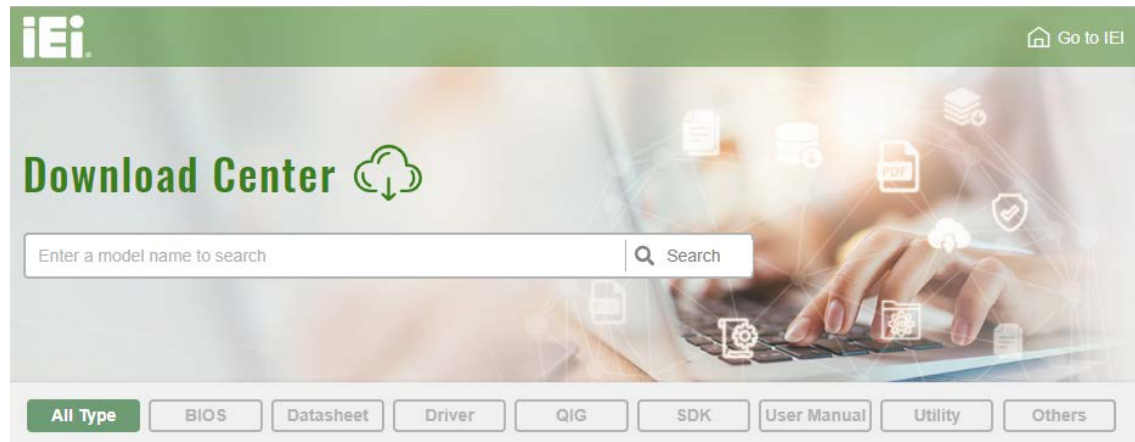
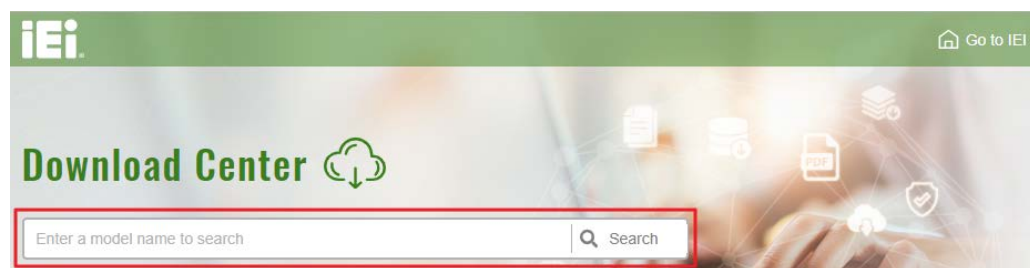

Figure 3-25: IEI Resource Download Center

3.14.1 Driver Download

To download drivers from IEI Resource Download Center, follow the steps below.

Step 1: Go to <https://download.ieiworld.com>. Type FLEX-BX200-Q370 and press Enter.



Step 2: All product-related software, utilities, and documentation will be listed. You can choose **Driver** to filter the result.

FLEX-BX200-Q370

[All Type](#)
[BIOS](#)
[Datasheet](#)
[Driver](#)
[QIG](#)
[SDK](#)
[User Manual](#)
[Utility](#)
[Others](#)

WAFER-BT-i1 [Product Info](#)

[Embedded Computer](#) ▶ [Single Board Computer](#) ▶ [Embedded Board](#)
 3.5" SBC with Intel® 22nm Atom™/Celeron® on-board SoC

Driver

File Name	Published	Version	File Checksum
7B000-001033-RS V2.3.iso (2.23 GB)	2017/10/03	2.30	3B2DB1F792779A93A8F50DDDBC3943E30

Step 3: Click the driver file name on the page and you will be prompted with the following window. You can download the entire ISO file (❶), or click the small arrow to find an individual driver and click the file name to download (❷).

7B000-001168-RS_V1.4.iso

❶ [Click here to download entire ISO file. \(2.99 GB\)](#)

* Download individual file *

- Docs
 - 1.Chipset
 - ❷ 10.1.1.12.zip (2.7 MB)
 - 2.VGA
 - 3.Audio
 - 4.Lan
 - 5.USB 3.0
 - 6.Serial IO
 - 7.TXE
 - 8.Manual



NOTE:

To install software from the downloaded ISO image file in Windows 8, 8.1 or 10, double-click the ISO file to mount it as a virtual drive to view its content. On Windows 7 system, an additional tool (such as Virtual CD-ROM Control Panel from Microsoft) is needed to mount the file.

3.15 RAID Configuration

The **FLEX-BX200-Q370** can provide data protection for serial ATA (SATA) disks via the Intel® Rapid Storage Technology. To access the Intel® Rapid Storage Technology, please follow the steps below.



WARNING!

Irrecoverable data loss occurs if a working drive is removed when trying to remove a failed drive. It is strongly recommended to mark the physical connections of all SATA disk drives. Drive locations can be identified by attaching stickers to the drive bays. If a drive member of a RAID array should fail, the failed drive can then be correctly identified.



CAUTION!

Do not accidentally disconnect the SATA drive cables. Carefully route the cables within the chassis to avoid system down time.

Step 1: Connect SATA drives to the system. Connect two or more SATA drives to the system. Make sure the drives have the same capacity, are the same type and have the same speed.



NOTE:

Make sure the SATA drives are EXACTLY the same when they are configured in a RAID configuration. If they are not the same size, disk drive capacity is sacrificed and overall performance affected.

Step 2: Enable SATA drives in BIOS. Start the computer and access the BIOS setup program. Go to **Chipset → PCH-IO Configuration → SATA Configuration → SATA Mode Selection**. Enable RAID support for all SATA devices.

FLEX-BX200-Q370

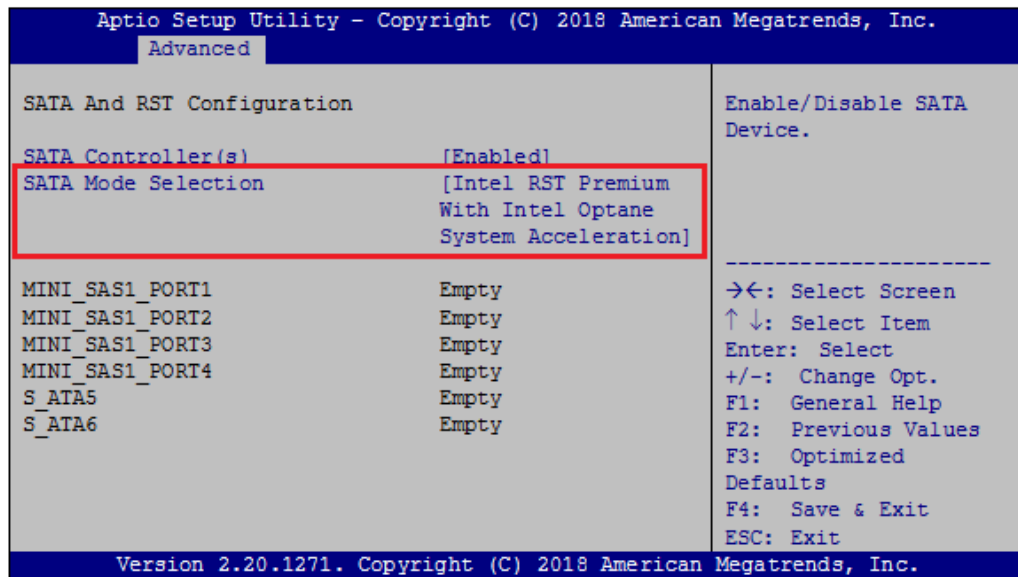
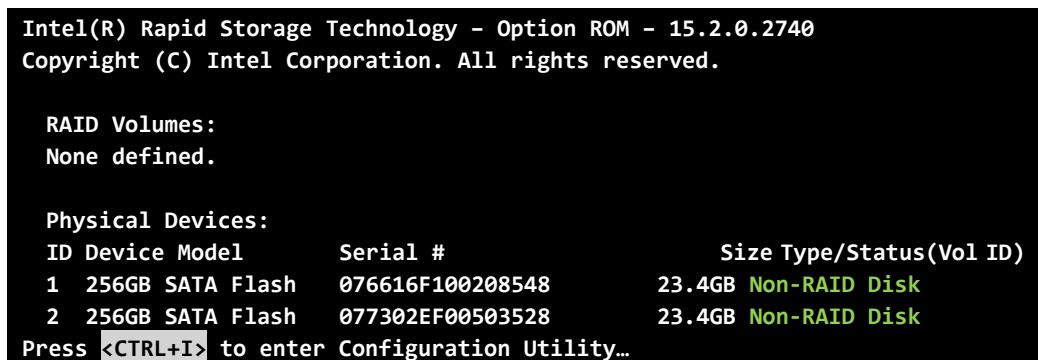

Figure 3-26: RAID Configuration–BIOS Setting

- Step 3: Save and Exit BIOS.** After the SATA support option is enabled, save and exit the BIOS.
- Step 4: Reboot the system.** Reboot the system after saving and exiting the BIOS.
- Step 5: Press Ctrl+I.** during the system boot process, press Ctrl+I when prompted to enter the RAID configuration software.



Step 6: Configure the RAID settings. Use the Intel® Rapid Storage Technology to configure the RAID array.

A) Select the option to **Create RAID Volume** from the Main Menu and press Enter.

```

Intel(R) Rapid Storage Technology - Option ROM - 15.2.0.2748
Copyright (C) Intel Corporation. All rights reserved.
===== [MAIN MENU] =====
  1. Create RAID Volume          4. Recovery Volume Options
  2. Delete RAID Volume         5. Acceleration Options
  3. Reset Disks to Non-RAID    6. Exit
===== [DISK/VOLUME INFORMATION] =====
RAID Volumes:
None defined.
    
```

B) Press the up/down arrows on the keyboard to choose the **RAID Level** and press Enter. Select the hard drives for the RAID configuration and press Enter when done.

```

Intel(R) Rapid Storage Technology - Option ROM - 15.2.0.2748
Copyright (C) Intel Corporation. All rights reserved.
===== [CREATE VOLUME MENU] =====
Name: Volume1
RAID Level: RAID0(Stripe)
Disks: Select Disks
Strip Size: 16KB
Capacity: 238.5 GB
Sync: N/A
Create Volume
    
```

Step 7: Create RAID Volume. Highlight **Create Volume** and press Enter, then choose Y when the warning prompt appears to create volume.

```

Intel(R) Rapid Storage Technology - Option ROM - 15.2.0.2748
Copyright (C) Intel Corporation. All rights reserved.
===== [CREATE VOLUME MENU] =====
Name: Volume1
RAID Level: RAID0(Stripe)
Disks: Select Disks
Strip Size: 16KB
Capacity: 238.5 GB
Sync: N/A
Create Volume
    
```

Chapter

4

BIOS

4.1 Introduction

The BIOS is programmed onto the BIOS chip. The BIOS setup program allows changes to certain system settings. This chapter outlines the options that can be changed.



NOTE:

Some of the BIOS options may vary throughout the life cycle of the product and are subject to change without prior notice.

4.1.1 Starting Setup

The UEFI BIOS is activated when the computer is turned on. The setup program can be activated in one of two ways.

1. Press the **DELETE** key as soon as the system is turned on or
2. Press the **DELETE** key when the “**Press Delete to enter SETUP**” message appears on the screen.

If the message disappears before the **DELETE** key is pressed, restart the computer and try again.

4.1.2 Using Setup

Use the arrow keys to highlight items, press **ENTER** to select, use the PageUp and PageDown keys to change entries, press **F1** for help and press **ESC** to quit. Navigation keys are shown in.

Key	Function
Up arrow	Move to the item above
Down arrow	Move to the item below
Left arrow	Move to the item on the left hand side
Right arrow	Move to the item on the right hand side
+	Increase the numeric value or make changes

FLEX-BX200-Q370

Key	Function
-	Decrease the numeric value or make changes
Page up	Move to the next page
Page down	Move to the previous page
Esc	Main Menu – Quit and do not save changes into CMOS Status Page Setup Menu and Option Page Setup Menu -- Exit current page and return to Main Menu
F1 key	General help, only for Status Page Setup Menu and Option Page Setup Menu
F2 key	Load previous values
F3 key	Load optimized defaults
F4 key	Save changes and Exit BIOS

Table 4-1: BIOS Navigation Keys

4.1.3 Getting Help

When **F1** is pressed a small help window describing the appropriate keys to use and the possible selections for the highlighted item appears. To exit the Help Window press **Esc** or the **F1** key again.

4.1.4 BIOS Menu Bar

The **menu bar** on top of the BIOS screen has the following main items:

- Main – Changes the basic system configuration.
- Advanced – Changes the advanced system settings.
- Chipset – Changes the chipset settings.
- Security – Sets User and Supervisor Passwords.
- Boot – Changes the system boot configuration.
- Save & Exit – Selects exit options and loads default settings

The following sections completely describe the configuration options found in the menu items at the top of the BIOS screen and listed above.

4.2 Main

The **Main** BIOS menu (**BIOS Menu 1**) appears when the **BIOS Setup** program is entered.

The **Main** menu gives an overview of the basic system information.

Aptio Setup Utility - Copyright (C) 2018 American Megatrends, Inc.		
Main	Advanced	Chipset Security Boot Save & Exit
BIOS Information		Set the Date. Use Tab to switch between Data elements.
BIOS Vendor	American Megatrends	
Core Version	5.13	
Compliance	UEFI 2.6; PI 1.4	
Project Version	Z525AR11.ROM	
Build Date and Time	08/29/2018 18:27:13	
iWDD Vender		
iWDD Version	iEi Z525ER10.bin	
Processor Information		
Name	CoffeeLake DT	
Brand String	Intel(R) Core(TM) CPU i3-8100T CPU @ 3.10GHz	
Speed	3100 MHz	----- →←: Select Screen ↑↓: Select Item Enter: Select +/-: Change Opt. F1: General Help F2: Previous Values F3: Optimized Defaults F4: Save & Exit ESC: Exit
ID	0X906EB	
Stepping	B0	
Number of Processors	4Core(s) / 4Thread(s)	
Microcode Revision	8E	
GT Info	GT2 (0x3E91)	
IGFX VBIOS Version	1012	
Memory RC Version	0.7.1.58	
Total Memory	8192 MB	
Memory Frequency	2133 MHz	
PCH Information		
Name	CNL PCH-H	
PCH SKU	Q370	
Stepping	B0	
ME FW Version	12.0.0.1068	
ME Firmware SKU	Corporate SKU	
Access Level	Administrator	
System Date	[Mon 08/17/2018]	
System Time	[11:10:27]	
Version 2.20.1271. Copyright (C) 2018 American Megatrends, Inc.		

BIOS Menu 1: Main

FLEX-BX200-Q370

The **Main** menu has two user configurable fields:

→ **System Date [xx/xx/xx]**

Use the **System Date** option to set the system date. Manually enter the day, month and year.

→ **System Time [xx:xx:xx]**

Use the **System Time** option to set the system time. Manually enter the hours, minutes and seconds.

4.3 Advanced

Use the **Advanced** menu (**BIOS Menu 2**) to configure the CPU and peripheral devices through the following sub-menus:



WARNING!

Setting the wrong values in the sections below may cause the system to malfunction. Make sure that the settings made are compatible with the hardware.

```
Aptio Setup Utility - Copyright (C) 2018 American Megatrends, Inc.
Main  Advanced  Chipset  Security  Boot  Save & Exit
-----
> CPU Configuration
> Thunderbolt(TM)Configuration
> Trusted Computing
> ACPI Settings
> iWDD H/M Monitor
> F81866 Super IO Configuration
> RTC Wake Settings
> Serial Port Console Redirection
> USB Configuration
> NVMe Configuration
> iEi QTS
> iEi Feature
System ACPI Parameters
-----
-><: Select Screen
↑↓: Select Item
Enter: Select
+/-: Change Opt.
F1: General Help
F2: Previous Values
F3: Optimized Defaults
F4: Save & Exit
ESC: Exit
Version 2.20.1271. Copyright (C) 2018 American Megatrends, Inc.
```

BIOS Menu 2: Advanced

FLEX-BX200-Q370

4.3.1 CPU Configuration

Use the **CPU Configuration** menu (**BIOS Menu 3**) to view detailed CPU specifications or enable the Intel Virtualization Technology.

```

Aptio Setup Utility - Copyright (C) 2018 American Megatrends, Inc.
  Advanced
CPU Configuration
Type                Intel(R) Core(TM) CPU
                   i3-8100T CPU @ 3.10GHz
ID                  0x906E8
Speed               3100 MHz
L1 Data Cache      32 kB x 4
L1 Instruction Cache 32 kB x 4
L2 Cache            256 kB x 4
L3 Cache            6 MB
L4 Cache            N/A
VMX                 Supported
SMX/TXT             Not Supported

Intel (VMX) Virtualization [Disabled]
Technology
Active Processor Cores [All]
Intel(R) SpeedStep(tm) [Enabled]
C states             [Disabled]

When enabled, a VMM can
utilize the additional
hardware capabilities
provided by Vanderpool
Technology.

-----
-><: Select Screen
^ v: Select Item
Enter: Select
+/-: Change Opt.
F1: General Help
F2: Previous Values
F3: Optimized Defaults
F4: Save & Exit
ESC: Exit

Version 2.20.1271. Copyright (C) 2018 American Megatrends, Inc.
  
```

BIOS Menu 3: CPU Configuration

→ Intel (VMX) Virtualization Technology [Disabled]

Use the **Intel (VMX) Virtualization Technology** option to enable or disable virtualization on the system. When combined with third party software, Intel® Virtualization technology allows several OSs to run on the same system at the same time.

- **Disabled** **DEFAULT** Disables Intel Virtualization Technology.
- **Enabled** Enables Intel Virtualization Technology.

→ Active Processor Cores [All]

Use the **Active Processor Cores** BIOS option to enable numbers of cores in the processor package.

- **All** **DEFAULT** Enable all cores in the processor package.
- **1** Enable one core in the processor package.
- **2** Enable two cores in the processor package.
- **3** Enable three cores in the processor package.

→ Intel(R) SpeedStep(tm) [Enabled]

Use the **Intel(R) SpeedStep(tm)** option to enable or disable the Intel® SpeedStep Technology which allows more than two frequency ranges to be supported.

- **Disabled** Disables Intel® SpeedStep Technology
- **Enabled** **DEFAULT** Enables Intel® SpeedStep Technology

→ C states [Disabled]

Use the **C states** option to enable or disable CPU power management which allows CPU to go to C states when it is not 100% utilized.

- **Disabled** **DEFAULT** Disables CPU power management
- **Enabled** Enables CPU power management

FLEX-BX200-Q370

4.3.2 Thunderbolt Configuration

Use the **Thunderbolt Configuration** menu (**BIOS Menu 4**) to enable or disable the support of Thunderbolt™.

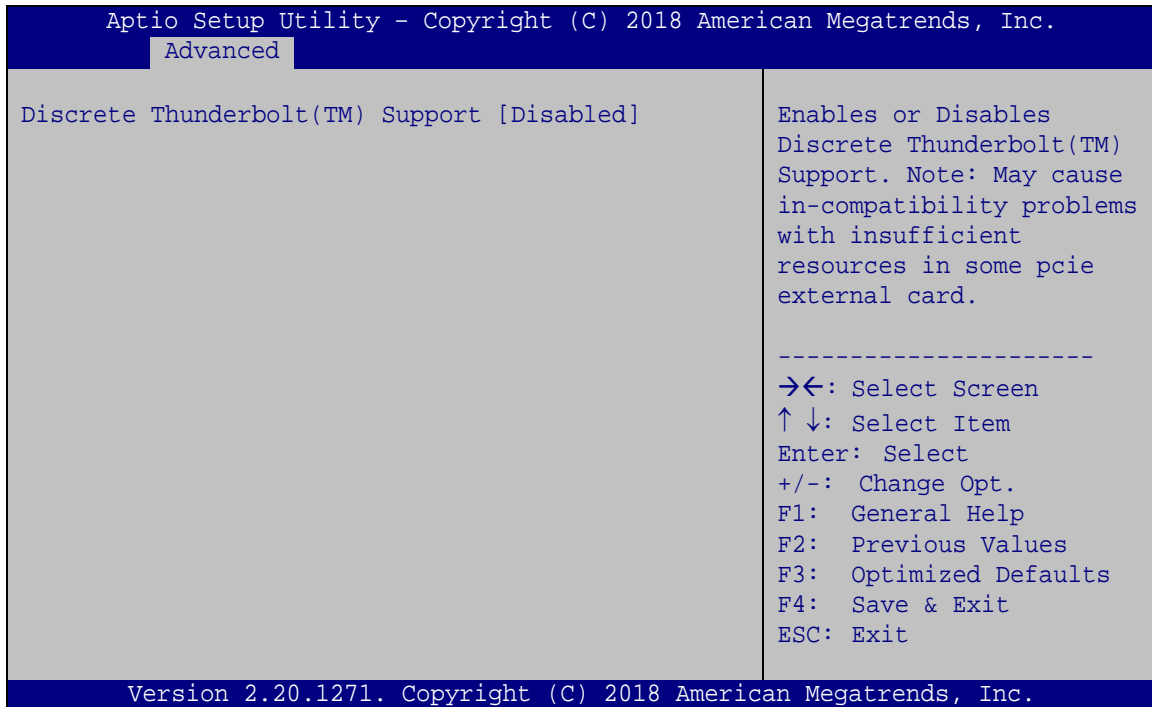

BIOS Menu 4: Thunderbolt Configuration

→ Discrete Thunderbolt(TM) Support [Disabled]

Use the **Discrete Thunderbolt(TM) Support** option to configure support for the Thunderbolt.

- **Disabled** **DEFAULT** Thunderbolt support is disabled.
- **Enabled** Thunderbolt support is enabled.

4.3.3 Trusted Computing

Use the **Trusted Computing** menu (**BIOS Menu 5**) to configure settings related to the Trusted Computing Group (TCG) Trusted Platform Module (TPM).

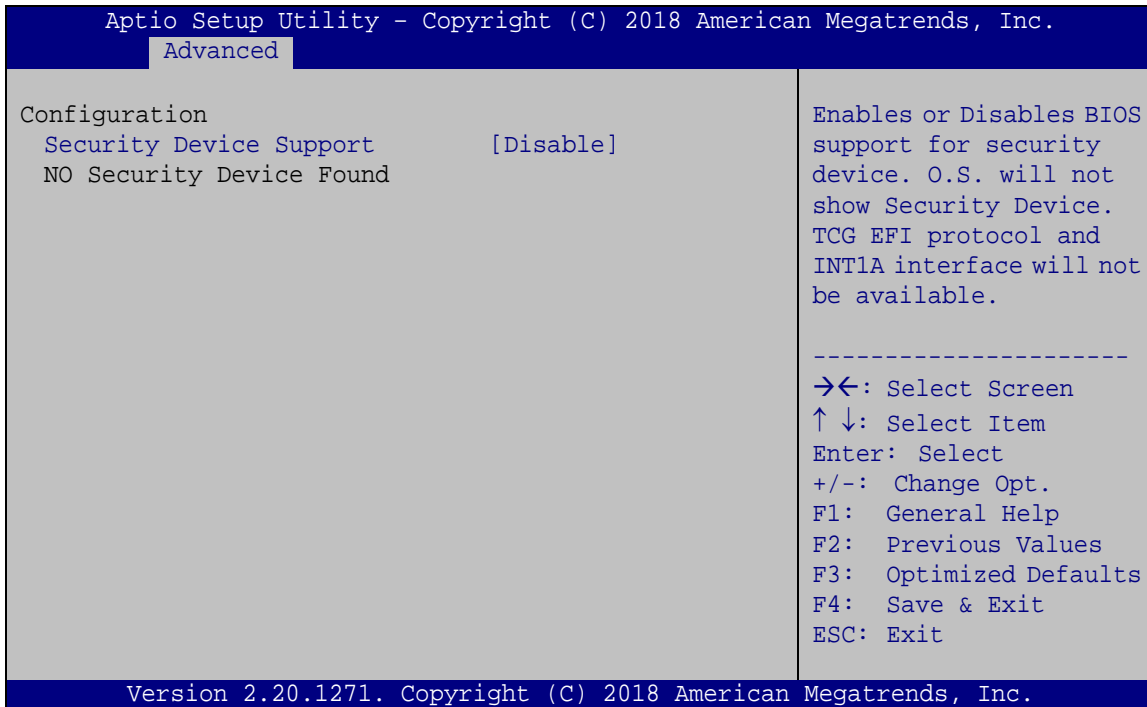

BIOS Menu 5: Trusted Computing

→ Security Device Support [Disable]

Use the **Security Device Support** option to configure support for the TPM.

- **Disable** DEFAULT TPM support is disabled.
- **Enable** TPM support is enabled.

FLEX-BX200-Q370

4.3.4 ACPI Settings

The **ACPI Settings** menu (**BIOS Menu 6**) configures the Advanced Configuration and Power Interface (ACPI) options.

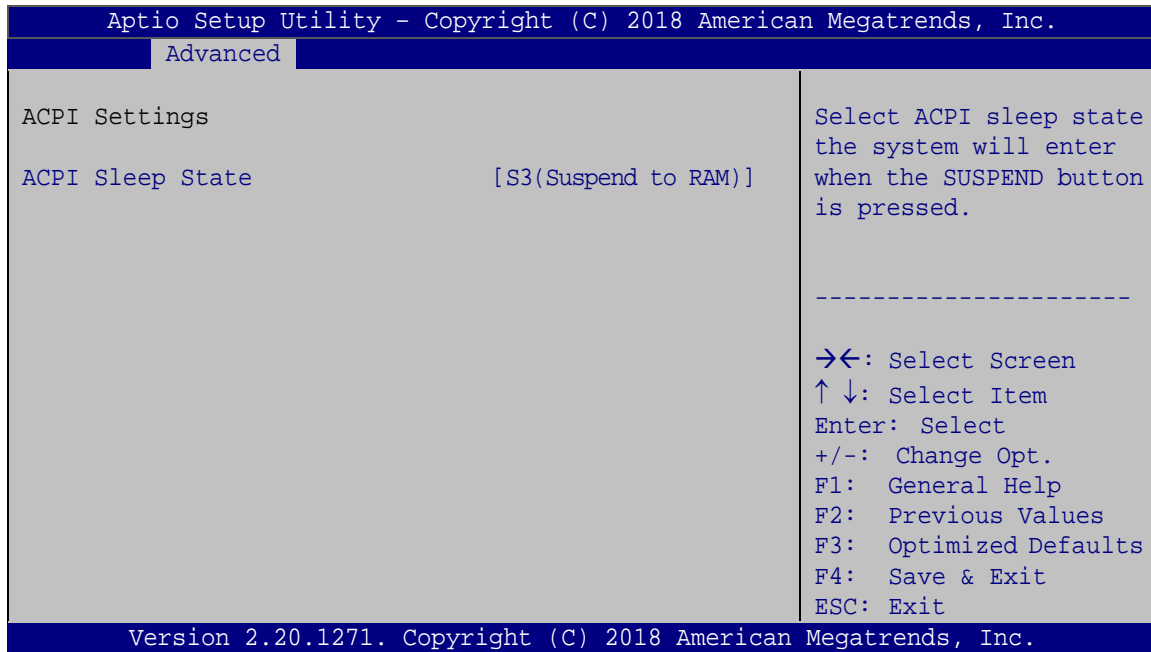

BIOS Menu 6: ACPI Configuration

→ ACPI Sleep State [S3 (Suspend to RAM)]

Use the **ACPI Sleep State** option to specify the sleep state the system enters when it is not being used.

- **S3 (Suspend to RAM)** **DEFAULT** The caches are flushed and the CPU is powered off. Power to the RAM is maintained. The computer returns slower to a working state, but more power is saved.

4.3.5 iWDD H/W Monitor

The **iWDD H/W Monitor** menu (**BIOS Menu 7**) contains the fan configuration submenu, and displays the system temperature and CPU fan speed.

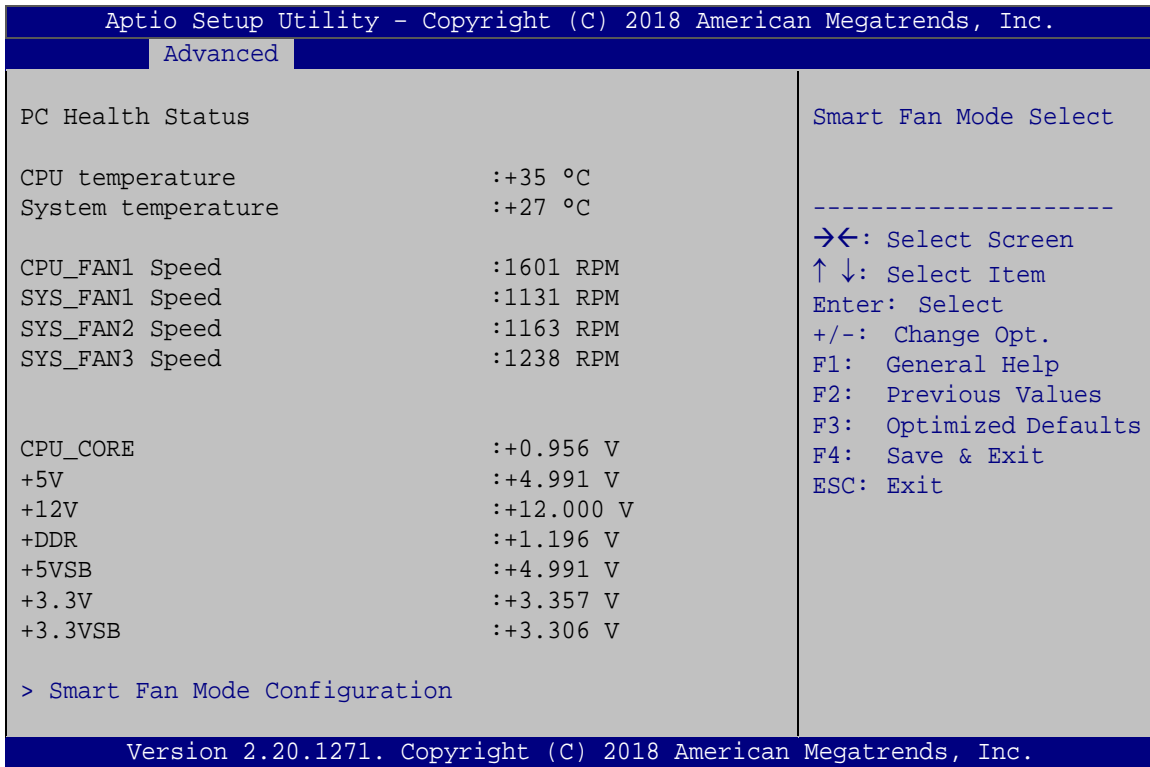

BIOS Menu 7: iWDD H/W Monitor

→ PC Health Status

The following system parameters and values are shown. The system parameters that are monitored are:

- System Temperatures:
 - CPU Temperature
 - System Temperature
- Fan Speeds:
 - CPU Fan Speed
 - System Fan Speed
- Voltages:

FLEX-BX200-Q370

- CPU_CORE
- +5V
- +12V
- DDR
- +5VSB
- +3.3V
- +3.3VSB

4.3.5.1 Smart Fan Mode Configuration

Use the **Smart Fan Mode Configuration** submenu (**BIOS Menu 8**) to configure the CPU/system fan temperature and speed settings.

```

Aptio Setup Utility - Copyright (C) 2018 American Megatrends, Inc.
-----
Advanced
-----
Smart Fan Mode Configuration
CPU_FAN1 Smart Fan Control      [Auto Mode]
Auto mode fan start temperature  50
Auto mode fan off temperature    40
Auto mode fan start PWM          30
Auto mode fan slope PWM          2

SYS_FAN1 Smart Fan Control      [Auto Mode]
Auto mode fan start temperature  30
Auto mode fan off temperature    20
Auto mode fan start PWM          40
Auto mode fan slope PWM          3

SYS_FAN2 Smart Fan Control      [Auto Mode]
Auto mode fan start temperature  30
Auto mode fan off temperature    20
Auto mode fan start PWM          40
Auto mode fan slope PWM          3

SYS_FAN3 Smart Fan Control      [Auto Mode]
Auto mode fan start temperature  30
Auto mode fan off temperature    20
Auto mode fan start PWM          40
Auto mode fan slope PWM          3

Smart Fan Mode Select
-----
-><-: Select Screen
↑ ↓: Select Item
Enter: Select
+/-: Change Opt.
F1: General Help
F2: Previous Values
F3: Optimized Defaults
F4: Save & Exit
ESC: Exit

Version 2.20.1271. Copyright (C) 2018 American Megatrends, Inc.

```

BIOS Menu 8: Smart Fan Mode Configuration

→ CPU_FAN1 Smart Fan Control/SYS_FAN Smart Fan Control [Auto Mode]

Use the **CPU_FAN1 Smart Fan Control/SYS_FAN Smart Fan Control** option to configure the CPU/System Smart Fan.

- Manual Mode** The fan spins at the speed set in Manual Mode settings.
- Auto Mode DEFAULT** The fan adjusts its speed using Auto Mode settings.

The following options can only be set if the CPU/SYS Smart Fan Control option is set to Auto Mode.

→ Auto mode fan start temperature

If the CPU temperature is between **fan off** and **fan start**, the fan speed change to **fan start PWM**. To set a value, Use the + or – key to change the value or enter a decimal number between 1 and 100.

→ Auto mode fan off temperature

If the CPU temperature is lower than the value set this option, the fan speed change to be lowest. To set a value, Use the + or – key to change the value or enter a decimal number between 1 and 100.

→ Auto mode fan start PWM

Use the **Auto mode fan start PWM** option to set the PWM start value. Use the + or – key to change the value or enter a decimal number between 1 and 100.

→ Auto mode fan slope PWM

Use the **Auto mode fan slope PWM** option to select the linear rate at which the PWM mode increases with respect to an increase in temperature. Use the + or – key to change the value or enter a decimal number between 1 and 8.

FLEX-BX200-Q370

4.3.6 F81866 Super IO Configuration

Use the **F81866 Super IO Configuration** menu (**BIOS Menu 9**) to set or change the configurations for the parallel ports and serial ports.

```

Aptio Setup Utility - Copyright (C) 2018 American Megatrends, Inc.
  Advanced
Super IO Configuration
Super IO Chip                F81866
> Serial Port 1 Configuration
> Serial Port 2 Configuration
> Serial Port 3 Configuration
> Serial Port 4 Configuration
> Serial Port 5 Configuration (UART Touch)
Case Open Detection          [Disabled]

Set Parameters of Serial
Port 1 (COMA)
-----
-><: Select Screen
↑↓: Select Item
Enter: Select
+/-: Change Opt.
F1: General Help
F2: Previous Values
F3: Optimized Defaults
F4: Save & Exit
ESC: Exit

Version 2.20.1271. Copyright (C) 2018 American Megatrends, Inc.

```

BIOS Menu 9: F81866 Super IO Configuration→ **Case Open Beep [Disabled]**

Use the **Case Open Beep** option to enable or disable the case open beep function.

- **Disabled** **DEFAULT** Disable the case open beep function
- **Enabled** Enable the case open beep function

4.3.6.1 Serial Port n Configuration

Use the **Serial Port n Configuration** menu (**BIOS Menu 10**) to configure the serial port n.

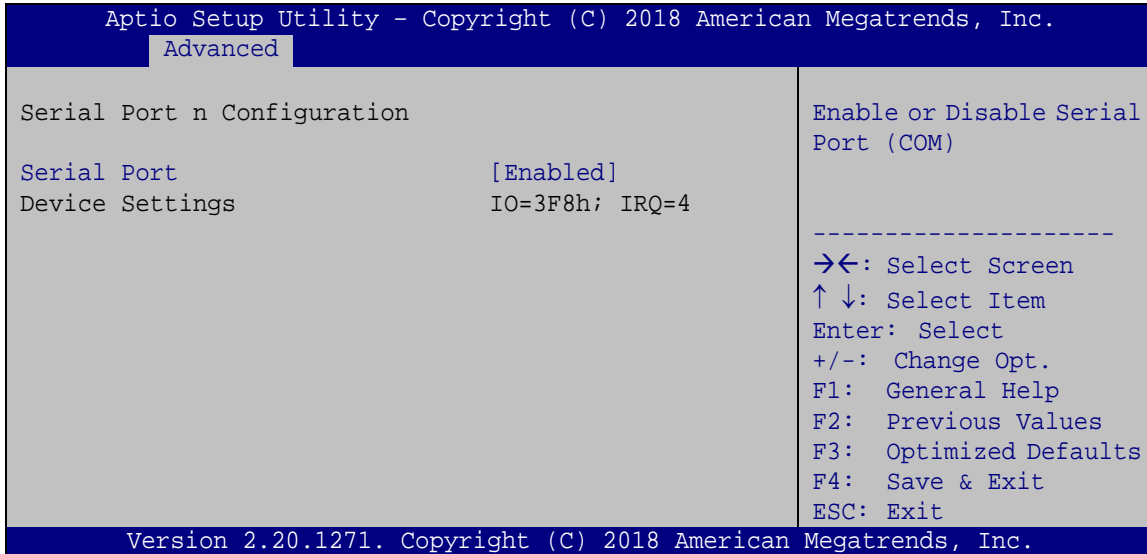

BIOS Menu 10: Serial Port n Configuration Menu

→ Serial Port [Enabled]

Use the **Serial Port** option to enable or disable the serial port.

- **Disabled** Disable the serial port
- **Enabled** **DEFAULT** Enable the serial port

FLEX-BX200-Q370

4.3.7 RTC Wake Settings

The **RTC Wake Settings** menu (**BIOS Menu 11**) enables the system to wake at the specified time.

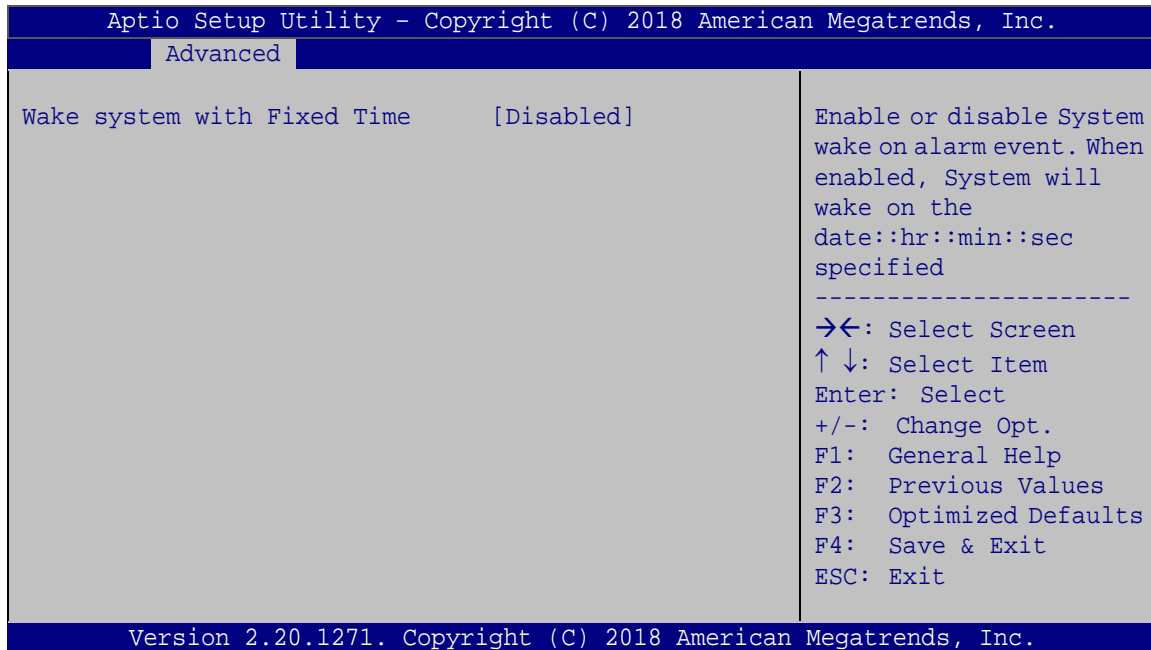

BIOS Menu 11: RTC Wake Settings

→ Wake system with Fixed Time [Disabled]

Use the **Wake system with Fixed Time** option to enable or disable the system wake on alarm event.

- **Disabled** **DEFAULT** The real time clock (RTC) cannot generate a wake event

- **Enabled** If selected, the **Wake up every day** option appears allowing you to enable to disable the system to wake every day at the specified time. Besides, the following options appear with values that can be selected:

Wake up date

Wake up hour

Wake up minute

Wake up second

After setting the alarm, the computer turns itself on from a suspend state when the alarm goes off.

4.3.8 Serial Port Console Redirection

The **Serial Port Console Redirection** menu (**BIOS Menu 12**) allows the console redirection options to be configured. Console redirection allows users to maintain a system remotely by re-directing keyboard input and text output through the serial port.

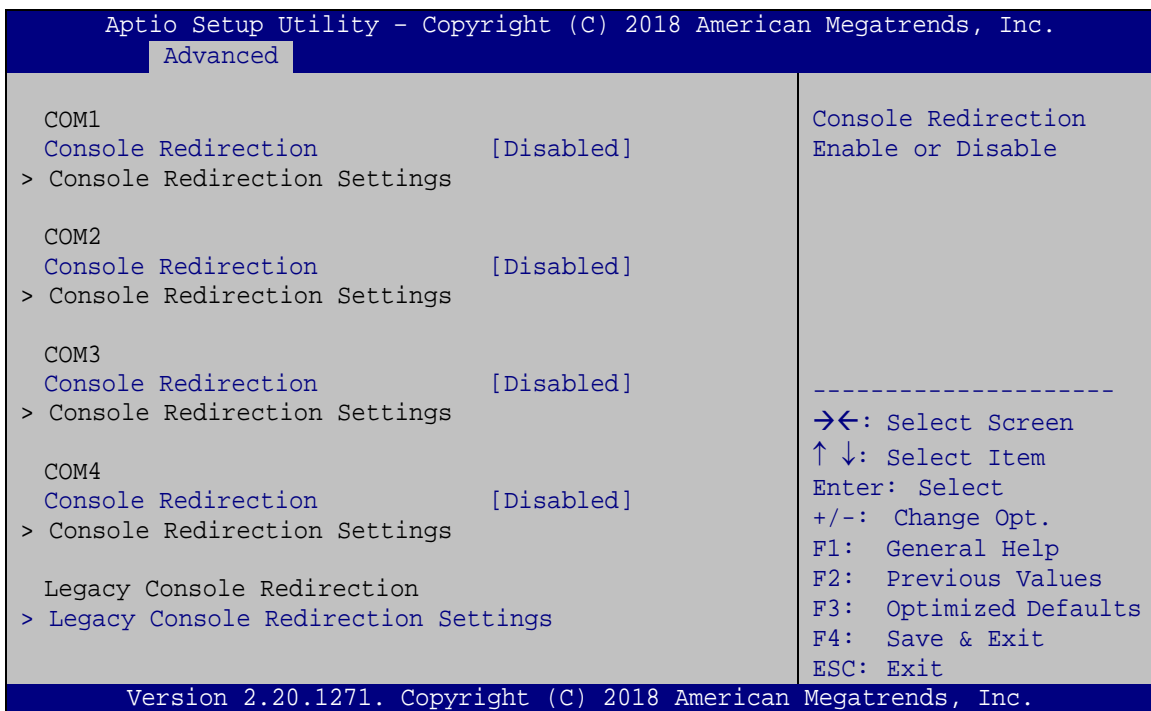

BIOS Menu 12: Serial Port Console Redirection

FLEX-BX200-Q370

→ **Console Redirection [Disabled]**

Use **Console Redirection** option to enable or disable the console redirection function.

- **Disabled** **DEFAULT** Disabled the console redirection function
- **Enabled** Enabled the console redirection function

The following options are available in the **Console Redirection Settings** submenu when the **Console Redirection** option is enabled.

→ **Terminal Type [ANSI]**

Use the **Terminal Type** option to specify the remote terminal type.

- **VT100** The target terminal type is VT100
- **VT100+** The target terminal type is VT100+
- **VT-UTF8** The target terminal type is VT-UTF8
- **ANSI** **DEFAULT** The target terminal type is ANSI

→ **Bits per second [115200]**

Use the **Bits per second** option to specify the serial port transmission speed. The speed must match the other side. Long or noisy lines may require lower speeds.

- **9600** Sets the serial port transmission speed at 9600.
- **19200** Sets the serial port transmission speed at 19200.
- **57600** Sets the serial port transmission speed at 57600.
- **115200** **DEFAULT** Sets the serial port transmission speed at 115200.

→ **Data Bits [8]**

Use the **Data Bits** option to specify the number of data bits.

- **7** Sets the data bits at 7.
- **8** **DEFAULT** Sets the data bits at 8.

→ Parity [None]

Use the **Parity** option to specify the parity bit that can be sent with the data bits for detecting the transmission errors.

- | | | |
|----------------|----------------|---|
| → None | DEFAULT | No parity bit is sent with the data bits. |
| → Even | | The parity bit is 0 if the number of ones in the data bits is even. |
| → Odd | | The parity bit is 0 if the number of ones in the data bits is odd. |
| → Mark | | The parity bit is always 1. This option does not provide error detection. |
| → Space | | The parity bit is always 0. This option does not provide error detection. |

→ Stop Bits [1]

Use the **Stop Bits** option to specify the number of stop bits used to indicate the end of a serial data packet. Communication with slow devices may require more than 1 stop bit.

- | | | |
|------------|----------------|------------------------------------|
| → 1 | DEFAULT | Sets the number of stop bits at 1. |
| → 2 | | Sets the number of stop bits at 2. |

FLEX-BX200-Q370

4.3.8.1 Legacy Console Redirection Settings

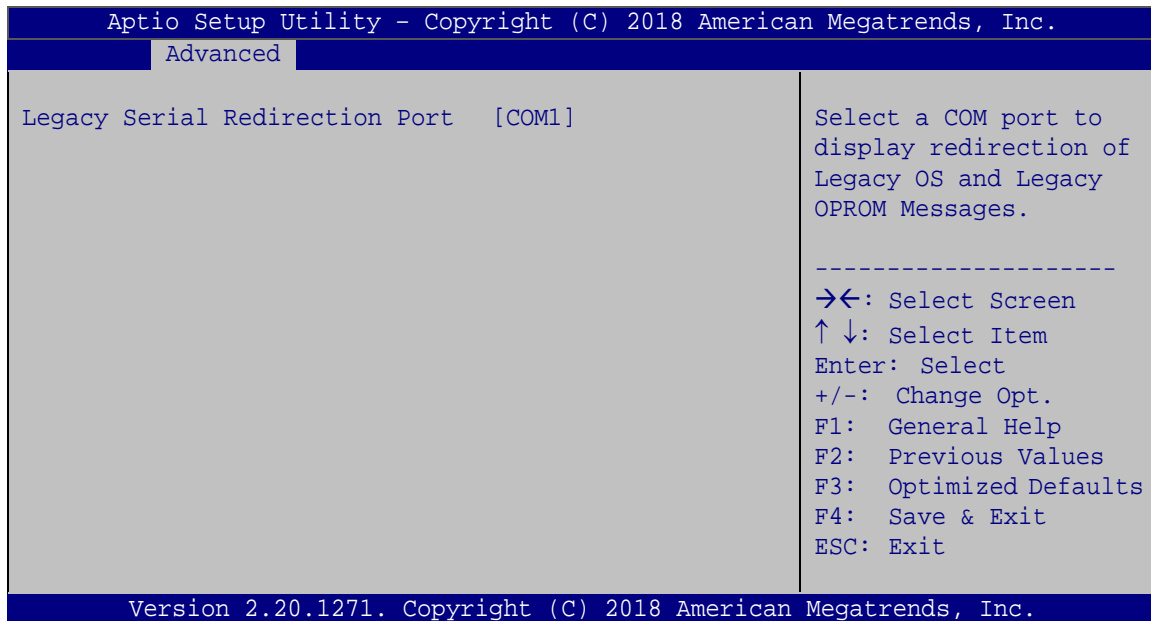

BIOS Menu 13: Legacy Console Redirection Settings

→ Legacy Serial Redirection Port [COM1]

Use the **Legacy Serial Redirection Port** option to select a COM port to display redirection of legacy OS and legacy OPRM messages. Configuration options are listed below.

- COM1 **Default**
- COM2
- COM3
- COM4

4.3.9 USB Configuration

Use the **USB Configuration** menu (**BIOS Menu 14**) to read USB configuration information and configure the USB settings.

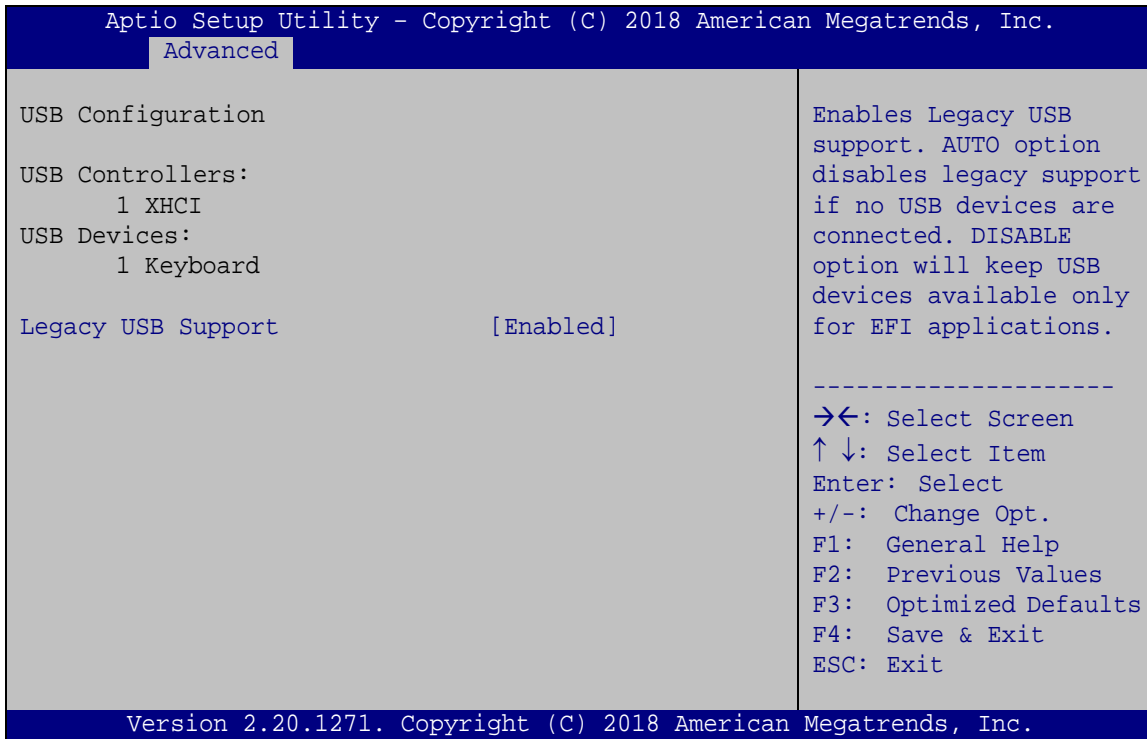

BIOS Menu 14: USB Configuration

➔ Legacy USB Support [Enabled]

Use the **Legacy USB Support** BIOS option to enable USB mouse and USB keyboard support. Normally if this option is not enabled, any attached USB mouse or USB keyboard does not become available until a USB compatible operating system is fully booted with all USB drivers loaded. When this option is enabled, any attached USB mouse or USB keyboard can control the system even when there is no USB driver loaded onto the system.

- ➔ **Enabled** **DEFAULT** Legacy USB support enabled
- ➔ **Disabled** Legacy USB support disabled
- ➔ **Auto** Legacy USB support disabled if no USB devices are connected

FLEX-BX200-Q370

4.3.10 NVMe Configuration

Use the **NVMe Configuration (BIOS Menu 15)** menu to display the NVMe controller and device information.

```

Aptio Setup Utility - Copyright (C) 2018 American Megatrends, Inc.
  Advanced
NVMe Configuration
No NVMe Device Found

-----
-><: Select Screen
↑↓: Select Item
Enter: Select
+/-: Change Opt.
F1: General Help
F2: Previous Values
F3: Optimized Defaults
F4: Save & Exit
ESC: Exit

Version 2.20.1271. Copyright (C) 2018 American Megatrends, Inc.
  
```

BIOS Menu 15: NVMe Configuration

4.3.1 IEI QTS

Use the **IEI QTS (BIOS Menu 16)** menu to display IEI QTS status.

```

Aptio Setup Utility - Copyright (C) 2018 American Megatrends, Inc.
  Advanced
IEI QTS Active Status      [Non-Activated]

-----
-><: Select Screen
↑↓: Select Item
Enter: Select
+/-: Change Opt.
F1: General Help
F2: Previous Values
F3: Optimized Defaults
F4: Save & Exit
ESC: Exit

Version 2.20.1271. Copyright (C) 2018 American Megatrends, Inc.
  
```

BIOS Menu 16: IEI QTS

4.3.2 IEI Feature

Use the **IEI Feature** menu (**BIOS Menu 17**) to configure One Key Recovery function.

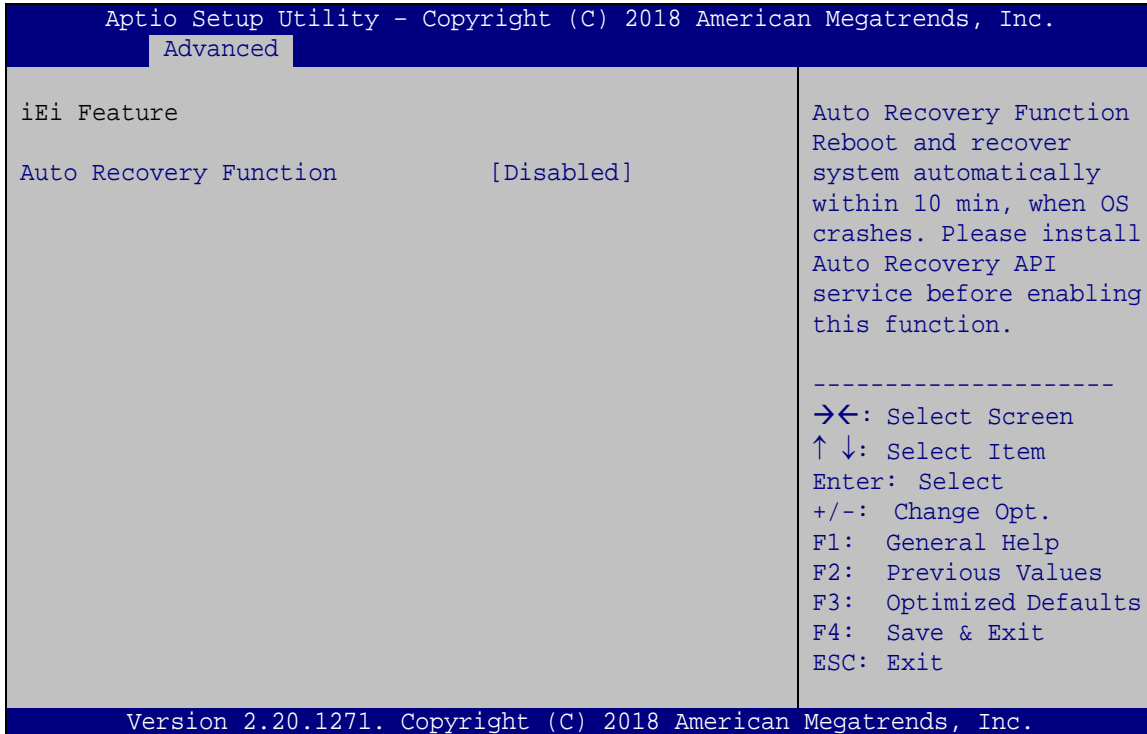

BIOS Menu 17: IEI Feature

➔ Auto Recovery Function [Disabled]

Use the **Auto Recovery Function** BIOS option to enable or disable the auto recovery function of the IEI One Key Recovery.

- ➔ **Disabled** **DEFAULT** Auto recovery function disabled
- ➔ **Enabled** Auto recovery function enabled

FLEX-BX200-Q370

4.4 Chipset

Use the **Chipset** menu (**BIOS Menu 18**) to access the PCH IO and System Agent (SA) configuration menus.

**WARNING!**

Setting the wrong values for the Chipset BIOS selections in the Chipset BIOS menu may cause the system to malfunction.

```
Aptio Setup Utility - Copyright (C) 2018 American Megatrends, Inc.
Main   Advanced  Chipset  Security  Boot   Save & Exit
-----
> System Agent (SA) Configuration      System Agent (SA)
> PCH-IO Configuration                Parameters
-----
-><: Select Screen
↑ ↓: Select Item
Enter: Select
+/-: Change Opt.
F1: General Help
F2: Previous Values
F3: Optimized Defaults
F4: Save & Exit
ESC: Exit

Version 2.20.1271. Copyright (C) 2018 American Megatrends, Inc.
```

BIOS Menu 18: Chipset

4.4.1 System Agent (SA) Configuration

Use the **System Agent (SA) Configuration** menu (**BIOS Menu 19**) to configure the System Agent (SA) parameters.

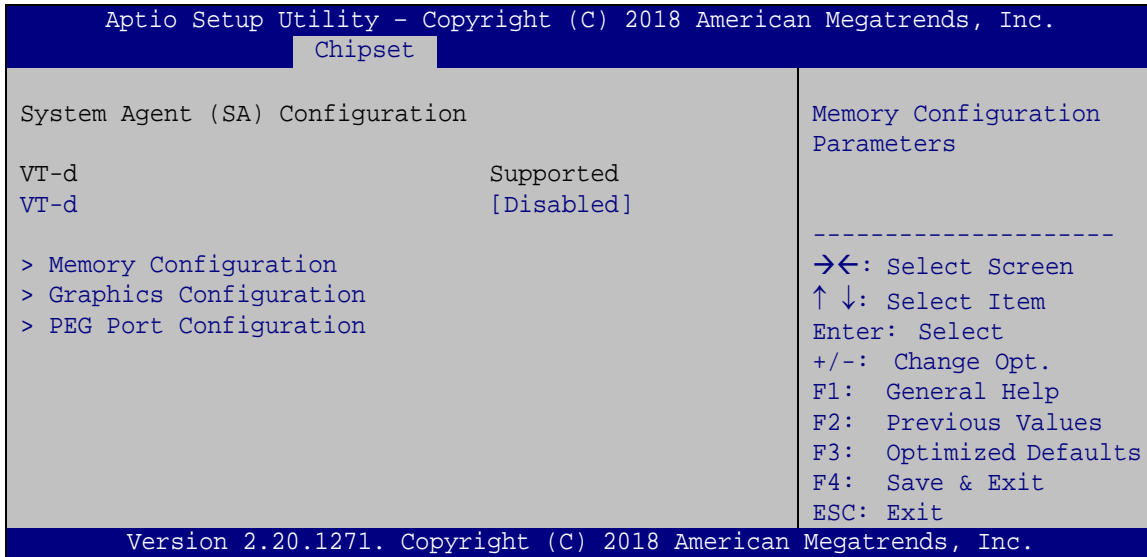

BIOS Menu 19: System Agent (SA) Configuration

→ VT-d [Disabled]

Use the **VT-d** option to enable or disable VT-d support.

- **Disabled** **DEFAULT** Disables VT-d support.
- **Enabled** Enables VT-d support.

FLEX-BX200-Q370

4.4.1.1 Memory Configuration

Use the **Memory Configuration** submenu (**BIOS Menu 20**) to view memory information.

```

Aptio Setup Utility - Copyright (C) 2018 American Megatrends, Inc.
Chipset
Memory Configuration
CHA_DIMM0      Populated & Enabled
  Size         8192 MB (DDR4)
  Number of Ranks 2
  Manufacturer Transcend
CHB_DIMM0      Not Populated/Disabled
-----
-><: Select Screen
↑↓: Select Item
Enter: Select
+/-: Change Opt.
F1: General Help
F2: Previous Values
F3: Optimized Defaults
F4: Save & Exit
ESC: Exit
Version 2.20.1271. Copyright (C) 2018 American Megatrends, Inc.

```

BIOS Menu 20: Memory Configuration

4.4.1.2 Graphics Configuration

Use the **Graphics Configuration (BIOS Menu 21)** menu to configure the video device connected to the system.

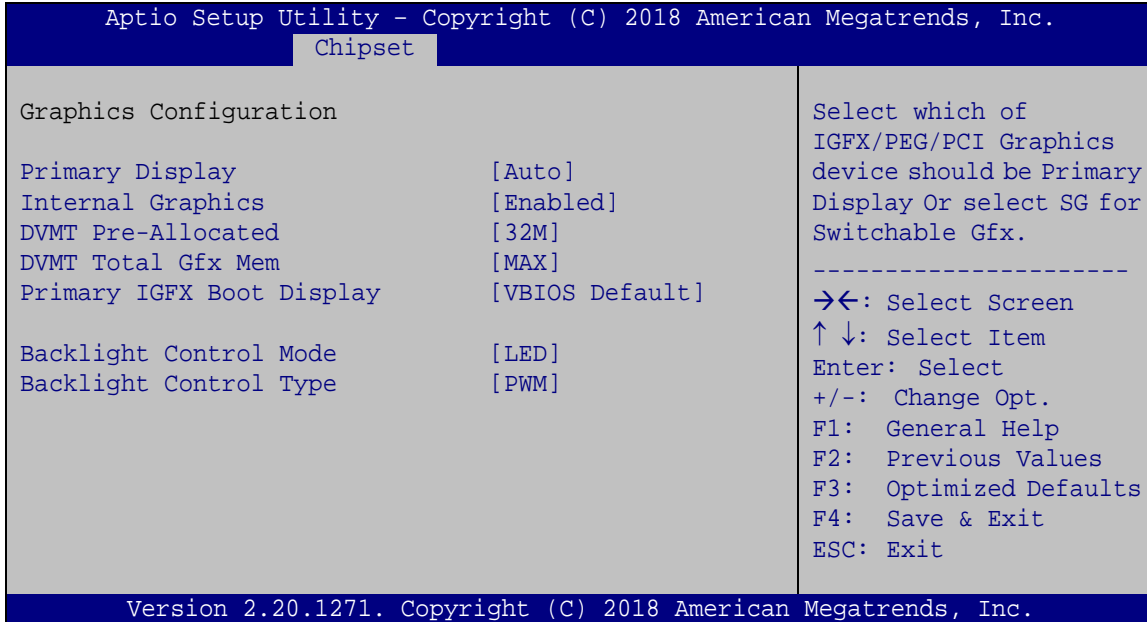

BIOS Menu 21: Graphics Configuration

→ Primary Display [Auto]

Use the **Primary Display** option to select the primary graphics controller the system uses.

The following options are available:

- Auto **Default**
- IGFX
- PEG
- PCIe

FLEX-BX200-Q370**→ Internal Graphics [Enabled]**

Use the **Internal Graphics** option to configure whether to keep IGFX enabled. If user wants to support dual display by internal graphics and external graphics, this Internal Graphics option should be set to Enabled and the above Primary Display option should be set to IGFX.

- **Auto** Auto mode
- **Disabled** Disables IGFX.
- **Enabled** **DEFAULT** Enables IGFX.

→ DVMT Pre-Allocated [32M]

Use the **DVMT Pre-Allocated** option to set the amount of system memory allocated to the integrated graphics processor when the system boots. The system memory allocated can then only be used as graphics memory, and is no longer available to applications or the operating system. Configuration options are listed below:

- 32M **Default**
- 64M

→ DVMT Total Gfx Mem [MAX]

Use the **DVMT Total Gfx Mem** option to select DVMT5.0 total graphic memory size used by the internal graphic device. The following options are available:

- 128M
- 256M
- MAX **Default**

→ Primary IGFX Boot Display [VBIOS Default]

Use the **Primary IGFX Boot Display** option to select the display device used by the system when it boots. **Configuration options are listed below.**

- VBIOS Default **Default**
- LVDS
- HDMI
- IDP1

➔ **Backlight Control Mode [LED]**

Use the **Backlight Control Mode** option to specify the backlight control mode. Configuration options are listed below.

- LED **Default**
- CCFL

➔ **Backlight Control Type [PWM]**

Use the **Backlight Control Type** option to specify the backlight control type. Configuration options are listed below.

- PWM **Default**
- DC

4.4.1.3 PEG Port Configuration

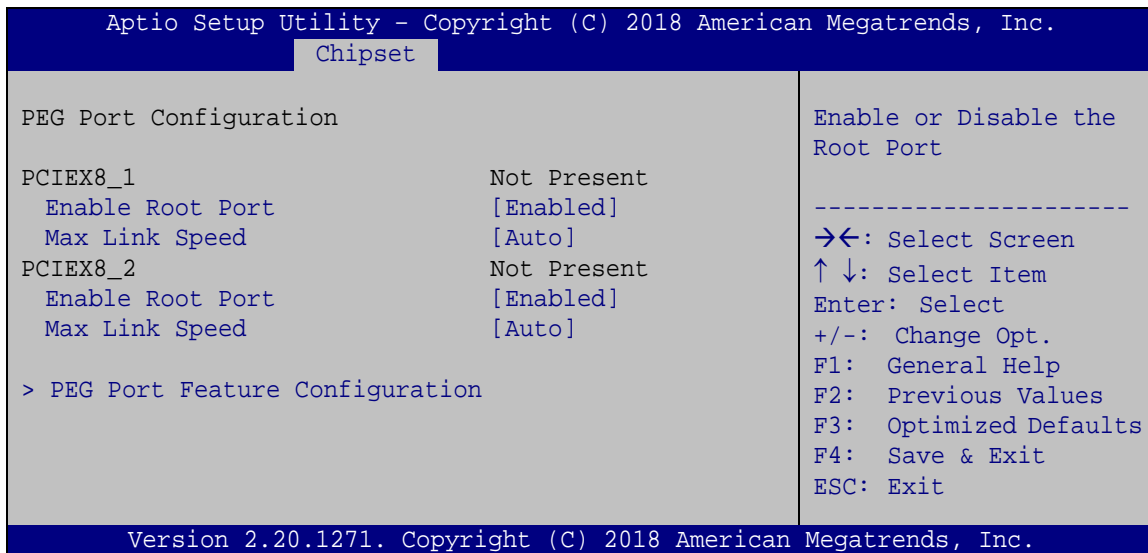

BIOS Menu 22: PEG Port Configuration

FLEX-BX200-Q370**→ Enable Root Port [Enabled]**

Use the **Enable Root Port** option to enable or disable the PCI Express (PEG) controller.

- Disabled** Disables the PCI Express (PEG) controller.
- Enabled** **DEFAULT** Enables the PCI Express (PEG) controller.

→ Max Link Speed [Auto]

Use the **Max Link Speed** option to select the maximum link speed of the PCI Express slot.

The following options are available:

- Auto **Default**
- Gen1
- Gen2
- Gen3

4.4.1.3.1 PEG Port Feature Configuration

Use the **PEG Port Feature Configuration** submenu (**BIOS Menu 23**) to configure the SA PCIe settings.

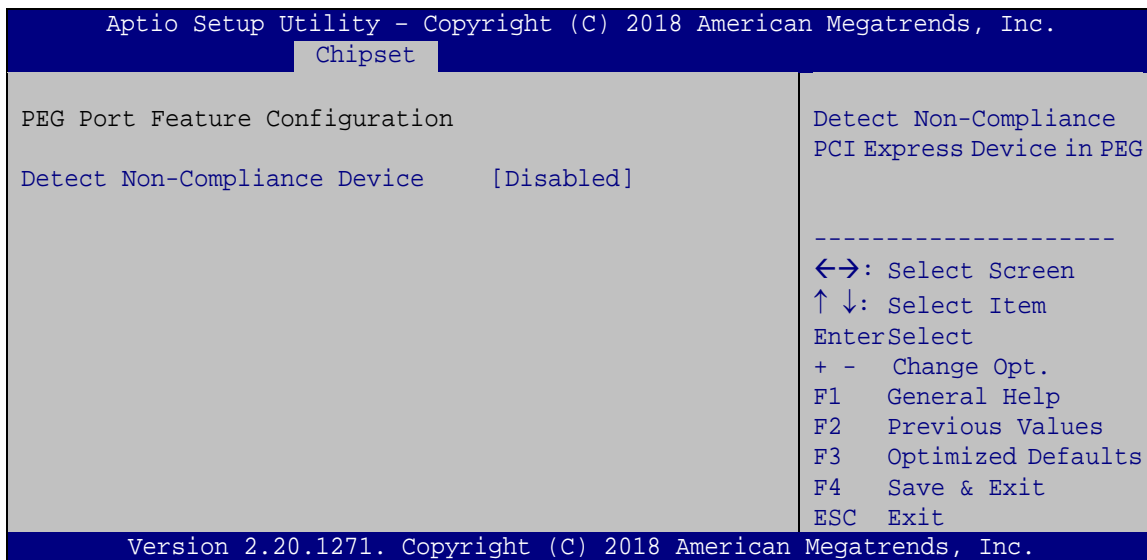

BIOS Menu 23: PEG Port Feature Configuration

➔ **Detect Non-Compliance Device [Disabled]**

Use the **Detect Non-Compliance Device** option to detect non-compliance PCIe device in PEG.

- ➔ **Disabled** **DEFAULT** Do not detect non-compliance PCIe device in PEG
- ➔ **Enabled** Detect non-compliance PCIe device in PEG

4.4.2 PCH-IO Configuration

Use the **PCH-IO Configuration** menu (**BIOS Menu 24**) to configure the PCH parameters.

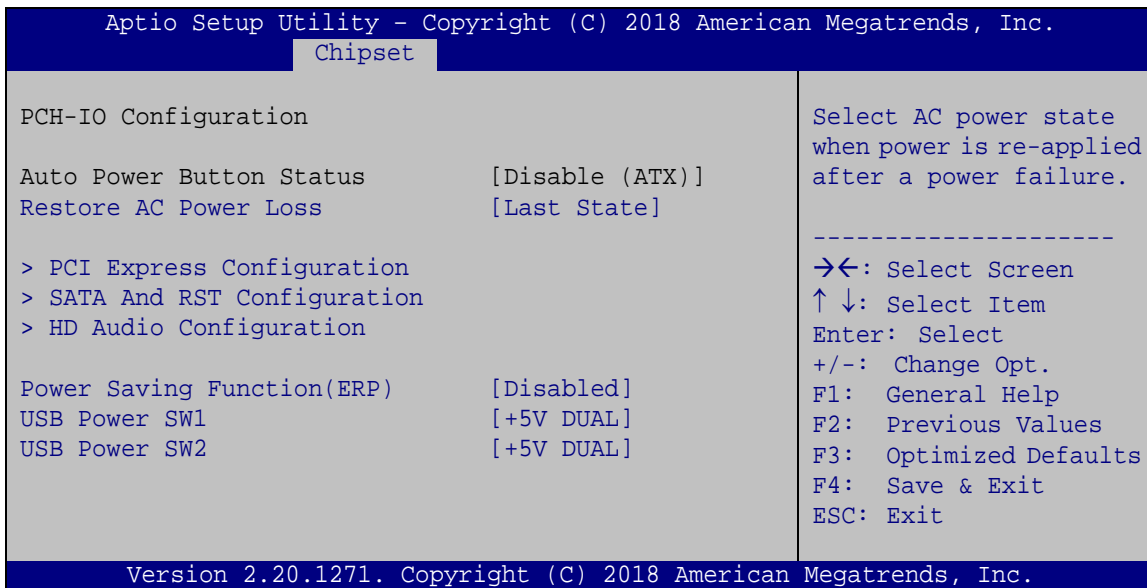

BIOS Menu 24: PCH-IO Configuration

➔ **Restore AC Power Loss [Last State]**

Use the **Restore AC Power Loss** BIOS option to specify what state the system returns to if there is a sudden loss of power to the system.

- ➔ **Power Off** The system remains turned off
- ➔ **Power On** The system turns on
- ➔ **Last State** **DEFAULT** The system returns to its previous state. If it was on, it turns itself on. If it was off, it remains off.

FLEX-BX200-Q370**→ Power Saving Function(ERP) [Disabled]**

Use the **Power Saving Function(ERP)** BIOS option to enable or disable the power saving function.

- **Disabled** **DEFAULT** Power saving function is disabled.
- **Enabled** Power saving function is enabled. It will reduce power consumption when the system is off.

→ USB Power SW1 [+5V DUAL]

Use the **USB Power SW1** BIOS option to configure whether to provide power to the four external USB 3.1 connectors (LAN1_USB1 & LAN2_USB2) when the system is in S3/S4 sleep state. This option is valid only when the above **Power Saving Function (ERP)** BIOS option is disabled.

- **+5V** **DEFAULT** Power is provided to the external USB 3.0 connectors when the system is in S3/S4 sleep state
DUAL
- **+5V** Power is not provided to the external USB 3.0 connectors when the system is in S3/S4 sleep state

→ USB Power SW2 [+5V DUAL]

Use the **USB Power SW2** BIOS option to configure whether to provide power to the two external USB 3.1 connectors (USB1) and the four internal USB 2.0 connectors when the system is in S3/S4 sleep state. This option is valid only when the above **Power Saving Function (ERP)** BIOS option is disabled.

- **+5V** **DEFAULT** Power is provided to the external USB 2.0 connectors when the system is in S3/S4 sleep state
DUAL
- **+5V** Power is not provided to the external USB 2.0 connectors when the system is in S3/S4 sleep state

4.4.2.1 PCI Express Configuration

Use the **PCI Express Configuration** menu (**BIOS Menu 25**) to configure the PCI Express and M.2 slots.

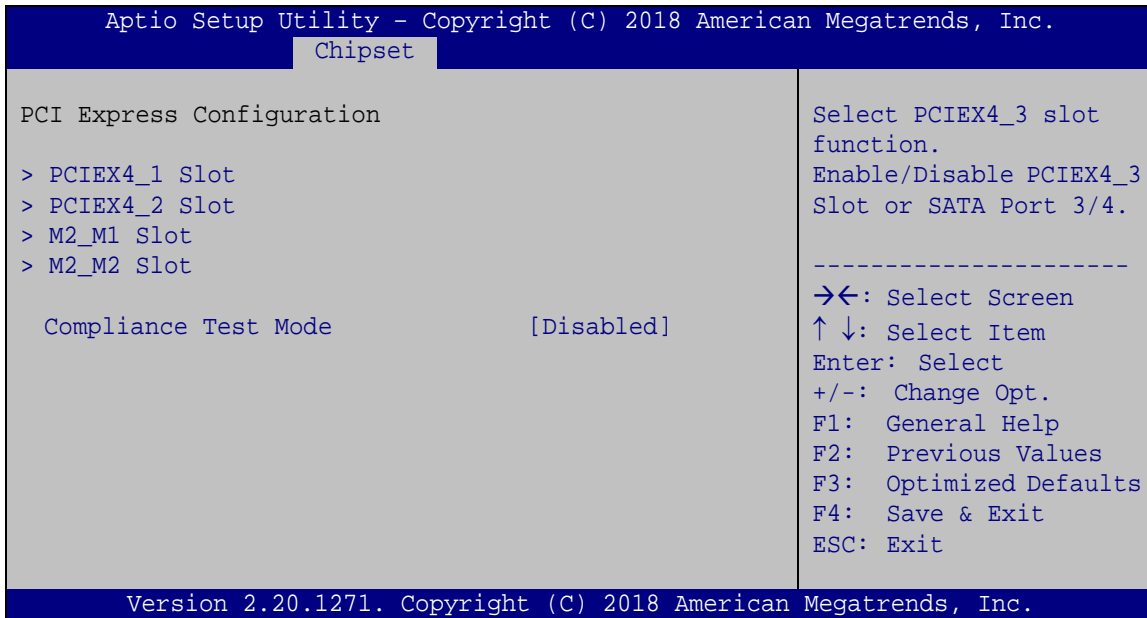

BIOS Menu 25: PCI Express Configuration

FLEX-BX200-Q370

4.4.2.1.1 PCIEX4_1 Slot, PCIEX4_2 Slot and M.2 Slots

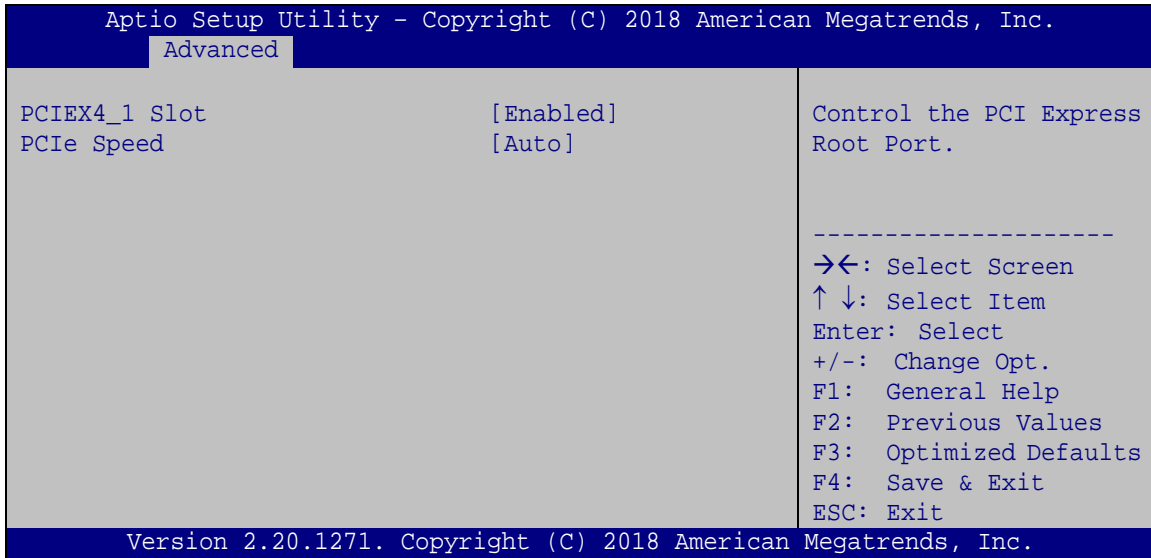

BIOS Menu 26: PCIe Slot Configuration Submenu

→ PCIEX4_1 Slot [Enabled]

Use the **PCIEX4_1 Slot** option to enable or disable the PCIEX4_1 PCI Express slot.

- **Disabled** Disables the PCIEX4_1 PCI Express slot.
- **Enabled** **DEFAULT** Enables the PCIEX4_1 PCI Express slot.

→ PCIEX4_2 Slot [Enabled]

Use the **PCIEX4_2 Slot** option to enable or disable the PCIEX4_2 PCI Express slot.

- **Disabled** Disables the PCIEX4_2 PCI Express slot.
- **Enabled** **DEFAULT** Enables the PCIEX4_2 PCI Express slot.

→ M2_M1 Slot [Enabled]

Use the **M2_M1 Slot** option to enable or disable the M.2 2280 M-key slot.

- Disabled** Disables the M.2 2280 M-key slot.
- Enabled** **DEFAULT** Enables the M.2 2280 M-key slot.

→ M2_M2 Slot [Enabled]

Use the **M2_M2 Slot** option to enable or disable the M.2 2280 M-key slot.

- Disabled** Disables the M.2 2280 M-key slot.
- Enabled** **DEFAULT** Enables the M.2 2280 M-key slot.

→ PCIe Speed [Auto]

Use this option to select the support type of the PCI Express slots. The following options are available:

- Auto **Default**
- Gen1
- Gen2
- Gen3

FLEX-BX200-Q370

4.4.2.2 SATA Configuration

Use the **SATA Configuration** menu (**BIOS Menu 27**) to change and/or set the configuration of the SATA devices installed in the system.

```

Aptio Setup Utility - Copyright (C) 2018 American Megatrends, Inc.
  Advanced
SATA And RST Configuration
SATA Controller(s)          [Enabled]
SATA Mode Selection         [AHCI]

MINI_SAS1_PORT1            Empty
  Hot Plug                  [Disabled]
MINI_SAS1_PORT2            Empty
  Hot Plug                  [Disabled]
MINI_SAS1_PORT3            Empty
  Hot Plug                  [Disabled]
MINI_SAS1_PORT4            Empty
  Hot Plug                  [Disabled]
S_ATA5                     Empty
  Hot Plug                  [Disabled]
S_ATA6                     Empty
  Hot Plug                  [Disabled]

-----
-><: Select Screen
↑ ↓: Select Item
Enter: Select
+/-: Change Opt.
F1: General Help
F2: Previous Values
F3: Optimized Defaults
F4: Save & Exit
ESC: Exit

Version 2.20.1271. Copyright (C) 2018 American Megatrends, Inc.
  
```

BIOS Menu 27: SATA Configuration

→ SATA Controller(s) [Enabled]

Use the **SATA Controller(s)** option to configure the SATA controller(s).

- **Enabled** **DEFAULT** Enables the on-board SATA controller(s).
- **Disabled** Disables the on-board SATA controller(s).

→ **SATA Mode Selection [AHCI]**

Use the **SATA Mode Selection** option to determine how the SATA devices operate.

- **AHCI** **DEFAULT** Configures SATA devices as AHCI device.
- **Intel RST**
Premium With
Intel Optane
System
Acceleration Configures SATA devices to the Intel RST Premium With Intel Optane System Acceleration mode.

→ **Hot Plug**

Use the **Hot Plug** option to enable or disable the hot plug function.

- **Disabled** **DEFAULT** Disables the hot plug function.
- **Enabled** Enables the hot plug function.

FLEX-BX200-Q370

4.4.2.3 HD Audio Configuration

Use the **HD Audio Configuration** menu (**BIOS Menu 28**) to configure the PCH Azalia settings.

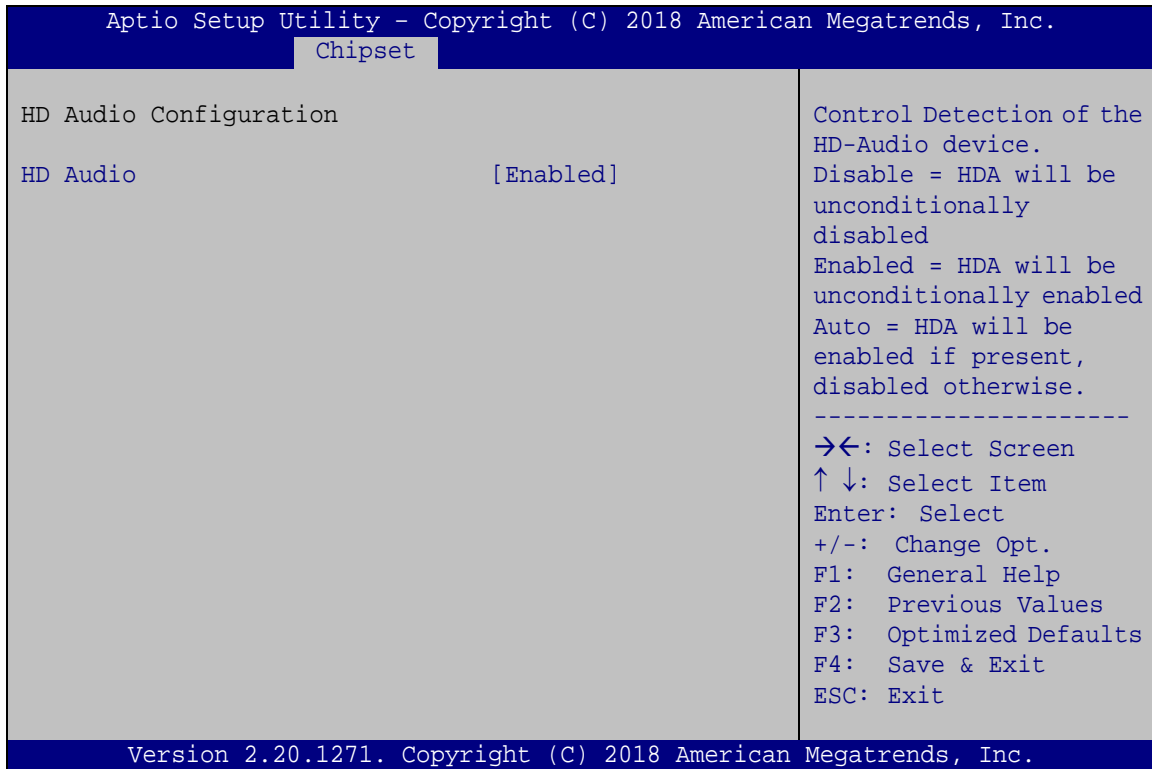

BIOS Menu 28: HD Audio Configuration

→ HD Audio [Enabled]

Use the **HD Audio** option to enable or disable the High Definition Audio controller.

- **Disabled** The onboard High Definition Audio controller is disabled.
- **Enabled** **DEFAULT** The onboard High Definition Audio controller is enabled.

4.5 Security

Use the **Security** menu (**BIOS Menu 29**) to set system and user passwords.

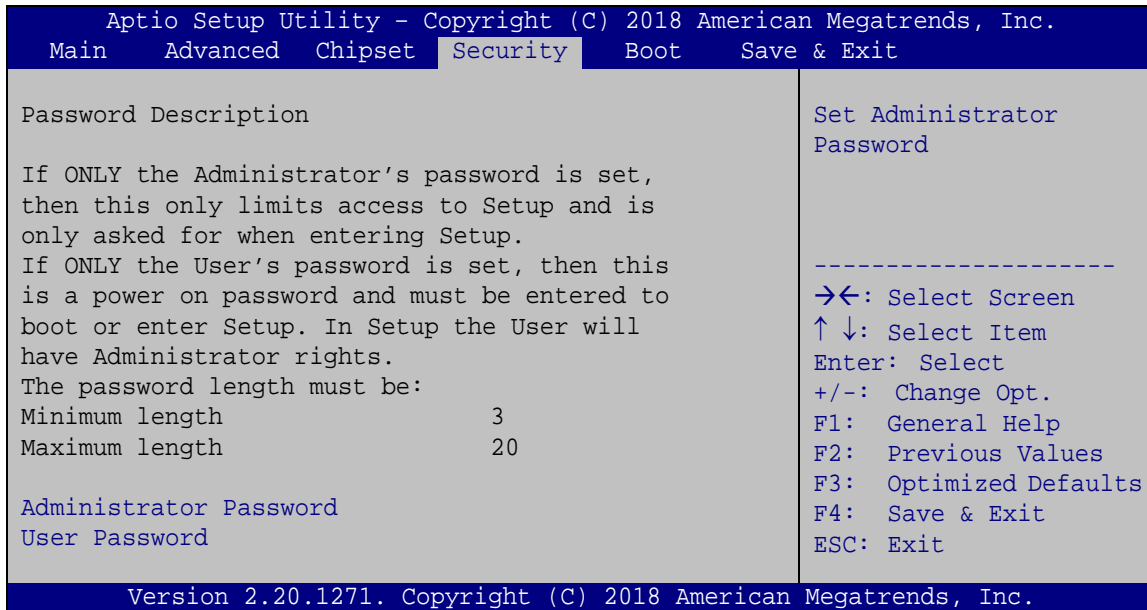

BIOS Menu 29: Security

→ Administrator Password

Use the **Administrator Password** to set or change a administrator password.

→ User Password

Use the **User Password** to set or change a user password.

FLEX-BX200-Q370

4.6 Boot

Use the **Boot** menu (**BIOS Menu 30**) to configure system boot options.

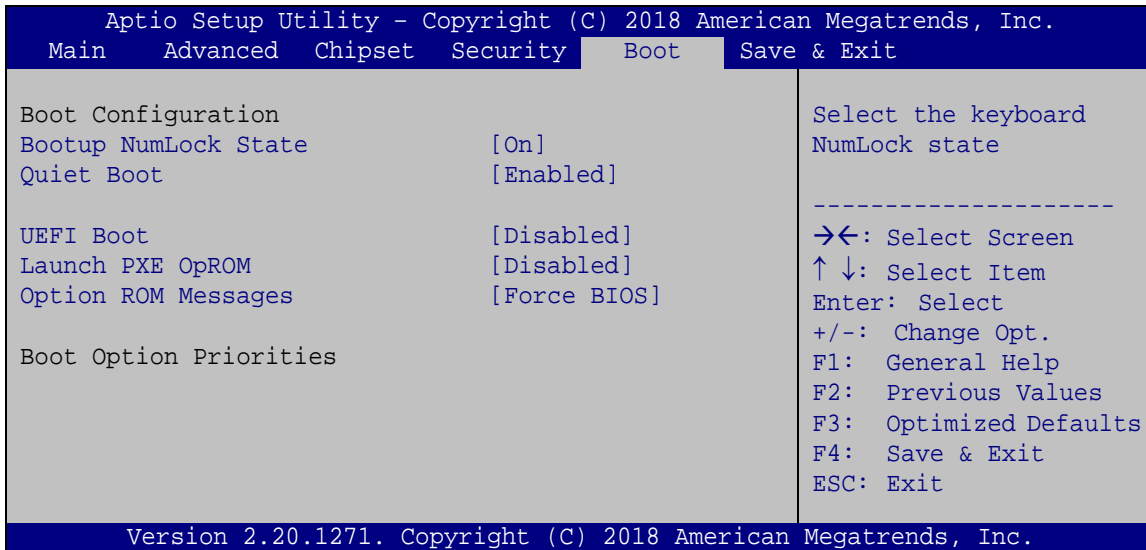

BIOS Menu 30: Boot

→ Bootup NumLock State [On]

Use the **Bootup NumLock State** BIOS option to specify if the number lock setting must be modified during boot up.

- **On** **DEFAULT** Allows the Number Lock on the keyboard to be enabled automatically when the computer system boots up. This allows the immediate use of the 10-key numeric keypad located on the right side of the keyboard. To confirm this, the Number Lock LED light on the keyboard is lit.
- **Off** Does not enable the keyboard Number Lock automatically. To use the 10-keys on the keyboard, press the Number Lock key located on the upper left-hand corner of the 10-key pad. The Number Lock LED on the keyboard lights up when the Number Lock is engaged.

→ Quiet Boot [Enabled]

Use the **Quiet Boot** BIOS option to select the screen display when the system boots.

- **Disabled** Normal POST messages displayed
- **Enabled** **DEFAULT** OEM Logo displayed instead of POST messages

→ UEFI Boot [Disabled]

Use the **UEFI Boot** option to enable or disable to boot from the UEFI devices.

- **Disabled** **DEFAULT** Boot from UEFI devices is disabled.
- **Enabled** Boot from UEFI devices is enabled.

→ Launch PXE OpROM [Disabled]

Use the **Launch PXE OpROM** option to enable or disable boot option for legacy network devices.

- **Disabled** **DEFAULT** Ignore all PXE Option ROMs
- **Enabled** Load PXE Option ROMs.

→ Option ROM Messages [Force BIOS]

Use the **Option ROM Messages** option to set the Option ROM display mode.

- **Force BIOS** **DEFAULT** Sets display mode to force BIOS.
- **Keep Current** Sets display mode to current.

FLEX-BX200-Q370

4.7 Save & Exit

Use the **Safe & Exit** menu (**BIOS Menu 31**) to load default BIOS values, optimal failsafe values and to save configuration changes.

```

Aptio Setup Utility - Copyright (C) 2018 American Megatrends, Inc.
Main   Advanced  Chipset  Security  Boot   Save & Exit
-----
Save Changes and Reset
Discard Changes and Reset

Restore Defaults
Save as User Defaults
Restore User Defaults

Exit the system after
saving the changes.

-----
-><: Select Screen
↑↓: Select Item
Enter: Select
+/-: Change Opt.
F1: General Help
F2: Previous Values
F3: Optimized Defaults
F4: Save & Exit
ESC: Exit

Version 2.20.1271. Copyright (C) 2018 American Megatrends, Inc.

```

BIOS Menu 31: Save & Exit

→ Save Changes and Reset

Use the **Save Changes and Reset** option to save the changes made to the BIOS options and reset the system.

→ Discard Changes and Reset

Use the **Discard Changes and Reset** option to exit the system without saving the changes made to the BIOS configuration setup program.

→ Restore Defaults

Use the **Restore Defaults** option to load the optimal default values for each of the parameters on the Setup menus. **F3 key can be used for this operation.**

→ Save as User Defaults

Use the **Save as User Defaults** option to save the changes done so far as user defaults.

→ Restore User Defaults

Use the **Restore User Defaults** option to restore the user defaults to all the setup options.

Chapter

5

Troubleshooting and Maintenance

FLEX-BX200-Q370



WARNING:

Take Anti-Static precautions whenever maintenance is being carried out on the system components. Failure to take anti-static precautions can cause permanent system damage. For more details on anti-static precautions, please refer to **Section 3.1**.

5.1 FLEX-BX200-Q370 System Maintenance Overview



NOTE:

When doing maintenance operations on the system, please follow the instructions in this chapter. Failure to follow these instructions may lead to personal injury and system damage.

To preserve the working integrity of the FLEX-BX200-Q370 box PC, the system must be properly maintained. If box PC components need replacement, the proper maintenance procedures must be followed to ensure the system can continue to operate normally.

5.2 System Troubleshooting

This section provides some simple troubleshooting suggestions.

5.2.1 The System Doesn't Turn On

If after turning the system on, there is no power (indicated by the power LED on the front panel not turning on) please do the following:

- Step 1:** Check that the power cable connector is properly connected to the system rear panel.
- Step 2:** Check that the power cable connector is properly plugged into the power source.
- Step 3:** Make sure the power button is turned on.

Step 4: Plug the system into a monitor and check to see if anything appears on the screen. If the boot-up screen appears it means the power LED has failed. To fix this problem, contact an IEI sales representative directly.

5.2.2 The System Doesn't Boot Up

If the system doesn't boot up please do the following:

Step 1: Check the power is turned on. See Section 5.2.1 above.

Step 2: Make sure the SO-DIMM modules are properly installed.

5.2.3 More Troubleshooting

Nothing appears on the monitor after booting up the system: Make sure the monitor is properly connected to the system and the monitor is connected to a power supply and turned on.



WARNING!

If all troubleshooting measures have been taken and the system still fails to start, contact the IEI reseller or vendor you purchased the FLEX-BX200-Q370 from or contact an IEI sales representative directly. To contact an IEI sales representative, please send an email to sales@ieiworld.com.

FLEX-BX200-Q370

5.3 Component Replacement

**WARNING!**

Users are not advised to attempt to repair or replace any internal or external components of the FLEX-BX200-Q370 box PC. If any other components fail or need replacement, contact the IEI reseller or vendor you purchased the FLEX-BX200-Q370 from or contact an IEI sales representative directly. To contact an IEI sales representative, please send an email to sales@ieiworld.com.

Chapter

6

Interface Connectors

FLEX-BX200-Q370

6.1 Peripheral Interface Connectors

The FLEX-BX200-Q370 box PC motherboard comes with a number of peripheral interface connectors and configuration jumpers. The connector locations are shown in **Figure 6-1** and **Figure 6-2**. The Pin 1 locations of the on-board connectors are also indicated in the diagrams. The connector pinouts for these connectors are listed in the following sections.

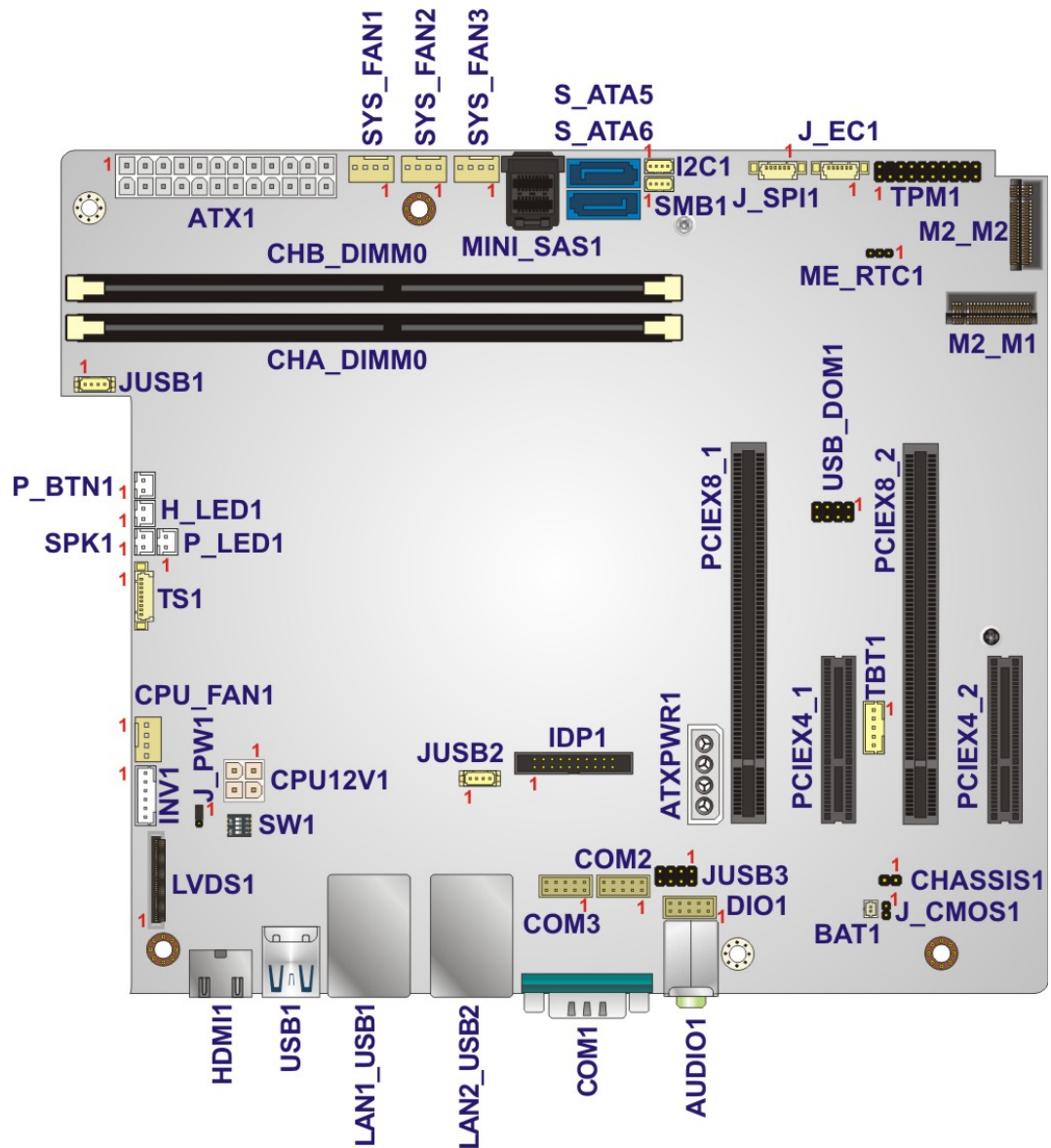

Figure 6-1: Main Board Layout Diagram (Front Side)

6.2 Internal Peripheral Connectors

Internal peripheral connectors are found on the motherboard and are only accessible when the motherboard is outside of the chassis. The table below shows a list of the peripheral interface connectors on the FLEX-BX200-Q370 motherboard. Pinouts of these connectors can be found in the following sections.

Connector	Type	Label
ATX power input connector	24-pin Molex	ATX1
Additional power connector	4-pin connector	ATXPWR1
Battery connector	2-pin wafer	BAT1
Chassis intrusion connector	2-pin header	CHASSIS1
CPU power connector	4-pin Molex	CPU12V1
DIMM sockets	DDR4 DIMM socket	CHA_DIMM0, CHB_DIMM0
DIO connector	10-pin box header	DIO1
EC debug port (solder side)	20-pin FPC	EC_DBG1
Fan connector (CPU)	4-pin wafer	CPU_FAN1
Fan connector (system)	4-pin wafer	SYS_FAN1, SYS_FAN2, SYS_FAN3
I ² C connector	4-pin wafer	I2C1
Internal DisplayPort connector	20-pin box header	IDP1
LED connector, HDD	2-pin wafer	H_LED1
LED connector, power	2-pin wafer	P_LED1
LVDS connector	40-pin wire-to-board	LVDS1
LVDS backlight connector	6-pin wafer	INV1
Mini SAS connector	Mini SAS	MINI_SAS1
M.2 M-key slots	M.2 2280 M-key	M2_M1, M2_M2
PCIe x4 slots	PCIe x4 slot	PCIEX4_1, PCIEX4_2
PCIe x8 slots	PCIe x16 slot	PCIEX8_1, PCIEX8_2
Power button connector	2-pin wafer	P_BTN1
Touch panel connector	9-pin wafer	TS1
RS-232 connector	10-pin box header	COM2
RS-422/485 connector (dual)	10-pin box header	COM3

FLEX-BX200-Q370

Connector	Type	Label
SATA 6Gb/s connectors	SATA connector	S_ATA5, S_ATA6
SMBus connector	4-pin wafer	SMB1
SPI flash connector	6-pin wafer	J_SPI1
SPI flash (EC) connector	6-pin wafer	J_EC1
Speaker connector	2-pin wafer	SPK1
TPM connector	20-pin header	TPM1
USB 2.0 connectors (single)	4-pin wafer	JUSB1, JUSB2
USB 2.0 connector (dual)	8-pin header	JUSB3
USB DOM connector	8-pin header	USB_DOM1

Table 6-1: Peripheral Interface Connectors

6.2.1 ATX Power Input Connector (ATX1)

PIN NO.	DESCRIPTION	PIN NO.	DESCRIPTION
1	VCC3V	13	VCC3V
2	VCC3V	14	-VCC12V
3	GND	15	GND
4	VCC5V	16	PS_ON
5	GND	17	GND
6	VCC5V	18	GND
7	GND	19	GND
8	PWR_OK	20	NC
9	SB5V	21	VCC5V
10	VCC12V	22	VCC5V
11	VCC12V	23	VCC5V
12	VCC3V	24	GND

Table 6-2: ATX Power Input Connector (ATX1) Pinouts

6.2.2 Additional Power Connector (ATXPWR1)

PIN NO.	DESCRIPTION
1	VCC12V
2	GND
3	GND
4	VCC5V

Table 6-3: Additional Power Connector (ATXPWR1) Pinouts

6.2.3 Battery Connector (BAT1)

PIN NO.	DESCRIPTION
1	VBATT
2	GND

Table 6-4: Battery Connector (BAT1) Pinouts

6.2.4 Chassis Intrusion Connector (CHASSIS1)

PIN NO.	DESCRIPTION
1	VCC3V
2	CHASSIE

Table 6-5: Chassis Intrusion Connector (CHASSIS1) Pinouts

6.2.5 CPU Power Connector (CPU12V1)

PIN NO.	DESCRIPTION	PIN NO.	DESCRIPTION
1	GND	2	GND
3	VCC12V	4	VCC12V

Table 6-6: CPU Power Connector (CPU12V1)

6.2.6 DIO Connector (DIO1)

PIN NO.	DESCRIPTION	PIN NO.	DESCRIPTION
1	GND	2	VCC
3	Output 3	4	Output 2
5	Output 1	6	Output 0
7	Input 3	8	Input 2
9	Input 1	10	Input 0

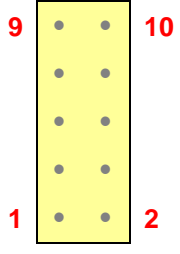

Table 6-7: DIO Connector (DIO1) Pinouts

6.2.7 EC Debug Port (EC_DBG1)

PIN NO.	DESCRIPTION	PIN NO.	DESCRIPTION
1	KSI0	2	KSO0
3	KSO1	4	KSO2
5	KSO3	6	KSO4
7	KSO5	8	KSO6
9	KSO7	10	KSO8
11	KSO9	12	KSO10
13	KSO12	14	KSI1
15	KSO11	16	KSI2
17	KSI3	18	GND
19	GND	20	GND

Table 6-8: EC Debug Port (EC_DBG1) Pinouts

6.2.8 Fan Connector, CPU (CPU_FAN1)

PIN NO.	DESCRIPTION
1	GND
2	+12V
3	FANIO
4	PWM

Table 6-9: CPU Fan Connector (CPU_FAN1) Pinouts

6.2.9 Fan Connectors, System (SYS_FAN1, SYS_FAN2, SYS_FAN3)

PIN NO.	DESCRIPTION
1	GND
2	+12V
3	FANIO
4	PWM

Table 6-10: System Fan Connectors (SYS_FAN1, SYS_FAN2, SYS_FAN3) Pinouts

6.2.10 I²C Connector (I2C1)

PIN NO.	DESCRIPTION
1	GND
2	I2C_DATA
3	I2C_CLK
4	+5V

Table 6-11: I²C Connector (I2C1) Pinouts

6.2.11 Internal DisplayPort Connector (IDP1)

PIN NO.	DESCRIPTION	PIN NO.	DESCRIPTION
1	HPD#	2	AUXP
3	GND	4	AUXN
5	DET_D	6	GND
7	GND	8	LANE2P
9	LANE3P	10	LANE2N
11	LANE3N	12	GND
13	GND	14	LANE0P
15	LANE1P	16	LANE0N
17	LANE1N	18	VCC3V
19	VCC5V	20	NC

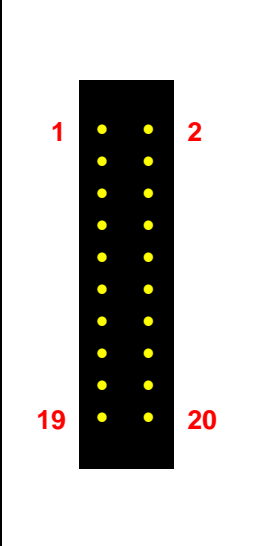

Table 6-12: Internal DisplayPort Connector (IDP1) Pinouts

6.2.12 LED Connector, HDD (H_LED1)

PIN NO.	DESCRIPTION
1	VCC5V
2	SATA_LED#

Table 6-13: HDD LED Connector (H_LED1) Pinouts

6.2.13 LED Connector, Power (P_LED1)

PIN NO.	DESCRIPTION
1	VCC5V
2	GND

Table 6-14: Power LED Connector (P_LED1) Pinouts

6.2.14 LVDS Connector (LVDS1)

PIN NO.	DESCRIPTION	PIN NO.	DESCRIPTION
1	LCD_VCC	2	LCD_VCC
3	LCD_VCC	4	LCD_VCC
5	LCD_VCC	6	NC
7	NC	8	GND
9	GND	10	GND
11	GND	12	CLK2P
13	CLK2M	14	GND
15	A7P	16	A7M
17	GND	18	A6P
19	A6M	20	GND
21	A5P	22	A5M
23	GND	24	A4P
25	A4M	26	GND
27	A3P	28	A3M
29	GND	30	CLK1P

PIN NO.	DESCRIPTION	PIN NO.	DESCRIPTION
31	CLK1M	32	GND
33	A2P	34	A2M
35	GND	36	A1P
37	A1M	38	GND
39	A0P	40	A0M

Table 6-15: LVDS Connector (LVDS1) Pinouts

6.2.15 LVDS Backlight Connector (INV1)

PIN NO.	DESCRIPTION
1	VCC12V
2	VCC12V
3	Backlight ON/OFF
4	Backlight Brightness Control
5	GND
6	GND

Table 6-16: LVDS Backlight Connector (INV1) Pinouts

6.2.16 Mini SAS Connector (MINI_SAS1)

PIN NO.	DESCRIPTION	PIN NO.	DESCRIPTION
A1	NC	B1	NC
A2	NC	B2	NC
A3	GND	B3	GND
A4	SATA_RX1+	B4	SATA_RX0+
A5	SATA_RX1-	B5	SATA_RX0-
A6	GND	B6	GND
A7	SATA_RX3+	B7	SATA_RX2+
A8	SATA_RX3-	B8	SATA_RX2-
A9	GND	B9	GND
C1	NC	D1	NC
C2	NC	D2	NC

FLEX-BX200-Q370

PIN NO.	DESCRIPTION	PIN NO.	DESCRIPTION
C3	GND	D3	GND
C4	SATA_TX1+	D4	SATA_TX0+
C5	SATA_TX1-	D5	SATA_TX0-
C6	GND	D6	GND
C7	SATA_TX3+	D7	SATA_TX2+
C8	SATA_TX3-	D8	SATA_TX2-
C9	GND	D9	GND

Table 6-17: Mini SAS Connector (MINI_SAS1) Pinouts

6.2.17 Power Button Connector (P_BTN1)

PIN NO.	DESCRIPTION
1	PWRBTN_SW#
2	GND

Table 6-18: Power Button Connector (P_BTN1) Pinouts

6.2.18 Touch Panel Connector (TS1)

PIN NO.	DESCRIPTION
1	X+
2	X-
3	Y+
4	SENSE
5	X+
6	X-
7	Y+
8	Y-
9	GND

Table 6-19: Touch Panel Connector (TS1) Pinouts

6.2.19 RS-232 Connector (COM2)

PIN NO.	DESCRIPTION	PIN NO.	DESCRIPTION
1	DCD	2	DSR
3	RX	4	RTS
5	TX	6	CTS
7	DTR	8	RI
9	GND	10	GND

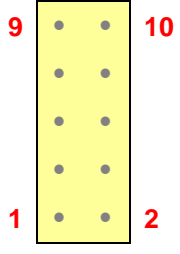

Table 6-20: RS-232 Connector (COM2) Pinouts

6.2.20 RS-422/485 Connector (COM3)

PIN NO.	DESCRIPTION	PIN NO.	DESCRIPTION
1	COM3_TX-	2	COM4_TX-
3	COM3_TX+	4	COM4_TX+
5	COM3_RT-	6	COM4_RT-
7	COM3_RX+	8	COM4_RX+
9	GND	10	GND

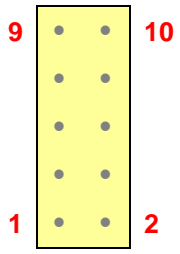

Table 6-21: RS-422/485 Connector (COM3) Pinouts

6.2.21 SMBus Connector (SMB1)

PIN NO.	DESCRIPTION
1	GND
2	SMB_DATA
3	SMB_CLK
4	VCC5V

Table 6-22: SMBus Connector (SMB1) Pinouts

6.2.22 SPI Flash Connector (J_SPI1)

PIN NO.	DESCRIPTION
1	VCC3V
2	SPI_CS
3	SPI_SO
4	SPI_CLK
5	SPI_SI
6	GND

Table 6-23: SPI Flash Connector (J_SPI1) Pinouts

6.2.23 SPI Flash (EC) Connector (J_EC1)

PIN NO.	DESCRIPTION
1	VCC3V
2	SPI_CS#0_CN_EC
3	SPI_SO_SW_EC
4	SPI_CLK_SW_EC
5	SPI_SI_SW_EC
6	GND

Table 6-24: SPI Flash (EC) Connector (J_EC1) Pinouts

6.2.24 Speaker Connector (SPK1)

PIN NO.	DESCRIPTION
1	VCC5V
2	PC_BEEP

Table 6-25: Speaker Connector (SPK1) Pinouts

6.2.25 TPM Connector (TPM1)

PIN NO.	DESCRIPTION	PIN NO.	DESCRIPTION
1	CLOCK	2	GND
3	FRAME	4	NC
5	RESET	6	VCC5V
7	LAD3	8	LAD2
9	VCC3V	10	LAD1
11	LAD0	12	GND
13	SMB_CLK	14	SMB_DATA
15	SB3V	16	SERIRQ
17	GND	18	CLKRUN
19	LPCPD	20	DRO

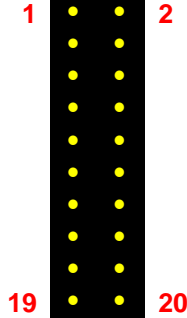

Table 6-26: TPM Connector (TPM1) Pinouts

6.2.26 USB 2.0 Connectors, Single (JUSB1, JUSB2)

PIN NO.	DESCRIPTION
1	SB5V
2	DATA-
3	DATA+
4	GND

Table 6-27: Single USB 2.0 Connectors (JUSB1, JUSB2) Pinouts

FLEX-BX200-Q370

6.2.27 USB 2.0 Connectors, Dual (JUSB3)

PIN NO.	DESCRIPTION	PIN NO.	DESCRIPTION
1	SB5V	2	GND
3	DATA-	4	DATA+
5	DATA+	6	DATA-
7	GND	8	SB5V

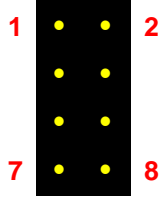

Table 6-28: Dual USB 2.0 Connector (JUSB3) Pinouts

6.2.1 USB DOM Connector (USB_DOM1)

PIN NO.	DESCRIPTION	PIN NO.	DESCRIPTION
1	VCC5V	2	NC
3	DATA-	4	NC
5	DATA+	6	NC
7	GND	8	NC

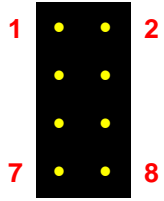

Table 6-29: USB DOM Connector (USB_DOM1) Pinouts

6.3 Jumpers

The following table shows a list of jumpers on the FLEX-BX200-Q370 motherboard.

Jumper Name	Type	Label
Clear CMOS	2-pin header	J_CMOS1
ME RTC register setting	3-pin header	ME_RTC1
LVDS panel resolution selection	DIP switch	SW1
Panel voltage selection	3-pin header	J_PW1

Table 6-30: Jumpers

6.3.1 Clear CMOS Jumper (J_CMOS1)

Pin	Description
Open	Keep current BIOS setup (Default)
Short	Clear BIOS

Table 6-31: Clear CMOS Jumper (J_CMOS1) Settings

6.3.2 ME RTC Register Setting Jumper (ME_RTC1)

Pin	Description
Short 1-2	Save ME RTC registers (Default)
Short 2-3	Clear ME RTC registers

Table 6-32: ME RTC Register Jumper (ME_RTC1) Settings

Appendix

A

Regulatory Compliance

DECLARATION OF CONFORMITY

This equipment is in conformity with the following EU directives:

- EMC Directive (2004/108/EC, 2014/30/EU)
- Low-Voltage Directive (2006/95/EC, 2014/35/EU)
- RoHS II Directive (2011/65/EU, 2015/863/EU)

If the user modifies and/or install other devices in the equipment, the CE conformity declaration may no longer apply.

If this equipment has telecommunications functionality, it also complies with the requirements of the Radio Equipment Directive 2014/53/EU.

English

IEI Integration Corp declares that this equipment is in compliance with the essential requirements and other relevant provisions of Directive 2014/53/EU.

Български [Bulgarian]

IEI Integration Corp. декларира, че този оборудване е в съответствие със съществените изисквания и другите приложими правила на Директива 2014/53/EU

Česky [Czech]

IEI Integration Corp tímto prohlašuje, že tento zařizení je ve shodě se základními požadavky a dalšími příslušnými ustanoveními směrnice 2014/53/EU.

Dansk [Danish]

IEI Integration Corp erklærer herved, at følgende udstyr overholder de væsentlige krav og øvrige relevante krav i direktiv 2014/53/EU.

Deutsch [German]

IEI Integration Corp, erklärt dieses Gerät entspricht den grundlegenden Anforderungen und den weiteren entsprechenden Vorgaben der Richtlinie 2014/53/EU.

Eesti [Estonian]

IEI Integration Corp deklareerib seadme seadme vastavust direktiivi 2014/53/EÜ põhinõuetele ja nimetatud direktiivist tulenevatele teistele asjakohastele sätetele.

FLEX-BX200-Q370

Español [Spanish]

IEI Integration Corp declara que el equipo cumple con los requisitos esenciales y cualesquiera otras disposiciones aplicables o exigibles de la Directiva 2014/53/EU.

Ελληνική [Greek]

IEI Integration Corp ΔΗΛΩΝΕΙ ΟΤΙ ΕΞΟΠΛΙΣΜΟΣ ΣΥΜΜΟΡΦΩΝΕΤΑΙ ΠΡΟΣ ΤΙΣ ΟΥΣΙΩΔΕΙΣ ΑΠΑΙΤΗΣΕΙΣ ΚΑΙ ΤΙΣ ΛΟΙΠΕΣ ΣΧΕΤΙΚΕΣ ΔΙΑΤΑΞΕΙΣ ΤΗΣ ΟΔΗΓΙΑΣ 2014/53/EU

Français [French]

IEI Integration Corp déclare que l'appareil est conforme aux exigences essentielles et aux autres dispositions pertinentes de la directive 2014/53/EU.

Italiano [Italian]

IEI Integration Corp dichiara che questo apparecchio è conforme ai requisiti essenziali ed alle altre disposizioni pertinenti stabilite dalla direttiva 2014/53/EU.

Latviski [Latvian]

IEI Integration Corp deklarē, ka iekārta atbilst būtiskajām prasībām un citiem ar to saistītajiem noteikumiem Direktīvas 2014/53/EU.

Lietuvių [Lithuanian]

IEI Integration Corp deklaruoja, kad šis įranga atitinka esminius reikalavimus ir kitas 2014/53/EU Direktyvos nuostatas.

Nederlands [Dutch]

IEI Integration Corp dat het toestel toestel in overeenstemming is met de essentiële eisen en de andere relevante bepalingen van richtlijn 2014/53/EU.

Malti [Maltese]

IEI Integration Corp jiddikjara li dan prodott jikkonforma mal-ħtiġijiet essenzjali u ma provvedimenti oħrajn relevanti li hemm fid-Dirrettiva 2014/53/EU.

Magyar [Hungarian]

IEI Integration Corp nyilatkozom, hogy a berendezés megfelel a vonatkozó alapvető követelményeknek és az 2014/53/EU irányelv egyéb előírásainak.

Polski [Polish]

IEI Integration Corp oświadcza, że wyrobu jest zgodny z zasadniczymi wymogami oraz pozostałym stosownymi postanowieniami Dyrektywy 2014/53/EU.

Português [Portuguese]

IEI Integration Corp declara que este equipamento está conforme com os requisitos essenciais e outras disposições da Directiva 2014/53/EU.

Româna [Romanian]

IEI Integration Corp declară că acest echipament este în conformitate cu cerințele esențiale și cu celelalte prevederi relevante ale Directivei 2014/53/EU.

Slovensko [Slovenian]

IEI Integration Corp izjavlja, da je ta opreme v skladu z bistvenimi zahtevami in ostalimi relevantnimi določili direktive 2014/53/EU.

Slovensky [Slovak]

IEI Integration Corp týmto vyhlasuje, že zariadenia spĺňa základné požiadavky a všetky príslušné ustanovenia Smernice 2014/53/EU.

Suomi [Finnish]

IEI Integration Corp vakuuttaa täten että laitteet on direktiivin 2014/53/EU oleellisten vaatimusten ja sitä koskevien direktiivin muiden ehtojen mukainen.

Svenska [Swedish]

IEI Integration Corp förklarar att denna utrustningstyp står i överensstämmelse med de väsentliga egenskapskrav och övriga relevanta bestämmelser som framgår av direktiv 2014/53/EU.

FCC WARNING

This equipment complies with Part 15 of the FCC Rules. Operation is subject to the following two conditions:

- This device may not cause harmful interference, and
- This device must accept any interference received, including interference that may cause undesired operation.

This equipment has been tested and found to comply with the limits for a Class A digital device, pursuant to part 15 of the FCC Rules. These limits are designed to provide reasonable protection against harmful interference when the equipment is operated in a commercial environment. This equipment generates, uses, and can radiate radio frequency energy and, if not installed and used in accordance with the instruction manual, may cause harmful interference to radio communications. Operation of this equipment in a residential area is likely to cause harmful interference in which case the user will be required to correct the interference at his own expense.

Federal Communication Commission Interference Statement

This equipment has been assembled with components that comply with the limits for a Class B digital device, pursuant to Part 15 of the FCC Rules. These limits are designed to provide reasonable protection against harmful interference in a residential installation. This equipment generates, uses and can radiate radio frequency energy and, if not installed and used in accordance with the instructions, may cause harmful interference to radio communications. However, there is no guarantee that interference will not occur in a particular installation. If this equipment does cause harmful interference to radio or television reception, which can be determined by turning the equipment off and on, the user is encouraged to try to correct the interference by one of the following measures:

- Reorient or relocate the receiving antenna.
- Increase the separation between the equipment and receiver.
- Connect the equipment into an outlet on a circuit different from that to which the receiver is connected.
- Consult the dealer or an experienced radio/TV technician for help.

Appendix

B

Safety Precautions

**WARNING:**

The precautions outlined in this chapter should be strictly followed. Failure to follow these precautions may result in permanent damage to the FLEX-BX200-Q370.

B.1 Safety Precautions

Please follow the safety precautions outlined in the sections that follow:

B.1.1 General Safety Precautions

Please ensure the following safety precautions are adhered to at all times.

- **Follow the electrostatic precautions** outlined below whenever the device is opened.
- **Make sure the power is turned off and the power cord is disconnected** whenever the FLEX-BX200-Q370 is being installed, moved or modified.
- **To prevent the risk of electric shock, make sure power cord is unplugged from wall socket.** To fully disengage the power to the unit, please disconnect the power cord from the power outlet. Refer servicing to qualified service personnel. The power outlet shall be readily available and accessible.
- **Do not apply voltage levels that exceed the specified voltage range.** Doing so may cause fire and/or an electrical shock. Use a power cord that matches the voltage of the power outlet, which has been approved and complies with the safety standard of your particular country.
- **Electric shocks can occur** if the FLEX-BX200-Q370 chassis is opened when it is running. To avoid risk of electric shock, this device must only be connected to a supply mains with protective earth.
- **Do not drop or insert any objects** into the ventilation openings of the FLEX-BX200-Q370.

- **If considerable amounts of dust, water, or fluids enter the device**, turn off the power supply immediately, unplug the power cord, and contact the FLEX-BX200-Q370 vendor.
- **DO NOT:**
 - Drop the device against a hard surface.
 - In a site where the ambient temperature exceeds the rated temperature

B.1.2 Anti-static Precautions



WARNING:

Failure to take ESD precautions during the installation of the FLEX-BX200-Q370 may result in permanent damage to the FLEX-BX200-Q370 and severe injury to the user.

Electrostatic discharge (ESD) can cause serious damage to electronic components, including the FLEX-BX200-Q370. Dry climates are especially susceptible to ESD. It is therefore critical that whenever the FLEX-BX200-Q370 is opened and any of the electrical components are handled, the following anti-static precautions are strictly adhered to.

- **Wear an anti-static wristband:** Wearing a simple anti-static wristband can help to prevent ESD from damaging any electrical component.
- **Self-grounding:** Before handling any electrical component, touch any grounded conducting material. During the time the electrical component is handled, frequently touch any conducting materials that are connected to the ground.
- **Use an anti-static pad:** When configuring or working with an electrical component, place it on an anti-static pad. This reduces the possibility of ESD damage.
- **Only handle the edges of the electrical component:** When handling the electrical component, hold the electrical component by its edges.

B.1.3 Product Disposal

**CAUTION:**

Risk of explosion if battery is replaced by an incorrect type. Only certified engineers should replace the on-board battery.

Dispose of used batteries according to instructions and local regulations.

- Outside the European Union–If you wish to dispose of used electrical and electronic products outside the European Union, please contact your local authority so as to comply with the correct disposal method.
- Within the European Union–The device that produces less waste and is easier to recycle is classified as electronic device in terms of the European Directive 2012/19/EU (WEEE), and must not be disposed of as domestic garbage.

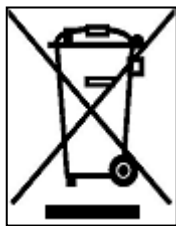

EU-wide legislation, as implemented in each Member State, requires that waste electrical and electronic products carrying the mark (left) must be disposed of separately from normal household waste. This includes monitors and electrical accessories, such as signal cables or power cords. When you need to dispose of your display products, please follow the guidance of your local authority, or ask the shop where you purchased the product. The mark on electrical and electronic products only applies to the current European Union Member States.

Please follow the national guidelines for electrical and electronic product disposal.

B.2 Maintenance and Cleaning Precautions

When maintaining or cleaning the FLEX-BX200-Q370, please follow the guidelines below.



WARNING:

- For safety reasons, turn-off the power and unplug the box PC before cleaning.
 - If you dropped any material or liquid such as water onto the box PC when cleaning, unplug the power cable immediately and contact your dealer or the nearest service center. Always make sure your hands are dry when unplugging the power cable.
-

B.2.1 Maintenance and Cleaning

Prior to cleaning any part or component of the FLEX-BX200-Q370, please read the details below.

- Never spray or squirt liquids directly onto any other components. To clean the box PC, gently wipe it with a piece of soft dry cloth or a slightly moistened cloth.
- The interior of the device does not require cleaning. Keep fluids away from the device interior.
- Be cautious of all small removable components when vacuuming the device.
- Never drop any objects or liquids through the openings of the device.
- Be cautious of any possible allergic reactions to solvents or chemicals used when cleaning the device.
- Avoid eating, drinking and smoking within vicinity of the device.

B.2.2 Cleaning Tools

Some components in the FLEX-BX200-Q370 may only be cleaned using a product specifically designed for the purpose. In such case, the product will be explicitly mentioned in the cleaning tips. Below is a list of items to use when cleaning the FLEX-BX200-Q370.

- **Cloth**— Although paper towels or tissues can be used, a soft, clean piece of cloth is recommended when cleaning the device.

FLEX-BX200-Q370

- **Water or rubbing alcohol**—A cloth moistened with water or rubbing alcohol can be used to clean the device.
- **Using solvents**—The use of solvents is not recommended when cleaning the device as they may damage the plastic parts.
- **Vacuum cleaner**—Using a vacuum specifically designed for computers is one of the best methods of cleaning the device. Dust and dirt can restrict the airflow in the device and cause its circuitry to corrode.
- **Cotton swabs**—Cotton swabs moistened with rubbing alcohol or water are excellent tools for wiping hard to reach areas.
- **Foam swabs**—Whenever possible, it is best to use lint free swabs such as foam swabs for cleaning.

Appendix

C

BIOS Menu Options

C.1 BIOS Configuration Options

Below is a list of BIOS configuration options described in **Chapter 4**.

<input type="checkbox"/>	System Date [xx/xx/xx]	51
<input type="checkbox"/>	System Time [xx:xx:xx]	51
<input type="checkbox"/>	Intel (VMX) Virtualization Technology [Disabled]	53
<input type="checkbox"/>	Active Processor Cores [All]	54
<input type="checkbox"/>	Intel(R) SpeedStep(tm) [Enabled]	54
<input type="checkbox"/>	C states [Disabled]	54
<input type="checkbox"/>	Discrete Thunderbolt(TM) Support [Disabled]	55
<input type="checkbox"/>	Security Device Support [Disable]	56
<input type="checkbox"/>	ACPI Sleep State [S3 (Suspend to RAM)]	57
<input type="checkbox"/>	PC Health Status	58
<input type="checkbox"/>	CPU_FAN1 Smart Fan Control/SYS_FAN Smart Fan Control [Auto Mode]	60
<input type="checkbox"/>	Auto mode fan start temperature	60
<input type="checkbox"/>	Auto mode fan off temperature	60
<input type="checkbox"/>	Auto mode fan start PWM	60
<input type="checkbox"/>	Auto mode fan slope PWM	60
<input type="checkbox"/>	Case Open Beep [Disabled]	61
<input type="checkbox"/>	Serial Port [Enabled]	62
<input type="checkbox"/>	Wake system with Fixed Time [Disabled]	63
<input type="checkbox"/>	Console Redirection [Disabled]	65
<input type="checkbox"/>	Terminal Type [ANSI]	65
<input type="checkbox"/>	Bits per second [115200]	65
<input type="checkbox"/>	Data Bits [8]	65
<input type="checkbox"/>	Parity [None]	66
<input type="checkbox"/>	Stop Bits [1]	66
<input type="checkbox"/>	Legacy Serial Redirection Port [COM1]	67
<input type="checkbox"/>	Legacy USB Support [Enabled]	68
<input type="checkbox"/>	Auto Recovery Function [Disabled]	70
<input type="checkbox"/>	VT-d [Disabled]	72
<input type="checkbox"/>	Primary Display [Auto]	74
<input type="checkbox"/>	Internal Graphics [Enabled]	75
<input type="checkbox"/>	DVMT Pre-Allocated [32M]	75

<input type="checkbox"/>	DVMT Total Gfx Mem [MAX].....	75
<input type="checkbox"/>	Primary IGFX Boot Display [VBIOS Default]	75
<input type="checkbox"/>	Backlight Control Mode [LED]	76
<input type="checkbox"/>	Backlight Control Type [PWM]	76
<input type="checkbox"/>	Enable Root Port [Enabled]	77
<input type="checkbox"/>	Max Link Speed [Auto]	77
<input type="checkbox"/>	Detect Non-Compliance Device [Disabled]	78
<input type="checkbox"/>	Restore AC Power Loss [Last State]	78
<input type="checkbox"/>	Power Saving Function(ERP) [Disabled].....	79
<input type="checkbox"/>	USB Power SW1 [+5V DUAL].....	79
<input type="checkbox"/>	USB Power SW2 [+5V DUAL].....	79
<input type="checkbox"/>	PCIEX4_1 Slot [Enabled].....	81
<input type="checkbox"/>	PCIEX4_2 Slot [Enabled].....	81
<input type="checkbox"/>	M2_M1 Slot [Enabled].....	82
<input type="checkbox"/>	M2_M2 Slot [Enabled].....	82
<input type="checkbox"/>	PCIe Speed [Auto].....	82
<input type="checkbox"/>	SATA Controller(s) [Enabled]	83
<input type="checkbox"/>	SATA Mode Selection [AHCI].....	84
<input type="checkbox"/>	Hot Plug	84
<input type="checkbox"/>	HD Audio [Enabled]	85
<input type="checkbox"/>	Administrator Password	86
<input type="checkbox"/>	User Password	86
<input type="checkbox"/>	Bootup NumLock State [On].....	87
<input type="checkbox"/>	Quiet Boot [Enabled]	88
<input type="checkbox"/>	UEFI Boot [Disabled]	88
<input type="checkbox"/>	Launch PXE OpROM [Disabled].....	88
<input type="checkbox"/>	Option ROM Messages [Force BIOS].....	88
<input type="checkbox"/>	Save Changes and Reset	89
<input type="checkbox"/>	Discard Changes and Reset	89
<input type="checkbox"/>	Restore Defaults	89
<input type="checkbox"/>	Save as User Defaults	89
<input type="checkbox"/>	Restore User Defaults	89

Appendix

D

Watchdog Timer

**NOTE:**

The following discussion applies to DOS environment. IEI support is contacted or the IEI website visited for specific drivers for more sophisticated operating systems, e.g., Windows and Linux.

The Watchdog Timer is provided to ensure that standalone systems can always recover from catastrophic conditions that cause the CPU to crash. This condition may have occurred by external EMI or a software bug. When the CPU stops working correctly, Watchdog Timer either performs a hardware reset (cold boot) or a Non-Maskable Interrupt (NMI) to bring the system back to a known state.

A BIOS function call (INT 15H) is used to control the Watchdog Timer:

INT 15H:

AH – 6FH Sub-function:	
AL – 2:	Sets the Watchdog Timer's period.
BL:	Time-out value (Its unit-second is dependent on the item "Watchdog Timer unit select" in CMOS setup).

Table D-1: AH-6FH Sub-function

Call sub-function 2 to set the time-out period of Watchdog Timer first. If the time-out value is not zero, the Watchdog Timer starts counting down. While the timer value reaches zero, the system resets. To ensure that this reset condition does not occur, calling sub-function 2 must periodically refresh the Watchdog Timer. However, the Watchdog timer is disabled if the time-out value is set to zero.

A tolerance of at least 10% must be maintained to avoid unknown routines within the operating system (DOS), such as disk I/O that can be very time-consuming.

FLEX-BX200-Q370

**NOTE:**

When exiting a program it is necessary to disable the Watchdog Timer, otherwise the system resets.

Example program:

```
; INITIAL TIMER PERIOD COUNTER
```

```
;
```

```
W_LOOP:
```

```

MOV    AX, 6F02H    ;setting the time-out value
MOV    BL, 30      ;time-out value is 48 seconds
INT    15H

```

```
;
```

```
; ADD THE APPLICATION PROGRAM HERE
```

```
;
```

```

CMP    EXIT_AP, 1    ;is the application over?
JNE    W_LOOP      ;No, restart the application

```

```

MOV    AX, 6F02H    ;disable Watchdog Timer
MOV    BL, 0        ;
INT    15H

```

```
;
```

```
; EXIT ;
```

Appendix

E

Panel Kit Dimensions

FLEX-BX200-Q370

E.1 FLEX-PLKIT-F15

The dimensions of the FLEX-PLKIT-F15 are listed below.

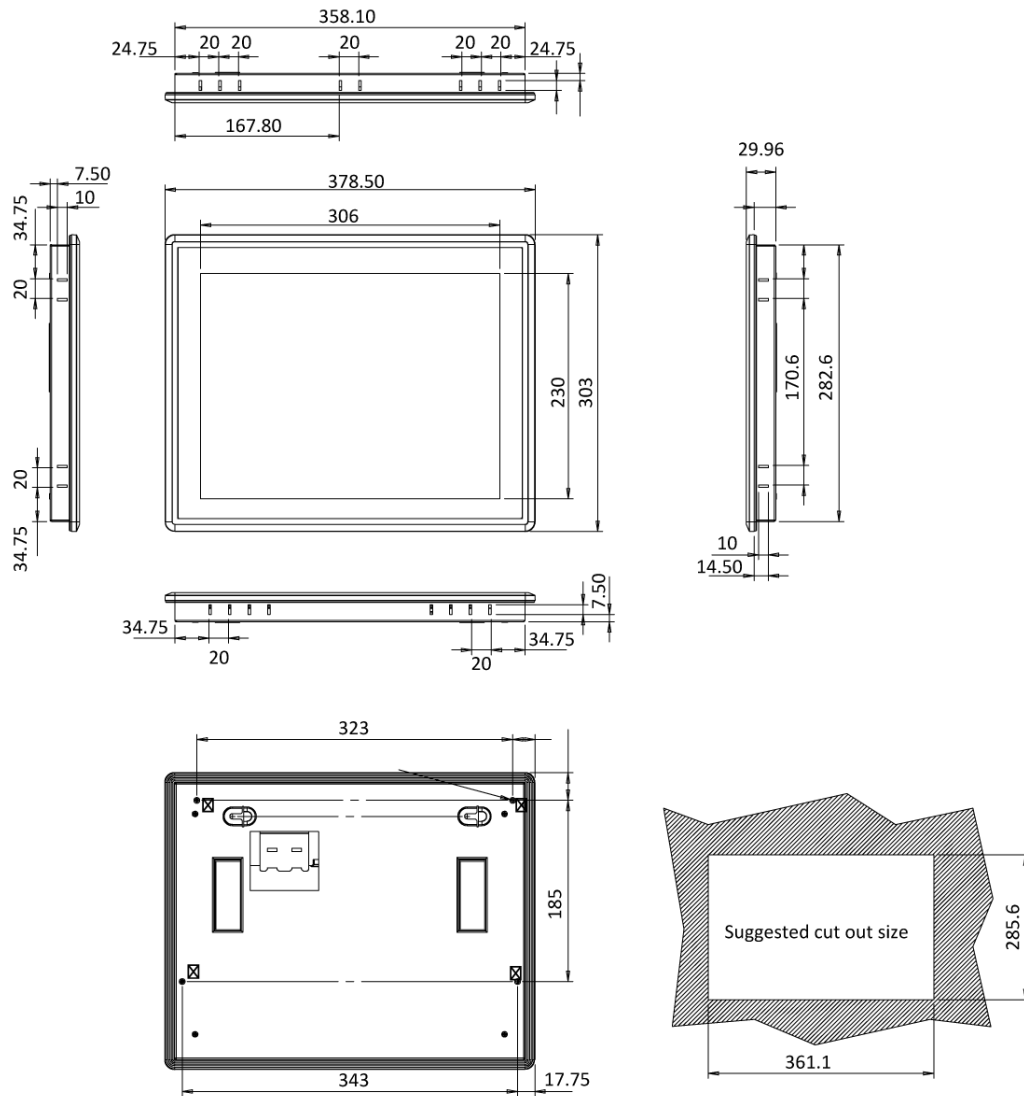

FLEX-PLKIT-F15 Dimensions (mm)

E.2 FLEX-PLKIT-FW15

The dimensions of the FLEX-PLKIT-FW15 are listed below.

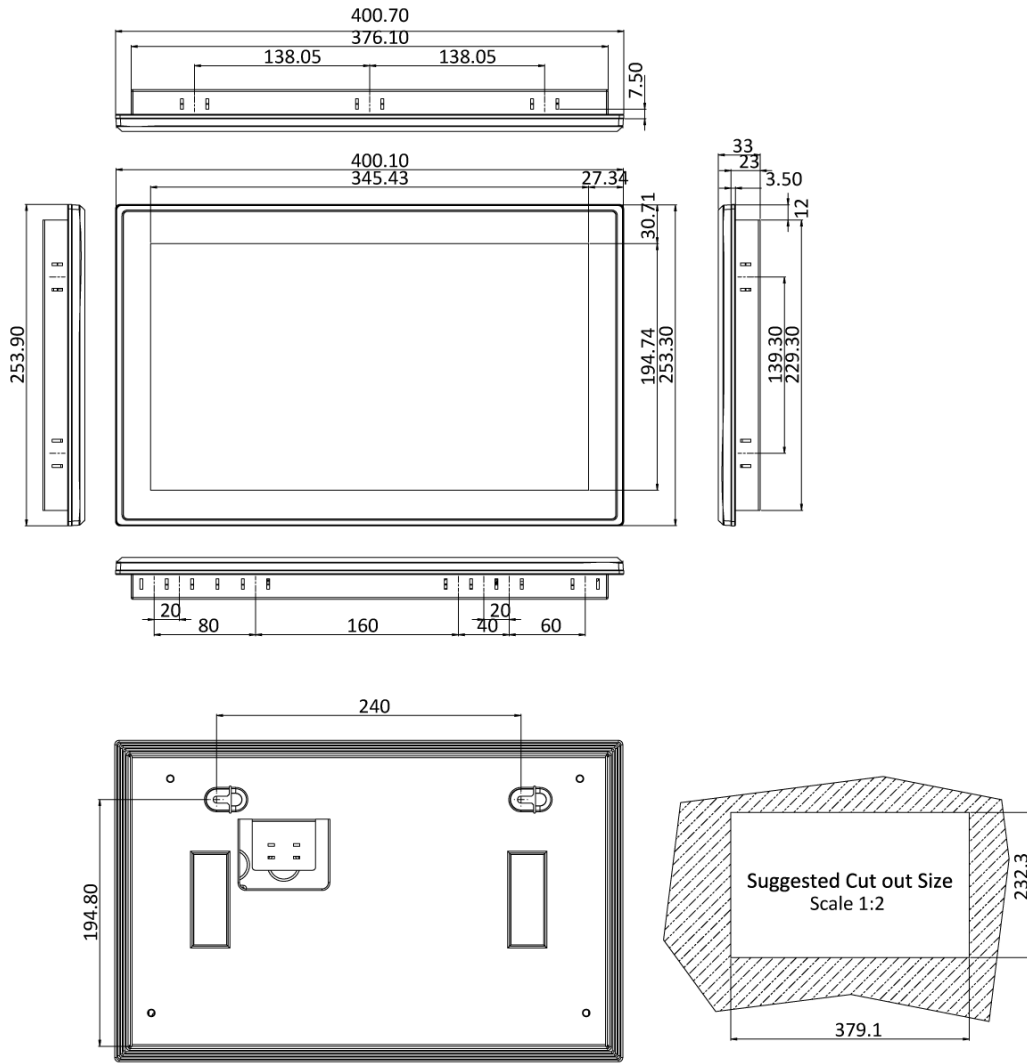

FLEX-PLKIT-FW15 Dimensions (mm)

FLEX-BX200-Q370

E.3 FLEX-PLKIT-F17

The dimensions of the FLEX-PLKIT-F17 are listed below.

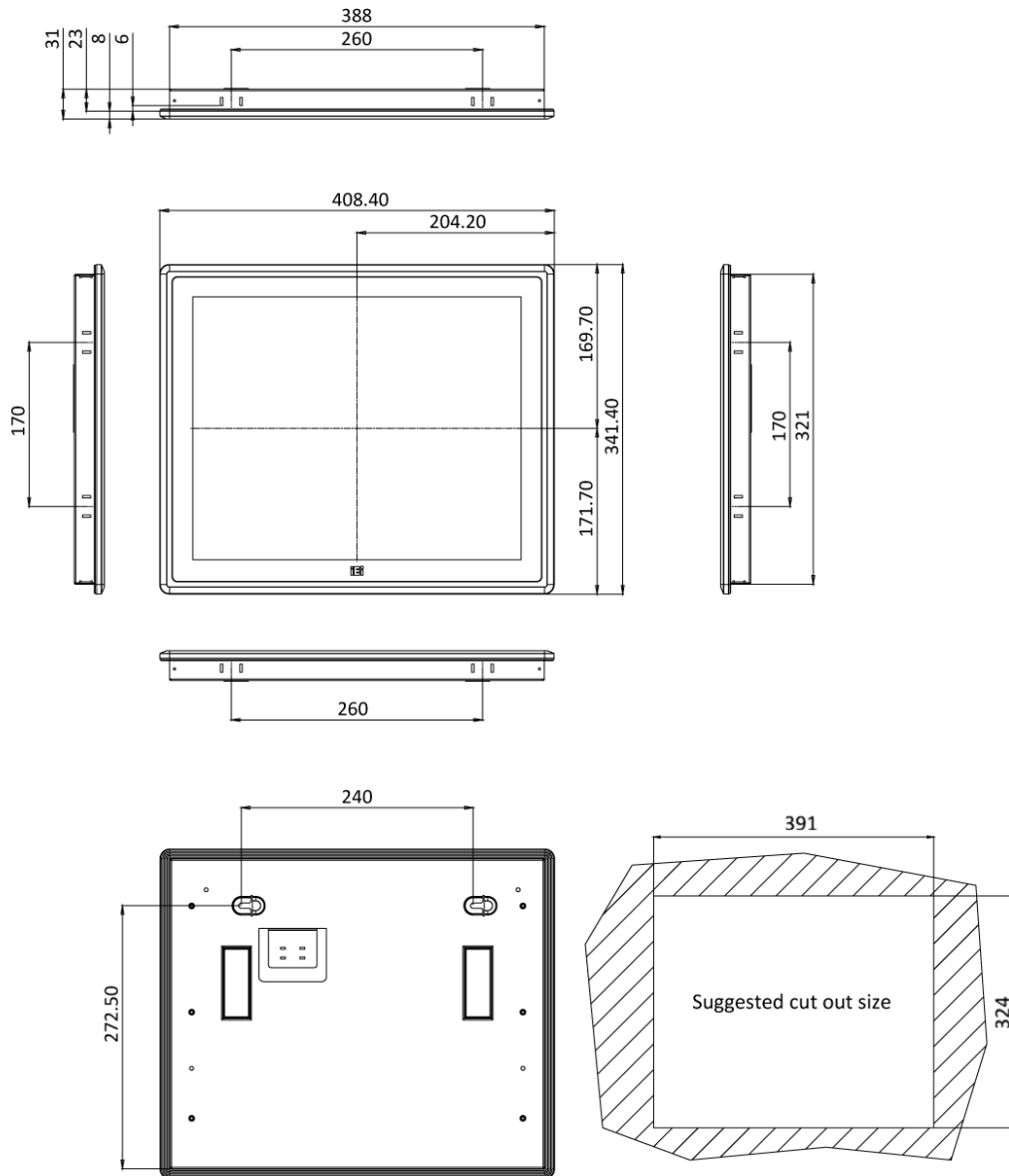

FLEX-PLKIT-F17 Dimensions (mm)

E.4 FLEX-PLKIT-FW19

The dimensions of the FLEX-PLKIT-FW19 are listed below.

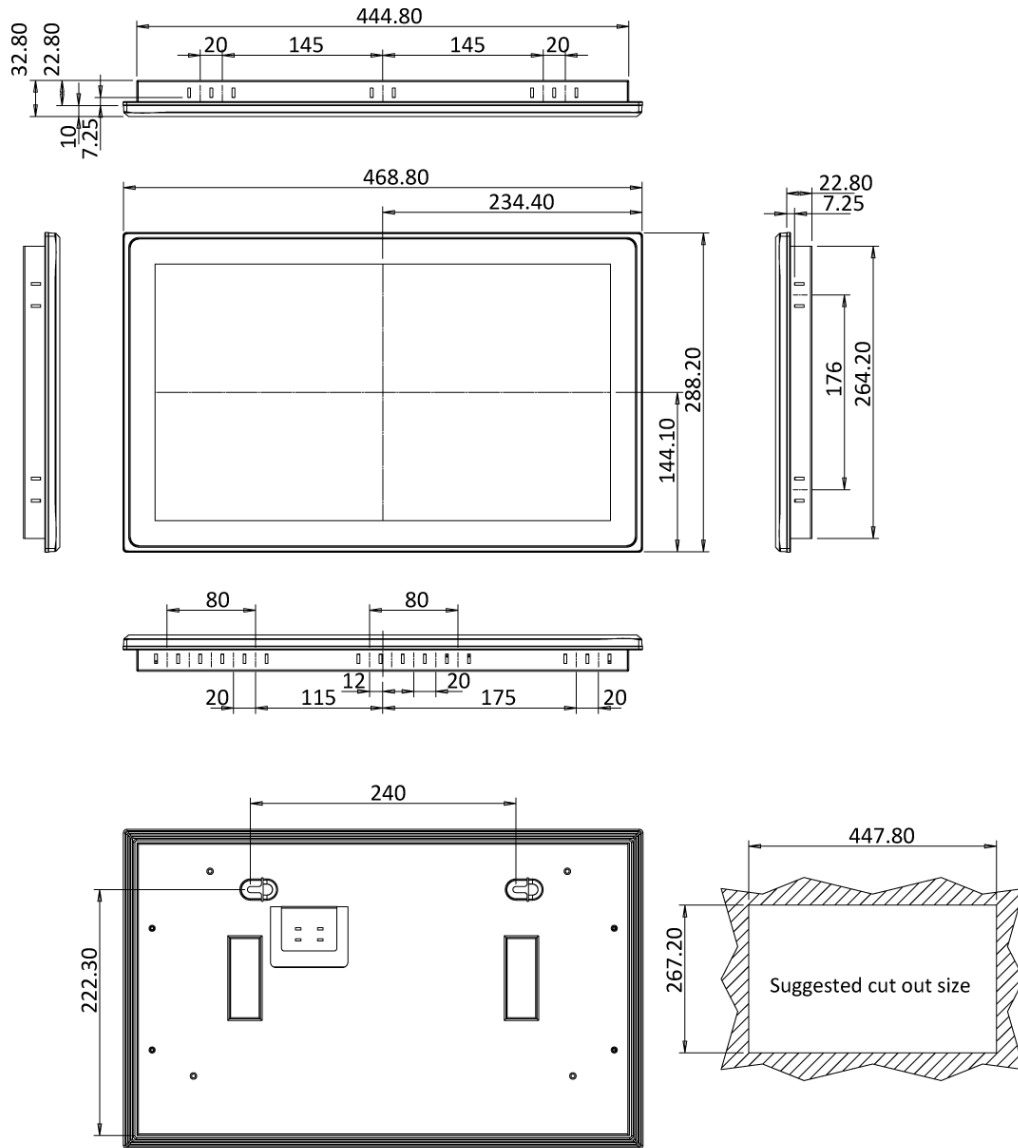

FLEX-PLKIT-FW19 Dimensions (mm)

FLEX-BX200-Q370

E.5 FLEX-PLKIT-FW22

The dimensions of the FLEX-PLKIT-FW22 are listed below.

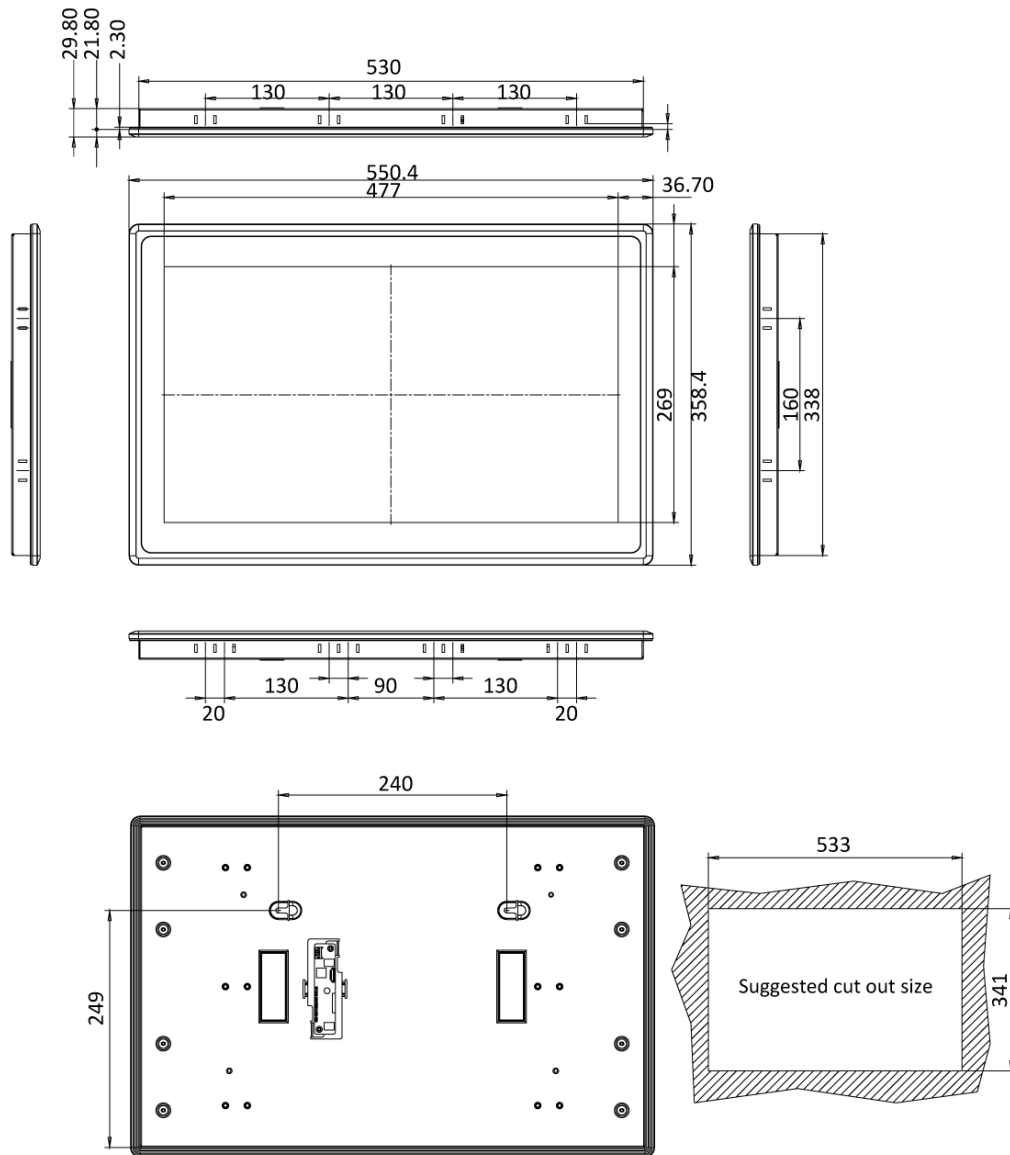

FLEX-PLKIT-FW22 Dimensions (mm)

E.6 FLEX-PLKIT-FW24

The dimensions of the FLEX-PLKIT-FW24 are listed below.

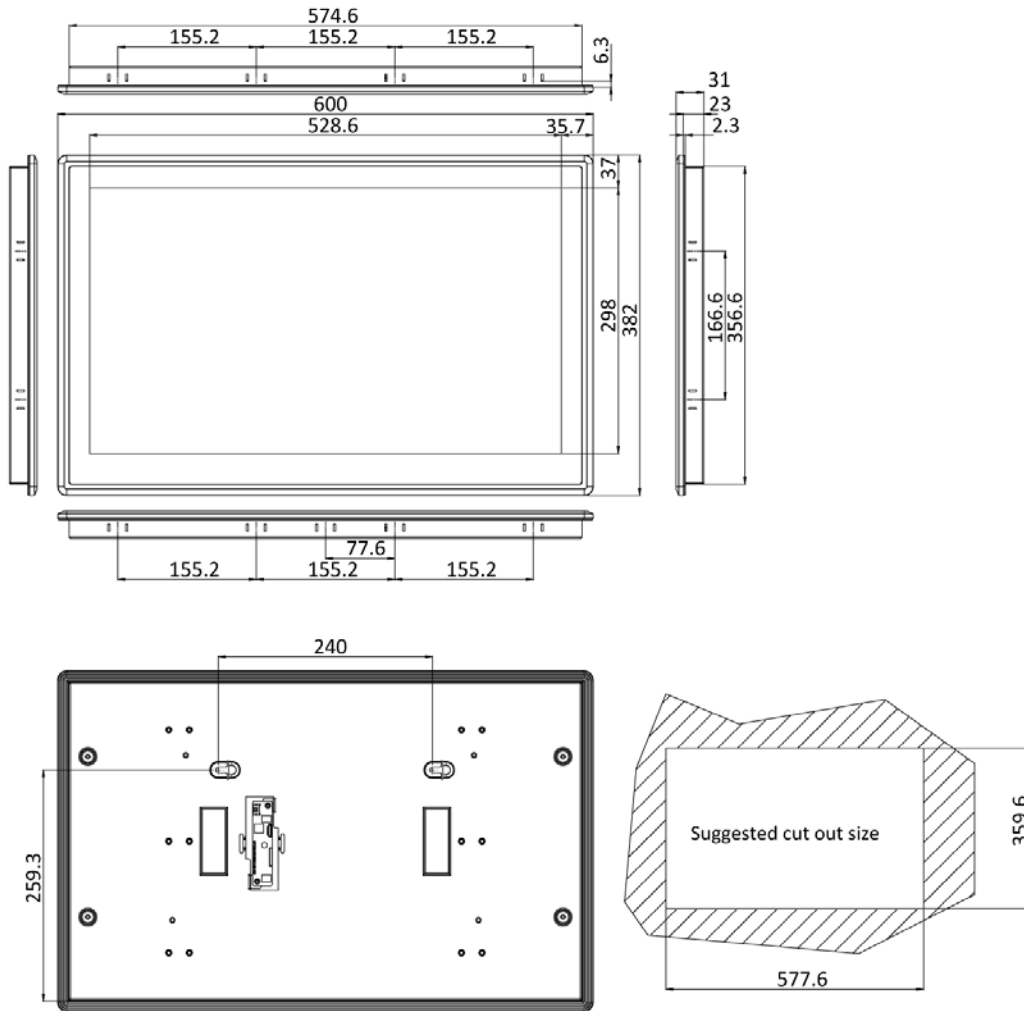

FLEX-PLKIT-FW24 Dimensions (mm)

Appendix

F

Hazardous Materials Disclosure

The details provided in this appendix are to ensure that the product is compliant with the Peoples Republic of China (China) RoHS standards. The table below acknowledges the presences of small quantities of certain materials in the product, and is applicable to China RoHS only.

A label will be placed on each product to indicate the estimated “Environmentally Friendly Use Period” (EFUP). This is an estimate of the number of years that these substances would “not leak out or undergo abrupt change.” This product may contain replaceable sub-assemblies/components which have a shorter EFUP such as batteries and lamps. These components will be separately marked.

Please refer to the following table.

Part Name	Toxic or Hazardous Substances and Elements					
	Lead (Pb)	Mercury (Hg)	Cadmium (Cd)	Hexavalent Chromium (CR(VI))	Polybrominated Biphenyls (PBB)	Polybrominated Diphenyl Ethers (PBDE)
Housing	O	O	O	O	O	O
Display	O	O	O	O	O	O
Printed Circuit Board	O	O	O	O	O	O
Metal Fasteners	O	O	O	O	O	O
Cable Assembly	O	O	O	O	O	O
Fan Assembly	O	O	O	O	O	O
Power Supply Assemblies	O	O	O	O	O	O
Battery	O	O	O	O	O	O

O: This toxic or hazardous substance is contained in all of the homogeneous materials for the part is below the limit requirement in SJ/T11363-2006 (now replaced by GB/T 26572-2011).

X: This toxic or hazardous substance is contained in at least one of the homogeneous materials for this part is above the limit requirement in SJ/T11363-2006 (now replaced by GB/T 26572-2011).

FLEX-BX200-Q370

此附件旨在确保本产品符合中国 RoHS 标准。以下表格标示此产品中某有毒物质的含量符合中国 RoHS 标准规定的限量要求。

本产品上会附有“环境友好使用期限”的标签，此期限是估算这些物质“不会有泄漏或突变”的年限。本产品可能包含有较短的环境友好使用期限的可替换元件，像是电池或灯管，这些元件将会单独标示出来。

部件名称	有毒有害物质或元素					
	铅 (Pb)	汞 (Hg)	镉 (Cd)	六价铬 (CR(VI))	多溴联苯 (PBB)	多溴二苯 醚 (PBDE)
壳体	○	○	○	○	○	○
显示	○	○	○	○	○	○
印刷电路板	○	○	○	○	○	○
金属螺帽	○	○	○	○	○	○
电缆组装	○	○	○	○	○	○
风扇组装	○	○	○	○	○	○
电力供应组装	○	○	○	○	○	○
电池	○	○	○	○	○	○

○: 表示该有毒有害物质在该部件所有物质材料中的含量均在 SJ/T 11363-2006 (现由 GB/T 26572-2011 取代) 标准规定的限量要求以下。

X: 表示该有毒有害物质至少在该部件的某一均质材料中的含量超出 SJ/T 11363-2006 (现由 GB/T 26572-2011 取代) 标准规定的限量要求。