

NANO-SE-i1/KBN-i1/GLX

EPIC SBC supports AMD® Embedded G-Series SoC with VGA/HDMI/LVDS, Dual PCIe GbE, USB 3.2 Gen 1 (5Gb/s), PCIe Mini, SATA 6Gb/s, mSATA, COM, iRIS-1010 and RoHS

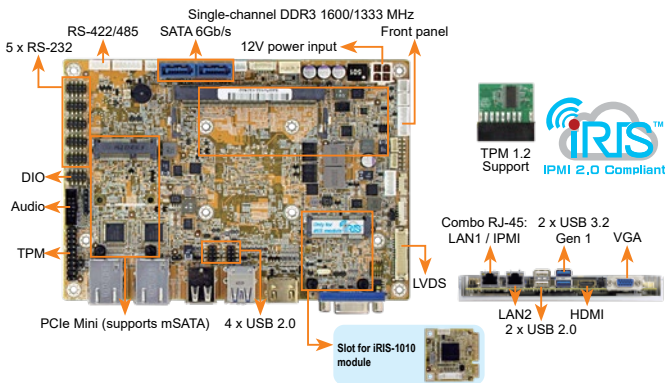

Specifications

- ◆ SoC
 - » AMD® Embedded G-Series "SteppE Eagle" SoC GX-424CC on-board Soc (2.4GHz, quad-core, 2MB cache, TDP=25W)
 - » AMD® Embedded G-Series "eKabini" SoC GX-415GA on-board Soc (1.5GHz, quad-core, 2MB cache, TDP=15W)
 - » AMD® Embedded G-Series "LX" SoC GX-210KL on-board Soc (1.0GHz, dual-core, 1MB cache, TDP=4.5W)
- ◆ BIOS: AMI UEFI BIOS
- ◆ Memory: One 204-pin 1600/1333 MHz single-channel DDR3 & DDR3L SDRAM unbuffered SO-DIMM slot supports up to 8 GB
- ◆ Graphics Engine
 - Support DX11.1, OpenGL 4.1 and OpenCL 1.2
 - UV/D.2 decode for H.264, MPEG2/4, VC1, MVC
 - VCE 2.0 encode for H.264, VCE
- ◆ Display Output
 - Dual independent display
 - 1 x VGA (up to 2048x1536@60Hz)
 - 1 x HDMI (up to 3840x2160@60Hz)
 - 1 x 18/24-bit dual-channel LVDS (up to 1920x1200@60Hz)
- ◆ LAN LED: 2 x LAN LED (1x2 pin)
- ◆ Ethernet
 - LAN1: Intel® I210-AT PCIe controller with NCSI support
 - LAN2: Intel® I211-AT PCIe controller
- ◆ iRIS Remote Management Module
 - 1 x iRIS-1010 slot (NANO-GLX-2101-R10 support by request)
- ◆ External I/O Interface
 - 2 x USB 2.0
 - 2 x USB 3.2 Gen 1 (5Gb/s)
- ◆ Internal I/O Interface
 - 1 x KB/MS (1x6 pin)
 - 4 x USB 2.0 (2x4 pin, P=2.0)
 - 1 x RS-422/485 (1x4 pin, P=2.0)
 - 5 x RS-232 (2x5 pin, P=2.0)
 - 2 x SATA 6Gb/s with 5V SATA power connector (no RAID)
- ◆ TPM: 1 x TPM (2x10 pin)
- ◆ SMBus: 1 x SMBus (1x4 pin)
- ◆ I²C: 1 x I²C (1x4 pin)
- ◆ Audio
 - Realtek ALC892 HD Audio codec
 - 1 x Front audio (2x5 pin)
 - 1 x S/PDIF (1x4 pin)
- ◆ Front Panel
 - 1 x Power LED & HDD LED (1x6 pin)
 - 1 x Power button (1x2 pin)
 - 1 x Reset button (1x2 pin)
- ◆ Expansion: 1 x Full-size PCIe Mini card slot (supports mSATA co-lay SATA port 2)
- ◆ Watchdog Timer: Software programmable, support 1~255 sec. system reset
- ◆ Digital I/O: 8-bit digital I/O (2x5 pin)
- ◆ Fan Connector: 1 x System smart fan (1x4 pin)
- ◆ Power Supply: 12V only DC input
- 1 x Internal power connector (2x2 pin) Support AT/ATX mode
- ◆ Power Consumption
 - 12V@1.02A (AMD GX-415GA 1.5GHz CPU with 1600 MHz 8 GB DDR3 memory)
- ◆ Operating Temperature: 0°C ~ 60°C
- ◆ Storage Temperature: -10°C ~ 70°C
- ◆ Operating Humidity: 5% ~ 95%, non-condensing
- ◆ Dimensions: 115mm x 165mm
- ◆ Weight: GW: 850g / NW: 350g
- ◆ CE/FCC compliant

Packing List

1 x NANO-KBN/SE-i1 single board computer with heatspreader	1 x Audio cable
2 x RS-232 cable	1 x Power cable
2 x SATA with power cable kit	1 x QIG

Ordering Information

Part No.	Description
NANO-SE-i1-4241-R10	EPIC SBC supports AMD® 28nm quad core GX-424CC 2.4GHz (25W) on-board SoC with VGA/HDMI/LVDS, Dual PCIe GbE, USB 3.2 Gen 1 (5Gb/s), Dual PCIe Mini, SATA 6Gb/s, mSATA, COM and Audio, iRIS-1010 and RoHS
NANO-KBN-i1-4151-R10	EPIC SBC supports AMD® 28nm quad-core GX-415GA 1.5GHz (15W) on-board SoC with VGA/HDMI/LVDS, Dual PCIe GbE, USB 3.2 Gen 1 (5Gb/s), PCIe Mini, SATA 6Gb/s, mSATA, COM, iRIS-1010, HD Audio and RoHS
NANO-GLX-2101-ECO-R10	EPIC SBC supports AMD® 28nm dual core GX-210KL 1.0GHz (4.5W) on-board SoC with VGA/HDMI/LVDS, Dual PCIe GbE, USB 3.2 Gen 1 (5Gb/s), Dual PCIe Mini, SATA 6Gb/s, mSATA, COM and Audio, ECO packing and RoHS (10 pcs/pack)
iRIS-1010-R10	IPMI 2.0 adapter card with AST1010 BMC chip (w/o KVM over IP function) for PCIe Mini socket interface
32001-008600-200-RS	Dual-port USB cable, 210mm, P=2.0
32006-001100-201-RS	PS/2 KB/MS cable, 135mm/110mm, P=2.0
32205-003800-300-RS	RS-422/485 cable, 200mm, P=2.0
TPM-IN01-R20	20-pin Infineon TPM module, software management tool, firmware v3.17

Note: Models with other CPUs not listed in the table are requested by MOQ - 100 pcs/lot.

NANO-QM871-i1

EPIC SBC supports 4th Generation Intel® Mobile Processor with VGA/Dual HDMI/LVDS, Dual PCIe GbE, USB 3.2 Gen 1 (5Gb/s), PCIe Mini, iRIS-1010

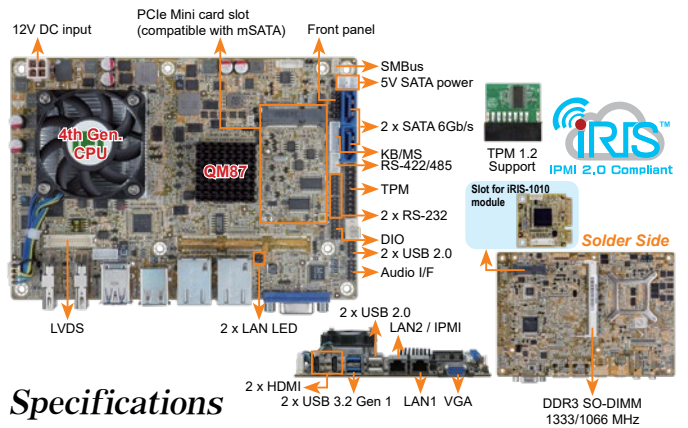

Specifications

- ◆ CPU
 - Intel® mobile Core™ i7-4700EQ on-board processor with Intel® AMT 9.0 support (2.4GHz, quad-core, 6MB cache, TDP=47W)
 - Intel® mobile Core™ i5-4400E on-board processor with Intel® AMT 9.0 support (2.7GHz, dual-core, 3MB cache, TDP=37W)
 - Intel® mobile Core™ i3-4100E on-board processor (2.4GHz, dual-core, 3MB cache, TDP=37W)
 - Intel® mobile Celeron® 2000E on-board processor (2.2GHz, dual-core, 2MB cache, TDP=37W)
 - Intel® mobile Core™ i5-4402E on-board processor with Intel® AMT 9.0 support (1.6GHz, dual-core, 3MB cache, TDP=25W)
 - Intel® mobile Core™ i3-4102E on-board processor (1.5GHz, dual-core, 2MB cache, TDP=25W)
 - Intel® mobile Celeron® 2002E on-board processor (1.5GHz, dual-core, 2MB cache, TDP=25W)
- ◆ Chipset: Intel® QM87
- ◆ BIOS: UEFI BIOS
- ◆ Memory: One 204-pin 1600/1333 MHz dual-channel DDR3 & DDR3L SDRAM unbuffered DIMM supports up to 8 GB
- ◆ Graphics Engine
 - Intel® HD Graphics Gen 7.5 supports DX11.1 and OpenCL 1.2, OpenGL 3.2 Full MPEG2, VC1, AVC Decode
- ◆ Display Output
 - 1 x VGA (up to 1920x1200@60Hz)
 - 1 x 18/24-bit dual-channel LVDS (up to 1920x1200@60Hz)
 - 2 x HDMI (up to 2500x1600@60Hz)
- ◆ TPM: 1 x TPM connector (2x10 pin)
- ◆ SMBus: 1 x SMBus (1x4 pin)
- ◆ Ethernet
 - LAN1: Intel® I217-LM PHY with Intel® AMT 9.0 support
 - LAN2: Intel® I210-AT PCIe controller
- ◆ External I/O Interface
 - 2 x USB 2.0
 - 2 x USB 3.2 Gen 1 (5Gb/s)
- ◆ Internal I/O Interface
 - 1 x KB/MS (1x6 pin)
 - 1 x RS-422/485 (1x4 pin, P=2.0)
 - 2 x RS-232 (2x5 pin, P=2.0)
 - 2 x SATA 6Gb/s with 5V SATA power connector (RAID 0,1 supported)
 - 2 x USB 2.0 (2x4 pin, P=2.0)
- ◆ iRIS Remote Management Module: 1 x iRIS-1010 slot
- ◆ Audio
 - Realtek ALC662 HD Audio codec
 - 1 x Front audio (2x5 pin)
- ◆ Front Panel: 1 x Front Panel (2x5 pin)
- ◆ LAN LED: 2 x LAN LED (1x2 pin)
- ◆ Expansion
 - 1 x Full-size PCIe Mini card slot (supports mSATA)
 - 1 x PCIe/104 Type 2 slot (optional)
- ◆ Watchdog Timer: Software programmable, support 1~255 sec. system reset
- ◆ Digital I/O: 8-bit digital I/O (2x5 pin)
- ◆ Fan Connector
 - 1 x CPU smart fan (1x4 pin)
 - 1 x System smart fan (1x4 pin)
- ◆ Power Supply
 - 12V only DC input
 - 1 x Internal power connector (2x2 pin) Support AT/ATX mode
- ◆ Power Consumption
 - 12V@4.78A (Intel® Core™ i7-4770EQ 2.4GHz CPU with 4 GB 1333 MHz DDR3 memory)
- ◆ Operating Temperature: -10°C ~ 60°C
- ◆ Storage Temperature: -20°C ~ 60°C
- ◆ Operating Humidity: 5% ~ 95%, non-condensing
- ◆ Dimensions: 115 mm x 165 mm
- ◆ Weight: GW: 850g / NW: 350g
- ◆ CE/FCC compliant

Packing List

1 x NANO-QM871-i1 single board computer	
1 x Audio cable	2 x RS-232 cable
1 x CPU cooler	2 x SATA with power cable kit
1 x Power cable	1 x QIG

Ordering Information

Part No.	Description
NANO-QM871-i1-i7-R10	EPIC SBC supports Intel® 22nm Mobile Core™ i7-4700EQ on-board Processor with VGA/Dual HDMI/LVDS, Dual PCIe GbE, AMT 9.0, PCIe Mini, USB 3.2 Gen 1 (5Gb/s), SATA 6Gb/s, iRIS-1010, Audio and RoHS
NANO-QM871-i1-i5-R10	EPIC SBC supports Intel® 22nm Mobile Core™ i5-4400E on-board Processor with VGA/Dual HDMI/LVDS, Dual PCIe GbE, AMT 9.0, PCIe Mini, USB 3.2 Gen 1 (5Gb/s), SATA 6Gb/s, iRIS-1010, Audio and RoHS
NANO-QM871-i1-i3-R10	EPIC SBC supports Intel® 22nm Mobile Core™ i3-4100E on-board Processor with VGA/Dual HDMI/LVDS, Dual PCIe GbE, PCIe Mini, USB 3.2 Gen 1 (5Gb/s), SATA 6Gb/s, iRIS-1010, Audio and RoHS
NANO-QM871-i1-C-R10	EPIC SBC supports Intel® 22nm Celeron 2000E on-board Processor (37W) with VGA/Dual HDMI/LVDS, Dual PCIe GbE, PCIe Mini, USB 3.2 Gen 1 (5Gb/s), SATA 6Gb/s, iRIS-1010, Audio and RoHS
iRIS-1010-R10	IPMI 2.0 adapter card with AST1010 BMC chip (W/O KVM over IP function) for PCIe Mini socket interface
32001-008600-200-RS	Dual-port USB 2.0 cable, 210mm, P=2.0
32006-001100-201-RS	PS/2 KB/MS cable, 135mm/110mm, P=2.0
32205-003800-300-RS	RS-422/485 cable, 200mm, P=2.0
TPM-IN01-R20	20-pin Infineon TPM module, software management tool, firmware v3.17

Note: Models with other CPUs not listed in the table are requested by MOQ - 100 pcs/lot.