



MODEL:
S19M/S24M

**19"/24" Marine Monitor with AC and DC Redundant Power,
Projected Capacitive Touchscreen, IP 66 Compliant
Front Panel and IP 22 Compliant Rear Cover**

User Manual

Revision

Date	Version	Changes
February 21, 2018	1.01	Added some notes
November 27, 2015	1.00	Initial release

Copyright

COPYRIGHT NOTICE

The information in this document is subject to change without prior notice in order to improve reliability, design and function and does not represent a commitment on the part of the manufacturer.

In no event will the manufacturer be liable for direct, indirect, special, incidental, or consequential damages arising out of the use or inability to use the product or documentation, even if advised of the possibility of such damages.

This document contains proprietary information protected by copyright. All rights are reserved. No part of this manual may be reproduced by any mechanical, electronic, or other means in any form without prior written permission of the manufacturer.

TRADEMARKS

All registered trademarks and product names mentioned herein are used for identification purposes only and may be trademarks and/or registered trademarks of their respective owners.

Manual Conventions

**WARNING**

Warnings appear where overlooked details may cause damage to the equipment or result in personal injury. Warnings should be taken seriously.

**CAUTION**

Cautionary messages should be heeded to help reduce the chance of losing data or damaging the product.

**NOTE**

These messages inform the reader of essential but non-critical information. These messages should be read carefully as any directions or instructions contained therein can help avoid making mistakes.

**HOT SURFACE**

This symbol indicates a hot surface that should not be touched without taking care.

Table of Contents

1 INTRODUCTION.....	1
1.1 OVERVIEW.....	2
1.2 MODEL VARIATIONS.....	2
1.3 FEATURES.....	3
1.4 FRONT PANEL.....	3
1.4.1 <i>Display Control Buttons</i>	4
1.5 BOTTOM PANEL.....	4
1.6 REAR PANEL.....	5
1.7 SYSTEM SPECIFICATIONS.....	6
1.8 DIMENSIONS.....	9
2 UNPACKING.....	11
2.1 ANTI-STATIC PRECAUTIONS.....	12
2.2 UNPACKING PRECAUTIONS.....	12
2.3 PACKING LIST.....	13
2.4 OPTIONAL ITEMS.....	14
3 INSTALLATION.....	15
3.1 INSTALLATION PRECAUTIONS.....	16
3.2 MOUNTING THE MONITOR.....	16
3.2.1 <i>Panel Mounting</i>	17
3.2.2 <i>Stand Mounting</i>	19
3.3 I/O INTERFACES.....	20
3.3.1 <i>BNC Video Input and Output</i>	20
3.3.2 <i>Buzzer</i>	20
3.3.3 <i>DVI Inputs</i>	21
3.3.4 <i>Power Inputs</i>	21
3.3.5 <i>RJ-45 for Remote Control</i>	22
3.3.6 <i>RS-232 for Remote Control</i>	22
3.3.7 <i>RS-422/485 for Remote Control</i>	23
3.3.8 <i>USB for Touchscreen</i>	23

3.3.9 VGA Inputs.....	24
3.3.10 VGA Output.....	24
3.4 TURNING ON/OFF THE MARINE MONITOR	25
4 ON-SCREEN DISPLAY (OSD) CONTROLS.....	26
4.1 OSD CONTROL BUTTONS.....	27
4.2 OSD MENU STRUCTURE AND OPTIONS	28
5 IEI MONITOR REMOTE APPLICATION.....	31
5.1 OVERVIEW.....	32
5.2 LAUNCHING THE IEI MONITOR REMOTE APPLICATION	32
5.3 REMOTE CONTROL VIA RS-232.....	32
5.4 REMOTE CONTROL VIA RS-422/485.....	34
5.5 REMOTE CONTROL VIA LAN.....	35
A REGULATORY COMPLIANCE	37
B SAFETY PRECAUTIONS	42
B.1 SAFETY PRECAUTIONS.....	43
<i>B.1.1 General Safety Precautions</i>	43
<i>B.1.2 Anti-static Precautions</i>	44
<i>B.1.3 Product Disposal</i>	45
B.2 MAINTENANCE AND CLEANING PRECAUTIONS	45
<i>B.2.1 Maintenance and Cleaning</i>	45
<i>B.2.2 Cleaning Tools</i>	46
C HAZARDOUS MATERIALS DISCLOSURE	47

List of Figures

Figure 1-1: S19M/S24M Marine Monitor.....	2
Figure 1-2: Front Panel	3
Figure 1-3: Display Control Buttons	4
Figure 1-4: Bottom Panel	5
Figure 1-5: S19M Rear Panel	5
Figure 1-6: S24M Rear Panel	6
Figure 1-7: S19M Dimensions (mm).....	9
Figure 1-8: S24M Dimensions (mm).....	10
Figure 3-1: S19M Cutout Dimensions.....	17
Figure 3-2: S24M Cutout Dimensions.....	17
Figure 3-3: S24M Panel Mounting Hole Covers.....	18
Figure 3-4: Tighten the Panel Mounting Clamp Screws	19
Figure 3-5: I/O Interfaces	20
Figure 3-6: 18V ~ 36V DC Power Input Terminal Block Pinouts	21
Figure 3-7: USB Type A Connector Pinouts	23
Figure 4-1: OSD Button Locations.....	27
Figure 4-2: Main Menu.....	28
Figure 5-1: IEI Monitor Remote Application Screen.....	32
Figure 5-2: IEI Monitor Remote AP – RS-232	33
Figure 5-3: IEI Monitor Remote AP – RS-422/485	35
Figure 5-4: IEI Monitor Remote AP – LAN	36

List of Tables

Table 1-1: Model Variations	2
Table 1-2: System Specifications.....	8
Table 3-1: Panel Mounting Clamps	18
Table 3-2: Buzzer Terminal Block Pinouts	20
Table 3-3: DVI Input Connector Pinouts.....	21
Table 3-4: RJ-45 Connector Pinouts.....	22
Table 3-5: RS-232 Connector Pinouts	22
Table 3-6: RS-422/485 Terminal Block Pinouts	23
Table 3-7: VGA Output Connector Pinouts	24
Table 3-8: VGA Output Connector Pinouts	24
Table 4-1: OSD Control Buttons.....	27
Table 4-2: OSD Menu Structure and Options	30

Chapter

1

Introduction

1.1 Overview



Figure 1-1: S19M/S24M Marine Monitor

The S19M/S24M marine-grade monitor, equipped with IP 66 compliant front panel and IP 22 compliant rear cover, is the latest member of IEI's line of sophisticated LCD designs. With two VGA, two DVI and one BNC inputs, the S19M/S24M provides multiple ways to connect with computers. In addition, one VGA and one BNC outputs allow simultaneous display on other monitors.

1.2 Model Variations

The model numbers and model variations are listed below.

Model	LCD Size	Max. Resolution	Contrast Ratio
S19M-AD/PC-R10	19"	1280 x 1024 (5:4)	2000:1
S24M-AD/PC-R10	24"	1920 x 1080 (16:9)	5000:1

Table 1-1: Model Variations

S19M/S24M Marine Monitor

1.3 Features

Some of the S19M/S24M features are listed below:

- IP 66 compliant front panel and IP 22 compliant rear cover
- Flat-bezel projected capacitive touchscreen
- -15°C ~ 55°C wide range operating temperature
- Excellent visual performance
 - Full OSD function configuration
 - 0 to 100% full range dimming
 - 178°/178° wide viewing angles
- Multiple video inputs, including two VGA, two DVI and one BNC
- Multiple video outputs, including one VGA and one BNC
- Isolated AC and DC inputs with redundant power protection

1.4 Front Panel

The front side of the S19M/S24M (**Figure 1-2**) is a flat panel LCD screen surrounded by an aluminum frame. The bottom frame includes four OSD buttons and an ambient light sensor.

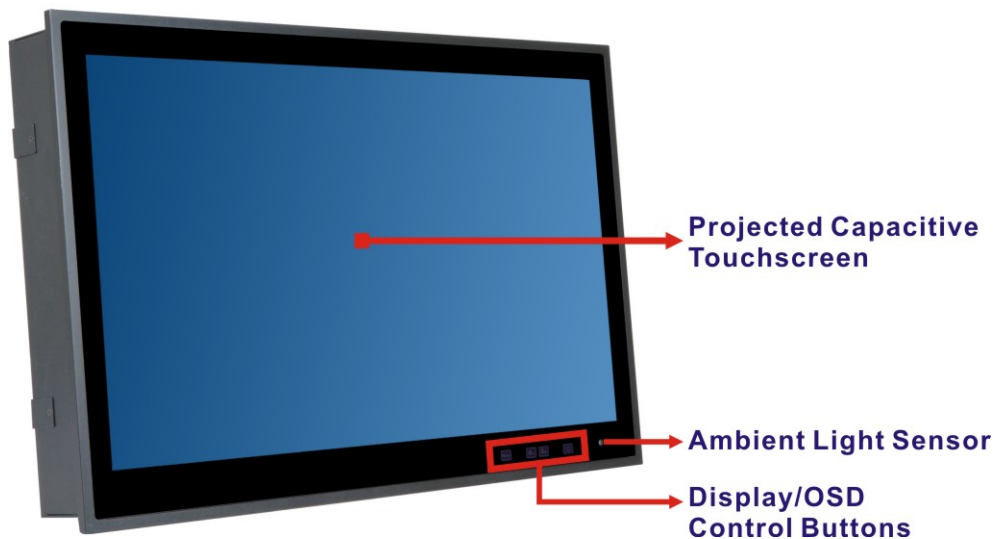

Figure 1-2: Front Panel

1.4.1 Display Control Buttons

The display control buttons are located on the bottom right corner of the front panel. The function of each button is described in the following diagram. These buttons can also be used to control OSD (on-screen display). Please refer to **Chapter 4** for more detail.

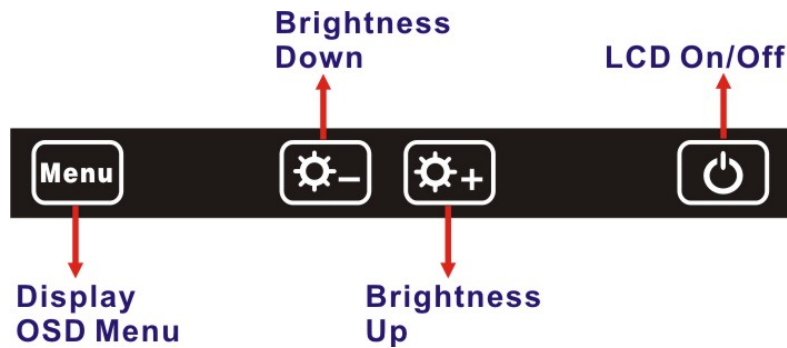

Figure 1-3: Display Control Buttons

1.5 Bottom Panel

The bottom panel of the S19M/S24M has the following I/O interfaces (**Figure 1-4**):

- 1 x 100 V ~ 240 V AC power input jack
- 1 x 18 V ~ 36 V DC power input terminal block
- 1 x Buzzer terminal block
- 1 x BNC composite video input connector
- 1 x BNC composite video output connector
- 2 x DVI input connectors
- 1 x RJ-45 connector for remote control
- 1 x RS-232 DB-9 connector for remote control
- 1 x RS-422/485 terminal block for remote control
- 1 x USB Type A connector for touchscreen
- 2 x VGA input connectors
- 1 x VGA output connector

S19M/S24M Marine Monitor

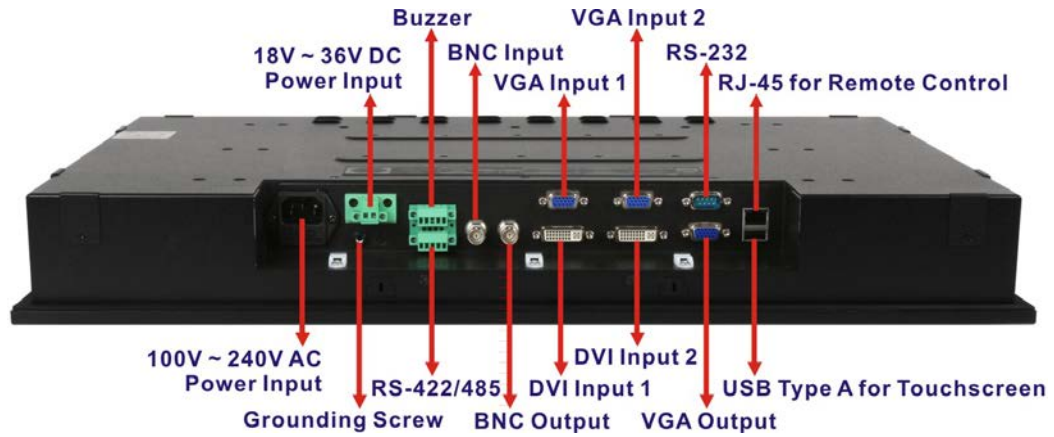

Figure 1-4: Bottom Panel

1.6 Rear Panel

The rear panel provides access to retention screw holes that support VESA mounting. See **Figure 1-5** and **Figure 1-6**.

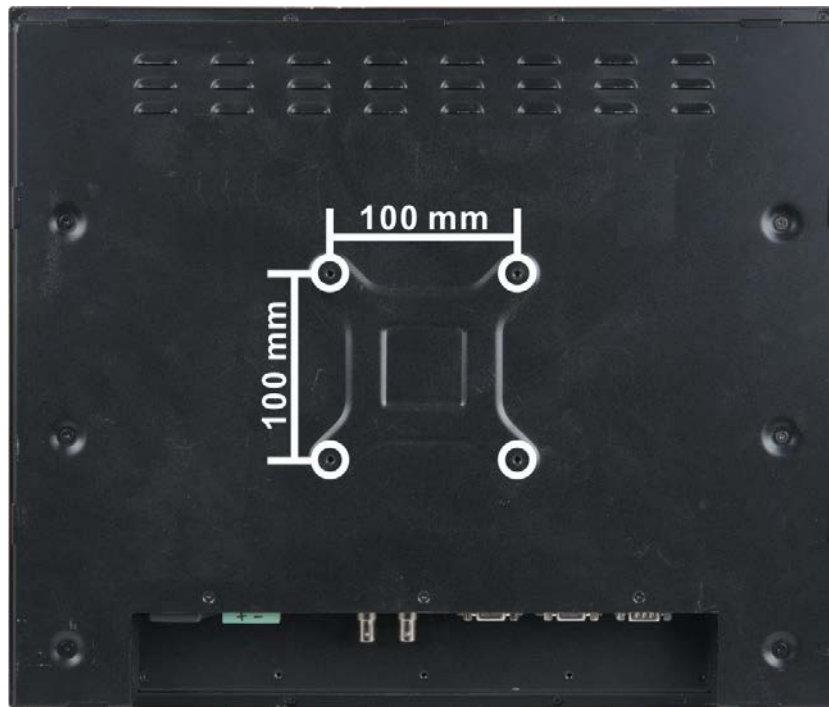

Figure 1-5: S19M Rear Panel

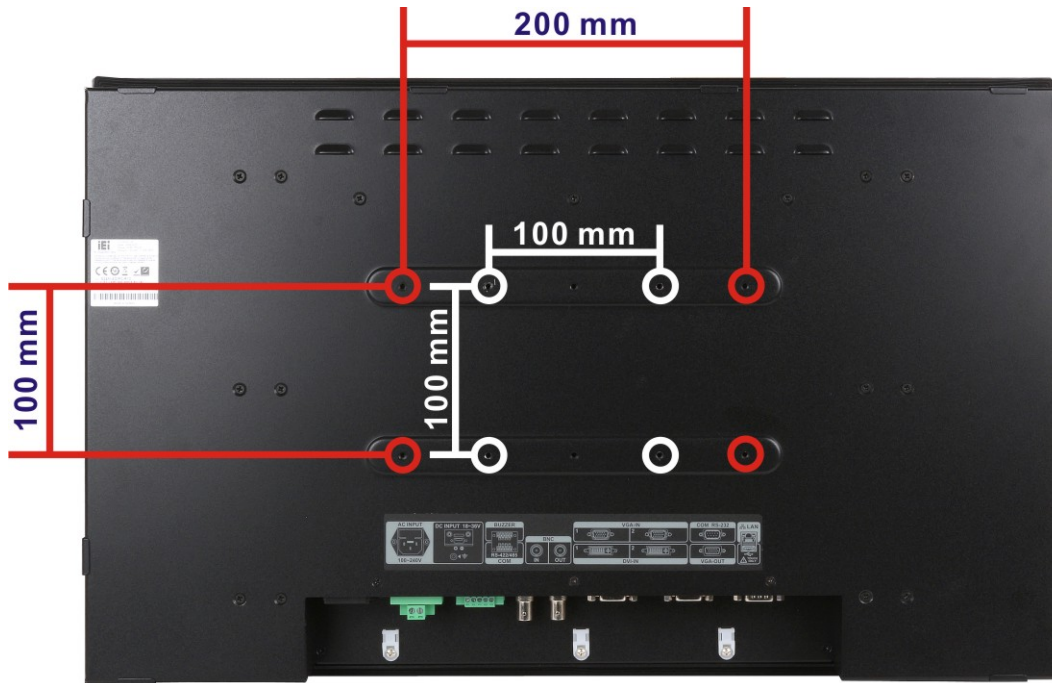

Figure 1-6: S24M Rear Panel

1.7 System Specifications

The technical specifications for the S19M/S24M are listed in **Table 1-2**.

Specifications	S19M	S24M
LCD Size	19"	24"
Panel Type	PMVA	AMVA
Max. Resolution	1280 x 1024 (5:4)	1920 x 1080 (16:9)
Contrast Ratio	2000:1	5000:1
Brightness (cd/m ²)	300	300
LCD Color	16.7M	16.7M
Pixel Pitch (um)	294 x 294	276.75 x 276.75
Viewing Angle (H-V)	178° / 178°	178° / 178°

S19M/S24M Marine Monitor

Specifications	S19M	S24M
Backlight MTBF (HRs)	50,000	50,000
Touch Controller	EXC3188 (10-point)	
Touchscreen	Projected capacitive type	
Scalar Chip	STDP8028	
I/O Interfaces	<p>DVI-D signal input: 2 x DVI (24-pin, female)</p> <p>VGA signal input: 2 x D-sub (15-pin, female)</p> <p>VGA signal output: 1 x D-sub (15-pin, female, clone of VGA input)</p> <p>Composite video input: 1 x BNC (female)</p> <p>Composite video output: 1 x BNC (female)</p> <p>Remote control: 1 x RS-232 DB-9 (non-isolated) 1 x RS-422/485 terminal block (5-pin, non-isolated) 1 x RJ-45</p> <p>Touchscreen: 1 x USB Type A (female)</p> <p>Isolated AC power inlet: 100 V ~ 240 V AC</p> <p>Isolated DC power input terminal block: 18 V ~ 36 V DC</p> <p>Buzzer: 1 x Buzzer (5-pin, terminal block)</p>	
PIP	Yes	
OSD Buttons	Four capacitive sensor buttons (menu, brightness down, brightness up, LCD on/off)	
Sensor	Ambient light sensor (0% ~ 100%)	
Power Requirement	<p>Dual power supply</p> <p>AC power: 100 V ~ 240 V, 2-1 A, 50-60 Hz</p> <p>DC power: 18 V ~ 36 V, 8-4 A (DNV-GL certified: 24 V, 6 A)</p>	
Operating Temperature	-15°C ~ 55°C	
Storage Temperature	-20°C ~ 60°C	

Specifications	S19M	S24M
Operating Humidity	5% ~ 95% RH	
Thermal Design	Fanless	
Housing	Aluminum front, sheet metal rear (Black C)	
Cut-out Dimensions (L x W)	442 mm x 373 mm	576 mm x 356 mm
Dimensions (L x W x D)	463 mm x 394 mm x 76 mm	592 mm x 374 mm x 74 mm
Mounting	VESA 100 mm x 100 mm	VESA 100 mm x 100 mm or 100 mm x 200 mm
Weight (Net/Gross)	7.74 kg/11.54 kg	11.48 kg/15.97 kg
IP Rating	IP 66 compliant front panel IP 22 compliant rear cover	
EMC	CE, FCC	
Safety	DNV, IEC 60945 4th, IACS-E10 compliant	

Table 1-2: System Specifications



NOTE:

- Auto-dimming function is not covered by DNV-GL certification (the function is disabled by default).
- Touch-screen function is not covered by DNV-GL certification.
- Not connected I/O ports need to be protected by protection caps (the S19M/S24M is shipped with all I/O ports protected by caps).

S19M/S24M Marine Monitor

1.8 Dimensions

The 19M dimensions are shown below.

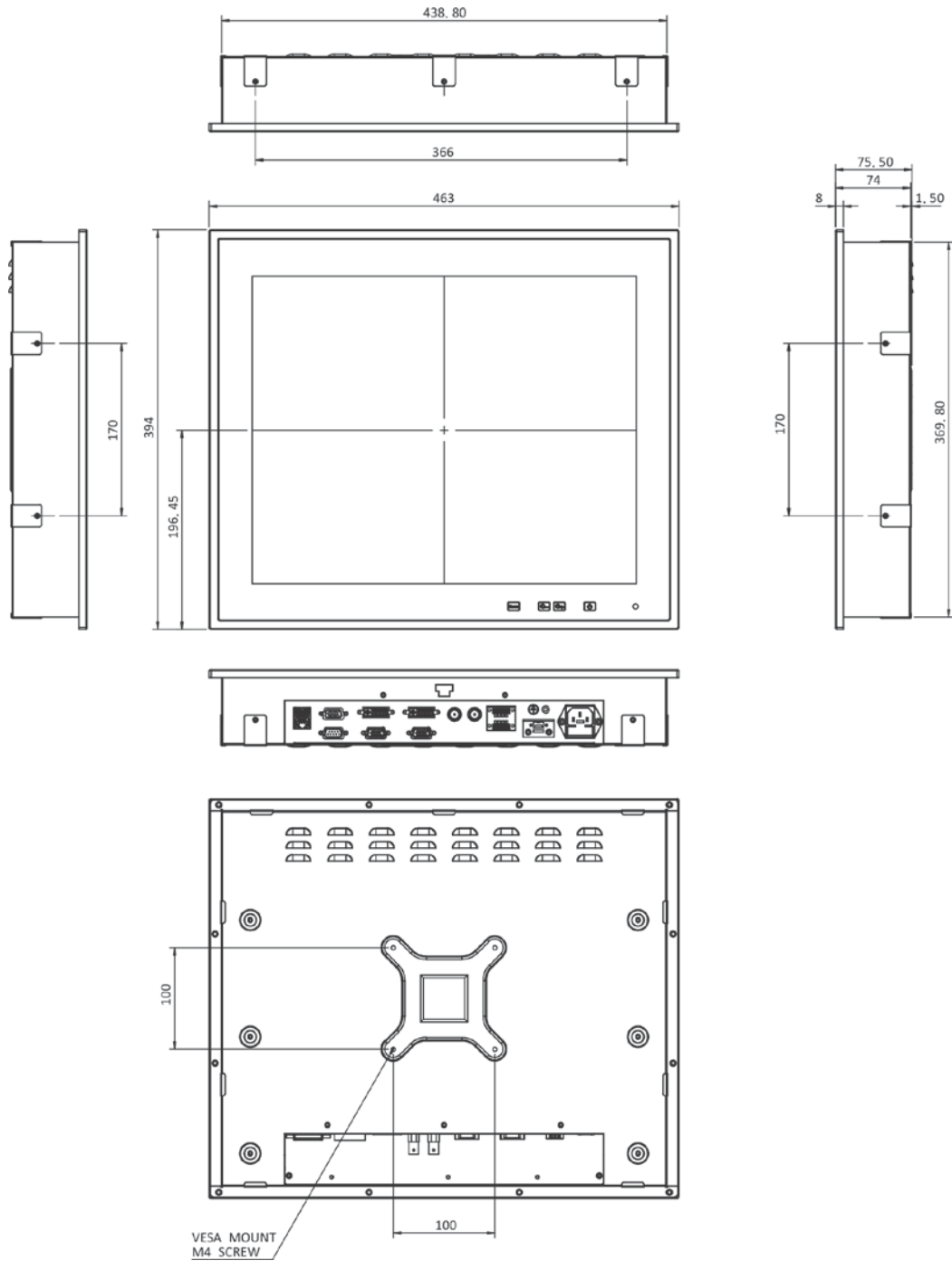

Figure 1-7: S19M Dimensions (mm)

The S24M dimensions are shown below.

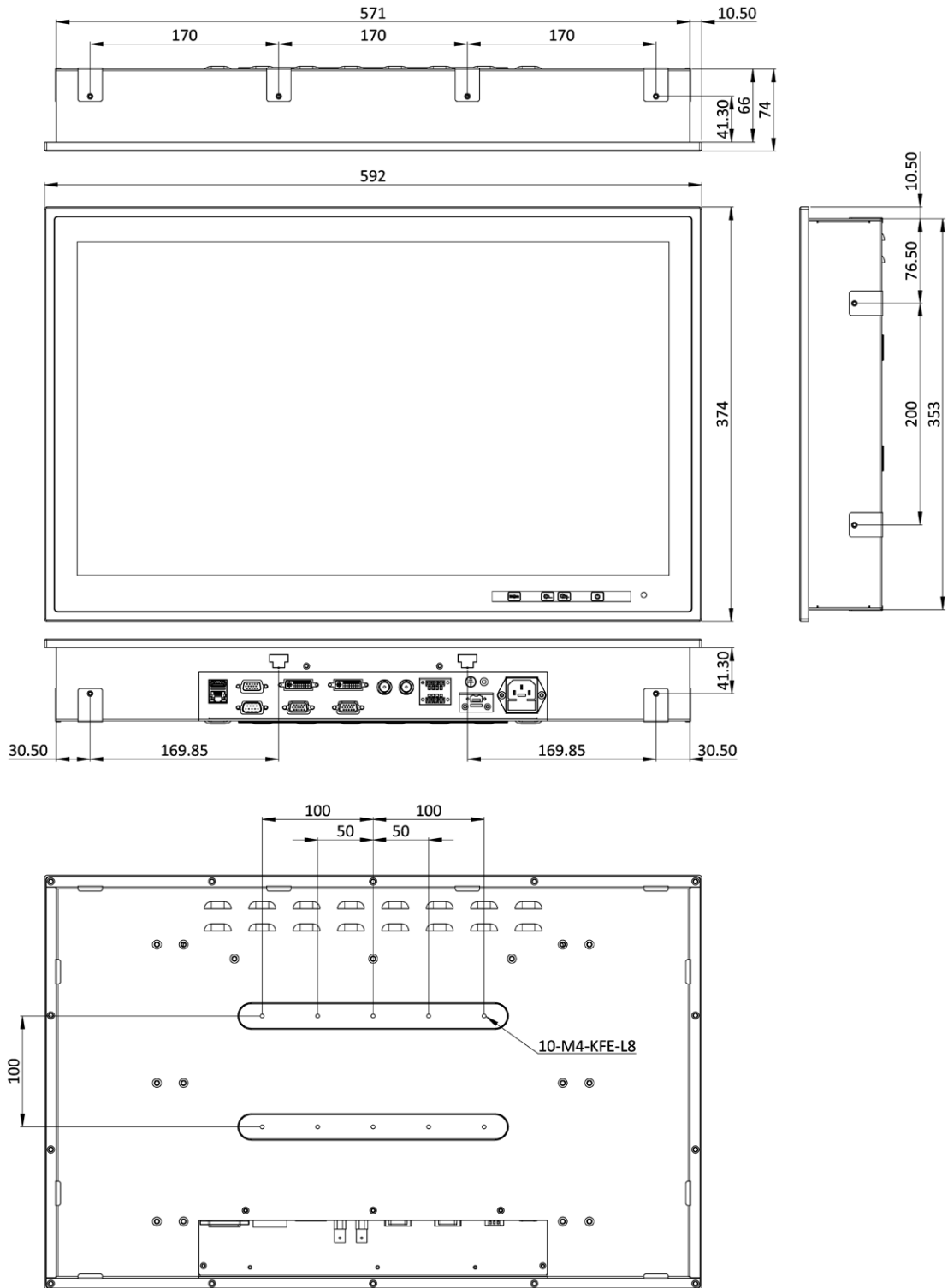

Figure 1-8: S24M Dimensions (mm)

Chapter

2

Unpacking

2.1 Anti-static Precautions



WARNING:

Failure to take ESD precautions during installation may result in permanent damage to the S19M/S24M and severe injury to the user.

Electrostatic discharge (ESD) can cause serious damage to electronic components, including the S19M/S24M. Dry climates are especially susceptible to ESD. It is therefore critical that whenever the S19M/S24M or any other electrical component is handled, the following anti-static precautions are strictly adhered to.

- **Wear an anti-static wristband:** Wearing a simple anti-static wristband can help to prevent ESD from damaging the board.
- **Self-grounding:** Before handling the board, touch any grounded conducting material. During the time the board is handled, frequently touch any conducting materials that are connected to the ground.
- **Use an anti-static pad:** When configuring the S19M/S24M, place it on an anti-static pad. This reduces the possibility of ESD damaging the S19M/S24M.

2.2 Unpacking Precautions

When the S19M/S24M is unpacked, please do the following:

- Follow the anti-static precautions outlined in **Section 2.1**.
- Make sure the packing box is facing upwards so the S19M/S24M does not fall out of the box.
- Make sure all the components shown in **Section 2.3** are present.

S19M/S24M Marine Monitor







2.3 Packing List



NOTE:



If any of the components listed in the checklist below are missing, do not proceed with the installation. Contact the IEI reseller or vendor the S19M/S24M was purchased from or contact an IEI sales representative directly by sending an email to sales@ieiworld.com.

The S19M/S24M marine monitor is shipped with the following components:

Quantity	Item	Image
1	S19M/S24M marine monitor	
1	VGA signal cable (P/N: 32000-036200-RS)	
1	DVI signal cable (P/N: 32000-086600-RS)	
1	Touchscreen USB cable (P/N: 32001-006100-200-RS)	
1	Power cord	
1	User manual and driver CD	

2.4 Optional Items

The following are optional components which may be separately purchased:

Item and Part Number	Image
Panel mounting kit (P/N: PK-S19M-R10) (P/N: PK-S24M-R10)	
Desktop stand (P/N: STAND-A21-R10)	

Chapter

3

Installation

3.1 Installation Precautions

When installing the marine monitor, please follow the precautions listed below:

- **Read the user manual:** The user manual provides a complete description of the S19M/S24M, installation instructions and configuration options.
- **Power turned off:** When installing the marine monitor, make sure the power is off. Failing to turn off the power may cause severe injury to the body and/or damage to the system.
- **Certified Engineers:** Only certified engineers should install and modify onboard functionalities.
- **Anti-static Discharge:** If a user open the rear panel of the marine monitor, to configure the jumpers or plug in added peripheral devices, ground themselves first and wear an anti-static wristband.

3.2 Mounting the Monitor



WARNING:

When mounting the S19M/S24M marine monitor onto a panel, it is better to have more than one person to help with the installation to make sure the S19M/S24M does not fall down and get damaged.

The following mounting methods are available:

- Panel mounting
- Stand mounting

The installation instructions are described in the following sub-sections. The mounting kits used in the following instructions can be purchased separately. Please contact IEI sales representatives for more detail.

S19M/S24M Marine Monitor

3.2.1 Panel Mounting

To mount the S19M/S24M marine monitor into a panel, please follow the steps below.

- Step 1:** Select the position on the panel to mount the S19M/S24M.
- Step 2:** Cut out a section of the panel that corresponds to the rear panel dimensions of the S19M/S24M. The recommended cutout sizes are shown below (**Figure 3-1** and **Figure 3-2**).

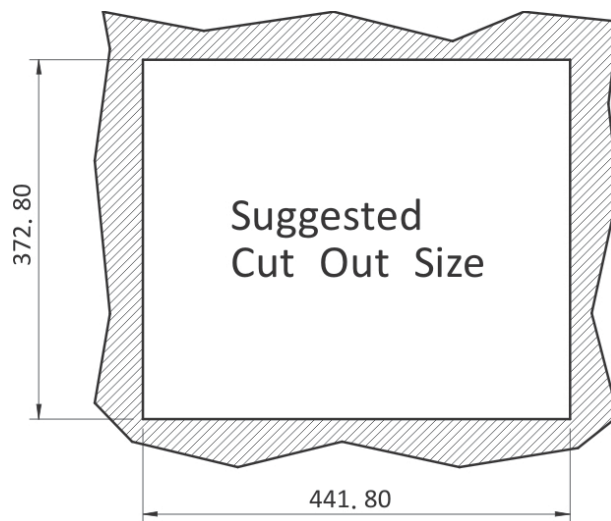

Figure 3-1: S19M Cutout Dimensions

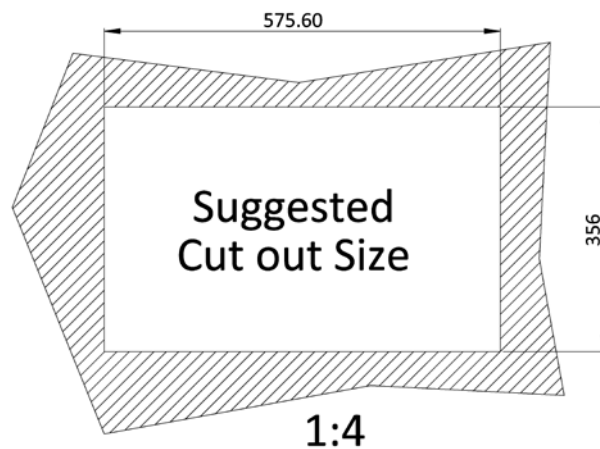

Figure 3-2: S24M Cutout Dimensions

Step 3: Remove the panel mounting hole covers from the rear panel. Each cover is secured to the rear panel with a retention screw. Remove the retention screw to remove the cover.



Figure 3-3: S24M Panel Mounting Hole Covers

Step 4: Slide the marine monitor through the hole until the aluminum frame is flush against the panel.

Step 5: Insert the panel mounting clamps into the pre-formed holes along the edges of the rear panel. The number of mounting clamps required to mount the marine monitor to a panel is listed below.

Model	Mounting Clamps
S19M	10
S24M	12

Table 3-1: Panel Mounting Clamps

Step 6: Tighten the screws that pass through the panel mounting clamps until the plastic caps at the front of all the screws are firmly secured to the panel (**Figure 3-4**).

S19M/S24M Marine Monitor

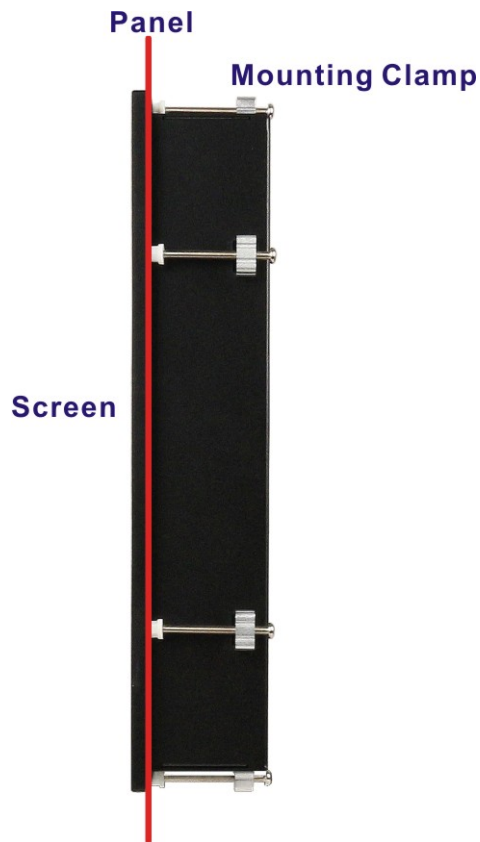

Figure 3-4: Tighten the Panel Mounting Clamp Screws

3.2.2 Stand Mounting

To mount the S19M/S24M using the stand mounting kit, please follow the steps below.

- Step 1:** Locate the screw holes on the rear of the S19M/S24M (Figure 1-5 and Figure 1-6). This is where the bracket will be attached.
- Step 2:** Align the bracket with the screw holes.
- Step 3:** To secure the bracket to the S19M/S24M insert the retention screws into the screw holes and tighten them.

3.3 I/O Interfaces

The S19M/S24M has the following I/O interfaces (**Figure 3-5**):

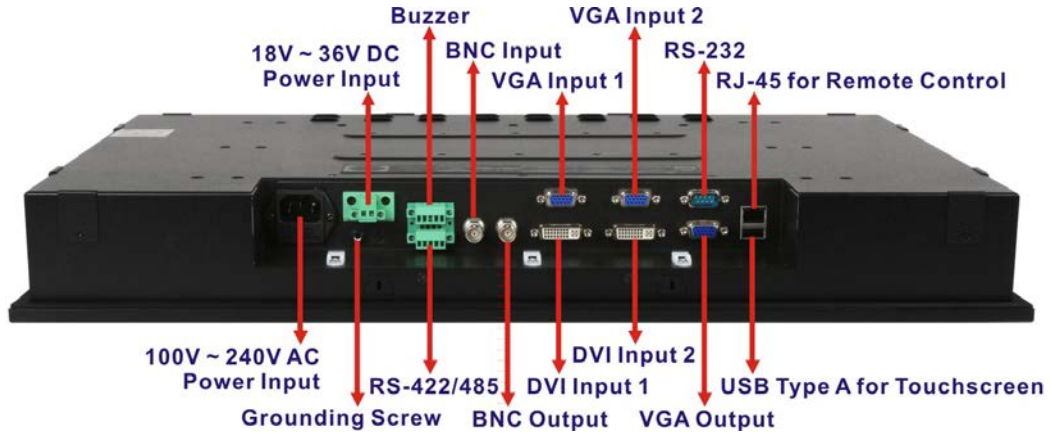

Figure 3-5: I/O Interfaces

3.3.1 BNC Video Input and Output

The S19M/S24M equips with one BNC video input and one BNC video output connectors. Refer to **Figure 3-5** for the connector locations.

3.3.2 Buzzer

The buzzer terminal block allows connection to a buzzer.

Pin	Description	
1	GND	
2	485_VCC (+5V)	
3	BEEP_485	
4	NC	
5	GND	

Table 3-2: Buzzer Terminal Block Pinouts

S19M/S24M Marine Monitor

3.3.3 DVI Inputs

The S19M/S24M provides two DVI input connectors. Refer to **Figure 3-5** for the connector locations.

Pin	Description	Pin	Description
1	DVI signal differential pair (2-)	2	DVI signal differential pair (2+)
3	GND	4	DVI signal differential pair (4-)
5	DVI signal differential pair (4+)	6	DDCLCK
7	DDCDATA	8	N/C
9	DVI signal differential pair (1-)	10	DVI signal differential pair (1+)
11	GND	12	DVI signal differential pair (3-)
13	DVI signal differential pair (3+)	14	5V supply
15	GND	16	Hot plug detect
17	DVI signal differential pair (0-)	18	DVI signal differential pair (0+)
19	GND	20	DVI signal differential pair (5-)
21	DVI signal differential pair (5+)	22	GND
23	DVI CLK(+)	24	DVI CLK(-)

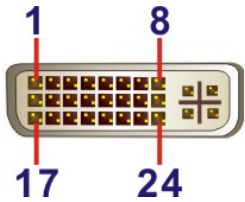

Table 3-3: DVI Input Connector Pinouts

3.3.4 Power Inputs

The S19M/S24M provides two types of power inputs: 18V ~ 36V DC power and 100V ~ 240V AC power. Refer to **Figure 3-5** for the locations of the power input connectors.

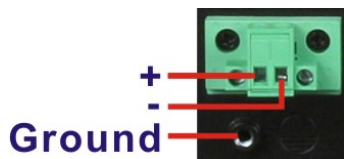

Figure 3-6: 18V ~ 36V DC Power Input Terminal Block Pinouts

3.3.5 RJ-45 for Remote Control

The S19M/S24M provides an RJ-45 connector for remote control.

Pin	Description	Pin	Description
R1	NC	R6	GND
R2	TX+NL	L1	NWAYEN
R3	TX-NL	L2	3.3V_NL
R4	RX+NL	L3	SPEED
R5	RX-NL	L4	3.3V_NL

Table 3-4: RJ-45 Connector Pinouts

3.3.6 RS-232 for Remote Control

The S19M/S24M provides an RS-232 DB-9 connector for remote control.



NOTE:

The default baud rate for the RS-232 connector is 38,400 bps. To change the baud rate for the connector, the user has to modify the firmware of the AD board.

Pin	Description	Pin	Description
1	+5V	6	NC
2	RX_C	7	RTS_C
3	TX_C	8	CTS_C
4	NC	9	COM_BEEP
5	GND		

Table 3-5: RS-232 Connector Pinouts

S19M/S24M Marine Monitor

3.3.7 RS-422/485 for Remote Control

The S19M/S24M provides an RS-422/485 terminal block for remote control.



NOTE:

The default baud rate for the RS-422/485 connector is 38,400 bps. To change the baud rate for the connector, the user has to modify the firmware of the AD board.

Pin	Description	
1	+RXD485	
2	#RXD485	
3	+TXD485	
4	#TXD485	
5	GND	

Table 3-6: RS-422/485 Terminal Block Pinouts

3.3.8 USB for Touchscreen

The USB Type A connector allows connecting the touch panel to the system using the supplied touchscreen USB cable.

Pin	Description
1	VCC_USB
2	USB_T-
3	USB_T+
4	USB_GND

Figure 3-7: USB Type A Connector Pinouts

3.3.9 VGA Inputs

The S19M/S24M provides two VGA input connectors. Refer to **Figure 3-5** for the connector locations.

Pin	Description	Pin	Description
1	RED	2	GREEN
3	BLUE	4	NC
5	GND	6	GND
7	GND	8	GND
9	5V	10	GND
11	NC	12	DDCDAT
13	HSYNC	14	VSYNC
15	DDCCLK		

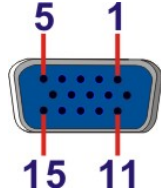

Table 3-7: VGA Output Connector Pinouts

3.3.10 VGA Output

The S19M/S24M provides one VGA output connector. Refer to **Figure 3-5** for the connector location.

Pin	Description	Pin	Description
1	RED	2	GREEN
3	BLUE	4	NC
5	GND	6	GND
7	GND	8	GND
9	VCC	10	GND
11	NC	12	DDCDA
13	HSYNC	14	VSYNC
15	DDCCLK		

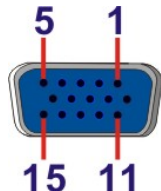



Table 3-8: VGA Output Connector Pinouts

S19M/S24M Marine Monitor

3.4 Turning On/Off the Marine Monitor

To turn on/off the marine monitor, follow the steps below:

Step 1: Ensure the marine monitor is connected to a power source. Refer to **Section 3.3.4** for detailed information of the power input connectors on the S19M/S24M.

Step 2: Press the  button located on the bottom right corner of the front panel to turn on or off the monitor.

Chapter

4

On-Screen Display (OSD) Controls

S19M/S24M Marine Monitor

4.1 OSD Control Buttons

The OSD control buttons are located on the bottom right corner of the front panel.



Figure 4-1: OSD Button Locations

The function of each button is described in the following table.





	<p>Press this button to open the OSD window.</p> <p>When inside the OSD menu, press this button to confirm the selection of the item.</p>
	<p>Press this button to decrease the backlight value.</p> <p>When inside the OSD menu, press this button to scroll down, to decrease the value, or to switch from one option to another.</p>
	<p>Press this button to increase the backlight value.</p> <p>When inside the OSD menu, press this button to scroll up, to increase the value, or to switch from one option to another.</p>
	<p>Press this button to exit the current menu or the OSD window.</p>

Table 4-1: OSD Control Buttons

4.2 OSD Menu Structure and Options

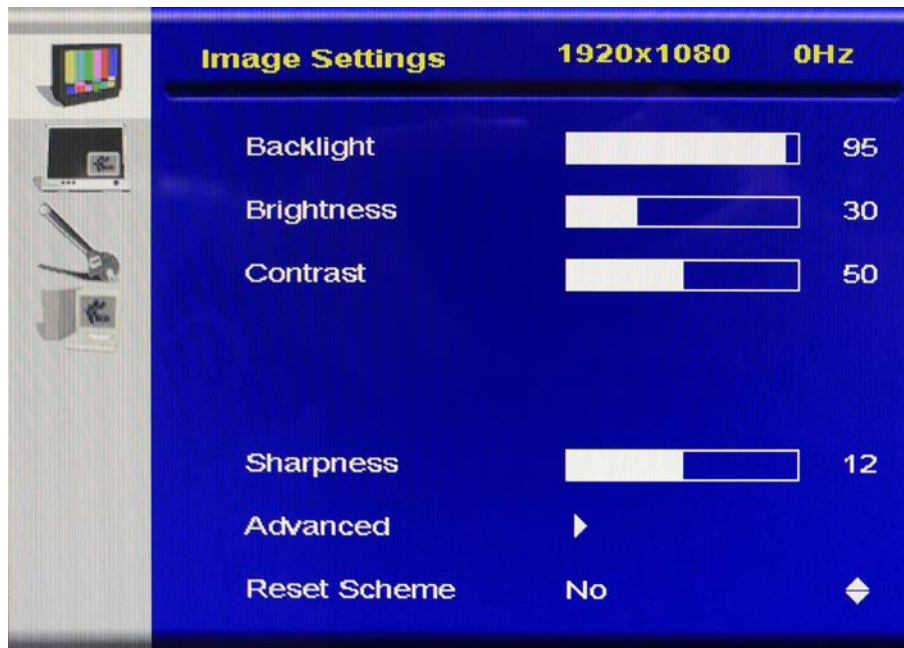

Figure 4-2: Main Menu

Table 4-2 shows the OSD menu structure and options for the S19M/S24M marine monitor.

Level 0	Level 1	Values/Options		
Image Settings	Backlight	0 to 100		
	Brightness	0 to 100		
	Contrast	0 to 100		
	Sharpness	0 to 24		
	Advanced	Auto Adjustment	Select	
		Vertical Position	31 to -31	
		Horizontal Position	100 to -100	
		Phase	0 to 63	
		Clocks/Line	1180 to 1478	
		Color	Auto Color Color Temp: 6500K, 8000K, 9300K, User	
Reset Scheme	No, Yes			

S19M/S24M Marine Monitor

Level 0	Level 1	Values/Options		
Display Settings	Auto AR	Off, On		
	Aspect Ratio	Full Screen, 1:1, Aspect Ratio		
	PIP	PIP Mode	Off, Small PIP, Side-by-Side	
		PIP Size	1 to 7	
		Vertical Position	0 to 100	
		Horizontal Position	0 to 100	
		Brightness	0 to 100	
		Contrast	0 to 100	
	AutoScan	On, Off		
	Main Source	VGA1, VGA2, DVI1, DVI2, VIDEO1		
PIP Source	VIDEO1, DVI1, DVI2			
Setup	OSD Settings	Horizontal Position	0 to 100	
		Vertical Position	0 to 100	
		Menu Timeout	0 to 30	
		Osd Transparency	0 to 100	
	LedLight (Inactive)	0 to 100		
	LedLight (Active)	0 to 100		
	Misc	Language	English	
		Factory Reset	No, Yes	
		Gamma	Yes, No	
		Auto Dimming	No, Yes	
Demo	Noise Reduction	CCS Mode	Off, Normal, Adaptive	
		Dynamic NR Mode	Low, Adaptive, Off, High, Medium	
		MPEG NR Mode	On, Off	
	Video Processing	DCDi	Main DCDi: Off, On PIP DCDi: Not available to be configured	
		Main MADI Mode	Normal, Adaptive, Off,	
		LCD Overdrive	Off	
		Split Screen	Off, On	
		Fleshtone Adjustment	Not available to be configured	
Blue Stretch	Not available to be configured			

Level 0	Level 1	Values/Options	
	Film Mode & Scaling	Film Mode Detection	Video-3:2, Video-3:2-2:2, Off, Video-2:2
		Film Display Mode	Not available to be configured
		Vert. Dynamic Scaling	Not available to be configured
		Horiz. Dynamic Scaling	Not available to be configured
	Smart ISP	Not available to be configured	
	Firmware Version	Displays firmware version	

Table 4-2: OSD Menu Structure and Options

Chapter

5

IEI Monitor Remote Application

5.1 Overview

The IEI Monitor Remote Application allows remote control of the marine monitor via LAN, RS-232 or RS-422/485 connection to a computer. Refer to the following sections for detailed information.

5.2 Launching the IEI Monitor Remote Application

Step 1: Insert the driver CD into an optical disk drive connected to the system.

Step 2: Locate the **IEIMonitorRemoteAP** file in the driver CD. Double click the file to launch the application.

The user may copy the **IEIMonitorRemoteAP** file to the Windows desktop, and then double click the file from the Windows desktop to launch the application.

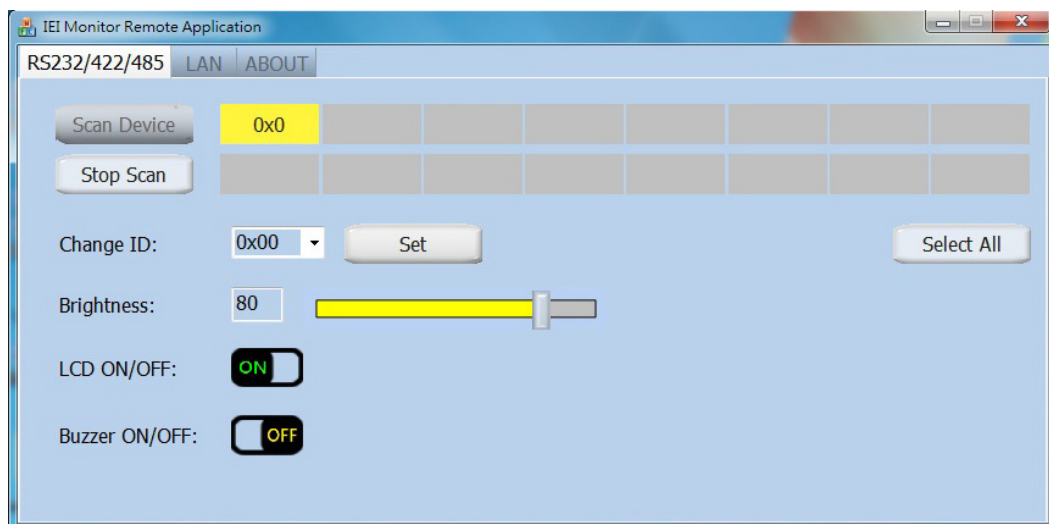

Figure 5-1: IEI Monitor Remote Application Screen

5.3 Remote Control via RS-232

To remotely control the marine monitor via RS-232 connection, please follow the steps below.

Step 1: Ensure the marine monitor is connected to the computer via the RS-232 interface. Refer to **Figure 1-4** for the location of the RS-232 connector on the S19M/S24M.

S19M/S24M Marine Monitor



NOTE:

The application will scan from COM1 to COM5 of the computer and will use the interface (RS-232 or RS-422/485) which is being detected first. If the user wants to use RS-232 interface, but the RS-422/485 connection is being detected first, please unplug the RS-422/485 cable from the computer.

Step 2: Click the **RS232/422/485** tab. The ID of the connected marine monitor should be displayed on the device list (**Figure 5-2**). If the device ID is not being displayed, click **Scan Device** to detect the connected marine monitor again.



NOTE:

When using the RS-232 interface, only one marine monitor can be controlled remotely.

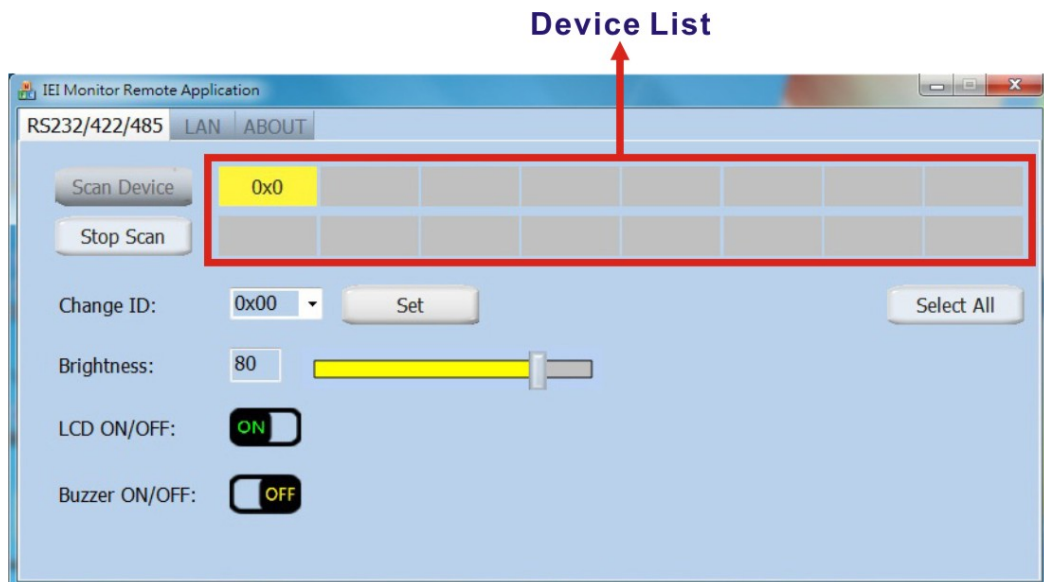

Figure 5-2: IEI Monitor Remote AP – RS-232

Step 3: Click the device ID to select the device to control. The user can set the device ID, adjust the brightness, turn on/off the monitor, and turn on/off the buzzer.

5.4 Remote Control via RS-422/485

To remotely control the marine monitor via RS-422/485 connection, please follow the steps below.

Step 1: Ensure the marine monitor is connected to the computer via the RS-422/485 interface. Refer to **Figure 1-4** for the location of the RS-422/485 terminal block on the S19M/S24M.



NOTE:

The application will scan from COM1 to COM5 of the computer and will use the interface (RS-232 or RS-422/485) which is being detected first. If the user wants to use RS-422/485 interface, but the RS-232 connection is being detected first, please unplug the RS-232 cable from the computer.

Step 2: Click the **RS232/422/485** tab. The ID of the connected marine monitors should be displayed on the device list (**Figure 5-3**). If the device ID is not being displayed, click **Scan Device** to detect the connected marine monitor again.



NOTE:

When using the RS-422/485 interface, up to 16 marine monitors can be controlled remotely. However, the user has to set different ID for each connected marine monitor.

S19M/S24M Marine Monitor

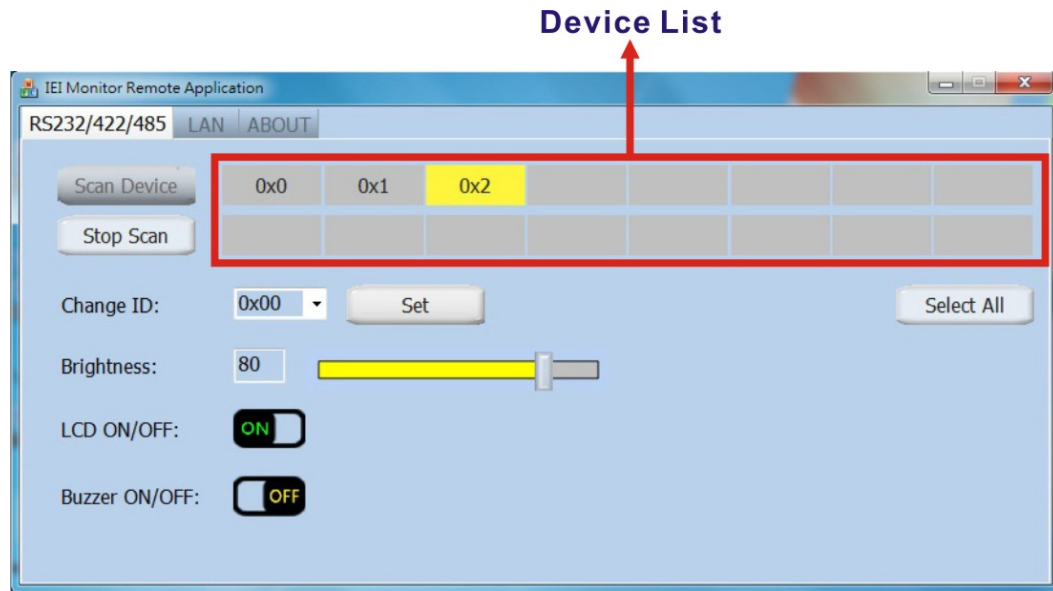

Figure 5-3: IEI Monitor Remote AP – RS-422/485

Step 3: Click the device ID to select the device to control. The user can set the device ID, adjust the brightness, turn on/off the monitor, and turn on/off the buzzer.

5.5 Remote Control via LAN

To remotely control the marine monitor via LAN, please follow the steps below.

Step 1: Ensure the marine monitor is connected to the network via the RJ-45 interface. Refer to **Figure 1-4** for the location of the RJ-45 connector on the S19M/S24M.



NOTE:

The marine monitor and the computer should be under the same domain.

Step 2: Click the **LAN** tab. The ID and IP address of the connected marine monitors should be displayed on the device list (**Figure 5-4**). If the device ID and IP address are not being displayed, click **Scan Device** to detect the connected marine monitor again.



NOTE:

When using the RJ-45 interface, up to 16 marine monitors can be controlled remotely.

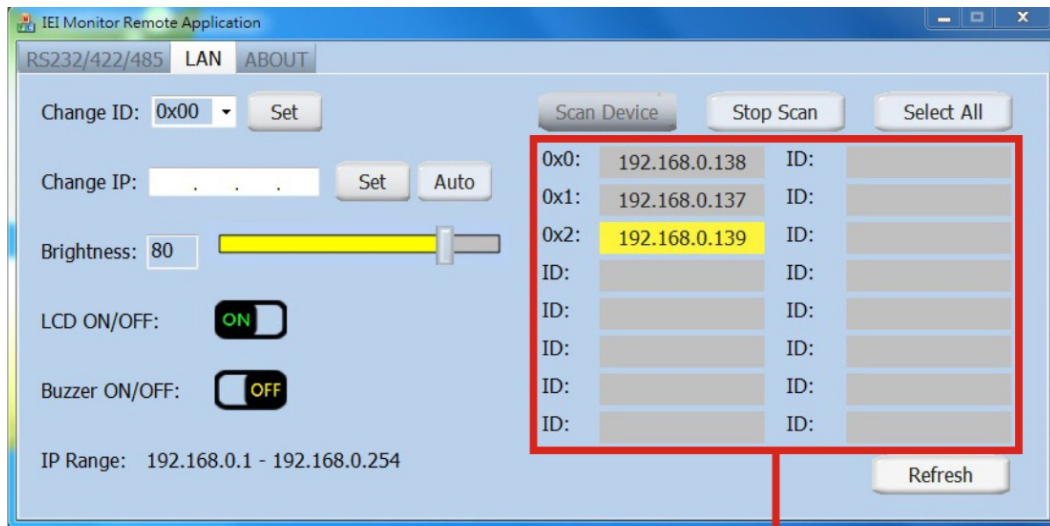

Device List

Figure 5-4: IEI Monitor Remote AP – LAN

Step 3: Click the IP address to select the device to control. The user can set the device ID and IP address, adjust the brightness, turn on/off the monitor, and turn on/off the buzzer.

Appendix

A

Regulatory Compliance

DECLARATION OF CONFORMITY

This equipment is in conformity with the following EU directives:

- EMC Directive 2004/108/EC
- Low-Voltage Directive 2006/95/EC
- RoHS II Directive 2011/65/EU

If the user modifies and/or install other devices in the equipment, the CE conformity declaration may no longer apply.

If this equipment has telecommunications functionality, it also complies with the requirements of the R&TTE Directive 1999/5/EC.

English

IEI Integration Corp declares that this equipment is in compliance with the essential requirements and other relevant provisions of Directive 1999/5/EC.

Български [Bulgarian]

IEI Integration Corp. декларира, че този оборудване е в съответствие със съществените изисквания и другите приложими правила на Директива 1999/5/EC.

Česky [Czech]

IEI Integration Corp tímto prohlašuje, že tento zařizení je ve shodě se základními požadavky a dalšími příslušnými ustanoveními směrnice 1999/5/ES.

Dansk [Danish]

IEI Integration Corp erklærer herved, at følgende udstyr overholder de væsentlige krav og øvrige relevante krav i direktiv 1999/5/EF.

Deutsch [German]

IEI Integration Corp, erklärt dieses Gerät entspricht den grundlegenden Anforderungen und den weiteren entsprechenden Vorgaben der Richtlinie 1999/5/EU.

Eesti [Estonian]

IEI Integration Corp deklareerib seadme seadme vastavust direktiivi 1999/5/EÜ põhinõuetele ja nimetatud direktiivist tulenevatele teistele asjakohastele sätetele.

S19M/S24M Marine Monitor

Español [Spanish]

IEI Integration Corp declara que el equipo cumple con los requisitos esenciales y cualesquiera otras disposiciones aplicables o exigibles de la Directiva 1999/5/CE.

Ελληνική [Greek]

IEI Integration Corp ΔΗΛΩΝΕΙ ΟΤΙ ΕΞΟΠΛΙΣΜΟΣ ΣΥΜΜΟΡΦΩΝΕΤΑΙ ΠΡΟΣ ΤΙΣ ΟΥΣΙΩΔΕΙΣ ΑΠΑΙΤΗΣΕΙΣ ΚΑΙ ΤΙΣ ΛΟΙΠΕΣ ΣΧΕΤΙΚΕΣ ΔΙΑΤΑΞΕΙΣ ΤΗΣ ΟΔΗΓΙΑΣ 1999/5/EK.

Français [French]

IEI Integration Corp déclare que l'appareil est conforme aux exigences essentielles et aux autres dispositions pertinentes de la directive 1999/5/CE.

Italiano [Italian]

IEI Integration Corp dichiara che questo apparecchio è conforme ai requisiti essenziali ed alle altre disposizioni pertinenti stabilite dalla direttiva 1999/5/CE.

Latviski [Latvian]

IEI Integration Corp deklarē, ka iekārta atbilst būtiskajām prasībām un citiem ar to saistītajiem noteikumiem Direktīvas 1999/5/EK.

Lietuvių [Lithuanian]

IEI Integration Corp deklaruoja, kad šis įranga atitinka esminius reikalavimus ir kitas 1999/5/EB Direktyvos nuostatas.

Nederlands [Dutch]

IEI Integration Corp dat het toestel toestel in overeenstemming is met de essentiële eisen en de andere relevante bepalingen van richtlijn 1999/5/EG.

Malti [Maltese]

IEI Integration Corp jiddikjara li dan prodott jikkonforma mal-ħtiġijiet essenzjali u ma provvedimenti oħrajn relevanti li hemm fid-Direttiva 1999/5/EC.

Magyar [Hungarian]

IEI Integration Corp nyilatkozom, hogy a berendezés megfelel a vonatkozó alapvető követelményeknek és az 1999/5/EC irányelv egyéb előírásainak.

Polski [Polish]

IEI Integration Corp oświadcza, że wyrobu jest zgodny z zasadniczymi wymogami oraz pozostałymi stosownymi postanowieniami Dyrektywy 1999/5/EC.

Português [Portuguese]

IEI Integration Corp declara que este equipamento está conforme com os requisitos essenciais e outras disposições da Directiva 1999/5/CE.

Româna [Romanian]

IEI Integration Corp declară că acest echipament este în conformitate cu cerințele esențiale și cu celelalte prevederi relevante ale Directivei 1999/5/CE.

Slovensko [Slovenian]

IEI Integration Corp izjavlja, da je ta opreme v skladu z bistvenimi zahtevami in ostalimi relevantnimi določili direktive 1999/5/ES.

Slovensky [Slovak]

IEI Integration Corp týmto vyhlasuje, že zariadenia spĺňa základné požiadavky a všetky príslušné ustanovenia Smernice 1999/5/ES.

Suomi [Finnish]

IEI Integration Corp vakuuttaa täten että laitteet on direktiivin 1999/5/EY oleellisten vaatimusten ja sitä koskevien direktiivin muiden ehtojen mukainen.

Svenska [Swedish]

IEI Integration Corp förklarar att denna utrustningstyp står i överensstämmelse med de väsentliga egenskapskrav och övriga relevanta bestämmelser som framgår av direktiv 1999/5/EG.

S19M/S24M Marine Monitor

FCC WARNING



This equipment complies with Part 15 of the FCC Rules. Operation is subject to the following two conditions:

- This device may not cause harmful interference, and
- This device must accept any interference received, including interference that may cause undesired operation.

This equipment has been tested and found to comply with the limits for a Class A digital device, pursuant to part 15 of the FCC Rules. These limits are designed to provide reasonable protection against harmful interference when the equipment is operated in a commercial environment. This equipment generates, uses, and can radiate radio frequency energy and, if not installed and used in accordance with the instruction manual, may cause harmful interference to radio communications. Operation of this equipment in a residential area is likely to cause harmful interference in which case the user will be required to correct the interference at his own expense.

Appendix

B

Safety Precautions

S19M/S24M Marine Monitor



WARNING:

The precautions outlined in this chapter should be strictly followed. Failure to follow these precautions may result in permanent damage to the S19M/S24M.

B.1 Safety Precautions

Please follow the safety precautions outlined in the sections that follow:

B.1.1 General Safety Precautions

Please ensure the following safety precautions are adhered to at all times.

- **Follow the electrostatic precautions** outlined below whenever the S19M/S24M is opened.
- **Make sure the power is turned off and the power cord is disconnected** whenever the S19M/S24M is being installed, moved or modified.
- **Do not apply voltage levels that exceed the specified voltage range.** Doing so may cause fire and/or an electrical shock.
- **Electric shocks can occur** if the S19M/S24M chassis is opened when the S19M/S24M is running.
- **Do not drop or insert any objects** into the ventilation openings of the S19M/S24M.
- **If considerable amounts of dust, water, or fluids enter the S19M/S24M,** turn off the power supply immediately, unplug the power cord, and contact the S19M/S24M vendor.
- **DO NOT:**
 - Drop the S19M/S24M against a hard surface.
 - Strike or exert excessive force onto the LCD panel.
 - Touch any of the LCD panels with a sharp object
 - In a site where the ambient temperature exceeds the rated temperature

B.1.2 Anti-static Precautions

**WARNING:**

Failure to take ESD precautions during the installation of the S19M/S24M may result in permanent damage to the S19M/S24M and severe injury to the user.

Electrostatic discharge (ESD) can cause serious damage to electronic components, including the S19M/S24M. Dry climates are especially susceptible to ESD. It is therefore critical that whenever the S19M/S24M is opened and any of the electrical components are handled, the following anti-static precautions are strictly adhered to.

- ***Wear an anti-static wristband:*** Wearing a simple anti-static wristband can help to prevent ESD from damaging any electrical component.
- ***Self-grounding:*** Before handling any electrical component, touch any grounded conducting material. During the time the electrical component is handled, frequently touch any conducting materials that are connected to the ground.
- ***Use an anti-static pad:*** When configuring or working with an electrical component, place it on an anti-static pad. This reduces the possibility of ESD damage.
- ***Only handle the edges of the electrical component:*** When handling the electrical component, hold the electrical component by its edges.

S19M/S24M Marine Monitor

B.1.3 Product Disposal



CAUTION:

Risk of explosion if battery is replaced by an incorrect type. Only certified engineers should replace the on-board battery.

Dispose of used batteries according to instructions and local regulations.

- Outside the European Union - If you wish to dispose of used electrical and electronic products outside the European Union, please contact your local authority so as to comply with the correct disposal method.
- Within the European Union:

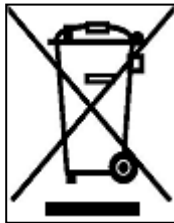

EU-wide legislation, as implemented in each Member State, requires that waste electrical and electronic products carrying the mark (left) must be disposed of separately from normal household waste. This includes monitors and electrical accessories, such as signal cables or power cords. When you need to dispose of your display products, please follow the guidance of your local authority, or ask the shop where you purchased the product. The mark on electrical and electronic products only applies to the current European Union Member States.

Please follow the national guidelines for electrical and electronic product disposal.

B.2 Maintenance and Cleaning Precautions

When maintaining or cleaning the S19M/S24M, please follow the guidelines below.

B.2.1 Maintenance and Cleaning

Prior to cleaning any part or component of the S19M/S24M, please read the details below.

- Except for the LCD panel, never spray or squirt liquids directly onto any other components. To clean the LCD panel, gently wipe it with a piece of soft dry cloth or a slightly moistened cloth.
- Never use alcohol to clean the external chassis.
- The interior of the S19M/S24M does not require cleaning. Keep fluids away from the S19M/S24M interior.
- Be cautious of all small removable components when vacuuming the S19M/S24M.
- Turn the S19M/S24M off before cleaning the S19M/S24M.
- Never drop any objects or liquids through the openings of the S19M/S24M.
- Be cautious of any possible allergic reactions to solvents or chemicals used when cleaning the S19M/S24M.
- Avoid eating, drinking and smoking within vicinity of the S19M/S24M.

B.2.2 Cleaning Tools

Some components in the S19M/S24M may only be cleaned using a product specifically designed for the purpose. In such case, the product will be explicitly mentioned in the cleaning tips. Below is a list of items to use when cleaning the S19M/S24M.

- **Cloth** – Although paper towels or tissues can be used, a soft, clean piece of cloth is recommended when cleaning the S19M/S24M.
- **Water** – A cloth moistened with water can be used to clean the S19M/S24M.
- **Using solvents** – The use of solvents is not recommended when cleaning the S19M/S24M as they may damage the plastic parts.
- **Vacuum cleaner** – Using a vacuum specifically designed for computers is one of the best methods of cleaning the S19M/S24M. Dust and dirt can restrict the airflow in the S19M/S24M and cause its circuitry to corrode.
- **Cotton swabs** - Cotton swaps moistened with water are excellent tools for wiping hard to reach areas.
- **Foam swabs** - Whenever possible, it is best to use lint free swabs such as foam swabs for cleaning.

Appendix

C

Hazardous Materials Disclosure

The details provided in this appendix are to ensure that the product is compliant with the Peoples Republic of China (China) RoHS standards. The table below acknowledges the presences of small quantities of certain materials in the product, and is applicable to China RoHS only.

A label will be placed on each product to indicate the estimated “Environmentally Friendly Use Period” (EFUP). This is an estimate of the number of years that these substances would “not leak out or undergo abrupt change.” This product may contain replaceable sub-assemblies/components which have a shorter EFUP such as batteries and lamps. These components will be separately marked.

Please refer to the following table.

Part Name	Toxic or Hazardous Substances and Elements					
	Lead (Pb)	Mercury (Hg)	Cadmium (Cd)	Hexavalent Chromium (CR(VI))	Polybrominated Biphenyls (PBB)	Polybrominated Diphenyl Ethers (PBDE)
Housing	O	O	O	O	O	O
Display	O	O	O	O	O	O
Printed Circuit Board	O	O	O	O	O	O
Metal Fasteners	O	O	O	O	O	O
Cable Assembly	O	O	O	O	O	O
Fan Assembly	O	O	O	O	O	O
Power Supply Assemblies	O	O	O	O	O	O
Battery	O	O	O	O	O	O

O: This toxic or hazardous substance is contained in all of the homogeneous materials for the part is below the limit requirement in SJ/T11363-2006 (now replaced by GB/T 26572-2011).

X: This toxic or hazardous substance is contained in at least one of the homogeneous materials for this part is above the limit requirement in SJ/T11363-2006 (now replaced by GB/T 26572-2011).

S19M/S24M Marine Monitor

此附件旨在确保本产品符合中国 RoHS 标准。以下表格标示此产品中某有毒物质的含量符合中国 RoHS 标准规定的限量要求。

本产品上会附有“环境友好使用期限”的标签，此期限是估算这些物质“不会有泄漏或突变”的年限。本产品可能包含有较短的环境友好使用期限的可替换元件，像是电池或灯管，这些元件将会单独标示出来。

部件名称	有毒有害物质或元素					
	铅 (Pb)	汞 (Hg)	镉 (Cd)	六价铬 (CR(VI))	多溴联苯 (PBB)	多溴二苯 醚 (PBDE)
壳体	○	○	○	○	○	○
显示	○	○	○	○	○	○
印刷电路板	○	○	○	○	○	○
金属螺帽	○	○	○	○	○	○
电缆组装	○	○	○	○	○	○
风扇组装	○	○	○	○	○	○
电力供应组装	○	○	○	○	○	○
电池	○	○	○	○	○	○

○: 表示该有毒有害物质在该部件所有物质材料中的含量均在 SJ/T 11363-2006 (现由 GB/T 26572-2011 取代) 标准规定的限量要求以下。

X: 表示该有毒有害物质至少在该部件的某一均质材料中的含量超出 SJ/T 11363-2006 (现由 GB/T 26572-2011 取代) 标准规定的限量要求。