

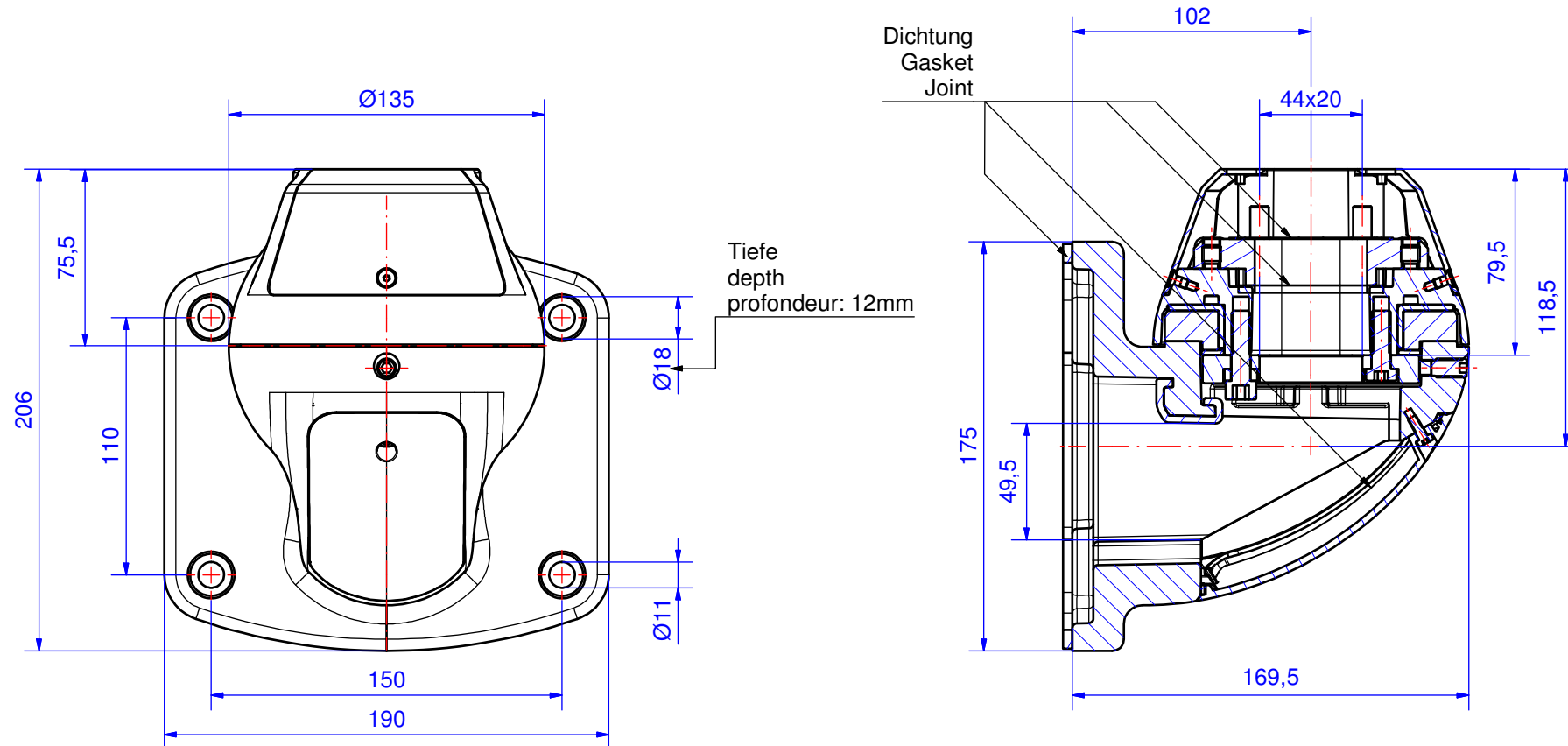

Tragarm-System profiPLUS 50

Type: Wandgelenk senkrecht

Artikel-Nr.: 142.010.001



Material Systemelemente	GD-AI Si 12 (DIN 1706)		Schwenkbereich	313°
Dichtung	4x Zellkautschuk (CR), schwarz		Gewicht	5.170 g
Montageschrauben	4x M8, Stahl verzinkt		Beschichtung	Pulverlackierung RAL 7035, lichtgrau
Schutzart	IP54 EN 60529		Toleranz	Außenmaße ±0,8mm, Restmaße nach GTA 13/5 DIN 1688-4