



RGPS-9222GCP-NP Series  
**Industrial Rack-Mount Ethernet Switch**

# User Manual

Version 1.1

Nov, 2015

[www.oring-networking.com](http://www.oring-networking.com)

## **COPYRIGHT NOTICE**

Copyright © 2014 ORing Industrial Networking Corp.

All rights reserved.

No part of this publication may be reproduced in any form without the prior written consent of ORing Industrial Networking Corp.

## **TRADEMARKS**

 is a registered trademark of ORing Industrial Networking Corp.

All other trademarks belong to their respective owners.

## **REGULATORY COMPLIANCE STATEMENT**

Product(s) associated with this publication complies/comply with all applicable regulations. Please refer to the Technical Specifications section for more details.

## **WARRANTY**

ORing warrants that all ORing products are free from defects in material and workmanship for a specified warranty period from the invoice date (5 years for most products). ORing will repair or replace products found by ORing to be defective within this warranty period, with shipment expenses apportioned by ORing and the distributor. This warranty does not cover product modifications or repairs done by persons other than ORing-approved personnel, and this warranty does not apply to ORing products that are misused, abused, improperly installed, or damaged by accidents.

Please refer to the Technical Specifications section for the actual warranty period(s) of the product(s) associated with this publication.

## **DISCLAIMER**

Information in this publication is intended to be accurate. ORing shall not be responsible for its use or infringements on third-parties as a result of its use. There may occasionally be unintentional errors on this publication. ORing reserves the right to revise the contents of this publication without notice.

## **CONTACT INFORMATION**

### **ORing Industrial Networking Corp.**

3F., NO.542-2, JhongJheng Rd., Sindian District, New Taipei City 231, Taiwan, R.O.C.

Tel: + 886 2 2218 1066 // Fax: + 886 2 2218 1014

Website: [www.oring-networking.com](http://www.oring-networking.com)

### **Technical Support**

E-mail: [support@oring-networking.com](mailto:support@oring-networking.com)

### **Sales Contact**

E-mail: [sales@oring-networking.com](mailto:sales@oring-networking.com) (Headquarters)

[sales@oring-networking.com.cn](mailto:sales@oring-networking.com.cn) (China)

# Table of Content

<b>Getting Started .....</b>	<b>6</b>
1.1 About the RGPS-92222GCP-NP Series .....	6
1.2 Software Features .....	6
1.3 Hardware Specifications .....	7
<b>Hardware Overview.....</b>	<b>8</b>
2.1 Front Panel.....	8
2.1.1 Ports and Connectors .....	8
2.1.2 LED .....	8
2.2 Rear Panel .....	9
<b>Hardware Installation.....</b>	<b>10</b>
3.1 Rack-mount Installation.....	10
3.2 Wiring .....	11
3.2.1 AC Power Connection .....	11
3.3 Connection .....	11
3.3.1 Cables .....	11
3.3.2 SFP.....	14
3.3.3 O-Ring/O-Chain.....	14
<b>Redundancy .....</b>	<b>18</b>
4.1 O-Ring .....	18
4.1.1 Introduction.....	18
4.1.2 Configurations .....	18
4.2 O-Chain .....	20
4.2.1 Introduction.....	20
4.2.2 Configurations .....	20
4.3 MRP.....	21
4.3.1 Introduction.....	21
4.3.2 Configurations .....	21
4.4 STP/RSTP/MSTP .....	22
4.4.1 STP/RSTP .....	22
4.4.2 MSTP .....	26
Bridge Settings .....	27
Bridge Port .....	28
4.5 Fast Recovery .....	30

<b>Management.....</b>	<b>32</b>
5.1 Basic Settings.....	33
5.1.1 System Information .....	33
5.1.2 Admin & Password .....	34
5.1.3 Authentication.....	35
5.1.4 IP Settings .....	35
5.1.5 IPv6 Settings.....	36
5.1.6 Daylight Saving Time.....	37
5.1.7 HTTPS.....	39
5.1.8 SSH .....	39
5.1.9 LLDP.....	40
5.1.10 Modbus TCP .....	43
5.1.11 Backup/Restore Configurations .....	43
5.1.12 Firmware Update.....	44
5.2 DHCP Server .....	44
5.2.1 Basic Settings.....	44
5.2.2 Dynamic Client List.....	45
5.2.3 Client List.....	45
5.2.4 Relay Agent .....	45
5.3 Port Setting .....	48
5.3.1 Port Control.....	48
5.3.2 Port Trunk .....	49
5.3.4 Loop Guard.....	54
5.4 VLAN.....	55
5.4.1 VLAN Membership .....	55
5.4.2 Port Configurations.....	56
5.4.3 Private VLAN .....	65
5.5 SNMP.....	66
5.5.1 SNMP System Configurations .....	66
5.5.2 SNMP Community Configurations.....	68
5.5.3 SNMP User Configurations .....	69
5.5.4 SNMP Group Configurations .....	70
5.5.5 SNMP View Configurations .....	71
5.5.6 SNMP Access Configurations.....	72
5.6 Traffic Prioritization .....	73
5.6.1 Storm Control.....	73
5.6.2 Port Classification .....	74

5.6.3	Port Tag Remaking .....	75
5.6.4	Port DSCP .....	76
5.6.5	Port Policing.....	77
5.6.6	Queue Policing .....	78
5.6.7	QoS Egress Port Scheduler and Shapers.....	79
5.6.8	Port Scheduled .....	81
5.6.9	Port Shaping.....	82
5.6.10	DSCP Based QoS .....	82
5.6.11	DSCP Translation.....	83
5.6.12	DSCP Classification .....	83
5.6.13	QoS Control List.....	84
5.6.14	QoS Counters.....	86
5.6.15	QCL Status .....	87
5.7	Multicast.....	88
5.7.1	IGMP Snooping .....	88
5.7.2	VLAN Configurations of IGMP Snooping .....	89
5.7.3	IGMP Snooping Status .....	89
5.7.4	Groups Information of IGMP Snooping .....	90
5.8	Security .....	91
5.8.1	Remote Control Security Configurations .....	91
5.8.2	Device Binding.....	92
5.8.3	ACL.....	97
5.8.4	AAA.....	108
5.8.6	NAS (802.1x) .....	114
5.9	Alerts .....	124
5.9.1	Fault Alarm.....	124
5.9.2	System Warning .....	125
5.10	Monitor and Diag.....	128
5.10.1	MAC Table .....	128
5.10.2	Port Statistics.....	131
5.10.3	Port Mirroring.....	133
5.10.4	System Log Information .....	134
5.10.5	Cable Diagnostics .....	135
5.10.6	SFP Monitor .....	136
5.10.7	Ping .....	136
5.11	PoE .....	137
5.11.1	Configuration .....	137

5.11.2	Status .....	140
5.11.3	PoE Schedule.....	141
5.11.4	PoE Auto-Ping.....	141
5.12	Troubleshooting .....	142
5.12.1	Factory Defaults .....	142
5.12.2	System Reboot .....	143
<b>Command Line Interface Management .....</b>		<b>144</b>

# **Getting Started**

## **1.1 About the RGPS-92222GCP-NP Series**

The RGPS-92222GCP-NP series which consist of RGPS-92222GCP-NP-LP, RGPS-92222GCP-NP-P and RGPS-92222GCP-NP are managed Ethernet switches designed for industrial applications, such as rolling stock, vehicle, and railway applications. Featuring 22 10/100/1000Base-T(X) IEEE802.3at P.S.E. ports, 2 Gigabit combo ports with IEEE802.3at P.S.E., and 2 100/1000Base-X SFP ports, the series are able to meet the needs for high port density and high-speed, long-distance transmission. The P.S.E-enabled ports are able to provide sufficient power for power-hungry devices with up to 30w per port. With complete support for Ethernet redundancy protocols such as O-Ring (recovery time < 30ms over 250 units of connection) and MSTP (RSTP/STP compatible), the switch can protect your mission-critical applications from network interruptions or temporary malfunctions with its fast recovery technology. Featuring a wide operating temperature from -40°C to 60°C, the device can be managed centrally and conveniently via Open-Vision, web browsers, Telnet and console (CLI) configuration, making it one of the most reliable choice for highly-managed and Fiber Ethernet power substation and rolling stock application.

## **1.2 Software Features**

- Supports Open-Ring to interoperate with other vendors' ring technology in open architecture
- Support O-Ring (recovery time < 30ms over 250 units of connection) and MSTP(RSTP/STP compatible) for Ethernet Redundancy
- Supports O-Chain to allow multiple redundant network rings
- Supports standard IEC 62439-2 MRP (Media Redundancy Protocol) function
- Supports IPV6 new Internet protocol
- Supports Modbus TCP protocol
- Supports IEEE 802.3az Energy-Efficient Ethernet technology
- Supports HTTPS/SSH protocols to enhance network security
- Supports SMTP client
- Supports IP-based bandwidth management
- Supports application-based QoS management
- Supports Device Binding security function
- Supports DOS/DDOS auto prevention
- Supports IGMP v2/v3 (IGMP snooping support) to filter multicast traffic
- Supports SNMP v1/v2c/v3 & RMON & 802.1Q VLAN network management

- Supports ACL, TACACS+ and 802.1x user authentication for security
- Supports 9.6K Bytes Jumbo Frame
- Supports multiple notifications for incidents
- Supports management via Web-based interfaces, Telnet, Console (CLI), and Windows utility (Open-Vision)
- Supports LLDP Protocol

## 1.3 Hardware Specifications

- 19-inch rack mountable design
- 22 x 10/100/1000Base-T(X) RJ-45 ports with PoE function
- 2xGigabit combo ports with PoE function
- 2x100/1000Base-X SFP ports
- Supports PoE scheduled configuration and PoE auto-ping check function
- 450 Watts power supply (RGPS-92222GCP-NP-LP); 1000 Watts power supply (RGPS-92222GCP-NP-P); No power supply include (RGPS-92222GCP-NP)
- Operating temperature: -40 to 60°C
- Storage temperature: -40 to 85°C
- Operating humidity: 5% to 95%, non-condensing
- Dimensions: 431 (W) x 342 (D) x 44 (H) mm (16.97 x 13.47 x 1.73 inch)



# Hardware Overview

## 2.1 Front Panel

### 2.1.1 Ports and Connectors

The RGPS-92222GCP-NP series come with the following ports and connectors on the front panel.

Port	Description
<b>Ethernet ports</b>	22 x 10/100/1000Base-T(X) IEEE802.3at P.S.E. ports
<b>Combo ports</b>	2 x Gigabit Combo ports with 10/100/1000Base-T(X) IEEE802.3at P.S.E. and 100/1000Base-X SFP ports
<b>Fiber ports</b>	2 x 100/1000Base-X SFP ports
<b>Console port</b>	1 x console port
<b>Reset button</b>	1 x reset button. Press the button for 3 seconds to reset and 5 seconds to return to factory default.

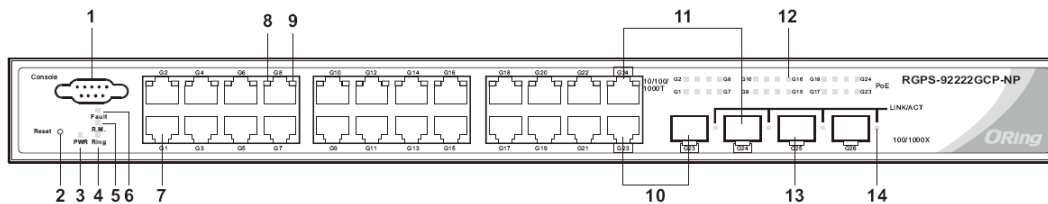

- |                    |  |
|--------------------|--|
| 1. Console port    | 8. LED for even Ethernet ports link / act status |
| 2. Reset button    | 9. LED for odd Ethernet ports link / act status  |
| 3. Power indicator | 10. First Gigabit combo port                     |
| 4. Ring status LED | 11. Second Gigabit combo port                    |
| 5. RM status LED   | 12. PoE status LED for LAN ports                 |
| 6. Fault indicator | 13. SFP port                                     |
| 7. LAN ports       | 14. LNK/ACT LED for SFP ports                    |

### 2.1.2 LED

LED	Color	Status	Description
<b>PWR</b>	Green	On	System power on
	Green	Blinking	Upgrading firmware
<b>R.M</b>	Green	On	Ring Master
<b>Ring</b>	Green	On	Ring enabled
		Blinking	Ring structure is broken
<b>Fault</b>	Amber	On	Errors (power failure or port malfunctioning)

10/100/1000Base-T(X) RJ45 port

<b>Link/Act</b>	Green	On	Port connected
		Blinking	Transmitting data
<b>PoE</b>	Green	On	PoE-enabled
100/1000Base-X SFP port			
<b>Link/Act</b>	Green	On	Port connected
		Blinking	Transmitting data

## 2.2 Rear Panel

On the rear panel of the switch sits two panel module slots and one terminal block. The terminal block includes two power pairs for redundant power supply.

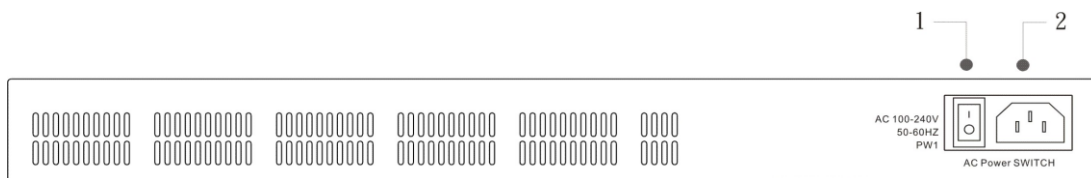

RGPS-92222GCP-NP/-LP/-P

1. Power switch
2. AC power input (100V~240V / 50~60Hz)

# Hardware Installation

## 3.1 Rack-mount Installation

The switch comes with two rack-mount kits to allow you to fasten the switch to a rack in any environments.

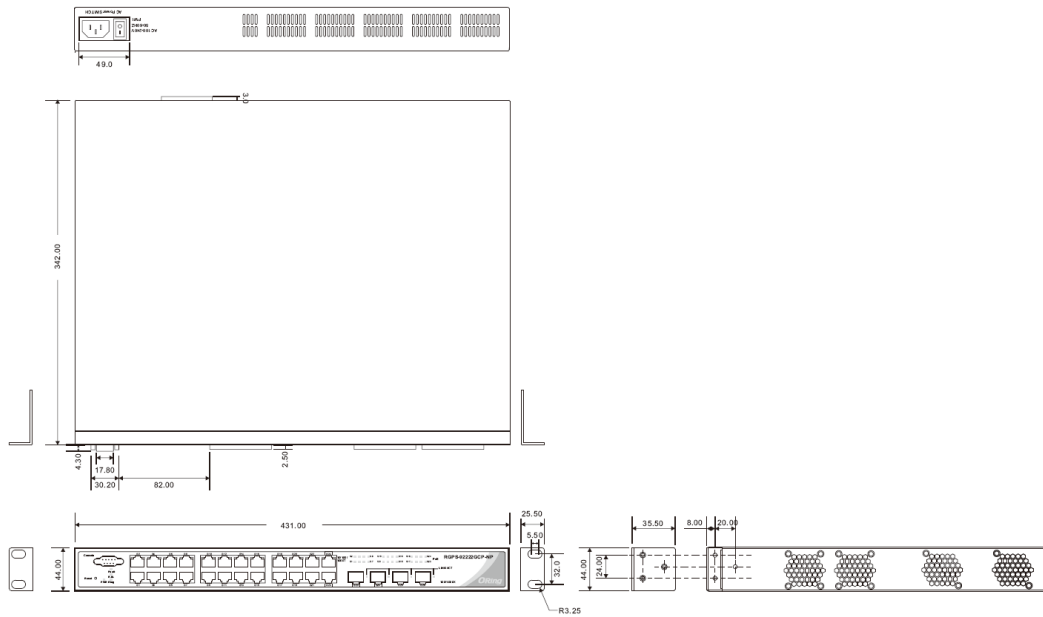

Follow the following steps to install the switch to a rack.

Step 1: Install the mounting brackets to the left and right front sides of the switch using three screws provided with the switch.

Step 2: With front brackets orientated in front of the rack, fasten the brackets to the rack using two more screws.

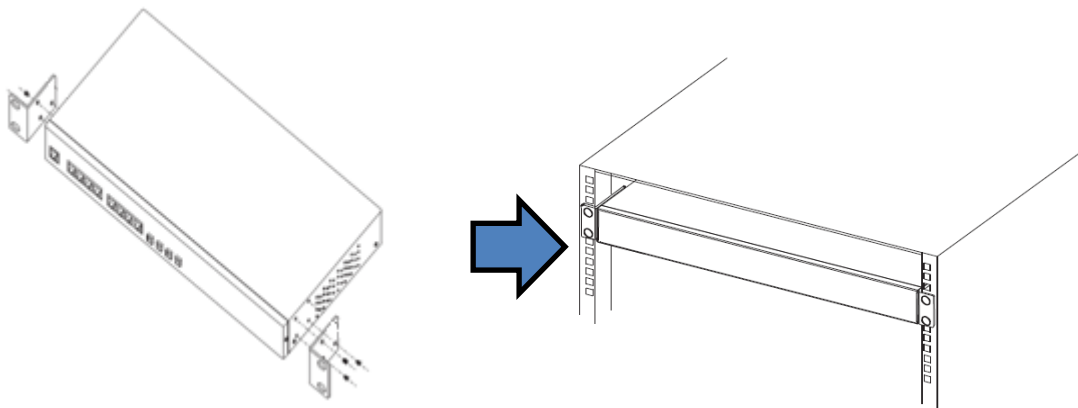

## 3.2 Wiring



### Attention

1. Be sure to disconnect the power cord before installing and/or wiring your switches.
2. Calculate the maximum possible current in each power wire and common wire. Observe all electrical codes dictating the maximum current allowable for each wire size.
3. If the current goes above the maximum ratings, the wiring could overheat, causing serious damage to your equipment.
4. Use separate paths to route wiring for power and devices. If power wiring and device wiring paths must cross, make sure the wires are perpendicular at the intersection point.
5. Do not run signal or communications wiring and power wiring through the same wire conduit. To avoid interference, wires with different signal characteristics should be routed separately.
6. You can use the type of signal transmitted through a wire to determine which wires should be kept separate. The rule of thumb is that wiring sharing similar electrical characteristics can be bundled together.
7. You should separate input wiring from output wiring.
8. It is advised to label the wiring to all devices in the system.

### 3.2.1 AC Power Connection

For power supply of RGPS-92222GCP-NP-LP / P, simply insert the AC power cable to the power connector at the back of the switch and turn on the power switch. The input voltage is 100V~240V / 50~60Hz.

## 3.3 Connection

### 3.3.1 Cables

#### 10/100BASE-T(X) & 1000BASE-T Pin Assignments

The device comes with standard Ethernet ports. According to the link type, the switch uses CAT 3, 4, 5, 5e UTP cables to connect to any other network devices (PCs, servers, switches, routers, or hubs). Please refer to the following table for cable specifications.

Cable	Type	Max. Length	Connector
10BASE-T	Cat. 3, 4, 5 100-ohm	UTP 100 m (328 ft)	RJ-45

100BASE-TX	Cat. 5 100-ohm UTP	UTP 100 m (328 ft)	RJ-45
1000BASE-T	Cat. 5/Cat. 5e 100-ohm UTP	UTP 100 m (328ft)	RJ-45

With 10/100/1000BASE-T(X) cables, pins 1 and 2 are used for transmitting data, and pins 3 and 6 are used for receiving data.

#### 10/100Base-T(X) P.S.E. RJ-45 port

Pin Number	Assignment
#1	TD+ with PoE Power input +
#2	TD- with PoE Power input +
#3	RD+ with PoE Power input -
#6	RD- with PoE Power input -

#### 10/100Base-T RJ-45 Pin Assignments

Pin Number	Assignment
1	TD+
2	TD-
3	RD+
4	Not used
5	Not used
6	RD-
7	Not used
8	Not used

#### 1000Base-T P.S.E. RJ-45 port

Pin Number	Assignment
#1	BI_DA+ with PoE Power input +
#2	BI_DA- with PoE Power input +
#3	BI_DB+ with PoE Power input -
#4	BI_DC+
#5	BI_DC-
#6	BI_DB- with PoE Power input -
#7	BI_DD+
#8	BI_DD-

## 1000 Base-T RJ-45 Pin Assignments

Pin Number	Assignment
1	BI_DA+
2	BI_DA-
3	BI_DB+
4	BI_DC+
5	BI_DC-
6	BI_DB-
7	BI_DD+
8	BI_DD-

The series also support auto MDI/MDI-X operation. You can use a cable to connect the switch to a PC. The table below shows the 10BASE-T/ 100BASE-TX MDI and MDI-X port pin outs.

## 10/100 Base-T(X) MDI/MDI-X Pin Assignments:

Pin Number	MDI port	MDI-X port
1	TD+(transmit)	RD+(receive)
2	TD-(transmit)	RD-(receive)
3	RD+(receive)	TD+(transmit)
4	Not used	Not used
5	Not used	Not used
6	RD-(receive)	TD-(transmit)
7	Not used	Not used
8	Not used	Not used

## 1000 Base-T MDI/MDI-X Pin Assignments:

Pin Number	MDI port	MDI-X port
1	BI_DA+	BI_DB+
2	BI_DA-	BI_DB-
3	BI_DB+	BI_DA+
4	BI_DC+	BI_DD+
5	BI_DC-	BI_DD-
6	BI_DB-	BI_DA-
7	BI_DD+	BI_DC+
8	BI_DD-	BI_DC-

**Note:** "+" and "-" signs represent the polarity of the wires that make up each wire pair.

### RS-232 console port wiring

The device can be managed via the console port using a RS-232 cable which can be found in the package. Connect each end of the RS-232 cable to the switch and a PC respectively.

PC pin out (male) assignment	RS-232 with DB9 female connector	DB9 to RJ 45
Pin #2 RD	Pin #2 TD	Pin #2
Pin #3 TD	Pin #3 RD	Pin #3
Pin #5 GD	Pin #5 GD	Pin #5

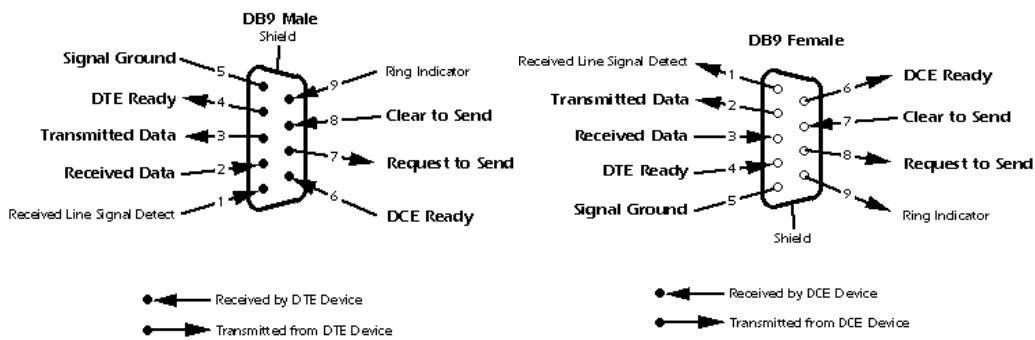

### 3.3.2 SFP

The switch comes with fiber optical ports that can connect to other devices using SFP modules. The fiber optical ports are in multi- or single-mode with LC connectors. Please remember that the TX port of Switch A should be connected to the RX port of Switch B.

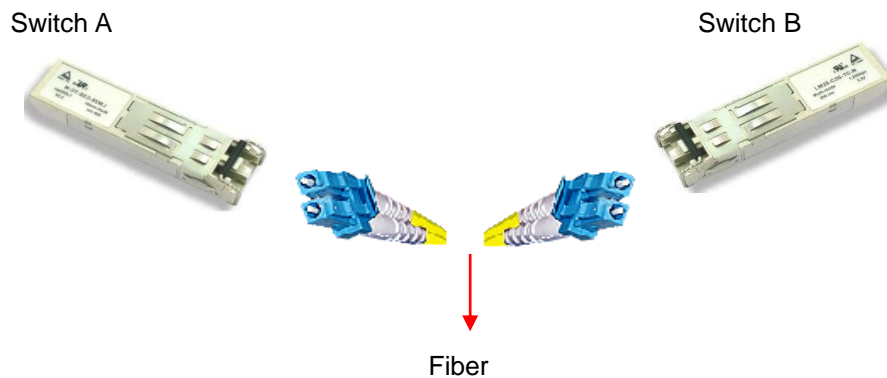

### 3.3.3 O-Ring/O-Chain

O-RING

You can connect three or more switches to form a ring topology to gain network redundancy capabilities through the following steps.

1. Connect each switch to form a daisy chain using an Ethernet cable.
2. Set one of the connected switches to be the master and make sure the port setting of each connected switch on the management page corresponds to the physical ports connected. For information about the port setting, please refer to [4.1.2 Configurations](#).
3. Connect the last switch to the first switch to form a ring topology.

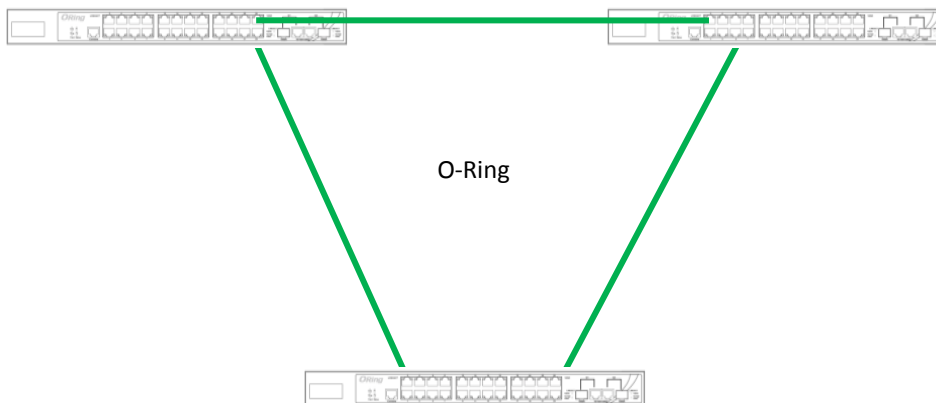

### Coupling Ring

If you already have two O-Ring topologies and would like to connect the rings, you can form them into a coupling ring. All you need to do is select two switches from each ring to be connected, for example, switch A and B from Ring 1 and switch C and D from Ring 2. Decide which port on each switch to be used as the coupling port and then link them together, for example, port 1 of switch A to port 2 of switch C and port 1 of switch B to port 2 of switch D. Then, enable Coupling Ring on the management page and select the coupling ring in correspondence to the connected port. For more information on port setting, please refer to [4.1.2 Configurations](#). Once the setting is completed, one of the connections will act as the main path while the other will act as the backup path.



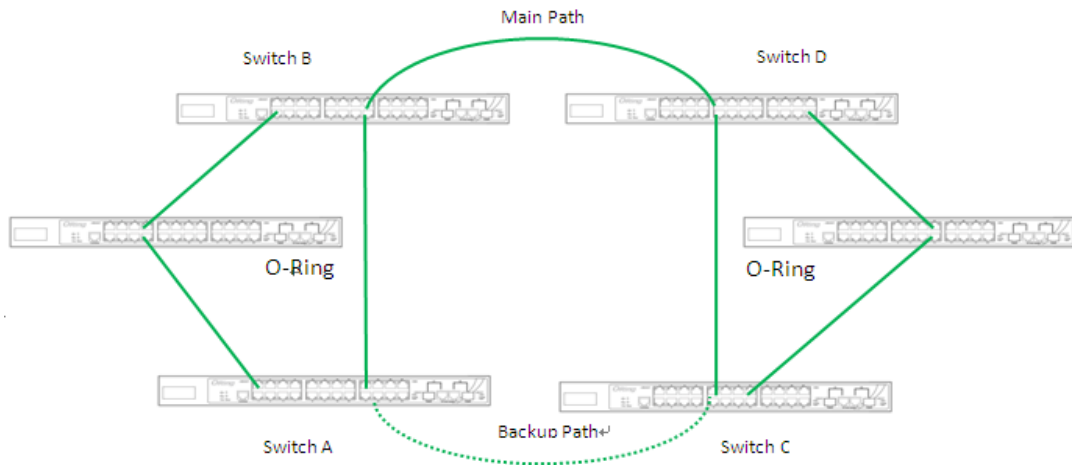

**Dual Homing**

If you want to connect your ring topology to a RSTP network environment, you can use dual homing. Choose two switches (Switch A & B) from the ring for connecting to the switches in the RSTP network (backbone switches). The connection of one of the switches (Switch A or B) will act as the primary path, while the other will act as the backup path that is activated when the primary path connection fails.

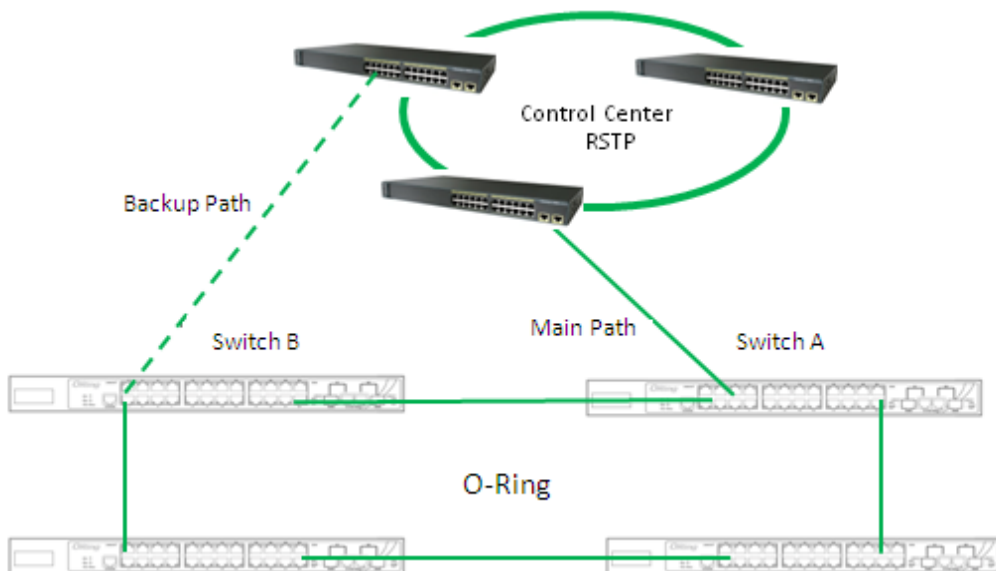

**O-Chain**

When connecting multiple O-Rings to meet your expansion demand, you can create an O-Chain topology through the following steps.

1. Select two switches from the chain (Switch A & B) that you want to connect to the O-Ring and connect them to the switches in the ring (Switch C & D).
2. In correspondence to the ports connected to the ring, configure an edge port for both of the connected switches in the chain by checking the box in the management page (see [4.1.2 Configurations](#)).
3. Once the setting is completed, one of the connections will act as the main path, and the other as the backup path.

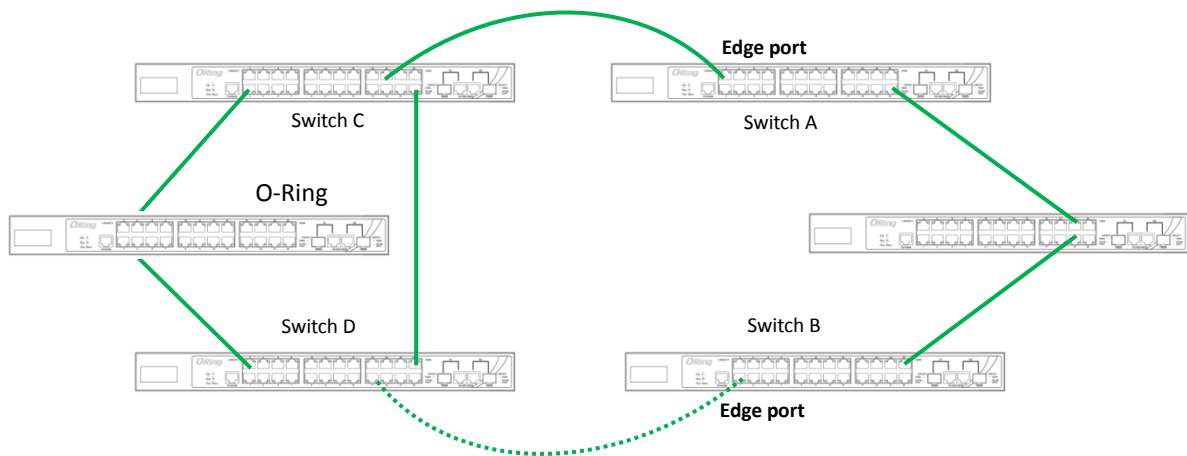

# Redundancy

Redundancy for minimized system downtime is one of the most important concerns for industrial networking devices. Hence, ORing has developed proprietary redundancy technologies including O-Ring, O-RSTP, and Open-Ring featuring faster recovery time than existing redundancy technologies widely used in commercial applications, such as STP, RSTP, and MSTP. ORing’s proprietary redundancy technologies not only support different networking topologies, but also assure the reliability of the network.

## 4.1 O-Ring

### 4.1.1 Introduction

O-Ring is ORing's proprietary redundant ring technology, with recovery time of less than 10 milliseconds and up to 250 nodes. The ring protocols identify one switch as the master of the network, and then automatically block packets from traveling through any of the network’s redundant loops. In the event that one branch of the ring gets disconnected from the rest of the network, the protocol automatically readjusts the ring so that the part of the network that was disconnected can reestablish contact with the rest of the network. The O-Ring redundant ring technology can protect mission-critical applications from network interruptions or temporary malfunction with its fast recover technology.

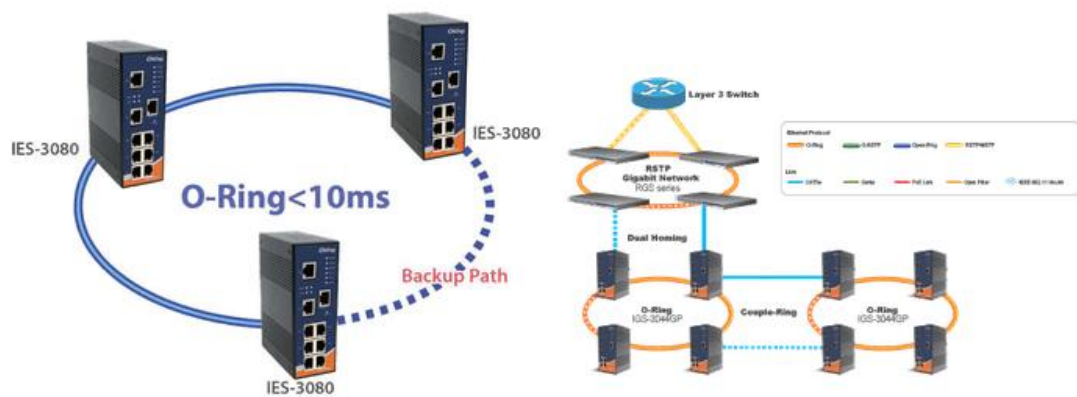

### 4.1.2 Configurations

O-Ring supports two ring topologies: **Coupling Ring**, and **Dual Homing**. You can configure the settings in the interface below.

### O-Ring Configuration

<input checked="" type="checkbox"/> <b>O-Ring</b>		
<b>Ring Master</b>	Disable ▾	This switch is Not a Ring Master.
<b>1st Ring Port</b>	Port 1 ▾	LinkDown
<b>2nd Ring Port</b>	Port 2 ▾	LinkDown
<input type="checkbox"/> <b>Coupling Ring</b>		
<b>Coupling Port</b>	Port 3 ▾	LinkDown
<input type="checkbox"/> <b>Dual Homing</b>		
<b>Homing Port</b>	Port 4 ▾	LinkDown

Label	Description
<b>Redundant Ring</b>	Check to enable O-Ring topology.
<b>Ring Master</b>	Only one ring master is allowed in a ring. However, if more than one switch are set to enable <b>Ring Master</b> , the switch with the lowest MAC address will be the active ring master and the others will be backup masters.
<b>1st Ring Port</b>	The primary port when the switch is ring master
<b>2nd Ring Port</b>	The backup port when the switch is ring master
<b>Coupling Ring</b>	Check to enable <b>Coupling Ring</b> . <b>Coupling Ring</b> can divide a big ring into two smaller rings to avoid network topology changes affecting all switches. It is a good method for connecting two rings.
<b>Coupling Port</b>	Ports for connecting multiple rings. A coupling ring needs four switches to build an active and a backup link. Links formed by the coupling ports will run in active/backup mode.
<b>Dual Homing</b>	Check to enable <b>Dual Homing</b> . When <b>Dual Homing</b> is enabled, the ring will be connected to normal switches through two RSTP links (ex: backbone Switch). The two links work in active/backup mode, and connect each ring to the normal switches in RSTP mode.
<b>Apply</b>	Click to apply the configurations.

**Note:** due to heavy loading, setting one switch as ring master and coupling ring at the same time is not recommended.

## 4.2 O-Chain

### 4.2.1 Introduction

O-Chain is ORing’s revolutionary network redundancy technology which enhances network redundancy for any backbone networks, providing ease-of-use and maximum fault-recovery swiftness, flexibility, compatibility, and cost-effectiveness in a set of network redundancy topologies. The self-healing Ethernet technology designed for distributed and complex industrial networks enables the network to recover in **less than 10ms** for up to 250 switches if at any time a segment of the chain fails.

O-Chain allows multiple redundant rings of different redundancy protocols to join and function together as a large and the most robust network topologies. It can create multiple redundant networks beyond the limitations of current redundant ring technologies.

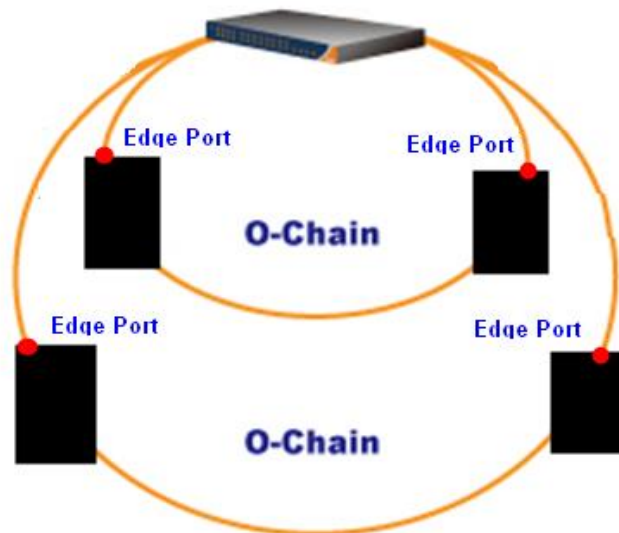

### 4.2.2 Configurations

O-Chain is very easy to configure and manage. Only one edge port of the edge switch needs to be defined. Other switches beside them just need to have O-Chain enabled.

O-Chain

<input checked="" type="checkbox"/> Enable			
	Uplink Port	Edge Port	State
1st	Port.01	<input type="checkbox"/>	Linkdown
2nd	Port.02	<input type="checkbox"/>	Forwarding

Apply

Label	Description
<b>Enable</b>	Check to enable O-Chain function
<b>1<sup>st</sup> Ring Port</b>	The first port connecting to the ring
<b>2<sup>nd</sup> Ring Port</b>	The second port connecting to the ring
<b>Edge Port</b>	An O-Chain topology must begin with edge ports. The ports with a smaller switch MAC address will serve as the backup link and RM LED will light up.

## 4.3 MRP

### 4.3.1 Introduction

MRP (Media Redundancy Protocol) is an industry standard for high-availability Ethernet networks. MRP allowing Ethernet switches in ring configuration to recover from failure rapidly to ensure seamless data transmission. A MRP ring (IEC 62439) can support up to 50 devices and will enable a back-up link in 80ms (adjustable to max. 200ms/500ms).

### 4.3.2 Configurations

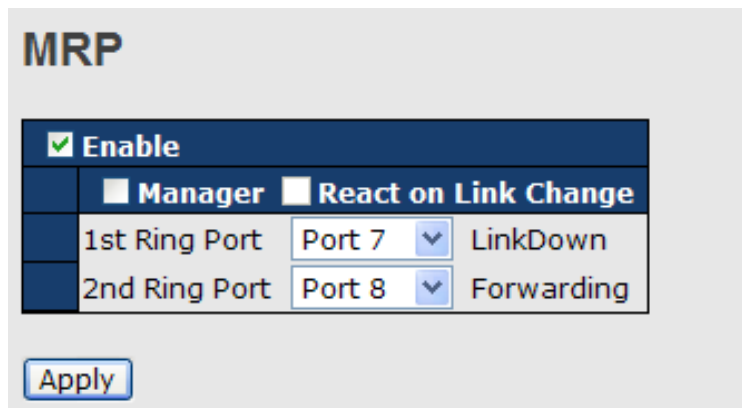

Label	Description
<b>Enable</b>	Enables the MRP function
<b>Manager</b>	Every MRP topology needs a MRP manager. One MRP topology can only have a Manager. If two or more switches are set to be Manager, the MRP topology will fail.
<b>React on Link Change (Advanced mode)</b>	Faster mode. Enabling this function will cause MRP topology to converge more rapidly. This function only can be set in MRP manager switch.
<b>1<sup>st</sup> Ring Port</b>	Chooses the port which connects to the MRP ring
<b>2<sup>nd</sup> Ring Port</b>	Chooses the port which connects to the MRP ring

## **4.4 STP/RSTP/MSTP**

### **4.4.1 STP/RSTP**

STP (Spanning Tree Protocol), and its advanced versions RSTP (Rapid Spanning Tree Protocol) and MSTP (Multiple Spanning Tree Protocol), are designed to prevent network loops and provide network redundancy. Network loops occur frequently in large networks as when two or more paths run to the same destination, broadcast packets may get in to an infinite loop and hence causing congestion in the network. STP can identify the best path to the destination, and block all other paths. The blocked links will stay connected but inactive. When the best path fails, the blocked links will be activated. Compared to STP which recovers a link in 30 to 50 seconds, RSTP can shorten the time to 5 to 6 seconds. In other words, RSTP provides faster spanning tree convergence after a topology changes. The switch supports STP and will auto detect the connected device running on STP or RSTP protocols.

### **RSTP Bridge Setting**

### STP Bridge Configuration

Basic Settings

<b>Protocol Version</b>	RSTP ▼
<b>Bridge Priority</b>	32/68 ▼
<b>Forward Delay</b>	15
<b>Max Age</b>	20
<b>Maximum Hop Count</b>	20
<b>Transmit Hold Count</b>	6

Advanced Settings

<b>Edge Port BPDU Filtering</b>	<input type="checkbox"/>
<b>Edge Port BPDU Guard</b>	<input type="checkbox"/>
<b>Port Error Recovery</b>	<input type="checkbox"/>
<b>Port Error Recovery Timeout</b>	<input style="width: 100%;" type="text"/>

Label	Description
<b>Protocol Version</b>	Select Spanning Tree type , support STP / RSTP / MSTP
<b>Bridge Priority (0-61440)</b>	A value used to identify the root bridge. The bridge with the lowest value has the highest priority and is selected as the root. If the value changes, you must reboot the switch. The value must be a multiple of 4096 according to the protocol standard rule
<b>Forwarding Delay Time (4-30)</b>	The time of a port waits before changing from RSTP learning and listening states to forwarding state. The valid value is between 4 through 30.
<b>Max Age Time(6-40)</b>	The number of seconds a bridge waits without receiving Spanning-tree Protocol configuration messages before attempting a reconfiguration. The valid value is between 6 through 40.
<b>Maximum Hop Count</b>	This defines the initial value of remaining Hops for MSTI information generated at the boundary of an MSTI region. It defines how many bridges a root bridge can distribute its BPDU information to. Valid values are in the range 6 to 40 hops.
<b>Transmit Hold Count</b>	The number of BPDU's a bridge port can send per second. When exceeded, transmission of the next BPDU will be delayed. Valid values are in the range 1 to 10 BPDU's per second.
<b>Edge Port BPDU</b>	Control whether a port explicitly configured as Edge will transmit



<b>Filtering</b>	and receive BPDUs.
<b>Edge Port BPDUGuard</b>	Control whether a port explicitly configured as Edge will disable itself upon reception of a BPDU. The port will enter the error-disabled state, and will be removed from the active topology.
<b>Port Error Recovery</b>	Control whether a port in the error-disabled state automatically will be enabled after a certain time. If recovery is not enabled, ports have to be disabled and re-enabled for normal STP operation. The condition is also cleared by a system reboot.
<b>Port Error Recovery Timeout</b>	The time to pass before a port in the error-disabled state can be enabled. Valid values are between 30 and 86400 seconds (24 hours).

**NOTE:** the calculation of the MAX Age, Hello Time, and Forward Delay Time is as follows:  
 $2 \times (\text{Forward Delay Time value} - 1) \geq \text{Max Age value} \geq 2 \times (\text{Hello Time value} + 1)$

The following pages show the information of the root bridge, including its port status.

### STP Detailed Bridge Status

Auto-refresh  Refresh

STP Bridge Status	
Bridge Instance	CIST
Bridge ID	32768.00-1E-94-FF-FF-FF
Root ID	32768.00-1E-94-FF-FF-FF
Root Cost	0
Root Port	-
Regional Root	32768.00-1E-94-FF-FF-FF
Internal Root Cost	0
Topology Flag	Steady
Topology Change Count	0
Topology Change Last	-

### STP CIST Port Configuration

CIST Aggregated Port Configuration

Port	STP Enabled	Path Cost	Priority	Admin Edge	Auto Edge	Restricted Role	TCN	BPDU Guard	Point-to-point
-	<input checked="" type="checkbox"/>	Auto	128	Non-Edge	<input checked="" type="checkbox"/>	<input type="checkbox"/>	<input type="checkbox"/>	<input type="checkbox"/>	Forced True

CIST Normal Port Configuration

Port	STP Enabled	Path Cost	Priority	Admin Edge	Auto Edge	Restricted Role	TCN	BPDU Guard	Point-to-point
*	<input checked="" type="checkbox"/>	<>	<>	<>	<input checked="" type="checkbox"/>	<input type="checkbox"/>	<input type="checkbox"/>	<input type="checkbox"/>	<>
1	<input checked="" type="checkbox"/>	Auto	128	Non-Edge	<input checked="" type="checkbox"/>	<input type="checkbox"/>	<input type="checkbox"/>	<input type="checkbox"/>	Auto
2	<input checked="" type="checkbox"/>	Auto	128	Non-Edge	<input checked="" type="checkbox"/>	<input type="checkbox"/>	<input type="checkbox"/>	<input type="checkbox"/>	Auto
3	<input checked="" type="checkbox"/>	Auto	128	Non-Edge	<input checked="" type="checkbox"/>	<input type="checkbox"/>	<input type="checkbox"/>	<input type="checkbox"/>	Auto
4	<input checked="" type="checkbox"/>	Auto	128	Non-Edge	<input checked="" type="checkbox"/>	<input type="checkbox"/>	<input type="checkbox"/>	<input type="checkbox"/>	Auto
5	<input checked="" type="checkbox"/>	Auto	128	Non-Edge	<input checked="" type="checkbox"/>	<input type="checkbox"/>	<input type="checkbox"/>	<input type="checkbox"/>	Auto
6	<input checked="" type="checkbox"/>	Auto	128	Non-Edge	<input checked="" type="checkbox"/>	<input type="checkbox"/>	<input type="checkbox"/>	<input type="checkbox"/>	Auto
7	<input checked="" type="checkbox"/>	Auto	128	Non-Edge	<input checked="" type="checkbox"/>	<input type="checkbox"/>	<input type="checkbox"/>	<input type="checkbox"/>	Auto
8	<input checked="" type="checkbox"/>	Auto	128	Non-Edge	<input checked="" type="checkbox"/>	<input type="checkbox"/>	<input type="checkbox"/>	<input type="checkbox"/>	Auto
9	<input checked="" type="checkbox"/>	Auto	128	Non-Edge	<input checked="" type="checkbox"/>	<input type="checkbox"/>	<input type="checkbox"/>	<input type="checkbox"/>	Auto

Label	Description
<b>Port</b>	<b>Port number</b>
<b>STP Enable</b>	<b>User can by port enable / disable STP Function</b>
<b>Path Cost Auto</b>	<b>User can setting Path Cost Auto or Specific</b>
<b>Path Cost Value (1-200000000)</b>	Controls the path cost incurred by the port. The Auto setting will set the path cost as appropriate by the physical link speed, using the 802.1D recommended values. Using the Specific setting, a user-defined value can be entered. The path cost is used when establishing the active topology of the network. Lower path cost ports are chosen as forwarding ports in favour of higher path cost ports. Valid values are in the range 1 to 200000000.
<b>Port Priority (0-240)</b>	Decide which port should be blocked by priority in the LAN. The valid value is between 0 and 240, and must be a multiple of 16
<b>Admin Edge</b>	Controls whether the operEdge flag should start as set or cleared. (The initial operEdge state when a port is initialized).
<b>Auto Edge</b>	Controls whether the bridge should enable automatic edge detection on the bridge port. This allows operEdge to be derived from whether BPDU's are received on the port or not.
<b>Restricted – Role</b>	If enabled, causes the port not to be selected as Root Port for the CIST or any MSTI, even if it has the best spanning tree priority vector. Such a port will be selected as an Alternate Port after the Root Port has been selected. If set, it can cause lack of spanning tree connectivity. It can be set by a network administrator to prevent bridges external to a core region of the network influence the spanning tree active topology, possibly because those bridges are not under the full control of the administrator. This feature is also known as Root Guard.
<b>Restrcted -TCN</b>	If enabled, causes the port not to propagate received topology change notifications and topology changes to other ports. If set it can cause temporary loss of connectivity after changes in a spanning tree's active topology as a result of persistently incorrect learned station location information. It is set by a network administrator to prevent bridges external to a core region of the network, causing address flushing in that region, possibly because those bridges are not under the full control of the administrator or the physical link state of the attached LANs transits frequently.
<b>BPDU Guard</b>	If enabled, causes the port to disable itself upon receiving valid

	BPDU's. Contrary to the similar bridge setting, the port Edge status does not effect this setting.
<b>Point to Point</b>	Controls whether the port connects to a point-to-point LAN rather than to a shared medium. This can be automatically determined, or forced either true or false. Transition to the forwarding state is faster for point-to-point LANs than for shared media.
<b>Apply</b>	Click to apply the configurations.

### 4.4.2 MSTP

Since the recovery time of STP and RSTP takes seconds, which is unacceptable in industrial applications, MSTP was developed. The technology supports multiple spanning trees within a network by grouping and mapping multiple VLANs into different spanning-tree instances, known as MSTIs, to form individual MST regions. Each switch is assigned to an MST region. Hence, each MST region consists of one or more MSTP switches with the same VLANs, at least one MST instance, and the same MST region name. Therefore, switches can use different paths in the network to effectively balance loads.

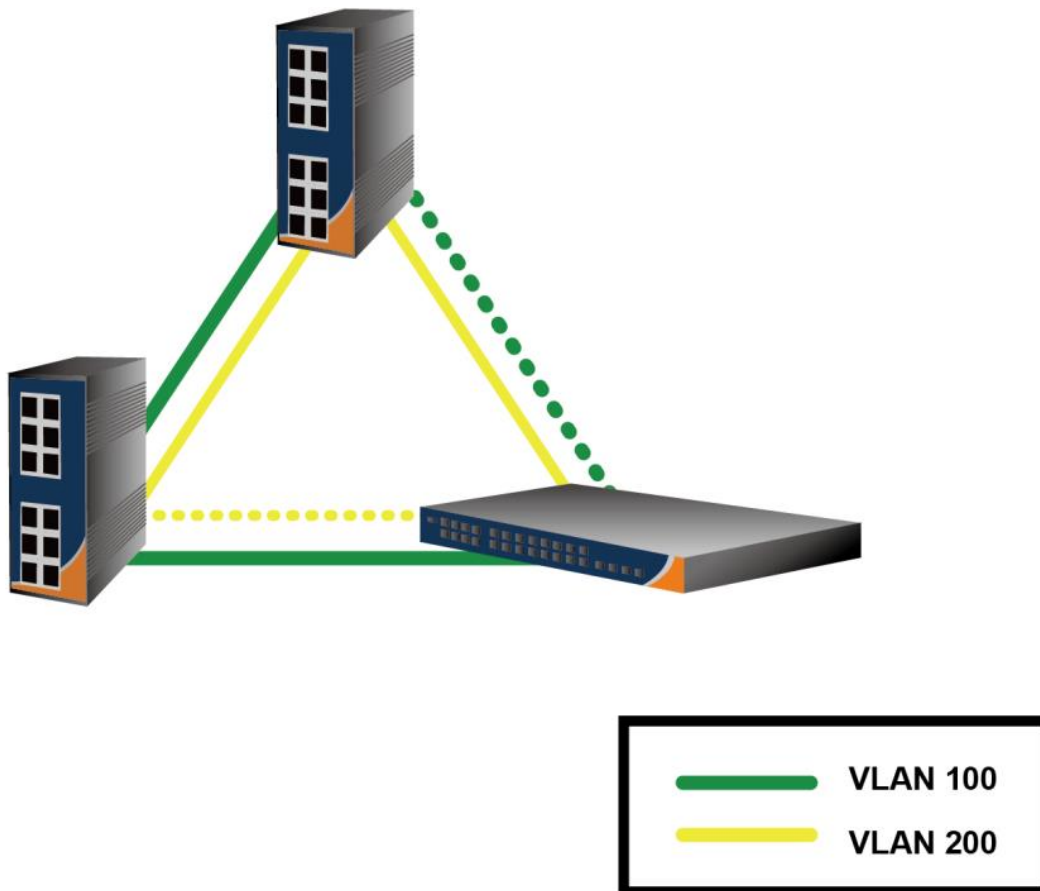

### Bridge Settings

This page allows you to examine and change the configurations of current MSTI ports. A MSTI port is a virtual port, which is instantiated separately for each active CIST (physical) port for each MSTI instance configured and applicable for the port. The MSTI instance must be selected before MSTI port configuration options are displayed.

#### MSTP - Bridge Setting

<b>MSTP Enable</b>	Enable <input type="button" value="v"/>
<b>Force Version</b>	MSTP <input type="button" value="v"/>
<b>Configuration Name</b>	<input type="text" value="MSTP_SWITCH"/>
<b>Revision Level (0-65535)</b>	<input type="text" value="0"/>
<b>Priority (0-61440)</b>	<input type="text" value="32768"/>
<b>Max Age Time (6-40)</b>	<input type="text" value="20"/>
<b>Hello Time (1-10)</b>	<input type="text" value="2"/>
<b>Forward Delay Time (4-30)</b>	<input type="text" value="15"/>
<b>Max Hops (1-40)</b>	<input type="text" value="20"/>

**Priority must be a multiple of 4096.  
 2\*(Forward Delay Time-1) should be greater than or equal to the Max Age.  
 The Max Age should be greater than or equal to 2\*(Hello Time + 1).**

Label	Description
<b>MSTP Enable</b>	Enables or disables MSTP function.
<b>Force Version</b>	Forces a VLAN bridge that supports RSTP to operate in an STP-compatible manner.
<b>Configuration Name</b>	The name which identifies the VLAN to MSTI mapping. Bridges must share the name and revision (see below), as well as the VLAN-to-MSTI mapping configurations in order to share spanning trees for MSTIs (intra-region). The name should not exceed 32 characters.
<b>Revision Level (0-65535)</b>	Revision of the MSTI configuration named above. This must be an integer between 0 and 65535.
<b>Priority (0-61440)</b>	A value used to identify the root bridge. The bridge with the lowest value has the highest priority and is selected as the root. If the value changes, you must reboot the switch. The value must be a multiple of 4096 according to the protocol standard rule.

<b>Max Age Time(6-40)</b>	The number of seconds a bridge waits without receiving Spanning-tree Protocol configuration messages before attempting a reconfiguration. The valid value is between 6 through 40.
<b>Hello Time (1-10)</b>	The time interval a switch sends out the BPDU packet to check RSTP current status. The time is measured in seconds and the valid value is between 1 through 10.
<b>Forwarding Delay Time (4-30)</b>	The time of a port waits before changing from RSTP learning and listening states to forwarding state. The valid value is between 4 through 30.
<b>Max Hops (1-40)</b>	An additional parameter for those specified for RSTP. A single value applies to all STP within an MST region (the CIST and all MSTIs) for which the bridge is the regional root.
<b>Apply</b>	Click to apply the configurations.

**Bridge Port**

**MSTP - Bridge Port**

Port No.	Priority (0-240)	Path Cost (1-200000000, 0:Auto)	Admin P2P	Admin Edge	Admin Non Stp
Port.01					
Port.02					
Port.03	128	0	auto	true	false
Port.04					
Port.05					

**priority must be a multiple of 16**

Apply

Label	Description
<b>Port No.</b>	The number of port you want to configure
<b>Priority (0-240)</b>	Decide which port should be blocked by priority in the LAN. The valid value is between 0 and 240, and must be a multiple of 16.
<b>Path Cost (1-200000000)</b>	The path cost incurred by the port. The path cost is used when establishing an active topology for the network. Lower path cost ports are chosen as forwarding ports in favor of higher path cost ports. The range of valid values is 1 to 200000000.
<b>Admin P2P</b>	Configures whether the port connects to a point-to-point LAN rather than a shared medium. This can be configured automatically or set to true or false manually. True means P2P enabling. False means P2P disabling. Transiting to forwarding

	state is faster for point-to-point LANs than for shared media.
<b>Admin Edge</b>	Specify whether this port is an edge port or a nonedge port. An edge port is not connected to any other bridge. Only edge ports and point-to-point links can rapidly transition to forwarding state. To configure the port as an edge port, set the port to True.
<b>Admin Non STP</b>	The port includes the STP mathematic calculation. True is not including STP mathematic calculation, false is including the STP mathematic calculation.
<b>Apply</b>	Click to apply the configurations.

### Instance Setting

This page allows you to change the configurations of current MSTI bridge instance.

**MSTP - Instance Setting**

Instance	State	VLANs	Priority (0-61440)
1 <input type="button" value="v"/>	Enable <input type="button" value="v"/>	1-4094	32768

**Priority must be a multiple of 4096.**

Label	Description
<b>Instance</b>	Set the instance from 1 to 15
<b>State</b>	Enables or disables the instance
<b>VLANs</b>	The VLAN which is mapped to the MSTI. A VLAN can only be mapped to one MSTI. An unused MSTI will be left empty (ex. without any mapped VLANs).
<b>Priority (0-61440)</b>	A value used to identify the root bridge. The bridge with the lowest value has the highest priority and is selected as the root. If the value changes, you must reboot the switch. The value must be a multiple of 4096 according to the protocol standard
<b>Apply</b>	Click to apply the configurations.

### Port Priority

This page allows you to change the configurations of current MSTI bridge instance priority.

**MSTP - Instance Port**

Instance:

Port	Priority (0-240)	Path Cost (1-200000000, 0:Auto)
Port.01		
Port.02		
Port.03	<input type="text" value="128"/>	<input type="text" value="0"/>
Port.04		
Port.05		

**Priority must be a multiple of 16**

Label	Description
<b>Instance</b>	The bridge instance. CIST is the default instance, which is always active.
<b>Port</b>	The port number which you want to configure.
<b>Priority (0-240)</b>	Decides the priority of ports to be blocked in the LAN. The valid value is between 0 and 240, and must be a multiple of 16
<b>Path Cost (1-200000000)</b>	The path cost incurred by the port. The path cost is used when establishing an active topology for the network. Lower path cost ports are chosen as forwarding ports in favor of higher path cost ports. The range of valid values is 1 to 200000000.
<b>Apply</b>	Click to apply the configurations.

## 4.5 Fast Recovery

Fast recovery mode can be set to connect multiple ports to one or more switches. The device with fast recovery mode will provide redundant links. Fast recovery mode supports 12 priorities. Only the first priority will be the active port, and the other ports with different priorities will be backup ports.

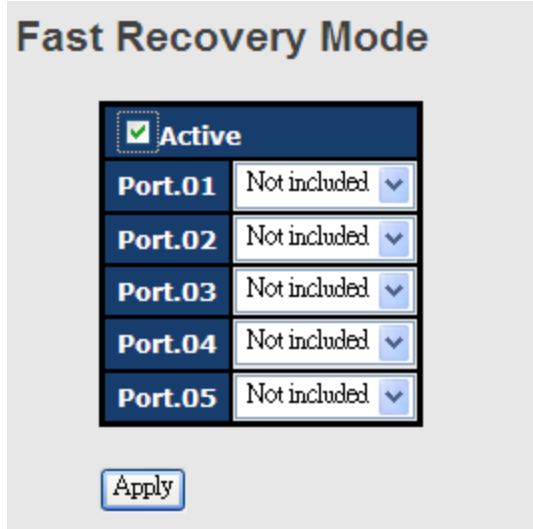

Label	Description
<b>Active</b>	Activate fast recovery mode
<b>Port</b>	Ports can be set to 12 priorities. Only the port with the highest priority will be the active port. 1st Priority is the highest.
<b>Apply</b>	Click to activate the configurations.



# Management

The switch can be controlled via a built-in web server which supports Internet Explorer (Internet Explorer 5.0 or above versions) and other Web browsers such as Chrome. Therefore, you can manage and configure the switch easily and remotely. You can also upgrade firmware via a web browser. The Web management function not only reduces network bandwidth consumption, but also enhances access speed and provides a user-friendly viewing screen.



By default, IE5.0 or later version do not allow Java applets to open sockets. You need to modify the browser setting separately in order to enable Java applets for network ports.

## Preparing for Web Management

You can access the management page of the switch via the following default values:

IP Address: **192.168.10.1**

Subnet Mask: **255.255.255.0**

Default Gateway: **192.168.10.254**

User Name: **admin**

Password: **admin**

## System Login

1. Launch the Internet Explorer.
2. Type `http://` and the IP address of the switch. Press **Enter**.

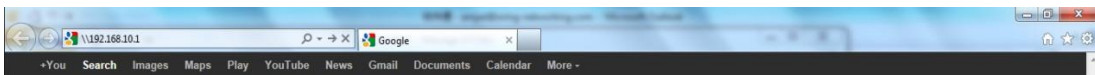

3. A login screen appears.
4. Type in the username and password. The default username and password is **admin**.
5. Click **Enter** or **OK** button, the management Web page appears.



After logging in, you can see the information of the switch as below.

System	
<b>Name</b>	RGPS-92222GCP-NP-P
<b>Description</b>	Industrial 26-port managed Gigabit PoE Ethernet switch with 22x10/100/1000Base-T(X) P.S.E., 2xGigabit combo ports and 2x100/1000Base-X, SFP socket, power supply included
<b>Location</b>	
<b>Contact</b>	
<b>OID</b>	1.3.6.1.4.1.25972.100.0.5.167
Hardware	
<b>MAC Address</b>	00-1e-94-00-22-57
Time	
<b>System Date</b>	1970-01-01 00:34:36+00:00
<b>System Uptime</b>	0d 00:34:36
Software	
<b>Kernel Version</b>	v9.03
<b>Software Version</b>	v1.00
<b>Software Date</b>	2014-01-10T17:18:34+08:00

Auto-refresh  Refresh

Enable Location Alert

On the right hand side of the management interface shows links to various settings. You can click on the links to access the configuration pages of different functions.

## 5.1 Basic Settings

Basic Settings allow you to configure the basic functions of the switch.

### 5.1.1 System Information

This page shows the general information of the switch.

### System Information Configuration

<b>System Name</b>	RGPS-92222GCP-NP-P
<b>System Description</b>	Industrial 26-port managed Gigab
<b>System Location</b>	
<b>System Contact</b>	

Save Reset

Label	Description
<b>System Name</b>	An administratively assigned name for the managed node. By convention, this is the node's fully-qualified domain name. A domain name is a text string consisting of alphabets (A-Z, a-z),

	digits (0-9), and minus sign (-). Space is not allowed to be part of the name. The first character must be an alpha character. And the first or last character must not be a minus sign. The allowed string length is 0 to 255.
<b>System Description</b>	Description of the device
<b>System Location</b>	The physical location of the node (e.g., telephone closet, 3rd floor). The allowed string length is 0 to 255, and only ASCII characters from 32 to 126 are allowed.
<b>System Contact</b>	The textual identification of the contact person for this managed node, together with information on how to contact this person. The allowed string length is 0 to 255, and only ASCII characters from 32 to 126 are allowed.
<b>Save</b>	Click to save changes.
<b>Reset</b>	Click to undo any changes made locally and revert to previously saved values.

### 5.1.2 Admin & Password

This page allows you to configure the system password required to access the web pages or log in from CLI.

Label	Description
<b>Old Password</b>	The existing password. If this is incorrect, you cannot set the new password.
<b>New Password</b>	The new system password. The allowed string length is 0 to 31, and only ASCII characters from 32 to 126 are allowed.
<b>Confirm New Password</b>	Re-type the new password.
<b>Save</b>	Click to save changes.

### 5.1.3 Authentication

This page allows you to configure how a user is authenticated when he/she logs into the switch via one of the management interfaces.

Client	Authentication Method	Fallback
console	local	<input type="checkbox"/>
telnet	local	<input type="checkbox"/>
ssh	local	<input type="checkbox"/>
web	local	<input type="checkbox"/>

Save Reset

Label	Description
<b>Client</b>	The management client for which the configuration below applies.
<b>Authentication Method</b>	Authentication Method can be set to one of the following values: <b>None:</b> authentication is disabled and login is not possible. <b>Local:</b> local user database on the switch is used for authentication. <b>Radius:</b> a remote RADIUS server is used for authentication.
<b>Fallback</b>	Check to enable fallback to local authentication. If none of the configured authentication servers are active, the local user database is used for authentication. This is only possible if <b>Authentication Method</b> is set to a value other than <b>none</b> or <b>local</b> .
<b>Save</b>	Click to save changes
<b>Reset</b>	Click to undo any changes made locally and revert to previously saved values

### 5.1.4 IP Settings

You can configure IP information of the switch in this page.

	Configured	Current
<b>DHCP Client</b>	<input type="checkbox"/>	Renew
<b>IP Address</b>	192.168.10.1	192.168.10.1
<b>IP Mask</b>	255.255.255.0	255.255.255.0
<b>IP Router</b>	0.0.0.0	0.0.0.0
<b>VLAN ID</b>	1	1
<b>DNS Server</b>	0.0.0.0	0.0.0.0

Label	Description
<b>DHCP Client</b>	Enable the DHCP client by checking this box. If DHCP fails or the configured IP address is zero, DHCP will retry. If DHCP retry fails, DHCP will stop trying and the configured IP settings will be used.
<b>IP Address</b>	Assigns the IP address of the network in use. If DHCP client function is enabled, you do not need to assign the IP address. The network DHCP server will assign the IP address to the switch and it will be displayed in this column. The default IP is 192.168.10.1.
<b>IP Mask</b>	Assigns the subnet mask of the IP address. If DHCP client function is enabled, you do not need to assign the subnet mask.
<b>IP Router</b>	Assigns the network gateway for the switch. The default gateway is 192.168.10.254.
<b>VLAN ID</b>	Provides the managed VLAN ID. The allowed range is 1 through 4095.
<b>DNS Server</b>	Provides the IP address of the DNS server in dotted decimal notation.
<b>Save</b>	Click to save changes
<b>Reset</b>	Click to undo any changes made locally and revert to previously saved values

### 5.1.5 IPv6 Settings

You can configure IPv6 information of the switch on the following page.

**IPv6 Configuration**

	Configured	Current
<b>Auto Configuration</b>	<input type="checkbox"/>	<input type="button" value="Renew"/>
<b>Address</b>	<input type="text" value="::192.0.2.1"/>	::192.0.2.1 Link-Local Address: fe80::21e:94ff:fe01:6735
<b>Prefix</b>	<input type="text" value="96"/>	96
<b>Router</b>	<input type="text" value="::"/>	::

Label	Description
<b>Auto Configuration</b>	Check to enable IPv6 auto-configuration. If the system cannot obtain the stateless address in time, the configured IPv6 settings will be used. The router may delay responding to a router solicitation for a few seconds; therefore, the total time needed to complete auto-configuration may be much longer.
<b>Address</b>	Provides the IPv6 address of the switch. IPv6 address consists of

	128 bits represented as eight groups of four hexadecimal digits with a colon separating each field (:). For example, in 'fe80::215:c5ff:fe03:4dc7', the symbol '::' is a special syntax that can be used as a shorthand way of representing multiple 16-bit groups of contiguous zeros; but it can appear only once. It can also represent a legally valid IPv4 address. For example, '::192.1.2.34'.
<b>Prefix</b>	Provides the IPv6 prefix of the switch. The allowed range is 1 to 128.
<b>Router</b>	Provides the IPv6 address of the switch. IPv6 address consists of 128 bits represented as eight groups of four hexadecimal digits with a colon separating each field (:). For example, in 'fe80::215:c5ff:fe03:4dc7', the symbol '::' is a special syntax that can be used as a shorthand way of representing multiple 16-bit groups of contiguous zeros; but it can appear only once. It can also represent a legally valid IPv4 address. For example, '::192.1.2.34'.
<b>Save</b>	Click to save changes
<b>Reset</b>	Click to undo any changes made locally and revert to previously saved values

## 5.1.6 Daylight Saving Time

### Time Zone Configuration

Label	Description
<b>Time Zone</b>	Select the time zone from the dropdown list according to the location of the switch and click <b>Save</b> .
<b>Acronym</b>	Set an acronym for the time zone. This is a user configurable acronym for identifying the time zone. Up to 16 alpha-numeric characters can be input. The acronym can contain '-', '_' or '!'.

### Daylight Saving Time Configuration



Label	Description
Daylight Saving Time	This is used to set the clock forward or backward according to the configurations set below for a defined Daylight Saving Time duration. Select <b>Disable</b> to disable the configuration or <b>Recurring</b> to configure the duration to repeat every year. Select <b>Non-Recurring</b> to configure the duration for single time configuration. Default is <b>Disabled</b> .

### Start Time Settings

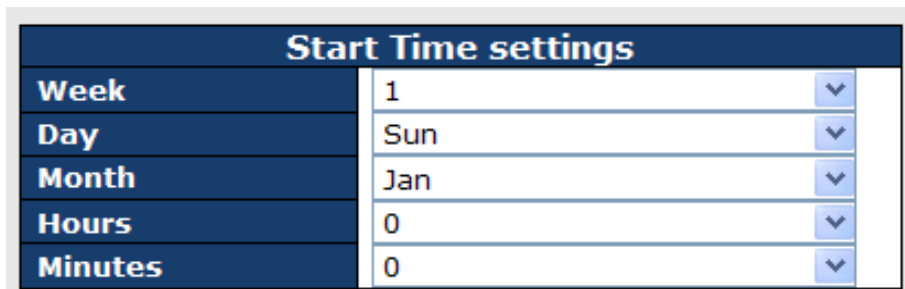

Label	Description
<b>Week</b>	Select the starting week number.
<b>Day</b>	Select the starting day.
<b>Month</b>	Select the starting month.
<b>Hours</b>	Select the starting hour.
<b>Minutes</b>	Select the starting minute.

### End Time Settings

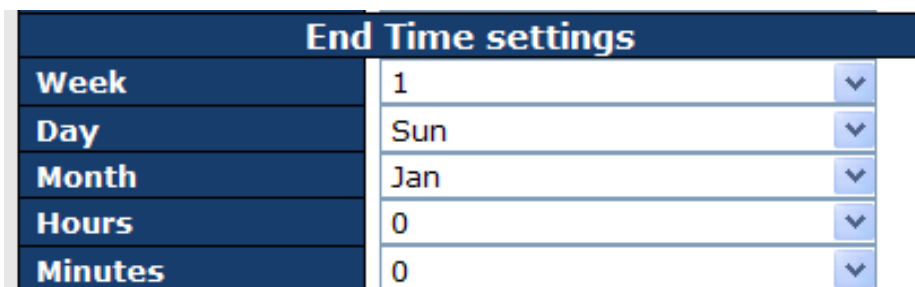

Label	Description
<b>Week</b>	Select the ending week number.
<b>Day</b>	Select the ending day.
<b>Month</b>	Select the ending month.
<b>Hours</b>	Select the ending hour.
<b>Minutes</b>	Select the ending minute.

### Offset Settings

The screenshot shows a configuration window titled "Offset settings". It contains a label "Offset" followed by a text input field containing the number "1" and a range indicator "(1 - 1440) Minutes".

Label	Description
<b>Offset</b>	Configures the offset time. The time is measured by minute.

### 5.1.7 HTTPS

You can configure HTTPS settings in the following page.

The screenshot shows a configuration window titled "HTTPS Configuration". It features a "Mode" dropdown menu currently set to "Disabled". Below the dropdown are two buttons: "Save" and "Reset".

Label	Description
<b>Mode</b>	Indicates the selected HTTPS mode. When the current connection is HTTPS, disabling HTTPS will automatically redirect web browser to an HTTP connection. The modes include: <b>Enabled:</b> enable HTTPS. <b>Disabled:</b> disable HTTPS.
<b>Save</b>	Click to save changes
<b>Reset</b>	Click to undo any changes made locally and revert to previously saved values

### 5.1.8 SSH

You can configure SSH settings in the following page.



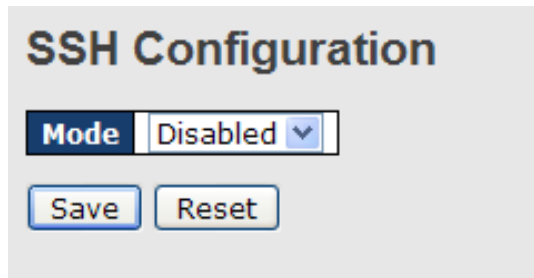

Label	Description
<b>Mode</b>	Indicates the selected SSH mode. The modes include: <b>Enabled:</b> enable SSH. <b>Disabled:</b> disable SSH.
<b>Save</b>	Click to save changes
<b>Reset</b>	Click to undo any changes made locally and revert to previously saved values

### 5.1.9 LLDP

#### LLDP Configurations

This page allows you to examine and configure LLDP port settings.

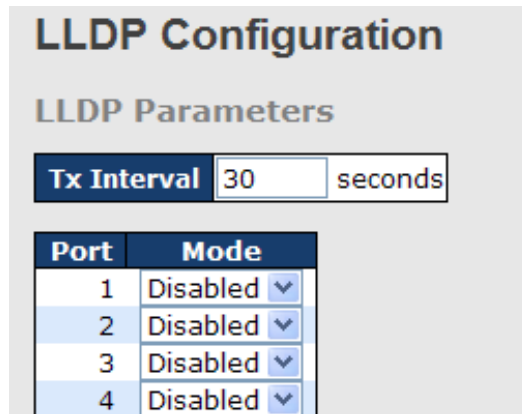

Label	Description
<b>Port</b>	The switch port number to which the following settings will be applied.
<b>Mode</b>	Indicates the selected LLDP mode <b>Rx only:</b> the switch will not send out LLDP information, but LLDP information from its neighbors will be analyzed. <b>Tx only:</b> the switch will drop LLDP information received from its neighbors, but will send out LLDP information. <b>Disabled:</b> the switch will not send out LLDP information, and will

	<p>drop LLDP information received from its neighbors.</p> <p><b>Enabled:</b> the switch will send out LLDP information, and will analyze LLDP information received from its neighbors.</p>
--	--

### LLDP Neighbor Information

This page provides a status overview for all LLDP neighbors. The following table contains information for each port on which an LLDP neighbor is detected. The columns include the following information:

Auto-refresh <input type="checkbox"/> Refresh						
Local Port	Chassis ID	Remote Port ID	System Name	Port Description	System Capabilities	Management Address
Port 8	00-1E-94-12-45-78	7	IGS-9812GP	Port #7	Bridge(+)	192.168.10.14 (IPv4)

Label	Description
<b>Local Port</b>	The port that you use to transmits and receives LLDP frames.
<b>Chassis ID</b>	The identification number of the neighbor sending out the LLDP frames.
<b>Remote Port ID</b>	The identification of the neighbor port
<b>System Name</b>	The name advertised by the neighbor.
<b>Port Description</b>	The description of the port advertised by the neighbor.
<b>System Capabilities</b>	<p>Description of the neighbor's capabilities. The capabilities include:</p> <ol style="list-style-type: none"> <li>1. <b>Other</b></li> <li>2. <b>Repeater</b></li> <li>3. <b>Bridge</b></li> <li>4. <b>WLAN Access Point</b></li> <li>5. <b>Router</b></li> <li>6. <b>Telephone</b></li> <li>7. <b>DOCSIS Cable Device</b></li> <li>8. <b>Station Only</b></li> <li>9. <b>Reserved</b></li> </ol> <p>When a capability is enabled, a (+) will be displayed. If the capability is disabled, a (-) will be displayed.</p>
<b>Management Address</b>	The neighbor's address which can be used to help network management. This may contain the neighbor's IP address.
<b>Refresh</b>	Click to refresh the page immediately
<b>Auto-refresh</b>	Check to enable an automatic refresh of the page at regular intervals

### Port Statistics

This page provides an overview of all LLDP traffic. Two types of counters are shown. Global counters will apply settings to the whole switch stack, while local counters will apply settings to specified switches.

Auto-refresh  Refresh Clear

Global Counters	
Neighbor entries were last changed at	1970-01-01 04:03:03 +0000 (26 sec. ago)
Total Neighbors Entries Added	1
Total Neighbors Entries Deleted	0
Total Neighbors Entries Dropped	0
Total Neighbors Entries Aged Out	0

LLDP Statistics

Local Counters									
Local Port	Tx Frames	Rx Frames	Rx Errors	Frames Discarded	TLVs Discarded	TLVs Unrecognized	Org. Discarded	Age-Outs	
1	1	0	0	0	0	0	0	0	0
2	0	0	0	0	0	0	0	0	0
3	4	0	0	0	0	0	0	0	0
4	0	0	0	0	0	0	0	0	0
5	2	1	0	0	0	0	0	0	0
6	0	0	0	0	0	0	0	0	0
7	0	0	0	0	0	0	0	0	0
8	1	0	0	0	0	0	0	0	0
9	0	0	0	0	0	0	0	0	0
10	0	0	0	0	0	0	0	0	0
11	0	0	0	0	0	0	0	0	0
12	0	0	0	0	0	0	0	0	0

### Global Counters

Label	Description
<b>Neighbor entries were last changed at</b>	Shows the time when the last entry was deleted or added.
<b>Total Neighbors Entries Added</b>	Shows the number of new entries added since switch reboot
<b>Total Neighbors Entries Deleted</b>	Shows the number of new entries deleted since switch reboot
<b>Total Neighbors Entries Dropped</b>	Shows the number of LLDP frames dropped due to full entry table
<b>Total Neighbors Entries Aged Out</b>	Shows the number of entries deleted due to expired time-to-live

### Local Counters

Label	Description
<b>Local Port</b>	The port that receives or transmits LLDP frames
<b>Tx Frames</b>	The number of LLDP frames transmitted on the port
<b>Rx Frames</b>	The number of LLDP frames received on the port
<b>Rx Errors</b>	The number of received LLDP frames containing errors
<b>Frames Discarded</b>	If a port receives an LLDP frame, and the switch's internal table is full, the LLDP frame will be counted and discarded. This situation

	is known as "too many neighbors" in the LLDP standard. LLDP frames require a new entry in the table if Chassis ID or Remote Port ID is not included in the table. Entries are removed from the table when a given port links down, an LLDP shutdown frame is received, or when the entry ages out.
<b>TLVs Discarded</b>	Each LLDP frame can contain multiple pieces of information, known as TLVs (Type Length Value). If a TLV is malformed, it will be counted and discarded.
<b>TLVs Unrecognized</b>	The number of well-formed TLVs, but with an unknown type value
<b>Org. Discarded</b>	The number of organizationally TLVs received
<b>Age-Outs</b>	Each LLDP frame contains information about how long the LLDP information is valid (age-out time). If no new LLDP frame is received during the age-out time, the LLDP information will be removed, and the value of the age-out counter will be incremented.
<b>Refresh</b>	Click to refresh the page immediately
<b>Clear</b>	Click to clear the local counters. All counters (including global counters) are cleared upon reboot.
<b>Auto-refresh</b>	Check to enable an automatic refresh of the page at regular intervals

### 5.1.10 Modbus TCP

This page shows Modbus TCP support of the switch. (For more information regarding Modbus, please visit <http://www.modbus.org/>)

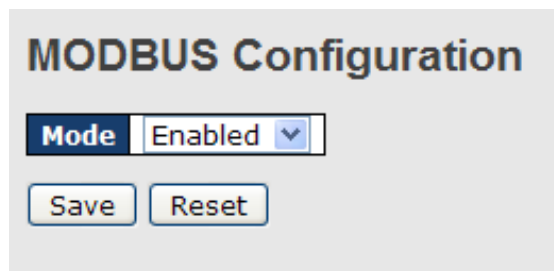

Label	Description
<b>Mode</b>	Shows the existing status of the Modbus TCP function

### 5.1.11 Backup/Restore Configurations

You can save/view or load switch configurations. The configuration file is in XML format.

### Configuration Save

Save configuration

### Configuration Upload

瀏覽... Upload

## 5.1.12 Firmware Update

This page allows you to update the firmware of the switch.

### Firmware Update

瀏覽... Upload

## 5.2 DHCP Server

The switch provides DHCP server functions. By enabling DHCP, the switch will become a DHCP server and dynamically assigns IP addresses and related IP information to network clients.

### 5.2.1 Basic Settings

This page allows you to set up DHCP settings for the switch. You can check the **Enabled** checkbox to activate the function. Once the box is checked, you will be able to input information in each column.

### DHCP Server Configuration

Enabled	<input checked="" type="checkbox"/>
Start IP Address	192.168.10.100
End IP Address	192.168.10.200
Subnet Mask	255.255.255.0
Router	192.168.10.254
DNS	192.168.10.254
Lease Time (sec.)	86400
TFTP Server	0.0.0.0
Boot File Name	

Save Reset

### 5.2.2 Dynamic Client List

When DHCP server functions are activated, the switch will collect DHCP client information and display in the following table.

#### DHCP Dynamic Client List

No.	Select	Type	MAC Address	IP Address	Surplus Lease
-----	--------	------	-------------	------------	---------------

### 5.2.3 Client List

You can assign a specific IP address within the dynamic IP range to a specific port. When a device is connected to the port and requests for dynamic IP assigning, the switch will assign the IP address that has previously been assigned to the connected device.

#### DHCP Client List

MAC Address	
IP Address	

No.	Select	Type	MAC Address	IP Address	Surplus Lease
-----	--------	------	-------------	------------	---------------

### 5.2.4 Relay Agent

DHCP relay is used to forward and transfer DHCP messages between the clients and the server when they are not in the same subnet domain. You can configure the function in this page.

#### DHCP Relay Configuration

Relay Mode	Disabled <input type="button" value="v"/>
Relay Server	0.0.0.0
Relay Information Mode	Enabled <input type="button" value="v"/>
Relay Information Policy	Replace <input type="button" value="v"/>

Label	Description
<b>Relay Mode</b>	Indicates the existing DHCP relay mode. The modes include: <b>Enabled:</b> activate DHCP relay. When DHCP relay is enabled, the agent forwards and transfers DHCP messages between the clients

	<p>and the server when they are not in the same subnet domain to prevent the DHCP broadcast message from flooding for security considerations.</p> <p><b>Disabled:</b> disable DHCP relay</p>
<b>Relay Server</b>	<p>Indicates the DHCP relay server IP address. A DHCP relay agent is used to forward and transfer DHCP messages between the clients and the server when they are not in the same subnet domain.</p>
<b>Relay Information Mode</b>	<p>Indicates the existing DHCP relay information mode. The format of DHCP option 82 circuit ID format is "[vlan_id][module_id][port_no]". The first four characters represent the VLAN ID, and the fifth and sixth characters are the module ID. In stand-alone devices, the module ID always equals to 0; in stacked devices, it means switch ID. The last two characters are the port number. For example, "00030108" means the DHCP message received form VLAN ID 3, switch ID 1, and port No. 8. The option 82 remote ID value equals to the switch MAC address.</p> <p>The modes include:</p> <p><b>Enabled:</b> activate DHCP relay information. When DHCP relay information is enabled, the agent inserts specific information (option 82) into a DHCP message when forwarding to a DHCP server and removes it from a DHCP message when transferring to a DHCP client. It only works when DHCP relay mode is enabled.</p> <p><b>Disabled:</b> disable DHCP relay information</p>
<b>Relay Information Policy</b>	<p>Indicates the policies to be enforced when receiving DHCP relay information. When DHCP relay information mode is enabled, if the agent receives a DHCP message that already contains relay agent information, it will enforce the policy. The Replace option is invalid when relay information mode is disabled. The policies includes:</p> <p><b>Replace:</b> replace the original relay information when a DHCP message containing the information is received.</p> <p><b>Keep:</b> keep the original relay information when a DHCP message containing the information is received.</p> <p><b>Drop:</b> drop the package when a DHCP message containing the information is received.</p>

The relay statistics shows the information of relayed packet of the switch.

Auto-refresh  Refresh Clear

### DHCP Relay Statistics

Server Statistics

Transmit to Server	Transmit Error	Receive from Server	Receive Missing Agent Option	Receive Missing Circuit ID	Receive Missing Remote ID	Receive Bad Circuit ID	Receive Bad Remote ID
0	0	0	0	0	0	0	0

Label	Description
<b>Transmit to Sever</b>	The number of packets relayed from the client to the server
<b>Transmit Error</b>	The number of packets with errors when being sent to clients
<b>Receive from Server</b>	The number of packets received from the server
<b>Receive Missing Agent Option</b>	The number of packets received without agent information
<b>Receive Missing Circuit ID</b>	The number of packets received with Circuit ID
<b>Receive Missing Remote ID</b>	The number of packets received with the Remote ID option missing.
<b>Receive Bad Circuit ID</b>	The number of packets whose Circuit ID do not match the known circuit ID
<b>Receive Bad Remote ID</b>	The number of packets whose Remote ID do not match the known Remote ID

Client Statistics

Transmit to Client	Transmit Error	Receive from Client	Receive Agent Option	Replace Agent Option	Keep Agent Option	Drop Agent Option
0	0	0	0	0	0	0

Label	Description
<b>Transmit to Client</b>	The number of packets relayed from the server to the client
<b>Transmit Error</b>	The number of packets with errors when being sent to servers
<b>Receive from Client</b>	The number of packets received from the server
<b>Receive Agent Option</b>	The number of received packets containing relay agent information
<b>Replace Agent Option</b>	The number of packets replaced when received messages contain relay agent information.
<b>Keep Agent Option</b>	The number of packets whose relay agent information is



	retained
<b>Drop Agent Option</b>	The number of packets dropped when received messages contain relay agent information.

## 5.3 Port Setting

Port Setting allows you to manage individual ports of the switch, including traffic, power, and trunks.

### 5.3.1 Port Control

This page shows current port configurations. Ports can also be configured here.

Port Configuration

Refresh

Port	Link	Current	Speed	Flow Control			Maximum Frame Size	Power Control
			Configured	Current Rx	Current Tx	Configured		
*			<>				9600	<>
1	Down	Down	Auto	X	X		9600	Disabled
2	Down	Down	Auto	X	X		9600	Disabled
3	Down	Down	Auto	X	X		9600	Disabled
4	Down	Down	Auto	X	X		9600	Disabled
5	Down	Down	Auto	X	X		9600	Disabled
6	Down	Down	Auto	X	X		9600	Disabled
7	1Gfdx	Up	Auto	X	X		9600	Disabled
8	Down	Down	Auto	X	X		9600	Disabled
9	Down	Down	Auto	X	X		9600	
10	Down	Down	Auto	X	X		9600	
11	Down	Down	Auto	X	X		9600	
12	Down	Down	Auto	X	X		9600	
13	Down	Down	Auto	X	X		9600	
14	Down	Down	Auto	X	X		9600	

Label	Description
<b>Port</b>	The switch port number to which the following settings will be applied.
<b>Link</b>	The current link state is shown by different colors. Green indicates the link is up and red means the link is down.
<b>Current Link Speed</b>	Indicates the current link speed of the port
<b>Configured Link Speed</b>	The drop-down list provides available link speed options for a given switch port <b>Auto</b> selects the highest speed supported by the link partner <b>Disabled</b> disables switch port configuration <b>&lt;&gt;</b> configures all ports
<b>Flow Control</b>	When <b>Auto</b> is selected for the speed, the flow control will be negotiated to the capacity advertised by the link partner. When a fixed-speed setting is selected, that is what is used.

	<p><b>Current Rx</b> indicates whether pause frames on the port are obeyed, and <b>Current Tx</b> indicates whether pause frames on the port are transmitted. The Rx and Tx settings are determined by the result of the last auto-negotiation.</p> <p>You can check the Configured column to use flow control. This setting is related to the setting of <b>Configured Link Speed</b>.</p>
<b>Maximum Frame</b>	You can enter the maximum frame size allowed for the switch port in this column, including FCS. The allowed range is 1518 bytes to 9600 bytes.
<b>Power Control</b>	<p>Shows the current power consumption of each port in percentage. The <b>Configured</b> column allows you to change power saving parameters for each port.</p> <p><b>Disabled:</b> all power savings functions are disabled</p> <p><b>ActiPHY:</b> link down and power savings enabled</p> <p><b>PerfectReach:</b> link up and power savings enabled</p> <p><b>Enabled:</b> both link up and link down power savings enabled</p>
<b>Total Power Usage</b>	Total power consumption of the board, measured in percentage
<b>Save</b>	Click to save changes
<b>Reset</b>	Click to undo any changes made locally and revert to previously saved values
<b>Refresh</b>	Click to refresh the page. Any changes made locally will be undone.

### 5.3.2 Port Trunk

This page allows you to configure the aggregation hash mode and the aggregation group.

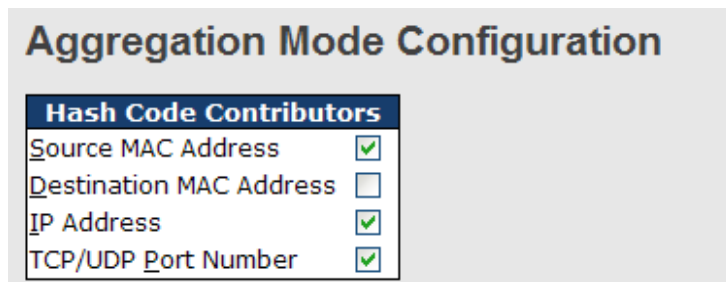

Label	Description
<b>Source MAC Address</b>	Calculates the destination port of the frame. You can check this box to enable the source MAC address, or uncheck to disable. By default, <b>Source MAC Address</b> is enabled.

<b>Destination MAC Address</b>	Calculates the destination port of the frame. You can check this box to enable the destination MAC address, or uncheck to disable. By default, <b>Destination MAC Address</b> is disabled.
<b>IP Address</b>	Calculates the destination port of the frame. You can check this box to enable the IP address, or uncheck to disable. By default, <b>IP Address</b> is enabled.
<b>TCP/UDP Port Number</b>	Calculates the destination port of the frame. You can check this box to enable the TCP/UDP port number, or uncheck to disable. By default, <b>TCP/UDP Port Number</b> is enabled.

Aggregation Group Configuration																				
Group ID	Port Members																			
	1	2	3	4	5	6	7	8	9	10	11	12	13	14	15	16	17	18	19	20
Normal	<input checked="" type="radio"/>	<input checked="" type="radio"/>	<input checked="" type="radio"/>	<input checked="" type="radio"/>	<input checked="" type="radio"/>	<input checked="" type="radio"/>	<input checked="" type="radio"/>	<input checked="" type="radio"/>	<input checked="" type="radio"/>	<input checked="" type="radio"/>	<input checked="" type="radio"/>	<input checked="" type="radio"/>	<input checked="" type="radio"/>	<input checked="" type="radio"/>	<input checked="" type="radio"/>	<input checked="" type="radio"/>	<input checked="" type="radio"/>	<input checked="" type="radio"/>	<input checked="" type="radio"/>	<input checked="" type="radio"/>
1	<input type="radio"/>	<input type="radio"/>	<input type="radio"/>	<input type="radio"/>	<input type="radio"/>	<input type="radio"/>	<input type="radio"/>	<input type="radio"/>	<input type="radio"/>	<input type="radio"/>	<input type="radio"/>	<input type="radio"/>	<input type="radio"/>	<input type="radio"/>	<input type="radio"/>	<input type="radio"/>	<input type="radio"/>	<input type="radio"/>	<input type="radio"/>	<input type="radio"/>
2	<input type="radio"/>	<input type="radio"/>	<input type="radio"/>	<input type="radio"/>	<input type="radio"/>	<input type="radio"/>	<input type="radio"/>	<input type="radio"/>	<input type="radio"/>	<input type="radio"/>	<input type="radio"/>	<input type="radio"/>	<input type="radio"/>	<input type="radio"/>	<input type="radio"/>	<input type="radio"/>	<input type="radio"/>	<input type="radio"/>	<input type="radio"/>	<input type="radio"/>
3	<input type="radio"/>	<input type="radio"/>	<input type="radio"/>	<input type="radio"/>	<input type="radio"/>	<input type="radio"/>	<input type="radio"/>	<input type="radio"/>	<input type="radio"/>	<input type="radio"/>	<input type="radio"/>	<input type="radio"/>	<input type="radio"/>	<input type="radio"/>	<input type="radio"/>	<input type="radio"/>	<input type="radio"/>	<input type="radio"/>	<input type="radio"/>	<input type="radio"/>
4	<input type="radio"/>	<input type="radio"/>	<input type="radio"/>	<input type="radio"/>	<input type="radio"/>	<input type="radio"/>	<input type="radio"/>	<input type="radio"/>	<input type="radio"/>	<input type="radio"/>	<input type="radio"/>	<input type="radio"/>	<input type="radio"/>	<input type="radio"/>	<input type="radio"/>	<input type="radio"/>	<input type="radio"/>	<input type="radio"/>	<input type="radio"/>	<input type="radio"/>
5	<input type="radio"/>	<input type="radio"/>	<input type="radio"/>	<input type="radio"/>	<input type="radio"/>	<input type="radio"/>	<input type="radio"/>	<input type="radio"/>	<input type="radio"/>	<input type="radio"/>	<input type="radio"/>	<input type="radio"/>	<input type="radio"/>	<input type="radio"/>	<input type="radio"/>	<input type="radio"/>	<input type="radio"/>	<input type="radio"/>	<input type="radio"/>	<input type="radio"/>
6	<input type="radio"/>	<input type="radio"/>	<input type="radio"/>	<input type="radio"/>	<input type="radio"/>	<input type="radio"/>	<input type="radio"/>	<input type="radio"/>	<input type="radio"/>	<input type="radio"/>	<input type="radio"/>	<input type="radio"/>	<input type="radio"/>	<input type="radio"/>	<input type="radio"/>	<input type="radio"/>	<input type="radio"/>	<input type="radio"/>	<input type="radio"/>	<input type="radio"/>
7	<input type="radio"/>	<input type="radio"/>	<input type="radio"/>	<input type="radio"/>	<input type="radio"/>	<input type="radio"/>	<input type="radio"/>	<input type="radio"/>	<input type="radio"/>	<input type="radio"/>	<input type="radio"/>	<input type="radio"/>	<input type="radio"/>	<input type="radio"/>	<input type="radio"/>	<input type="radio"/>	<input type="radio"/>	<input type="radio"/>	<input type="radio"/>	<input type="radio"/>
8	<input type="radio"/>	<input type="radio"/>	<input type="radio"/>	<input type="radio"/>	<input type="radio"/>	<input type="radio"/>	<input type="radio"/>	<input type="radio"/>	<input type="radio"/>	<input type="radio"/>	<input type="radio"/>	<input type="radio"/>	<input type="radio"/>	<input type="radio"/>	<input type="radio"/>	<input type="radio"/>	<input type="radio"/>	<input type="radio"/>	<input type="radio"/>	<input type="radio"/>
9	<input type="radio"/>	<input type="radio"/>	<input type="radio"/>	<input type="radio"/>	<input type="radio"/>	<input type="radio"/>	<input type="radio"/>	<input type="radio"/>	<input type="radio"/>	<input type="radio"/>	<input type="radio"/>	<input type="radio"/>	<input type="radio"/>	<input type="radio"/>	<input type="radio"/>	<input type="radio"/>	<input type="radio"/>	<input type="radio"/>	<input type="radio"/>	<input type="radio"/>
10	<input type="radio"/>	<input type="radio"/>	<input type="radio"/>	<input type="radio"/>	<input type="radio"/>	<input type="radio"/>	<input type="radio"/>	<input type="radio"/>	<input type="radio"/>	<input type="radio"/>	<input type="radio"/>	<input type="radio"/>	<input type="radio"/>	<input type="radio"/>	<input type="radio"/>	<input type="radio"/>	<input type="radio"/>	<input type="radio"/>	<input type="radio"/>	<input type="radio"/>

Label	Description
<b>Group ID</b>	Indicates the ID of each aggregation group. <b>Normal</b> means no aggregation. Only one group ID is valid per port.
<b>Port Members</b>	Lists each switch port for each group ID. Select a radio button to include a port in an aggregation, or clear the radio button to remove the port from the aggregation. By default, no ports belong to any aggregation group. Only full duplex ports can join an aggregation and the ports must be in the same speed in each group.

### 5.3.3 LACP

This page allows you to enable LACP functions to group ports together to form single virtual links, thereby increasing the bandwidth between the switch and other LACP-compatible devices. LACP trunks are similar to static port trunks, but they are more flexible because LACP is compliant with the IEEE 802.3ad standard. Hence, it is interoperable with equipment from other vendors that also comply with the standard. You can change LACP

port settings in this page.

### LACP Port Configuration

Open in new window

Port	LACP Enabled	Key	Role
1	<input type="checkbox"/>	Auto	Active
2	<input type="checkbox"/>	Auto	Active
3	<input type="checkbox"/>	Auto	Active
4	<input type="checkbox"/>	Auto	Active
5	<input type="checkbox"/>	Auto	Active
6	<input type="checkbox"/>	Auto	Active
7	<input type="checkbox"/>	Auto	Active
8	<input type="checkbox"/>	Auto	Active
9	<input type="checkbox"/>	Auto	Active
10	<input type="checkbox"/>	Auto	Active
11	<input type="checkbox"/>	Auto	Active
12	<input type="checkbox"/>	Auto	Active

Save    Reset

Label	Description
<b>Port</b>	Indicates the ID of each aggregation group. <b>Normal</b> indicates there is no aggregation. Only one group ID is valid per port.
<b>LACP Enabled</b>	Lists each switch port for each group ID. Check to include a port in an aggregation, or clear the box to remove the port from the aggregation. By default, no ports belong to any aggregation group. Only full duplex ports can join an aggregation and the ports must be in the same speed in each group.
<b>Key</b>	The <b>Key</b> value varies with the port, ranging from 1 to 65535. <b>Auto</b> will set the key according to the physical link speed (10Mb = 1, 100Mb = 2, 1Gb = 3). <b>Specific</b> allows you to enter a user-defined value. Ports with the same key value can join in the same aggregation group, while ports with different keys cannot.
<b>Role</b>	Indicates LACP activity status. <b>Active</b> will transmit LACP packets every second, while <b>Passive</b> will wait for a LACP packet from a partner (speak if spoken to).
<b>Save</b>	Click to save changes
<b>Reset</b>	Click to undo any changes made locally and revert to previously

	saved values
--	--------------

### LACP System Status

This page provides a status overview for all LACP instances.

#### LACP System Status

Auto-refresh  Refresh Open in new window

Aggr ID	Partner System ID	Partner Key	Last Changed	Local Ports
No ports enabled or no existing partners				

Label	Description
<b>Aggr ID</b>	The aggregation ID is associated with the aggregation instance. For LLAG, the ID is shown as ' <b>isid:aggr-id</b> ' and for GLAGs as ' <b>aggr-id</b> '
<b>Partner System ID</b>	System ID (MAC address) of the aggregation partner
<b>Partner Key</b>	The key assigned by the partner to the aggregation ID
<b>Last Changed</b>	The time since this aggregation changed.
<b>Last Changed</b>	Indicates which ports belong to the aggregation of the switch/stack. The format is: " <b>Switch ID:Port</b> ".
<b>Refresh</b>	Click to refresh the page immediately
<b>Auto-refresh</b>	Check to enable an automatic refresh of the page at regular intervals

### LACP Status

This page provides an overview of the LACP status for all ports.

#### LACP Status

Auto-refresh  Refresh Open in new window

Port	LACP	Key	Aggr ID	Partner System ID	Partner Port
1	No	-	-	-	-
2	No	-	-	-	-
3	No	-	-	-	-
4	No	-	-	-	-
5	No	-	-	-	-

Label	Description
-------	-------------

<b>Port</b>	Switch port number
<b>LACP</b>	<b>Yes</b> means LACP is enabled and the port link is up. <b>No</b> means LACP is not enabled or the port link is down. <b>Backup</b> means the port cannot join in the aggregation group unless other ports are removed. The LACP status is disabled.
<b>Key</b>	The key assigned to the port. Only ports with the same key can be aggregated
<b>Aggr ID</b>	The aggregation ID assigned to the aggregation group
<b>Partner System ID</b>	The partner's system ID (MAC address)
<b>Partner Port</b>	The partner's port number associated with the port
<b>Refresh</b>	Click to refresh the page immediately
<b>Auto-refresh</b>	Check to enable an automatic refresh of the page at regular intervals

### LACP Statistics

This page provides an overview of the LACP statistics for all ports.

#### LACP Statistics

Auto-refresh  Refresh Clear

Port	LACP		Discarded	
	Transmitted	Received	Unknown	Illegal
1	0	0	0	0
2	0	0	0	0
3	0	0	0	0
4	0	0	0	0
5	0	0	0	0
6	0	0	0	0
7	0	0	0	0
8	0	0	0	0
9	0	0	0	0
10	0	0	0	0
11	0	0	0	0
12	0	0	0	0

Label	Description
<b>Port</b>	Switch port number
<b>LACP Transmitted</b>	The number of LACP frames sent from each port
<b>LACP Received</b>	The number of LACP frames received at each port
<b>Discarded</b>	The number of unknown or illegal LACP frames discarded at each port.
<b>Refresh</b>	Click to refresh the page immediately
<b>Auto-refresh</b>	Check to enable an automatic refresh of the page at regular intervals

<b>Clear</b>	Click to clear the counters for all ports
--------------	---

### 5.3.4 Loop Gourd

This feature prevents loop attack. When receiving loop packets, the port will be disabled automatically, preventing the loop attack from affecting other network devices.

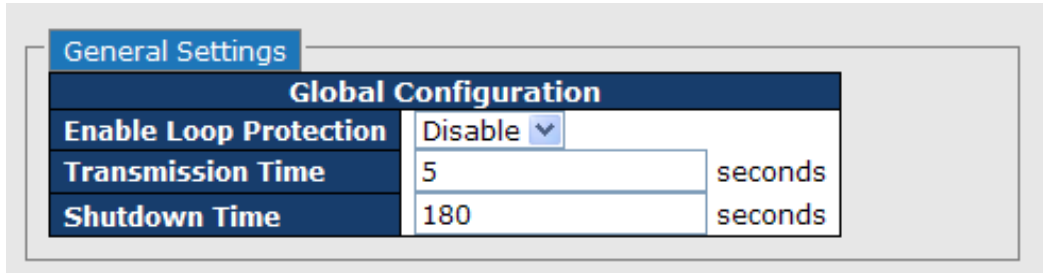

Label	Description
<b>Enable Loop Protection</b>	Activate loop protection functions (as a whole)
<b>Transmission Time</b>	The interval between each loop protection PDU sent on each port. The valid value is 1 to 10 seconds.
<b>Shutdown Time</b>	The period (in seconds) for which a port will be kept disabled when a loop is detected (shutting down the port). The valid value is 0 to 604800 seconds (7 days). A value of zero will keep a port disabled permanently (until the device is restarted).

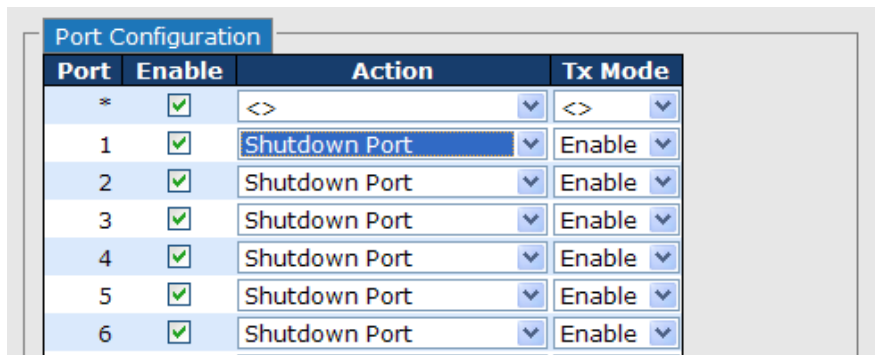

Label	Description
<b>Port</b>	Switch port number
<b>Enable</b>	Activate loop protection functions (as a whole)
<b>Action</b>	Configures the action to take when a loop is detected. Valid values include <b>Shutdown Port</b> , <b>Shutdown Port</b> , and <b>Log or Log Only</b> .

<b>Tx Mode</b>	Controls whether the port is actively generating loop protection PDUs or only passively look for looped PDUs.
----------------	---

**Loop Protection Status**

Auto-refresh

Port	Action	Transmit	Loops	Status	Loop	Time of Last Loop
1	Shutdown	Enabled	0	Down	-	-
2	Shutdown	Enabled	1	Disabled	Loop	1970-01-01 00:11:29+00:00
3	Shutdown	Enabled	0	Down	-	-
4	Shutdown	Enabled	0	Down	-	-
5	Shutdown	Enabled	0	Down	-	-
6	Shutdown	Enabled	0	Down	-	-
7	Shutdown	Enabled	0	Down	-	-
8	Shutdown	Enabled	0	Up	-	-
9	Shutdown	Enabled	0	Down	-	-
10	Shutdown	Enabled	0	Down	-	-

Label	Description
<b>Port</b>	The switch port number of the logical port.
<b>Action</b>	The currently configured port action.
<b>Transmit</b>	The currently configured port transmit mode.
<b>Loops</b>	The number of loops detected on this port.
<b>Status</b>	The current loop protection status of the port
<b>Loop</b>	Whether a loop is currently detected on the port.
<b>Time of Last Loop</b>	The time of the last loop event detected.

## 5.4 VLAN

### 5.4.1 VLAN Membership

You can view and change VLAN membership configurations for a selected switch stack in this page. Up to 64 VLANs are supported. This page allows for adding and deleting VLANs as well as adding and deleting port members of each VLAN.

**VLAN Membership Configuration**

Start from VLAN  with  entries per page.

Delete	VLAN ID	VLAN Name	Port Members												
			1	2	3	4	5	6	7	8	9	10	11	12	
<input type="checkbox"/>	1	default	<input checked="" type="checkbox"/>	<input checked="" type="checkbox"/>	<input checked="" type="checkbox"/>	<input checked="" type="checkbox"/>	<input checked="" type="checkbox"/>	<input checked="" type="checkbox"/>	<input checked="" type="checkbox"/>	<input checked="" type="checkbox"/>	<input checked="" type="checkbox"/>	<input checked="" type="checkbox"/>	<input checked="" type="checkbox"/>	<input checked="" type="checkbox"/>	<input checked="" type="checkbox"/>

Label	Description
<b>Delete</b>	Check to delete the entry. It will be deleted during the next save.



<b>VLAN ID</b>	The VLAN ID for the entry
<b>MAC Address</b>	The MAC address for the entry
<b>Port Members</b>	Checkmarks indicate which ports are members of the entry. Check or uncheck as needed to modify the entry
<b>Add New VLAN</b>	<p>Click to add a new VLAN ID. An empty row is added to the table, and the VLAN can be configured as needed. Valid values for a VLAN ID are 1 through 4095.</p> <p>After clicking <b>Save</b>, the new VLAN will be enabled on the selected switch stack but contains no port members.</p> <p>A VLAN without any port members on any stack will be deleted when you click Save.</p> <p>Click <b>Delete</b> to undo the addition of new VLANs.</p>

### 5.4.2 Port Configurations

This page allows you to set up VLAN ports individually.

Auto-refresh

Ethertype for Custom S-ports 0x

#### VLAN Port Configuration

Port	Port Type	Ingress Filtering	Frame Type	Port VLAN		Tx Tag
				Mode	ID	
*	<>	<input type="checkbox"/>	<>	<>	1	<>
1	Unaware	<input type="checkbox"/>	All	Specific	1	Untag_pvid
2	Unaware	<input type="checkbox"/>	All	Specific	1	Untag_pvid
3	Unaware	<input type="checkbox"/>	All	Specific	1	Untag_pvid
4	Unaware	<input type="checkbox"/>	All	Specific	1	Untag_pvid
5	Unaware	<input type="checkbox"/>	All	Specific	1	Untag_pvid
6	Unaware	<input type="checkbox"/>	All	Specific	1	Untag_pvid
7	Unaware	<input type="checkbox"/>	All	Specific	1	Untag_pvid
8	Unaware	<input type="checkbox"/>	All	Specific	1	Untag_pvid
9	Unaware	<input type="checkbox"/>	All	Specific	1	Untag_pvid
10	Unaware	<input type="checkbox"/>	All	Specific	1	Untag_pvid
11	Unaware	<input type="checkbox"/>	All	Specific	1	Untag_pvid
12	Unaware	<input type="checkbox"/>	All	Specific	1	Untag_pvid

Label	Description
<b>Ethertype for customer S-Ports</b>	This field specifies the Ether type used for custom S-ports. This is a global setting for all custom S-ports.
<b>Port</b>	The switch port number to which the following settings will be applied.
<b>Port type</b>	Port can be one of the following types: <b>Unaware</b> , <b>Customer (C-port)</b> ,

	<p><b>Service (S-port), Custom Service (S-custom-port).</b></p> <p>If port type is <b>Unaware</b>, all frames are classified to the port VLAN ID and tags are not removed.</p>
<b>Ingress Filtering</b>	<p>Enable ingress filtering on a port by checking the box. This parameter affects VLAN ingress processing. If ingress filtering is enabled and the ingress port is not a member of the classified VLAN of the frame, the frame will be discarded. By default, ingress filtering is disabled (no check mark).</p>
<b>Frame Type</b>	<p>Determines whether the port accepts all frames or only tagged/untagged frames. This parameter affects VLAN ingress processing. If the port only accepts tagged frames, untagged frames received on the port will be discarded. By default, the field is set to <b>All</b>.</p>
<b>Port VLAN Mode</b>	<p>The allowed values are <b>None</b> or <b>Specific</b>. This parameter affects VLAN ingress and egress processing.</p> <p>If <b>None</b> is selected, a VLAN tag with the classified VLAN ID is inserted in frames transmitted on the port. This mode is normally used for ports connected to VLAN-aware switches. Tx tag should be set to Untag_pvid when this mode is used.</p> <p>If <b>Specific</b> (the default value) is selected, a port VLAN ID can be configured (see below). Untagged frames received on the port are classified to the port VLAN ID. If VLAN awareness is disabled, all frames received on the port are classified to the port VLAN ID. If the classified VLAN ID of a frame transmitted on the port is different from the port VLAN ID, a VLAN tag with the classified VLAN ID will be inserted in the frame.</p>
<b>Port VLAN ID</b>	<p>Configures the VLAN identifier for the port. The allowed range of the values is 1 through 4095. The default value is 1. The port must be a member of the same VLAN as the port VLAN ID.</p>
<b>Tx Tag</b>	<p>Determines egress tagging of a port. <b>Untag_pvid</b>: all VLANs except the configured PVID will be tagged. <b>Tag_all</b>: all VLANs are tagged. <b>Untag_all</b>: all VLANs are untagged.</p>

### Introduction of Port Types

Below is a detailed description of each port type, including Unaware, C-port, S-port, and S-custom-port.

	Ingress action	Egress action
<b>Unaware</b>	When the port receives untagged frames,	The TPID of a frame

<p><b>The function of Unaware can be used for 802.1QinQ (double tag).</b></p>	<p>an untagged frame obtains a tag (based on PVID) and is forwarded.</p> <p>When the port receives tagged frames:</p> <ol style="list-style-type: none"> <li>1. If the tagged frame contains a TPID of 0x8100, it will become a double-tag frame and will be forwarded.</li> <li>2. If the TPID of tagged frame is not 0x8100 (ex. 0x88A8), it will be discarded.</li> </ol>	<p>transmitted by Unaware port will be set to 0x8100.</p> <p>The final status of the frame after egressing will also be affected by the Egress Rule.</p>
<p><b>C-port</b></p>	<p>When the port receives untagged frames, an untagged frame obtains a tag (based on PVID) and is forwarded.</p> <p>When the port receives tagged frames:</p> <ol style="list-style-type: none"> <li>1. If the tagged frame contains a TPID of 0x8100, it will be forwarded.</li> <li>2. If the TPID of tagged frame is not 0x8100 (ex. 0x88A8), it will be discarded.</li> </ol>	<p>The TPID of a frame transmitted by C-port will be set to 0x8100.</p>
<p><b>S-port</b></p>	<p>When the port receives untagged frames, an untagged frame obtains a tag (based on PVID) and is forwarded.</p> <p>When the port receives tagged frames:</p> <ol style="list-style-type: none"> <li>1. If the tagged frame contains a TPID of 0x8100, it will be forwarded.</li> <li>2. If the TPID of tagged frame is not 0x88A8 (ex. 0x8100), it will be discarded.</li> </ol>	<p>The TPID of a frame transmitted by S-port will be set to 0x88A8.</p>
<p><b>S-custom-port</b></p>	<p>When the port receives untagged frames, an untagged frame obtains a tag (based on PVID) and is forwarded.</p> <p>When the port receives tagged frames:</p> <ol style="list-style-type: none"> <li>1. If the tagged frame contains a TPID of 0x8100, it will be forwarded.</li> <li>2. If the TPID of tagged frame is not 0x88A8 (ex. 0x8100), it will be discarded.</li> </ol>	<p>The TPID of a frame transmitted by S-custom-port will be set to a self-customized value, which can be set by the user via <b>Ethertype for Custom S-ports</b>.</p>

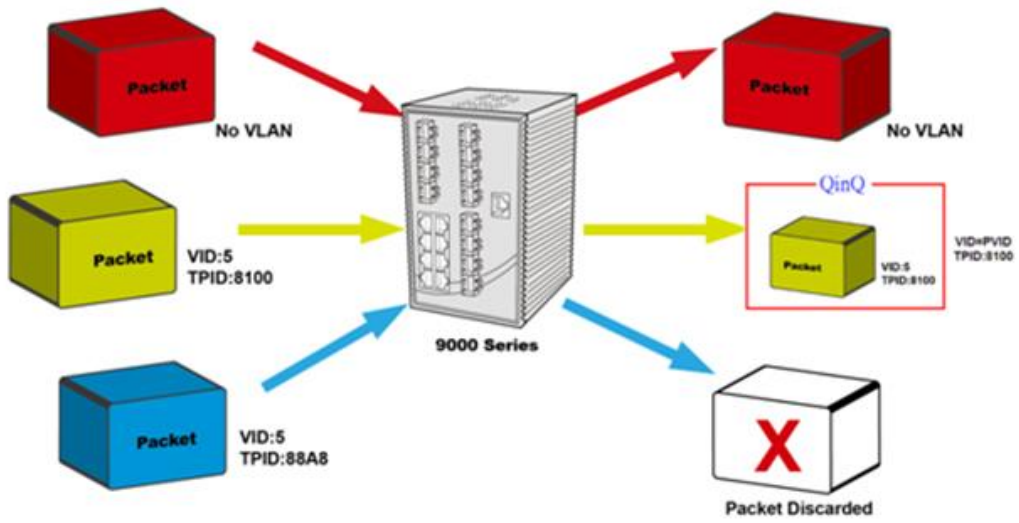

Unaware

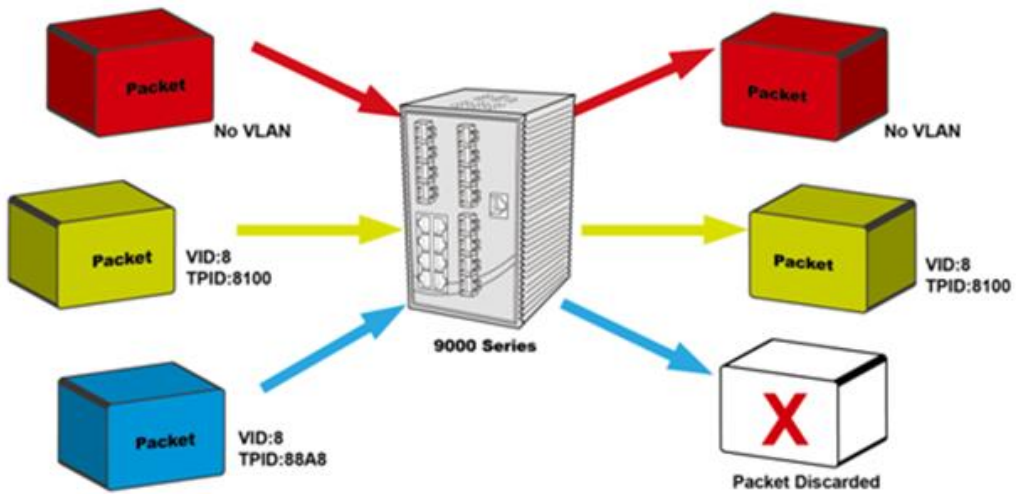

C-port

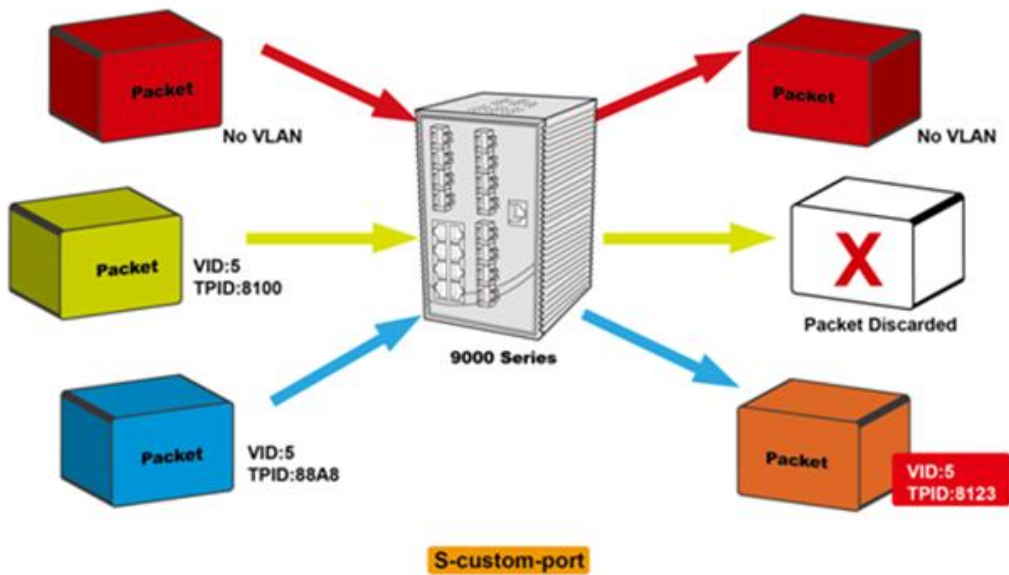
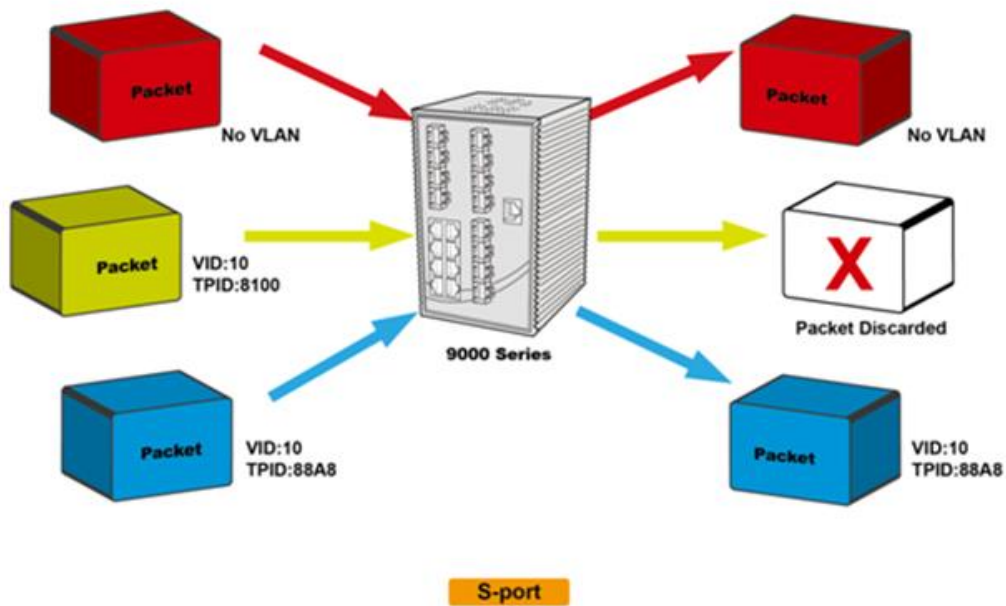

S-custom-port is used for user defined TPID .While Ethertype for Custom S-ports is configured to 8123 , outgoing packet will bring with TPID 8123 tag .

## Examples of VLAN Settings

### VLAN Access Mode:

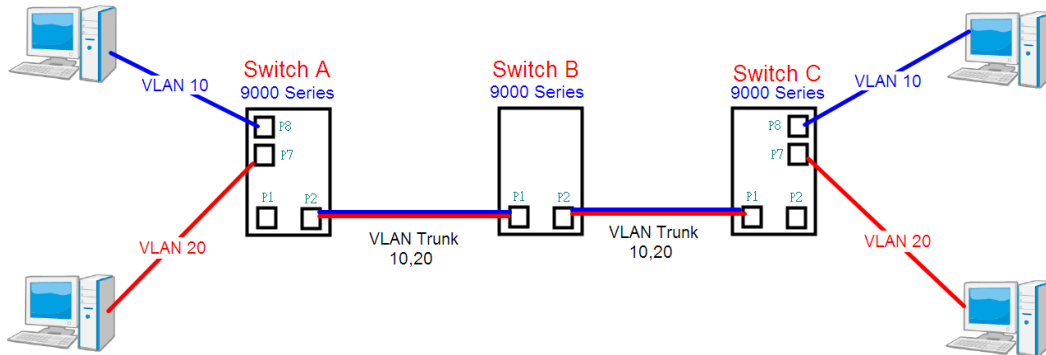

### Switch A,

Port 7 is VLAN Access mode = Untagged 20

Port 8 is VLAN Access mode = Untagged 10

Below are the switch settings.

- Open all
- System Information
- Front Panel
- Basic Setting
- DHCP Server/Relay
- Port Setting
- Redundancy
- VLAN
  - VLAN Membership
  - Ports
  - Private VLAN
- SNMP
- Traffic Prioritization
- Multicast
- Security
- Warning
- Monitor and Diag
- Synchronization
- PoE

### VLAN Membership Configuration

Refresh | << | >>

Start from VLAN  with  entries per page.

Delete	VLAN ID	VLAN Name	Port Members												
			1	2	3	4	5	6	7	8	9	10	11	12	
<input type="checkbox"/>	1	default	✓	✓	✓	✓	✓	✓	✓	✓	✓	✓	✓	✓	✓
<input type="checkbox"/>	10	vlan10	✓												
<input type="checkbox"/>	20	vlan20	✓									✓			

Add New VLAN

Save | Reset

for port 1 VLAN trunk setting

for port 7 & port 8 VLAN Access

- VLAN
- VLAN Membership
- Ports
- Private VLAN
- SNMP
- Traffic Prioritization
- Multicast
- Security
- Warning
- Monitor and Diag
- Synchronization
- PoE
- Factory Default
- System Reboot

Port	Port Type	Ingress Filtering	Frame Type	Mode	ID	Pk Tag
*	<>	<input type="checkbox"/>	<>	<>	1	<>
1	C-port	<input type="checkbox"/>	Tagged	Specific	1	Tag_all
2	Unaware	<input type="checkbox"/>	All	None	1	Untag_pvid
3	Unaware	<input type="checkbox"/>	All	Specific	1	Untag_pvid
4	Unaware	<input type="checkbox"/>	All	Specific	1	Untag_pvid
5	Unaware	<input type="checkbox"/>	All	Specific	1	Untag_pvid
6	Unaware	<input type="checkbox"/>	Untagged	Specific	10	Untag_pvid
7	Unaware	<input type="checkbox"/>	Untagged	Specific	20	Untag_pvid
8	Unaware	<input type="checkbox"/>	Untagged	Specific	30	Untag_pvid
9	Unaware	<input type="checkbox"/>	All	Specific	1	Untag_pvid
10	Unaware	<input type="checkbox"/>	All	Specific	1	Untag_pvid
11	Unaware	<input type="checkbox"/>	All	Specific	1	Untag_pvid

**VLAN 1Q Trunk Mode:**

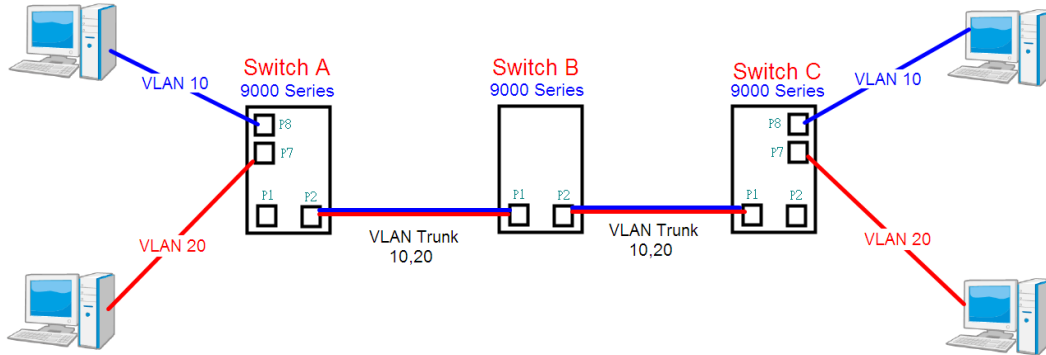

**Switch B,**

Port 1 = VLAN 1Qtrunk mode = tagged 10, 20

Port 2 = VLAN 1Qtrunk mode = tagged 10, 20

Below are the switch settings.

**VLAN Membership Configuration**

Refresh | << >>

Start from VLAN 1 with 20 entries per page.

Delete	VLAN ID	VLAN Name	Port Members												
			1	2	3	4	5	6	7	8	9	10	11	12	
<input type="checkbox"/>	1	default	<input checked="" type="checkbox"/>	<input checked="" type="checkbox"/>	<input checked="" type="checkbox"/>	<input checked="" type="checkbox"/>	<input checked="" type="checkbox"/>	<input checked="" type="checkbox"/>	<input checked="" type="checkbox"/>	<input checked="" type="checkbox"/>	<input checked="" type="checkbox"/>	<input checked="" type="checkbox"/>	<input checked="" type="checkbox"/>	<input checked="" type="checkbox"/>	<input checked="" type="checkbox"/>
<input type="checkbox"/>	10	VLAN10	<input checked="" type="checkbox"/>	<input checked="" type="checkbox"/>	<input type="checkbox"/>	<input type="checkbox"/>	<input type="checkbox"/>	<input type="checkbox"/>	<input type="checkbox"/>	<input type="checkbox"/>	<input type="checkbox"/>	<input type="checkbox"/>	<input type="checkbox"/>	<input type="checkbox"/>	<input type="checkbox"/>
<input type="checkbox"/>	20	VLAN20	<input checked="" type="checkbox"/>	<input checked="" type="checkbox"/>	<input type="checkbox"/>	<input type="checkbox"/>	<input type="checkbox"/>	<input type="checkbox"/>	<input type="checkbox"/>	<input type="checkbox"/>	<input type="checkbox"/>	<input type="checkbox"/>	<input type="checkbox"/>	<input type="checkbox"/>	<input type="checkbox"/>

Add New VLAN

Save Reset

Auto-refresh  Refresh

Ethertype for Custom S-ports 0x88A8

**VLAN Port Configuration**

Port	Port Type	Ingress Filtering	Frame Type	Port VLAN Mode	ID	Tx Tag
*	<>	<input type="checkbox"/>	<>	<>	1	<>
1	C-port	<input type="checkbox"/>	Tagged	Specific	1	Tag_all
2	C-port	<input type="checkbox"/>	Tagged	Specific	1	Tag_all
3	Unaware	<input type="checkbox"/>	All	Specific	1	Untag_pvid
4	Unaware	<input type="checkbox"/>	All	Specific	1	Untag_pvid
5	Unaware	<input type="checkbox"/>	All	Specific	1	Untag_pvid
6	Unaware	<input type="checkbox"/>	All	Specific	1	Untag_pvid
7	Unaware	<input type="checkbox"/>	All	Specific	1	Untag_pvid
8	Unaware	<input type="checkbox"/>	All	Specific	1	Untag_pvid
9	Unaware	<input type="checkbox"/>	All	Specific	1	Untag_pvid
10	Unaware	<input type="checkbox"/>	All	Specific	1	Untag_pvid
11	Unaware	<input type="checkbox"/>	All	Specific	1	Untag_pvid
12	Unaware	<input type="checkbox"/>	All	Specific	1	Untag_pvid

Save Reset



**VLAN Hybrid Mode:**

Port 1 VLAN Hybrid mode = untagged 10  
 Tagged 10, 20

Below are the switch settings.

**VLAN Membership Configuration**

Refresh | << >>

Start from VLAN 1 with 20 entries per page.

Delete	VLAN ID	VLAN Name	Port Members											
			1	2	3	4	5	6	7	8	9	10	11	12
<input type="checkbox"/>	1	default	<input checked="" type="checkbox"/>	<input checked="" type="checkbox"/>	<input checked="" type="checkbox"/>	<input checked="" type="checkbox"/>	<input checked="" type="checkbox"/>	<input checked="" type="checkbox"/>	<input checked="" type="checkbox"/>	<input checked="" type="checkbox"/>	<input checked="" type="checkbox"/>	<input checked="" type="checkbox"/>	<input checked="" type="checkbox"/>	<input checked="" type="checkbox"/>
<input type="checkbox"/>	10	vlan10	<input checked="" type="checkbox"/>	<input type="checkbox"/>	<input type="checkbox"/>	<input type="checkbox"/>	<input type="checkbox"/>	<input type="checkbox"/>	<input type="checkbox"/>	<input type="checkbox"/>	<input type="checkbox"/>	<input type="checkbox"/>	<input type="checkbox"/>	<input type="checkbox"/>
<input type="checkbox"/>	20	vlan20	<input checked="" type="checkbox"/>	<input type="checkbox"/>	<input type="checkbox"/>	<input type="checkbox"/>	<input type="checkbox"/>	<input type="checkbox"/>	<input type="checkbox"/>	<input type="checkbox"/>	<input type="checkbox"/>	<input type="checkbox"/>	<input type="checkbox"/>	<input type="checkbox"/>

Add New VLAN

Save Reset

Auto-refresh  Refresh

Ethertype for Custom S-ports 0x88A8

**VLAN Port Configuration**

Port	Port Type	Ingress Filtering	Frame Type	Port VLAN		Tx Tag
				Mode	ID	
*	<>	<input type="checkbox"/>	<>	<>	1	<>
1	C-port	<input type="checkbox"/>	All	Specific	10	Untag_all
2	Unaware	<input type="checkbox"/>	All	None	1	Untag_pvid
3	Unaware	<input type="checkbox"/>	All	Specific	1	Untag_pvid
4	Unaware	<input type="checkbox"/>	All	Specific	1	Untag_pvid
5	Unaware	<input type="checkbox"/>	All	Specific	1	Untag_pvid
6	Unaware	<input type="checkbox"/>	All	Specific	1	Untag_pvid
7	Unaware	<input type="checkbox"/>	All	Specific	1	Untag_pvid
8	Unaware	<input type="checkbox"/>	All	Specific	1	Untag_pvid
9	Unaware	<input type="checkbox"/>	All	Specific	1	Untag_pvid
10	Unaware	<input type="checkbox"/>	All	Specific	1	Untag_pvid
11	Unaware	<input type="checkbox"/>	All	Specific	1	Untag_pvid
12	Unaware	<input type="checkbox"/>	All	Specific	1	Untag_pvid

Save Reset



**VLAN QinQ Mode:**

VLAN QinQ mode is usually adopted when there are unknown VLANs, as shown in the figure below.

VLAN "X" = Unknown VLAN

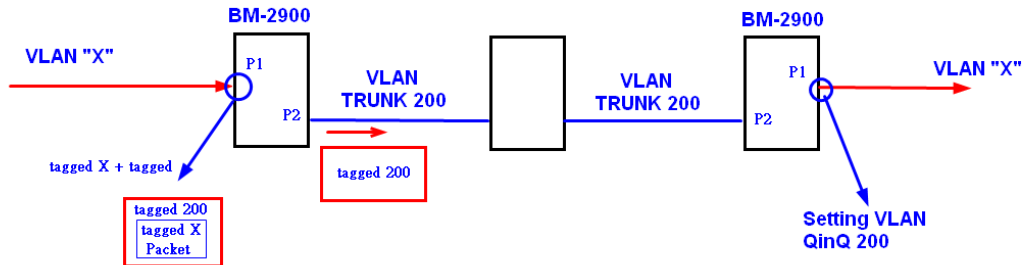

**9000 Series Port 1 VLAN Settings:**

**VLAN Membership Configuration**

Refresh | << | >>

Start from VLAN 1 with 20 entries per page.

Delete	VLAN ID	VLAN Name	Port Members											
			1	2	3	4	5	6	7	8	9	10	11	12
<input type="checkbox"/>	1	default	<input checked="" type="checkbox"/>	<input checked="" type="checkbox"/>	<input checked="" type="checkbox"/>	<input checked="" type="checkbox"/>	<input checked="" type="checkbox"/>	<input checked="" type="checkbox"/>	<input checked="" type="checkbox"/>	<input checked="" type="checkbox"/>	<input checked="" type="checkbox"/>	<input checked="" type="checkbox"/>	<input checked="" type="checkbox"/>	<input checked="" type="checkbox"/>
<input type="checkbox"/>	200	QinQ	<input checked="" type="checkbox"/>	<input checked="" type="checkbox"/>	<input type="checkbox"/>	<input type="checkbox"/>	<input type="checkbox"/>	<input type="checkbox"/>	<input type="checkbox"/>	<input type="checkbox"/>	<input type="checkbox"/>	<input type="checkbox"/>	<input type="checkbox"/>	<input type="checkbox"/>

Add New VLAN

Save | Reset

Auto-refresh  Refresh

Ethertype for Custom S-ports 0x88A8

**VLAN Port Configuration**

Port	Port Type	Ingress Filtering	Frame Type	Port VLAN Mode		Tx Tag
				Mode	ID	
*	<>	<input type="checkbox"/>	<>	<>	1	<>
1	Unaware	<input type="checkbox"/>	All	Specific	200	Untag_all
2	C-port	<input type="checkbox"/>	Tagged	None	1	Tag_all
3	Unaware	<input type="checkbox"/>	All	Specific	1	Untag_pvid
4	Unaware	<input type="checkbox"/>	All	Specific	1	Untag_pvid
5	Unaware	<input type="checkbox"/>	All	Specific	1	Untag_pvid
6	Unaware	<input type="checkbox"/>	All	Specific	1	Untag_pvid

**VLAN ID Settings**

When setting the management VLAN, only the same VLAN ID port can be used to control the switch.

**9000series VLAN Settings:**

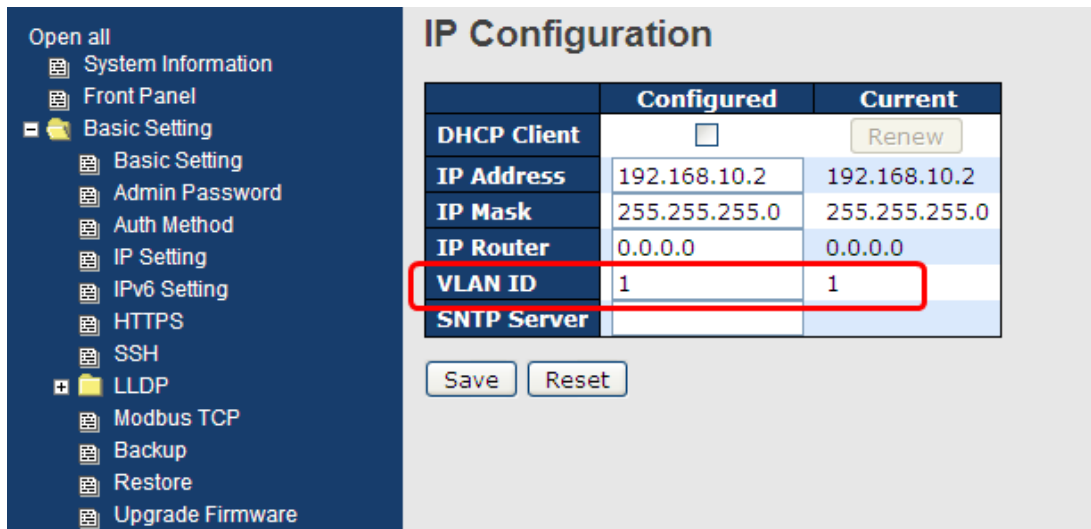

### 5.4.3 Private VLAN

The private VLAN membership configuration for the switch can be monitored and modified here. Private VLANs can be added or deleted here. Port members of each private VLAN can be added or removed here. Private VLANs are based on the source port mask, and there are no connections to VLANs. This means that VLAN IDs and private VLAN IDs can be identical. A port must be a member of both a VLAN and a private VLAN to be able to forward packets. By default, all ports are VLAN unaware and members of VLAN 1 and private VLAN 1. A VLAN-unaware port can only be a member of one VLAN, but it can be a member of multiple private VLANs.

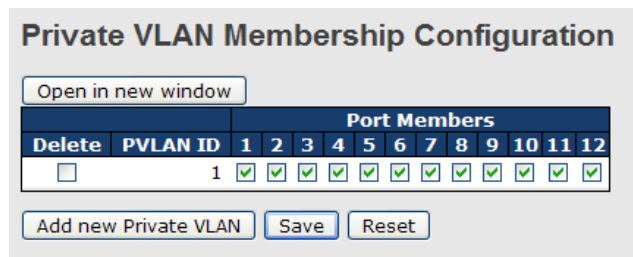

Label	Description
<b>Delete</b>	Check to delete the entry. It will be deleted during the next save.
<b>Private VLAN ID</b>	Indicates the ID of this particular private VLAN.
<b>MAC Address</b>	The MAC address for the entry.
<b>Port Members</b>	A row of check boxes for each port is displayed for each private VLAN ID. You can check the box to include a port in a private VLAN. To remove or exclude the port from the private VLAN, make sure the box is unchecked. By default, no ports are members, and all boxes are unchecked.

<p><b>Adding a New Static Entry</b></p>	<p>Click <b>Add new Private LAN</b> to add a new private VLAN ID. An empty row is added to the table, and the private VLAN can be configured as needed. The allowed range for a private VLAN ID is the same as the switch port number range. Any values outside this range are not accepted, and a warning message appears. Click OK to discard the incorrect entry, or click Cancel to return to the editing and make a correction.</p> <p>The private VLAN is enabled when you click Save.</p> <p>The <b>Delete</b> button can be used to undo the addition of new private VLANs.</p>
---	---

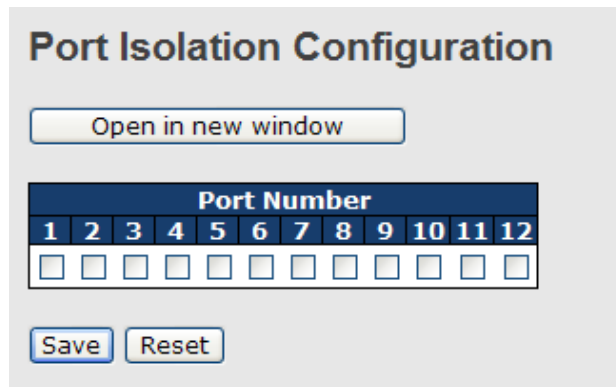

Label	Description
<p><b>Port Members</b></p>	<p>A check box is provided for each port of a private VLAN. When checked, port isolation is enabled for that port. When unchecked, port isolation is disabled for that port. By default, port isolation is disabled for all ports.</p>

## 5.5 SNMP

### 5.5.1 SNMP System Configurations

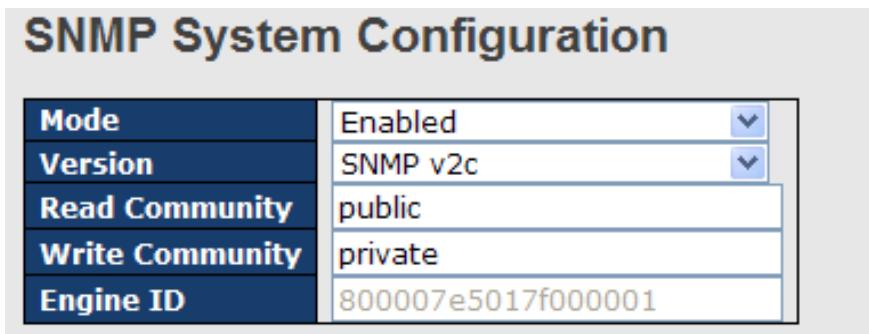

Label	Description
-------	-------------

<b>Mode</b>	Indicates existing SNMP mode. Possible modes include: <b>Enabled:</b> enable SNMP mode <b>Disabled:</b> disable SNMP mode
<b>Version</b>	Indicates the supported SNMP version. Possible versions include: <b>SNMP v1:</b> supports SNMP version 1. <b>SNMP v2c:</b> supports SNMP version 2c. <b>SNMP v3:</b> supports SNMP version 3.
<b>Read Community</b>	Indicates the read community string to permit access to SNMP agent. The allowed string length is 0 to 255, and only ASCII characters from 33 to 126 are allowed. The field only suits to SNMPv1 and SNMPv2c. SNMPv3 uses USM for authentication and privacy and the community string will be associated with SNMPv3 community table.
<b>Write Community</b>	Indicates the write community string to permit access to SNMP agent. The allowed string length is 0 to 255, and only ASCII characters from 33 to 126 are allowed. The field only suits to SNMPv1 and SNMPv2c. SNMPv3 uses USM for authentication and privacy and the community string will be associated with SNMPv3 community table.
<b>Engine ID</b>	Indicates the SNMPv3 engine ID. The string must contain an even number between 10 and 64 hexadecimal digits, but all-zeros and all-'F's are not allowed. Change of the Engine ID will clear all original local users.

### SNMP Trap Configuration

<b>Trap Mode</b>	Disabled <input type="button" value="v"/>
<b>Trap Version</b>	SNMP v1 <input type="button" value="v"/>
<b>Trap Community</b>	public
<b>Trap Destination Address</b>	
<b>Trap Destination IPv6 Address</b>	::
<b>Trap Authentication Failure</b>	Enabled <input type="button" value="v"/>
<b>Trap Link-up and Link-down</b>	Enabled <input type="button" value="v"/>
<b>Trap Inform Mode</b>	Enabled <input type="button" value="v"/>
<b>Trap Inform Timeout (seconds)</b>	1
<b>Trap Inform Retry Times</b>	5

Label	Description
<b>Trap Mode</b>	Indicates existing SNMP trap mode. Possible modes include:

	<p><b>Enabled:</b> enable SNMP trap mode</p> <p><b>Disabled:</b> disable SNMP trap mode</p>
<b>Trap Version</b>	<p>Indicates the supported SNMP trap version. Possible versions include:</p> <p><b>SNMP v1:</b> supports SNMP trap version 1</p> <p><b>SNMP v2c:</b> supports SNMP trap version 2c</p> <p><b>SNMP v3:</b> supports SNMP trap version 3</p>
<b>Trap Community</b>	<p>Indicates the community access string when sending SNMP trap packets. The allowed string length is 0 to 255, and only ASCII characters from 33 to 126 are allowed.</p>
<b>Trap Destination Address</b>	<p>Indicates the SNMP trap destination address</p>
<b>Trap Destination IPv6 Address</b>	<p>Provides the trap destination IPv6 address of this switch. IPv6 address consists of 128 bits represented as eight groups of four hexadecimal digits with a colon separating each field (:). For example, in 'fe80::215:c5ff:fe03:4dc7', the symbol '::' is a special syntax that can be used as a shorthand way of representing multiple 16-bit groups of contiguous zeros; but it can only appear once. It also uses a following legally IPv4 address. For example, '::192.1.2.34'.</p>
<b>Trap Authentication Failure</b>	<p>Indicates the SNMP entity is permitted to generate authentication failure traps. Possible modes include:</p> <p><b>Enabled:</b> enable SNMP trap authentication failure</p> <p><b>Disabled:</b> disable SNMP trap authentication failure</p>
<b>Trap Link-up and Link-down</b>	<p>Indicates the SNMP trap link-up and link-down mode. Possible modes include:</p> <p><b>Enabled:</b> enable SNMP trap link-up and link-down mode</p> <p><b>Disabled:</b> disable SNMP trap link-up and link-down mode</p>
<b>Trap Inform Mode</b>	<p>Indicates the SNMP trap inform mode. Possible modes include:</p> <p><b>Enabled:</b> enable SNMP trap inform mode</p> <p><b>Disabled:</b> disable SNMP trap inform mode</p>
<b>Trap Inform Timeout(seconds)</b>	<p>Configures the SNMP trap inform timeout. The allowed range is 0 to 2147.</p>
<b>Trap Inform Retry Times</b>	<p>Configures the retry times for SNMP trap inform. The allowed range is 0 to 255.</p>

## 5.5.2 SNMP Community Configurations

This page allows you to configure SNMPv3 community table. The entry index key is

Community.

Delete	Community	Source IP	Source Mask
<input type="checkbox"/>	public	0.0.0.0	0.0.0.0
<input type="checkbox"/>	private	0.0.0.0	0.0.0.0

Label	Description
<b>Delete</b>	Check to delete the entry. It will be deleted during the next save.
<b>Community</b>	Indicates the community access string to permit access to SNMPv3 agent. The allowed string length is 1 to 32, and only ASCII characters from 33 to 126 are allowed.
<b>Source IP</b>	Indicates the SNMP source address
<b>Source Mask</b>	Indicates the SNMP source address mask

### 5.5.3 SNMP User Configurations

This page allows you to configure SNMPv3 user table. The entry index keys are **Engine ID** and **User Name**.

Delete	Engine ID	User Name	Security Level	Authentication Protocol	Authentication Password	Privacy Protocol	Privacy Password
<input type="checkbox"/>	800007e5017f000001	default_user	NoAuth, NoPriv	None	None	None	None

Label	Description
<b>Delete</b>	Check to delete the entry. It will be deleted during the next save.
<b>Engine ID</b>	An octet string identifying the engine ID that this entry should belong to. The string must contain an even number between 10 and 64 hexadecimal digits, but all-zeros and all-'F's are not allowed. The SNMPv3 architecture uses User-based Security Model (USM) for message security and View-based Access Control Model (VACM) for access control. For the USM entry, the <b>usmUserEngineID</b> and <b>usmUserName</b> are the entry keys. In a simple agent, usmUserEngineID is always that agent's own snmpEngineID value. The value can also take the value of the snmpEngineID of a remote SNMP

	<p>engine with which this user can communicate. In other words, if user engine ID is the same as system engine ID, then it is local user; otherwise it's remote user.</p>
<b>User Name</b>	<p>A string identifying the user name that this entry should belong to. The allowed string length is 1 to 32, and only ASCII characters from 33 to 126 are allowed.</p>
<b>Security Level</b>	<p>Indicates the security model that this entry should belong to. Possible security models include:</p> <p><b>NoAuth, NoPriv:</b> no authentication and none privacy  <b>Auth, NoPriv:</b> Authentication and no privacy  <b>Auth, Priv:</b> Authentication and privacy</p> <p>The value of security level cannot be modified if the entry already exists, which means the value must be set correctly at the time of entry creation.</p>
<b>Authentication Protocol</b>	<p>Indicates the authentication protocol that this entry should belong to. Possible authentication protocols include:</p> <p><b>None:</b> no authentication protocol  <b>MD5:</b> an optional flag to indicate that this user is using MD5 authentication protocol  <b>SHA:</b> an optional flag to indicate that this user is using SHA authentication protocol</p> <p>The value of security level cannot be modified if the entry already exists, which means the value must be set correctly at the time of entry creation.</p>
<b>Authentication Password</b>	<p>A string identifying the authentication pass phrase. For MD5 authentication protocol, the allowed string length is 8 to 32. For SHA authentication protocol, the allowed string length is 8 to 40. Only ASCII characters from 33 to 126 are allowed.</p>
<b>Privacy Protocol</b>	<p>Indicates the privacy protocol that this entry should belong to. Possible privacy protocols include:</p> <p><b>None:</b> no privacy protocol  <b>DES:</b> an optional flag to indicate that this user is using DES authentication protocol</p>
<b>Privacy Password</b>	<p>A string identifying the privacy pass phrase. The allowed string length is 8 to 32, and only ASCII characters from 33 to 126 are allowed.</p>

### 5.5.4 SNMP Group Configurations

This page allows you to configure SNMPv3 group table. The entry index keys are **Security**

**Model and Security Name.**

### SNMPv3 Groups Configuration

Delete	Security Model	Security Name	Group Name
<input type="checkbox"/>	v1	public	default_ro_group
<input type="checkbox"/>	v1	private	default_rw_group
<input type="checkbox"/>	v2c	public	default_ro_group
<input type="checkbox"/>	v2c	private	default_rw_group
<input type="checkbox"/>	usm	default_user	default_rw_group

Label	Description
<b>Delete</b>	Check to delete the entry. It will be deleted during the next save.
<b>Security Model</b>	Indicates the security model that this entry should belong to. Possible security models included: <b>v1:</b> Reserved for SNMPv1. <b>v2c:</b> Reserved for SNMPv2c. <b>usm:</b> User-based Security Model (USM).
<b>Security Name</b>	A string identifying the security name that this entry should belong to. The allowed string length is 1 to 32, and only ASCII characters from 33 to 126 are allowed.
<b>Group Name</b>	A string identifying the group name that this entry should belong to. The allowed string length is 1 to 32, and only ASCII characters from 33 to 126 are allowed.

### 5.5.5 SNMP View Configurations

This page allows you to configure SNMPv3 view table. The entry index keys are **View Name** and **OID Subtree**.

### SNMPv3 Views Configuration

Delete	View Name	View Type	OID Subtree
<input type="checkbox"/>	default_view	included <input type="button" value="v"/>	.1

Label	Description
<b>Delete</b>	Check to delete the entry. It will be deleted during the next save.



<b>View Name</b>	A string identifying the view name that this entry should belong to. The allowed string length is 1 to 32, and only ASCII characters from 33 to 126 are allowed.
<b>View Type</b>	Indicates the view type that this entry should belong to. Possible view types include:  <b>Included:</b> an optional flag to indicate that this view subtree should be included.  <b>Excluded:</b> An optional flag to indicate that this view subtree should be excluded.  Generally, if an entry's view type is <b>Excluded</b> , it should exist another entry whose view type is <b>Included</b> , and its OID subtree oversteps the <b>Excluded</b> entry.
<b>OID Subtree</b>	The OID defining the root of the subtree to add to the named view. The allowed OID length is 1 to 128. The allowed string content is digital number or asterisk (*).

### 5.5.6 SNMP Access Configurations

This page allows you to configure SNMPv3 access table. The entry index keys are **Group Name**, **Security Model**, and **Security Level**.

**SNMPv3 Accesses Configuration**

Delete	Group Name	Security Model	Security Level	Read View Name	Write View Name
<input type="checkbox"/>	default_ro_group	any	NoAuth, NoPriv	default_view	None
<input type="checkbox"/>	default_rw_group	any	NoAuth, NoPriv	default_view	default_view

Label	Description
<b>Delete</b>	Check to delete the entry. It will be deleted during the next save.
<b>Group Name</b>	A string identifying the group name that this entry should belong to. The allowed string length is 1 to 32, and only ASCII characters from 33 to 126 are allowed.
<b>Security Model</b>	Indicates the security model that this entry should belong to. Possible security models include:  <b>any:</b> Accepted any security model (v1 v2c usm). <b>v1:</b> Reserved for SNMPv1. <b>v2c:</b> Reserved for SNMPv2c. <b>usm:</b> User-based Security Model (USM).
<b>Security Level</b>	Indicates the security model that this entry should belong to. Possible

	<p>security models include:</p> <p><b>NoAuth, NoPriv:</b> no authentication and no privacy</p> <p><b>Auth, NoPriv:</b> Authentication and no privacy</p> <p><b>Auth, Priv:</b> Authentication and privacy</p>
<b>Read View Name</b>	The name of the MIB view defining the MIB objects for which this request may request the current values. The allowed string length is 1 to 32, and only ASCII characters from 33 to 126 are allowed.
<b>Write View Name</b>	The name of the MIB view defining the MIB objects for which this request may potentially SET new values. The allowed string length is 1 to 32, and only ASCII characters from 33 to 126 are allowed.

## 5.6 Traffic Prioritization

### 5.6.1 Storm Control

There is a unicast storm rate control, multicast storm rate control, and a broadcast storm rate control. These only affect flooded frames, i.e. frames with a (VLAN ID, DMAC) pair not present on the MAC Address table.

The rate is  $2^n$ , where n is equal to or less than 15, or "No Limit". The unit of the rate can be either pps (packets per second) or kpps (kilopackets per second). The configuration indicates the permitted packet rate for unicast, multicast, or broadcast traffic across the switch.

Note: frames sent to the CPU of the switch are always limited to approximately 4 kpps. For example, broadcasts in the management VLAN are limited to this rate. The management VLAN is configured on the IP setup page.

Frame Type	Status	Rate (pps)
Unicast	<input type="checkbox"/>	1K
Multicast	<input type="checkbox"/>	1K
Broadcast	<input type="checkbox"/>	1K

Save    Reset

Label	Description
<b>Frame Type</b>	The settings in a particular row apply to the frame type listed here: <b>unicast, multicast, or broadcast.</b>
<b>Status</b>	Enable or disable the storm control status for the given frame type.
<b>Rate</b>	The rate unit is packet per second (pps), configure the rate as 1K, 2K, 4K, 8K, 16K, 32K, 64K, 128K, 256K, 512K, or 1024K.

	The 1 kpps is actually 1002.1 pps.
--	------------------------------------

### 5.6.2 Port Classification

QoS is an acronym for Quality of Service. It is a method to achieve efficient bandwidth utilization between individual applications or protocols.

Port	QoS class	DP level	PCP	DEI	Tag Class.	DSCP Based
*	<> v	<> v	<> v	<> v		<input type="checkbox"/>
1	0 v	0 v	0 v	0 v	Disabled	<input type="checkbox"/>
2	0 v	0 v	0 v	0 v	Disabled	<input type="checkbox"/>
3	0 v	0 v	0 v	0 v	Disabled	<input type="checkbox"/>
4	0 v	0 v	0 v	0 v	Disabled	<input type="checkbox"/>
5	0 v	0 v	0 v	0 v	Disabled	<input type="checkbox"/>
6	0 v	0 v	0 v	0 v	Disabled	<input type="checkbox"/>
7	0 v	0 v	0 v	0 v	Disabled	<input type="checkbox"/>
8	0 v	0 v	0 v	0 v	Disabled	<input type="checkbox"/>
9	0 v	0 v	0 v	0 v	Disabled	<input type="checkbox"/>
10	0 v	0 v	0 v	0 v	Disabled	<input type="checkbox"/>
11	0 v	0 v	0 v	0 v	Disabled	<input type="checkbox"/>
12	0 v	0 v	0 v	0 v	Disabled	<input type="checkbox"/>
13	0 v	0 v	0 v	0 v	Disabled	<input type="checkbox"/>

Label	Description
<b>Port</b>	The port number for which the configuration below applies
<b>QoS Class</b>	<p>Controls the default QoS class</p> <p>All frames are classified to a QoS class. There is a one to one mapping between QoS class, queue, and priority. A QoS class of 0 (zero) has the lowest priority.</p> <p>If the port is VLAN aware and the frame is tagged, then the frame is classified to a QoS class that is based on the PCP value in the tag as shown below. Otherwise the frame is classified to the default QoS class.</p> <p>PCP value: 0 1 2 3 4 5 6 7</p> <p>QoS class: 1 0 2 3 4 5 6 7</p> <p>If the port is VLAN aware, the frame is tagged, and Tag Class is enabled, then the frame is classified to a QoS class that is mapped from the PCP and DEI value in the tag. Otherwise the frame is classified to the default QoS class.</p> <p>The classified QoS class can be overruled by a QCL entry.</p> <p>Note: if the default QoS class has been dynamically changed, then the actual default QoS class is shown in parentheses after the configured</p>

	default QoS class.
<b>DP level</b>	<p>Controls the default Drop Precedence Level</p> <p>All frames are classified to a DP level.</p> <p>If the port is VLAN aware and the frame is tagged, then the frame is classified to a DP level that is equal to the DEI value in the tag. Otherwise the frame is classified to the default DP level.</p> <p>If the port is VLAN aware, the frame is tagged, and Tag Class is enabled, then the frame is classified to a DP level that is mapped from the PCP and DEI value in the tag. Otherwise the frame is classified to the default DP level.</p> <p>The classified DP level can be overruled by a QCL entry.</p>
<b>PCP</b>	<p>Controls the default PCP value</p> <p>All frames are classified to a PCP value.</p> <p>If the port is VLAN aware and the frame is tagged, then the frame is classified to the PCP value in the tag. Otherwise the frame is classified to the default PCP value.</p>
<b>DEI</b>	<p>Controls the default DEI value</p> <p>All frames are classified to a DEI value.</p> <p>If the port is VLAN aware and the frame is tagged, then the frame is classified to the DEI value in the tag. Otherwise the frame is classified to the default DEI value.</p>
<b>Tag Class</b>	<p>Shows the classification mode for tagged frames on this port</p> <p><b>Disabled:</b> Use default QoS class and DP level for tagged frames</p> <p><b>Enabled:</b> Use mapped versions of PCP and DEI for tagged frames</p> <p>Click on the mode to configure the mode and/or mapping</p> <p>Note: this setting has no effect if the port is VLAN unaware. Tagged frames received on VLAN-unaware ports are always classified to the default QoS class and DP level.</p>
<b>DSCP Based</b>	Click to enable DSCP Based QoS Ingress Port Classification

### 5.6.3 Port Tag Remaking

This page provides an overview of QoS Egress Port Tag Remarking for all switch ports.

### QoS Egress Port Tag Remarking

Port	Mode
1	Classified
2	Classified
3	Classified
4	Classified
5	Classified
6	Classified
7	Classified
8	Classified
9	Classified
10	Classified
11	Classified
12	Classified
13	Classified
14	Classified
15	Classified
16	Classified
17	Classified
18	Classified
19	Classified
20	Classified

Label	Description
<b>Port</b>	The switch port number to which the following settings will be applied. Click on the port number to configure tag remarking
<b>Mode</b>	Shows the tag remarking mode for this port <b>Classified:</b> use classified PCP/DEI values <b>Default:</b> use default PCP/DEI values <b>Mapped:</b> use mapped versions of QoS class and DP level

### 5.6.4 Port DSCP

This page allows you to configure basic QoS Port DSCP settings for all switch ports.

#### QoS Port DSCP Configuration

Port	Ingress		Egress
	Translate	Classify	Rewrite
*	<input type="checkbox"/>	<>	<>
1	<input type="checkbox"/>	Disable	Disable
2	<input type="checkbox"/>	Disable	Disable
3	<input type="checkbox"/>	Disable	Disable
4	<input type="checkbox"/>	Disable	Disable
5	<input type="checkbox"/>	Disable	Disable
6	<input type="checkbox"/>	Disable	Disable
7	<input type="checkbox"/>	Disable	Disable
8	<input type="checkbox"/>	Disable	Disable
9	<input type="checkbox"/>	Disable	Disable
10	<input type="checkbox"/>	Disable	Disable
11	<input type="checkbox"/>	Disable	Disable
12	<input type="checkbox"/>	Disable	Disable
13	<input type="checkbox"/>	Disable	Disable
14	<input type="checkbox"/>	Disable	Disable
15	<input type="checkbox"/>	Disable	Disable

Label	Description
<b>Port</b>	Shows the list of ports for which you can configure DSCP Ingress and Egress settings.
<b>Ingress</b>	In <b>Ingress</b> settings you can change ingress translation and classification settings for individual ports. There are two configuration parameters available in Ingress: 1. <b>Translate</b> 2. <b>Classify</b>
<b>1. Translate</b>	Check to enable ingress translation
<b>2. Classify</b>	Classification has 4 different values. Disable: no Ingress DSCP classification DSCP=0: classify if incoming (or translated if enabled) DSCP is 0. Selected: classify only selected DSCP whose classification is enabled as specified in <b>DSCP Translation</b> window for the specific DSCP. All: classify all DSCP
<b>Egress</b>	Port egress rewriting can be one of the following options: <b>Disable</b> : no Egress rewrite <b>Enable</b> : rewrite enabled without remapping <b>Remap DP Unaware</b> : DSCP from the analyzer is remapped and the frame is remarked with a remapped DSCP value. The remapped DSCP value is always taken from the ' <b>DSCP Translation-&gt;Egress Remap DP0</b> ' table. <b>Remap DP Aware</b> : DSCP from the analyzer is remapped and the frame is remarked with a remapped DSCP value. Depending on the DP level of the frame, the remapped DSCP value is either taken from the ' <b>DSCP Translation-&gt;Egress Remap DP0</b> ' table or from the ' <b>DSCP Translation-&gt;Egress Remap DP1</b> ' table.

### 5.6.5 Port Policing

This page allows you to configure Policer settings for all switch ports.

### QoS Ingress Port Policers

Port	Enabled	Rate	Unit	Flow Control
*	<input type="checkbox"/>	500	<>	<input type="checkbox"/>
1	<input type="checkbox"/>	500	kbps	<input type="checkbox"/>
2	<input type="checkbox"/>	500	kbps	<input type="checkbox"/>
3	<input type="checkbox"/>	500	kbps	<input type="checkbox"/>
4	<input type="checkbox"/>	500	kbps	<input type="checkbox"/>
5	<input type="checkbox"/>	500	kbps	<input type="checkbox"/>
6	<input type="checkbox"/>	500	kbps	<input type="checkbox"/>
7	<input type="checkbox"/>	500	kbps	<input type="checkbox"/>
8	<input type="checkbox"/>	500	kbps	<input type="checkbox"/>
9	<input type="checkbox"/>	500	kbps	<input type="checkbox"/>
10	<input type="checkbox"/>	500	kbps	<input type="checkbox"/>
11	<input type="checkbox"/>	500	kbps	<input type="checkbox"/>
12	<input type="checkbox"/>	500	kbps	<input type="checkbox"/>
13	<input type="checkbox"/>	500	kbps	<input type="checkbox"/>
14	<input type="checkbox"/>	500	kbps	<input type="checkbox"/>

Label	Description
<b>Port</b>	The port number for which the configuration below applies
<b>Enable</b>	Check to enable the policer for individual switch ports
<b>Rate</b>	Configures the rate of each policer. The default value is <b>500</b> . This value is restricted to 100 to 1000000 when the <b>Unit</b> is <b>kbps</b> or <b>fps</b> , and is restricted to 1 to 3300 when the <b>Unit</b> is <b>Mbps</b> or <b>kfps</b> .
<b>Unit</b>	Configures the unit of measurement for each policer rate as <b>kbps</b> , <b>Mbps</b> , <b>fps</b> , or <b>kfps</b> . The default value is <b>kbps</b> .
<b>Flow Control</b>	If <b>Flow Control</b> is enabled and the port is in <b>Flow Control</b> mode, then pause frames are sent instead of being discarded.

### 5.6.6 Queue Policing

This page allows you to configure Queue Policer settings for all switch ports.

### QoS Ingress Queue Policers

Port	Queue 0		Queue 1	Queue 2	Queue 3	Queue 4	Queue 5	Queue 6	Queue 7
	E	Rate	Unit	Enable	Enable	Enable	Enable	Enable	Enable
*	<input checked="" type="checkbox"/>	500	<>	<input type="checkbox"/>	<input type="checkbox"/>	<input type="checkbox"/>	<input type="checkbox"/>	<input type="checkbox"/>	<input type="checkbox"/>
1	<input checked="" type="checkbox"/>	500	kbps	<input type="checkbox"/>	<input type="checkbox"/>	<input type="checkbox"/>	<input type="checkbox"/>	<input type="checkbox"/>	<input type="checkbox"/>
2	<input checked="" type="checkbox"/>	500	kbps	<input type="checkbox"/>	<input type="checkbox"/>	<input type="checkbox"/>	<input type="checkbox"/>	<input type="checkbox"/>	<input type="checkbox"/>
3	<input checked="" type="checkbox"/>	500	kbps	<input type="checkbox"/>	<input type="checkbox"/>	<input type="checkbox"/>	<input type="checkbox"/>	<input type="checkbox"/>	<input type="checkbox"/>
4	<input checked="" type="checkbox"/>	500	kbps	<input type="checkbox"/>	<input type="checkbox"/>	<input type="checkbox"/>	<input type="checkbox"/>	<input type="checkbox"/>	<input type="checkbox"/>
5	<input checked="" type="checkbox"/>	500	kbps	<input type="checkbox"/>	<input type="checkbox"/>	<input type="checkbox"/>	<input type="checkbox"/>	<input type="checkbox"/>	<input type="checkbox"/>

Label	Description
<b>Port</b>	The port number for which the configuration below applies.
<b>Enable(E)</b>	Check to enable queue policer for individual switch ports
<b>Rate</b>	Configures the rate of each queue policer. The default value is <b>500</b> . This value is restricted to 100 to 1000000 when the <b>Unit</b> is <b>kbps</b> , and is restricted to 1 to 3300 when the <b>Unit</b> is <b>Mbps</b> . This field is only shown if at least one of the queue policers is enabled.
<b>Unit</b>	Configures the unit of measurement for each queue policer rate as kbps or Mbps. The default value is <b>kbps</b> . This field is only shown if at least one of the queue policers is enabled.

### 5.6.7 QoS Egress Port Scheduler and Shapers

This page allows you to configure Scheduler and Shapers for a specific port.

#### Strict Priority

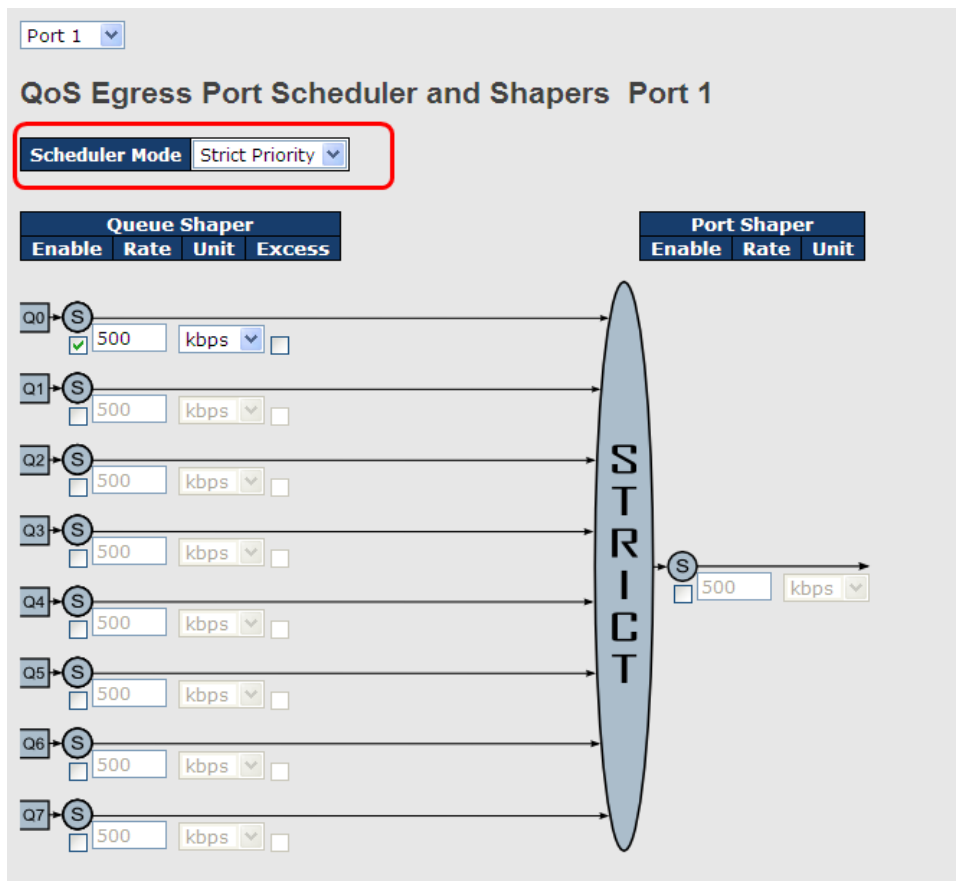

Label	Description
<b>Scheduler Mode</b>	Controls whether the scheduler mode is <b>Strict Priority</b> or



	<b>Weighted</b> on this switch port
<b>Queue Shaper Enable</b>	Check to enable queue shaper for individual switch ports
<b>Queue Shaper Rate</b>	Configures the rate of each queue shaper. The default value is <b>500</b> . This value is restricted to 100 to 1000000 when the <b>Unit</b> is <b>kbps</b> ", and it is restricted to 1 to 3300 when the <b>Unit</b> is <b>Mbps</b> .
<b>Queues Shaper Unit</b>	Configures the rate for each queue shaper. The default value is <b>500</b> . This value is restricted to 100 to 1000000 when the <b>Unit</b> is <b>kbps</b> , and it is restricted to 1 to 3300 when the <b>Unit</b> is <b>Mbps</b> .
<b>Queue Shaper Excess</b>	Allows the queue to use excess bandwidth
<b>Port Shaper Enable</b>	Check to enable port shaper for individual switch ports
<b>Port Shaper Rate</b>	Configures the rate of each port shaper. The default value is <b>500</b> This value is restricted to 100 to 1000000 when the <b>Unit</b> is <b>kbps</b> , and it is restricted to 1 to 3300 when the <b>Unit</b> is <b>Mbps</b> .
<b>Port Shaper Unit</b>	Configures the unit of measurement for each port shaper rate as <b>kbps</b> or <b>Mbps</b> . The default value is <b>kbps</b> .

**Weighted**

Port 1

**QoS Egress Port Scheduler and Shapers Port 1**

Scheduler Mode: **Weighted**

Queue Shaper				Queue Scheduler		Port Shaper		
Enable	Rate	Unit	Excess	Weight	Percent	Enable	Rate	Unit
<input type="checkbox"/>	500	kbps	<input type="checkbox"/>	17	17%	<input type="checkbox"/>	500	kbps
<input type="checkbox"/>	500	kbps	<input type="checkbox"/>	17	17%	<input type="checkbox"/>	500	kbps
<input type="checkbox"/>	500	kbps	<input type="checkbox"/>	17	17%	<input type="checkbox"/>	500	kbps
<input type="checkbox"/>	500	kbps	<input type="checkbox"/>	17	17%	<input type="checkbox"/>	500	kbps
<input type="checkbox"/>	500	kbps	<input type="checkbox"/>	17	17%	<input type="checkbox"/>	500	kbps
<input type="checkbox"/>	500	kbps	<input type="checkbox"/>	17	17%	<input type="checkbox"/>	500	kbps
<input type="checkbox"/>	500	kbps	<input type="checkbox"/>	17	17%	<input type="checkbox"/>	500	kbps
<input type="checkbox"/>	500	kbps	<input type="checkbox"/>	17	17%	<input type="checkbox"/>	500	kbps

Diagram showing traffic flow through DRR and STRICT schedulers, followed by a port shaper.

Label	Description
-------	-------------

<b>Scheduler Mode</b>	Controls whether the scheduler mode is <b>Strict Priority</b> or <b>Weighted</b> on this switch port
<b>Queue Shaper Enable</b>	Check to enable queue shaper for individual switch ports
<b>Queue Shaper Rate</b>	Configures the rate of each queue shaper. The default value is <b>500</b> . This value is restricted to 100 to 1000000 when the <b>Unit</b> is <b>kbps</b> , and it is restricted to 1 to 3300 when the <b>Unit</b> is <b>Mbps</b> .
<b>Queues Shaper Unit</b>	Configures the rate of each queue shaper. The default value is <b>500</b> . This value is restricted to 100 to 1000000 when the <b>Unit</b> " is <b>kbps</b> , and it is restricted to 1 to 3300 when the <b>Unit</b> is <b>Mbps</b> .
<b>Queue Shaper Excess</b>	Allows the queue to use excess bandwidth
<b>Queue Scheduler Weight</b>	Configures the weight of each queue. The default value is <b>17</b> . This value is restricted to 1 to 100. This parameter is only shown if <b>Scheduler Mode</b> is set to <b>Weighted</b> .
<b>Queue Scheduler Percent</b>	Shows the weight of the queue in percentage. This parameter is only shown if <b>Scheduler Mode</b> is set to <b>Weighted</b> .
<b>Port Shaper Enable</b>	Check to enable port shaper for individual switch ports
<b>Port Shaper Rate</b>	Configures the rate of each port shaper. The default value is <b>500</b> . This value is restricted to 100 to 1000000 when the <b>Unit</b> is <b>kbps</b> , and it is restricted to 1 to 3300 when the <b>Unit</b> is <b>Mbps</b> .
<b>Port Shaper Unit</b>	Configures the unit of measurement for each port shaper rate as <b>kbps</b> or <b>Mbps</b> . The default value is <b>kbps</b> .

### 5.6.8 Port Scheduled

This page provides an overview of QoS Egress Port Schedulers for all switch ports.

**QoS Egress Port Schedulers**

Port	Mode	Weight					
		Q0	Q1	Q2	Q3	Q4	Q5
1	Strict Priority	-	-	-	-	-	-
2	Strict Priority	-	-	-	-	-	-
3	Strict Priority	-	-	-	-	-	-
4	Strict Priority	-	-	-	-	-	-
5	Strict Priority	-	-	-	-	-	-
6	Strict Priority	-	-	-	-	-	-

Label	Description
<b>Port</b>	The switch port number to which the following settings will be applied. Click on the port number to configure the schedulers

<b>Mode</b>	Shows the scheduling mode for this port
<b>Qn</b>	Shows the weight for this queue and port

### 5.6.9 Port Shaping

This page provides an overview of QoS Egress Port Shapers for all switch ports.

**QoS Egress Port Shapers**

Port	Shapers								Port	
	Q0	Q1	Q2	Q3	Q4	Q5	Q6	Q7		
1	disabled	disabled	disabled	disabled	disabled	disabled	disabled	disabled	disabled	disabled
2	disabled	disabled	disabled	disabled	disabled	disabled	disabled	disabled	disabled	disabled
3	disabled	disabled	disabled	disabled	disabled	disabled	disabled	disabled	disabled	disabled
4	disabled	disabled	disabled	disabled	disabled	disabled	disabled	disabled	disabled	disabled
5	disabled	disabled	disabled	disabled	disabled	disabled	disabled	disabled	disabled	disabled
6	disabled	disabled	disabled	disabled	disabled	disabled	disabled	disabled	disabled	disabled

Label	Description
<b>Port</b>	The switch port number to which the following settings will be applied. Click on the port number to configure the shapers
<b>Mode</b>	Shows <b>disabled</b> or actual queue shaper rate - e.g. "800 Mbps"
<b>Qn</b>	Shows <b>disabled</b> or actual port shaper rate - e.g. "800 Mbps"

### 5.6.10 DSCP Based QoS

This page allows you to configure basic QoS DSCP-based QoS Ingress Classification settings for all switches.

**DSCP-Based QoS Ingress Classification**

DSCP	Trust	QoS Class	DPL
∞	<input type="checkbox"/>	<> ▾	<> ▾
0 (BE)	<input type="checkbox"/>	0 ▾	0 ▾
1	<input type="checkbox"/>	0 ▾	0 ▾
2	<input type="checkbox"/>	0 ▾	0 ▾
3	<input type="checkbox"/>	0 ▾	0 ▾
4	<input type="checkbox"/>	0 ▾	0 ▾
5	<input type="checkbox"/>	0 ▾	0 ▾

Label	Description
<b>DSCP</b>	Maximum number of supported DSCP values is 64
<b>Trust</b>	Check to trust a specific DSCP value. Only frames with trusted DSCP values are mapped to a specific QoS class and drop precedence level. Frames with untrusted DSCP values are treated as a non-IP frame.

<b>QoS Class</b>	QoS class value can be any number from 0-7.
<b>DPL</b>	Drop Precedence Level (0-1)

### 5.6.11 DSCP Translation

This page allows you to configure basic QoS DSCP translation settings for all switches. DSCP translation can be done in **Ingress** or **Egress**.

DSCP	Ingress		Egress	
	Translate	Classify	Remap DP0	Remap DP1
*	<>	<input type="checkbox"/>	<>	<>
0 (BE)	0 (BE)	<input type="checkbox"/>	0 (BE)	0 (BE)
1	1	<input type="checkbox"/>	1	1
2	2	<input type="checkbox"/>	2	2
3	3	<input type="checkbox"/>	3	3
4	4	<input type="checkbox"/>	4	4
5	5	<input type="checkbox"/>	5	5
6	6	<input type="checkbox"/>	6	6
7	7	<input type="checkbox"/>	7	7
8 (CS1)	8 (CS1)	<input type="checkbox"/>	8 (CS1)	8 (CS1)
9	9	<input type="checkbox"/>	9	9

Label	Description
<b>DSCP</b>	Maximum number of supported DSCP values is 64 and valid DSCP value ranges from 0 to 63.
<b>Ingress</b>	Ingress DSCP can be first translated to new DSCP before using the DSCP for QoS class and DPL map. There are two configuration parameters for DSCP Translation - 1. <b>Translate:</b> DSCP can be translated to any of (0-63) DSCP values. 2. <b>Classify:</b> check to enable ingress classification
<b>Egress</b>	Configurable egress parameters include; <b>Remap DP0:</b> controls the remapping for frames with DP level 0. You can select the DSCP value from a selected menu to which you want to remap. DSCP value ranges form 0 to 63. <b>Remap DP1:</b> controls the remapping for frames with DP level 1. You can select the DSCP value from a selected menu to which you want to remap. DSCP value ranges form 0 to 63.

### 5.6.12 DSCP Classification

This page allows you to configure the mapping of QoS class and Drop Precedence Level to

DSCP value.

QoS Class	DPL	DSCP
*	*	<>
0	0	0 (BE)
0	1	8 (CS1)
1	0	14 (AF13)
1	1	0 (BE)
2	0	0 (BE)

Label	Description
<b>QoS Class</b>	Actual QoS class
<b>DPL</b>	Actual Drop Precedence Level
<b>DSCP</b>	Select the classified DSCP value (0-63)

### 5.6.13 QoS Control List

This page allows you to edit or insert a single QoS control entry at a time. A QCE consists of several parameters. These parameters vary with the frame type you select.

#### QCE Configuration

Port Members																			
1	2	3	4	5	6	7	8	9	10	11	12	13	14	15	16	17	18	19	20
<input checked="" type="checkbox"/>	<input checked="" type="checkbox"/>	<input checked="" type="checkbox"/>	<input checked="" type="checkbox"/>	<input checked="" type="checkbox"/>	<input checked="" type="checkbox"/>	<input checked="" type="checkbox"/>	<input checked="" type="checkbox"/>	<input checked="" type="checkbox"/>	<input checked="" type="checkbox"/>	<input checked="" type="checkbox"/>	<input checked="" type="checkbox"/>	<input checked="" type="checkbox"/>	<input checked="" type="checkbox"/>	<input checked="" type="checkbox"/>	<input checked="" type="checkbox"/>	<input checked="" type="checkbox"/>	<input checked="" type="checkbox"/>	<input checked="" type="checkbox"/>	<input checked="" type="checkbox"/>

#### Key Parameters

<b>Tag</b>	Tag	<input type="text"/>
<b>VID</b>	Specific	Value: <input type="text"/>
<b>PCP</b>	2	
<b>DEI</b>	0	
<b>SMAC</b>	Specific	0x00-00-00
<b>DMAC Type</b>	UC	
<b>Frame Type</b>	Ethernet	

#### Action Parameters

<b>Class</b>	3
<b>DPL</b>	1
<b>DSCP</b>	28 (AF32)

#### MAC Parameters

<b>Ether Type</b>	Specific	Value: 0xFFFF
-------------------	----------	---------------

Label	Description
-------	-------------

Port Members	Check to include the port in the QCL entry. By default, all ports are included.
Key Parameters	<p>Key configurations include:</p> <p><b>Tag:</b> value of tag, can be <b>Any</b>, <b>Untag</b> or <b>Tag</b>.</p> <p><b>VID:</b> valid value of VLAN ID, can be any value from 1 to 4095 <b>Any:</b> user can enter either a specific value or a range of VIDs.</p> <p><b>PCP:</b> Priority Code Point, can be specific numbers (0, 1, 2, 3, 4, 5, 6, 7), a range (0-1, 2-3, 4-5, 6-7, 0-3, 4-7) or <b>Any</b></p> <p><b>DEI:</b> Drop Eligible Indicator, can be any of values between 0 and 1 or <b>Any</b></p> <p><b>SMAC:</b> Source MAC Address, can be 24 MS bits (OUI) or <b>Any</b></p> <p><b>DMAC Type:</b> Destination MAC type, can be <b>unicast (UC)</b>, <b>multicast (MC)</b>, <b>broadcast (BC)</b> or <b>Any</b></p> <p>Frame Type can be the following values:</p> <p><b>Any</b></p> <p><b>Ethernet</b></p> <p><b>LLC</b></p> <p><b>SNAP</b></p> <p><b>IPv4</b></p> <p><b>IPv6</b></p> <p>Note: all frame types are explained below.</p>
Any	Allow all types of frames
Ethernet	Valid Ethernet values can range from 0x600 to 0xFFFF or <b>Any</b> but excluding 0x800(IPv4) and 0x86DD(IPv6). The default value is <b>Any</b> .
LLC	<p>SSAP Address: valid SSAP (Source Service Access Point) values can range from 0x00 to 0xFF or <b>Any</b>. The default value is <b>Any</b>.</p> <p>DSAP Address: valid DSAP (Destination Service Access Point) values can range from 0x00 to 0xFF or <b>Any</b>. The default value is <b>Any</b>.</p> <p>Control Valid Control: valid values can range from 0x00 to 0xFF or <b>Any</b>. The default value is <b>Any</b>.</p>
SNAP	PID: valid PID (a.k.a ethernet type) values can range from 0x00 to 0xFFFF or <b>Any</b> . The default value is <b>Any</b> .
IPv4	<p>Protocol IP Protocol Number: (0-255, TCP or UDP) or <b>Any</b></p> <p>Source IP: specific Source IP address in value/mask format or <b>Any</b>. IP and mask are in the format of x.y.z.w where x, y, z, and w are decimal numbers between 0 and 255. When the mask is converted to a 32-bit binary string and read from left to right, all bits following the first zero must also be zero.</p> <p>DSCP (Differentiated Code Point): can be a specific value, a range, or <b>Any</b>.</p>

	<p>DSCP values are in the range 0-63 including BE, CS1-CS7, EF or AF11-AF43.</p> <p>IP Fragment: Ipv4 frame fragmented options include 'yes', 'no', and 'any'.</p> <p>Sport Source TCP/UDP Port: (0-65535) or <b>Any</b>, specific value or port range applicable for IP protocol UDP/TCP</p> <p>Dport Destination TCP/UDP Port: (0-65535) or <b>Any</b>, specific value or port range applicable for IP protocol UDP/TCP</p>
IPv6	<p>Protocol IP protocol number: (0-255, TCP or UDP) or <b>Any</b></p> <p>Source IP IPv6 source address: (a.b.c.d) or <b>Any</b>, 32 LS bits</p> <p>DSCP (Differentiated Code Point): can be a specific value, a range, or <b>Any</b>. DSCP values are in the range 0-63 including BE, CS1-CS7, EF or AF11-AF43.</p> <p>Sport Source TCP/UDP port: (0-65535) or <b>Any</b>, specific value or port range applicable for IP protocol UDP/TCP</p> <p>Dport Destination TCP/UDP port: (0-65535) or <b>Any</b>, specific value or port range applicable for IP protocol UDP/TCP</p>
Action Parameters	<p>Class QoS class: (0-7) or <b>Default</b></p> <p>Valid Drop Precedence Level value can be (0-1) or <b>Default</b>.</p> <p>Valid DSCP value can be (0-63, BE, CS1-CS7, EF or AF11-AF43) or <b>Default</b>.</p> <p>Default means that the default classified value is not modified by this QCE.</p>

### 5.6.14 QoS Counters

This page provides the statistics of individual queues for all switch ports.

#### Queuing Counters

Auto-refresh  Refresh Clear

Port	Q0		Q1		Q2		Q3		Q4		Q5		Q6		Q7	
	Rx	Tx	Rx	Tx	Rx	Tx	Rx	Tx	Rx	Tx	Rx	Tx	Rx	Tx	Rx	Tx
1	0	0	0	0	0	0	0	0	0	0	0	0	0	0	0	0
2	0	0	0	0	0	0	0	0	0	0	0	0	0	0	0	0
3	0	0	0	0	0	0	0	0	0	0	0	0	0	0	0	0
4	0	0	0	0	0	0	0	0	0	0	0	0	0	0	0	0
5	0	0	0	0	0	0	0	0	0	0	0	0	0	0	0	0
6	0	0	0	0	0	0	0	0	0	0	0	0	0	0	0	0
7	586	0	0	0	0	0	0	0	0	0	0	0	0	0	0	493
8	1307	0	0	0	0	0	0	0	0	0	0	0	0	0	0	2326
9	0	0	0	0	0	0	0	0	0	0	0	0	0	0	0	0

Label	Description
-------	-------------

<b>Port</b>	The switch port number to which the following settings will be applied.
<b>Qn</b>	There are 8 QoS queues per port. Q0 is the lowest priority
<b>Rx / Tx</b>	The number of received and transmitted packets per queue

### 5.6.15 QCL Status

This page shows the QCL status by different QCL users. Each row describes the QCE that is defined. It is a conflict if a specific QCE is not applied to the hardware due to hardware limitations. The maximum number of QCEs is 256 on each switch.

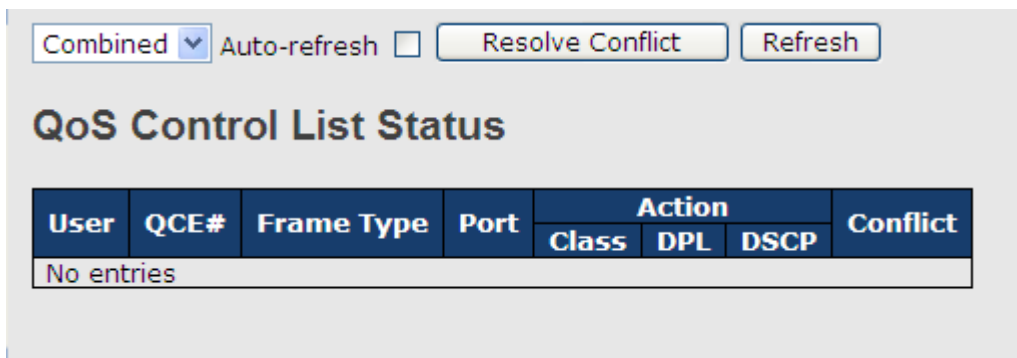

Label	Description
<b>User</b>	Indicates the QCL user
<b>QCE#</b>	Indicates the index of QCE
<b>Frame Type</b>	Indicates the type of frame to look for incoming frames. Possible frame types are: <b>Any</b> : the QCE will match all frame type. <b>Ethernet</b> : Only Ethernet frames (with Ether Type 0x600-0xFFFF) are allowed. <b>LLC</b> : Only (LLC) frames are allowed. <b>SNAP</b> : Only (SNAP) frames are allowed. <b>IPv4</b> : the QCE will match only IPV4 frames. <b>IPv6</b> : the QCE will match only IPV6 frames.
<b>Port</b>	Indicates the list of ports configured with the QCE.
<b>Action</b>	Indicates the classification action taken on ingress frame if parameters configured are matched with the frame's content. There are three action fields: <b>Class</b> , <b>DPL</b> , and <b>DSCP</b> . <b>Class</b> : Classified QoS; if a frame matches the QCE, it will be put in the queue. <b>DPL</b> : Drop Precedence Level; if a frame matches the QCE, then DP level



	<p>will set to a value displayed under DPL column.</p> <p><b>DSCP:</b> if a frame matches the QCE, then DSCP will be classified with the value displayed under DSCP column.</p>
<b>Conflict</b>	<p>Displays the conflict status of QCL entries. As hardware resources are shared by multiple applications, resources required to add a QCE may not be available. In that case, it shows conflict status as <b>Yes</b>, otherwise it is always <b>No</b>. Please note that conflict can be resolved by releasing the hardware resources required to add the QCL entry by pressing <b>Resolve Conflict</b> button.</p>

## 5.7 Multicast

### 5.7.1 IGMP Snooping

This page provides IGMP Snooping related configurations.

The screenshot shows the 'IGMP Snooping Configuration' interface. It is divided into two main sections:

- Global Configuration:** Contains two checkboxes: 'Snooping Enabled' (unchecked) and 'Unregistered IPMCv4 Flooding Enabled' (checked).
- Port Related Configuration:** A table with three columns: 'Port', 'Router Port', and 'Fast Leave'. The 'Port' column lists values from '\*' to 6. The 'Router Port' and 'Fast Leave' columns each contain a checkbox, all of which are currently unchecked.

Label	Description
<b>Snooping Enabled</b>	Check to enable global IGMP snooping
<b>Unregistered IPMCv4 Flooding enabled</b>	Check to enable unregistered IPMC traffic flooding
<b>Router Port</b>	<p>Specifies which ports act as router ports. A router port is a port on the Ethernet switch that leads towards the Layer 3 multicast device or IGMP querier.</p> <p>If an aggregation member port is selected as a router port, the whole aggregation will act as a router port.</p>

<b>Fast Leave</b>	Check to enable fast leave on the port
-------------------	--

### 5.7.2 VLAN Configurations of IGMP Snooping

Each page shows up to 99 entries from the VLAN table, with a default value of 20, selected by the **Entries Per Page** input field. When first visited, the web page will show the first 20 entries from the beginning of the VLAN Table. The first displayed will be the one with the lowest VLAN ID found in the VLAN Table.

The **VLAN** input field allows the user to select the starting point in the VLAN Table. Clicking the **Refresh** button will update the displayed table starting from that or the next closest VLAN Table match.

The **>>** will use the last entry of the currently displayed entry as a basis for the next lookup. When the end is reached, the text **No more entries** is shown in the displayed table. Use the **|<<** button to start over.

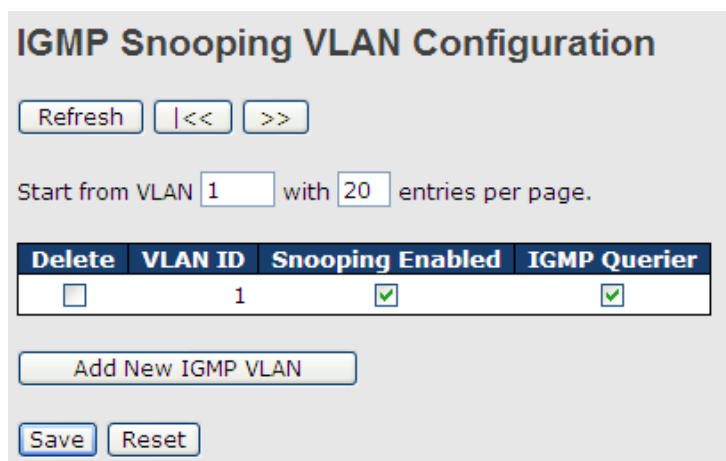

Label	Description
<b>Delete</b>	Check to delete the entry. The designated entry will be deleted during the next save.
<b>VLAN ID</b>	The VLAN ID of the entry
<b>IGMP Snooping Enable</b>	Check to enable IGMP snooping for individual VLAN. Up to 32 VLANs can be selected.
<b>IGMP Querier</b>	Check to enable the IGMP Querier in the VLAN

### 5.7.3 IGMP Snooping Status

This page provides IGMP snooping status.

Auto-refresh  Refresh Clear

### IGMP Snooping Status

Statistics

VLAN ID	Querier Version	Host Version	Querier Status	Queries Transmitted	Queries Received	V1 Reports Received	V2 Reports Received	V3 Reports Received	V2 Leaves Received
1	v3	v3	DISABLE	0	0	0	0	0	0

Router Port

Port	Status
1	-
2	-
3	-
4	-
5	-
6	-

Label	Description
<b>VLAN ID</b>	The VLAN ID of the entry
<b>Querier Version</b>	Active Querier version
<b>Host Version</b>	Active Host version
<b>Querier Status</b>	Shows the Querier status as <b>ACTIVE</b> or <b>IDLE</b>
<b>Querier Receive</b>	The number of transmitted Querier
<b>V1 Reports Receive</b>	The number of received V1 reports
<b>V2 Reports Receive</b>	The number of received V2 reports
<b>V3 Reports Receive</b>	The number of received V3 reports
<b>V2 Leave Receive</b>	The number of received V2 leave packets
<b>Refresh</b>	Click to refresh the page immediately
<b>Clear</b>	Clear all statistics counters
<b>Auto-refresh</b>	Check to enable an automatic refresh of the page at regular intervals
<b>Port</b>	Switch port number
<b>Status</b>	Indicates whether a specific port is a router port or not

### 5.7.4 Groups Information of IGMP Snooping

Entries in the **IGMP Group Table** are shown on this page. The **IGMP Group Table** is sorted first by VLAN ID, and then by group.

### IGMP Snooping Group Information

Auto-refresh  Refresh |<< >>

Start from VLAN  and group address  with  entries per page.

VLAN ID	Groups	Port Members																			
		1	2	3	4	5	6	7	8	9	10	11	12	13	14	15	16	17	18	19	20
No more entries																					

Label	Description
<b>VLAN ID</b>	The VLAN ID of the group
<b>Groups</b>	The group address of the group displayed
<b>Port Members</b>	Ports under this group

## 5.8 Security

### 5.8.1 Remote Control Security Configurations

Remote Control Security allows you to limit the remote access to the management interface.

When enabled, requests of the client which is not in the allow list will be rejected.

### Remote Control Security Configuration

Mode

Delete	Port	IP	Web	Telnet	SNMP
<input type="button" value="Delete"/>	<input type="text" value="Any"/>	<input type="text" value="0.0.0.0"/>	<input type="checkbox"/>	<input type="checkbox"/>	<input type="checkbox"/>

Label	Description
<b>Port</b>	Port number of the remote client
<b>IP Address</b>	IP address of the remote client. <b>0.0.0.0</b> means "any IP".
<b>Web</b>	Check to enable management via a Web interface
<b>Telnet</b>	Check to enable management via a Telnet interface
<b>SNMP</b>	Check to enable management via a SNMP interface
<b>Delete</b>	Check to delete entries

### 5.8.2 Device Binding

This page provides device binding configurations. Device binding is a powerful way to monitor devices and network security.

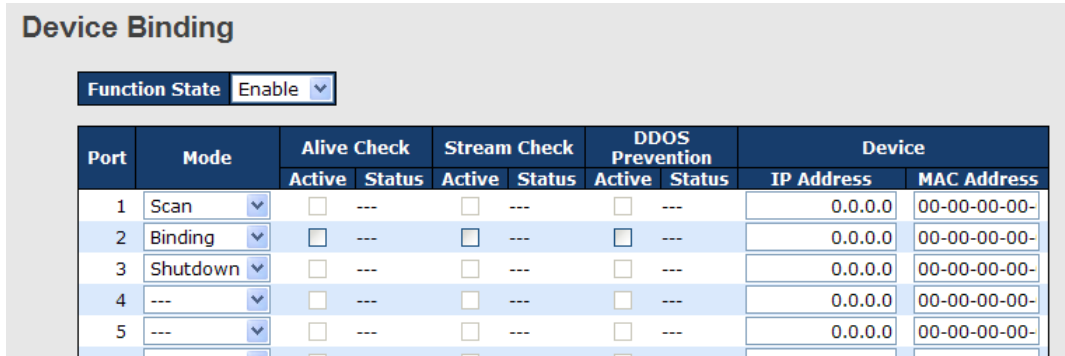

Label	Description
<b>Mode</b>	Indicates the device binding operation for each port. Possible modes are: ---: disable <b>Scan</b> : scans IP/MAC automatically, but no binding function <b>Binding</b> : enables binding. Under this mode, any IP/MAC that does not match the entry will not be allowed to access the network. <b>Shutdown</b> : shuts down the port (No Link)
<b>Alive Check Active</b>	Check to enable alive check. When enabled, switch will ping the device continually.
<b>Alive Check Status</b>	Indicates alive check status. Possible statuses are: ---: disable <b>Got Reply</b> : receive ping reply from device, meaning the device is still alive <b>Lost Reply</b> : not receiving ping reply from device, meaning the device might have been dead.
<b>Stream Check Active</b>	Check to enable stream check. When enabled, the switch will detect the stream change (getting low) from the device.
<b>Stream Check Status</b>	Indicates stream check status. Possible statuses are: ---: disable <b>Normal</b> : the stream is normal. <b>Low</b> : the stream is getting low.
<b>DDoS Prevention Acton</b>	Check to enable DDOS prevention. When enabled, the switch will monitor the device against DDOS attacks.

<b>DDoS Prevention Status</b>	Indicates DDoS prevention status. Possible statuses are: ---: disable <b>Analyzing</b> : analyzes packet throughput for initialization <b>Running</b> : analysis completes and ready for next move <b>Attacked</b> : DDoS attacks occur
<b>Device IP Address</b>	Specifies IP address of the device
<b>Device MAC Address</b>	Specifies MAC address of the device

## Advanced Configurations

### Alias IP Address

This page provides Alias IP Address configuration. Some devices might have more than one IP addresses. You could specify the other IP address here.

Port	Alias IP Address
1	0.0.0.0
2	0.0.0.0
3	0.0.0.0
4	0.0.0.0
5	0.0.0.0
6	0.0.0.0
7	0.0.0.0

Label	Description
<b>Alias IP Address</b>	Specifies alias IP address. Keep <b>0.0.0.0</b> if the device does not have an alias IP address.

### Alive Check

You can use ping commands to check port link status. If port link fails, you can set actions from the drop-down list.

### Alive Check

Port	Mode	Action	Status
1	---	---	---
2	---	---	---
3	---	---	---
4	---	---	---
5	---	---	---
6	---	---	---
7	---	---	---
8	---	---	---
9	---	---	---
10	---	---	---
11	---	---	---
12	---	---	---

- Link Change
- Only Log it
- Shunt Down the Port
- Reboot Device

Label	Description
<b>Link Change</b>	Disables or enables the port
<b>Only log it</b>	Simply sends logs to the log server
<b>Shunt Down the Port</b>	Disables the port
<b>Reboot Device</b>	Disables or enables PoE power

### DDoS Prevention

This page provides DDOS Prevention configurations. The switch can monitor ingress packets, and perform actions when DDOS attack occurred on this port. You can configure the setting to achieve maximum protection.

#### DDOS Prevention

Port	Mode	Sensibility	Packet Type	Socket Number		Filter	Action	Status
				Low	High			
1	Enabled	Normal	TCP	80	80	Destination	---	Running...
2	---	Normal	TCP	80	80	Destination	---	---
3	---	Normal	TCP	80	80	Destination	---	---
4	---	Normal	TCP	80	80	Destination	---	---
5	---	Normal	TCP	80	80	Destination	---	---
6	---	Normal	TCP	80	80	Destination	---	---
7	---	Normal	TCP	80	80	Destination	---	---
8	---	Normal	TCP	80	80	Destination	---	---
9	---	Normal	TCP	80	80	Destination	---	---
10	---	Normal	TCP	80	80	Destination	---	---
11	---	Normal	TCP	80	80	Destination	---	---

- Blocking 1 minute
- Blocking 10 minute
- Blocking
- Shunt Down the Port
- Only Log it
- Reboot Device

Label	Description
<b>Mode</b>	Enables or disables DDOS prevention of the port
<b>Sensibility</b>	Indicates the level of DDOS detection. Possible levels are: <b>Low:</b> low sensibility <b>Normal:</b> normal sensibility

	<p><b>Medium:</b> medium sensibility</p> <p><b>High:</b> high sensibility</p>
<b>Packet Type</b>	<p>Indicates the types of DDoS attack packets to be monitored. Possible types are:</p> <p><b>RX Total:</b> all ingress packets</p> <p><b>RX Unicast:</b> unicast ingress packets</p> <p><b>RX Multicast:</b> multicast ingress packets</p> <p><b>RX Broadcast:</b> broadcast ingress packets</p> <p><b>TCP:</b> TCP ingress packets</p> <p><b>UDP:</b> UDP ingress packets</p>
<b>Socket Number</b>	<p>If packet type is UDP (or TCP), please specify the socket number here. The socket number can be a range, from low to high. If the socket number is only one, please fill the same number in the low and high fields.</p>
<b>Filter</b>	<p>If packet type is UDP (or TCP), please choose the socket direction (<b>Destination/Source</b>).</p>
<b>Action</b>	<p>Indicates the action to take when DDOS attacks occur. Possible actions are:</p> <p>---: no action</p> <p><b>Blocking 1 minute:</b> blocks the forwarding for 1 minute and log the event</p> <p><b>Blocking 10 minute:</b> blocks the forwarding for 10 minutes and log the event</p> <p><b>Blocking:</b> blocks and logs the event</p> <p><b>Shunt Down the Port:</b> shuts down the port (No Link) and logs the event</p> <p><b>Only Log it:</b> simply logs the event</p> <p><b>Reboot Device:</b> if PoE is supported, the device can be rebooted. The event will be logged.</p>
<b>Status</b>	<p>Indicates the DDOS prevention status. Possible statuses are:</p> <p>---: disables DDOS prevention</p> <p><b>Analyzing:</b> analyzes packet throughput for initialization</p> <p><b>Running:</b> analysis completes and ready for next move</p> <p><b>Attacked:</b> DDOS attacks occur</p>

## Device Description

This page allows you to configure device description settings.



### Device Description

Port	Device		
	Type	Location Address	Description
1	IP Camera		
2	IP Phone		
3	Access Point		
4	PC		
5	PLC		
6	Network Video Recorder		
7	---		
8	---		
9	---		
10	---		
11	---		
12	---		

Label	Description
<b>Device Type</b>	Indicates device types. Possible types are: --- (no specification), <b>IP Camera</b> , <b>IP Phone</b> , <b>Access Point</b> , <b>PC</b> , <b>PLC</b> , and <b>Network Video Recorder</b>
<b>Location Address</b>	Indicates location information of the device. The information can be used for Google Mapping.
<b>Description</b>	Device descriptions

### Stream Check

This page allows you to configure stream check settings.

### Stream Check

Port	Mode	Action	Status
1	Enabled	Log it	Normal
2	---	---	---
3	---	---	---
4	---	---	---
5	---	---	---
6	---	---	---
7	---	---	---
8	---	---	---
9	---	---	---
10	---	---	---
11	---	---	---
12	---	---	---

Label	Description
<b>Mode</b>	Enables or disables stream monitoring of the port
<b>Action</b>	Indicates the action to take when the stream gets low. Possible actions are: ---: no action <b>Log it:</b> simply logs the event

### 5.8.3 ACL

#### Ports

This page allows you to configure the ACL parameters (ACE) of each switch port. These parameters will affect frames received on a port unless the frame matches a specific ACE.

#### ACL Ports Configuration

Port	Policy ID	Action	Rate Limiter ID	Port Copy	Logging	Shutdown	Counter
1	1	Permit	Disabled	Disabled	Disabled	Disabled	108498
2	1	Permit	Disabled	Disabled	Disabled	Disabled	0
3	1	Permit	Disabled	Disabled	Disabled	Disabled	68732984
4	1	Permit	Disabled	Disabled	Disabled	Disabled	0
5	1	Permit	Disabled	Disabled	Disabled	Disabled	0
6	1	Permit	Disabled	Disabled	Disabled	Disabled	68732984
7	1	Permit	Disabled	Disabled	Disabled	Disabled	0
8	1	Permit	Disabled	Disabled	Disabled	Disabled	0

Label	Description
<b>Port</b>	The switch port number to which the following settings will be applied
<b>Policy ID</b>	Select to apply a policy to the port. The allowed values are 1 to 8. The default value is 1.
<b>Action</b>	Select to <b>Permit</b> to permit or <b>Deny</b> to deny forwarding. The default value is <b>Permit</b> .
<b>Rate Limiter ID</b>	Select a rate limiter for the port. The allowed values are <b>Disabled</b> or numbers from 1 to 15. The default value is <b>Disabled</b> .
<b>Port Copy</b>	Select which port frames are copied to. The allowed values are <b>Disabled</b> or a specific port number. The default value is <b>Disabled</b> .
<b>Logging</b>	Specifies the logging operation of the port. The allowed values are: <b>Enabled:</b> frames received on the port are stored in the system log <b>Disabled:</b> frames received on the port are not logged The default value is <b>Disabled</b> . Please note that system log memory

	capacity and logging rate is limited.
<b>Shutdown</b>	Specifies the shutdown operation of this port. The allowed values are: <b>Enabled:</b> if a frame is received on the port, the port will be disabled. <b>Disabled:</b> port shut down is disabled. The default value is <b>Disabled</b> .
<b>Counter</b>	Counts the number of frames that match this ACE.

### Rate Limiters

This page allows you to configure the rate limiter for the ACL of the switch.

Rate Limiter ID	Rate (pps)
1	1
2	1
3	1
4	1
5	1
6	1
7	1
8	1
9	1
10	1
11	1
12	1

Label	Description
<b>Rate Limiter ID</b>	The rate limiter ID for the settings contained in the same row.
<b>Rate</b>	The rate unit is packet per second (pps), which can be configured as 1, 2, 4, 8, 16, 32, 64, 128, 256, 512, 1K, 2K, 4K, 8K, 16K, 32K, 64K, 128K, 256K, 512K, or 1024K. The 1 kpps is actually 1002.1 pps.

### ACL Control List

This page allows you to configure ACE (Access Control Entry).

An ACE consists of several parameters. These parameters vary with the frame type you have selected. First select the ingress port for the ACE, and then the frame type. Different parameter options are displayed according to the frame type you have selected.

A frame matching the ACE can be configured here.

### ACE Configuration

<b>Ingress Port</b>	Port 1	<b>Action</b>	Permit
<b>Frame Type</b>	IPv4	<b>Rate Limiter</b>	Disabled
		<b>Port Copy</b>	Disabled
		<b>Logging</b>	Disabled
		<b>Shutdown</b>	Disabled
		<b>Counter</b>	5197

Label	Description
<b>Ingress Port</b>	<p>Indicates the ingress port to which the ACE will apply.</p> <p><b>Any:</b> the ACE applies to any port</p> <p><b>Port n:</b> the ACE applies to this port number, where n is the number of the switch port.</p> <p><b>Policy n:</b> the ACE applies to this policy number, where n can range from 1 to 8.</p>
<b>Frame Type</b>	<p>Indicates the frame type of the ACE. These frame types are mutually exclusive.</p> <p><b>Any:</b> any frame can match the ACE.</p> <p><b>Ethernet Type:</b> only Ethernet type frames can match the ACE. The IEEE 802.3 describes the value of length/types should be greater than or equal to 1536 decimal (equal to 0600 hexadecimal).</p> <p><b>ARP:</b> only ARP frames can match the ACE. Notice the ARP frames will not match the ACE with Ethernet type.</p> <p><b>IPv4:</b> only IPv4 frames can match the ACE. Notice the IPv4 frames will not match the ACE with Ethernet type.</p>
<b>Action</b>	<p>Specifies the action to take when a frame matches the ACE.</p> <p>Permit: takes action when the frame matches the ACE.</p> <p>Deny: drops the frame matching the ACE.</p>
<b>Rate Limiter</b>	<p>Specifies the rate limiter in number of base units. The allowed range is 1 to 15. <b>Disabled</b> means the rate limiter operation is disabled.</p>
<b>Port Copy</b>	<p>Frames matching the ACE are copied to the port number specified here. The allowed range is the same as the switch port number range. Disabled means the port copy operation is disabled.</p>
<b>Logging</b>	<p>Specifies the logging operation of the ACE. The allowed values are:</p> <p><b>Enabled:</b> frames matching the ACE are stored in the system log.</p> <p><b>Disabled:</b> frames matching the ACE are not logged.</p>

	Please note that system log memory capacity and logging rate is limited.
<b>Shutdown</b>	Specifies the shutdown operation of the ACE. The allowed values are: <b>Enabled:</b> if a frame matches the ACE, the ingress port will be disabled. <b>Disabled:</b> port shutdown is disabled for the ACE.
<b>Counter</b>	Indicates the number of times the ACE matched by a frame.

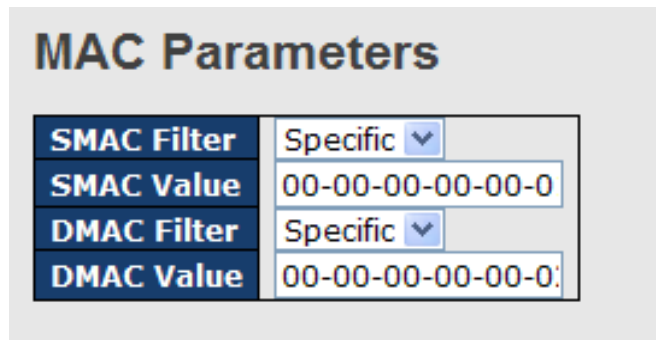

Label	Description
<b>SMAC Filter</b>	(Only displayed when the frame type is Ethernet Type or ARP.) Specifies the source MAC filter for the ACE. <b>Any:</b> no SMAC filter is specified (SMAC filter status is "don't-care"). <b>Specific:</b> if you want to filter a specific source MAC address with the ACE, choose this value. A field for entering an SMAC value appears.
<b>SMAC Value</b>	When <b>Specific</b> is selected for the SMAC filter, you can enter a specific source MAC address. The legal format is "xx-xx-xx-xx-xx-xx". Frames matching the ACE will use this SMAC value.
<b>DMAC Filter</b>	Specifies the destination MAC filter for this ACE <b>Any:</b> no DMAC filter is specified (DMAC filter status is "don't-care"). <b>MC:</b> frame must be multicast. <b>BC:</b> frame must be broadcast. <b>UC:</b> frame must be unicast. <b>Specific:</b> If you want to filter a specific destination MAC address with the ACE, choose this value. A field for entering a DMAC value appears.
<b>DMAC Value</b>	When <b>Specific</b> is selected for the DMAC filter, you can enter a specific destination MAC address. The legal format is "xx-xx-xx-xx-xx-xx". Frames matching the ACE will use this DMAC value.

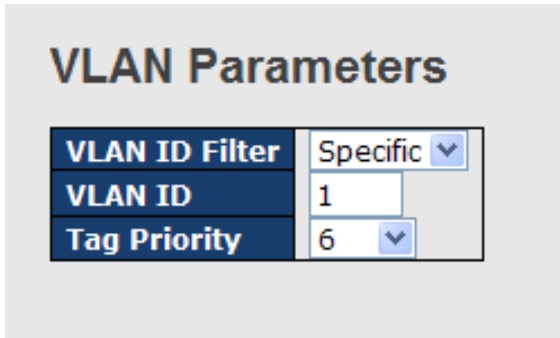

Label	Description
VLAN ID Filter	Specifies the VLAN ID filter for the ACE <b>Any:</b> no VLAN ID filter is specified (VLAN ID filter status is "don't-care"). <b>Specific:</b> if you want to filter a specific VLAN ID with the ACE, choose this value. A field for entering a VLAN ID number appears.
VLAN ID	When <b>Specific</b> is selected for the VLAN ID filter, you can enter a specific VLAN ID number. The allowed range is 1 to 4095. Frames matching the ACE will use this VLAN ID value.
Tag Priority	Specifies the tag priority for the ACE. A frame matching the ACE will use this tag priority. The allowed number range is 0 to 7. <b>Any</b> means that no tag priority is specified (tag priority is "don't-care").

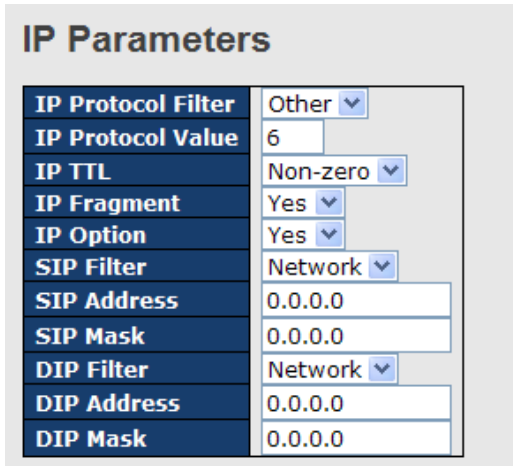

Label	Description
IP Protocol Filter	Specifies the IP protocol filter for the ACE <b>Any:</b> no IP protocol filter is specified ("don't-care"). <b>Specific:</b> if you want to filter a specific IP protocol filter with the ACE, choose this value. A field for entering an IP protocol filter appears.

	<p>ICMP: selects ICMP to filter IPv4 ICMP protocol frames. Extra fields for defining ICMP parameters will appear. For more details of these fields, please refer to the help file.</p> <p><b>UDP:</b> selects UDP to filter IPv4 UDP protocol frames. Extra fields for defining UDP parameters will appear. For more details of these fields, please refer to the help file.</p> <p><b>TCP:</b> selects TCP to filter IPv4 TCP protocol frames. Extra fields for defining TCP parameters will appear. For more details of these fields, please refer to the help file.</p>
<b>IP Protocol Value</b>	<p><b>Specific</b> allows you to enter a specific value. The allowed range is 0 to 255. Frames matching the ACE will use this IP protocol value.</p>
<b>IP TTL</b>	<p>Specifies the time-to-live settings for the ACE</p> <p><b>Zero:</b> IPv4 frames with a time-to-live value greater than zero must not be able to match this entry.</p> <p><b>Non-zero:</b> IPv4 frames with a time-to-live field greater than zero must be able to match this entry.</p> <p><b>Any:</b> any value is allowed ("<b>don't-care</b>").</p>
<b>IP Fragment</b>	<p>Specifies the fragment offset settings for the ACE. This includes settings of More Fragments (MF) bit and Fragment Offset (FRAG OFFSET) for an IPv4 frame.</p> <p><b>No:</b> IPv4 frames whose MF bit is set or the FRAG OFFSET field is greater than zero must not be able to match this entry.</p> <p><b>Yes:</b> IPv4 frames whose MF bit is set or the FRAG OFFSET field is greater than zero must be able to match this entry.</p> <p><b>Any:</b> any value is allowed ("<b>don't-care</b>").</p>
<b>IP Option</b>	<p>Specifies the options flag settings for the ACE</p> <p><b>No:</b> IPv4 frames whose options flag is set must not be able to match this entry.</p> <p><b>Yes:</b> IPv4 frames whose options flag is set must be able to match this entry.</p> <p><b>Any:</b> any value is allowed ("<b>don't-care</b>").</p>
<b>SIP Filter</b>	<p>Specifies the source IP filter for this ACE</p> <p><b>Any:</b> no source IP filter is specified (Source IP filter is "<b>don't-care</b>").</p> <p><b>Host:</b> source IP filter is set to <b>Host</b>. Specify the source IP address in the <b>SIP Address</b> field that appears.</p> <p><b>Network:</b> source IP filter is set to <b>Network</b>. Specify the source IP address and source IP mask in the <b>SIP Address</b> and <b>SIP Mask</b></p>

	fields that appear.
<b>SIP Address</b>	When <b>Host</b> or <b>Network</b> is selected for the source IP filter, you can enter a specific SIP address in dotted decimal notation.
<b>SIP Mask</b>	When <b>Network</b> is selected for the source IP filter, you can enter a specific SIP mask in dotted decimal notation.
<b>DIP Filter</b>	Specifies the destination IP filter for the ACE <b>Any</b> : no destination IP filter is specified (destination IP filter is "don't-care"). <b>Host</b> : destination IP filter is set to <b>Host</b> . Specify the destination IP address in the <b>DIP Address</b> field that appears. <b>Network</b> : destination IP filter is set to <b>Network</b> . Specify the destination IP address and destination IP mask in the <b>DIP Address</b> and <b>DIP Mask</b> fields that appear.
<b>DIP Address</b>	When <b>Host</b> or <b>Network</b> is selected for the destination IP filter, you can enter a specific DIP address in dotted decimal notation.
<b>DIP Mask</b>	When <b>Network</b> is selected for the destination IP filter, you can enter a specific DIP mask in dotted decimal notation.

### ARP Parameters

<b>ARP/RARP</b>	Other	<b>ARP SMAC Match</b>	1
<b>Request/Reply</b>	Request	<b>RARP SMAC Match</b>	1
<b>Sender IP Filter</b>	Network	<b>IP/Ethernet Length</b>	Any
<b>Sender IP Address</b>	192.168.1.1	<b>IP</b>	0
<b>Sender IP Mask</b>	255.255.255.0	<b>Ethernet</b>	1
<b>Target IP Filter</b>	Network		
<b>Target IP Address</b>	192.168.1.254		
<b>Target IP Mask</b>	255.255.255.0		

Label	Description
<b>ARP/RARP</b>	Specifies the available ARP/RARP opcode (OP) flag for the ACE <b>Any</b> : no ARP/RARP OP flag is specified (OP is "don't-care"). <b>ARP</b> : frame must have ARP/RARP opcode set to ARP <b>RARP</b> : frame must have ARP/RARP opcode set to RARP. <b>Other</b> : frame has unknown ARP/RARP Opcode flag.
<b>Request/Reply</b>	Specifies the available ARP/RARP opcode (OP) flag for the ACE <b>Any</b> : no ARP/RARP OP flag is specified (OP is "don't-care"). <b>Request</b> : frame must have ARP Request or RARP Request OP flag



	<p>set.</p> <p><b>Reply:</b> frame must have ARP Reply or RARP Reply OP flag.</p>
<b>Sender IP Filter</b>	<p>Specifies the sender IP filter for the ACE</p> <p><b>Any:</b> no sender IP filter is specified (sender IP filter is "<b>don't-care</b>").</p> <p><b>Host:</b> sender IP filter is set to <b>Host</b>. Specify the sender IP address in the <b>SIP Address</b> field that appears.</p> <p><b>Network:</b> sender IP filter is set to <b>Network</b>. Specify the sender IP address and sender IP mask in the <b>SIP Address</b> and <b>SIP Mask</b> fields that appear.</p>
<b>Sender IP Address</b>	<p>When Host or Network is selected for the sender IP filter, you can enter a specific sender IP address in dotted decimal notation.</p>
<b>Sender IP Mask</b>	<p>When Network is selected for the sender IP filter, you can enter a specific sender IP mask in dotted decimal notation.</p>
<b>Target IP Filter</b>	<p>Specifies the target IP filter for the specific ACE</p> <p><b>Any:</b> no target IP filter is specified (target IP filter is "<b>don't-care</b>").</p> <p><b>Host:</b> target IP filter is set to <b>Host</b>. Specify the target IP address in the <b>Target IP Address</b> field that appears.</p> <p><b>Network:</b> target IP filter is set to <b>Network</b>. Specify the target IP address and target IP mask in the <b>Target IP Address</b> and <b>Target IP Mask</b> fields that appear.</p>
<b>Target IP Address</b>	<p>When <b>Host</b> or <b>Network</b> is selected for the target IP filter, you can enter a specific target IP address in dotted decimal notation.</p>
<b>Target IP Mask</b>	<p>When <b>Network</b> is selected for the target IP filter, you can enter a specific target IP mask in dotted decimal notation.</p>
<b>ARP SMAC Match</b>	<p>Specifies whether frames will meet the action according to their sender hardware address field (SHA) settings.</p> <p><b>0:</b> ARP frames where SHA is not equal to the SMAC address</p> <p><b>1:</b> ARP frames where SHA is equal to the SMAC address</p> <p><b>Any:</b> any value is allowed ("<b>don't-care</b>").</p>
<b>RARP SMAC Match</b>	<p>Specifies whether frames will meet the action according to their target hardware address field (THA) settings.</p> <p><b>0:</b> RARP frames where THA is not equal to the SMAC address</p> <p><b>1:</b> RARP frames where THA is equal to the SMAC address</p> <p><b>Any:</b> any value is allowed ("<b>don't-care</b>")</p>
<b>IP/Ethernet Length</b>	<p>Specifies whether frames will meet the action according to their ARP/RARP hardware address length (HLN) and protocol address length (PLN) settings.</p>

	<p><b>0:</b> ARP/RARP frames where the HLN is equal to Ethernet (0x06) and the (PLN) is equal to IPv4 (0x04) must not match this entry.</p> <p><b>1:</b> ARP/RARP frames where the HLN is equal to Ethernet (0x06) and the (PLN) is equal to IPv4 (0x04) must match this entry.</p> <p><b>Any:</b> any value is allowed ("<b>don't-care</b>").</p>
<b>IP</b>	<p>Specifies whether frames will meet the action according to their ARP/RARP hardware address space (HRD) settings.</p> <p><b>0:</b> ARP/RARP frames where the HLD is equal to Ethernet (1) must not match this entry.</p> <p><b>1:</b> ARP/RARP frames where the HLD is equal to Ethernet (1) must match this entry.</p> <p><b>Any:</b> any value is allowed ("<b>don't-care</b>").</p>
<b>Ethernet</b>	<p>Specifies whether frames will meet the action according to their ARP/RARP protocol address space (PRO) settings.</p> <p><b>0:</b> ARP/RARP frames where the PRO is equal to IP (0x800) must not match this entry.</p> <p><b>1:</b> ARP/RARP frames where the PRO is equal to IP (0x800) must match this entry.</p> <p><b>Any:</b> any value is allowed ("<b>don't-care</b>").</p>

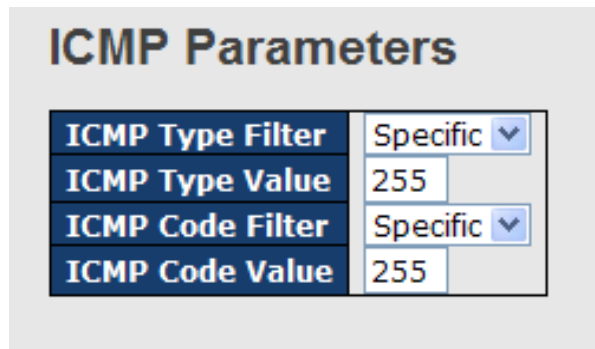

Label	Description
<b>ICMP Type Filter</b>	<p>Specifies the ICMP filter for the ACE</p> <p><b>Any:</b> no ICMP filter is specified (ICMP filter status is "<b>don't-care</b>").</p> <p><b>Specific:</b> if you want to filter a specific ICMP filter with the ACE, you can enter a specific ICMP value. A field for entering an ICMP value appears.</p>
<b>ICMP Type Value</b>	<p>When <b>Specific</b> is selected for the ICMP filter, you can enter a specific ICMP value. The allowed range is 0 to 255. A frame matching</p>

	the ACE will use this ICMP value.
<b>ICMP Code Filter</b>	<p>Specifies the ICMP code filter for the ACE</p> <p><b>Any:</b> no ICMP code filter is specified (ICMP code filter status is "don't-care").</p> <p><b>Specific:</b> if you want to filter a specific ICMP code filter with the ACE, you can enter a specific ICMP code value. A field for entering an ICMP code value appears.</p>
<b>ICMP Code Value</b>	When <b>Specific</b> is selected for the ICMP code filter, you can enter a specific ICMP code value. The allowed range is 0 to 255. A frame matching the ACE will use this ICMP code value.

### TCP Parameters

Source Port Filter	Specific
Source Port No.	0
Dest. Port Filter	Specific
Dest. Port No.	80
TCP FIN	Any
TCP SYN	Any
TCP RST	Any
TCP PSH	Any
TCP ACK	Any
TCP URG	Any

### UDP Parameters

Source Port Filter	Specific
Source Port No.	0
Dest. Port Filter	Range
Dest. Port Range	80 - 65535

Label	Description
<b>TCP/UDP Source Filter</b>	<p>Specifies the TCP/UDP source filter for the ACE</p> <p><b>Any:</b> no TCP/UDP source filter is specified (TCP/UDP source filter status is "don't-care").</p> <p><b>Specific:</b> if you want to filter a specific TCP/UDP source filter with the ACE, you can enter a specific TCP/UDP source value. A field for entering a TCP/UDP source value appears.</p> <p><b>Range:</b> if you want to filter a specific TCP/UDP source range filter with the ACE, you can enter a specific TCP/UDP source range. A field for entering a TCP/UDP source value appears.</p>
<b>TCP/UDP Source No.</b>	When <b>Specific</b> is selected for the TCP/UDP source filter, you can enter a specific TCP/UDP source value. The allowed range is 0 to 65535. A frame matching the ACE will use this TCP/UDP source value.

<b>TCP/UDP Source Range</b>	<p>When <b>Range</b> is selected for the TCP/UDP source filter, you can enter a specific TCP/UDP source range value. The allowed range is 0 to 65535. A frame matching the ACE will use this TCP/UDP source value.</p>
<b>TCP/UDP Destination Filter</b>	<p>Specifies the TCP/UDP destination filter for the ACE</p> <p><b>Any:</b> no TCP/UDP destination filter is specified (TCP/UDP destination filter status is "<b>don't-care</b>").</p> <p><b>Specific:</b> if you want to filter a specific TCP/UDP destination filter with the ACE, you can enter a specific TCP/UDP destination value. A field for entering a TCP/UDP destination value appears.</p> <p><b>Range:</b> if you want to filter a specific range TCP/UDP destination filter with the ACE, you can enter a specific TCP/UDP destination range. A field for entering a TCP/UDP destination value appears.</p>
<b>TCP/UDP Destination Number</b>	<p>When <b>Specific</b> is selected for the TCP/UDP destination filter, you can enter a specific TCP/UDP destination value. The allowed range is 0 to 65535. A frame matching the ACE will use this TCP/UDP destination value.</p>
<b>TCP/UDP Destination Range</b>	<p>When <b>Range</b> is selected for the TCP/UDP destination filter, you can enter a specific TCP/UDP destination range value. The allowed range is 0 to 65535. A frame matching the ACE will use this TCP/UDP destination value.</p>
<b>TCP FIN</b>	<p>Specifies the TCP FIN ("no more data from sender") value for the ACE.</p> <p><b>0:</b> TCP frames where the FIN field is set must not be able to match this entry.</p> <p><b>1:</b> TCP frames where the FIN field is set must be able to match this entry.</p> <p><b>Any:</b> any value is allowed ("<b>don't-care</b>").</p>
<b>TCP SYN</b>	<p>Specifies the TCP SYN ("synchronize sequence numbers") value for the ACE</p> <p><b>0:</b> TCP frames where the SYN field is set must not be able to match this entry.</p> <p><b>1:</b> TCP frames where the SYN field is set must be able to match this entry.</p> <p><b>Any:</b> any value is allowed ("<b>don't-care</b>").</p>
<b>TCP PSH</b>	<p>Specifies the TCP PSH ("push function") value for the ACE</p> <p><b>0:</b> TCP frames where the PSH field is set must not be able to match</p>

	<p>this entry.</p> <p><b>1:</b> TCP frames where the PSH field is set must be able to match this entry.</p> <p><b>Any:</b> any value is allowed ("<b>don't-care</b>").</p>
<b>TCP ACK</b>	<p>Specifies the TCP ACK ("acknowledgment field significant") value for the ACE</p> <p><b>0:</b> TCP frames where the ACK field is set must not be able to match this entry.</p> <p><b>1:</b> TCP frames where the ACK field is set must be able to match this entry.</p> <p><b>Any:</b> any value is allowed ("<b>don't-care</b>").</p>
<b>TCP URG</b>	<p>Specifies the TCP URG ("urgent pointer field significant") value for the ACE</p> <p><b>0:</b> TCP frames where the URG field is set must not be able to match this entry.</p> <p><b>1:</b> TCP frames where the URG field is set must be able to match this entry.</p> <p><b>Any:</b> any value is allowed ("<b>don't-care</b>").</p>

### 5.8.4 AAA

#### Common Server Configurations

This page allows you to configure authentication servers.

### Authentication Server Configuration

Common Server Configuration

<b>Timeout</b>	<input style="width: 40px;" type="text" value="15"/>	seconds
<b>Dead Time</b>	<input style="width: 40px;" type="text" value="300"/>	seconds

Label	Description
<b>Timeout</b>	<p>The timeout, which can be set to a number between 3 and 3600 seconds, is the maximum time to wait for a reply from a server.</p> <p>If the server does not reply within this time frame, we will consider it to be dead and continue with the next enabled server (if any).</p> <p>RADIUS servers are using the UDP protocol, which is unreliable by design.</p>

	In order to cope with lost frames, the timeout interval is divided into 3 subintervals of equal length. If a reply is not received within the subinterval, the request is transmitted again. This algorithm causes the RADIUS server to be queried up to 3 times before it is considered to be dead.
<b>Dead Time</b>	The dead time, which can be set to a number between 0 and 3600 seconds, is the period during which the switch will not send new requests to a server that has failed to respond to a previous request. This will stop the switch from continually trying to contact a server that it has already determined as dead. Setting the dead time to a value greater than 0 (zero) will enable this feature, but only if more than one server has been configured.

### 5.8.5 RADIUS

#### Authentication and Accounting Server Configurations

The table has one row for each RADIUS authentication server and a number of columns, which are:

**RADIUS Authentication Server Configuration**

#	Enabled	IP Address	Port	Secret
1	<input type="checkbox"/>		1812	
2	<input type="checkbox"/>		1812	
3	<input type="checkbox"/>		1812	
4	<input type="checkbox"/>		1812	
5	<input type="checkbox"/>		1812	

Label	Description
<b>#</b>	The RADIUS authentication server number for which the configuration below applies.
<b>Enabled</b>	Check to enable the RADIUS authentication server.
<b>IP Address</b>	The IP address or hostname of the RADIUS authentication server. IP address is expressed in dotted decimal notation.
<b>Port</b>	The UDP port to use on the RADIUS authentication server. If the port is set to <b>0</b> (zero), the default port (1812) is used on the RADIUS authentication server.
<b>Secret</b>	The secret - up to 29 characters long - shared between the RADIUS authentication server and the switch stack.

**RADIUS Accounting Server Configuration**

#	Enabled	IP Address	Port	Secret
1	<input type="checkbox"/>		1813	
2	<input type="checkbox"/>		1813	
3	<input type="checkbox"/>		1813	
4	<input type="checkbox"/>		1813	
5	<input type="checkbox"/>		1813	

Label	Description
#	The RADIUS accounting server number for which the configuration below applies.
Enabled	Check to enable the RADIUS accounting server
IP Address	The IP address or hostname of the RADIUS accounting server. IP address is expressed in dotted decimal notation.
Port	The UDP port to use on the RADIUS accounting server. If the port is set to 0 (zero), the default port (1813) is used on the RADIUS accounting server.
Secret	The secret - up to 29 characters long - shared between the RADIUS accounting server and the switch stack.

### Authentication and Accounting Server Status Overview

This page provides an overview of the status of the RADIUS servers configurable on the authentication configuration page.

**RADIUS Authentication Server Status Overview**

Auto-refresh

#	IP Address	Status
1	0.0.0.0:1812	Disabled
2	0.0.0.0:1812	Disabled
3	0.0.0.0:1812	Disabled
4	0.0.0.0:1812	Disabled
5	0.0.0.0:1812	Disabled

Label	Description
#	The RADIUS server number. Click to navigate to detailed statistics of the server
IP Address	The IP address and UDP port number (in <IP Address>:<UDP Port> notation) of the server

<p><b>Status</b></p>	<p>The current status of the server. This field has one of the following values:</p> <p><b>Disabled:</b> the server is disabled.</p> <p><b>Not Ready:</b> the server is enabled, but IP communication is not yet up and running.</p> <p><b>Ready:</b> the server is enabled, IP communications are built, and the RADIUS module is ready to accept access attempts.</p> <p><b>Dead (X seconds left):</b> access attempts are made to this server, but it does not reply within the configured timeout. The server has temporarily been disabled, but will be re-enabled when the dead-time expires. The number of seconds left before this occurs is displayed in parentheses. This state is only reachable when more than one server is enabled.</p>
----------------------	---

### RADIUS Accounting Server Status Overview

#	IP Address	Status
1	0.0.0.0:1813	Disabled
2	0.0.0.0:1813	Disabled
3	0.0.0.0:1813	Disabled
4	0.0.0.0:1813	Disabled
5	0.0.0.0:1813	Disabled

Label	Description
#	The RADIUS server number. Click to navigate to detailed statistics of the server
IP Address	The IP address and UDP port number (in <IP Address>:<UDP Port> notation) of the server
Status	<p>The current status of the server. This field has one of the following values:</p> <p>Disabled: the server is disabled.</p> <p><b>Not Ready:</b> the server is enabled, but IP communication is not yet up and running.</p> <p><b>Ready:</b> the server is enabled, IP communication is up and running, and the RADIUS module is ready to accept accounting attempts.</p> <p><b>Dead (X seconds left):</b> accounting attempts are made to this server, but it does not reply within the configured timeout. The server has temporarily been disabled, but will be re-enabled when the dead-time</p>



	expires. The number of seconds left before this occurs is displayed in parentheses. This state is only reachable when more than one server is enabled.
--	--

## Authentication and Accounting Server Statistics

The statistics map closely to those specified in RFC4668 - RADIUS Authentication Client MIB. Use the server drop-down list to switch between the backend servers to show related details.

### RADIUS Authentication Statistics for Server #1

Server #1

Receive Packets		Transmit Packets	
Access Accepts	0	Access Requests	0
Access Rejects	0	Access Retransmissions	0
Access Challenges	0	Pending Requests	0
Malformed Access Responses	0	Timeouts	0
Bad Authenticators	0		
Unknown Types	0		
Packets Dropped	0		
Other Info			
IP Address	0.0.0.0:1812		
State	Disabled		
Round-Trip Time	0 ms		

Label	Description																																																
<b>Packet Counters</b>	RADIUS authentication server packet counters. There are seven 'receive' and four 'transmit' counters.																																																
	<table border="1" style="width: 100%; border-collapse: collapse; font-size: small;"> <thead> <tr style="background-color: #003366; color: white;"> <th>Direction</th> <th>Name</th> <th>RFC4668 Name</th> <th>Description</th> </tr> </thead> <tbody> <tr> <td>Rx</td> <td><b>Access Accepts</b></td> <td>radiusAuthClientExtAccessAccepts</td> <td>The number of RADIUS Access-Accept packets (valid or invalid) received from the server.</td> </tr> <tr> <td>Rx</td> <td><b>Access Rejects</b></td> <td>radiusAuthClientExtAccessRejects</td> <td>The number of RADIUS Access-Reject packets (valid or invalid) received from the server.</td> </tr> <tr> <td>Rx</td> <td><b>Access Challenges</b></td> <td>radiusAuthClientExtAccessChallenges</td> <td>The number of RADIUS Access-Challenge packets (valid or invalid) received from the server.</td> </tr> <tr> <td>Rx</td> <td><b>Malformed Access Responses</b></td> <td>radiusAuthClientExtMalformedAccessResponses</td> <td>The number of malformed RADIUS Access-Response packets received from the server. Malformed packets include packets with an invalid length. Bad authenticators or Message Authenticator attributes or unknown types are not included as malformed access responses.</td> </tr> <tr> <td>Rx</td> <td><b>Bad Authenticators</b></td> <td>radiusAuthClientExtBadAuthenticators</td> <td>The number of RADIUS Access-Response packets containing invalid authenticators or Message Authenticator attributes received from the server.</td> </tr> <tr> <td>Rx</td> <td><b>Unknown Types</b></td> <td>radiusAuthClientExtUnknownTypes</td> <td>The number of RADIUS packets that were received from the server on the authentication port and dropped for some other reason.</td> </tr> <tr> <td>Rx</td> <td><b>Packets Dropped</b></td> <td>radiusAuthClientExtPacketsDropped</td> <td>The number of RADIUS packets that were received from the server on the authentication port and dropped for some other reason.</td> </tr> <tr> <td>Tx</td> <td><b>Access Requests</b></td> <td>radiusAuthClientExtAccessRequests</td> <td>The number of RADIUS Access-Request packets sent to the server. This does not include retransmissions.</td> </tr> <tr> <td>Tx</td> <td><b>Access Retransmissions</b></td> <td>radiusAuthClientExtAccessRetransmissions</td> <td>The number of RADIUS Access-Request packets retransmitted to the RADIUS authentication server.</td> </tr> <tr> <td>Tx</td> <td><b>Pending Requests</b></td> <td>radiusAuthClientExtPendingRequests</td> <td>The number of RADIUS Access-Request packets destined for the server that have not yet timed out or received a response. This variable is incremented when an Access-Request is sent and decremented due to receipt of an Access-Accept, Access-Reject, Access-Challenge, timeout, or retransmission.</td> </tr> <tr> <td>Tx</td> <td><b>Timeouts</b></td> <td>radiusAuthClientExtTimeouts</td> <td>The number of authentication timeouts to the server. After a timeout, the client may retry to the same server, send to a different server, or give up. A retry to the same server is counted as a retransmit as well as a timeout. A send to a different server is counted as a Request as well as a timeout.</td> </tr> </tbody> </table>	Direction	Name	RFC4668 Name	Description	Rx	<b>Access Accepts</b>	radiusAuthClientExtAccessAccepts	The number of RADIUS Access-Accept packets (valid or invalid) received from the server.	Rx	<b>Access Rejects</b>	radiusAuthClientExtAccessRejects	The number of RADIUS Access-Reject packets (valid or invalid) received from the server.	Rx	<b>Access Challenges</b>	radiusAuthClientExtAccessChallenges	The number of RADIUS Access-Challenge packets (valid or invalid) received from the server.	Rx	<b>Malformed Access Responses</b>	radiusAuthClientExtMalformedAccessResponses	The number of malformed RADIUS Access-Response packets received from the server. Malformed packets include packets with an invalid length. Bad authenticators or Message Authenticator attributes or unknown types are not included as malformed access responses.	Rx	<b>Bad Authenticators</b>	radiusAuthClientExtBadAuthenticators	The number of RADIUS Access-Response packets containing invalid authenticators or Message Authenticator attributes received from the server.	Rx	<b>Unknown Types</b>	radiusAuthClientExtUnknownTypes	The number of RADIUS packets that were received from the server on the authentication port and dropped for some other reason.	Rx	<b>Packets Dropped</b>	radiusAuthClientExtPacketsDropped	The number of RADIUS packets that were received from the server on the authentication port and dropped for some other reason.	Tx	<b>Access Requests</b>	radiusAuthClientExtAccessRequests	The number of RADIUS Access-Request packets sent to the server. This does not include retransmissions.	Tx	<b>Access Retransmissions</b>	radiusAuthClientExtAccessRetransmissions	The number of RADIUS Access-Request packets retransmitted to the RADIUS authentication server.	Tx	<b>Pending Requests</b>	radiusAuthClientExtPendingRequests	The number of RADIUS Access-Request packets destined for the server that have not yet timed out or received a response. This variable is incremented when an Access-Request is sent and decremented due to receipt of an Access-Accept, Access-Reject, Access-Challenge, timeout, or retransmission.	Tx	<b>Timeouts</b>	radiusAuthClientExtTimeouts	The number of authentication timeouts to the server. After a timeout, the client may retry to the same server, send to a different server, or give up. A retry to the same server is counted as a retransmit as well as a timeout. A send to a different server is counted as a Request as well as a timeout.
	Direction	Name	RFC4668 Name	Description																																													
	Rx	<b>Access Accepts</b>	radiusAuthClientExtAccessAccepts	The number of RADIUS Access-Accept packets (valid or invalid) received from the server.																																													
	Rx	<b>Access Rejects</b>	radiusAuthClientExtAccessRejects	The number of RADIUS Access-Reject packets (valid or invalid) received from the server.																																													
	Rx	<b>Access Challenges</b>	radiusAuthClientExtAccessChallenges	The number of RADIUS Access-Challenge packets (valid or invalid) received from the server.																																													
	Rx	<b>Malformed Access Responses</b>	radiusAuthClientExtMalformedAccessResponses	The number of malformed RADIUS Access-Response packets received from the server. Malformed packets include packets with an invalid length. Bad authenticators or Message Authenticator attributes or unknown types are not included as malformed access responses.																																													
	Rx	<b>Bad Authenticators</b>	radiusAuthClientExtBadAuthenticators	The number of RADIUS Access-Response packets containing invalid authenticators or Message Authenticator attributes received from the server.																																													
	Rx	<b>Unknown Types</b>	radiusAuthClientExtUnknownTypes	The number of RADIUS packets that were received from the server on the authentication port and dropped for some other reason.																																													
	Rx	<b>Packets Dropped</b>	radiusAuthClientExtPacketsDropped	The number of RADIUS packets that were received from the server on the authentication port and dropped for some other reason.																																													
	Tx	<b>Access Requests</b>	radiusAuthClientExtAccessRequests	The number of RADIUS Access-Request packets sent to the server. This does not include retransmissions.																																													
	Tx	<b>Access Retransmissions</b>	radiusAuthClientExtAccessRetransmissions	The number of RADIUS Access-Request packets retransmitted to the RADIUS authentication server.																																													
Tx	<b>Pending Requests</b>	radiusAuthClientExtPendingRequests	The number of RADIUS Access-Request packets destined for the server that have not yet timed out or received a response. This variable is incremented when an Access-Request is sent and decremented due to receipt of an Access-Accept, Access-Reject, Access-Challenge, timeout, or retransmission.																																														
Tx	<b>Timeouts</b>	radiusAuthClientExtTimeouts	The number of authentication timeouts to the server. After a timeout, the client may retry to the same server, send to a different server, or give up. A retry to the same server is counted as a retransmit as well as a timeout. A send to a different server is counted as a Request as well as a timeout.																																														

<b>Other Info</b>	This section contains information about the state of the server and the latest round-trip time.									
	<table border="1"> <thead> <tr> <th>Name</th> <th>RFC4668 Name</th> <th>Description</th> </tr> </thead> <tbody> <tr> <td>State</td> <td>-</td> <td>Shows the state of the server. It takes one of the following values:  <b>Disabled</b> : The selected server is disabled.  <b>Not_Ready</b> : The server is enabled, but IP communication is not yet up and running.  <b>Ready</b> : The server is enabled, IP communication is up and running, and the RADIUS module is ready to accept access attempts.  <b>Dead (X seconds left)</b> : Access attempts were made to this server, but it did not reply within the configured timeout. The server has temporarily been disabled, but will get re-enabled when the dead-time expires. The number of seconds left before this occurs is displayed in parentheses. This state is only reachable when more than one server is enabled.</td> </tr> <tr> <td>Round-Trip Time</td> <td>radiusAuthClientExtRoundTripTime</td> <td>The time interval (measured in milliseconds) between the most recent Access-Reply/Access-Challenge and the Access-Request that matched it from the RADIUS authentication server. The granularity of this measurement is 100 ms. A value of 0 ms indicates that there hasn't been round-trip communication with the server yet.</td> </tr> </tbody> </table>	Name	RFC4668 Name	Description	State	-	Shows the state of the server. It takes one of the following values: <b>Disabled</b> : The selected server is disabled. <b>Not_Ready</b> : The server is enabled, but IP communication is not yet up and running. <b>Ready</b> : The server is enabled, IP communication is up and running, and the RADIUS module is ready to accept access attempts. <b>Dead (X seconds left)</b> : Access attempts were made to this server, but it did not reply within the configured timeout. The server has temporarily been disabled, but will get re-enabled when the dead-time expires. The number of seconds left before this occurs is displayed in parentheses. This state is only reachable when more than one server is enabled.	Round-Trip Time	radiusAuthClientExtRoundTripTime	The time interval (measured in milliseconds) between the most recent Access-Reply/Access-Challenge and the Access-Request that matched it from the RADIUS authentication server. The granularity of this measurement is 100 ms. A value of 0 ms indicates that there hasn't been round-trip communication with the server yet.
Name	RFC4668 Name	Description								
State	-	Shows the state of the server. It takes one of the following values: <b>Disabled</b> : The selected server is disabled. <b>Not_Ready</b> : The server is enabled, but IP communication is not yet up and running. <b>Ready</b> : The server is enabled, IP communication is up and running, and the RADIUS module is ready to accept access attempts. <b>Dead (X seconds left)</b> : Access attempts were made to this server, but it did not reply within the configured timeout. The server has temporarily been disabled, but will get re-enabled when the dead-time expires. The number of seconds left before this occurs is displayed in parentheses. This state is only reachable when more than one server is enabled.								
Round-Trip Time	radiusAuthClientExtRoundTripTime	The time interval (measured in milliseconds) between the most recent Access-Reply/Access-Challenge and the Access-Request that matched it from the RADIUS authentication server. The granularity of this measurement is 100 ms. A value of 0 ms indicates that there hasn't been round-trip communication with the server yet.								

### RADIUS Accounting Statistics for Server #1

Receive Packets		Transmit Packets	
Responses	0	Requests	0
Malformed Responses	0	Retransmissions	0
Bad Authenticators	0	Pending Requests	0
Unknown Types	0	Timeouts	0
Packets Dropped	0		
Other Info			
IP Address	0.0.0.0:1813		
State	Disabled		
Round-Trip Time	0 ms		

Label	Description																																								
<b>Packet Counters</b>	RADIUS accounting server packet counters. There are five 'receive' and four 'transmit' counters.																																								
	<table border="1"> <thead> <tr> <th>Direction</th> <th>Name</th> <th>RFC4670 Name</th> <th>Description</th> </tr> </thead> <tbody> <tr> <td>Rx</td> <td><b>Responses</b></td> <td>radiusAccClientExtResponses</td> <td>The number of RADIUS packets (valid or invalid) received from the server.</td> </tr> <tr> <td>Rx</td> <td><b>Malformed Responses</b></td> <td>radiusAccClientExtMalformedResponses</td> <td>The number of malformed RADIUS packets received from the server. Malformed packets include packets with an invalid length. Bad authenticators or unknown types are not included as malformed access responses.</td> </tr> <tr> <td>Rx</td> <td><b>Bad Authenticators</b></td> <td>radiusAccClientExtBadAuthenticators</td> <td>The number of RADIUS packets containing invalid authenticators received from the server.</td> </tr> <tr> <td>Rx</td> <td><b>Unknown Types</b></td> <td>radiusAccClientExtUnknownTypes</td> <td>The number of RADIUS packets of unknown types that were received from the server on the accounting port.</td> </tr> <tr> <td>Rx</td> <td><b>Packets Dropped</b></td> <td>radiusAccClientExtPacketsDropped</td> <td>The number of RADIUS packets that were received from the server on the accounting port and dropped for some other reason.</td> </tr> <tr> <td>Tx</td> <td><b>Requests</b></td> <td>radiusAccClientExtRequests</td> <td>The number of RADIUS packets sent to the server. This does not include retransmissions.</td> </tr> <tr> <td>Tx</td> <td><b>Retransmissions</b></td> <td>radiusAccClientExtRetransmissions</td> <td>The number of RADIUS packets retransmitted to the RADIUS accounting server.</td> </tr> <tr> <td>Tx</td> <td><b>Pending Requests</b></td> <td>radiusAccClientExtPendingRequests</td> <td>The number of RADIUS packets destined for the server that have not yet timed out or received a response. This variable is incremented when a Request is sent and decremented due to receipt of a Response, timeout, or retransmission.</td> </tr> <tr> <td>Tx</td> <td><b>Timeouts</b></td> <td>radiusAccClientExtTimeouts</td> <td>The number of accounting timeouts to the server. After a timeout, the client may retry to the same server, send to a different server, or give up. A retry to the same server is counted as a retransmit as well as a timeout. A send to a different server is counted as a Request as well as a timeout.</td> </tr> </tbody> </table>	Direction	Name	RFC4670 Name	Description	Rx	<b>Responses</b>	radiusAccClientExtResponses	The number of RADIUS packets (valid or invalid) received from the server.	Rx	<b>Malformed Responses</b>	radiusAccClientExtMalformedResponses	The number of malformed RADIUS packets received from the server. Malformed packets include packets with an invalid length. Bad authenticators or unknown types are not included as malformed access responses.	Rx	<b>Bad Authenticators</b>	radiusAccClientExtBadAuthenticators	The number of RADIUS packets containing invalid authenticators received from the server.	Rx	<b>Unknown Types</b>	radiusAccClientExtUnknownTypes	The number of RADIUS packets of unknown types that were received from the server on the accounting port.	Rx	<b>Packets Dropped</b>	radiusAccClientExtPacketsDropped	The number of RADIUS packets that were received from the server on the accounting port and dropped for some other reason.	Tx	<b>Requests</b>	radiusAccClientExtRequests	The number of RADIUS packets sent to the server. This does not include retransmissions.	Tx	<b>Retransmissions</b>	radiusAccClientExtRetransmissions	The number of RADIUS packets retransmitted to the RADIUS accounting server.	Tx	<b>Pending Requests</b>	radiusAccClientExtPendingRequests	The number of RADIUS packets destined for the server that have not yet timed out or received a response. This variable is incremented when a Request is sent and decremented due to receipt of a Response, timeout, or retransmission.	Tx	<b>Timeouts</b>	radiusAccClientExtTimeouts	The number of accounting timeouts to the server. After a timeout, the client may retry to the same server, send to a different server, or give up. A retry to the same server is counted as a retransmit as well as a timeout. A send to a different server is counted as a Request as well as a timeout.
	Direction	Name	RFC4670 Name	Description																																					
	Rx	<b>Responses</b>	radiusAccClientExtResponses	The number of RADIUS packets (valid or invalid) received from the server.																																					
	Rx	<b>Malformed Responses</b>	radiusAccClientExtMalformedResponses	The number of malformed RADIUS packets received from the server. Malformed packets include packets with an invalid length. Bad authenticators or unknown types are not included as malformed access responses.																																					
	Rx	<b>Bad Authenticators</b>	radiusAccClientExtBadAuthenticators	The number of RADIUS packets containing invalid authenticators received from the server.																																					
	Rx	<b>Unknown Types</b>	radiusAccClientExtUnknownTypes	The number of RADIUS packets of unknown types that were received from the server on the accounting port.																																					
	Rx	<b>Packets Dropped</b>	radiusAccClientExtPacketsDropped	The number of RADIUS packets that were received from the server on the accounting port and dropped for some other reason.																																					
	Tx	<b>Requests</b>	radiusAccClientExtRequests	The number of RADIUS packets sent to the server. This does not include retransmissions.																																					
	Tx	<b>Retransmissions</b>	radiusAccClientExtRetransmissions	The number of RADIUS packets retransmitted to the RADIUS accounting server.																																					
Tx	<b>Pending Requests</b>	radiusAccClientExtPendingRequests	The number of RADIUS packets destined for the server that have not yet timed out or received a response. This variable is incremented when a Request is sent and decremented due to receipt of a Response, timeout, or retransmission.																																						
Tx	<b>Timeouts</b>	radiusAccClientExtTimeouts	The number of accounting timeouts to the server. After a timeout, the client may retry to the same server, send to a different server, or give up. A retry to the same server is counted as a retransmit as well as a timeout. A send to a different server is counted as a Request as well as a timeout.																																						

<b>Other Info</b>	This section contains information about the state of the server and the latest round-trip time.		
	<b>Name</b>	<b>RFC4670 Name</b>	<b>Description</b>
<b>State</b>	-	Shows the state of the server. It takes one of the following values: <b>Disabled</b> : The selected server is disabled. <b>Not_Ready</b> : The server is enabled, but IP communication is not yet up and running. <b>Ready</b> : The server is enabled, IP communication is up and running, and the RADIUS module is ready to accept accounting attempts. <b>Dead (X seconds left)</b> : Accounting attempts were made to this server, but it did not reply within the configured timeout. The server has temporarily been disabled, but will get re-enabled when the dead-time expires. The number of seconds left before this occurs is displayed in parentheses. This state is only reachable when more than one server is enabled.	
<b>Round-Trip Time</b>	radiusAccClientExtRoundTripTime	The time interval (measured in milliseconds) between the most recent Response and the Request that matched it from the RADIUS accounting server. The granularity of this measurement is 100 ms. A value of 0 ms indicates that there hasn't been round-trip communication with the server yet.	

### 5.8.6 NAS (802.1x)

This page allows you to configure the IEEE 802.1X and MAC-based authentication system and port settings.

The IEEE 802.1X standard defines a port-based access control procedure that prevents unauthorized access to a network by requiring users to first submit credentials for authentication. One or more central servers (the backend servers) determine whether the user is allowed access to the network. These backend (RADIUS) servers are configured on the authentication configuration page.

MAC-based authentication allows for authentication of more than one user on the same port, and does not require the users to have special 802.1X software installed on their system. The switch uses the users' MAC addresses to authenticate against the backend server. As intruders can create counterfeit MAC addresses, MAC-based authentication is less secure than 802.1X authentication.

#### Overview of 802.1X (Port-Based) Authentication

In an 802.1X network environment, the user is called the supplicant, the switch is the authenticator, and the RADIUS server is the authentication server. The switch acts as the man-in-the-middle, forwarding requests and responses between the supplicant and the authentication server. Frames sent between the supplicant and the switch are special 802.1X frames, known as EAPOL (EAP Over LANs) frames which encapsulate EAP PDUs (RFC3748). Frames sent between the switch and the RADIUS server are RADIUS packets. RADIUS packets also encapsulate EAP PDUs together with other attributes like the switch's IP address, name, and the supplicant's port number on the switch. EAP is very flexible as it allows for different authentication methods, like MD5-Challenge, PEAP, and TLS. The important thing is that the authenticator (the switch) does not need to know which authentication method the supplicant and the authentication server are using, or how many information exchange frames

are needed for a particular method. The switch simply encapsulates the EAP part of the frame into the relevant type (EAPOL or RADIUS) and forwards it.

When authentication is complete, the RADIUS server sends a special packet containing a success or failure indication. Besides forwarding the result to the supplicant, the switch uses it to open up or block traffic on the switch port connected to the supplicant.

Note: in an environment where two backend servers are enabled, the server timeout is configured to X seconds (using the authentication configuration page), and the first server in the list is currently down (but not considered dead), if the supplicant retransmits EAPOL Start frames at a rate faster than X seconds, it will never be authenticated because the switch will cancel on-going backend authentication server requests whenever it receives a new EAPOL Start frame from the supplicant. Since the server has not failed (because the X seconds have not expired), the same server will be contacted when the next backend authentication server requests from the switch. This scenario will loop forever. Therefore, the server timeout should be smaller than the supplicant's EAPOL Start frame retransmission rate.

### **Overview of MAC-Based Authentication**

Unlike 802.1X, MAC-based authentication is not a standard, but merely a best-practices method adopted by the industry. In MAC-based authentication, users are called clients, and the switch acts as the supplicant on behalf of clients. The initial frame (any kind of frame) sent by a client is snooped by the switch, which in turn uses the client's MAC address as both username and password in the subsequent EAP exchange with the RADIUS server. The 6-byte MAC address is converted to a string in the following form "xx-xx-xx-xx-xx-xx", that is, a dash (-) is used as separator between the lower-cased hexadecimal digits. The switch only supports the MD5-Challenge authentication method, so the RADIUS server must be configured accordingly.

When authentication is complete, the RADIUS server sends a success or failure indication, which in turn causes the switch to open up or block traffic for that particular client, using static entries into the MAC Table. Only then will frames from the client be forwarded on the switch. There are no EAPOL frames involved in this authentication, and therefore, MAC-based authentication has nothing to do with the 802.1X standard.

The advantage of MAC-based authentication over 802.1X is that several clients can be connected to the same port (e.g. through a 3rd party switch or a hub) and still require individual authentication, and that the clients do not need special supplicant software to authenticate.

The disadvantage is that MAC addresses can be spoofed by malicious users, equipment whose MAC address is a valid RADIUS user can be used by anyone, and only the MD5-Challenge method is supported.

802.1X and MAC-Based authentication configurations consist of two sections: system- and port-wide.

Refresh

### Network Access Server Configuration

#### System Configuration

<b>Mode</b>	Disabled	
<b>Reauthentication Enabled</b>	<input type="checkbox"/>	
<b>Reauthentication Period</b>	3600	seconds
<b>EAPOL Timeout</b>	30	seconds
<b>Aging Period</b>	300	seconds
<b>Hold Time</b>	10	seconds

#### Port Configuration

Port	Admin State	Port State	Restart	
*	<>			
1	Force Authorized	Globally Disabled	Reauthenticate	Reinitialize
2	Force Unauthorized	Globally Disabled	Reauthenticate	Reinitialize
3	802.1X	Globally Disabled	Reauthenticate	Reinitialize
4	MAC-based Auth.	Globally Disabled	Reauthenticate	Reinitialize
5	Force Authorized	Globally Disabled	Reauthenticate	Reinitialize

Label	Description
<b>Mode</b>	Indicates if 802.1X and MAC-based authentication is globally enabled or disabled on the switch. If globally disabled, all ports are allowed to forward frames.
<b>Reauthentication Enabled</b>	If checked, clients are reauthenticated after the interval specified by the Reauthentication Period. Reauthentication for 802.1X-enabled ports can be used to detect if a new device is plugged into a switch port. For MAC-based ports, reauthentication is only useful if the RADIUS server configuration has changed. It does not involve communication between the switch and the client, and therefore does not imply that a client is still present on a port (see Age Period below).
<b>Reauthentication</b>	Determines the period, in seconds, after which a connected client must be re-authenticated. This is only active if the <b>Reauthentication Enabled</b>

<b>Period</b>	checkbox is checked. Valid range of the value is 1 to 3600 seconds.
<b>EAPOL Timeout</b>	Determines the time for retransmission of Request Identity EAPOL frames. Valid range of the value is 1 to 65535 seconds. This has no effect for MAC-based ports.
<b>Age Period</b>	<p>This setting applies to the following modes, i.e. modes using the <b>Port Security</b> functionality to secure MAC addresses:</p> <p><b>MAC-Based Auth.:</b></p> <p>When the NAS module uses the Port Security module to secure MAC addresses, the Port Security module needs to check for activity on the MAC address in question at regular intervals and free resources if no activity is seen within a given period of time. This parameter controls exactly this period and can be set to a number between 10 and 1000000 seconds.</p> <p>For ports in <b>MAC-based Auth.</b> mode, reauthentication does not cause direct communications between the switch and the client, so this will not detect whether the client is still attached or not, and the only way to free any resources is to age the entry.</p>
<b>Hold Time</b>	<p>This setting applies to the following modes, i.e. modes using the <b>Port Security</b> functionality to secure MAC addresses:</p> <p><b>MAC-Based Auth.:</b></p> <p>If a client is denied access - either because the RADIUS server denies the client access or because the RADIUS server request times out (according to the timeout specified on the "<b>Configuration</b>→<b>Security</b>→<b>AAA</b>" page) - the client is put on hold in Unauthorized state. The hold timer does not count during an on-going authentication.</p> <p>The switch will ignore new frames coming from the client during the hold time.</p> <p>The hold time can be set to a number between 10 and 1000000 seconds.</p>
<b>Port</b>	The port number for which the configuration below applies
<b>Admin State</b>	<p>If NAS is globally enabled, this selection controls the port's authentication mode. The following modes are available:</p> <p><b>Force Authorized</b></p> <p>In this mode, the switch will send one EAPOL Success frame when the port link is up, and any client on the port will be allowed network access without authentication.</p> <p><b>Force Unauthorized</b></p> <p>In this mode, the switch will send one EAPOL Failure frame when the port</p>

link is up, and any client on the port will be disallowed network access.

### **Port-based 802.1X**

In an 802.1X network environment, the user is called the supplicant, the switch is the authenticator, and the RADIUS server is the authentication server. The authenticator acts as the man-in-the-middle, forwarding requests and responses between the supplicant and the authentication server. Frames sent between the supplicant and the switch are special 802.1X frames, known as EAPOL (EAP Over LANs) frames which encapsulate EAP PDUs (RFC3748). Frames sent between the switch and the RADIUS server is RADIUS packets. RADIUS packets also encapsulate EAP PDUs together with other attributes like the switch's IP address, name, and the supplicant's port number on the switch. EAP is very flexible as it allows for different authentication methods, like MD5-Challenge, PEAP, and TLS. The important thing is that the authenticator (the switch) does not need to know which authentication method the supplicant and the authentication server are using, or how many information exchange frames are needed for a particular method. The switch simply encapsulates the EAP part of the frame into the relevant type (EAPOL or RADIUS) and forwards it.

When authentication is complete, the RADIUS server sends a special packet containing a success or failure indication. Besides forwarding the result to the supplicant, the switch uses it to open up or block traffic on the switch port connected to the supplicant.

Note: in an environment where two backend servers are enabled, the server timeout is configured to X seconds (using the authentication configuration page), and the first server in the list is currently down (but not considered dead), if the supplicant retransmits EAPOL Start frames at a rate faster than X seconds, it will never be authenticated because the switch will cancel on-going backend authentication server requests whenever it receives a new EAPOL Start frame from the supplicant. Since the server has not failed (because the X seconds have not expired), the same server will be contacted when the next backend authentication server request from the switch. This scenario will loop forever. Therefore, the server timeout should be smaller than the supplicant's EAPOL Start frame retransmission rate.

#### **a. Single 802.1X**

In port-based 802.1X authentication, once a supplicant is successfully authenticated on a port, the whole port is opened for network traffic. This allows other clients connected to the port (for instance through a hub) to



piggy-back on the successfully authenticated client and get network access even though they are not authenticated individually. To overcome this security breach, use the Single 802.1X variant.

Single 802.1X is not yet an IEEE standard, but features many of the same characteristics as port-based 802.1X. In Single 802.1X, at most one supplicant can get authenticated on the port at a time. Normal EAPOL frames are used in the communications between the supplicant and the switch. If more than one supplicant are connected to a port, the one that comes first when the port's link is connected will be the first one considered. If that supplicant does not provide valid credentials within a certain amount of time, the chance will be given to another supplicant. Once a supplicant is successfully authenticated, only that supplicant will be allowed access. This is the most secure of all the supported modes. In this mode, the Port Security module is used to secure a supplicant's MAC address once successfully authenticated.

**b. Multi 802.1X**

In port-based 802.1X authentication, once a supplicant is successfully authenticated on a port, the whole port is opened for network traffic. This allows other clients connected to the port (for instance through a hub) to piggy-back on the successfully authenticated client and get network access even though they are not authenticated individually. To overcome this security breach, use the Multi 802.1X variant.

Multi 802.1X is not yet an IEEE standard, but features many of the same characteristics as port-based 802.1X. In Multi 802.1X, one or more supplicants can be authenticated on the same port at the same time. Each supplicant is authenticated individually and secured in the MAC table using the Port Security module.

In Multi 802.1X it is not possible to use the multicast BPDU MAC address as the destination MAC address for EAPOL frames sent from the switch to the supplicant, since that would cause all supplicants attached to the port to reply to requests sent from the switch. Instead, the switch uses the supplicant's MAC address, which is obtained from the first EAPOL Start or EAPOL Response Identity frame sent by the supplicant. An exception to this is when no supplicants are attached. In this case, the switch sends EAPOL Request Identity frames using the BPDU multicast MAC address as destination - to wake up any supplicants that might be on the port.

The maximum number of supplicants that can be attached to a port can be



	<p>limited using the Port Security Limit Control functionality.</p> <p><b>MAC-based Auth.</b></p> <p>Unlike port-based 802.1X, MAC-based authentication is not a standard, but merely a best-practices method adopted by the industry. In MAC-based authentication, users are called clients, and the switch acts as the supplicant on behalf of clients. The initial frame (any kind of frame) sent by a client is snooped by the switch, which in turn uses the client's MAC address as both username and password in the subsequent EAP exchange with the RADIUS server. The 6-byte MAC address is converted to a string in the following form "xx-xx-xx-xx-xx-xx", that is, a dash (-) is used as separator between the lower-cased hexadecimal digits. The switch only supports the MD5-Challenge authentication method, so the RADIUS server must be configured accordingly.</p> <p>When authentication is complete, the RADIUS server sends a success or failure indication, which in turn causes the switch to open up or block traffic for that particular client, using the Port Security module. Only then will frames from the client be forwarded on the switch. There are no EAPOL frames involved in this authentication, and therefore, MAC-based authentication has nothing to do with the 802.1X standard.</p> <p>The advantage of MAC-based authentication over port-based 802.1X is that several clients can be connected to the same port (e.g. through a 3rd party switch or a hub) and still require individual authentication, and that the clients don't need special supplicant software to authenticate. The advantage of MAC-based authentication over 802.1X-based authentication is that the clients do not need special supplicant software to authenticate. The disadvantage is that MAC addresses can be spoofed by malicious users - equipment whose MAC address is a valid RADIUS user can be used by anyone. Also, only the MD5-Challenge method is supported. The maximum number of clients that can be attached to a port can be limited using the Port Security Limit Control functionality.</p>
<p><b>Port State</b></p>	<p>The current state of the port. It can undertake one of the following values:</p> <p><b>Globally Disabled:</b> NAS is globally disabled.</p> <p><b>Link Down:</b> NAS is globally enabled, but there is no link on the port.</p> <p><b>Authorized:</b> the port is in Force Authorized or a single-supplicant mode and the supplicant is authorized.</p> <p><b>Unauthorized:</b> the port is in Force Unauthorized or a single-supplicant mode and the supplicant is not successfully authorized by the RADIUS server.</p>

	<p><b>X Auth/Y Unauth:</b> the port is in a multi-supPLICANT mode. Currently X clients are authorized and Y are unauthorized.</p>
<b>Restart</b>	<p>Two buttons are available for each row. The buttons are only enabled when authentication is globally enabled and the port's Admin State is in an EAPOL-based or MAC-based mode.</p> <p>Clicking these buttons will not cause settings changed on the page to take effect.</p> <p><b>Reauthenticate:</b> schedules a reauthentication whenever the quiet-period of the port runs out (EAPOL-based authentication). For MAC-based authentication, reauthentication will be attempted immediately.</p> <p>The button only has effect on successfully authenticated clients on the port and will not cause the clients to be temporarily unauthorized.</p> <p><b>Reinitialize:</b> forces a reinitialization of the clients on the port and hence a reauthentication immediately. The clients will transfer to the unauthorized state while the reauthentication is in progress.</p>

**NAS Status**

This page provides an overview of the current NAS port states.

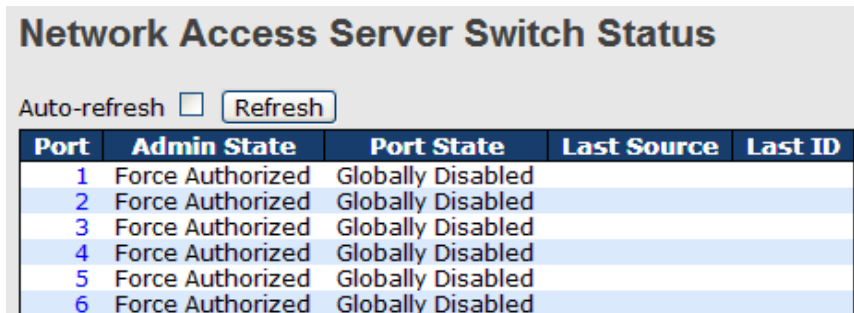

Label	Description
<b>Port</b>	The switch port number. Click to navigate to detailed 802.1X statistics of each port.
<b>Admin State</b>	The port's current administrative state. Refer to <b>NAS Admin State</b> for more details regarding each value.
<b>Port State</b>	The current state of the port. Refer to <b>NAS Port State</b> for more details regarding each value.
<b>Last Source</b>	The source MAC address carried in the most recently received EAPOL frame for EAPOL-based authentication, and the most recently received frame from a new client for MAC-based authentication.

<b>Last ID</b>	The user name (supplicant identity) carried in the most recently received Response Identity EAPOL frame for EAPOL-based authentication, and the source MAC address from the most recently received frame from a new client for MAC-based authentication.
----------------	--

This page provides detailed IEEE 802.1X statistics for a specific switch port using port-based authentication. For MAC-based ports, only selected backend server (RADIUS Authentication Server) statistics is showed. Use the port drop-down list to select which port details to be displayed.

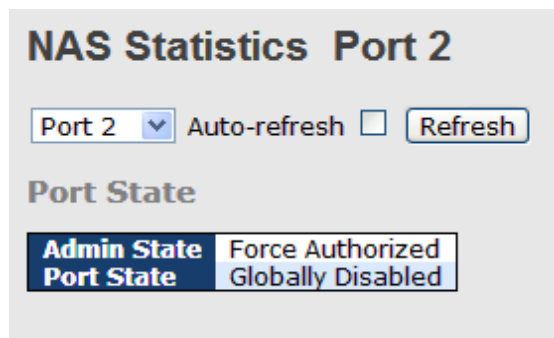

Label	Description
<b>Admin State</b>	The port's current administrative state. Refer to <b>NAS Admin State</b> for more details regarding each value.
<b>Port State</b>	The current state of the port. Refer to <b>NAS Port State</b> for more details regarding each value.
<b>EAPOL Counters</b>	These supplicant frame counters are available for the following administrative states: <ul style="list-style-type: none"> <li>• <b>Force Authorized</b></li> <li>• <b>Force Unauthorized</b></li> <li>• 802.1X</li> </ul>

	<table border="1"> <thead> <tr> <th colspan="4">EAPOL Counters</th> </tr> <tr> <th>Direction</th> <th>Name</th> <th>IEEE Name</th> <th>Description</th> </tr> </thead> <tbody> <tr> <td>Rx</td> <td><b>Total</b></td> <td>dot1xAuthEapolFramesRx</td> <td>The number of valid EAPOL frames of any type that have been received by the switch.</td> </tr> <tr> <td>Rx</td> <td><b>Response ID</b></td> <td>dot1xAuthEapolRespIdFramesRx</td> <td>The number of valid EAP Resp/ID frames that have been received by the switch.</td> </tr> <tr> <td>Rx</td> <td><b>Responses</b></td> <td>dot1xAuthEapolRespFramesRx</td> <td>The number of valid EAPOL response frames (other than Resp/ID frames) that have been received by the switch.</td> </tr> <tr> <td>Rx</td> <td><b>Start</b></td> <td>dot1xAuthEapolStartFramesRx</td> <td>The number of EAPOL Start frames that have been received by the switch.</td> </tr> <tr> <td>Rx</td> <td><b>Logoff</b></td> <td>dot1xAuthEapolLogoffFramesRx</td> <td>The number of valid EAPOL logoff frames that have been received by the switch.</td> </tr> <tr> <td>Rx</td> <td><b>Invalid Type</b></td> <td>dot1xAuthInvalidEapolFramesRx</td> <td>The number of EAPOL frames that have been received by the switch in which the frame type is not recognized.</td> </tr> <tr> <td>Rx</td> <td><b>Invalid Length</b></td> <td>dot1xAuthEapolLengthErrorFramesRx</td> <td>The number of EAPOL frames that have been received by the switch in which the Packet Body Length field is invalid.</td> </tr> <tr> <td>Tx</td> <td><b>Total</b></td> <td>dot1xAuthEapolFramesTx</td> <td>The number of EAPOL frames of any type that have been transmitted by the switch.</td> </tr> <tr> <td>Tx</td> <td><b>Request ID</b></td> <td>dot1xAuthEapolReqIdFramesTx</td> <td>The number of EAP initial request frames that have been transmitted by the switch.</td> </tr> <tr> <td>Tx</td> <td><b>Requests</b></td> <td>dot1xAuthEapolReqFramesTx</td> <td>The number of valid EAP Request frames (other than initial request frames) that have been transmitted by the switch.</td> </tr> </tbody> </table>	EAPOL Counters				Direction	Name	IEEE Name	Description	Rx	<b>Total</b>	dot1xAuthEapolFramesRx	The number of valid EAPOL frames of any type that have been received by the switch.	Rx	<b>Response ID</b>	dot1xAuthEapolRespIdFramesRx	The number of valid EAP Resp/ID frames that have been received by the switch.	Rx	<b>Responses</b>	dot1xAuthEapolRespFramesRx	The number of valid EAPOL response frames (other than Resp/ID frames) that have been received by the switch.	Rx	<b>Start</b>	dot1xAuthEapolStartFramesRx	The number of EAPOL Start frames that have been received by the switch.	Rx	<b>Logoff</b>	dot1xAuthEapolLogoffFramesRx	The number of valid EAPOL logoff frames that have been received by the switch.	Rx	<b>Invalid Type</b>	dot1xAuthInvalidEapolFramesRx	The number of EAPOL frames that have been received by the switch in which the frame type is not recognized.	Rx	<b>Invalid Length</b>	dot1xAuthEapolLengthErrorFramesRx	The number of EAPOL frames that have been received by the switch in which the Packet Body Length field is invalid.	Tx	<b>Total</b>	dot1xAuthEapolFramesTx	The number of EAPOL frames of any type that have been transmitted by the switch.	Tx	<b>Request ID</b>	dot1xAuthEapolReqIdFramesTx	The number of EAP initial request frames that have been transmitted by the switch.	Tx	<b>Requests</b>	dot1xAuthEapolReqFramesTx	The number of valid EAP Request frames (other than initial request frames) that have been transmitted by the switch.
EAPOL Counters																																																	
Direction	Name	IEEE Name	Description																																														
Rx	<b>Total</b>	dot1xAuthEapolFramesRx	The number of valid EAPOL frames of any type that have been received by the switch.																																														
Rx	<b>Response ID</b>	dot1xAuthEapolRespIdFramesRx	The number of valid EAP Resp/ID frames that have been received by the switch.																																														
Rx	<b>Responses</b>	dot1xAuthEapolRespFramesRx	The number of valid EAPOL response frames (other than Resp/ID frames) that have been received by the switch.																																														
Rx	<b>Start</b>	dot1xAuthEapolStartFramesRx	The number of EAPOL Start frames that have been received by the switch.																																														
Rx	<b>Logoff</b>	dot1xAuthEapolLogoffFramesRx	The number of valid EAPOL logoff frames that have been received by the switch.																																														
Rx	<b>Invalid Type</b>	dot1xAuthInvalidEapolFramesRx	The number of EAPOL frames that have been received by the switch in which the frame type is not recognized.																																														
Rx	<b>Invalid Length</b>	dot1xAuthEapolLengthErrorFramesRx	The number of EAPOL frames that have been received by the switch in which the Packet Body Length field is invalid.																																														
Tx	<b>Total</b>	dot1xAuthEapolFramesTx	The number of EAPOL frames of any type that have been transmitted by the switch.																																														
Tx	<b>Request ID</b>	dot1xAuthEapolReqIdFramesTx	The number of EAP initial request frames that have been transmitted by the switch.																																														
Tx	<b>Requests</b>	dot1xAuthEapolReqFramesTx	The number of valid EAP Request frames (other than initial request frames) that have been transmitted by the switch.																																														
<p><b>Backend Server Counters</b></p>	<p>These backend (RADIUS) frame counters are available for the following administrative states:</p> <ul style="list-style-type: none"> <li>• <b>802.1X</b></li> <li>• <b>MAC-based Auth.</b></li> </ul> <table border="1"> <thead> <tr> <th colspan="4">Backend Server Counters</th> </tr> <tr> <th>Direction</th> <th>Name</th> <th>IEEE Name</th> <th>Description</th> </tr> </thead> <tbody> <tr> <td>Rx</td> <td><b>Access Challenges</b></td> <td>dot1xAuthBackendAccessChallenges</td> <td><b>Port-based:</b> Counts the number of times that the switch receives the first request from the backend server following the first response from the supplicant. Indicates that the backend server has communication with the switch. <b>MAC-based:</b> Counts all Access Challenges received from the backend server for this port (left-most table) or client (right-most table).</td> </tr> <tr> <td>Rx</td> <td><b>Other Requests</b></td> <td>dot1xAuthBackendOtherRequestsToSupplicant</td> <td><b>Port-based:</b> Counts the number of times that the switch sends an EAP Request packet following the first to the supplicant. Indicates that the backend server chose an EAP-method. <b>MAC-based:</b> Not applicable.</td> </tr> <tr> <td>Rx</td> <td><b>Auth. Successes</b></td> <td>dot1xAuthBackendAuthSuccesses</td> <td><b>Port- and MAC-based:</b> Counts the number of times that the switch receives a success indication. Indicates that the supplicant/client has successfully authenticated to the backend server.</td> </tr> <tr> <td>Rx</td> <td><b>Auth. Failures</b></td> <td>dot1xAuthBackendAuthFails</td> <td><b>Port- and MAC-based:</b> Counts the number of times that the switch receives a failure message. This indicates that the supplicant/client has not authenticated to the backend server.</td> </tr> <tr> <td>Tx</td> <td><b>Responses</b></td> <td>dot1xAuthBackendResponses</td> <td><b>Port-based:</b> Counts the number of times that the switch attempts to send a supplicant's first response packet to the backend server. Indicates the switch attempted communication with the backend server. Possible retransmissions are not counted. <b>MAC-based:</b> Counts all the backend server packets sent from the switch towards the backend server for a given port (left-most table) or client (right-most table). Possible retransmissions are not counted.</td> </tr> </tbody> </table>	Backend Server Counters				Direction	Name	IEEE Name	Description	Rx	<b>Access Challenges</b>	dot1xAuthBackendAccessChallenges	<b>Port-based:</b> Counts the number of times that the switch receives the first request from the backend server following the first response from the supplicant. Indicates that the backend server has communication with the switch. <b>MAC-based:</b> Counts all Access Challenges received from the backend server for this port (left-most table) or client (right-most table).	Rx	<b>Other Requests</b>	dot1xAuthBackendOtherRequestsToSupplicant	<b>Port-based:</b> Counts the number of times that the switch sends an EAP Request packet following the first to the supplicant. Indicates that the backend server chose an EAP-method. <b>MAC-based:</b> Not applicable.	Rx	<b>Auth. Successes</b>	dot1xAuthBackendAuthSuccesses	<b>Port- and MAC-based:</b> Counts the number of times that the switch receives a success indication. Indicates that the supplicant/client has successfully authenticated to the backend server.	Rx	<b>Auth. Failures</b>	dot1xAuthBackendAuthFails	<b>Port- and MAC-based:</b> Counts the number of times that the switch receives a failure message. This indicates that the supplicant/client has not authenticated to the backend server.	Tx	<b>Responses</b>	dot1xAuthBackendResponses	<b>Port-based:</b> Counts the number of times that the switch attempts to send a supplicant's first response packet to the backend server. Indicates the switch attempted communication with the backend server. Possible retransmissions are not counted. <b>MAC-based:</b> Counts all the backend server packets sent from the switch towards the backend server for a given port (left-most table) or client (right-most table). Possible retransmissions are not counted.																				
Backend Server Counters																																																	
Direction	Name	IEEE Name	Description																																														
Rx	<b>Access Challenges</b>	dot1xAuthBackendAccessChallenges	<b>Port-based:</b> Counts the number of times that the switch receives the first request from the backend server following the first response from the supplicant. Indicates that the backend server has communication with the switch. <b>MAC-based:</b> Counts all Access Challenges received from the backend server for this port (left-most table) or client (right-most table).																																														
Rx	<b>Other Requests</b>	dot1xAuthBackendOtherRequestsToSupplicant	<b>Port-based:</b> Counts the number of times that the switch sends an EAP Request packet following the first to the supplicant. Indicates that the backend server chose an EAP-method. <b>MAC-based:</b> Not applicable.																																														
Rx	<b>Auth. Successes</b>	dot1xAuthBackendAuthSuccesses	<b>Port- and MAC-based:</b> Counts the number of times that the switch receives a success indication. Indicates that the supplicant/client has successfully authenticated to the backend server.																																														
Rx	<b>Auth. Failures</b>	dot1xAuthBackendAuthFails	<b>Port- and MAC-based:</b> Counts the number of times that the switch receives a failure message. This indicates that the supplicant/client has not authenticated to the backend server.																																														
Tx	<b>Responses</b>	dot1xAuthBackendResponses	<b>Port-based:</b> Counts the number of times that the switch attempts to send a supplicant's first response packet to the backend server. Indicates the switch attempted communication with the backend server. Possible retransmissions are not counted. <b>MAC-based:</b> Counts all the backend server packets sent from the switch towards the backend server for a given port (left-most table) or client (right-most table). Possible retransmissions are not counted.																																														
<p><b>Last Supplicant/Client Info</b></p>	<p>Information about the last supplicant/client that attempts to authenticate. This information is available for the following administrative states:</p> <ul style="list-style-type: none"> <li>• <b>802.1X</b></li> <li>• <b>MAC-based Auth.</b></li> </ul>																																																

Last Supplicant/Client Info		
Name	IEEE Name	Description
<b>MAC Address</b>	dot1xAuthLastEapolFrameSource	The MAC address of the last supplicant/client.
<b>VLAN ID</b>	-	The VLAN ID on which the last frame from the last supplicant/client was received. <b>802.1X-based:</b>
<b>Version</b>	dot1xAuthLastEapolFrameVersion	The protocol version number carried in the most recently received EAPOL frame. <b>MAC-based:</b> Not applicable.
<b>Identity</b>	-	The user name (supplicant identity) carried in the most recently received Response Identity EAPOL frame. <b>MAC-based:</b> Not applicable.

## 5.9 Alerts

### 5.9.1 Fault Alarm

When any selected fault event happens, the Fault LED on the switch panel will light up and the electric relay will signal at the same time.

### Fault Alarm

**Power Failure**

PWR 1       PWR 2

**Port Link Down/Broken**

Port	Active
1	<input type="checkbox"/>
2	<input type="checkbox"/>
3	<input type="checkbox"/>
4	<input type="checkbox"/>
5	<input type="checkbox"/>
6	<input type="checkbox"/>
7	<input type="checkbox"/>

## 5.9.2 System Warning

### SYSLOG Setting

The SYSLOG is a protocol that transmits event notifications across networks. For more details, please refer to RFC 3164 - The BSD SYSLOG Protocol.

Label	Description
Server Mode	Indicates existing server mode. When the mode operation is enabled, the syslog message will be sent to syslog server. The syslog protocol is based on UDP communications and received on UDP port 514 and the syslog server will not send acknowledgments back to the sender since UDP is a connectionless protocol and it does not provide acknowledgments. The syslog packet will always be sent even if the syslog server does not exist. Possible modes are: <b>Enabled:</b> enable server mode <b>Disabled:</b> disable server mode
<b>SYSLOG Server IP Address</b>	Indicates the IPv4 host address of syslog server. If the switch provides DNS functions, it also can be a host name.

### SMTP Setting

SMTP (Simple Mail Transfer Protocol) is a protocol for transmitting e-mails across the Internet. For more information, please refer to RFC 821 - Simple Mail Transfer Protocol.

**SMTP Setting**

E-mail Alert :  ▾

<b>SMTP Server Address</b>	<input type="text" value="0.0.0.0"/>
<b>Sender E-mail Address</b>	<input type="text" value="administrator"/>
<b>Mail Subject</b>	<input type="text" value="Automated Email Alert"/>
<input type="checkbox"/> <b>Authentication</b>	
<b>Recipient E-mail Address 1</b>	<input type="text"/>
<b>Recipient E-mail Address 2</b>	<input type="text"/>
<b>Recipient E-mail Address 3</b>	<input type="text"/>
<b>Recipient E-mail Address 4</b>	<input type="text"/>
<b>Recipient E-mail Address 5</b>	<input type="text"/>
<b>Recipient E-mail Address 6</b>	<input type="text"/>

Label	Description
<b>E-mail Alarm</b>	Enables or disables transmission of system warnings by e-mail
<b>Sender E-mail Address</b>	SMTP server IP address
<b>Mail Subject</b>	Subject of the mail
<b>Authentication</b>	<ul style="list-style-type: none"> <li>■ <b>Username:</b> the authentication username</li> <li>■ <b>Password:</b> the authentication password</li> <li>■ <b>Confirm Password:</b> re-enter password</li> </ul>
<b>Recipient E-mail Address</b>	The recipient's e-mail address. A mail allows for 6 recipients.
<b>Apply</b>	Click to activate the configurations
<b>Help</b>	Shows help file

### Event Selection

SYSLOG and SMTP are two warning methods supported by the system. Check the corresponding box to enable the system event warning method you want. Please note that the checkbox cannot be checked when SYSLOG or SMTP is disabled.

### System Warning - Event Selection

System Events	SYSLOG	SMTP
System Start	<input type="checkbox"/>	<input type="checkbox"/>
Power Status	<input type="checkbox"/>	<input type="checkbox"/>
SNMP Authentication Failure	<input type="checkbox"/>	<input type="checkbox"/>
Redundant Ring Topology Change	<input type="checkbox"/>	<input type="checkbox"/>

Port	SYSLOG	SMTP
1	Disabled ▾	Link Up and Link Down ▾
2	Disabled ▾	Link Up ▾
3	Disabled ▾	Link Down ▾
4	Disabled ▾	Disabled ▾
5	Disabled ▾	Disabled ▾
6	Disabled ▾	Disabled ▾
7	Disabled ▾	Disabled ▾
8	Disabled ▾	Disabled ▾
9	Disabled ▾	Disabled ▾
10	Disabled ▾	Disabled ▾
11	Disabled ▾	Disabled ▾
12	Disabled ▾	Disabled ▾

Label	Description
<b>System Cold Start</b>	Sends out alerts when the system is restarted
<b>Power Status</b>	Sends out alerts when power is up or down
<b>SNMP Authentication Failure</b>	Sends out alert when SNMP authentication fails
<b>O-Ring Topology Change</b>	Sends out alerts when O-Ring topology changes
<b>Port Event</b> <b>SYSLOG / SMTP event</b>	<ul style="list-style-type: none"> <li>■ Disable</li> <li>■ Link Up</li> <li>■ Link Down</li> <li>■ Link Up &amp; Link Down</li> </ul>
<b>Apply</b>	Click to activate the configurations
<b>Help</b>	Shows help file



## 5.10 Monitor and Diag

### 5.10.1 MAC Table

The MAC address table can be configured on this page. You can set timeouts for entries in the dynamic MAC table and configure the static MAC table here.

#### MAC Address Table Configuration

**Aging Configuration**

**Disable Automatic Aging**

**Age Time**  seconds

**MAC Table Learning**

	Port Members											
	1	2	3	4	5	6	7	8	9	10	11	12
<b>Auto</b>	<input type="radio"/>	<input checked="" type="radio"/>	<input checked="" type="radio"/>	<input checked="" type="radio"/>	<input checked="" type="radio"/>	<input checked="" type="radio"/>	<input checked="" type="radio"/>	<input checked="" type="radio"/>	<input checked="" type="radio"/>	<input checked="" type="radio"/>	<input checked="" type="radio"/>	<input checked="" type="radio"/>
<b>Disable</b>	<input type="radio"/>	<input type="radio"/>	<input type="radio"/>	<input type="radio"/>	<input type="radio"/>	<input type="radio"/>	<input type="radio"/>	<input type="radio"/>	<input type="radio"/>	<input type="radio"/>	<input type="radio"/>	<input type="radio"/>
<b>Secure</b>	<input checked="" type="radio"/>	<input type="radio"/>	<input type="radio"/>	<input type="radio"/>	<input type="radio"/>	<input type="radio"/>	<input type="radio"/>	<input type="radio"/>	<input type="radio"/>	<input type="radio"/>	<input type="radio"/>	<input type="radio"/>

#### Static MAC Table Configuration

Delete	VLAN ID	MAC Address	Port Members												
			1	2	3	4	5	6	7	8	9	10	11	12	
<input type="checkbox"/>	1	00-1E-94-98-89-89	<input checked="" type="checkbox"/>	<input type="checkbox"/>	<input type="checkbox"/>	<input type="checkbox"/>	<input type="checkbox"/>	<input type="checkbox"/>	<input type="checkbox"/>	<input type="checkbox"/>	<input type="checkbox"/>	<input type="checkbox"/>	<input type="checkbox"/>	<input type="checkbox"/>	<input type="checkbox"/>

#### Aging Configuration

By default, dynamic entries are removed from the MAC after 300 seconds. This removal is called aging. You can configure aging time by entering a value in the box of **Age Time**. The allowed range is 10 to 1000000 seconds. You can also disable the automatic aging of dynamic entries by checking **Disable Automatic Aging**.

#### MAC Table Learning

If the learning mode for a given port is grayed out, it means another module is in control of the mode, and thus the user cannot change the configurations. An example of such a module is MAC-Based authentication under 802.1X.

You can configure the port to dynamically learn the MAC address based upon the following settings:

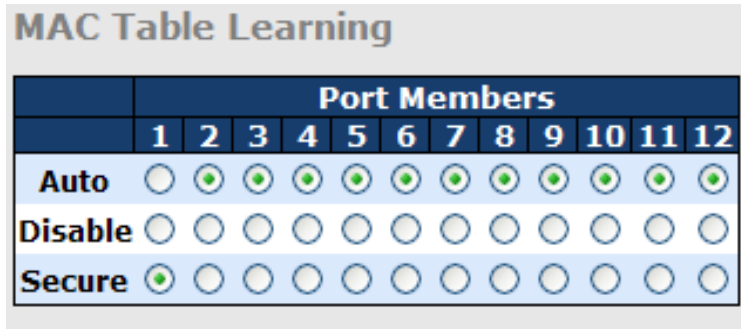

Label	Description
<b>Auto</b>	Learning is done automatically as soon as a frame with unknown SMAC is received.
<b>Disable</b>	No learning is done.
<b>Secure</b>	Only static MAC entries are learned, all other frames are dropped. Note: make sure the link used for managing the switch is added to the static Mac table before changing to secure learning mode, otherwise the management link will be lost and can only be restored by using another non-secure port or by connecting to the switch via the serial interface.

### Static MAC Table Configurations

The static entries in the MAC table are shown in this table. The static MAC table can contain up to 64 entries. The entries are for the whole stack, not for individual switches. The MAC table is sorted first by VLAN ID and then by MAC address.

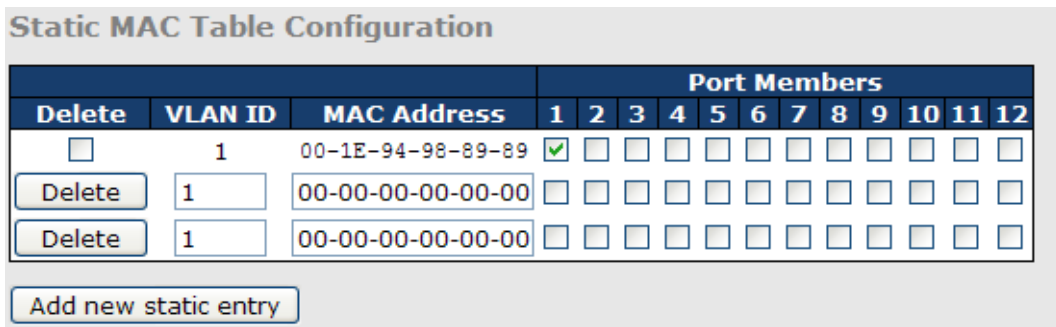

Label	Description
<b>Delete</b>	Check to delete an entry. It will be deleted during the next save.
<b>VLAN ID</b>	The VLAN ID for the entry
<b>MAC Address</b>	The MAC address for the entry
<b>Port Members</b>	Checkmarks indicate which ports are members of the entry.

	Check or uncheck to modify the entry.
<b>Adding New Static Entry</b>	Click to add a new entry to the static MAC table. You can specify the VLAN ID, MAC address, and port members for the new entry. Click <b>Save</b> to save the changes.

### MAC Table

Each page shows up to 999 entries from the MAC table, with a default value of 20, selected by the **Entries Per Page** input field. When first visited, the web page will show the first 20 entries from the beginning of the MAC Table. The first displayed will be the one with the lowest VLAN ID and the lowest MAC address found in the MAC Table.

Each page shows up to 999 entries from the MAC table, with a default value of 20, selected by the **Entries Per Page** input field. When first visited, the web page will show the first 20 entries from the beginning of the MAC Table. The first displayed will be the one with the lowest VLAN ID and the lowest MAC address found in the MAC Table.

The **Start from MAC address** and **VLAN** fields allow the user to select the starting point in the MAC table. Clicking the **Refresh** button will update the displayed table starting from that or the closest next MAC table match. In addition, the two input fields will – upon clicking **Refresh** - assume the value of the first displayed entry, allows for continuous refresh with the same start address.

The >> will use the last entry of the currently displayed VLAN/MAC address pairs as a basis for the next lookup. When it reaches the end, the text "**no more entries**" is shown in the displayed table. Use the << button to start over.

### MAC Address Table

Auto-refresh  Refresh Clear |<< >>

Start from VLAN  and MAC address  with  entries per page.

Type	VLAN	MAC Address	CPU	Port Members												
				1	2	3	4	5	6	7	8	9	10	11	12	
Static	1	00-1E-94-98-89-89	✓													
Static	1	00-1E-94-FF-FF-FF	✓													
Static	1	01-80-C2-4A-44-06	✓	✓	✓	✓	✓	✓	✓	✓	✓	✓	✓	✓	✓	✓
Static	1	33-33-FF-A8-0A-01	✓													
Static	1	33-33-FF-FF-FF-FF	✓													
Static	1	FF-FF-FF-FF-FF-FF	✓	✓	✓	✓	✓	✓	✓	✓	✓	✓	✓	✓	✓	✓

<b>Label</b>	Description
<b>Type</b>	Indicates whether the entry is a static or dynamic entry
<b>MAC address</b>	The MAC address of the entry
<b>VLAN</b>	The VLAN ID of the entry
<b>Port Members</b>	The ports that are members of the entry.

## 5.10.2 Port Statistics

### Traffic Overview

This page provides an overview of general traffic statistics for all switch ports.

Port Statistics Overview									
Auto-refresh <input type="checkbox"/> Refresh Clear									
Port	Packets		Bytes		Errors		Drops		Filtered
	Receive	Transmit	Receive	Transmit	Receive	Transmit	Receive	Transmit	Receive
	117980	86946125	9117790	6259918088	3	0	0	0	0
2	0	0	0	0	0	0	0	0	0
4	68732984	68732987	4957477714	4957477932	0	0	0	0	24710409
6	0	0	0	0	0	0	0	0	0
8	68732985	68732987	4957477883	4957477932	1	0	0	0	25204638
10	0	0	0	0	0	0	0	0	0
12	0	0	0	0	0	0	0	0	0

<b>Label</b>	Description
<b>Port</b>	The switch port number to which the following settings will be applied.
<b>Packets</b>	The number of received and transmitted packets per port
<b>Bytes</b>	The number of received and transmitted bytes per port
<b>Errors</b>	The number of frames received in error and the number of incomplete transmissions per port
<b>Drops</b>	The number of frames discarded due to ingress or egress congestion
<b>Filtered</b>	The number of received frames filtered by the forwarding process
<b>Auto-refresh</b>	Check to enable an automatic refresh of the page at regular intervals.
<b>Refresh</b>	Updates the counter entries, starting from the current entry ID.
<b>Clear</b>	Flushes all counters entries

### Detailed Statistics

This page provides detailed traffic statistics for a specific switch port. Use the port drop-down list to decide the details of which switch port to be displayed.

The displayed counters include the total number for receive and transmit, the size for receive and transmit, and the errors for receive and transmit.

**Detailed Statistics – Total Receive & Transmit**

Detailed Port Statistics Port 1			
Port 1		Auto-refresh <input type="checkbox"/>	Refresh <input type="button" value="Refresh"/> Clear <input type="button" value="Clear"/>
Receive Total		Transmit Total	
Rx Packets	0	Tx Packets	0
Rx Octets	0	Tx Octets	0
Rx Unicast	0	Tx Unicast	0
Rx Multicast	0	Tx Multicast	0
Rx Broadcast	0	Tx Broadcast	0
Rx Pause	0	Tx Pause	0
Receive Size Counters		Transmit Size Counters	
Rx 64 Bytes	0	Tx 64 Bytes	0
Rx 65-127 Bytes	0	Tx 65-127 Bytes	0
Rx 128-255 Bytes	0	Tx 128-255 Bytes	0
Rx 256-511 Bytes	0	Tx 256-511 Bytes	0
Rx 512-1023 Bytes	0	Tx 512-1023 Bytes	0
Rx 1024-1526 Bytes	0	Tx 1024-1526 Bytes	0
Rx 1527- Bytes	0	Tx 1527- Bytes	0
Receive Queue Counters		Transmit Queue Counters	
Rx Q0	0	Tx Q0	0
Rx Q1	0	Tx Q1	0
Rx Q2	0	Tx Q2	0
Rx Q3	0	Tx Q3	0
Rx Q4	0	Tx Q4	0
Rx Q5	0	Tx Q5	0
Rx Q6	0	Tx Q6	0
Rx Q7	0	Tx Q7	0
Receive Error Counters		Transmit Error Counters	
Rx Drops	0	Tx Drops	0
Rx CRC/Alignment	0	Tx Late/Exc. Coll.	0
Rx Undersize	0		
Rx Oversize	0		
Rx Fragments	0		
Rx Jabber	0		
Rx Filtered	0		

Label	Description
<b>Rx and Tx Packets</b>	The number of received and transmitted (good and bad) packets
<b>Rx and Tx Octets</b>	The number of received and transmitted (good and bad) bytes, including FCS, except framing bits
<b>Rx and Tx Unicast</b>	The number of received and transmitted (good and bad) unicast packets
<b>Rx and Tx Multicast</b>	The number of received and transmitted (good and bad) multicast packets
<b>Rx and Tx Broadcast</b>	The number of received and transmitted (good and bad) broadcast packets
<b>Rx and Tx Pause</b>	The number of MAC Control frames received or transmitted on this port that have an opcode indicating a PAUSE operation

<b>Rx Drops</b>	The number of frames dropped due to insufficient receive buffer or egress congestion
<b>Rx CRC/Alignment</b>	The number of frames received with CRC or alignment errors
<b>Rx Undersize</b>	The number of short <sup>1</sup> frames received with a valid CRC
<b>Rx Oversize</b>	The number of long <sup>2</sup> frames received with a valid CRC
<b>Rx Fragments</b>	The number of short <sup>1</sup> frames received with an invalid CRC
<b>Rx Jabber</b>	The number of long <sup>2</sup> frames received with an invalid CRC
<b>Rx Filtered</b>	The number of received frames filtered by the forwarding process
<b>Tx Drops</b>	The number of frames dropped due to output buffer congestion
<b>Tx Late / Exc.Coll.</b>	The number of frames dropped due to excessive or late collisions

1. Short frames are frames smaller than 64 bytes.
2. Long frames are frames longer than the maximum frame length configured for this port.

### 5.10.3 Port Mirroring

You can configure port mirroring on this page.

To solve network problems, selected traffic can be copied, or mirrored, to a mirror port where a frame analyzer can be attached to analyze the frame flow.

The traffic to be copied to the mirror port is selected as follows:

All frames received on a given port (also known as ingress or source mirroring).

All frames transmitted on a given port (also known as egress or destination mirroring).

Port to mirror is also known as the mirror port. Frames from ports that have either source (rx) or destination (tx) mirroring enabled are mirrored to this port. Disabled option disables mirroring.

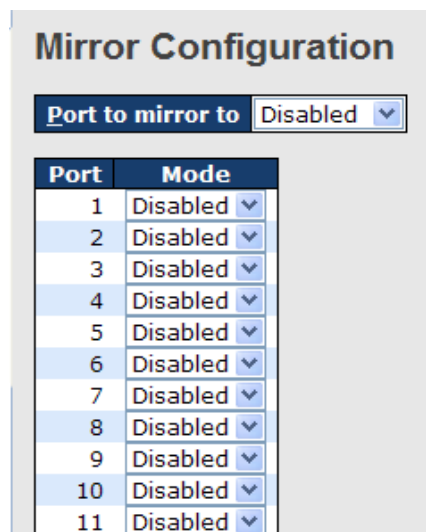

Label	Description
<b>Port</b>	The switch port number to which the following settings will be applied.
<b>Mode</b>	<p>Drop-down list for selecting a mirror mode.</p> <p><b>Rx only:</b> only frames received on this port are mirrored to the mirror port. Frames transmitted are not mirrored.</p> <p><b>Tx only:</b> only frames transmitted from this port are mirrored to the mirror port. Frames received are not mirrored.</p> <p><b>Disabled:</b> neither transmitted nor received frames are mirrored.</p> <p><b>Enabled:</b> both received and transmitted frames are mirrored to the mirror port.</p> <p>Note: for a given port, a frame is only transmitted once. Therefore, you cannot mirror Tx frames to the mirror port. In this case, mode for the selected mirror port is limited to <b>Disabled</b> or <b>Rx only</b>.</p>

### 5.10.4 System Log Information

This page provides switch system log information.

Label	Description
<b>ID</b>	The ID ( $\geq 1$ ) of the system log entry
<b>Level</b>	<p>The level of the system log entry. The following level types are supported:</p> <p><b>Info:</b> provides general information</p> <p><b>Warning:</b> provides warning for abnormal operation</p> <p><b>Error:</b> provides error message</p> <p><b>All:</b> enables all levels</p>
<b>Time</b>	The time of the system log entry
<b>Message</b>	The MAC address of the switch
<b>Auto-refresh</b>	Check this box to enable an automatic refresh of the page at regular

	intervals.
<b>Refresh</b>	Updates system log entries, starting from the current entry ID
<b>Clear</b>	Flushes all system log entries
<<	Updates system log entries, starting from the first available entry ID
<<	Updates system log entries, ending at the last entry currently displayed
>>	Updates system log entries, starting from the last entry currently displayed.
>>	Updates system log entries, ending at the last available entry ID.

### 5.10.5 Cable Diagnostics

This page allows you to perform VeriPHY cable diagnostics.

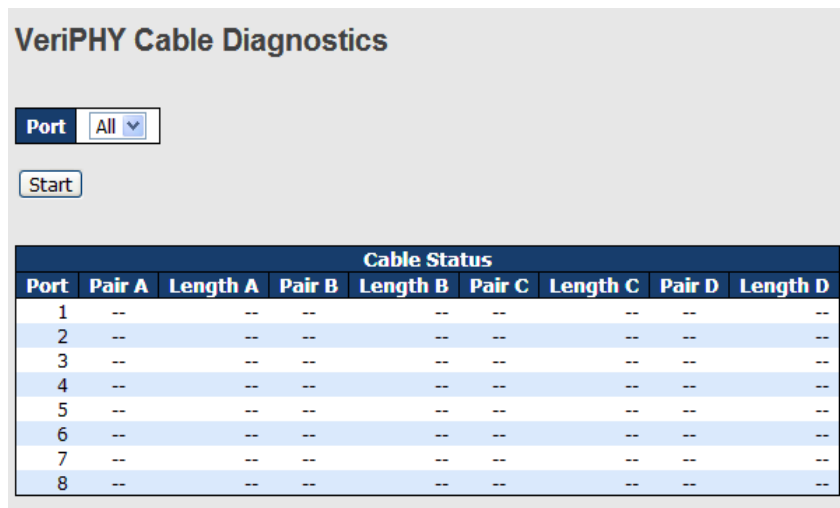

Press **Start** to run the diagnostics. This will take approximately 5 seconds. If all ports are selected, this can take approximately 15 seconds. When completed, the page refreshes automatically, and you can view the cable diagnostics results in the cable status table. Note that VeriPHY diagnostics is only accurate for cables 7 - 140 meters long.

10 and 100 Mbps ports will be disconnected while running VeriPHY diagnostics. Therefore, running VeriPHY on a 10 or 100 Mbps management port will cause the switch to stop responding until VeriPHY is complete.

Label	Description
<b>Port</b>	The port for which VeriPHY Cable Diagnostics is requested
<b>Cable Status</b>	Port: port number Pair: the status of the cable pair Length: the length (in meters) of the cable pair



### 5.10.6 SFP Monitor

SFP modules with DDM (Digital Diagnostic Monitoring) function can measure the temperature of the apparatus, helping you monitor the status of connection and detect errors immediately. You can manage and set up event alarms through DDM Web interface.

#### SFP Monitor

Auto-refresh

Port No.	Temperature (°C)	Vcc (V)	TX Bias(mA)	TX Power(μW)	RX Power(μW)
1	N/A	N/A	N/A	N/A	N/A
2	N/A	N/A	N/A	N/A	N/A
3	N/A	N/A	N/A	N/A	N/A
4	N/A	N/A	N/A	N/A	N/A
5	N/A	N/A	N/A	N/A	N/A
6	N/A	N/A	N/A	N/A	N/A
7	N/A	N/A	N/A	N/A	N/A
8	N/A	N/A	N/A	N/A	N/A
9	N/A	N/A	N/A	N/A	N/A
10	N/A	N/A	N/A	N/A	N/A
11	N/A	N/A	N/A	N/A	N/A
12	N/A	N/A	N/A	N/A	N/A

**Warning Temperature :**

°C(0~100)

**Event Alarm :**

Syslog

### 5.10.7 Ping

This page allows you to issue ICMP PING packets to troubleshoot IP connectivity issues.

#### ICMP Ping

IP Address	0.0.0.0
Ping Size	64

After you press **Start**, five ICMP packets will be transmitted, and the sequence number and roundtrip time will be displayed upon reception of a reply. The page refreshes automatically until responses to all packets are received, or until a timeout occurs.

```
PING6 server ::10.10.132.20
64 bytes from ::10.10.132.20: icmp_seq=0, time=0ms
```

64 bytes from ::10.10.132.20: icmp\_seq=1, time=0ms

64 bytes from ::10.10.132.20: icmp\_seq=2, time=0ms

64 bytes from ::10.10.132.20: icmp\_seq=3, time=0ms

64 bytes from ::10.10.132.20: icmp\_seq=4, time=0ms

Sent 5 packets, received 5 OK, 0 bad

You can configure the following properties of the issued ICMP packets:

Label	Description
<b>IP Address</b>	The destination IP Address
<b>Ping Size</b>	The payload size of the ICMP packet. Values range from 8 to 1400 bytes.

## IPv6 Ping

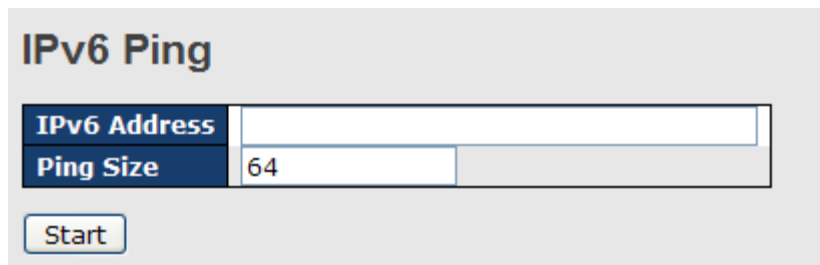

PING6 server ::192.168.10.1

sendto

sendto

sendto

sendto

sendto

Sent 5 packets, received 0 OK, 0 bad

## 5.11 PoE

### 5.11.1 Configuration

PoE (Power Over Ethernet) is a technology that transmits electrical power to devices such as IP telephones, wireless LAN access points, and IP cameras over standard Ethernet cables.

The ability is very useful in places where power supply is difficult or expensive deploy.

## Power Over Ethernet Configuration

<b>Reserved Power determined by</b>	<input checked="" type="radio"/> Class	<input type="radio"/> Allocation	<input type="radio"/> LLDP-MED
<b>Power Management Mode</b>	<input type="radio"/> Actual Consumption	<input checked="" type="radio"/> Reserved Power	

### PoE Power Supply Configuration

<b>Primary Power Supply [W]</b>	720
---------------------------------	-----

### PoE Port Configuration

Port	PoE Mode	Priority	Maximum Power [W]
*	<>	<>	15.4
1	PoE+	Low	15.4
2	PoE+	Low	15.4
3	PoE+	Low	15.4
4	PoE+	Low	15.4
5	PoE+	Low	15.4
6	PoE+	Low	15.4
7	PoE+	Low	15.4
8	PoE+	Low	15.4
9	PoE+	Low	15.4
10	PoE+	Low	15.4
11	PoE+	Low	15.4

Label	Description
<b>Reserved Power determined by</b>	<p>There are three modes available when configuring the reserved power of each port or power devices.</p> <p><b>Allocation:</b> users can allocate the amount of power that each port reserves. The allocated/reserved power for each port/power device is specified in the Maximum Power field.</p> <p><b>Class:</b> each port automatically determines how much power to reserve according to the class the connected power device belongs to, and then reserves the power accordingly. Four different port classes are available, including 4, 7, 15.4, and 30 Watts. In this mode, the maximum power field will gray out.</p> <p><b>LLDP-MED:</b> this mode is similar to the <b>Class</b> mode expect that each port determines the amount power it wants to reserve by exchanging PoE information using the LLDP protocol. If no LLDP information is available for the port, the port will reserve power using the <b>Class</b> mode. In this mode, the maximum power fields will gray out.</p> <p>In all of the abovementioned modes, if a port uses more power</p>

	than the reserved power for the port, the port is shut down.
<b>Power Management Mode</b>	<p>There are two modes available when configuring when to shut down the port:</p> <p><b>Actual Consumption:</b> the ports are shut down when the actual power consumption for all ports exceeds the amount of power that the power supply can deliver or if the actual power consumption for a given port exceeds the reserved power of that port. The ports are shut down according to port priority. If two ports have the same priority, the port with the highest port number is shut down.</p> <p><b>Reserved Power:</b> the ports are shut down when total reserved power exceeds the amount of power that the power supply can deliver. The port power will not be turned on if the power device requests more power than available from the power supply.</p>
<b>Primary and Backup Power Source</b>	<p>Some switches support two PoE power supplies. One is used as primary power source, and one as a backup. If the switch does not support backup power supply, only the primary power supply settings will be shown. If the primary power source fails, the backup power source will take over. To determine the amount of power allowed for the power device, you must configure the amount of power the primary and backup power sources can deliver.</p> <p>Valid values are in the range 0 to 2000 watts.</p>
<b>Port</b>	<p>The logical port number for this row.</p> <p>Ports that are not PoE-capable are grayed out and thus unable to be configured.</p>
<b>PoE Mode</b>	<p>A drop-down list for selecting PoE operations. The modes include:</p> <p><b>Disabled:</b> disable PoE</p> <p><b>PoE:</b> enable PoE IEEE 802.3af (Class 4 PDs limited to 15.4W)</p> <p><b>PoE+:</b> enable PoE+ IEEE 802.3at (Class 4 PDs limited to 30W)</p>
<b>Priority</b>	<p>Indicates port priority. There are three levels of power priority: <b>Low, High, and Critical.</b></p> <p>The priority is used when remote devices require more power than the power supply can deliver. The port with the lowest priority will be turn off and power will be supplied to the port with the highest port number.</p>
<b>Maximum Power</b>	<p>Indicates the maximum power in watts that can be delivered to a remote device (the maximum allowed value is 30 W).</p>

### 5.11.2 Status

This page allows you to examine the current status for all PoE ports.

**Power Over Ethernet Status**

Auto-refresh  Refresh

Local Port	PD class	Power Requested	Power Allocated	Power Used	Current Used	Priority	Port Status
1	-	0 [W]	0 [W]	0 [W]	0 [mA]	Low	No PD detected
2	-	0 [W]	0 [W]	0 [W]	0 [mA]	Low	No PD detected
3	-	0 [W]	0 [W]	0 [W]	0 [mA]	Low	No PD detected
4	-	0 [W]	0 [W]	0 [W]	0 [mA]	Low	No PD detected
5	-	0 [W]	0 [W]	0 [W]	0 [mA]	Low	No PD detected
6	-	0 [W]	0 [W]	0 [W]	0 [mA]	Low	No PD detected
7	-	0 [W]	0 [W]	0 [W]	0 [mA]	Low	No PD detected
8	-	0 [W]	0 [W]	0 [W]	0 [mA]	Low	No PD detected
9	-	0 [W]	0 [W]	0 [W]	0 [mA]	Low	No PD detected
10	-	0 [W]	0 [W]	0 [W]	0 [mA]	Low	No PD detected
11	-	0 [W]	0 [W]	0 [W]	0 [mA]	Low	No PD detected
12	-	0 [W]	0 [W]	0 [W]	0 [mA]	Low	No PD detected
13	-	0 [W]	0 [W]	0 [W]	0 [mA]	Low	No PD detected
14	-	0 [W]	0 [W]	0 [W]	0 [mA]	Low	No PD detected

Label	Description
<b>Local Port</b>	The switch port number to which the following settings will be applied.
<b>PD Class</b>	Each power device is classified according to the class that defines the maximum power consumed by the PD. This setting includes five classes: <b>Class 0:</b> Max. power 15.4 W <b>Class 1:</b> Max. power 4.0 W <b>Class 2:</b> Max. power 7.0 W <b>Class 3:</b> Max. power 15.4 W <b>Class 4:</b> Max. power 30.0 W
<b>Power Requested</b>	Shows the amount of power requested by the power device
<b>Power Allocated</b>	Shows the amount of power the switch has allocated for the power device
<b>Power Used</b>	Shows how much power the power device currently is using
<b>Current Used</b>	Shows how much current the PD currently is using
<b>Priority</b>	Shows the port's priority configured by the user
<b>Port Status</b>	Shows the port's status. The status can be one of the following values: <b>PoE not available:</b> no PoE chip found <b>PoE turned OFF:</b> PoE is disabled by user. <b>PoE turned OFF:</b> power budget exceeded. The total requested or used power by the power devices exceeds the maximum power

	<p>the power supply can deliver, and port(s) with the lowest priority will be powered down.</p> <p><b>No PD detected:</b> no power devices detected on the port</p> <p><b>PoE turned OFF:</b> power devices overload. The power devices have requested or used more power than the port can deliver, and the port is powered down.</p> <p><b>PoE turned OFF:</b> the power device is turned off.</p> <p><b>Invalid PD:</b> the power device is detected, but is not working correctly.</p>
--	--

### 5.11.3 PoE Schedule

You can appoint a date and time as well as enable or disable PoE functions. The switch will perform PoE functions based on your configurations (SNTP function must be enabled).

**Power Over Ethernet Schedule Configuration**

Configure port #

Schedule Mode

Select all

Hour	Sunday	Monday	Tuesday	Wednesday	Thursday	Friday	Saturday
00	<input type="checkbox"/>	<input type="checkbox"/>	<input type="checkbox"/>	<input type="checkbox"/>	<input type="checkbox"/>	<input type="checkbox"/>	<input type="checkbox"/>
01	<input type="checkbox"/>	<input type="checkbox"/>	<input type="checkbox"/>	<input type="checkbox"/>	<input type="checkbox"/>	<input type="checkbox"/>	<input type="checkbox"/>
02	<input type="checkbox"/>	<input type="checkbox"/>	<input type="checkbox"/>	<input type="checkbox"/>	<input type="checkbox"/>	<input type="checkbox"/>	<input type="checkbox"/>
03	<input type="checkbox"/>	<input type="checkbox"/>	<input type="checkbox"/>	<input type="checkbox"/>	<input type="checkbox"/>	<input type="checkbox"/>	<input type="checkbox"/>
04	<input type="checkbox"/>	<input type="checkbox"/>	<input type="checkbox"/>	<input type="checkbox"/>	<input type="checkbox"/>	<input type="checkbox"/>	<input type="checkbox"/>
05	<input type="checkbox"/>	<input type="checkbox"/>	<input type="checkbox"/>	<input type="checkbox"/>	<input type="checkbox"/>	<input type="checkbox"/>	<input type="checkbox"/>

Label	Description
<b>Configure port</b>	Select a port for the schedule
<b>Schedule mode</b>	Enables or disables the schedule mode
<b>Select all</b>	Check to have the schedule enabled at all time
<b>Hour</b>	Check to choose the hour for the schedule
<b>Sunday - Saturday</b>	Check to choose the day for the schedule

### 5.11.4 PoE Auto-Ping

You can control PoE functions via ping commands which will enable or disable other PoE devices connected to the configured ports.

**Auto-Ping Check**

Ping Check:  ▾

Port	Ping IP Address	Interval Time (10~120) seconds	Retry Time (1~5)	Failure Log	Failure Action	Reboot Time (3~120) seconds
1	<input type="text" value="0.0.0.0"/>	<input type="text" value="10"/>	<input type="text" value="1"/>	error=0 total=0	<input type="button" value="Nothing"/> ▾	<input type="text" value="3"/>
2	<input type="text" value="0.0.0.0"/>	<input type="text" value="10"/>	<input type="text" value="1"/>	error=0 total=0	<input type="button" value="Nothing"/> ▾	<input type="text" value="3"/>
3	<input type="text" value="0.0.0.0"/>	<input type="text" value="10"/>	<input type="text" value="1"/>	error=0 total=0	<input type="button" value="Nothing"/> ▾	<input type="text" value="3"/>
4	<input type="text" value="0.0.0.0"/>	<input type="text" value="10"/>	<input type="text" value="1"/>	error=0 total=0	<input type="button" value="Nothing"/> ▾	<input type="text" value="3"/>
5	<input type="text" value="0.0.0.0"/>	<input type="text" value="10"/>	<input type="text" value="1"/>	error=0 total=0	<input type="button" value="Nothing"/> ▾	<input type="text" value="3"/>
6	<input type="text" value="0.0.0.0"/>	<input type="text" value="10"/>	<input type="text" value="1"/>	error=0 total=0	<input type="button" value="Nothing"/> ▾	<input type="text" value="3"/>
7	<input type="text" value="0.0.0.0"/>	<input type="text" value="10"/>	<input type="text" value="1"/>	error=0 total=0	<input type="button" value="Nothing"/> ▾	<input type="text" value="3"/>

Label	Description
<b>Ping Check</b>	Enables or disables ping check function
<b>Send Mail</b>	When ping fails, an email notification will be sent
<b>Port</b>	Ports which you want to perform auto-ping check function
<b>Ping IP Address</b>	Enter an IP address
<b>Interval Time</b>	Assigns a time interval for the check (10 - 120 seconds)
<b>Retry Time</b>	Set up the number of times for which the function will perform repeatedly
<b>Failure Log</b>	Note down failed results
<b>Failure Action</b>	Assign the action you want to perform
<b>Reboot Time</b>	Assigns the time for rebooting the switch after check fails

## 5.12 Troubleshooting

### 5.12.1 Factory Defaults

You can reset the configuration of the stack switch on this page. Only the IP configuration is retained.

#### Factory Defaults



Label	Description
<b>Yes</b>	Click to reset the configuration to factory defaults
<b>No</b>	Click to return to the Port State page without resetting

### 5.12.2 System Reboot

You can reset the stack switch on this page. After reset, the system will boot normally as if you have powered on the devices.

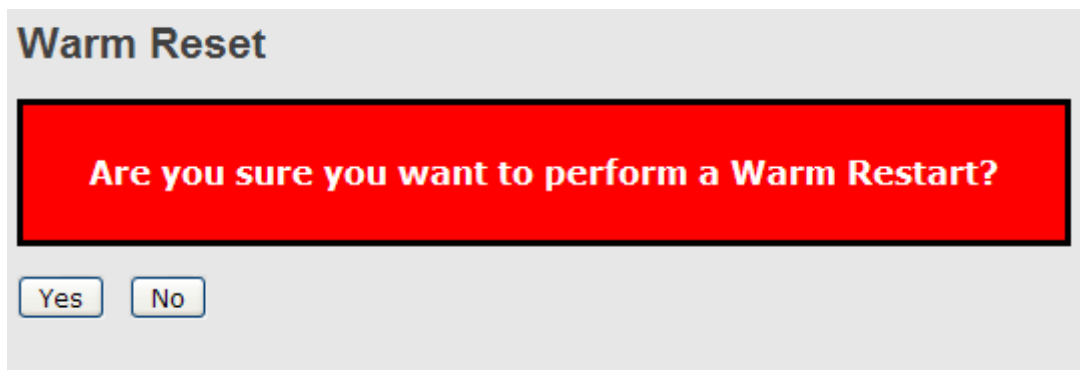

Label	Description
<b>Yes</b>	Click to reboot device
<b>No</b>	Click to return to the <b>Port State</b> page without rebooting



# Command Line Interface Management

Besides Web-based management, the RGPS-92222GCP-NP series also support CLI management. You can use console or telnet to manage the switch by CLI.

## **CLI Management by RS-232 Serial Console (115200, 8, none, 1, none)**

Before configuring RS-232 serial console, connect the RS-232 port of the switch to your PC Com port using a RJ45 to DB9-F cable.

Follow the steps below to access the console via RS-232 serial cable.

Step 1: On Windows desktop, click on **Start -> Programs -> Accessories -> Communications -> Hyper Terminal**

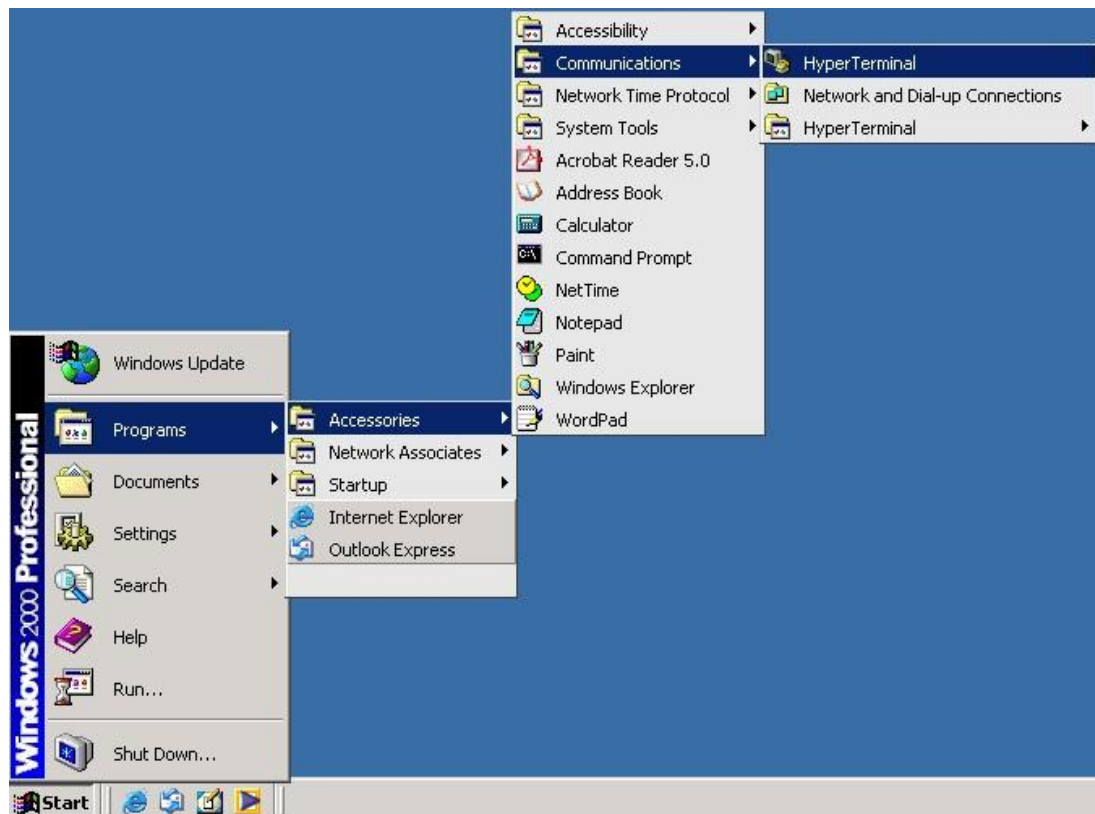

Step 2: Input a name for the new connection.

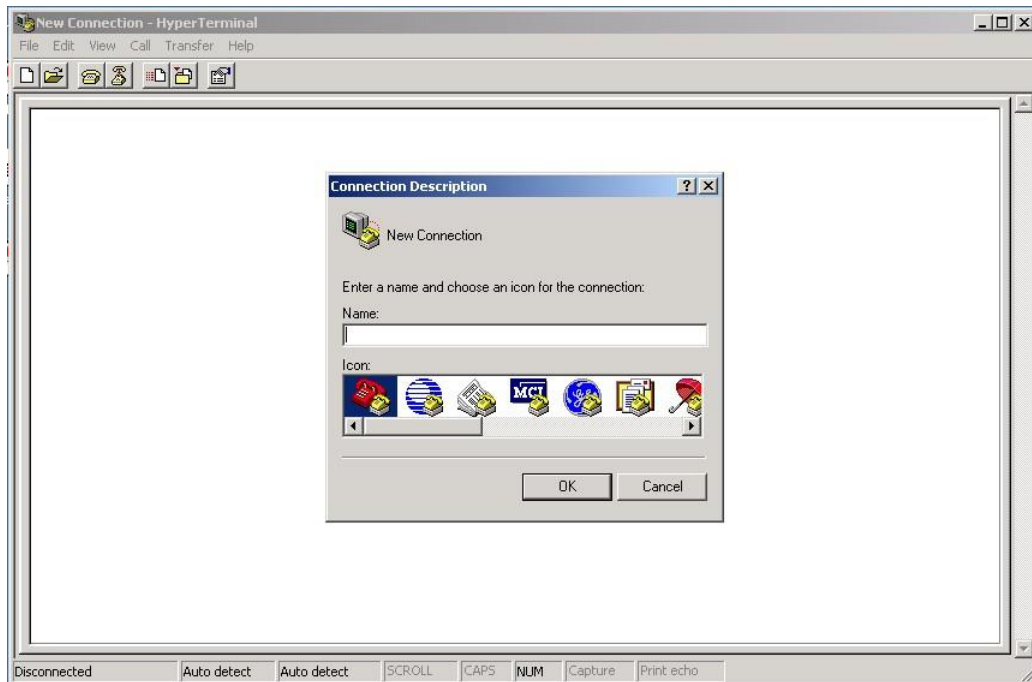

Step 3: Select a COM port in the drop-down list.

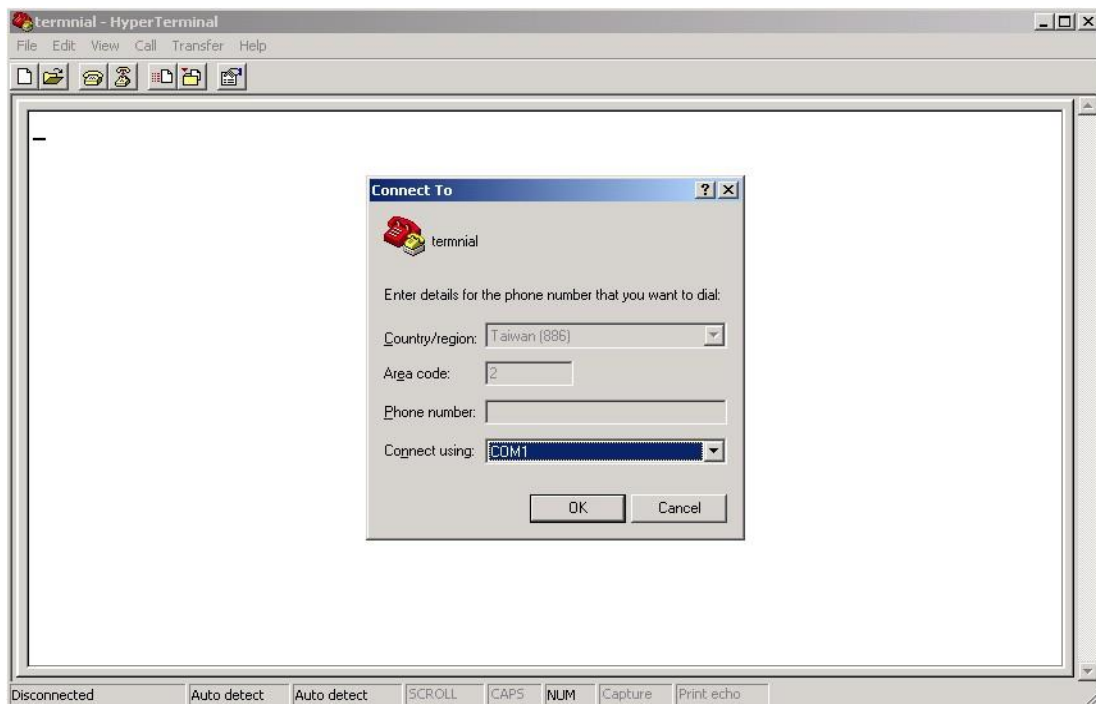

Step 4: A pop-up window that indicates COM port properties appears, including bits per

second, data bits, parity, stop bits, and flow control.

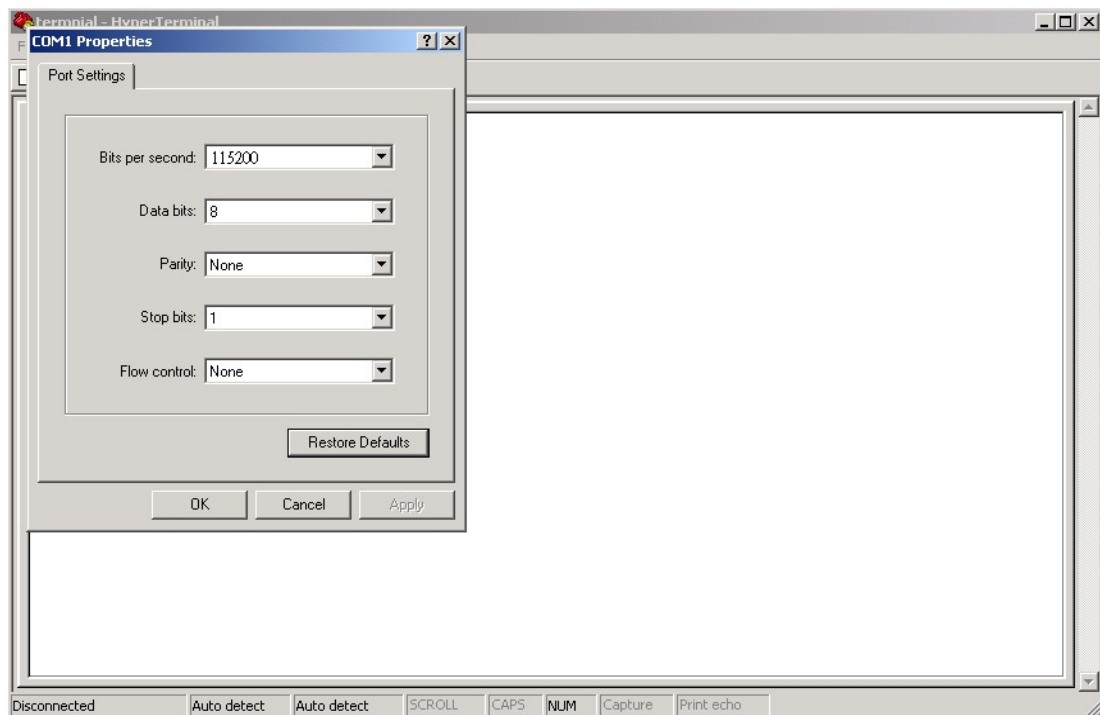

Step 5: The console login screen will appear. Use the keyboard to enter the Username and Password (same as the password for Web browsers), then press **Enter**.

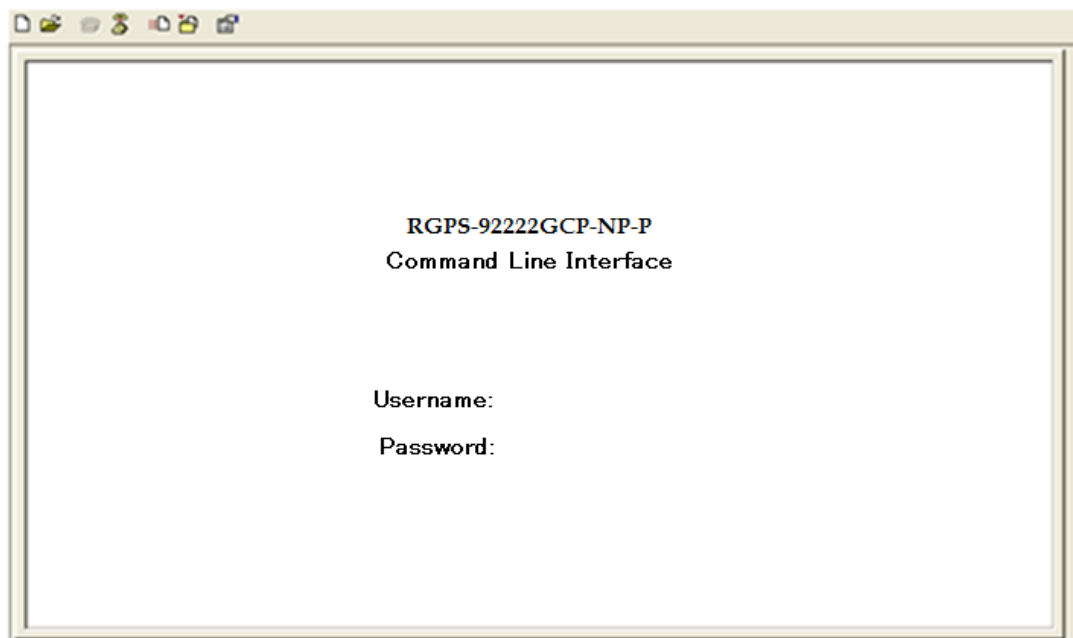

### CLI Management by Telnet

You can use **TELNET** to configure the switch. The default values are:

IP Address: **192.168.10.1**

Subnet Mask: **255.255.255.0**

Default Gateway: **192.168.10.254**

User Name: **admin**

Password: **admin**

Follow the steps below to access console via Telnet.

Step 1: Telnet to the IP address of the switch from the **Run** window by inputting commands (or from the MS-DOS prompt) as below.

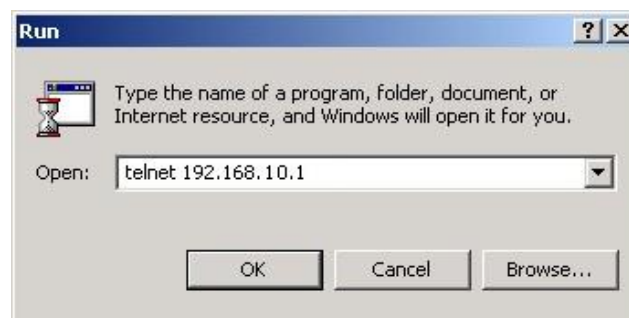

Step 2: The Login screen will appear. Use the keyboard to enter the Username and Password (same as the password for Web browser), and then press **Enter**.

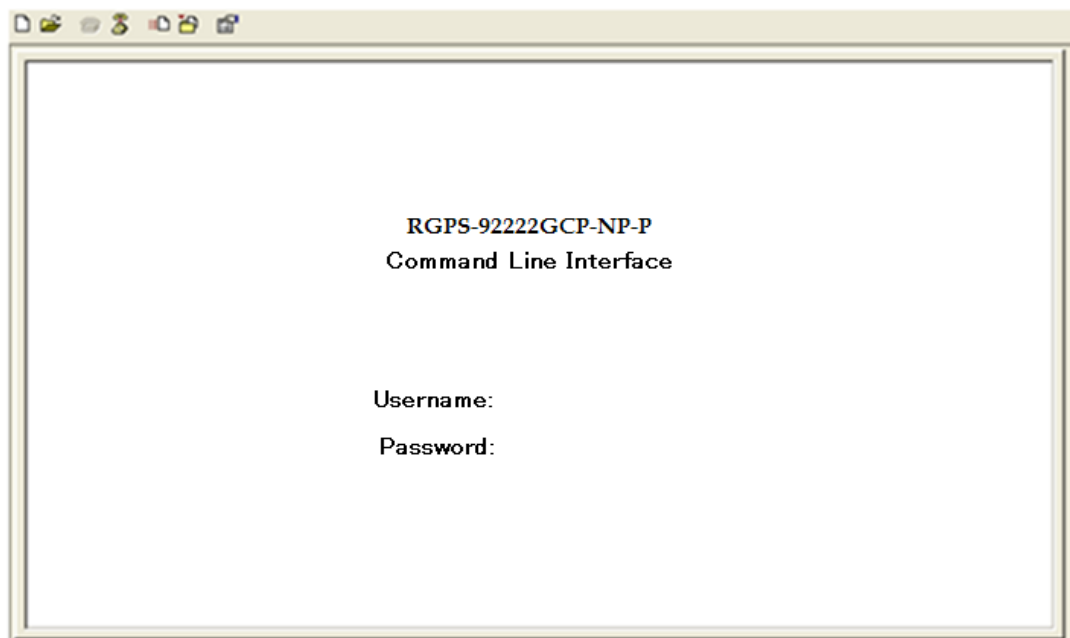

## Commander Groups

```
Command Groups :
-----
System      : System settings and reset options
IP          : IP configuration and Ping
Port       : Port management
MAC        : MAC address table
ULAN       : Virtual LAN
PULAN      : Private ULAN
Security    : Security management
STP        : Spanning Tree Protocol
Aggr       : Link Aggregation
LACP       : Link Aggregation Control Protocol
LLDP       : Link Layer Discovery Protocol
PoE        : Power Over Ethernet
QoS        : Quality of Service
Mirror     : Port mirroring
Config     : Load/Save of configuration via TFTP
Firmware   : Download of firmware via TFTP
PTP        : IEEE1588 Precision Time Protocol
Loop Protect : Loop Protection
IPMC       : MLD/IGMP Snooping
Fault      : Fault Alarm Configuration
Event      : Event Selection
DHCP Server : DHCP Server Configuration
Ring       : Ring Configuration
Chain      : Chain Configuration
RCS        : Remote Control Security
Fastrecovery : Fast-Recovery Configuration
SFP        : SFP Monitor Configuration
DeviceBinding : Device Binding Configuration
MRP        : MRP Configuration
Modbus     : Modbus TCP Configuration
```

**System**

System>	Configuration [all] [<port_list>]
	Reboot
	Restore Default [keep_ip]
	Contact [<contact>]
	Name [<name>]
	Location [<location>]
	Description [<description>]
	Password <password>
	Username [<username>]
	Timezone [<offset>]
	Log [<log_id>] [all info warning error] [clear]

**IP**

IP>	Configuration
	DHCP [enable disable]
	Setup [<ip_addr>] [<ip_mask>] [<ip_router>] [<vid>]
	Ping <ip_addr_string> [<ping_length>]
	SNTP [<ip_addr_string>]

**Port**

port>	Configuration [<port_list>] [up down]
	Mode [<port_list>] [auto 10hdx 10fdx 100hdx 100fdx 1000fdx sfp_auto_ams]
	Flow Control [<port_list>] [enable disable]
	State [<port_list>] [enable disable]
	MaxFrame [<port_list>] [<max_frame>]
	Power [<port_list>] [enable disable actiphy dynamic]
	Excessive [<port_list>] [discard restart]
	Statistics [<port_list>] [<command>] [up down]
	VeriPHY [<port_list>]
	SFP [<port_list>]

**MAC**

MAC>	Configuration [<port_list>]
	Add <mac_addr> <port_list> [<vid>]

	Delete <mac_addr> [<vid>]
	Lookup <mac_addr> [<vid>]
	Agetime [<age_time>]
	Learning [<port_list>] [auto disable secure]
	Dump [<mac_max>] [<mac_addr>] [<vid>]
	Statistics [<port_list>]
	Flush

**VLAN**

	Configuration [<port_list>]
	PVID [<port_list>] [<vid> none]
	FrameType [<port_list>] [all tagged untagged]
	IngressFilter [<port_list>] [enable disable]
	tx_tag [<port_list>] [untag_pvid untag_all tag_all]
	PortType [<port_list>] [unaware c-port s-port s-custom-port]
	EtypeCustomSport [<etype>]
	Add <vid> <name> [<ports_list>]
VLAN>	Forbidden Add <vid> <name> [<port_list>]
	Delete <vid> <name>
	Forbidden Delete <vid> <name>
	Forbidden Lookup [<vid>] [(name <name>)]
	Lookup [<vid>] [(name <name>)] [combined static nas all]
	Name Add <name> <vid>
	Name Delete <name>
	Name Lookup [<name>]
	Status [<port_list>] [combined static nas mstp all conflicts]

**Private VLAN**

	Configuration [<port_list>]
	Add <pvlan_id> [<port_list>]
PVLAN>	Delete <pvlan_id>
	Lookup [<pvlan_id>]
	Isolate [<port_list>] [enable disable]

**Security**

Security >	Switch <a href="#">Switch security setting</a>
------------	--

	Network	<b>Network security setting</b>
	AAA	<b>Authentication, Authorization and Accounting setting</b>

**Security Switch**

Security/switch>	Password <password>
	Auth <b>Authentication</b>
	SSH <b>Secure Shell</b>
	HTTPS <b>Hypertext Transfer Protocol over Secure Socket Layer</b>
	RMON <b>Remote Network Monitoring</b>

**Security Switch Authentication**

Security/switch/auth>	Configuration
	Method [console telnet ssh web] [none local radius]
	[enable disable]

**Security Switch SSH**

Security/switch/ssh>	Configuration
	Mode [enable disable]

**Security Switch HTTPS**

Security/switch/ssh>	Configuration
	Mode [enable disable]

**Security Switch RMON**

Security/switch/rmon>	Statistics Add <stats_id> <data_source>
	Statistics Delete <stats_id>
	Statistics Lookup [<stats_id>]
	History Add <history_id> <data_source> [<interval> [<buckets>]]
	History Delete <history_id>
	History Lookup [<history_id>]
	Alarm Add <alarm_id> <interval> <alarm_variable> [absolute delta]<rising_threshold> <rising_event_index> <falling_threshold> <falling_event_index> [rising falling both]
	Alarm Delete <alarm_id>



	Alarm Lookup [<alarm_id>]
--	---------------------------

**Security Network**

Security/Network>	Psec	<b>Port Security Status</b>
	NAS	<b>Network Access Server (IEEE 802.1X)</b>
	ACL	<b>Access Control List</b>
	DHCP	<b>Dynamic Host Configuration Protocol</b>

**Security Network Psec**

Security/Network/Psec>	Switch [<port_list>]
	Port [<port_list>]

**Security Network NAS**

Security/Network/NAS>	Configuration [<port_list>]
	Mode [enable disable]
	State [<port_list>] [auto authorized unauthorized macbased]
	Reauthentication [enable disable]
	ReauthPeriod [<reauth_period>]
	EapolTimeout [<eapol_timeout>]
	Agetime [<age_time>]
	Holdtime [<hold_time>]
	Authenticate [<port_list>] [now]
	Statistics [<port_list>] [clear eapol radius]

**Security Network ACL**

Security/Network/ACL>	Configuration [<port_list>]
	Action [<port_list>] [permit deny] [<rate_limiter>][<port_redirect>] [<mirror>] [<logging>] [<shutdown>]
	Policy [<port_list>] [<policy>]
	Rate [<rate_limiter_list>] [<rate_unit>] [<rate>]
	Add [<ace_id>] [<ace_id_next>][(port <port_list>)] [(policy <policy> <policy_bitmask>)] [<tagged>] [<vid> [<tag_prio>] [<dmac_type>][(etype [<etype>] [<smac>] [<dmac>])   (arp  [<sip>] [<dip>] [<smac>] [<arp_opcode>] [<arp_flags>)]   (ip   [<sip>] [<dip>] [<protocol>]

	[<ip_flags>)]   icmp [<sip>] [<dip>] [<icmp_type>] [<icmp_code>] [<ip_flags>)]   (udp  [<sip>] [<dip>] [<sport>] [<dport>] [<ip_flags>)]   (tcp  [<sip>] [<dip>] [<sport>] [<dport>] [<ip_flags>] [<tcp_flags>))] [permit deny] [<rate_limiter>] [<port_redirect>] [<mirror>] [<logging>][<shutdown>]
	Delete <ace_id>
	Lookup [<ace_id>]
	Clear
	Status [combined static loop_protect dhcp ptp ipmc conflicts]
	Port State [<port_list>] [enable disable]

**Security Network DHCP**

Security/Network/DHCP>	Configuration
	Mode [enable disable]
	Server [<ip_addr>]
	Information Mode [enable disable]
	Information Policy [replace keep drop]
	Statistics [clear]

**Security Network AAA**

Security/Network/AAA>	Configuration
	Timeout [<timeout>]
	Deadtime [<dead_time>]
	RADIUS [<server_index>] [enable disable] [<ip_addr_string>] [<secret>] [<server_port>]
	ACCT_RADIUS [<server_index>] [enable disable] [<ip_addr_string>] [<secret>] [<server_port>]
	Statistics [<server_index>]

**STP**

STP>	Configuration
	Version [<stp_version>]
	Non-certified release, v

	Txhold [<holdcount>]lt 15:15:15, Dec 6 2007
	MaxAge [<max_age>]
	FwdDelay [<delay>]
	bpduFilter [enable disable]
	bpduGuard [enable disable]
	recovery [<timeout>]
	CName [<config-name>] [<integer>]
	Status [<msti>] [<port_list>]
	Msti Priority [<msti>] [<priority>]
	Msti Map [<msti>] [clear]
	Msti Add <msti> <vid>
	Port Configuration [<port_list>]
	Port Mode [<port_list>] [enable disable]
	Port Edge [<port_list>] [enable disable]
	Port AutoEdge [<port_list>] [enable disable]
	Port P2P [<port_list>] [enable disable auto]
	Port RestrictedRole [<port_list>] [enable disable]
	Port RestrictedTcn [<port_list>] [enable disable]
	Port bpduGuard [<port_list>] [enable disable]
	Port Statistics [<port_list>]
	Port Mcheck [<port_list>]
	Msti Port Configuration [<msti>] [<port_list>]
	Msti Port Cost [<msti>] [<port_list>] [<path_cost>]
	Msti Port Priority [<msti>] [<port_list>] [<priority>]

**Aggr**

Aggr>	Configuration
	Add <port_list> [<aggr_id>]
	Delete <aggr_id>
	Lookup [<aggr_id>]
	Mode [smac dmac ip port] [enable disable]

**LACP**

LACP>	Configuration [<port_list>]
	Mode [<port_list>] [enable disable]

	Key [<port_list>] [<key>]
	Role [<port_list>] [active passive]
	Status [<port_list>]
	Statistics [<port_list>] [clear]

**LLDP**

LLDP>	Configuration [<port_list>]
	Mode [<port_list>] [enable disable]
	Statistics [<port_list>] [clear]
	Info [<port_list>]

**PoE**

PoE>	Configuration [<port_list>]
	Mode [<port_list>] [disabled poe poe+]
	Priority [<port_list>] [low high critical]
	Mgmt_mode [class_con class_res al_con al_res lldp_res lldp_con]
	Maximum_Power [<port_list>] [<port_power>]
	Status
	Primary_Supply [<supply_power>]
	Schedule Configuration [<port_list>]
	Schedule Mode [<port_list>] [enable disable]
	Schedule Port [<port_list>] [enable disable] [sun mon tue wed thu fri sat] [ <hour>]
	AutoPing Configuration [<port_list>]
	AutoPing Log [clear]
	AutoPing Mode [enable disable]
	AutoPing Port [<port>] [<ip_addr>] [<ping_interval>] [<retry>] [nothing rest art-forever restart-once power-on power-off] [<reboot>]
	PoE>

**QoS**

QoS>	DSCP Map [<dscp_list>] [<class>] [<dpl>]
	DSCP Translation [<dscp_list>] [<trans_dscp>]
	DSCP Trust [<dscp_list>] [enable disable]

	DSCP Classification Mode [<dscp_list>] [enable disable]
	DSCP Classification Map [<class_list>] [<dpl_list>] [<dscp>]
	DSCP EgressRemap [<dscp_list>] [<dpl_list>] [<dscp>]
	Storm Unicast [enable disable] [<packet_rate>]
	Storm Multicast [enable disable] [<packet_rate>]
	Storm Broadcast [enable disable] [<packet_rate>]
	QCL Add [<qce_id>] [<qce_id_next> [<port_list> [<tag>] [<vid>] [<pcp>] [<dei>] [<smac>] [<dmac_type>] [(etype [<etype>])   (LLC  [<DSAP>] [<SSAP>] [<control>])   (SNAP  [<PID>])   (ipv4  [<protocol>] [<sip>] [<dscp>] [<fragment>] [<sport> [<dport>])   (ipv6  [<protocol>] [<sip_v6>] [<dscp>] [<sport>] [<dport>])] [<class>] [<dp>] [<classified_dscp>]
	QCL Delete <qce_id>
	QCL Lookup [<qce_id>]
	QCL Status [combined static conflicts]
	QCL Refresh

**Mirror**

Mirror>	Configuration [<port_list>]
	Port [<port> disable]
	Mode [<port_list>] [enable disable rx tx]

**Dot1x**

Dot1x>	Configuration [<port_list>]
	Mode [enable disable]
	State [<port_list>] [macbased auto authorized unauthorized]
	Authenticate [<port_list>] [now]
	Reauthentication [enable disable]
	Period [<reauth_period>]
	Timeout [<eapol_timeout>]
	Statistics [<port_list>] [clear eapol radius]
	Clients [<port_list>] [all <client_cnt>]
Agetime [<age_time>]	

	Holdtime [<hold_time>]
--	------------------------

**IGMP**

IGMP>	Configuration [<port_list>]
	Mode [enable disable]
	State [<vid>] [enable disable]
	Querier [<vid>] [enable disable]
	Fastleave [<port_list>] [enable disable]
	Router [<port_list>] [enable disable]
	Flooding [enable disable]
	Groups [<vid>]
Status [<vid>]	

**ACL**

ACL>	Configuration [<port_list>]
	Action [<port_list>] [permit deny] [<rate_limiter>] [<port_copy>] [<logging>] [<shutdown>]
	Policy [<port_list>] [<policy>]
	Rate [<rate_limiter_list>] [<packet_rate>]
	Add [<ace_id>] [<ace_id_next>] [switch   (port <port>)   (policy <policy>)]
	[<vid>] [<tag_prio>] [<dmac_type>]
	[(etype [<etype>] [<smac>] [<dmac>])
	(arp [<sip>] [<dip>] [<smac>] [<arp_opcode>] [<arp_flags>)]
	(ip [<sip>] [<dip>] [<protocol>] [<ip_flags>)]
	(icmp [<sip>] [<dip>] [<icmp_type>] [<icmp_code>] [<ip_flags>)]
(udp [<sip>] [<dip>] [<sport>] [<dport>] [<ip_flags>)]	
(tcp [<sip>] [<dip>] [<sport>] [<dport>] [<ip_flags>] [<tcp_flags>))	
[permit deny] [<rate_limiter>] [<port_copy>] [<logging>] [<shutdown>]	
Delete <ace_id>	
Lookup [<ace_id>]	
Clear	

**Mirror**

Mirror>	Configuration [<port_list>]
	Port [<port> disable]
	Mode [<port_list>] [enable disable rx tx]

**Config**

Config>	Save <ip_server> <file_name>
	Load <ip_server> <file_name> [check]

**Firmware**

Firmware >	Load <ip_addr_string> <file_name>
---------------	-----------------------------------

**SNMP**

SNMP>	Trap Inform Retry Times [<retries>]
	Trap Probe Security Engine ID [enable disable]
	Trap Security Engine ID [<engineid>]
	Trap Security Name [<security_name>]
	Engine ID [<engineid>]
	Community Add <community> [<ip_addr>] [<ip_mask>]
	Community Delete <index>
	Community Lookup [<index>]
	User Add <engineid> <user_name> [MD5 SHA] [<auth_password>] [DES] [<priv_password>]
	User Delete <index>
	User Changekey <engineid> <user_name> <auth_password> [<priv_password>]
	User Lookup [<index>]
	Group Add <security_model> <security_name> <group_name>
	Group Delete <index>
	Group Lookup [<index>]
	View Add <view_name> [included excluded] <oid_subtree>
	View Delete <index>
	View Lookup [<index>]

	Access Add <group_name> <security_model> <security_level> [<read_view_name>] [<write_view_name>]
	Access Delete <index>
	Access Lookup [<index>]

**Firmware**

Firmware >	Load <ip_addr_string> <file_name>
---------------	-----------------------------------

**PTP**

PTP>	Configuration [<clockinst>]
	PortState <clockinst> [<port_list>] [enable disable internal]
	ClockCreate <clockinst> [<devtype>] [<twostep>] [<protocol>] [<oneway>] [<clockid>] [<tag_enable>] [<vid>] [<prio>]
	ClockDelete <clockinst> [<devtype>]
	DefaultDS <clockinst> [<priority1>] [<priority2>] [<domain>]
	CurrentDS <clockinst>
	ParentDS <clockinst>
	Timingproperties <clockinst> [<utcoffset>] [<valid>] [<leap59>] [<leap61>] [<timetrac>] [<freqtrac>] [<ptptimescale>] [<timesource>]
	PTP PortDataSet <clockinst> [<port_list>] [<announceintv>] [<announceto>] [<syncintv>] [<delaymech>] [<minpdelayreqintv>] [<delayasymmetry>] [<ingressLatency>]
	LocalClock <clockinst> [update show ratio] [<clockratio>]
	Filter <clockinst> [<def_delay_filt>] [<period>] [<dist>]
	Servo <clockinst> [<displaystates>] [<ap_enable>] [<ai_enable>] [<ad_enable>] [<ap>] [<ai>] [<ad>]
	SlaveTableUnicast <clockinst>
	UniConfig <clockinst> [<index>] [<duration>] [<ip_addr>]
	ForeignMasters <clockinst> [<port_list>]
	EgressLatency [show clear]
	MasterTableUnicast <clockinst>
	ExtClockMode [<one_pps_mode>] [<ext_enable>] [<clockfreq>] [<vcxo_enable>]
	OnePpsAction [<one_pps_clear>]
	DebugMode <clockinst> [<debug_mode>]
	Wireless mode <clockinst> [<port_list>] [enable disable]



	Wireless pre notification <clockinst> <port_list>
	Wireless delay <clockinst> [<port_list>] [<base_delay>] [<incr_delay>]

**Loop Protect**

Loop Protect>	Configuration
	Mode [enable disable]
	Transmit [<transmit-time>]
	Shutdown [<shutdown-time>]
	Port Configuration [<port_list>]
	Port Mode [<port_list>] [enable disable]
	Port Action [<port_list>] [shutdown shut_log log]
	Port Transmit [<port_list>] [enable disable]
	Status [<port_list>]

**IPMC**

IPMC>	Configuration [igmp]
	Mode [igmp] [enable disable]
	Flooding [igmp] [enable disable]
	VLAN Add [igmp] <vid>
	VLAN Delete [igmp] <vid>
	State [igmp] [<vid>] [enable disable]
	Querier [igmp] [<vid>] [enable disable]
	Fastleave [igmp] [<port_list>] [enable disable]
	Router [igmp] [<port_list>] [enable disable]
	Status [igmp] [<vid>]
	Groups [igmp] [<vid>]
	Version [igmp] [<vid>]

**Fault**

Fault>	Alarm PortLinkDown [<port_list>] [enable disable]
	Alarm PowerFailure [pwr1 pwr2 pwr3] [enable disable]

**Event**

Event>	Configuration
	Syslog SystemStart [enable disable]
	Syslog PowerStatus [enable disable]

	Syslog SnmpAuthenticationFailure [enable disable]
	Syslog RingTopologyChange [enable disable]
	Syslog Port [<port_list>] [disable linkup linkdown both]
	SMTP SystemStart [enable disable]
	SMTP PowerStatus [enable disable]
	SMTP SnmpAuthenticationFailure [enable disable]
	SMTP RingTopologyChange [enable disable]
	SMTP Port [<port_list>] [disable linkup linkdown both]

**DHCP Server**

DHCP Server>	Mode [enable disable]
	Setup [<ip_start>] [<ip_end>] [<ip_mask>] [<ip_router>] [<ip_dns>] [<ip_tftp>] [<lease>] [<bootfile>]

**Ring**

Ring>	Mode [enable disable]
	Master [enable disable]
	1stRingPort [<port>]
	2ndRingPort [<port>]
	Couple Mode [enable disable]
	Couple Port [<port>]
	Dualhoming Mode [enable disable]
	Dualhoming Port [<port>]

**Chain**

Chain>	Configuration
	Mode [enable disable]
	1stUplinkPort [<port>]
	2ndUplinkPort [<port>]
	EdgePort [1st 2nd none]

**RCS**

RCS>	Mode [enable disable]
	Add [<ip_addr>] [<port_list>] [web_on web_off] [telnet_on telnet_off] [snmp_on snmp_off]
	Del <index>

	Configuration
--	---------------

**FastRecovery**

FastRecovery>	Mode [enable disable]
	Port [<port_list>] [<fr_priority>]

**SFP**

SFP>	syslog [enable disable]
	temp [<temperature>]
	Info

**DeviceBinding**

Devicebinding>	Mode [enable disable]
	Port Mode [<port_list>] [disable scan binding shutdown]
	Port DDOS Mode [<port_list>] [enable disable]
	Port DDOS Sensibility [<port_list>] [low normal medium high]
	Port DDOS Packet [<port_list>] [rx_total rx_unicast rx_multicast rx_broadcast tcp udp]
	Port DDOS Low [<port_list>] [<socket_number>]
	Port DDOS High [<port_list>] [<socket_number>]
	Port DDOS Filter [<port_list>] [source destination]
	Port DDOS Action [<port_list>] [do_nothing block_1_min block_10_mins block shutdown only_log reboot_device]
	Port DDOS Status [<port_list>]
	Port Alive Mode [<port_list>] [enable disable]
	Port Alive Action [<port_list>] [do_nothing link_change shutdown only_log reboot_device]
	Port Alive Status [<port_list>]
	Port Stream Mode [<port_list>] [enable disable]
	Port Stream Action [<port_list>] [do_nothing only_log]
	Port Stream Status [<port_list>]
	Port Addr [<port_list>] [<ip_addr>] [<mac_addr>]
	Port Alias [<port_list>] [<ip_addr>]
	Port DeviceType [<port_list>] [unknown ip_cam ip_phone ap pc plc nvr]
	Port Location [<port_list>] [<device_location>]

	Port Description [<port_list>] [<device_description>]
--	---

**MRP**

MRP>	Configuration
	Mode [enable disable]
	Manager [enable disable]
	React [enable disable]
	1stRingPort [<mrp_port>]
	2ndRingPort [<mrp_port>]
	Parameter MRP_TOPchgT [<value>]
	Parameter MRP_TOPNRmax [<value>]
	Parameter MRP_TSTshortT [<value>]
	Parameter MRP_TSTdefaultT [<value>]
	Parameter MRP_TSTNRmax [<value>]
	Parameter MRP_LNKdownT [<value>]
	Parameter MRP_LNKupT [<value>]
Parameter MRP_LNKNRmax [<value>]	

**Modbus**

Modbus>	Status
	Mode [enable disable]

# Technical Specifications

ORing Switch Model	RGPS-92222GCP-NP-LP	RGPS-92222GCP-NP-P	RGPS-92222GCP-NP
<b>Physical Ports</b>			
10/100/1000Base-T(X) with <b>P.S.E.</b> Ports in RJ45 Auto MDI/MDIX	<b>22</b>		
Gigabit Combo port with 10/100/1000Base-T(X) <b>P.S.E.</b> and 100/1000Base-X SFP ports	<b>2</b>		
100/1000Base-X with SFP port	<b>2</b>		
<b>Technology</b>			
Ethernet Standards	IEEE 802.3 for 10Base-T IEEE 802.3u for 100Base-TX and 100Base-FX IEEE 802.3ab for 1000Base-T IEEE 802.z for 1000Base-X IEEE 802.3x for Flow control IEEE 802.3ad for LACP (Link Aggregation Control Protocol ) IEEE 802.1p for COS (Class of Service) IEEE 802.1Q for VLAN Tagging IEEE 802.1w for RSTP (Rapid Spanning Tree Protocol) IEEE 802.1s for MSTP (Multiple Spanning Tree Protocol) IEEE 802.1x for Authentication IEEE 802.1AB for LLDP (Link Layer Discovery Protocol) IEEE 802.3at PoE specification (up to 30 Watts per port for P.S.E.) <b>RGPS-92222GCP-NP-LP : Total power budget is 320Watts with maximum</b> <b>RGPS-92222GCP-NP-P : Total power budget is 720Watts with maximum</b> <b>RGPS-92222GCP-NP : Total power budget is 720Watts and based-on external power supply spec</b>		
MAC Table	8k		
Priority Queues	8		
Processing	Store-and-Forward		
Switch Properties	Switching latency: 7 us Switching bandwidth: 52Gbps Max. Number of Available VLANs: 4095 VLAN ID Range : VID 1 to 4094 IGMP multicast groups: 256 for each VLAN Port rate limiting: User Define		
Jumbo frame	Up to 9.6K Bytes		
Security Features	Device Binding security feature Enable/disable ports, MAC based port security Port based network access control (802.1x) Single 802.1x and Multiple 802.1x MAC-based authentication QoS assignment Guest VLAN MAC address limit TACACS+ VLAN (802.1Q ) to segregate and secure network traffic Radius centralized password management SNMPv3 encrypted authentication and access security Https / SSH enhance network security Web and CLI authentication and authorization Authorization (15 levels) IP source guard		
Software Features	IEEE 802.1D Bridge, auto MAC address learning/aging and MAC address (static) Multiple Registration Protocol (MRP) MSTP (RSTP/STP compatible) Redundant Ring (O-Ring) with recovery time less than 30ms over 250 units TOS/Diffserv supported Quality of Service (802.1p) for real-time traffic		

	VLAN (802.1Q) with VLAN tagging IGMP v2/v3 Snooping IP-based bandwidth management Application-based QoS management DOS/DDOS auto prevention Port configuration, status, statistics, monitoring, security DHCP Server/Client DHCP Relay Modbus TCP DNS client proxy SMTP Client NTP server		
Network Redundancy	O-Ring Open-Ring O-Chain MRP MSTP (RSTP/STP compatible)		
RS-232 Serial Console Port	RS-232 in DB-9 connector with console cable. 115200bps, 8, N, 1		
<b>LED indicators</b>			
Power Indicator (PWR)	Green : Power indicator		
Ring Master Indicator (R.M.)	Green : Indicates that the system is operating in O-Ring Master mode		
O-Ring Indicator (Ring)	Green : Indicates that the system operating in O-Ring mode Green Blinking : Indicates that the Ring is broken.		
Fault Indicator (Fault)	Amber : Indicate unexpected event occurred		
10/100/1000Base-T(X) RJ45 Port Indicator	Dual color LED for Speed/Link/Act indicator ~ Green : 1000Mbps Link/Act Amber : 10/100Mbps Link/Act		
100/1000Base-X SFP Port Indicator	Green for port Link/Act.		
PoE Indicator	Green : PoE enabled LED x 24		
<b>Power</b>			
Power Input	100~240VAC with power socket		50 ~ 57VDC with terminal block
Power supply	450 Watts power supply included (320W power budget)	1000 Watts power supply included (720W power budget)	Power supply not include
Power consumption (Typ.)	37 Watts (P.D. not included)	37 Watts (P.D. not included)	17 Watts (P.D. not included)
Overload current protection	Present		
Reverse Polarity Protection	Not Present		
<b>Physical Characteristic</b>			
Enclosure	19 inches rack mountable		
Dimension (W x D x H)	431 (W) x 342 (D) x 44 (H) mm (16.97 x 13.47 x 1.73 inch)		
Weight (g)	5000 g	5730 g	3982 g
<b>Environmental</b>			
Storage Temperature	-40 to 85°C (-40 to 185°F)		
Operating Temperature	-40 to 60°C (-40 to 140°F )		
Operating Humidity	5% to 95% Non-condensing		
<b>Regulatory approvals</b>			
EMI	FCC Part 15, CISPR (EN55022) class A		
EMS	EN61000-4-2 (ESD) EN61000-4-3 (RS), EN61000-4-4 (EFT), EN61000-4-5 (Surge), EN61000-4-6 (CS), EN61000-4-8, EN61000-4-11		
Shock	IEC60068-2-27		
Free Fall	IEC60068-2-32		

Vibration	IEC60068-2-6
Safety	EN60950-1
<b>Warranty</b>	5 years