



MODEL:
ECW-281B-BTi

IEI Fanless Embedded System with Intel® Celeron® J1900
RoHS Compliant, Dual GbE LAN, COM Ports, USB 3.0

User Manual

Revision

Date	Version	Changes
September 7, 2015	1.00	Initial release

Copyright

COPYRIGHT NOTICE

The information in this document is subject to change without prior notice in order to improve reliability, design and function and does not represent a commitment on the part of the manufacturer.

In no event will the manufacturer be liable for direct, indirect, special, incidental, or consequential damages arising out of the use or inability to use the product or documentation, even if advised of the possibility of such damages.

This document contains proprietary information protected by copyright. All rights are reserved. No part of this manual may be reproduced by any mechanical, electronic, or other means in any form without prior written permission of the manufacturer.

TRADEMARKS

All registered trademarks and product names mentioned herein are used for identification purposes only and may be trademarks and/or registered trademarks of their respective owners.

Manual Conventions



WARNING

Warnings appear where overlooked details may cause damage to the equipment or result in personal injury. Warnings should be taken seriously.



CAUTION

Cautionary messages should be heeded to help reduce the chance of losing data or damaging the product.



NOTE

These messages inform the reader of essential but non-critical information. These messages should be read carefully as any directions or instructions contained therein can help avoid making mistakes.



HOT SURFACE

This symbol indicates a hot surface that should not be touched without taking care.

Table of Contents

1 INTRODUCTION.....	1
1.1 OVERVIEW.....	2
1.2 BENEFITS	2
1.3 FEATURES.....	3
1.4 MODEL VARIATIONS	3
1.5 EXTERNAL OVERVIEW.....	4
1.5.1 Front Panel	4
1.5.2 Rear Panel	5
1.5.3 Bottom Surface.....	6
1.6 INTERNAL OVERVIEW.....	7
1.7 TECHNICAL SPECIFICATIONS	8
1.8 POWER MODULE SPECIFICATIONS (OPTIONAL)	10
1.9 DIMENSIONS.....	11
2 UNPACKING	12
2.1 UNPACKING.....	13
2.2 PACKING LIST.....	13
2.3 OPTIONAL ITEMS	14
3 INSTALLATION	15
3.1 ANTI-STATIC PRECAUTIONS	16
3.2 INSTALLATION PRECAUTIONS	16
3.2.1 High Surface Temperature	17
3.3 INSTALLATION PROCEDURE	18
3.4 BOTTOM SURFACE REMOVAL	18
3.5 CONFIGURE THE JUMPER SETTINGS.....	19
3.5.1 Clear CMOS.....	19
3.5.2 AT/ATX Mode Selection	20
3.6 HARD DRIVE INSTALLATION.....	21
3.7 FULL-SIZE PCIE MINI/MSATA CARD INSTALLATION.....	24
3.8 HALF-SIZE PCIE MINI CARD INSTALLATION.....	26

3.9 WIRELESS LAN MODULE INSTALLATION (OPTIONAL)	29
3.10 DIGITAL I/O CONNECTION	32
3.11 RS-422/485 SERIAL PORT CONNECTION	32
3.12 RS-232 SERIAL PORT CONNECTOR.....	32
3.13 MOUNTING THE SYSTEM	33
3.13.1 Mounting with Mounting Brackets.....	33
3.13.2 Mounting with VESA Mount Kit (Optional).....	34
3.14 POWER-ON PROCEDURE.....	36
3.14.1 Installation Checklist	36
3.14.2 Terminal Block Pinouts	36
3.14.3 Power-on Procedure	37
3.15 DRIVER INSTALLATION.....	37
3.16 IPMI SETUP PROCEDURE	38
4 BIOS.....	39
4.1 INTRODUCTION.....	40
4.1.1 Starting Setup.....	40
4.1.2 Using Setup	40
4.1.3 Getting Help.....	41
4.1.4 Unable to Reboot After Configuration Changes.....	41
4.1.5 BIOS Menu Bar.....	41
4.2 MAIN.....	42
4.3 ADVANCED	43
4.3.1 ACPI Settings	44
4.3.2 Super IO Configuration	45
4.3.2.1 Serial Port n Configuration	46
4.3.3 Hardware Monitor.....	51
4.3.3.1 Smart Fan Function.....	52
4.3.4 RTC Wake Settings	54
4.3.5 Serial Port Console Redirection	55
4.3.5.1 Console Redirection Settings.....	56
4.3.6 iEi Feature	58
4.3.7 CPU Configuration.....	59
4.3.8 IDE Configuration	61
4.3.9 USB Configuration.....	62

ECW-281B-BTi Embedded System

4.4 CHIPSET	63
4.4.1 North Bridge	64
4.4.1.1 Intel IGD Configuration.....	65
4.4.2 South Bridge.....	66
4.4.2.1 PCI Express Configuration	67
4.5 SECURITY.....	68
4.6 BOOT.....	69
4.7 SAVE & EXIT	71
4.8 SERVER MGMT	72
4.8.1 System Event Log	73
4.8.2 BMC Network Configuration.....	74
5 TROUBLESHOOTING AND MAINTENANCE	76
5.1 ECW-281B-BTi SYSTEM MAINTENANCE OVERVIEW	77
5.2 SYSTEM TROUBLESHOOTING.....	77
5.2.1 The System Doesn't Turn On.....	77
5.2.2 The System Doesn't Boot Up.....	78
5.2.3 More Troubleshooting	79
5.3 COMPONENT REPLACEMENT PROCEDURE	79
5.3.1 SO-DIMM Replacement.....	80
6 SYSTEM COMPONENTS	82
6.1 EMBEDDED SYSTEM MOTHERBOARD.....	83
6.1.1 WAFER-BT-i1 Motherboard Overview	83
6.2 PERIPHERAL INTERFACE CONNECTORS.....	84
6.2.1 Peripheral Interface Connectors	84
6.3 INTERNAL PERIPHERAL CONNECTORS	85
6.3.1 +12V DC-IN Power Connector	85
6.3.2 Audio Connector	85
6.3.3 Battery Connector.....	86
6.3.4 Buzzer Connector.....	87
6.3.5 DDR3L SO-DIMM Slot.....	87
6.3.6 Digital I/O Connector.....	88
6.3.7 Front Panel Connector	89
6.3.8 iRIS-1010 module slot.....	89

6.3.9	<i>PCIe Mini Card/mSATA Slot</i>	90
6.3.10	<i>Power Button Connector</i>	90
6.3.11	<i>Reset Button Connector</i>	91
6.3.12	<i>RS-232 Serial Port Connectors</i>	92
6.3.13	<i>RS-422/485 Serial Port Connector</i>	93
6.3.14	<i>SATA 3Gb/s Drive Connector</i>	94
6.3.15	<i>SATA Power Connector</i>	94
6.3.16	<i>USB Connectors</i>	95
6.4	EXTERNAL PERIPHERAL INTERFACE CONNECTOR PANEL	96
6.4.1	<i>LAN Connector</i>	96
6.4.2	<i>RS-232 Serial Port Connector</i>	97
6.4.3	<i>USB Connectors</i>	97
6.4.4	<i>VGA Connector</i>	98
A REGULATORY COMPLIANCE		99
B SAFETY PRECAUTIONS		104
B.1	SAFETY PRECAUTIONS	105
B.1.1	<i>General Safety Precautions</i>	105
B.1.2	<i>Anti-static Precautions</i>	106
B.1.3	<i>Product Disposal</i>	107
B.2	MAINTENANCE AND CLEANING PRECAUTIONS	107
B.2.1	<i>Maintenance and Cleaning</i>	107
B.2.2	<i>Cleaning Tools</i>	108
C BIOS MENU OPTIONS		109
C.1	BIOS CONFIGURATION OPTIONS	110
D DIGITAL I/O INTERFACE		112
D.1	INTRODUCTION	113
D.2	ASSEMBLY LANGUAGE SAMPLE 1	114
D.3	ASSEMBLY LANGUAGE SAMPLE 2	114
E WATCHDOG TIMER		115
F HAZARDOUS MATERIALS DISCLOSURE		118
F.1	HAZARDOUS MATERIALS DISCLOSURE TABLE FOR IPB PRODUCTS CERTIFIED AS	

ECW-281B-BTi Embedded System

ROHS COMPLIANT UNDER 2002/95/EC WITHOUT MERCURY119

List of Figures

Figure 1-1: ECW-281B-BTi Series Embedded System.....	2
Figure 1-2: Front Panel	4
Figure 1-3: Rear Panel.....	5
Figure 1-4: Bottom Surface	6
Figure 1-5: Internal Overview	7
Figure 1-6: Dimensions (mm).....	11
Figure 3-1: Bottom Surface Retention Screws	19
Figure 3-2: Clear CMOS Button.....	20
Figure 3-3: AT/ATX Mode Select Switch Location	20
Figure 3-4:HDD Bracket Retention Screws.....	21
Figure 3-5: HDD Retention Screws	22
Figure 3-6: HDD Installation	23
Figure 3-7: PCIe Mini Slot Location	24
Figure 3-8: Removing the Screw and Standoff for Half-size PCIe Mini Card	24
Figure 3-9: Removing the Retention Screw	25
Figure 3-10: Inserting the Full-size PCIe Mini Card into the Slot at an Angle	25
Figure 3-11: Securing the Full-size PCIe Mini Card	26
Figure 3-12: PCIe Mini Slot Location	27
Figure 3-13: Removing the Screw	27
Figure 3-14: Inserting the Half-size PCIe Mini Card into the Slot at an Angle.....	28
Figure 3-15: Securing the Half-size PCIe Mini Card	28
Figure 3-16: Knockout Holes for Wireless Antenna.....	29
Figure 3-17: PCIe Mini Slot Location	29
Figure 3-18: Removing the Retention Screw	30
Figure 3-19: Inserting the WLAN Module	30
Figure 3-20: Securing WLAN Module and Connecting RF Cables	31
Figure 3-21: Securing SMA Connector and External Antenna Installation	31
Figure 3-22: Mounting Bracket Retention Screws	33
Figure 3-23: Wall-mounting Bracket.....	34
Figure 3-24: Mount the Embedded System.....	35
Figure 3-25: Terminal Block Pinouts	36

ECW-281B-BTi Embedded System

Figure 3-26: Power Button	37
Figure 5-1: SO-DIMM Location	80
Figure 5-2: SO-DIMM Installation	81
Figure 6-1: WAFER-BT-i1 Jumper and Connector Locations	83
Figure 6-2: +12V DC-IN Power Connector Location.....	85
Figure 6-3: Audio Connector Location	86
Figure 6-4: Battery Connector Location.....	86
Figure 6-5: Buzzer Connector Location	87
Figure 6-6: DDR3L SO-DIMM Slot Location	88
Figure 6-7: Digital I/O Connector Location	88
Figure 6-8: Front Panel Connector Location	89
Figure 6-9: iRIS-1010 Module Slot Location	89
Figure 6-10: PCIe Mini Card Slot Location.....	90
Figure 6-11: Power Button Connector Location.....	91
Figure 6-12: Reset Button Connector Location.....	91
Figure 6-13: RS-232 Serial Port Connectors Locations.....	92
Figure 6-14: RS-422/485 Connector Location.....	93
Figure 6-15: SATA 3Gb/s Drive Connectors Locations	94
Figure 6-16: SATA Power Connector Location	95
Figure 6-17: USB Connectors Locations.....	95
Figure 6-18: External Peripheral Interface Connector	96
Figure 6-19: LAN Connector	96
Figure 6-20: RS-232 Serial Port Connector	97
Figure 6-21: VGA Connector	98

List of Tables

Table 1-1: Model Variations	3
Table 1-2: Technical Specifications.....	9
Table 1-3: DC-to-DC Power Module Specifications.....	10
Table 2-1: Package List.....	14
Table 2-2: Package List.....	14
Table 3-1: AT/ATX Mode Select Switch Settings.....	21
Table 3-2: Digital I/O Connector Pinouts.....	32
Table 3-3: DB-9 RS-422/485 Pinouts.....	32
Table 3-4: RS-232 Serial Port Connector Pinouts	33
Table 4-1: BIOS Navigation Keys	41
Table 6-1: Peripheral Interface Connectors	84
Table 6-2: +12V DC-IN Power Connector Pinouts	85
Table 6-3: Audio Connector Pinouts	86
Table 6-4: Battery Connector Pinouts	87
Table 6-5: Buzzer Connector Pinouts.....	87
Table 6-6: Digital I/O Connector Pinouts.....	88
Table 6-7: Front Panel Connector Pinouts.....	89
Table 6-8: Power Button Connector Pinouts	91
Table 6-9: Reset Button Connector Pinouts	92
Table 6-10: RS-232 Serial Port Connector Pinouts	92
Table 6-11: RS-422/485 Connector Pinouts	93
Table 6-12: DB-9 RS-422/485 Pinouts.....	93
Table 6-13: SATA Power Connector Pinouts.....	95
Table 6-14: USB Connectors Pinouts.....	95
Table 6-15: LAN Pinouts	97
Table 6-16: Connector LEDs.....	97
Table 6-17: RS-232 Serial Port Connector Pinouts	97
Table 6-18: USB 3.0 Port Pinouts.....	98
Table 6-19: USB 2.0 Port Pinouts.....	98
Table 6-20: VGA Connector Pinouts.....	98

List of BIOS Menus

BIOS Menu 1: Main	42
BIOS Menu 2: Advanced	44
BIOS Menu 3: ACPI Settings	44
BIOS Menu 4: Super IO Configuration.....	45
BIOS Menu 5: Serial Port n Configuration Menu.....	46
BIOS Menu 6: Hardware Monitor	51
BIOS Menu 7: Smart Fan Function Menu.....	52
BIOS Menu 8: RTC Wake Settings	54
BIOS Menu 9: Serial Port Console Redirection	55
BIOS Menu 10: Console Redirection Settings.....	56
BIOS Menu 11: iEi Feature	58
BIOS Menu 12: CPU Configuration	59
BIOS Menu 13: IDE Configuration.....	61
BIOS Menu 14: USB Configuration	62
BIOS Menu 15: Chipset	64
BIOS Menu 16: North Bridge	64
BIOS Menu 17: Intel IGD Configuration.....	65
BIOS Menu 18: South Bridge.....	66
BIOS Menu 19: PCI Express Configuration	67
BIOS Menu 20: Security	68
BIOS Menu 21: Boot	69
BIOS Menu 22: Save & Exit.....	71
BIOS Menu 23: Server Mgmt	72
BIOS Menu 24: System Event Log	73
BIOS Menu 25: System Event Log	74

Chapter

1

Introduction

1.1 Overview



Figure 1-1: ECW-281B-BTi Series Embedded System

The ECW-281B-BTi fanless embedded system is powered by Intel® Celeron® processor J1900. It is designed for harsh environment applications that require minimum installation space.

The ECW-281B-BTi accepts a wide range of DC power input (9 V - 36 V), allowing it to be powered anywhere. One USB 3.0, three USB 2.0, two GbE, three RS-232, one RS-422/485, and one 8-bit DIO provide rich I/O options for various applications. The ECW-281B-BTi embedded subsystems are all capable of supporting one 2.5" SATA hard disk drive.

In addition, the ECW-281B-BTi features Intelligent Platform Management Interface 2.0 (IPMI 2.0) that helps lower the overall costs of server management by enabling users to maximize IT resource, save time and manage multiple systems. The ECW-281B-BTi supports IPMI 2.0 through the optional iRIS-1010 module.

1.2 Benefits

The ECW-281B-BTi embedded system has the following benefits:

- Easy installation saves installation time
- Complete integration saves solution development time and cost
- Secure storage with one SATA hard drive supported
- Compact size saves space
- Powerful preinstalled Intel® Celeron® processor J1900 and motherboard ensures rigorous processing needs can be met

ECW-281B-BTi Embedded System

1.3 Features

The ECW-281B-BTi has the following features

- RoHS compliant design
- Fanless system
- 2.42 GHz Intel® Celeron® processor J1900 supported
- Dual GbE LAN for high speed network applications
- Support four COM ports (three RS-232, one RS-422/485)
- One SATA hard drive supported
- VESA 100 mount supported
- Support iRIS (IEI Remote Intelligent System) solution
- Optional 802.11b/g/n 1T1R wireless connection

1.4 Model Variations

There are two models in the ECW-281B-BTi embedded system series. The two models are all preinstalled with an Intel® Celeron® processor J1900 and 2 GB of DDR3L memory. The model variations are listed in **Table 1-1** below.

	Power	Wireless
ECW-281B-BTi-J1	12 V DC input (60 W adapter)	Optional
ECW-281BWD-BTi-J1	9 V – 36 V DC input	Optional

Table 1-1: Model Variations

1.5 External Overview

The ECW-281B-BTi RoHS compliant, Intel® Celeron® J1900 fanless embedded system features industrial grade components that offer longer operating life, high shock/vibration resistance and endurance over a wide temperature range. The ECW-281B-BTi combines these features in an aluminum enclosure. Featuring two LAN, four USB, four serial communication ports, digital I/O, as well as audio, and VGA, the ECW-281B-BTi offers system integrators and developers the best selection of robust and high performance computing system platforms. An internal bracket supports one 2.5" SATA hard drive.

1.5.1 Front Panel

The ECW-281B-BTi front panel contains:

- 2 x USB 2.0 port connectors
- 1 x Audio line-out jack
- 1 x HDD LED indicator
- 1 x Power button

An overview of the front panel is shown in **Figure 1-2** below.

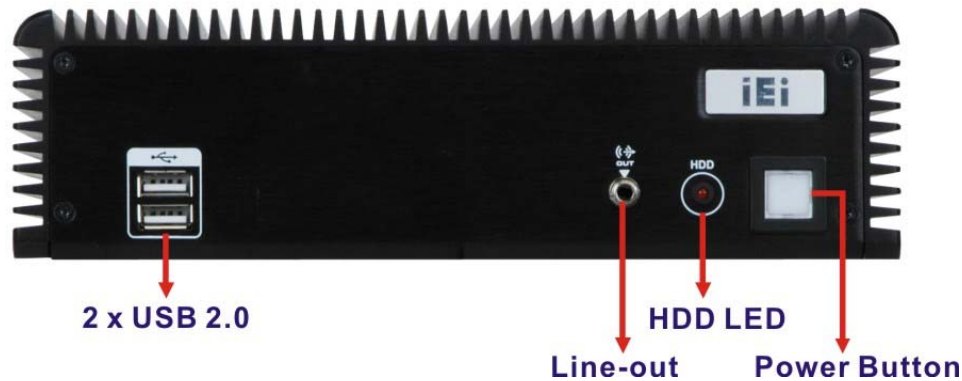

Figure 1-2: Front Panel

ECW-281B-BTi Embedded System

1.5.2 Rear Panel

The rear panel of the ECW-281B-BTi provides access to the following external I/O connectors.

- 1 x 12 V (or 9 V – 36 V) DC power input jack
- 1 x 9 V – 36 V DC power input terminal block (WD model only)
- 1 x Digital I/O connector
- 2 x RJ-45 Ethernet connector
- 3 x RS-232 serial ports
- 1 x RS-422/485 serial port
- 1 x USB 2.0 port connector
- 1 x USB 3.0 port connector
- 1 x VGA connector
- 1 x Reset button
- 1 x Wireless antenna connector (optional)

An overview of the rear panel is shown in **Figure 1-3**.

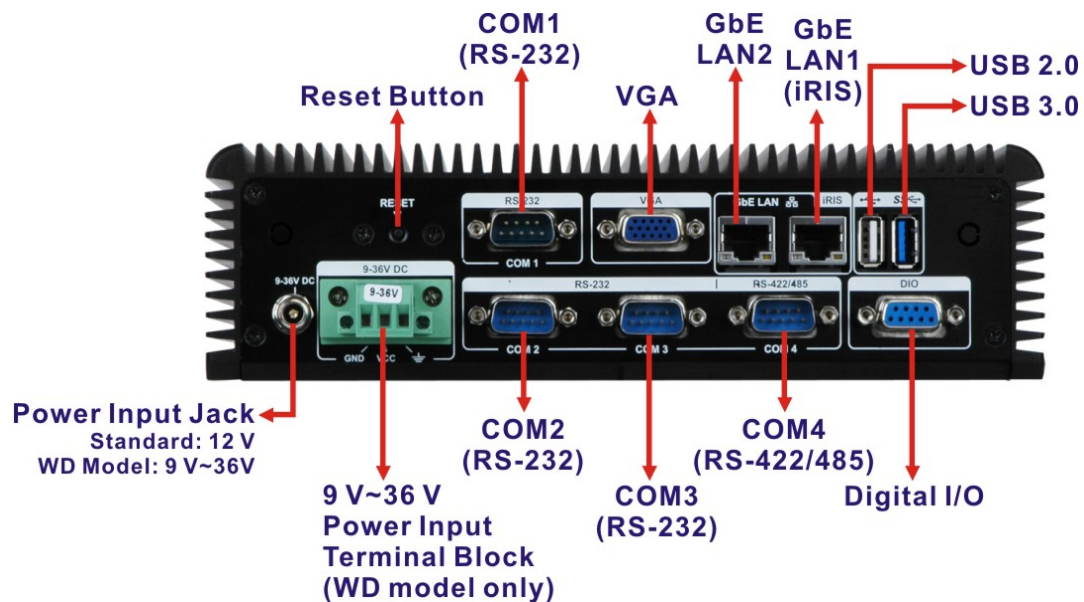

Figure 1-3: Rear Panel

1.5.3 Bottom Surface



WARNING:

Never remove the bottom access panel from the chassis while power is still being fed into the system. Before removing the bottom access panel, make sure the system has been turned off and all power connectors unplugged.

The bottom surface of the ECW-281B-BTi contains the retention screw holes for the VESA MIS-D 100 wall-mount kit and two side mounting brackets.

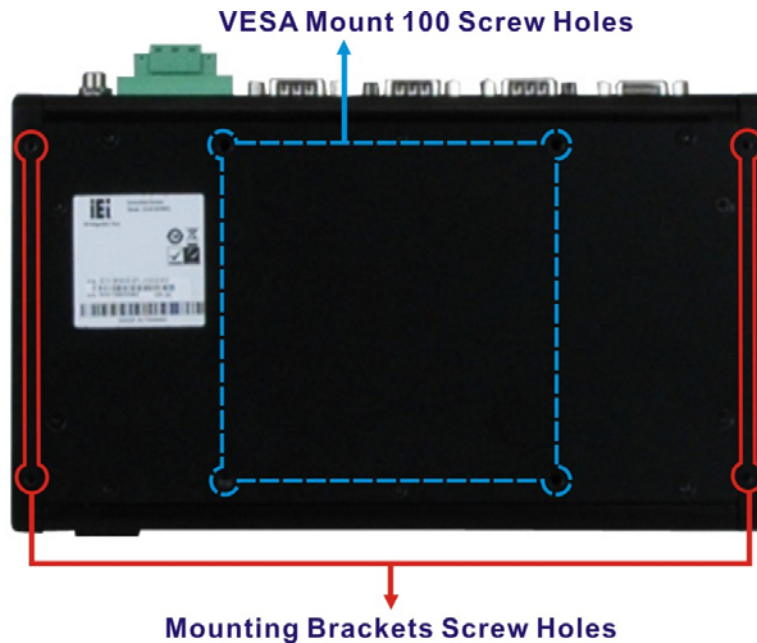

Figure 1-4: Bottom Surface

ECW-281B-BTi Embedded System

1.6 Internal Overview

The ECW-281B-BTi internal components are listed below:

- 1 x IEI WAFER-BTi motherboard
- 1 x IEI IDD-936260A DC-to-DC power converter (WD model only)
- 1 x IEI iRIS-1010 IPMI module
- 1 x 2 GB DDR3L SO-DIMM module

All the components are accessed by removing the bottom surface.



Figure 1-5: Internal Overview

1.7 Technical Specifications

The specifications for the Intel based embedded systems are listed below.

	ECW-281B-BTi
CPU (SoC)	Intel® Celeron® processor J1900 (2M cache, 2.42 GHz)
System Memory	1 x 204-pin 1066/1333 MHz single-channel DDR3L SO-DIMM slot Preinstalled 2.0 GB DDR3L SDRAM SO-DIMM (system max. 4 GB)
Ethernet	LAN1: PCIe GbE by Intel® I210 Ethernet controller LAN2: PCIe GbE by Intel® I211 Ethernet controller
Wireless LAN	Optional 802.11b/g/n 1T1R wireless module
Display	1 x VGA port (up to 2560x1600 @ 60 Hz)
Serial Port	3 x RS-232 1 x RS-422/485
Digital I/O	8-bit digital I/O (4-bit input, 4-bit output)
USB	3 x USB 2.0 ports 1 x USB 3.0 port
Audio	1 x Audio line-out
Storage	1 x 2.5" SATA 3Gb/s HDD bay
Expansion	1 x Full-size/Half-size PCIe Mini card slot with mSATA support (SATA2 and mSATA share same SATA signal) 1 x Half-size PCIe Mini card slot (only for iRIS module)
Chassis Construction	Aluminum alloy with heavy duty metal

ECW-281B-BTi Embedded System

Power Supply	<p>9 V – 36 V DC model:</p> <p>Internal DC-to-DC power converter (IDD-936260A)</p> <p>One 9 V – 36 V DC power input jack</p> <p>One 9 V – 36 V DC power input terminal block</p> <p>12 V DC model:</p> <p>External power adapter, 90V AC – 264V AC @ 47Hz – 63Hz, 60 W</p> <p>One 12 V DC power input jack</p>
Power Consumption	12V@1.45A (with Intel® Celeron® processor J1900 and one 8 GB 1333 MHz DDR3 memory)
Operating Shock	<p>Half-sine wave shock 5G; 11ms; 3 shocks per axis (non-operational)</p> <p>MIL-STD-810G, Method 516.6, Procedure V, crash hazard shock test=60g</p>
Operating Vibration	MIL-STD-810F 514.5C-1 (HDD)
Operating Temperature	-20°C – 60°C with air flow (SSD)
Storage Temperature	-20°C – 60°C
Humidity	10% – 95%, non-condensing
Color	Black
Mounting	<p>Mounting with two mounting brackets</p> <p>VESA MIS-D 100 mount</p>
Weight (Net/Gross)	2.1 kg/3.9 kg
Dimensions (W x D x H)	229 mm x 132 mm x 64 mm
EMC	FCC Class A, CE

Table 1-2: Technical Specifications

1.8 Power Module Specifications (Optional)

A DC-to-DC power converter module is preinstalled in the WD model to provide 9 V – 36 V power input. The specifications for the IDD-936260A are shown in **Table 1-3**.

IDD-936260A	
Input	9 V DC – 36 V DC
Output	12 V: 3 A (max.)
	5 V: 10 A (max.)
	5 VSB: 0.5 A (max.)
Max. Total Output	60 W
Performance Characteristics	
Noise & Ripple	< 240 mV
Line Regulation	< 50 mV
Load Regulation	< 100 mV
Efficiency	Up to 90%
Environment	
Dimensions	40 mm x 100 mm
Net Weight	58 g
Operating Temperature	-20°C – 70°C

Table 1-3: DC-to-DC Power Module Specifications

ECW-281B-BTi Embedded System

1.9 Dimensions

The dimensions of the ECW-281B-BTi are listed below and shown in **Figure 1-6**.

- **Height:** 64.00 mm
- **Width:** 229.00 mm
- **Length:** 132.00 mm

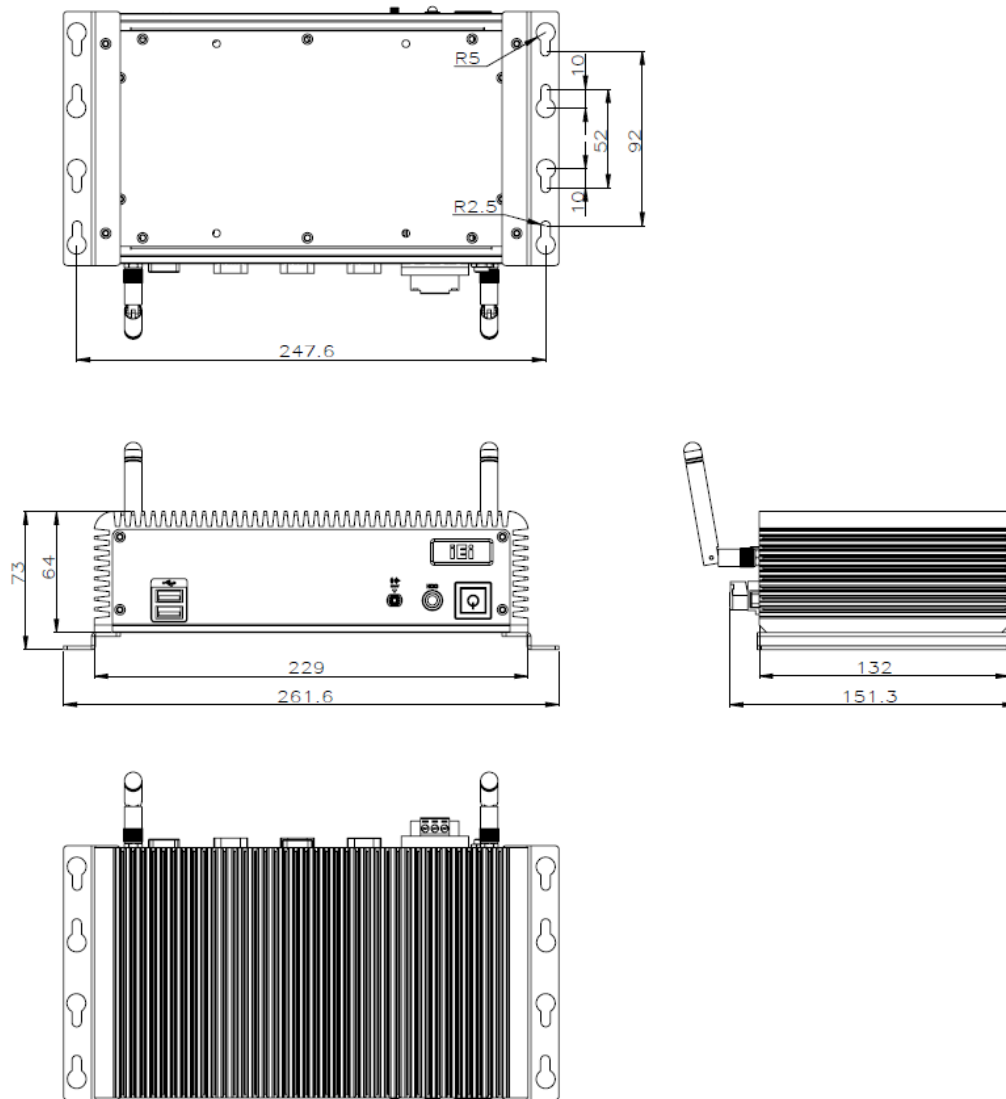

Figure 1-6: Dimensions (mm)

Chapter

2

Unpacking

ECW-281B-BTi Embedded System

2.1 Unpacking

To unpack the embedded system, follow the steps below:

- Step 1:** Use box cutters, a knife or a sharp pair of scissors that seals the top side of the external (second) box.
- Step 2:** Open the external (second) box.
- Step 3:** Use box cutters, a knife or a sharp pair of scissors that seals the top side of the internal (first) box.
- Step 4:** Lift the system out of the boxes.
- Step 5:** Remove both polystyrene ends, one from each side.
- Step 6:** Make sure all the components listed in the packing list are present.

2.2 Packing List



NOTE:

If any of the components listed in the checklist below are missing, do not proceed with the installation. Contact the IEI reseller or vendor the ECW-281B-BTi was purchased from or contact an IEI sales representative directly by sending an email to sales@ieiworld.com.

The ECW-281B-BTi embedded system is shipped with the following components:

Quantity	Item	Image
1	ECW-281B-BTi embedded system	







2	Mounting brackets	
6	Screws (M3*5) for mounting brackets	
1	Power cord (12 V DC-in model only)	
1	12 V 60 W power adapter with ERP and PSE certificates (12 V DC-in model only)	
1	Driver and manual CD	
1	One Key Recovery CD	

Table 2-1: Package List

2.3 Optional Items

The following are optional component(s) which may be separately purchased:

Wi-Fi kit (P/N: EMB-WIFI-KIT01-R11)	
VESA MIS-D 100 wall mount kit	

Table 2-2: Package List

Chapter

3

Installation

3.1 Anti-static Precautions

**WARNING:**

Failure to take ESD precautions during the maintenance of the ECW-281B-BTi may result in permanent damage to the ECW-281B-BTi and severe injury to the user.

Electrostatic discharge (ESD) can cause serious damage to electronic components, including the WAFER series motherboard and the power module. (Dry climates are especially susceptible to ESD.) It is therefore critical that whenever the ECW-281B-BTi is opened and any electrical component handled, the following anti-static precautions are strictly adhered to.

- **Wear an anti-static wristband:** Wearing a simple anti-static wristband can help to prevent ESD from damaging the board.
- **Self-grounding:** Before handling the board, touch any grounded conducting material. During the time the board is handled, frequently touch any conducting materials that are connected to the ground.
- **Use an anti-static pad:** When configuring the ECW-281B-BTi, place it on an anti-static pad. This reduces the possibility of ESD damaging the ECW-281B-BTi.

3.2 Installation Precautions

During installation, be aware of the precautions below:

- **Read the user manual:** The user manual provides a complete description of the ECW-281B-BTi, installation instructions and configuration options.
- **DANGER! Disconnect Power:** Power to the ECW-281B-BTi must be disconnected during the installation process. Failing to disconnect the power may cause severe injury to the body and/or damage to the system.
- **Qualified Personnel:** The ECW-281B-BTi must be installed and operated only by trained and qualified personnel. Maintenance, upgrades, or repairs

ECW-281B-BTi Embedded System

may only be carried out by qualified personnel who are familiar with the associated dangers.

- **Air Circulation:** Make sure there is sufficient air circulation when installing the ECW-281B-BTi. The ECW-281B-BTi's cooling vents must not be obstructed by any objects. Blocking the vents can cause overheating of the ECW-281B-BTi. Leave at least 5 cm of clearance around the ECW-281B-BTi to prevent overheating.
- **Grounding:** The ECW-281B-BTi should be properly grounded. The voltage feeds must not be overloaded. Adjust the cabling and provide external overcharge protection per the electrical values indicated on the label attached to the back of the ECW-281B-BTi.

3.2.1 High Surface Temperature



WARNING:

Some surfaces of the equipment may become hot during operation.

The surface temperature may be up to several tens of degrees hotter than the ambient temperature. Under these circumstances, the equipment needs to be protected against accidental contact.

The equipment is intended for installation in a RESTRICTED ACCESS LOCATION.

- Access can only be gained by SERVICE PERSONS or by USERS who have been instructed about the reasons for the restrictions applied to the location and about any precautions that shall be taken.
- Access is through the use of a TOOL or lock and key, or other means of security, and is controlled by the authority responsible for the location.

3.3 Installation Procedure

To properly install the ECW-281B-BTi, the following steps must be followed. Detailed descriptions of these instructions are listed in the sections that follow.

Step 1: Unpacking

Step 2: Configure the jumper settings

Step 3: Install the SATA hard disk drive (HDD)

Step 4: Mount the ECW-281B-BTi

Step 5: Connect the front panel peripheral connectors

Step 6: Power the system up

3.4 Bottom Surface Removal



WARNING:

Over-tightening bottom cover screws will cause damage to the bottom surface. Maximum torque for cover screws is 5 kg-cm (0.36 lb-ft/0.49 Nm).

Before the jumper settings can be configured and the hard disk drive can be installed, the bottom surface must be removed. To remove the bottom surface, please follow the steps below:

Step 1: Remove the bottom surface retention screws. The bottom surface is secured to the chassis with six retention screws (**Figure 3-1**). All 10 screws must be removed.

ECW-281B-BTi Embedded System

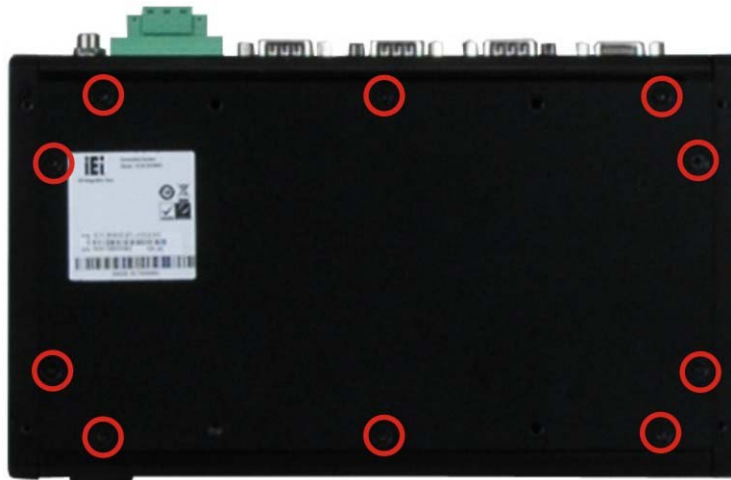

Figure 3-1: Bottom Surface Retention Screws

Step 2: Gently remove the bottom surface from the ECW-281B-BTi.

3.5 Configure the Jumper Settings

To configure the jumper settings, please follow the steps below.

Step 1: Remove the bottom surface. See **Section 3.4**.

Step 2: Locate the jumper settings on the embedded motherboard.

Step 3: Make the jumper settings in accordance with the settings described and defined in the following sections.

3.5.1 Clear CMOS

If the ECW-281B-BTi fails to boot due to improper BIOS settings, the clear CMOS button clears the CMOS data and resets the system BIOS information. To do this, push the clear CMOS button for three seconds, then restart the system. The clear CMOS button location is shown in **Figure 3-2**.

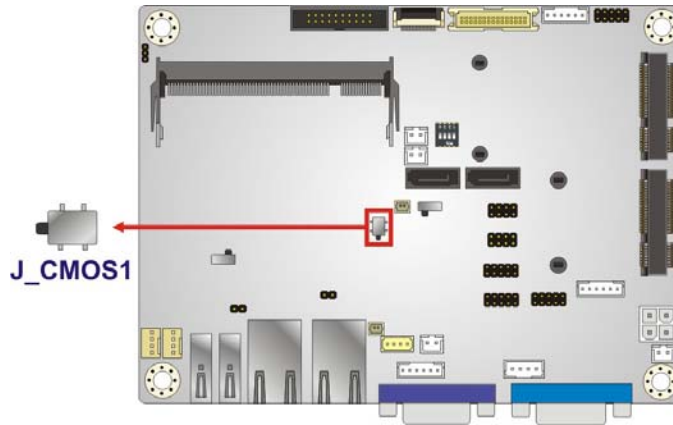

Figure 3-2: Clear CMOS Button

If the “CMOS Settings Wrong” message is displayed during the boot up process, the fault may be corrected by pressing the F1 to enter the CMOS Setup menu. Do one of the following:

- Enter the correct CMOS setting
- Load Optimal Defaults
- Load Failsafe Defaults.

After having done one of the above, save the changes and exit the CMOS Setup menu.

3.5.2 AT/ATX Mode Selection

AT or ATX power mode can be used on the ECW-281B-BTi. The selection is made through an AT/ATX switch located on the motherboard (**Figure 3-3**).

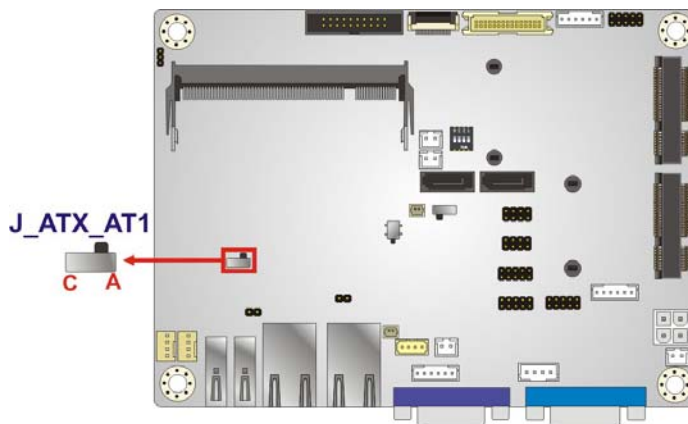

Figure 3-3: AT/ATX Mode Select Switch Location

ECW-281B-BTi Embedded System

Setting	Description
Short A-B	ATX Mode (Default)
Short B-C	AT Mode

Table 3-1: AT/ATX Mode Select Switch Settings

3.6 Hard Drive Installation

One 2.5" SATA hard drive can be installed in the ECW-281B-BTi. The SATA drive is installed into a hard drive bracket attached on the inside of the bottom panel. To install the hard drive into the system, please follow the steps below.

Step 1: Remove the bottom surface. See **Section 3.4**.

Step 2: Remove the hard drive bracket from the bottom surface by removing the four retention screws that secure the bracket to the bottom surface. (**Figure 3-4**)

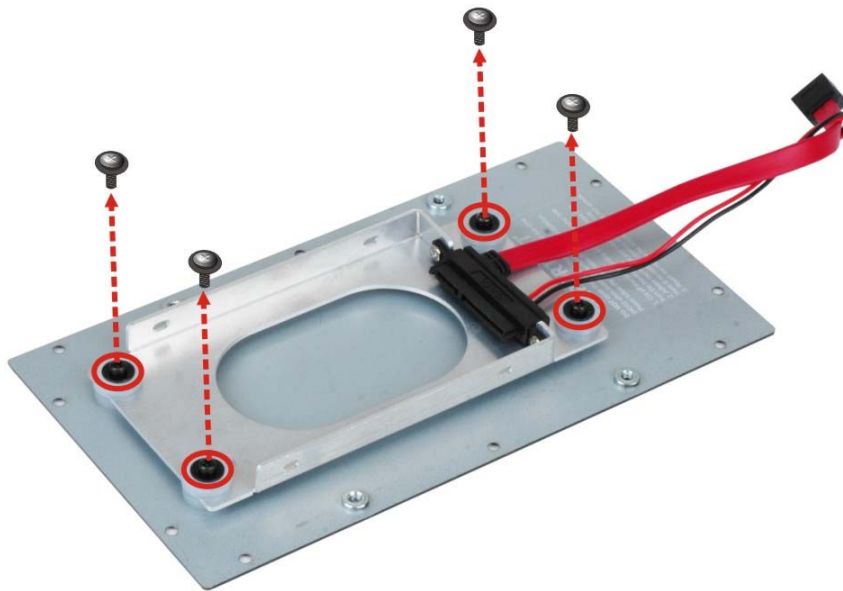

Figure 3-4:HDD Bracket Retention Screws

Step 3: Slide the HDD into the bracket and connect the HDD to the SATA cable connector on the bracket (**Figure 3-5**).

Step 4: Align the retention screw holes in the HDD with those in both sides of the bracket.

Step 5: Secure the HDD with the bracket by inserting four retention screws (M3*4) into the sides of the bracket (**Figure 3-5**).



Figure 3-5: HDD Retention Screws

Step 6: Replace the HDD bracket onto the bottom surface by inserting the four retention screw holes in the HDD bracket to the four standoffs on the back of the bottom surface.

Step 7: Reinsert the four previously removed retention screws.

ECW-281B-BTi Embedded System

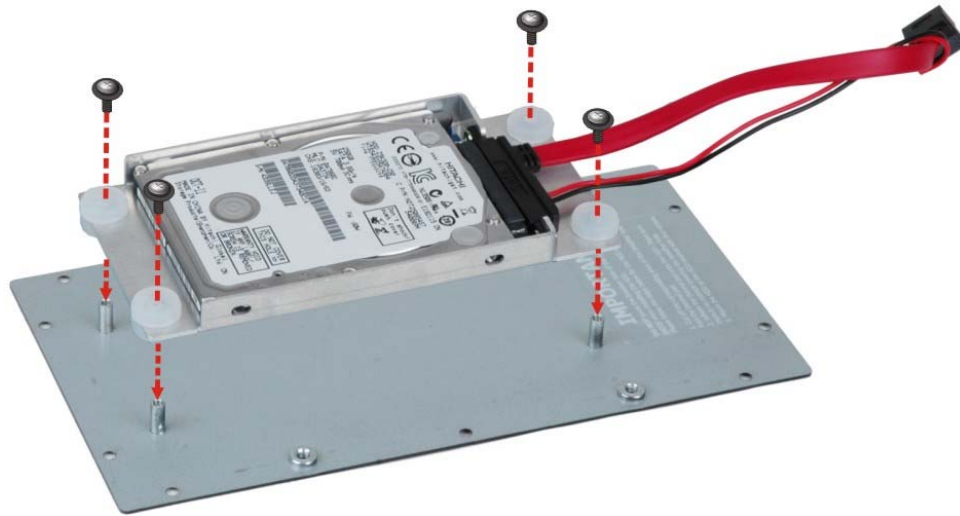

Figure 3-6: HDD Installation

- Step 8:** Connect the SATA cable and the SATA power cable to the SATA connector and the SATA power connector on the motherboard.
- Step 9:** Replace the bottom surface to the bottom panel by reinserting the 10 previously removed retention screws.



NOTE:

If an mSATA module is installed in the PCIe Mini slot (CN1), the SATA port 2 (SATA2) will be disabled. Choose either the SATA2 connector or the mSATA module for storage.



WARNING:

Over-tightening bottom cover screws will cause damage to the bottom surface. Maximum torque for cover screws is 5 kg-cm (0.36 lb-ft/0.49 Nm).

3.7 Full-size PCIe Mini/mSATA Card Installation

The PCIe Mini slot allows installation of either a full-size or half-size PCIe Mini card. To install a full-size PCIe Mini card or an mSATA module, please follow the steps below.

Step 1: Remove the bottom surface. See Section 3.4.

Step 2: Locate the PCIe Mini slot.



Figure 3-7: PCIe Mini Slot Location

Step 3: Remove the retention screw and standoff for a half-size PCIe Mini card. To avoid interference of the board circuit, remove the retention screw and standoff for a half-size PCIe Mini card as shown in **Figure 3-8**.

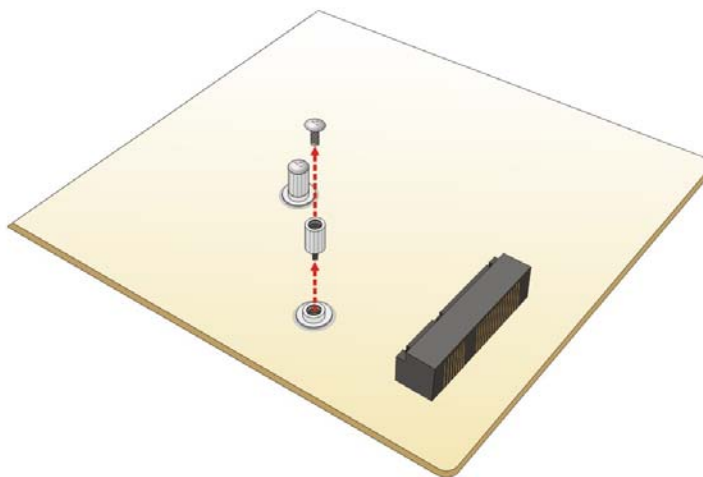

Figure 3-8: Removing the Screw and Standoff for Half-size PCIe Mini Card

ECW-281B-BTi Embedded System

Step 4: Remove the retention screw. Remove the retention screw as shown in Figure 3-9.

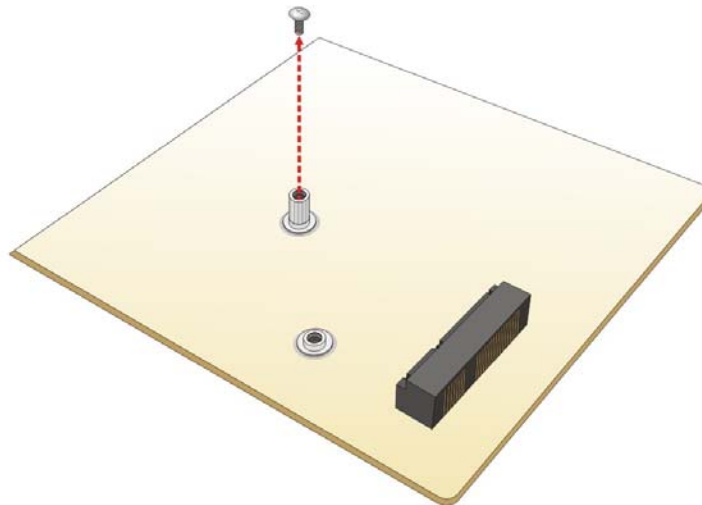

Figure 3-9: Removing the Retention Screw

Step 5: Insert into the socket at an angle. Line up the notch on the card with the notch on the slot. Slide the PCIe Mini card into the socket at an angle of about 20° (Figure 3-10).

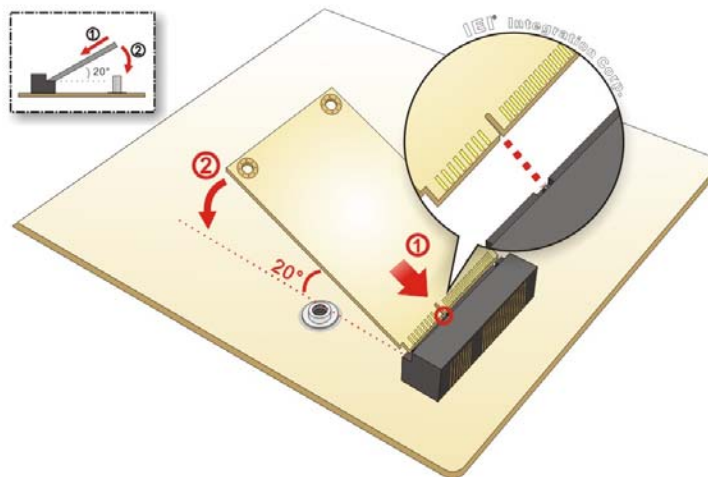

Figure 3-10: Inserting the Full-size PCIe Mini Card into the Slot at an Angle

Step 6: Secure the full-size PCIe Mini card. Secure the full-size PCIe Mini card with the retention screw previously removed (Figure 3-11).

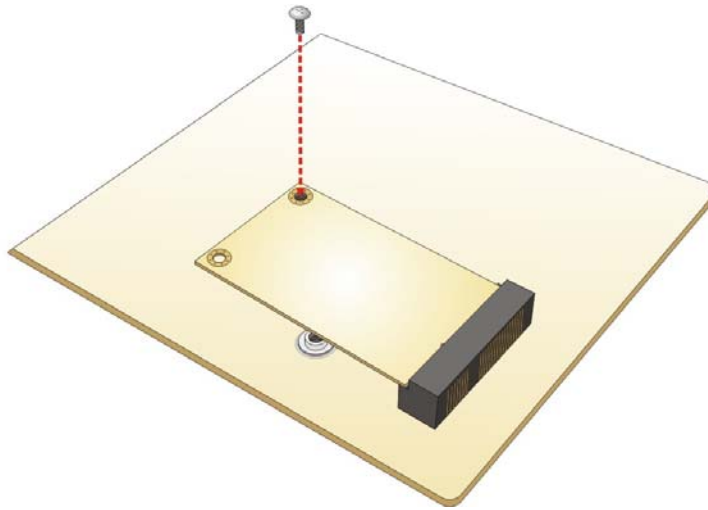

Figure 3-11: Securing the Full-size PCIe Mini Card



NOTE:

If an mSATA module is installed in the PCIe Mini slot (CN1), the SATA port 2 (SATA2) will be disabled. Choose either the SATA2 connector or the mSATA module for storage.

3.8 Half-size PCIe Mini Card Installation

The PCIe Mini slot allows installation of either a full-size or half-size PCIe Mini card. To install a half-size PCIe Mini card, please follow the steps below.

Step 1: Remove the bottom surface. See **Section 3.4**.

Step 2: Locate the PCIe Mini slot.

ECW-281B-BTi Embedded System

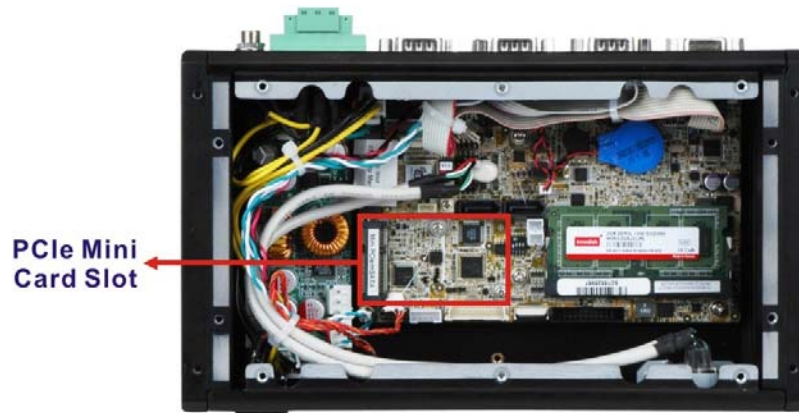

Figure 3-12: PCIe Mini Slot Location

Step 3: Remove the retention screw. Remove the retention screw as shown in Figure 3-13.

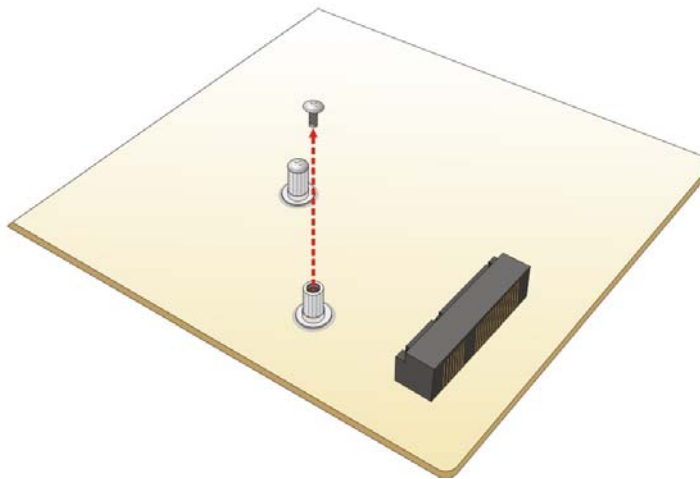

Figure 3-13: Removing the Screw

Step 4: Insert into the socket at an angle. Line up the notch on the card with the notch on the slot. Slide the PCIe Mini card into the socket at an angle of about 20° (Figure 3-14).

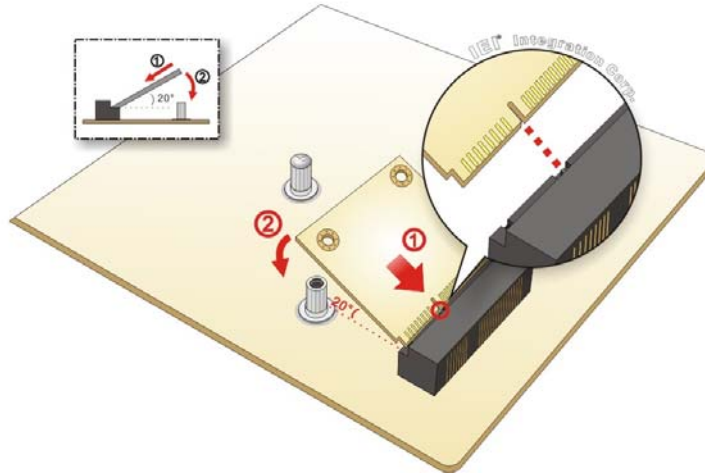

Figure 3-14: Inserting the Half-size PCIe Mini Card into the Slot at an Angle

Step 5: Secure the half-size PCIe Mini card. Secure the half-size PCIe Mini card with the retention screw previously removed (**Figure 3-15**).

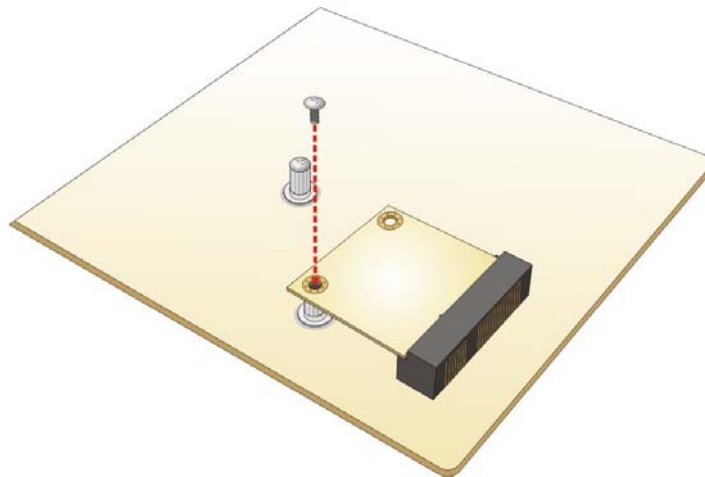

Figure 3-15: Securing the Half-size PCIe Mini Card

ECW-281B-BTi Embedded System

3.9 Wireless LAN Module Installation (Optional)

To install the optional wireless LAN (WLAN) module, please follow the steps below.

Step 1: Remove the bottom surface. See Section 3.4.

Step 2: Remove the two knockout holes for antenna installation. The two knockout holes are located on the rear panel of the ECW-281B-BTi as shown in Figure 3-16.



Figure 3-16: Knockout Holes for Wireless Antenna

Step 3: Locate the PCIe Mini slot (Figure 3-17).

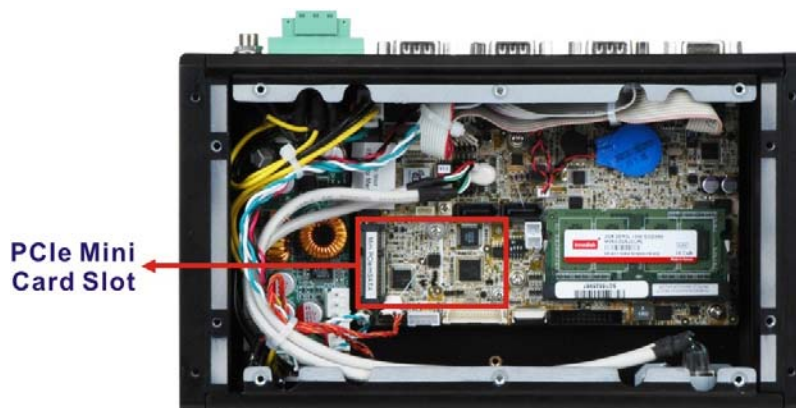

Figure 3-17: PCIe Mini Slot Location

Step 4: Remove the retention screw. Remove the retention screw for half-size card installation as shown in Figure 3-18.

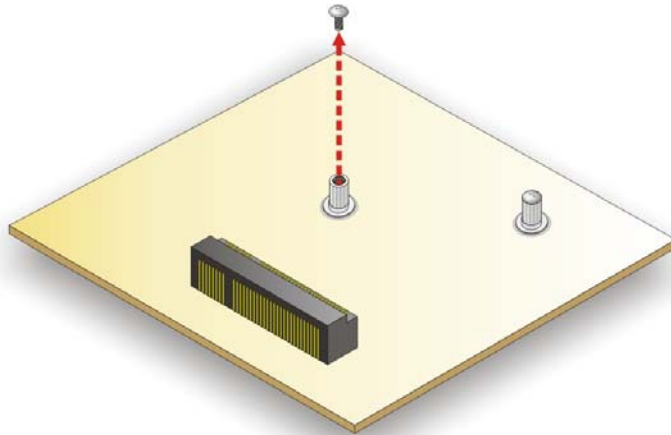

Figure 3-18: Removing the Retention Screw

Step 5: **Insert into the socket at an angle.** Line up the notch on the WLAN module with the notch on the slot. Slide the WLAN module into the slot at an angle of about 20° (Figure 3-19).

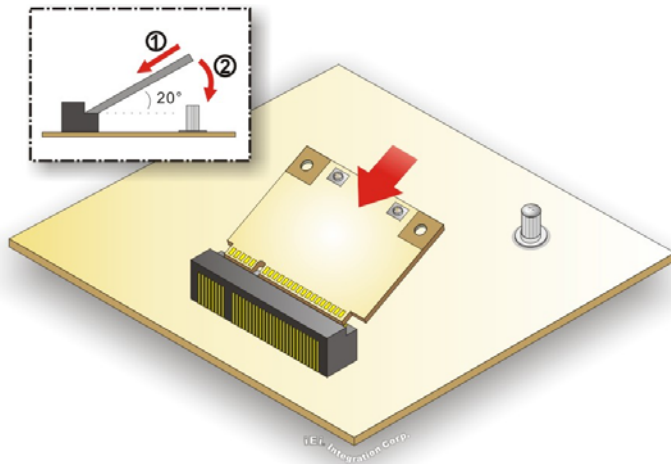

Figure 3-19: Inserting the WLAN Module

Step 6: **Secure the WLAN module.** Secure the WLAN module with the retention screw previously removed (Figure 3-20).

Step 7: **Connect the two RF cables** to the antenna connectors on the WLAN module (Figure 3-20).

ECW-281B-BTi Embedded System

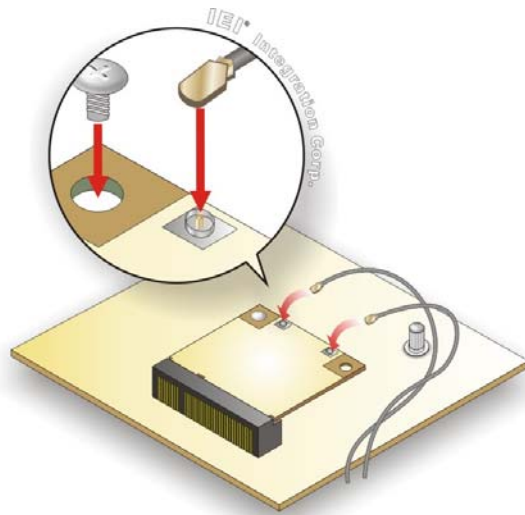

Figure 3-20: Securing WLAN Module and Connecting RF Cables

Step 8: Remove the nut and washer from the SMA connector at the other end of the RF cable.

Step 9: Insert the SMA connector to the antenna connector holes on the rear panel.

Step 10: Secure the SMA connector by inserting the washer and tightening it with nut.

Step 11: Install the external antenna.

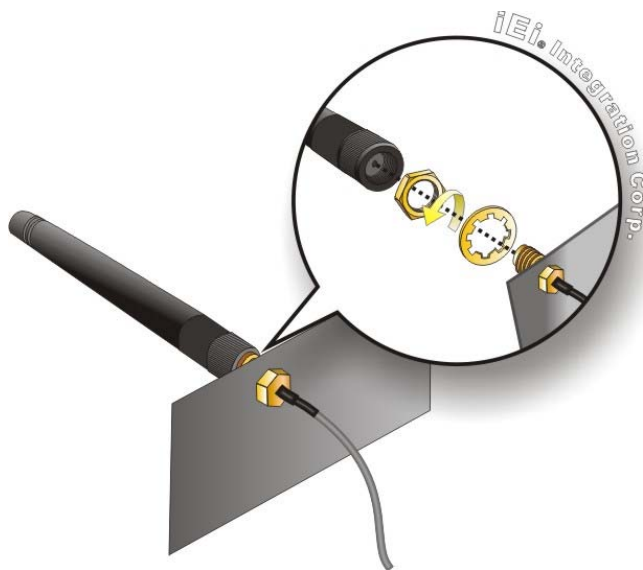

Figure 3-21: Securing SMA Connector and External Antenna Installation

3.10 Digital I/O Connection

The DIO connector on the ECW-281B-BTi is interfaced to GPIO ports on the Super I/O chipset. The DIO has both 4-bit digital inputs and 4-bit digital outputs. The pinouts of the D-sub 9 female connector are listed below.

PIN NO.	DESCRIPTION	PIN NO.	DESCRIPTION
1	DGPIO	6	DGPO2
2	DGPO0	7	DGPI3
3	DGPI1	8	DGPO3
4	DGPO1	9	+5V
5	DGPI2		

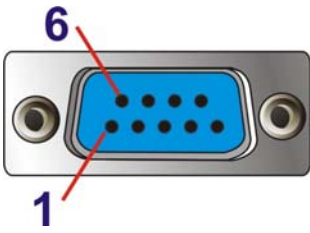

Table 3-2: Digital I/O Connector Pinouts

3.11 RS-422/485 Serial Port Connection

The rear panel of the ECW-281B-BTi has one D-sub 9 male connector for RS-422/485 connection. Use the optional RS-422/485 cable to connect to a serial device. The pinouts of the D-sub 9 connector are listed below.

RS-422 Pinouts	RS-485 Pinouts
	

Table 3-3: DB-9 RS-422/485 Pinouts

3.12 RS-232 Serial Port Connector

The serial port connects to a RS-232 serial communications device. The pinouts of the RS-232 connector are listed below.

ECW-281B-BTi Embedded System

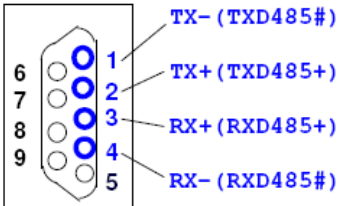
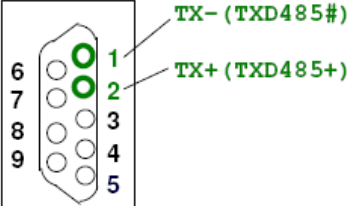
PIN NO.	DESCRIPTION	PIN NO.	DESCRIPTION
1	NDCD	6	NDSR
2	NRXD	7	NRTS
3	NTXD	8	NCTS
4	NDTR	9	NRI
5	GND		

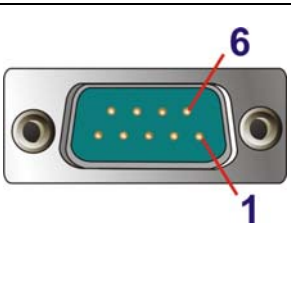

Table 3-4: RS-232 Serial Port Connector Pinouts

3.13 Mounting the System

There are two ways to mount the ECW-281B-BTi. The mounting instructions are described below.

3.13.1 Mounting with Mounting Brackets

To mount the embedded system onto a wall or some other surface using the two mounting brackets, please follow the steps below.

- Step 1:** Turn the embedded system over.
- Step 2:** Align the two retention screw holes in each bracket with the corresponding retention screw holes on the sides of the bottom surface.
- Step 3:** Secure the brackets to the system by inserting two retention screws (M3*5) into each bracket (**Figure 3-22**).

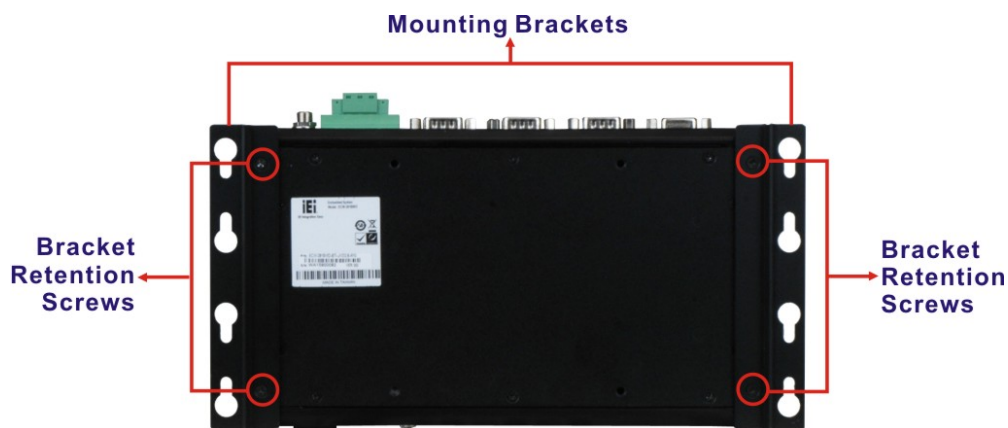

Figure 3-22: Mounting Bracket Retention Screws

- Step 4:** Drill holes in the intended installation surface.
- Step 5:** Align the mounting holes in the sides of the mounting brackets with the predrilled holes in the mounting surface.
- Step 6:** Insert four retention screws, two in each bracket, to secure the system to the wall.

3.13.2 Mounting with VESA Mount Kit (Optional)

To mount the embedded system onto a wall using the optional VESA MIS-D 100 wall mount kit, please follow the steps below.

- Step 1:** Select the location on the wall for the wall-mounting bracket.
- Step 2:** Carefully mark the locations of the four bracket screw holes on the wall.
- Step 3:** Drill four pilot holes at the marked locations on the wall for the bracket retention screws.
- Step 4:** Align the wall-mounting bracket screw holes with the pilot holes.
- Step 5:** Secure the mounting-bracket to the wall by inserting the retention screws into the four pilot holes and tightening them (**Figure 3-23**).

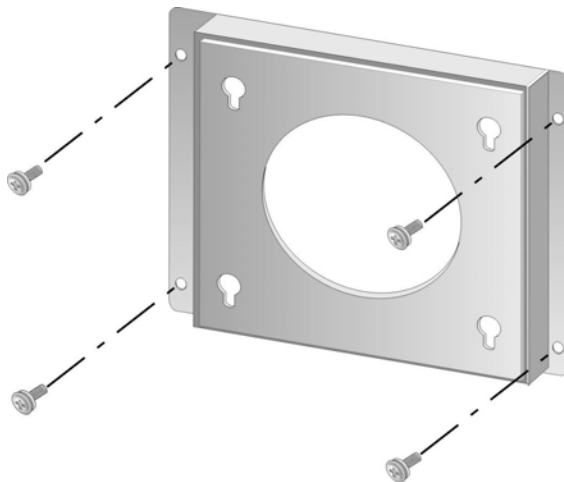

Figure 3-23: Wall-mounting Bracket

ECW-281B-BTi Embedded System

- Step 6:** Insert the four monitor mounting screws provided in the wall mounting kit into the four screw holes on the bottom panel of the system and tighten until the screw shank is secured against the bottom panel (**Figure 3-24**).
- Step 7:** Align the mounting screws on the ECW-281B-BTi bottom panel with the mounting holes on the bracket.
- Step 8:** Carefully insert the screws through the holes and gently pull the monitor downwards until the ECW-281B-BTi rests securely in the slotted holes (**Figure 3-24**). Ensure that all four of the mounting screws fit snugly into their respective slotted holes.



NOTE:

In the diagram below the bracket is already installed on the wall.

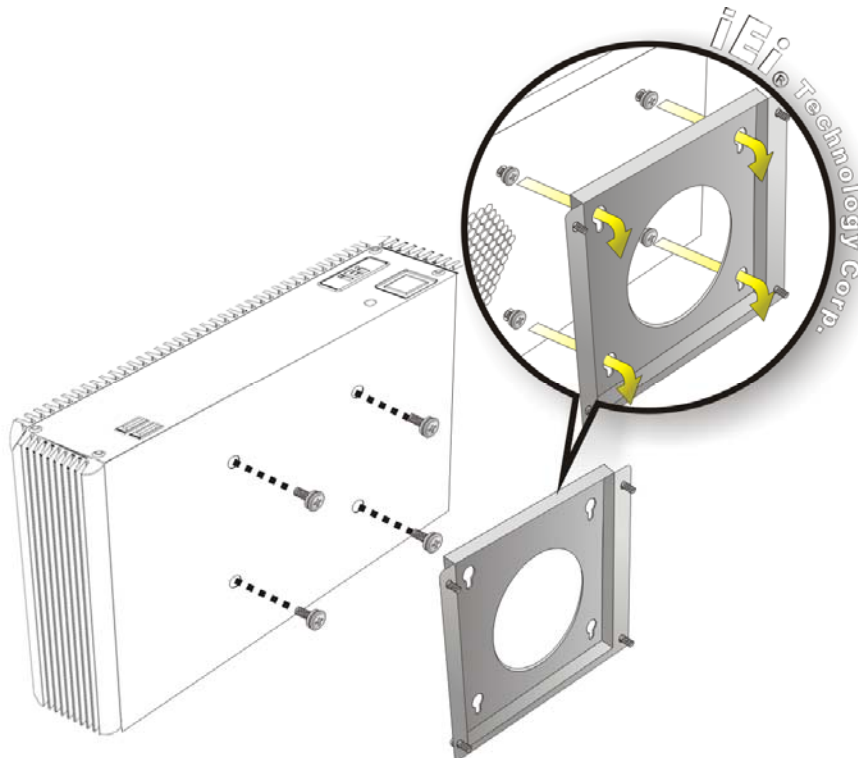

Figure 3-24: Mount the Embedded System

3.14 Power-On Procedure

3.14.1 Installation Checklist



WARNING:

Make sure a power supply with the correct input voltage is being fed into the system. Incorrect voltages applied to the system may cause damage to the internal electronic components and may also cause injury to the user.

To power on the embedded system please make sure of the following:

- The bottom surface panel is installed
- All peripheral devices (VGA monitor, serial communications devices etc.) are connected
- The power cables are plugged in
- The system is securely mounted

3.14.2 Terminal Block Pinouts

The WD model has a 9 V – 36 V power input terminal block. The terminal block pinouts are shown in **Figure 3-25**.

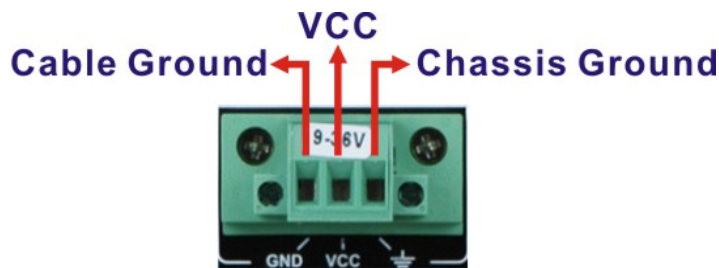

Figure 3-25: Terminal Block Pinouts

The chassis ground is connected to the ECW-281B-BTi chassis internally. The cable ground is connected to the ground pin on the input power connector of the power module.

ECW-281B-BTi Embedded System

3.14.3 Power-on Procedure

To power-on the ECW-281B-BTi please follow the steps below:

- Step 1:** Connect the power source to the power input jack or the power input terminal block.
- Step 2:** Push the power button (**Figure 3-26**).
- Step 3:** Once turned on, the power button should turn to blue.



Figure 3-26: Power Button

3.15 Driver Installation



NOTE:

The content of the CD may vary throughout the life cycle of the product and is subject to change without prior notice. Visit the IEI website or contact technical support for the latest updates.

All the drivers for the ECW-281B-BTi are on the utility CD that came with the system. The utility CD contains drivers for Windows 7 and Windows 8 operating systems. Please select the corresponding drivers for the system.

The following drivers can be installed on the **Windows 7** operating system:

- Chipset
- I/O driver

- Graphics (Intel® EMGD)
- TXE
- USB 3.0
- LAN
- Audio

The following drivers can be installed on the **Windows 8** operating system:

- Chipset
- Serial I/O driver (64-bit only)
- TXE
- Graphics
- LAN
- Audio

3.16 IPMI Setup Procedure

The ECW-281B-BTi features Intelligent Platform Management Interface (IPMI) that helps lower the overall costs of server management by enabling users to maximize IT resources, save time and manage multiple systems. The ECW-281B-BTi supports IPMI 2.0 through the optional iRIS-1010 module. Follow the steps below to setup IPMI.

The hardware configuration of the managed system (ECW-281B-BTi) is described below.

Step 1: Make sure that an iRIS-1010 module is installed to the iRIS-1010 module slot of the ECW-281B-BTi.

Step 2: Make sure a DDR3L SO-DIMM is installed in the SO-DIMM socket.

Step 3: Connect an Ethernet cable to the RJ-45 LAN port with **iRIS** label (**Figure 1-3**).

Chapter

4

BIOS

4.1 Introduction

The BIOS is programmed onto the BIOS chip. The BIOS setup program allows changes to certain system settings. This chapter outlines the options that can be changed.



NOTE:

Some of the BIOS options may vary throughout the life cycle of the product and are subject to change without prior notice.

4.1.1 Starting Setup

The UEFI BIOS is activated when the computer is turned on. The setup program can be activated in one of two ways.

1. Press the **DELETE** key as soon as the system is turned on or
2. Press the **DELETE** key when the “**Press Delete to enter SETUP**” message appears on the screen.

If the message disappears before the **DELETE** key is pressed, restart the computer and try again.

4.1.2 Using Setup

Use the arrow keys to highlight items, press **ENTER** to select, use the PageUp and PageDown keys to change entries, press **F1** for help and press **ESC** to quit. Navigation keys are shown in.

Key	Function
Up arrow	Move to the item above
Down arrow	Move to the item below
Left arrow	Move to the item on the left hand side
Right arrow	Move to the item on the right hand side
+	Increase the numeric value or make changes

ECW-281B-BTi Embedded System

Key	Function
-	Decrease the numeric value or make changes
Page up	Move to the next page
Page down	Move to the previous page
Esc	Main Menu – Quit and do not save changes into CMOS Status Page Setup Menu and Option Page Setup Menu -- Exit current page and return to Main Menu
F1 key	General help, only for Status Page Setup Menu and Option Page Setup Menu
F2 key	Load previous values
F3 key	Load optimized defaults
F4 key	Save changes and Exit BIOS

Table 4-1: BIOS Navigation Keys

4.1.3 Getting Help

When **F1** is pressed a small help window describing the appropriate keys to use and the possible selections for the highlighted item appears. To exit the Help Window press **Esc** or the **F1** key again.

4.1.4 Unable to Reboot After Configuration Changes

If the computer cannot boot after changes to the system configuration is made, clear CMOS defaults by using the clear CMOS button described in **Section 3.5.1**.

4.1.5 BIOS Menu Bar

The **menu bar** on top of the BIOS screen has the following main items:

- Main – Changes the basic system configuration.
- Advanced – Changes the advanced system settings.
- Chipset – Changes the chipset settings.
- Security – Sets User and Supervisor Passwords.
- Boot – Changes the system boot configuration.

- Save & Exit – Selects exit options and loads default settings
- Server Mgmt – Changes the server management configuration.

The following sections completely describe the configuration options found in the menu items at the top of the BIOS screen and listed above.

4.2 Main

The **Main** BIOS menu (**BIOS Menu 1**) appears when the **BIOS Setup** program is entered.

The **Main** menu gives an overview of the basic system information.

Aptio Setup Utility - Copyright (C) 2013 American Megatrends, Inc.						
Main	Advanced	Chipset	Security	Boot	Save & Exit	Server Mgmt
BIOS Information						Set the Date. Use Tab to switch between Data elements.
BIOS Vendor			American Megatrends			
Core Version			5.009			
Compliance			UEFI 2.3; PI 1.2			
Project Version			SAA8AM13.ROM			
Build Date and Time			12/02/2014 15:53:57			
iWDD Vendor			iEi			
iWDD Version			SAA8ER11.bin			
IPMI Module			iRIS-1010			
Memory Information						-----
Total Memory			2048 MB (LPDDR3)			
TXE Information						→←: Select Screen
Sec RC Version			00.05.00.00			↑↓: Select Item
TXE FW Version			01.00.02.1060			Enter: Select
System Date			[Mon 08/17/2015]			+/-: Change Opt.
System Time			[11:10:27]			F1: General Help
Access Level			Administrator			F2: Previous Values
						F3: Optimized Defaults
						F4: Save & Exit
						ESC: Exit
Version 2.16.1242. Copyright (C) 2013 American Megatrends, Inc.						

BIOS Menu 1: Main

ECW-281B-BTi Embedded System

The **Main** menu has two user configurable fields:

→ **System Date [xx/xx/xx]**

Use the **System Date** option to set the system date. Manually enter the day, month and year.

→ **System Time [xx:xx:xx]**

Use the **System Time** option to set the system time. Manually enter the hours, minutes and seconds.

4.3 Advanced

Use the **Advanced** menu (**BIOS Menu 2**) to configure the CPU and peripheral devices through the following sub-menus:



WARNING!

Setting the wrong values in the sections below may cause the system to malfunction. Make sure that the settings made are compatible with the hardware.

```

Aptio Setup Utility - Copyright (C) 2013 American Megatrends, Inc.
Main  Advanced  Chipset  Security  Boot  Save & Exit  Server Mgmt
-----
> ACPI Settings
> Super IO Configuration
> Hardware Monitor
> RTC Wake Settings
> Serial Port Console Redirection
> iEi Feature
> CPU Configuration
> IDE Configuration
> USB Configuration

System ACPI Parameters
-----
-><: Select Screen
↑↓: Select Item
Enter: Select
+/-: Change Opt.
F1: General Help
F2: Previous Values
F3: Optimized Defaults
F4: Save & Exit
ESC: Exit

Version 2.16.1242. Copyright (C) 2013 American Megatrends, Inc.

```

BIOS Menu 2: Advanced

4.3.1 ACPI Settings

The **ACPI Settings** menu (**BIOS Menu 3**) configures the Advanced Configuration and Power Interface (ACPI) options.

```

Aptio Setup Utility - Copyright (C) 2013 American Megatrends, Inc.
Advanced
-----
ACPI Settings
ACPI Sleep State          [S3 (Suspend to RAM)]

Select the ACPI sleep state
the system will enter when
the SUSPEND button is
pressed.
-----
-><: Select Screen
↑↓: Select Item
Enter: Select
+/-: Change Opt.
F1: General Help
F2: Previous Values
F3: Optimized Defaults
F4: Save & Exit
ESC: Exit

Version 2.16.1242. Copyright (C) 2013 American Megatrends, Inc.

```

BIOS Menu 3: ACPI Settings

ECW-281B-BTi Embedded System

→ ACPI Sleep State [S3 (Suspend to RAM)]

Use the **ACPI Sleep State** option to specify the sleep state the system enters when it is not being used.

- **Suspend Disabled** **DEFAULT** The suspend function is disabled.
- **S3 only (Suspend to RAM)** **DEFAULT** The caches are flushed and the CPU is powered off. Power to the RAM is maintained. The computer returns slower to a working state, but more power is saved.

4.3.2 Super IO Configuration

Use the **Super IO Configuration** menu (**BIOS Menu 4**) to set or change the configurations for the serial ports.

```

Aptio Setup Utility - Copyright (C) 2013 American Megatrends, Inc.
  Advanced
-----
Super IO Configuration
Super IO Chip                F81866
> Serial Port 1 Configuration
> Serial Port 2 Configuration
> Serial Port 3 Configuration
> Serial Port 4 Configuration

Set Parameters of Serial
Port 1 (COMA)

-----
-><: Select Screen
↑↓: Select Item
Enter: Select
+/-: Change Opt.
F1: General Help
F2: Previous Values
F3: Optimized Defaults
F4: Save & Exit
ESC: Exit

Version 2.16.1242. Copyright (C) 2013 American Megatrends, Inc.
  
```

BIOS Menu 4: Super IO Configuration

4.3.2.1 Serial Port n Configuration

Use the **Serial Port n Configuration** menu (**BIOS Menu 5**) to configure the serial port n.

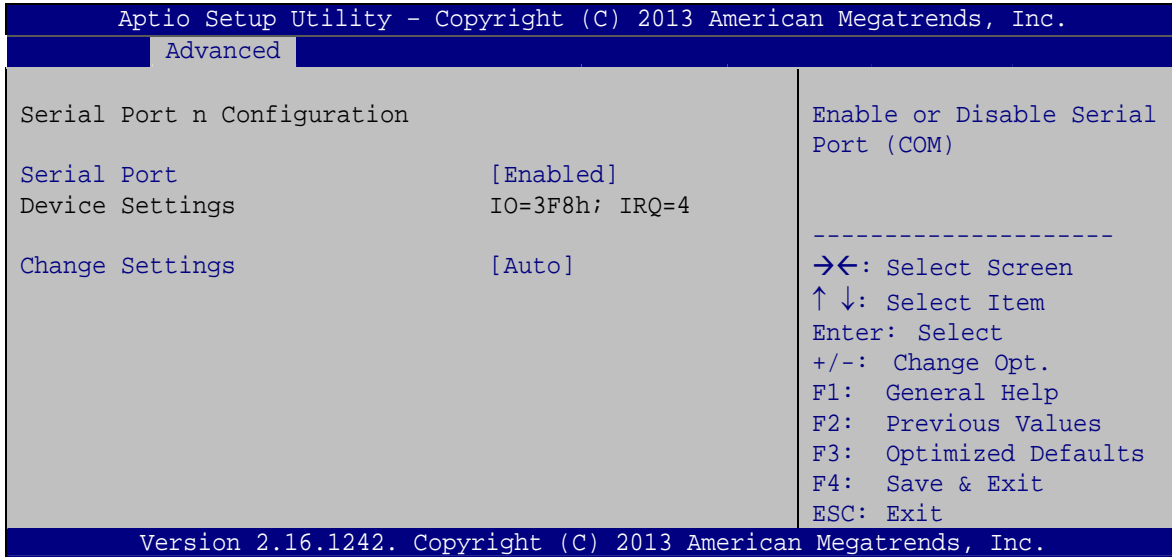

BIOS Menu 5: Serial Port n Configuration Menu

4.3.2.1.1 Serial Port 1 Configuration

→ Serial Port [Enabled]

Use the **Serial Port** option to enable or disable the serial port.

- **Disabled** Disable the serial port
- **Enabled DEFAULT** Enable the serial port

→ Change Settings [Auto]

Use the **Change Settings** option to change the serial port IO port address and interrupt address.

- **Auto DEFAULT** The serial port IO port address and interrupt address are automatically detected.
- **IO=3F8h; Serial Port I/O port address is 3F8h and the interrupt
IRQ=4 address is IRQ4**

ECW-281B-BTi Embedded System

- ➔ **IO=3F8h;**
IRQ=3, 4,
5, 6, 7, 9,
10, 11, 12

Serial Port I/O port address is 3F8h and the interrupt address is IRQ3, 4, 5, 6, 7, 9, 10, 11, 12
- ➔ **IO=2F8h;**
IRQ=3, 4,
5, 6, 7, 9,
10, 11, 12

Serial Port I/O port address is 2F8h and the interrupt address is IRQ3, 4, 5, 6, 7, 9, 10, 11, 12
- ➔ **IO=3E8h;**
IRQ=3, 4,
5, 6, 7, 9,
10, 11, 12

Serial Port I/O port address is 3E8h and the interrupt address is IRQ3, 4, 5, 6, 7, 9, 10, 11, 12
- ➔ **IO=2E8h;**
IRQ=3, 4,
5, 6, 7, 9,
10, 11, 12

Serial Port I/O port address is 2E8h and the interrupt address is IRQ3, 4, 5, 6, 7, 9, 10, 11, 12

4.3.2.1.2 Serial Port 2 Configuration

➔ Serial Port [Enabled]

Use the **Serial Port** option to enable or disable the serial port.

- ➔ **Disabled** Disable the serial port
- ➔ **Enabled** **DEFAULT** Enable the serial port

➔ Change Settings [Auto]

Use the **Change Settings** option to change the serial port IO port address and interrupt address.

- ➔ **Auto** **DEFAULT** The serial port IO port address and interrupt address are automatically detected.

- IO=2F8h; Serial Port I/O port address is 2F8h and the interrupt address is IRQ3
- IO=3F8h; Serial Port I/O port address is 3F8h and the interrupt address is IRQ3, 4, 5, 6, 7, 9, 10, 11, 12
 IRQ=3, 4,
 5, 6, 7, 9,
 10, 11, 12
- IO=2F8h; Serial Port I/O port address is 2F8h and the interrupt address is IRQ3, 4, 5, 6, 7, 9, 10, 11, 12
 IRQ=3, 4,
 5, 6, 7, 9,
 10, 11, 12
- IO=3E8h; Serial Port I/O port address is 3E8h and the interrupt address is IRQ3, 4, 5, 6, 7, 9, 10, 11, 12
 IRQ=3, 4,
 5, 6, 7, 9,
 10, 11, 12
- IO=2E8h; Serial Port I/O port address is 2E8h and the interrupt address is IRQ3, 4, 5, 6, 7, 9, 10, 11, 12
 IRQ=3, 4,
 5, 6, 7, 9,
 10, 11, 12

4.3.2.1.3 Serial Port 3 Configuration

→ Serial Port [Enabled]

Use the **Serial Port** option to enable or disable the serial port.

- Disabled Disable the serial port
- Enabled DEFAULT Enable the serial port

→ Change Settings [Auto]

Use the **Change Settings** option to change the serial port IO port address and interrupt address.

ECW-281B-BTi Embedded System

- | | | | |
|---|--|----------------|---|
| → | Auto | DEFAULT | The serial port IO port address and interrupt address are automatically detected. |
| → | IO=3E8h;
IRQ=7 | | Serial Port I/O port address is 3E8h and the interrupt address is IRQ7 |
| → | IO=3F8h;
IRQ=3, 4,
5, 6, 7, 9,
10, 11, 12 | | Serial Port I/O port address is 3F8h and the interrupt address is IRQ3, 4, 5, 6, 7, 9, 10, 11, 12 |
| → | IO=2F8h;
IRQ=3, 4,
5, 6, 7, 9,
10, 11, 12 | | Serial Port I/O port address is 2F8h and the interrupt address is IRQ3, 4, 5, 6, 7, 9, 10, 11, 12 |
| → | IO=3E8h;
IRQ=3, 4,
5, 6, 7, 9,
10, 11, 12 | | Serial Port I/O port address is 3E8h and the interrupt address is IRQ3, 4, 5, 6, 7, 9, 10, 11, 12 |
| → | IO=2E8h;
IRQ=3, 4,
5, 6, 7, 9,
10, 11, 12 | | Serial Port I/O port address is 2E8h and the interrupt address is IRQ3, 4, 5, 6, 7, 9, 10, 11, 12 |
| → | IO=2F0h;
IRQ=3, 4,
5, 6, 7, 9,
10, 11, 12 | | Serial Port I/O port address is 2F0h and the interrupt address is IRQ3, 4, 5, 6, 7, 9, 10, 11, 12 |
| → | IO=2E0h;
IRQ=3, 4,
5, 6, 7, 9,
10, 11, 12 | | Serial Port I/O port address is 2E0h and the interrupt address is IRQ3, 4, 5, 6, 7, 9, 10, 11, 12 |

4.3.2.1.4 Serial Port 4 Configuration

➔ **Serial Port [Enabled]**

Use the **Serial Port** option to enable or disable the serial port.

- ➔ **Disabled** Disable the serial port
- ➔ **Enabled DEFAULT** Enable the serial port

➔ **Change Settings [Auto]**

Use the **Change Settings** option to change the serial port IO port address and interrupt address.

- ➔ **Auto DEFAULT** The serial port IO port address and interrupt address are automatically detected.
- ➔ **IO=2E8h;
IRQ=7** Serial Port I/O port address is 2E8h and the interrupt address is IRQ7
- ➔ **IO=3F8h;
IRQ=3, 4,
5, 6, 7, 9,
10, 11, 12** Serial Port I/O port address is 3F8h and the interrupt address is IRQ3, 4, 5, 6, 7, 9, 10, 11, 12
- ➔ **IO=2F8h;
IRQ=3, 4,
5, 6, 7, 9,
10, 11, 12** Serial Port I/O port address is 2F8h and the interrupt address is IRQ3, 4, 5, 6, 7, 9, 10, 11, 12
- ➔ **IO=3E8h;
IRQ=3, 4,
5, 6, 7, 9,
10, 11, 12** Serial Port I/O port address is 3E8h and the interrupt address is IRQ3, 4, 5, 6, 7, 9, 10, 11, 12
- ➔ **IO=2E8h;
IRQ=3, 4,
5, 6, 7, 9,
10, 11, 12** Serial Port I/O port address is 2E8h and the interrupt address is IRQ3, 4, 5, 6, 7, 9, 10, 11, 12

ECW-281B-BTi Embedded System

- ➔ **IO=2F0h;** Serial Port I/O port address is 2F0h and the interrupt address is IRQ3, 4, 5, 6, 7, 9, 10, 11, 12
IRQ=3, 4,
5, 6, 7, 9,
10, 11, 12
- ➔ **IO=2E0h;** Serial Port I/O port address is 2E0h and the interrupt address is IRQ3, 4, 5, 6, 7, 9, 10, 11, 12
IRQ=3, 4,
5, 6, 7, 9,
10, 11, 12

4.3.3 Hardware Monitor

The Hardware Monitor menu (**BIOS Menu 6**) displays operating temperature and fan speeds.

```

Aptio Setup Utility - Copyright (C) 2013 American Megatrends, Inc.
Advanced
PC Health Status
> Smart Fan Function
CPU temperature           : +52 °C
System temperature       : +36 °C
CPU Fan Speed             : N/A
SYS Fan Speed            : N/A
Enable or Disable Smart Fan

-----
-><: Select Screen
↑↓: Select Item
Enter: Select
+/-: Change Opt.
F1: General Help
F2: Previous Values
F3: Optimized Defaults
F4: Save & Exit
ESC: Exit
Version 2.16.1242. Copyright (C) 2013 American Megatrends, Inc.

```

BIOS Menu 6: Hardware Monitor

➔ PC Health Status

The following system parameters and values are shown. The system parameters that are monitored are:

- System Temperatures:

- CPU Temperature
- System Temperature
- Fan speed:
 - CPU fan speed
 - System fan speed

4.3.3.1 Smart Fan Function

Use the **Smart Fan Function** menu (**BIOS Menu 7**) to configure the smart fan temperature and speed settings.

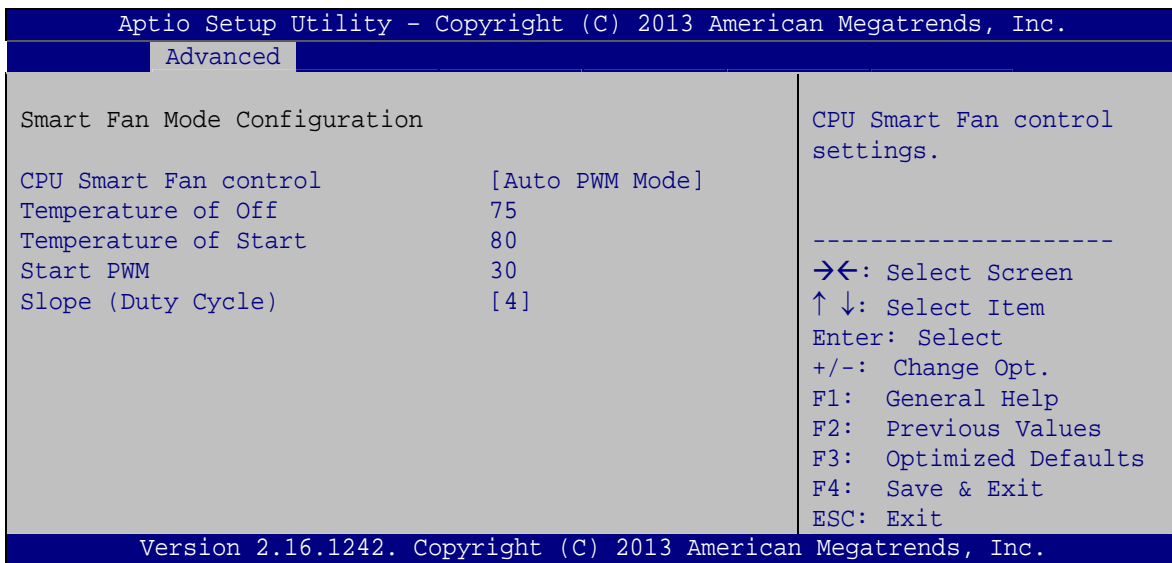

BIOS Menu 7: Smart Fan Function Menu

→ CPU Smart Fan control [Auto PWM Mode]

Use the **CPU Smart Fan control** option to configure the CPU Smart Fan.

- **Full Mode** The fan spins at full speed.
- **Manual PWM Mode** The fan spins at the speed set in Manual PWM Settings.
- **Auto PWM DEFAULT Mode** The fan spins at the speed set in Auto PWM Mode settings

ECW-281B-BTi Embedded System

→ Temperature of Off

Use the + or – key to change the **Temperature of Off** value or enter a decimal number between 1 and 127. If the CPU temperature is lower than the value set in this option, the fan speed will change to the lowest speed.

→ Temperature of Start

Use the + or – key to change the **Temperature of Start** value or enter a decimal number between 1 and 127. If the CPU temperature is between the values set in **Temperature of Off** and **Temperature of Start**, the fan speed will change to the speed set in **Start PWM**.

→ Start PWM

Use the + or – key to change the **Start PWM** value or enter a decimal number between 1 and 100. If the CPU temperature is between the values set in **Temperature of Off** and **Temperature of Start**, the fan speed will change to the speed set in **Start PWM**.

→ Slope (Duty Cycle)

If the CPU temperature is higher than the value set in **Temperature of Start**, the fan speed will change according the percentage set in **Slope (Duty Cycle)**. The available options include:

- 0
- 1
- 2
- 4
- 8
- 16

4.3.4 RTC Wake Settings

The **RTC Wake Settings** menu (**BIOS Menu 8**) enables the system to wake at the specified time.

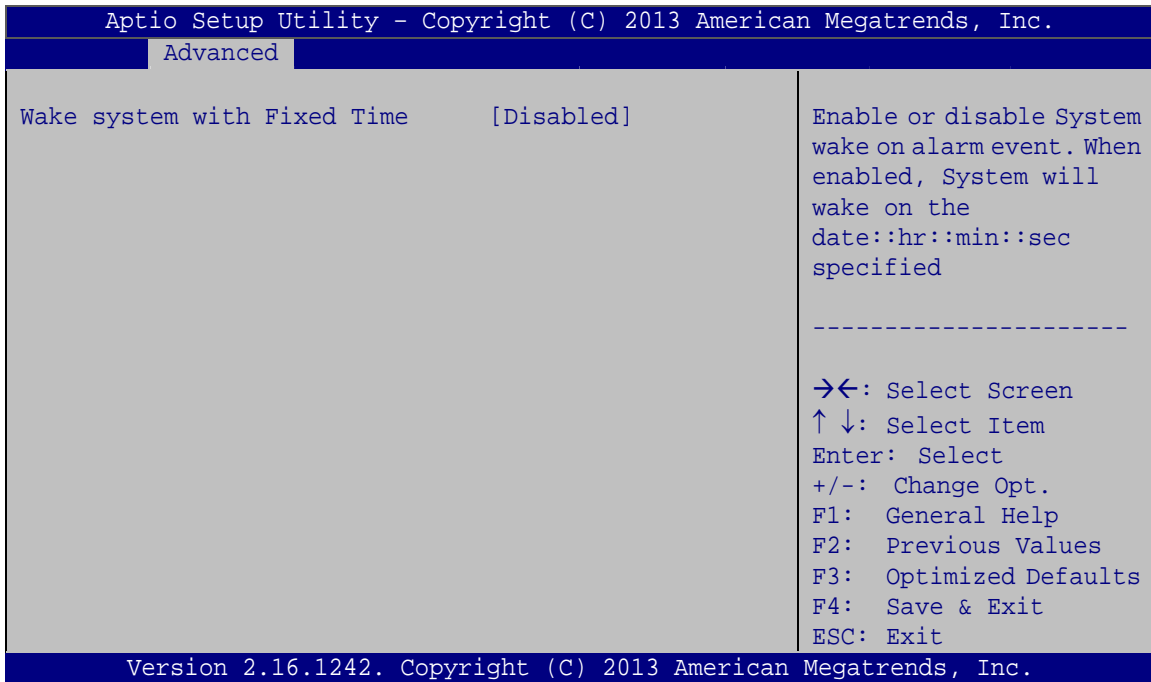

BIOS Menu 8: RTC Wake Settings

→ Wake system with Fixed Time [Disabled]

Use the **Wake system with Fixed Time** option to enable or disable the system wake on alarm event.

- **Disabled** **DEFAULT** The real time clock (RTC) cannot generate a wake event
- **Enabled** If selected, the **Wake up every day** option appears allowing you to enable to disable the system to wake every day at the specified time. Besides, the following options appear with values that can be selected:

Wake up date

Wake up hour

ECW-281B-BTi Embedded System

Wake up minute

Wake up second

After setting the alarm, the computer turns itself on from a suspend state when the alarm goes off.

4.3.5 Serial Port Console Redirection

The **Serial Port Console Redirection** menu (**BIOS Menu 9**) allows the console redirection options to be configured. Console redirection allows users to maintain a system remotely by re-directing keyboard input and text output through the serial port.

```

Aptio Setup Utility - Copyright (C) 2013 American Megatrends, Inc.
  Advanced
COM1
Console Redirection          [Disabled]      Console Redirection
> Console Redirection Settings      Enable or Disable

COM2
Console Redirection          [Disabled]
> Console Redirection Settings

COM3
Console Redirection          [Disabled]
> Console Redirection Settings

COM4
Console Redirection          [Disabled]
> Console Redirection Settings

COM5 (BMC)
Console Redirection          [Disabled]
> Console Redirection Settings

-----
-><: Select Screen
↑↓: Select Item
Enter: Select
+/-: Change Opt.
F1: General Help
F2: Previous Values
F3: Optimized Defaults
F4: Save & Exit
ESC: Exit

Version 2.16.1242. Copyright (C) 2013 American Megatrends, Inc.
  
```

BIOS Menu 9: Serial Port Console Redirection

→ Console Redirection [Disabled]

Use **Console Redirection** option to enable or disable the console redirection function.

- **Disabled** **DEFAULT** Disabled the console redirection function
- **Enabled** Enabled the console redirection function

4.3.5.1 Console Redirection Settings

Use the **Console Redirection Settings** menu (**BIOS Menu 10**) to configure console redirection settings of the specified serial port. This menu appears only when the Console Redirection is enabled.

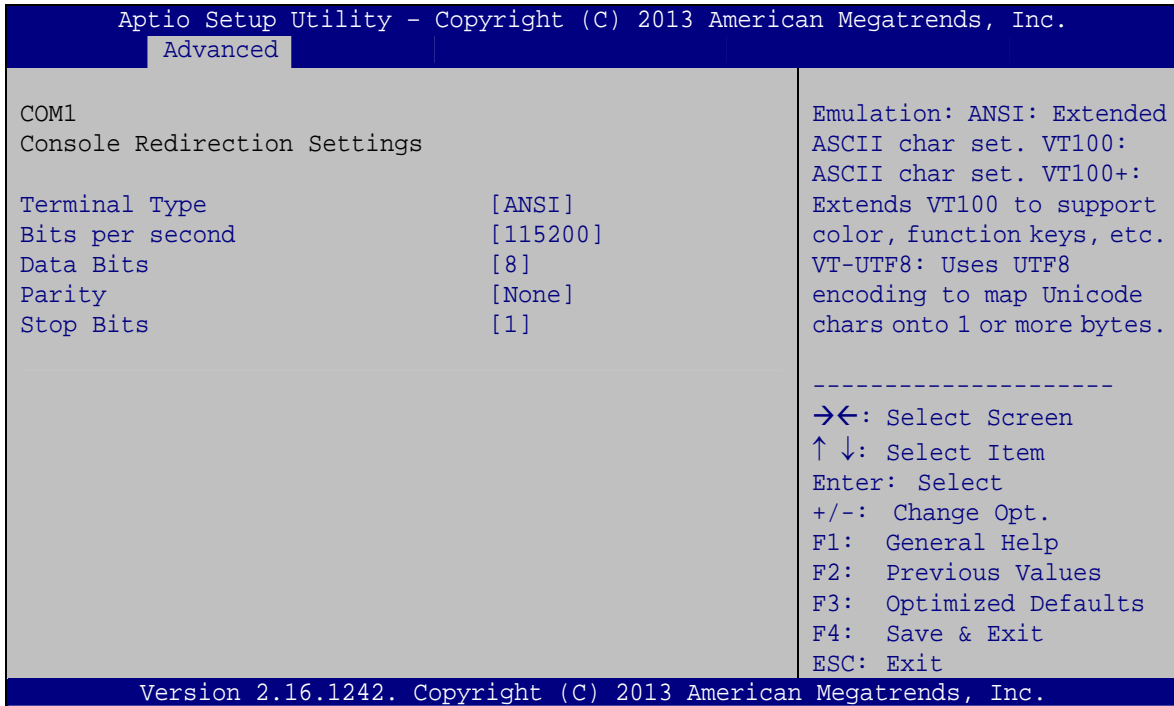

BIOS Menu 10: Console Redirection Settings

→ Terminal Type [ANSI]

Use the **Terminal Type** option to specify the remote terminal type.

- **VT100** The target terminal type is VT100
- **VT100+** The target terminal type is VT100+
- **VT-UTF8** The target terminal type is VT-UTF8
- **ANSI** **DEFAULT** The target terminal type is ANSI

→ Bits per second [115200]

Use the **Bits per second** option to specify the serial port transmission speed. The speed must match the other side. Long or noisy lines may require lower speeds.

ECW-281B-BTi Embedded System

- **9600** Sets the serial port transmission speed at 9600.
- **19200** Sets the serial port transmission speed at 19200.
- **38400** Sets the serial port transmission speed at 39400.
- **57600** Sets the serial port transmission speed at 57600.
- **115200** **DEFAULT** Sets the serial port transmission speed at 115200.

→ **Data Bits [8]**

Use the **Data Bits** option to specify the number of data bits.

- **7** Sets the data bits at 7.
- **8** **DEFAULT** Sets the data bits at 8.

→ **Parity [None]**

Use the **Parity** option to specify the parity bit that can be sent with the data bits for detecting the transmission errors.

- **None** **DEFAULT** No parity bit is sent with the data bits.
- **Even** The parity bit is 0 if the number of ones in the data bits is even.
- **Odd** The parity bit is 0 if the number of ones in the data bits is odd.
- **Mark** The parity bit is always 1. This option does not provide error detection.
- **Space** The parity bit is always 0. This option does not provide error detection.

→ **Stop Bits [1]**

Use the **Stop Bits** option to specify the number of stop bits used to indicate the end of a serial data packet. Communication with slow devices may require more than 1 stop bit.

- 1 **DEFAULT** Sets the number of stop bits at 1.
- 2 Sets the number of stop bits at 2.

4.3.6 iEi Feature

Use the **iEi Feature** menu (**BIOS Menu 11**) to configure One Key Recovery function.

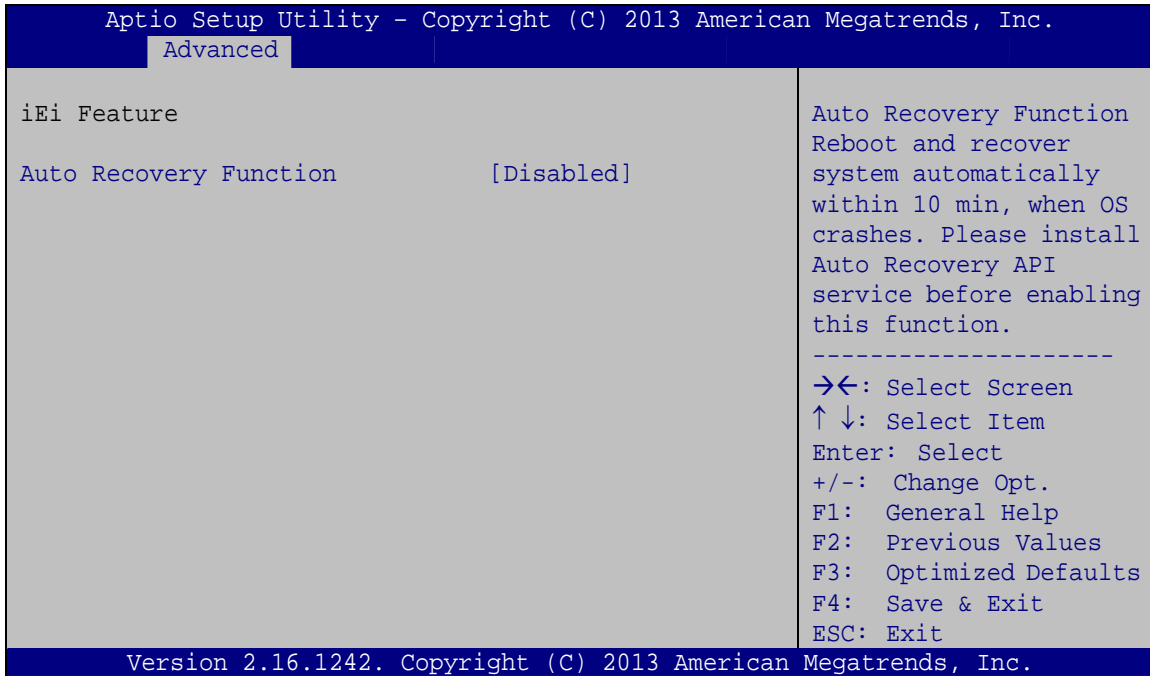

BIOS Menu 11: iEi Feature

→ Auto Recovery Function [Disabled]

Use the **Auto Recovery Function** BIOS option to enable or disable the auto recovery function of the IEI One Key Recovery.

- **Disabled** **DEFAULT** Auto recovery function disabled
- **Enabled** Auto recovery function enabled

ECW-281B-BTi Embedded System

4.3.7 CPU Configuration

Use the **CPU Configuration** menu (**BIOS Menu 12**) to view detailed CPU specifications and configure the CPU.

```

Aptio Setup Utility - Copyright (C) 2013 American Megatrends, Inc.
Advanced
CPU Configuration
Intel(R) Celeron(R) CPU J1900 @ 1.99GHz
CPU Signature          30678
Microcode Patch        809
Max CPU Speed          1990 MHz
Min CPU Speed          1334 MHz
Processor Cores        4
Intel HT Technology     Not Supported
Intel VT-x Technology   Supported

L1 Data Cache          24 KB x 4
L1 Code Cache          32 KB x 4
L2 Cache               1024 KB x 2
L3 Cache               Not Present
CPU Speed              2001 MHz
64-bit                 Supported

Intel Virtualization Technology [Enabled]
EIST                   [Enabled]

When enabled, a VMM can utilize the additional hardware capabilities provided by Vanderpool Technology

-----
-><: Select Screen
↑ ↓: Select Item
Enter: Select
+/-: Change Opt.
F1: General Help
F2: Previous Values
F3: Optimized Defaults
F4: Save & Exit
ESC: Exit

Version 2.16.1242. Copyright (C) 2013 American Megatrends, Inc.
    
```

BIOS Menu 12: CPU Configuration

The CPU Configuration menu (**BIOS Menu 12**) lists the following CPU details:

- CPU Signature: Lists the CPU signature value.
- Microcode Patch: Lists the microcode patch being used.
- Max CPU Speed: Lists the maximum CPU processing speed.
- Min CPU Speed: Lists the minimum CPU processing speed.
- Processor Cores: Lists the number of the processor core
- Intel HT Technology: Indicates if Intel HT Technology is supported by the CPU.
- Intel VT-x Technology: Indicates if Intel VT-x Technology is supported by the CPU.
- L1 Data Cache: Lists the amount of data storage space on the L1 cache.
- L1 Code Cache: Lists the amount of code storage space on the L1 cache.
- L2 Cache: Lists the amount of storage space on the L2 cache.

- L3 Cache: Lists the amount of storage space on the L3 cache.
- CPU Speed: Lists the CPU speed.
- 64-bit: Indicates if 64-bit system is supported by the CPU.

→ **Intel Virtualization Technology [Enabled]**

Use the **Intel Virtualization Technology** option to enable or disable virtualization on the system. When combined with third party software, Intel® Virtualization technology allows several OSs to run on the same system at the same time.

- **Disabled** Disables Intel Virtualization Technology.
- **Enabled** **DEFAULT** Enables Intel Virtualization Technology.

→ **EIST [Enabled]**

Use the **EIST** option to enable or disable the Enhanced Intel® SpeedStep Technology (EIST).

- **Disabled** Disables Enhanced Intel® SpeedStep Technology
- **Enabled** **DEFAULT** Enables Enhanced Intel® SpeedStep Technology

ECW-281B-BTi Embedded System

4.3.8 IDE Configuration

Use the **IDE Configuration** menu (**BIOS Menu 13**) to change and/or set the configuration of the SATA devices installed in the system.

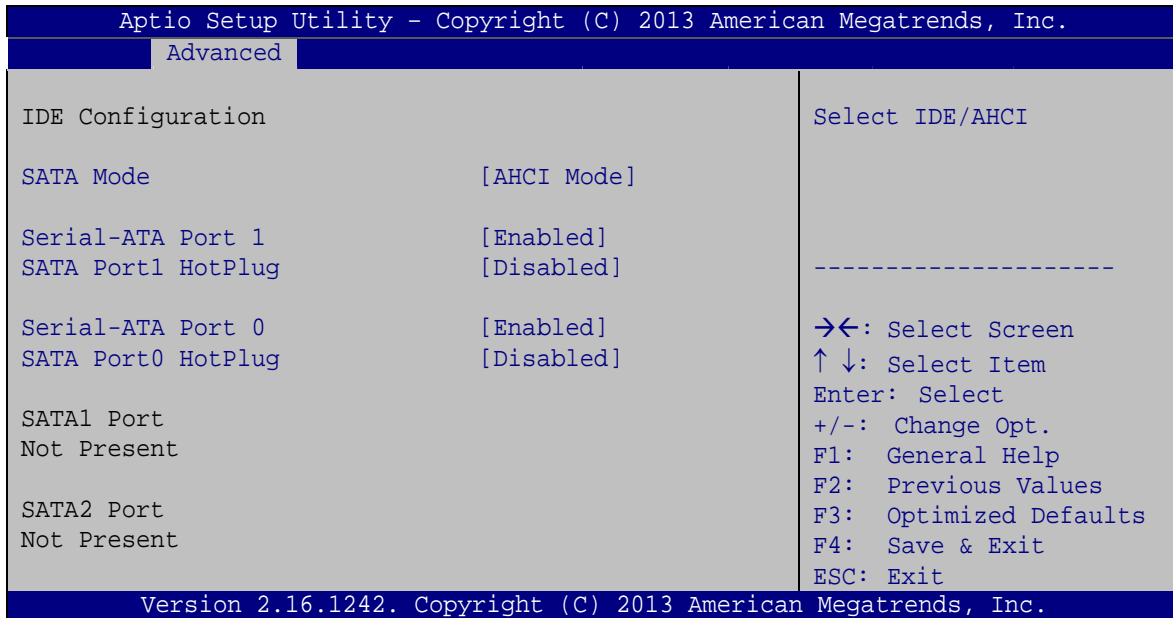

BIOS Menu 13: IDE Configuration

→ SATA Mode [AHCI Mode]

Use the **SATA Mode** option to determine how SATA devices operate.

- **IDE Mode** Configures SATA devices as normal IDE device.
- **AHCI Mode** **DEFAULT** Configures SATA devices as AHCI device.

→ Serial-ATA Port 1/0 [Enabled]

Use the **Serial-ATA Port 1/0** option to configure the SATA controller(s).

- **Enabled** **DEFAULT** Enables the on-board SATA controller(s).
- **Disabled** Disables the on-board SATA controller(s).

→ SATA Port 1/0 HotPlug [Disabled]

Use the **SATA Port 1/0 HotPlug** option to enable or disable the hot plug function of the SATA port.

- **Enabled** Enables the hot plug function of the SATA port.
- **Disabled** **DEFAULT** Disables the hot plug function of the SATA port.

4.3.9 USB Configuration

Use the **USB Configuration** menu (**BIOS Menu 14**) to read USB configuration information and configure the USB settings.

```

Aptio Setup Utility - Copyright (C) 2013 American Megatrends, Inc.
  Advanced
-----
USB Configuration
USB Devices:
  1 Keyboard, 2 Hubs
Legacy USB Support          [Enabled]
-----
                Enables Legacy USB
                support. AUTO option
                disables legacy support
                if no USB devices are
                connected. DISABLE
                option will keep USB
                devices available only
                for EFI applications.
-----
                →←: Select Screen
                ↑ ↓: Select Item
                Enter: Select
                +/-: Change Opt.
                F1:  General Help
                F2:  Previous Values
                F3:  Optimized Defaults
                F4:  Save & Exit
                ESC: Exit
-----
Version 2.16.1242. Copyright (C) 2013 American Megatrends, Inc.

```

BIOS Menu 14: USB Configuration

→ USB Devices

The **USB Devices** field lists the USB devices that are enabled on the system

ECW-281B-BTi Embedded System

→ Legacy USB Support [Enabled]

Use the **Legacy USB Support** BIOS option to enable USB mouse and USB keyboard support. Normally if this option is not enabled, any attached USB mouse or USB keyboard does not become available until a USB compatible operating system is fully booted with all USB drivers loaded. When this option is enabled, any attached USB mouse or USB keyboard can control the system even when there is no USB driver loaded onto the system.

- | | | | |
|---|-----------------|----------------|---|
| → | Enabled | DEFAULT | Legacy USB support enabled |
| → | Disabled | | Legacy USB support disabled |
| → | Auto | | Legacy USB support disabled if no USB devices are connected |

4.4 Chipset

Use the **Chipset** menu (**BIOS Menu 15**) to access the North Bridge and South Bridge configuration menus.



WARNING!

Setting the wrong values for the Chipset BIOS selections in the Chipset BIOS menu may cause the system to malfunction.

```

Aptio Setup Utility - Copyright (C) 2013 American Megatrends, Inc.
Main   Advanced  Chipset   Security  Boot   Save & Exit  Server Mgmt
-----
> North Bridge
> South Bridge

North Bridge Parameters
-----
-><: Select Screen
↑↓: Select Item
Enter: Select
+/-: Change Opt.
F1: General Help
F2: Previous Values
F3: Optimized Defaults
F4: Save & Exit
ESC: Exit

Version 2.16.1242. Copyright (C) 2013 American Megatrends, Inc.
  
```

BIOS Menu 15: Chipset

4.4.1 North Bridge

Use the **North Bridge** menu (**BIOS Menu 16**) to configure the north bridge parameters.

```

Aptio Setup Utility - Copyright (C) 2013 American Megatrends, Inc.
-----
Chipset
-----
> Intel IGD Configuration

Memory Information
Total Memory          2048 MB (LPDDR3)
Memory Slot0         2048 MB (LPDDR3)

Config Intel IGD Settings
-----
-><: Select Screen
↑↓: Select Item
Enter: Select
+/-: Change Opt.
F1: General Help
F2: Previous Values
F3: Optimized Defaults
F4: Save & Exit
ESC: Exit

Version 2.16.1242. Copyright (C) 2013 American Megatrends, Inc.
  
```

BIOS Menu 16: North Bridge

ECW-281B-BTi Embedded System

4.4.1.1 Intel IGD Configuration

Use the **Intel IGD Configuration** submenu (**BIOS Menu 17**) to configure the graphics settings.

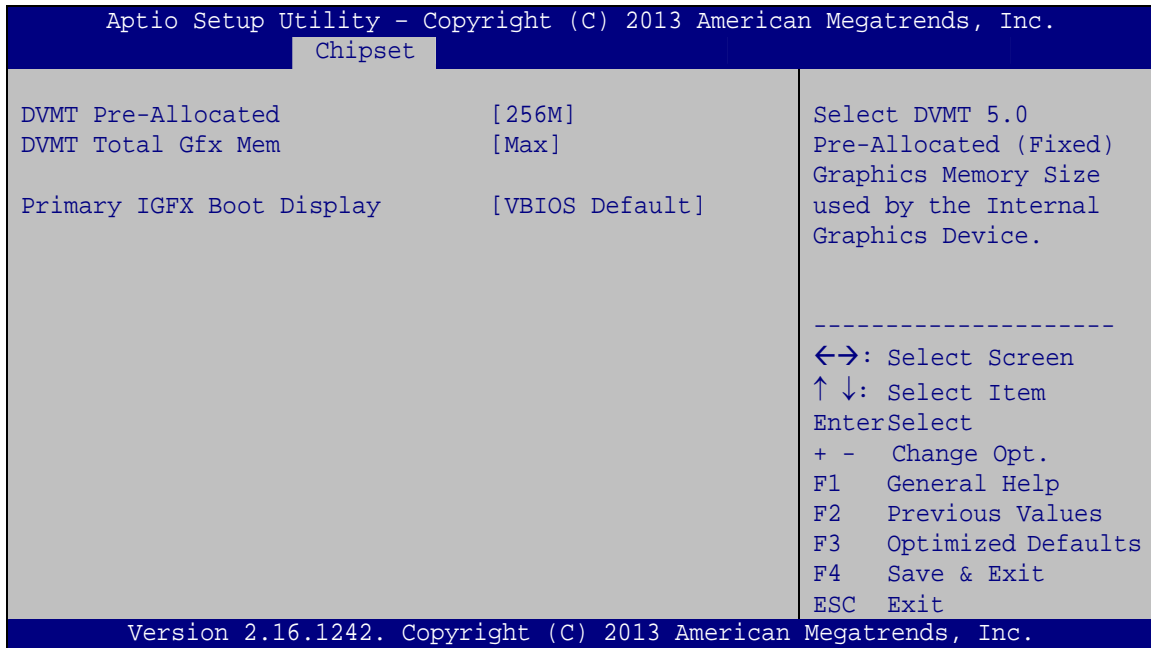

BIOS Menu 17: Intel IGD Configuration

→ DVMT Pre-Allocated [256M]

Use the **DVMT Pre-Allocated** option to specify the amount of system memory that can be used by the internal graphics device.

- **64M** 64 MB of memory used by internal graphics device
- **128M** 128 MB of memory used by internal graphics device
- **256M** **DEFAULT** 256 MB of memory used by internal graphics device
- **512M** 512 MB of memory used by internal graphics device

→ DVMT Total Gfx Mem [Max]

Use the **DVMT Total Gfx Mem** option to specify the maximum amount of memory that can be allocated as graphics memory. Configuration options are listed below.

- 128MB
- 256MB
- Max **DEFAULT**

→ Primary IGFX Boot Display [VBIOS Default]

Use the **Primary IGFX Boot Display** option to select the display device used by the system when it boots. Configuration options are listed below.

- VBIOS Default **DEFAULT**
- CRT
- LVDS
- DP Port

4.4.2 South Bridge

Use the **South Bridge** menu (**BIOS Menu 18**) to configure the south bridge parameters.

```

Aptio Setup Utility - Copyright (C) 2013 American Megatrends, Inc.
Chipset
Auto Power Button Status      [Disabled(ATX)]      Select AC power state
                             when power is re-applied
Restore AC Power Loss         [Last State]         after a power failure.
> PCI Express Configuration
Audio Configuration
Audio Controller              [Enabled]
-----
<->: Select Screen
↑ ↓: Select Item
Enter>Select
+ - Change Opt.
F1  General Help
F2  Previous Values
F3  Optimized Defaults
F4  Save & Exit
ESC Exit
Version 2.16.1242. Copyright (C) 2013 American Megatrends, Inc.
    
```

BIOS Menu 18: South Bridge

ECW-281B-BTi Embedded System

→ Restore AC Power Loss [Last State]

Use the **Restore AC Power** BIOS option to specify what state the system returns to if there is a sudden loss of power to the system.

- **Power Off** The system remains turned off
- **Power On** **DEFAULT** The system turns on
- **Last State** The system returns to its previous state. If it was on, it turns itself on. If it was off, it remains off.

→ Audio Controller [Enabled]

Use the **Audio Controller** BIOS option to enable or disable the High Definition Audio controller.

- **Disabled** The High Definition Audio controller is disabled.
- **Enabled** **DEFAULT** The High Definition Audio controller is enabled.

4.4.2.1 PCI Express Configuration

Use the **PCI Express Configuration** submenu (**BIOS Menu 19**) to configure the PCI Express slots.

Aptio Setup Utility - Copyright (C) 2013 American Megatrends, Inc.		
Chipset		
PCI Express Configuration		Enable or Disable the PCE Express Port 0 in the Chpset.
PCI Express Port 0	[Enabled]	
Speed	[Auto]	
PCI Express Port 1	[Enabled]	-----
Speed	[Auto]	←→: Select Screen
PCI Express Port 2	[Enabled]	↑ ↓: Select Item
Speed	[Auto]	EnterSelect
PCI Express Port 3	[Enabled]	+ - Change Opt.
Speed	[Auto]	F1 General Help
		F2 Previous Values
		F3 Optimized Defaults
		F4 Save & Exit
		ESC Exit
Version 2.16.1242. Copyright (C) 2013 American Megatrends, Inc.		

BIOS Menu 19: PCI Express Configuration

→ PCI Express Port n [Enabled]

Use the **PCI Express Port n** BIOS option to enable or disable the PCI Express slot.

- **Enabled** **DEFAULT** Enable the PCI Express slot.
- **Disabled** Disable the PCI Express slot.

→ Speed [Auto]

Use the **Speed** option to configure the PCIe interface speed.

- Auto **DEFAULT**
- Gen 2
- Gen 1

4.5 Security

Use the **Security** menu (**BIOS Menu 20**) to set system and user passwords.

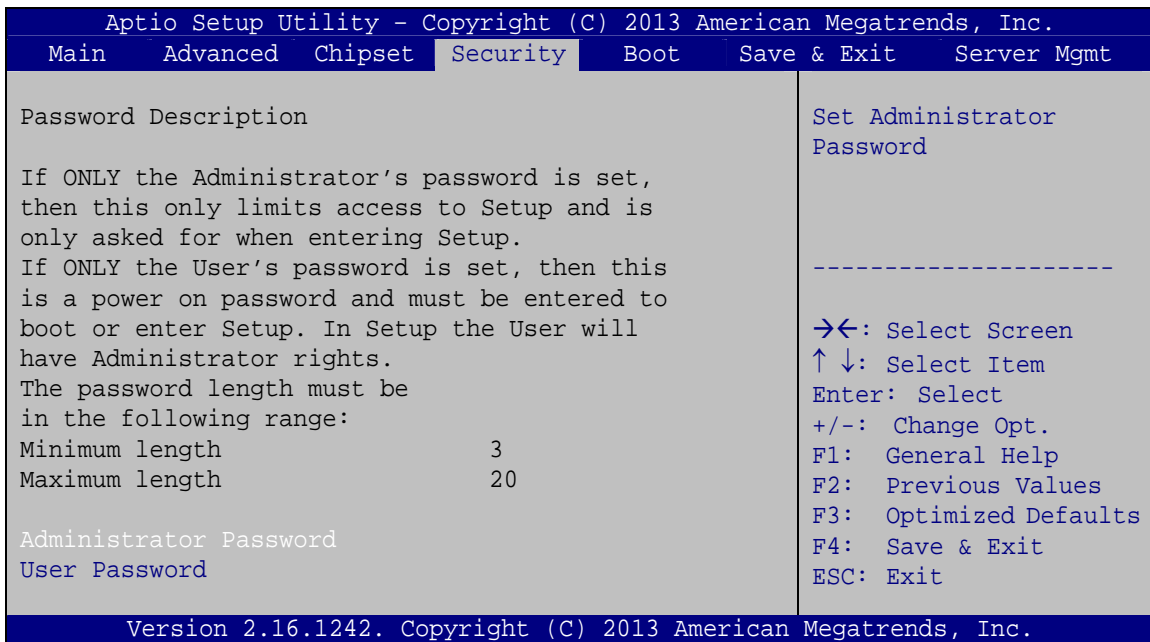

BIOS Menu 20: Security

→ Administrator Password

Use the **Administrator Password** to set or change an administrator password.

ECW-281B-BTi Embedded System

→ User Password

Use the **User Password** to set or change a user password.

4.6 Boot

Use the **Boot** menu (**BIOS Menu 21**) to configure system boot options.

```

Aptio Setup Utility - Copyright (C) 2013 American Megatrends, Inc.
Main   Advanced  Chipset  Security  Boot   Save & Exit  Server Mgmt
-----
Boot Configuration
Bootup NumLock State      [On]
Quiet Boot                 [Enabled]
Option ROM Messages       [Keep Current]
UEFI Boot                  [Disabled]
Launch PXE OpROM          [Disabled]

Boot Option Priorities

-----
Select the keyboard
NumLock state

-----
→←: Select Screen
↑↓: Select Item
Enter: Select
+/-: Change Opt.
F1:  General Help
F2:  Previous Values
F3:  Optimized Defaults
F4:  Save & Exit
ESC: Exit

Version 2.16.1242. Copyright (C) 2013 American Megatrends, Inc.
  
```

BIOS Menu 21: Boot

→ Bootup NumLock State [On]

Use the **Bootup NumLock State** BIOS option to specify if the number lock setting must be modified during boot up.

- **On** **DEFAULT** Allows the Number Lock on the keyboard to be enabled automatically when the computer system boots up. This allows the immediate use of the 10-key numeric keypad located on the right side of the keyboard. To confirm this, the Number Lock LED light on the keyboard is lit.

→ Off Does not enable the keyboard Number Lock automatically. To use the 10-keys on the keyboard, press the Number Lock key located on the upper left-hand corner of the 10-key pad. The Number Lock LED on the keyboard lights up when the Number Lock is engaged.

→ **Quiet Boot [Enabled]**

Use the **Quiet Boot** BIOS option to select the screen display when the system boots.

→ Disabled		Normal POST messages displayed
→ Enabled	DEFAULT	OEM Logo displayed instead of POST messages

→ **Option ROM Messages [Keep Current]**

Use the **Option ROM Messages** option to set the Option ROM display mode.

→ Force BIOS		Sets display mode to force BIOS.
→ Keep Current	DEFAULT	Sets display mode to current.

→ **UEFI Boot [Disabled]**

Use the **UEFI Boot** option to enable or disable to boot from the UEFI devices.

→ Enabled		Boot from UEFI devices is enabled.
→ Disabled	DEFAULT	Boot from UEFI devices is disabled.

ECW-281B-BTi Embedded System

→ Launch PXE OpROM [Disabled]

Use the **Launch PXE OpROM** option to enable or disable boot option for legacy network devices.

- **Disabled** **DEFAULT** Ignore all PXE Option ROMs
- **Enabled** Load PXE Option ROMs

4.7 Save & Exit

Use the **Save & Exit** menu (**BIOS Menu 22**) to load default BIOS values, optimal failsafe values and to save configuration changes.

```

Aptio Setup Utility - Copyright (C) 2013 American Megatrends, Inc.
Main   Advanced   Chipset   Security   Boot   Save& Exit   Server Mgmt
-----
Save Changes and Reset
Discard Changes and Reset

Restore Defaults
Save as User Defaults
Restore User Defaults

Exit the system after
saving the changes.

-----
→←: Select Screen
↑↓: Select Item
Enter: Select
+/-: Change Opt.
F1: General Help
F2: Previous Values
F3: Optimized Defaults
F4: Save & Exit
ESC: Exit

Version 2.16.1242. Copyright (C) 2013 American Megatrends, Inc.
    
```

BIOS Menu 22: Save & Exit

→ Save Changes and Reset

Use the **Save Changes and Reset** option to save the changes made to the BIOS options and reset the system.

→ Discard Changes and Reset

Use the **Discard Changes and Reset** option to exit the system without saving the changes made to the BIOS configuration setup program.

→ Restore Defaults

Use the **Restore Defaults** option to load the optimal default values for each of the parameters on the Setup menus. **F3 key can be used for this operation.**

→ Save as User Defaults

Use the **Save as User Defaults** option to save the changes done so far as user defaults.

→ Restore User Defaults

Use the **Restore User Defaults** option to restore the user defaults to all the setup options.

4.8 Server Mgmt

Use the **Server Mgmt** menu (**BIOS Menu 23**) to configure system event log and BMC network parameters.

```

Aptio Setup Utility - Copyright (C) 2013 American Megatrends, Inc.
Main   Advanced  Chipset  Security  Boot   Save & Exit  Server Mgmt
-----
BMC Self Test Status          FAILED
BMC Firmware Revision         Unknown
> System Event Log
> BMC network configuration

Configure BMC network
parameters

-----
→←: Select Screen
↑↓: Select Item
Enter: Select
+/-: Change Opt.
F1: General Help
F2: Previous Values
F3: Optimized Defaults
F4: Save & Exit
ESC: Exit

Version 2.16.1242. Copyright (C) 2013 American Megatrends, Inc.

```

BIOS Menu 23: Server Mgmt

ECW-281B-BTi Embedded System

4.8.1 System Event Log

Use the **System Event Log** menu (**BIOS Menu 24**) to configure system event log options.

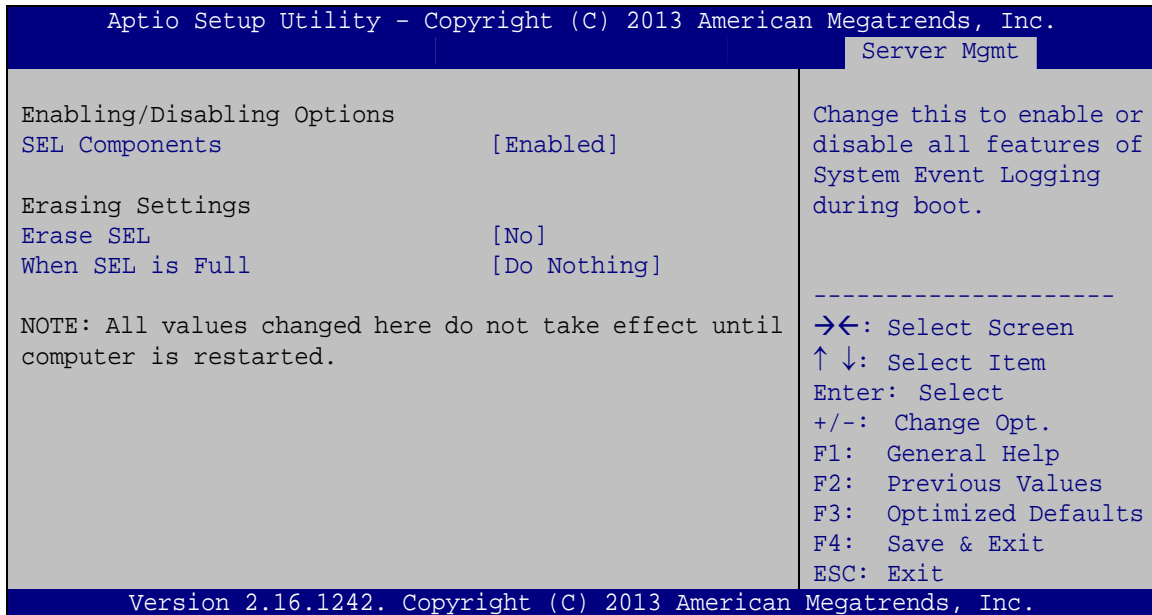

BIOS Menu 24: System Event Log

→ SEL Components [Enabled]

Use the **SEL Components** option to enable or disable all features of System Event Log during boot.

- **Disabled** System Event Log features disabled.
- **Enabled** **DEFAULT** System Event Log features enabled.

→ Erase SEL [No]

Use the **Erase SEL** option to select an option for erasing SEL (system event log).

- **No** **DEFAULT** Do not erase SEL
- **Yes,**
On next reset Erase SEL on next reset

→ Yes, Erase SEL on every reset
On every reset

→ **When SEL is Full [Do Nothing]**

Use the **When SEL is Full** option to select an option for reaction to a full SEL.

→ **Do Nothing** **DEFAULT** Do nothing when SEL is full

→ **Erase** Erase SEL immediately when SEL is full
Immediately

4.8.2 BMC Network Configuration

Use the **BMC Network Configuration** menu (**BIOS Menu 25**) to configure BMC network parameters.

Aptio Setup Utility - Copyright (C) 2013 American Megatrends, Inc.		Server Mgmt
BMC network configuration		Select to configure LAN channel parameters statically or dynamically (by BIOS or BMC). Unspecified option will not modify any BMC network parameters during BIOS phase
Lan channel 1		
Configuration Address source	[Unspecified]	
Current Configuration Address sour	-	
Station IP address	-	
Subnet mask	-	
Station MAC address	-	
Router IP address	-	
Router MAC address	-	

		→←: Select Screen
		↑ ↓: Select Item
		Enter: Select
		+/-: Change Opt.
		F1: General Help
		F2: Previous Values
		F3: Optimized Defaults
		F4: Save & Exit
		ESC: Exit
Version 2.16.1242. Copyright (C) 2013 American Megatrends, Inc.		

BIOS Menu 25: System Event Log

ECW-281B-BTi Embedded System

→ Configuration Address source [Unspecified]

Use the **Configuration Address source** to configure LAN channel parameters statically or dynamically (by BIOS or BMC).

- | | | |
|----------------------------|----------------|--|
| → Unspecified | DEFAULT | BMC network parameters will not be modified during BIOS phase. |
| → Static | | Select to modify the following BMC network parameters: <ul style="list-style-type: none">▪ Station IP address▪ Subnet mask▪ Router IP address▪ Router MAC address |
| → DynamicBmcDhcp | | Select to configure LAN channel parameters dynamically by BMC running DHCP |
| → DynamicBmcNonDhcp | | Select to configure LAN channel parameters dynamically by BMC running other address assignment protocol |

Chapter

5

Troubleshooting and Maintenance

**WARNING:**

Take Anti-Static precautions whenever maintenance is being carried out on the system components. Failure to take anti-static precautions can cause permanent system damage. For more details on anti-static precautions, please refer to **Section 3.1**.

5.1 ECW-281B-BTi System Maintenance Overview

**NOTE:**

When doing maintenance operations on the system, please follow the instructions in this chapter. Failure to follow these instructions may lead to personal injury and system damage.

To preserve the working integrity of the ECW-281B-BTi embedded system, the system must be properly maintained. If embedded system components need replacement, the proper maintenance procedures must be followed to ensure the system can continue to operate normally.

5.2 System Troubleshooting

This section provides some simple troubleshooting suggestions.

5.2.1 The System Doesn't Turn On

If after turning the system on, there is no power (indicated by the power button on the front panel not turning on) please do the following:

- Step 1:** Check that the power cable connector is properly connected to the terminal block or power socket on the system rear panel.

Step 2: Check that the power cable connector is properly plugged into the power source.

Step 3: Make sure the power button is turned on.

Step 4: Plug the system into a monitor and check to see if anything appears on the screen. If the boot-up screen appears it means the power LED has become disconnected. To fix this problem, open the top cover and reconnect the power LED to the motherboard.

If the above steps have been completed and the system still doesn't turn on, please do the following.

Step 1: Open the bottom surface (**Section 3.4**)

Step 2: Check the terminal block/power socket power cable connector is properly connected to the power module or motherboard.

Step 3: Check that the power button cable connector is properly connected to the motherboard.

Step 4: Make sure the cable connecting to the terminal block/power socket are properly attached and have not become separated.

Step 5: Make sure the cable connecting the power button to the motherboard is still properly attached to the power button and has not been separated.

5.2.2 The System Doesn't Boot Up

If the system doesn't boot up please do the following:

Step 1: Check the power is turned on. See **Section 5.2.1** above.

Step 2: Make sure the SO-DIMM module is properly installed.

Step 3: Reset the system using the reset CMOS jumper.

ECW-281B-BTi Embedded System

5.2.3 More Troubleshooting

Nothing appears on the monitor after booting up the system: Make sure the monitor is properly connected to the system and the monitor is connected to a power supply and turned on.



WARNING!

If all troubleshooting measures have been taken and the system still fails to start, contact the IEI reseller or vendor you purchased the ECW-281B-BTi from or contact an IEI sales representative directly. To contact an IEI sales representative, please send an email to sales@ieiworld.com.

5.3 Component Replacement Procedure



WARNING!

Users are not advised to attempt to repair or replace any internal or external components of the ECW-281B-BTi embedded system other than those listed below. If any other components fail or need replacement, contact the IEI reseller or vendor you purchased the ECW-281B-BTi from or contact an IEI sales representative directly. To contact an IEI sales representative, please send an email to sales@ieiworld.com.

The embedded system components listed below can all be replaced if they fail:

- SO-DIMM module
- Internal hard disk drive (see **Section 3.6**)

5.3.1 SO-DIMM Replacement

**WARNING:**

Using incorrectly specified SO-DIMM may cause permanently damage the ECW-281B-BTi. Please make sure the purchased SO-DIMM complies with the memory specifications of the ECW-281B-BTi.

To replace a SO-DIMM memory module into a SO-DIMM socket, please follow the steps below.

Step 1: Remove the bottom surface panel. Place the ECW-281B-BTi on an anti-static pad with the bottom panel facing up and the bottom surface removed (see Section 3.4).

Step 2: Locate the SO-DIMM on the motherboard.



Figure 5-1: SO-DIMM Location

Step 3: Remove the SO-DIMM by releasing the arms on the SO-DIMM socket.

Step 4: Align the new SO-DIMM with the socket. The SO-DIMM must be oriented in such a way that the notch in the middle of the SO-DIMM must be aligned with the plastic bridge in the socket (Figure 5-2).

ECW-281B-BTi Embedded System

Step 5: Insert the **SO-DIMM**. Push the SO-DIMM chip into the socket at an angle (Figure 5-2).

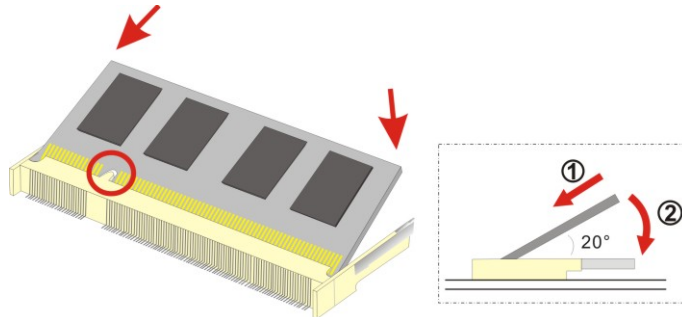

Figure 5-2: SO-DIMM Installation

Step 6: Open the **SO-DIMM socket arms**. Gently pull the arms of the SO-DIMM socket out and push the rear of the SO-DIMM down (See **Figure 5-2**).

Step 7: Secure the **SO-DIMM**. Release the arms on the SO-DIMM socket. They clip into place and secure the SO-DIMM in the socket.

Chapter

6

System Components

ECW-281B-BTi Embedded System

6.1 Embedded System Motherboard



NOTE:

The jumpers and connectors shown in the section below are those jumpers and connectors that are relevant to the configuration and installation of the embedded system. For a complete list of jumpers and connectors on the WAFER-BT-i1 motherboard, please refer to the WAFER-BT-i1 user manual.

The ECW-281B-BTi models have a WAFER-BT-i1 motherboard installed in the system. The following sections describe the relevant connectors and jumpers on the motherboard.

6.1.1 WAFER-BT-i1 Motherboard Overview

The locations of the WAFER-BT-i1 jumpers and connectors used on the ECW-281B-BTi are shown in **Figure 6-1** below.

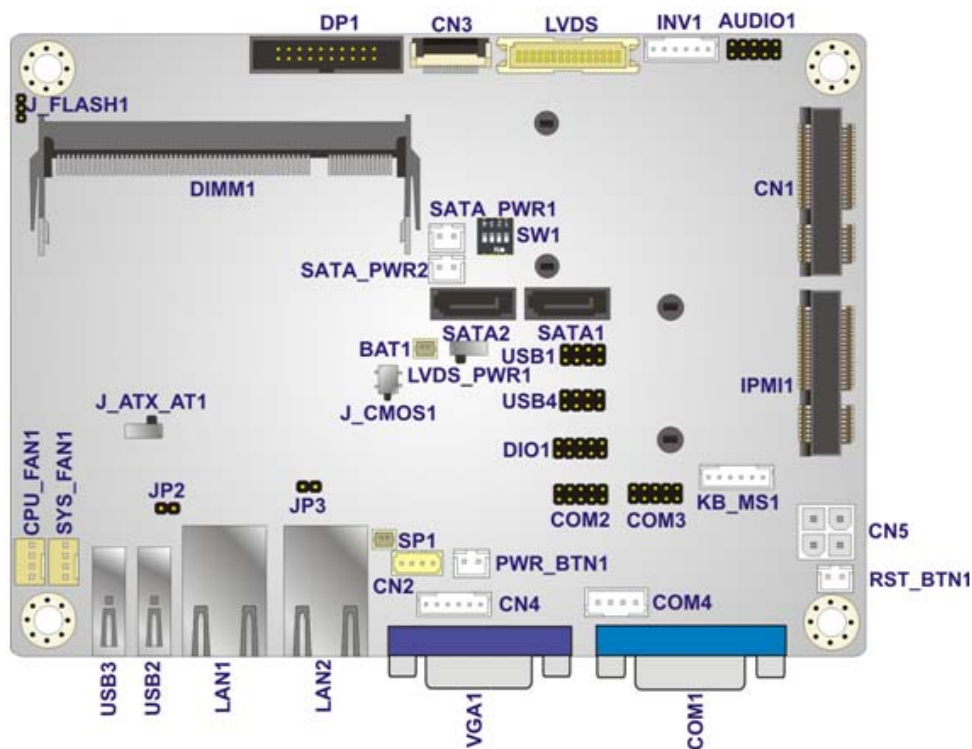

Figure 6-1: WAFER-BT-i1 Jumper and Connector Locations

6.2 Peripheral Interface Connectors

Section 6.2.1 lists all the peripheral interface connectors seen in Section 6.1.1.

6.2.1 Peripheral Interface Connectors

Table 6-1 shows a list of the peripheral interface connectors on the WAFER-BT-i1 that are used for the ECW-281B-BTi. Detailed descriptions of these connectors can be found in Section 6.3.

Connector	Type	Label
+12V DC-IN power connector	4-pin Molex	CN5
Audio connector	10-pin header	AUDIO1
Battery connector	2-pin wafer	BAT1
Buzzer connector	2-pin wafer	SP1
DDR3L SO-DIMM slot	DDR3L SO-DIMM slot	DIMM1
Digital I/O connector	10-pin header	DIO1
Front panel connector	6-pin wafer	CN4
iRIS-1010 module slot	iRIS-1010 module slot	IPMI1
PCIe Mini card/mSATA slot	PCIe Mini card slot	CN1
Power button connector	2-pin wafer	PWR_BTN1
Reset button connector	2-pin wafer	RST_BTN1
RS-232 serial port connectors	10-pin header	COM2, COM3
RS-422/485 serial port connector	4-pin wafer	COM4
SATA 3Gb/s drive connectors	7-pin SATA connector	SATA1
SATA power connectors	2-pin wafer	SATA_PWR1
USB 2.0 connector	8-pin header	USB4

Table 6-1: Peripheral Interface Connectors

ECW-281B-BTi Embedded System

6.3 Internal Peripheral Connectors

Internal peripheral connectors are found on the motherboard and are only accessible when the motherboard is outside of the chassis. This section has complete descriptions of the internal, peripheral connectors on the WAFER-BT-i1 that are used for the ECW-281B-BTi.

6.3.1 +12V DC-IN Power Connector

The connector supports the +12V power supply.

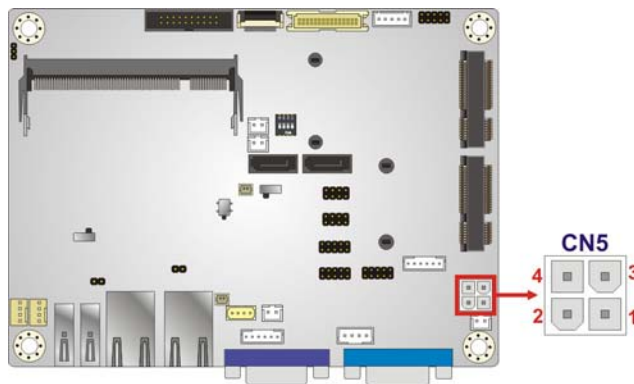

Figure 6-2: +12V DC-IN Power Connector Location

PIN NO.	DESCRIPTION	PIN NO.	DESCRIPTION
1	GND	2	GND
3	+12V	4	+12V

Table 6-2: +12V DC-IN Power Connector Pinouts

6.3.2 Audio Connector

The audio connector is connected to external audio devices including speakers and microphones for the input and output of audio signals to and from the system.

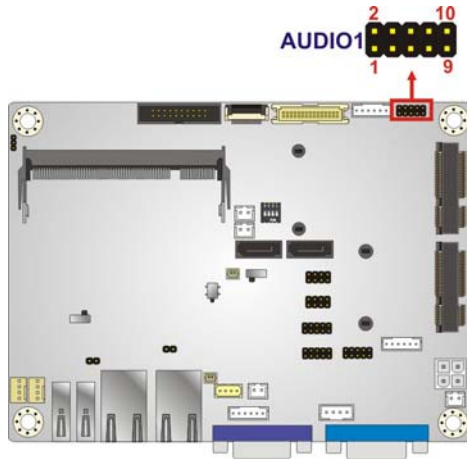

Figure 6-3: Audio Connector Location

PIN NO.	DESCRIPTION	PIN NO.	DESCRIPTION
1	LINE_OUTR	2	LINEIN_R
3	Analog_GND	4	Analog_GND
5	LINE_OUTL	6	LINEIN_L
7	Analog_GND	8	Analog_GND
9	LMIC1-R	10	LMIC1-L

Table 6-3: Audio Connector Pinouts

6.3.3 Battery Connector

The battery connector is connected to the system battery. The battery provides power to the system clock to retain the time when power is turned off.

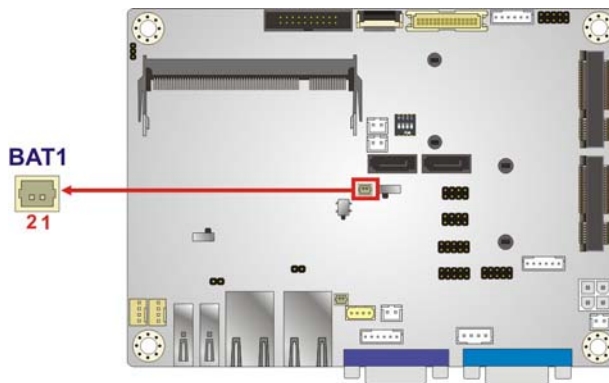

Figure 6-4: Battery Connector Location

ECW-281B-BTi Embedded System

PIN NO.	DESCRIPTION	PIN NO.	DESCRIPTION
1	VBATT	2	GND

Table 6-4: Battery Connector Pinouts

6.3.4 Buzzer Connector

The buzzer connector is connected to the buzzer.

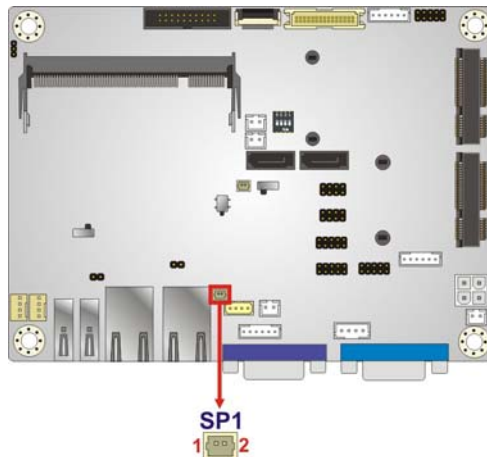

Figure 6-5: Buzzer Connector Location

PIN NO.	DESCRIPTION	PIN NO.	DESCRIPTION
1	Buzzer +	2	Buzzer -

Table 6-5: Buzzer Connector Pinouts

6.3.5 DDR3L SO-DIMM Slot

The DDR3L SO-DIMM slot is for DDR3L SO-DIMM memory module.

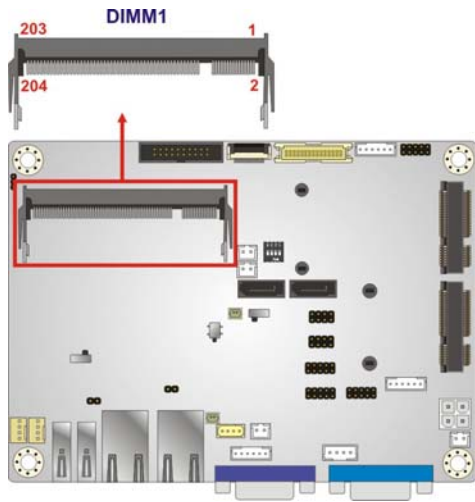

Figure 6-6: DDR3L SO-DIMM Slot Location

6.3.6 Digital I/O Connector

The digital I/O connector provides programmable input and output for external devices. The digital I/O provides 4-bit output and 4-bit input.

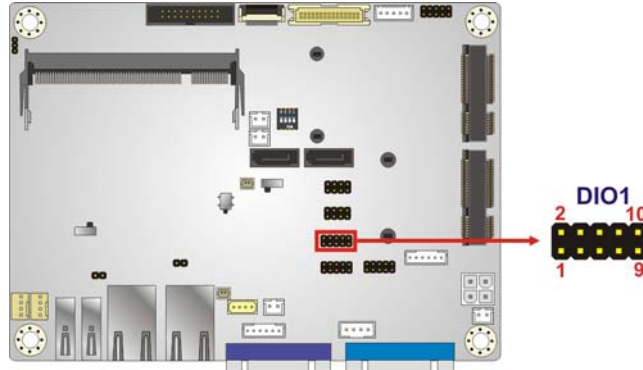

Figure 6-7: Digital I/O Connector Location

PIN NO.	DESCRIPTION	PIN NO.	DESCRIPTION
1	GND	2	+5V
3	DGPO3	4	DGPO2
5	DGPO1	6	DGPO0
7	DGPI3	8	DGPI2
9	DGPI1	10	DGPI0

Table 6-6: Digital I/O Connector Pinouts

ECW-281B-BTi Embedded System

6.3.7 Front Panel Connector

The front panel connector connects to the indicator LEDs on the system front panel.

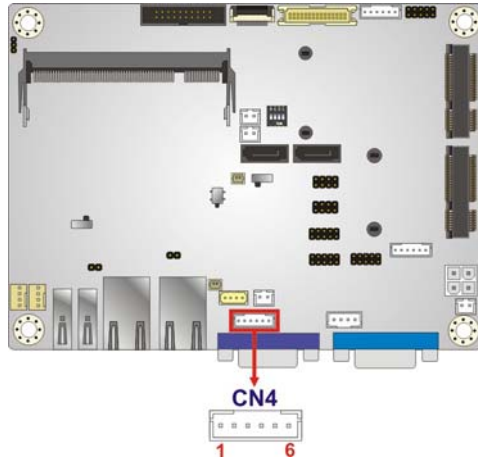

Figure 6-8: Front Panel Connector Location

PIN NO.	DESCRIPTION	PIN NO.	DESCRIPTION
1	+5V	2	GND
3	PWR_LED+	4	PWR_LED-
5	HDD_LED+	6	HDD_LED-

Table 6-7: Front Panel Connector Pinouts

6.3.8 iRIS-1010 module slot

The iRIS-1010 module slot allows installation of the iRIS-1010 module.

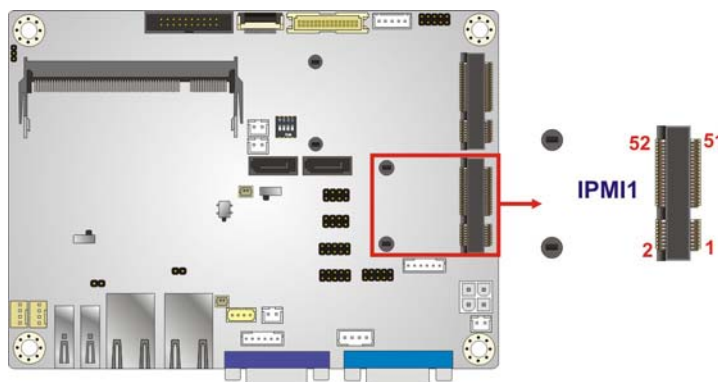

Figure 6-9: iRIS-1010 Module Slot Location



WARNING:

The iRIS-1010 module slot is designed to install the IEI iRIS-1010 IPMI 2.0 module. DO NOT install other modules into the iRIS-1010 module slot. Doing so may cause damage to the ECW-281B-BTi.

6.3.9 PCIe Mini Card/mSATA Slot

The PCIe Mini card slot is for installing a PCIe Mini expansion card or an mSATA module.

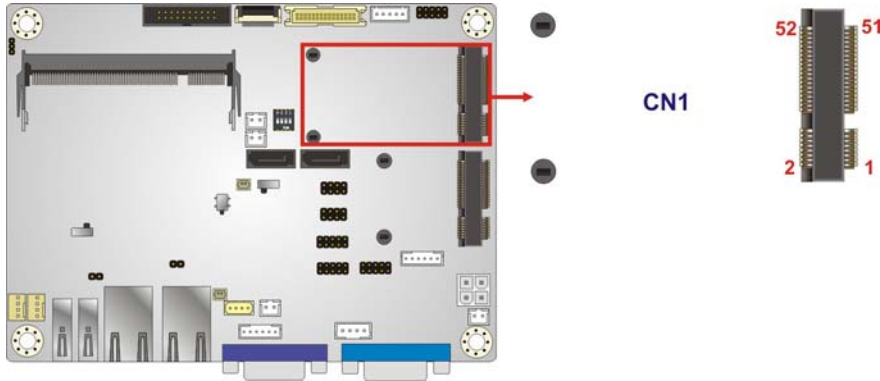

Figure 6-10: PCIe Mini Card Slot Location



NOTE:

If an mSATA module is installed in the PCIe Mini slot (CN1), the SATA port 2 (SATA2) will be disabled. Choose either the SATA2 connector or the mSATA module for storage.

6.3.10 Power Button Connector

The power button connector is connected to a power switch on the system chassis to enable users to turn the system on and off.

ECW-281B-BTi Embedded System

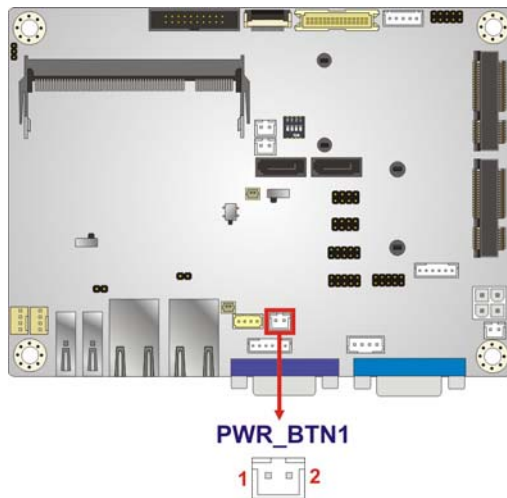

Figure 6-11: Power Button Connector Location

PIN NO.	DESCRIPTION
1	PWRBTN_SW#
2	GND

Table 6-8: Power Button Connector Pinouts

6.3.11 Reset Button Connector

The reset button connector is connected to a reset switch on the system chassis to enable users to reboot the system when the system is turned on.

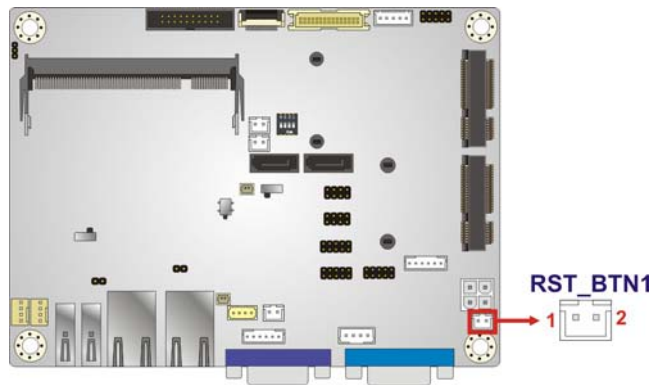

Figure 6-12: Reset Button Connector Location

PIN NO.	DESCRIPTION
1	PM_SYSRST_R#
2	GND

Table 6-9: Reset Button Connector Pinouts

6.3.12 RS-232 Serial Port Connectors

The serial connector provides RS-232 connection.

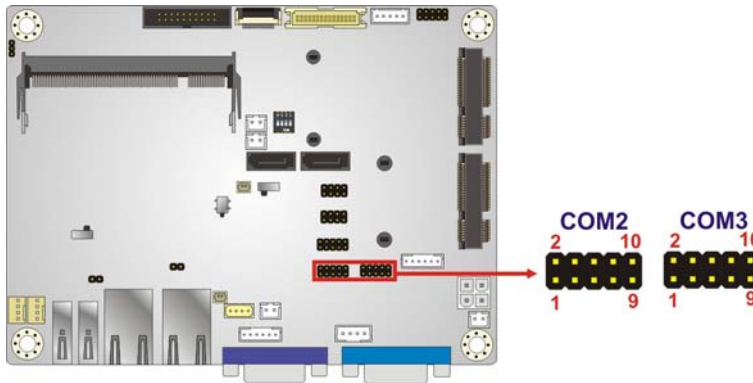

Figure 6-13: RS-232 Serial Port Connectors Locations

PIN NO.	DESCRIPTION	PIN NO.	DESCRIPTION
1	DCD	2	DSR
3	RXD	4	RTS
5	TXD	6	CTS
7	DTR	8	RI
9	GND	10	GND

Table 6-10: RS-232 Serial Port Connector Pinouts

ECW-281B-BTi Embedded System

6.3.13 RS-422/485 Serial Port Connector

This connector provides RS-422 or RS-485 communications.

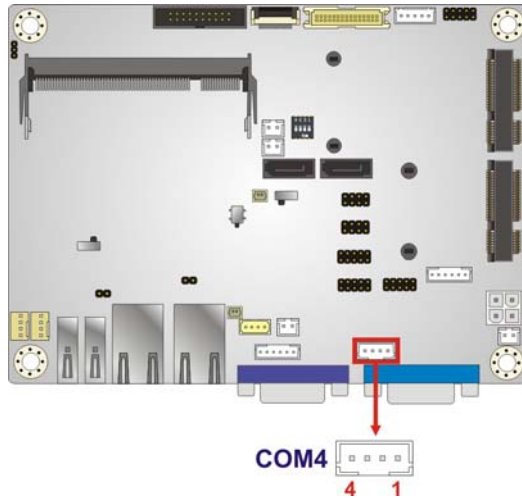

Figure 6-14: RS-422/485 Connector Location

PIN NO.	DESCRIPTION	PIN NO.	DESCRIPTION
1	RXD422-	2	RXD422+
3	TXD422+/TXD485+	4	TXD422-/TXD485-

Table 6-11: RS-422/485 Connector Pinouts

Use the optional RS-422/485 cable to connect to a serial device. The pinouts of the DB-9 connector are listed below.

RS-422 Pinouts	RS-485 Pinouts

Table 6-12: DB-9 RS-422/485 Pinouts

6.3.14 SATA 3Gb/s Drive Connector

The SATA 3Gb/s drive connector is connected to a SATA 3Gb/s drive. The SATA 3Gb/s drive transfers data at speeds as high as 3Gb/s.

**NOTE:**

If an HDD is connected to the SATA port 2 (SATA2), an mSATA module will not be supported by the PCIe Mini slot (CN1). Choose either the SATA2 connector or the mSATA module for storage.

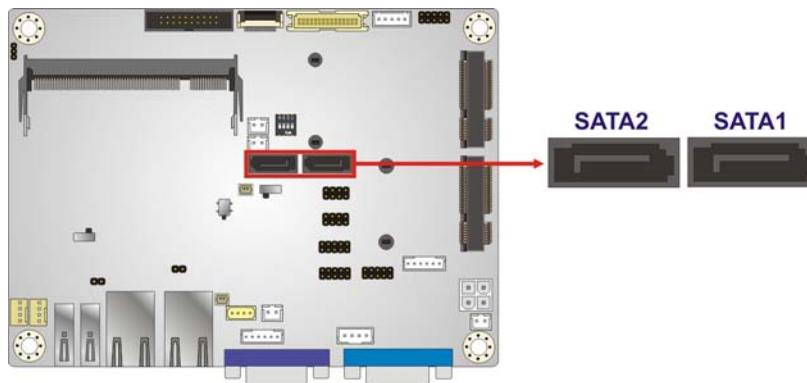

Figure 6-15: SATA 3Gb/s Drive Connectors Locations

6.3.15 SATA Power Connector

The SATA power connector provides +5V power output to the SATA connector.

ECW-281B-BTi Embedded System

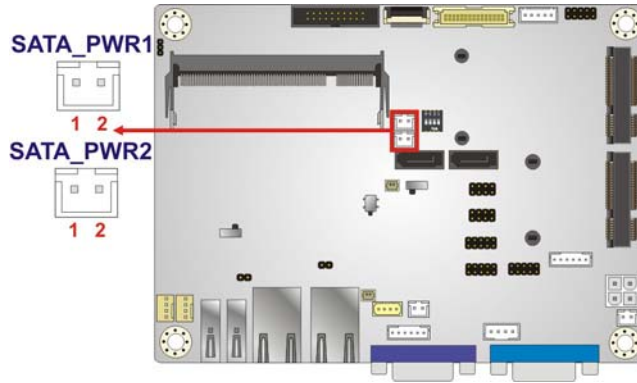

Figure 6-16: SATA Power Connector Location

PIN NO.	DESCRIPTION
1	+5V
2	GND

Table 6-13: SATA Power Connector Pinouts

6.3.16 USB Connectors

The USB connectors provide four USB 2.0 ports by dual-port USB cable.

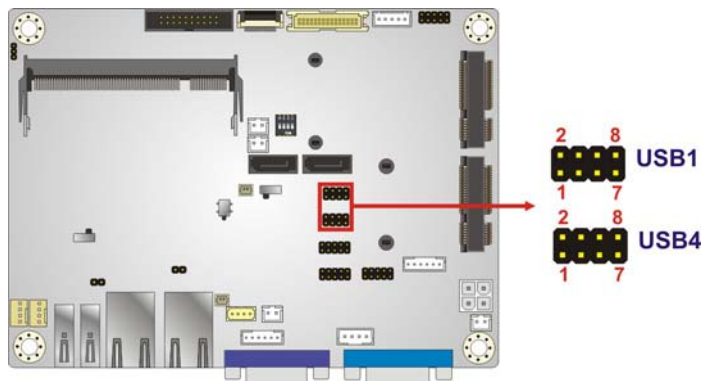

Figure 6-17: USB Connectors Locations

PIN NO.	DESCRIPTION	PIN NO.	DESCRIPTION
1	+5V	2	GND
3	-DATA_USB1/3	4	+DATA_USB2/4
5	+DATA_USB1/3	6	-DATA_USB2/4
7	GND	8	+5V

Table 6-14: USB Connectors Pinouts

6.4 External Peripheral Interface Connector Panel

Figure 6-18 shows the WAFER-BT-i1 external peripheral interface connector (EPIC) panel. The EPIC panel consists of the following:

- 2 x LAN connectors
- 1 x USB 3.0 connector
- 1 x USB 2.0 connector
- 1 x RS-232 serial port connector
- 1 x VGA connector

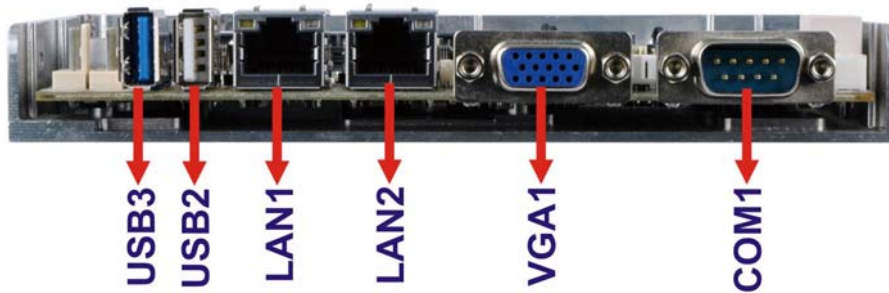

Figure 6-18: External Peripheral Interface Connector

6.4.1 LAN Connector

The LAN connector connects to a local network.

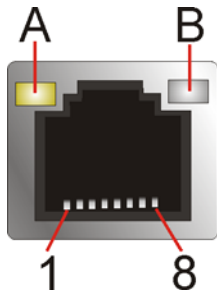

Figure 6-19: LAN Connector

PIN NO.	DESCRIPTION	PIN NO.	DESCRIPTION
1	MDIA3-	5	MDIA2+
2	MDIA3+	6	MDIA1+
3	MDIA1-	7	MDIA0-

ECW-281B-BTi Embedded System

4	MDIA2-	8	MDIA0+
---	--------	---	--------

Table 6-15: LAN Pinouts

LED	Description	LED	Description
A	on: linked blinking: data is being sent/received	B	off: 10 Mb/s green: 100 Mb/s orange: 1000 Mb/s

Table 6-16: Connector LEDs

6.4.2 RS-232 Serial Port Connector

The serial port connects to a RS-232 serial communications device.

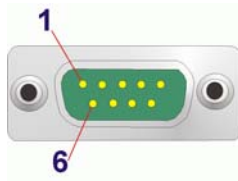

Figure 6-20: RS-232 Serial Port Connector

PIN NO.	DESCRIPTION	PIN NO.	DESCRIPTION
1	NDCD	6	NDSR
2	NRXD	7	NRTS
3	NTXD	8	NCTS
4	NDTR	9	NRI
5	GND		

Table 6-17: RS-232 Serial Port Connector Pinouts

6.4.3 USB Connectors

The ECW-281B-BTi has one external USB 2.0 port and one external USB 3.0 port. The USB connector can be connected to a USB device. The pinouts of USB 2.0 port & USB 3.0 connectors are shown below.

PIN NO.	DESCRIPTION	PIN NO.	DESCRIPTION
1	+5V	2	USB2P0-
3	USB2P0+	4	GND

PIN NO.	DESCRIPTION	PIN NO.	DESCRIPTION
5	USB3P0_RXDN1	6	USB3P0_RXDP1
7	GND	8	USB3P0_TXDN1
9	USB3P0_TXDP1		

Table 6-18: USB 3.0 Port Pinouts

PIN NO.	DESCRIPTION	PIN NO.	DESCRIPTION
1	+5V	2	-DATA_USB3
3	-DATA_USB4	4	GND

Table 6-19: USB 2.0 Port Pinouts

6.4.4 VGA Connector

The VGA port connects to a monitor that accepts a standard VGA input.

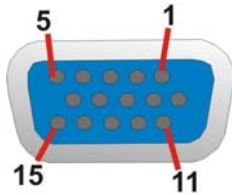

Figure 6-21: VGA Connector

PIN NO.	DESCRIPTION	PIN NO.	DESCRIPTION
1	Red	2	Green
3	Blue	4	NC
5	GND	6	GND
7	GND	8	GND
9	VGAVCC	10	HOTPLUG
11	NC	12	DDCDAT
13	HSYNC	14	VSYNC
15	DDCCLK		

Table 6-20: VGA Connector Pinouts

Appendix

A

Regulatory Compliance

DECLARATION OF CONFORMITY

This equipment is in conformity with the following EU directives:

- EMC Directive 2004/108/EC
- Low-Voltage Directive 2006/95/EC
- RoHS II Directive 2011/65/EU
- Ecodesign Directive 2009/125/EC

If the user modifies and/or install other devices in the equipment, the CE conformity declaration may no longer apply.

If this equipment has telecommunications functionality, it also complies with the requirements of the R&TTE Directive 1999/5/EC.

English

IEI Integration Corp declares that this equipment is in compliance with the essential requirements and other relevant provisions of Directive 1999/5/EC.

Български [Bulgarian]

IEI Integration Corp. декларира, че този оборудване е в съответствие със съществените изисквания и другите приложими правила на Директива 1999/5/EC.

Česky [Czech]

IEI Integration Corp tímto prohlašuje, že tento zařizení je ve shodě se základními požadavky a dalšími příslušnými ustanoveními směrnice 1999/5/ES.

Dansk [Danish]

IEI Integration Corp erklærer herved, at følgende udstyr overholder de væsentlige krav og øvrige relevante krav i direktiv 1999/5/EF.

Deutsch [German]

IEI Integration Corp, erklärt dieses Gerät entspricht den grundlegenden Anforderungen und den weiteren entsprechenden Vorgaben der Richtlinie 1999/5/EU.

Eesti [Estonian]

IEI Integration Corp deklareerib seadme seadme vastavust direktiivi 1999/5/EÜ põhinõuetele ja nimetatud direktiivist tulenevatele teistele asjakohastele sätetele.

ECW-281B-BTi Embedded System

Español [Spanish]

IEI Integration Corp declara que el equipo cumple con los requisitos esenciales y cualesquiera otras disposiciones aplicables o exigibles de la Directiva 1999/5/CE.

Ελληνική [Greek]

IEI Integration Corp ΔΗΛΩΝΕΙ ΟΤΙ ΕΞΟΠΛΙΣΜΟΣ ΣΥΜΜΟΡΦΩΝΕΤΑΙ ΠΡΟΣ ΤΙΣ ΟΥΣΙΩΔΕΙΣ ΑΠΑΙΤΗΣΕΙΣ ΚΑΙ ΤΙΣ ΛΟΙΠΕΣ ΣΧΕΤΙΚΕΣ ΔΙΑΤΑΞΕΙΣ ΤΗΣ ΟΔΗΓΙΑΣ 1999/5/EK.

Français [French]

IEI Integration Corp déclare que l'appareil est conforme aux exigences essentielles et aux autres dispositions pertinentes de la directive 1999/5/CE.

Italiano [Italian]

IEI Integration Corp dichiara che questo apparecchio è conforme ai requisiti essenziali ed alle altre disposizioni pertinenti stabilite dalla direttiva 1999/5/CE.

Latviski [Latvian]

IEI Integration Corp deklarē, ka iekārta atbilst būtiskajām prasībām un citiem ar to saistītajiem noteikumiem Direktīvas 1999/5/EK.

Lietuvių [Lithuanian]

IEI Integration Corp deklaruoja, kad šis įranga atitinka esminius reikalavimus ir kitas 1999/5/EB Direktyvos nuostatas.

Nederlands [Dutch]

IEI Integration Corp dat het toestel toestel in overeenstemming is met de essentiële eisen en de andere relevante bepalingen van richtlijn 1999/5/EG.

Malti [Maltese]

IEI Integration Corp jiddikjara li dan prodott jikkonforma mal-ħtiġijiet essenzjali u ma provvedimenti oħrajn relevanti li hemm fid-Dirrettiva 1999/5/EC.

Magyar [Hungarian]

IEI Integration Corp nyilatkozom, hogy a berendezés megfelel a vonatkozó alapvető követelményeknek és az 1999/5/EC irányelv egyéb előírásainak.

Polski [Polish]

IEI Integration Corp oświadcza, że wyrobu jest zgodny z zasadniczymi wymogami oraz pozostałymi stosownymi postanowieniami Dyrektywy 1999/5/EC.

Português [Portuguese]

IEI Integration Corp declara que este equipamento está conforme com os requisitos essenciais e outras disposições da Directiva 1999/5/CE.

Româna [Romanian]

IEI Integration Corp declară că acest echipament este în conformitate cu cerințele esențiale și cu celelalte prevederi relevante ale Directivei 1999/5/CE.

Slovensko [Slovenian]

IEI Integration Corp izjavlja, da je ta opreme v skladu z bistvenimi zahtevami in ostalimi relevantnimi določili direktive 1999/5/ES.

Slovensky [Slovak]

IEI Integration Corp týmto vyhlasuje, že zariadenia spĺňa základné požiadavky a všetky príslušné ustanovenia Smernice 1999/5/ES.

Suomi [Finnish]

IEI Integration Corp vakuuttaa täten että laitteet on direktiivin 1999/5/EY oleellisten vaatimusten ja sitä koskevien direktiivin muiden ehtojen mukainen.

Svenska [Swedish]

IEI Integration Corp förklarar att denna utrustningstyp står i överensstämmelse med de väsentliga egenskapskrav och övriga relevanta bestämmelser som framgår av direktiv 1999/5/EG.

FCC WARNING

This equipment complies with Part 15 of the FCC Rules. Operation is subject to the following two conditions:

- This device may not cause harmful interference, and
- This device must accept any interference received, including interference that may cause undesired operation.

This equipment has been tested and found to comply with the limits for a Class A digital device, pursuant to part 15 of the FCC Rules. These limits are designed to provide reasonable protection against harmful interference when the equipment is operated in a commercial environment. This equipment generates, uses, and can radiate radio frequency energy and, if not installed and used in accordance with the instruction manual, may cause harmful interference to radio communications. Operation of this equipment in a residential area is likely to cause harmful interference in which case the user will be required to correct the interference at his own expense.

Federal Communication Commission Interference Statement

This equipment has been assembled with components that comply with the limits for a Class B digital device, pursuant to Part 15 of the FCC Rules. These limits are designed to provide reasonable protection against harmful interference in a residential installation. This equipment generates, uses and can radiate radio frequency energy and, if not installed and used in accordance with the instructions, may cause harmful interference to radio communications. However, there is no guarantee that interference will not occur in a particular installation. If this equipment does cause harmful interference to radio or television reception, which can be determined by turning the equipment off and on, the user is encouraged to try to correct the interference by one of the following measures:

- Reorient or relocate the receiving antenna.
- Increase the separation between the equipment and receiver.
- Connect the equipment into an outlet on a circuit different from that to which the receiver is connected.
- Consult the dealer or an experienced radio/TV technician for help.

Appendix

B

Safety Precautions

**WARNING:**

The precautions outlined in this chapter should be strictly followed. Failure to follow these precautions may result in permanent damage to the ECW-281B-BTi.

B.1 Safety Precautions

Please follow the safety precautions outlined in the sections that follow:

B.1.1 General Safety Precautions

Please ensure the following safety precautions are adhered to at all times.

- **Follow the electrostatic precautions** outlined below whenever the ECW-281B-BTi is opened.
- **Make sure the power is turned off and the power cord is disconnected** whenever the ECW-281B-BTi is being installed, moved or modified.
- **Do not apply voltage levels that exceed the specified voltage range.** Doing so may cause fire and/or an electrical shock.
- **Electric shocks can occur** if the ECW-281B-BTi chassis is opened when the ECW-281B-BTi is running.
- **Do not drop or insert any objects** into the ventilation openings of the ECW-281B-BTi.
- **If considerable amounts of dust, water, or fluids enter the ECW-281B-BTi,** turn off the power supply immediately, unplug the power cord, and contact the ECW-281B-BTi vendor.
- **DO NOT:**
 - Drop the ECW-281B-BTi against a hard surface.
 - In a site where the ambient temperature exceeds the rated temperature

B.1.2 Anti-static Precautions

**WARNING:**

Failure to take ESD precautions during the installation of the ECW-281B-BTi may result in permanent damage to the ECW-281B-BTi and severe injury to the user.

Electrostatic discharge (ESD) can cause serious damage to electronic components, including the ECW-281B-BTi. Dry climates are especially susceptible to ESD. It is therefore critical that whenever the ECW-281B-BTi is opened and any of the electrical components are handled, the following anti-static precautions are strictly adhered to.

- ***Wear an anti-static wristband:*** Wearing a simple anti-static wristband can help to prevent ESD from damaging any electrical component.
- ***Self-grounding:*** Before handling any electrical component, touch any grounded conducting material. During the time the electrical component is handled, frequently touch any conducting materials that are connected to the ground.
- ***Use an anti-static pad:*** When configuring or working with an electrical component, place it on an anti-static pad. This reduces the possibility of ESD damage.
- ***Only handle the edges of the electrical component:*** When handling the electrical component, hold the electrical component by its edges.

ECW-281B-BTi Embedded System

B.1.3 Product Disposal



CAUTION:

Risk of explosion if battery is replaced by and incorrect type. Only certified engineers should replace the on-board battery.

Dispose of used batteries according to instructions and local regulations.

- Outside the European Union - If you wish to dispose of used electrical and electronic products outside the European Union, please contact your local authority so as to comply with the correct disposal method.
- Within the European Union:

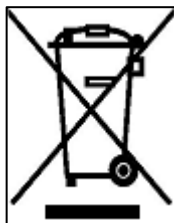

EU-wide legislation, as implemented in each Member State, requires that waste electrical and electronic products carrying the mark (left) must be disposed of separately from normal household waste. This includes monitors and electrical accessories, such as signal cables or power cords.

When you need to dispose of your display products, please follow the guidance of your local authority, or ask the shop where you purchased the product. The mark on electrical and electronic products only applies to the current European Union Member States.

Please follow the national guidelines for electrical and electronic product disposal.

B.2 Maintenance and Cleaning Precautions

When maintaining or cleaning the ECW-281B-BTi, please follow the guidelines below.

B.2.1 Maintenance and Cleaning

Prior to cleaning any part or component of the ECW-281B-BTi, please read the details below.

- The interior of the ECW-281B-BTi does not require cleaning. Keep fluids away from the ECW-281B-BTi interior.
- Be cautious of all small removable components when vacuuming the ECW-281B-BTi.
- Turn the ECW-281B-BTi off before cleaning the ECW-281B-BTi.
- Never drop any objects or liquids through the openings of the ECW-281B-BTi.
- Be cautious of any possible allergic reactions to solvents or chemicals used when cleaning the ECW-281B-BTi.
- Avoid eating, drinking and smoking within vicinity of the ECW-281B-BTi.

B.2.2 Cleaning Tools

Some components in the ECW-281B-BTi may only be cleaned using a product specifically designed for the purpose. In such case, the product will be explicitly mentioned in the cleaning tips. Below is a list of items to use when cleaning the ECW-281B-BTi.

- **Cloth** – Although paper towels or tissues can be used, a soft, clean piece of cloth is recommended when cleaning the ECW-281B-BTi.
- **Water or rubbing alcohol** – A cloth moistened with water or rubbing alcohol can be used to clean the ECW-281B-BTi.
- **Using solvents** – The use of solvents is not recommended when cleaning the ECW-281B-BTi as they may damage the plastic parts.
- **Vacuum cleaner** – Using a vacuum specifically designed for computers is one of the best methods of cleaning the ECW-281B-BTi. Dust and dirt can restrict the airflow in the ECW-281B-BTi and cause its circuitry to corrode.
- **Cotton swabs** - Cotton swabs moistened with rubbing alcohol or water are excellent tools for wiping hard to reach areas.
- **Foam swabs** - Whenever possible, it is best to use lint free swabs such as foam swabs for cleaning.

Appendix

C

BIOS Menu Options

C.1 BIOS Configuration Options

Below is a list of BIOS configuration options described in **Chapter 4**.

System Date [xx/xx/xx]	43
System Time [xx:xx:xx]	43
ACPI Sleep State [S3 (Suspend to RAM)]	45
Serial Port [Enabled]	46
Change Settings [Auto]	46
Serial Port [Enabled]	47
Change Settings [Auto]	47
Serial Port [Enabled]	48
Change Settings [Auto]	48
Serial Port [Enabled]	50
Change Settings [Auto]	50
PC Health Status	51
CPU Smart Fan control [Auto PWM Mode]	52
Temperature of Off	53
Temperature of Start	53
Start PWM	53
Slope (Duty Cycle)	53
Wake system with Fixed Time [Disabled]	54
Console Redirection [Disabled]	55
Terminal Type [ANSI]	56
Bits per second [115200]	56
Data Bits [8]	57
Parity [None]	57
Stop Bits [1]	57
Auto Recovery Function [Disabled]	58
Intel Virtualization Technology [Enabled]	60
EIST [Enabled]	60
SATA Mode [AHCI Mode]	61
Serial-ATA Port 1/0 [Enabled]	61
SATA Port 1/0 HotPlug [Disabled]	62
USB Devices	62

ECW-281B-BTi Embedded System

Legacy USB Support [Enabled].....	63
DVMT Pre-Allocated [256M]	65
DVMT Total Gfx Mem [Max].....	66
Primary IGFX Boot Display [VBIOS Default]	66
Restore AC Power Loss [Last State]	67
Audio Controller [Enabled]	67
PCI Express Port n [Enabled]	68
Speed [Auto].....	68
Administrator Password	68
User Password	69
Bootup NumLock State [On].....	69
Quiet Boot [Enabled]	70
Option ROM Messages [Keep Current]	70
UEFI Boot [Disabled]	70
Launch PXE OpROM [Disabled].....	71
Save Changes and Reset	71
Discard Changes and Reset	71
Restore Defaults	72
Save as User Defaults	72
Restore User Defaults	72
SEL Components [Enabled].....	73
Erase SEL [No].....	73
When SEL is Full [Do Nothing].....	74
Configuration Address source [Unspecified]	75

Appendix

D

Digital I/O Interface

ECW-281B-BTi Embedded System

D.1 Introduction

The DIO connector on the ECW-281B-BTi is interfaced to GPIO ports on the Super I/O chipset. The DIO has both 4-bit digital inputs and 4-bit digital outputs. The digital inputs and digital outputs are generally control signals that control the on/off circuit of external devices or TTL devices. Data can be read or written to the selected address to enable the DIO functions.



NOTE:

For further information, please refer to the datasheet for the Super I/O chipset.

The BIOS interrupt call **INT 15H** controls the digital I/O.

INT 15H:

AH – 6FH

Sub-function:

AL – 8 : Set the digital port as INPUT

AL : Digital I/O input value

D.2 Assembly Language Sample 1

```
MOV    AX, 6F08H    ;setting the digital port as input  
INT    15H        ;
```

AL low byte = value

AH – 6FH

Sub-function:

AL – 9 : Set the digital port as OUTPUT

BL : Digital I/O input value

D.3 Assembly Language Sample 2

```
MOV    AX, 6F09H    ;setting the digital port as output  
MOV    BL, 09H      ;digital value is 09H  
INT    15H        ;
```

Digital Output is 1001b

Appendix

E

Watchdog Timer



NOTE:

The following discussion applies to DOS environment. IEI support is contacted or the IEI website visited for specific drivers for more sophisticated operating systems, e.g., Windows and Linux.

The Watchdog Timer is provided to ensure that standalone systems can always recover from catastrophic conditions that cause the CPU to crash. This condition may have occurred by external EMI or a software bug. When the CPU stops working correctly, Watchdog Timer either performs a hardware reset (cold boot) or a Non-Maskable Interrupt (NMI) to bring the system back to a known state.

A BIOS function call (INT 15H) is used to control the Watchdog Timer:

INT 15H:

AH – 6FH Sub-function:	
AL – 2:	Sets the Watchdog Timer's period.
BL:	Time-out value (Its unit-second is dependent on the item "Watchdog Timer unit select" in CMOS setup).

Table E-1: AH-6FH Sub-function

Call sub-function 2 to set the time-out period of Watchdog Timer first. If the time-out value is not zero, the Watchdog Timer starts counting down. While the timer value reaches zero, the system resets. To ensure that this reset condition does not occur, calling sub-function 2 must periodically refresh the Watchdog Timer. However, the Watchdog timer is disabled if the time-out value is set to zero.

A tolerance of at least 10% must be maintained to avoid unknown routines within the operating system (DOS), such as disk I/O that can be very time-consuming.

**NOTE:**

When exiting a program it is necessary to disable the Watchdog Timer, otherwise the system resets.

Example program:

```
; INITIAL TIMER PERIOD COUNTER
;
W_LOOP:

    MOV    AX, 6F02H    ;setting the time-out value
    MOV    BL, 30      ;time-out value is 48 seconds
    INT    15H

;
; ADD THE APPLICATION PROGRAM HERE
;

    CMP    EXIT_AP, 1    ;is the application over?
    JNE    W_LOOP      ;No, restart the application

    MOV    AX, 6F02H    ;disable Watchdog Timer
    MOV    BL, 0        ;
    INT    15H

;
; EXIT ;
```

Appendix

F

Hazardous Materials Disclosure

F.1 Hazardous Materials Disclosure Table for IPB Products Certified as RoHS Compliant Under 2002/95/EC Without Mercury

The details provided in this appendix are to ensure that the product is compliant with the Peoples Republic of China (China) RoHS standards. The table below acknowledges the presences of small quantities of certain materials in the product, and is applicable to China RoHS only.

A label will be placed on each product to indicate the estimated “Environmentally Friendly Use Period” (EFUP). This is an estimate of the number of years that these substances would “not leak out or undergo abrupt change.” This product may contain replaceable sub-assemblies/components which have a shorter EFUP such as batteries and lamps. These components will be separately marked.

Please refer to the table on the next page.

Part Name	Toxic or Hazardous Substances and Elements					
	Lead (Pb)	Mercury (Hg)	Cadmium (Cd)	Hexavalent Chromium (CR(VI))	Polybrominated Biphenyls (PBB)	Polybrominated Diphenyl Ethers (PBDE)
Housing	<input type="radio"/>	<input type="radio"/>	<input type="radio"/>	<input type="radio"/>	<input type="radio"/>	<input type="radio"/>
Display	<input type="radio"/>	<input type="radio"/>	<input type="radio"/>	<input type="radio"/>	<input type="radio"/>	<input type="radio"/>
Printed Circuit Board	<input type="radio"/>	<input type="radio"/>	<input type="radio"/>	<input type="radio"/>	<input type="radio"/>	<input type="radio"/>
Metal Fasteners	<input type="radio"/>	<input type="radio"/>	<input type="radio"/>	<input type="radio"/>	<input type="radio"/>	<input type="radio"/>
Cable Assembly	<input type="radio"/>	<input type="radio"/>	<input type="radio"/>	<input type="radio"/>	<input type="radio"/>	<input type="radio"/>
Fan Assembly	<input type="radio"/>	<input type="radio"/>	<input type="radio"/>	<input type="radio"/>	<input type="radio"/>	<input type="radio"/>
Power Supply Assemblies	<input type="radio"/>	<input type="radio"/>	<input type="radio"/>	<input type="radio"/>	<input type="radio"/>	<input type="radio"/>
Battery	<input type="radio"/>	<input type="radio"/>	<input type="radio"/>	<input type="radio"/>	<input type="radio"/>	<input type="radio"/>

O: This toxic or hazardous substance is contained in all of the homogeneous materials for the part is below the limit requirement in SJ/T11363-2006

X: This toxic or hazardous substance is contained in at least one of the homogeneous materials for this part is above the limit requirement in SJ/T11363-2006

ECW-281B-BTi Embedded System

此附件旨在确保本产品符合中国 RoHS 标准。以下表格标示此产品中某有毒物质的含量符合中国 RoHS 标准规定的限量要求。

本产品上会附有“环境友好使用期限”的标签，此期限是估算这些物质“不会有泄漏或突变”的年限。本产品可能包含有较短的环境友好使用期限的可替换元件，像是电池或灯管，这些元件将会单独标示出来。

部件名称	有毒有害物质或元素					
	铅 (Pb)	汞 (Hg)	镉 (Cd)	六价铬 (CR(VI))	多溴联苯 (PBB)	多溴二苯 醚 (PBDE)
壳体	○	○	○	○	○	○
显示	○	○	○	○	○	○
印刷电路板	○	○	○	○	○	○
金属螺帽	○	○	○	○	○	○
电缆组装	○	○	○	○	○	○
风扇组装	○	○	○	○	○	○
电力供应组装	○	○	○	○	○	○
电池	○	○	○	○	○	○

○: 表示该有毒有害物质在该部件所有物质材料中的含量均在 SJ/T11363-2006 标准规定的限量要求以下。
 X: 表示该有毒有害物质至少在该部件的某一均质材料中的含量超出 SJ/T11363-2006 标准规定的限量要求。