

**MODEL:
WSB-H610**

Full-Size PICMG 1.0 CPU Card Supports 32nm LGA1155 Intel® Core™ i7/i5/i3/Pentium®/Celeron® CPU, Intel® H61 Chipset, DDR3, VGA/DVI-D, Dual Realtek PCIe GbE, USB 2.0, COM, SATA 3Gb/s, HD Audio and RoHS

User Manual

Revision

Date	Version	Changes
August 25, 2015	1.03	Modified Section 3.2.18: Serial Port Connectors, RS-232
November 5, 2014	1.02	Modified LAN pinouts Updated Chapter 2: Packing List
July 8, 2013	1.01	Removed Restore on AC Power Loss BIOS option Added JSPI2 connector
February 17, 2012	1.00	Initial release

Copyright

COPYRIGHT NOTICE

The information in this document is subject to change without prior notice in order to improve reliability, design and function and does not represent a commitment on the part of the manufacturer.

In no event will the manufacturer be liable for direct, indirect, special, incidental, or consequential damages arising out of the use or inability to use the product or documentation, even if advised of the possibility of such damages.

This document contains proprietary information protected by copyright. All rights are reserved. No part of this manual may be reproduced by any mechanical, electronic, or other means in any form without prior written permission of the manufacturer.

TRADEMARKS

All registered trademarks and product names mentioned herein are used for identification purposes only and may be trademarks and/or registered trademarks of their respective owners.

Manual Conventions

**WARNING**

Warnings appear where overlooked details may cause damage to the equipment or result in personal injury. Warnings should be taken seriously.

**CAUTION**

Cautionary messages should be heeded to help reduce the chance of losing data or damaging the product.

**NOTE**

These messages inform the reader of essential but non-critical information. These messages should be read carefully as any directions or instructions contained therein can help avoid making mistakes.

**HOT SURFACE**

This symbol indicates a hot surface that should not be touched without taking care.

Table of Contents

1 INTRODUCTION.....	1
1.1 INTRODUCTION.....	2
1.2 MODEL VARIATIONS	3
1.3 FEATURES.....	3
1.4 CONNECTORS	4
1.5 DIMENSIONS.....	5
1.6 DATA FLOW	7
1.7 TECHNICAL SPECIFICATIONS	8
2 PACKING LIST.....	10
2.1 ANTI-STATIC PRECAUTIONS	11
2.2 UNPACKING PRECAUTIONS.....	11
2.3 PACKING LIST.....	12
2.4 OPTIONAL ITEMS	13
3 CONNECTORS	16
3.1 PERIPHERAL INTERFACE CONNECTORS.....	17
3.1.1 WSB-H610 Layout.....	17
3.1.2 Peripheral Interface Connectors	17
3.1.3 External Interface Panel Connectors.....	18
3.2 INTERNAL PERIPHERAL CONNECTORS	19
3.2.1 ATX Power Supply Enable Connector	19
3.2.2 Audio Kit Connector	20
3.2.3 Battery Connector.....	21
3.2.4 CPU Power Input Connector.....	22
3.2.5 DDR3 DIMM Slots.....	22
3.2.6 Digital I/O Connector.....	23
3.2.7 DVI-D Connector (DVI Model Only)	24
3.2.8 EC SPI Flash Connector.....	25
3.2.9 Fan Connector (CPU).....	26

3.2.10 Floppy Disk Drive Connector.....	26
3.2.11 Front Panel Connector.....	28
3.2.12 I2C Connector.....	29
3.2.13 Infrared Interface Connector.....	29
3.2.14 Keyboard/Mouse Connector.....	30
3.2.15 Parallel Port Connector.....	31
3.2.16 PCIe Mini Card Slot.....	32
3.2.17 SATA 3Gb/s Drive Connectors.....	33
3.2.18 Serial Port Connectors, RS-232.....	34
3.2.19 Serial Port Connector, RS-422/485.....	35
3.2.20 SMBus Connector.....	36
3.2.21 SPI ROM Connector.....	37
3.2.22 TPM Connector.....	38
3.2.23 USB Connectors.....	39
3.3 EXTERNAL PERIPHERAL INTERFACE CONNECTOR PANEL.....	40
3.3.1 Ethernet Connectors.....	40
3.3.2 Keyboard/Mouse Connector.....	41
3.3.3 USB Connector.....	42
3.3.4 VGA Connector.....	42
4 INSTALLATION.....	44
4.1 ANTI-STATIC PRECAUTIONS.....	45
4.2 INSTALLATION CONSIDERATIONS.....	45
4.2.1 Socket LGA1155 CPU Installation.....	47
4.2.2 Socket LGA1155 Cooling Kit Installation.....	50
4.2.3 DIMM Installation.....	51
4.3 JUMPER SETTINGS.....	52
4.3.1 AT/ATX Power Select Jumper.....	52
4.3.2 Clear CMOS Jumper.....	53
4.3.3 Wake-on LAN Jumper.....	54
4.4 CHASSIS INSTALLATION.....	55
4.4.1 Airflow.....	55
4.4.2 CPU Card Installation.....	55
4.5 INTERNAL PERIPHERAL DEVICE CONNECTIONS.....	55
4.5.1 Dual RS-232 Cable with Slot Bracket.....	55

WSB-H610 PICMG 1.0 CPU Card

4.5.2 DVI-D/USB Kit Installation (DVI Model Only).....	56
4.5.3 SATA Drive Connection	57
4.5.4 USB Cable (Dual Port) with Slot Bracket	59
4.5.5 PCIe Mini Card Installation	60
4.6 EXTERNAL PERIPHERAL INTERFACE CONNECTION	61
4.6.1 LAN Connection.....	61
4.6.2 USB Device Connection (Single Connector).....	62
4.6.3 VGA Monitor Connection	63
5 BIOS.....	65
5.1 INTRODUCTION.....	66
5.1.1 Starting Setup.....	66
5.1.2 Using Setup	66
5.1.3 Getting Help.....	67
5.1.4 Unable to Reboot after Configuration Changes	67
5.1.5 BIOS Menu Bar.....	67
5.2 MAIN.....	68
5.3 ADVANCED	69
5.3.1 ACPI Settings	70
5.3.2 Trusted Computing.....	71
5.3.3 CPU Configuration.....	72
5.3.3.1 CPU Information.....	73
5.3.4 SATA Configuration	74
5.3.5 Intel TXT(LT) Configuration.....	75
5.3.6 USB Configuration.....	76
5.3.7 Super IO Configuration	77
5.3.7.1 Floppy Disk Controller Configuration.....	78
5.3.7.2 Serial Port n Configuration	78
5.3.7.3 Parallel Port Configuration	83
5.3.8 H/W Monitor	84
5.3.8.1 CPU_FAN 1 Configuration.....	86
5.3.9 Serial Port Console Redirection	87
5.3.10 iEi Feature	89
5.4 CHIPSET	90
5.4.1 Northbridge Configuration	91

5.4.2 Southbridge Configuration	94
5.4.3 Integrated Graphics	95
5.5 BOOT	96
5.6 SECURITY	98
5.7 EXIT	99
6 SOFTWARE DRIVERS	101
6.1 AVAILABLE SOFTWARE DRIVERS	102
6.2 SOFTWARE INSTALLATION	102
6.3 CHIPSET DRIVER INSTALLATION	104
6.4 GRAPHICS DRIVER INSTALLATION	107
6.5 LAN DRIVER INSTALLATION	110
6.6 AUDIO DRIVER INSTALLATION	112
A REGULATORY COMPLIANCE	114
B BIOS OPTIONS	116
C TERMINOLOGY	119
D DIGITAL I/O INTERFACE	123
D.1 INTRODUCTION	124
D.2 ASSEMBLY LANGUAGE SAMPLE 1	125
D.3 ASSEMBLY LANGUAGE SAMPLE 2	125
E WATCHDOG TIMER	126
F HAZARDOUS MATERIALS DISCLOSURE	129
F.1 HAZARDOUS MATERIALS DISCLOSURE TABLE FOR IPB PRODUCTS CERTIFIED AS ROHS COMPLIANT UNDER 2002/95/EC WITHOUT MERCURY	130

List of Figures

Figure 1-1: WSB-H610	2
Figure 1-2: Connectors	4
Figure 1-3: WSB-H610 Dimensions (mm).....	5
Figure 1-4: External Interface Panel Dimensions (mm).....	6
Figure 1-5: Data Flow Diagram.....	7
Figure 3-1: Connectors and Jumpers.....	17
Figure 3-2: ATX Power Supply Enable Connector Location	19
Figure 3-3: Audio Connector Location	20
Figure 3-4: Battery Connector Location.....	21
Figure 3-5: ATX Power Connector Pinout Location.....	22
Figure 3-6: DDR3 DIMM Slot Locations	23
Figure 3-7: Digital I/O Connector Location	23
Figure 3-8: DVI-D Connector Location	24
Figure 3-9: EC SPI Flash Connector Location.....	25
Figure 3-10: CPU Fan Connector Location	26
Figure 3-11: Floppy Disk Connector Location.....	27
Figure 3-12: Front Panel Connector Location	28
Figure 3-13: I2C Connector Location.....	29
Figure 3-14: Infrared Connector Location.....	30
Figure 3-15: Keyboard/Mouse Connector Location	30
Figure 3-16: Parallel Port Connector Location	31
Figure 3-17: PCIe Mini Card Slot Location.....	32
Figure 3-18: SATA 3Gb/s Drive Connector Location	34
Figure 3-19: Serial Port Connector Location	35
Figure 3-20: RS-422/485 Connector Location.....	36
Figure 3-21: SMBus Connector Location	37
Figure 3-22: SPI ROM Connector Location.....	37
Figure 3-23: TPM Connector Location.....	38
Figure 3-24: USB Connector Pinout Locations	39
Figure 3-25: External Peripheral Interface Connector	40

Figure 3-26: Ethernet Connector.....	40
Figure 3-27: PS/2 Pinout and Configuration	41
Figure 3-28: VGA Connector	43
Figure 4-1: Disengage the CPU Socket Load Lever.....	47
Figure 4-2: Remove Protective Cover.....	48
Figure 4-3: Insert the Socket LGA1155 CPU.....	49
Figure 4-4: Close the Socket LGA1155	49
Figure 4-5: Cooling Kit Support Bracket.....	50
Figure 4-6: DIMM Installation.....	51
Figure 4-7: AT/ATX Power Mode Jumper Location.....	53
Figure 4-8: Clear BIOS Jumper Location	53
Figure 4-9: Wake-on LAN Jumper Location.....	54
Figure 4-10: Dual RS-232 Cable Installation	56
Figure 4-11: DVI-D/USB Kit Installation	57
Figure 4-12: SATA Drive Cable Connection.....	58
Figure 4-13: SATA Power Drive Connection.....	59
Figure 4-14: Dual USB Cable Connection	60
Figure 4-15: PCIe Mini Card Installation.....	61
Figure 4-16: LAN Connection	62
Figure 4-17: USB Device Connection	63
Figure 4-18: VGA Connector	64
Figure 6-1: Introduction Screen	103
Figure 6-2: Available Drivers	103
Figure 6-3: Chipset Driver Screen.....	104
Figure 6-4: Chipset Driver Welcome Screen.....	105
Figure 6-5: Chipset Driver License Agreement	105
Figure 6-6: Chipset Driver Read Me File	106
Figure 6-7: Chipset Driver Setup Operations	106
Figure 6-8: Chipset Driver Installation Finish Screen.....	107
Figure 6-9: Graphics Driver Welcome Screen	108
Figure 6-10: Graphics Driver License Agreement.....	108
Figure 6-11: Graphics Driver Setup Operations	109
Figure 6-12: Graphics Driver Installation Finish Screen	109
Figure 6-13: LAN Driver Welcome Screen	110
Figure 6-14: LAN Driver Installation	111

WSB-H610 PICMG 1.0 CPU Card

Figure 6-15: LAN Driver Installation Complete.....	111
Figure 6-16: Audio Driver – Extracting Files.....	112
Figure 6-17: Audio Driver Installation Welcome Screen.....	113
Figure 6-18: Audio Driver Installation.....	113
Figure 6-19: Audio Driver Installation Complete	113

List of Tables

Table 1-1: WSB-H610 Model Variations.....	3
Table 1-2: WSB-H610 Specifications	9
Table 2-1: Packing List.....	13
Table 2-2: Optional Items.....	15
Table 3-1: Peripheral Interface Connectors	18
Table 3-2: Rear Panel Connectors	19
Table 3-3: ATX Power Supply Enable Connector Pinouts	19
Table 3-4: Audio Connector Pinouts	20
Table 3-5: Battery Connector Pinouts	21
Table 3-6: ATX Power Connector Pinouts	22
Table 3-7: Digital I/O Connector Pinouts.....	24
Table 3-8: DVI-D Connector Pinouts.....	25
Table 3-9: EC SPI Flash Connector Pinouts	25
Table 3-10: CPU Fan Connector Pinouts	26
Table 3-11: Floppy Disk Connector Pinouts	27
Table 3-12: Front Panel Connector Pinouts.....	28
Table 3-13: I2C Connector Pinouts	29
Table 3-14: Infrared Connector Pinouts	30
Table 3-15: Keyboard/Mouse Connector Pinouts	31
Table 3-16: Parallel Port Connector Pinouts	32
Table 3-17: PCIe Mini Card Slot Pinouts	33
Table 3-18: SATA 3Gb/s Drive Connector Pinouts.....	34
Table 3-19: Serial Port Connector Pinouts	35
Table 3-20: RS-422/485 Connector Pinouts	36
Table 3-21: DB-9 RS-422/485 Pinouts.....	36
Table 3-22: SMBus Connector Pinouts	37
Table 3-23: SPI ROM Connector Pinouts	38
Table 3-24: TPM Connector Pinouts.....	39
Table 3-25: USB Port Connector Pinouts.....	39
Table 3-26: LAN Pinouts	40

WSB-H610 PICMG 1.0 CPU Card

Table 3-27: Connector LEDs.....	41
Table 3-28: Keyboard Connector Pinouts.....	41
Table 3-29: USB Port Pinouts.....	42
Table 3-30: VGA Connector Pinouts.....	43
Table 4-1: Jumpers.....	52
Table 4-2: AT/ATX Power Mode Jumper Settings.....	53
Table 4-3: Clear BIOS Jumper Settings.....	53
Table 4-4: Wake-on LAN Jumper Settings.....	54
Table 4-5: Wake-on LAN Jumper Pinouts.....	54
Table 5-1: BIOS Navigation Keys.....	67

BIOS Menus

BIOS Menu 1: Main	68
BIOS Menu 2: Advanced	70
BIOS Menu 3: ACPI Configuration	70
BIOS Menu 4: TPM Configuration	71
BIOS Menu 5: CPU Configuration	72
BIOS Menu 6: CPU Configuration	73
BIOS Menu 7: SATA Configuration	74
BIOS Menu 8: Intel TXT(LT) Configuration	75
BIOS Menu 9: USB Configuration	76
BIOS Menu 10: Super IO Configuration.....	77
BIOS Menu 11: Serial Port n Configuration Menu	78
BIOS Menu 12: Serial Port n Configuration Menu	79
BIOS Menu 13: Parallel Port Configuration Menu	83
BIOS Menu 14: H/W Monitor	85
BIOS Menu 15: FAN 1 Configuration	86
BIOS Menu 16: Serial Port Console Redirection	87
BIOS Menu 17: IEI Feature	90
BIOS Menu 18: Chipset	91
BIOS Menu 19:Northbridge Chipset Configuration.....	91
BIOS Menu 20: Southbridge Chipset Configuration	94
BIOS Menu 21: Integrated Graphics	95
BIOS Menu 22: Boot	96
BIOS Menu 23: Security	98
BIOS Menu 24:Exit.....	99

Chapter

1

Introduction

1.1 Introduction



Figure 1-1: WSB-H610

The WSB-H610 PICMG 1.0 CPU card is a Socket LGA1155 32nm Intel® Core™ i3/i5/i7/Pentium®/Celeron® processor platform that supports two 240-pin 1066/1333 MHz dual-channel DDR3/DDR3L DIMM modules up to 16.0 GB.

The WSB-H610 supports two GbE interfaces through the Realtek RTL8111E PCIe Ethernet controllers. The integrated Intel® H61 chipset supports four SATA 3Gb/s drives. One USB 2.0 on the rear panel, six USB 2.0 by pin header and one PCIe Mini interface provide flexible expansion options. High Definition Audio (HDA) support ensures HDA devices can be easily implemented on the WSB-H610.

WSB-H610 PICMG 1.0 CPU Card

1.2 Model Variations

The model variations of the WSB-H610 are listed below.

Model No.	CPU Supported	DVI-D by 26-pin header
WSB-H610-DVI-R10	LGA1155 Intel® Core™ i7/i5/i3/Pentium®/Celeron®	Yes
WSB-H610-R10	LGA1155 Intel® Core™ i7/i5/i3/Pentium®/Celeron®	No

Table 1-1: WSB-H610 Model Variations

1.3 Features

Some of the WSB-H610 motherboard features are listed below:

- PICMG 1.0 full-size graphics grade solution
- LGA1155 CPU socket
- Intel® H61 chipset
- Dual-channel DDR3/DDR3L DIMMs support up to 16.0 GB
- Dual independent display by VGA and DVI-D (DVI model only)
- One PCIe Mini expansion slot
- Two Realtek PCIe Gigabit Ethernet connectors (LAN1 with ASF 2.0 support)
- Four SATA 3Gb/s connectors
- TPM V1.2 hardware security function supported by the TPM module
- High Definition Audio
- RoHS compliant

1.4 Connectors

The connectors on the WSB-H610 are shown in the figure below.

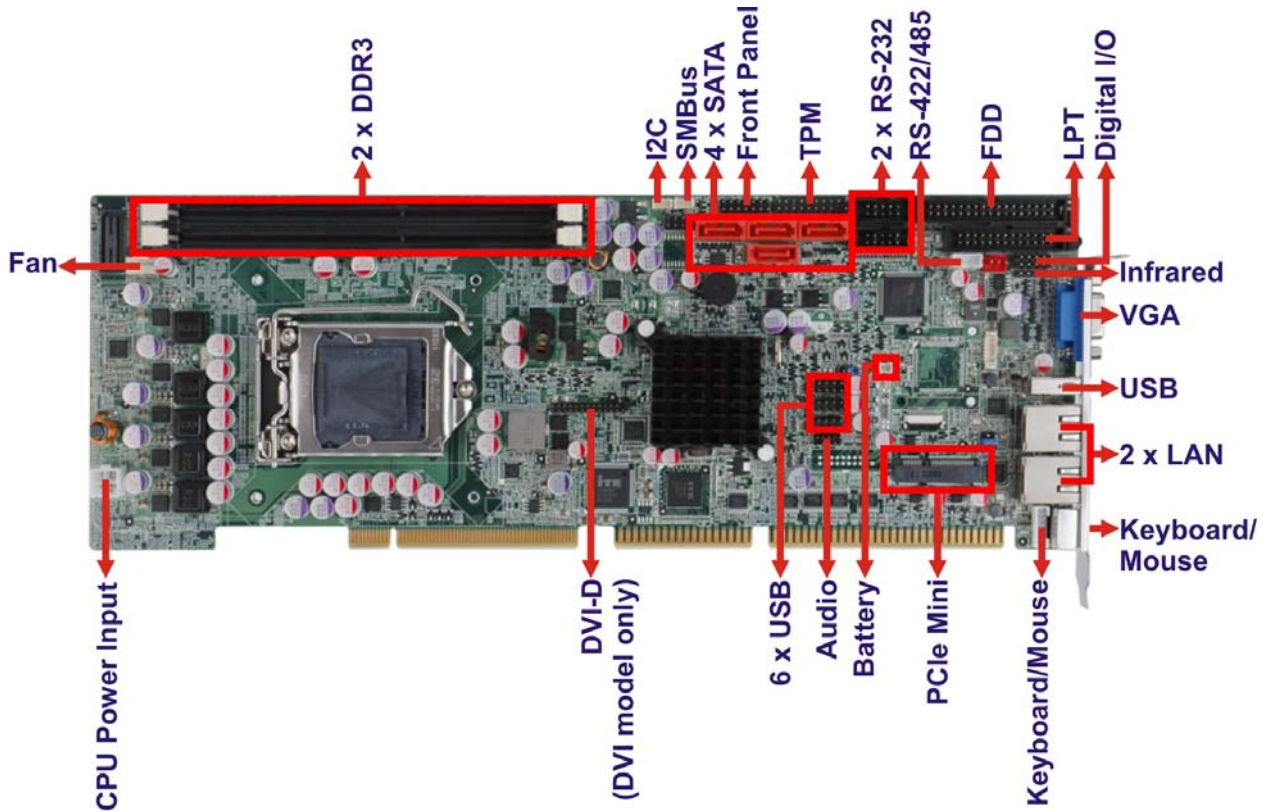

Figure 1-2: Connectors

WSB-H610 PICMG 1.0 CPU Card

1.5 Dimensions

The main dimensions of the WSB-H610 are shown in the diagram below.

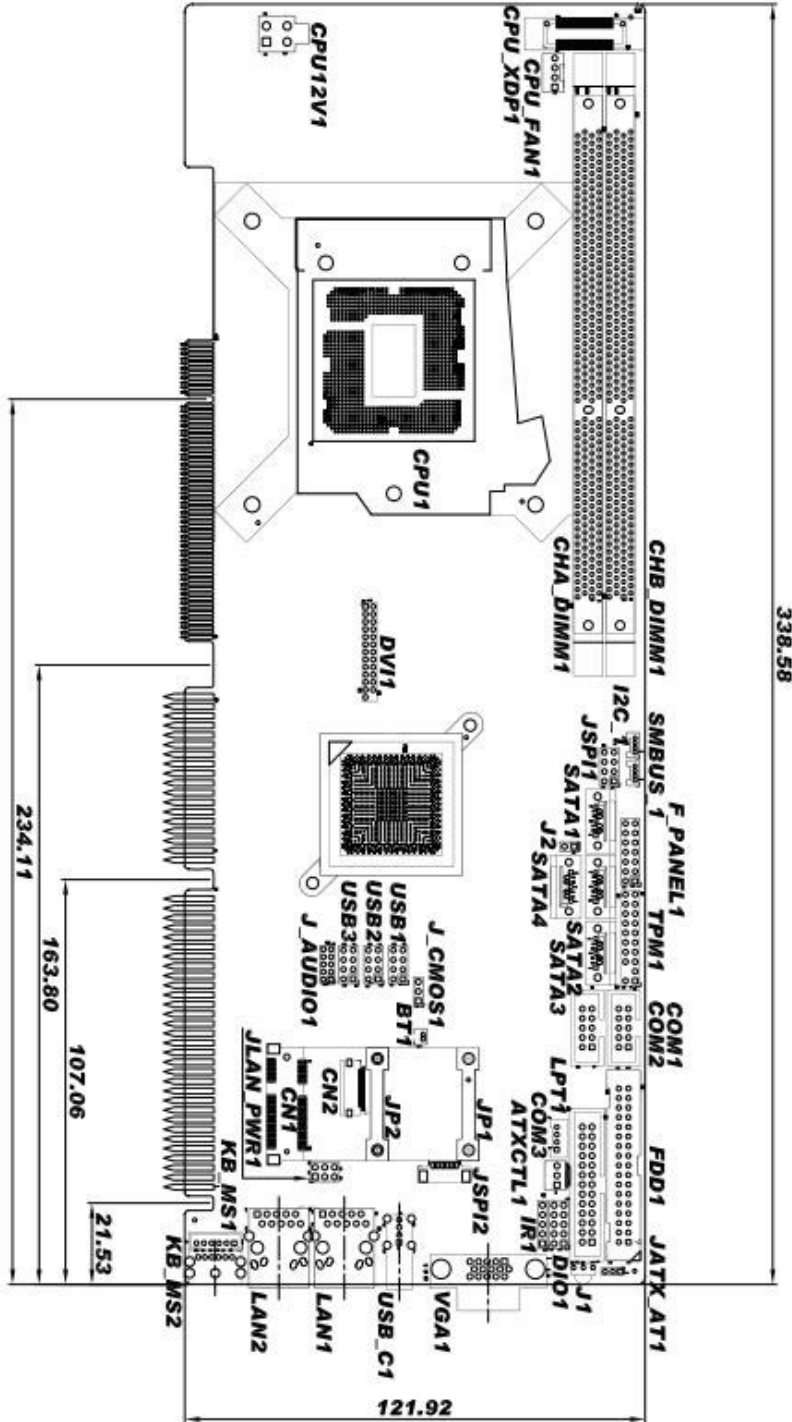

Figure 1-3: WSB-H610 Dimensions (mm)

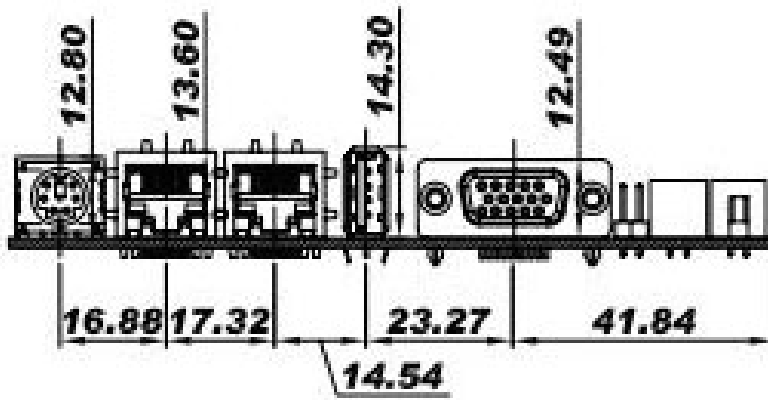

Figure 1-4: External Interface Panel Dimensions (mm)

WSB-H610 PICMG 1.0 CPU Card

1.6 Data Flow

Figure 1-5 shows the data flow between the system chipset, the CPU and other components installed on the motherboard.

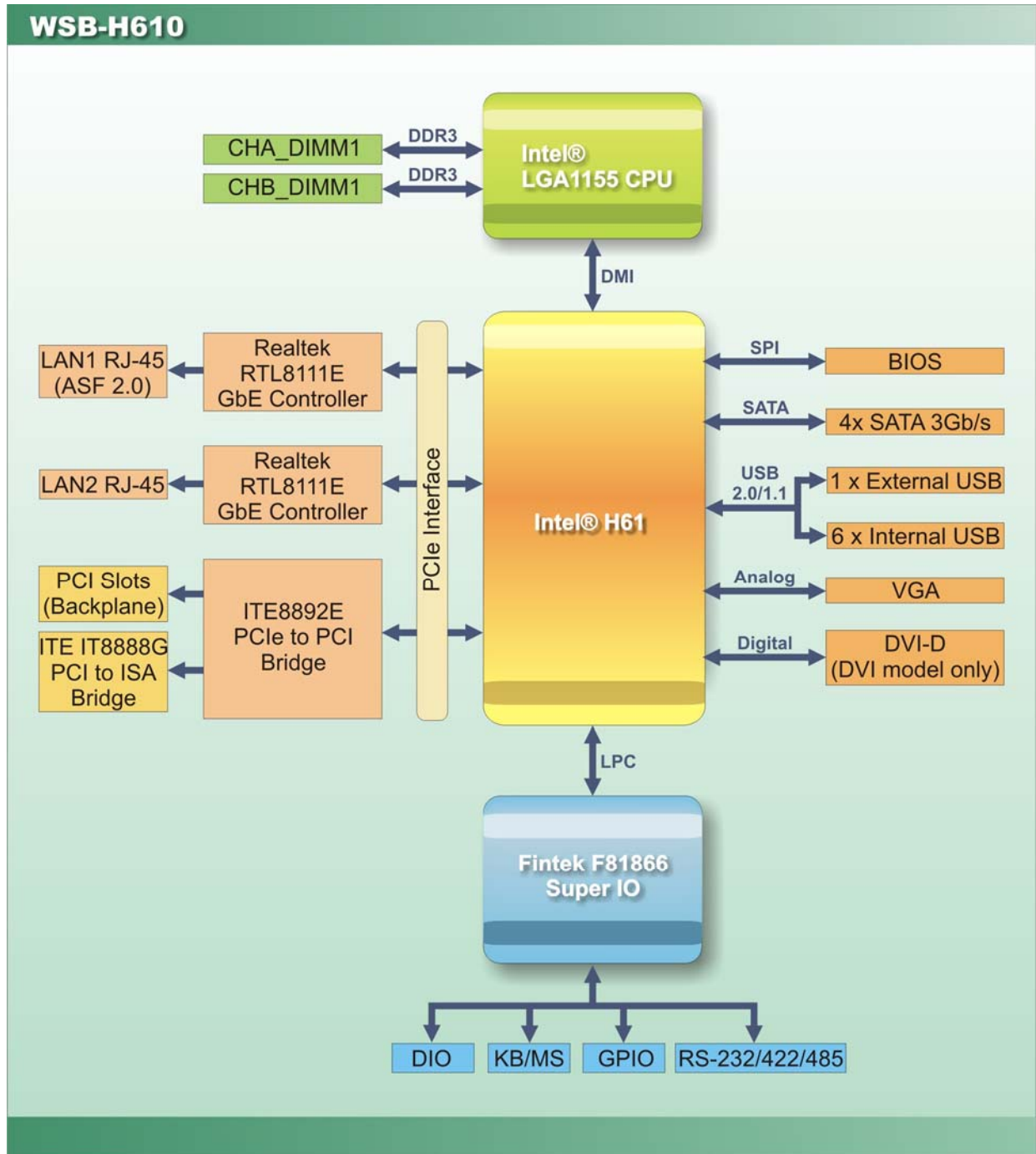

Figure 1-5: Data Flow Diagram

1.7 Technical Specifications

The WSB-H610 technical specifications are listed below.

Specification/Model	WSB-H610
Form Factor	PICMG 1.0
CPU Supported	LGA1155 Intel® Core™ i7/i5/i3/Pentium®/Celeron® CPU
PCH	Intel® H61
Memory	Two 240-pin 1333/1066 MHz dual-channel unbuffered DDR3/DDR3L (1.35V) SDRAM DIMMs support (system max. 16.0 GB)
Graphics Engine	Intel® HD Graphics Gen 6 supports DirectX 10.1 and OpenGL 3.0 Full MPEG2, VC1, AVC Decode
Audio	Supports IEI AC-KIT-892HD audio kit
BIOS	UEFI BIOS
Ethernet Controllers	Dual Realtek RTL8111E PCIe GbE Ethernet controller (LAN1 with ASF 2.0 support)
Super I/O Controller	Fintek F81866
Watchdog Timer	Software programmable supports 1~255 sec. system reset
Expansion	One PCIe Mini slot PCI signal and ISA signal via golden fingers
I/O Interface Connectors	
Audio Connector	One internal audio connector (10-pin header)
Digital I/O	8-bit digital I/O
Display Output	One VGA integrated in the Intel® H61 (rear I/O) One DVI-D integrated in the Intel® H61 (via 26-pin header to the DVI-D/USB kit; DVI model only)
Ethernet	Two RJ-45 GbE ports
Fan	One 4-pin wafer connector
FDD	One 34-pin floppy disk drive connector

WSB-H610 PICMG 1.0 CPU Card

Specification/Model	WSB-H610
Front Panel	One 14-pin header (power LED, HDD LED, speaker, power button, reset button)
I2C	One 4-pin wafer connector
Infrared	One via 5-pin header
Keyboard/Mouse	One PS/2 keyboard/mouse port One 6-pin wafer connector
Parallel Port	One parallel port via internal 26-pin box header
Serial ATA	Four SATA 3Gb/s connectors
Serial Ports	Two RS-232 via internal box headers One RS-422/485 via internal 4-pin wafer connector
SMBus	One 4-pin wafer connector
TPM	One via 20-pin header
USB Ports	One external USB 2.0 port on rear IO Six internal USB 2.0 ports by three pin headers
Environmental and Power Specifications	
Power Supply	5V/12V, AT/ATX power supported
Power Consumption	5V@4.53A , 12V@0.19A, Vcore_12V@7.81A, 5VSB@0.18A (3.40 GHz Intel® Core™ i7-2600K CPU with two 2GB 1333 MHz DDR3 memory)
Operating Temperature	-10°C ~ 60°C
Storage Temperature	-20°C ~ 70°C
Humidity	5% ~ 95% (non-condensing)
Physical Specifications	
Dimensions	338 mm x 126 mm
Weight	1.2 kg

Table 1-2: WSB-H610 Specifications

Chapter

2

Packing List

WSB-H610 PICMG 1.0 CPU Card

2.1 Anti-static Precautions



WARNING!

Static electricity can destroy certain electronics. Make sure to follow the ESD precautions to prevent damage to the product, and injury to the user.

Make sure to adhere to the following guidelines:

- ***Wear an anti-static wristband:*** Wearing an anti-static wristband can prevent electrostatic discharge.
- ***Self-grounding:*** Touch a grounded conductor every few minutes to discharge any excess static buildup.
- ***Use an anti-static pad:*** When configuring any circuit board, place it on an anti-static mat.
- ***Only handle the edges of the PCB:*** Don't touch the surface of the motherboard. Hold the motherboard by the edges when handling.

2.2 Unpacking Precautions

When the WSB-H610 is unpacked, please do the following:

- Follow the anti-static guidelines above.
- Make sure the packing box is facing upwards when opening.
- Make sure all the packing list items are present.







2.3 Packing List



NOTE:

If any of the components listed in the checklist below are missing, do not proceed with the installation. Contact the IEI reseller or vendor the WSB-H610 was purchased from or contact an IEI sales representative directly by sending an email to sales@ieiworld.com.

The WSB-H610 is shipped with the following components:

Quantity	Item and Part Number	Image
1	WSB-H610 CPU card	
2	SATA cable (P/N: 32000-062800-RS)	
1	Dual RS-232 cable (P/N: 19800-000051-RS)	
1	Dual USB cable with bracket (P/N: CB-USB02-RS)	
1	PS/2 keyboard and mouse cable (P/N: 32006-000300-100-RS)	
1	Mini jumper pack	

WSB-H610 PICMG 1.0 CPU Card









Quantity	Item and Part Number	Image
1	DVI-D/USB kit (DVI model only) (P/N: IO-KIT-001-R20)	
1	One Key Recovery CD	
1	Utility CD	
1	Quick Installation Guide	

Table 2-1: Packing List

2.4 Optional Items

The following are optional components which may be separately purchased:

Item and Part Number	Image
RS-422/485 cable, 200 mm (P/N: 32205-003800-300-RS)	
PS/2 KB/MS cable with bracket (6-pin header) (P/N: 19800-000075-RS)	
SATA to IDE/CF converter board (P/N: SAIDE-KIT01-R10)	
SATA power cable (P/N: 32102-000100-200-RS)	

Item and Part Number	Image
FDD flat cable (P/N: 32200-000017-RS)	
LPT cable (P/N: 19800-000049-RS)	
7.1-channel HD audio kit with Realtek ALC892 audio codec supporting dual audio stream (P/N: AC-KIT-892HD-R10)	
20-pin Infineon TPM module (P/N: TPM-IN01-R11)	
LGA1155/LGA1156 cooler kit (1U chassis compatible, 73W) (P/N: CF-1156A-RS-R11)	
LGA1155/LGA1156 cooler kit (1U chassis compatible, 45W) (P/N: CF-1156C-RS)	
LGA1155/LGA1156 cooler kit (1U chassis compatible, 65W) (P/N: CF-1156D-RS)	
High-performance LGA1155/LGA1156 cooler kit (95W) (P/N: CF-1156E-R11)	

WSB-H610 PICMG 1.0 CPU Card

Item and Part Number	Image
<p>Intel® Core™ i5-2500T processor (LGA1155, quad core 2.3 GHz, 6M cache, 45W, compatible with CF-1156C-RS CPU cooler kit)</p> <p>(P/N: CPU-DT-i5-2500T)</p>	
<p>Intel® Core™ i5-2390T processor (LGA1155, dual core 2.7 GHz, 3M cache, 35W, compatible with CF-1156C-RS CPU cooler kit)</p> <p>(P/N: CPU-DT-i5-2390T)</p>	
<p>Intel® Core™ i3-2120T processor (LGA1155, dual core 2.6 GHz, 3M cache, 35W, compatible with CF-1156C-RS CPU cooler kit)</p> <p>(P/N: CPU-DT-i3-2120T)</p>	
<p>Intel® Pentium® G630T processor (LGA1155, dual core 2.3 GHz, 3M cache, 35W, compatible with CF-1156C-RS CPU cooler kit)</p> <p>(P/N: CPU-DT-P-G630T)</p>	
<p>Intel® Celeron® G440 processor (LGA1155, single core 1.6 GHz, 1M cache, 35W, compatible with CF-1156C-RS CPU cooler kit)</p> <p>(P/N: CPU-DT-C-G440)</p>	

Table 2-2: Optional Items

Chapter

3

Connectors

WSB-H610 PICMG 1.0 CPU Card

3.1 Peripheral Interface Connectors

This chapter details all the jumpers and connectors.

3.1.1 WSB-H610 Layout

The figures below show all the connectors and jumpers.

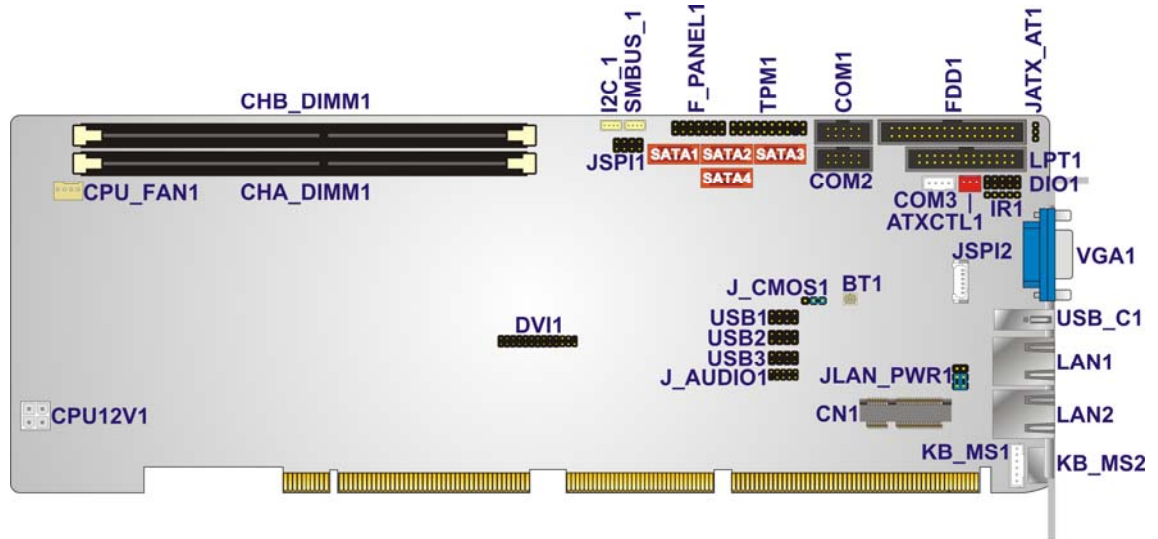

Figure 3-1: Connectors and Jumpers

3.1.2 Peripheral Interface Connectors

The table below lists all the connectors on the board.

Connector	Type	Label
ATX power supply enable connector	3-pin wafer	ATXCTL1
Audio kit connector	10-pin header	J_AUDIO1
Battery connector	2-pin wafer	BT1
CPU power input connector	4-pin Molex power connector	CPU12V1
DDR3 DIMM sockets	240-pin socket	CHA_DIMM1 CHB_DIMM1
Digital I/O connector	10-pin header	DIO1

Connector	Type	Label
DVI-D connector (DVI model only)	26-pin header	DVI1
EC SPI flash connector	6-pin wafer	JSPI2
Fan connector (CPU)	4-pin wafer	CPU_FAN1
Floppy disk drive connector	34-pin box header	FDD1
Front panel connector	14-pin header	F_PANEL1
I2C connector	4-pin wafer	I2C_1
Infrared connector	5-pin header	IR1
Keyboard and mouse connector	6-pin wafer	KB_MS1
Parallel port connector	26-pin box header	LPT1
PCIe Mini slot	PCIe Mini	CN1
SATA 3Gb/s drive connector	7-pin SATA connector	SATA1, SATA2, SATA3, SATA4
Serial port, RS-422/485	4-pin wafer	COM3
Serial port, RS-232	10-pin box header	COM1, COM2
SMBus connector	4-pin wafer	SMBUS_1
SPI ROM connector	8-pin header	JSPI1
TPM connector	20-pin header	TPM1
USB connectors	8-pin header	USB1, USB2, USB3

Table 3-1: Peripheral Interface Connectors

3.1.3 External Interface Panel Connectors

The table below lists the connectors on the external I/O panel.

Connector	Type	Label
Ethernet connector	RJ-45	LAN1
Ethernet connector	RJ-45	LAN2
Keyboard and mouse connector	PS/2	KB_MS2

WSB-H610 PICMG 1.0 CPU Card

Connector	Type	Label
USB port	USB	USB_C1
VGA connector	15-pin female	VGA1

Table 3-2: Rear Panel Connectors

3.2 Internal Peripheral Connectors

The section describes all of the connectors on the WSB-H610.

3.2.1 ATX Power Supply Enable Connector

- CN Label:** ATXCTL1
- CN Type:** 3-pin wafer
- CN Location:** See **Figure 3-2**
- CN Pinouts:** See **Table 3-3**

The ATX power supply enable connector enables the WSB-H610 to be connected to an ATX power supply. To enable an ATX power supply, the AT/ATX Power Select jumper must also be configured. Please refer to Chapter 4 for more details.

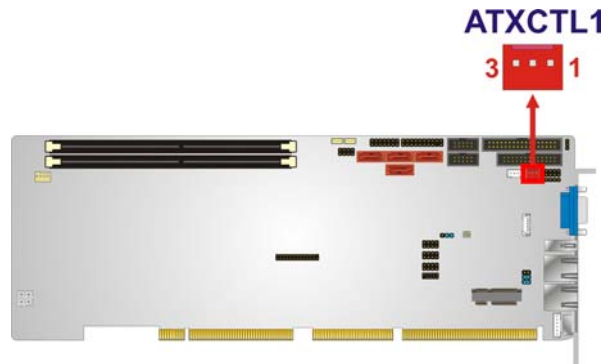

Figure 3-2: ATX Power Supply Enable Connector Location

Pin	Description
1	GND
2	PS_ON#
3	5VSB

Table 3-3: ATX Power Supply Enable Connector Pinouts

3.2.2 Audio Kit Connector

- CN Label:** J_AUDIO1
- CN Type:** 10-pin header
- CN Location:** See **Figure 3-3**
- CN Pinouts:** See **Table 3-4**

This connector connects to an external audio kit.

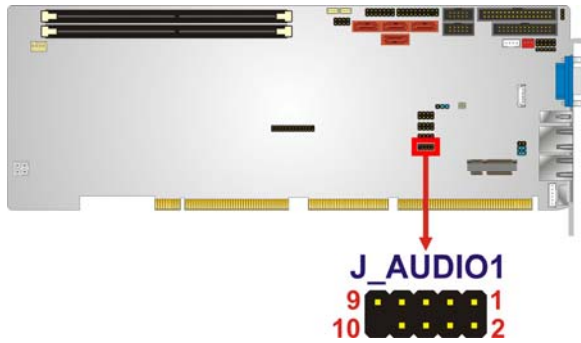

Figure 3-3: Audio Connector Location

Pin	Description	Pin	Description
1	ACZ_SYNC	2	ACZ_BITCLK
3	ACZ_SDOUT	4	ACZ_PCBEEP
5	ACZ_SDIN	6	ACZ_RST#
7	ACZ_VCC	8	ACZ_GND
9	ACZ_12V	10	ACZ_GND

Table 3-4: Audio Connector Pinouts

WSB-H610 PICMG 1.0 CPU Card

3.2.3 Battery Connector



CAUTION:

Risk of explosion if battery is replaced by an incorrect type. Only certified engineers should replace the on-board battery.

Dispose of used batteries according to instructions and local regulations.

- CN Label:** BT1
- CN Type:** 2-pin wafer
- CN Location:** See **Figure 3-4**
- CN Pinouts:** See **Table 3-5**

This is connected to the system battery. The battery provides power to the system clock to retain the time when power is turned off.

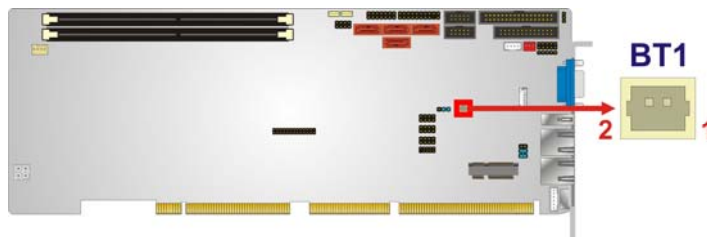

Figure 3-4: Battery Connector Location

Pin	Description
1	Battery+
2	GND

Table 3-5: Battery Connector Pinouts

3.2.4 CPU Power Input Connector

- CN Label:** CPU12V1
- CN Type:** 4-pin Molex power connector
- CN Location:** See **Figure 3-5**
- CN Pinouts:** See **Table 3-6**

The connector supports the 12V power supply.

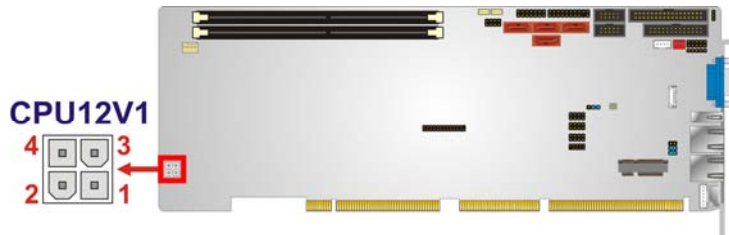

Figure 3-5: ATX Power Connector Pinout Location

Pin	Description	Pin	Description
1	GND	2	GND
3	+12V	4	+12V

Table 3-6: ATX Power Connector Pinouts

3.2.5 DDR3 DIMM Slots

- CN Label:** CHA_DIMM1, CHB_DIMM1
- CN Type:** DDR3 DIMM slot
- CN Location:** See **Figure 3-6**

The DIMM slots are for DDR3 DIMM memory modules.

WSB-H610 PICMG 1.0 CPU Card

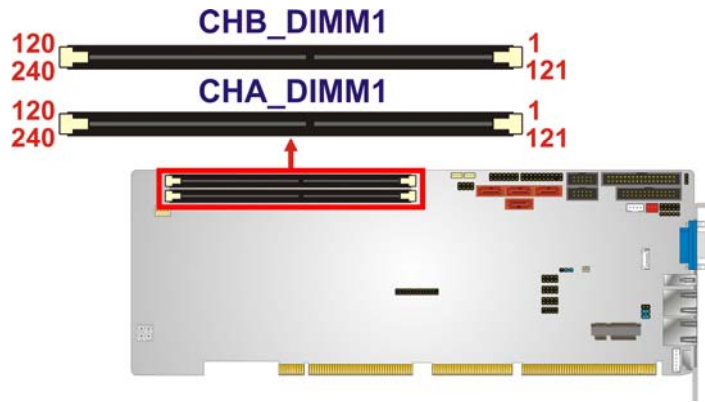

Figure 3-6: DDR3 DIMM Slot Locations

3.2.6 Digital I/O Connector

- CN Label:** DIO1
- CN Type:** 10-pin header
- CN Location:** See Figure 3-7
- CN Pinouts:** See Table 3-7

The digital I/O connector provides programmable input and output for external devices. The digital I/O provides 4-bit output and 4-bit input.

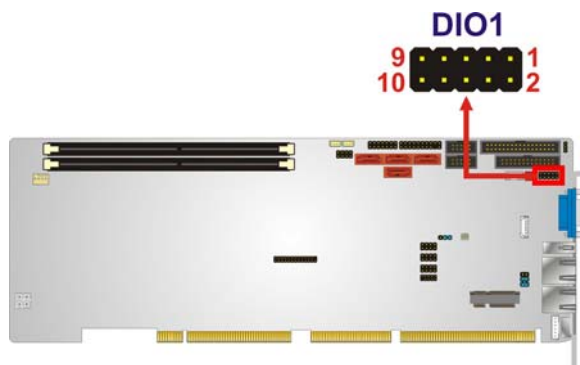

Figure 3-7: Digital I/O Connector Location

Pin	Description	Pin	Description
1	GND	2	VCC
3	Output 3	4	Output 2
5	Output 1	6	Output 0

Pin	Description	Pin	Description
7	Input 3	8	Input 2
9	Input 1	10	Input 0

Table 3-7: Digital I/O Connector Pinouts

3.2.7 DVI-D Connector (DVI Model Only)

- CN Label:** DVI1
- CN Type:** 26-pin header
- CN Location:** See **Figure 3-8**
- CN Pinouts:** See **Table 3-8**

The DVI-D connector connects to a monitor that supports DVI video input via the DVI-D/USB kit.

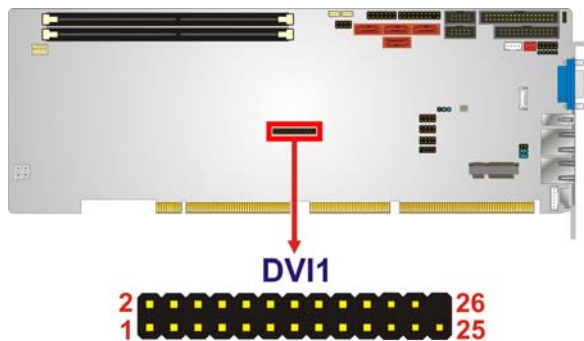

Figure 3-8: DVI-D Connector Location

Pin	Description	Pin	Description
1	CK_DVI_DATA2#	2	DVI_VCC
3	CK_DVI_DATA2	4	GND
5	GND	6	HP_DET
7	NC	8	CK_DVI_DATA0#
9	NC	10	CK_DVI_DATA0
11	DVI_SCL	12	GND
13	DVI_SDA	14	NC
15	NC	16	NC
17	CK_DVI_DATA1#	18	GND

WSB-H610 PICMG 1.0 CPU Card

Pin	Description	Pin	Description
19	CK_DVI_DATA1	20	CK_DVI_CLK#
21	GND	22	CK_DVI_CLK
23	NC	24	GND
25	NC		

Table 3-8: DVI-D Connector Pinouts

3.2.8 EC SPI Flash Connector

- CN Label:** JSPI2
- CN Type:** 6-pin wafer
- CN Location:** See **Figure 3-9**
- CN Pinouts:** See **Table 3-9**

The EC SPI flash connector is for flashing new BIOS onto the embedded controller.

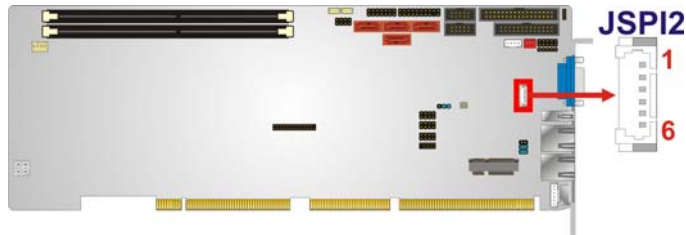

Figure 3-9: EC SPI Flash Connector Location

Pin	Description
1	+V3.3A_EC_CONN
2	FSCE#
3	FMISO
4	FSCK
5	FMOSI
6	GROUND

Table 3-9: EC SPI Flash Connector Pinouts

3.2.9 Fan Connector (CPU)

- CN Label:** CPU_FAN1
- CN Type:** 4-pin wafer
- CN Location:** See **Figure 3-10**
- CN Pinouts:** See **Table 3-10**

The fan connector attaches to a CPU cooling fan.

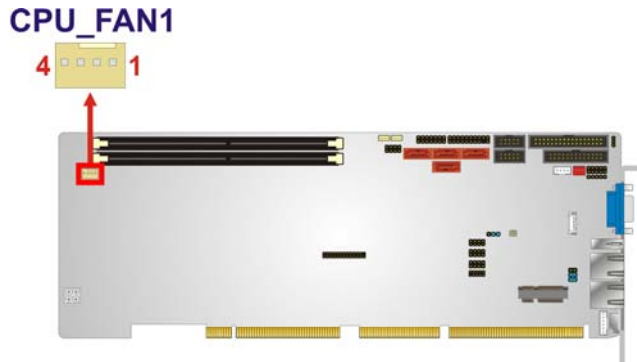

Figure 3-10: CPU Fan Connector Location

Pin	Description
1	GND
2	+12 V
3	Rotation Signal
4	PWM Control Signal

Table 3-10: CPU Fan Connector Pinouts

3.2.10 Floppy Disk Drive Connector

- CN Label:** FDD1
- CN Type:** 34-pin header
- CN Location:** See **Figure 3-11**
- CN Pinouts:** See **Table 3-11**

The floppy disk drive connector is connected to a floppy disk drive.

WSB-H610 PICMG 1.0 CPU Card

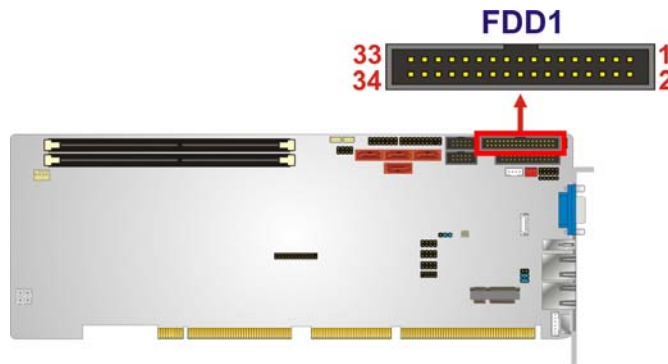

Figure 3-11: Floppy Disk Connector Location

Pin	Description	Pin	Description
1	GND	2	DENSEL
3	GND	4	NC
5	NC	6	NC
7	GND	8	INDEX-
9	GND	10	MOTEA-
11	GND	12	NC
13	GND	14	DRVA-
15	GND	16	NC
17	GND	18	DIR-
19	GND	20	STEP-
21	GND	22	WDATA-
23	GND	24	WGATE-
25	GND	26	TK00-
27	GND	28	WPT-
29	GND	30	RDATA-
31	GND	32	SIDE1-
33	GND	34	DSKCHG-

Table 3-11: Floppy Disk Connector Pinouts

3.2.11 Front Panel Connector

- CN Label:** F_PANEL1
- CN Type:** 14-pin header
- CN Location:** See **Figure 3-12**
- CN Pinouts:** See **Table 3-12**

The front panel connector connects to the indicator LEDs and buttons on the computer's front panel.

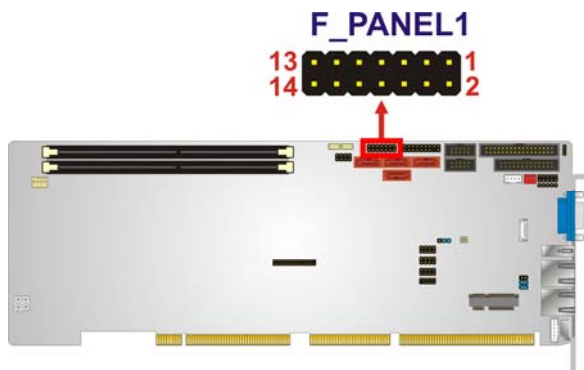

Figure 3-12: Front Panel Connector Location

Function	Pin	Description	Function	Pin	Description
Power LED	1	+5V	Speaker	2	+5V
	3	N/C		4	N/C
	5	GROUND		6	N/C
Power Button	7	PWR_BTN+	8	Speaker	
	9	PWR_BTN-	Reset	10	N/C
HDD LED	11	+5V		12	RESET-
	13	HDD_LED-		14	GROUND

Table 3-12: Front Panel Connector Pinouts

WSB-H610 PICMG 1.0 CPU Card

3.2.12 I2C Connector

- CN Label:** I2C_1
- CN Type:** 4-pin wafer
- CN Location:** See **Figure 3-13**
- CN Pinouts:** See **Table 3-13**

The I2C connector is for system debug.

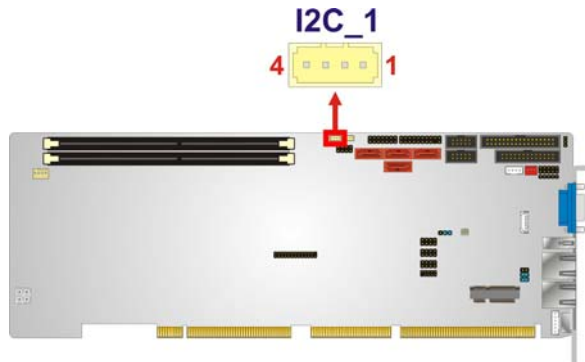

Figure 3-13: I2C Connector Location

Pin	Description
1	+5VS
2	PCH_GP38_PU
3	PCH_GP39_PU
4	GND

Table 3-13: I2C Connector Pinouts

3.2.13 Infrared Interface Connector

- CN Label:** IR1
- CN Type:** 5-pin header
- CN Location:** See **Figure 3-14**
- CN Pinouts:** See **Table 3-14**

The infrared connector attaches to an infrared receiver for use with remote controls.

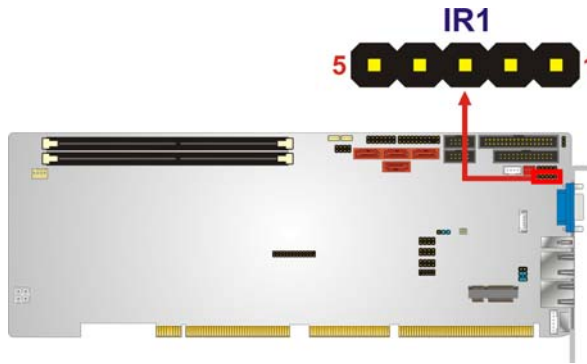

Figure 3-14: Infrared Connector Location

Pin	Description
1	VCC
2	NC
3	IR-RX
4	GND
5	IR-TX

Table 3-14: Infrared Connector Pinouts

3.2.14 Keyboard/Mouse Connector

CN Label: KB_MS1

CN Type: 6-pin wafer

CN Location: See **Figure 3-15**

CN Pinouts: See **Table 3-15**

The keyboard/mouse connector connects to a PS/2 Y-cable that can be connected to a PS/2 keyboard and mouse.

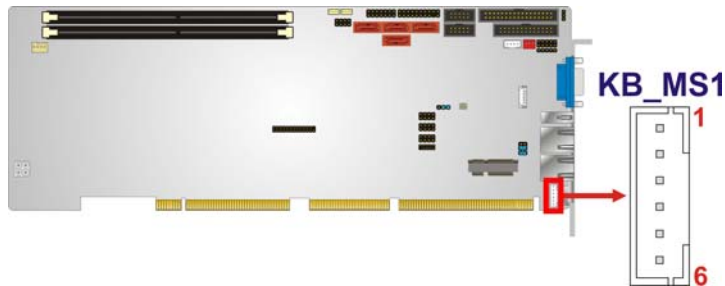

Figure 3-15: Keyboard/Mouse Connector Location

WSB-H610 PICMG 1.0 CPU Card

Pin	Description
1	+5 VCC
2	Mouse Data
3	Mouse Clock
4	Keyboard Data
5	Keyboard Clock
6	GROUND

Table 3-15: Keyboard/Mouse Connector Pinouts

3.2.15 Parallel Port Connector

- CN Label:** LPT1
- CN Type:** 26-pin box header
- CN Location:** See **Figure 3-16**
- CN Pinouts:** See **Table 3-16**

The parallel port connector connects to a parallel port connector interface or some other parallel port device such as a printer.

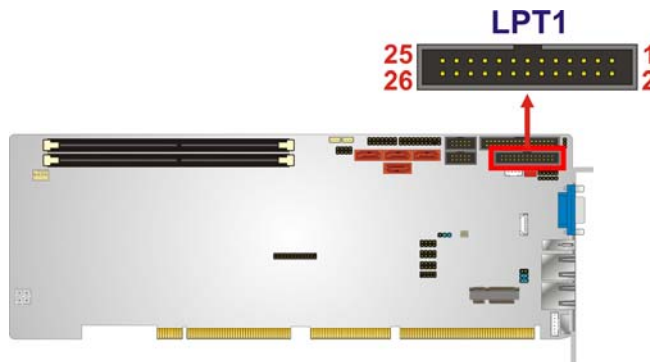

Figure 3-16: Parallel Port Connector Location

Pin	Description	Pin	Description
1	STB	2	AFD
3	PPD0	4	ERROR
5	PPD1	6	INIT
7	PPD2	8	SLIN

Pin	Description	Pin	Description
9	PPD3	10	GND
11	PPD4	12	GND
13	PPD5	14	GND
15	PPD6	16	GND
17	PPD7	18	GND
19	ACK	20	GND
21	BUSY	22	GND
23	PE	24	GND
25	SLCT		

Table 3-16: Parallel Port Connector Pinouts

3.2.16 PCIe Mini Card Slot

- CN Label:** CN1
- CN Type:** PCIe Mini card slot
- CN Location:** See **Figure 3-17**
- CN Pinouts:** See **Table 3-17**

The PCIe Mini card slot is for installing a PCIe Mini expansion card.

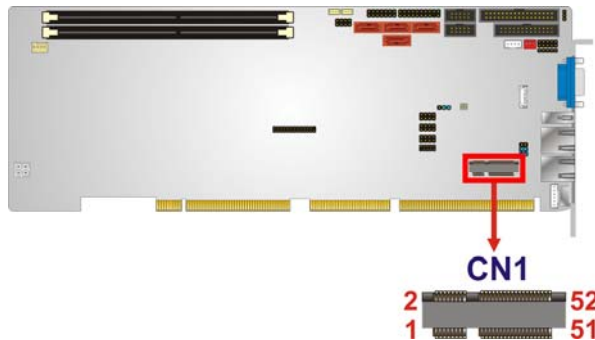

Figure 3-17: PCIe Mini Card Slot Location

Pin	Description	Pin	Description
1	PCIE_WAKE#	2	VCC3
3	NC	4	GND
5	NC	6	1.5V

WSB-H610 PICMG 1.0 CPU Card

Pin	Description	Pin	Description
7	CLKREQ#	8	LFRAME#
9	GND	10	LAD3
11	CLK-	12	LAD2
13	CLK+	14	LAD1
15	GND	16	LAD0
17	PCIRST#	18	GND
19	LPC	20	VCC3
21	GND	22	PCIRST#
23	PERN2	24	3VDual
25	PERP2	26	GND
27	GND	28	1.5V
29	GND	30	SMBCLK
31	PETN2	32	SMBDATA
33	PETP2	34	GND
35	GND	36	USB-
37	NC	38	USB+
39	NC	40	GND
41	NC	42	NC
43	NC	44	RF_LINK#
45	NC	46	BLUELED#
47	NC	48	1.5V
49	NC	50	GND
51	NC	52	VCC3

Table 3-17: PCIe Mini Card Slot Pinouts

3.2.17 SATA 3Gb/s Drive Connectors

CN Label: SATA1, SATA2, SATA3, SATA4

CN Type: 7-pin SATA drive connector

CN Location: See **Figure 3-18**

CN Pinouts: See **Table 3-18**

The SATA drive connectors can be connected to SATA drives and support up to 3Gb/s data transfer rate.

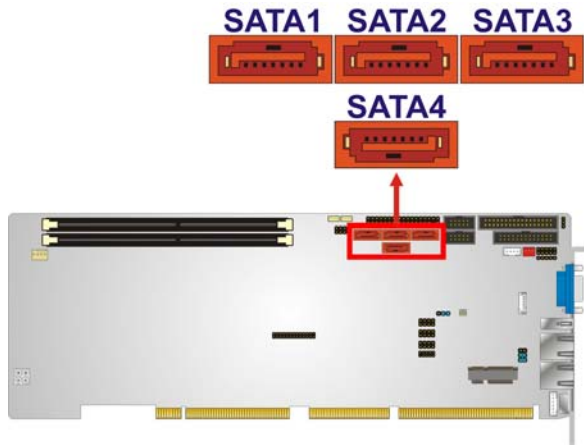

Figure 3-18: SATA 3Gb/s Drive Connector Location

Pin	Description	Pin	Description
1	GND	2	TX+
3	TX-	4	GND
5	RX-	6	RX+
7	GND		

Table 3-18: SATA 3Gb/s Drive Connector Pinouts

3.2.18 Serial Port Connectors, RS-232

- CN Label:** COM1, COM2
- CN Type:** 10-pin box header
- CN Location:** See **Figure 3-19**
- CN Pinouts:** See **Table 3-19**

Each of these connectors provides RS-232 connections.

WSB-H610 PICMG 1.0 CPU Card

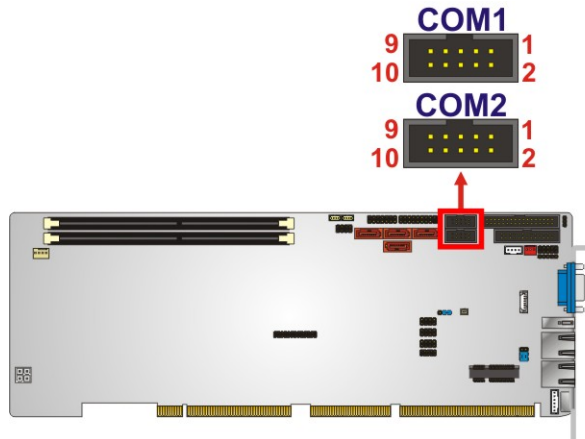

Figure 3-19: Serial Port Connector Location

Pin	Description	Pin	Description
1	DATA CARRIER DETECT (DCD)	2	DATA SET READY (DSR)
3	RECEIVE DATA (RXD)	4	REQUEST TO SEND (RTS)
5	TRANSMIT DATA (TXD)	6	CLEAR TO SEND (CTS)
7	DATA TERMINAL READY (DTR)	8	RING INDICATOR (RI)
9	GND	10	GND

Table 3-19: Serial Port Connector Pinouts

3.2.19 Serial Port Connector, RS-422/485

- CN Label:** COM3
- CN Type:** 4-pin wafer
- CN Location:** See Figure 3-20
- CN Pinouts:** See Table 3-20



NOTE:

These pins are shared with those on the main serial port. Use either the pins on the main connector, or on this connector, but not both.

This connector provides RS-422 or RS-485 communications.

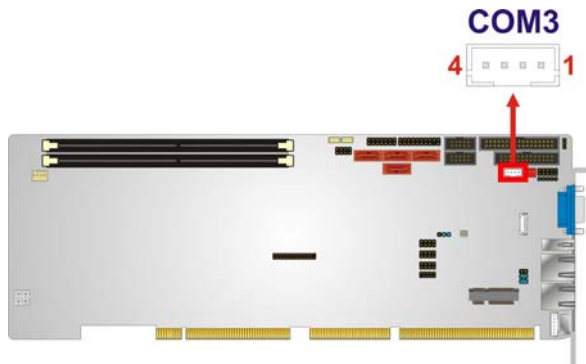

Figure 3-20: RS-422/485 Connector Location

Pin	Description	Pin	Description
1	RXD422-	3	TXD422+/TXD485+
2	RXD422+	4	TXD422-/TXD485-

Table 3-20: RS-422/485 Connector Pinouts

Use the optional RS-422/485 cable to connect to a serial device. The pinouts of the DB-9 connector are listed below.

RS-422 Pinouts	RS-485 Pinouts

Table 3-21: DB-9 RS-422/485 Pinouts

3.2.20 SMBus Connector

- CN Label:** SMBUS_1
- CN Type:** 4-pin wafer
- CN Location:** See **Figure 3-21**
- CN Pinouts:** See **Table 3-22**

The SMBus (System Management Bus) connector provides low-speed system management communications.

WSB-H610 PICMG 1.0 CPU Card

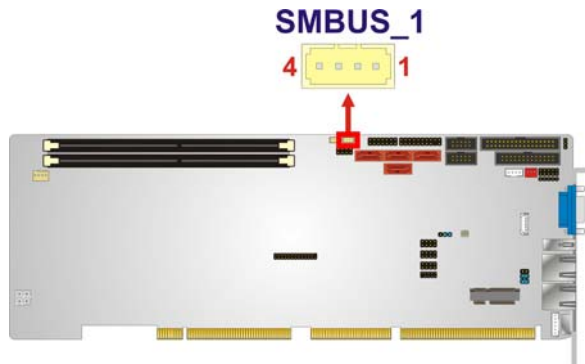

Figure 3-21: SMBus Connector Location

Pin	Description
1	+5VS
2	SMB_CLK
3	SMB_DATA
4	GND

Table 3-22: SMBus Connector Pinouts

3.2.21 SPI ROM Connector

- CN Label:** JSPI1
- CN Type:** 8-pin header
- CN Location:** See **Figure 3-22**
- CN Pinouts:** See **Table 3-23**

The SPI ROM connector is used to flash new BIOS onto the SPI BIOS chip.

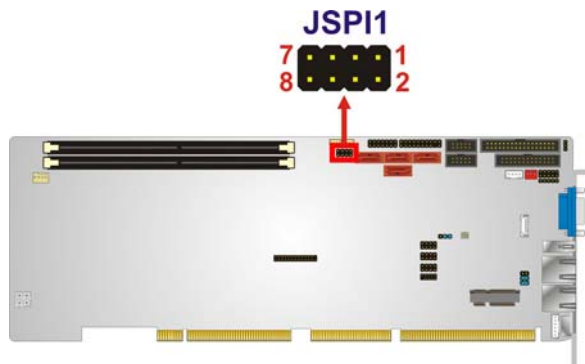

Figure 3-22: SPI ROM Connector Location

Pin	Description	Pin	Description
1	SPI_VCC	2	GND
3	SPI_CS0	4	SPI_CLK
5	SPI_MISO	6	SPI_MOSI
7	NC	8	NC

Table 3-23: SPI ROM Connector Pinouts

3.2.22 TPM Connector

- CN Label:** TPM1
- CN Type:** 20-pin header
- CN Location:** See **Figure 3-23**
- CN Pinouts:** See **Table 3-24**

The TPM connector connects to a TPM module.

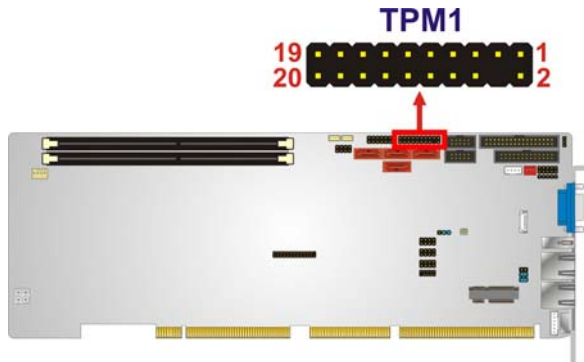

Figure 3-23: TPM Connector Location

Pin	Description	Pin	Description
1	CLK	2	GND
3	ERAME#	4	NC
5	RESRT#	6	+5V
7	AD3	8	AD2
9	+3V	10	AD1
11	AD0	12	GND
13	SMB_CLK	14	SMB_DATA

WSB-H610 PICMG 1.0 CPU Card

Pin	Description	Pin	Description
15	SB3V	16	SERIRQ
17	GND	18	+3V
19	PM_SUS_STAT#	20	DRO#

Table 3-24: TPM Connector Pinouts

3.2.23 USB Connectors

CN Label: USB1, USB2, USB3

CN Type: 8-pin header

CN Location: See Figure 3-24

CN Pinouts: See Table 3-25

The USB connectors connect to USB devices. Each pin header provides two USB ports.

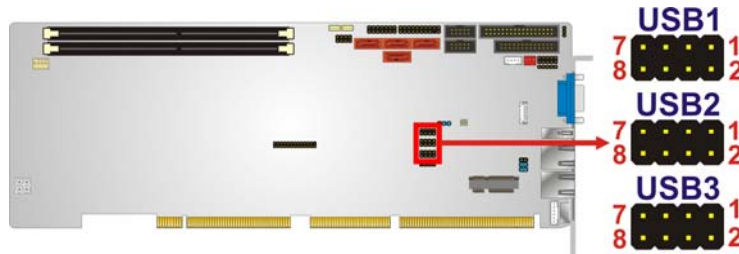

Figure 3-24: USB Connector Pinout Locations

Pin	Description	Pin	Description
1	VCC	2	GND
3	DATA-	4	DATA+
5	DATA+	6	DATA-
7	GND	8	VCC

Table 3-25: USB Port Connector Pinouts

3.3 External Peripheral Interface Connector Panel

The figure below shows the external peripheral interface connector (EPIC) panel. The EPIC panel consists of the following:

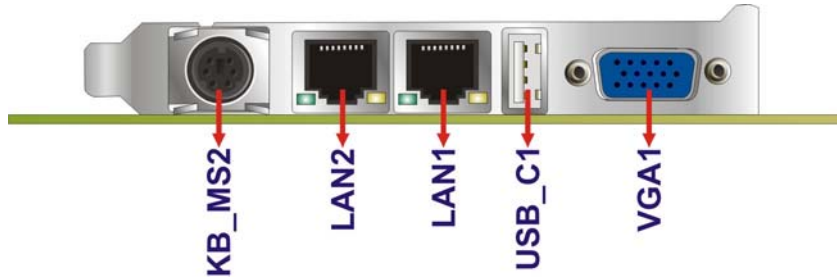

Figure 3-25: External Peripheral Interface Connector

3.3.1 Ethernet Connectors

- CN Label:** LAN1 and LAN2
- CN Type:** RJ-45
- CN Location:** See **Figure 3-25**
- CN Pinouts:** See **Figure 3-26** and **Table 3-26**

The WSB-H610 is equipped with two built-in RJ-45 Ethernet controllers. Each controller can connect to the LAN through one RJ-45 LAN connector.

Pin	Description	Pin	Description
1	MDIA3-	5	MDIA2+
2	MDIA3+	6	MDIA1+
3	MDIA1-	7	MDIA0-
4	MDIA2-	8	MDIA0+

Table 3-26: LAN Pinouts

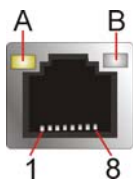

Figure 3-26: Ethernet Connector

WSB-H610 PICMG 1.0 CPU Card

LED	Description	LED	Description
A	on: linked blinking: data is being sent/received	B	off: 10 Mb/s green: 100 Mb/s orange: 1000 Mb/s

Table 3-27: Connector LEDs

3.3.2 Keyboard/Mouse Connector

- CN Label:** KB_MS2
- CN Type:** PS/2
- CN Location:** See **Figure 3-25**
- CN Pinouts:** See **Table 3-28, Figure 3-27**

The keyboard and mouse connector is a standard PS/2 connector.

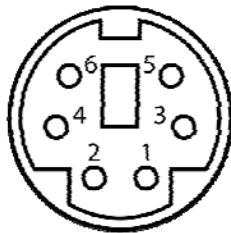

Figure 3-27: PS/2 Pinout and Configuration

Pin	Description
1	KEYBOARD DATA
2	MOUSE DATA
3	GROUND
4	VCC
5	KEYBOARD CLOCK
6	MOUSE CLOCK

Table 3-28: Keyboard Connector Pinouts

3.3.3 USB Connector

- CN Label:** USB_C1
- CN Type:** USB port
- CN Location:** See **Figure 3-25**
- CN Pinouts:** See **Table 3-29**

The WSB-H610 has one external USB 2.0 port. The port connects to both USB 2.0 and USB 1.1 devices.

Pin	Description
1	VCC
2	DATA-
3	DATA+
4	GROUND

Table 3-29: USB Port Pinouts

3.3.4 VGA Connector

- CN Label:** VGA1
- CN Type:** 15-pin Female
- CN Location:** See **Figure 3-25**
- CN Pinouts:** See **Figure 3-28** and **Table 3-30**

The VGA connector connects to a monitor that accepts a standard VGA input.

Pin	Description	Pin	Description
1	RED	2	GREEN
3	BLUE	4	NC
5	GND	6	GND
7	GND	8	GND
9	VGAVCC	10	GND
11	NC	12	DCCDAT

WSB-H610 PICMG 1.0 CPU Card

Pin	Description	Pin	Description
13	HSYNC	14	VSYNC
15	DDCCLK		

Table 3-30: VGA Connector Pinouts

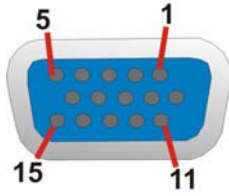

Figure 3-28: VGA Connector

Chapter

4

Installation

WSB-H610 PICMG 1.0 CPU Card

4.1 Anti-static Precautions



WARNING:

Failure to take ESD precautions during the installation of the WSB-H610 may result in permanent damage to the WSB-H610 and severe injury to the user.

Electrostatic discharge (ESD) can cause serious damage to electronic components, including the WSB-H610. Dry climates are especially susceptible to ESD. It is therefore critical that whenever the WSB-H610 or any other electrical component is handled, the following anti-static precautions are strictly adhered to.

- **Wear an anti-static wristband:** - Wearing a simple anti-static wristband can help to prevent ESD from damaging the board.
- **Self-grounding:** - Before handling the board touch any grounded conducting material. During the time the board is handled, frequently touch any conducting materials that are connected to the ground.
- **Use an anti-static pad:** When configuring the WSB-H610, place it on an anti-static pad. This reduces the possibility of ESD damaging the WSB-H610.
- **Only handle the edges of the PCB:-** When handling the PCB, hold the PCB by the edges.

4.2 Installation Considerations



NOTE:

The following installation notices and installation considerations should be read and understood before installation. All installation notices must be strictly adhered to. Failing to adhere to these precautions may lead to severe damage and injury to the person performing the installation.

**WARNING:**

The installation instructions described in this manual should be carefully followed in order to prevent damage to the components and injury to the user.

Before and during the installation please **DO** the following:

- Read the user manual:
 - The user manual provides a complete description of the WSB-H610 installation instructions and configuration options.
- Wear an electrostatic discharge cuff (ESD):
 - Electronic components are easily damaged by ESD. Wearing an ESD cuff removes ESD from the body and helps prevent ESD damage.
- Place the WSB-H610 on an anti-static pad:
 - When installing or configuring the motherboard, place it on an anti-static pad. This helps to prevent potential ESD damage.
- Turn all power to the WSB-H610 off:
 - When working with the WSB-H610, make sure that it is disconnected from all power supplies and that no electricity is being fed into the system.

Before and during the installation of the WSB-H610 **DO NOT**:

- Remove any of the stickers on the PCB board. These stickers are required for warranty validation.
- Use the product before verifying all the cables and power connectors are properly connected.
- Allow screws to come in contact with the PCB circuit, connector pins, or its components.

WSB-H610 PICMG 1.0 CPU Card

4.2.1 Socket LGA1155 CPU Installation



WARNING:

CPUs are expensive and sensitive components. When installing the CPU please be careful not to damage it in anyway. Make sure the CPU is installed properly and ensure the correct cooling kit is properly installed.

DO NOT touch the pins at the bottom of the CPU. When handling the CPU, only hold it on the sides.

To install the CPU, follow the steps below.

Step 1: **Disengage the load lever** by pressing the lever down and slightly outward to clear the retention tab. Fully open the lever. See **Figure 4-1**.

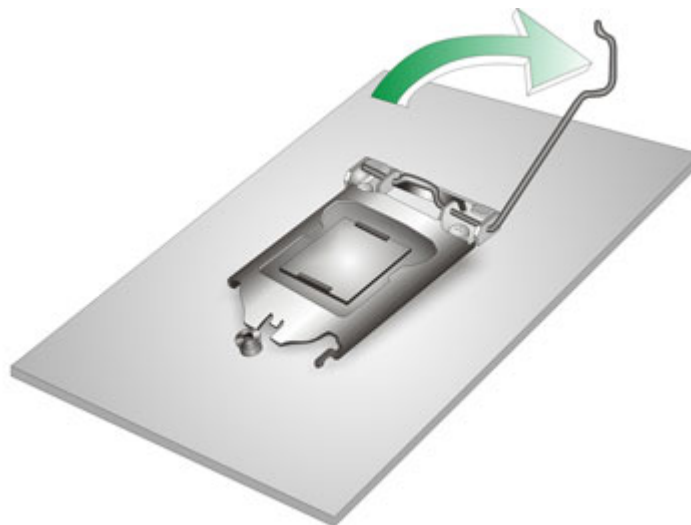

Figure 4-1: Disengage the CPU Socket Load Lever

Step 2: **Open the socket and remove the protective cover.** The black protective cover can be removed by pulling up on the tab labeled "Remove". See **Figure 4-2**.

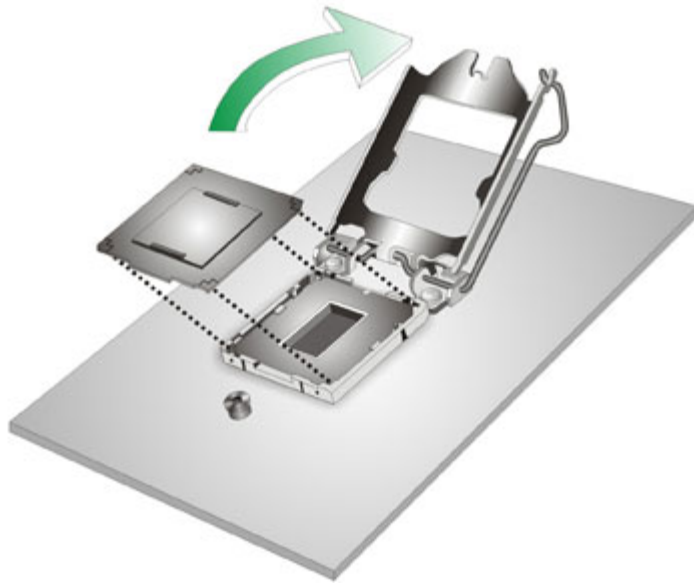

Figure 4-2: Remove Protective Cover

- Step 3: Inspect the CPU socket.** Make sure there are no bent pins and make sure the socket contacts are free of foreign material. If any debris is found, remove it with compressed air.
- Step 4: Orientate the CPU properly.** The contact array should be facing the CPU socket.
- Step 5: Correctly position the CPU.** Match the Pin 1 mark with the cut edge on the CPU socket.
- Step 6: Align the CPU pins.** Locate pin 1 and the two orientation notches on the CPU. Carefully match the two orientation notches on the CPU with the socket alignment keys.
- Step 7: Insert the CPU.** Gently insert the CPU into the socket. If the CPU pins are properly aligned, the CPU should slide into the CPU socket smoothly. See **Figure 4-3**.

WSB-H610 PICMG 1.0 CPU Card

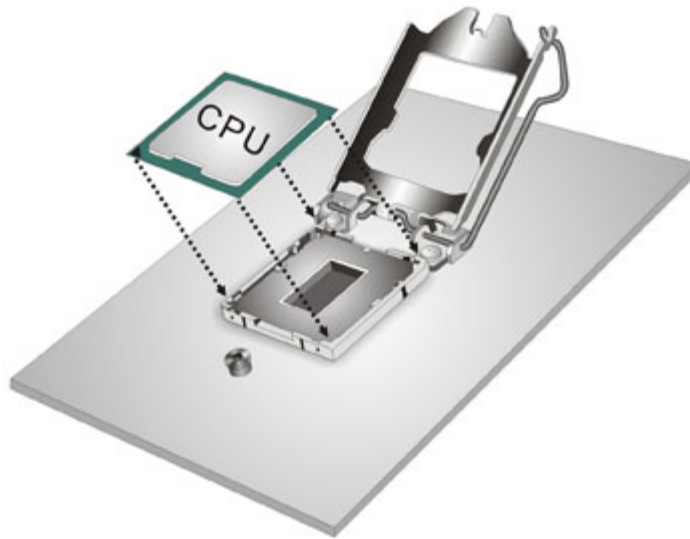

Figure 4-3: Insert the Socket LGA1155 CPU

Step 8: Close the CPU socket. Close the load plate and pull the load lever back a little to have the load plate be able to secure to the knob. Engage the load lever by pushing it back to its original position (**Figure 4-4**). There will be some resistance, but will not require extreme pressure.

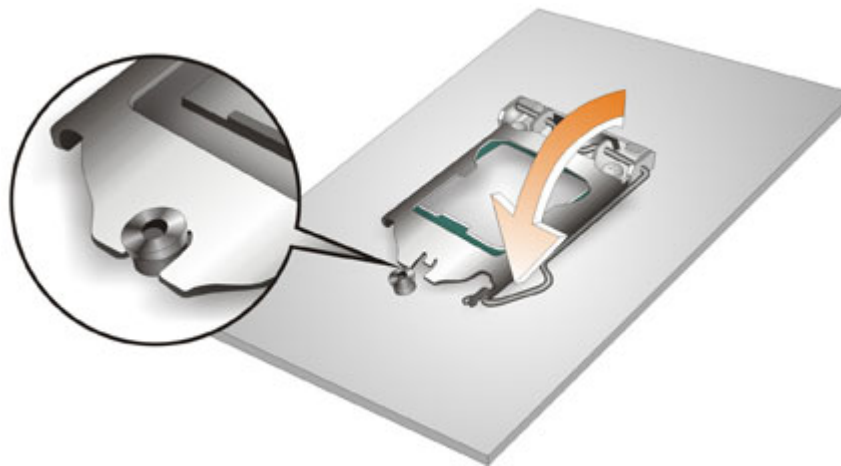

Figure 4-4: Close the Socket LGA1155

Step 9: Connect the 12 V power to the board. Connect the 12 V power from the power supply to the board.

4.2.2 Socket LGA1155 Cooling Kit Installation

The cooling kit can be bought from IEI. The cooling kit has a heatsink and fan.



WARNING:

Do not wipe off (accidentally or otherwise) the pre-sprayed layer of thermal paste on the bottom of the heat sink. The thermal paste between the CPU and the heat sink is important for optimum heat dissipation.

To install the cooling kit, follow the instructions below.

Step 1: A cooling kit bracket is pre-installed on the rear of the motherboard. See **Figure 4-5**.

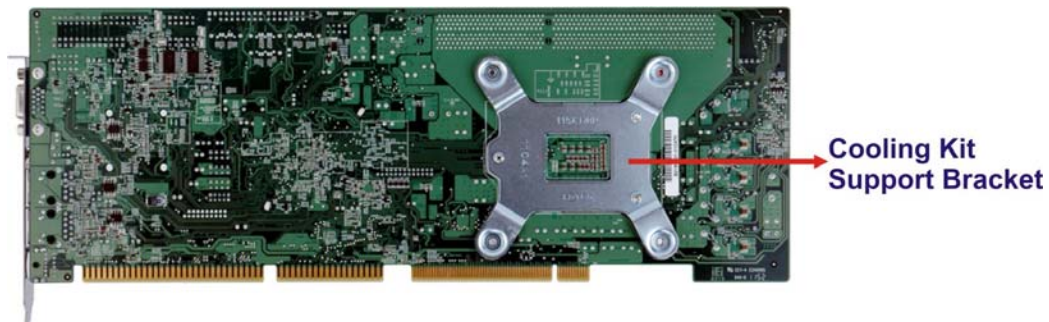

Figure 4-5: Cooling Kit Support Bracket

Step 2: Place the cooling kit onto the socket LGA1155 CPU. Make sure the CPU cable can be properly routed when the cooling kit is installed.

Step 3: Mount the cooling kit. Gently place the cooling kit on top of the CPU. Make sure the four threaded screws on the corners of the cooling kit properly pass through the holes of the cooling kit bracket.

Step 4: Secure the cooling kit by fastening the four retention screws of the cooling kit.

WSB-H610 PICMG 1.0 CPU Card

Step 5: Connect the fan cable. Connect the cooling kit fan cable to the fan connector on the WSB-H610. Carefully route the cable and avoid heat generating chips and fan blades.

4.2.3 DIMM Installation

To install a DIMM, please follow the steps below and refer to **Figure 4-6**.

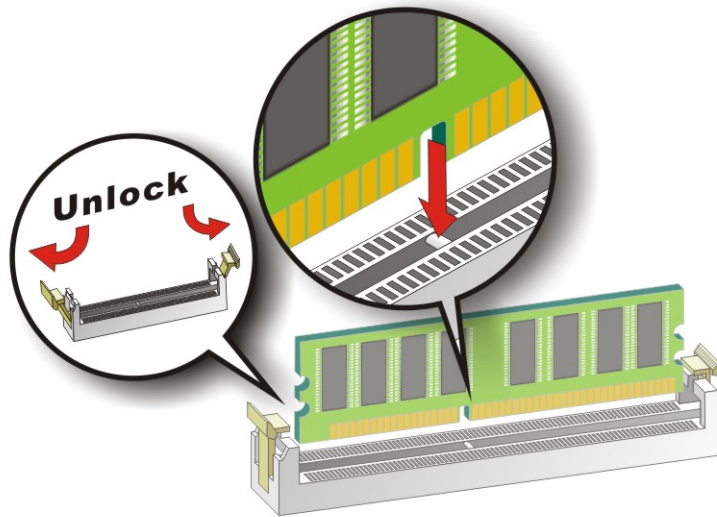

Figure 4-6: DIMM Installation

- Step 1: Open the DIMM socket handles.** Open the two handles outwards as far as they can. See **Figure 4-6**.
- Step 2: Align the DIMM with the socket.** Align the DIMM so the notch on the memory lines up with the notch on the memory socket. See **Figure 4-6**.
- Step 3: Insert the DIMM.** Once aligned, press down until the DIMM is properly seated. Clip the two handles into place. See **Figure 4-6**.
- Step 4: Removing a DIMM.** To remove a DIMM, push both handles outward. The memory module is ejected by a mechanism in the socket.

4.3 Jumper Settings



NOTE:

A jumper is a metal bridge used to close an electrical circuit. It consists of two or three metal pins and a small metal clip (often protected by a plastic cover) that slides over the pins to connect them. To CLOSE/SHORT a jumper means connecting the pins of the jumper with the plastic clip and to OPEN a jumper means removing the plastic clip from a jumper.

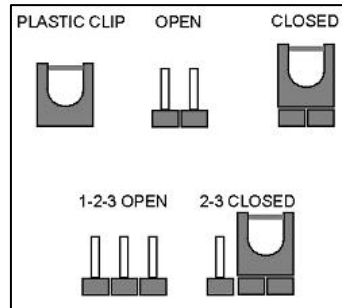

The hardware jumpers must be set before installation. Jumpers are shown in **Table 4-1**.

Description	Label	Type
AT/ATX power select	JATX_AT1	3-pin header
Clear CMOS jumper	J_CMOS1	3-pin header
Wake-on LAN	JLAN_PWR1	6-pin header

Table 4-1: Jumpers

4.3.1 AT/ATX Power Select Jumper

- Jumper Label:** JATX_AT1
- Jumper Type:** 3-pin header
- Jumper Settings:** See **Table 4-2**
- Jumper Location:** See **Figure 4-7**

The AT/ATX Power Select jumper specifies the systems power mode as AT or ATX.

WSB-H610 PICMG 1.0 CPU Card

Setting	Description
Short 1-2	Use ATX power (Default)
Short 2-3	Use AT power

Table 4-2: AT/ATX Power Mode Jumper Settings

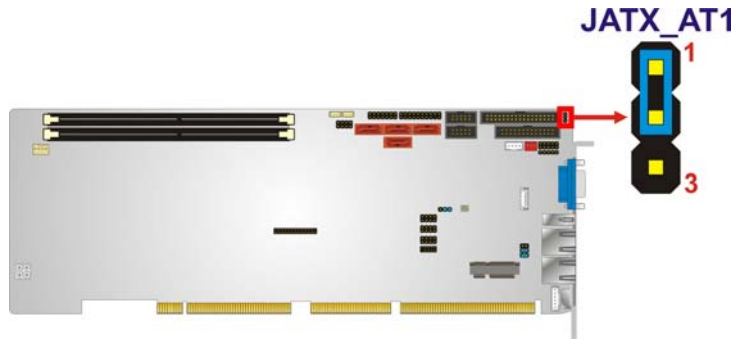

Figure 4-7: AT/ATX Power Mode Jumper Location

4.3.2 Clear CMOS Jumper

- Jumper Label:** J_CMOS1
- Jumper Type:** 3-pin header
- Jumper Settings:** See Table 4-3
- Jumper Location:** See Figure 4-8

To reset the BIOS, move the jumper to the "Clear BIOS" position for 3 seconds or more, and then move back to the default position.

Setting	Description
Short 1-2	Normal
Short 2-3	Clear BIOS

Table 4-3: Clear BIOS Jumper Settings

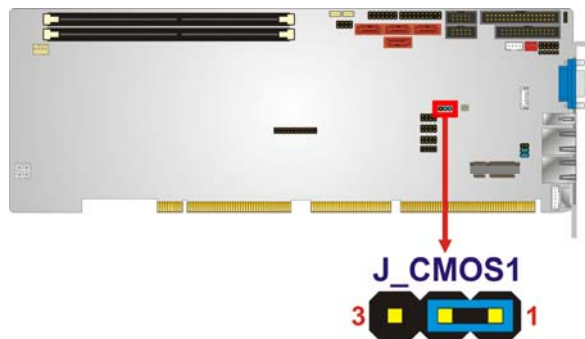

Figure 4-8: Clear BIOS Jumper Location

4.3.3 Wake-on LAN Jumper

- CN Label:** JLAN_PWR1
- CN Type:** 6-pin header
- CN Location:** See **Figure 4-9**
- CN Pinouts:** See **Table 4-4**

The Wake-on LAN jumper allows the user to enable or disable the Wake-on LAN (WOL) function.

Setting	Description
Short 1-3	Enable LAN 2 Wake-on LAN (Default)
Short 2-4	Enable LAN 1 Wake-on LAN (Default)
Short 3-5	Disable LAN 2 Wake-on-LAN
Short 4-6	Disable LAN 1 Wake-on LAN

Table 4-4: Wake-on LAN Jumper Settings

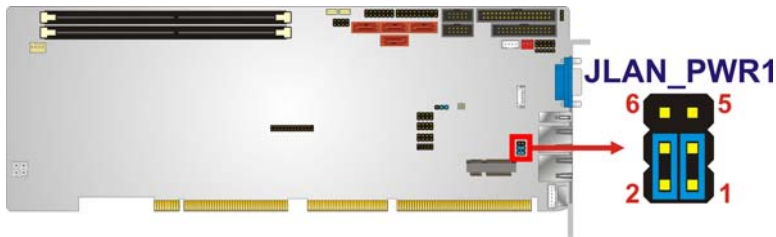

Figure 4-9: Wake-on LAN Jumper Location

Pin	Description	Pin	Description
1	+3.3V_DUAL	2	+3.3V_DUAL
3	+V3.3_LAN2	4	+V3.3_LAN1
5	+3.3V	6	+3.3V

Table 4-5: Wake-on LAN Jumper Pinouts

WSB-H610 PICMG 1.0 CPU Card

4.4 Chassis Installation

4.4.1 Airflow



WARNING:

Airflow is critical to the cooling of the CPU and other onboard components. The chassis in which the WSB-H610 must have air vents to allow cool air to move into the system and hot air to move out.

The WSB-H610 must be installed in a chassis with ventilation holes on the sides allowing airflow to travel through the heat sink surface. In a system with an individual power supply unit, the cooling fan of a power supply can also help generate airflow through the board surface.

4.4.2 CPU Card Installation

To install the CPU card onto the backplane, carefully align the CPU card edge connector with the CPU card socket on the backplane. To do this, please refer to the reference material that came with the backplane. Next, secure the CPU card to the chassis. To do this, please refer to the reference material that came with the chassis.

4.5 Internal Peripheral Device Connections

This section outlines the installation of peripheral devices to the onboard connectors.

4.5.1 Dual RS-232 Cable with Slot Bracket

The dual RS-232 cable slot connector consists of two connectors attached to two independent cables. Each cable is then attached to a D-sub 9 male connector that is mounted onto a slot. To install the dual RS-232 cable, please follow the steps below.

Step 1: Locate the connectors. The locations of the RS-232 connectors are shown in Chapter 3.

Step 2: **Insert the cable connectors.** Insert one connector into each serial port box headers (**Figure 4-10**). A key on the front of the cable connectors ensures the connector can only be installed in one direction.

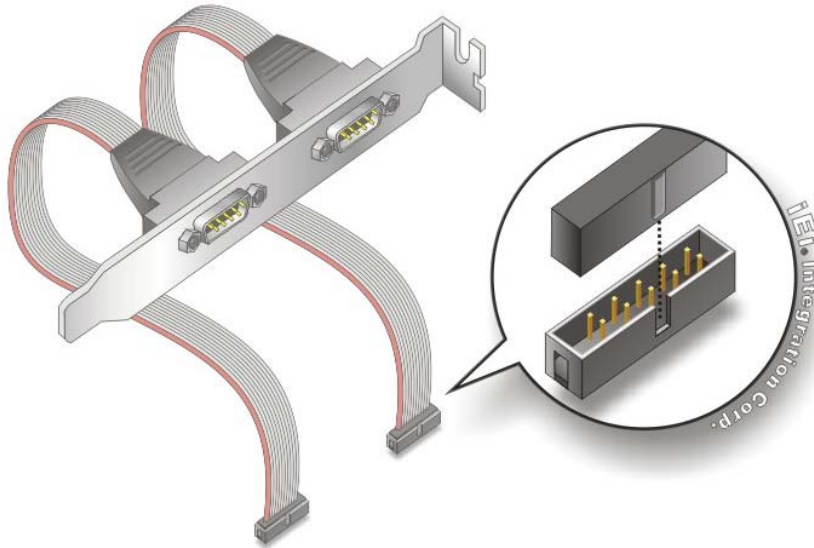

Figure 4-10: Dual RS-232 Cable Installation

Step 3: **Secure the bracket.** The dual RS-232 connector has two D-sub 9 male connectors secured on a bracket. To secure the bracket to the chassis please refer to the reference material that came with the chassis.

4.5.2 DVI-D/USB Kit Installation (DVI Model Only)

The DVI-D/USB kit, consisting of one DVI-D and four USB ports, connects to the DVI-D and USB connectors on the WSB-H610. To install the DVI-D/USB kit, please follow the steps below.

Step 1: **Connect the cables to the DVI-D/USB kit.** Connect the included cables to the DVI-D/USB kit.

Step 2: **Connect the cables to the board.** Connect the other ends of the included cables to the board.

WSB-H610 PICMG 1.0 CPU Card

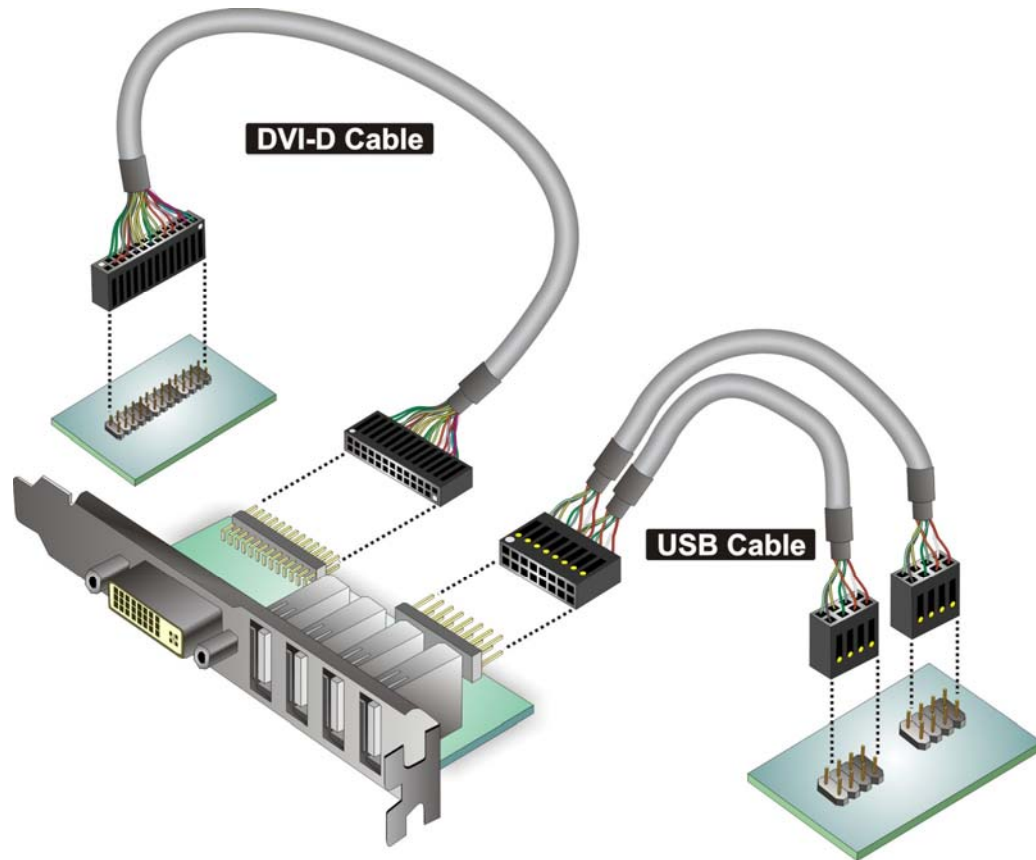

Figure 4-11: DVI-D/USB Kit Installation

Step 3: Mount the DVI-D/USB kit onto the chassis. Once the DVI-D/USB kit is connected to the board, secure the DVI-D/USB kit bracket to the system chassis.

4.5.3 SATA Drive Connection

The WSB-H610 is shipped with four SATA drive cables. To connect the SATA drives to the connectors, please follow the steps below.

Step 1: Locate the connectors. The locations of the SATA drive connectors are shown in **Chapter 3**.

Step 2: Insert the cable connector. Insert the cable connector into the on-board SATA drive connector until it clips into place. See **Figure 4-12**.

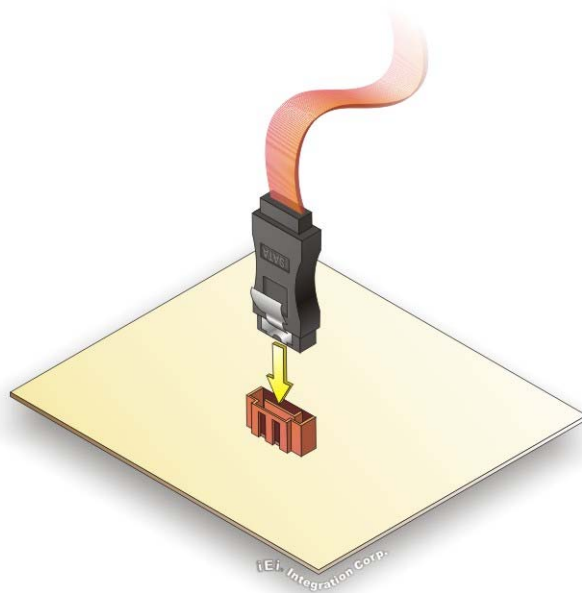

Figure 4-12: SATA Drive Cable Connection

- Step 3:** Connect the cable to the SATA disk. Connect the connector on the other end of the cable to the connector at the back of the SATA drive. See **Figure 4-13**.
- Step 4:** Connect the SATA power cable (optional). Connect the SATA power connector to the back of the SATA drive. See **Figure 4-13**.

WSB-H610 PICMG 1.0 CPU Card

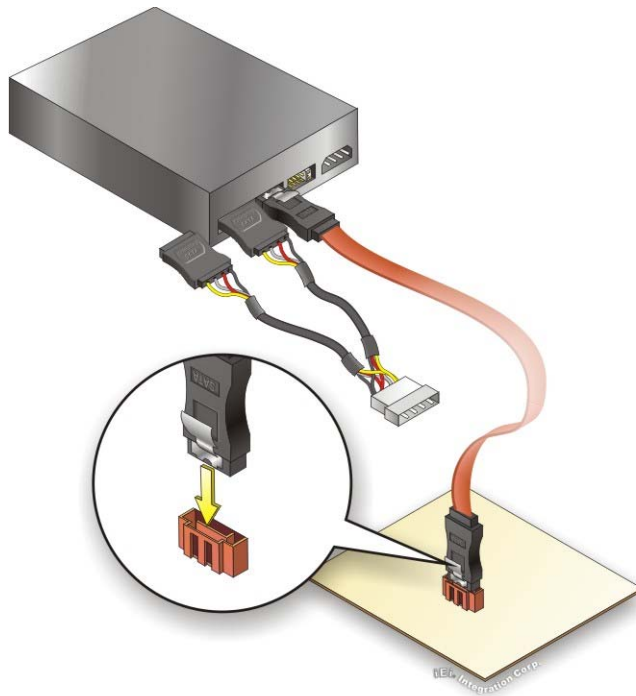

Figure 4-13: SATA Power Drive Connection

4.5.4 USB Cable (Dual Port) with Slot Bracket

The WSB-H610 is shipped with a dual port USB 2.0 cable. To connect the USB cable connector, please follow the steps below.

Step 1: **Locate the connectors.** The locations of the USB connectors are shown in Chapter 3.



WARNING:

If the USB pins are not properly aligned, the USB device can burn out.

Step 2: **Align the connectors.** The cable has two connectors. Correctly align pin 1 on each cable connector with pin 1 on the WSB-H610 USB connector.

Step 3: Insert the cable connectors Once the cable connectors are properly aligned with the USB connectors on the WSB-H610, connect the cable connectors to the on-board connectors. See **Figure 4-14**.

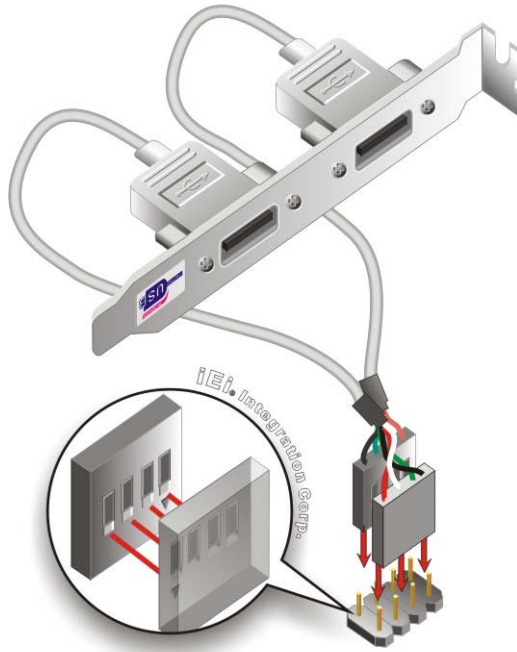

Figure 4-14: Dual USB Cable Connection

Step 4: Attach the bracket to the chassis. The USB 2.0 connectors are attached to a bracket. To secure the bracket to the chassis please refer to the installation instructions that came with the chassis.

4.5.5 PCIe Mini Card Installation

To install the PCIe Mini card, please refer to the diagram and instructions below.

WSB-H610 PICMG 1.0 CPU Card

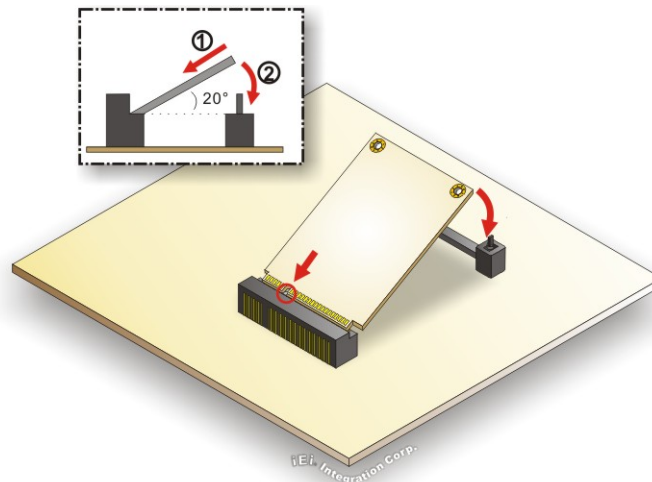

Figure 4-15: PCIe Mini Card Installation

- Step 1:** **Insert into the socket at an angle.** Line up the notch on the card with the notch on the connector. Slide the PCIe Mini card into the socket at an angle of about 20°.
- Step 2:** **Push down until the card clips into place.** Push the other end of the card down until it clips into place on the plastic connector.

4.6 External Peripheral Interface Connection

This section describes connecting devices to the external connectors on the WSB-H610.

4.6.1 LAN Connection

There are two external RJ-45 LAN connectors. The RJ-45 connectors enable connection to an external network. To connect a LAN cable with an RJ-45 connector, please follow the instructions below.

- Step 1:** **Locate the RJ-45 connectors.** The locations of the RJ-45 connectors are shown in **Chapter 3**.
- Step 2:** **Align the connectors.** Align the RJ-45 connector on the LAN cable with one of the RJ-45 connectors on the WSB-H610. See **Figure 4-16**.

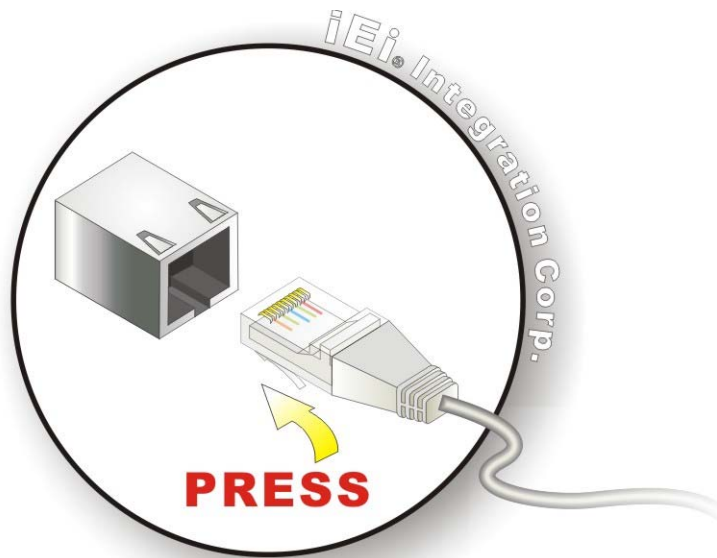

Figure 4-16: LAN Connection

Step 3: Insert the LAN cable RJ-45 connector. Once aligned, gently insert the LAN cable RJ-45 connector into the on-board RJ-45 connector.

4.6.2 USB Device Connection (Single Connector)

There is one external USB 2.0 connector. The connector is perpendicular to the WSB-H610. To connect a USB 2.0 or USB 1.1 device, please follow the instructions below.

Step 1: Located the USB connector. The location of the USB connector is shown in Chapter 3.

Step 2: Align the connectors. Align the USB device connector with the connector on the WSB-H610. See **Figure 4-17**.

WSB-H610 PICMG 1.0 CPU Card

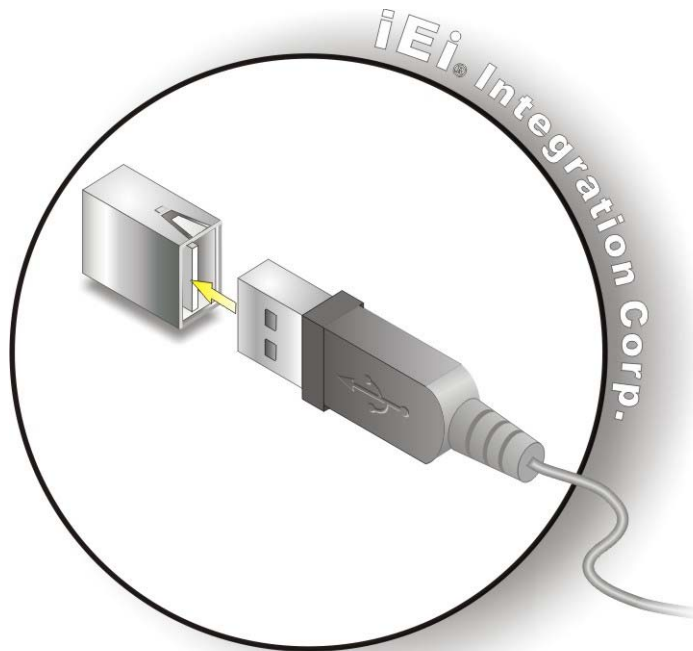

Figure 4-17: USB Device Connection

Step 3: **Insert the device connector.** Once aligned, gently insert the USB device connector into the on-board connector.

4.6.3 VGA Monitor Connection

The WSB-H610 has a single female DB-15 connector on the external peripheral interface panel. The DB-15 connector is connected to a CRT or VGA monitor. To connect a monitor to the WSB-H610, please follow the instructions below.

- Step 1:** **Locate the female DB-15 connector.** The location of the female DB-15 connector is shown in **Chapter 3**.
- Step 2:** **Align the VGA connector.** Align the male DB-15 connector on the VGA screen cable with the female DB-15 connector on the external peripheral interface.
- Step 3:** **Insert the VGA connector** Once the connectors are properly aligned with the insert the male connector from the VGA screen into the female connector on the WSB-H610. See **Figure 4-18**.

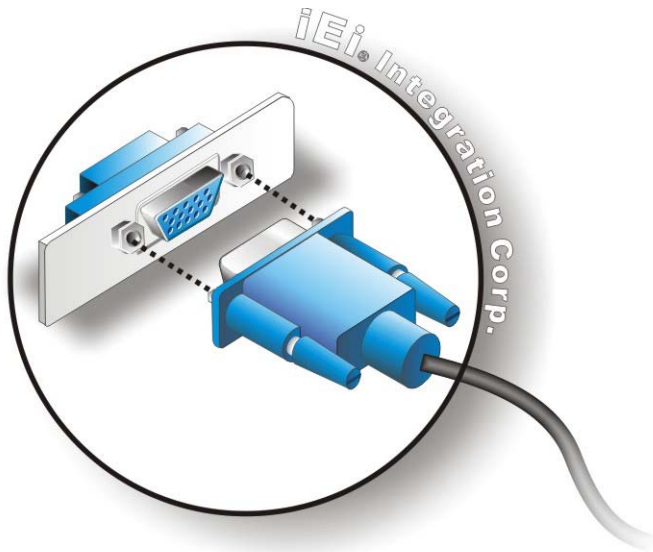

Figure 4-18: VGA Connector

Step 4: Secure the connector. Secure the DB-15 VGA connector from the VGA monitor to the external interface by tightening the two retention screws on either side of the connector.

Chapter

5

BIOS

5.1 Introduction

The BIOS is programmed onto the BIOS chip. The BIOS setup program allows changes to certain system settings. This chapter outlines the options that can be changed.



NOTE:

Some of the BIOS options may vary throughout the life cycle of the product and are subject to change without prior notice.

5.1.1 Starting Setup

The UEFI BIOS is activated when the computer is turned on. The setup program can be activated in one of two ways.

1. Press the **DEL** or **F2** key as soon as the system is turned on or
2. Press the **DEL** or **F2** key when the “**Press DEL or F2 to enter SETUP**” message appears on the screen.

If the message disappears before the **DEL** or **F2** key is pressed, restart the computer and try again.

5.1.2 Using Setup

Use the arrow keys to highlight items, press **ENTER** to select, use the PageUp and PageDown keys to change entries, press **F1** for help and press **ESC** to quit. Navigation keys are shown in.

Key	Function
Up arrow	Move to previous item
Down arrow	Move to next item
Left arrow	Move to the item on the left hand side
Right arrow	Move to the item on the right hand side
+	Increase the numeric value or make changes

WSB-H610 PICMG 1.0 CPU Card

Key	Function
-	Decrease the numeric value or make changes
Page Up key	Increase the numeric value or make changes
Page Dn key	Decrease the numeric value or make changes
Esc key	Main Menu – Quit and not save changes into CMOS Status Page Setup Menu and Option Page Setup Menu -- Exit current page and return to Main Menu
F1	General help, only for Status Page Setup Menu and Option Page Setup Menu
F2	Previous values
F3	Load optimized defaults
F4	Save changes and Exit BIOS

Table 5-1: BIOS Navigation Keys

5.1.3 Getting Help

When **F1** is pressed a small help window describing the appropriate keys to use and the possible selections for the highlighted item appears. To exit the Help Window press **Esc** or the **F1** key again.

5.1.4 Unable to Reboot after Configuration Changes

If the computer cannot boot after changes to the system configuration is made, CMOS defaults. Use the jumper described in Chapter 4.

5.1.5 BIOS Menu Bar

The **menu bar** on top of the BIOS screen has the following main items:

- Main – Changes the basic system configuration.
- Advanced – Changes the advanced system settings.
- Chipset – Changes the chipset settings.
- Boot – Changes the system boot configuration.
- Security – Sets User and Supervisor Passwords.

- Save & Exit – Selects exit options and loads default settings

The following sections completely describe the configuration options found in the menu items at the top of the BIOS screen and listed above.

5.2 Main

The **Main** BIOS menu (**BIOS Menu 1**) appears when the **BIOS Setup** program is entered. The **Main** menu gives an overview of the basic system information.

```

Aptio Setup Utility - Copyright (C) 2011 American Megatrends, Inc.
Main  Advanced  Chipset  Boot  Security  Save & Exit
-----
BIOS Information
BIOS Vendor                American Megatrends
Core Version                4.6.4.0 0.03
Complieny                  UEFI 2.0
Project Version            B219AT08.ROM
Build Date and Time        01/19/2012 14:17:42

Memory Information
Total Memory                1024 MB (DDR3 1333)

System Date                [Thu 02/02/2012]
System Time                 [15:10:27]

Access Level                Administrator

Set the Date. Use Tab to
switch between Data
elements.

-----
-><: Select Screen
^ v: Select Item
Enter>Select
+/-: Change Opt.
F1:  General Help
F2:  Previous Values
F3:  Optimized Defaults
F4:  Save & Exit
ESC: Exit

Version 2.11.1210. Copyright (C) 2011 American Megatrends, Inc.
    
```

BIOS Menu 1: Main

➔ System Overview

The **BIOS Information** lists a brief summary of the BIOS. The fields in **BIOS Information** cannot be changed. The items shown in the system overview include:

- **BIOS Vendor:** Installed BIOS vendor
- **Core Version:** Current BIOS version
- **Project Version:** the board version
- **Build Date and Time:** Date and time the current BIOS version was made

WSB-H610 PICMG 1.0 CPU Card

→ Memory Information

The **Memory Information** lists a brief summary of the on-board memory. The fields in **Memory Information** cannot be changed.

- Total Memory: Displays the auto-detected system memory size and type.

The System Overview field also has two user configurable fields:

→ System Date [xx/xx/xx]

Use the **System Date** option to set the system date. Manually enter the day, month and year.

→ System Time [xx:xx:xx]

Use the **System Time** option to set the system time. Manually enter the hours, minutes and seconds.

5.3 Advanced

Use the **Advanced** menu (**BIOS Menu 2**) to configure the CPU and peripheral devices through the following sub-menus:



WARNING!

Setting the wrong values in the sections below may cause the system to malfunction. Make sure that the settings made are compatible with the hardware.

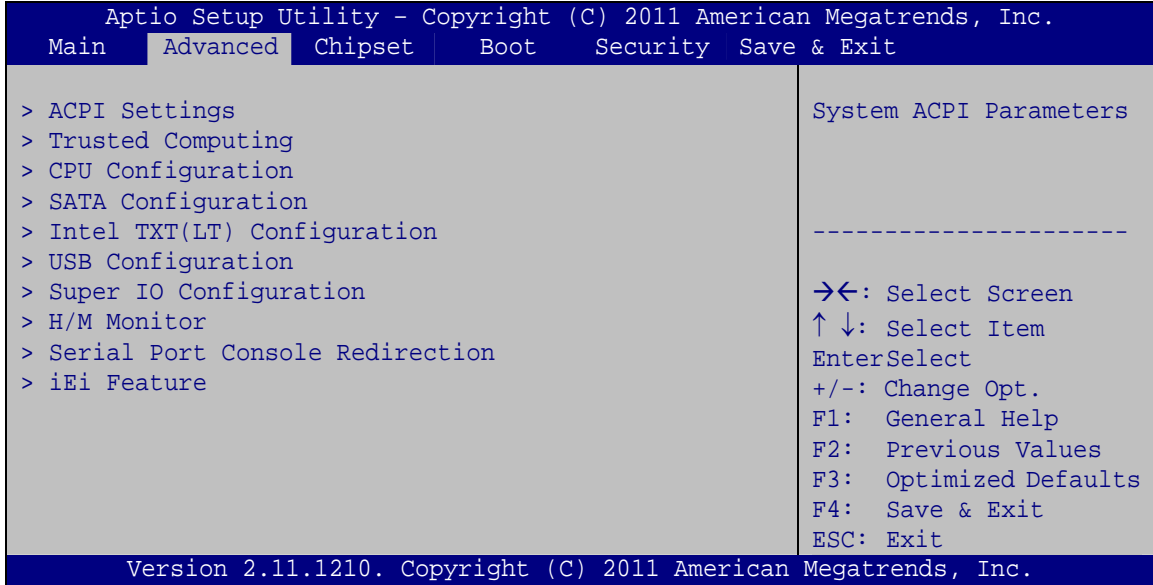

BIOS Menu 2: Advanced

5.3.1 ACPI Settings

The **ACPI Settings** menu (**BIOS Menu 3**) configures the Advanced Configuration and Power Interface (ACPI) options.

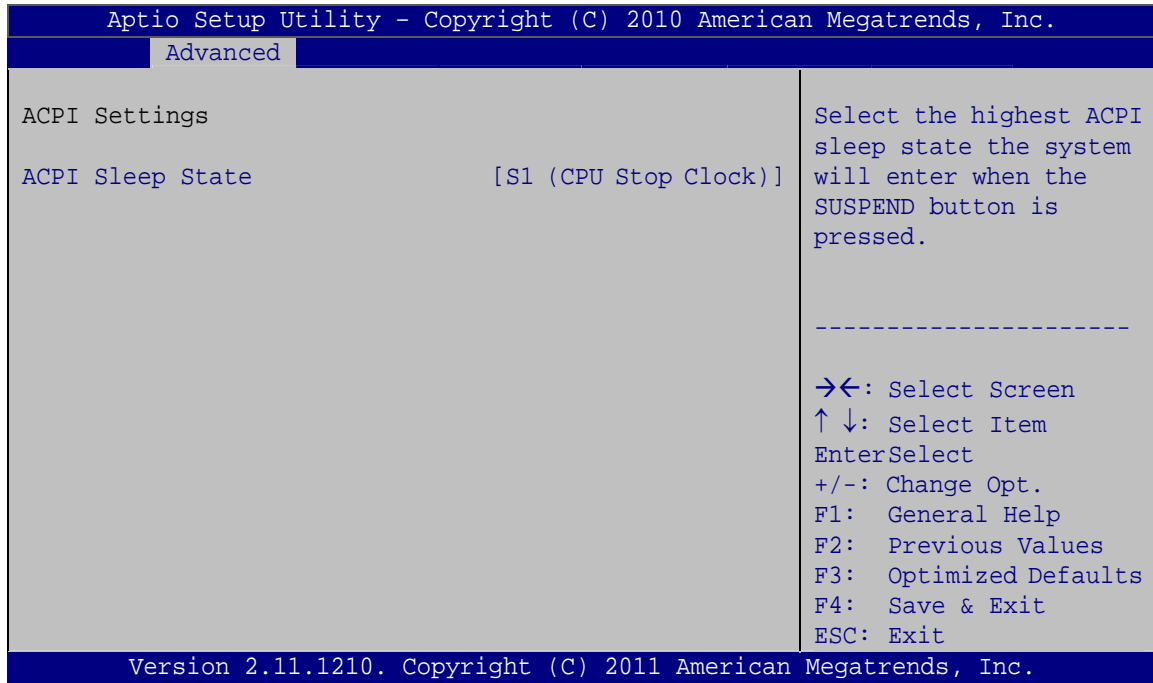

BIOS Menu 3: ACPI Configuration

WSB-H610 PICMG 1.0 CPU Card

→ ACPI Sleep State [S1 (CPU Stop Clock)]

Use the **ACPI Sleep State** option to specify the sleep state the system enters when it is not being used.

- **S1 (CPU Stop Clock)** **DEFAULT** The system enters S1 (POS) sleep state. The system appears off. The CPU is stopped; RAM is refreshed; the system is running in a low power mode.

- **S3 (Suspend to RAM)** The caches are flushed and the CPU is powered off. Power to the RAM is maintained. The computer returns slower to a working state, but more power is saved.

5.3.2 Trusted Computing

Use the **Trusted Computing** menu (**BIOS Menu 4**) to configure settings related to the Trusted Computing Group (TCG) Trusted Platform Module (TPM).

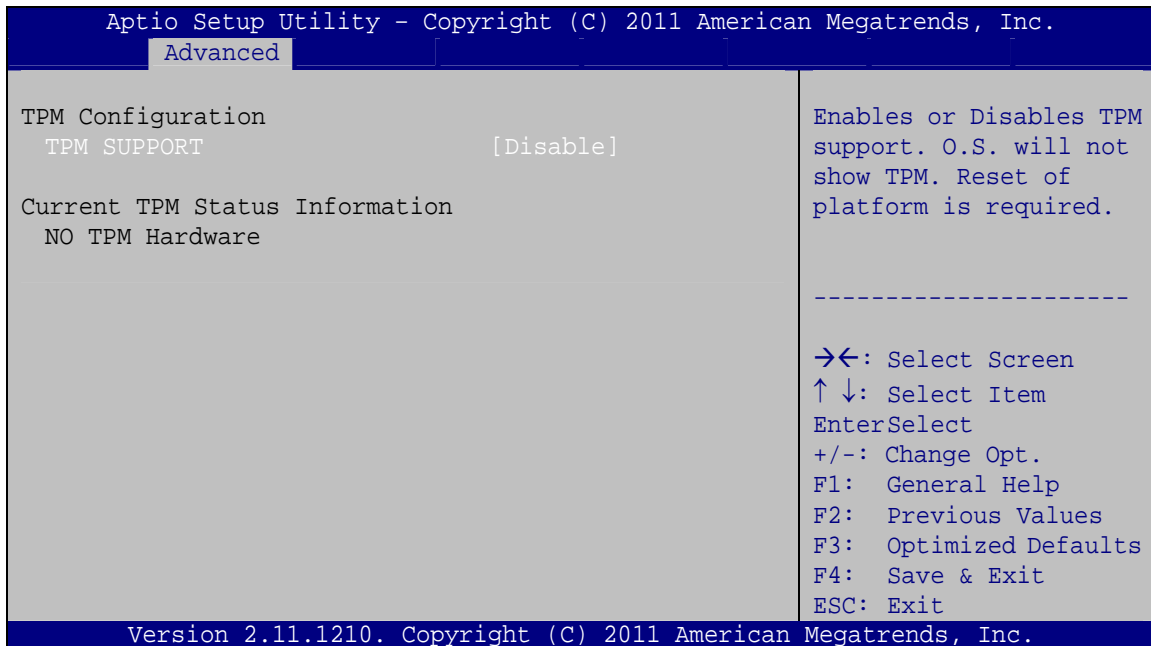

BIOS Menu 4: TPM Configuration

→ **TPM Support [Disable]**

Use the **TPM Support** option to configure support for the TPM.

- **Disable** **DEFAULT** TPM support is disabled.
- **Enable** TPM support is enabled.

5.3.3 CPU Configuration

Use the **CPU Configuration** menu (**BIOS Menu 5**) to enter the **CPU Information** submenu or enable Intel Virtualization Technology.

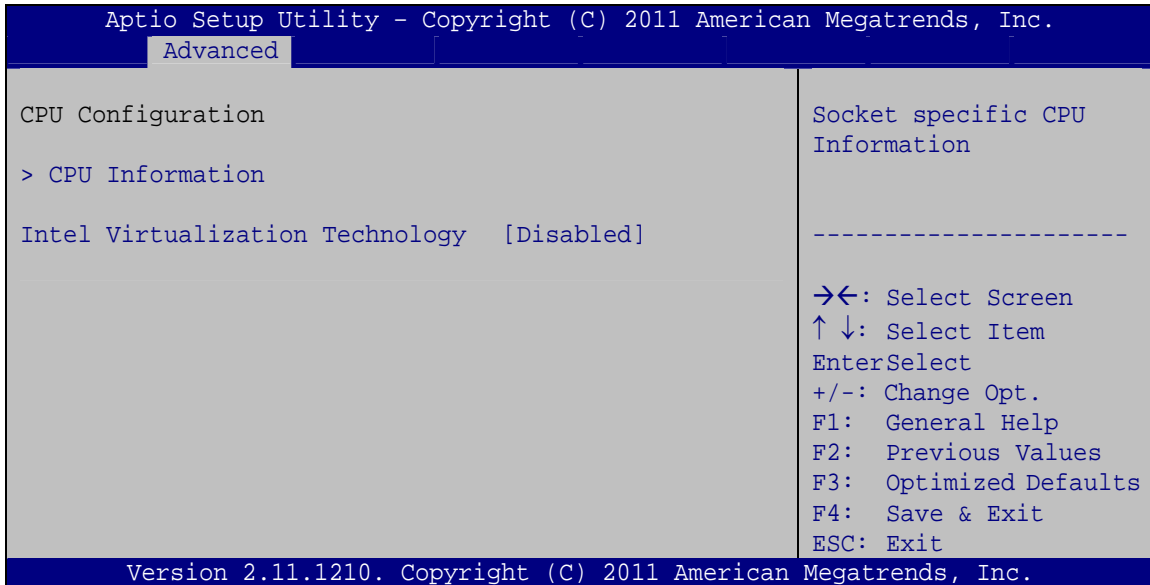

BIOS Menu 5: CPU Configuration

→ **Intel Virtualization Technology [Disabled]**

Use the **Intel Virtualization Technology** option to enable or disable virtualization on the system. When combined with third party software, Intel® Virtualization technology allows several OSs to run on the same system at the same time.

- **Disabled** **DEFAULT** Disables Intel Virtualization Technology.
- **Enabled** Enables Intel Virtualization Technology.

WSB-H610 PICMG 1.0 CPU Card

5.3.3.1 CPU Information

Use the **CPU Information** submenu (**BIOS Menu 6**) to view detailed CPU specifications and configure the CPU.

```

Aptio Setup Utility - Copyright (C) 2011 American Megatrends, Inc.
  Advanced
CPU Information

Intel(R) Core(TM) i5-2400 CPU 0 @ 3.10GHz
CPU Signature                206a7
Microcode Patch              14
Max CPU Speed                 3100 MHz
Min CPU Speed                 1600 MHz
Processor Cores               4
Intel HT Technology           Not Supported
Intel VT-x Technology         Supported
Intel SMX Technology          Supported

L1 Data Cache                 32 kB x 2
L1 Code Cache                 32 kB x 2
L2 Cache                      256 kB x 2
L3 Cache                      6144 kB

-----
-><: Select Screen
↑↓: Select Item
Enter>Select
+/-: Change Opt.
F1: General Help
F2: Previous Values
F3: Optimized Defaults
F4: Save & Exit
ESC: Exit

Version 2.11.1210. Copyright (C) 2011 American Megatrends, Inc.
  
```

BIOS Menu 6: CPU Configuration

The CPU Configuration menu (**BIOS Menu 6**) lists the following CPU details:

- Processor Type: Lists the brand name of the CPU being used
- CPU Signature: Lists the CPU signature value.
- Microcode Patch: Lists the microcode patch being used.
- Max CPU Speed: Lists the maximum CPU processing speed.
- Min CPU Speed: Lists the minimum CPU processing speed.
- Processor Cores: Lists the number of the processor core
- Intel HT Technology: Indicates if Intel HT Technology is supported by the CPU.
- Intel VT-x Technology: Indicates if Intel VT-x Technology is supported by the CPU.
- Intel SMX Technology: Indicates if Intel SMX Technology is supported by the CPU.
- L1 Data Cache: Lists the amount of data storage space on the L1 cache.
- L1 Code Cache: Lists the amount of code storage space on the L1 cache.

- L2 Cache: Lists the amount of storage space on the L2 cache.
- L3 Cache: Lists the amount of storage space on the L3 cache.

5.3.4 SATA Configuration

Use the **SATA Configuration** menu (**BIOS Menu 7**) to change and/or set the configuration of the SATA devices installed in the system.

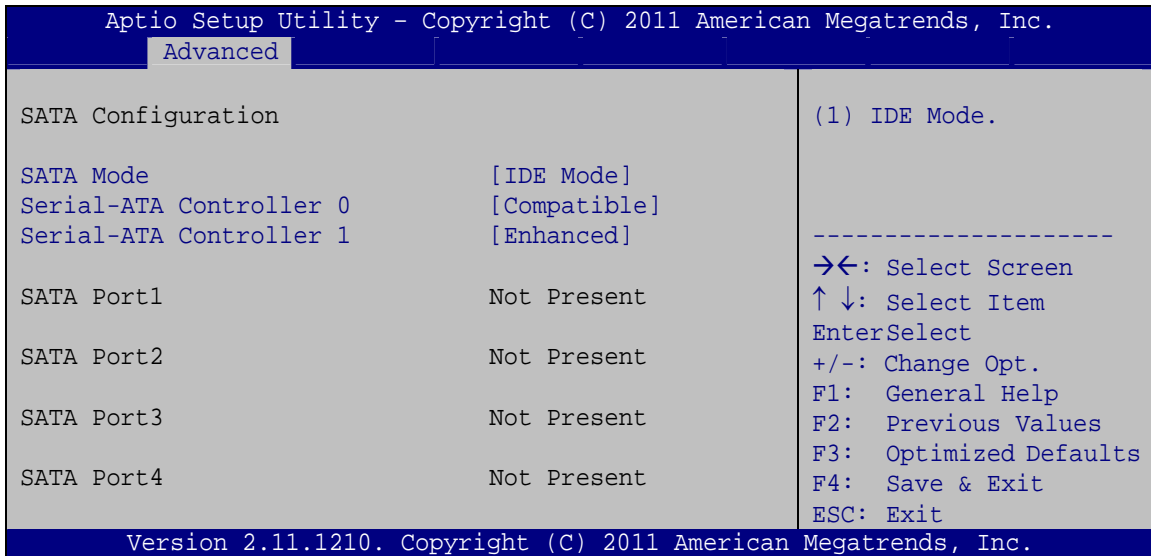

BIOS Menu 7: SATA Configuration

→ SATA Mode [IDE Mode]

Use the **SATA Mode** option to configure SATA devices as normal IDE devices.

- **IDE Mode** **DEFAULT** Configures SATA devices as normal IDE device.

→ Serial-ATA Controller 0 [Compatible]

Use the **Serial-ATA Controller 0** option to configure the serial ATA controller 0.

- **Disabled** Disables the on-board ATA controller.
- **Enhanced** Configures the on-board ATA controller to be in Enhanced mode. In this mode, IDE channels and SATA channels are separated. This mode supports up to 6

WSB-H610 PICMG 1.0 CPU Card

storage devices. Some legacy OS do not support this mode.

- **Compatible** **DEFAULT** Configures the on-board ATA controller to be in compatible mode. In this mode, a SATA channel will replace one of the IDE channels. This mode supports up to 4 storage devices.

→ **Serial-ATA Controller 1 [Enhanced]**

Use the **Serial-ATA Controller 1** option to configure the serial ATA controller 1.

- **Disabled** Disables the on-board ATA controller.
- **Enhanced** **DEFAULT** Configures the on-board ATA controller to be in Enhanced mode. In this mode, IDE channels and SATA channels are separated.

5.3.5 Intel TXT(LT) Configuration

Use the **Intel TXT(LT) Configuration** menu to configure Intel Trusted Execution Technology support.

```

Aptio Setup Utility - Copyright (C) 2011 American Megatrends, Inc.
  Advanced
-----
Intel Trusted Execution Technology Configuration

Intel TXT support only can be enabled/disabled if SMX
is enabled. VT and VT-d support must also be enabled prior
to TXT.

Secure Mode Extensons (SMX)            Enabled
Intel TXT(LT) Support                    [Disabled]

-----
-><: Select Screen
↑↓: Select Item
Enter>Select
+/-: Change Opt.
F1: General Help
F2: Previous Values
F3: Optimized Defaults
F4: Save & Exit
ESC: Exit

Version 2.11.1210. Copyright (C) 2011 American Megatrends, Inc.
  
```

BIOS Menu 8: Intel TXT(LT) Configuration

5.3.6 USB Configuration

Use the **USB Configuration** menu (**BIOS Menu 9**) to read USB configuration information and configure the USB settings.

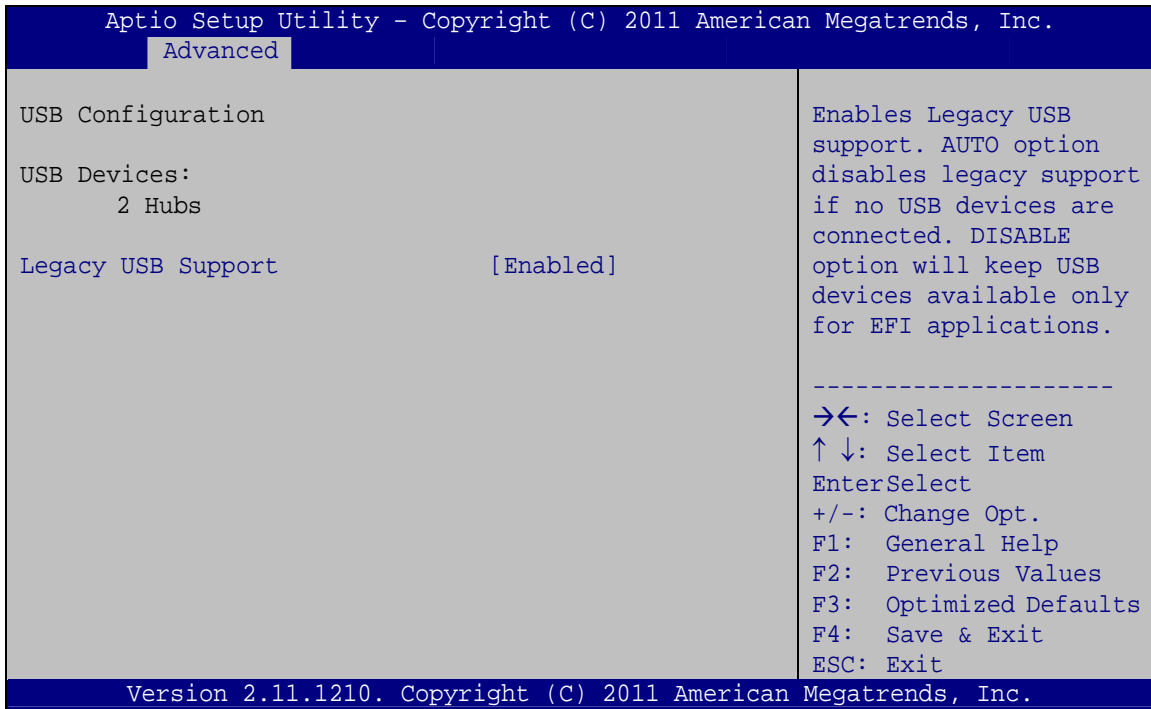

BIOS Menu 9: USB Configuration

→ USB Devices

The **USB Devices Enabled** field lists the USB devices that are enabled on the system

→ Legacy USB Support [Enabled]

Use the **Legacy USB Support** BIOS option to enable USB mouse and USB keyboard support. Normally if this option is not enabled, any attached USB mouse or USB keyboard does not become available until a USB compatible operating system is fully booted with all USB drivers loaded. When this option is enabled, any attached USB mouse or USB keyboard can control the system even when there is no USB driver loaded onto the system.

WSB-H610 PICMG 1.0 CPU Card

- ➔ **Enabled** **DEFAULT** Legacy USB support enabled
- ➔ **Disabled** Legacy USB support disabled
- ➔ **Auto** Legacy USB support is disabled if no USB devices are connected.

5.3.7 Super IO Configuration

Use the **Super IO Configuration** menu (**BIOS Menu 10**) to set or change the configurations for the FDD controllers, parallel ports and serial ports.

```

Aptio Setup Utility - Copyright (C) 2011 American Megatrends, Inc.
  Advanced
-----
Super IO Configuration
Super IO Chip                      Fintek F81866
> Floppy Disk Controller Configuration
> Serial Port 1 Configuration
> Serial Port 2 Configuration
> Serial Port 3 Configuration
> IrDA Configuration
> Parallel Port Configuration

Set Parameters of Floppy
Disk Controller (FDC)

-----
-><: Select Screen
↑ ↓: Select Item
Enter>Select
+/-: Change Opt.
F1: General Help
F2: Previous Values
F3: Optimized Defaults
F4: Save & Exit
ESC: Exit

Version 2.11.1210. Copyright (C) 2011 American Megatrends, Inc.
  
```

BIOS Menu 10: Super IO Configuration

5.3.7.1 Floppy Disk Controller Configuration

Use the **Floppy Disk Controller Configuration** menu (**BIOS Menu 12**) to configure the floppy disk controller.

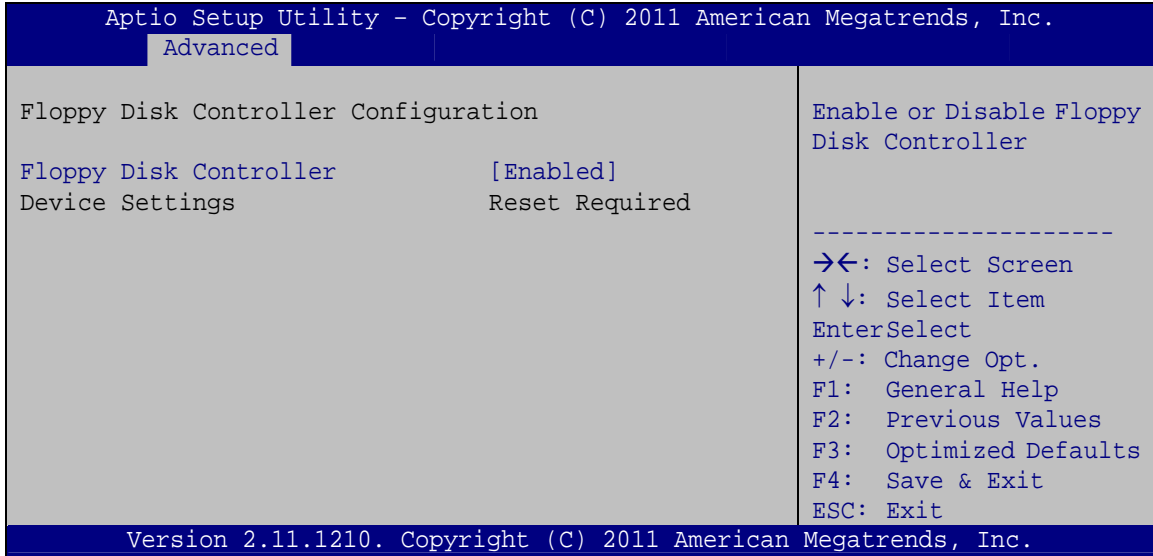

BIOS Menu 11: Serial Port n Configuration Menu

→ Floppy Disk Controller [Enabled]

Use the **Floppy Disk Controller** option to enable or disable the floppy disk controller.

- **Disabled** Floppy disk controller disabled
- **Enabled** **DEFAULT** Floppy disk controller enabled

5.3.7.2 Serial Port n Configuration

Use the **Serial Port n Configuration** menu (**BIOS Menu 12**) to configure the serial port n.

WSB-H610 PICMG 1.0 CPU Card

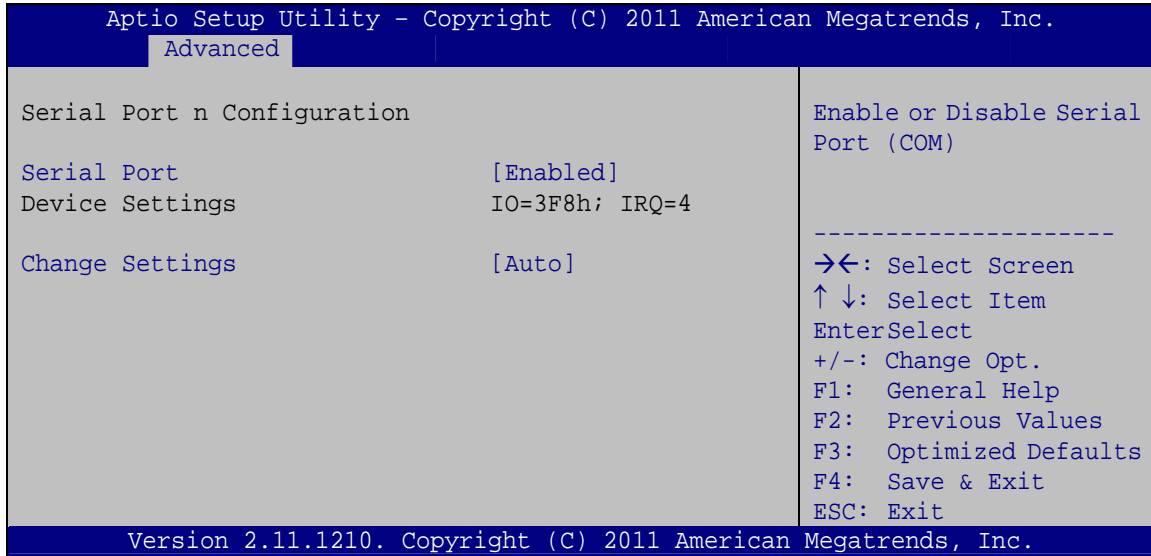

BIOS Menu 12: Serial Port n Configuration Menu

5.3.7.2.1 Serial Port 1 Configuration

→ Serial Port [Enabled]

Use the **Serial Port** option to enable or disable the serial port.

- **Disabled** Disable the serial port
- **Enabled** **DEFAULT** Enable the serial port

→ Change Settings [Auto]

Use the **Change Settings** option to change the serial port IO port address and interrupt address.

- **Auto** **DEFAULT** The serial port IO port address and interrupt address are automatically detected.
- **IO=3F8h;**
IRQ=4 Serial Port I/O port address is 3F8h and the interrupt address is IRQ4
- **IO=3F8h;**
IRQ=3, 4 Serial Port I/O port address is 3F8h and the interrupt address is IRQ3, 4

- **IO=2F8h;**
IRQ=3, 4 Serial Port I/O port address is 2F8h and the interrupt address is IRQ3, 4
- **IO=2C0h;**
IRQ=3, 4 Serial Port I/O port address is 2C0h and the interrupt address is IRQ3, 4
- **IO=2C8h;**
IRQ=3, 4 Serial Port I/O port address is 2C8h and the interrupt address is IRQ3, 4

5.3.7.2.2 Serial Port 2 Configuration

→ **Serial Port [Enabled]**

Use the **Serial Port** option to enable or disable the serial port.

- **Disabled** Disable the serial port
- **Enabled DEFAULT** Enable the serial port

→ **Change Settings [Auto]**

Use the **Change Settings** option to change the serial port IO port address and interrupt address.

- **Auto DEFAULT** The serial port IO port address and interrupt address are automatically detected.
- **IO=2F8h;**
IRQ=3 Serial Port I/O port address is 2F8h and the interrupt address is IRQ3
- **IO=3F8h;**
IRQ=3, 4 Serial Port I/O port address is 3F8h and the interrupt address is IRQ3, 4
- **IO=2F8h;**
IRQ=3, 4 Serial Port I/O port address is 2F8h and the interrupt address is IRQ3, 4
- **IO=2C0h;**
IRQ=3, 4 Serial Port I/O port address is 2C0h and the interrupt address is IRQ3, 4
- **IO=2C8h;**
IRQ=3, 4 Serial Port I/O port address is 2C8h and the interrupt address is IRQ3, 4

WSB-H610 PICMG 1.0 CPU Card

5.3.7.2.3 Serial Port 3 Configuration

→ Serial Port [Enabled]

Use the **Serial Port** option to enable or disable the serial port.

- **Disabled** Disable the serial port
- **Enabled DEFAULT** Enable the serial port

→ Change Settings [Auto]

Use the **Change Settings** option to change the serial port IO port address and interrupt address.

- **Auto DEFAULT** The serial port IO port address and interrupt address are automatically detected.
- **IO=2E8h;
IRQ=10** Serial Port I/O port address is 2E8h and the interrupt address is IRQ10
- **IO=3E8h;
IRQ=10, 11** Serial Port I/O port address is 3E8h and the interrupt address is IRQ10, 11
- **IO=2E8h;
IRQ=10, 11** Serial Port I/O port address is 2E8h and the interrupt address is IRQ10, 11
- **IO=2D0h;
IRQ=10, 11** Serial Port I/O port address is 2D0h and the interrupt address is IRQ10, 11
- **IO=2D8h;
IRQ=10, 11** Serial Port I/O port address is 2D8h and the interrupt address is IRQ10, 11

→ Device Mode [RS422/485]

Use the **Device Mode** option to select the serial port mode.

- **RS422/485 DEFAULT** Enables serial port RS-422/485 support.

5.3.7.2.4 IrDA Configuration

→ **Serial Port [Enabled]**

Use the **Serial Port** option to enable or disable the serial port.

- **Disabled** Disable the serial port
- **Enabled DEFAULT** Enable the serial port

→ **Change Settings [Auto]**

Use the **Change Settings** option to change the serial port IO port address and interrupt address.

- **Auto DEFAULT** The serial port IO port address and interrupt address are automatically detected.
- **IO=2E0h;
IRQ=10** Serial Port I/O port address is 2E0h and the interrupt address is IRQ10
- **IO=2C0h;
IRQ=10, 11** Serial Port I/O port address is 2C0h and the interrupt address is IRQ10, 11
- **IO=2C8h;
IRQ=10, 11** Serial Port I/O port address is 2C8h and the interrupt address is IRQ10, 11
- **IO=2D0h;
IRQ=10, 11** Serial Port I/O port address is 2D0h and the interrupt address is IRQ10, 11
- **IO=2D8h;
IRQ=10, 11** Serial Port I/O port address is 2D8h and the interrupt address is IRQ10, 11
- **IO=2E0h;
IRQ=10, 11** Serial Port I/O port address is 2E0h and the interrupt address is IRQ10, 11

WSB-H610 PICMG 1.0 CPU Card

5.3.7.3 Parallel Port Configuration

Use the **Parallel Port Configuration** menu (**BIOS Menu 12**) to configure the serial port n.

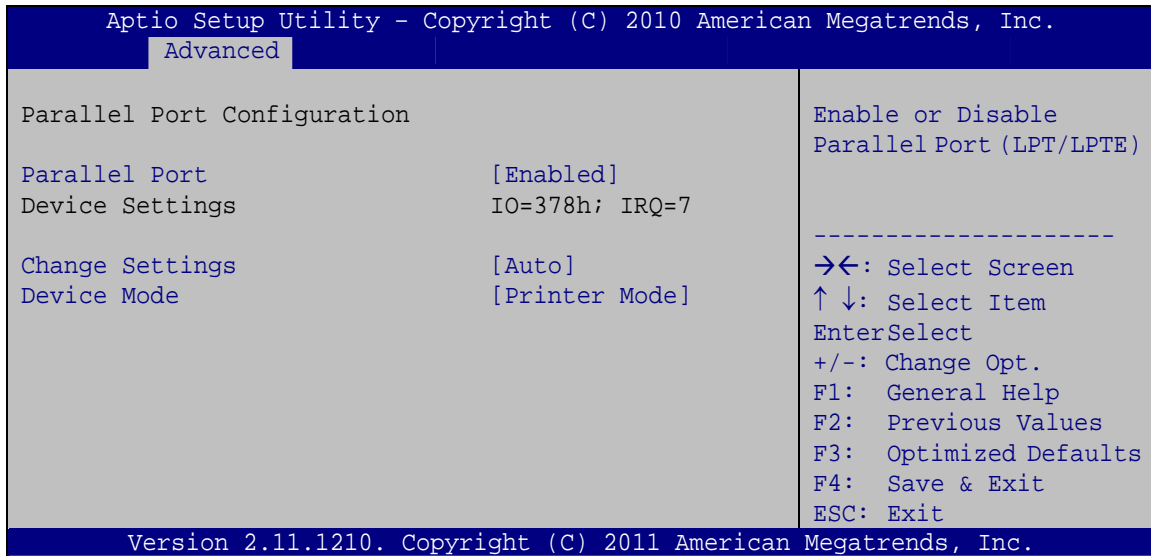

BIOS Menu 13: Parallel Port Configuration Menu

→ Parallel Port [Enabled]

Use the **Parallel Port** option to enable or disable the parallel port.

- **Disabled** Disable the parallel port
- **Enabled** **DEFAULT** Enable the parallel port

→ Change Settings [Auto]

Use the **Change Settings** option to change the parallel port IO port address and interrupt address.

- **Auto** **DEFAULT** The parallel port IO port address and interrupt address are automatically detected.
- **IO=378h;**
IRQ=7 Parallel Port I/O port address is 378h and the interrupt address is IRQ7

- IO=278h; Parallel Port I/O port address is 278h and the
 IRQ=7 interrupt address is IRQ7
- IO=3BCh; Parallel Port I/O port address is 3BCh and the
 IRQ=7 interrupt address is IRQ7

→ **Device Mode [Printer Mode]**

Use the **Device Mode** option to select the mode the parallel port operates in. Configuration options are listed below.

- Printer Mode **Default**
- SPP Mode
- EPP-1.9 and SPP Mode
- EPP-1.7 and SPP Mode
- ECP Mode
- ECP and EPP 1.9 Mode
- ECP and EPP 1.7 Mode

5.3.8 H/W Monitor

The H/W Monitor menu (**BIOS Menu 14**) contains the fan configuration submenus and displays operating temperature, fan speeds and system voltages.

WSB-H610 PICMG 1.0 CPU Card

```

Aptio Setup Utility - Copyright (C) 2011 American Megatrends, Inc.
Advanced
PC Health Status
CPU Temperature           :+52 C
Accuracy: 1.(-5~+10) degree around 100 degree
                2.(-10~+15) degree around 50 degree
SYS Temperature          :+34 C
CPU_FAN1 Speed           :2255 RPM
VCC3V                    :+3.344 V
V_CPU_CORE               :+1.248 V
+3.3V                    :+3.344 V
V_1P05_ME                :+1.048 V
V_SM                     :+1.616 V
VSB3V                    :+3.392 V
VBAT                     :+3.120 V
5VSB                     :+4.920 V

Smart FAN Configuration
-----
-><: Select Screen
↑↓: Select Item
EnterSelect
+/-: Change Opt.
F1:  General Help
F2:  Previous Values
F3:  Optimized Defaults
F4:  Save & Exit
ESC: Exit

> CPU_FAN1 Configuration
Version 2.11.1210. Copyright (C) 2011 American Megatrends, Inc.

```

BIOS Menu 14: H/W Monitor

→ PC Health Status

The following system parameters and values are shown. The system parameters that are monitored are:

- System Temperatures:
 - CPU Temperature
 - System Temperature
- Fan Speeds:
 - CPU Fan Speed
- Voltages:
 - VCC3V
 - V_CPU_CORE
 - +3.3V
 - V_1P05_ME
 - V_SM
 - VSB3V
 - VBAT
 - 5VSB

5.3.8.1 CPU_FAN 1 Configuration

Use the **CPU_FAN 1 Configuration submenu (BIOS Menu 15)** to configure fan 1 temperature and speed settings.

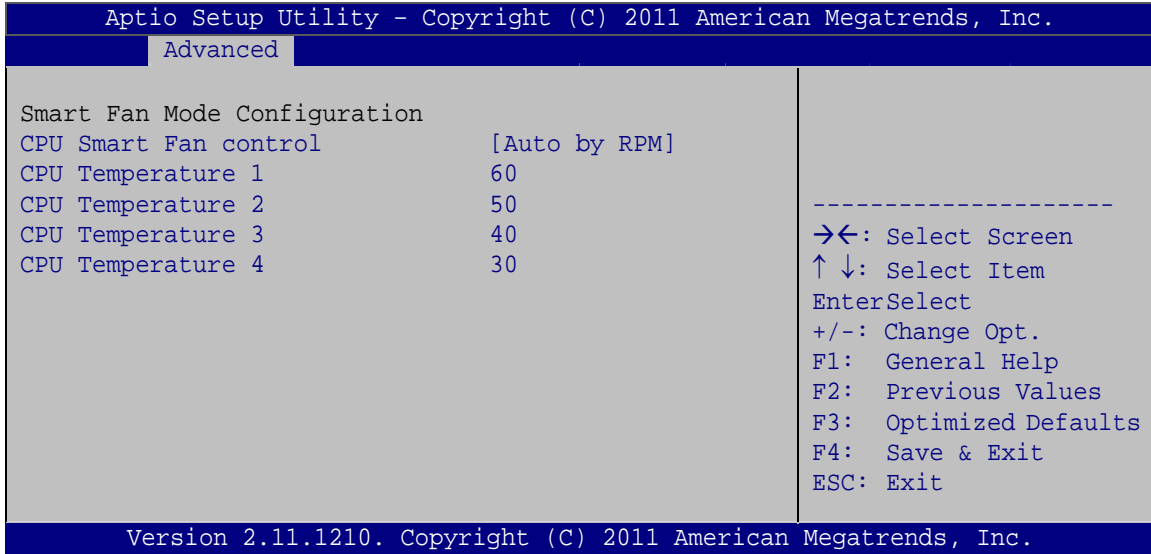

BIOS Menu 15: FAN 1 Configuration

→ CPU Smart Fan control [Auto by RPM]

Use the **CPU Smart Fan control** option to configure the CPU Smart Fan.

- **Auto by RPM** **DEFAULT** The fan adjusts its speed using Auto by RPM settings
- **Auto by Duty-Cycle** The fan adjusts its speed using Auto by Duty-Cycle settings
- **Manual by RPM** The fan spins at the speed set in Manual by RPM settings
- **Manual by Duty-Cycle** The fan spins at the speed set in Manual by Duty Cycle settings

→ CPU Temperature n

Use the + or – key to change the fan **CPU Temperature n** value. Enter a decimal number between 0 and 127.

WSB-H610 PICMG 1.0 CPU Card

5.3.9 Serial Port Console Redirection

The **Serial Port Console Redirection** menu (**BIOS Menu 16**) allows the console redirection options to be configured. Console redirection allows users to maintain a system remotely by re-directing keyboard input and text output through the serial port.

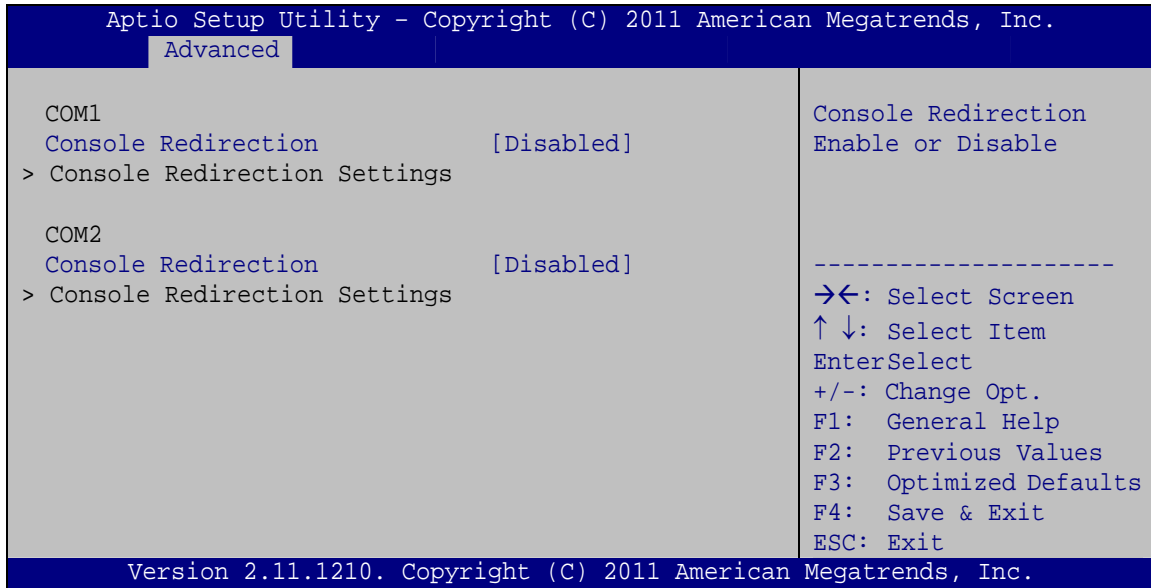

BIOS Menu 16: Serial Port Console Redirection

→ Console Redirection [Disabled]

Use **Console Redirection** option to enable or disable the console redirection function.

- **Disabled** **DEFAULT** Disabled the console redirection function
- **Enabled** Enabled the console redirection function

→ Terminal Type [ANSI]

Use the **Terminal Type** option to specify the remote terminal type.

- **VT100** The target terminal type is VT100
- **VT100+** The target terminal type is VT100+
- **VT-UTF8** The target terminal type is VT-UTF8
- **ANSI** **DEFAULT** The target terminal type is ANSI

→ Bits per second [115200]

Use the **Bits per second** option to specify the serial port transmission speed. The speed must match the other side. Long or noisy lines may require lower speeds.

- 9600** Sets the serial port transmission speed at 9600.
- 19200** Sets the serial port transmission speed at 19200.
- 38400** Sets the serial port transmission speed at 38400.
- 57600** Sets the serial port transmission speed at 57600.
- 115200** **DEFAULT** Sets the serial port transmission speed at 115200.

→ Data Bits [8]

Use the **Data Bits** option to specify the number of data bits.

- 7** Sets the data bits at 7.
- 8** **DEFAULT** Sets the data bits at 8.

→ Parity [None]

Use the **Parity** option to specify the parity bit that can be sent with the data bits for detecting the transmission errors.

- None** **DEFAULT** No parity bit is sent with the data bits.
- Even** The parity bit is 0 if the number of ones in the data bits is even.
- Odd** The parity bit is 0 if the number of ones in the data bits is odd.
- Mark** The parity bit is always 1. This option does not provide error detection.
- Space** The parity bit is always 0. This option does not provide error detection.

WSB-H610 PICMG 1.0 CPU Card

→ Stop Bits [1]

Use the **Stop Bits** option to specify the number of stop bits used to indicate the end of a serial data packet. Communication with slow devices may require more than 1 stop bit.

- 1 **DEFAULT** Sets the number of stop bits at 1.
- 2 Sets the number of stop bits at 2.

→ Flow Control [None]

Use the **Flow Control** option to report the flow control method for the console redirection application.

- **None** **DEFAULT** No control flow.
- **Hardware**
RTS/CTS Hardware is set as the console redirection.

5.3.10 iEi Feature

Use the **iEi Feature** menu (**BIOS Menu 17**) to configure One Key Recovery function.

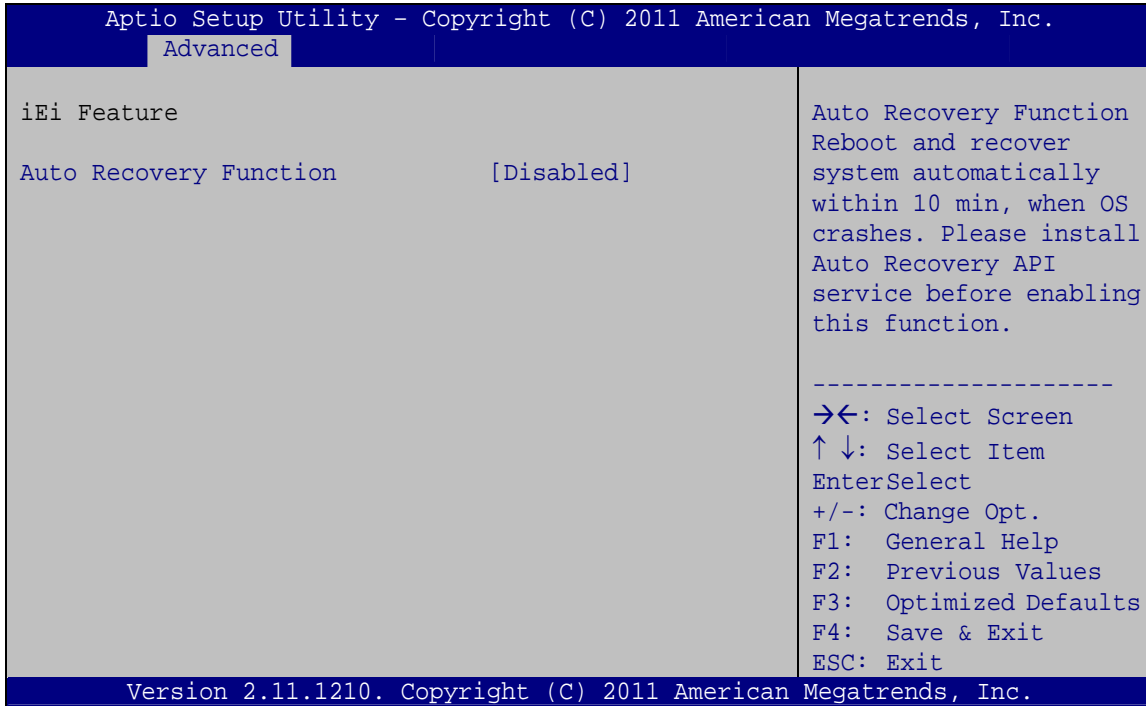

BIOS Menu 17: IEI Feature

➔ **Auto Recovery Function [Disabled]**

Use the **Auto Recovery Function** BIOS option to enable or disable the auto recovery function of the IEI One Key Recovery.

- ➔ **Disabled** **DEFAULT** Auto recovery function disabled
- ➔ **Enabled** Auto recovery function enabled

5.4 Chipset

Use the **Chipset** menu (**BIOS Menu 18**) to access the Northbridge, Southbridge, Integrated Graphics, and ME Subsystem configuration menus.



WARNING!

Setting the wrong values for the Chipset BIOS selections in the Chipset BIOS menu may cause the system to malfunction.

WSB-H610 PICMG 1.0 CPU Card

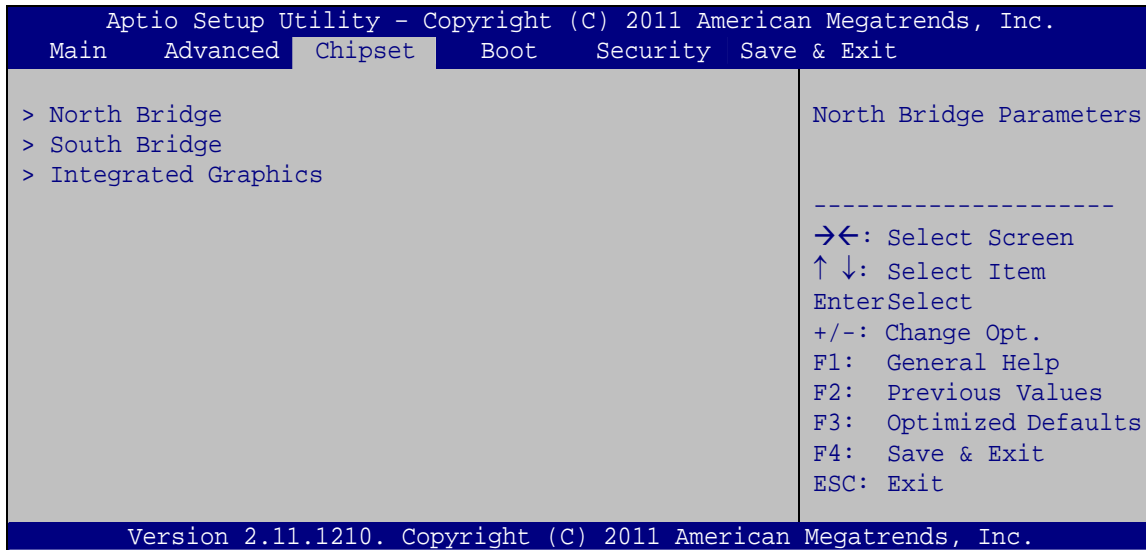

BIOS Menu 18: Chipset

5.4.1 Northbridge Configuration

Use the **North Bridge** menu (**BIOS Menu 19**) to configure the Northbridge chipset.

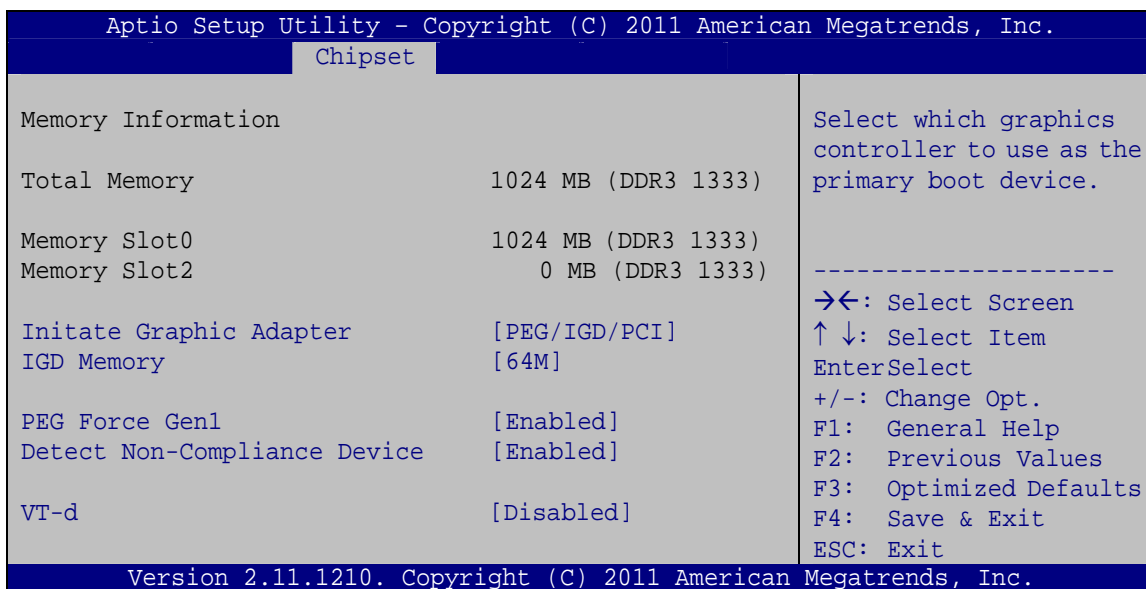

BIOS Menu 19:Northbridge Chipset Configuration

→ Initiate Graphic Adapter [PEG/IGD/PCI]

Use the **Initiate Graphic Adapter** option to select the graphics controller used as the primary boot device. Select either an integrated graphics controller (IGD) or a combination

of PCI graphics controller, a PCI express (PEG) controller or an IGD. Configuration options are listed below:

- IGD
- PEG/IGD/PCI **DEFAULT**

→ IGD Memory [64M]

Use the **IGD Memory** option to specify the amount of system memory that can be used by the internal graphics device.

- | | | |
|---|----------------|---|
| → | Disable | |
| → | 32M | 32 MB of memory used by internal graphics device |
| → | 64M | DEFAULT 64 MB of memory used by internal graphics device |
| → | 96M | 96 MB of memory used by internal graphics device |
| → | 128M | 128 MB of memory used by internal graphics device |
| → | 160M | 160 MB of memory used by internal graphics device |
| → | 192M | 192 MB of memory used by internal graphics device |
| → | 224M | 224 MB of memory used by internal graphics device |
| → | 256M | 256 MB of memory used by internal graphics device |
| → | 288M | 288 MB of memory used by internal graphics device |
| → | 320M | 320 MB of memory used by internal graphics device |
| → | 352M | 352 MB of memory used by internal graphics device |
| → | 384M | 384 MB of memory used by internal graphics device |

WSB-H610 PICMG 1.0 CPU Card

- ➔ **416M** 416 MB of memory used by internal graphics device
- ➔ **448M** 448 MB of memory used by internal graphics device
- ➔ **480M** 480 MB of memory used by internal graphics device
- ➔ **512M** 512 MB of memory used by internal graphics device

➔ **PEG Force Gen1 [Enabled]**

Use the **PEG Force Gen1** option to force the PCI Express port to run at Gen1 speed.

- ➔ **Disabled** Disables this function.
- ➔ **Enabled** **DEFAULT** Force the PCI Express port to run at Gen1 speed.

➔ **Detect Non-Compliance Device [Enabled]**

Use the **Detect Non-Compliance Device** option to enable or disable detecting if a non-compliance PCI Express device is connected to the PCI Express port.

- ➔ **Disabled** Disables to detect if a non-compliance PCI Express device is connected to the PCI Express port.
- ➔ **Enabled** **DEFAULT** Enables to detect if a non-compliance PCI Express device is connected to the PCI Express port.

➔ **VT-d [Disabled]**

Use the **VT-d** option to enable or disable VT-d support.

- ➔ **Disabled** **DEFAULT** Disables VT-d support.
- ➔ **Enabled** Enables VT-d support.

5.4.2 Southbridge Configuration

Use the **South Bridge** menu (**BIOS Menu 20**) to configure the Southbridge chipset.

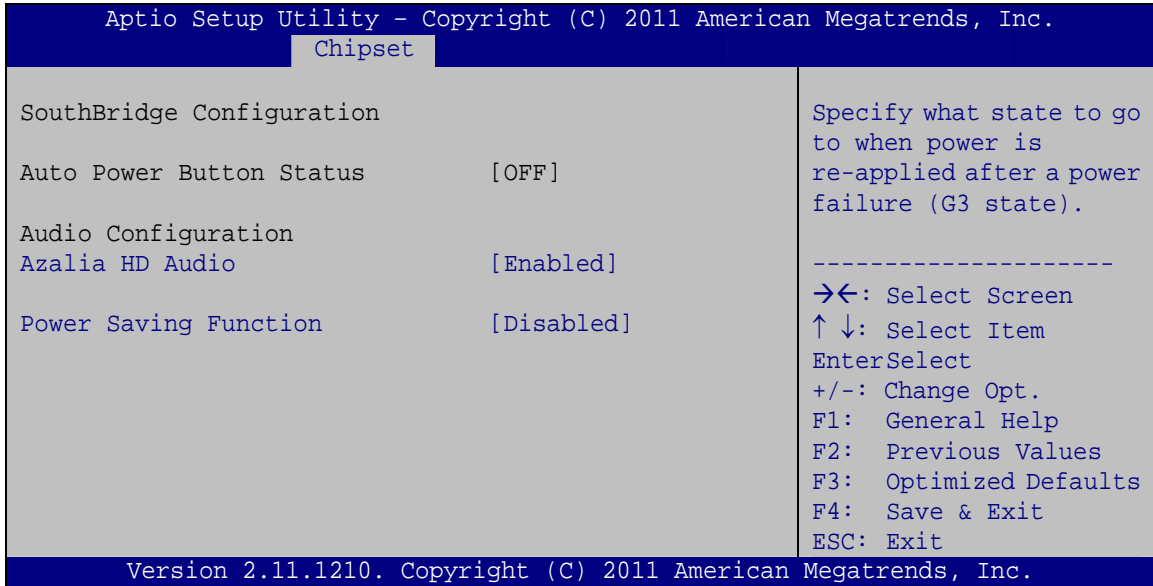

BIOS Menu 20: Southbridge Chipset Configuration

→ Azalia HD Audio [Enabled]

Use the **Azalia HD Audio** option to enable or disable the High Definition Audio controller.

- **Disabled** The onboard High Definition Audio controller is disabled
- **Enabled** **DEFAULT** The onboard High Definition Audio controller is detected automatically and enabled

→ Power Saving Function [Disabled]

Use the **Power Saving Function** BIOS option to enable or reduce power consumption in the S5 state. When enabled, the system can only be powered-up using the power button.

- **Disabled** **DEFAULT** Power saving function support disabled
- **Enabled** Power saving function support enabled

WSB-H610 PICMG 1.0 CPU Card

5.4.3 Integrated Graphics

Use the **Integrated Graphics** menu (**BIOS Menu 21**) to configure the video device connected to the system.

```

Aptio Setup Utility - Copyright (C) 2011 American Megatrends, Inc.
-----
Advanced
-----
Intel IGD SWSCI OpRegion Configuration
DVMT Mode Select          [DVMT Mode]
DVMT Memory               [Maximum]
IGD - Boot Type          [AUTO]

Select DVMT Mode used by
Internal Graphics
Device. If Fixed Mode
selected, IGD Memory
might need to be changed
to a larger value, for
IGD to have sufficient
memory.

-----
-><: Select Screen
↑↓: Select Item
Enter>Select
+/-: Change Opt.
F1:  General Help
F2:  Previous Values
F3:  Optimized Defaults
F4:  Save & Exit
ESC: Exit

Version 2.11.1211. Copyright (C) 2011 American Megatrends, Inc.
  
```

BIOS Menu 21: Integrated Graphics

→ DVMT Mode Select [DVMT Mode]

Use the **DVMT Mode Select** option to select the Intel Dynamic Video Memory Technology (DVMT) operating mode.

- **Fixed Mode** A fixed portion of graphics memory is reserved as graphics memory.
- **DVMT Mode** **DEFAULT** Graphics memory is dynamically allocated according to the system and graphics needs.

→ **DVMT Memory [Maximum]**

Use the **DVMT Memory** option to specify the maximum amount of memory that can be allocated as graphics memory. Configuration options are listed below.

- 128 MB
- 256 MB
- Maximum **DEFAULT**

→ **IGD - Boot Type [AUTO]**

Use the **IGD - Boot Type** option to select the display device used by the system when it boots. For dual display support, select “Auto.” Configuration options are listed below.

- AUTO **DEFAULT**
- CRT
- DVI

5.5 Boot

Use the **Boot** menu (**BIOS Menu 22**) to configure system boot options.

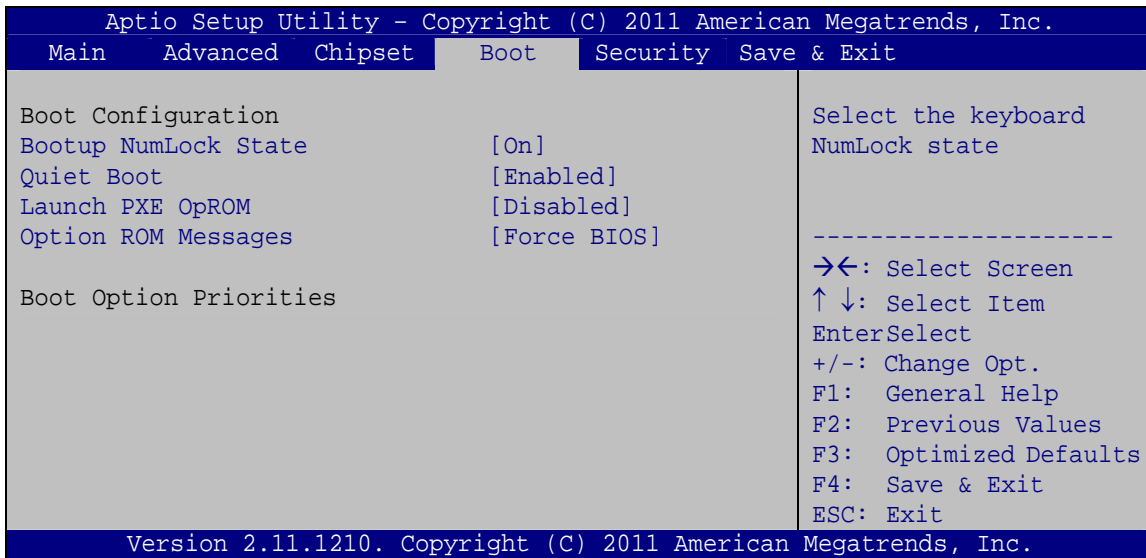

BIOS Menu 22: Boot

WSB-H610 PICMG 1.0 CPU Card

→ **Bootup NumLock State [On]**

Use the **Bootup NumLock State** BIOS option to specify if the number lock setting must be modified during boot up.

- | | | |
|--------------|----------------|--|
| → On | DEFAULT | Allows the Number Lock on the keyboard to be enabled automatically when the computer system boots up. This allows the immediate use of the 10-key numeric keypad located on the right side of the keyboard. To confirm this, the Number Lock LED light on the keyboard is lit. |
| → Off | | Does not enable the keyboard Number Lock automatically. To use the 10-keys on the keyboard, press the Number Lock key located on the upper left-hand corner of the 10-key pad. The Number Lock LED on the keyboard lights up when the Number Lock is engaged. |

→ **Quiet Boot [Enabled]**

Use the **Quiet Boot** BIOS option to select the screen display when the system boots.

- | | | |
|-------------------|----------------|---|
| → Disabled | | Normal POST messages displayed |
| → Enabled | DEFAULT | OEM Logo displayed instead of POST messages |

→ **Launch PXE OpROM [Disabled]**

Use the **Launch PXE OpROM** option to enable or disable boot option for legacy network devices.

- | | | |
|-------------------|----------------|----------------------------|
| → Disabled | DEFAULT | Ignore all PXE Option ROMs |
| → Enabled | | Load PXE Option ROMs. |

➔ **Option ROM Messages [Force BIOS]**

Use the **Option ROM Messages** option to set the Option ROM display mode.

- ➔ **Force BIOS** **DEFAULT** Sets display mode to force BIOS.
- ➔ **Keep Current** Sets display mode to current.

5.6 Security

Use the **Security** menu (**BIOS Menu 23**) to set system and user passwords.

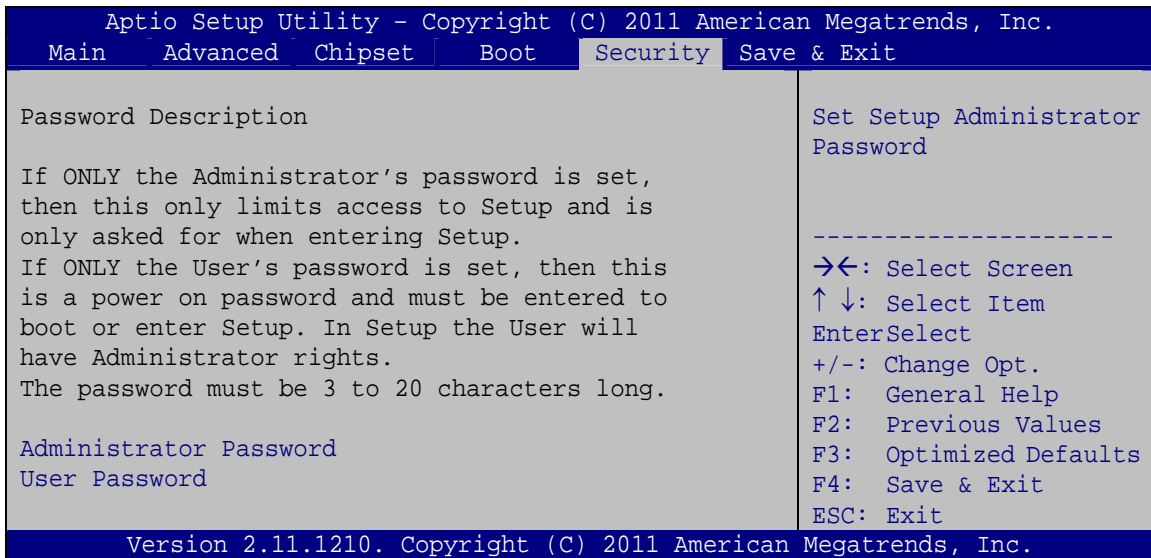

BIOS Menu 23: Security

➔ **Administrator Password**

Use the **Administrator Password** to set or change a administrator password.

➔ **User Password**

Use the **User Password** to set or change a user password.

WSB-H610 PICMG 1.0 CPU Card

5.7 Exit

Use the **Exit** menu (**BIOS Menu 24**) to load default BIOS values, optimal failsafe values and to save configuration changes.

```

Aptio Setup Utility - Copyright (C) 2011 American Megatrends, Inc.
Main   Advanced  Chipset  Boot   Security  Save & Exit
-----
Save Changes and Reset
Discard Changes and Reset

Restore Defaults
Save as User Defaults
Restore User Defaults

Exit the system after
saving the changes.

-----
-><: Select Screen
↑ ↓: Select Item
Enter>Select
+/-: Change Opt.
F1:  General Help
F2:  Previous Values
F3:  Optimized Defaults
F4:  Save & Exit
ESC: Exit

Version 2.11.1210. Copyright (C) 2011 American Megatrends, Inc.

```

BIOS Menu 24:Exit**→ Save Changes and Reset**

Use the **Save Changes and Reset** option to save the changes made to the BIOS options and reset the system.

→ Discard Changes and Reset

Use the **Discard Changes and Reset** option to exit the system without saving the changes made to the BIOS configuration setup program.

→ Restore Defaults

Use the **Restore Defaults** option to load the optimal default values for each of the parameters on the Setup menus. **F3 key can be used for this operation.**

→ **Save as User Defaults**

Use the **Save as User Defaults** option to save the changes done so far as user defaults.

→ **Restore User Defaults**

Use the **Restore User Defaults** option to restore the user defaults to all the setup options.

Chapter

6

Software Drivers

6.1 Available Software Drivers



NOTE:

The content of the CD may vary throughout the life cycle of the product and is subject to change without prior notice. Visit the IEI website or contact technical support for the latest updates.

The following drivers can be installed on the system:

- Chipset
- Graphic
- LAN
- Audio
- Intel® AMT
 - Intel® Management Engine Components driver
 - Intel® IT Director application

Installation instructions are given below.

6.2 Software Installation

All the drivers for the WSB-H610 are on the CD that came with the system. To install the drivers, please follow the steps below.

Step 1: Insert the CD into a CD drive connected to the system.



NOTE:

If the installation program doesn't start automatically:
Click "Start->My Computer->CD Drive->autorun.exe"

Step 2: The driver main menu appears (**Figure 6-1**).

WSB-H610 PICMG 1.0 CPU Card

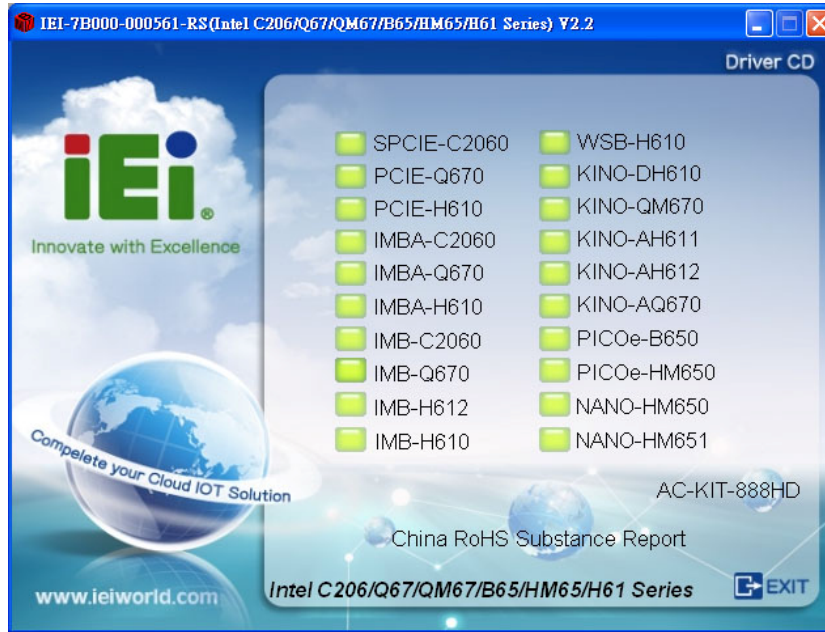

Figure 6-1: Introduction Screen

Step 3: Click WSB-H610.

Step 4: A new screen with a list of available drivers appears (**Figure 6-2**).



Figure 6-2: Available Drivers

Step 5: Install all of the necessary drivers in this menu.

6.3 Chipset Driver Installation

To install the chipset driver, please do the following.

Step 1: Access the driver list. (See **Section 6.2**)

Step 2: Click “Chipset”.

Step 3: Locate the setup file and double click on it.

Step 4: The setup files are extracted as shown in **Figure 6-3**.

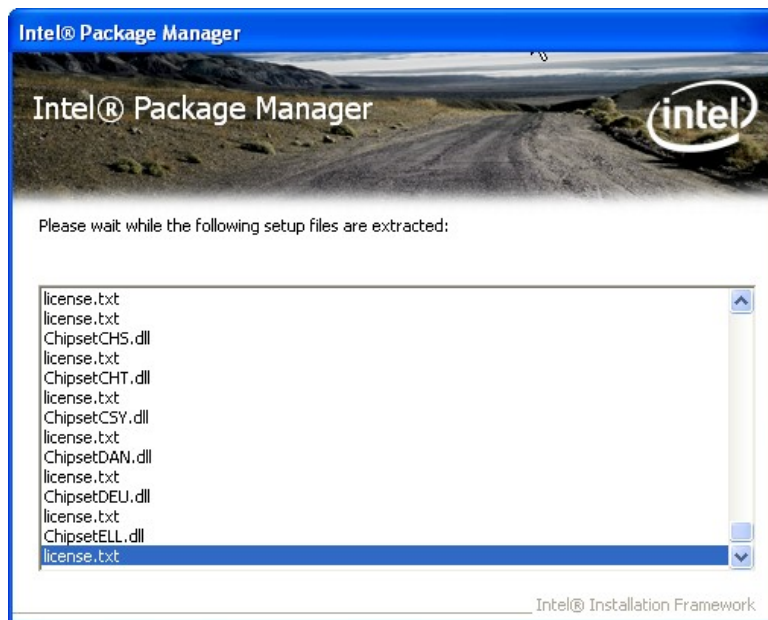

Figure 6-3: Chipset Driver Screen

Step 5: When the setup files are completely extracted the **Welcome Screen** in **Figure 6-4** appears.

Step 6: Click **Next** to continue.

WSB-H610 PICMG 1.0 CPU Card



Figure 6-4: Chipset Driver Welcome Screen

Step 7: The license agreement in Figure 6-5 appears.

Step 8: Read the License Agreement.

Step 9: Click Yes to continue.



Figure 6-5: Chipset Driver License Agreement

Step 10: The Read Me file in Figure 6-6 appears.

Step 11: Click **Next** to continue.



Figure 6-6: Chipset Driver Read Me File

Step 12: **Setup Operations** are performed as shown in **Figure 6-7**.

Step 13: Once the **Setup Operations** are complete, click **Next** to continue.



Figure 6-7: Chipset Driver Setup Operations

WSB-H610 PICMG 1.0 CPU Card

Step 14: The **Finish** screen in **Figure 6-8** appears.

Step 15: Select “**Yes, I want to restart this computer now**” and click **Finish**.



Figure 6-8: Chipset Driver Installation Finish Screen

6.4 Graphics Driver Installation

To install the Graphics driver, please do the following.

Step 1: Access the driver list. (See **Section 6.2**)

Step 2: Click “**VGA**” and select the folder which corresponds to the operating system.

Step 3: Double click the setup file.

Step 4: The **Welcome Screen** in **Figure 6-9** appears.

Step 5: Click **Next** to continue.

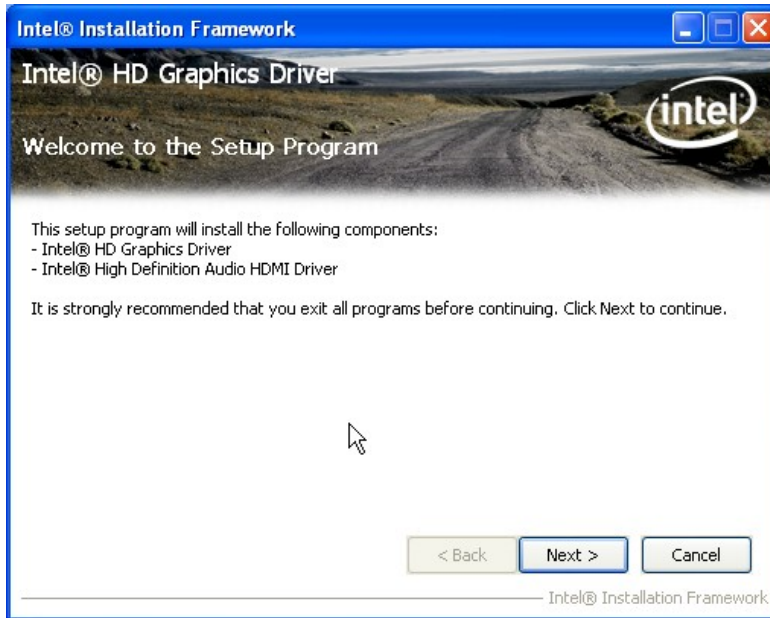

Figure 6-9: Graphics Driver Welcome Screen

Step 6: The **License Agreement** in **Figure 6-10** appears.

Step 7: Click **Yes** to accept the agreement and continue.



Figure 6-10: Graphics Driver License Agreement

Step 8: **Setup Operations** are performed as shown in **Figure 6-11**.

WSB-H610 PICMG 1.0 CPU Card

Step 9: Once the **Setup Operations** are complete, click **Next** to continue.

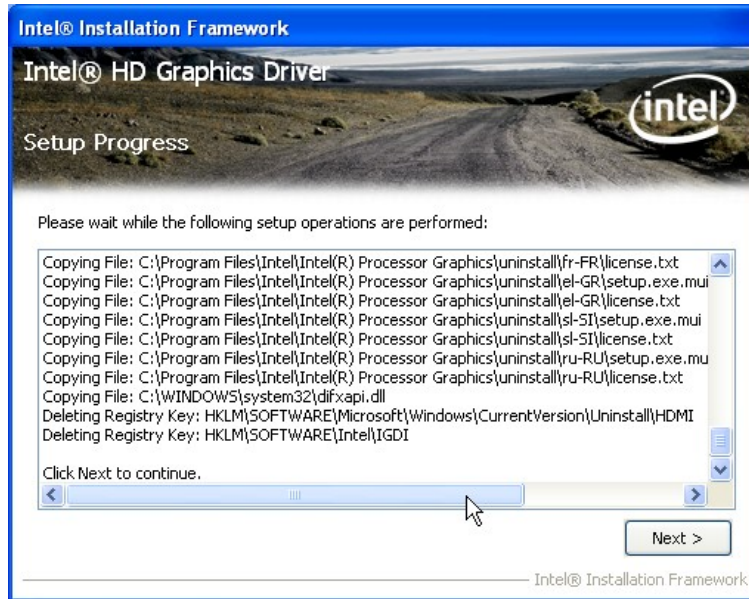

Figure 6-11: Graphics Driver Setup Operations

Step 10: The **Finish** screen in **Figure 6-12** appears.

Step 11: Select **“Yes, I want to restart this computer now”** and click **Finish**.

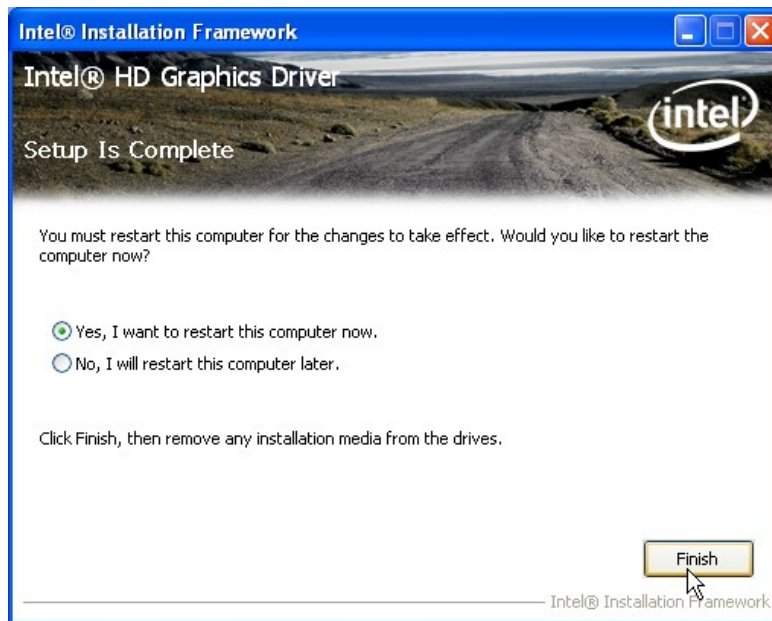

Figure 6-12: Graphics Driver Installation Finish Screen

6.5 LAN Driver Installation

To install the LAN driver, please do the following.

Step 1: Access the driver list. (See **Section 6.2**)

Step 2: Click “LAN”.

Step 3: Locate the Autorun file and double click it.

Step 4: The **Welcome** screen in **Figure 6-13** appears.

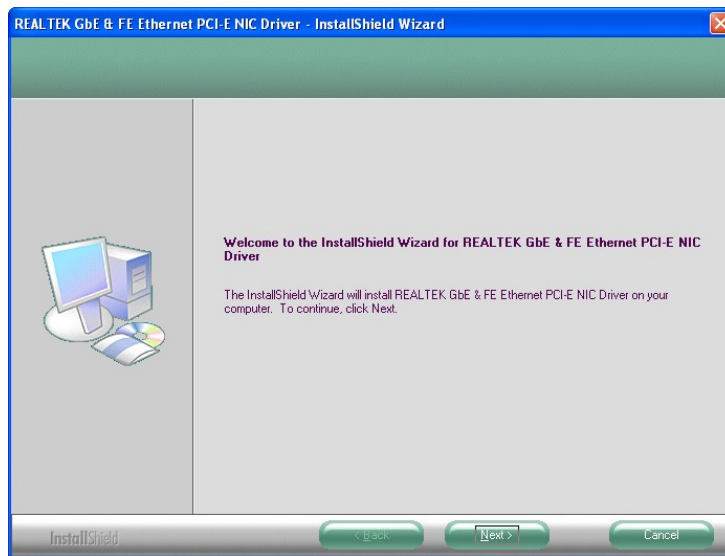

Figure 6-13: LAN Driver Welcome Screen

Step 5: Click **Next** to continue.

Step 6: The **Ready to Install the Program** screen in **Figure 6-14** appears.

Step 7: Click **Install** to proceed with the installation.

WSB-H610 PICMG 1.0 CPU Card

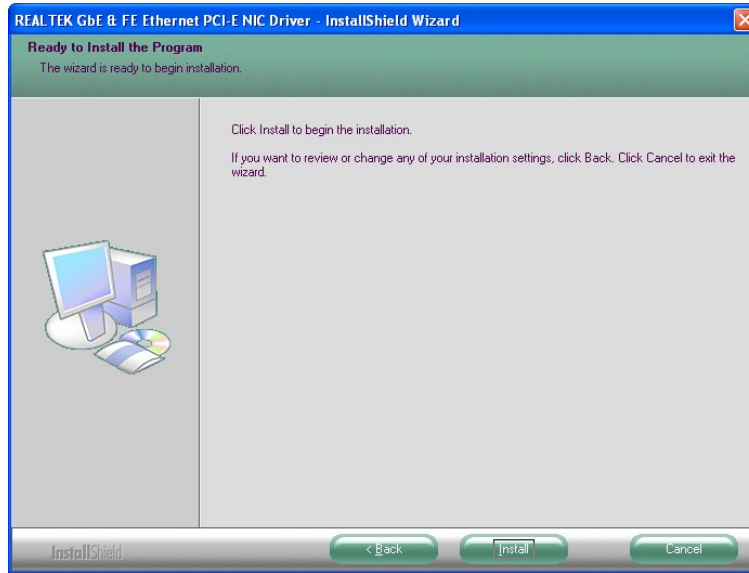

Figure 6-14: LAN Driver Installation

Step 8: The program begins to install.

Step 9: When the driver installation is complete, the screen in **Figure 6-15** appears.

Step 10: Click **Finish** to exit.

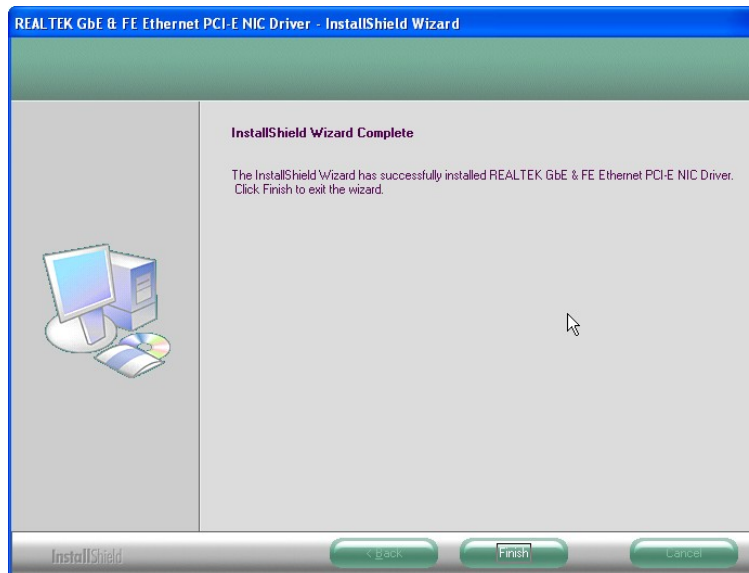

Figure 6-15: LAN Driver Installation Complete

6.6 Audio Driver Installation

To install the audio driver, please do the following.

Step 1: Access the driver list. (See **Section 6.2**)

Step 2: Click “**Audio**” and select the folder which corresponds to the operating system.

Step 3: Double click the setup file.

Step 4: The InstallShield Wizard starts to extracting files (**Figure 6-16**).



Figure 6-16: Audio Driver – Extracting Files

Step 5: The Audio Driver Installation screen in **Figure 6-17** appears.

Step 6: Click **Yes** to install the audio driver.

WSB-H610 PICMG 1.0 CPU Card



Figure 6-17: Audio Driver Installation Welcome Screen

Step 7: The driver installation begins. See **Figure 6-18**.

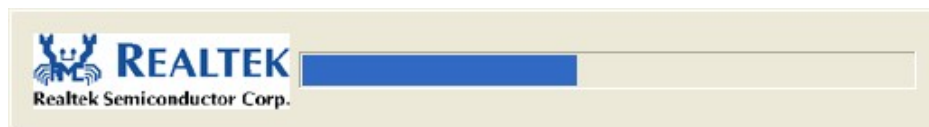

Figure 6-18: Audio Driver Installation

Step 8: When the driver is installed, the driver installation finish screen in **Figure 6-19** appears.

Step 9: Select “Yes, I wish to restart my computer now” and click **Finish**.



Figure 6-19: Audio Driver Installation Complete

Step 10: The system reboots.

Appendix

A

Regulatory Compliance

DECLARATION OF CONFORMITY

This equipment has been tested and found to comply with specifications for CE marking. If the user modifies and/or installs other devices in the equipment, the CE conformity declaration may no longer apply.

FCC WARNING

This equipment complies with Part 15 of the FCC Rules. Operation is subject to the following two conditions:

- This device may not cause harmful interference, and
- This device must accept any interference received, including interference that may cause undesired operation.

This equipment has been tested and found to comply with the limits for a Class A digital device, pursuant to part 15 of the FCC Rules. These limits are designed to provide reasonable protection against harmful interference when the equipment is operated in a commercial environment. This equipment generates, uses, and can radiate radio frequency energy and, if not installed and used in accordance with the instruction manual, may cause harmful interference to radio communications. Operation of this equipment in a residential area is likely to cause harmful interference in which case the user will be required to correct the interference at his own expense.

Appendix

B

BIOS Options

WSB-H610 PICMG 1.0 CPU Card

Below is a list of BIOS configuration options in the BIOS chapter.

System Overview	68
Memory Information	69
System Date [xx/xx/xx]	69
System Time [xx:xx:xx]	69
ACPI Sleep State [S1 (CPU Stop Clock)]	71
TPM Support [Disable]	72
Intel Virtualization Technology [Disabled]	72
SATA Mode [IDE Mode]	74
Serial-ATA Controller 0 [Compatible]	74
Serial-ATA Controller 1 [Enhanced]	75
USB Devices	76
Legacy USB Support [Enabled]	76
Floppy Disk Controller [Enabled]	78
Serial Port [Enabled]	79
Change Settings [Auto]	79
Serial Port [Enabled]	80
Change Settings [Auto]	80
Serial Port [Enabled]	81
Change Settings [Auto]	81
Device Mode [RS422/485]	81
Serial Port [Enabled]	82
Change Settings [Auto]	82
Parallel Port [Enabled]	83
Change Settings [Auto]	83
Device Mode [Printer Mode]	84
PC Health Status	85
CPU Smart Fan control [Auto by RPM]	86
CPU Temperature n	86
Console Redirection [Disabled]	87
Terminal Type [ANSI]	87
Bits per second [115200]	88
Data Bits [8]	88
Parity [None]	88

Stop Bits [1].....	89
Flow Control [None].....	89
Auto Recovery Function [Disabled].....	90
Initiate Graphic Adapter [PEG/IGD/PCI].....	91
IGD Memory [64M]	92
PEG Force Gen1 [Enabled]	93
Detect Non-Compliance Device [Enabled]	93
VT-d [Disabled].....	93
Azalia HD Audio [Enabled].....	94
Power Saving Function [Disabled].....	94
DVMT Mode Select [DVMT Mode].....	95
DVMT Memory [Maximum]	96
IGD - Boot Type [AUTO]	96
Bootup NumLock State [On].....	97
Quiet Boot [Enabled]	97
Launch PXE OpROM [Disabled].....	97
Option ROM Messages [Force BIOS].....	98
Administrator Password	98
User Password	98
Save Changes and Reset	99
Discard Changes and Reset	99
Restore Defaults	99
Save as User Defaults	100
Restore User Defaults	100

▪

Appendix

C

Terminology

AC '97	Audio Codec 97 (AC'97) refers to a codec standard developed by Intel® in 1997.
ACPI	Advanced Configuration and Power Interface (ACPI) is an OS-directed configuration, power management, and thermal management interface.
AHCI	Advanced Host Controller Interface (AHCI) is a SATA Host controller register-level interface.
ATA	The Advanced Technology Attachment (ATA) interface connects storage devices including hard disks and CD-ROM drives to a computer.
ARMD	An ATAPI Removable Media Device (ARMD) is any ATAPI device that supports removable media, besides CD and DVD drives.
ASKIR	Amplitude Shift Keyed Infrared (ASKIR) is a form of modulation that represents a digital signal by varying the amplitude (“volume”) of the signal. A low amplitude signal represents a binary 0, while a high amplitude signal represents a binary 1.
BIOS	The Basic Input/Output System (BIOS) is firmware that is first run when the computer is turned on and can be configured by the end user
CODEC	The Compressor-Decompressor (CODEC) encodes and decodes digital audio data on the system.
CMOS	Complimentary metal-oxide-conductor is an integrated circuit used in chips like static RAM and microprocessors.
COM	COM refers to serial ports. Serial ports offer serial communication to expansion devices. The serial port on a personal computer is usually a male DB-9 connector.
DAC	The Digital-to-Analog Converter (DAC) converts digital signals to analog signals.
DDR	Double Data Rate refers to a data bus transferring data on both the rising and falling edges of the clock signal.
DMA	Direct Memory Access (DMA) enables some peripheral devices to bypass the system processor and communicate directly with the system memory.

WSB-H610 PICMG 1.0 CPU Card

DIMM	Dual Inline Memory Modules are a type of RAM that offer a 64-bit data bus and have separate electrical contacts on each side of the module.
DIO	The digital inputs and digital outputs are general control signals that control the on/off circuit of external devices or TTL devices. Data can be read or written to the selected address to enable the DIO functions.
EHCI	The Enhanced Host Controller Interface (EHCI) specification is a register-level interface description for USB 2.0 Host Controllers.
EIDE	Enhanced IDE (EIDE) is a newer IDE interface standard that has data transfer rates between 4.0 MBps and 16.6 MBps.
EIST	Enhanced Intel® SpeedStep Technology (EIST) allows users to modify the power consumption levels and processor performance through application software. The application software changes the bus-to-core frequency ratio and the processor core voltage.
FSB	The Front Side Bus (FSB) is the bi-directional communication channel between the processor and the Northbridge chipset.
GbE	Gigabit Ethernet (GbE) is an Ethernet version that transfers data at 1.0 Gbps and complies with the IEEE 802.3-2005 standard.
GPIO	General purpose input
HDD	Hard disk drive (HDD) is a type of magnetic, non-volatile computer storage device that stores digitally encoded data.
ICH	The Input/Output Control Hub (ICH) is an Intel® Southbridge chipset.
IrDA	Infrared Data Association (IrDA) specify infrared data transmission protocols used to enable electronic devices to wirelessly communicate with each other.
L1 Cache	The Level 1 Cache (L1 Cache) is a small memory cache built into the system processor.
L2 Cache	The Level 2 Cache (L2 Cache) is an external processor memory cache.
LCD	Liquid crystal display (LCD) is a flat, low-power display device that consists of two polarizing plates with a liquid crystal panel in between.

LVDS	Low-voltage differential signaling (LVDS) is a dual-wire, high-speed differential electrical signaling system commonly used to connect LCD displays to a computer.
POST	The Power-on Self Test (POST) is the pre-boot actions the system performs when the system is turned-on.
RAM	Random Access Memory (RAM) is volatile memory that loses data when power is lost. RAM has very fast data transfer rates compared to other storage like hard drives.
SATA	Serial ATA (SATA) is a serial communications bus designed for data transfers between storage devices and the computer chipsets. The SATA bus has transfer speeds up to 1.5 Gbps and the SATA II bus has data transfer speeds of up to 3.0 Gbps.
S.M.A.R.T	Self Monitoring Analysis and Reporting Technology (S.M.A.R.T) refers to automatic status checking technology implemented on hard disk drives.
UART	Universal Asynchronous Receiver-transmitter (UART) is responsible for asynchronous communications on the system and manages the system's serial communication (COM) ports.
UHCI	The Universal Host Controller Interface (UHCI) specification is a register-level interface description for USB 1.1 Host Controllers.
USB	The Universal Serial Bus (USB) is an external bus standard for interfacing devices. USB 1.1 supports 12Mbps data transfer rates and USB 2.0 supports 480Mbps data transfer rates.
VGA	The Video Graphics Array (VGA) is a graphics display system developed by IBM.

Appendix

D

Digital I/O Interface

D.1 Introduction

The DIO connector on the WSB-H610 is interfaced to GPIO ports on the Super I/O chipset. The DIO has both 4-bit digital inputs and 4-bit digital outputs. The digital inputs and digital outputs are generally control signals that control the on/off circuit of external devices or TTL devices. Data can be read or written to the selected address to enable the DIO functions.



NOTE:

For further information, please refer to the datasheet for the Super I/O chipset.

The BIOS interrupt call **INT 15H** controls the digital I/O.

INT 15H:

AH – 6FH	
<u>Sub-function:</u>	
AL – 8	: Set the digital port as INPUT
AL	: Digital I/O input value

WSB-H610 PICMG 1.0 CPU Card

D.2 Assembly Language Sample 1

```

MOV     AX, 6F08H      ;setting the digital port as input
INT     15H           ;

```

AL low byte = value

AH – 6FH
<u>Sub-function:</u>
AL – 9 : Set the digital port as OUTPUT
BL : Digital I/O input value

D.3 Assembly Language Sample 2

```

MOV     AX, 6F09H      ;setting the digital port as output
MOV     BL, 09H        ;digital value is 09H
INT     15H           ;

```

Digital Output is 1001b

Appendix

E

Watchdog Timer

WSB-H610 PICMG 1.0 CPU Card

**NOTE:**

The following discussion applies to DOS environment. Contact IEI support or visit the IEI website for specific drivers for other operating systems.

The Watchdog Timer is provided to ensure that standalone systems can always recover from catastrophic conditions that cause the CPU to crash. This condition may have occurred by external EMIs or a software bug. When the CPU stops working correctly, Watchdog Timer either performs a hardware reset (cold boot) or a Non-Maskable Interrupt (NMI) to bring the system back to a known state.

A BIOS function call (INT 15H) is used to control the Watchdog Timer.

INT 15H:

AH – 6FH Sub-function:	
AL – 2:	Sets the Watchdog Timer's period.
BL:	Time-out value (Its unit-second is dependent on the item "Watchdog Timer unit select" in CMOS setup).

Table E-1: AH-6FH Sub-function

Call sub-function 2 to set the time-out period of Watchdog Timer first. If the time-out value is not zero, the Watchdog Timer starts counting down. When the timer value reaches zero, the system resets. To ensure that this reset condition does not occur, calling sub-function 2 must periodically refresh the Watchdog Timer. However, the watchdog timer is disabled if the time-out value is set to zero.

A tolerance of at least 10% must be maintained to avoid unknown routines within the operating system (DOS), such as disk I/O that can be very time-consuming.

**NOTE:**

When exiting a program it is necessary to disable the Watchdog Timer, otherwise the system resets.

EXAMPLE PROGRAM:

```
; INITIAL TIMER PERIOD COUNTER
```

```
;
```

```
W_LOOP:
```

```
;
```

```
    MOV     AX, 6F02H      ;setting the time-out value  
    MOV     BL, 30         ;time-out value is 48 seconds  
    INT     15H
```

```
;
```

```
; ADD THE APPLICATION PROGRAM HERE
```

```
;
```

```
    CMP     EXIT_AP, 1     ;is the application over?  
    JNE     W_LOOP        ;No, restart the application
```

```
    MOV     AX, 6F02H      ;disable Watchdog Timer  
    MOV     BL, 0         ;  
    INT     15H
```

```
;
```

```
; EXIT ;
```

Appendix

F

Hazardous Materials Disclosure

F.1 Hazardous Materials Disclosure Table for IPB Products Certified as RoHS Compliant Under 2002/95/EC Without Mercury

The details provided in this appendix are to ensure that the product is compliant with the Peoples Republic of China (China) RoHS standards. The table below acknowledges the presences of small quantities of certain materials in the product, and is applicable to China RoHS only.

A label will be placed on each product to indicate the estimated “Environmentally Friendly Use Period” (EFUP). This is an estimate of the number of years that these substances would “not leak out or undergo abrupt change.” This product may contain replaceable sub-assemblies/components which have a shorter EFUP such as batteries and lamps. These components will be separately marked.

Please refer to the table on the next page.

WSB-H610 PICMG 1.0 CPU Card

Part Name	Toxic or Hazardous Substances and Elements					
	Lead (Pb)	Mercury (Hg)	Cadmium (Cd)	Hexavalent Chromium (CR(VI))	Polybrominated Biphenyls (PBB)	Polybrominated Diphenyl Ethers (PBDE)
Housing	<input type="radio"/>	<input type="radio"/>	<input type="radio"/>	<input type="radio"/>	<input type="radio"/>	<input type="radio"/>
Display	<input type="radio"/>	<input type="radio"/>	<input type="radio"/>	<input type="radio"/>	<input type="radio"/>	<input type="radio"/>
Printed Circuit Board	<input type="radio"/>	<input type="radio"/>	<input type="radio"/>	<input type="radio"/>	<input type="radio"/>	<input type="radio"/>
Metal Fasteners	<input type="radio"/>	<input type="radio"/>	<input type="radio"/>	<input type="radio"/>	<input type="radio"/>	<input type="radio"/>
Cable Assembly	<input type="radio"/>	<input type="radio"/>	<input type="radio"/>	<input type="radio"/>	<input type="radio"/>	<input type="radio"/>
Fan Assembly	<input type="radio"/>	<input type="radio"/>	<input type="radio"/>	<input type="radio"/>	<input type="radio"/>	<input type="radio"/>
Power Supply Assemblies	<input type="radio"/>	<input type="radio"/>	<input type="radio"/>	<input type="radio"/>	<input type="radio"/>	<input type="radio"/>
Battery	<input type="radio"/>	<input type="radio"/>	<input type="radio"/>	<input type="radio"/>	<input type="radio"/>	<input type="radio"/>

O: This toxic or hazardous substance is contained in all of the homogeneous materials for the part is below the limit requirement in SJ/T11363-2006

X: This toxic or hazardous substance is contained in at least one of the homogeneous materials for this part is above the limit requirement in SJ/T11363-2006

此附件旨在确保本产品符合中国 RoHS 标准。以下表格标示此产品中某有毒物质的含量符合中国 RoHS 标准规定的限量要求。

本产品上会附有“环境友好使用期限”的标签，此期限是估算这些物质“不会有泄漏或突变”的年限。本产品可能包含有较短的环境友好使用期限的可替换元件，像是电池或灯管，这些元件将会单独标示出来。

部件名称	有毒有害物质或元素					
	铅 (Pb)	汞 (Hg)	镉 (Cd)	六价铬 (CR(VI))	多溴联苯 (PBB)	多溴二苯 醚 (PBDE)
壳体	○	○	○	○	○	○
显示	○	○	○	○	○	○
印刷电路板	○	○	○	○	○	○
金属螺帽	○	○	○	○	○	○
电缆组装	○	○	○	○	○	○
风扇组装	○	○	○	○	○	○
电力供应组装	○	○	○	○	○	○
电池	○	○	○	○	○	○

○: 表示该有毒有害物质在该部件所有物质材料中的含量均在 SJ/T11363-2006 标准规定的限量要求以下。
 X: 表示该有毒有害物质至少在该部件的某一均质材料中的含量超出 SJ/T11363-2006 标准规定的限量要求。