



IEI Technology Corp.



MODEL:
AFL-HM55 Series

All-in-one Panel PC with 2.66 GHz Intel® Core™ i7/i5/i3 Processor, TFT LCD, Wireless LAN, Bluetooth, Touch Screen, RS-232/422/485 and RoHS

User Manual

Rev. 1.01 – 26 August, 2011



Revision

Date	Version	Changes
26 August, 2011	1.01	Updated KeypadAP driver to version 2.2 Updated driver CD to version 1.1
21 June, 2011	1.00	Initial release

Copyright

COPYRIGHT NOTICE

The information in this document is subject to change without prior notice in order to improve reliability, design and function and does not represent a commitment on the part of the manufacturer.

In no event will the manufacturer be liable for direct, indirect, special, incidental, or consequential damages arising out of the use or inability to use the product or documentation, even if advised of the possibility of such damages.

This document contains proprietary information protected by copyright. All rights are reserved. No part of this manual may be reproduced by any mechanical, electronic, or other means in any form without prior written permission of the manufacturer.

TRADEMARKS

All registered trademarks and product names mentioned herein are used for identification purposes only and may be trademarks and/or registered trademarks of their respective owners.

Table of Contents

1 INTRODUCTION.....	1
1.1 AFL-HM55 SERIES FLAT PANEL PC OVERVIEW	2
1.1.1 Features	3
1.1.2 Applications	3
1.2 EXTERNAL OVERVIEW.....	3
1.2.1 General Description.....	3
1.2.2 Front Panel	4
1.2.3 Rear Panel	5
1.2.4 I/O Interface Panel	5
1.2.5 OSD Control Buttons	6
1.3 INTERNAL OVERVIEW.....	7
1.4 SYSTEM SPECIFICATIONS.....	7
1.5 AFL-HM55 SERIES DIMENSIONS.....	9
2 UNPACKING	12
2.1 UNPACKING.....	13
2.1.1 Packing List	13
2.1.1.1 Optional Items List	15
3 INSTALLATION	18
3.1 ANTI-STATIC PRECAUTIONS	19
3.2 INSTALLATION PRECAUTIONS	19
3.3 INSTALLATION AND CONFIGURATION STEPS	20
3.4 REMOVING THE HDD COVER.....	20
3.5 INSTALLING A SATA DOM CARD.....	21
3.6 INSTALLING AN HDD	22
3.7 REMOVING THE REAR PANEL COVER	23
3.8 REMOVING THE INTERNAL ALUMINUM COVER	24
3.9 JUMPER SETTINGS	25
3.9.1 Access the Jumpers	26
3.9.2 Preconfigured Jumpers	26

AFL-HM55 Series Panel PC

3.9.3	<i>Clear CMOS Jumper</i>	27
3.9.4	<i>COM1 Pin 9 Setting</i>	28
3.9.5	<i>COM3 TX Function Select Jumper</i>	30
3.9.6	<i>COM3 RS-232/422/485 Jumper</i>	31
3.9.6.1	<i>COM3 RS-422 and RS-485 Pinouts</i>	32
3.9.7	<i>COM3 RS Function Select Jumper</i>	33
3.9.8	<i>ME Debug Mode Jumper</i>	34
3.9.9	<i>iTPM Setting Jumper</i>	35
3.9.10	<i>ME RTC Select Jumper</i>	36
3.9.11	<i>SPI Setting Jumper</i>	37
3.10	MOUNTING THE SYSTEM	38
3.10.1	<i>Wall Mounting</i>	38
3.10.2	<i>Panel Mounting</i>	41
3.10.3	<i>Arm Mounting</i>	44
3.10.4	<i>Cabinet and Rack Installation (15-inch and 17-inch models only)</i>	45
3.11	BOTTOM PANEL CONNECTORS	46
3.11.1	<i>LAN Connection</i>	46
3.11.2	<i>Serial Device Connection</i>	46
3.11.3	<i>USB Device Connection</i>	47
3.11.4	<i>VGA Monitor Connection</i>	48
3.12	AT/ATX MODE SELECTION	49
3.12.1	<i>AT Power Mode</i>	50
3.12.2	<i>ATX Power Mode</i>	50
4	SYSTEM MAINTENANCE	51
4.1	SYSTEM MAINTENANCE INTRODUCTION	52
4.2	ANTI-STATIC PRECAUTIONS	52
4.3	TURN OFF THE POWER	53
4.4	REPLACING COMPONENTS	53
4.4.1	<i>Memory Module Replacement</i>	53
4.4.2	<i>SATA DOM Card Replacement</i>	56
4.4.3	<i>HDD Card Replacement</i>	56
5	BIOS SETUP	57
5.1	INTRODUCTION	58

5.1.1 Starting Setup.....	58
5.1.2 Using Setup.....	58
5.1.3 Getting Help.....	59
5.1.4 Unable to Reboot After Configuration Changes.....	59
5.1.5 BIOS Menu Bar.....	59
5.2 MAIN.....	60
5.3 ADVANCED.....	61
5.3.1 ACPI Settings.....	62
5.3.2 Trusted Computing.....	63
5.3.3 CPU Configuration.....	64
5.3.4 SATA Configuration.....	65
5.3.5 USB Configuration.....	66
5.3.6 Super IO Configuration.....	67
5.3.6.1 Serial Port n Configuration.....	68
5.3.7 H/W Monitor.....	72
5.3.8 Serial Port Console Redirection.....	73
5.4 CHIPSET.....	74
5.4.1 Northbridge Configuration.....	75
5.4.2 Southbridge Configuration.....	76
5.4.3 Intel IGD SWSCI OpRegion.....	77
5.5 BOOT.....	79
5.6 SECURITY.....	80
5.7 EXIT.....	81
6 SOFTWARE DRIVERS.....	83
6.1 AVAILABLE SOFTWARE DRIVERS.....	84
6.2 STARTING THE DRIVER PROGRAM.....	84
6.3 CHIPSET DRIVER INSTALLATION.....	85
6.4 VGA DRIVER INSTALLATION.....	89
6.5 LAN DRIVER INSTALLATION.....	93
6.6 AUDIO DRIVER INSTALLATION.....	96
6.6.1 BIOS Setup.....	96
6.6.2 Driver Installation.....	96
6.7 TOUCH SCREEN DRIVER.....	99
6.8 WIRELESS DRIVER.....	102

AFL-HM55 Series Panel PC

6.9 BLUETOOTH DRIVER	105
6.10 KEYPAD DRIVER	109
A SAFETY PRECAUTIONS	114
A.1 SAFETY PRECAUTIONS	115
<i>A.1.1 General Safety Precautions</i>	<i>115</i>
<i>A.1.2 Anti-static Precautions</i>	<i>116</i>
A.2 MAINTENANCE AND CLEANING PRECAUTIONS	116
<i>A.2.1 Maintenance and Cleaning.....</i>	<i>116</i>
<i>A.2.2 Cleaning Tools.....</i>	<i>117</i>
B BIOS CONFIGURATION OPTIONS.....	118
B.1 BIOS CONFIGURATION OPTIONS	119
C WATCHDOG TIMER	121
D HAZARDOUS MATERIALS DISCLOSURE	124
D.1 HAZARDOUS MATERIAL DISCLOSURE TABLE FOR IPB PRODUCTS CERTIFIED AS ROHS COMPLIANT UNDER 2002/95/EC WITHOUT MERCURY	125

List of Figures

Figure 1-1: AFL-HM55 Series Flat Panel PC	2
Figure 1-2: AFL-HM55 Series Front View	4
Figure 1-3: AFL-HM55 Series Rear View	5
Figure 1-4: AFL-HM55 Series I/O Interface Connector Panel.....	6
Figure 1-5: OSD Control Buttons	6
Figure 1-6: AFL-HM55 Dimensions (mm)	9
Figure 1-7: AFL-17i-HM55 Dimensions (mm).....	10
Figure 1-8: AFL-19i-HM55 Dimensions (mm).....	11
Figure 3-1: AFL-HM55 Series HDD Cover Retention Screw	21
Figure 3-2: SATA DOM Card Installation.....	22
Figure 3-3: HDD Installation	23
Figure 3-4: AFL-HM55 Series Back Cover Retention Screws	24
Figure 3-5: AFL-HM55 Series Aluminum Back Cover Retention Screws.....	25
Figure 3-6: Clear CMOS Jumper	28
Figure 3-7: JP7 Jumper Setting Location	29
Figure 3-8: JP8 Jumper Setting Location	30
Figure 3-9: COM3 TX Function Select Jumper Location	31
Figure 3-10: COM3 RS-232/422/485 Serial Port Select Jumper Location.....	32
Figure 3-11: COM3 RX Function Select Jumper Location.....	34
Figure 3-12: ME Debug Mode Jumper Location	35
Figure 3-13: iTPM Jumper Location.....	36
Figure 3-14: ME RTC Jumper Location	37
Figure 3-15: SPI Jumper Location	38
Figure 3-16: Wall-mounting Bracket.....	39
Figure 3-17: Chassis Support Screws.....	40
Figure 3-18: Securing the Panel PC.....	41
Figure 3-19: 15-inch AFL-HM55 Series Panel Opening (Unit: mm)	42
Figure 3-20: 17-inch AFL-HM55 Series Panel Opening (Unit: mm)	42
Figure 3-21: 19-inch AFL-HM55 Series Panel Opening (Unit: mm)	42
Figure 3-22: Panel Mounting	43
Figure 3-23: Arm Mounting Retention Screw Holes.....	44

AFL-HM55 Series Panel PC

Figure 3-24: The Rack/Cabinet Bracket.....	45
Figure 3-25: LAN Connection	46
Figure 3-26: Serial Device Connector.....	47
Figure 3-27: USB Device Connection	48
Figure 3-28: VGA Connector	49
Figure 3-29: AT/ATX Switch Location.....	50
Figure4-1: HDD Bracket Screws.....	54
Figure 4-2: SO-DIMM Socket Location	55
Figure 4-3: DDR SO-DIMM Module Installation.....	56
Figure 6-1: Drivers	85
Figure 6-2: Chipset Driver File Extraction Screen.....	86
Figure 6-3: Chipset Driver Welcome Screen.....	86
Figure 6-4: Chipset Driver License Agreement	87
Figure 6-5: Readme File Information Screen	88
Figure 6-6: Setup Progress Screen.....	88
Figure 6-7: Chipset Driver Installation Finish Screen.....	89
Figure 6-8: VGA Driver Readme File.....	90
Figure 6-9: VGA Driver Setup File Extraction Screen	90
Figure 6-10: VGA Driver Welcome Screen	91
Figure 6-11: VGA Driver License Agreement.....	91
Figure 6-12: VGA Driver Readme File.....	92
Figure 6-13: VGA Driver Setup Operations	92
Figure 6-14: VGA Driver Setup Is Complete Screen	93
Figure 6-15: LAN Driver Welcome Screen	94
Figure 6-16: LAN Driver Welcome Screen	94
Figure 6-17: LAN Driver Installation	95
Figure 6-18: LAN Driver Installation Complete.....	95
Figure 6-19: The InstallShield Wizard Starts	96
Figure 6-20: Preparing Setup Screen	97
Figure 6-21: InstallShield Wizard Welcome Screen	97
Figure 6-22: Audio Driver Progress Screen.....	98
Figure 6-23: Installation Wizard Updates the System.....	98
Figure 6-24: Restart the Computer	99
Figure 6-25: PenMount Welcome Screen.....	100
Figure 6-26: License Agreement	100

Figure 6-27: Choose Install Location.....	101
Figure 6-28: Installing PenMount Universal Driver V2.1.0.263.....	102
Figure 6-29: PenMount Universal Driver Update Complete	102
Figure 6-30: Wireless Driver License Agreement.....	103
Figure 6-31: Wireless Driver Configuration Tool Options	103
Figure 6-32: Wireless Mode Select Window	104
Figure 6-33: Wireless Driver Installation	105
Figure 6-34: Welcome Screen	106
Figure 6-35: License Agreement	106
Figure 6-36: Bluetooth Driver Destination Folder	107
Figure 6-37: Ready to Install the Program	107
Figure 6-38: Installing BlueSoleil	108
Figure 6-39: Bluetooth Driver Complete Installation Screen	108
Figure 6-40: Reboot the Computer	109
Figure 6-41: Keypad Driver Welcome Screen.....	110
Figure 6-42: Customer Information Screen	110
Figure 6-43: Setup Type.....	111
Figure 6-44: Ready to Install the Program	111
Figure 6-45: Installing KeypadAP v2.2	112
Figure 6-46: Keypad Driver Installation Complete Screen	112
Figure 6-47: Reboot the Computer	113

List of Tables

Table 1-1: AFL-HM55 Series System Specifications	8
Table 3-1: Jumpers	26
Table 3-2: Preconfigured Jumpers	27
Table 3-3: Clear CMOS Jumper Settings	28
Table 3-4: COM1 Pin 9 Setting Jumper Settings	29
Table 3-5: COM3 Pin 9 Setting Jumper Settings	29
Table 3-6: COM3 TX Function Select Jumper Settings	31
Table 3-7: COM3 RS-232/422/485 Serial Port Select Jumper Settings	32
Table 3-8: RS-422 Pinouts	33
Table 3-9: RS-485 Pinouts	33
Table 3-10: COM3 RX Function Select Jumper Settings	33
Table 3-11: ME Debug Mode Jumper Settings	34
Table 3-12: iTPM Jumper Settings	35
Table 3-13: ME RTC Jumper Settings	36
Table 3-14: SPI Jumper Settings	37
Table 5-1: BIOS Navigation Keys	59

Chapter

1

Introduction

1.1 AFL-HM55 Series Flat Panel PC Overview



Figure 1-1: AFL-HM55 Series Flat Panel PC

The AFL-HM55 Series is an Intel® Core™ powered flat panel PC with a rich variety of functions and peripherals. All AFL-HM55 Series models are designed for easy and simplified integration into kiosk and point-of-sales (POS) applications.

An Intel® Core™ i7/i5/i3 processor coupled with the Intel® HM55 chipset delivers optimal memory, graphics, and peripheral I/O support. The system comes with 2.0 GB of preinstalled DDR3 dual-channel SO-DIMMs and supports a maximum of 8.0 GB ensuring smooth data throughputs with reduced bottlenecks and fast system access. The AFL-HM55 Series features a Gen 5.7 Enhanced Graphics Engine with 12 execution units and DirectX 10 and Open GL 2.1 support for high quality video performance. Dual display support is provided via VGA and HDMI ports.

Two serial ports and four external USB 2.0 ports provide simplified connectivity to a variety of external peripheral devices. Wi-Fi capabilities and two RJ-45 GbE connectors allow for smooth connection of the system to an external LAN. The AFL-HM55 Series also supports a 2.5" SATA HDD drive which can be accessed without removing the entire back panel.

AFL-HM55 Series Panel PC

1.1.1 Features

The AFL-HM55 Series features the following:

- Intel® Core™ i7/i5/i3 processor
- Intel® HM55 chipset
- 2.0 GB 800/1066 MHz DDR3 dual-channel SO-DIMMs preinstalled
- 802.11 b/g/n wireless module
- Four USB 2.0 ports
- Watchdog timer that triggers a system reset if the system hangs for some reason
- IP 64 compliant front panel
- AT or ATX power mode
- Touch screen
- Bluetooth
- Optional HSDPA module support
- RoHS compliance

1.1.2 Applications

AFL-HM55 Series Panel PCs are multifunctional, sophisticated systems that can be easily implemented in commercial, industrial and corporate environments.

1.2 External Overview

1.2.1 General Description

The stylish AFL-HM55 Series panel PC is comprised of a screen, rear panel and bottom panel. An ABS/PC plastic front frame surrounds the front screen. The rear panel provides screw holes for a wall-mounting bracket compliant with VESA FDMI standard. An I/O interface on the bottom panel provides access to external interface connectors that include LAN, USB 2.0, serial port, reset button, VGA, HDMI, audio connector, power connector, power switch and AT/ATX mode switch. The right side panel provides access to a SATA HDD drive.

1.2.2 Front Panel

The front side of the AFL-HM55 Series is a flat panel TFT LCD screen surrounded by an ABS/PC plastic frame. The power LED is located at the top center of the front panel (Figure 1-2).

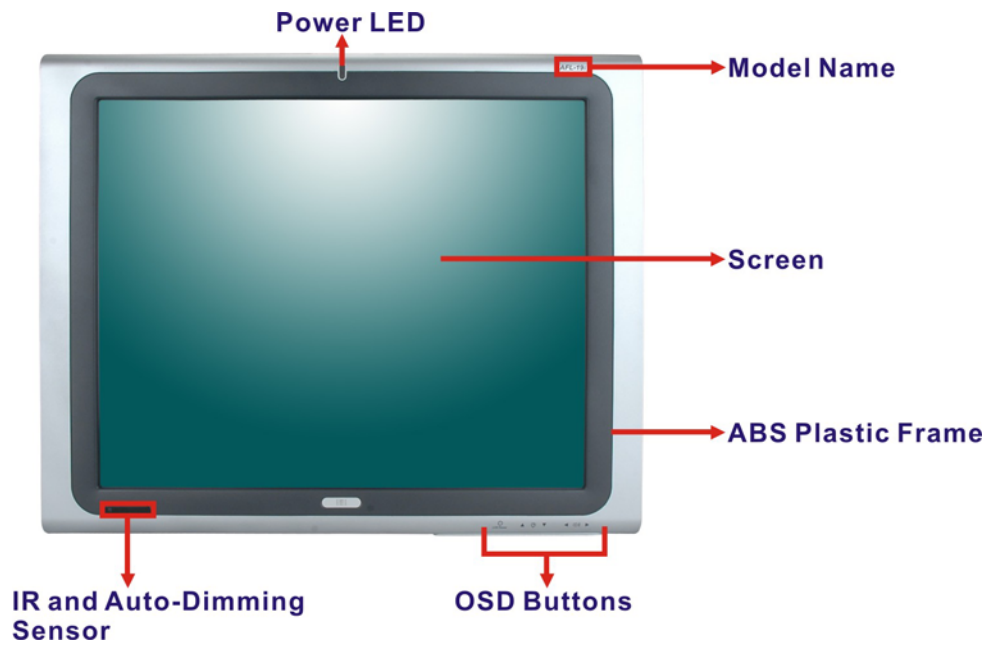

Figure 1-2: AFL-HM55 Series Front View

AFL-HM55 Series Panel PC

1.2.3 Rear Panel

The rear panel provides access to retention screw holes that support the wall mounting. Refer to **Figure 1-3**.

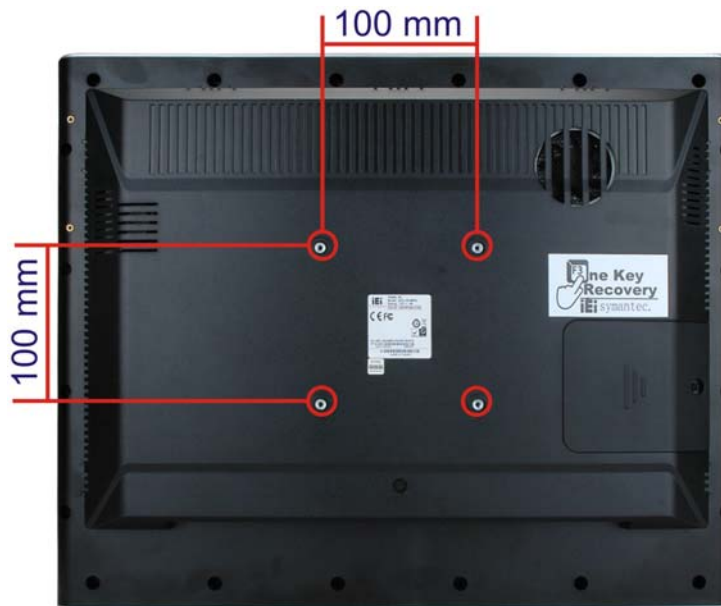

Figure 1-3: AFL-HM55 Series Rear View

1.2.4 I/O Interface Panel

The I/O interface panel located on the bottom of the AFL-HM55 Series has the following I/O interface connectors:

- 1 x Power switch
- 1 x 12 V DC In connector
- 1 x RS-232 connector
- 1 x RS-232/422/485 connector
- 2 x RJ-45 for Giga LAN connectors
- 1 x AT/ATX power mode switch
- 4 x USB 2.0 connectors
- 1 x HDMI connector
- 1 x Audio line-out connector
- 1 x VGA connector
- 1 x Reset button

The external I/O interface connector panel is shown in **Figure 1-4**.

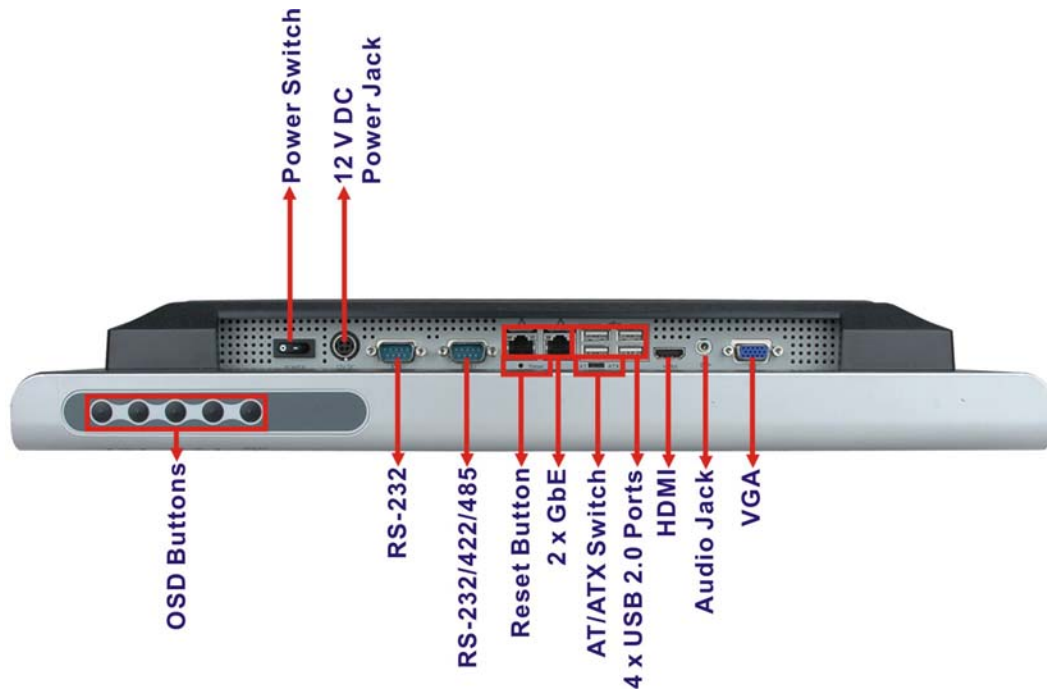

Figure 1-4: AFL-HM55 Series I/O Interface Connector Panel

1.2.5 OSD Control Buttons

The AFL-HM55 Series has seven OSD control buttons as shown below.

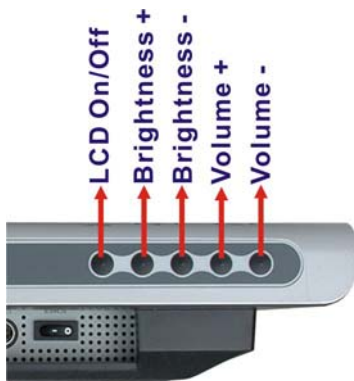

Figure 1-5: OSD Control Buttons

AFL-HM55 Series Panel PC

1.3 Internal Overview

The AFL-HM55 Series has the following components installed internally:

- 1 x Mainboard
- 1 x 2.0 GB 800/1066 MHz DDR3 dual-channel SO-DIMM
- 1 x Wireless module
- 1 x Bluetooth module

1.4 System Specifications

The technical specifications for the AFL-HM55 Series systems are listed in **Table 1-1**.

Specification	15i	15iE	17i	19i
LCD Size	15"	15"	17"	19"
Max. Resolution	1024 x 768	1024 x 768	1280 x 1024	1280 x 1024
Contrast Ratio	350	250	350	450
Brightness (cd/m ²)	700:1	450:1	800:1	1000:1
LCD Color	16.2 M	16.2 M	16.7 M	16.7 M
Pixel Pitch (H x V) (mm)	0.297	0.297	0.264	0.294
Viewing Angle (H-V)	140 ° / 125 °	120 ° / 100 °	160 ° / 160 °	178 ° / 178 °
Backlight MTBF	50,000 hours	40,000 hours	50,000	50,000
SBC Model	AFLMB2-HM55			
CPU	Intel® Celeron P4500 1.86G CPU Intel® Core™ i3-330M 2.26G CPU Intel® Core™ i5-520M 2.4G CPU Intel® Core™ i7-620M 2.66G CPU			
Chipset	Intel HM55 (Calpella)			
Memory	Two 204-pin 800 / 1066 DDR3 dual-channel SO-DIMM (system max. 8GB)			
LAN Controller	Realtek RTL8111E			
Audio Codec	ALC888 + TPA2012 2.1w/ch CLASS D amplifier			
Speaker	AMP 3 W + AMP 3 W (built-in stereo speakers)			
SSD	One SATA DOM card slot			
Watchdog Timer	Software Programmable supports 1 sec. ~ 255 sec. system reset			
Expansion	1 x PCIe mini card (wireless LAN 802.11 b/g/n module)			
	1 x Bluetooth module (internal USB interface, Bluetooth v 2.1+EDR)			

Specification	15i	15iE	17i	19i
HDD Drive Bay	1 x 2.5" SATA HDD bay			
Construction Material	ABS + PC plastic front frame			
Mounting	Panel Wall Rack Stand Arm (VESA 75 mm x 75 mm or 100 mm x 100 mm)			
Front Panel Color	Sliver (877U) & Gray (ABSA2037)			
Dimensions (mm) (W x H x D)	394 x 309 x 75		428 x 350 x 76	470 x 383 x 79
Operation Temperature	0°C ~ 50°C			
Storage Temperature	-20°C ~ 60°C			
Net weight	3.2kg		6.0kg	6.2kg
IP level (front panel)	IP 64			
EMC	CE, FCC and CCC			
Safety	CB			
Touch Screen	Resistive Type 5-wire (touch controller is on board)			
Power Adapter	96W			
	Input: 90 VAC ~ 264 VAC @ 50 Hz / 60 Hz			
	Output: 12 V DC			
Power Consumption	80W		85W	87W
I/O Ports and Switches	1 x 12 V DC input jack			
	1 x Audio line-out connector			
	1 x RS-232 COM port connector			
	1 x RS-232/422/485 COM port connector			
	2 x RJ-45 for GbE LAN			
	1 x HDMI port			
	4 x USB 2.0 ports			
	1 x VGA connector			
	1 x Power switch			
	1 x Reset button			

Table 1-1: AFL-HM55 Series System Specifications

AFL-HM55 Series Panel PC

1.5 AFL-HM55 Series Dimensions

The AFL-HM55 dimensions are shown in **Figure 1-6** and listed below.

- **Width:** 393.1 mm
- **Height:** 308.1 mm
- **Depth:** 75 mm (approximate)

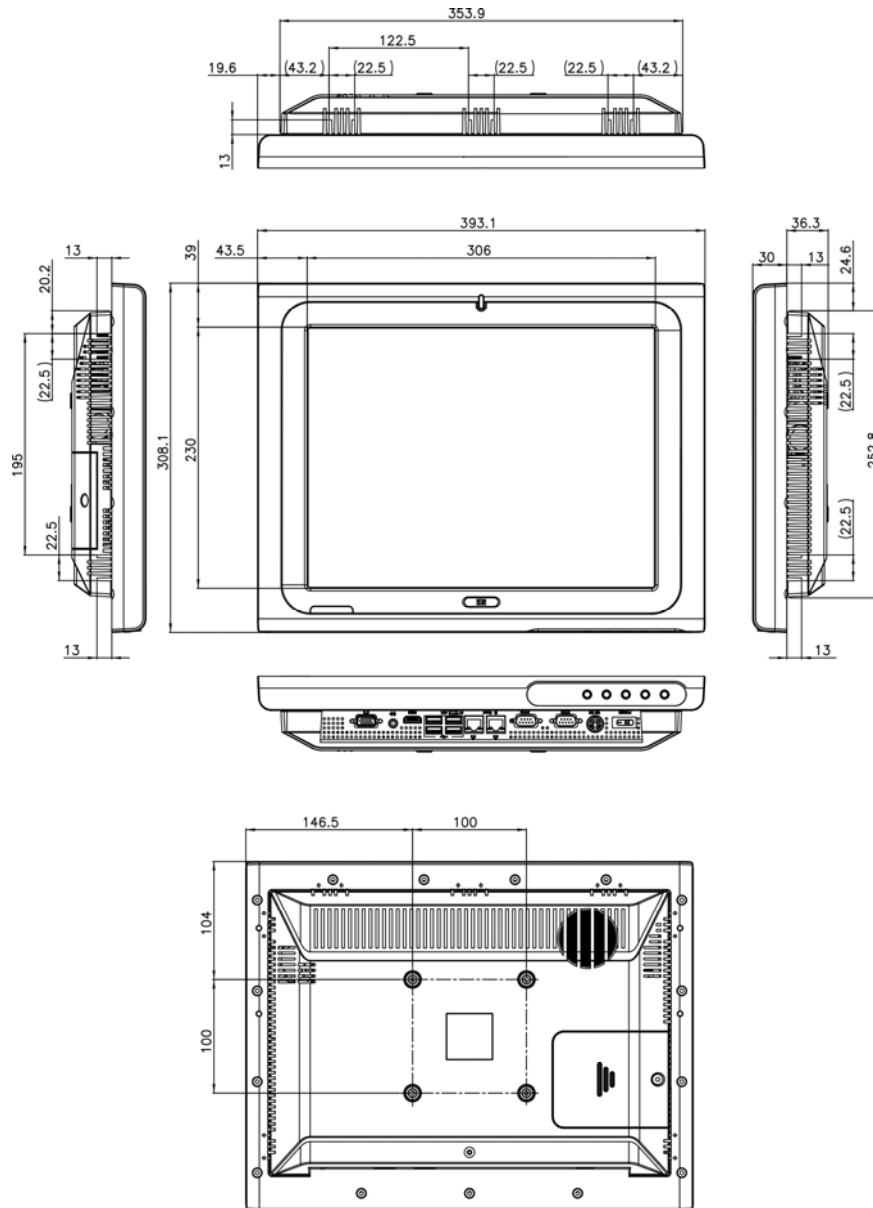

Figure 1-6: AFL-HM55 Dimensions (mm)

The AFL-17i-HM55 dimensions are shown in **Figure 1-7** and listed below.

- **Width:** 428 mm
- **Height:** 250.1 mm
- **Depth:** 76 mm (approximate)

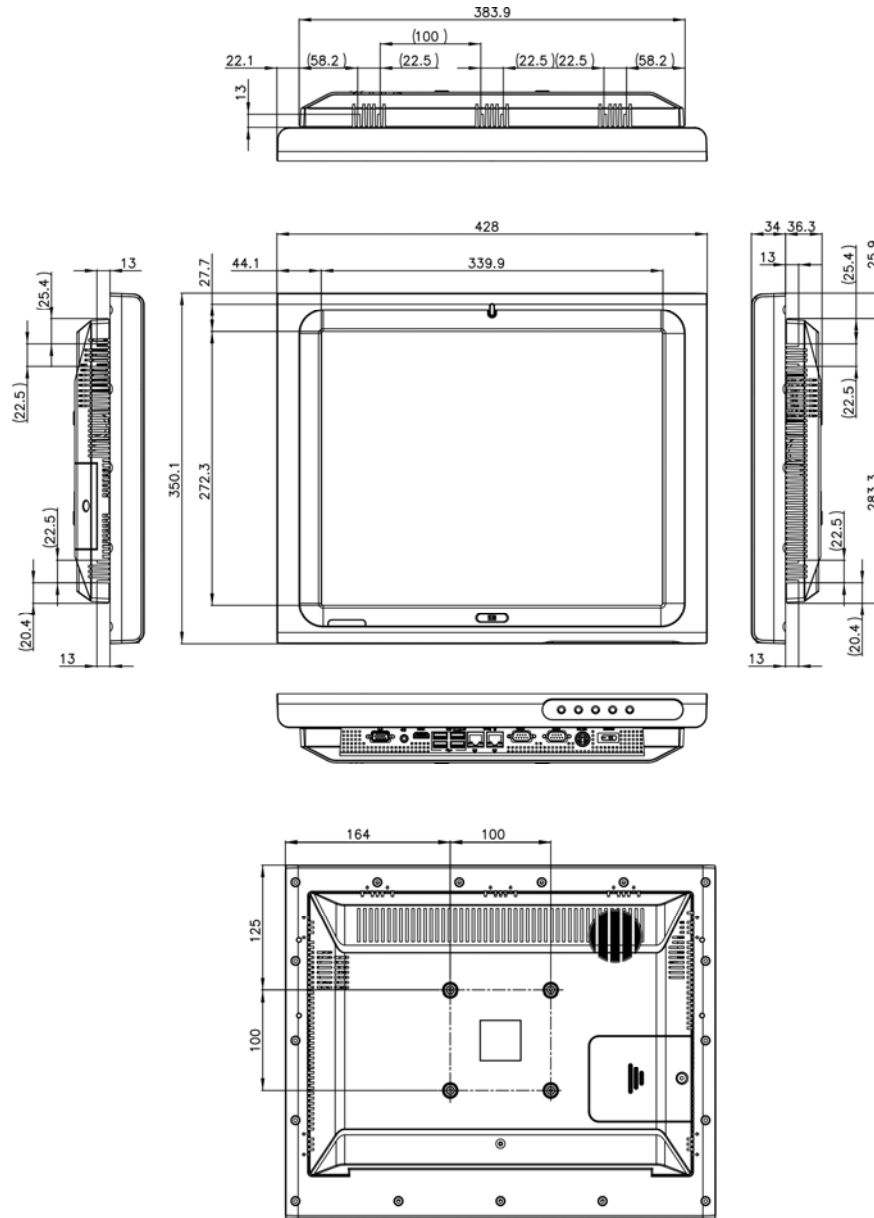

Figure 1-7: AFL-17i-HM55 Dimensions (mm)

AFL-HM55 Series Panel PC

The AFL-19i-HM55 dimensions are shown in **Figure 1-8** and listed below.

- **Width:** 469.9 mm
- **Height:** 382.5 mm
- **Depth:** 79 mm (approximate)

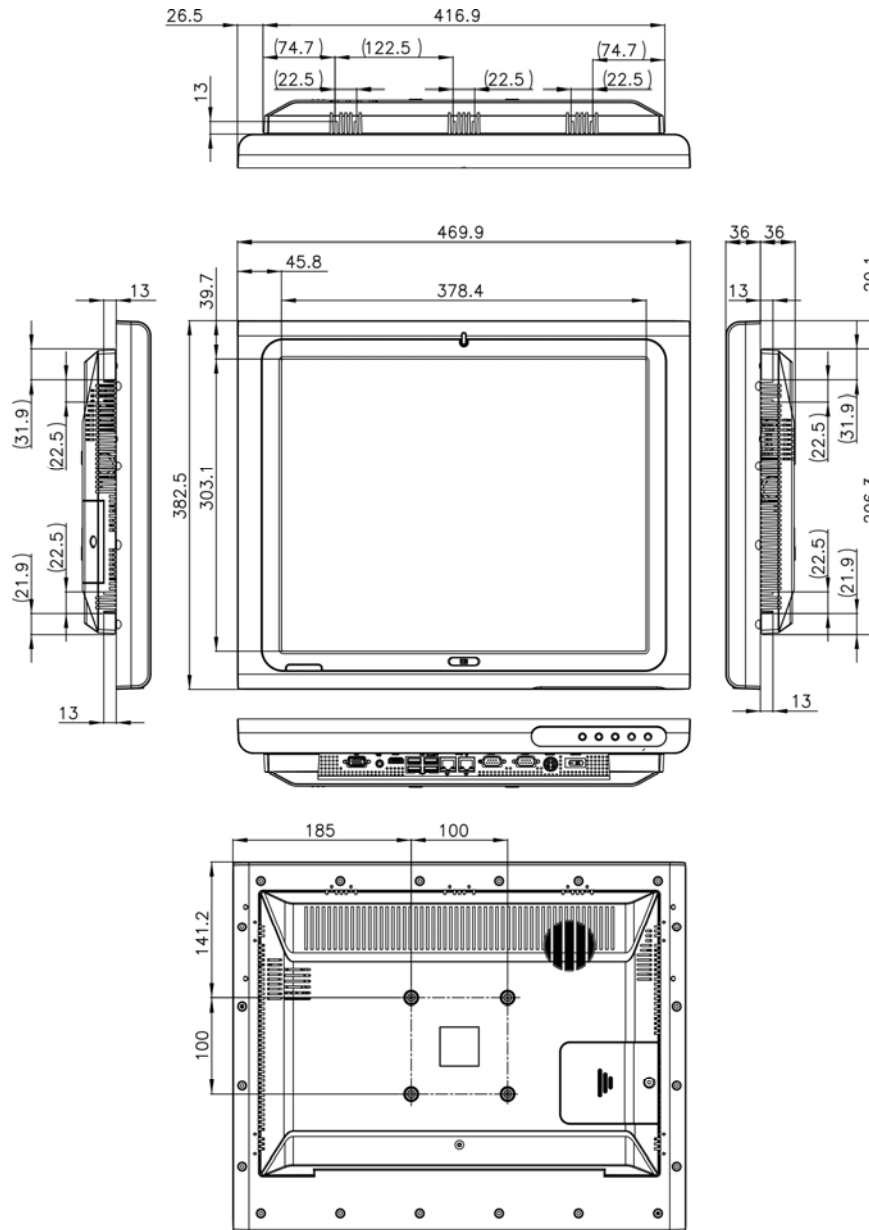

Figure 1-8: AFL-19i-HM55 Dimensions (mm)

Chapter

2

Unpacking

2.1 Unpacking

To unpack the flat panel PC, follow the steps below:



WARNING!

The front side LCD screen has a protective plastic cover stuck to the screen. Only remove the plastic cover after the flat panel PC has been properly installed. This ensures the screen is protected during the installation process.

Use box cutters, a knife or a sharp pair of scissors that seals the top side of the external (second) box.

Open the external (second) box.

Use box cutters, a knife or a sharp pair of scissors that seals the top side of the internal (first) box.

Lift the monitor out of the boxes.

Remove both polystyrene ends, one from each side.

Pull the plastic cover off the flat panel PC.

Make sure all the components listed in the packing list are present.

2.1.1 Packing List

The AFL-HM55 Series flat panel PC is shipped with the following components:



NOTE:

If any of these items are missing or damaged, contact the distributor or sales representative immediately.

Quantity	Item	Image
Standard		
1	AFL-HM55 Series	
1	Power adapter (P/N: 63000-FSP096AHB-RS)	
1	Power cord (round plug) (P/N: 32000-000002-RS)	
1	Screw kit (P/N: 44013-030041-RS)	
1	Remote Controller (P/N: 7Z000-8T00320ICP05G-RS)	
1	Touch pen (P/N: 43125-0002C0-00-RS)	
1	User manual CD and driver CD (P/N: 7B000-000087-RS)	

AFL-HM55 Series Panel PC

2.1.1.1 Optional Items List

Item	Image
Panel/Rack Mount Kit (P/N: AFLPK-19B)	
Wall mounting kit (P/N: AFLWK-19) (P/N: AFLWK-19B)	
Rack Mounting Kit 15" (P/N: AFLRK-15B)	
Rack Mounting Kit 17" (P/N: AFLRK-17B)	
Arm (P/N: ARM-11-RS)	
Arm (P/N: ARM-31-RS)	
Stand (P/N: STAND-A19)	

<p>Stand (P/N: STAND-B19)</p>	
<p>Stand (P/N: STAND-C19)</p>	
<p>Stand (P/N: STAND-210-R11)</p>	
<p>Hybrid Card Reader (P/N: AFLP-19AMSI-U)</p>	
<p>Magnetic Stripe Reader (P/N: AFLP-19AMSR-U)</p>	
<p>DC 12 V Input UPS (P/N: AUPS-B10-R10)</p>	
<p>DC 9~36 V Input UPS (P/N: AUPS-B20-R10)</p>	

AFL-HM55 Series Panel PC

OS: Win XPE (P/N: AFLSD-15-HM55-2G-XPE) (P/N: AFLSD-17-HM55-2G-XPE) (P/N: AFLSD-19-HM55-2G-XPE)	N/A
OS: Win (P/N: AFLSD-15-HM55-4G-WES7E-R10) (P/N: AFLSD-17-HM55-4G- WES7E-R10) (P/N: AFLSD-19-HM55-4G- WES7E-R10)	N/A
OS Windows Embedded Standard 7	N/A

Chapter

3

Installation

3.1 Anti-static Precautions

**WARNING:**

Failure to take ESD precautions during the maintenance of the device may result in permanent damage to the device and severe injury to the user.

Electrostatic discharge (ESD) can cause serious damage to electronic components, including the AFL-HM55. Dry climates are especially susceptible to ESD. It is therefore critical that whenever the AFL-HM55 is accessed internally, or any other electrical component is handled, the following anti-static precautions are strictly adhered to.

- **Wear an anti-static wristband:** - Wearing a simple anti-static wristband can help to prevent ESD from damaging the board.
- **Self-grounding:** - Before handling the board touch any grounded conducting material. During the time the board is handled, frequently touch any conducting materials that are connected to the ground.
- **Use an anti-static pad:** - When configuring the AFL-HM55, place it on an anti-static pad. This reduces the possibility of ESD damaging the device.
- **Only handle the edges of the PCB:** - When handling the PCB, hold the PCB by the edges.

3.2 Installation Precautions

When installing the flat panel PC, please follow the precautions listed below:

- **Power turned off:** When installing the flat panel PC, make sure the power is off. Failing to turn off the power may cause severe injury to the body and/or damage to the system.
- **Certified Engineers:** Only certified engineers should install and modify onboard functionalities.
- **Anti-static Discharge:** If a user opens the rear panel of the flat panel PC, to configure the jumpers or plug in added peripheral devices, ground themselves first and wear an anti-static wristband.

3.3 Installation and Configuration Steps

The following installation steps must be followed.

Remove the HDD cover

Install a SATA DOM card

Install an HDD

Remove the rear panel cover

Remove the internal aluminum cover

Configure the system jumpers

Connect peripheral devices to the bottom panel of the flat panel PC

Mount the flat panel PC

3.4 Removing the HDD Cover

Remove one (1) retention screw on the cover. See **Figure 3-1**.

AFL-HM55 Series Panel PC



Figure 3-1: AFL-HM55 Series HDD Cover Retention Screw

Lift the cover off to expose the HDD slot and SATA DOM card slot.

3.5 Installing a SATA DOM Card

The AFL-HM55 Series has one SATA DOM card slot inside the rear panel. To install a SATA DOM card, follow the instructions below.

Remove the HDD cover (See **Section 3.4**).

Locate the SATA DOM card slot and insert the card into the slot. (**Figure 3-2**).



Figure 3-2: SATA DOM Card Installation

Replace the HDD cover and secure using one (1) retention screw.

3.6 Installing an HDD

To install an HDD, please follow the steps below:

Remove the HDD cover (See **Section 3.4**).

Line up the HDD with the SATA connector.

Insert the HDD into SATA connector until it is securely in place (**Figure 3-3**).

AFL-HM55 Series Panel PC



Figure 3-3: HDD Installation

Replace the HDD cover and secure using one (1) retention screw.

3.7 Removing the Rear Panel Cover



WARNING:

Over-tightening rear cover screws will crack the plastic frame.
Maximum torque for cover screws is 5 kg-cm (0.36 lb-ft/0.49 Nm).

To access the AFL-HM55 internally, the rear panel cover must first be removed. To remove the rear panel cover, please follow the steps below.

Remove twenty-one (21) retention screws from the rear panel cover. See **Figure 3-4**.



Figure 3-4: AFL-HM55 Series Back Cover Retention Screws

Lift the cover off the AFL-HM55 Series panel PC.

3.8 Removing the Internal Aluminum Cover



WARNING:

Over-tightening rear cover screws will crack the plastic frame.
Maximum torque for cover screws is 5 kg-cm (0.36 lb-ft/0.49 Nm).

To remove the internal aluminum cover, follow the steps below.

Remove sixteen (16) retention screws securing the internal aluminum cover.

Figure 3-5 shows the aluminum cover retention screws of the AFL-HM55 Series.

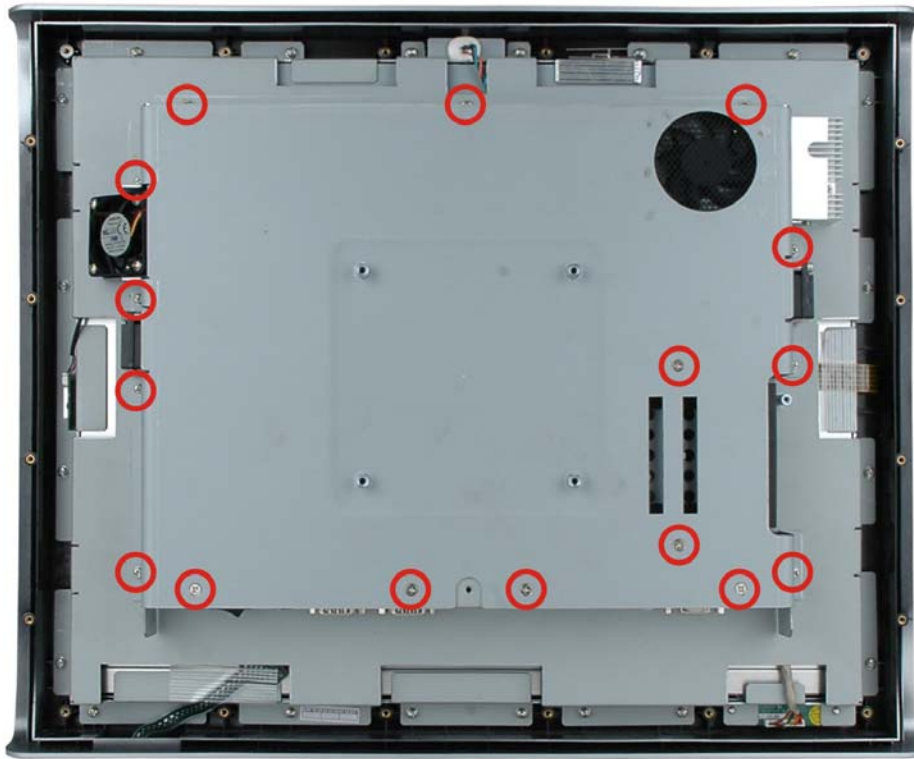

Figure 3-5: AFL-HM55 Series Aluminum Back Cover Retention Screws

Lift the aluminum cover away to expose the mainboard jumpers.

3.9 Jumper Settings



NOTE:

A jumper is a metal bridge used to close an electrical circuit. It consists of two or three metal pins and a small metal clip (often protected by a plastic cover) that slides over the pins to connect them. To CLOSE/SHORT a jumper means connecting the pins of the jumper with the plastic clip and to OPEN a jumper means removing the plastic clip from a jumper.

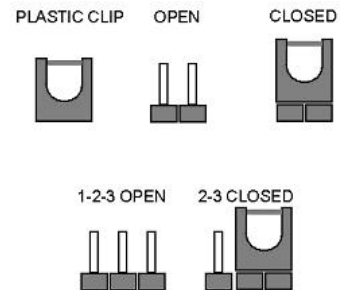

The following jumpers can be found on the motherboard installed in the AFL-HM55 Series. Before the AFL-HM55 Series is installed, the jumpers must be set in accordance with the desired configuration. The jumpers on the AFL-HM55 Series motherboard are listed in **Table 3-1**.

Description	Label	Type
Clear CMOS setting	J_CMOS1	3-pin header
COM1 Pin 9 setting	JP7, JP8	6-pin header
COM3 TX function select	JP9	6-pin header
COM3 RS-232/422/485	JP10	12-pin header
COM3 RS function select	JP11	8-pin header
ME Debug Mode	JP12	2-pin header
iTPM setting	J_ITPM1	3-pin header
ME RTC select	ME_RTC1	3-pin header
SPI setting	J_SPI1	3-pin header

Table 3-1: Jumpers

3.9.1 Access the Jumpers

To access the jumpers, please remove the back panel and the internal aluminum chassis (see **Section 3.7** and **Section 3.8**).

3.9.2 Preconfigured Jumpers



WARNING:

Do not change the settings on the jumpers in described here. Doing so may disable or damage the system.

AFL-HM55 Series Panel PC

The following jumpers are preconfigured for the AFL-HM55 Series. Users should not change these jumpers (**Table 3-2**).

Jumper Name	Label	Type
MCU Detect LCD Type	JP3	4-pin header
MCU PWM Power	JP4	3-pin header
LCD Power Select	J_VLVDS1	6-pin header

Table 3-2: Preconfigured Jumpers

3.9.3 Clear CMOS Jumper

Jumper Label:	J_CMOS1
Jumper Type:	3-pin header
Jumper Settings:	See Table 3-3
Jumper Location:	See Figure 3-6

If the AFL-HM55 Series fails to boot due to improper BIOS settings, the clear CMOS jumper clears the CMOS data and resets the system BIOS information. To do this, use the jumper cap to close the pins for a few seconds then remove the jumper clip.

If the “CMOS Settings Wrong” message is displayed during the boot up process, the fault may be corrected by pressing F1 to enter the CMOS Setup menu. Do one of the following:

- Enter the correct CMOS setting
- Load Optimal Defaults
- Load Failsafe Defaults.

After having done one of the above, save the changes and exit the CMOS Setup menu.

The clear CMOS jumper settings are shown in **Table 3-3**.

Clear CMOS	Description
Short 1 - 2	Keep CMOS Setup

Short 2 - 3	Clear CMOS Setup
-------------	------------------

Table 3-3: Clear CMOS Jumper Settings

The location of the clear CMOS jumper is shown in **Figure 3-6** below.

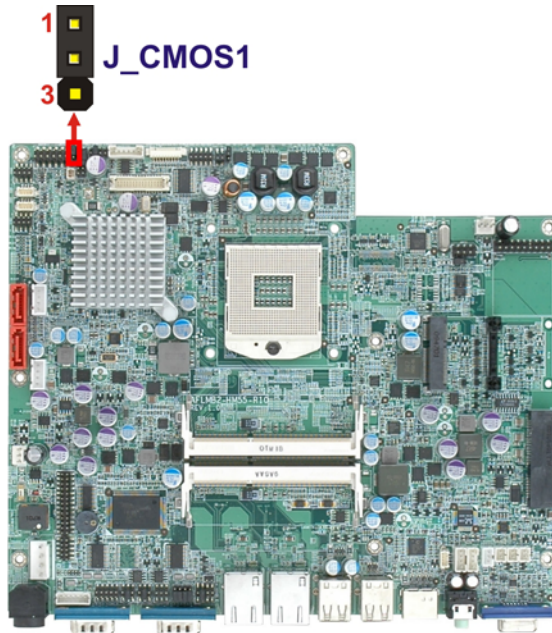
Figure 3-6: Clear CMOS Jumper

3.9.4 COM1 Pin 9 Setting

- Jumper Label:** JP7 and JP8
- Jumper Type:** 6-pin header
- Jumper Settings:** See **Table 3-4** and **Table 3-5**
- Jumper Location:** See **Figure 3-7** and **Figure 3-8**

Two jumpers (JP7 and JP8) configure pin 9 on COM1 and COM3 DB-9 connectors. Pin 9 on the COM1 and the COM3 DB-9 connectors can be set as the ring (RI) signal, +5 V or +12 V. The COM1 and COM3 Pin 9 Setting jumper selection options are shown in the tables below.

AFL-HM55 Series Panel PC

JP7	Description
Short 1-2	COM1 RI +12 V
Short 3-4	COM1 RI Normal
Short 5-6	COM1 RI Pin +5 V

Table 3-4: COM1 Pin 9 Setting Jumper Settings

The JP7 jumper location is shown below.

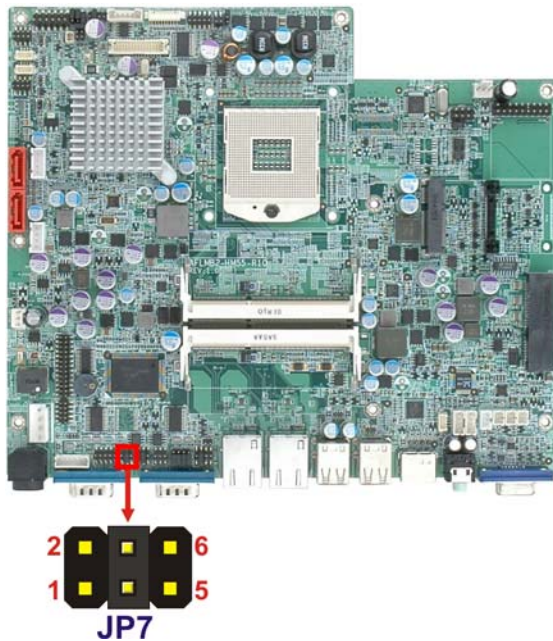

Figure 3-7: JP7 Jumper Setting Location

JP8	Description
Short 1-2	COM3 RI +12 V
Short 3-4	COM3 RI Normal
Short 5-6	COM3 RI +5 V

Table 3-5: COM3 Pin 9 Setting Jumper Settings

The JP8 jumper location is shown below.

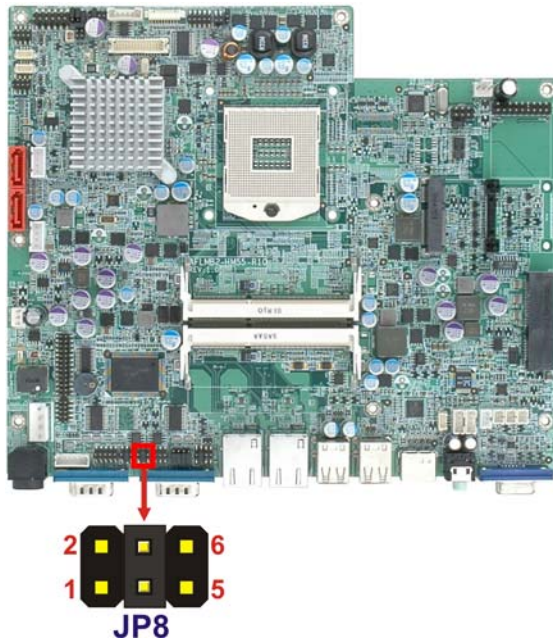

Figure 3-8: JP8 Jumper Setting Location

3.9.5 COM3 TX Function Select Jumper

- Jumper Label:** JP9
- Jumper Type:** 6-pin header
- Jumper Settings:** See Table 3-6
- Jumper Location:** See Figure 3-9

The COM3 TX Function Select jumper configures the TX pin on COM3 serial port connector as RS-422 or RS-485. The COM3 TX Function Select jumper selection options are shown in **Table 3-6**.

JP9	Description
Short 1 – 3	RS-422 TX-
Short 2 – 4	RS-422 TX+
Short 3 – 5	RS-485 D-
Short 4 – 6	RS-485 D+

Table 3-6: COM3 TX Function Select Jumper Settings

The COM3 TX Function Select jumper location is shown in **Figure 3-9** below.

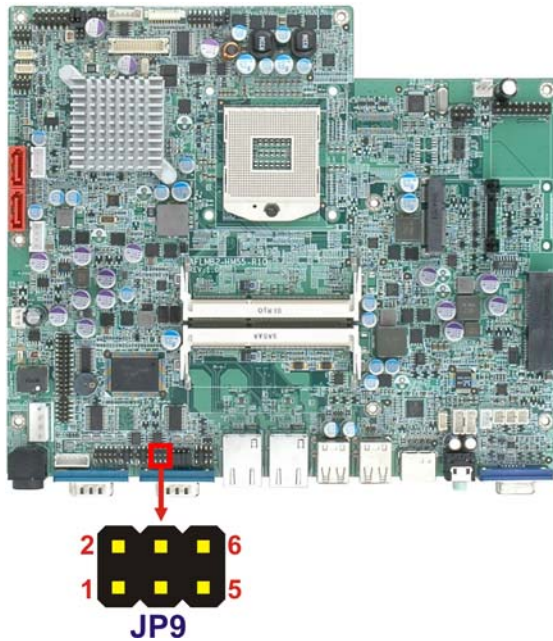

Figure 3-9: COM3 TX Function Select Jumper Location

3.9.6 COM3 RS-232/422/485 Jumper

- Jumper Label:** JP10
- Jumper Type:** 12-pin header (four 3-pin headers combined)
- Jumper Settings:** See **Table 3-7**
- Jumper Location:** See **Figure 3-10**

The COM3 RS-232/422/485 Serial Port Select jumper sets the communication protocol used by the second serial communications port (COM3) as RS-232, RS-422 or RS-485. The COM3 RS-232/422/485 Serial Port Select settings are shown in **Table 3-7**.

JP10	Description
Short 1-2	RS-232

Short 4-5	RS-232
Short 7-8	RS-232
Short 10-11	RS-232
Short 2-3	RS-422/485
Short 5-6	RS-422/485
Short 8-9	RS-422/485
Short 11-12	RS-422/485

Table 3-7: COM3 RS-232/422/485 Serial Port Select Jumper Settings

The COM3 RS-232/422/485 Serial Port Select jumper location is shown in **Figure 3-10**.

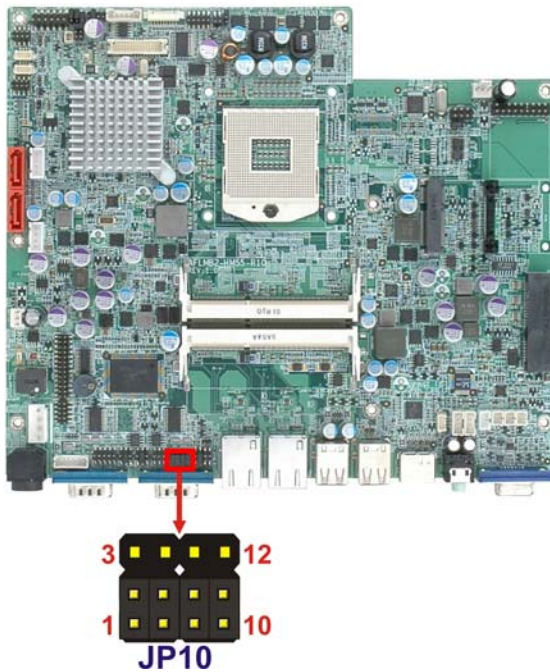

Figure 3-10: COM3 RS-232/422/485 Serial Port Select Jumper Location

3.9.6.1 COM3 RS-422 and RS-485 Pinouts

The pinouts for RS-422 and RS-485 operation of external serial port COM 3 are detailed below.

COM 3	RS-422 Description
Pin 1	TX-

AFL-HM55 Series Panel PC

Pin 2	TX+
Pin 6	RX-
Pin 7	RX+

Table 3-8: RS-422 Pinouts

COM 3	RS-485 Description
Pin 1	Data-
Pin 2	Data+

Table 3-9: RS-485 Pinouts

3.9.7 COM3 RS Function Select Jumper

- Jumper Label:** JP11
- Jumper Type:** 8-pin header
- Jumper Settings:** See **Table 3-10**
- Jumper Location:** See **Figure 3-11**

The COM3 RX Function Select jumper sets the communication protocol used by the RX serial communications port COM3 as RS-232, RS-422 or RS-485. The COM3 RX Function Select jumper settings are shown in **Table 3-10**.

COM3 RX Function Select	Description
Short 1-2	DET BIOS RS232/422/485
Short 3-4	RS-232
Short 5-6	RS-422
Short 7-8	RS-485

Table 3-10: COM3 RX Function Select Jumper Settings

The COM3 RX Function Select jumper location is shown in **Figure 3-11**.

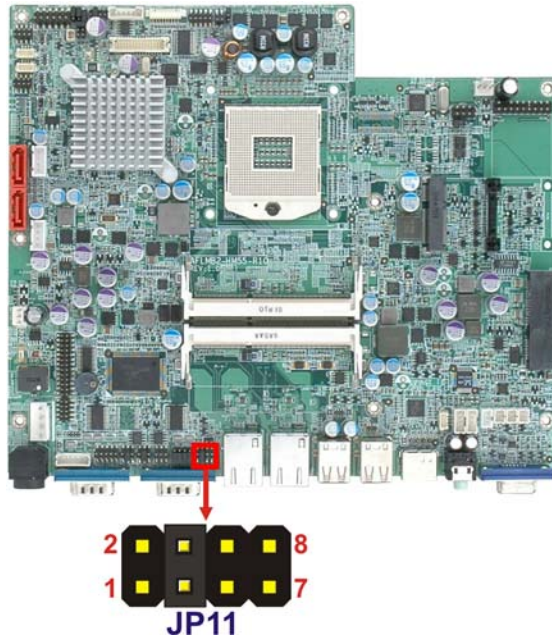

Figure 3-11: COM3 RX Function Select Jumper Location

3.9.8 ME Debug Mode Jumper

- Jumper Label:** JP12
- Jumper Type:** 2-pin header
- Jumper Settings:** See Table 3-11
- Jumper Location:** See Figure 3-12

The ME Debug Mode jumper allows ME firmware overwrite protection. The ME Debug Mode jumper settings are shown in **Table 3-11**.

ME Debug Mode	Description
Open	Disabled
Closed	Enabled

Table 3-11: ME Debug Mode Jumper Settings

The ME Debug Mode jumper location is shown in **Figure 3-12**.

AFL-HM55 Series Panel PC

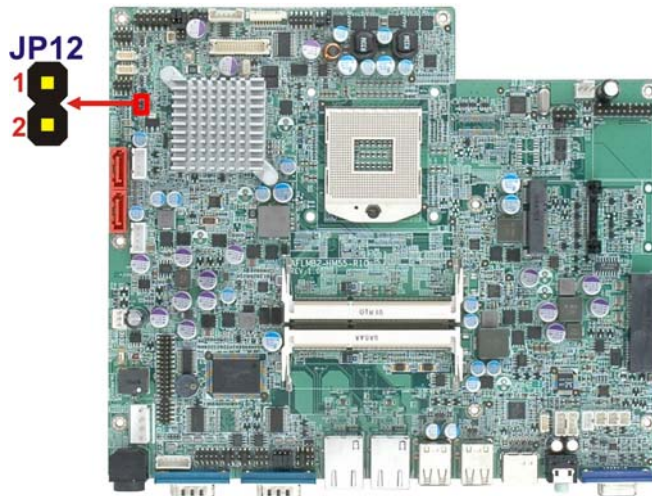

Figure 3-12: ME Debug Mode Jumper Location

3.9.9 iTPM Setting Jumper

- Jumper Label:** J_ITPM1
- Jumper Type:** 3-pin header
- Jumper Settings:** See Table 3-12
- Jumper Location:** See Figure 3-13

The iTPM jumper settings are shown in **Table 3-12**.

iTPM setting	Description
Short 1-2	Disable iTPM
Short 2-3	Enable iTPM

Table 3-12: iTPM Jumper Settings

The iTPM jumper location is shown in **Figure 3-13**.

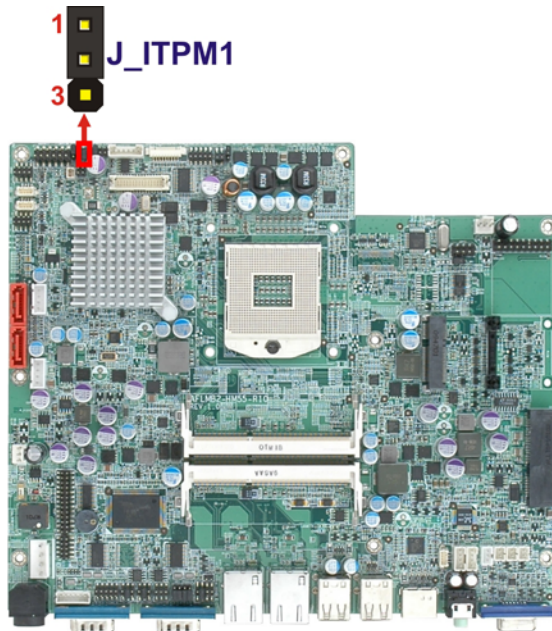

Figure 3-13: iTPM Jumper Location

3.9.10 ME RTC Select Jumper

- Jumper Label:** ME_RTC1
- Jumper Type:** 3-pin header
- Jumper Settings:** See **Table 3-13**
- Jumper Location:** See **Figure 3-14**

The ME RTC select jumper settings are shown in **Table 3-13**.

ME RTC select	Description
Short 1-2	Keep ME RTC
Short 2-3	Clear ME RTC

Table 3-13: ME RTC Jumper Settings

The ME RTC jumper location is shown in **Figure 3-14**.

AFL-HM55 Series Panel PC

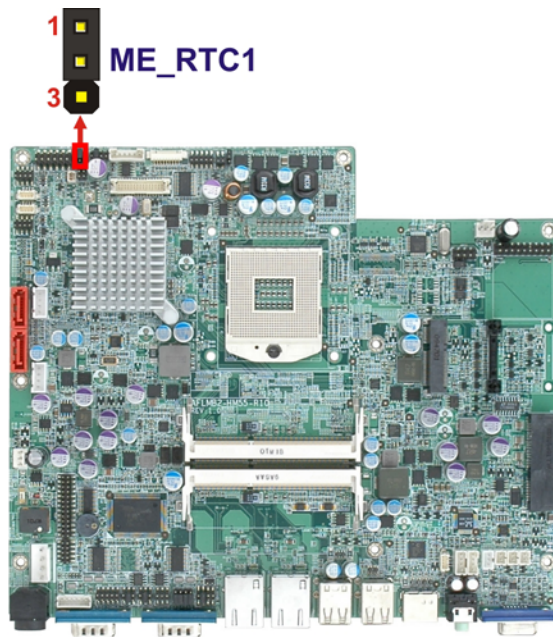

Figure 3-14: ME RTC Jumper Location

3.9.11 SPI Setting Jumper

- Jumper Label:** J_SPI
- Jumper Type:** 3-pin header
- Jumper Settings:** See Table 3-14
- Jumper Location:** See Figure 3-15

The SPI jumper settings are shown in Table 3-14.

SPI setting	Description
Short 1-2	Program SP10
Short 2-3	Program SPI1

Table 3-14: SPI Jumper Settings

The SPI jumper location is shown in Figure 3-15.

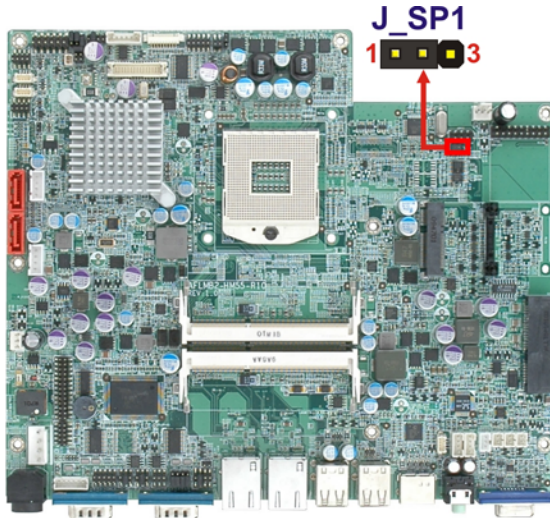

Figure 3-15: SPI Jumper Location

3.10 Mounting the System



WARNING!

When mounting the flat panel PC onto an arm, onto the wall or onto a panel, it is better to have more than one person to help with the installation to make sure the panel PC does not fall down and get damaged.

The four methods of mounting the AFL-HM55 Series are listed below.

- Wall mounting
- Panel mounting
- Arm mounting
- Rack mounting

The four mounting methods are described below.

3.10.1 Wall Mounting

To mount the flat panel PC onto the wall, please follow the steps below.

Select the location on the wall for the wall-mounting bracket.

AFL-HM55 Series Panel PC

Carefully mark the locations of the four screw holes in the bracket on the wall.

Drill four pilot holes at the marked locations on the wall for the bracket retention screws.

Align the wall-mounting bracket screw holes with the pilot holes.

Secure the mounting-bracket to the wall by inserting the retention screws into the four pilot holes and tightening them (**Figure 3-16**).

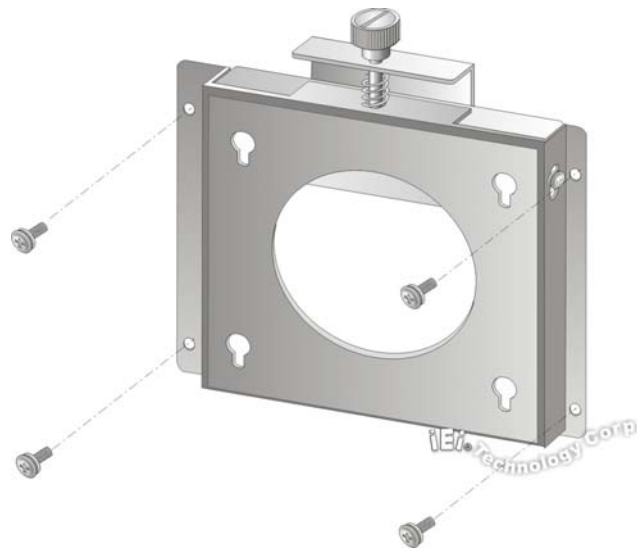

Figure 3-16: Wall-mounting Bracket

Insert the four monitor mounting screws provided in the wall mounting kit into the four screw holes on the rear panel of the flat panel PC and tighten until the screw shank is secured against the rear panel (**Figure 3-17**).

Align the mounting screws on the monitor rear panel with the mounting holes on the bracket.

Carefully insert the screws through the holes and gently pull the monitor downwards until the monitor rests securely in the slotted holes (**Figure 3-17**). Ensure that all four of the mounting screws fit snugly into their respective slotted holes.



NOTE:

In the diagram below the bracket is already installed on the wall.

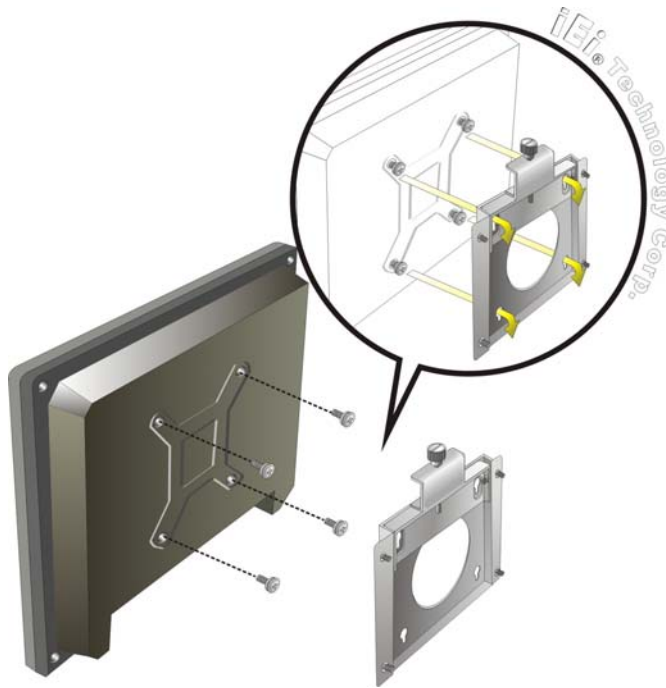

Figure 3-17: Chassis Support Screws

Secure the panel PC by fastening the retention screw of the wall-mounting bracket.

(Figure 3-18).

AFL-HM55 Series Panel PC

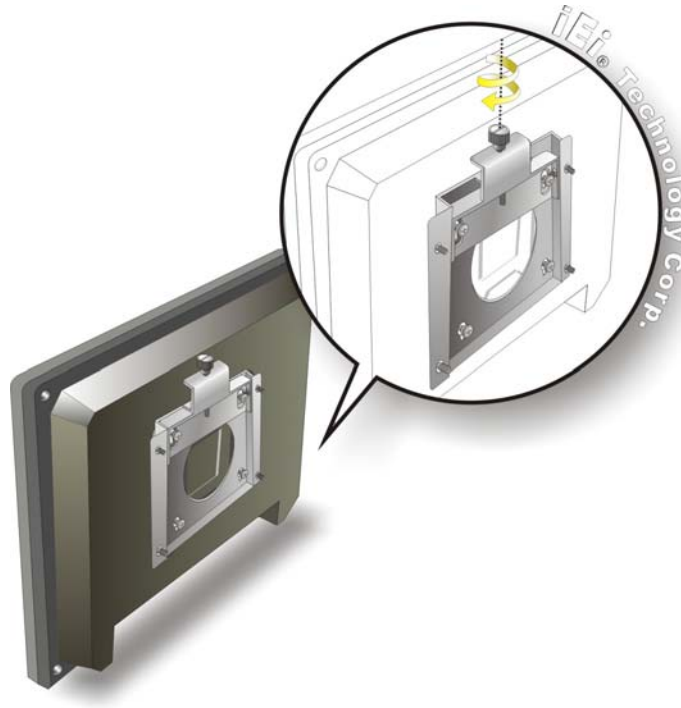

Figure 3-18: Securing the Panel PC

3.10.2 Panel Mounting

To mount the AFL-HM55 Series flat panel PC into a panel, please follow the steps below.

Select the position on the panel to mount the flat panel PC.

Cut out a section from the panel that corresponds to the rear panel dimensions of the flat panel PC. Take care that the panel section that is cut out is smaller than the overall size of the frame that surrounds the flat panel PC, but just large enough for the rear panel of the flat panel PC to fit through. See the figures below for the appropriate cut out area dimensions.

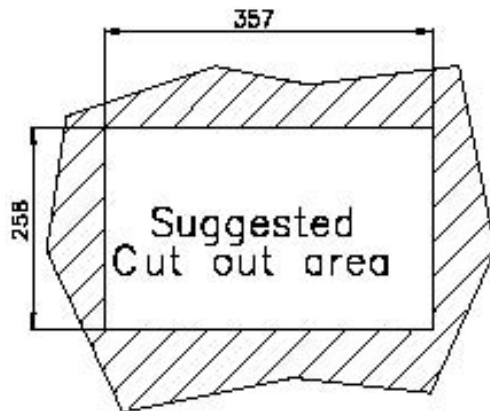

Figure 3-19: 15-inch AFL-HM55 Series Panel Opening (Unit: mm)

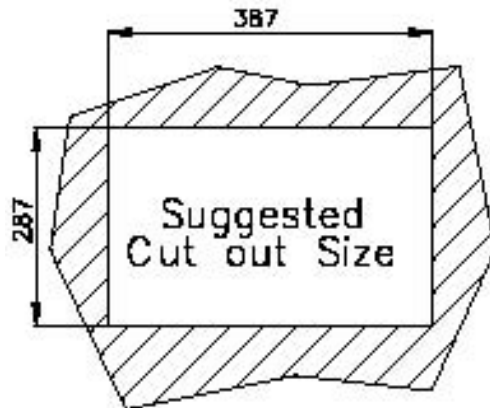

Figure 3-20: 17-inch AFL-HM55 Series Panel Opening (Unit: mm)

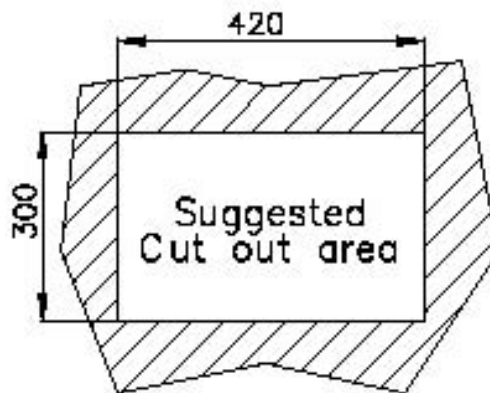

Figure 3-21: 19-inch AFL-HM55 Series Panel Opening (Unit: mm)

Slide the flat panel PC through the hole until the frame is flush against the panel.

AFL-HM55 Series Panel PC

Align the panel mounting bracket screw holes with the VESA mounting holes on the rear of the panel PC.

Secure the two panel mounting brackets to the rear of the panel PC by inserting the four retention screws into the VESA mounting holes (**Figure 3-22 ①**).

Insert the panel mounting clamps into the pre-formed holes along the two edges of the panel mounting brackets (**Figure 3-22 ②**). There are a total of 4 panel mounting clamps for AFL-HM55 Series.

Tighten the screws that pass through the panel mounting clamps until the plastic caps at the front of all the screws are firmly secured to the panel (**Figure 3-22 ③**).

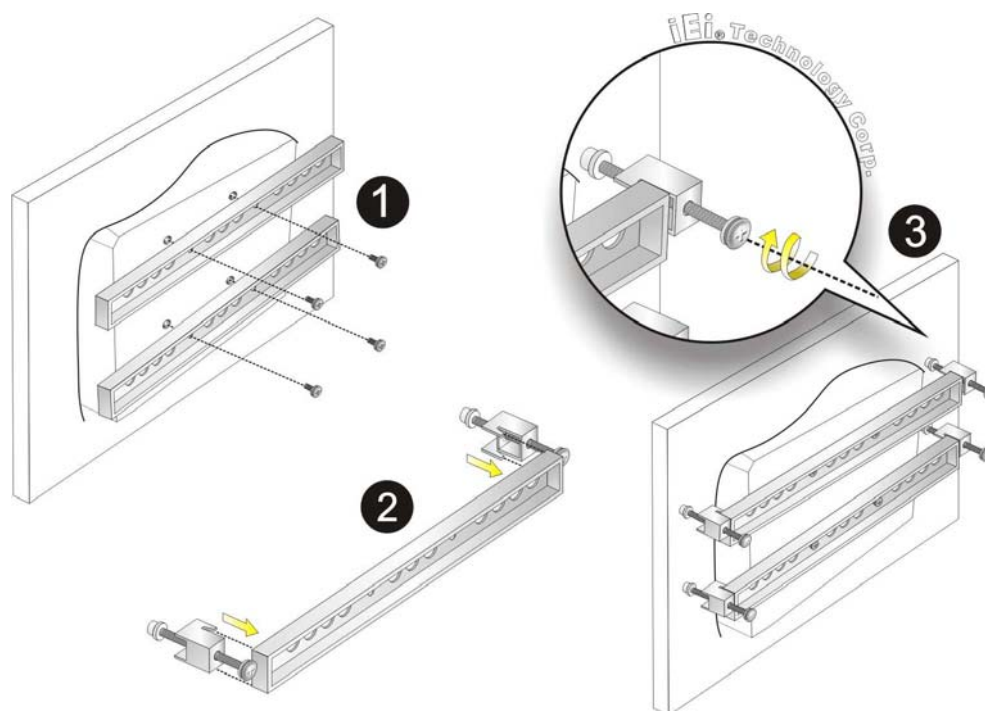

Figure 3-22: Panel Mounting

3.10.3 Arm Mounting

The AFL-HM55 Series is VESA (Video Electronics Standards Association) compliant and can be mounted on an arm with a 75mm or 100mm interface pad. To mount the AFL-HM55 Series on an arm, please follow the steps below.

The arm is a separately purchased item. Please correctly mount the arm onto the surface it uses as a base. To do this, refer to the installation documentation that came with the mounting arm.



NOTE:

When purchasing the arm please ensure that it is VESA compliant and that the arm has a 100 mm interface pad. If the mounting arm is not VESA compliant it cannot be used to support the AFL-HM55 Series flat panel PC.

Once the mounting arm has been firmly attached to the surface, lift the flat panel PC onto the interface pad of the mounting arm.

Align the retention screw holes on the mounting arm interface with those in the flat panel PC. The AFL-HM55 Series arm mount retention screw holes are shown in

Figure 3-23.

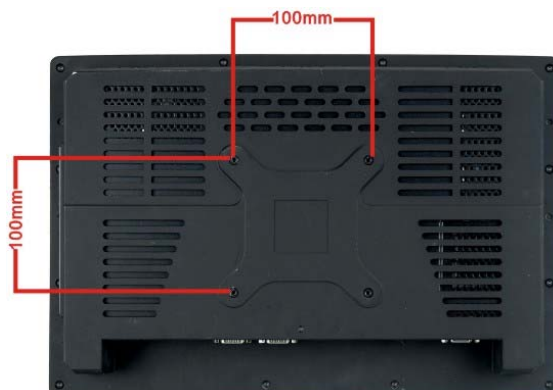

Figure 3-23: Arm Mounting Retention Screw Holes

AFL-HM55 Series Panel PC

Secure the flat panel PC to the interface pad by inserting four retention screws through the bottom of the mounting arm interface pad and into the flat panel PC.

3.10.4 Cabinet and Rack Installation (15-inch and 17-inch models only)

The AFL-HM55 Series flat panel PC can be installed into a cabinet or rack. The installation procedures are similar to the panel mounting installation. To do this, please follow the steps below:



NOTE:

When purchasing the cabinet/rack installation bracket, make sure it is compatible with both the AFL-HM55 Series flat panel PC and the rack/cabinet into which the AFL-HM55 Series is installed.

Slide the rear chassis of the AFL-HM55 Series flat panel PC through the rack/cabinet bracket until the aluminum frame is flush against the front of the bracket (**Figure 3-24**).

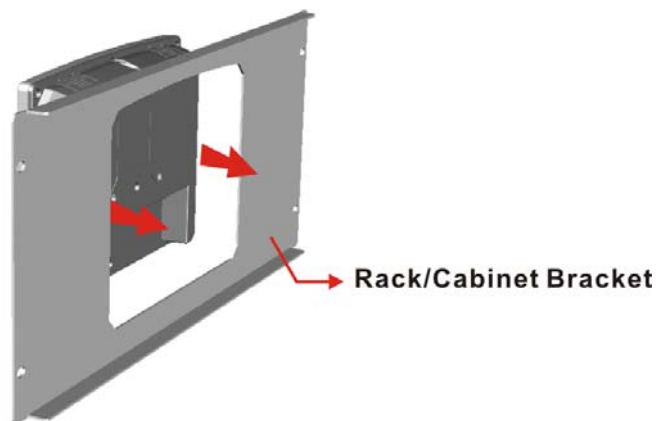

Figure 3-24: The Rack/Cabinet Bracket

Follow the **Step 4 ~ Step 7** in **Section 3.10.2** to mount the AFL-HM55 Series into a cabinet or rack.

3.11 Bottom Panel Connectors

3.11.1 LAN Connection

There are two external RJ-45 LAN connectors. The RJ-45 connector enables connection to an external network. To connect a LAN cable with an RJ-45 connector, please follow the instructions below.

Locate the RJ-45 connectors on the bottom panel of the AFL-HM55 Series.

Align the connectors. Align the RJ-45 connector on the LAN cable with one of the RJ-45 connectors on the bottom panel of the AFL-HM55 Series. See **Figure 3-25**.

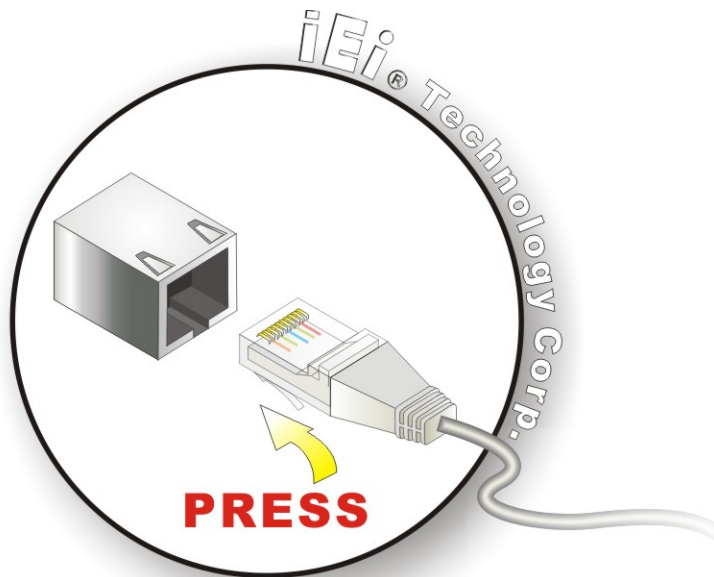

Figure 3-25: LAN Connection

Insert the LAN cable RJ-45 connector. Once aligned, gently insert the LAN cable RJ-45 connector into the onboard RJ-45 connector.

3.11.2 Serial Device Connection

The AFL-HM55 Series has two male DB-9 connectors on the bottom panel for serial devices to be connected. Follow the steps below to connect a serial device to the AFL-HM55 Series panel PC.

AFL-HM55 Series Panel PC

Locate the DB-9 connector. The location of the DB-9 connector is shown in **Chapter 2**.

Insert the serial connector. Insert the DB-9 connector of a serial device into the DB-9 connector on the bottom panel. See **Figure 3-26**.

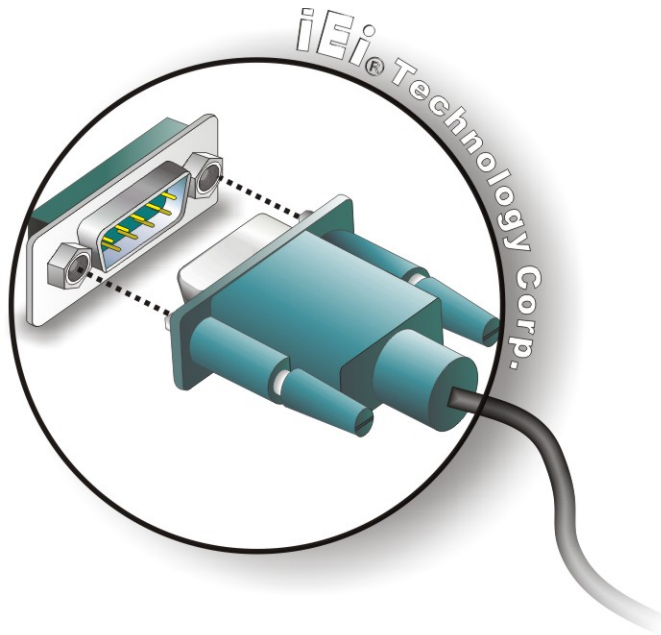

Figure 3-26: Serial Device Connector

Secure the connector. Secure the serial device connector to the external interface by tightening the two retention screws on either side of the connector.

3.11.3 USB Device Connection

There are four external USB 2.0 connectors. All connectors are perpendicular to the AFL-HM55 Series. To connect a USB 2.0 or USB 1.1 device, please follow the instructions below.

Located the USB connectors. The locations of the USB connectors are shown in **Chapter 2**.

Align the connectors. Align the USB device connector with one of the connectors on the bottom panel. See **Figure 3-27**.

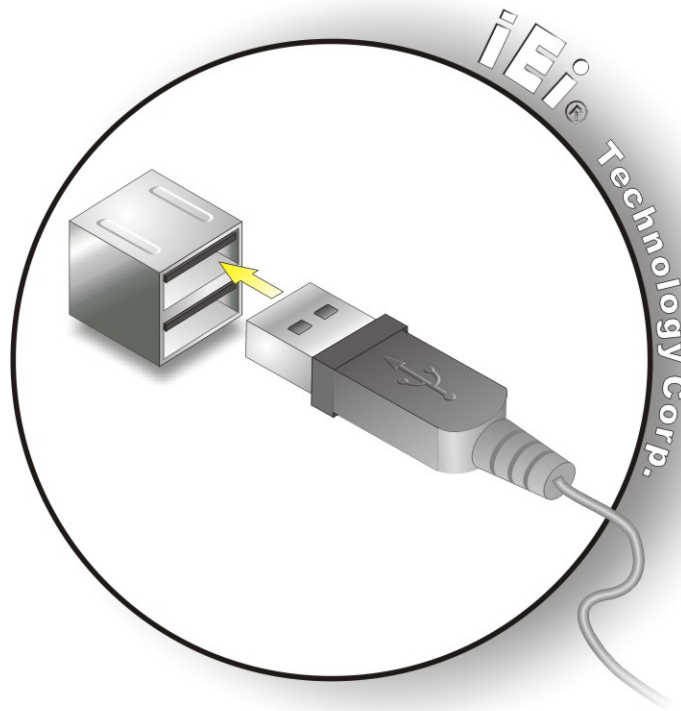

Figure 3-27: USB Device Connection

Insert the device connector. Once aligned, gently insert the USB device connector into the onboard connector.

3.11.4 VGA Monitor Connection

The AFL-HM55 Series has a single female DB-15 connector on the external peripheral interface panel. The DB-15 connector is connected to a CRT or VGA monitor. To connect a monitor to the AFL-HM55 Series, please follow the instructions below.

- Step 1: Locate the female DB-15 connector.** The location of the female DB-15 connector is shown in **Section 1.2.4**.
- Step 2: Align the VGA connector.** Align the male DB-15 connector on the VGA screen cable with the female DB-15 connector on the external peripheral interface.

AFL-HM55 Series Panel PC

Step 3: Insert the VGA connector Once the connectors are properly aligned with the insert the male connector from the VGA screen into the female connector on the AFL-HM55 Series. See Figure 3-28.

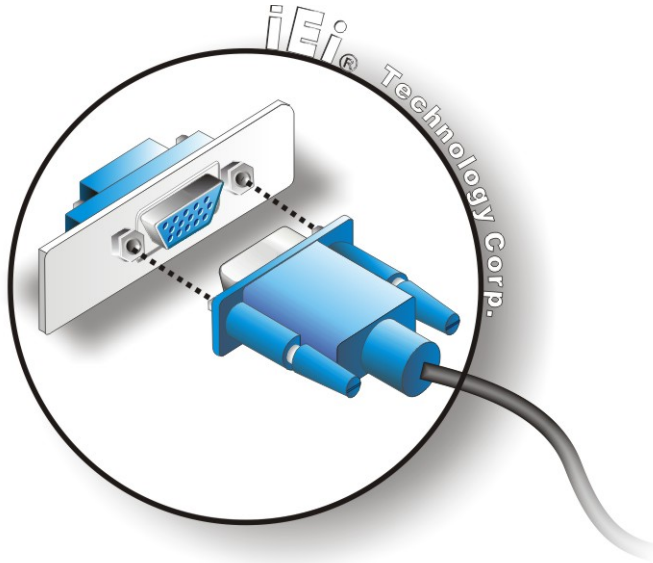

Figure 3-28: VGA Connector

Step 4: Secure the connector. Secure the DB-15 VGA connector from the VGA monitor to the external interface by tightening the two retention screws on either side of the connector.

3.12 AT/ATX Mode Selection

AT and ATX power modes can both be used on the AFL-HM55 Series. The selection is made through an AT/ATX switch on bottom panel (**Figure 3-29**). To select AT mode or ATX mode, follow the steps below.

Locate the AT/ATX switch on the bottom panel (**Figure 3-29**).

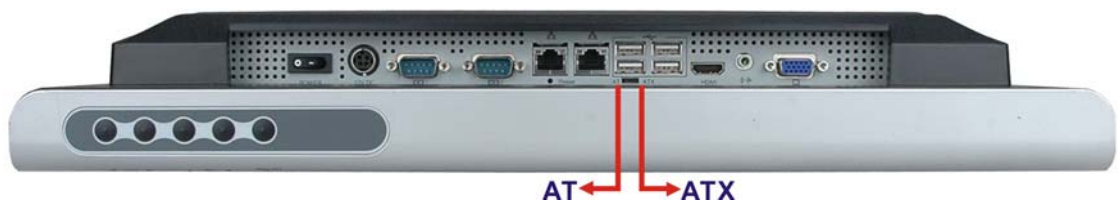

Figure 3-29: AT/ATX Switch Location

Adjust the switch according to the preferred setting.

3.12.1 AT Power Mode

With the AT mode selected, the power is controlled by a central power unit rather than a power switch. The AFL-HM55 Series panel PC turns on automatically when the power is connected. The AT mode benefits a production line to control multiple panel PCs from a central management center and other applications including:

- ATM
- Self-service kiosk
- Plant environment monitoring system
- Factory automation platform
- Manufacturing shop flow

3.12.2 ATX Power Mode

With the ATX mode selected, the AFL-HM55 Series panel PC goes in a standby mode when it is turned off. The panel PC can be easily turned on via network or a power switch in standby mode. Remote power control is perfect for advertising applications since the broadcasting time for each panel PC can be set individually and controlled remotely. Other possible application includes

- Security surveillance
- Point-of-Sale (POS)
- Advertising terminal

Chapter

4

System Maintenance

4.1 System Maintenance Introduction

If the components of the AFL-HM55 Series fail they must be replaced. Components that can be replaced include:

- SO-DIMM module
- SATA DOM module
- HDD drive

Please contact the system reseller or vendor to purchase replacement parts.

4.2 Anti-static Precautions



WARNING:

Failure to take ESD precautions during the maintenance of the AFL-HM55 Series may result in permanent damage to the AFL-HM55 Series and severe injury to the user.

Electrostatic discharge (ESD) can cause serious damage to electronic components, including the AFL-HM55 Series. Dry climates are especially susceptible to ESD. It is therefore critical that whenever the panel PC is accessed internally, or any other electrical component is handled, the following anti-static precautions are strictly adhered to.

- ***Wear an anti-static wristband:*** - Wearing a simple anti-static wristband can help to prevent ESD from damaging the board.
- ***Self-grounding:*** - Before handling the board touch any grounded conducting material. During the time the board is handled, frequently touch any conducting materials that are connected to the ground.
- ***Use an anti-static pad:*** - When configuring the AFL-HM55 Series, place it on an anti-static pad. This reduces the possibility of ESD damaging the AFL-HM55 Series.
- ***Only handle the edges of the PCB:*** - When handling the PCB, hold the PCB by the edges.

4.3 Turn off the Power



WARNING:

Failing to turn off the system before opening it can cause permanent damage to the system and serious or fatal injury to the user.

Before any maintenance procedures are carried out on the system, make sure the system is turned off.

4.4 Replacing Components

4.4.1 Memory Module Replacement

The flat panel PC features two DDR3 dual-channel SO-DIMM sockets supporting a system max of 8GB. If the memory module fails, follow the instructions below to replace the memory module.

Remove the back cover. See **Section 3.7**.

Remove the internal aluminum back cover. See **Section 3.8**.

Remove four (4) retention screws securing the HDD bracket to the chassis. See the following figure.

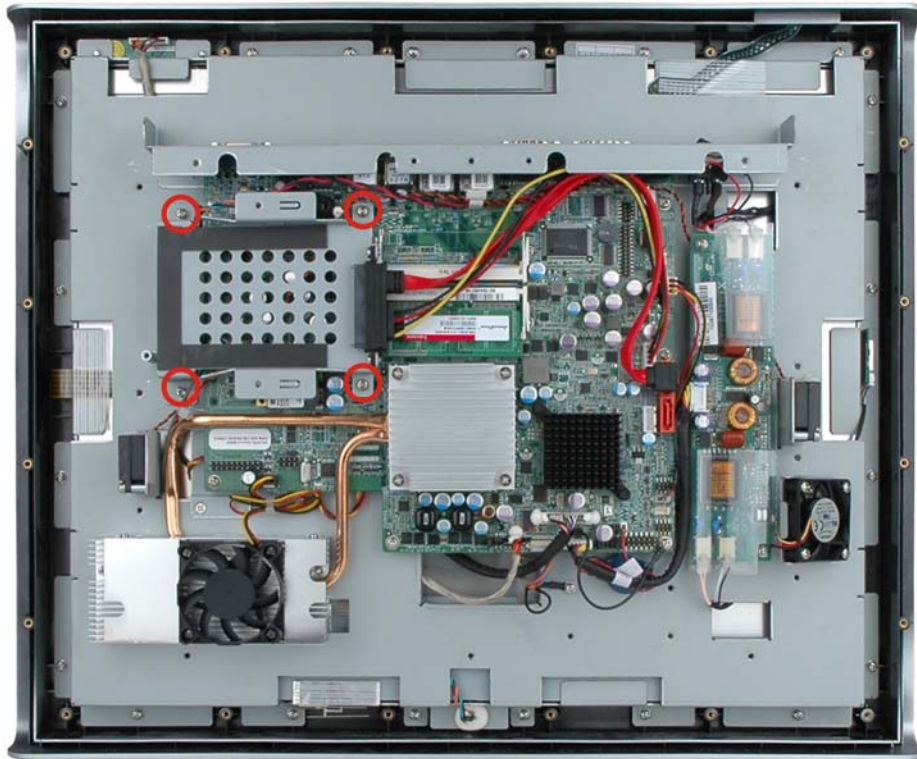
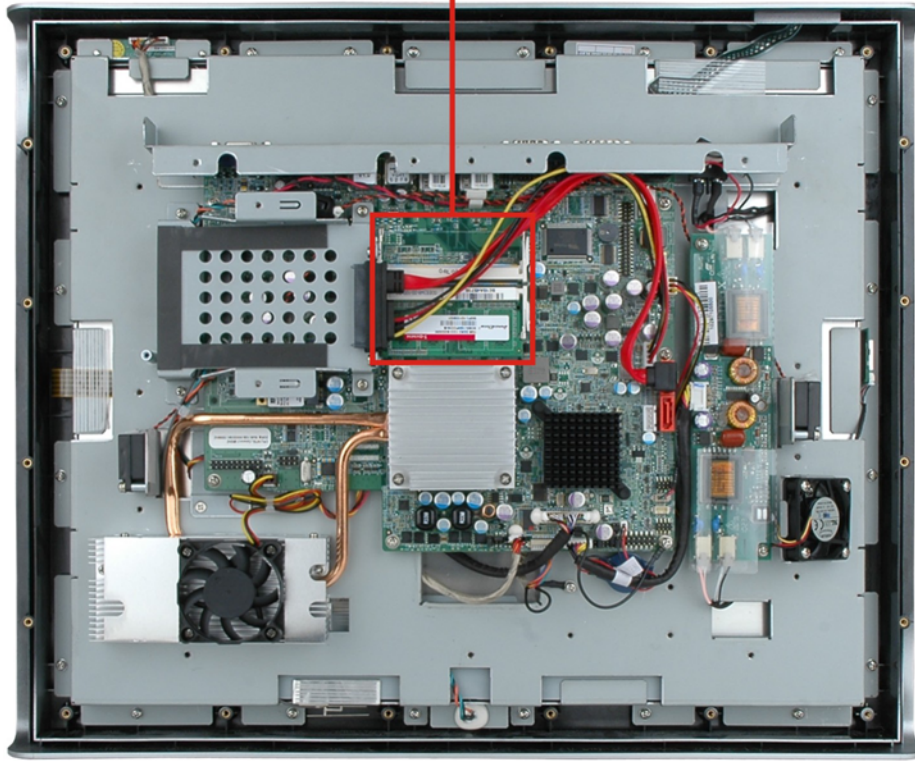

Figure 4-1: HDD Bracket Screws

Lift the HDD bracket away to expose the DIMM connectors. See (Figure 4-2).

AFL-HM55 Series Panel PC

Two DDR3 SO-DIMM Sockets

**Figure 4-2: SO-DIMM Socket Location**

Remove the DDR memory module by pulling both the spring retainer clips outward from the socket.

Grasp the DDR memory module by the edges and carefully pull it out of the socket.

Install the new DDR memory module by pushing it into the socket at an angle (**Figure 4-3**).

Gently pull the spring retainer clips of the SO-DIMM socket out and push the rear of the DDR memory module down (**Figure 4-3**).

Release the spring retainer clips on the SO-DIMM socket. They clip into place and secure the DDR memory module in the socket.

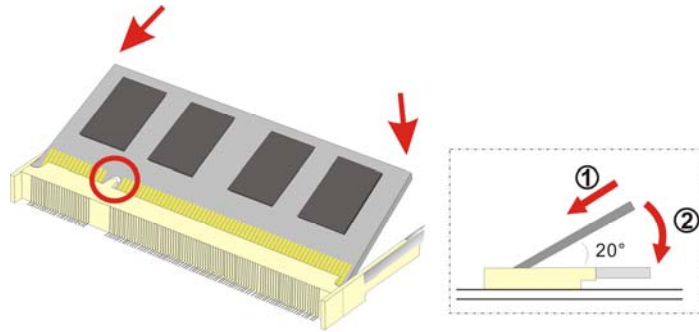

Figure 4-3: DDR SO-DIMM Module Installation

4.4.2 SATA DOM Card Replacement

The AFL-HM55 Series has one SATA DOM card slot. To replace the SATA DOM card, follow the instructions below.

Follow all anti-static procedures. See **Section 4.2**.

Turn off the power. See **Section 4.3**.

Remove the HDD Cover. See **Section 3.4**.

Follow the instructions listed in **Section 3.5** to replace the SATA DOM card.

4.4.3 HDD Card Replacement

The AFL-HM55 Series has one HDD slot. To replace the HDD, follow the instructions below.

Follow all anti-static procedures. See **Section 4.2**.

Turn off the power. See **Section 4.3**.

Remove the HDD Cover. See **Section 3.4**.

Follow the instructions listed in **Section 3.6** to replace the HDD card.

Chapter

5

BIOS Setup

5.1 Introduction

A licensed copy of the BIOS is preprogrammed into the ROM BIOS. The BIOS setup program allows users to modify the basic system configuration. This chapter describes how to access the BIOS setup program and the configuration options that may be changed.

5.1.1 Starting Setup

The UEFI BIOS is activated when the computer is turned on. The setup program can be activated in one of two ways.

1. Press the **F2** key as soon as the system is turned on or
2. Press the **F2** key when the “**Press F2 to enter SETUP**” message appears on the screen.

If the message disappears before the **F2** key is pressed, restart the computer and try again.

5.1.2 Using Setup

Use the arrow keys to highlight items, press **ENTER** to select, use the PageUp and PageDown keys to change entries, press **F1** for help and press **Esc** to quit. Navigation keys are shown in the following table.

Key	Function
Up arrow	Move to the item above
Down arrow	Move to the item below
Left arrow	Move to the item on the left hand side
Right arrow	Move to the item on the right hand side
+	Increase the numeric value or make changes
-	Decrease the numeric value or make changes
Page Up key	Move to the next page
Page Dn key	Move to the previous page

AFL-HM55 Series Panel PC

Esc key	Main Menu – Quit and do not save changes into CMOS Status Page Setup Menu and Option Page Setup Menu -- Exit current page and return to Main Menu
F1 key	General help, only for Status Page Setup Menu and Option Page Setup Menu
F9 key	Load optimized defaults
F10 key	Save changes and Exit BIOS

Table 5-1: BIOS Navigation Keys

5.1.3 Getting Help

When **F1** is pressed a small help window describing the appropriate keys to use and the possible selections for the highlighted item appears. To exit the Help Window press **Esc** or the **F1** key again.

5.1.4 Unable to Reboot After Configuration Changes

If the computer cannot boot after changes to the system configuration are made, CMOS defaults. Use the jumper described in **Chapter 4**.

5.1.5 BIOS Menu Bar

The **menu bar** on top of the BIOS screen has the following main items:

- **Main** Changes the basic system configuration.
- **Advanced** Changes the advanced system settings.
- **Chipset** Changes the chipset settings
- **Boot** Changes the system boot configuration.
- **Security** Sets User and Supervisor Passwords.
- **Save & Exit** Selects exit options and loads default settings

The following sections completely describe the configuration options found in the menu items at the top of the BIOS screen and listed above.

5.2 Main

The **Main** BIOS menu (**BIOS Menu 1**) appears when the **BIOS Setup** program is entered. The **Main** menu gives an overview of the basic system information.

Aptio Setup Utility - Copyright (C) 2010 American Megatrends, Inc.					
Main	Advanced	Chipset	Boot	Security	Save & Exit
BIOS Information					Set the Date. Use Tab to switch between Date elements.
BIOS Vendor			American Megatrends		
Core Version			4.6.3.7 0.16		
Project Version			H615AR10.ROM		
Build Date			10/12/2010 15:39:09		

Memory Information					←→: Select Screen
Total Memory			1024 MB (DDR3 1066)		↑ ↓: Select Item
System Date			[Wed 04/20/2011]		EnterSelect
System Time			[14:27:27]		+/-: Change Opt.
Access Level			Administrator		F1: General Help
					F2: Previous Values
					F3: Optimized Defaults
					F4: Save & Exit
					ESC: Exit
Version 2.02.1205. Copyright (C) 2010 American Megatrends, Inc.					

BIOS Menu 1: Main

→ System Overview

The **System Overview** lists a brief summary of different system components. The fields in **System Overview** cannot be changed. The items shown in the system overview include:

- **BIOS Vendor:** Installed BIOS vendor
- **Core Version:** Current BIOS version
- **Project Version:** The board version
- **Build Date:** Date the current BIOS version was made
- **Access Level:** User access level

→ Memory Information

The **Memory Information** lists a brief summary of the on-board memory. The fields in **Memory Information** cannot be changed.

- **Total Memory:** Displays the auto-detected system memory size and type.

AFL-HM55 Series Panel PC

The **System Overview** field also has two user configurable fields:

→ **System Date [xx/xx/xx]**

Use the **System Date** option to set the system date. Manually enter the day, month and year.

→ **System Time [xx:xx:xx]**

Use the **System Time** option to set the system time. Manually enter the hours, minutes and seconds.

5.3 Advanced

Use the **Advanced** menu (**BIOS Menu 2**) to configure the CPU and peripheral devices through the following sub-menus:



WARNING:

Setting the wrong values in the sections below may cause the system to malfunction. Make sure that the settings made are compatible with the hardware.

- ACPI Settings
- Trusted Computing
- CPU Configuration
- SATA Configuration
- USB Configuration
- Super IO Configuration
- H/W Monitor
- Serial Port Console Redirection

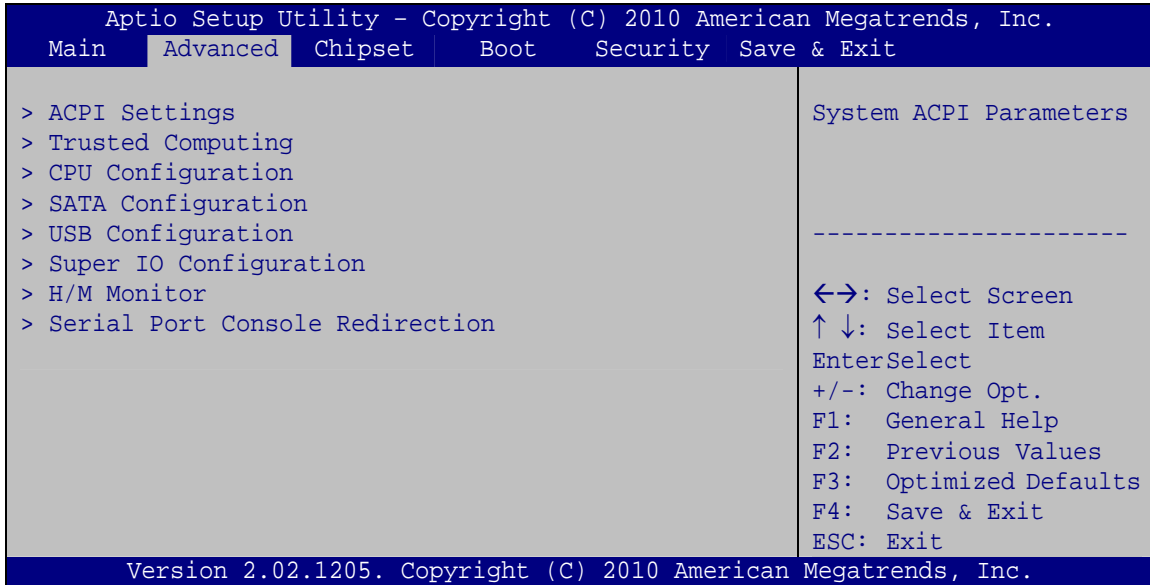
BIOS Menu 2: Advanced
5.3.1 ACPI Settings

The **ACPI Settings** menu (**BIOS Menu 5**) configures the Advanced Configuration and Power Interface (ACPI) options.

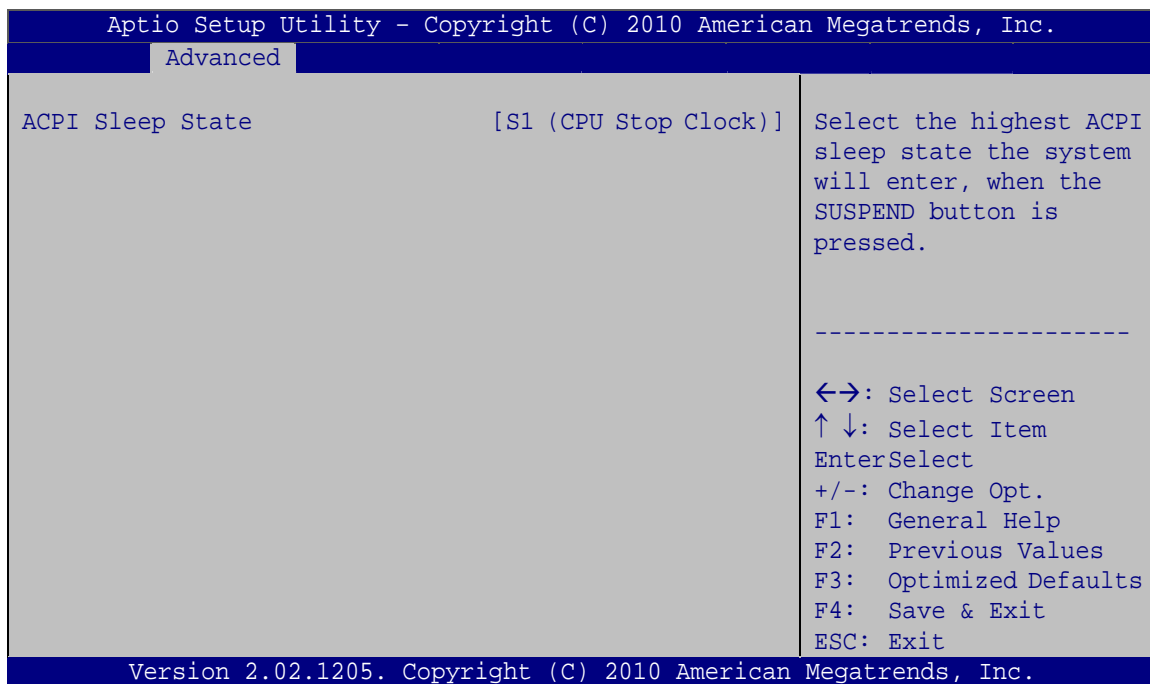
BIOS Menu 3: ACPI Configuration

AFL-HM55 Series Panel PC

→ ACPI Sleep State [S3 (CPU Stop Clock)]

Use the **ACPI Sleep State** option to specify the sleep state the system enters when it is not being used.

- **S1 (CPU Stop DEFAULT Clock)** The system enters S1 (POS) sleep state. The system appears off. The CPU is stopped; RAM is refreshed; the system is running in a low power mode.
- **S3 (Suspend to RAM)** The caches are flushed and the CPU is powered off. Power to the RAM is maintained. The computer returns slower to a working state, but more power is saved.

5.3.2 Trusted Computing

Use the **Trusted Computing** menu (**BIOS Menu 4**) to configure settings related to the Trusted Computing Group (TCG) Trusted Platform Module (TPM).

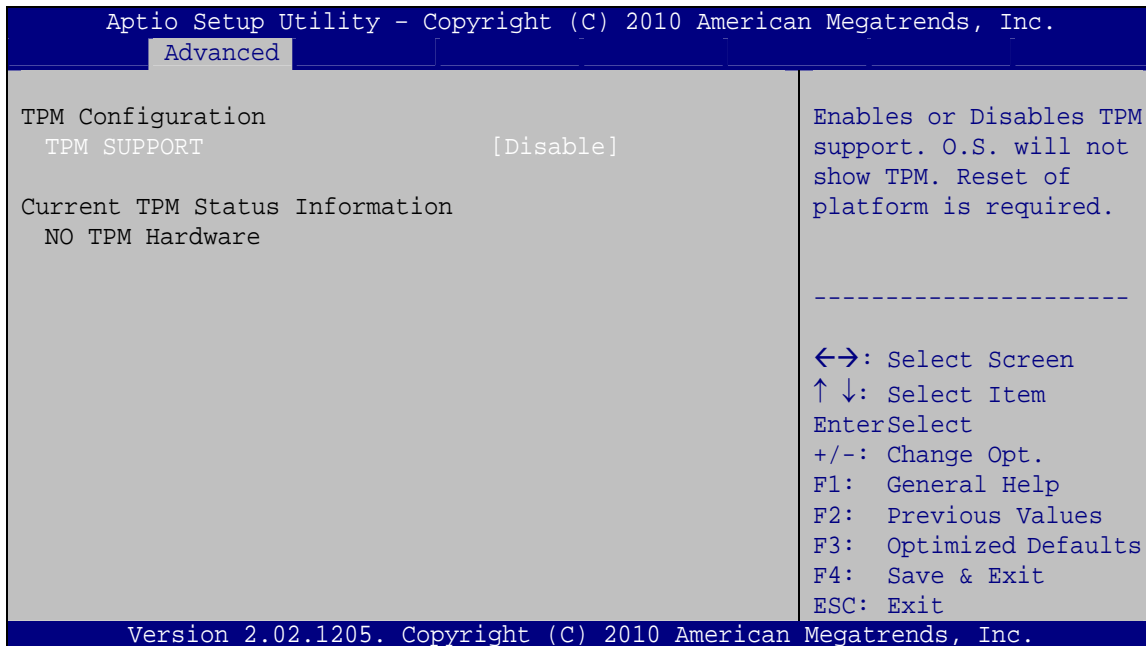

BIOS Menu 4: TPM Configuration

→ TPM Support [Disable]

Use the **TPM Support** option to configure support for the TPM.

→ **Disable** **DEFAULT** TPM support is disabled.

→ **Enable** TPM support is enabled.

5.3.3 CPU Configuration

Use the **CPU Configuration** menu (**BIOS Menu 5**) to view detailed CPU specifications and configure the CPU.

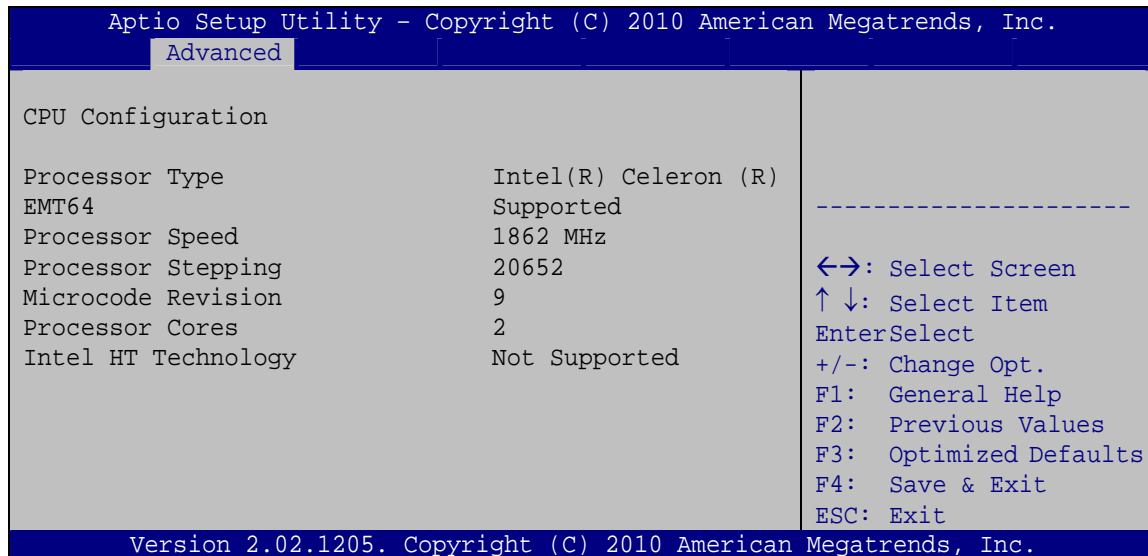
BIOS Menu 5: CPU Configuration

The CPU Configuration menu (**BIOS Menu 5**) lists the following CPU details:

- Processor Type: Lists the brand name of the CPU being used
- EMT64: Indicates if EM64T is supported by the CPU.
- Processor Speed: Lists the CPU processing speed
- Processor Stepping: Lists the CPU processing stepping
- Microcode Revision: Lists the microcode revision
- Processor Cores: Lists the number of the processor core
- Intel HT Technology: Indicates if Intel HT Technology is supported by the CPU.

AFL-HM55 Series Panel PC

5.3.4 SATA Configuration

Use the **SATA Configuration** menu (**BIOS Menu 6**) to change and/or set the configuration of the SATA devices installed in the system.

```

Aptio Setup Utility - Copyright (C) 2010 American Megatrends, Inc.
  Advanced
SATA Configuration
SATA Port0          Not Present
SATA Port1          Not Present
SATA Port2          Not Present

SATA Mode           [IDE Mode]
Serial-ATA Controller 0 [Compatible]
Serial-ATA Controller 1 [Enhanced]

(1) IDE Mode. (2) AHCI Mode.

-----
<->: Select Screen
↑ ↓: Select Item
Enter>Select
+/-: Change Opt.
F1:  General Help
F2:  Previous Values
F3:  Optimized Defaults
F4:  Save & Exit
ESC: Exit

Version 2.02.1205. Copyright (C) 2010 American Megatrends, Inc.
  
```

BIOS Menu 6: IDE Configuration

→ SATA Mode [IDE Mode]

Use the **SATA Mode** option to configure SATA devices as normal IDE devices.

- **Disable** Disables SATA devices.
- **IDE Mode** **DEFAULT** Configures SATA devices as normal IDE device.
- **AHCI Mode** Configures SATA devices as AHCI device.

→ Serial-ATA Controller n [Compatible]

Use the **Serial-ATA Controller** option to configure the SATA controller.

- **Disabled** Disables the on-board SATA controller.
- **Enhanced** Configures the on-board SATA controller to be in Enhanced mode. In this mode, IDE channels and SATA channels are separated.

- ➔ **Compatible** **DEFAULT** Configures the on-board SATA controller to be in compatible mode. In this mode, a SATA channel will replace one of the IDE channels. This mode supports up to 6 storage devices.

5.3.5 USB Configuration

Use the **USB Configuration** menu (**BIOS Menu 7**) to read USB configuration information and configure the USB settings.

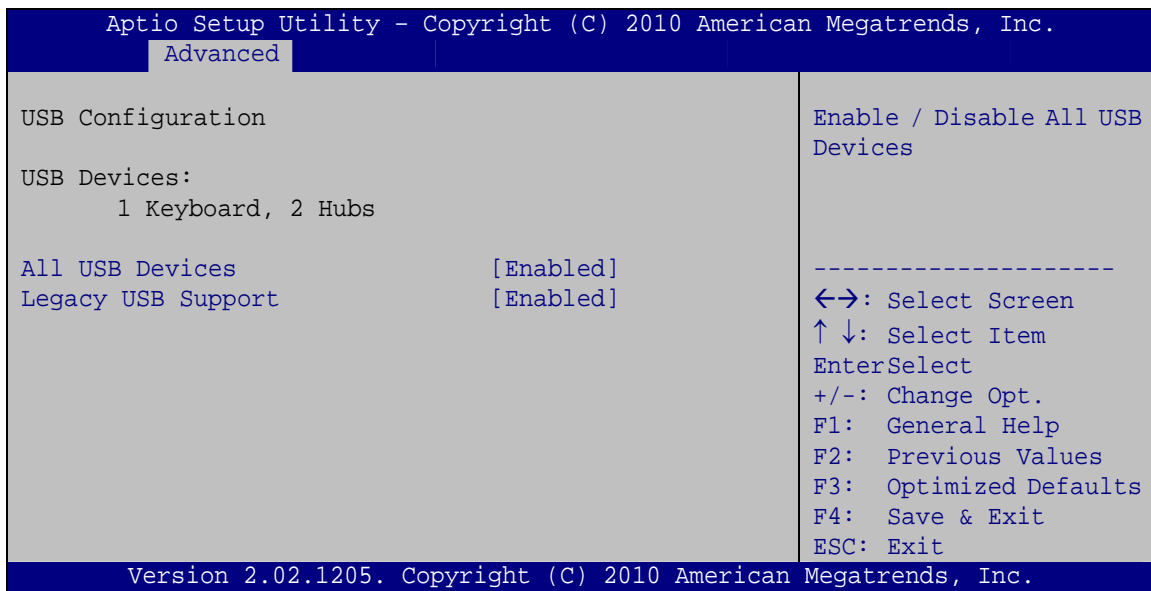

BIOS Menu 7: USB Configuration

➔ USB Devices

The **USB Devices Enabled** field lists the USB devices that are enabled on the system

➔ All USB Devices [Enabled]

Use this option to enable or disable all USB device support on the system.

- ➔ **Disabled** All USB device support disabled
- ➔ **Enabled** **DEFAULT** All USB device support enabled

AFL-HM55 Series Panel PC

→ Legacy USB Support [Enabled]

Use the **Legacy USB Support** BIOS option to enable USB mouse and USB keyboard support. Normally if this option is not enabled, any attached USB mouse or USB keyboard does not become available until a USB compatible operating system is fully booted with all USB drivers loaded. When this option is enabled, any attached USB mouse or USB keyboard can control the system even when there is no USB driver loaded onto the system.

- **Disabled** Legacy USB support disabled
- **Enabled** **DEFAULT** Legacy USB support enabled
- **Auto** Legacy USB support disabled if no USB devices are connected

5.3.6 Super IO Configuration

Use the **Super IO Configuration** menu (**BIOS Menu 8**) to set or change the configurations for the FDD controllers, parallel ports and serial ports.

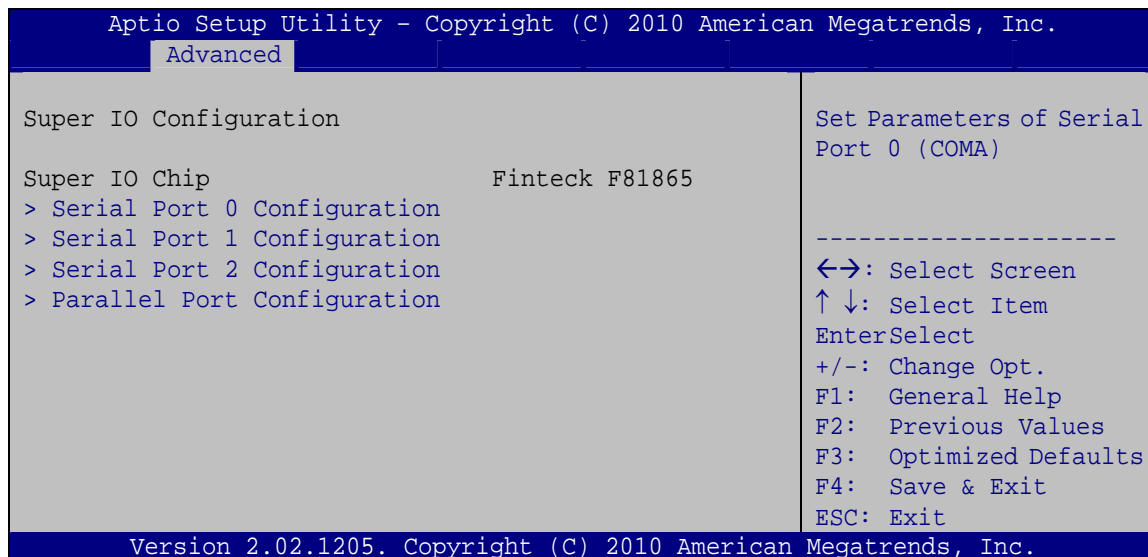

BIOS Menu 8: Super IO Configuration

5.3.6.1 Serial Port n Configuration

Use the **Serial Port n Configuration** menu (**BIOS Menu 9**) to configure the serial port n.

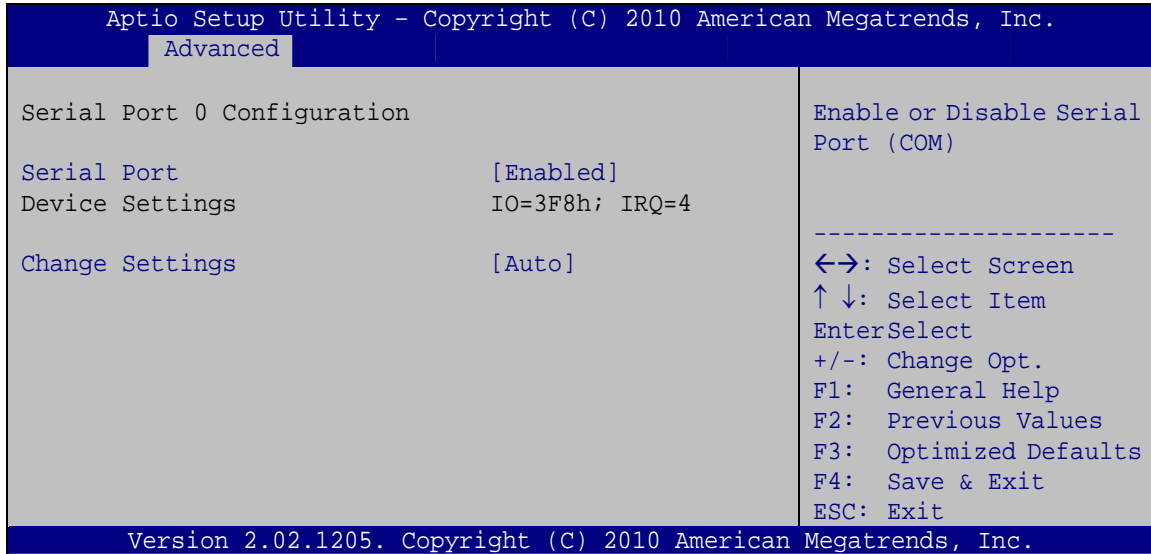

BIOS Menu 9: Serial Port n Configuration Menu

5.3.6.1.1 Serial Port 0 Configuration

→ Serial Port [Enabled]

Use the **Serial Port** option to enable or disable the serial port.

- **Disabled** Disable the serial port
- **Enabled** **DEFAULT** Enable the serial port

→ Change Settings [Auto]

Use the **Change Settings** option to change the serial port IO port address and interrupt address.

- **Auto** **DEFAULT** The serial port IO port address and interrupt address are automatically detected.
- **IO=3F8h;**
IRQ=4 Serial Port I/O port address is 3F8h and the interrupt address is IRQ4

AFL-HM55 Series Panel PC

- ➔ **IO=3F8h;**
IRQ=3, 4 Serial Port I/O port address is 3F8h and the interrupt address is IRQ3, 4
- ➔ **IO=2F8h;**
IRQ=3, 4 Serial Port I/O port address is 2F8h and the interrupt address is IRQ3, 4
- ➔ **IO=2C0h;**
IRQ=3, 4 Serial Port I/O port address is 2C0h and the interrupt address is IRQ3, 4
- ➔ **IO=2C8h;**
IRQ=3, 4 Serial Port I/O port address is 2C8h and the interrupt address is IRQ3, 4

5.3.6.1.2 Serial Port 1 Configuration

➔ Serial Port [Enabled]

Use the **Serial Port** option to enable or disable the serial port.

- ➔ **Disabled** Disable the serial port
- ➔ **Enabled** **DEFAULT** Enable the serial port

➔ Change Settings [Auto]

Use the **Change Settings** option to change the serial port IO port address and interrupt address.

- ➔ **Auto** **DEFAULT** The serial port IO port address and interrupt address are automatically detected.
- ➔ **IO=2F8h;**
IRQ=3 Serial Port I/O port address is 2F8h and the interrupt address is IRQ3
- ➔ **IO=3F8h;**
IRQ=3, 4 Serial Port I/O port address is 3F8h and the interrupt address is IRQ3, 4
- ➔ **IO=2F8h;**
IRQ=3, 4 Serial Port I/O port address is 2F8h and the interrupt address is IRQ3, 4
- ➔ **IO=2C0h;**
IRQ=3, 4 Serial Port I/O port address is 2C0h and the interrupt address is IRQ3, 4

AFL-HM55 Series Panel PC

5.3.6.1.4 Parallel Port Configuration

→ Parallel Port [Enabled]

Use the **Parallel Port** option to enable or disable the parallel port.

- **Disabled** Disable the parallel port
- **Enabled DEFAULT** Enable the parallel port

→ Change Settings [Auto]

Use the **Change Settings** option to change the parallel port IO port address and interrupt address.

- **Auto DEFAULT** The parallel port IO port address and interrupt address are automatically detected.
- **IO=378h;
IRQ=7** Parallel Port I/O port address is 378h and the interrupt address is IRQ7
- **IO=278h;
IRQ=7** Parallel Port I/O port address is 278h and the interrupt address is IRQ7
- **IO=3BCh;
IRQ=7** Parallel Port I/O port address is 3BCh and the interrupt address is IRQ7
- **IO=378h** Parallel Port I/O port address is 378h
- **IO=278h** Parallel Port I/O port address is 278h
- **IO=3BCh** Parallel Port I/O port address is 3BCh

→ Device Mode [Printer Mode]

Use the **Device Mode** option to select the mode the parallel port operates in. Configuration options are listed below.

- Standard and Bi-direction (SPP) mode **Default**
- EPP-1.9 and SPP Mode
- ECP Mode
- ECP and EPP 1.9 Mode

- Printer mode
- EPP-1.7 and SPP Mode
- ECP and EPP 1.7 Mode

5.3.7 H/W Monitor

The H/W Monitor menu (**BIOS Menu 10**) shows the operating temperature, fan speeds and system voltages.

```

Aptio Setup Utility - Copyright (C) 2010 American Megatrends, Inc.
-----
Advanced
-----
PC Health Status

CPU Temperature           :+91 C
SYS Temperature          :+58 C
CPU FAN Speed            :4702 RPM
SYS FAN Speed            :3722 RPM
VCC3C                    :+3.360 V
V_core                   :+1.192 V
+5V                      :+5.045 V
+12V                     :+12.056 V
+1.5V                    :+1.520 V
VSB3V                    :+3.360 V
VBAT                     :+3.280 V

-----
<->: Select Screen
↑ ↓: Select Item
EnterSelect
+/-: Change Opt.
F1:  General Help
F2:  Previous Values
F3:  Optimized Defaults
F4:  Save & Exit
ESC: Exit

Version 2.02.1205. Copyright (C) 2010 American Megatrends, Inc.
  
```

BIOS Menu 10: Hardware Health Configuration

→ PC Health Status

The following system parameters and values are shown. The system parameters that are monitored are:

- System Temperatures:
 - CPU Temperature
 - System Temperature
- Fan Speeds:
 - CPU Fan Speed
 - System Fan Speed
- Voltages:

AFL-HM55 Series Panel PC

- VCC3V
- Vcore
- +5V
- +12 V
- +1.5V
- VSB3V
- VBAT

5.3.8 Serial Port Console Redirection

The **Serial Port Console Redirection** menu (**BIOS Menu 11**) allows the console redirection options to be configured. Console redirection allows users to maintain a system remotely by re-directing keyboard input and text output through the serial port.

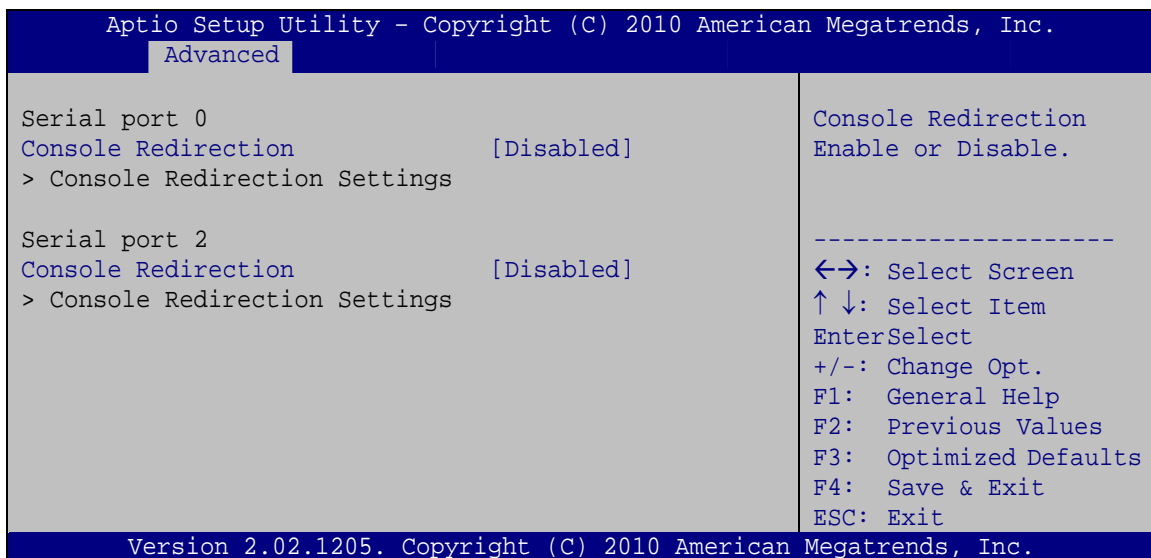

BIOS Menu 11: Serial Port Console Redirection

➔ Console Redirection [Disabled]

Use **Console Redirection** option to enable or disable the console redirection function.

- ➔ **Disabled** **DEFAULT** Disabled the console redirection function
- ➔ **Enabled** Enabled the console redirection function

5.4 Chipset

Use the **Chipset** menu (**BIOS Menu 12**) to access the Northbridge and Southbridge configuration menus



WARNING!

Setting the wrong values for the Chipset BIOS selections in the Chipset BIOS menu may cause the system to malfunction.

```
Aptio Setup Utility - Copyright (C) 2010 American Megatrends, Inc.
Main   Advanced  Chipset  Boot   Security  Save & Exit
-----
> North Bridge          North Bridge Parameters
> South Bridge
> Intel IGD SWSCI OpRegion

-----
<=>: Select Screen
↑↓: Select Item
Enter>Select
+/-: Change Opt.
F1:  General Help
F2:  Previous Values
F3:  Optimized Defaults
F4:  Save & Exit
ESC: Exit

Version 2.02.1205. Copyright (C) 2010 American Megatrends, Inc.
```

BIOS Menu 12: Chipset

AFL-HM55 Series Panel PC

5.4.1 Northbridge Configuration

Use the **Northbridge Chipset Configuration** menu (**BIOS Menu 13**) to configure the Northbridge chipset.

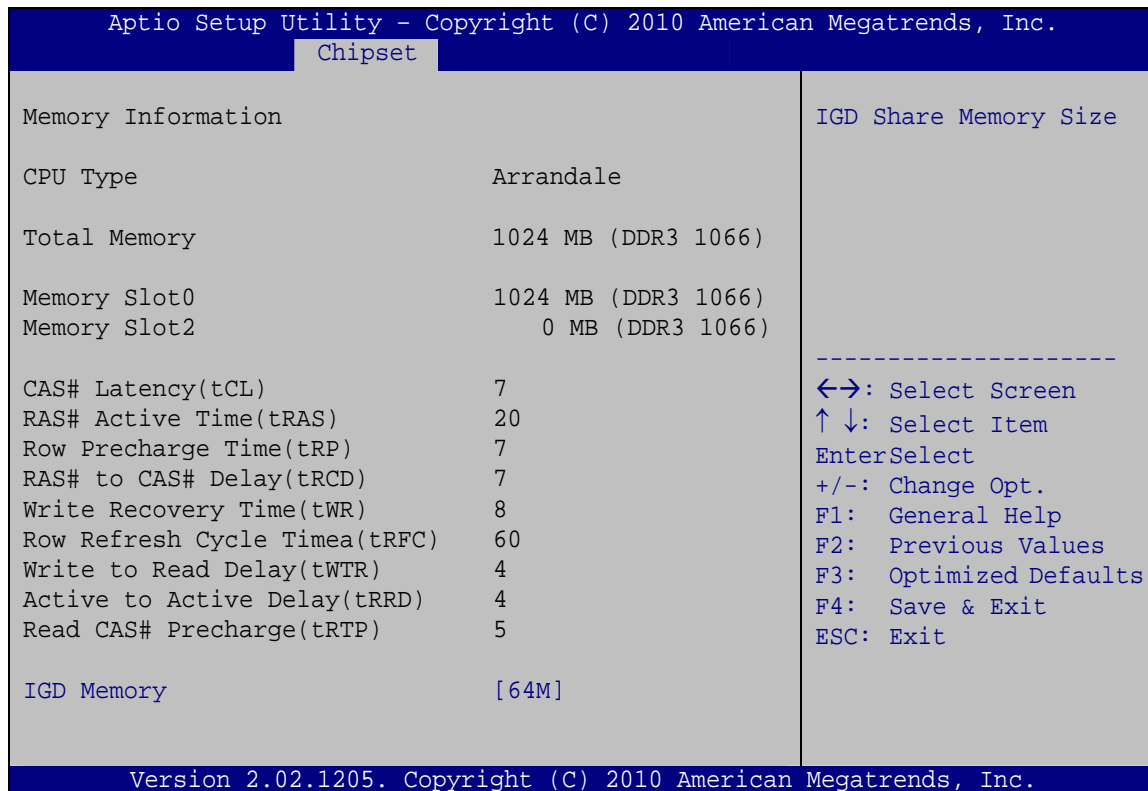

BIOS Menu 13: Northbridge Chipset Configuration

→ IGD Memory [32 MB]

Use the **IGD Memory** option to specify the amount of system memory that can be used by the Internal graphics device.

- **Disable**
- **32 MB** **DEFAULT** 32 MB of memory used by internal graphics device
- **64 MB** 64 MB of memory used by internal graphics device

5.4.2 Southbridge Configuration

Use the **Southbridge Configuration** menu (**BIOS Menu 14**) to configure the Southbridge chipset.

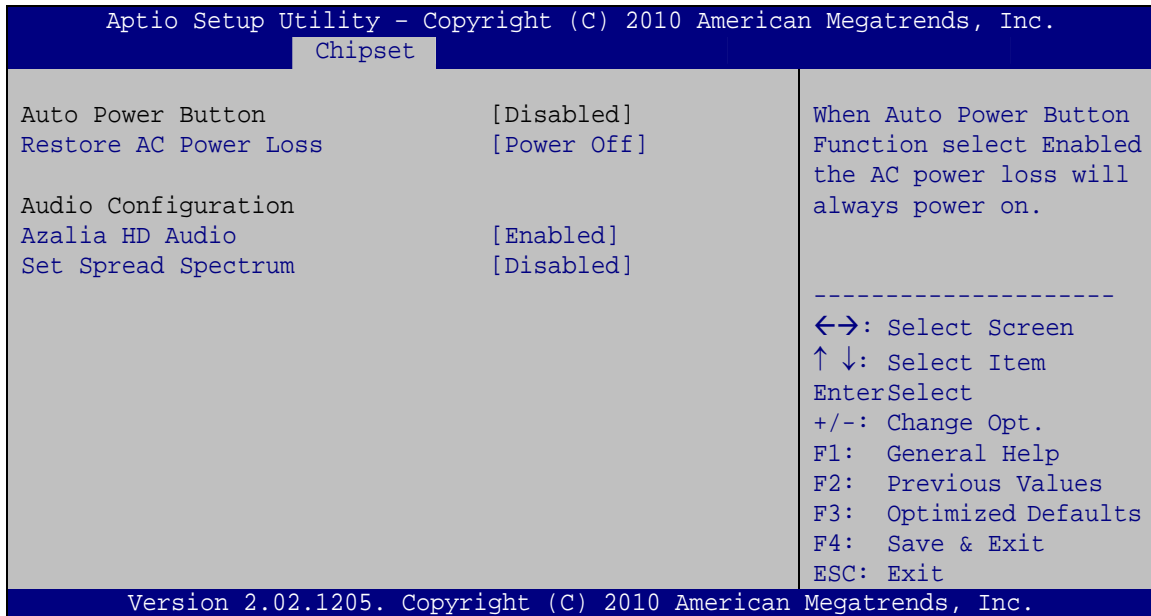

BIOS Menu 14: Southbridge Chipset Configuration

→ Restore on AC Power Loss [Power Off]

Use the **Restore on AC Power Loss** BIOS option to specify what state the system returns to if there is a sudden loss of power to the system.

- **Power Off** **DEFAULT** The system remains turned off
- **Power On** The system turns on
- **Last State** The system returns to its previous state. If it was on, it turns itself on. If it was off, it remains off.

→ Azalia HD Audio [Enabled]

Use the **Azalia HD Audio** option to enable or disable the High Definition Audio controller.

- **Disabled** The onboard High Definition Audio controller is disabled

AFL-HM55 Series Panel PC

➔ **Enabled** **DEFAULT** The onboard High Definition Audio controller automatically detected and enabled

➔ **Set Spread Spectrum [Disabled]**

Use the **Set Spread Spectrum** option to enable or disable the Set Spread Spectrum function.

➔ **Disabled** **DEFAULT** Set Spread Spectrum is disabled

➔ **Enabled** Set Spread Spectrum is enabled

5.4.3 Intel IGD SWSCI OpRegion

Use the **Intel IGD SWSCI OpRegion** menu (**BIOS Menu 15**) to configure the video device connected to the system.

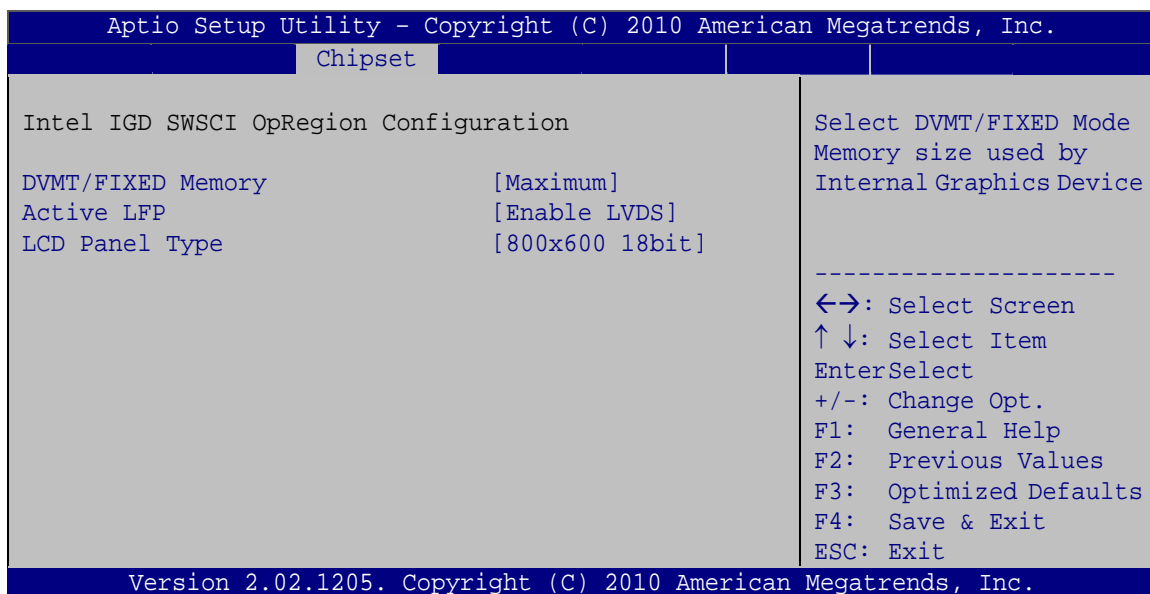

BIOS Menu 15: Intel IGD SWSCI OpRegion

➔ **DVMT/FIXED Memory [Maximum]**

Use the **DVMT/FIXED Memory** option to specify the maximum amount of memory that can be allocated as graphics memory. Configuration options are listed below.

- 128 MB

- 256 MB
- Maximum **Default**

→ **Active LFP [Enable LVDS]**

Use the **Active LFP** option to enable or disable LVDS.

- **Disable** **DEFAULT** LVDS is disabled
LVDS
- **Enable** LVDS is enabled
LVDS

→ **LCD Panel Type [Select by Panel ID]**

Use the **LCD Panel Type** option to select the type of flat panel connected to the system.

Configuration options are listed below.

- Select by Panel ID **DEFAULT**
- 800x600 18bit
- 1024x768 18bit
- 1024x768 24bit
- 1280x800 18bit
- 1366x768 18bit
- 1400x1050 48bit
- 1440x900 48bit
- 1600x900 48bit
- 1600x1200 48bit
- 1680x1050 48bit
- 1920x1080 48bit
- 1920x1200 48bit
- 2048x1536 48bit

AFL-HM55 Series Panel PC

5.5 Boot

Use the **Boot** menu (**BIOS Menu 16**) to configure system boot options.

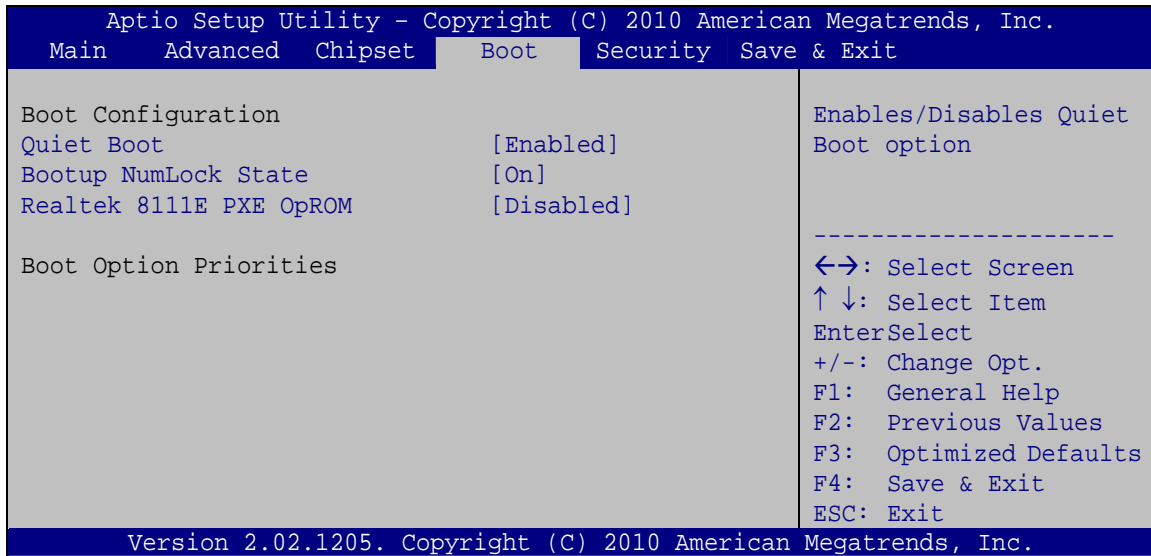

BIOS Menu 16: Boot

→ Quiet Boot [Enabled]

Use the **Quiet Boot** BIOS option to select the screen display when the system boots.

- **Disabled** Normal POST messages displayed
- **Enabled** **DEFAULT** OEM Logo displayed instead of POST messages

→ Bootup NumLock State [On]

Use the **Bootup NumLock State** BIOS option to specify if the number lock setting must be modified during boot up.

- **On** **DEFAULT** Allows the Number Lock on the keyboard to be enabled automatically when the computer system boots up. This allows the immediate use of the 10-key numeric keypad located on the right side of the keyboard. To confirm this, the Number Lock LED light on the keyboard is lit.

➔ Off

Does not enable the keyboard Number Lock automatically. To use the 10-keys on the keyboard, press the Number Lock key located on the upper left-hand corner of the 10-key pad. The Number Lock LED on the keyboard lights up when the Number Lock is engaged.

➔ **Realtek 8111E PXE OpROM [Disabled]**

Use the **Realtek 8111E PXE OpROM** BIOS option to enable or disable Boot Option for Legacy Network Devices.

➔ **Disabled** **DEFAULT** Disables Boot Option for Legacy Network Devices.

➔ **Enabled** Enables Boot Option for Legacy Network Devices.

5.6 Security

Use the **Security** menu (**BIOS Menu 17**) to set system and user passwords.

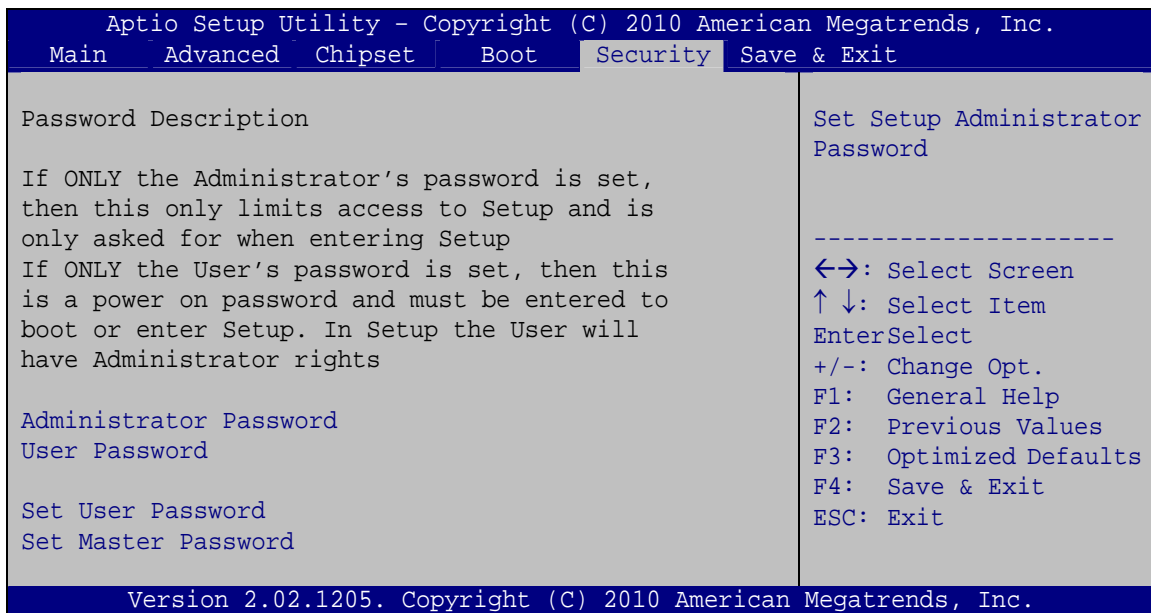

BIOS Menu 17: Security

AFL-HM55 Series Panel PC

→ Administrator Password

Use the **Administrator Password** field to set or change a administrator password.

→ User Password

Use the **User Password** field to set or change a user password.

→ Set User Password

Use the **Set User Password** field to set or change an HDD user password.



NOTE:

It is recommended that the system be reset after setting a new HDD password.

5.7 Exit

Use the **Exit** menu (**BIOS Menu 18**) to load default BIOS values, optimal failsafe values and to save configuration changes.

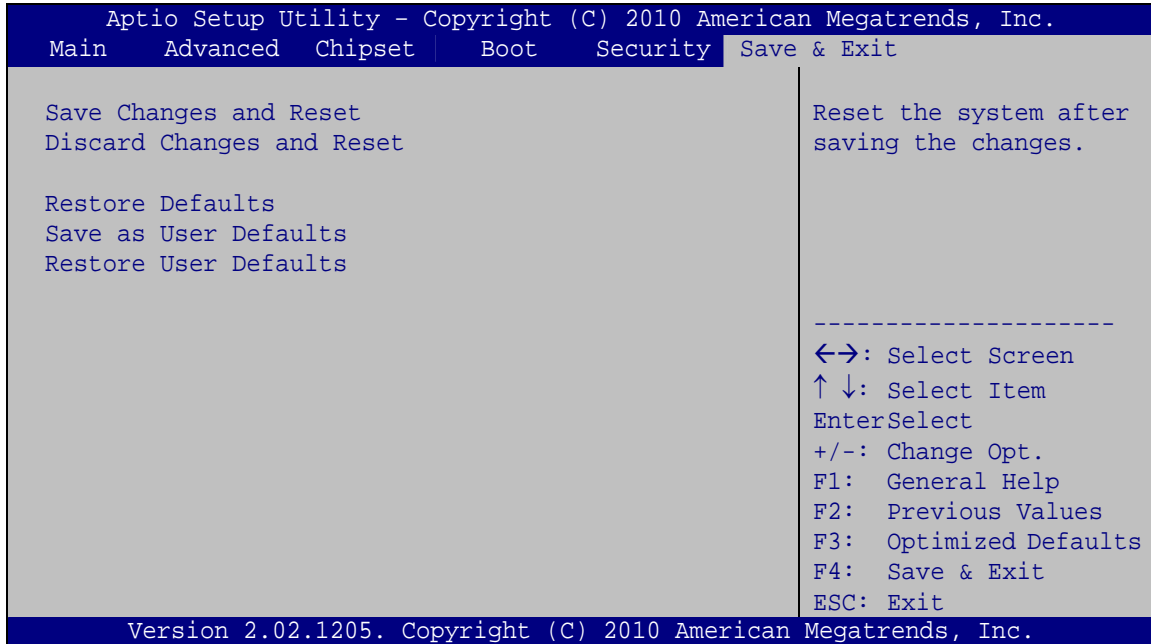

BIOS Menu 18: Exit

→ Save Changes and Reset

Use the **Save Changes and Reset** option to save the changes made to the BIOS options and reset the system.

→ Discard Changes and Reset

Use the **Discard Changes and Reset** option to exit the system without saving the changes made to the BIOS configuration setup program.

→ Restore Defaults

Use the **Restore Defaults** option to load the optimal default values for each of the parameters on the Setup menus. **F3 key can be used for this operation.**

→ Save as User Defaults

Use the **Save as User Defaults** option to save the changes done so far as user defaults.

→ Restore User Defaults

Use the **Restore User Defaults** option to restore the user defaults to all the setup options.

Chapter

6

Software Drivers

6.1 Available Software Drivers



NOTE:

The content of the CD may vary throughout the life cycle of the product and is subject to change without prior notice. Visit the IEI website or contact technical support for the latest updates.

The following drivers can be installed on the system:

- Chipset
- VGA
- LAN
- Audio
- Touch screen
- Wireless
- Bluetooth
- Keypad function

Installation instructions are given below.

6.2 Starting the Driver Program

To access the driver installation programs, please do the following.

Attach a portable CD-ROM drive to your panel PC (CD-ROM drive not included).

Insert the Driver CD into the CD-ROM drive.

On the Driver main menu screen click **AFL HM55 Series**.

The list of drivers in **Figure 6-1** appears.

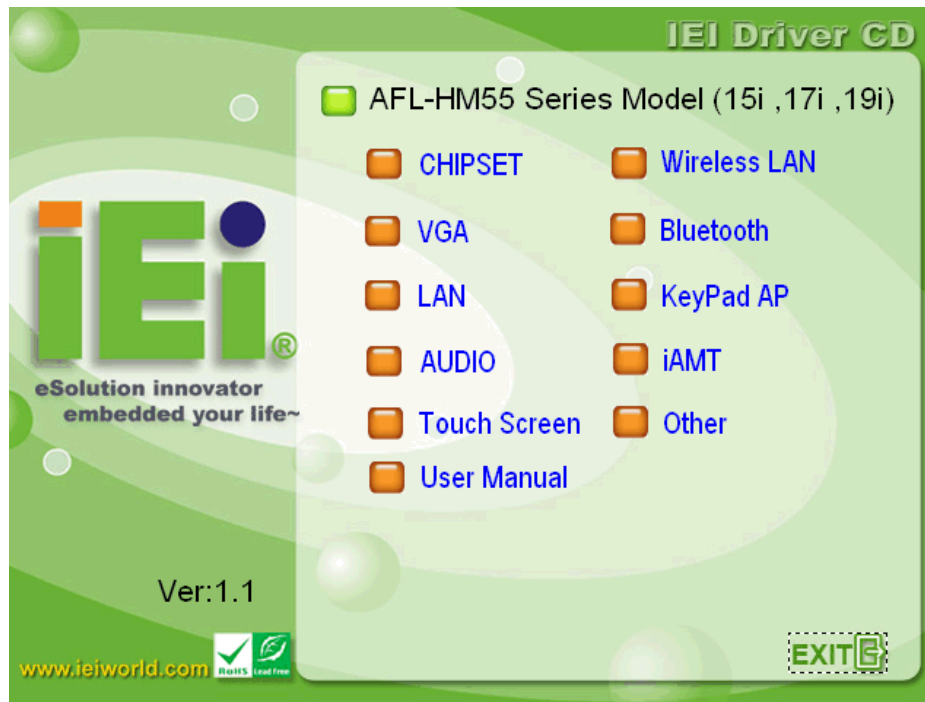

Figure 6-1: Drivers

6.3 Chipset Driver Installation

To install the chipset driver, please do the following.

Access the driver list shown in **Figure 6-1**. (See **Section 6.2**)

Click **Chipset** and locate the install icon “**infinst_autol_9_1_1_1024.exe**”. Double click the install icon.

The setup files are extracted as shown in **Figure 6-2**.



Figure 6-2: Chipset Driver File Extraction Screen

When the setup files are completely extracted the **Welcome Screen** in **Figure 6-3** appears.

Click **NEXT** to continue.



Figure 6-3: Chipset Driver Welcome Screen

AFL-HM55 Series Panel PC

The license agreement in **Figure 6-4** appears.

Read the **License Agreement** and click **YES** to continue.



Figure 6-4: Chipset Driver License Agreement

The **Readme File Information** screen in **Figure 6-5** appears.

Click **NEXT** to continue.

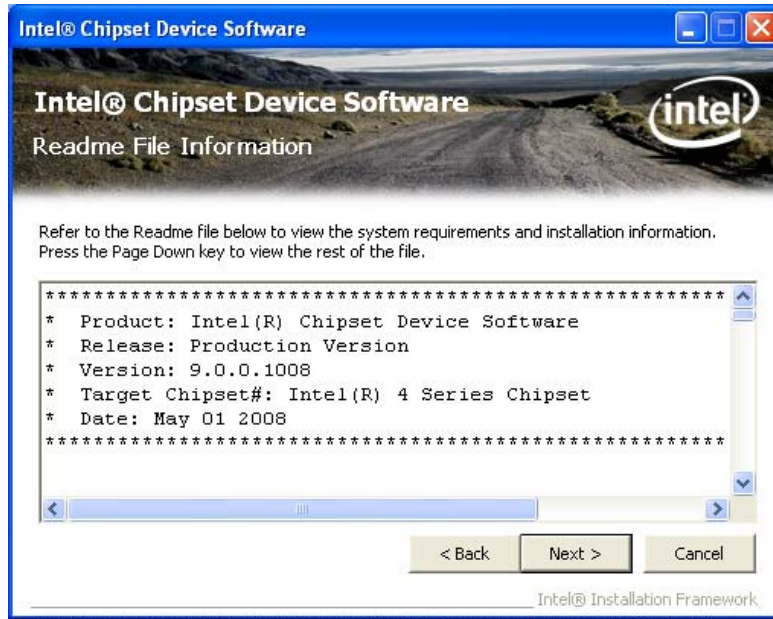

Figure 6-5: Readme File Information Screen

Setup operations are performed as shown in **Figure 6-6**.

Once the setup operations are complete, click **NEXT** to continue.

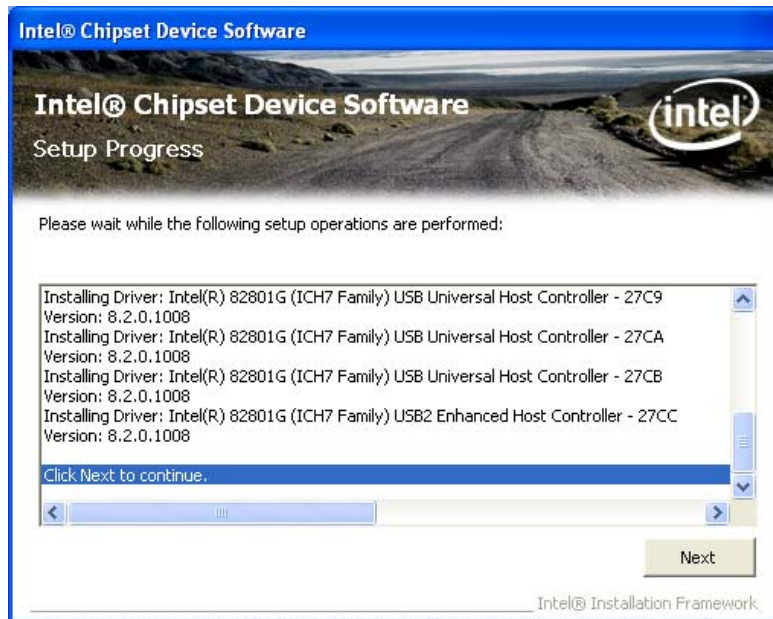

Figure 6-6: Setup Progress Screen

The **Setup Is Complete** screen appears.

AFL-HM55 Series Panel PC

Select “Yes, I want to restart the computer now” and click **Finish** (Figure 6-7).



Figure 6-7: Chipset Driver Installation Finish Screen

6.4 VGA Driver Installation

To install the VGA driver, please do the following.

Access the driver list shown in **Figure 6-1**. (See **Section 6.2**)

Click **VGA** and double click on the folder which corresponds to your operating system.

Double click on the install icon.

The **VGA Readme File** in **Figure 6-8** appears.

Click **NEXT** to continue.

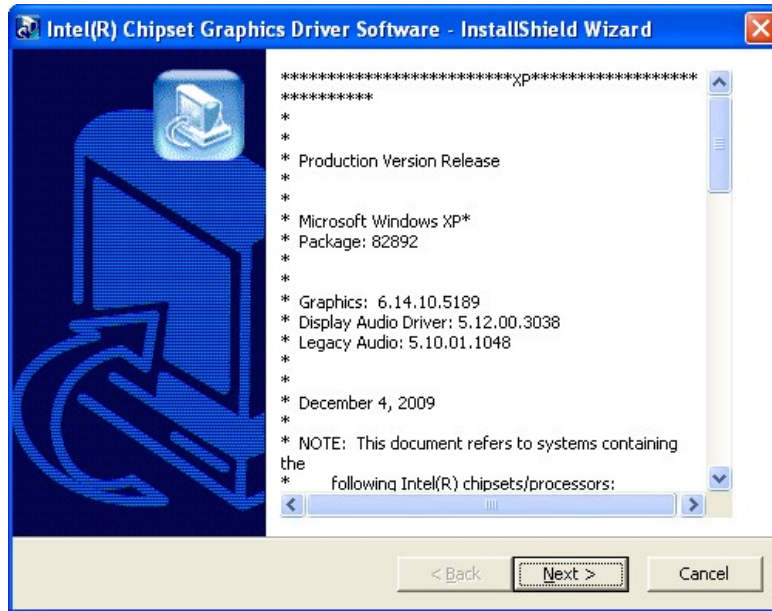

Figure 6-8: VGA Driver Readme File

The installation files are extracted as shown in **Figure 6-9**.

Click **NEXT** to continue.

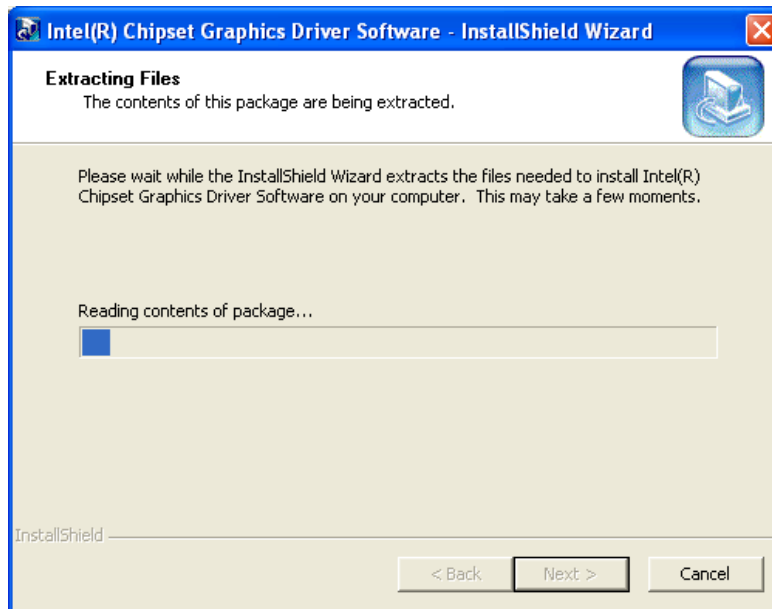

Figure 6-9: VGA Driver Setup File Extraction Screen

The **Welcome Screen** in **Figure 6-10** appears.

AFL-HM55 Series Panel PC

Click **NEXT** to continue.



Figure 6-10: VGA Driver Welcome Screen

The **License Agreement** in **Figure 6-11** appears.

Click **YES** to accept and continue.

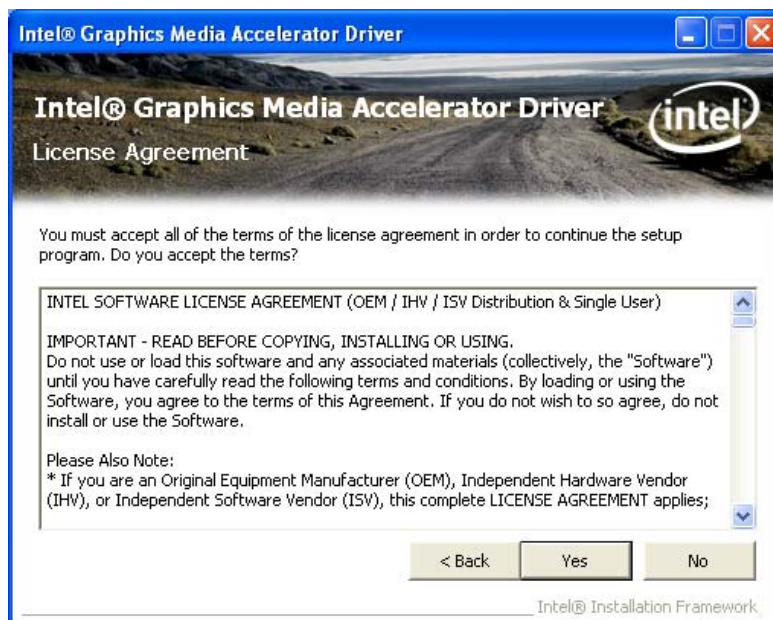

Figure 6-11: VGA Driver License Agreement

The Readme File in Figure 6-12 appears.

Click **NEXT** to continue.

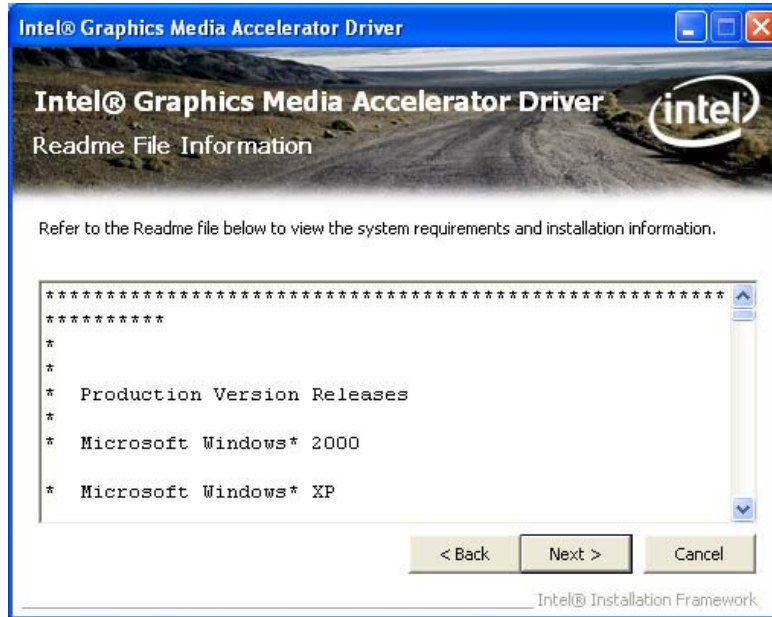

Figure 6-12: VGA Driver Readme File

Setup operations are performed as shown in Figure 6-13.

Once the setup operations are complete, click **NEXT** to continue.

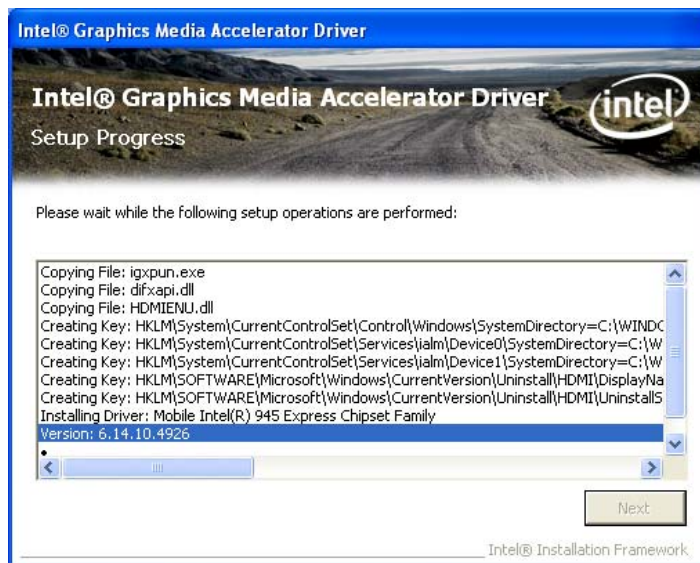

Figure 6-13: VGA Driver Setup Operations

AFL-HM55 Series Panel PC

The **Setup Is Complete** screen appears.

Select “**Yes, I want to restart the computer now**” and click **FINISH**. See **Figure 6-14**.



Figure 6-14: VGA Driver Setup Is Complete Screen

6.5 LAN Driver Installation

To install the LAN driver, please do the following.

Access the driver list shown in **Figure 6-1**. (See **Section 6.2**)

Locate the installation icon **setup.exe** and double click on it.

The **Welcome** screen in **Figure 6-15** appears.

Click **NEXT** to continue.

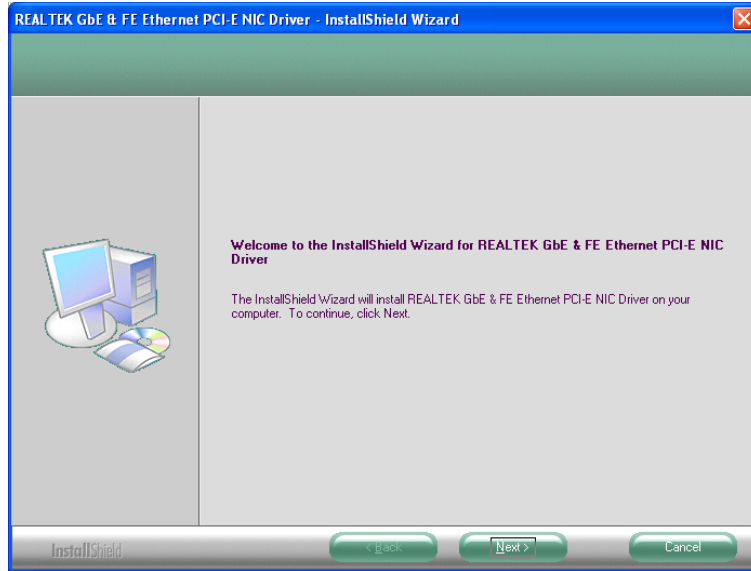

Figure 6-15: LAN Driver Welcome Screen

The **Ready to Install** screen in **Figure 6-16** appears.

Click **INSTALL** to proceed with the installation.

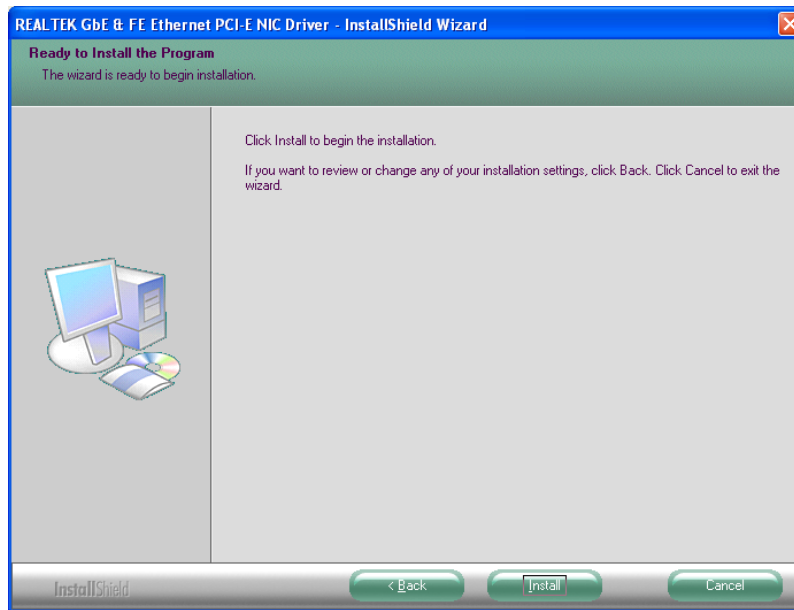

Figure 6-16: LAN Driver Welcome Screen

The program begins to install.

The installation progress can be monitored in the progress bar shown in **Figure 6-17**.

AFL-HM55 Series Panel PC

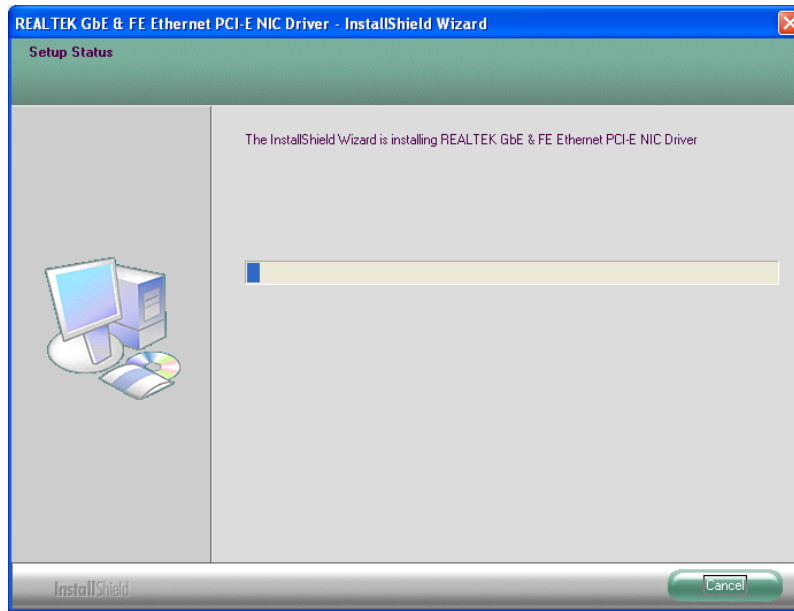

Figure 6-17: LAN Driver Installation

When the driver installation is complete, the screen in **Figure 6-18** appears.

Click **FINISH** to exit setup.

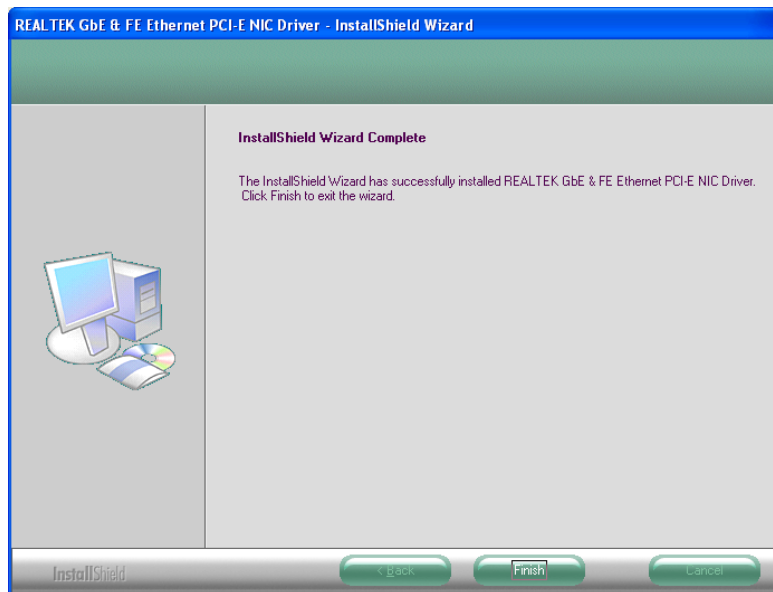

Figure 6-18: LAN Driver Installation Complete

6.6 Audio Driver Installation

To install the Realtek High Definition (HD) Audio driver, please follow the steps below.

6.6.1 BIOS Setup

Enter the BIOS setup. To do this, reboot the system and press **F2** during POST.

Go to the Southbridge Configuration menu. Set the **Audio Controller** option to [Azalia].

Press **F10** to save the changes and exit the BIOS setup. The system reboots.

6.6.2 Driver Installation

To install the audio driver, please do the following.

Access the driver list shown in **Figure 6-1**. (See **Section 6.2**)

Click **Audio** then double click on the folder which corresponds to your operating system.

Locate the install icon and double click on it.

The **InstallShield Wizard** starts (**Figure 6-19**).

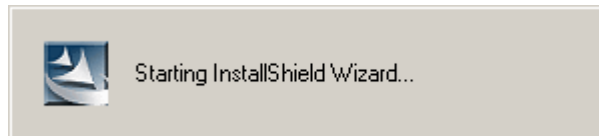

Figure 6-19: The InstallShield Wizard Starts

The **InstallShield Wizard** is prepared to guide the user through the rest of the process

(**Figure 6-20**).

AFL-HM55 Series Panel PC

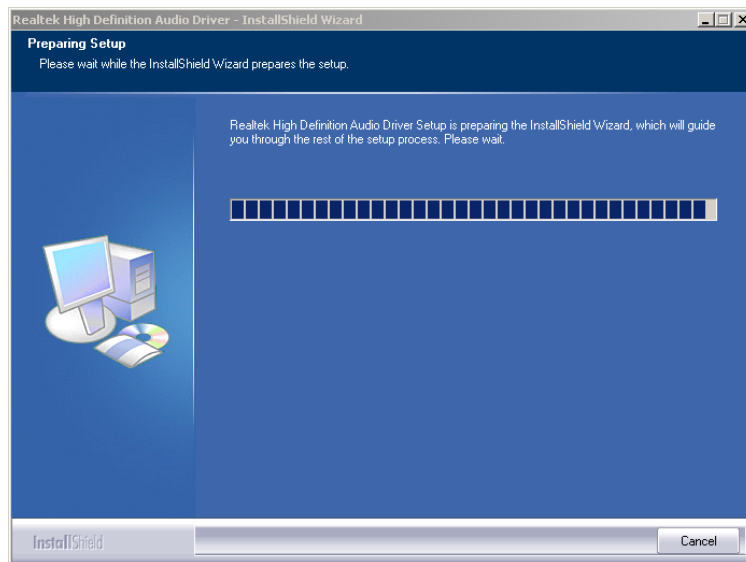

Figure 6-20: Preparing Setup Screen

Once initialized, the **InstallShield Wizard** welcome screen appears (**Figure 6-21**).

Click **NEXT** to continue the installation.

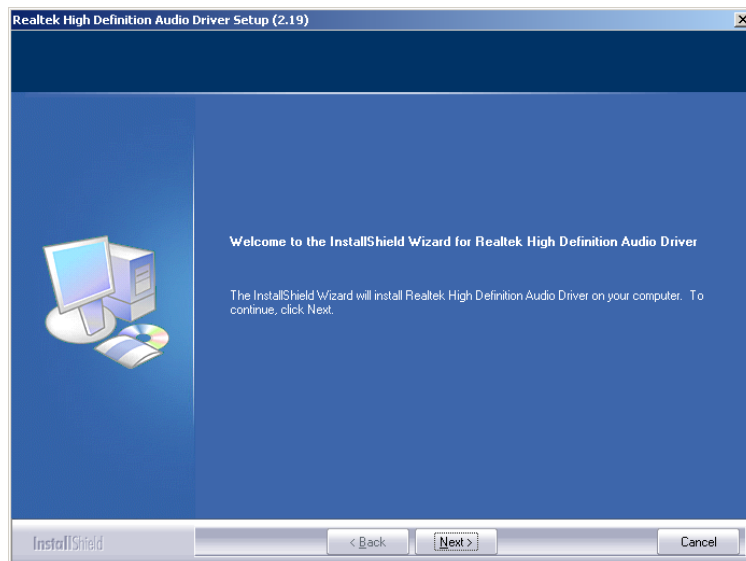

Figure 6-21: InstallShield Wizard Welcome Screen

InstallShield starts to install the new software as shown in **Figure 6-22**.

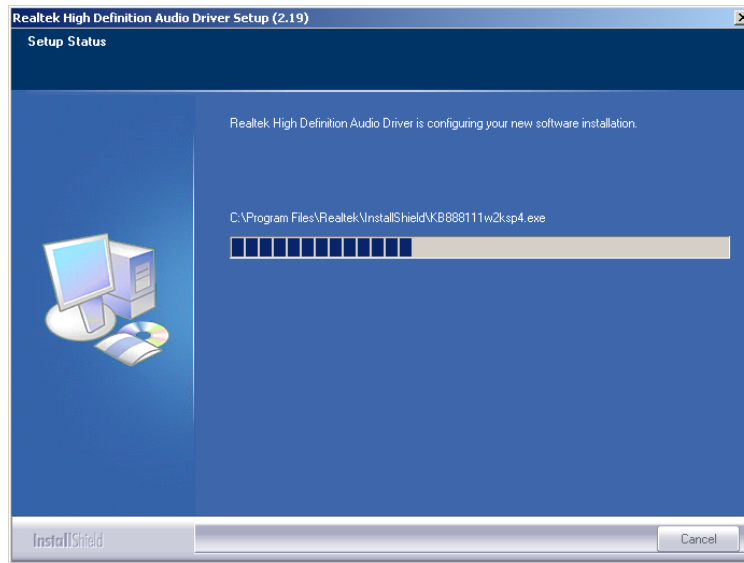

Figure 6-22: Audio Driver Progress Screen

The Installation Wizard updates the system as shown in **Figure 6-23**.

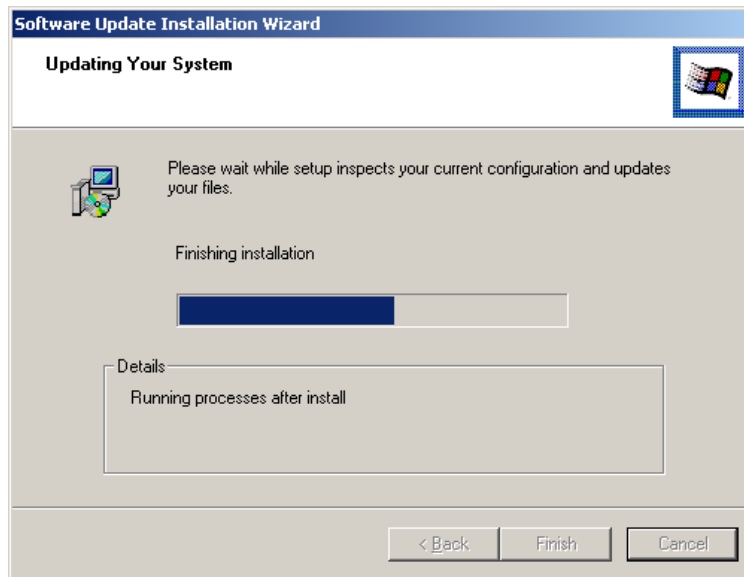

Figure 6-23: Installation Wizard Updates the System

After the driver installation process is complete, a confirmation screen appears
(**Figure 6-24**).

The confirmation screen offers the option of restarting the computer now or later. For the settings to take effect, the computer must be restarted.

AFL-HM55 Series Panel PC

Click **FINISH** to restart the computer.

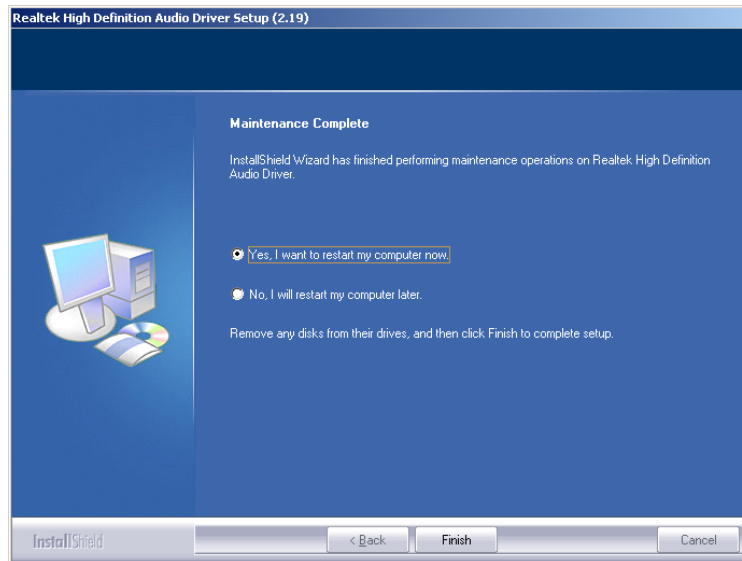

Figure 6-24: Restart the Computer

6.7 Touch Screen Driver

To install the touch panel software driver, please follow the steps below.

Access the driver list shown in **Figure 6-1**. (See **Section 6.2**)

Click **Touch Screen**.

Open the **x:\5. Touch Screen\PenMount Windows Universal Driver V2.1.0.263**

directory and locate the installation icon **setup.exe**. Double click on the icon.

The **Welcome Screen** appears (**Figure 6-25**).

Click **NEXT** to continue the installation process.

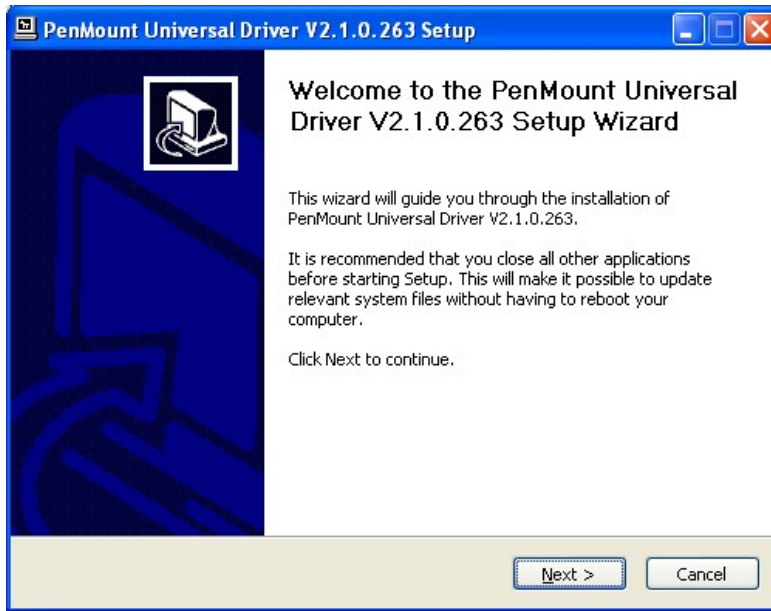

Figure 6-25: PenMount Welcome Screen

The License Agreement shown in Figure 6-26 appears.

Click I AGREE to accept and continue.

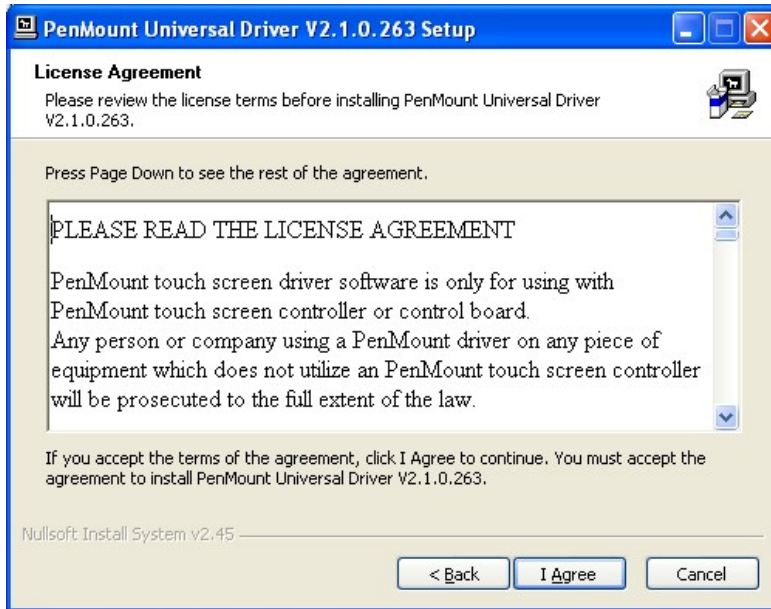

Figure 6-26: License Agreement

AFL-HM55 Series Panel PC

Browse for an install location or use the one suggested then click **INSTALL** to continue

(Figure 6-27).

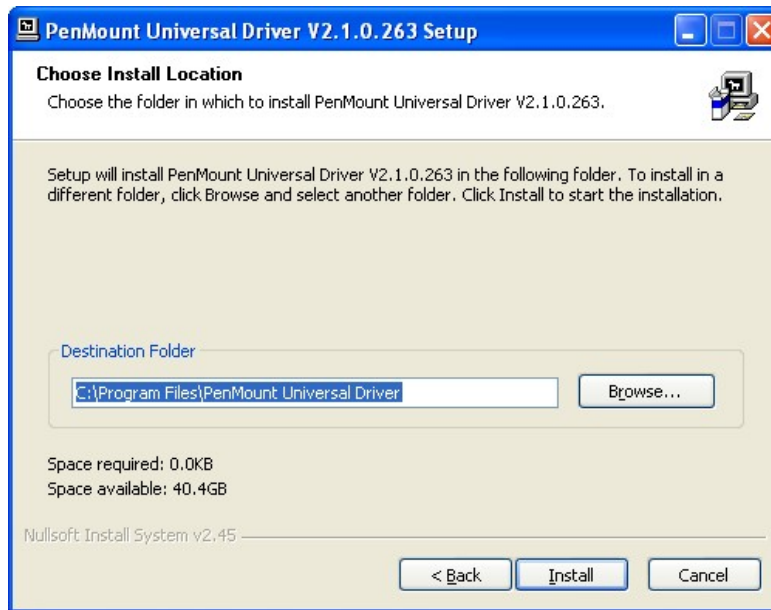

Figure 6-27: Choose Install Location

The **Install** screen appears and displays the progress of the installation (Figure 6-28).

Click **NEXT** to continue.

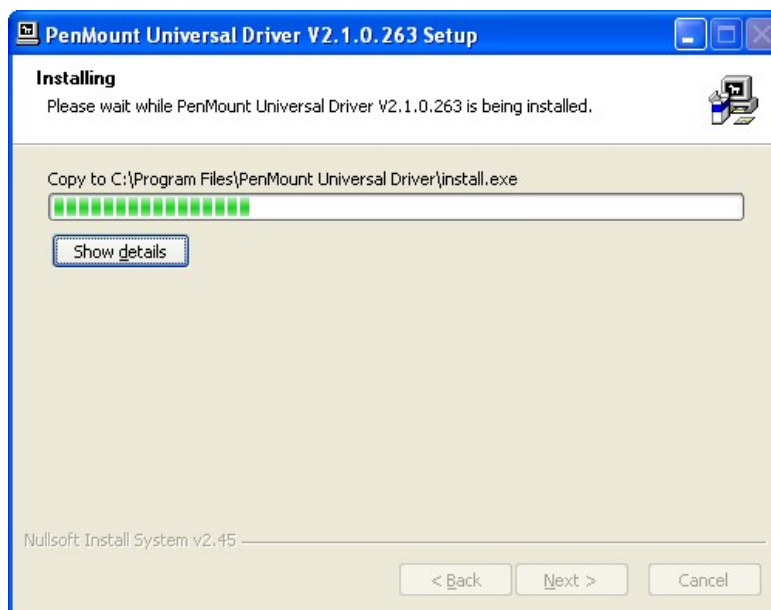

Figure 6-28: Installing PenMount Universal Driver V2.1.0.263

When the installation is complete, click **FINISH** to exit setup (Figure 6-29).

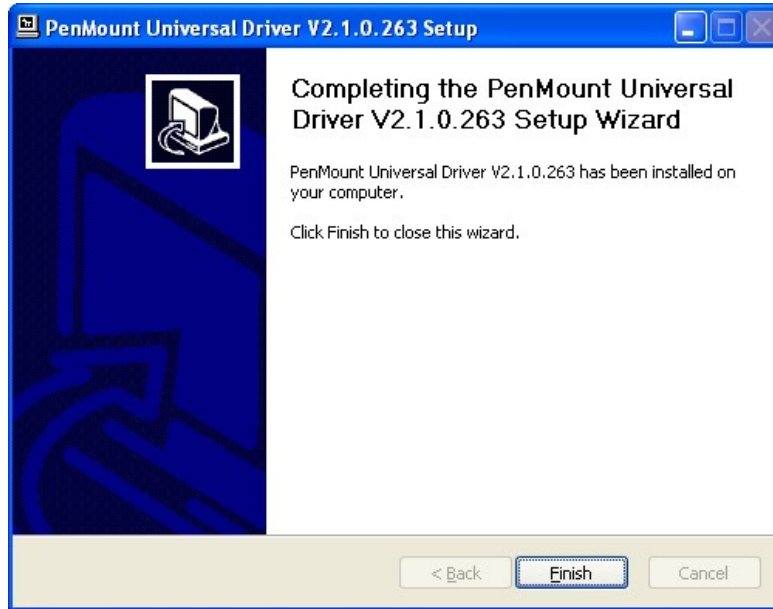

Figure 6-29: PenMount Universal Driver Update Complete

6.8 Wireless Driver

To install the wireless driver, please follow the steps below.

Select **Wireless** from the list in **Figure 6-1**. (See **Section 6.2**)

Select an OS folder then double click the installation icon **setup.exe**.

The license agreement in **Figure 6-30** appears.

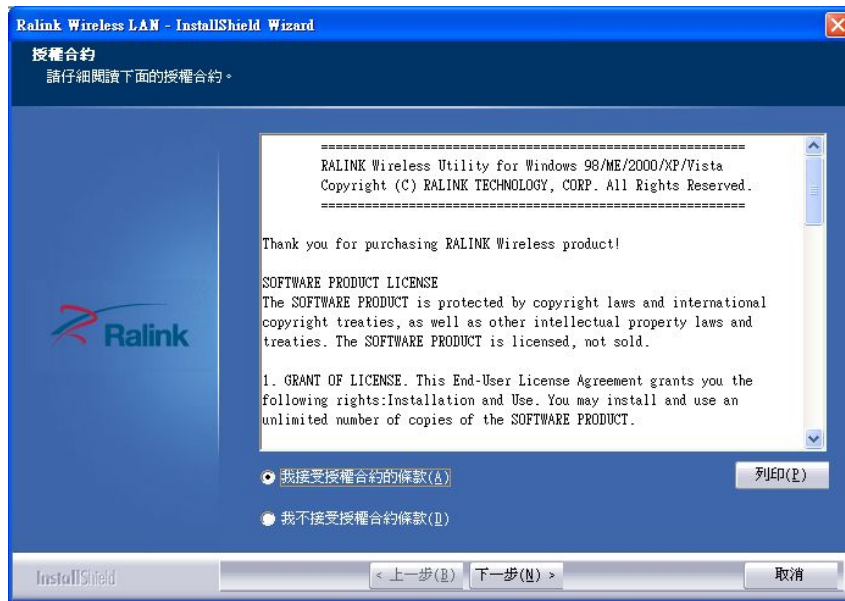

Figure 6-30: Wireless Driver License Agreement

Accept the conditions of the license agreement and click **NEXT** to continue.

The **Configuration Tool Options** screen in **Figure 6-31** appears next.

Select the configuration tool in and click **NEXT** to continue.



Figure 6-31: Wireless Driver Configuration Tool Options

The **Wireless Mode Options** window in **Figure 6-32** appears.

Click **NEXT** in **Figure 6-32**.



Figure 6-32: Wireless Mode Select Window

Click **INSTALL** in **Figure 6-33** to start to install the driver.



Figure 6-33: Wireless Driver Installation

After the installation is complete, click **FINISH** to exit setup.

6.9 Bluetooth Driver

To install the Bluetooth software driver, please follow the steps below.

Select **Bluetooth** from the list in **Figure 6-1**. (See **Section 6.2**)

Locate the installation icon **setup.exe** and double click on it.

The **Welcome Screen** appears (**Figure 6-34**).

Click **NEXT** to continue the installation process.

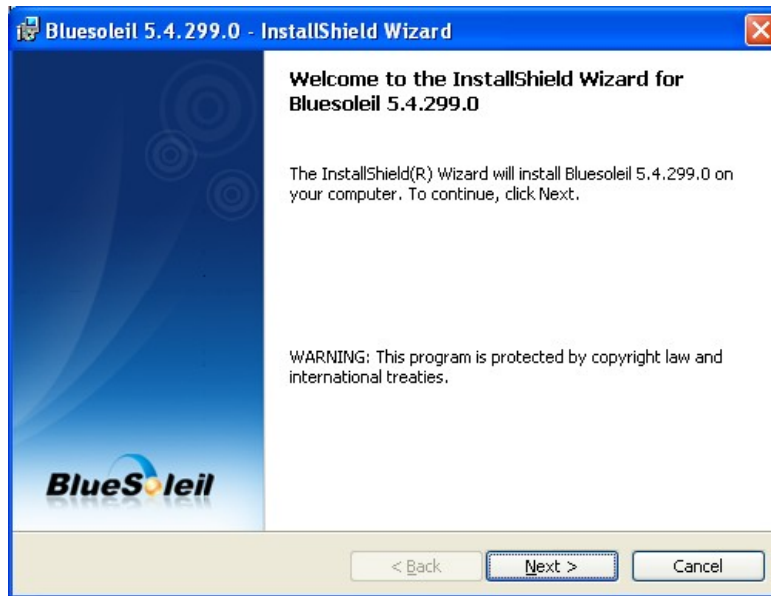

Figure 6-34: Welcome Screen

The License Agreement appears as shown in Figure 6-35.

Agree to the license by selecting "I accept the terms in the license agreement" and click NEXT.



Figure 6-35: License Agreement

AFL-HM55 Series Panel PC

Browse for an install location or use the one suggested (**Figure 6-36**) and click **NEXT**.

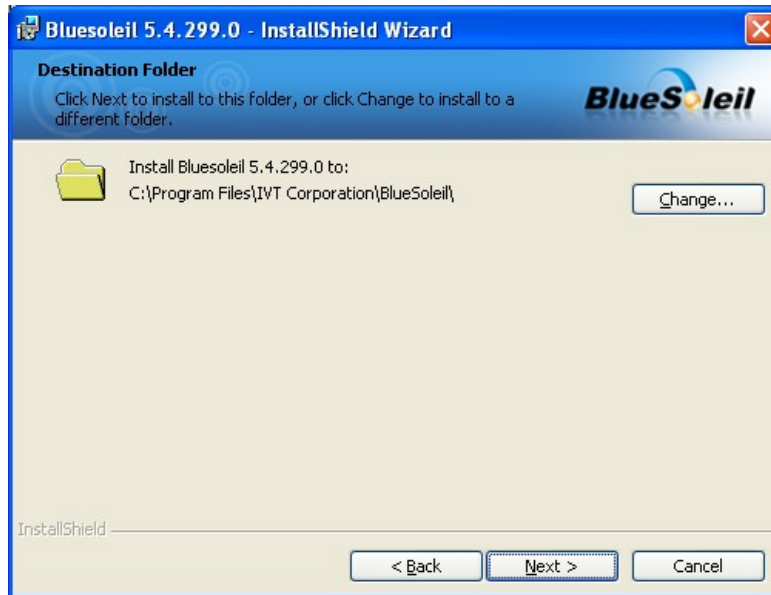

Figure 6-36: Bluetooth Driver Destination Folder

The InstallShield Wizard is ready to install the program.

Click **INSTALL** to continue (**Figure 6-37**).

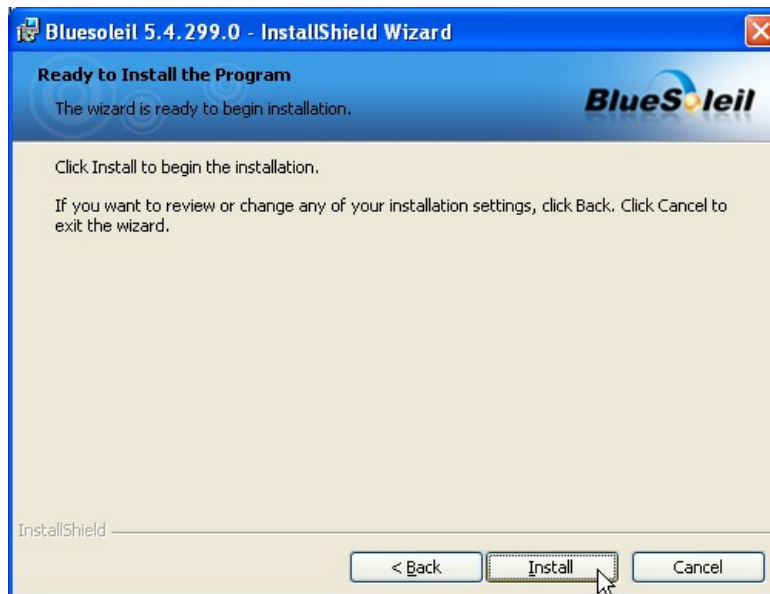

Figure 6-37: Ready to Install the Program

The installation screen appears and displays the progress of the installation (Figure 6-38).

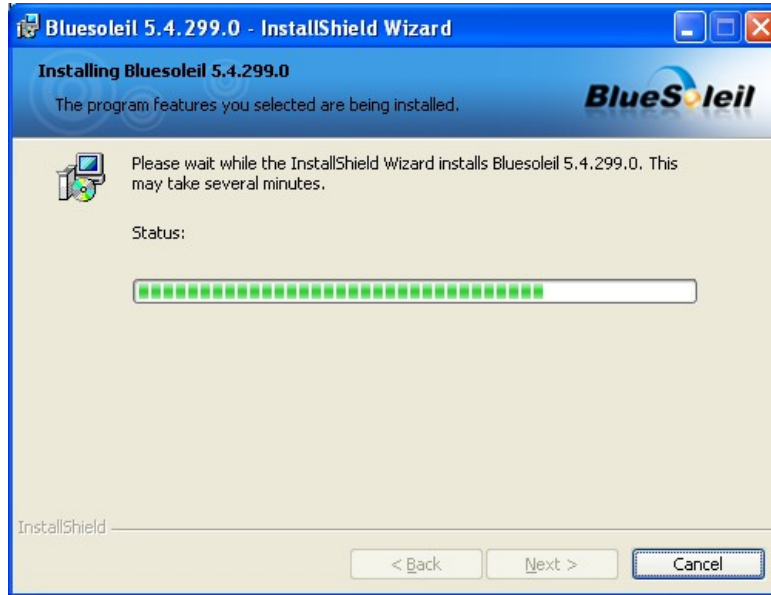

Figure 6-38: Installing BlueSoleil

When the installation process is complete, click **FINISH**. See Figure 6-39.

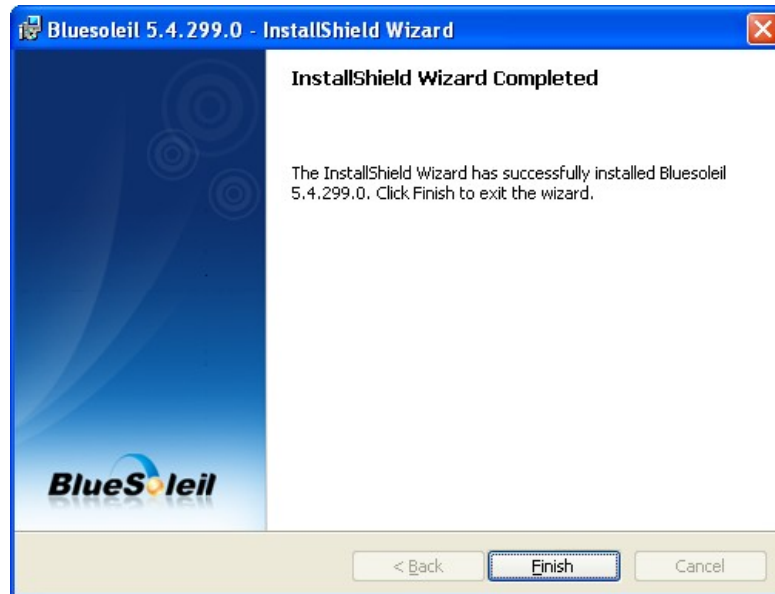

Figure 6-39: Bluetooth Driver Complete Installation Screen

AFL-HM55 Series Panel PC

The user is then prompted to select to restart the computer now or later (**Figure 6-40**).

For the settings to take effect, the computer must be restarted.

Click **YES** to restart the computer.

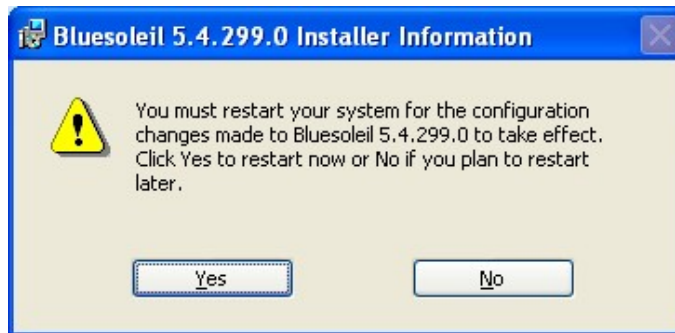

Figure 6-40: Reboot the Computer

6.10 Keypad Driver

To install the Keypad software driver, please follow the steps below.

Select **Keypad** from the list in **Figure 6-1**. (See **Section 6.2**)

Locate the installation icon "**KeypadAP_v2.2.msi**" and double click on it.

The **Welcome Screen** appears (**Figure 6-41**).

Click **NEXT** to continue the installation process.



Figure 6-41: Keypad Driver Welcome Screen

The **Customer Information** appears as shown in **Figure 6-42**.

Enter user and organization name in the fields provided then click **NEXT**.



Figure 6-42: Customer Information Screen

Select a setup type (**Figure 6-43**) and click **NEXT**.

AFL-HM55 Series Panel PC



Figure 6-43: Setup Type

The InstallShield Wizard is ready to install the program.

Click **INSTALL** to continue (**Figure 6-44**).

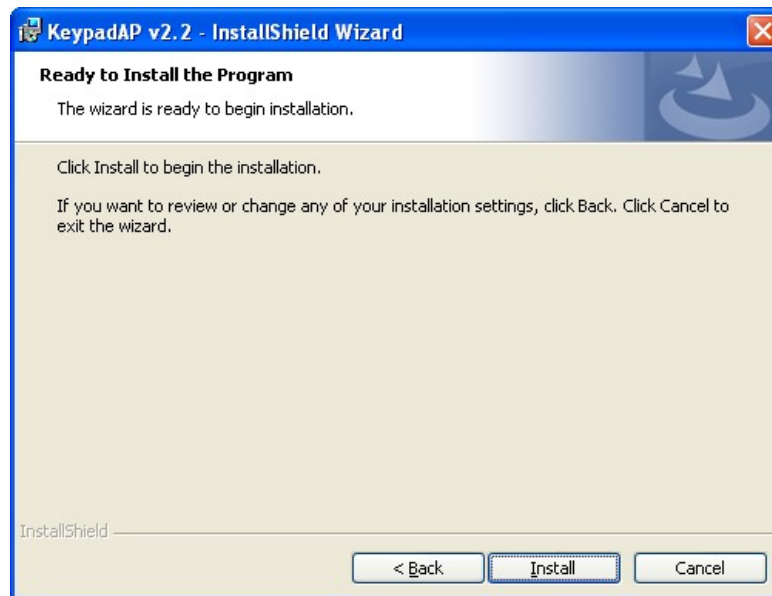

Figure 6-44: Ready to Install the Program

The installation screen appears and displays the progress of the installation (**Figure 6-45**).

Click **NEXT** to continue.

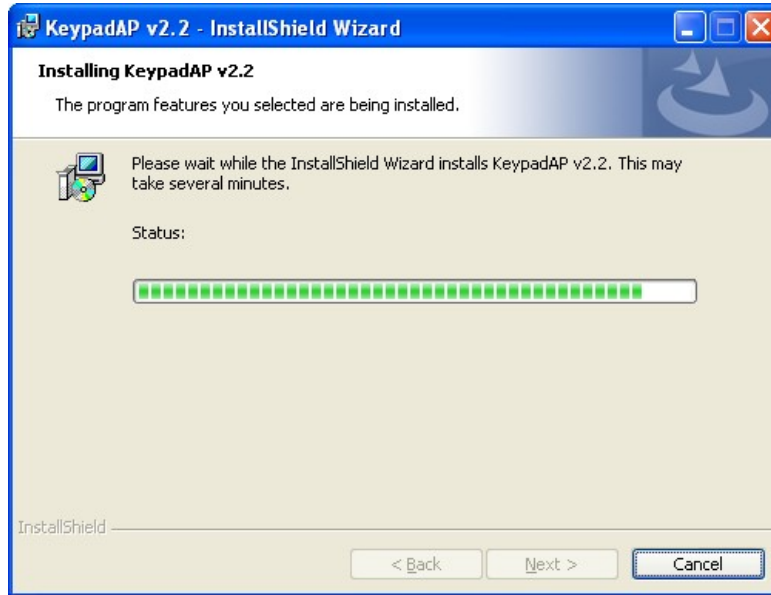

Figure 6-45: Installing KeypadAP v2.2

When the installation process is complete, click **FINISH**. See Figure 6-46.

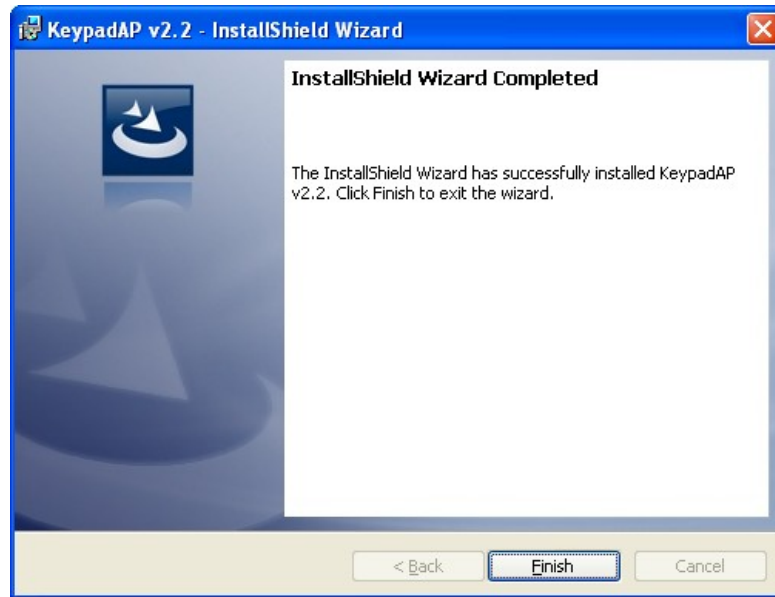

Figure 6-46: Keypad Driver Installation Complete Screen

AFL-HM55 Series Panel PC

The user is then prompted to select to restart the computer now or later (**Figure 6-47**). For the settings to take effect, the computer must be restarted.

Click **Yes** to restart the computer.



Figure 6-47: Reboot the Computer

Appendix

A

Safety Precautions

**WARNING:**

The precautions outlined in this chapter should be strictly followed. Failure to follow these precautions may result in permanent damage to the AFL-HM55 Series.

A.1 Safety Precautions

Please follow the safety precautions outlined in the sections that follow:

A.1.1 General Safety Precautions

Please ensure the following safety precautions are adhered to at all times.

- **Follow the electrostatic precautions** outlined below whenever the AFL-HM55 Series is opened.
- **Make sure the power is turned off and the power cord is disconnected** whenever the AFL-HM55 Series is being installed, moved or modified.
- **Do not apply voltage levels that exceed the specified voltage range.** Doing so may cause fire and/or an electrical shock.
- **Electric shocks can occur** if the AFL-HM55 Series chassis is opened when the AFL-HM55 Series is running.
- **Do not drop or insert any objects** into the ventilation openings of the AFL-HM55 Series.
- **If considerable amounts of dust, water, or fluids enter the AFL-HM55 Series**, turn off the power supply immediately, unplug the power cord, and contact the AFL-HM55 Series vendor.
- **DO NOT:**
 - Drop the AFL-HM55 Series against a hard surface.
 - Strike or exert excessive force onto the LCD panel.
 - Touch any of the LCD panels with a sharp object
 - In a site where the ambient temperature exceeds the rated temperature

A.1.2 Anti-static Precautions



WARNING:

Failure to take ESD precautions during the installation of the AFL-HM55 Series may result in permanent damage to the AFL-HM55 Series and severe injury to the user.

Electrostatic discharge (ESD) can cause serious damage to electronic components, including the AFL-HM55 Series. Dry climates are especially susceptible to ESD. It is therefore critical that whenever the AFL-HM55 Series is opened and any of the electrical components are handled, the following anti-static precautions are strictly adhered to.

- **Wear an anti-static wristband:** Wearing a simple anti-static wristband can help to prevent ESD from damaging any electrical component.
- **Self-grounding:** Before handling any electrical component, touch any grounded conducting material. During the time the electrical component is handled, frequently touch any conducting materials that are connected to the ground.
- **Use an anti-static pad:** When configuring or working with an electrical component, place it on an anti-static pad. This reduces the possibility of ESD damage.
- **Only handle the edges of the electrical component:** When handling the electrical component, hold the electrical component by its edges.

A.2 Maintenance and Cleaning Precautions

When maintaining or cleaning the AFL-HM55 Series, please follow the guidelines below.

A.2.1 Maintenance and Cleaning

Prior to cleaning any part or component of the AFL-HM55 Series, please read the details below.

AFL-HM55 Series Panel PC

- Except for the LCD panel, never spray or squirt liquids directly onto any other components. To clean the LCD panel, gently wipe it with a piece of soft dry cloth or a slightly moistened cloth.
- The interior of the AFL-HM55 Series does not require cleaning. Keep fluids away from the AFL-HM55 Series interior.
- Be cautious of all small removable components when vacuuming the AFL-HM55 Series.
- Turn the AFL-HM55 Series off before cleaning the AFL-HM55 Series.
- Never drop any objects or liquids through the openings of the AFL-HM55 Series.
- Be cautious of any possible allergic reactions to solvents or chemicals used when cleaning the AFL-HM55 Series.
- Avoid eating, drinking and smoking within vicinity of the AFL-HM55 Series.

A.2.2 Cleaning Tools

Some components in the AFL-HM55 Series may only be cleaned using a product specifically designed for the purpose. In such case, the product will be explicitly mentioned in the cleaning tips. Below is a list of items to use when cleaning the AFL-HM55 Series.

- **Cloth** – Although paper towels or tissues can be used, a soft, clean piece of cloth is recommended when cleaning the AFL-HM55 Series.
- **Water or rubbing alcohol** – A cloth moistened with water or rubbing alcohol can be used to clean the AFL-HM55 Series.
- **Using solvents** – The use of solvents is not recommended when cleaning the AFL-HM55 Series as they may damage the plastic parts.
- **Vacuum cleaner** – Using a vacuum specifically designed for computers is one of the best methods of cleaning the AFL-HM55 Series. Dust and dirt can restrict the airflow in the AFL-HM55 Series and cause its circuitry to corrode.
- **Cotton swabs** - Cotton swabs moistened with rubbing alcohol or water are excellent tools for wiping hard to reach areas.
- **Foam swabs** - Whenever possible, it is best to use lint free swabs such as foam swabs for cleaning.

Appendix

C

BIOS Configuration Options

B.1 BIOS Configuration Options

Below is a list of BIOS configuration options described in **Chapter 5**.

System Overview	60
Memory Information	60
System Date [xx/xx/xx]	61
System Time [xx:xx:xx]	61
ACPI Sleep State [S3 (CPU Stop Clock)]	63
TPM Support [Disable]	64
SATA Mode [IDE Mode]	65
Serial-ATA Controller n [Compatible]	65
USB Devices	66
All USB Devices [Enabled]	66
Legacy USB Support [Enabled]	67
Serial Port [Enabled]	68
Change Settings [Auto]	68
Serial Port [Enabled]	69
Change Settings [Auto]	69
Serial Port [Enabled]	70
Change Settings [Auto]	70
Parallel Port [Enabled]	71
Change Settings [Auto]	71
Device Mode [Printer Mode]	71
PC Health Status	72
Console Redirection [Disabled]	73
IGD Memory [32 MB]	75
Restore on AC Power Loss [Power Off]	76
Azalia HD Audio [Enabled]	76
Set Spread Spectrum [Disabled]	77
DVMT/FIXED Memory [Maximum]	77
Active LFP [Enable LVDS]	78
LCD Panel Type [Select by Panel ID]	78
Quiet Boot [Enabled]	79
Bootup NumLock State [On]	79

Realtek 8111E PXE OpROM [Disabled].....	80
Administrator Password	81
User Password	81
Set User Password	81
Save Changes and Reset	82
Discard Changes and Reset	82
Restore Defaults	82
Save as User Defaults	82
Restore User Defaults	82

Appendix

D

Watchdog Timer

NOTE:

The following discussion applies to DOS environment. IEI support is contacted or the IEI website visited for specific drivers for more sophisticated operating systems, e.g., Windows and Linux.

The Watchdog Timer is provided to ensure that standalone systems can always recover from catastrophic conditions that cause the CPU to crash. This condition may have occurred by external EMI or a software bug. When the CPU stops working correctly, Watchdog Timer either performs a hardware reset (cold boot) or a Non-Maskable Interrupt (NMI) to bring the system back to a known state.

A BIOS function call (INT 15H) is used to control the Watchdog Timer:

INT 15H:

AH – 6FH Sub-function:	
AL – 2:	Sets the Watchdog Timer's period.
BL:	Time-out value (Its unit-second is dependent on the item "Watchdog Timer unit select" in CMOS setup).

Table C-1: AH-6FH Sub-function

Call sub-function 2 to set the time-out period of Watchdog Timer first. If the time-out value is not zero, the Watchdog Timer starts counting down. While the timer value reaches zero, the system resets. To ensure that this reset condition does not occur, the calling sub-function 2 must periodically refresh the Watchdog Timer. However, the Watchdog timer is disabled if the time-out value is set to zero.

A tolerance of at least 10% must be maintained to avoid unknown routines within the operating system (DOS), such as disk I/O that can be very time-consuming.



NOTE:

When exiting a program it is necessary to disable the Watchdog Timer, otherwise the system resets.

Example program:

```

; INITIAL TIMER PERIOD COUNTER
;
W_LOOP:

    MOV     AX, 6F02H    ;setting the time-out value
    MOV     BX, 05      ;time-out value is 5 seconds
    INT     15H

;
; ADD THE APPLICATION PROGRAM HERE
;

    CMP     EXIT_AP, 1  ;is the application over?
    JNE     W_LOOP     ;No, restart the application

    MOV     AX, 6F02H   ;disable Watchdog Timer
    MOV     BX, 0       ;
    INT     15H

;
; EXIT ;

```

Appendix

E

Hazardous Materials Disclosure

D.1 Hazardous Material Disclosure Table for IPB Products Certified as RoHS Compliant Under 2002/95/EC Without Mercury

The details provided in this appendix are to ensure that the product is compliant with the Peoples Republic of China (China) RoHS standards. The table below acknowledges the presences of small quantities of certain materials in the product, and is applicable to China RoHS only.

A label will be placed on each product to indicate the estimated “Environmentally Friendly Use Period” (EFUP). This is an estimate of the number of years that these substances would “not leak out or undergo abrupt change.” This product may contain replaceable sub-assemblies/components which have a shorter EFUP such as batteries and lamps. These components will be separately marked.

Please refer to the table on the next page.

Part Name	Toxic or Hazardous Substances and Elements					
	Lead (Pb)	Mercury (Hg)	Cadmium (Cd)	Hexavalent Chromium (CR(VI))	Polybrominated Biphenyls (PBB)	Polybrominated Diphenyl Ethers (PBDE)
Housing	X	O	O	O	O	X
Display	X	O	O	O	O	X
Printed Circuit Board	X	O	O	O	O	X
Metal Fasteners	X	O	O	O	O	O
Cable Assembly	X	O	O	O	O	X
Fan Assembly	X	O	O	O	O	X
Power Supply Assemblies	X	O	O	O	O	X
Battery	O	O	O	O	O	O

O: This toxic or hazardous substance is contained in all of the homogeneous materials for the part is below the limit requirement in SJ/T11363-2006

X: This toxic or hazardous substance is contained in at least one of the homogeneous materials for this part is above the limit requirement in SJ/T11363-2006

AFL-HM55 Series Panel PC

此附件旨在确保本产品符合中国 RoHS 标准。以下表格标示此产品中某有毒物质的含量符合中国 RoHS 标准规定的限量要求。

本产品上会附有“环境友好使用期限”的标签，此期限是估算这些物质“不会有泄漏或突变”的年限。本产品可能包含有较短的环境友好使用期限的可替换元件，像是电池或灯管，这些元件将会单独标示出来。

部件名称	有毒有害物质或元素					
	铅 (Pb)	汞 (Hg)	镉 (Cd)	六价铬 (CR(VI))	多溴联苯 (PBB)	多溴二苯醚 (PBDE)
壳体	X	O	O	O	O	X
显示	X	O	O	O	O	X
印刷电路板	X	O	O	O	O	X
金属螺帽	X	O	O	O	O	O
电缆组装	X	O	O	O	O	X
风扇组装	X	O	O	O	O	X
电力供应组装	X	O	O	O	O	X
电池	O	O	O	O	O	O

O: 表示该有毒有害物质在该部件所有物质材料中的含量均在 SJ/T11363-2006 标准规定的限量要求以下。
X: 表示该有毒有害物质至少在该部件的某一均质材料中的含量超出 SJ/T11363-2006 标准规定的限量要求。