



IEI Technology Corp.



MODEL:

AFL2-10A-N28 Series

Flat Bezel Panel PC with Intel® Atom™ N2800 Dual-Core CPU
Touchscreen, Wi-Fi, Bluetooth, USB, GbE LAN, RS-232/422/485,
2-Megapixel Camera, HD Audio and RoHS

User Manual

Rev. 1.00 - 26 February, 2013



Revision

Date	Version	Changes
26 February, 2013	1.00	Initial release

Copyright

COPYRIGHT NOTICE

The information in this document is subject to change without prior notice in order to improve reliability, design and function and does not represent a commitment on the part of the manufacturer.

In no event will the manufacturer be liable for direct, indirect, special, incidental, or consequential damages arising out of the use or inability to use the product or documentation, even if advised of the possibility of such damages.

This document contains proprietary information protected by copyright. All rights are reserved. No part of this manual may be reproduced by any mechanical, electronic, or other means in any form without prior written permission of the manufacturer.

TRADEMARKS

All registered trademarks and product names mentioned herein are used for identification purposes only and may be trademarks and/or registered trademarks of their respective owners.

Table of Contents

1 INTRODUCTION.....	1
1.1 OVERVIEW.....	2
1.1.1 Features	3
1.2 EXTERNAL OVERVIEW.....	3
1.2.1 Front Panel	3
1.2.1.1 LED Indicators.....	4
1.2.1.2 Function Keys.....	6
1.2.2 Rear Panel	7
1.2.3 Bottom Panel.....	7
1.2.4 Left Side Panel.....	8
1.3 INTERNAL OVERVIEW.....	9
1.4 SYSTEM SPECIFICATIONS.....	9
1.5 DIMENSIONS.....	11
2 UNPACKING	12
2.1 UNPACKING.....	13
2.1.1 Packing List	13
3 INSTALLATION	17
3.1 ANTI-STATIC PRECAUTIONS	18
3.2 INSTALLATION PRECAUTIONS	18
3.3 INSTALLATION AND CONFIGURATION STEPS	19
3.4 HDD INSTALLATION.....	19
3.5 RFID READER INSTALLATION (OPTIONAL)	22
3.6 AT/ATX MODE SELECTION	24
3.6.1 AT Power Mode.....	24
3.6.2 ATX Power Mode.....	24
3.7 CLEAR CMOS.....	25
3.8 RESET THE SYSTEM	25
3.9 POWERING ON THE SYSTEM.....	26
3.10 POWERING OFF THE SYSTEM.....	26

AFL2-10A-N28 Panel PC

3.11 MOUNTING THE SYSTEM	26
3.11.1 Wall Mounting	27
3.11.2 Panel Mounting	30
3.11.3 Cabinet and Rack Installation.....	31
3.11.4 Arm Mounting	34
3.11.5 Stand Mounting	36
3.11.6 V-Stand Mounting.....	36
3.12 EXTERNAL PERIPHERAL DEVICE CONNECTION	38
3.12.1 Audio Connection.....	39
3.12.2 DisplayPort Connection.....	39
3.12.3 LAN Connection.....	40
3.12.4 Serial Device Connection	41
3.12.4.1 DB-9 Serial Port Connection	41
3.12.4.2 RJ-45 Serial Port Connection.....	42
3.12.5 USB Device Connection.....	44
4 BIOS SETUP	45
4.1 INTRODUCTION.....	46
4.1.1 Starting Setup.....	46
4.1.2 Using Setup	46
4.1.3 Getting Help.....	47
4.1.4 Unable to Reboot after Configuration Changes	47
4.1.5 BIOS Menu Bar.....	47
4.2 MAIN.....	48
4.3 ADVANCED	49
4.3.1 ACPI Settings	50
4.3.2 RTC Wake Settings	51
4.3.3 CPU Configuration.....	52
4.3.4 SATA Configuration	54
4.3.5 USB Configuration.....	55
4.3.6 F81866 Super IO Configuration	56
4.3.6.1 Serial Port n Configuration	57
4.3.6.1.1 Serial Port 1 Configuration	57
4.3.6.1.2 Serial Port 2 Configuration	58
4.3.6.1.3 Serial Port 3 Configuration	58

4.3.7 H/W Monitor	60
4.3.8 Serial Port Console Redirection	60
4.4 iEi FEATURE	62
4.5 CHIPSET	63
4.5.1 Host Bridge Configuration	64
4.5.1.1 Internal IGD Configuration.....	64
4.5.2 South Bridge Configuration.....	65
4.6 BOOT.....	67
4.7 SECURITY.....	69
4.8 SAVE & EXIT	70
5 SOFTWARE DRIVERS	72
5.1 AVAILABLE SOFTWARE DRIVERS	73
5.2 STARTING THE DRIVER PROGRAM	73
5.3 CHIPSET DRIVER INSTALLATION.....	74
5.4 GRAPHICS DRIVER INSTALLATION.....	77
5.5 TOUCH SCREEN DRIVER.....	80
5.5.1 Calibrating the Touch Screen.....	83
5.6 AUDIO DRIVER INSTALLATION	86
5.7 LAN DRIVER INSTALLATION.....	88
5.8 USB 3.0 DRIVER INSTALLATION	90
5.9 WI-FI DRIVER INSTALLATION.....	93
5.10 BLUETOOTH DRIVER	96
5.11 CAMERA DRIVER INSTALLATION	100
6 SYSTEM MAINTENANCE	103
6.1 SYSTEM MAINTENANCE INTRODUCTION	104
6.2 ANTI-STATIC PRECAUTIONS	104
6.3 TURN OFF THE POWER	105
6.4 OPENING THE SYSTEM.....	105
6.4.1 Removing the Back Cover.....	105
6.4.2 Removing the Internal Cover.....	106
6.5 REPLACING COMPONENTS.....	108
6.5.1 Memory Module Replacement	108
6.5.2 WLAN Card Replacement	109

AFL2-10A-N28 Panel PC

6.6 REINSTALLING THE COVERS	112
7 INTERFACE CONNECTORS	113
7.1 PERIPHERAL INTERFACE CONNECTORS	114
7.2 INTERNAL PERIPHERAL CONNECTORS	115
7.2.1 Audio Connector (AUDIO1)	117
7.2.2 Battery Connector (CN2)	117
7.2.3 Bluetooth USB Connector (BLUETOOTH1)	117
7.2.4 CRT Connector (VGA1)	118
7.2.5 Debug Connector (LPC_DEBUG1)	118
7.2.6 EC Debug Connector (CN1)	118
7.2.7 HDD Connector (JSATA1)	119
7.2.8 Hot Key LED Connector (HOTKEYLEDCN1)	119
7.2.9 Hot Key Connector (HOTKEYCN1)	120
7.2.10 LED Indicator Connector (LEDCN1)	120
7.2.11 LVDS Connector (LCD1)	120
7.2.12 LVDS Backlight Connector (INVERTER1)	121
7.2.13 microSD Connector (MICRO_SD1)	121
7.2.14 Mini USB Connector (MINI_USB1)	121
7.2.15 Power Button Connector (PW_BT1)	122
7.2.16 RFID USB Connector (RFID1)	122
7.2.17 RFID COM Connector (RFID_COM1)	122
7.2.18 SATA LED Connector (JP5)	122
7.2.19 Speaker Connector (SPKR1)	123
7.2.20 SPI Flash Connector (SPI1)	123
7.2.21 EC SPI Flash Connector (JSPI2)	123
7.2.22 Touch Panel Connector (TS1)	124
7.2.23 Touch Panel Connector (TOUCH1)	124
7.2.24 Type K Thermocouple Connector (K_TYPE1, K_TYPE2)	124
7.2.25 Webcam Connector (CAMERA1)	125
7.2.26 Webcam Microphone Connector (WEBCAM_DMIC1)	125
7.3 EXTERNAL INTERFACE PANEL CONNECTORS	125
7.3.1 Ethernet Connector (JP6)	126
7.3.2 Power Connector (DC_IN1)	126
7.3.3 RS-232 DB-9 Serial Ports (COM1)	126

7.3.4 RS-422/485 RJ-45 Serial Port (COM2).....	127
7.3.5 RS-232 RJ-45 Serial Ports (COM3)	127
7.3.6 USB 2.0 Connectors (USB1).....	128
7.3.7 USB 3.0 Connectors (USB3_1).....	128
7.3.8 DisplayPort Connector (DISPLAY_PORT1).....	128
A SAFETY PRECAUTIONS	130
A.1 SAFETY PRECAUTIONS	131
A.1.1 General Safety Precautions	131
A.1.2 CPU Temperature Warning	132
A.1.3 Anti-static Precautions	132
A.1.4 Product Disposal	133
A.2 MAINTENANCE AND CLEANING PRECAUTIONS	133
A.2.1 Maintenance and Cleaning.....	133
A.2.2 Cleaning Tools.....	134
B BIOS MENU OPTIONS	135
C ONE KEY RECOVERY.....	138
C.1 ONE KEY RECOVERY INTRODUCTION	139
C.1.1 System Requirement	140
C.1.2 Supported Operating System.....	141
C.2 SETUP PROCEDURE FOR WINDOWS	142
C.2.1 Hardware and BIOS Setup	143
C.2.2 Create Partitions	143
C.2.3 Install Operating System, Drivers and Applications.....	147
C.2.4 Building the Recovery Partition.....	148
C.2.5 Create Factory Default Image	150
C.3 AUTO RECOVERY SETUP PROCEDURE	155
C.4 SETUP PROCEDURE FOR LINUX	160
C.5 RECOVERY TOOL FUNCTIONS	163
C.5.1 Factory Restore	165
C.5.2 Backup System.....	166
C.5.3 Restore Your Last Backup.....	167
C.5.4 Manual	168
C.6 RESTORE SYSTEMS FROM A LINUX SERVER THROUGH LAN	169

AFL2-10A-N28 Panel PC

<i>C.6.1 Configure DHCP Server Settings</i>	170
<i>C.6.2 Configure TFTP Settings</i>	171
<i>C.6.3 Configure One Key Recovery Server Settings</i>	172
<i>C.6.4 Start the DHCP, TFTP and HTTP</i>	173
<i>C.6.5 Create Shared Directory</i>	173
<i>C.6.6 Setup a Client System for Auto Recovery</i>	174
C.7 OTHER INFORMATION	177
<i>C.7.1 Using AHCI Mode or ALi M5283 / VIA VT6421A Controller</i>	177
<i>C.7.2 System Memory Requirement</i>	179
D WATCHDOG TIMER	180
E HAZARDOUS MATERIALS DISCLOSURE	183
E.1 HAZARDOUS MATERIAL DISCLOSURE TABLE FOR IPB PRODUCTS CERTIFIED AS ROHS COMPLIANT UNDER 2002/95/EC WITHOUT MERCURY	184

List of Figures

Figure 1-1: AFL2-10A-N28 Flat Bezel Panel PC	2
Figure 1-2: Front View	3
Figure 1-3: LED Indicators	4
Figure 1-4: Function Keys	6
Figure 1-5: Rear View	7
Figure 1-6: Bottom Panel	8
Figure 1-7: Left Side Panel	8
Figure 1-8: AFL2-10A-N28 Dimensions (mm)	11
Figure 3-1: HDD Cover Retention Screws	20
Figure 3-2: HDD Bracket Removal	20
Figure 3-3: Inserting the HDD	21
Figure 3-4: Securing the HDD	21
Figure 3-5: Back Cover Retention Screws	22
Figure 3-6: Internal Cover Retention Screws	22
Figure 3-7: RFID Reader Module Installation	23
Figure 3-8: RFID Reader Connection	23
Figure 3-9: AT/ATX Switch Location	24
Figure 3-10: Clear CMOS Switch Location	25
Figure 3-11: Reset Button Location	25
Figure 3-12: Wall-mounting Bracket	27
Figure 3-13: Chassis Support Screws	29
Figure 3-14: Secure the Panel PC	29
Figure 3-15: Cutout Dimensions	30
Figure 3-16: Tighten the Panel Mounting Clamp Screws	31
Figure 3-17: The Rack/Cabinet Bracket	32
Figure 3-18: Secure the Rack/Cabinet Bracket	33
Figure 3-19: Install into a Rack/Cabinet	33
Figure 3-20: Arm Mounting Retention Screw Holes	35
Figure 3-21: Arm Mounting	35
Figure 3-22: Stand Mounting (Stand-A/Bxx)	36
Figure 3-23: Drill Pilot Holes for V-Stand	37

AFL2-10A-N28 Panel PC

Figure 3-24: Secure System to V-Stand	37
Figure 3-25: Secure V-Stand to Mounting Area	38
Figure 3-26: Audio Connector	39
Figure 3-27: DisplayPort Connection	40
Figure 3-28: LAN Connection	41
Figure 3-29: DB-9 Serial Port Connector	42
Figure 3-30: RJ-45 Serial Port Connector	43
Figure 3-31: DB-9 Connector Pinout Locations	43
Figure 3-32: USB Device Connection	44
Figure 5-1: Drivers	74
Figure 5-2: Chipset Driver Screen	75
Figure 5-3: Chipset Driver Welcome Screen	75
Figure 5-4: Chipset Driver License Agreement	76
Figure 5-5: Chipset Driver Read Me File	76
Figure 5-6: Chipset Driver Setup Operations	77
Figure 5-7: Graphics Driver Welcome Screen	78
Figure 5-8: Graphics Driver License Agreement	78
Figure 5-9: Graphics Driver Read Me File	79
Figure 5-10: Graphics Driver Setup Operations	79
Figure 5-11: Graphics Driver Installation Finish Screen	80
Figure 5-12: Touch Screen Driver Welcome Screen	81
Figure 5-13: Touch Screen Driver License Agreement	81
Figure 5-14: Touch Screen Driver Choose Install Location	82
Figure 5-15: Touch Screen Driver Installation Screen	82
Figure 5-16: Touch Screen Driver Update Complete	83
Figure 5-17: PenMount Monitor Icon	83
Figure 5-18: PenMount Monitor Popup Menu	84
Figure 5-19: Configuration Screen	84
Figure 5-20: Calibration Initiation Screen	85
Figure 5-21: Calibration Screen	85
Figure 5-22: Audio Driver – Extracting Files	86
Figure 5-23: Audio Driver Welcome Screen	87
Figure 5-24: Audio Driver Installation	87
Figure 5-25: Audio Driver Installation Complete	87
Figure 5-26: LAN Driver Welcome Screen	88

Figure 5-27: LAN Driver Ready to Install Screen.....	89
Figure 5-28: LAN Driver Setup Status Screen	89
Figure 5-29: LAN Driver Installation Complete.....	90
Figure 5-30: USB 3.0 Driver Welcome Screen	91
Figure 5-31: USB 3.0 Driver License Agreement.....	91
Figure 5-32: USB 3.0 Driver Installation	92
Figure 5-33: USB 3.0 Driver Update Complete	92
Figure 5-34: License Agreement	93
Figure 5-35: Setup Type.....	94
Figure 5-36: Configuration Tool.....	94
Figure 5-37: Ready to Install the Program	95
Figure 5-38: Setup Status	95
Figure 5-39: Installation Complete.....	96
Figure 5-40: Welcome Screen	97
Figure 5-41: License Agreement	97
Figure 5-42: Bluetooth Driver Destination Folder	98
Figure 5-43: Ready to Install the Program	98
Figure 5-44: Installing BlueSoleil.....	99
Figure 5-45: Bluetooth Driver Complete Installation Screen	99
Figure 5-46: Reboot the Computer	100
Figure 5-47: AMCap Driver Welcome Screen	101
Figure 5-48: AMCap Driver Choose Install Location.....	101
Figure 5-49: AMCap Driver Installation Complete.....	102
Figure 6-1: Back Cover Retention Screws	106
Figure 6-2: Internal Cover Retention Screws.....	107
Figure 6-3: Internal Components	107
Figure 6-4: DDR SO-DIMM Module Installation.....	109
Figure 6-5: Releasing the WLAN Card.....	110
Figure 6-6: Removing the WLAN card.....	110
Figure 6-7: Attaching the Antennas.....	111
Figure 7-1: Main Board Layout Diagram (Front Side).....	114
Figure 7-2: Main Board Layout Diagram (Solder Side).....	115
Figure C-1: IEI One Key Recovery Tool Menu	139
Figure C-2: Launching the Recovery Tool	144
Figure C-3: Recovery Tool Setup Menu	144

AFL2-10A-N28 Panel PC

Figure C-4: Command Prompt	145
Figure C-5: Partition Creation Commands.....	146
Figure C-6: Launching the Recovery Tool	148
Figure C-7: Manual Recovery Environment for Windows	148
Figure C-8: Building the Recovery Partition.....	149
Figure C-9: Press Any Key to Continue	149
Figure C-10: Press F3 to Boot into Recovery Mode.....	150
Figure C-11: Recovery Tool Menu	150
Figure C-12: About Symantec Ghost Window.....	151
Figure C-13: Symantec Ghost Path	151
Figure C-14: Select a Local Source Drive	152
Figure C-15: Select a Source Partition from Basic Drive	152
Figure C-16: File Name to Copy Image to	153
Figure C-17: Compress Image.....	153
Figure C-18: Image Creation Confirmation	154
Figure C-19: Image Creation Complete	154
Figure C-20: Image Creation Complete	154
Figure C-21: Press Any Key to Continue	155
Figure C-22: Auto Recovery Utility	156
Figure C-23: Disable Automatically Restart.....	156
Figure C-24: Launching the Recovery Tool	157
Figure C-25: Auto Recovery Environment for Windows	157
Figure C-26: Building the Auto Recovery Partition.....	158
Figure C-27: Factory Default Image Confirmation	158
Figure C-28: Image Creation Complete	159
Figure C-29: Press any key to continue	159
Figure C-30: Partitions for Linux.....	161
Figure C-31: Manual Recovery Environment for Linux	162
Figure C-32: Access menu.lst in Linux (Text Mode).....	162
Figure C-33: Recovery Tool Menu	163
Figure C-34: Recovery Tool Main Menu	164
Figure C-35: Restore Factory Default.....	165
Figure C-36: Recovery Complete Window	165
Figure C-37: Backup System.....	166
Figure C-38: System Backup Complete Window	166



Figure C-39: Restore Backup	167
Figure C-40: Restore System Backup Complete Window	167
Figure C-41: Symantec Ghost Window	168
Figure C-42: Disable Automatically Restart.....	175

List of Tables

Table 1-1: LED Indicators	5
Table 1-2: Function Key Descriptions	6
Table 1-3: System Specifications.....	10
Table 3-1: DB-9 Connector Pinout	43
Table 6-1: BIOS Navigation Keys	47
Table 7-1: Peripheral Interface Connectors	116
Table 7-2: Audio Connector (AUDIO1) Pinouts	117
Table 7-3: Battery Connector (CN2) Pinouts	117
Table 7-4: Bluetooth USB Connector (BLUETOOTH1) Pinouts	117
Table 7-5: CRT Connector (VGA1) Pinouts	118
Table 7-6: Debug Connector (LPC_DEBUG1) Pinouts.....	118
Table 7-7: EC Debug Connector (CN1) Pinouts.....	119
Table 7-8: HDD Connector (JSTAT1) Pinouts.....	119
Table 7-9: Hotkey LED Connector (HOTKEYLEDCN1) Pinouts	119
Table 7-10: Hotkey Connector (HOTKEYCN1) Pinouts.....	120
Table 7-11: LED Indicator Connector (LEDCN1) Pinouts	120
Table 7-12: LVDS Connector (LCD1) Pinouts	121
Table 7-13: LVDS Backlight Connector (INVERTER1) Pinouts.....	121
Table 7-14: microSD Connector (MICRO_SD1) Pinouts	121
Table 7-15: Mini USB Connector (MINI_USB1) Pinouts	121
Table 7-16: Power Button Connector (PW_BT1) Pinouts	122
Table 7-17: RFID USB Connector (RFID1) Pinouts.....	122
Table 7-18: RFID COM Connector (RFID_COM1) Pinouts	122
Table 7-19: SATA LED Connector (JP5) Pinouts.....	122
Table 7-20: Speaker Connector (SPKR1) Pinouts	123
Table 7-21: SPI Flash Connector (SPI1) Pinouts	123
Table 7-22: EC SPI Flash Connector (JSPI2) Pinouts.....	123
Table 7-23: Touch Panel Connector (TS1) Pinouts	124
Table 7-24: Touch Panel Connector (TOUCH1) Pinouts.....	124
Table 7-25: Type K Thermocouple Connector Pinouts.....	124
Table 7-26: Webcam Connector (CAMERA1) Pinouts	125



Table 7-27: Webcam Microphone Connector (WEBCAM_DMIC1) Pinouts..... 125

Table 7-28: Rear Panel Connectors 125

Table 7-29: Ethernet Connector (JP6) Pinouts 126

Table 7-30: Power Connector (DC_IN1) Pinouts 126

Table 7-31: RS-232 DB-9 Serial Ports (COM1) Pinouts 126

Table 7-32: RS-422/485 Serial Port (COM2) Pinouts 127

Table 7-33: DB-9 Connector Pinout 127

Table 7-34: RS-232 RJ-45 Serial Ports (COM3) Pinouts..... 127

Table 7-35: USB 2.0 Connectors (USB1) Pinouts..... 128

Table 7-36: USB 3.0 Connectors (USB3_1) Pinouts..... 128

Table 7-37: DisplayPort Connector (DISPLAY_PORT1) Pinouts 129

List of BIOS Menus

BIOS Menu 1: Main	48
BIOS Menu 2: Advanced	50
BIOS Menu 3: ACPI Configuration	50
BIOS Menu 4: RTC Wake Settings	51
BIOS Menu 5: CPU Configuration	53
BIOS Menu 6: SATA Configuration	54
BIOS Menu 7: USB Configuration	55
BIOS Menu 8: Super IO Configuration.....	56
BIOS Menu 9: Serial Port n Configuration Menu	57
BIOS Menu 10: Hardware Health Configuration	60
BIOS Menu 11: Serial Port Console Redirection	61
BIOS Menu 12: iEi Feature	62
BIOS Menu 13: Chipset	63
BIOS Menu 14: Northbridge Chipset Configuration.....	64
BIOS Menu 15: Internal IGD Configuration	64
BIOS Menu 16: South Bridge Configuration.....	66
BIOS Menu 17: Boot	67
BIOS Menu 18: Security	69
BIOS Menu 19: Exit.....	70
BIOS Menu 20: IEI Feature	160

Chapter

1

Introduction

1.1 Overview



Figure 1-1: AFL2-10A-N28 Flat Bezel Panel PC

The AFL2-10A-N28 is an Intel® Atom™ N2800 dual-core processor powered flat bezel panel PC with a rich variety of functions and peripherals. The AFL2-10A-N28 is designed for easy and simplified integration into kiosk and point-of-sales (POS) applications.

An Intel® NM10 chipset ensures optimal memory, graphics, and peripheral I/O support. The system comes with two 2.0 GB of DDR3 SO-DIMMs ensuring smooth data throughputs with reduced bottlenecks and fast system access.

Three serial ports, two external USB 2.0 ports and two external USB 3.0 ports ensure simplified connectivity to a variety of external peripheral devices. Wi-Fi capabilities and one RJ-45 Ethernet connector provide the system with smooth connection to an external LAN. An optional MSR card reader can equip the system for scanning credit cards, identification cards, loyalty cards, gift cards, and more.

AFL2-10A-N28 Panel PC

1.1.1 Features

The AFL2-10A-N28 features are listed below:

- Flat-bezel LCD with LED backlight
- 1.86 GHz Intel® Atom™ N2800 dual-core processor
- One 204-pin DDR3 SO-DIMM slot (system max. 4 GB) preinstalled with 2 GB memory
- 5-wire resistive type touchscreen
- Wi-Fi 802.11b/g/n 2T2R high speed wireless
- Built-in 2-megapixel camera with AF, AE and AWB capabilities
- Built-in two 1.5 W speakers and digital microphone
- Optional RFID reader
- IP 64 compliant front panel

1.2 External Overview

1.2.1 Front Panel

The front side of the AFL2-10A-N28 is a flat bezel panel TFT LCD screen surrounded by a PC/ABS plastic frame.

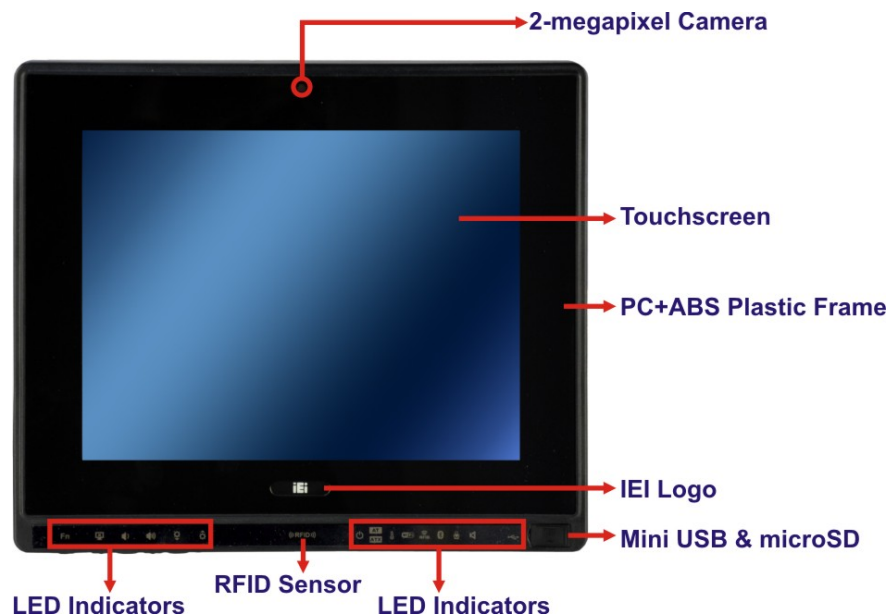

Figure 1-2: Front View

1.2.1.1 LED Indicators

There are several LED indicators located along the bottom of the LCD screen (**Figure 1-3**).

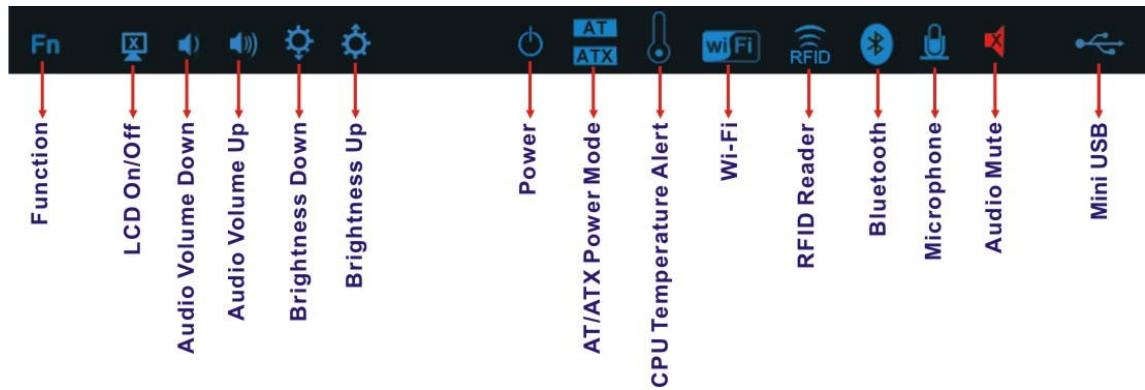

Figure 1-3: LED Indicators

The descriptions of each LED indicator are listed below.

LED Indicator	Description
Power	<p>Off: power cord not attached or power supply failure</p> <p>Blinking amber: the system is connected to a power source and is ready to be turned on.</p> <p>Solid blue: the system is turned on.</p> <p><i>Power on/off by the hot keys. See Table 1-3</i></p>
AT/ATX Mode	<p>AT: the system is in AT power mode</p> <p>ATX: the system is in ATX power mode</p> <p><i>Controlled by the AT/ATX power mode switch.</i></p>
CPU Temperature Alert	<p>Blue: CPU temperature is normal.</p> <p>Red: CPU temperature is too high.</p>
Wi-Fi	<p>On: the Wi-Fi module is enabled</p> <p>Off: the Wi-Fi module is disabled.</p> <p><i>Controlled by the BIOS. See Section 4.5.2</i></p>
RFID	<p>On: the optional RFID reader is enabled</p> <p>Off: the optional RFID reader is disabled.</p> <p><i>Controlled by the hot keys. See Table 1-3</i></p>

AFL2-10A-N28 Panel PC

Bluetooth	<p>On: the Bluetooth module is enabled.</p> <p>Off: the Bluetooth module is disabled.</p> <p><i>Controlled by the BIOS. See Section 4.5.2</i></p>
Microphone	<p>On: the digital microphone is enabled</p> <p>Off: the digital microphone is disabled.</p> <p><i>Controlled by the BIOS. See Section 4.5.2</i></p>
Audio Mute	<p>On (solid red): the audio is turned off</p> <p>Off: the audio is turned on</p> <p><i>Controlled by the hot keys. See Table 1-3</i></p>
Mini USB	<p>On: the Mini USB 2.0 module is enabled</p> <p>Off: the Mini USB 2.0 module is disabled.</p> <p><i>Controlled by the hot keys. See Table 1-3</i></p>
Function	Shows the status of the function keys below the LED indicators. Blinks when the corresponding button is pushed.
LCD On/Off	
Audio Volume Down	
Audio Volume Up	
Brightness Down	
Brightness Up	
Table 1-1: LED Indicators	



WARNING:

If the CPU temperature alert LED shows in red, the user must lower the environments temperature or close some running applications to cool down the CPU.

1.2.1.2 Function Keys

The function keys are located under the bottom right hand corner of the LCD screen (Figure 1-4).



Figure 1-4: Function Keys

The function keys are described in Table 1-3:

Key Combination	Function Key Description
Fn	Function key.
Fn + LCD On/Off	Enable/Disable RFID
Fn + Audio Volume Down	Mute audio
Fn + Audio Volume Up	Enable/Disable camera
Fn + Brightness Down	Enable/Disable Mini USB or microSD
Fn + Brightness Up	Power On/Off Note: To power on the system, hold down the Fn + Brightness Up buttons for six seconds. To power down the system, hold down the Fn + Brightness Up buttons for eight seconds.

Table 1-2: Function Key Descriptions

AFL2-10A-N28 Panel PC

1.2.2 Rear Panel

The rear panel provides access to retention screw holes that support VESA mounting. The HDD bay is protected by the HDD cover. Refer to **Figure 1-5**.

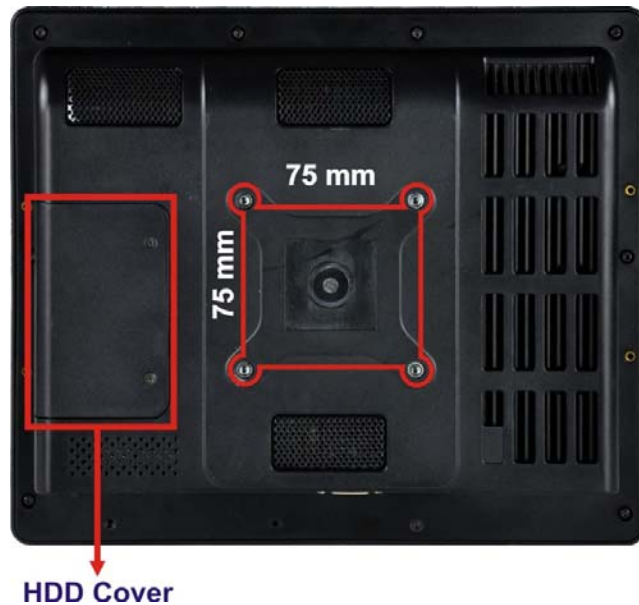

Figure 1-5: Rear View

1.2.3 Bottom Panel

The bottom panel of the AFL2-10A-N28 has the following connectors and switches (**Figure 1-6**):

- 1 x 9 V ~ 36 V DC input power jack
- 1 x Audio line-out jack
- 1 x AT/ATX switch
- 1 x Clear CMOS switch
- 1 x DisplayPort connector
- 6 x Function keys
- 1 x GbE RJ-45 connector
- 1 x Digital microphone
- 1 x Power button
- 1 x Reset button
- 1 x RS-232 DB-9 connector (COM1)

- 1 x RS-232 RJ-45 connector (COM3)
- 1 x RS-422/485 RJ-45 connector
- 2 x USB 2.0 connectors
- 2 x USB 3.0 connectors

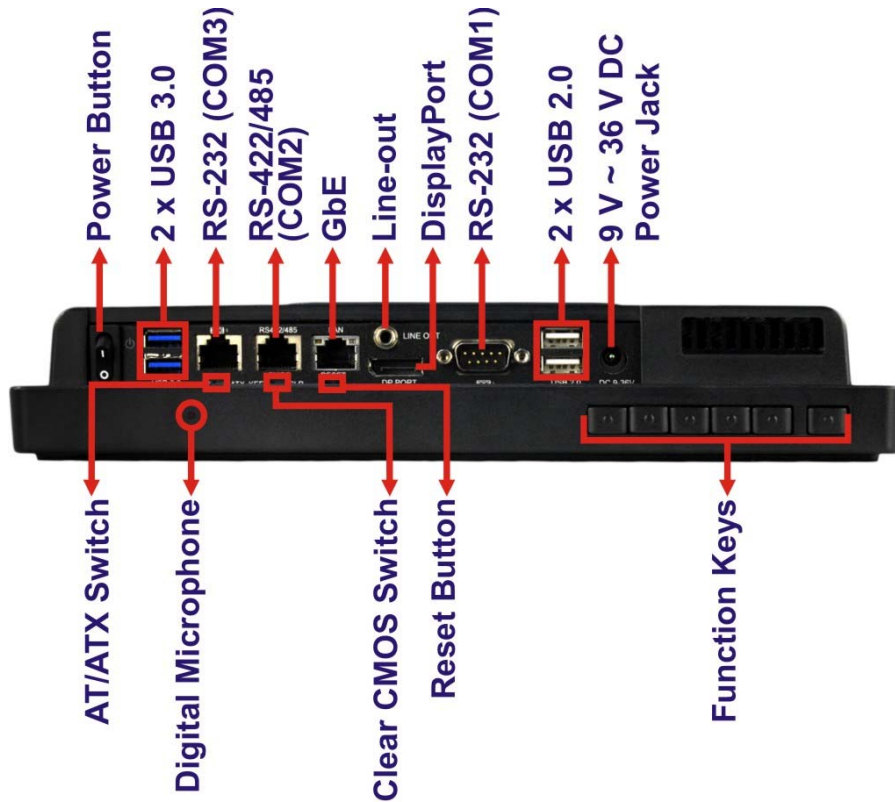

Figure 1-6: Bottom Panel

1.2.4 Left Side Panel

The left side panel of the AFL2-10A-N28 has a temperature sensor (Figure 1-7).

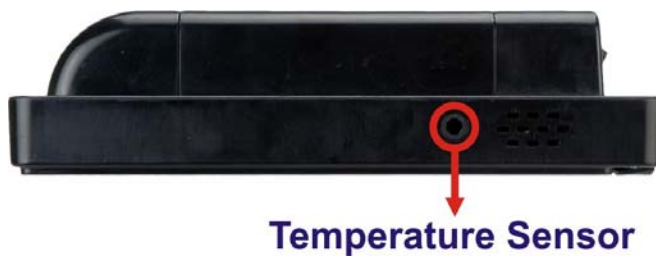

Figure 1-7: Left Side Panel

AFL2-10A-N28 Panel PC

1.3 Internal Overview

The AFL2-10A-N28 has the following components installed internally:

- 1 x Motherboard
- 1 x 2.0 GB 1066 MHz DDR3 SO-DIMM
- 1 x 802.11b/g/n wireless LAN module

1.4 System Specifications

The technical specifications for the AFL2-10A-N28 systems are listed in **Table 1-4**.

Specification	AFL2-10A-N28
LCD Size	10.4"
Max. Resolution	800 (W) x 600 (H)
Brightness (cd/m ²)	400
Contrast Ratio	700:1
LCD Color	262K/16.2M
Pixel Pitch (H x V) (mm)	0.264 (H) x 0.264 (V)
Viewing Angle (H-V)	160° / 140°
Backlight	LED backlight (MTBF: 30,000 hrs)
Touchscreen	5-Wire resistive type touch screen
CPU	1.86 GHz Intel® Atom™ N2800 dual-core processor
Chipset	Intel® NM10
Ethernet	Realtek RTL8111E PCIe GbE controller support ASF2.0
Memory	Preinstalled one 204-pin 1066 MHz 2 GB DDR3 SO-DIMM (max. 4 G)
HDD	2.5" SATA 3Gb/s HDD bay
Audio	Realtek ALC892 HD Audio codec (Line-out)
Speaker	AMP 1.5 W + 1.5 W (built-in stereo speakers)
Camera	2-megapixel camera with low light function
Microphone	Digital microphone located on the bottom of the front frame
Wireless	1 x Wireless LAN 802.11 b/g/n module (PCIe Mini card)
Bluetooth	Optional internal USB interface, Bluetooth V2.0+EDR
RFID Reader	EM 125 KHz or MIFARE 13.56 MHz card reader (optional)
MSR Card Reader	MSR card reader (optional)

OSD Function	LCD on/off, brightness up/down, volume up/down, Hot Key
Construction Material	PC+ABS plastic front frame
Mounting	VESA 75 mm x 75 mm (Panel, Wall, Rack, Stand or Arm)
Front Panel Color	Black
Weight (N/G)	2.98 kg / 4.5 kg
Dimensions (W x H x D)	282.5 mm x 242.7 mm x 51.0 mm
Operating Temperature	-20°C ~ 45°C
Storage Temperature	-20°C ~ 60°C
Humidity	10% ~ 95% (no-condensing)
IP level	IP 64 compliant front panel
Power Supply	65 W power adapter
	Input: 100 V AC ~ 240 V AC @ 50 / 60 Hz
	Output: 19 V DC
Power Requirement	9 V ~ 36 V DC
Power Consumption	19 V @ 1.6 A (Intel® Atom™ N2800 CPU with 2 GB DDR3 memory)
Safety/EMC	CE, FCC
I/O Ports and Switches	1 x RS-232 (DB-9 connector)
	1 x RS-232 (RJ-45 connector)
	1 x RS-422/485 (RJ-45 connector)
	1 x GbE LAN (RJ-45 connector)
	2 x USB 2.0 connectors
	2 x USB 3.0 connectors
	1 x Mini USB 2.0 connector (on front panel)
	1 x microSD card slot (on front panel)
	1 x Audio line-out jack
	1 x DisplayPort connector
	1 x Power switch
	1 x AT/ATX switch
	1 x Reset button
1 x Clear CMOS button	
1 x 9 V ~ 36 V DC input jack	

Table 1-3: System Specifications

AFL2-10A-N28 Panel PC

1.5 Dimensions

The AFL2-10A-N28 dimensions are shown below.

- **Width:** 282.5 mm
- **Height:** 242.7 mm
- **Depth:** 51.0 mm

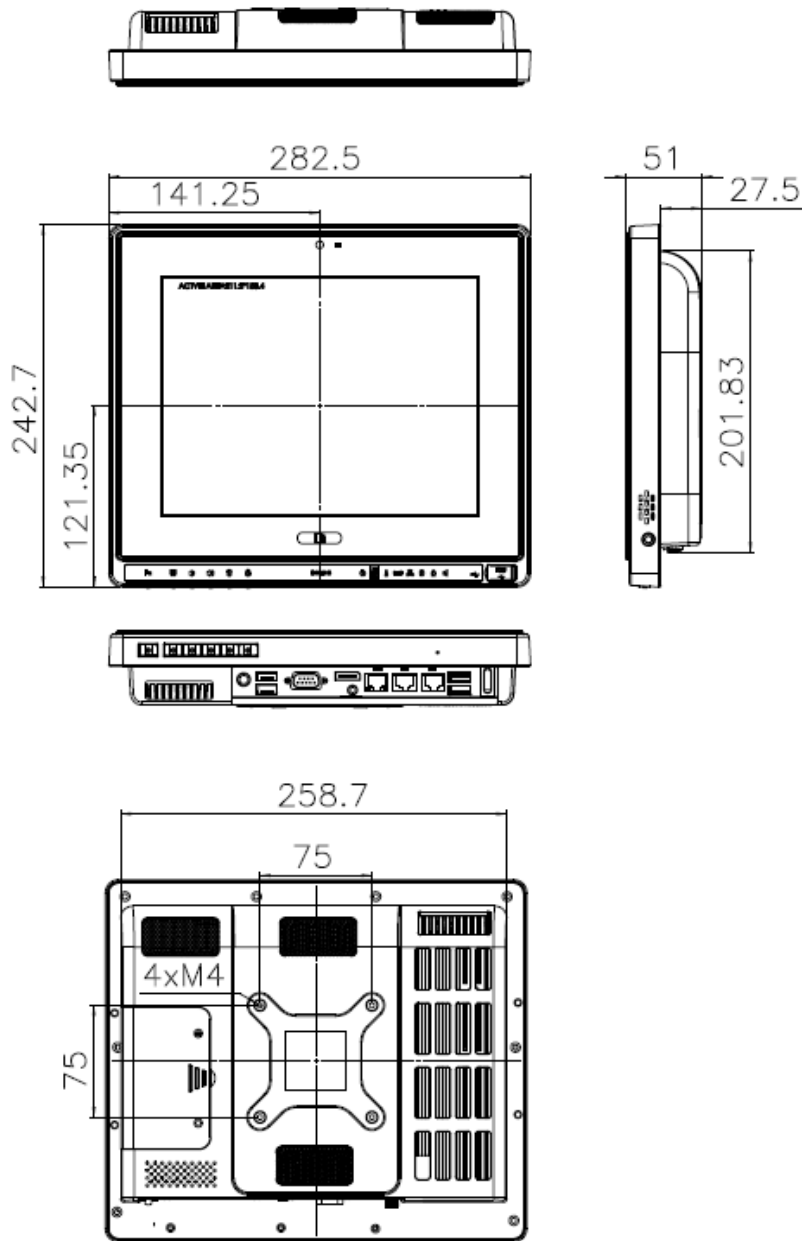

Figure 1-8: AFL2-10A-N28 Dimensions (mm)

Chapter

2

Unpacking

AFL2-10A-N28 Panel PC

2.1 Unpacking

To unpack the flat bezel panel PC, follow the steps below:



WARNING!

The front side LCD screen has a protective plastic cover stuck to the screen. Only remove the plastic cover after the flat bezel panel PC has been properly installed. This ensures the screen is protected during the installation process.

- Step 1:** Use box cutters, a knife or a sharp pair of scissors that seals the top side of the external (second) box.
- Step 2:** Open the external (second) box.
- Step 3:** Use box cutters, a knife or a sharp pair of scissors that seals the top side of the internal (first) box.
- Step 4:** Lift the monitor out of the boxes.
- Step 5:** Remove both polystyrene ends, one from each side.
- Step 6:** Pull the plastic cover off the flat bezel panel PC.
- Step 7:** Make sure all the components listed in the packing list are present.

2.1.1 Packing List

The AFL2-10A-N28 flat bezel panel PC is shipped with the following components:

Quantity	Item	Image
Standard		
1	AFL2-10A-N28 panel PC	
1	Power adapter (P/N: 63040-010060-030-RS)	
1	Power cord (P/N: 32702-000401-100-RS)	
1	Power transfer cord (P/N: 32702-000300-100-RS)	
1	RJ-45 to DB-9 COM Port Cable (P/N: 32005-000200-200-RS)	
1	Pen for resistive touchscreen (P/N: 43125-0002C0-00-RS)	
4	M3*4 flat head screw pack for HDD installation (P/N: 44013-030041-RS)	
4	M4*6 pan head screw pack for VESA mount (P/N: 44403-040061-RS)	
1	Utility CD	
1	One Key Recovery CD (P/N: 7B000-000724-RS)	

AFL2-10A-N28 Panel PC

Optional	
Wall mounting kit (P/N: AFLWK-12)	
Panel mounting kit (P/N: AFL2PK-10A)	
Rack mounting kit (P/N: AFL2RK-10A)	
Stand (P/N: STAND-C12/ STAND-B19)	
Stand (P/N: VSTAND-A10)	
Hybrid card reader (P/N: AFL2P-12AMSI-U-R10)	
Magnetic stripe reader (P/N: AFL2P-12AMSR-U-R10)	
Bluetooth module kit (P/N: AFL2-BT-KIT01-R11)	
OS: Win CE 6.0 (CD-ROM) (P/N: AFL2-W10A-CV-CE060-R10)	

OS: Win XPE (CD-ROM) (P/N: AFL2-W10A-CV-XPE-R10)	
OS: Linux (CD-ROM) (P/N: AFL2-W10A-CV-LNX-R10)	
OS: Win 7 Embedded (DVD-ROM) (P/N: AFL2-W10A-CV-WES7P-R10 or AFL2-W10A-CV-WES7E-R10)	

If any of these items are missing or damaged, contact the distributor or sales representative immediately.

Chapter

3

Installation

3.1 Anti-static Precautions



WARNING:

Failure to take ESD precautions during the maintenance of the AFL2-10A-N28 may result in permanent damage to the AFL2-10A-N28 and severe injury to the user.

Electrostatic discharge (ESD) can cause serious damage to electronic components, including the AFL2-10A-N28. Dry climates are especially susceptible to ESD. It is therefore critical that whenever the AFL2-10A-N28 is accessed internally, or any other electrical component is handled, the following anti-static precautions are strictly adhered to.

- **Wear an anti-static wristband:** - Wearing a simple anti-static wristband can help to prevent ESD from damaging the board.
- **Self-grounding:** - Before handling the board touch any grounded conducting material. During the time the board is handled, frequently touch any conducting materials that are connected to the ground.
- **Use an anti-static pad:** - When configuring the AFL2-10A-N28, place it on an anti-static pad. This reduces the possibility of ESD damaging the AFL2-10A-N28.
- **Only handle the edges of the PCB:** - When handling the PCB, hold the PCB by the edges.

3.2 Installation Precautions

When installing the flat bezel panel PC, please follow the precautions listed below:

- **Power turned off:** When installing the flat bezel panel PC, make sure the power is off. Failing to turn off the power may cause severe injury to the body and/or damage to the system.
- **Certified Engineers:** Only certified engineers should install and modify onboard functionalities.

AFL2-10A-N28 Panel PC

- **Anti-static Discharge:** If a user open the rear panel of the flat bezel panel PC, to configure the jumpers or plug in added peripheral devices, ground themselves first and wear an anti-static wristband.

3.3 Installation and Configuration Steps

The following installation steps must be followed.

- Step 1:** Unpack the flat bezel panel PC.
- Step 2:** Install the HDD.
- Step 3:** Install the RFID reader. (optional)
- Step 4:** Configure the system.
- Step 5:** Connect peripheral devices to the flat bezel panel PC.
- Step 6:** Mount the flat bezel panel PC.

3.4 HDD Installation



WARNING:

Over-tightening back cover screws will crack the plastic frame.
Maximum torque for cover screws is 5 kg-cm (0.36 lb-ft/0.49 Nm).

To install the HDD into the AFL2-10A-N28, please follow the steps below:

- Step 1:** Remove two (2) retention screws from the HDD cover (**Figure 3-1**).



Figure 3-1: HDD Cover Retention Screws

Step 2: Remove the HDD cover from the device.

Step 3: Loosen the captive screw to release the HDD bracket from the chassis. Slide the HDD bracket out of the device as shown (Figure 3-2).

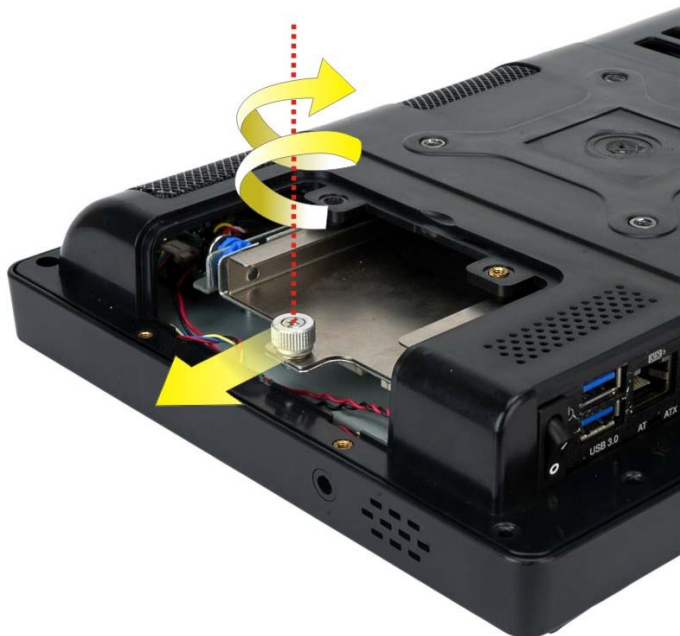

Figure 3-2: HDD Bracket Removal

Step 4: Insert an HDD into the bracket as shown in Figure 3-3.

AFL2-10A-N28 Panel PC



Figure 3-3: Inserting the HDD

Step 5: Secure the HDD to the bracket using four (4) M3*4 retention screws (two screws on each side) (**Figure 3-4**).



Figure 3-4: Securing the HDD

Step 6: Slide the HDD module back into the device.

Step 7: Tighten the captive screw.

Step 8: Replace the HDD cover and secure it using two (2) retention screws.

3.5 RFID Reader Installation (Optional)

An optional RFID reader can be installed in the AFL2-10A-N28. To install the RFID reader, follow the instructions below.

Step 1: Remove a total of eleven (11) retention screws from the back cover (**Figure 3-5**).



Figure 3-5: Back Cover Retention Screws

Step 2: Remove the five (5) retention screws securing the internal cover to the chassis (**Figure 3-6**).

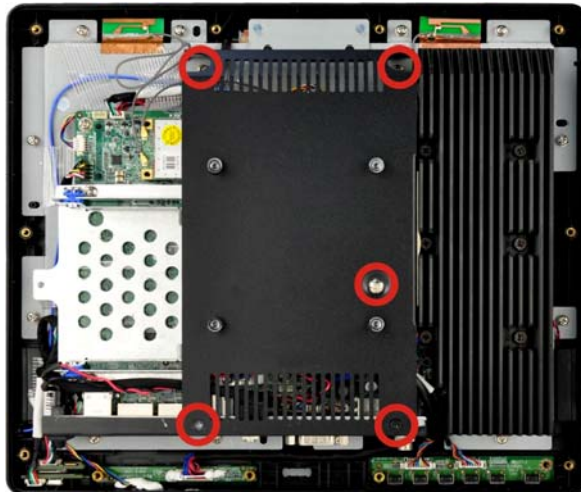

Figure 3-6: Internal Cover Retention Screws

AFL2-10A-N28 Panel PC

Step 3: Using two retention screws to install the RFID reader module in the location shown in **Figure 3-7**.

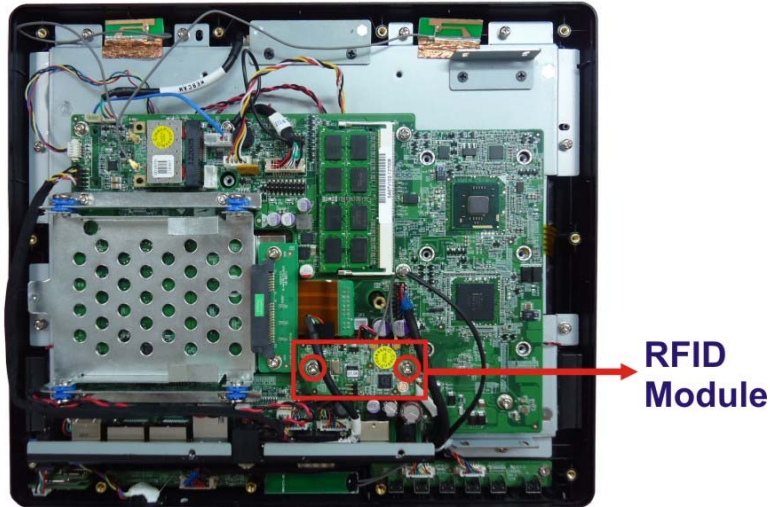

Figure 3-7: RFID Reader Module Installation

Step 4: Connect the RFID module to the RFID connector on the main board (**Figure 3-8**). The RFID connector pinouts are listed in Section 7.2.17.

Step 5: Place the RFID antenna on the location shown in **Figure 3-8**. Connect the RFID antenna to the RFID antenna connector on the RFID module.

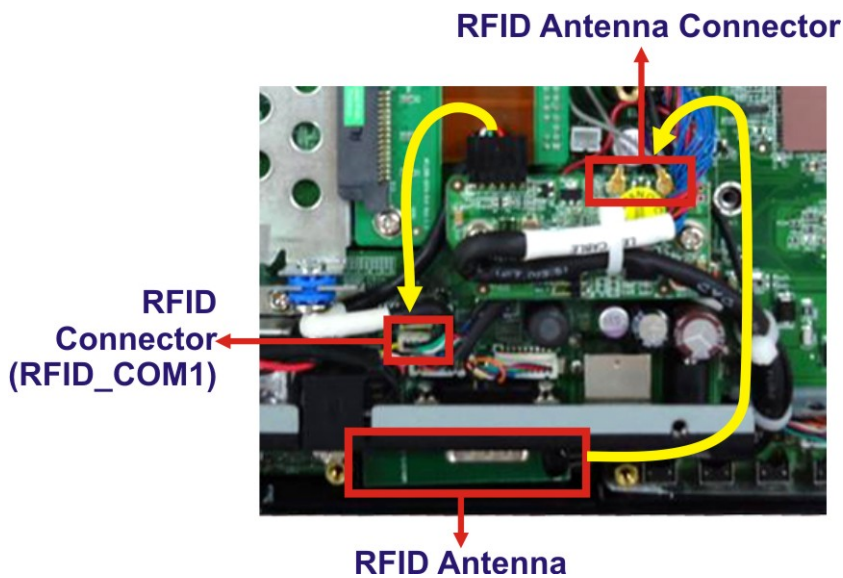

Figure 3-8: RFID Reader Connection

Step 6: Replace the internal cover and back cover using previously removed retention screws.

3.6 AT/ATX Mode Selection

AT or ATX power mode can be used on the AFL2-10A-N28. The selection is made through an AT/ATX switch located on the bottom panel. To select AT mode or ATX mode, follow the steps below.

Step 1: Locate the AT/ATX switch on the bottom panel (**Figure 3-9**).



Figure 3-9: AT/ATX Switch Location

Step 2: Adjust the AT/ATX switch.

3.6.1 AT Power Mode

With the AT mode selected, the power is controlled by a central power unit rather than a power switch. The AFL2-10A-N28 panel PC turns on automatically when the power is connected. The AT mode benefits a production line to control multiple panel PCs from a central management center and other applications including:

- ATM
- Self-service kiosk
- Plant environment monitoring system
- Factory automation platform
- Manufacturing shop flow

3.6.2 ATX Power Mode

With the ATX mode selected, the AFL2-10A-N28 panel PC goes in a standby mode when it is turned off. The panel PC can be easily turned on via network or a power switch in standby mode. Remote power control is perfect for advertising applications since the

AFL2-10A-N28 Panel PC

broadcasting time for each panel PC can be set individually and controlled remotely. Other possible application includes

- Security surveillance
- Point-of-Sale (POS)
- Advertising terminal

3.7 Clear CMOS

If the AFL2-10A-N28 fails to boot due to improper BIOS settings, the clear CMOS switch clears the CMOS data and resets the system BIOS information. To do this, adjust the clear CMOS switch to clear CMOS mode for a few seconds then adjust the clear CMOS switch back to keep CMOS mode.

Step 1: Locate the clear CMOS switch on the bottom panel (**Figure 3-10**).



Figure 3-10: Clear CMOS Switch Location

Step 2: Adjust the clear CMOS switch.

3.8 Reset the System

The reset button enables user to reboot the system when the system is turned on. To reboot the system, follow the steps below.

Step 1: Locate the reset button on the bottom panel (**Figure 3-11**).



Figure 3-11: Reset Button Location

Step 2: Press the reset button.

3.9 Powering On the System

To power on the system, follow the steps below:

Step 1: Locate the **Function** and **Brightness Up** function keys. See **Section 1.2.1.2**.

Step 2: Hold down the Function and Brightness Up buttons for **six** seconds to power on the system.

3.10 Powering Off the System

To power off the system, follow the steps below:

Step 1: Locate the **Function** and **Brightness Up** function keys. See **Section 1.2.1.2**.

Step 2: Hold down the Function and Brightness Up buttons for **six** seconds to power off the system.

3.11 Mounting the System



WARNING:

When mounting the flat bezel panel PC onto an arm, onto the wall or onto a panel, it is better to have more than one person to help with the installation to make sure the panel PC does not fall down and get damaged.

The five methods of mounting the AFL2-10A-N28 are listed below.

- Wall mounting
- Panel mounting
- Rack mounting
- Arm mounting
- Stand mounting

AFL2-10A-N28 Panel PC

- V-Stand mounting

The five mounting methods are described below.

3.11.1 Wall Mounting

To mount the flat bezel panel PC onto the wall, please follow the steps below.

- Step 1:** Select the location on the wall for the wall-mounting bracket.
- Step 2:** Carefully mark the locations of the four screw holes in the bracket on the wall.
- Step 3:** Drill four pilot holes at the marked locations on the wall for the bracket retention screws.
- Step 4:** Align the wall-mounting bracket screw holes with the pilot holes.
- Step 5:** Secure the mounting-bracket to the wall by inserting the retention screws into the four pilot holes and tightening them (**Figure 3-12**).

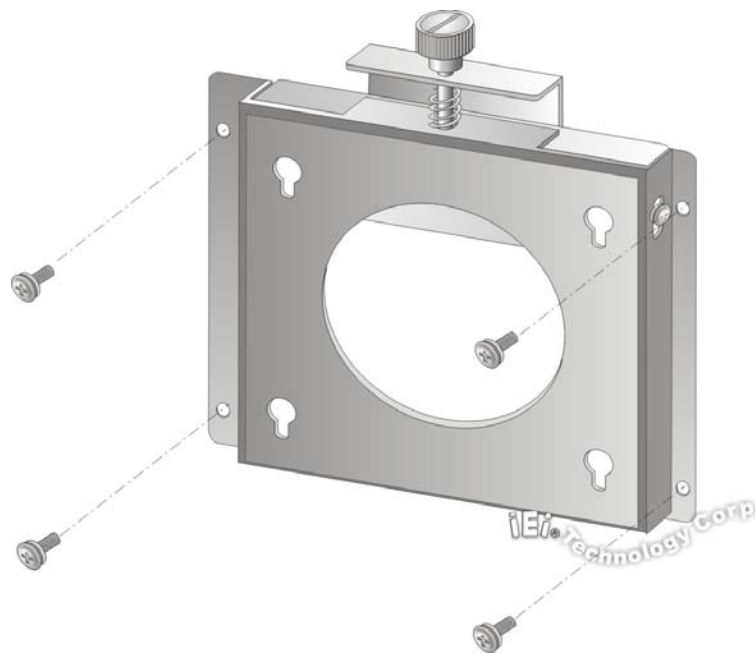

Figure 3-12: Wall-mounting Bracket

Step 6: Insert the four monitor mounting screws provided in the wall mount kit into the four screw holes on the rear panel of the flat bezel panel PC and tighten until the screw shank is secured against the rear panel (**Figure 3-13**).



WARNING:

Please use the M4 screws provided in the wall mount kit for the rear panel. If the screw is missing, the thread depth of the replacement screw should be not more than 4 mm.

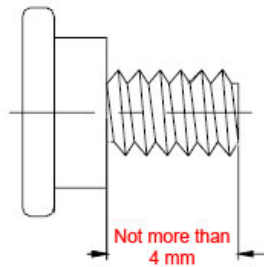

Step 7: Align the mounting screws on the monitor rear panel with the mounting holes on the bracket.

Step 8: Carefully insert the screws through the holes and gently pull the monitor downwards until the monitor rests securely in the slotted holes (**Figure 3-13**). Ensure that all four of the mounting screws fit snugly into their respective slotted holes.



NOTE:

In the diagram below the bracket is already installed on the wall.

AFL2-10A-N28 Panel PC

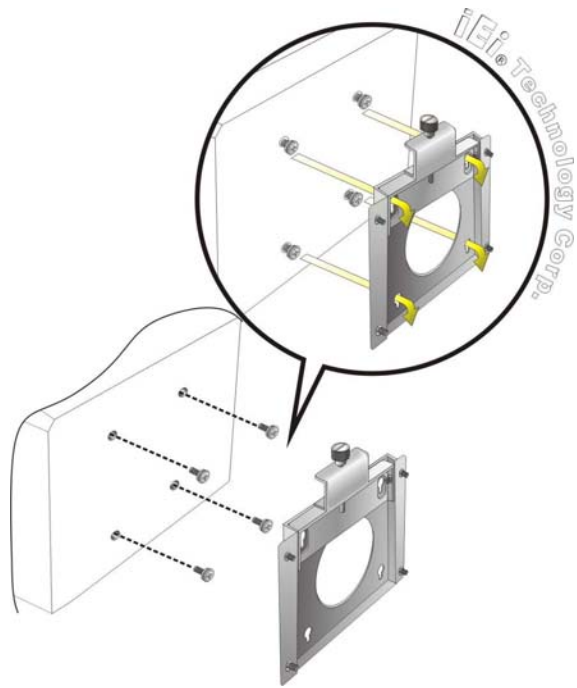

Figure 3-13: Chassis Support Screws

Step 9: Secure the panel PC by fastening the retention screw of the wall-mounting bracket. (Figure 3-14).

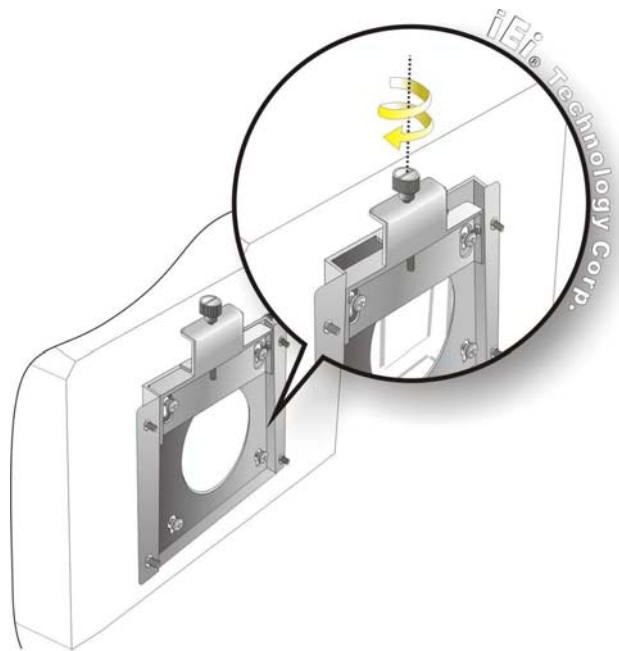

Figure 3-14: Secure the Panel PC

3.11.2 Panel Mounting

To mount the AFL2-10A-N28 flat bezel panel PC into a panel, please follow the steps below.

- Step 1:** Select the position on the panel to mount the flat bezel panel PC.
- Step 2:** Cut out a section corresponding to the size shown below. The size must be smaller than the outer edge.

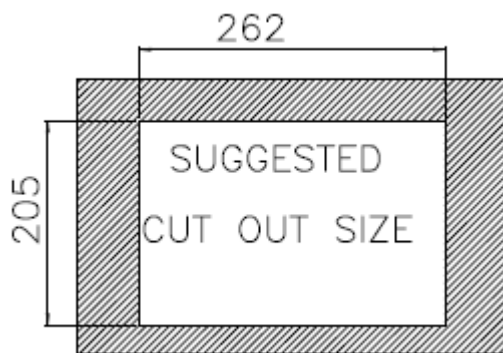

Figure 3-15: Cutout Dimensions

- Step 3:** Slide the flat bezel panel PC through the hole until the frame is flush against the panel.
- Step 4:** Align the panel mounting bracket screw holes with the VESA mounting holes on the rear of the panel PC.
- Step 5:** Secure the two panel mounting brackets to the rear of the panel PC by inserting the four retention screws into the VESA mounting holes (**Figure 3-16 ①**).
- Step 6:** Insert the panel mounting clamps into the holes of the panel mounting brackets (**Figure 3-16 ②**). There are a total of 4 panel mounting clamps for AFL2-10A-N28.

AFL2-10A-N28 Panel PC

- Step 7:** Tighten the screws that pass through the panel mounting clamps until the plastic caps at the front of all the screws are firmly secured to the panel.
- Step 8:** Install the covers into the panel mounting bracket. Each mounting bracket includes two side covers and one top cover (**Figure 3-16** ③).

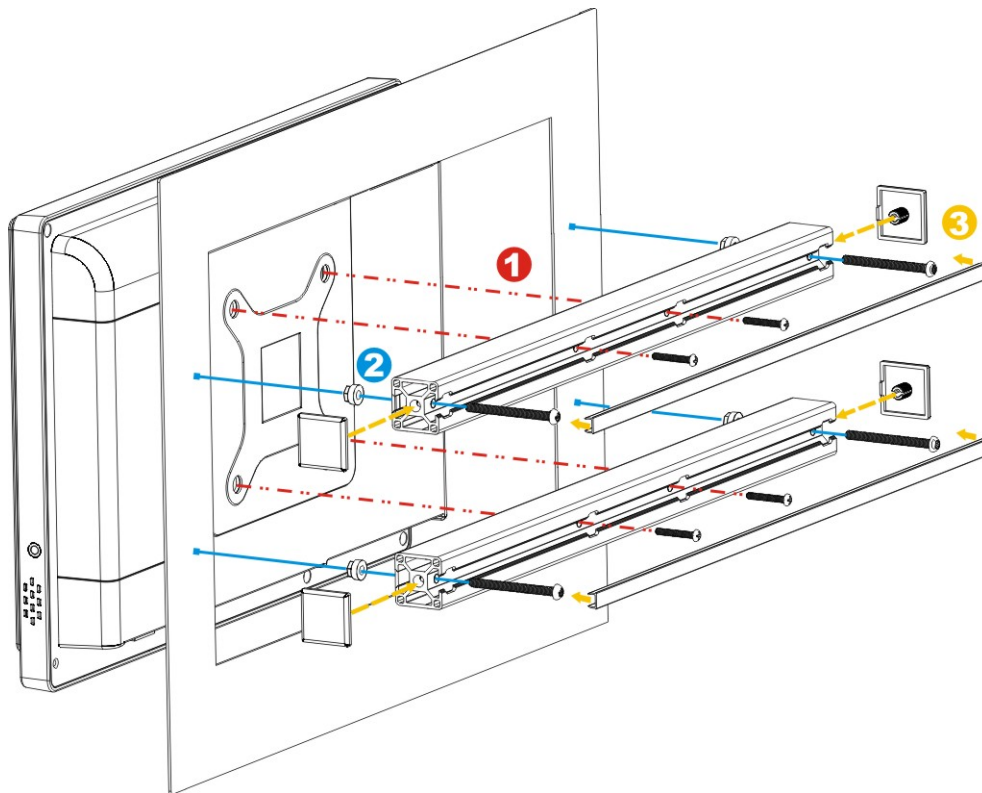

Figure 3-16: Tighten the Panel Mounting Clamp Screws

3.11.3 Cabinet and Rack Installation

The AFL2-10A-N28 flat bezel panel PC can be installed into a cabinet or rack. The installation procedures are similar to the panel mounting installation. To do this, please follow the steps below:

NOTE:

When purchasing the cabinet/rack installation bracket, make sure it is compatible with both the AFL2-10A-N28 flat bezel panel PC and the rack/cabinet into which the AFL2-10A-N28 is installed.

- Step 1:** Slide the rear chassis of the AFL2-10A-N28 flat bezel panel PC through the rack/cabinet bracket until the frame is flush against the front of the bracket (Figure 3-17).

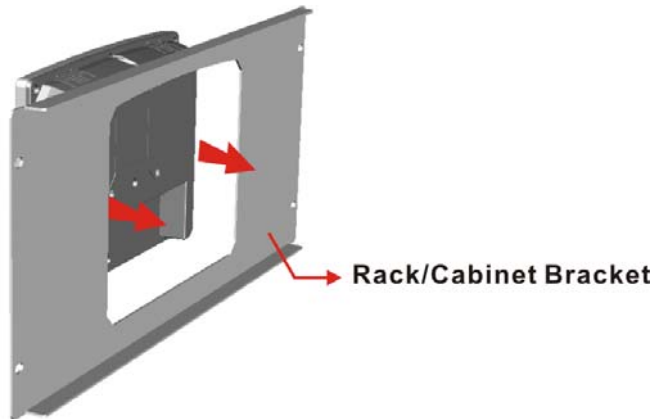

Figure 3-17: The Rack/Cabinet Bracket

- Step 2:** Align the panel mounting bracket screw holes with the VESA mounting holes on the rear of the panel PC.
- Step 3:** Secure the two rack mounting brackets to the rear of the panel PC by inserting the four retention screws into the VESA mounting holes (Figure 3-18 ①).
- Step 4:** Insert the rack mounting clamps into the holes of the rack mounting brackets (Figure 3-18 ②). There are a total of 4 rack mounting clamps for AFL2-10A-N28.
- Step 5:** Tighten the screws that pass through the rack mounting clamps until the plastic caps at the front of all the screws are firmly secured to the panel.

AFL2-10A-N28 Panel PC

Step 6: Install the covers into the rack mounting bracket. Each mounting bracket includes two side covers and one top cover (**Figure 3-18 ③**).

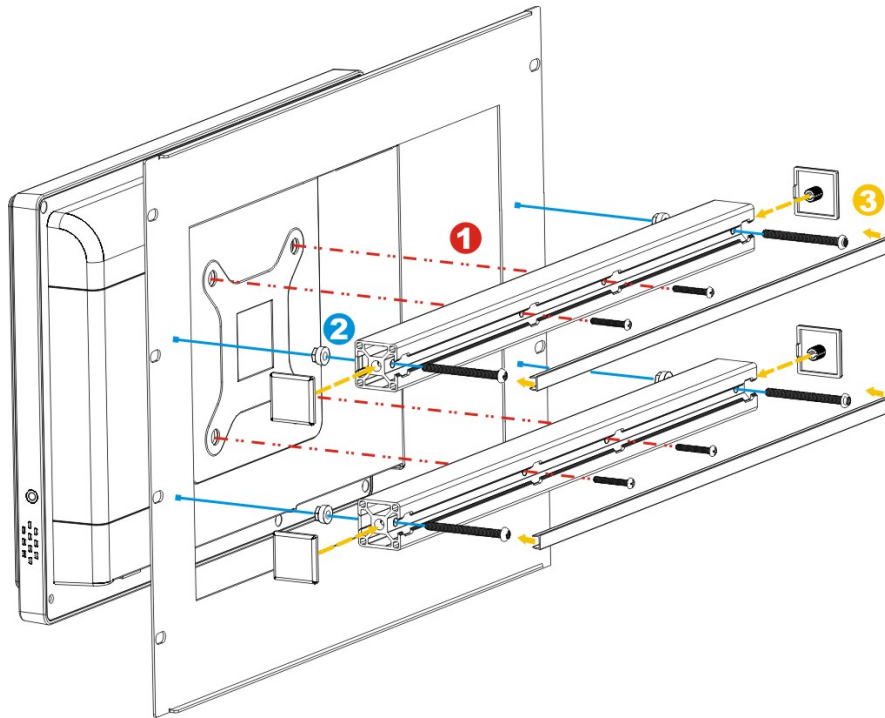

Figure 3-18: Secure the Rack/Cabinet Bracket

Step 7: Slide the flat bezel panel PC with the attached rack/cabinet bracket into a rack or cabinet (**Figure 3-19**).

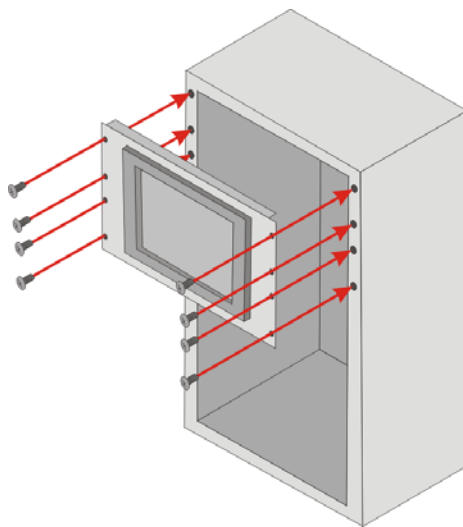

Figure 3-19: Install into a Rack/Cabinet

Step 8: Once the flat bezel panel PC with the attached rack/cabinet bracket has been properly inserted into the rack or cabinet, secure the front of the rack/cabinet bracket to the front of the rack or cabinet (**Figure 3-19**).

3.11.4 Arm Mounting

The AFL2-10A-N28 is VESA (Video Electronics Standards Association) compliant and can be mounted on an arm with a 75 mm interface pad. To mount the AFL2-10A-N28 on an arm, please follow the steps below.

Step 1: The arm is a separately purchased item. Please correctly mount the arm onto the surface it uses as a base. To do this, refer to the installation documentation that came with the mounting arm.



NOTE:

When purchasing the arm please ensure that it is VESA compliant and that the arm has a 75 mm interface pad. If the mounting arm is not VESA compliant it cannot be used to support the AFL2-10A-N28 flat bezel panel PC.

Step 2: Once the mounting arm has been firmly attached to the surface, lift the flat bezel panel PC onto the interface pad of the mounting arm.

Step 3: Align the retention screw holes on the mounting arm interface with those in the flat bezel panel PC (**Figure 3-20**).

AFL2-10A-N28 Panel PC

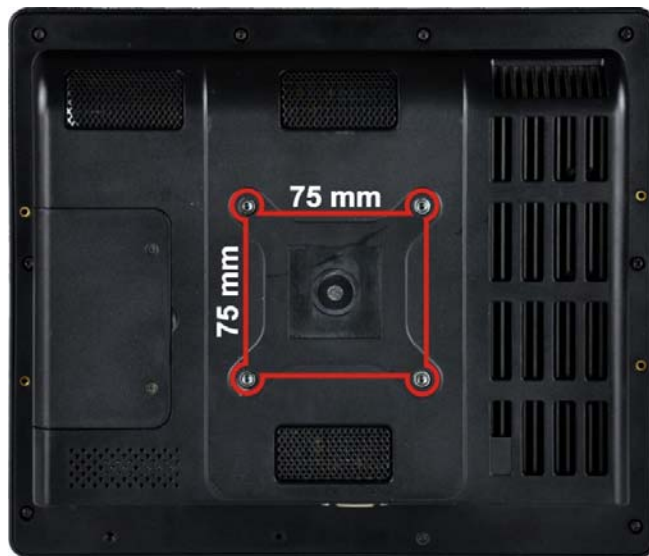

Figure 3-20: Arm Mounting Retention Screw Holes

Step 4: Secure the AFL2-10A-N28 to the interface pad by inserting four retention screws through the mounting arm interface pad and into the AFL2-10A-N28.

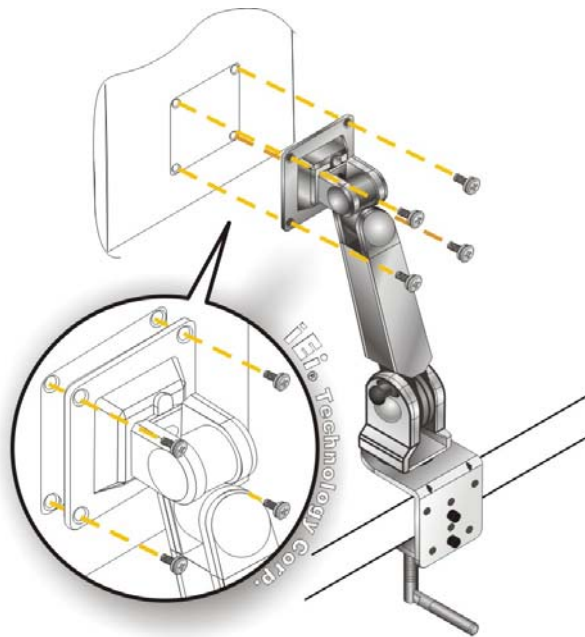

Figure 3-21: Arm Mounting

3.11.5 Stand Mounting

To mount the AFL2-10A-N28 using the stand mounting kit, please follow the steps below.

- Step 1:** Locate the screw holes on the rear of the AFL2-10A-N28. This is where the bracket will be attached.
- Step 2:** Align the bracket with the screw holes.
- Step 3:** To secure the bracket to the AFL2-10A-N28 insert the retention screws into the screw holes and tighten them.

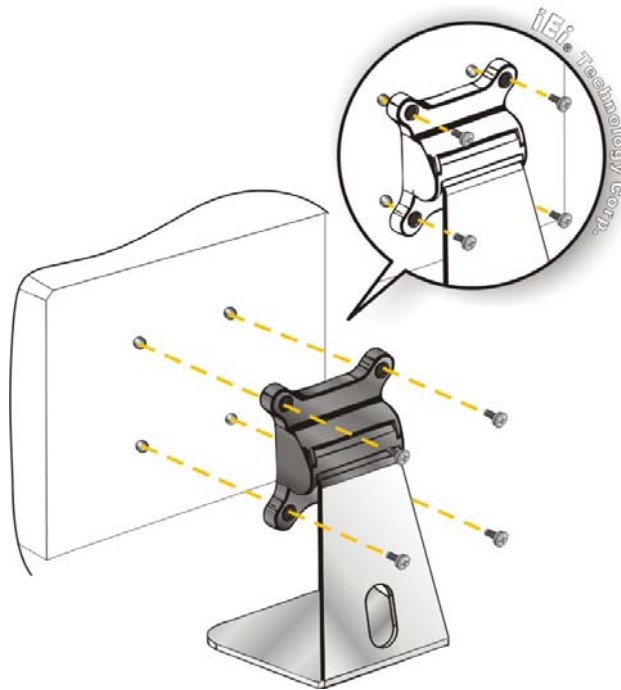

Figure 3-22: Stand Mounting (Stand-A/Bxx)

3.11.6 V-Stand Mounting

To mount the AFL2-10A-N28 using the V-Stand mounting kit, please follow the steps below.

- Step 1:** Carefully mark the locations of the four V-Stand screw holes on the mounting area. Drill four pilot holes at the marked locations for the V-Stand retention screws.

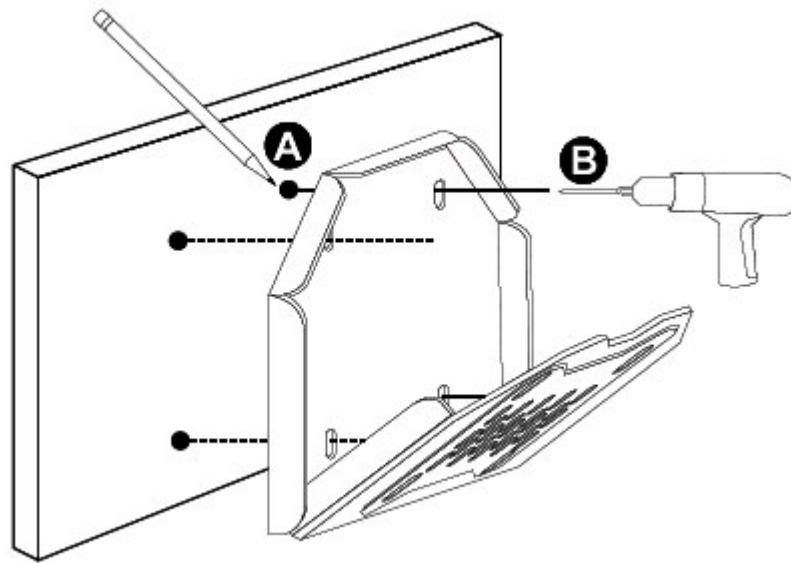

Figure 3-23: Drill Pilot Holes for V-Stand

- Step 2:** Align the screw holes on the V-Stand with the VESA mount screw holes on the system rear panel.
- Step 3:** Insert the four VESA mount screws into the four screw holes on the system rear panel. Adjust the V-Stand to a proper position.
- Step 4:** Tighten until the screw shank is secured against the rear panel.

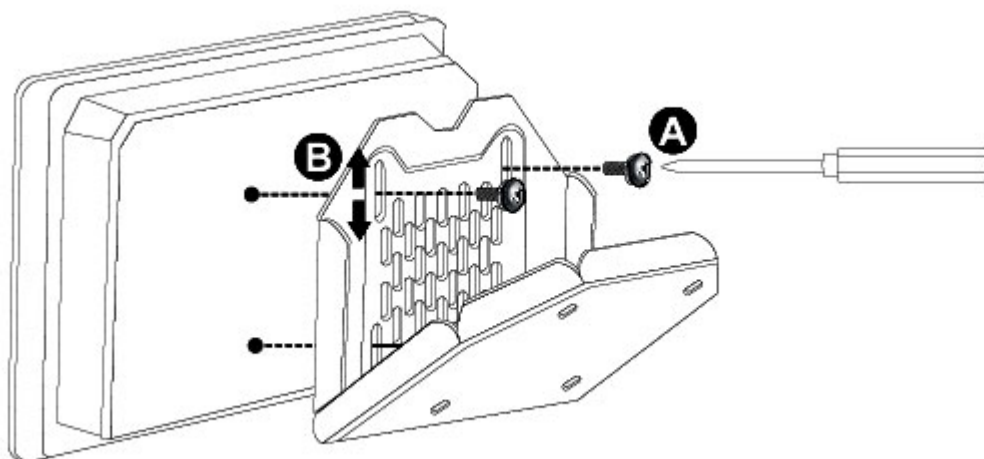

Figure 3-24: Secure System to V-Stand

Step 5: Align the V-Stand screw holes with the pilot holes on the mounting area. Mount the V-Stand by inserting the retention screws into the four pilot holes and tightening them.

Step 6: Adjust the V-Stand to have a best viewing angle to operate the system.

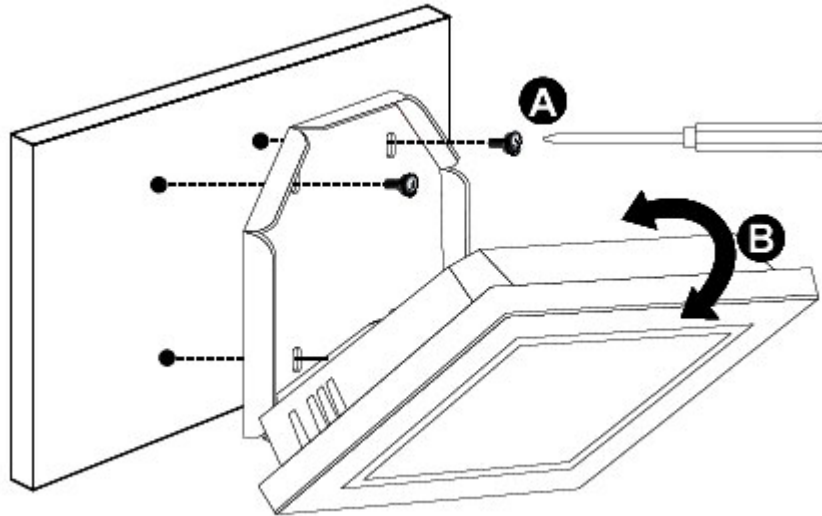

Figure 3-25: Secure V-Stand to Mounting Area

3.12 External Peripheral Device Connection

The following external peripheral devices can be connected to the external peripheral interface connectors.

- Audio devices
- HDMI devices
- RJ-45 Ethernet cable connector
- Serial port devices
- USB devices
- VGA monitor

To install these devices, connect the corresponding cable connector from the actual device to the corresponding AFL2-10A-N28 external peripheral interface connector making sure the pins are properly aligned.

AFL2-10A-N28 Panel PC

3.12.1 Audio Connection

The audio jack on the external audio connector enables the AFL2-10A-N28 to be connected to a stereo sound setup. To install the audio devices, follow the steps below.

Step 1: Identify the audio plugs. The plugs on your home theater system or speakers may not match the colors on the rear panel. If audio plugs are plugged into the wrong jacks, sound quality will be very bad.

Step 2: Plug the audio plug into the audio jack. Plug the audio plug into the audio jack. If the plug on your speakers is different, an adapter will need to be used to plug them into the audio jack. The audio jack on the AFL2-10A-N28 is a line-out port which connects to a headphone or a speaker.

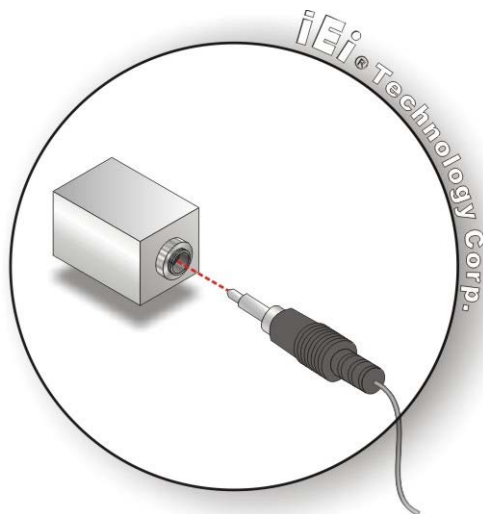

Figure 3-26: Audio Connector

Step 3: Check audio clarity. Check that the sound is coming through the right speakers by adjusting the balance front to rear and left to right.

3.12.2 DisplayPort Connection

The DisplayPort connector transmits a digital signal to compatible DisplayPort display devices such as a TV or computer screen. To connect the DisplayPort cable to the AFL2-10A-N28, follow the steps below.

Step 1: Locate the DisplayPort connector. The location is shown in **Chapter 3**.

Step 2: Align the connector. Align the DisplayPort connector with the DisplayPort port. Make sure the orientation of the connector is correct.

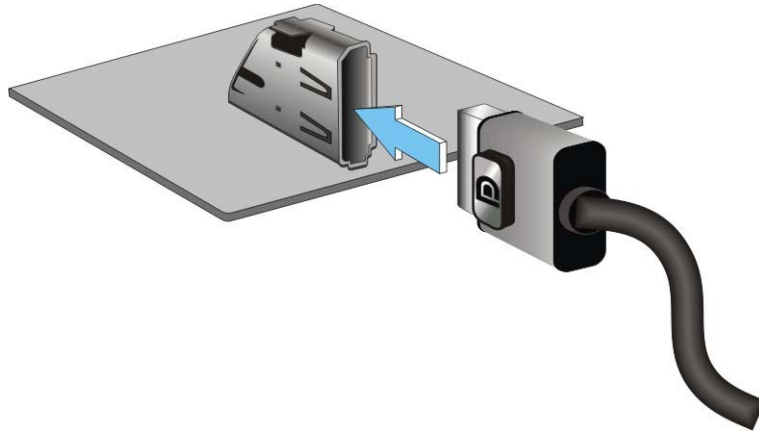

Figure 3-27: DisplayPort Connection

Step 3: Insert the DisplayPort connector. Gently insert the DisplayPort connector. The connector should engage with a gentle push. If the connector does not insert easily, check again that the connector is aligned correctly, and that the connector is being inserted with the right way up.

3.12.3 LAN Connection

There is one external RJ-45 LAN connectors. The RJ-45 connector enables connection to an external network. To connect a LAN cable with an RJ-45 connector, please follow the instructions below.

Step 1: Locate the RJ-45 connector. The location of the LAN connector is shown in **Chapter 1**.

Step 2: Align the connectors. Align the RJ-45 connector on the LAN cable with the RJ-45 connectors on the AFL2-10A-N28. See **Figure 3-28**.

AFL2-10A-N28 Panel PC

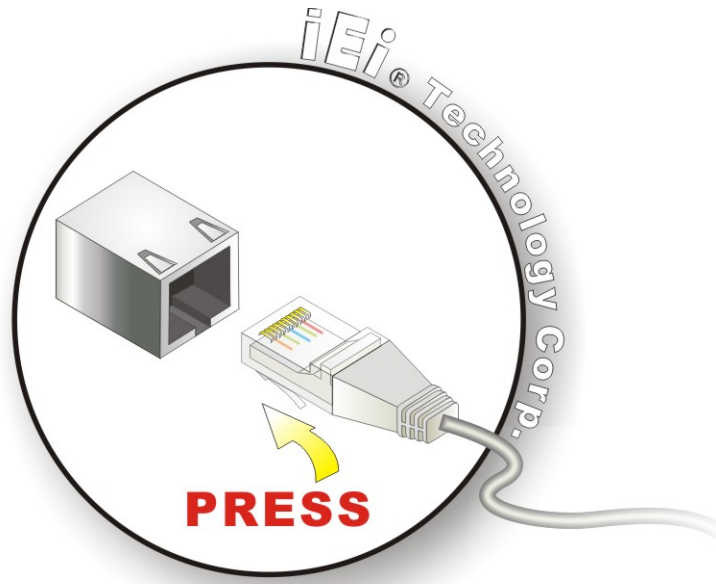

Figure 3-28: LAN Connection

Step 3: Insert the LAN cable RJ-45 connector. Once aligned, gently insert the LAN cable RJ-45 connector into the external interface.

3.12.4 Serial Device Connection

There are two external RS-232 connectors (one by DB-9 and one by RJ-45) and one RS-422/485 RJ-45 connector for serial device connection. Follow the steps below to connect a serial device to the AFL2-10A-N28.

3.12.4.1 DB-9 Serial Port Connection

Follow the steps below to connect a serial device to the DB-9 connector of the AFL2-10A-N28 panel PC.

Step 1: Locate the DB-9 connector. The location of the DB-9 connectors is shown in Chapter 1.

Step 2: Insert the serial connector. Insert the DB-9 connector of a serial device into the DB-9 connector on the bottom panel. See **Figure 3-29**.

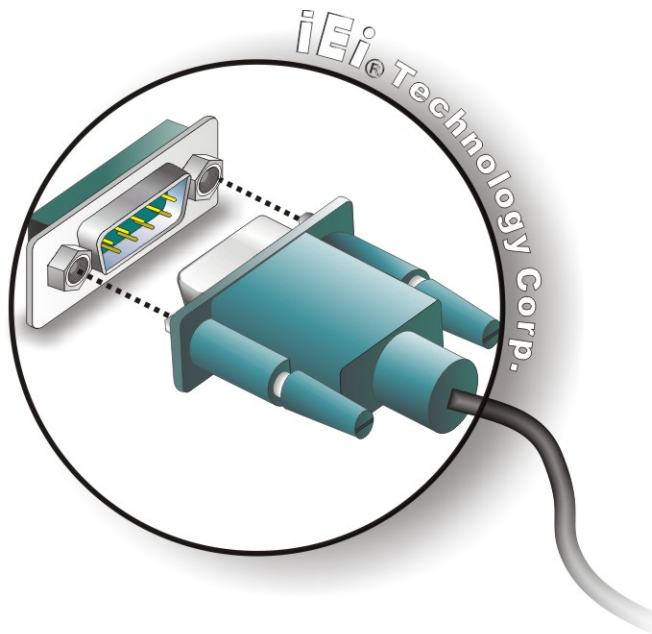

Figure 3-29: DB-9 Serial Port Connector

Step 3: **Secure the connector.** Secure the serial device connector to the external interface by tightening the two retention screws on either side of the connector.

3.12.4.2 RJ-45 Serial Port Connection

Follow the steps below to connect a serial device to the RJ-45 serial port connector of the AFL2-10A-N28 panel PC.

Step 1: **Locate the RJ-45 serial port.** The location of the RJ-45 serial port is shown in Chapter 1.

Step 2: **Connect the RJ-45 to COM port cable to the panel PC.** Insert the RJ-45 connector end of cable into the RJ-45 serial port. See **Figure 3-30**.

Step 3: **Connect the serial device.** Connect a serial device to the DB-9 connector end of the cable. See **Figure 3-30**.

AFL2-10A-N28 Panel PC

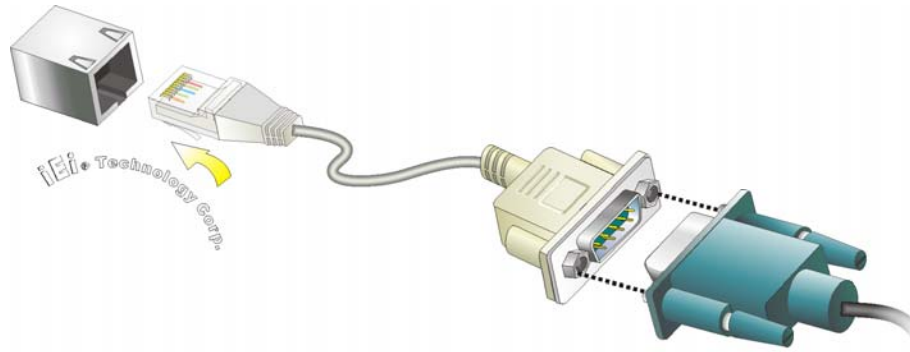

Figure 3-30: RJ-45 Serial Port Connector

Step 4: Secure the connector. Secure the serial device connector to the external interface by tightening the two retention screws on either side of the connector.

The DB-9 connector pinouts are listed below.

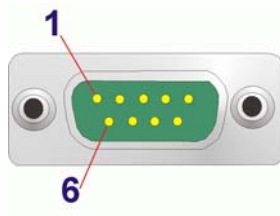

Figure 3-31: DB-9 Connector Pinout Locations

PIN NO.	RS-232	RS-422	RS-485
1	DCD	RX+	-
2	RX	RX-	-
3	TX	TX+	DATA+
4	DTR	TX-	DATA-
5	GND	-	-
6	DSR	-	-
7	RTS	-	-
8	CTS	-	-
9	RI	-	-

Table 3-1: DB-9 Connector Pinout

3.12.5 USB Device Connection

**NOTE:**

User must install the USB 3.0 driver before connecting a USB device to the system or else the system may not recognize the connected device.

There are two USB 2.0 connectors and two USB 3.0 connectors on the AFL2-10A-N28. To connect a USB device, please follow the instructions below.

Step 1: Locate the USB connectors. The locations of the USB connectors are shown in **Chapter 1**.

Step 2: Align the connectors. Align the USB device connector with one of the connectors on the AFL2-10A-N28. See **Figure 3-32**.

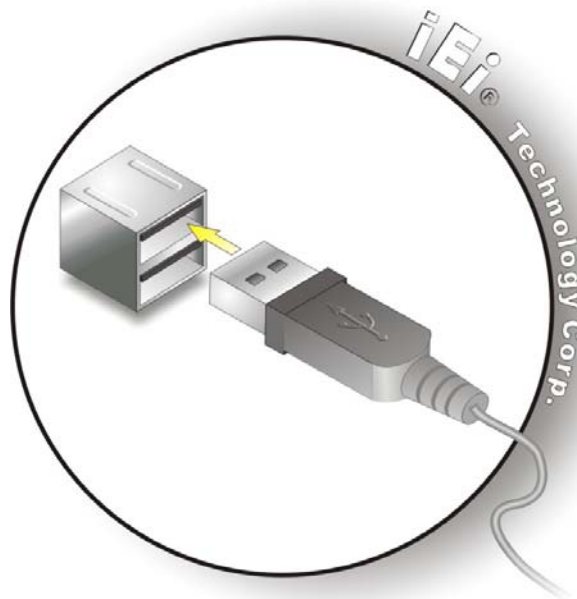

Figure 3-32: USB Device Connection

Step 3: Insert the device connector. Once aligned, gently insert the USB device connector into the onboard connector.

Chapter

4

BIOS Setup

4.1 Introduction

A licensed copy of the BIOS is preprogrammed into the ROM BIOS. The BIOS setup program allows users to modify the basic system configuration. This chapter describes how to access the BIOS setup program and the configuration options that may be changed.

4.1.1 Starting Setup

The UEFI BIOS is activated when the computer is turned on. The setup program can be activated in one of two ways.

1. Press the **DEL** or **F2** key as soon as the system is turned on or
2. Press the **DEL** or **F2** key when the “**Press DEL or F2 to enter SETUP**” message appears on the screen.

If the message disappears before the **DEL** or **F2** key is pressed, restart the computer and try again.

4.1.2 Using Setup

Use the arrow keys to highlight items, press **ENTER** to select, use the PageUp and PageDown keys to change entries, press **F1** for help and press **ESC** to quit. Navigation keys are shown in the following table.

Key	Function
Up arrow	Move to the item above
Down arrow	Move to the item below
Left arrow	Move to the item on the left hand side
Right arrow	Move to the item on the right hand side
+	Increase the numeric value or make changes
-	Decrease the numeric value or make changes
F1 key	General help, only for Status Page Setup Menu and Option Page Setup Menu

AFL2-10A-N28 Panel PC

F2 key	Load previous values.
F3 key	Load optimized defaults
F4 key	Save changes and Exit BIOS
Esc key	Main Menu – Quit and do not save changes into CMOS Status Page Setup Menu and Option Page Setup Menu -- Exit current page and return to Main Menu

Table 6-1: BIOS Navigation Keys

4.1.3 Getting Help

When **F1** is pressed a small help window describing the appropriate keys to use and the possible selections for the highlighted item appears. To exit the Help Window press **Esc** or the **F1** key again.

4.1.4 Unable to Reboot after Configuration Changes

If the computer cannot boot after changes to the system configuration are made, CMOS defaults.

4.1.5 BIOS Menu Bar

The **menu bar** on top of the BIOS screen has the following main items:

- Main – Changes the basic system configuration.
- Advanced – Changes the advanced system settings.
- Chipset – Changes the chipset settings.
- Boot – Changes the system boot configuration.
- Security – Sets User and Supervisor Passwords.
- Save & Exit – Selects exit options and loads default settings

The following sections completely describe the configuration options found in the menu items at the top of the BIOS screen and listed above.

4.2 Main

The **Main** BIOS menu (**BIOS Menu 1**) appears when the **BIOS Setup** program is entered. The **Main** menu gives an overview of the basic system information.

```

Aptio Setup Utility - Copyright (C) 2011 American Megatrends, Inc.
Main  Advanced  Chipset  Boot  Security  Save & Exit

BIOS Information
BIOS Vendor                American Megatrends
Core Version               4.6.5.3 0.16
Compliancy                 UEFI 2.3; PI 1.2
Project Version            SE25AR12.ROM
Build Date and Time        11/01/2012 14:50:49
-----
iWDD Vendor                ICP
iWDD Version               SE25ER12.bin
-----
System Date                [Fri 01/01/2010]
System Time                [13:16:27]
-----
Access Level               Administrator

Set the Date. Use Tab to
switch between Data
elements.

<->: Select Screen
^ v: Select Item
EnterSelect
+/-: Change Opt.
F1:  General Help
F2:  Previous Values
F3:  Optimized Defaults
F4:  Save & Exit
ESC: Exit

Version 2.14.1219. Copyright (C) 2011 American Megatrends, Inc.

```

BIOS Menu 1: Main

→ BIOS Information

The **BIOS Information** lists a brief summary of the BIOS. The fields in **BIOS Information** cannot be changed. The items shown in the system overview include:

- **BIOS Vendor:** Installed BIOS vendor
- **Core Version:** Current BIOS version
- **Compliancy:** Current compliant version
- **Project Version:** the board version
- **Build Date and Time:** Date the current BIOS version was made

→ iWDD Vendor

- The **iWDD Vendor** displays the installed iWDD vendor. The fields in **iWDD Vendor** cannot be changed.

AFL2-10A-N28 Panel PC

→ iWDD Version

- The **iWDD Version** displays the current iWDD version. The fields in **iWDD Version** cannot be changed.

→ System Date [xx/xx/xx]

Use the **System Date** option to set the system date. Manually enter the day, month and year.

→ System Time [xx:xx:xx]

Use the **System Time** option to set the system time. Manually enter the hours, minutes and seconds.

4.3 Advanced

Use the **Advanced** menu (**BIOS Menu 2**) to configure the CPU and peripheral devices through the following sub-menus:



WARNING:

Setting the wrong values in the sections below may cause the system to malfunction. Make sure that the settings made are compatible with the hardware.

- ACPI Settings
- RTC Wake Settings
- CPU Configuration
- SATA Configuration
- USB Configuration
- F81866 Super IO Configuration
- H/W Monitor
- Serial Port Console Redirection
- iEi Feature

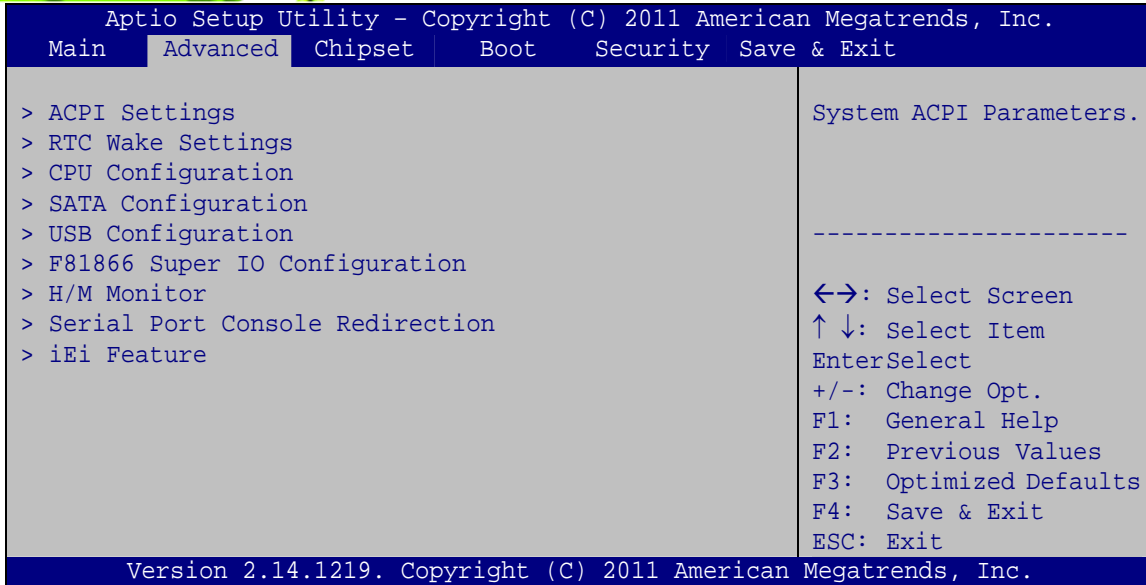

BIOS Menu 2: Advanced

4.3.1 ACPI Settings

The **ACPI Settings** menu (**BIOS Menu 3**) configures the Advanced Configuration and Power Interface (ACPI) options.

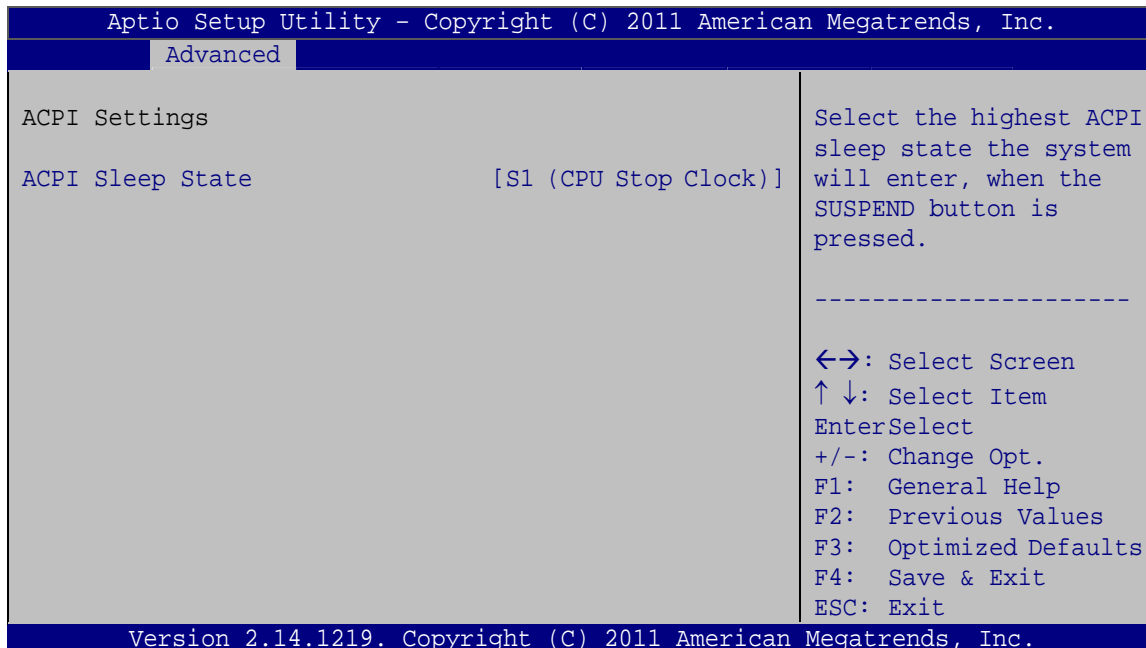

BIOS Menu 3: ACPI Configuration

AFL2-10A-N28 Panel PC

→ ACPI Sleep State [S1 (CPU Stop Clock)]

Use the **ACPI Sleep State** option to specify the sleep state the system enters when it is not being used.

- **S1 (CPU Stop Clock)** **DEFAULT** The system enters S1 (POS) sleep state. The system appears off. The CPU is stopped; RAM is refreshed; the system is running in a low power mode.
- **S3 (Suspend to RAM)** The caches are flushed and the CPU is powered off. Power to the RAM is maintained. The computer returns slower to a working state, but more power is saved.

4.3.2 RTC Wake Settings

The **RTC Wake Settings** menu (**BIOS Menu 4**) configures RTC wake event.

```

Aptio Setup Utility - Copyright (C) 2011 American Megatrends, Inc.
  Advanced
Wake system with Fixed Time      [Disabled]
Enable or disable System
wake on alarm event. When
enabled, System will
wake on the
dat::hr::min::sec
specified

-----
←→: Select Screen
↑↓: Select Item
Enter>Select
F1   General Help
F2   Previous Values
F3   Optimized Defaults
F4   Save
ESC  Exit

Version 2.14.1219. Copyright (C) 2011 American Megatrends, Inc.
  
```

BIOS Menu 4: RTC Wake Settings

→ Wake System with Fixed Time [Disabled]

Use the **Wake System with Fixed Time** option to specify the time the system should be roused from a suspended state.

- Disabled** **DEFAULT** The real time clock (RTC) cannot generate a wake event

- Enabled** If selected, the following appears with values that can be selected:
 - *Wake up every day
 - *Wake up date
 - *Wake up hour
 - *Wake up minute
 - *Wake up secondAfter setting the alarm, the computer turns itself on from a suspend state when the alarm goes off.

4.3.3 CPU Configuration

Use the **CPU Configuration (BIOS Menu 5)** to view detailed CPU specifications and configure the CPU.

AFL2-10A-N28 Panel PC

Aptio Setup Utility - Copyright (C) 2011 American Megatrends, Inc.		
Advanced		
CPU Configuration		Enabled for Windows XP and Linux (OS optimized for Hyper-Threading Technology) and Disabled for other OS (OS not optimized for Hyper-Threading Technology).
Processor Type	Intel(R) Atom(TM) CPU N2800 @ 1.86GHz	
EMT64	Supported	
Processor Speed	1865 MHz	
System Bus Speed	533 MHz	
Ratio Status	14	
Actual Ratio	14	
System Bus Speed	533 MHz	
Processor Stepping	30661	←→: Select Screen
Microcode Revision	268	↑ ↓: Select Item
L1 Cache RAM	2x56 k	Enter>Select
L2 Cache RAM	2x512 k	+/-: Change Opt.
Processor Core	Dual	F1: General Help
Hyper-Threading	Supported	F2: Previous Values
		F3: Optimized Defaults
		F4: Save & Exit
		ESC: Exit
Hyper Threading	[Enabled]	
Version 2.14.1219. Copyright (C) 2011 American Megatrends, Inc.		

BIOS Menu 5: CPU Configuration

The CPU Configuration menu (**BIOS Menu 6**) lists the following CPU details:

- Processor Type: Lists the brand name of the CPU being used
- EMT64: Indicates if EM64T is supported by the CPU.
- Processor Speed: Lists the CPU processing speed
- System Bus Speed: Lists the system bus speed
- Ratio Status: Lists the ratio status
- Actual Ratio: Lists the actual ratio
- Processor Stepping: Lists the CPU processing stepping
- Microcode Revision: Lists the microcode revision
- L1 Cache RAM: Lists the amount of storage space on the L1 Cache
- L2 Cache RAM: Lists the amount of storage space on the L2 Cache
- Processor Core: Lists the number of the processor cores
- Hyper-Threading: Indicates if Hyper-Threading is supported by the CPU.

→ Hyper-Threading [Enabled]

Use the **Hyper-Threading** option to enable or disable Hyper-Threading Technology on the system.

- ➔ **Disabled** Disables Hyper-Threading Technology
- ➔ **Enabled** **DEFAULT** Enables Hyper-Threading Technology

4.3.4 SATA Configuration

Use the **SATA Configuration** menu (**BIOS Menu 6**) to change and/or set the configuration of the SATA devices installed in the system.

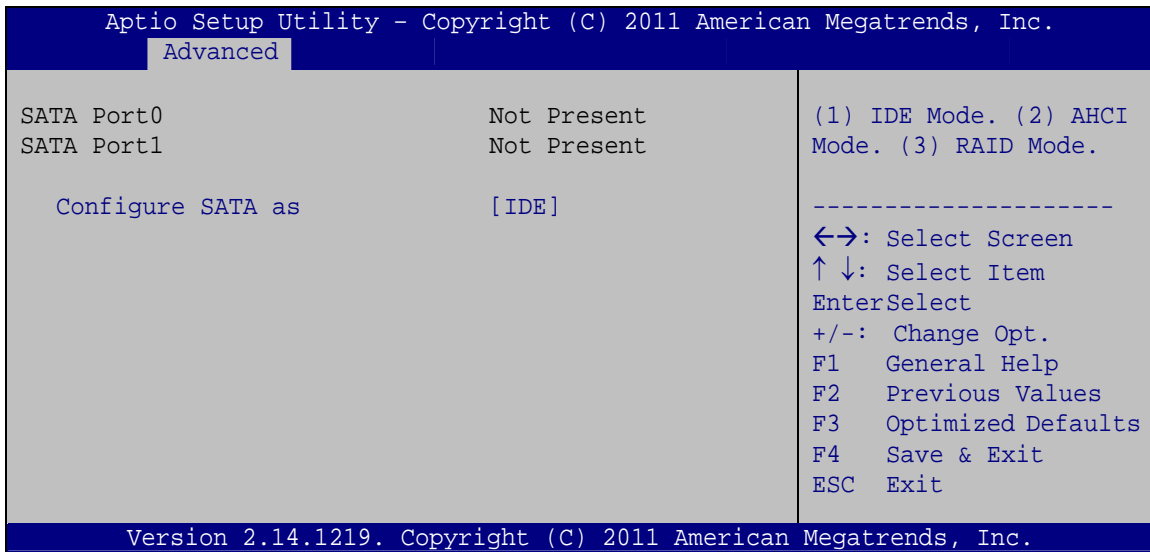

BIOS Menu 6: SATA Configuration

➔ **Configure SATA as [IDE]**

Use the **Configure SATA as** option to configure SATA devices as normal IDE devices.

- ➔ **IDE** **DEFAULT** Configures SATA devices as normal IDE device.
- ➔ **AHCI** The SATA drive connected to the nth SATA drive port is specified as a normal SATA drive.

AFL2-10A-N28 Panel PC

4.3.5 USB Configuration

Use the **USB Configuration** menu (**BIOS Menu 7**) to read USB configuration information and configure the USB settings.

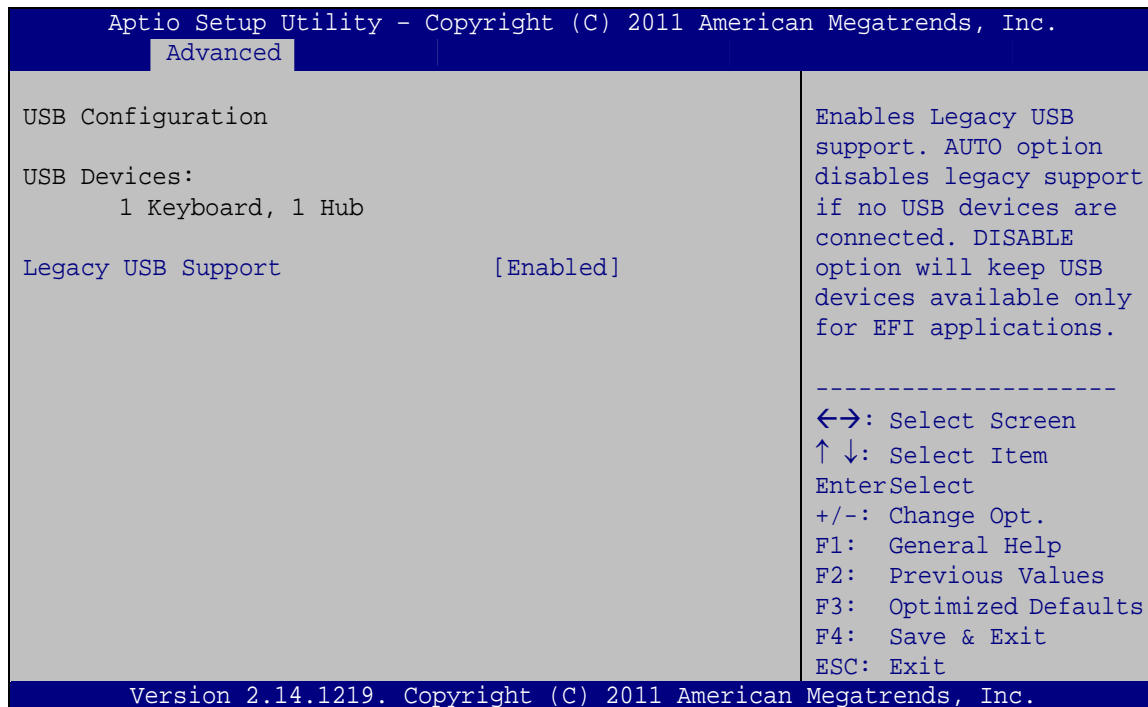

BIOS Menu 7: USB Configuration

→ USB Devices

The **USB Devices Enabled** field lists the USB devices that are enabled on the system

→ Legacy USB Support [Enabled]

Use the **Legacy USB Support** BIOS option to enable USB mouse and USB keyboard support. Normally if this option is not enabled, any attached USB mouse or USB keyboard does not become available until a USB compatible operating system is fully booted with all USB drivers loaded. When this option is enabled, any attached USB mouse or USB keyboard can control the system even when there is no USB driver loaded onto the system.

→ **Enabled** **DEFAULT** Legacy USB support enabled

- ➔ **Disabled** Legacy USB support disabled
- ➔ **Auto** Legacy USB support disabled if no USB devices are connected

4.3.6 F81866 Super IO Configuration

Use the **F81866 Super IO Configuration** menu (**BIOS Menu 8**) to set or change the configurations for the serial ports.

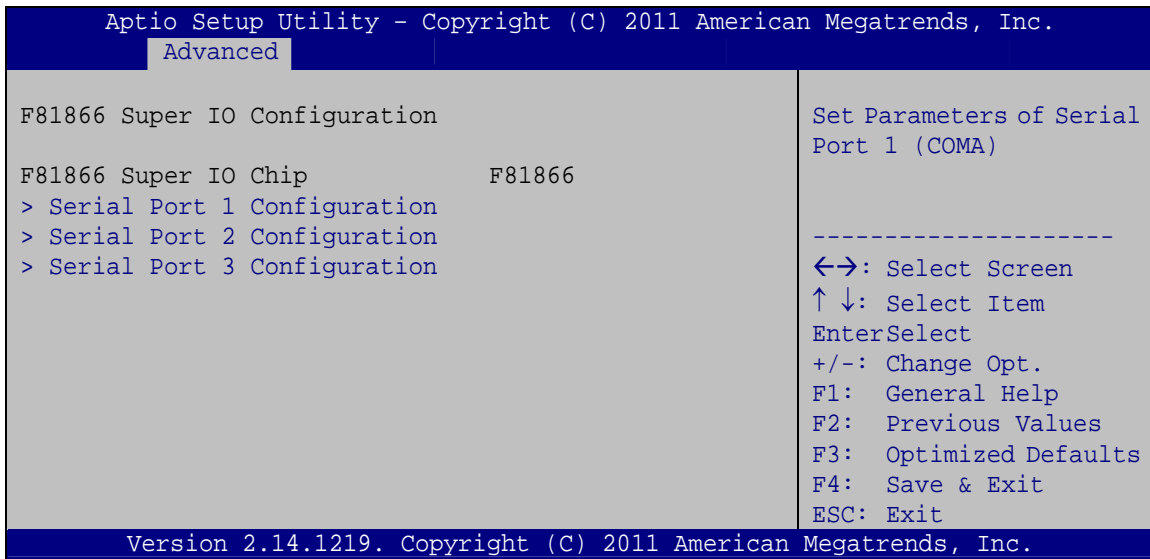

BIOS Menu 8: Super IO Configuration

AFL2-10A-N28 Panel PC

4.3.6.1 Serial Port n Configuration

Use the **Serial Port n Configuration** menu (**BIOS Menu 9**) to configure the serial port n.

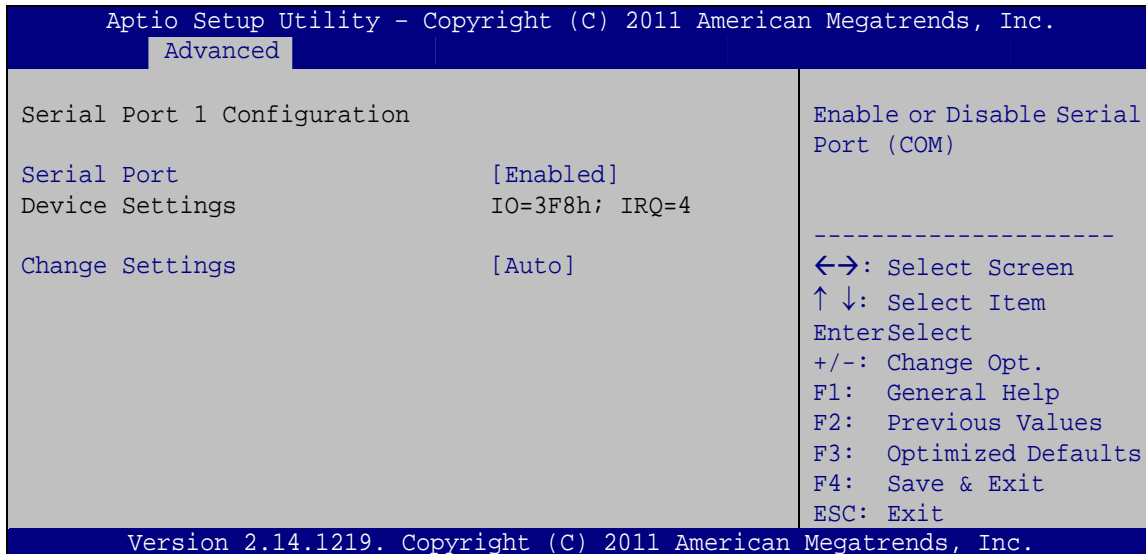

BIOS Menu 9: Serial Port n Configuration Menu

4.3.6.1.1 Serial Port 1 Configuration

→ Serial Port [Enabled]

Use the **Serial Port** option to enable or disable the serial port.

- **Disabled** Disable the serial port
- **Enabled** **DEFAULT** Enable the serial port

→ Change Settings [Auto]

Use the **Change Settings** option to change the serial port IO port address and interrupt address.

- **Auto** **DEFAULT** The serial port IO port address and interrupt address are automatically detected.
- **IO=3F8h; IRQ=4** Serial Port I/O port address is 3F8h and the interrupt address is IRQ4

→ IO=2F8h; IRQ=3

Serial Port I/O port address is 2F8h and the interrupt address is IRQ3

4.3.6.1.2 Serial Port 2 Configuration

→ Serial Port [Enabled]

Use the **Serial Port** option to enable or disable the serial port.

→ Disabled Disable the serial port

→ Enabled **DEFAULT** Enable the serial port

→ Change Settings [Auto]

Use the **Change Settings** option to change the serial port IO port address and interrupt address.

→ Auto **DEFAULT** The serial port IO port address and interrupt address are automatically detected.

→ IO=2F8h; IRQ=3 Serial Port I/O port address is 2F8h and the interrupt address is IRQ3

→ IO=3F8h; IRQ=4 Serial Port I/O port address is 3F8h and the interrupt address is IRQ4

→ Device Mode [RS422/485]

Use the **Device Mode** option to select the serial port mode.

→ RS422/485 **DEFAULT** Enables serial port RS-422/485 support.

4.3.6.1.3 Serial Port 3 Configuration

→ Serial Port [Enabled]

Use the **Serial Port** option to enable or disable the serial port.

AFL2-10A-N28 Panel PC

- ➔ **Disabled** Disable the serial port
- ➔ **Enabled** **DEFAULT** Enable the serial port

➔ **Change Settings [Auto]**

Use the **Change Settings** option to change the serial port IO port address and interrupt address.

- ➔ **Auto** **DEFAULT** The serial port IO port address and interrupt address are automatically detected.
- ➔ **IO=3E8h; IRQ=10** Serial Port I/O port address is 3E8h and the interrupt address is IRQ10
- ➔ **IO=3E8h;
IRQ=10,11** Serial Port I/O port address is 3E8h and the interrupt address is IRQ10, 11
- ➔ **IO=2E8h;
IRQ=10,11** Serial Port I/O port address is 2E8h and the interrupt address is IRQ10, 11
- ➔ **IO=2F0h;
IRQ=10,11** Serial Port I/O port address is 2F0h and the interrupt address is IRQ10, 11
- ➔ **IO=2E0h;
IRQ=10,11** Serial Port I/O port address is 2E0h and the interrupt address is IRQ10, 11

4.3.7 H/W Monitor

The H/W Monitor menu (**BIOS Menu 10**) shows the operating temperature.

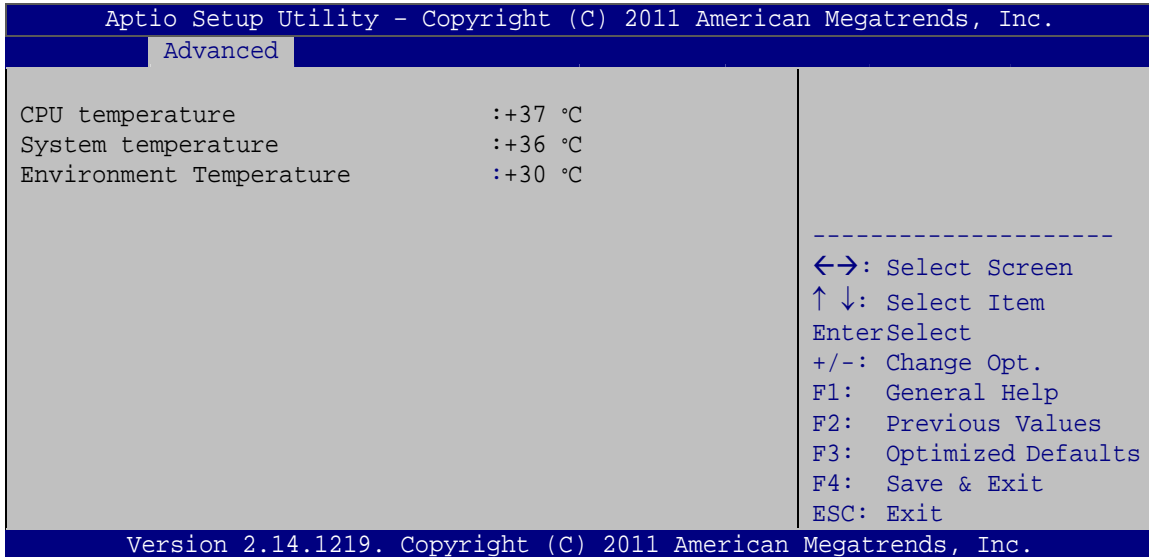

BIOS Menu 10: Hardware Health Configuration

→ Hardware Health Status

The following system parameters and values are shown. The system parameters that are monitored are:

- CPU Temperature
- System Temperature
- Environment Temperature

4.3.8 Serial Port Console Redirection

The **Serial Port Console Redirection** menu (**BIOS Menu 14**) allows the console redirection options to be configured. Console redirection allows users to maintain a system remotely by re-directing keyboard input and text output through the serial port.

AFL2-10A-N28 Panel PC

```

Aptio Setup Utility - Copyright (C) 2011 American Megatrends, Inc.
  Advanced
COM1
Console Redirection          [Disabled]      Console Redirection
> Console Redirection Settings          Enable or Disable.

COM3
Console Redirection          [Disabled]
> Console Redirection Settings

-----
<->: Select Screen
↑ ↓: Select Item
Enter>Select
+/-: Change Opt.
F1:  General Help
F2:  Previous Values
F3:  Optimized Defaults
F4:  Save & Exit
ESC: Exit

Version 2.14.1219. Copyright (C) 2011 American Megatrends, Inc.
  
```

BIOS Menu 11: Serial Port Console Redirection

→ Console Redirection [Disabled]

Use **Console Redirection** option to enable or disable the console redirection function.

- **Disabled** **DEFAULT** Disabled the console redirection function
- **Enabled** Enabled the console redirection function

4.4 iEi Feature

Use the **iEi Feature** menu (**BIOS Menu 15**) to configure the auto recovery function.

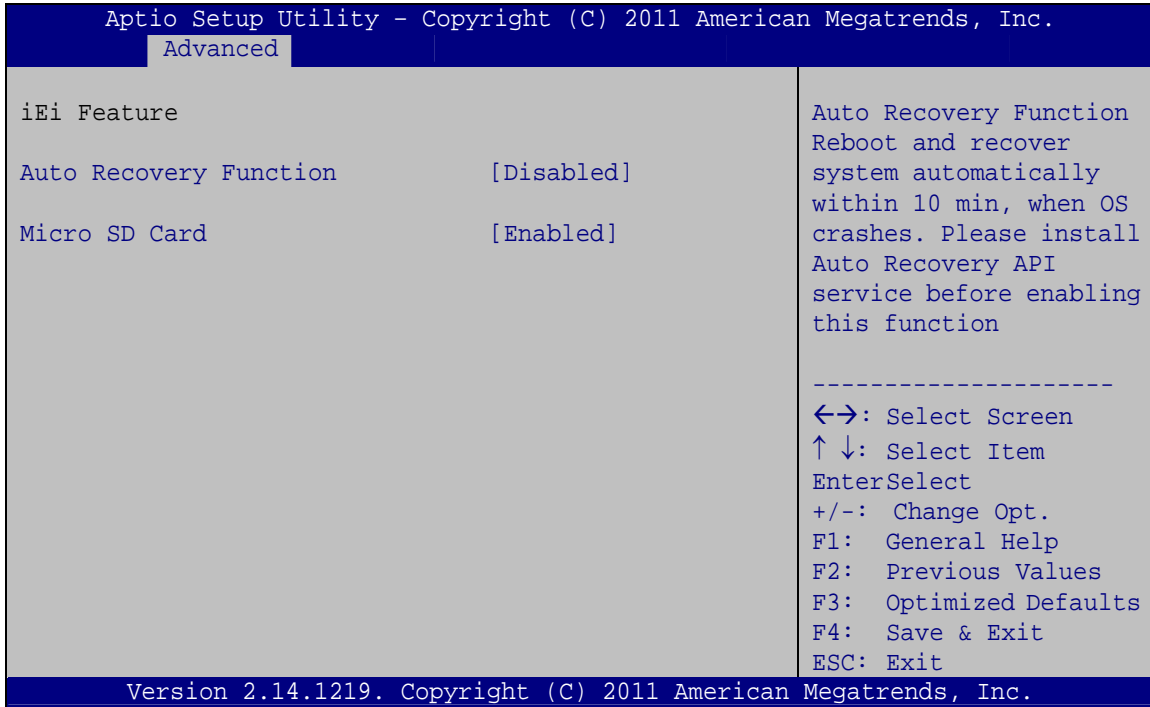

BIOS Menu 12: iEi Feature

→ Auto Recovery Function [Disabled]

Use the **Auto Recovery Function** option to enable or disable auto recovery on the system.

- **Disabled** **DEFAULT** Auto Recovery Function support disabled
- **Enabled** Auto Recovery Function support enabled

→ Micro SD Card [Enabled]

Use the **Micro SD Card** option to enable or disable the microSD card slot function on the front panel. Disable the microSD function first before running the auto recovery function.

- **Disabled** microSD function disabled
- **Enabled** **DEFAULT** microSD function enabled

AFL2-10A-N28 Panel PC

4.5 Chipset

Use the **Chipset** menu (**BIOS Menu 16**) to access the North Bridge, South Bridge, and Integrated Graphics configuration menus.



WARNING!

Setting the wrong values for the Chipset BIOS selections in the Chipset BIOS menu may cause the system to malfunction.

```

Aptio Setup Utility - Copyright (C) 2011 American Megatrends, Inc.
Main   Advanced  Chipset  Boot   Security  Save & Exit
-----
> Host Bridge
> South Bridge

Host Bridge Parameters
-----
<=>: Select Screen
↑ ↓: Select Item
EnterSelect
+ - Change Opt.
F1  General Help
F2  Previous Values
F3  Optimized Defaults
F4  Save & Exit
ESC Exit

Version 2.14.1219. Copyright (C) 2011 American Megatrends, Inc.
    
```

BIOS Menu 13: Chipset

4.5.1 Host Bridge Configuration

Use the **Host Bridge** menu (**BIOS Menu 17**) to configure the host bridge chipset.

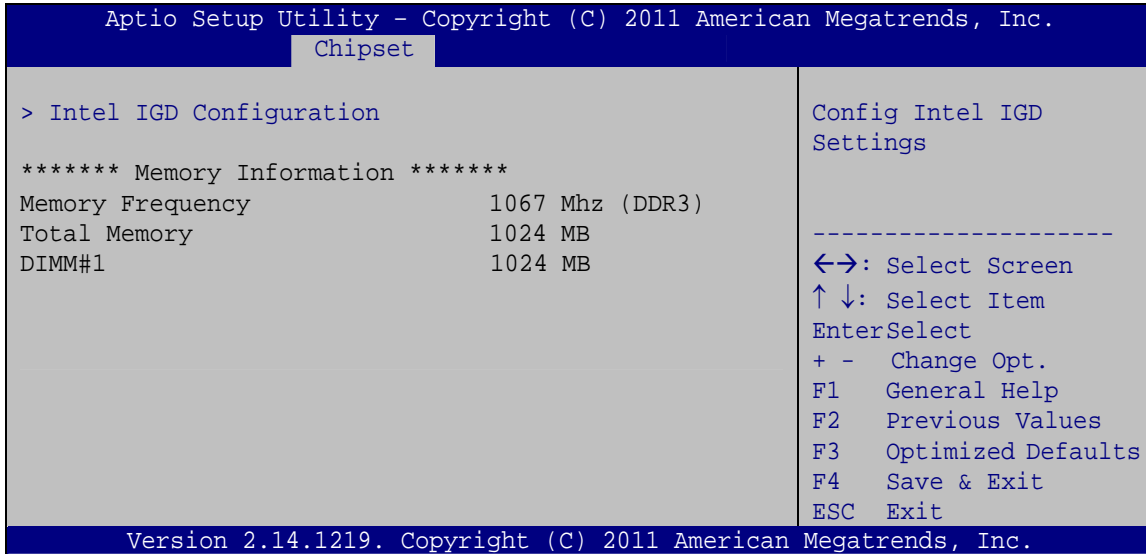

BIOS Menu 14: Northbridge Chipset Configuration

4.5.1.1 Internal IGD Configuration

Use the Internal IGD Configuration (**BIOS Menu 15**) menu to set the integrated graphics.

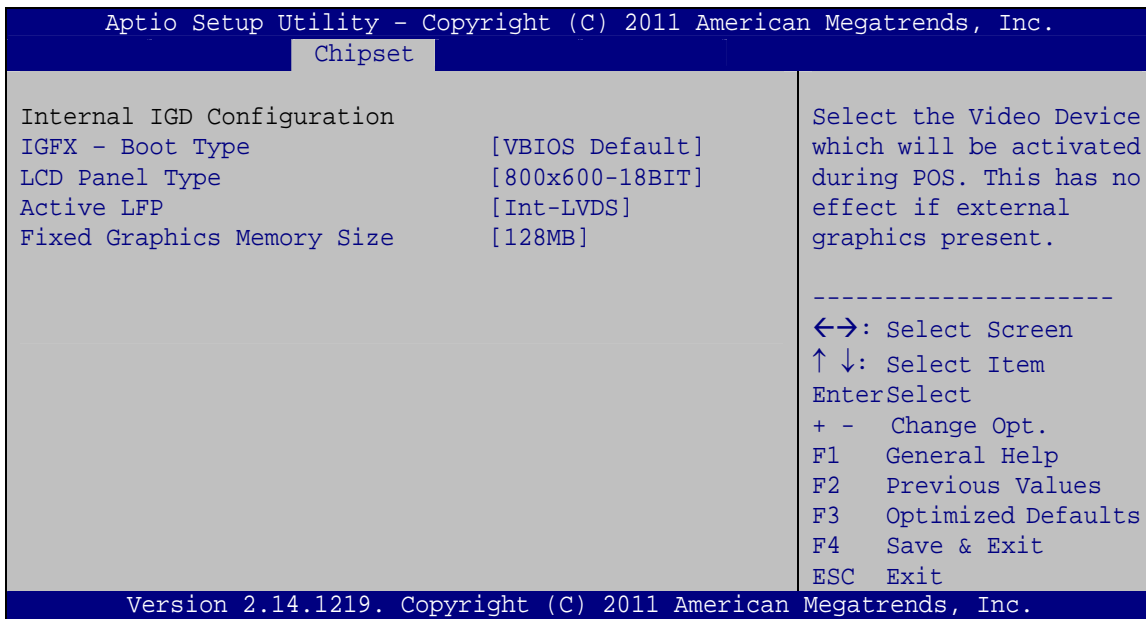

BIOS Menu 15: Internal IGD Configuration

AFL2-10A-N28 Panel PC

→ IGFX - Boot Type [VBIOS Default]

Use the **IGFX – Boot Type** option to select the display device used by the system when it boots. Configuration option is listed below.

- VBIOS Default **DEFAULT**

→ LCD Panel Type [800x600-18BIT]

Use the **LCD Panel Type** option to select the type of flat panel connected to the system. Configuration option is listed below.

- 800x600-18BIT **DEFAULT**

→ Active LFP [Int-LVDS]

Use the **Active LFP** option to select the Active LFP configuration.

- **Int-LVDS** **DEFAULT** BIOS enables LVDS. Driven by integrated encoder.

→ Fixed Graphics Memory Size [128 MB]

Use the **Fixed Graphics Memory Size** option to specify the maximum amount of memory that can be allocated as graphics memory. Configuration options are listed below.

- 128MB **Default**
- 256MB

4.5.2 South Bridge Configuration

Use the **South Bridge** menu (**BIOS Menu 18**) to configure the Southbridge chipset.

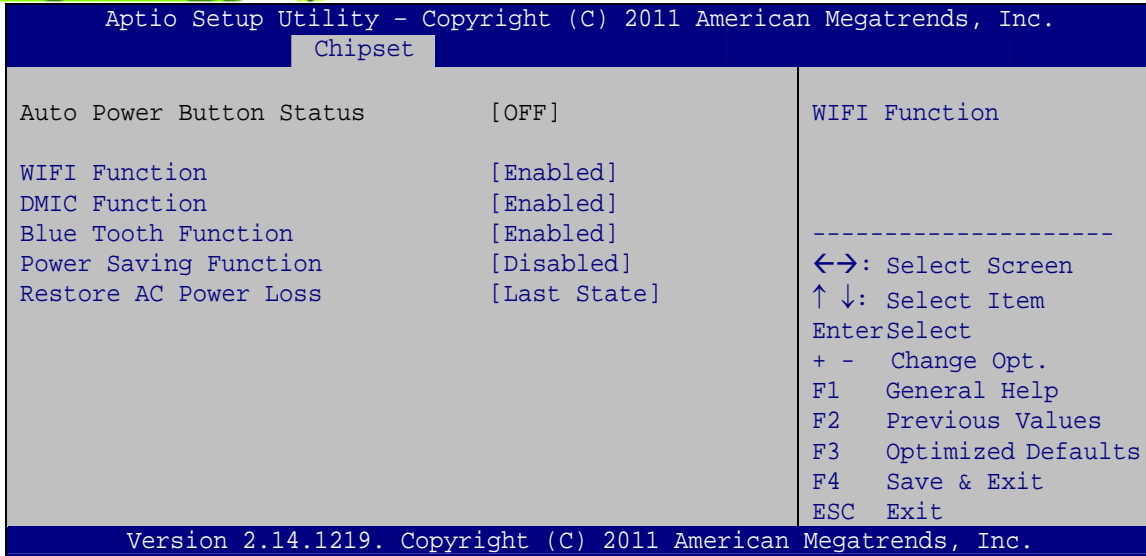

BIOS Menu 16: South Bridge Configuration

→ **WIFI Function [Enabled]**

Use the **WIFI Function** option to enable or disable the Wi-Fi function.

- **Disabled** Wi-Fi function disabled
- **Enabled** **DEFAULT** Wi-Fi function enabled

→ **DMIC Function [Enabled]**

Use the **DMIC Function** option to enable or disable the digital microphone.

- **Disabled** Digital microphone disabled
- **Enabled** **DEFAULT** Digital microphone enabled

→ **Blue Tooth Function [Enabled]**

Use the **Blue Tooth Function** option to enable or disable the Bluetooth function. This option shows only when a Bluetooth module is installed in the system.

- **Disabled** Bluetooth disabled
- **Enabled** **DEFAULT** Bluetooth enabled

AFL2-10A-N28 Panel PC

→ Power Saving Function [Disabled]

Use the **Power Saving Function** BIOS option to enable or disable the power saving function.

- **Disabled** **DEFAULT** Power saving function is disabled.
- **Enabled** Power saving function is enabled. It will reduce power consumption when the system is off.

→ Restore on AC Power Loss [Last State]

Use the **Restore on AC Power Loss** BIOS option to specify what state the system returns to if there is a sudden loss of power to the system.

- **Power Off** The system remains turned off
- **Power On** The system turns on
- **Last State** **DEFAULT** The system returns to its previous state. If it was on, it turns itself on. If it was off, it remains off.

4.6 Boot

Use the **Boot** menu (**BIOS Menu 21**) to configure system boot options.

```

Aptio Setup Utility - Copyright (C) 2011 American Megatrends, Inc.
Main   Advanced  Chipset  Boot   Security  Save & Exit
-----
Boot Configuration
Bootup NumLock State      [On]
Quiet Boot                 [Enabled]
Launch PXE OpROM          [Disabled]
Option ROM Messages       [Force BIOS]
UEFI Boot                 [Disabled]

Boot Option Priorities

-----
<->: Select Screen
↑ ↓: Select Item
Enter>Select
+/-: Change Opt.
F1:  General Help
F2:  Previous Values
F3:  Optimized Defaults
F4:  Save & Exit
ESC: Exit

Version 2.14.1219. Copyright (C) 2011 American Megatrends, Inc.

```

BIOS Menu 17: Boot

→ **Bootup NumLock State [On]**

Use the **Bootup NumLock State** BIOS option to specify if the number lock setting must be modified during boot up.

→ **On** **DEFAULT** Allows the Number Lock on the keyboard to be enabled automatically when the computer system boots up. This allows the immediate use of the 10-key numeric keypad located on the right side of the keyboard. To confirm this, the Number Lock LED light on the keyboard is lit.

→ **Off** Does not enable the keyboard Number Lock automatically. To use the 10-keys on the keyboard, press the Number Lock key located on the upper left-hand corner of the 10-key pad. The Number Lock LED on the keyboard lights up when the Number Lock is engaged.

→ **Quiet Boot [Enabled]**

Use the **Quiet Boot** BIOS option to select the screen display when the system boots.

→ **Disabled** Normal POST messages displayed

→ **Enabled** **DEFAULT** OEM Logo displayed instead of POST messages

→ **Launch PXE OpROM [Disabled]**

Use the **Launch PXE OpROM** option to enable or disable boot option for legacy network devices.

→ **Disabled** **DEFAULT** Ignore all PXE Option ROMs

→ **Enabled** Load PXE Option ROMs

→ **Option ROM Messages [Force BIOS]**

Use the **Option ROM Messages** option to set the Option ROM display mode.

AFL2-10A-N28 Panel PC

→ **Force BIOS** **DEFAULT** Sets display mode to force BIOS.

→ **Keep Current** Sets display mode to current.

→ **UEFI Boot [Disabled]**

Use the **UEFI Boot** BIOS option to enable or disable UEFI boot.

→ **Enabled** Enable UEFI boot if the 1st boot device is a GPT HDD.

→ **Disabled** **DEFAULT** Disable UEFI boot.

4.7 Security

Use the **Security** menu (**BIOS Menu 22**) to set system and user passwords.

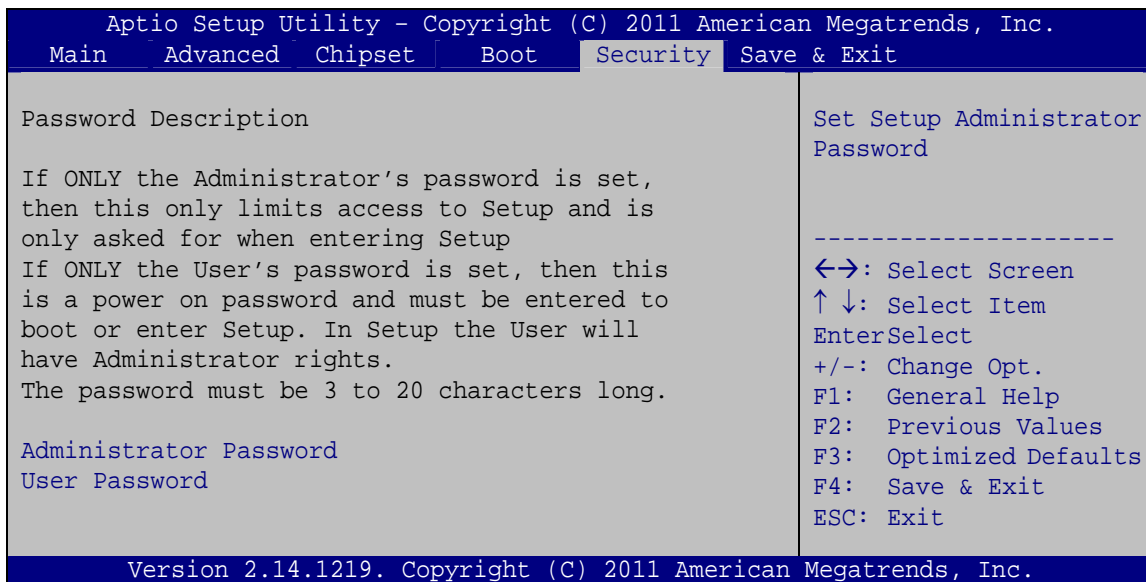

BIOS Menu 18: Security

→ **Administrator Password**

Use the **Administrator Password** field to set or change an administrator password.

→ **User Password**

Use the **User Password** field to set or change a user password.

4.8 Save & Exit

Use the **Save & Exit** menu (**BIOS Menu 19**) to load default BIOS values, optimal failsafe values and to save configuration changes.

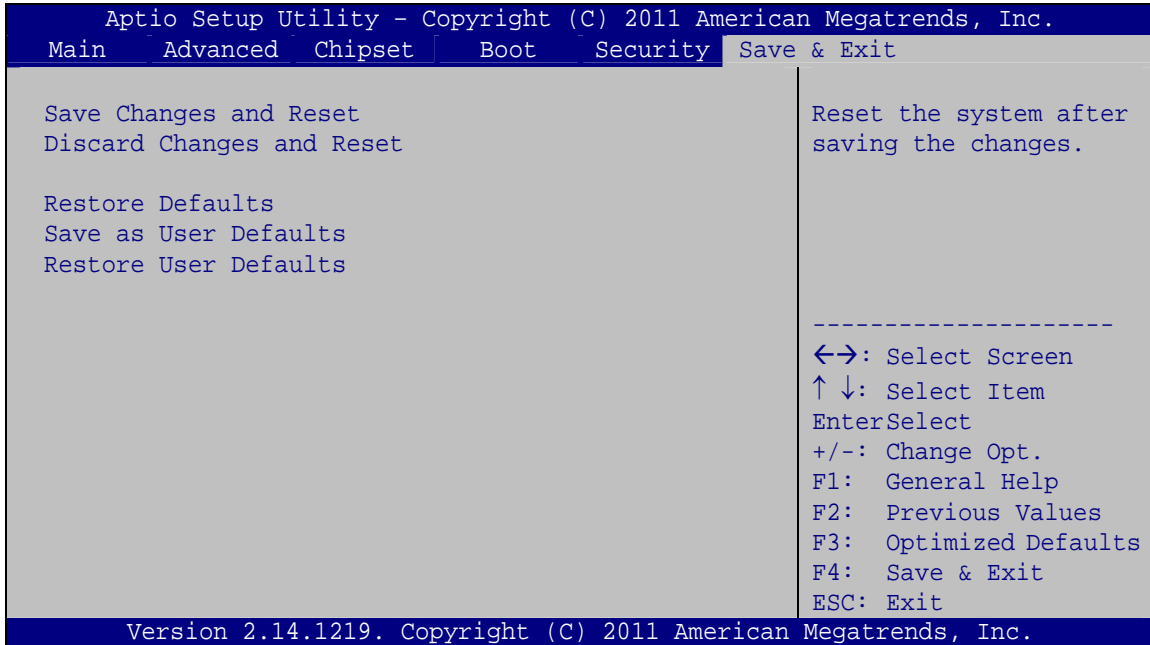

BIOS Menu 19: Exit

→ **Save Changes and Reset**

Use the **Save Changes and Reset** option to save the changes made to the BIOS options and reset the system.

→ **Discard Changes and Reset**

Use the **Discard Changes and Reset** option to exit the system without saving the changes made to the BIOS configuration setup program.

→ **Restore Defaults**

Use the **Restore Defaults** option to load the optimal default values for each of the parameters on the Setup menus. **F3 key can be used for this operation.**

AFL2-10A-N28 Panel PC

→ Save as User Defaults

Use the **Save as User Defaults** option to save the changes done so far as user defaults.

→ Restore User Defaults

Use the **Restore User Defaults** option to restore the user defaults to all the setup options.

Chapter

5

Software Drivers

5.1 Available Software Drivers



NOTE:

The content of the CD may vary throughout the life cycle of the product and is subject to change without prior notice. Visit the IEI website or contact technical support for the latest updates.

The following drivers can be installed on the system:

- Chipset
- Graphic
- Touch
- Audio
- LAN
- USB 3.0
- Wi-Fi
- Bluetooth
- Camera

Installation instructions are given below.

5.2 Starting the Driver Program

To access the driver installation programs, please do the following.

Step 1: Insert the CD-ROM that came with the system into a CD-ROM drive attached to the system.

Step 2: Click **AFL2-10A-N28 Driver**.

Step 3: A list of available drivers appears.



Figure 5-1: Drivers

5.3 Chipset Driver Installation

To install the chipset driver, please do the following.

- Step 1:** Access the driver list. (See **Section 5.2**)
- Step 2:** Click “Chipset.”
- Step 3:** Locate the setup file and double click on it.
- Step 4:** The setup files are extracted as shown in **Figure 5-2**.

AFL2-10A-N28 Panel PC

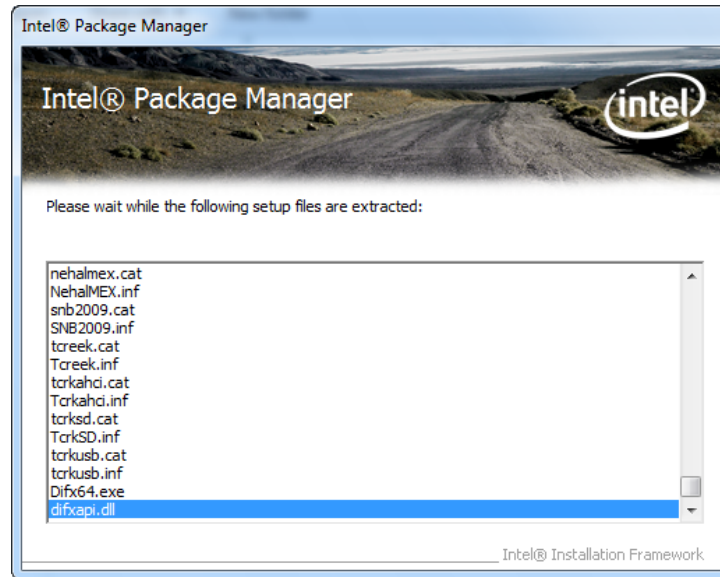

Figure 5-2: Chipset Driver Screen

Step 5: When the setup files are completely extracted the **Welcome Screen** in **Figure 5-3** appears.

Step 6: Click **Next** to continue.



Figure 5-3: Chipset Driver Welcome Screen

Step 7: The license agreement in **Figure 5-4** appears.

Step 8: Read the **License Agreement**.

Step 9: Click **Yes** to continue.

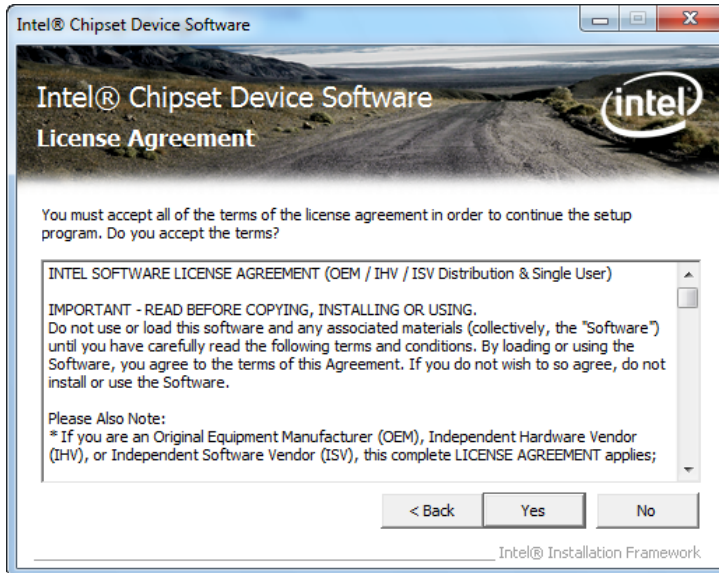

Figure 5-4: Chipset Driver License Agreement

Step 10: The **Read Me** file in **Figure 5-5** appears.

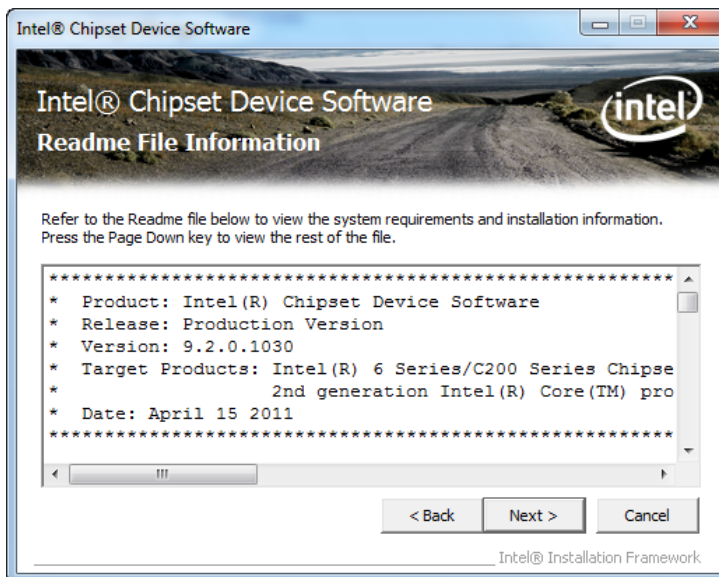

Figure 5-5: Chipset Driver Read Me File

Step 11: Click **Next** to continue

Step 12: Once the setup process is complete, click **Finish**.

AFL2-10A-N28 Panel PC



Figure 5-6: Chipset Driver Setup Operations

5.4 Graphics Driver Installation

To install the Graphics driver, please do the following.

- Step 1:** Access the driver list. (See **Section 5.2**)
- Step 2:** Click "**Graphic**" and select the folder which corresponds to your operating system.
- Step 3:** Double click the setup file.
- Step 4:** The **Welcome Screen** in **Figure 5-7** appears.
- Step 5:** Click **Next** to continue.



Figure 5-7: Graphics Driver Welcome Screen

Step 6: The License Agreement in Figure 5-8 appears.

Step 7: Click **Yes** to accept the agreement and continue.



Figure 5-8: Graphics Driver License Agreement

Step 8: The Read Me file in Figure 5-9 appears.

Step 9: Click **Next** to continue.

AFL2-10A-N28 Panel PC

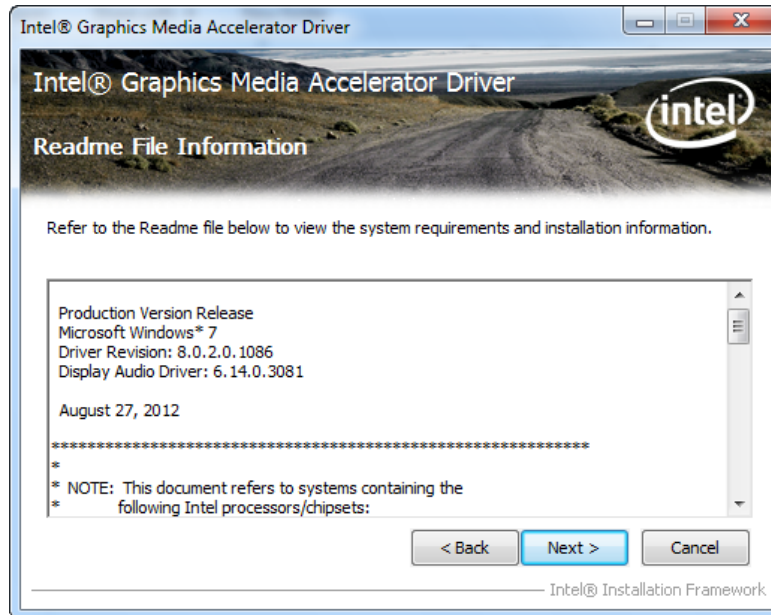

Figure 5-9: Graphics Driver Read Me File

Step 10: Setup Operations are performed as shown in **Figure 5-10**.

Step 11: Once the **Setup Operations** are complete, click **Next** to continue.

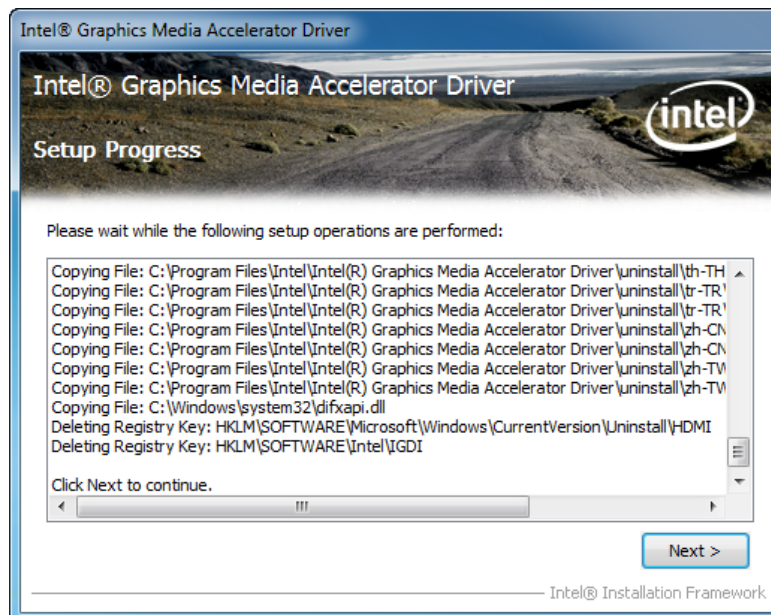

Figure 5-10: Graphics Driver Setup Operations

Step 12: The **Finish Screen** in **Figure 5-11** appears.

Step 13: Select **“Yes, I want to restart this computer now”** and click **Finish**.

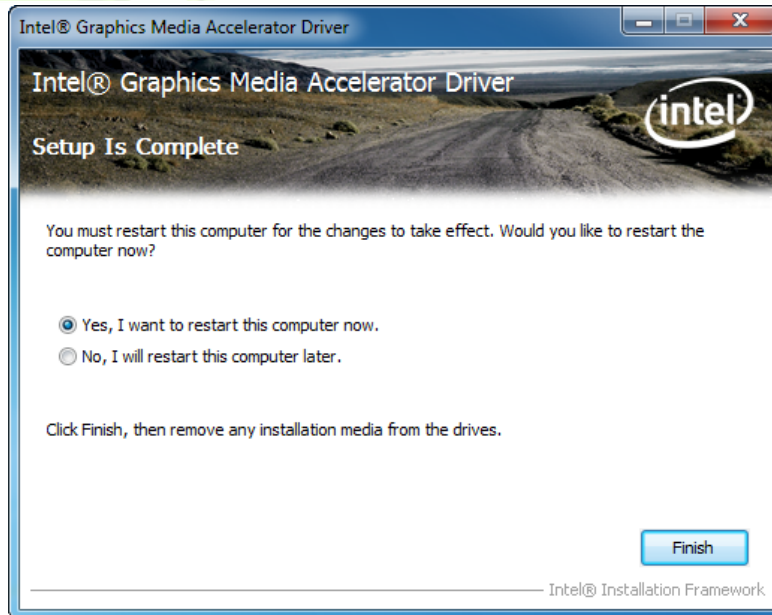

Figure 5-11: Graphics Driver Installation Finish Screen

5.5 Touch Screen Driver

To install the touch panel software driver, please follow the steps below.

- Step 1:** Access the driver list. (See **Section 5.2**)
- Step 2:** Click “Touch”.
- Step 3:** Locate the setup file and double click on it.
- Step 4:** A **Welcome Screen** appears (**Figure 5-12**).
- Step 5:** Click **NEXT** to continue.

AFL2-10A-N28 Panel PC

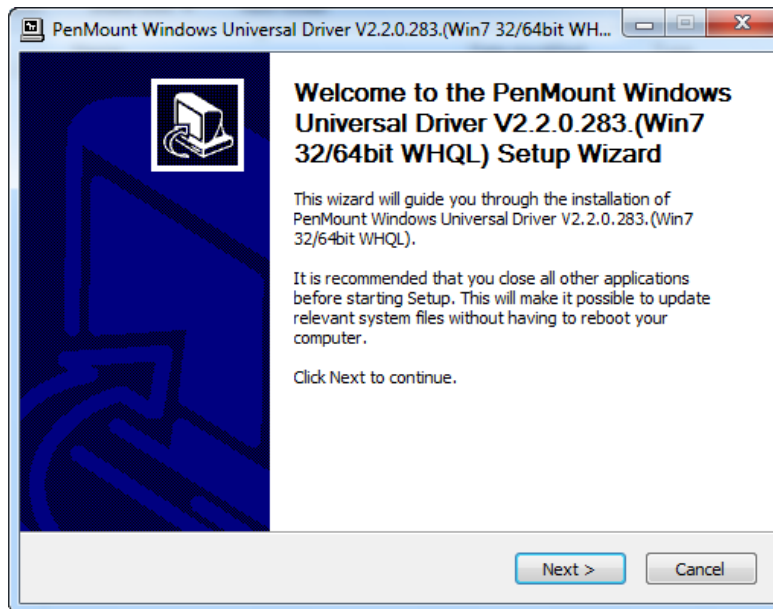

Figure 5-12: Touch Screen Driver Welcome Screen

Step 6: The **License Agreement** shown in **Figure 5-13** appears.

Step 7: Click **I AGREE** to accept and continue.

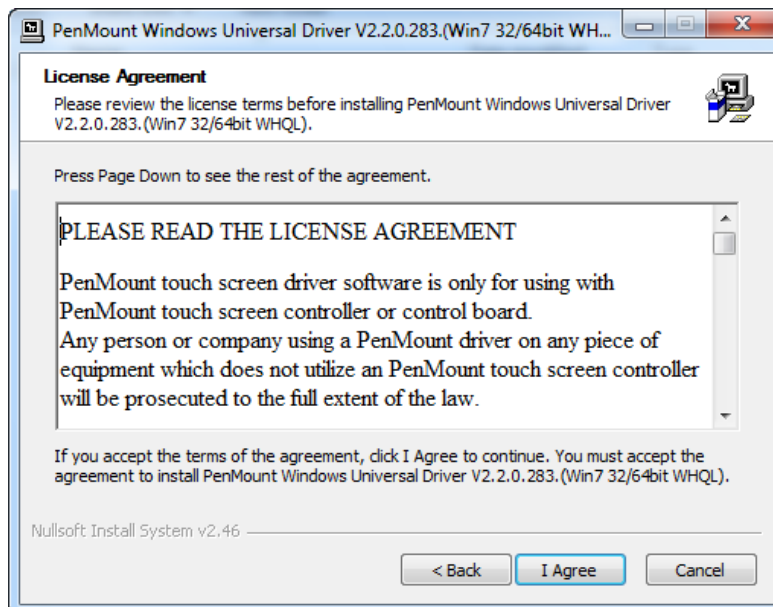

Figure 5-13: Touch Screen Driver License Agreement

Step 8: Browse for an install location or use the one suggested (**Figure 5-14**).

Step 9: Click **INSTALL** to continue.

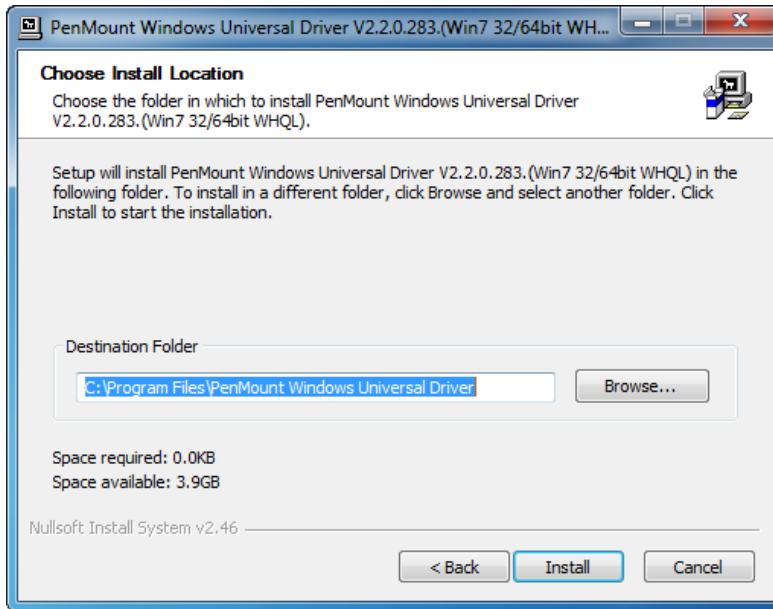

Figure 5-14: Touch Screen Driver Choose Install Location

Step 10: The **Install** screen appears and displays the progress of the installation (Figure 5-15).

Step 11: Click **NEXT** to continue.

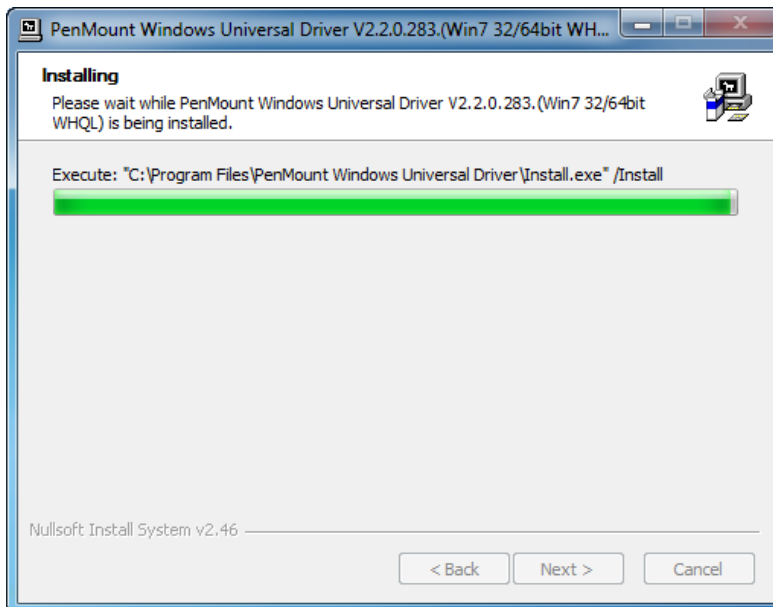

Figure 5-15: Touch Screen Driver Installation Screen

Step 12: When the installation is complete, click **FINISH** to exit setup. (Figure 5-16).

AFL2-10A-N28 Panel PC

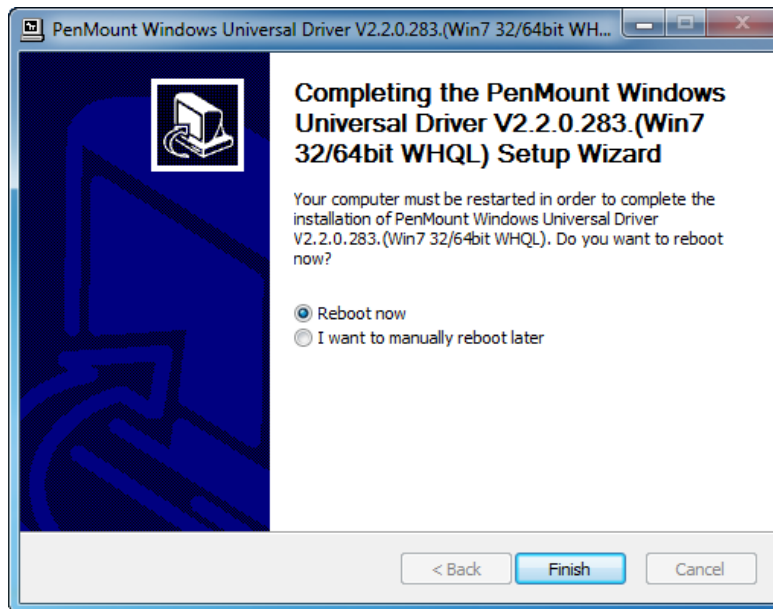

Figure 5-16: Touch Screen Driver Update Complete

5.5.1 Calibrating the Touch Screen

To calibrate the touch screen cursor with the motion of the touch screen pen (or finger), please follow the steps below:

Step 1: Make sure the touch screen driver is properly installed.

Step 2: Locate the PenMount Monitor icon in the bottom right corner of the screen.



Figure 5-17: PenMount Monitor Icon

Step 3: Click the icon. A pop up menu appears. See **Figure 5-18**.

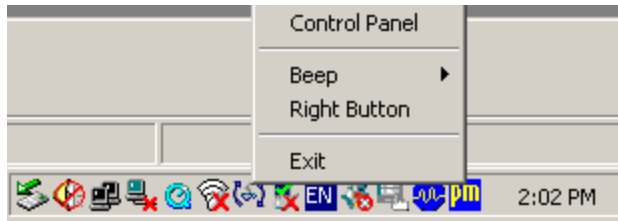

Figure 5-18: PenMount Monitor Popup Menu

Step 4: Click Control Panel in the pop up menu shown in **Figure 5-18**.

Step 5: The configuration screen in **Figure 5-19** appears.

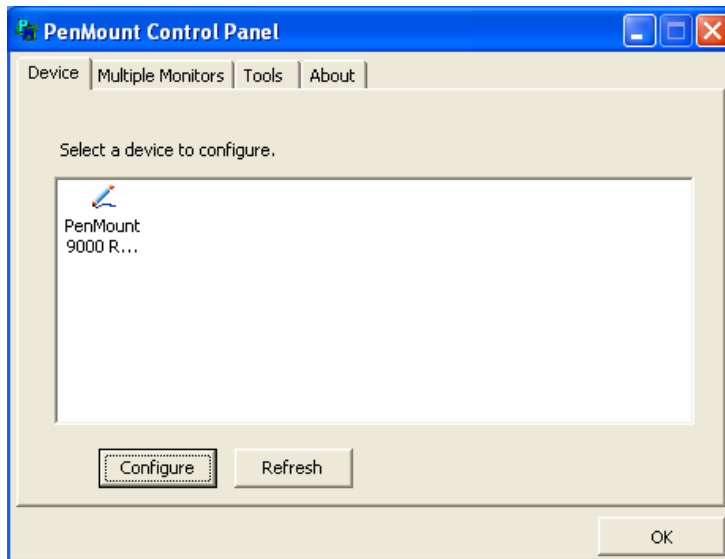

Figure 5-19: Configuration Screen

Step 6: Double click the PenMount 9000 icon as shown in **Figure 5-19**.

Step 7: The calibration initiation screen in **Figure 5-20** appears.

Step 8: Select the **Standard Calibration** button as shown in **Figure 5-20**.

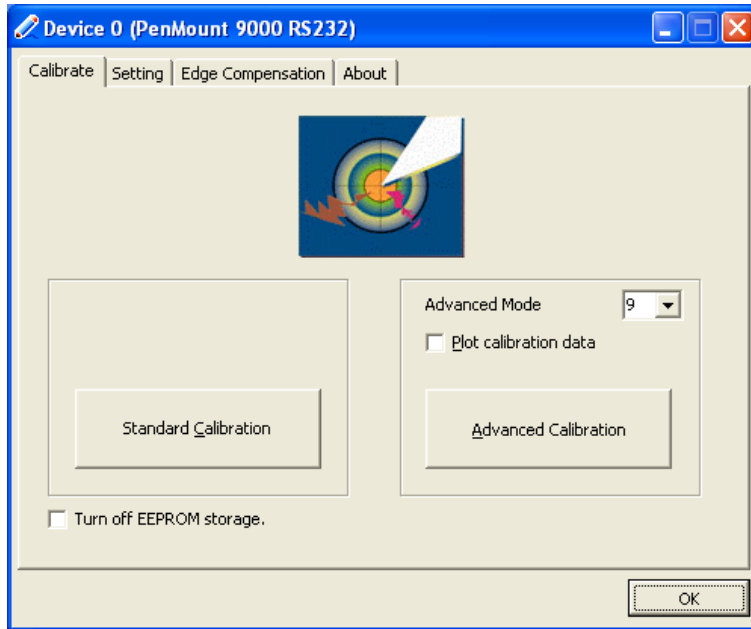

Figure 5-20: Calibration Initiation Screen

Step 9: The calibration screen in is shown. See **Figure 5-21**.

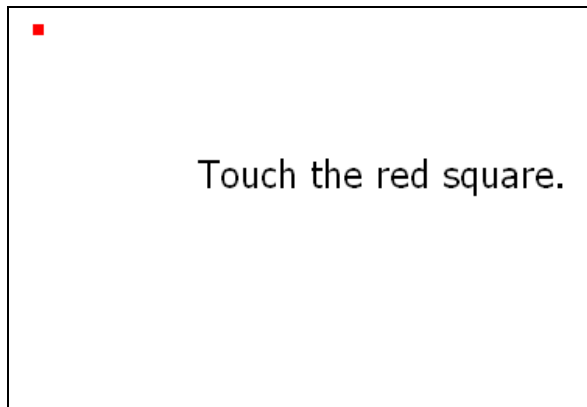

Figure 5-21: Calibration Screen

Step 10: Follow the instructions. The user is asked touch the screen at five specified points after which the screen is calibrated.

5.6 Audio Driver Installation

To install the audio driver, please do the following.

Step 1: Access the driver list. (See **Section 5.2**)

Step 2: Click “**Audio**” and select the folder which corresponds to the operating system.

Step 3: Double click the setup file.

Step 4: The InstallShield Wizard starts to extracting files (**Figure 5-22**).

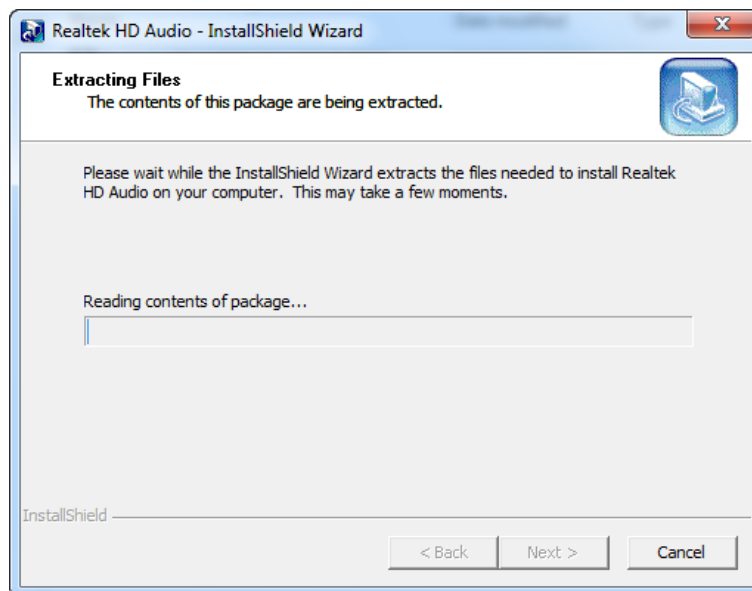

Figure 5-22: Audio Driver – Extracting Files

Step 5: The **Audio Driver Welcome** message in **Figure 5-23** appears.

Step 6: Click **Yes** to install the audio driver.

AFL2-10A-N28 Panel PC

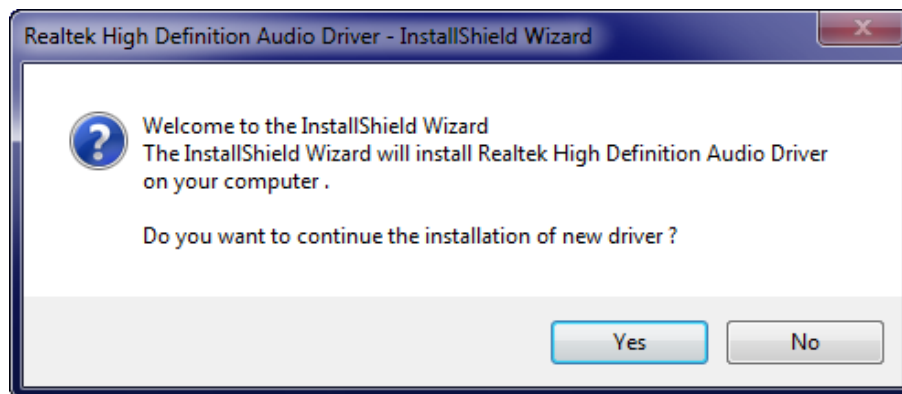

Figure 5-23: Audio Driver Welcome Screen

Step 7: The audio driver installation begins. See **Figure 5-24**.

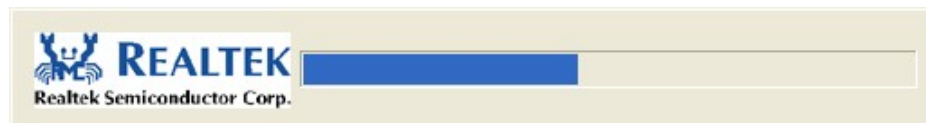

Figure 5-24: Audio Driver Installation

Step 8: When the installation is complete, the screen in **Figure 5-25** appears.

Step 9: Select “Yes, I want to restart my computer now” and click **Finish**.



Figure 5-25: Audio Driver Installation Complete

5.7 LAN Driver Installation

To install the LAN driver, please do the following.

Step 1: Access the driver list. (See **Section 5.2**)

Step 2: Click “LAN” and select the folder which corresponds to the operating system.

Step 3: Double click the setup file.

Step 4: The **Welcome** screen in **Figure 5-26** appears.

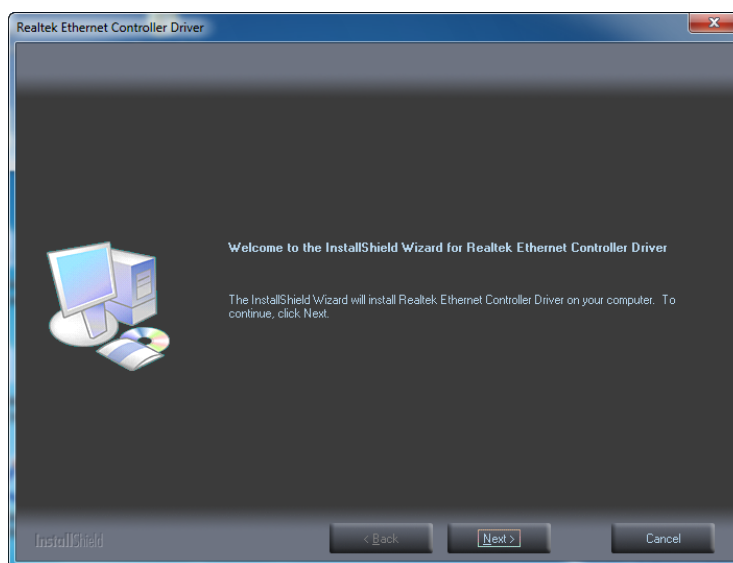

Figure 5-26: LAN Driver Welcome Screen

Step 5: Click **Next** to continue.

Step 6: The **Ready to Install the Program** Screen in **Figure 5-27** appears.

Step 7: Click **Install** to proceed with the installation.

AFL2-10A-N28 Panel PC

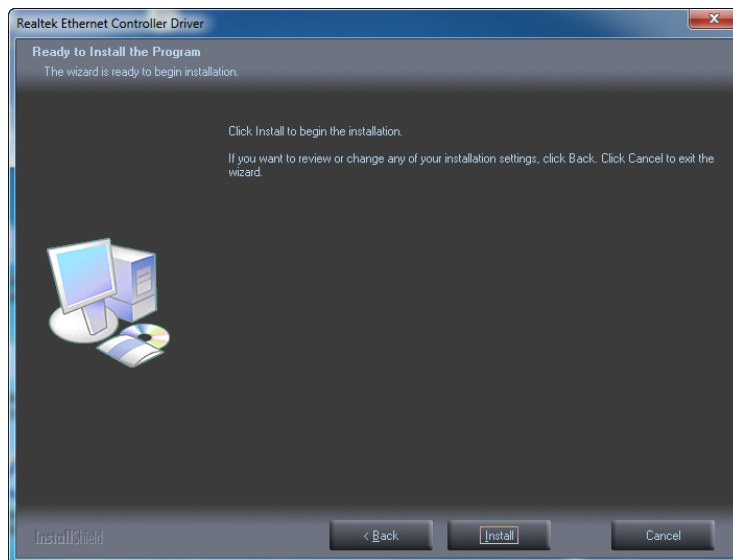

Figure 5-27: LAN Driver Ready to Install Screen

Step 8: The program begins to install.

Step 9: The **Setup Status** screen in **Figure 5-28** appears.

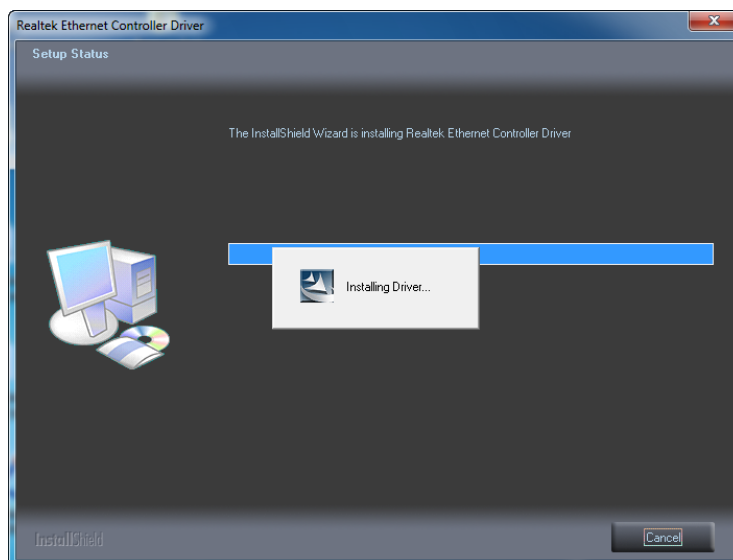

Figure 5-28: LAN Driver Setup Status Screen

Step 10: When the driver installation is complete, the screen in **Figure 5-29** appears.

Step 11: Click **Finish** to exit.

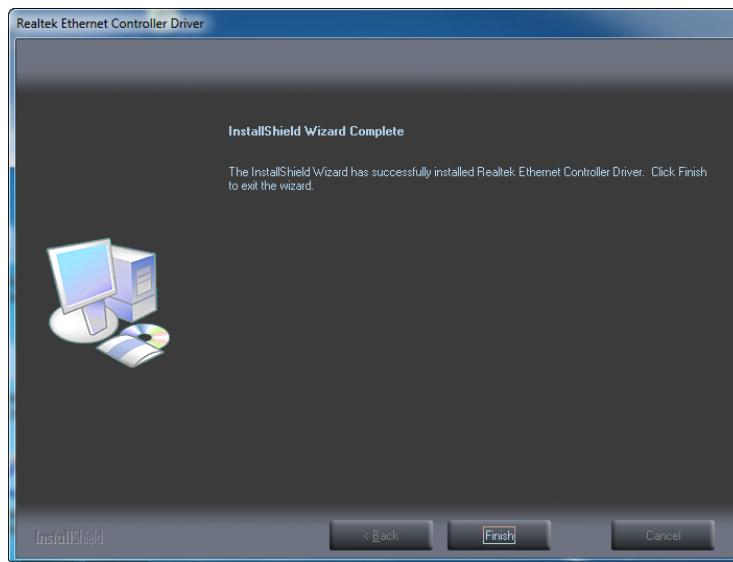

Figure 5-29: LAN Driver Installation Complete

5.8 USB 3.0 Driver Installation

To install the touch panel software driver, please follow the steps below.

- Step 1:** Access the driver list. (See **Section 5.2**)
- Step 2:** Click "**USB 3.0**".
- Step 3:** Locate the setup file and double click on it.
- Step 4:** A **Welcome Screen** appears (**Figure 5-30**).
- Step 5:** Click **Next** to continue.

AFL2-10A-N28 Panel PC



Figure 5-30: USB 3.0 Driver Welcome Screen

Step 6: The **License Agreement** shown in **Figure 5-31** appears.

Step 7: Accept the agreement by selecting “I accept the terms in the license agreement”.

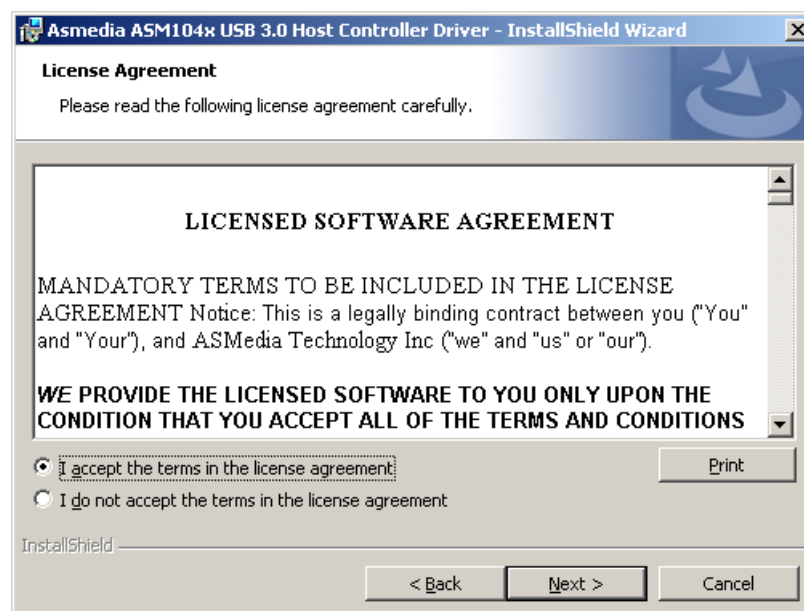

Figure 5-31: USB 3.0 Driver License Agreement

Step 8: Click **NEXT** to continue.

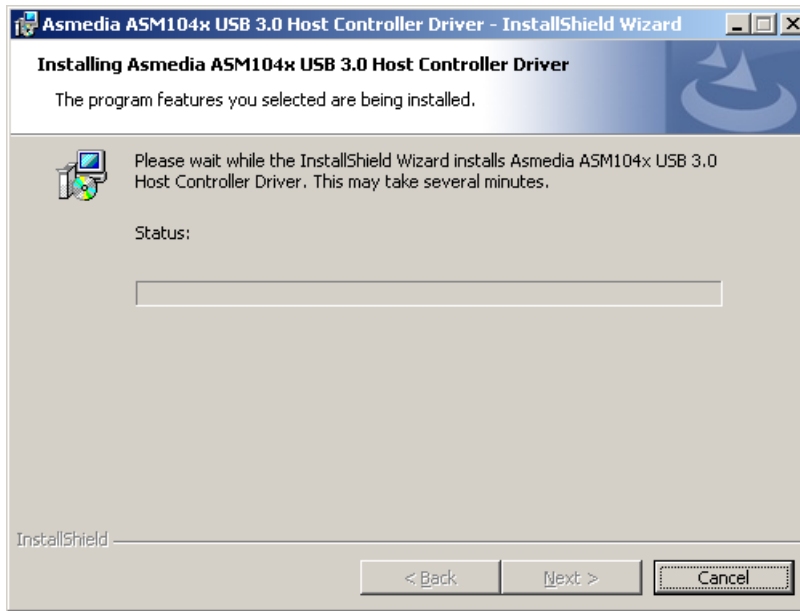

Figure 5-32: USB 3.0 Driver Installation

Step 9: The **Install** screen appears and displays the progress of the installation.

Step 10: When the installation is complete, click **Finish** to exit setup. (Figure 5-33).



Figure 5-33: USB 3.0 Driver Update Complete

AFL2-10A-N28 Panel PC

5.9 Wi-Fi Driver Installation

To install the wireless LAN driver, please follow the steps below.

- Step 1:** Access the driver list. (See **Section 5.2**)
- Step 2:** Click **“WiFi”** and select the folder which corresponds to your operating system.
- Step 3:** Double click the setup file.
- Step 4:** The **License Agreement** screen in **Figure 5-34** appears.

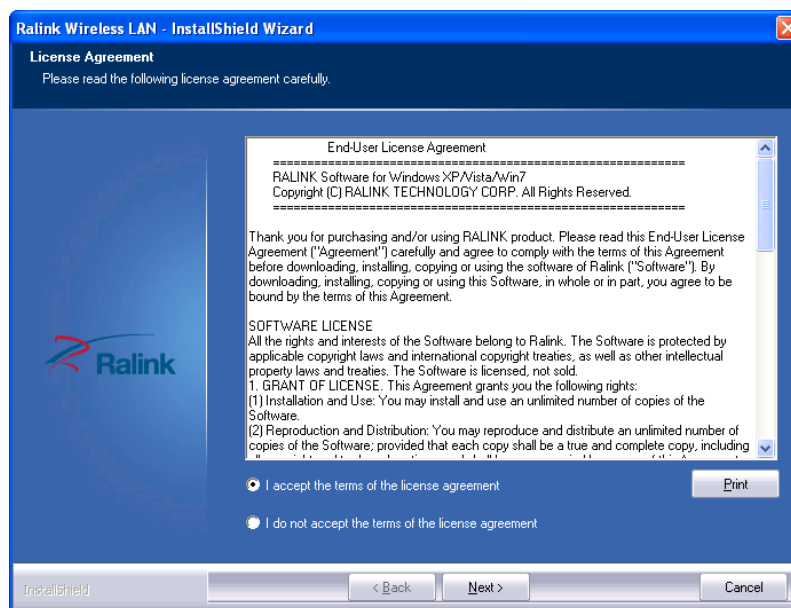

Figure 5-34: License Agreement

- Step 5:** Accept the conditions of the license agreement and click **NEXT** to continue.
- Step 6:** The **Setup Type** screen in **Figure 5-35** appears.

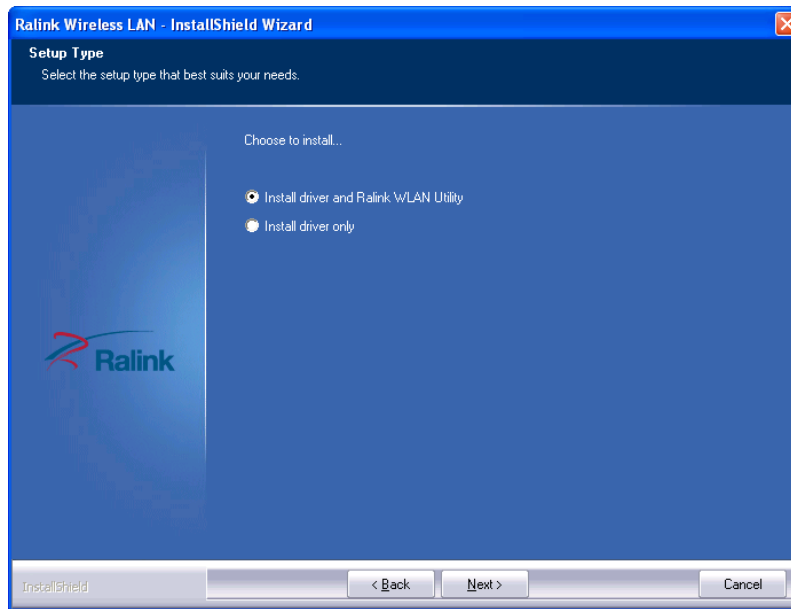

Figure 5-35: Setup Type

Step 7: Select “Install driver and Ralink WLAN Utility” and click **NEXT** to continue.

Step 8: The **Configuration Tool** screen in **Figure 5-36** appears.

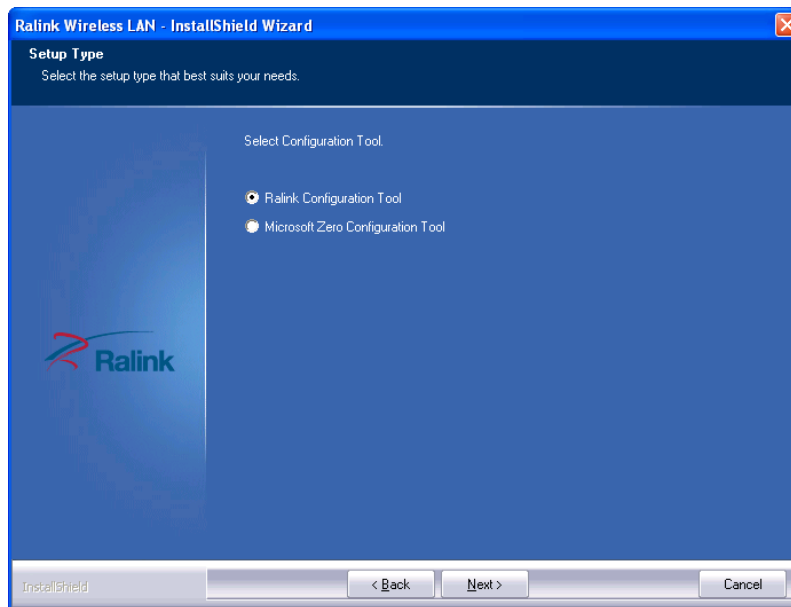

Figure 5-36: Configuration Tool

Step 9: Select “Ralink Configuration Tool” and click **NEXT** to continue.

Step 10: The **Ready to Install the Program** screen in **Figure 5-37** appears.

AFL2-10A-N28 Panel PC

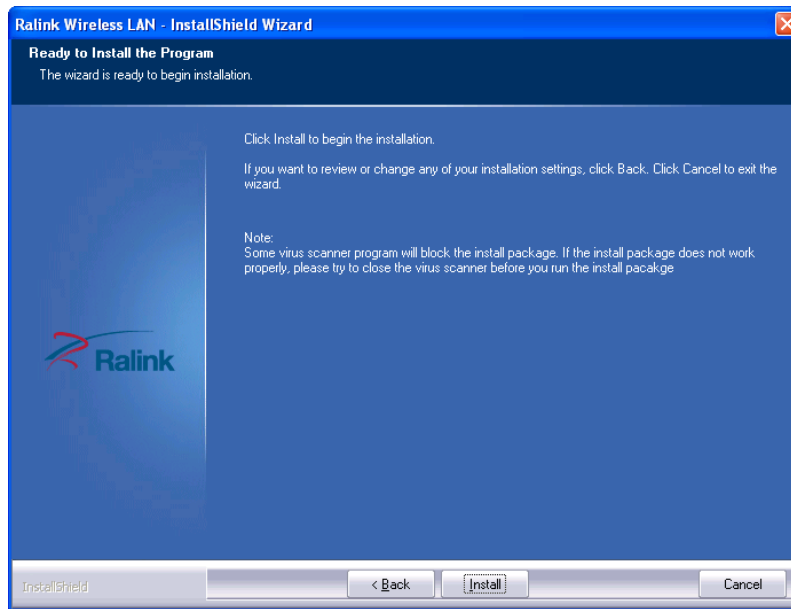

Figure 5-37: Ready to Install the Program

Step 11: Click **Install** to proceed with the installation.

Step 12: The **Setup Status** screen in **Figure 5-38** appears and displays the progress of the installation.

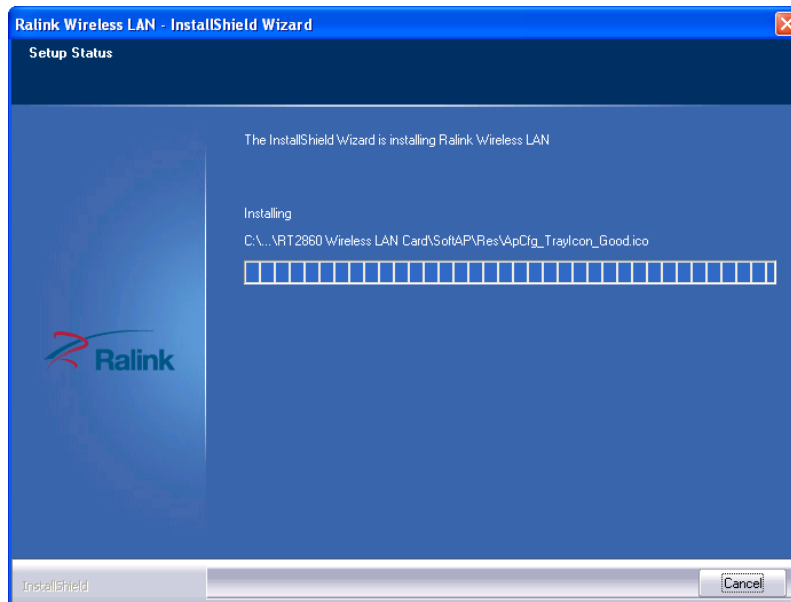

Figure 5-38: Setup Status

Step 13: When the driver installation is complete, the screen in **Figure 5-39** appears.

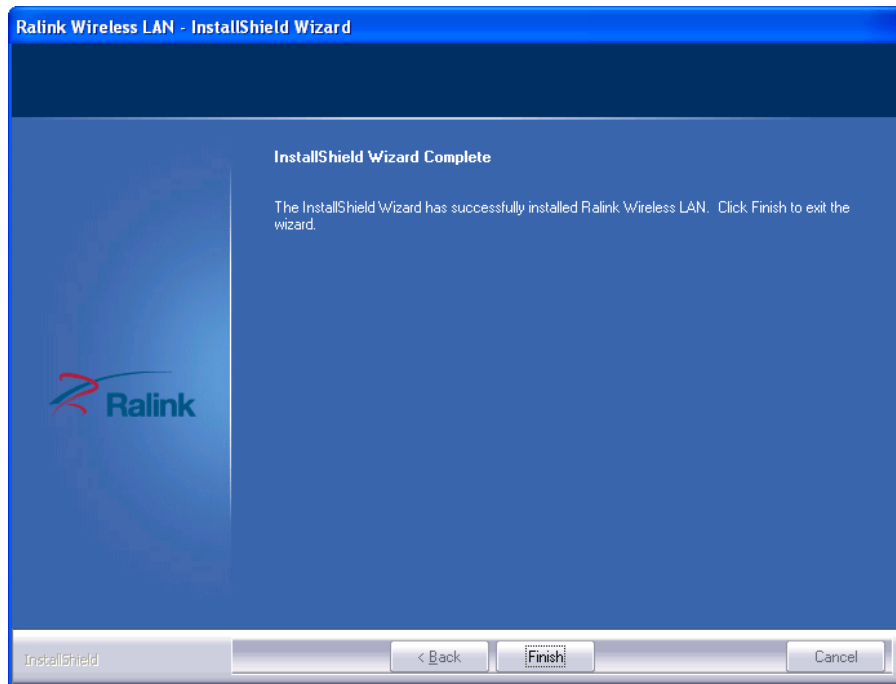

Figure 5-39: Installation Complete

Step 14: Click **FINISH** to complete installation.

5.10 Bluetooth Driver

To install the Bluetooth software driver, please follow the steps below.

Step 1: Access the driver list. (See **Section 5.2**)

Step 2: Click **"Bluetooth"** and select the folder which corresponds to your operating system.

Step 3: Double click the setup file.

Step 4: The **Welcome Screen** appears (**Figure 5-40**).

Step 5: Click **NEXT** to continue the installation process.

AFL2-10A-N28 Panel PC

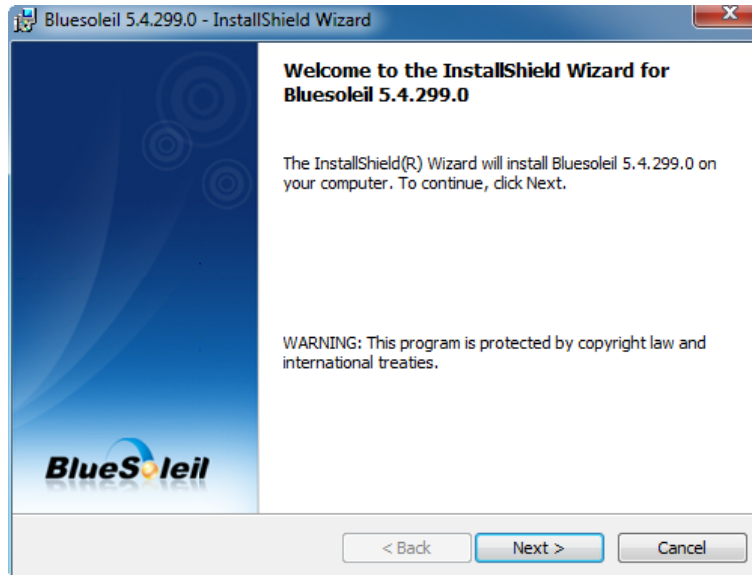

Figure 5-40: Welcome Screen

Step 6: The **License Agreement** appears as shown in **Figure 5-41**.

Step 7: Agree to the license by selecting “I accept the terms in the license agreement” and click **NEXT**.



Figure 5-41: License Agreement

Step 8: Browse for an install location or use the one suggested (**Figure 5-42**) and click **NEXT**.

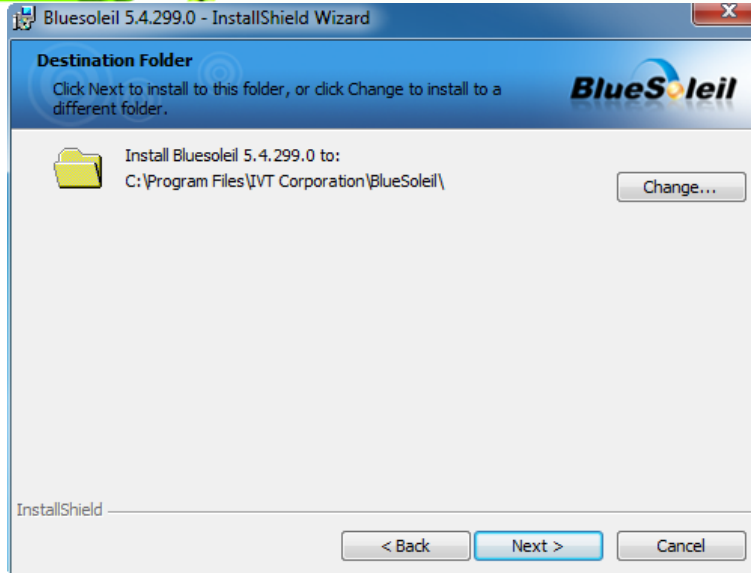

Figure 5-42: Bluetooth Driver Destination Folder

Step 9: The InstallShield Wizard is ready to install the program.

Step 10: Click **INSTALL** to continue (Figure 5-43).

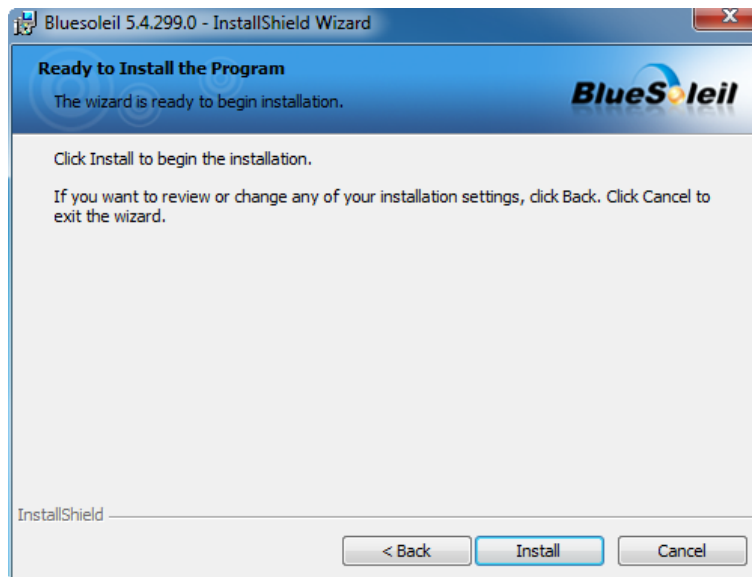

Figure 5-43: Ready to Install the Program

Step 11: The installation screen appears and displays the progress of the installation (Figure 5-44).

AFL2-10A-N28 Panel PC

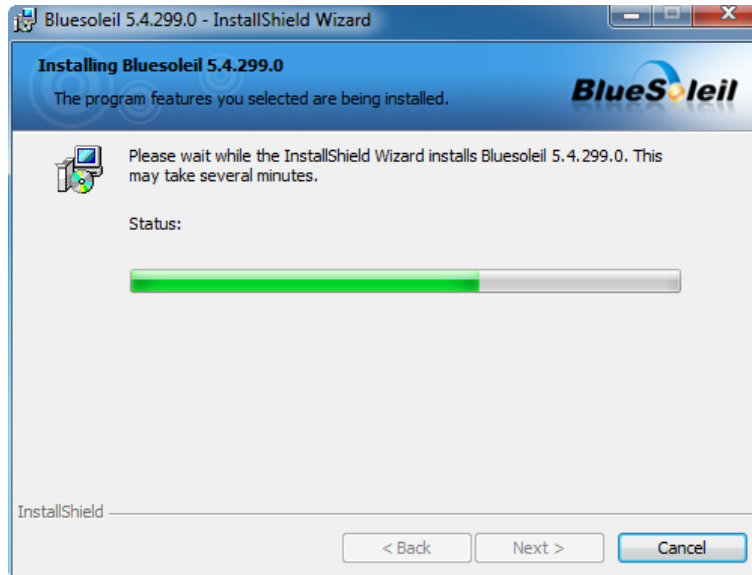

Figure 5-44: Installing BlueSoleil

Step 12: When the installation process is complete, click **FINISH**. See **Figure 5-45**.

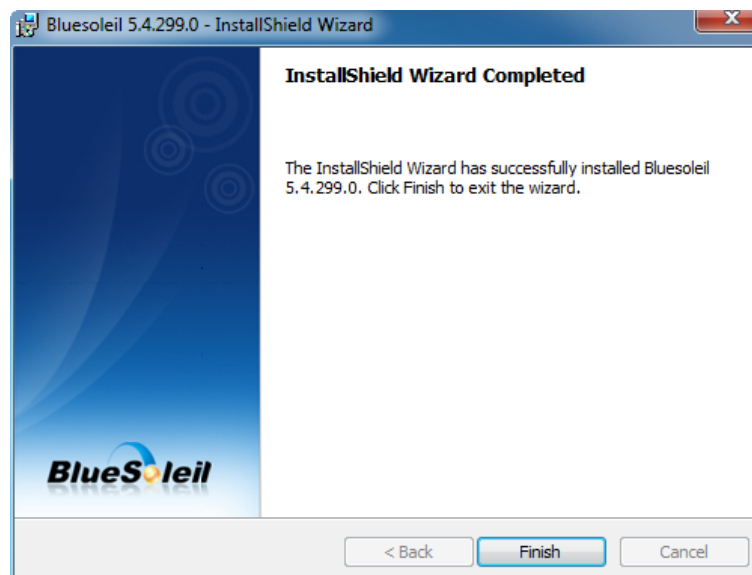

Figure 5-45: Bluetooth Driver Complete Installation Screen

Step 13: The user is then prompted to select to restart the computer now or later (**Figure 5-46**). For the settings to take effect, the computer must be restarted.

Step 14: Click **YES** to restart the computer.

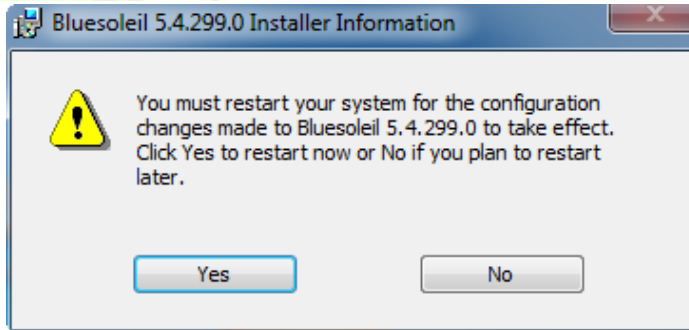

Figure 5-46: Reboot the Computer

5.11 Camera Driver Installation

To install the camera driver, please do the following.

- Step 1:** Access the driver list. (See **Section 5.2**)
- Step 2:** Click "**Camera**" and select the folder which corresponds to your operating system.
- Step 3:** Double click the setup file.
- Step 4:** The **Welcome Screen** in **Figure 5-47** appears.
- Step 5:** Click **Next** to continue.

AFL2-10A-N28 Panel PC

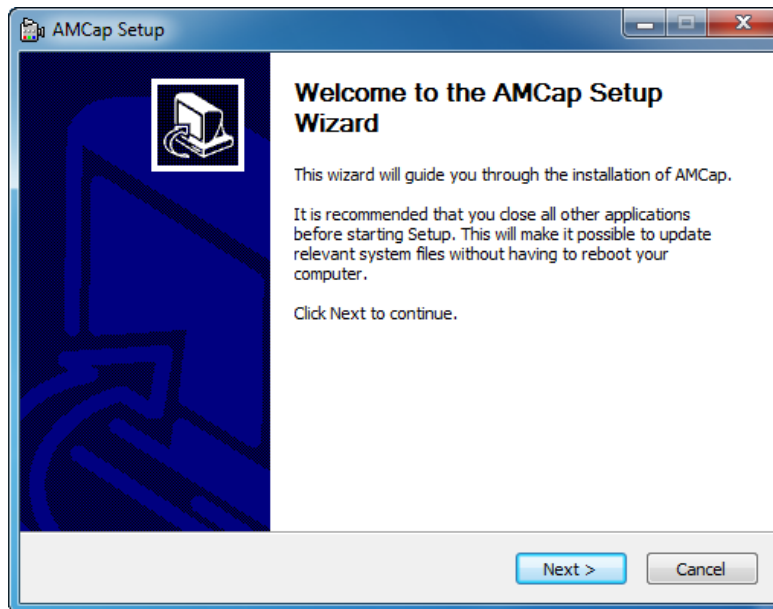

Figure 5-47: AMCap Driver Welcome Screen

Step 6: Browse for an install location or use the one suggested (Figure 5-48).

Step 7: Click **INSTALL** to continue.

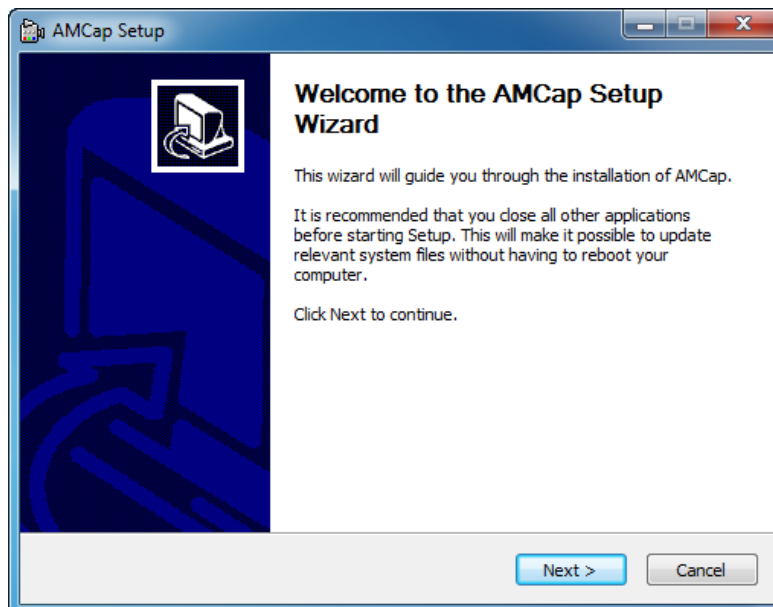

Figure 5-48: AMCap Driver Choose Install Location

Step 8: The program begins to install.

Step 9: When the driver installation is complete, the screen in Figure 5-49 appears.

Step 10: Click **Finish** to save and exit.

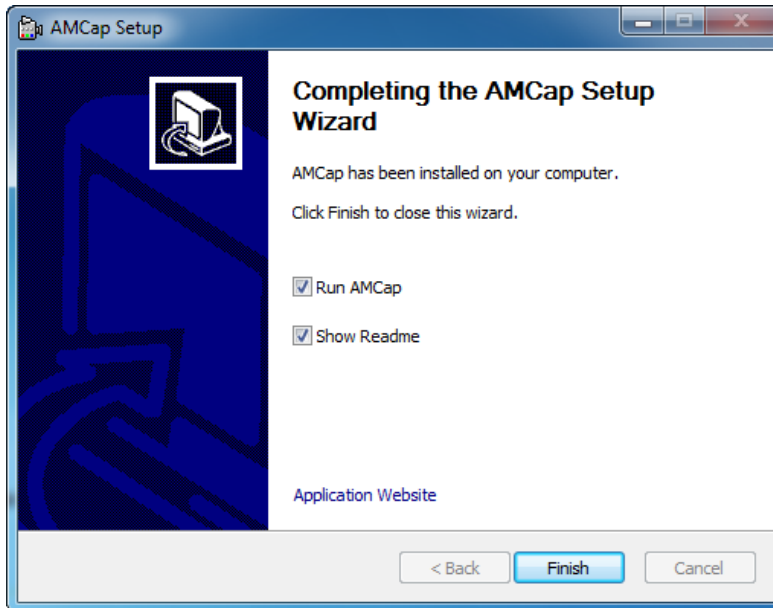

Figure 5-49: AMCap Driver Installation Complete

Chapter

6

System Maintenance

6.1 System Maintenance Introduction

If the components of the AFL2-10A-N28 fail they must be replaced. Components that can be replaced include:

- SO-DIMM module
- WLAN module

Please contact the system reseller or vendor to purchase the replacement parts. Back cover removal instructions for the AFL2-10A-N28 are described below.

6.2 Anti-static Precautions



WARNING:

Failure to take ESD precautions during the maintenance of the AFL2-10A-N28 may result in permanent damage to the AFL2-10A-N28 and severe injury to the user.

Electrostatic discharge (ESD) can cause serious damage to electronic components, including the AFL2-10A-N28. Dry climates are especially susceptible to ESD. It is therefore critical that whenever the AFL2-10A-N28 is accessed internally, or any other electrical component is handled, the following anti-static precautions are strictly adhered to.

- ***Wear an anti-static wristband:*** - Wearing a simple anti-static wristband can help to prevent ESD from damaging the board.
- ***Self-grounding:*** - Before handling the board touch any grounded conducting material. During the time the board is handled, frequently touch any conducting materials that are connected to the ground.
- ***Use an anti-static pad:*** - When configuring the AFL2-10A-N28, place it on an anti-static pad. This reduces the possibility of ESD damaging the AFL2-10A-N28.
- ***Only handle the edges of the PCB:*** - When handling the PCB, hold the PCB by the edges.

AFL2-10A-N28 Panel PC

6.3 Turn off the Power



WARNING:

Failing to turn off the system before opening it can cause permanent damage to the system and serious or fatal injury to the user.

Before any maintenance procedures are carried out on the system, make sure the system is turned off.

To power off the system, follow the steps below:

Step 1: Locate the Function and Brightness Up function keys. See Section 1.2.1.2.

Step 2: Hold down the Function and Brightness Up buttons for **six** seconds to power off the system.

6.4 Opening the System

6.4.1 Removing the Back Cover



WARNING:

Over-tightening back cover screws will crack the plastic frame. Maximum torque for cover screws is 5 kg-cm (0.36 lb-ft/0.49 Nm).

To access the AFL2-10A-N28 internally the back cover must be removed. To remove the back cover, please follow the steps below.

Step 1: Follow all anti-static procedures. See Section 6.2.

Step 2: Turn off the power. See Section 6.3.

Step 3: Remove a total of eleven (11) retention screws from the back cover (**Figure 6-1**).



Figure 6-1: Back Cover Retention Screws

Step 4: Carefully separate the back cover from the chassis and lift the cover clear of the device

6.4.2 Removing the Internal Cover

To remove the internal cover, follow the steps below.

Step 1: Remove the five (5) retention screws securing the internal cover to the chassis (**Figure 6-2**).

AFL2-10A-N28 Panel PC

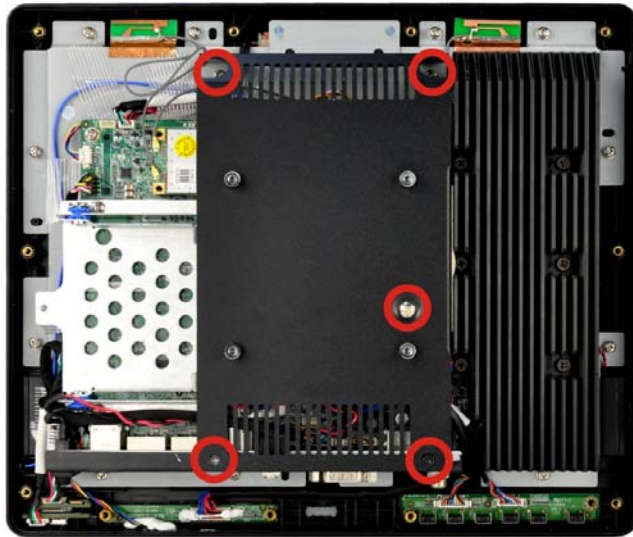

Figure 6-2: Internal Cover Retention Screws

Step 2: Lift the internal cover off the AFL2-10A-N28.

Step 3: The internal parts will all be viewable.

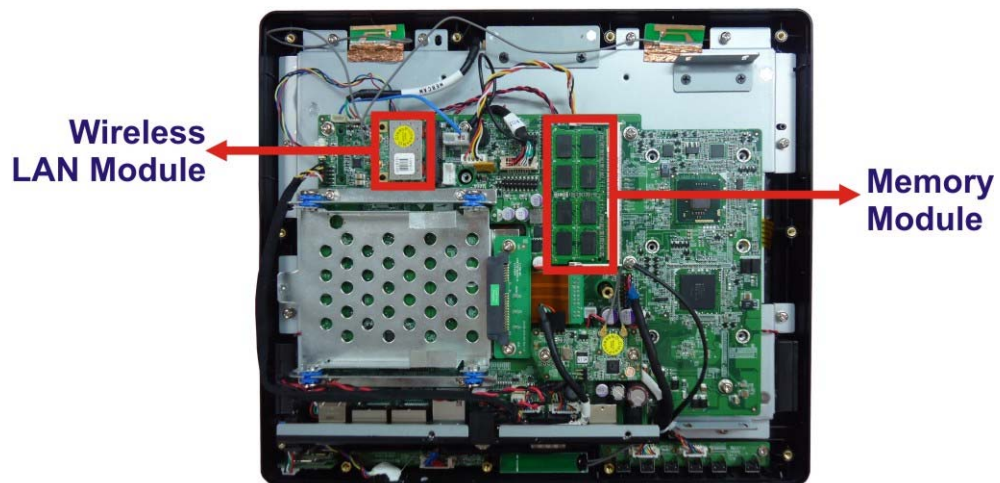

Figure 6-3: Internal Components

6.5 Replacing Components

6.5.1 Memory Module Replacement

The flat bezel panel PC is preinstalled with one 2.0 GB DDR3 memory module. If the memory module fails, follow the instructions below to replace the memory module.

- Step 1:** Follow all anti-static procedures. See **Section 6.2**.
- Step 2:** Turn off the power. See **Section 6.3**.
- Step 3:** Remove the back cover. See **Section 6.4.1** above.
- Step 4:** Remove the internal back cover. See **Section 6.4.2** above.
- Step 5:** Locate the DDR3 SO-DIMM on the motherboard.
- Step 6:** Remove the DDR3 memory module by pulling both the spring retainer clips outward from the socket.
- Step 7:** Grasp the DDR3 memory module by the edges and carefully pull it out of the socket.
- Step 8:** Install the new DDR3 memory module by pushing it into the socket at an angle (**Figure 6-4**).
- Step 9:** Gently pull the spring retainer clips of the SO-DIMM socket out and push the rear of the DDR memory module down (**Figure 6-4**).
- Step 10:** Release the spring retainer clips on the SO-DIMM socket. They clip into place and secure the DDR memory module in the socket.

AFL2-10A-N28 Panel PC

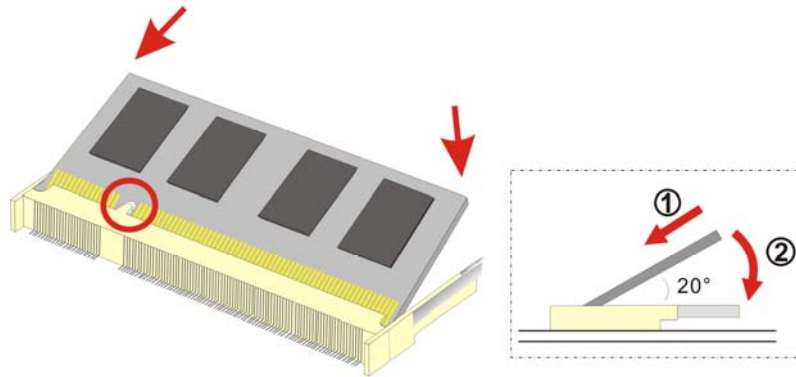

Figure 6-4: DDR SO-DIMM Module Installation

Step 11: Replace the internal cover and secure it to the chassis using the previously removed retention screws.

Step 12: Replace the back cover and secure it using the previously removed retention screws.

6.5.2 WLAN Card Replacement

The AFL2-10A-N28 has one WLAN card slot. To replace the WLAN card, follow the instructions below.

Step 1: Follow all anti-static procedures. See **Section 6.2**.

Step 2: Turn off the power. See **Section 6.3**.

Step 3: Remove the back cover. See **Section 6.4.1** above.

Step 4: Remove the internal back cover. See **Section 6.4.2** above.

Step 5: Locate the WLAN card.

Step 6: Disconnect the main and auxiliary antennas on the WLAN module and push the two spring clips in to release the WLAN card (**Figure 6-5**).

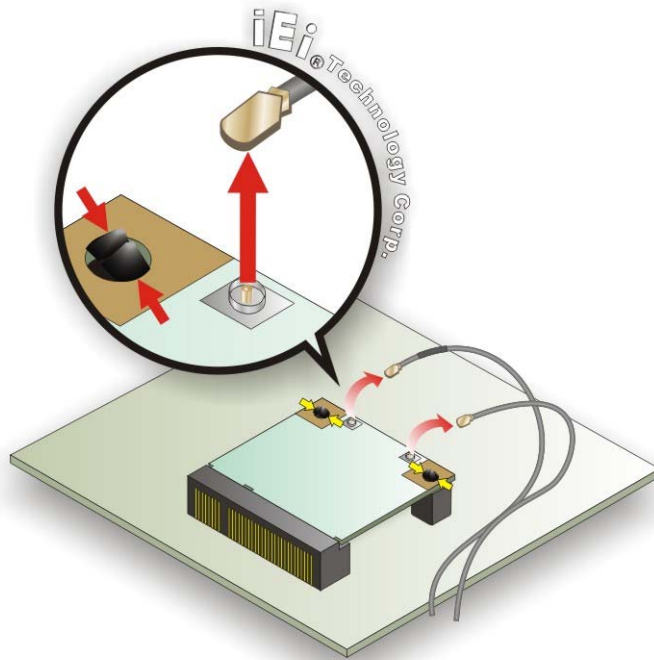

Figure 6-5: Releasing the WLAN Card

Step 7: Grasp the WLAN card by the edges and carefully pull it out of the socket (**Figure 6-6**).

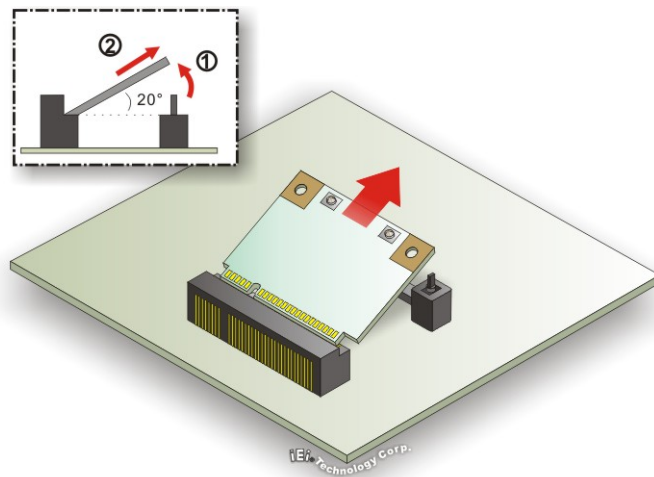

Figure 6-6: Removing the WLAN card

Step 8: Install a new WLAN card by inserting the card into the slot at an angle

Step 9: Push the WLAN card down until the spring retainer clips lock into place.

AFL2-10A-N28 Panel PC

Step 10: Connect the main (1) and auxiliary (2) antennas. The main antenna is indicated with a strip of black electrical tape. See **Figure 6-7**.



NOTE:

To ensure the WLAN module functions correctly, please make sure the WLAN antennas are attached in the proper configuration.

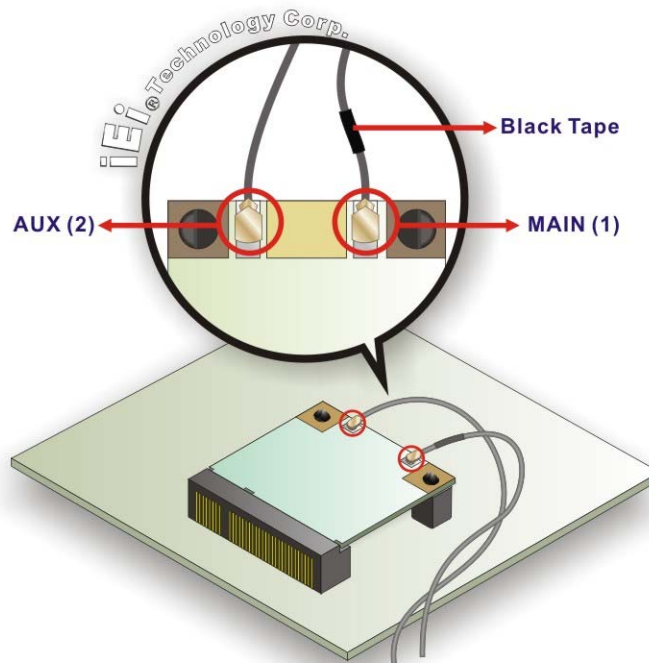

Figure 6-7: Attaching the Antennas

Step 11: Replace the internal cover and secure it to the chassis using the previously removed retention screws.

Step 12: Replace the back cover and secure it using the previously removed retention screws.

6.6 Reinstalling the Covers



WARNING:

Failing to reinstall the covers may result in permanent damage to the system. Please make sure all coverings are properly installed.

When maintenance procedures are complete, please make sure all the covers are replaced, including the following:

- Internal cover
- Plastic back cover

Chapter

7

Interface Connectors

7.1 Peripheral Interface Connectors

The AFL2-10A-N28 panel PC motherboard comes with a number of peripheral interface connectors and configuration jumpers. The connector locations are shown in **Figure 7-1**. The Pin 1 locations of the on-board connectors are also indicated in the diagram below. The connector pinouts for these connectors are listed in the following sections.

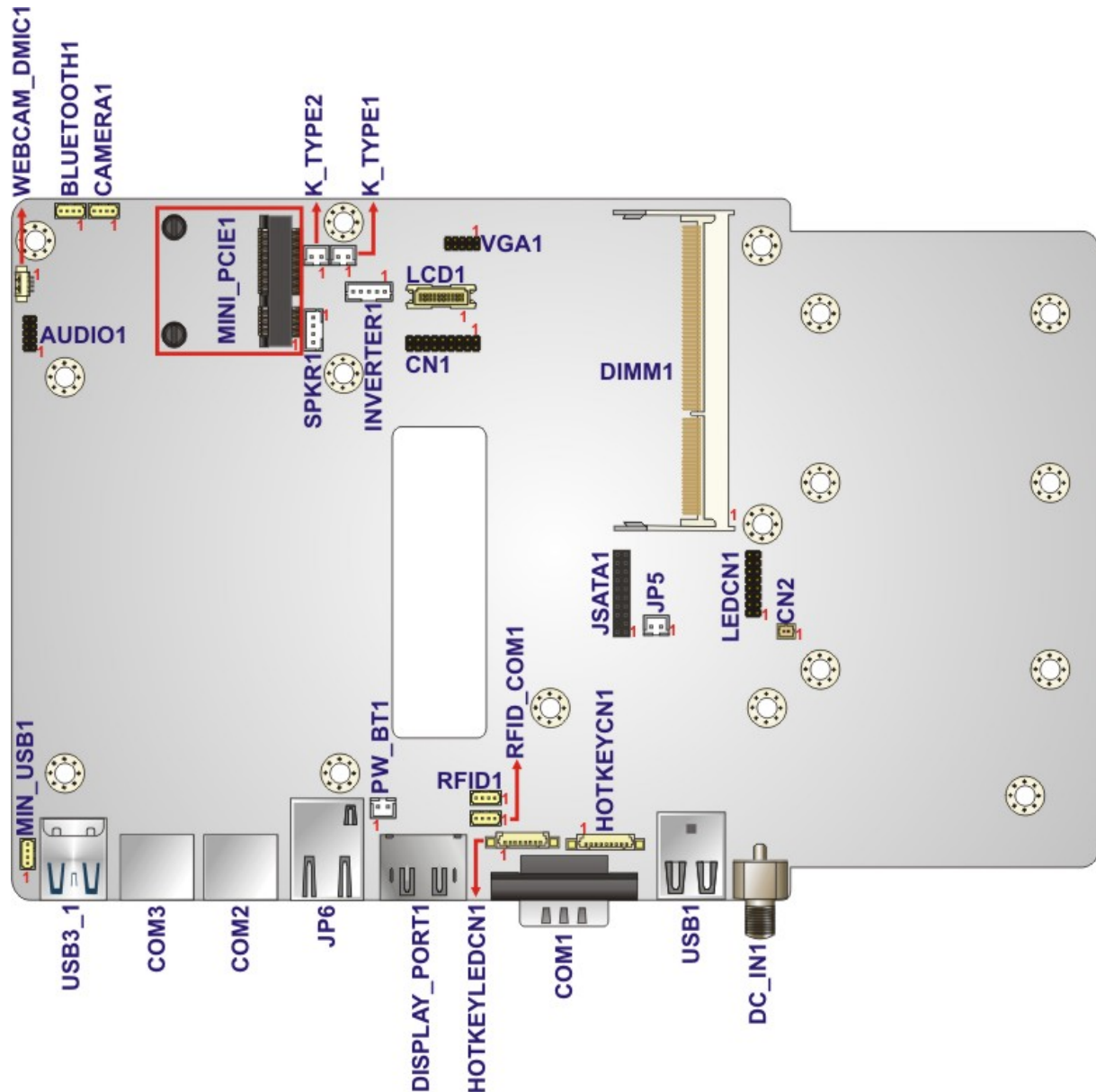

Figure 7-1: Main Board Layout Diagram (Front Side)

AFL2-10A-N28 Panel PC

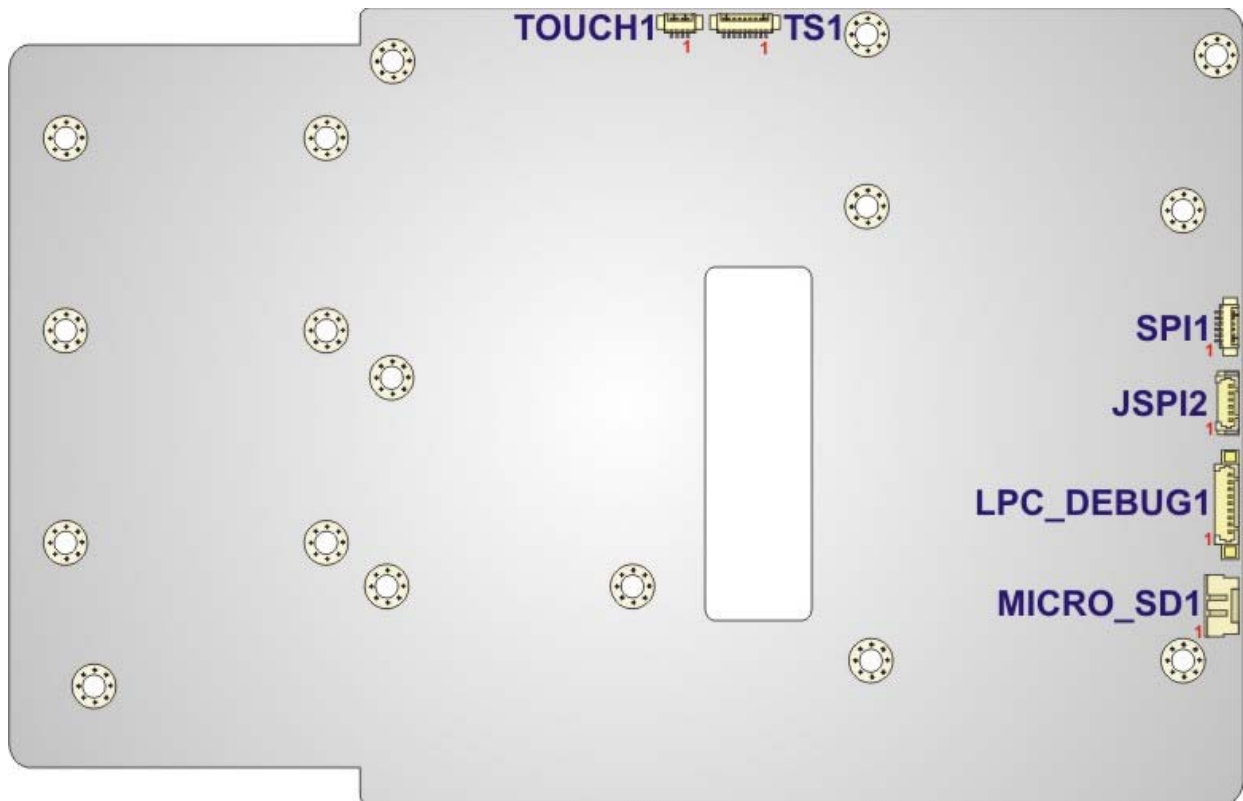

Figure 7-2: Main Board Layout Diagram (Solder Side)

7.2 Internal Peripheral Connectors

Internal peripheral connectors are found on the motherboard and are only accessible when the motherboard is outside of the chassis. The table below shows a list of the peripheral interface connectors on the AFL2MB-15A. Pinouts of these connectors can be found in the following sections.

Connector	Type	Label
Audio connector	10-pin header	AUDIO1
Battery connector	2-pin wafer	CN2
Bluetooth USB connector	4-pin wafer	BLUETOOTH1
CRT connector	10-pin header	VGA1
Debug port	9-pin wafer	LPC_DEBUG1

Connector	Type	Label
EC debug connector	18-pin header	CN1
HDD connector	20-pin connector	JSATA1
Hot key connector	9-pin wafer	HOTKEYCN1
Hot key LED connector	8-pin wafer	HOTKEYLEDCN1
LED indicator connector	16-pin header	LEDCN1
LVDS connector	20-pin crimp	LCD1
LVDS backlight connector	5-pin wafer	INVERTER1
microSD connector	5-pin wafer	MICRO_SD1
Mini USB connector	4-pin wafer	MINI_USB1
PCIe Mini card slot	PCIe Mini card slot	MINI_PCIE1
Power button connector	2-pin wafer	PW_BT1
RFID COM connector	4-pin wafer	RFID_COM1
RFID USB connector	4-pin wafer	RFID1
SATA LED connector	2-pin wafer	JP5
SO-DIMM connector	SO-DIMM connector	DIMM1
Speaker connector	4-pin wafer	SPKR1
SPI Flash connector	6-pin wafer	SPI1
SPI Flash connector (EC)	6-pin wafer	JSPI2
Touch panel connector (1)	9-pin wafer	TS1
Touch panel connector (2)	4-pin wafer	TOUCH1
Type K thermocouple connector	2-pin wafer	K_TYPE1, K_TYPE2
Webcam USB connector	4-pin wafer	CAMERA1
Webcam microphone connector	4-pin wafer	WEBCAM_DMIC1

Table 7-1: Peripheral Interface Connectors

AFL2-10A-N28 Panel PC

7.2.1 Audio Connector (AUDIO1)

PIN NO.	DESCRIPTION	PIN NO.	DESCRIPTION
1	LINE_OUTR	2	LMIC1-L
3	AMP_INR	4	LMIC1-R
5	LINE_OUTL	6	FRONT_JD
7	FRONT_JD	8	MIC1_JD
9	GND_AUDIO	10	GND_AUDIO

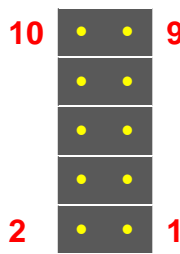

Table 7-2: Audio Connector (AUDIO1) Pinouts

7.2.2 Battery Connector (CN2)

PIN NO.	DESCRIPTION
1	VCC
2	GND

Table 7-3: Battery Connector (CN2) Pinouts

7.2.3 Bluetooth USB Connector (BLUETOOTH1)

PIN NO.	DESCRIPTION
1	VCC
2	-DATA7
3	+DATA7
4	GND

Table 7-4: Bluetooth USB Connector (BLUETOOTH1) Pinouts

7.2.4 CRT Connector (VGA1)

PIN NO.	DESCRIPTION	PIN NO.	DESCRIPTION
1	L_RED	2	DDC_DATA
3	L_GREEN	4	DDC_CLK
5	L_BLUE	6	D_GND
7	HSYNC	8	GND
9	VSYNC	10	GND

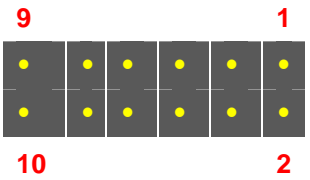

Table 7-5: CRT Connector (VGA1) Pinouts

7.2.5 Debug Connector (LPC_DEBUG1)

PIN NO.	DESCRIPTION
1	PLT_RST#
2	LPC_DEBUG_CLK
3	GND
4	LPC_AD3
5	LPC_AD2
6	LPC_AD1
7	LPC_AD0
8	LPC-FRAME#
9	VCC3

Table 7-6: Debug Connector (LPC_DEBUG1) Pinouts

7.2.6 EC Debug Connector (CN1)

PIN NO.	DESCRIPTION	PIN NO.	DESCRIPTION
1	EC_EPP_STB#	2	EC_EPP_AFD#
3	EC_EPP_PD0	4	EC_EPP_ERR#
5	EC_EPP_PD1	6	EC_EPP_INIT#
7	EC_EPP_PD2	8	EC_EPP_SLIN#
9	EC_EPP_PD3	10	GND
11	EC_EPP_PD4	12	EC_EPP_ACK#
13	EC_EPP_PD5	14	EC_EPP_BUSY

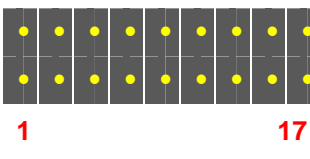

AFL2-10A-N28 Panel PC

15	EC_EPP_PD6	16	EC_EPP_PE
17	EC_EPP_PD7	18	EC_EPP_SLCT

Table 7-7: EC Debug Connector (CN1) Pinouts

7.2.7 HDD Connector (JSATA1)

PIN NO.	DESCRIPTION	PIN NO.	DESCRIPTION
1	GND	2	VCC12
3	NC	4	VCC12
5	NC	6	NC
7	GND	8	VCC5
9	SATA_RXP0_C	10	VCC5
11	SATA_RXN0_C	12	VCC5
13	GND	14	VCC5
15	SATA_TXN0_C	16	GND
17	SATA_TXP0_C	18	VCC3
19	GND	20	VCC3

Table 7-8: HDD Connector (JSTAT1) Pinouts

7.2.8 Hot Key LED Connector (HOTKEYLEDCN1)

PIN NO.	DESCRIPTION	PIN NO.	DESCRIPTION
1	KEYLED1	2	KEYLED2
3	KEYLED3	4	KEYLED4
5	KEYLED5	6	KEYLED6
7	GND	8	VCC3

Table 7-9: Hotkey LED Connector (HOTKEYLEDCN1) Pinouts

7.2.9 Hot Key Connector (HOTKEYCN1)

PIN NO.	DESCRIPTION	PIN NO.	DESCRIPTION
1	EC_KSO0	2	EC_KSO1
3	EC_KSO2	4	EC_KSO3
5	EC_KSO4	6	EC_KSO5
7	EC_KSI6	8	EC_KSI7
9	GND		

Table 7-10: Hotkey Connector (HOTKEYCN1) Pinouts

7.2.10 LED Indicator Connector (LEDCN1)

PIN NO.	DESCRIPTION	PIN NO.	DESCRIPTION
1	AUDIO_LED#	2	PWRLED01#
3	MIC_LED#	4	PWRLED02#
5	CPU_LED02#	6	AT_LED#
7	CPU_LED01#	8	ATX_LED#
9	AD_LED#	10	VCC3
11	WiFi_LED#	12	VCC3
13	BT_LED#	14	+V3.3A_EC
15	VCC_RFID	16	GROUND

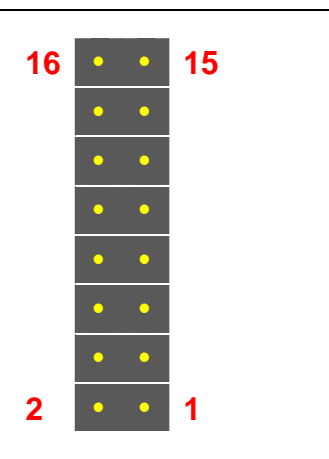
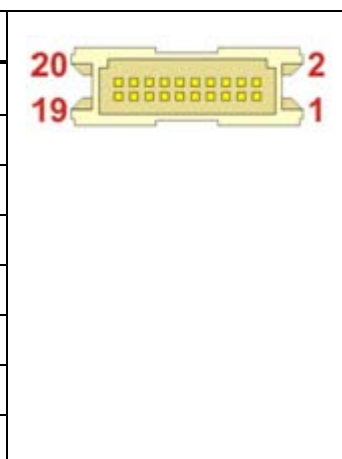

Table 7-11: LED Indicator Connector (LEDCN1) Pinouts

7.2.11 LVDS Connector (LCD1)

PIN NO.	DESCRIPTION	PIN NO.	DESCRIPTION
1	GND	2	GND
3	LVDSA_DATA0_R	4	LVDSA_DATA#0_R
5	LVDSA_DATA1_R	6	LVDSA_DATA#1_R
7	LVDSA_DATA2_R	8	LVDSA_DATA#2_R
9	LVDSA_CLK_R	10	LVDSA_CLK#_R
11	LVDSA_DATA3_R	12	LVDSA_DATA#3_R
13	GND	14	GND
15	SET68	16	NC



AFL2-10A-N28 Panel PC

17	VCC3	18	VCC_LCD
19	VCC_LCD	20	VCC_LCD

Table 7-12: LVDS Connector (LCD1) Pinouts

7.2.12 LVDS Backlight Connector (INVERTER1)

PIN NO.	DESCRIPTION
1	BRIGHTNESS
2	GND
3	BKL_POWER
4	GND
5	ENABKL

Table 7-13: LVDS Backlight Connector (INVERTER1) Pinouts

7.2.13 microSD Connector (MICRO_SD1)

PIN NO.	DESCRIPTION
1	VCC_MSD
2	-DATA3
3	+DATA3
4	GND
5	VCC3

Table 7-14: microSD Connector (MICRO_SD1) Pinouts

7.2.14 Mini USB Connector (MINI_USB1)

PIN NO.	DESCRIPTION
1	VCC_MINIUSB
2	-DATA2
3	+DATA2
4	GND

Table 7-15: Mini USB Connector (MINI_USB1) Pinouts

7.2.15 Power Button Connector (PW_BT1)

PIN NO.	DESCRIPTION
1	PWRBTN_SW#
2	GND

Table 7-16: Power Button Connector (PW_BT1) Pinouts

7.2.16 RFID USB Connector (RFID1)

PIN NO.	DESCRIPTION
1	VCC
2	-DATA5
3	+DATA5
4	GND

Table 7-17: RFID USB Connector (RFID1) Pinouts

7.2.17 RFID COM Connector (RFID_COM1)

PIN NO.	DESCRIPTION
1	VCC
2	SIN2
3	SOUT2
4	GND

Table 7-18: RFID COM Connector (RFID_COM1) Pinouts

7.2.18 SATA LED Connector (JP5)

PIN NO.	DESCRIPTION
1	HDD LED+
2	HDD LED-

Table 7-19: SATA LED Connector (JP5) Pinouts

7.2.19 Speaker Connector (SPKR1)

PIN NO.	DESCRIPTION
1	SPK_OUT_P_R
2	SPK_OUT_N_R
3	SPK_OUT_N_L
4	SPK_OUT_P_L

Table 7-20: Speaker Connector (SPKR1) Pinouts

7.2.20 SPI Flash Connector (SPI1)

PIN NO.	DESCRIPTION
1	SPI_VCC
2	SPI_2N_CS#
3	SPI_2N_MISO
4	SPI_2N_CLK
5	SPI_2N_MOSI
6	GND

Table 7-21: SPI Flash Connector (SPI1) Pinouts

7.2.21 EC SPI Flash Connector (JSPI2)

PIN NO.	DESCRIPTION
1	SPI_VCC
2	FSCE#_S
3	FMISO_S
4	FSCK_S
5	FMOSI_S
6	GND

Table 7-22: EC SPI Flash Connector (JSPI2) Pinouts

7.2.22 Touch Panel Connector (TS1)

PIN NO.	DESCRIPTION
1	X+
2	X-
3	Y+
4	SENSE
5	X+
6	X-
7	Y+
8	Y-
9	GND

Table 7-23: Touch Panel Connector (TS1) Pinouts

7.2.23 Touch Panel Connector (TOUCH1)

PIN NO.	DESCRIPTION
1	VCC
2	-DATA4
3	+DATA4
4	GND

Table 7-24: Touch Panel Connector (TOUCH1) Pinouts

7.2.24 Type K Thermocouple Connector (K_TYPE1, K_TYPE2)

PIN NO.	DESCRIPTION
1	D-
2	D+

Table 7-25: Type K Thermocouple Connector Pinouts

AFL2-10A-N28 Panel PC

7.2.25 Webcam Connector (CAMERA1)

PIN NO.	DESCRIPTION
1	VCC
2	-DATA6
3	+DATA6
4	GND

Table 7-26: Webcam Connector (CAMERA1) Pinouts

7.2.26 Webcam Microphone Connector (WEBCAM_DMIC1)

PIN NO.	DESCRIPTION
1	DMIC_CLK_R
2	DMIC_DATA_R
3	VCC
4	GND

Table 7-27: Webcam Microphone Connector (WEBCAM_DMIC1) Pinouts

7.3 External Interface Panel Connectors

The table below lists the rear panel connectors on the AFL2MB-15A motherboard. Pinouts of these connectors can be found in the following sections.

Connector	Type	Label
DisplayPort connector	DisplayPort	DISPLAY_PORT1
Ethernet connector	RJ-45	JP6
Power connector	Power jack	DC_IN1
RS-232 serial port	DB-9	COM1
RS-232 serial port	RJ-45	COM3
RS-422/485 serial port	RJ-45	COM2
USB 2.0 connectors	USB 2.0 port	USB1
USB 3.0 connectors	USB 3.0 port	USB3_1

Table 7-28: Rear Panel Connectors

7.3.1 Ethernet Connector (JP6)

PIN NO.	DESCRIPTION	PIN NO.	DESCRIPTION
1	DA+	5	DC-
2	DA-	6	DB-
3	DB+	7	DD+
4	DC+	8	DD-

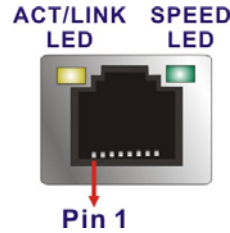

Table 7-29: Ethernet Connector (JP6) Pinouts

7.3.2 Power Connector (DC_IN1)

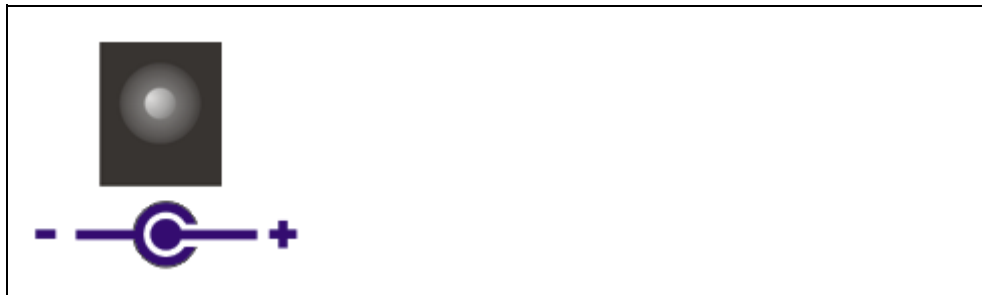

Table 7-30: Power Connector (DC_IN1) Pinouts

7.3.3 RS-232 DB-9 Serial Ports (COM1)

PIN NO.	DESCRIPTION	PIN NO.	DESCRIPTION
1	NDCD1	2	NRX1
3	NTX1	4	NDTR1
5	GND	6	NDSR1
7	NRTS1	8	NCTS1
9	NRI1		

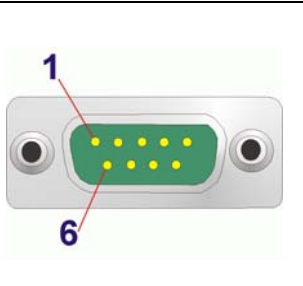

Table 7-31: RS-232 DB-9 Serial Ports (COM1) Pinouts

AFL2-10A-N28 Panel PC

7.3.4 RS-422/485 RJ-45 Serial Port (COM2)

PIN NO.	DESCRIPTION	PIN NO.	DESCRIPTION
1	RXD422+	2	NC
3	RXD422-	4	NC
5	TXD422+/TXD485+	6	NC
7	TXD422-/TXD485-	8	NC

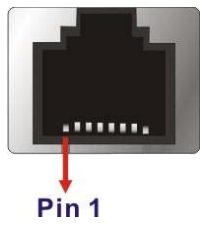

Table 7-32: RS-422/485 Serial Port (COM2) Pinouts

The serial device is connected to the system through the RJ-45 to COM port cable. The DB-9 connector pinouts of the cable are listed below.

PIN NO.	RS-422	RS-485
1	RX+	-
2	RX-	-
3	TX+	DATA+
4	TX-	DATA-
5	-	-
6	-	-
7	-	-
8	-	-
9	-	-

Table 7-33: DB-9 Connector Pinout

7.3.5 RS-232 RJ-45 Serial Ports (COM3)

PIN NO.	DESCRIPTION	PIN NO.	DESCRIPTION
1	ND3D3	2	NDSR4
3	NRXD4	4	NRTS4
5	NTX4	6	NCTS4
7	NDTR4	8	NR14

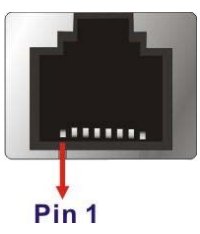

Table 7-34: RS-232 RJ-45 Serial Ports (COM3) Pinouts

7.3.6 USB 2.0 Connectors (USB1)

PIN NO.	DESCRIPTION	PIN NO.	DESCRIPTION
1	POWER	5	Power
2	DATA0-	6	DATA1-
3	DATA0+	7	DATA1+
4	GND	8	GND

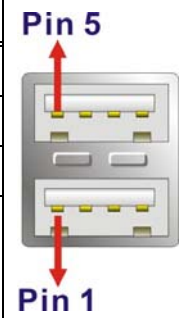

Table 7-35: USB 2.0 Connectors (USB1) Pinouts

7.3.7 USB 3.0 Connectors (USB3_1)

PIN NO.	DESCRIPTION	PIN NO.	DESCRIPTION
1	USB3_PWR1	10	USB3_PWR2
2	USB2P0_DM1_L	11	USB2P0_DM2_L
3	USB2P0_DP1_L	12	USB2P0_DP2_L
4	GND	13	GND
5	USB3P0_RXDN1_L	14	USB3P0_RXDN2_L
6	USB3P0_RXDP1_L	15	USB3P0_RXDP2_L
7	GND	16	GND
8	USB3P0_TXDN1_C_L	17	USB3P0_TXDN2_C_L
9	USB3P0_TXDP1_C_L	18	USB3P0_TXDP2_C_L

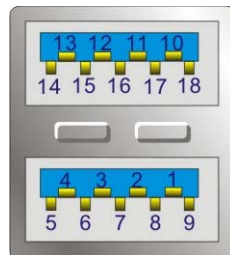

Table 7-36: USB 3.0 Connectors (USB3_1) Pinouts

7.3.8 DisplayPort Connector (DISPLAY_PORT1)

PIN NO.	DESCRIPTION	PIN NO.	DESCRIPTION
1	C_DDIO_DP_DATA0	2	GND
3	C_DDIO_DP_DATA0#	4	C_DDIO_DP_DATA1
5	GND	6	C_DDIO_DP_DATA1#
7	C_DDIO_DP_DATA2	8	GND
9	C_DDIO_DP_DATA2#	10	C_DDIO_DP_DATA3
11	GND	12	C_DDIO_DP_DATA3#

AFL2-10A-N28 Panel PC

13	GND	14	GND
15	C_DDIO_DP_AUXP	16	GND
17	C_DDIO_DP_AUXN	18	C_DDIO_DP_HPD
19	GND	20	VCC
21	GND	22	GND
23	GND	24	GND

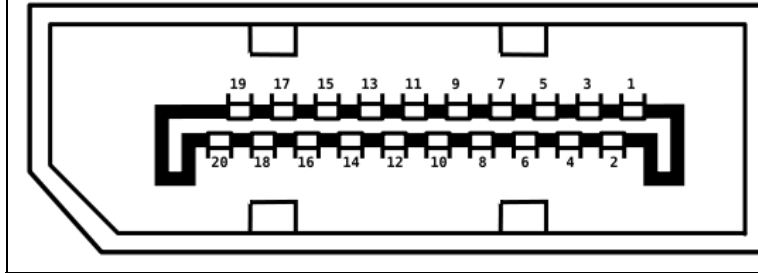

Table 7-37: DisplayPort Connector (DISPLAY_PORT1) Pinouts

Appendix

A

Safety Precautions

**WARNING:**

The precautions outlined in this chapter should be strictly followed. Failure to follow these precautions may result in permanent damage to the AFL2-10A-N28.

A.1 Safety Precautions

Please follow the safety precautions outlined in the sections that follow:

A.1.1 General Safety Precautions

Please ensure the following safety precautions are adhered to at all times.

- **Follow the electrostatic precautions** outlined below whenever the AFL2-10A-N28 is opened.
- **Make sure the power is turned off and the power cord is disconnected** whenever the AFL2-10A-N28 is being installed, moved or modified.
- **Do not apply voltage levels that exceed the specified voltage range.** Doing so may cause fire and/or an electrical shock.
- **Electric shocks can occur** if the AFL2-10A-N28 chassis is opened when the AFL2-10A-N28 is running.
- **Do not drop or insert any objects** into the ventilation openings of the AFL2-10A-N28.
- **If considerable amounts of dust, water, or fluids enter the AFL2-10A-N28,** turn off the power supply immediately, unplug the power cord, and contact the AFL2-10A-N28 vendor.
- **DO NOT:**
 - Drop the AFL2-10A-N28 against a hard surface.
 - Strike or exert excessive force onto the LCD panel.
 - Touch any of the LCD panels with a sharp object
 - In a site where the ambient temperature exceeds the rated temperature

A.1.2 CPU Temperature Warning

**WARNING:**

If the CPU Temperature Alert LED shows **RED**, the CPU core temperature is too high. To lower the CPU temperature, lower the environment temperature or decrease the amount of running programs.

A.1.3 Anti-static Precautions

**WARNING:**

Failure to take ESD precautions during the installation of the AFL2-10A-N28 may result in permanent damage to the AFL2-10A-N28 and severe injury to the user.

Electrostatic discharge (ESD) can cause serious damage to electronic components, including the AFL2-10A-N28. Dry climates are especially susceptible to ESD. It is therefore critical that whenever the AFL2-10A-N28 is opened and any of the electrical components are handled, the following anti-static precautions are strictly adhered to.

- ***Wear an anti-static wristband:*** Wearing a simple anti-static wristband can help to prevent ESD from damaging any electrical component.
- ***Self-grounding:*** Before handling any electrical component, touch any grounded conducting material. During the time the electrical component is handled, frequently touch any conducting materials that are connected to the ground.
- ***Use an anti-static pad:*** When configuring or working with an electrical component, place it on an anti-static pad. This reduces the possibility of ESD damage.
- ***Only handle the edges of the electrical component:*** When handling the electrical component, hold the electrical component by its edges.

AFL2-10A-N28 Panel PC

A.1.4 Product Disposal



CAUTION:

Risk of explosion if battery is replaced by and incorrect type. Only certified engineers should replace the on-board battery.

Dispose of used batteries according to instructions and local regulations.

- Outside the European Union - If you wish to dispose of used electrical and electronic products outside the European Union, please contact your local authority so as to comply with the correct disposal method.
- Within the European Union:

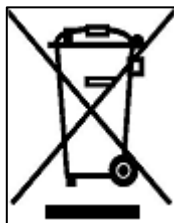

EU-wide legislation, as implemented in each Member State, requires that waste electrical and electronic products carrying the mark (left) must be disposed of separately from normal household waste. This includes monitors and electrical accessories, such as signal cables or power cords.

When you need to dispose of your display products, please follow the guidance of your local authority, or ask the shop where you purchased the product. The mark on electrical and electronic products only applies to the current European Union Member States.

Please follow the national guidelines for electrical and electronic product disposal.

A.2 Maintenance and Cleaning Precautions

When maintaining or cleaning the AFL2-10A-N28, please follow the guidelines below.

A.2.1 Maintenance and Cleaning

Prior to cleaning any part or component of the AFL2-10A-N28, please read the details below.

- Except for the LCD panel, never spray or squirt liquids directly onto any other components. To clean the LCD panel, gently wipe it with a piece of soft dry cloth or a slightly moistened cloth.
- Never use alcohol to clean the external chassis.
- The interior of the AFL2-10A-N28 does not require cleaning. Keep fluids away from the AFL2-10A-N28 interior.
- Be cautious of all small removable components when vacuuming the AFL2-10A-N28.
- Turn the AFL2-10A-N28 off before cleaning the AFL2-10A-N28.
- Never drop any objects or liquids through the openings of the AFL2-10A-N28.
- Be cautious of any possible allergic reactions to solvents or chemicals used when cleaning the AFL2-10A-N28.
- Avoid eating, drinking and smoking within vicinity of the AFL2-10A-N28.

A.2.2 Cleaning Tools

Some components in the AFL2-10A-N28 may only be cleaned using a product specifically designed for the purpose. In such case, the product will be explicitly mentioned in the cleaning tips. Below is a list of items to use when cleaning the AFL2-10A-N28.

- **Cloth** – Although paper towels or tissues can be used, a soft, clean piece of cloth is recommended when cleaning the AFL2-10A-N28.
- **Water** – A cloth moistened with water can be used to clean the AFL2-10A-N28.
- **Using solvents** – The use of solvents is not recommended when cleaning the AFL2-10A-N28 as they may damage the plastic parts.
- **Vacuum cleaner** – Using a vacuum specifically designed for computers is one of the best methods of cleaning the AFL2-10A-N28. Dust and dirt can restrict the airflow in the AFL2-10A-N28 and cause its circuitry to corrode.
- **Cotton swabs** - Cotton swabs moistened with water are excellent tools for wiping hard to reach areas.
- **Foam swabs** - Whenever possible, it is best to use lint free swabs such as foam swabs for cleaning.

Appendix

B

BIOS Menu Options

BIOS Information	48
iWDD Vendor	48
iWDD Version	49
System Date [xx/xx/xx]	49
System Time [xx:xx:xx]	49
ACPI Sleep State [S1 (CPU Stop Clock)]	51
Wake System with Fixed Time [Disabled]	52
Hyper-Threading [Enabled]	53
Configure SATA as [IDE]	54
USB Devices	55
Legacy USB Support [Enabled]	55
Serial Port [Enabled]	57
Change Settings [Auto]	57
Serial Port [Enabled]	58
Change Settings [Auto]	58
Device Mode [RS422/485]	58
Serial Port [Enabled]	58
Change Settings [Auto]	59
Hardware Health Status	60
Console Redirection [Disabled]	61
Auto Recovery Function [Disabled]	62
Micro SD Card [Enabled]	62
IGFX - Boot Type [VBIOS Default]	65
LCD Panel Type [800x600-18BIT]	65
Active LFP [Int-LVDS]	65
Fixed Graphics Memory Size [128 MB]	65
WIFI Function [Enabled]	66
DMIC Function [Enabled]	66
Blue Tooth Function [Enabled]	66
Power Saving Function [Disabled]	67
Restore on AC Power Loss [Last State]	67
Bootup NumLock State [On]	68
Quiet Boot [Enabled]	68
Launch PXE OpROM [Disabled]	68

AFL2-10A-N28 Panel PC

Option ROM Messages [Force BIOS].....	68
UEFI Boot [Disabled]	69
Administrator Password	69
User Password	70
Save Changes and Reset	70
Discard Changes and Reset	70
Restore Defaults	70
Save as User Defaults	71
Restore User Defaults	71

Appendix

C

One Key Recovery

C.1 One Key Recovery Introduction

The IEI one key recovery is an easy-to-use front end for the Norton Ghost system backup and recovery tool. This tool provides quick and easy shortcuts for creating a backup and reverting to that backup or reverting to the factory default settings.



NOTE:

The latest One Key Recovery software provides an auto recovery function that allows a system running Microsoft Windows OS to automatically restore from the factory default image after encountering a Blue Screen of Death (BSoD) or a hang for around 10 minutes. Please refer to Section C.3 for the detailed setup procedure.

The IEI One Key Recovery tool menu is shown below.

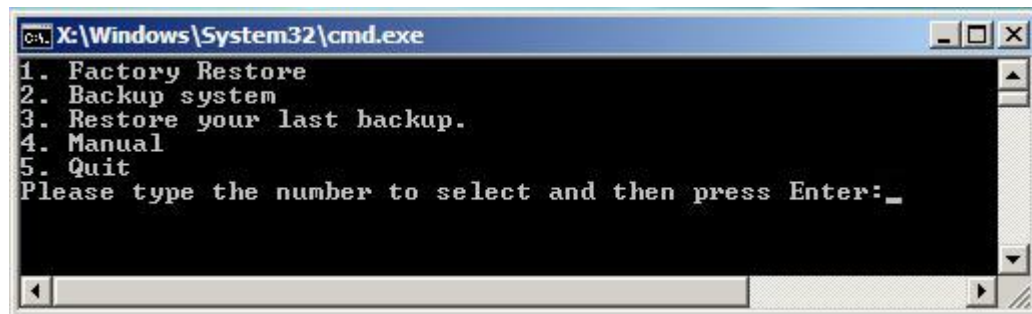

Figure C-1: IEI One Key Recovery Tool Menu

Prior to using the IEI One Key Recovery tool (as shown in **Figure C-1**) to backup or restore Windows system, five setup procedures are required.

1. Hardware and BIOS setup (see **Section C.2.1**)
2. Create partitions (see **Section C.2.2**)
3. Install operating system, drivers and system applications (see **Section C.2.3**)
4. Build the recovery partition (see **Section C.2.4**)
5. Create factory default image (see **Section C.2.5**)

After completing the five initial setup procedures as described above, users can access the recovery tool by pressing <F3> while booting up the system. The detailed information of each function is described in **Section C.5**.



NOTE:

The initial setup procedures for Linux system are described in **Section C.3**.

C.1.1 System Requirement



NOTE:

The recovery CD can only be used with IEI products. The software will fail to run and a warning message will appear when used on non-IEI hardware.

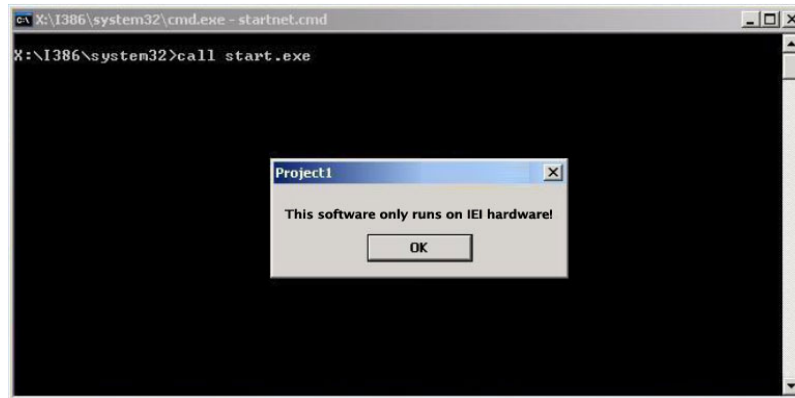

To create the system backup, the main storage device must be split into two partitions (three partitions for Linux). The first partition will be for the operating system, while the second partition will be invisible to the operating system and contain the backup made by the one key recovery software.

The partition created for recovery images must be big enough to contain both the factory default image and the user backup image. The size must be calculated before creating the

AFL2-10A-N28 Panel PC

partitions. Please take the following table as a reference when calculating the size of the partition.

	OS	OS Image after Ghost	Compression Ratio
Windows® 7	7 GB	5 GB	70%
Windows® XPE	776 MB	560 MB	70%
Windows® CE 6.0	36 MB	28 MB	77%



NOTE:

Specialized tools are required to change the partition size if the operating system is already installed.

C.1.2 Supported Operating System

The recovery CD is compatible with both Microsoft Windows and Linux operating systems (OS). The supported OS versions are listed below.

- Microsoft Windows
 - Windows 2000
 - Windows XP (Service Pack 2 or 3 required)
 - Windows Vista
 - Windows 7
 - Windows CE 5.0
 - Windows CE 6.0
 - Windows XP Embedded
 - Windows Embedded Standard 7



NOTE:

The auto recovery function (described in Section C.3) and the restore through LAN function (described in Section C.6) are not supported in the Windows CE 5.0/6.0 operating system environment.

- Linux
 - Fedora Core 12 (Constantine)
 - Fedora Core 11 (Leonidas)
 - Fedora Core 10 (Cambridge)
 - Fedora Core 8 (Werewolf)
 - Fedora Core 7 (Moonshine)
 - RedHat RHEL-5.4
 - RedHat 9 (Ghirke)
 - Ubuntu 8.10 (Intrepid)
 - Ubuntu 7.10 (Gutsy)
 - Ubuntu 6.10 (Edgy)
 - Debian 5.0 (Lenny)
 - Debian 4.0 (Etch)
 - SuSe 11.2
 - SuSe 10.3

**NOTE:**

Installing unsupported OS versions may cause the recovery tool to fail.

C.2 Setup Procedure for Windows

Prior to using the recovery tool to backup or restore, a few setup procedures are required.

Step 1: Hardware and BIOS setup (see **Section C.2.1**)

Step 2: Create partitions (see **Section C.2.2**)

Step 3: Install operating system, drivers and system applications (see **Section C.2.3**)

Step 4: Build the recovery partition (see **Section C.2.4**) or build the auto recovery partition (see **Section C.3**)

Step 5: Create factory default image (see **Section C.2.5**)

AFL2-10A-N28 Panel PC

The detailed descriptions are described in the following sections.



NOTE:

The setup procedures described below are for Microsoft Windows operating system users. For Linux, most of the setup procedures are the same except for several steps described in **Section C.3**.

C.2.1 Hardware and BIOS Setup

- Step 1:** Make sure the system is powered off and unplugged.
- Step 2:** Install a hard drive or SSD in the system. An unformatted and unpartitioned disk is recommended.
- Step 3:** Connect an optical disk drive to the system and insert the recovery CD.
- Step 4:** Turn on the system.
- Step 5:** Press the <DELETE> key as soon as the system is turned on to enter the BIOS.
- Step 6:** Select the connected optical disk drive as the 1st boot device. (**Boot** → **Boot Device Priority** → **1st Boot Device**).
- Step 7:** Save changes and restart the computer. Continue to the next section for instructions on partitioning the internal storage.

C.2.2 Create Partitions

To create the system backup, the main storage device must be split into two partitions (three partitions for Linux). The first partition will be for the operating system, while the second partition will be invisible to the operating system and contain the backup made by the one key recovery software.

- Step 1:** Put the recovery CD in the optical drive of the system.

Step 2: Boot the system from recovery CD. When prompted, press any key to boot from the recovery CD. It will take a while to launch the recovery tool. Please be patient!

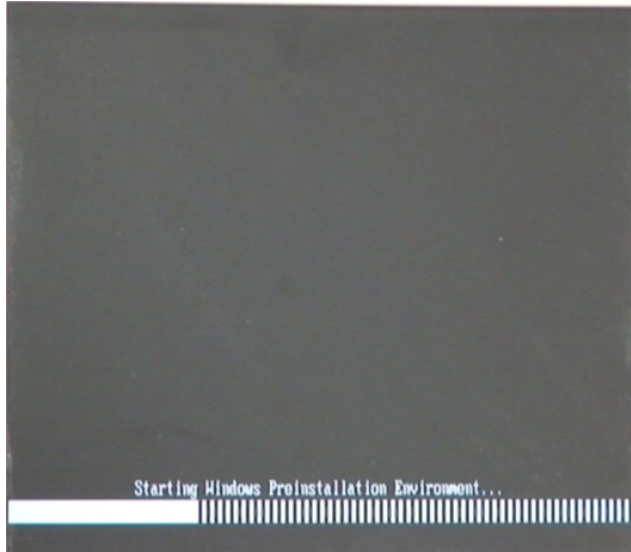

Figure C-2: Launching the Recovery Tool

Step 3: The recovery tool setup menu is shown as below.

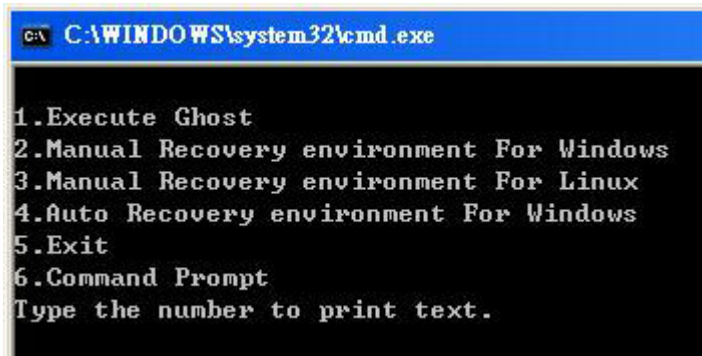
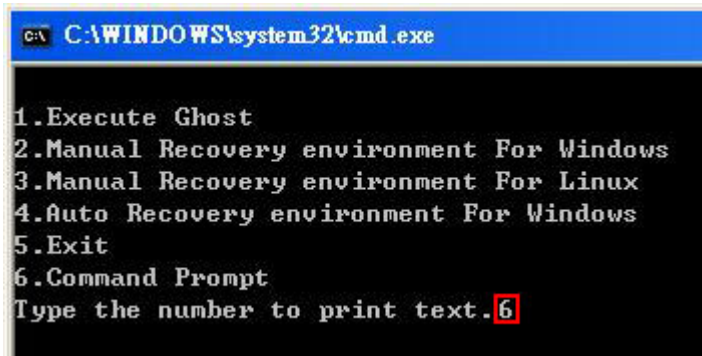

Figure C-3: Recovery Tool Setup Menu

Step 4: Press <6> then <Enter>.

AFL2-10A-N28 Panel PC



```
C:\WINDOWS\system32\cmd.exe

1.Execute Ghost
2.Manual Recovery environment For Windows
3.Manual Recovery environment For Linux
4.Auto Recovery environment For Windows
5.Exit
6.Command Prompt
Type the number to print text.6
```

Figure C-4: Command Prompt

Step 5: The command prompt window appears. Type the following commands (marked in red) to create two partitions. One is for the OS installation; the other is for saving recovery files and images which will be an invisible partition. (Press <Enter> after entering each line below)

```
system32>diskpart
DISKPART>list vol
DISKPART>sel disk 0
DISKPART>create part pri size= ____
DISKPART>assign letter=N
DISKPART>create part pri size= ____
DISKPART>assign letter=F
DISKPART>exit
system32>format N: /fs:ntfs /q /y
system32>format F: /fs:ntfs /q /v:Recovery /y
system32>exit
```

```

X:\I386\SYSTEM32\CMD.EXE
X:\I386\SYSTEM32>diskpart → Starts the Microsoft disk partitioning tool.
Microsoft DiskPart version 5.2.3790.1830
Copyright (C) 1999-2001 Microsoft Corporation.
On computer: MININT-JUC

DISKPART> list vol → Show partition information

Volume ### Ltr Label Fs Type Size Status Info
-----
Volume 0 X CD_ROM CDFS DUD-ROM 405 MB Healthy Boot
Volume 1 D FAT32 Removeable 3854 MB Healthy

DISKPART> sel disk 0 → Select a disk
Disk 0 is now the selected disk.

DISKPART> create part pri size=2000 → Create partition 1 and assign a size.
This partition is for OS installation.
DiskPart succeeded in creating the specified partition.

DISKPART> assign letter=N → Assign partition 1 a code name (N).
DiskPart successfully assigned the drive letter or mount point.

DISKPART> create part pri size=1800 → Create partition 2 and assign a size.
This partition is for recovery images.
DiskPart succeeded in creating the specified partition.

DISKPART> assign letter=F → Assign partition 2 a code name (F).
DiskPart successfully assigned the drive letter or mount point.

DISKPART> exit → Exit diskpart
X:\I386\SYSTEM32>format n: /fs:ntfs /q /y → Format partition 1 (N) as NTFS format.
The type of the file system is RAW.
The new file system is NTFS.
QuickFormatting 2000M
Creating file system structures.
Format complete.
2048254 KB total disk space.
2035620 KB are available.

X:\I386\SYSTEM32>format f: /fs:ntfs /q /v:Recovery /y → Formate partition 2 (F) as NTFS formate and
name it as "Recovery".
The type of the file system is RAW.
The new file system is NTFS.
QuickFormatting 1804M
Creating file system structures.
Format complete.
1847474 KB total disk space.
1835860 KB are available.

X:\I386\SYSTEM32>exit → Exit Windows PE
  
```

Figure C-5: Partition Creation Commands

AFL2-10A-N28 Panel PC



NOTE:

Use the following commands to check if the partitions were created successfully.

```
X:\I386\SYSTEM32>diskpart
Microsoft DiskPart version 5.2.3790.1830
Copyright (C) 1999-2001 Microsoft Corporation.
On computer: MININT-JUC

DISKPART> sel disk 0
Disk 0 is now the selected disk.

DISKPART> list part

   Partition ###   Type              Size              Offset
-----
   Partition 1     Primary            2000 MB           32 KB
   Partition 2     Primary            1804 MB          2000 MB

DISKPART> exit
```

Step 6: Press any key to exit the recovery tool and automatically reboot the system.

Please continue to the following procedure: Build the Recovery Partition.

C.2.3 Install Operating System, Drivers and Applications

Install the operating system onto the unlabelled partition. The partition labeled "Recovery" is for use by the system recovery tool and should not be used for installing the operating system or any applications.



NOTE:

The operating system installation program may offer to reformat the chosen partition. DO NOT format the partition again. The partition has already been formatted and is ready for installing the new operating system.

To install the operating system, insert the operating system installation CD into the optical drive. Restart the computer and follow the installation instructions.

C.2.4 Building the Recovery Partition

- Step 1:** Put the recover CD in the optical drive.
- Step 2:** Start the system.
- Step 3:** **Boot the system from the recovery CD.** When prompted, press any key to boot from the recovery CD. It will take a while to launch the recovery tool. Please be patient!

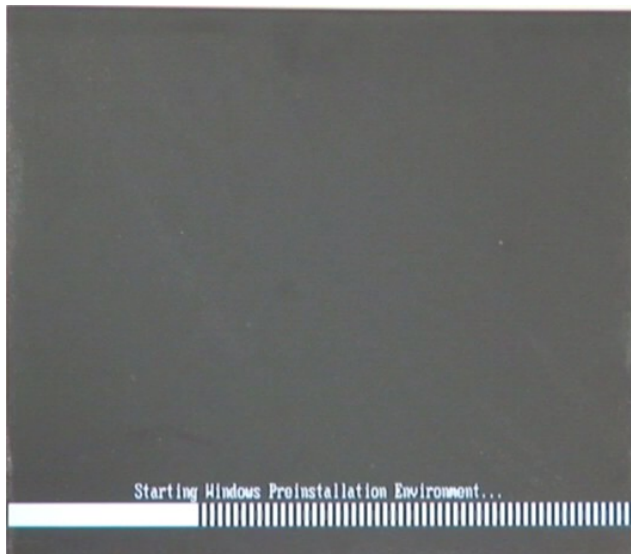

Figure C-6: Launching the Recovery Tool

- Step 4:** When the recovery tool setup menu appears, press <2> then <Enter>.

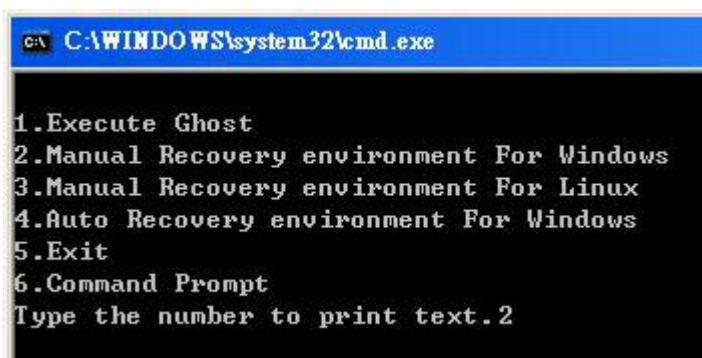

Figure C-7: Manual Recovery Environment for Windows

AFL2-10A-N28 Panel PC

Step 5: The Symantec Ghost window appears and starts configuring the system to build a recovery partition. In this process the partition created for recovery files in **Section C.2.2** is hidden and the recovery tool is saved in this partition.

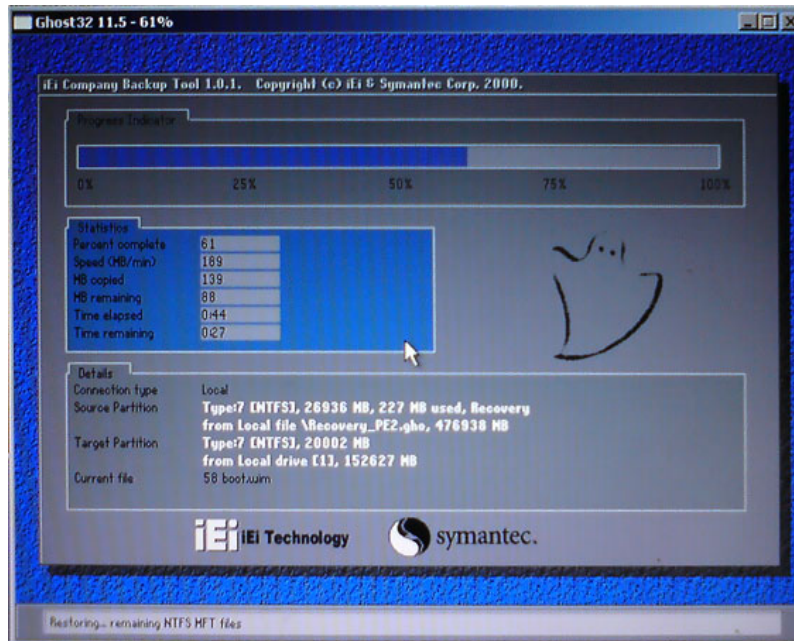

Figure C-8: Building the Recovery Partition

Step 6: After completing the system configuration, press any key in the following window to reboot the system.

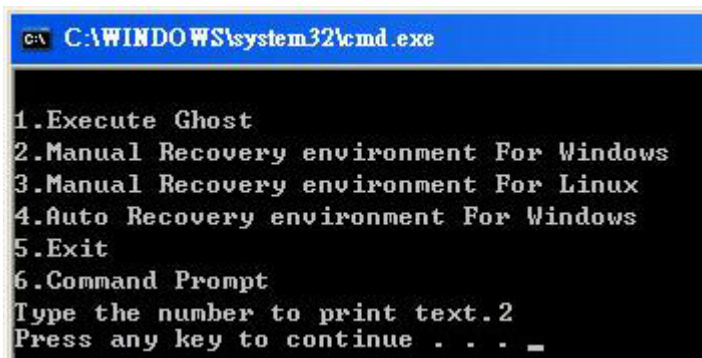

Figure C-9: Press Any Key to Continue

Step 7: Eject the recovery CD.

C.2.5 Create Factory Default Image



NOTE:

Before creating the factory default image, please configure the system to a factory default environment, including driver and application installations.

To create a factory default image, please follow the steps below.

Step 1: Turn on the system. When the following screen displays (**Figure C-10**), press the <F3> key to access the recovery tool. The message will display for 10 seconds, please press F3 before the system boots into the operating system.

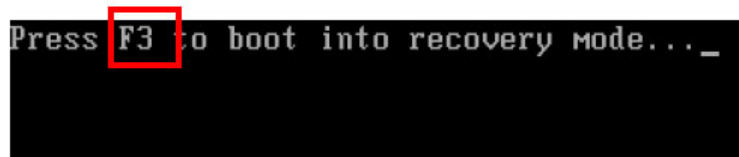

Figure C-10: Press F3 to Boot into Recovery Mode

Step 2: The recovery tool menu appears. Type <4> and press <Enter>. (**Figure C-11**)

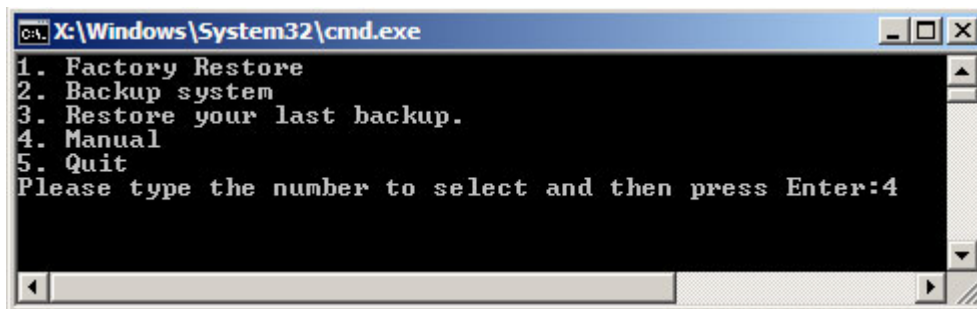

Figure C-11: Recovery Tool Menu

Step 3: The About Symantec Ghost window appears. Click **OK** button to continue.

AFL2-10A-N28 Panel PC

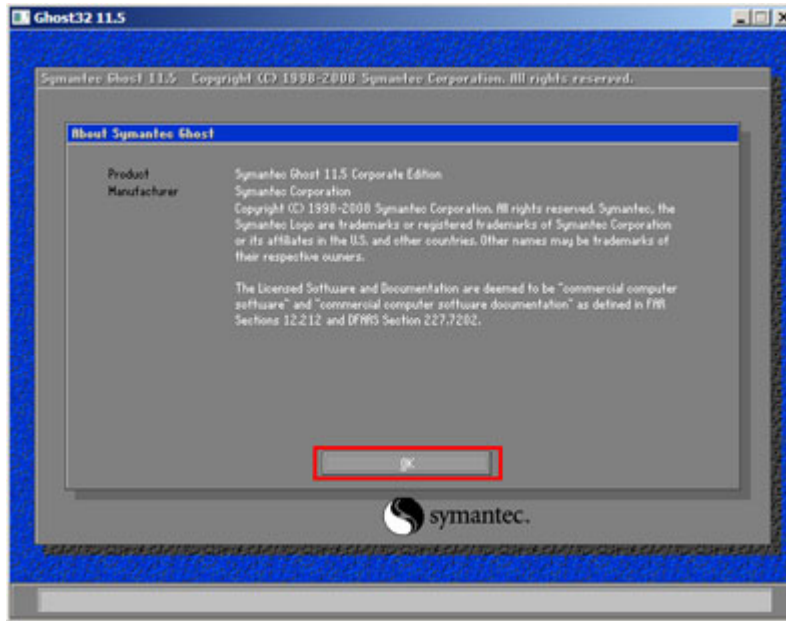

Figure C-12: About Symantec Ghost Window

Step 4: Use mouse to navigate to the option shown below (Figure C-13).

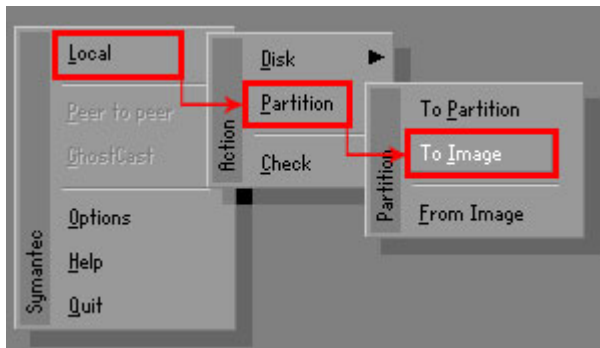

Figure C-13: Symantec Ghost Path

Step 5: Select the local source drive (Drive 1) as shown in Figure C-14. Then click OK.

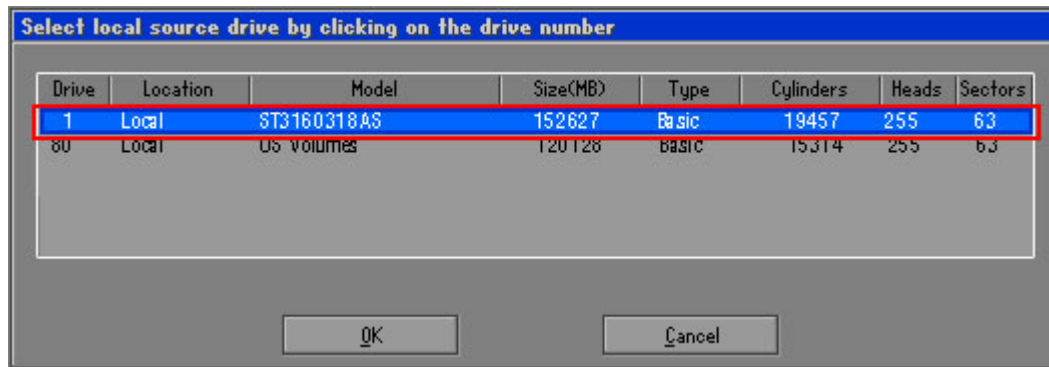

Figure C-14: Select a Local Source Drive

Step 6: Select a source partition (Part 1) from basic drive as shown in **Figure C-15**. Then click OK.

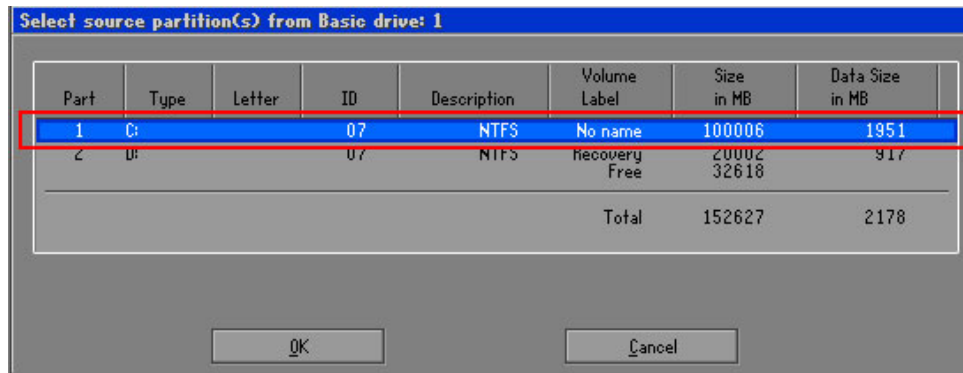

Figure C-15: Select a Source Partition from Basic Drive

Step 7: Select **1.2: [Recovery] NTFS drive** and enter a file name called **iei** (**Figure C-16**). Click **Save**. The factory default image will then be saved in the selected recovery drive and named **IEI.GHO**.



WARNING:

The file name of the factory default image must be **iei.GHO**.

AFL2-10A-N28 Panel PC

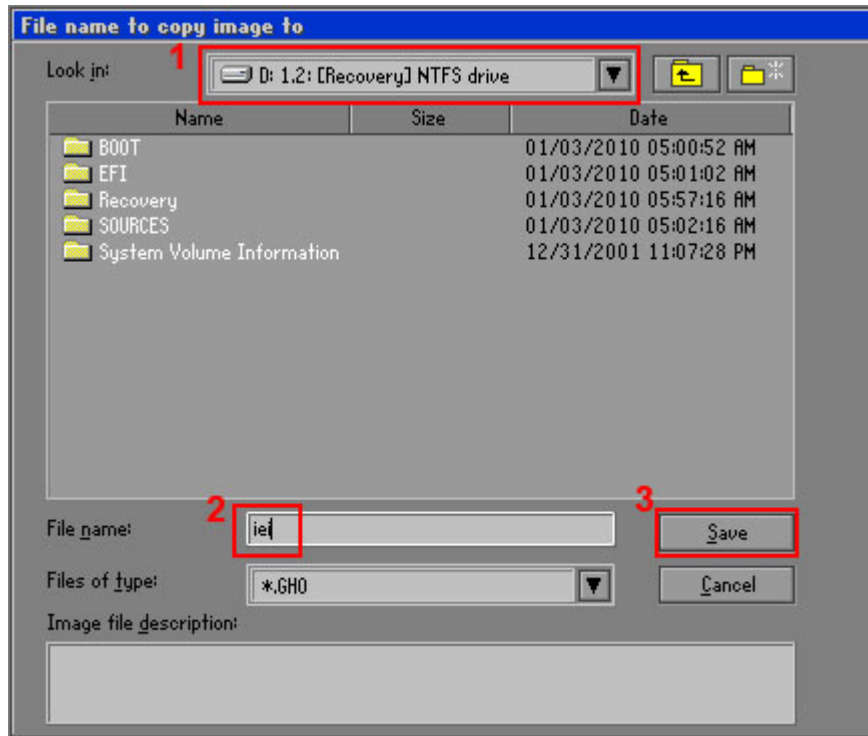

Figure C-16: File Name to Copy Image to

Step 8: When the Compress Image screen in **Figure C-17** prompts, click **High** to make the image file smaller.

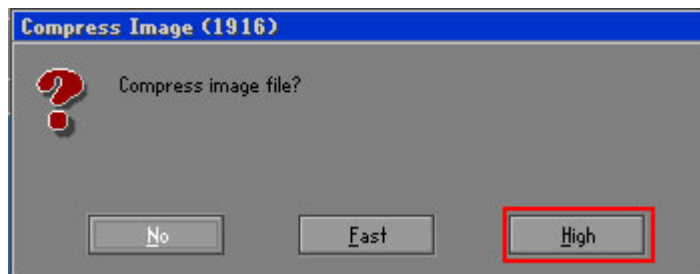

Figure C-17: Compress Image

Step 9: The Proceed with partition image creation window appears, click **Yes** to continue.

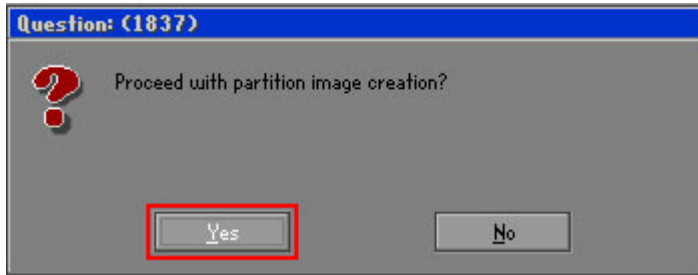

Figure C-18: Image Creation Confirmation

Step 10: The Symantec Ghost starts to create the factory default image (**Figure C-19**).

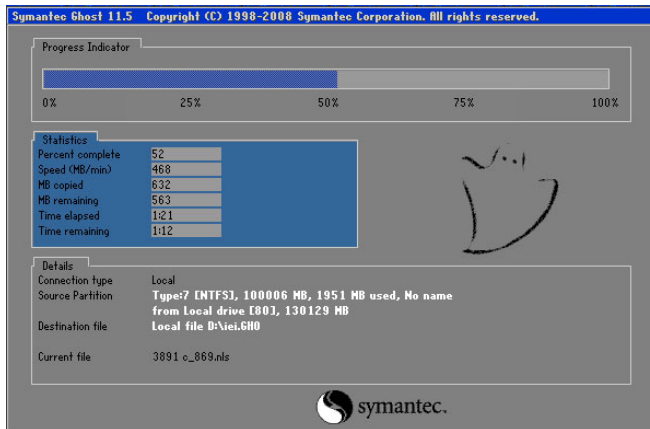

Figure C-19: Image Creation Complete

Step 11: When the image creation completes, a screen prompts as shown in **Figure C-20**.

Click **Continue** and close the Ghost window to exit the program.

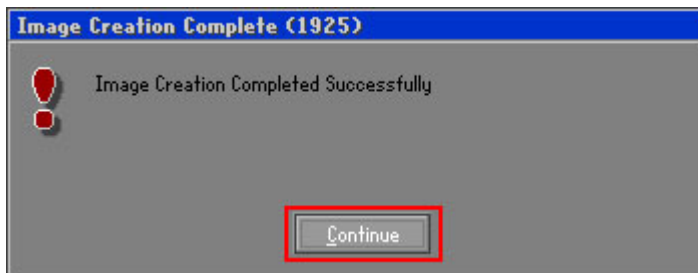
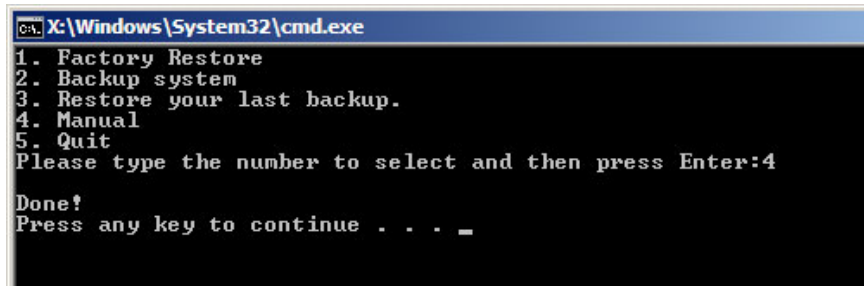

Figure C-20: Image Creation Complete

AFL2-10A-N28 Panel PC

Step 12: The recovery tool main menu window is shown as below. Press any key to reboot the system.



```
C:\Windows\System32\cmd.exe
1. Factory Restore
2. Backup system
3. Restore your last backup.
4. Manual
5. Quit
Please type the number to select and then press Enter:4
Done!
Press any key to continue . . . _
```

Figure C-21: Press Any Key to Continue

C.3 Auto Recovery Setup Procedure

The auto recovery function allows a system to automatically restore from the factory default image after encountering a Blue Screen of Death (BSoD) or a hang for around 10 minutes. To use the auto recovery function, follow the steps described in the following sections.



CAUTION:

The auto recovery function can only run on a Microsoft Windows system with the following OS versions:

- Windows 2000
- Windows XP
- Windows Vista
- Windows 7
- Windows XP Embedded
- Windows Embedded Standard 7



CAUTION:

The setup procedure may include a step to create a factory default image. It is suggested to configure the system to a factory default environment before the configuration, including driver and application installations.

Step 1: Follow the steps described in **Section C.2.1 ~ Section C.2.3** to setup BIOS, create partitions and install operating system.

Step 2: Install the auto recovery utility into the system by double clicking the **Utility/AUTORECOVERY-SETUP.exe** in the One Key Recovery CD. This utility **MUST** be installed in the system, otherwise, the system will automatically restore from the factory default image every ten (10) minutes.



Figure C-22: Auto Recovery Utility

Step 3: **Disable the automatically restart function before creating the factory default image.** Go to: My Computer → Properties → Advanced. Click the Settings button of Startup and Recovery. Deselect “Automatically restart”. Click OK to save the settings and exit. (See Figure C-23)

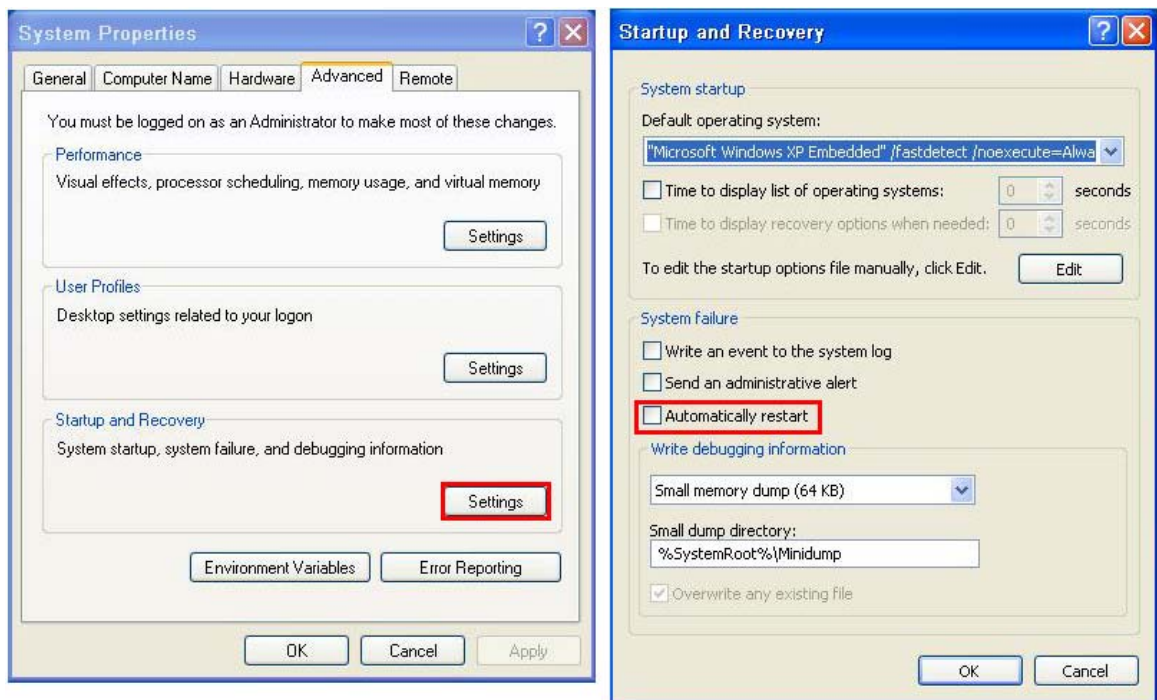

Figure C-23: Disable Automatically Restart

AFL2-10A-N28 Panel PC

Step 4: Reboot the system from the recovery CD. When prompted, press any key to boot from the recovery CD. It will take a while to launch the recovery tool. Please be patient!

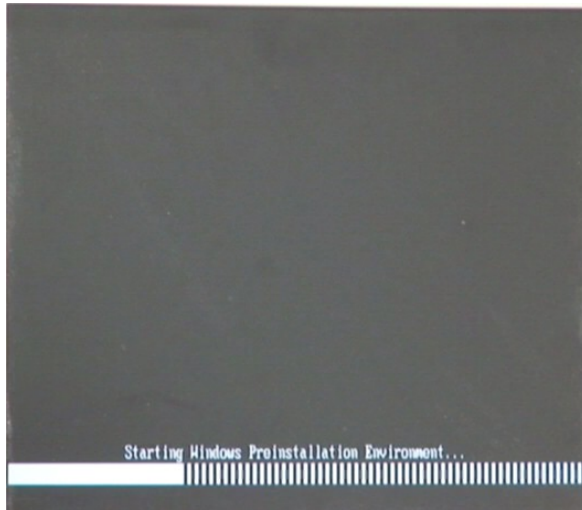

Figure C-24: Launching the Recovery Tool

Step 5: When the recovery tool setup menu appears, press <4> then <Enter>.

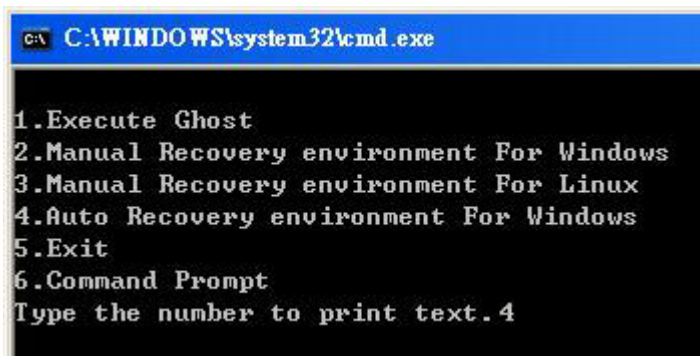

Figure C-25: Auto Recovery Environment for Windows

Step 6: The Symantec Ghost window appears and starts configuring the system to build an auto recovery partition. In this process the partition created for recovery files in **Section C.2.2** is hidden and the auto recovery tool is saved in this partition.

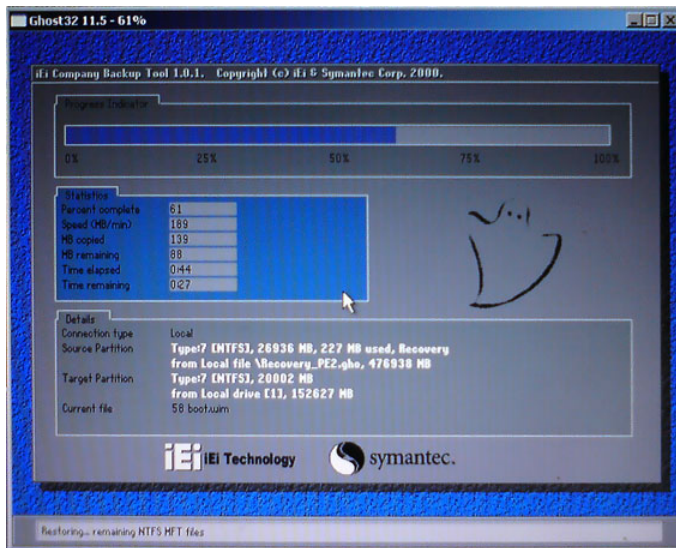

Figure C-26: Building the Auto Recovery Partition

Step 7: After completing the system configuration, the following message prompts to confirm whether to create a factory default image. Type **Y** to have the system create a factory default image automatically. Type **N** within 6 seconds to skip this process (The default option is YES). It is suggested to choose YES for this option.

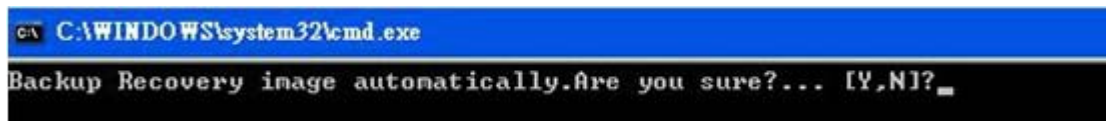

Figure C-27: Factory Default Image Confirmation

AFL2-10A-N28 Panel PC

Step 8: The Symantec Ghost starts to create the factory default image (**Figure C-28**).

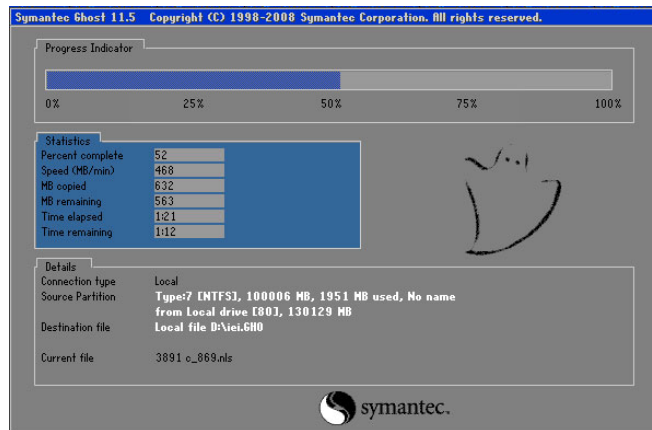

Figure C-28: Image Creation Complete

Step 9: After completing the system configuration, press any key in the following window to restart the system.

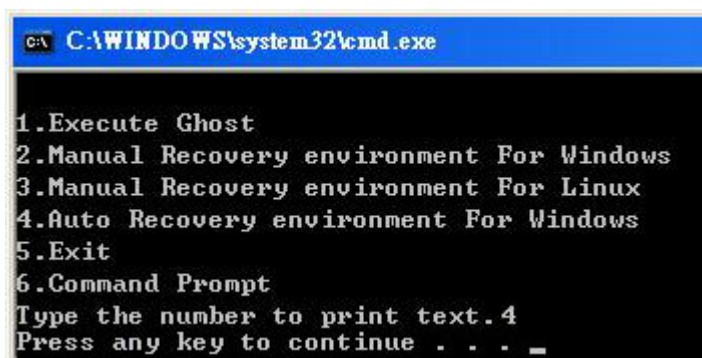
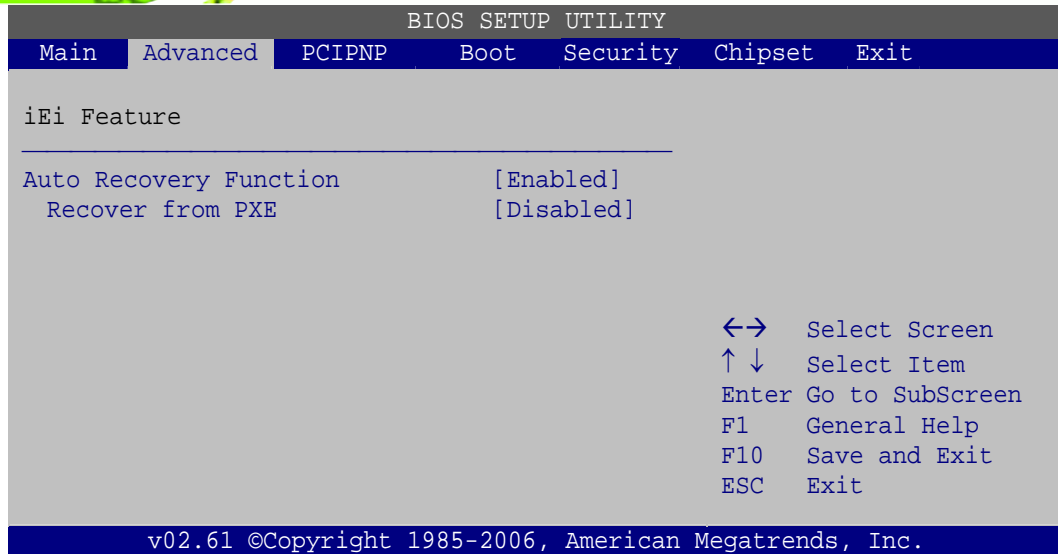

Figure C-29: Press any key to continue

Step 10: Eject the One Key Recovery CD and restart the system.

Step 11: Press the <DELETE> key as soon as the system is turned on to enter the BIOS.

Step 12: Enable the Auto Recovery Function option (**Advanced** → **iEi Feature** → **Auto Recovery Function**).



BIOS Menu 20: IEI Feature

Step 13: Save changes and restart the system. If the system encounters a Blue Screen of Death (BSoD) or a hang for around 10 minutes, it will automatically restore from the factory default image.

C.4 Setup Procedure for Linux

The initial setup procedure for Linux system is mostly the same with the procedure for Microsoft Windows. Please follow the steps below to setup recovery tool for Linux OS.

Step 1: Hardware and BIOS setup. Refer to **Section C.2.1**.

Step 2: Install Linux operating system. Make sure to install GRUB (v0.97 or earlier) MBR type and Ext3 partition type. Leave enough space on the hard drive to create the recover partition later.



NOTE:

If the Linux OS is not installed with GRUB (v0.97 or earlier) and Ext3, the Symantec Ghost may not function properly.

While installing Linux OS, please create two partitions:

AFL2-10A-N28 Panel PC

- Partition 1: /
- Partition 2: SWAP

**NOTE:**

Please reserve enough space for partition 3 for saving recovery images.

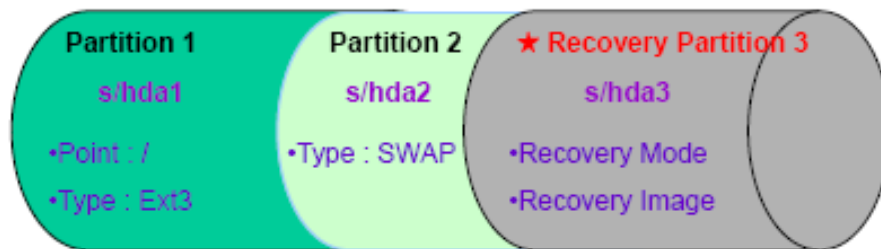

Figure C-30: Partitions for Linux

Step 3: Create a recovery partition. Insert the recovery CD into the optical disk drive.

Follow **Step 1 ~ Step 3** described in **Section C.2.2**. Then type the following commands (marked in red) to create a partition for recovery images.

```
system32>diskpart
DISKPART>list vol
DISKPART>sel disk 0
DISKPART>create part pri size= ____
DISKPART>assign letter=N
DISKPART>exit
system32>format N: /fs:ntfs /q /v:Recovery /y
system32>exit
```

Step 4: Build the recovery partition. Press any key to boot from the recovery CD. It will take a while to launch the recovery tool. Please be patient. When the recovery tool setup menu appears, type <3> and press <Enter> (**Figure C-31**). The Symantec Ghost window appears and starts configuring the system to build a

recovery partition. After completing the system configuration, press any key to reboot the system. Eject the recovery CD.

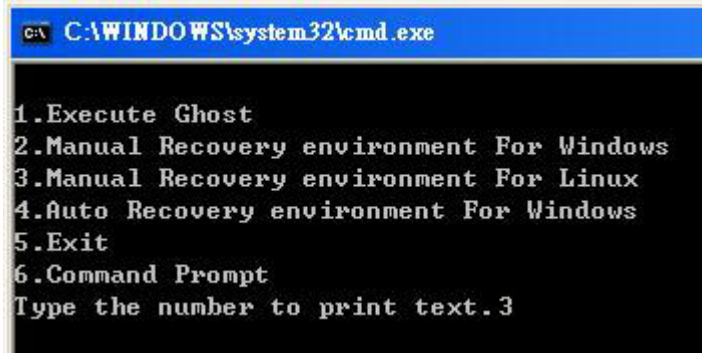

Figure C-31: Manual Recovery Environment for Linux

Step 5: Access the recovery tool main menu by modifying the “menu.lst”. To first access the recovery tool main menu, the menu.lst must be modified. In Linux, enter Administrator (root). When prompt appears, type:

cd /boot/grub

vi menu.lst

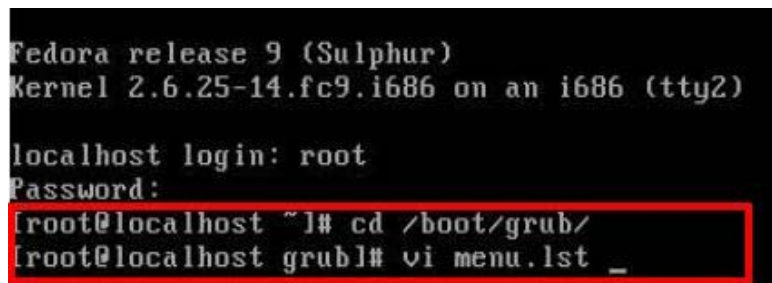

Figure C-32: Access menu.lst in Linux (Text Mode)

Step 6: Modify the menu.lst as shown below.

AFL2-10A-N28 Panel PC

```
#boot=/dev/sda
default=0
timeout=10 ← Modify timeout=10
splashimage=(hd0,0)/grub/splash.xpm.gz
hiddenmenu
title Fedora (2.6.25-14.fc9.i686)
    root (hd0,0)
    kernel /vmlinuz-2.6.25-14.fc9.i686 ro root=UUID=10f1acd
ac38b5c78910 rhgb quiet
    initrd /initrd-2.6.25-14.fc9.i686.img

title Recovery Partition
root (hd0,2)
makeactive ← Type command
chainloader +1
```

- Type command:
title Recovery Partition
root (hd0,2)
makeactive
chainloader +1

Step 7: The recovery tool menu appears. (Figure C-33)

```
1. Factory Restore
2. Backup system
3. Restore your last backup.
4. Manual
5. Quit
Please type the number to select and then press Enter:
```

Figure C-33: Recovery Tool Menu

Step 8: Create a factory default image. Follow **Step 2 ~ Step 12** described in **Section C.2.5** to create a factory default image.

C.5 Recovery Tool Functions

After completing the initial setup procedures as described above, users can access the recovery tool by pressing **<F3>** while booting up the system. However, if the setup procedure in Section C.3 has been completed and the auto recovery function is enabled, the system will automatically restore from the factory default image without pressing the F3 key. The recovery tool main menu is shown below.

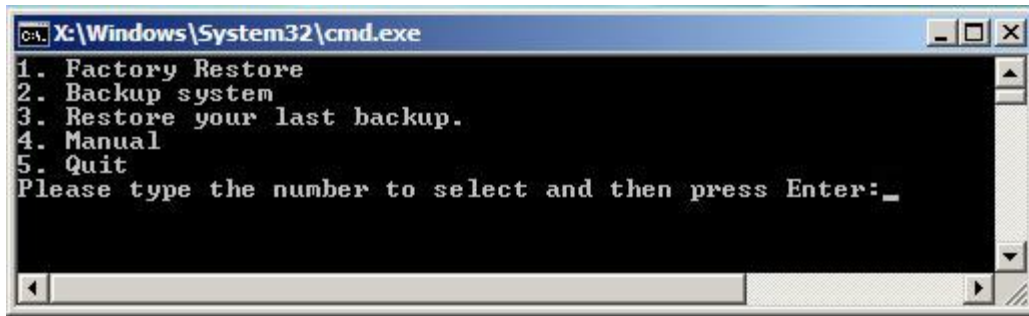

Figure C-34: Recovery Tool Main Menu

The recovery tool has several functions including:

1. **Factory Restore:** Restore the factory default image (iei.GHO) created in Section C.2.5.
2. **Backup system:** Create a system backup image (iei_user.GHO) which will be saved in the hidden partition.
3. **Restore your last backup:** Restore the last system backup image
4. **Manual:** Enter the Symantec Ghost window to configure manually.
5. **Quit:** Exit the recovery tool and restart the system.



WARNING:

Please do not turn off the system power during the process of system recovery or backup.



WARNING:

All data in the system will be deleted during the system recovery. Please backup the system files before restoring the system (either Factory Restore or Restore Backup).

AFL2-10A-N28 Panel PC

C.5.1 Factory Restore

To restore the factory default image, please follow the steps below.

Step 1: Type <1> and press <Enter> in the main menu.

Step 2: The Symantec Ghost window appears and starts to restore the factory default. A factory default image called **iei.GHO** is created in the hidden Recovery partition.

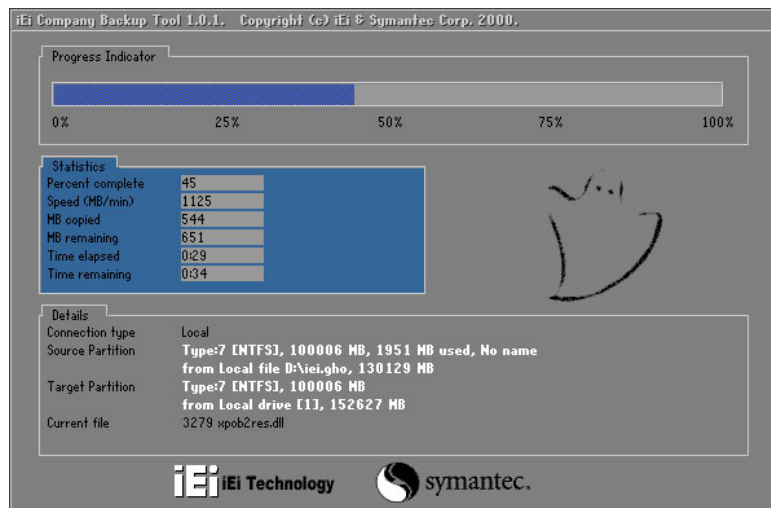

Figure C-35: Restore Factory Default

Step 3: The screen shown in **Figure C-36** appears when completed. Press any key to reboot the system.

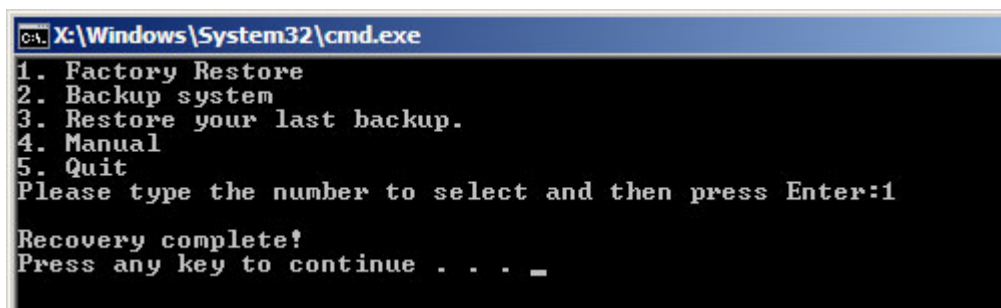

Figure C-36: Recovery Complete Window

C.5.2 Backup System

To backup the system, please follow the steps below.

Step 1: Type <2> and press <Enter> in the main menu.

Step 2: The Symantec Ghost window appears and starts to backup the system. A backup image called `iei_user.GHO` is created in the hidden Recovery partition.

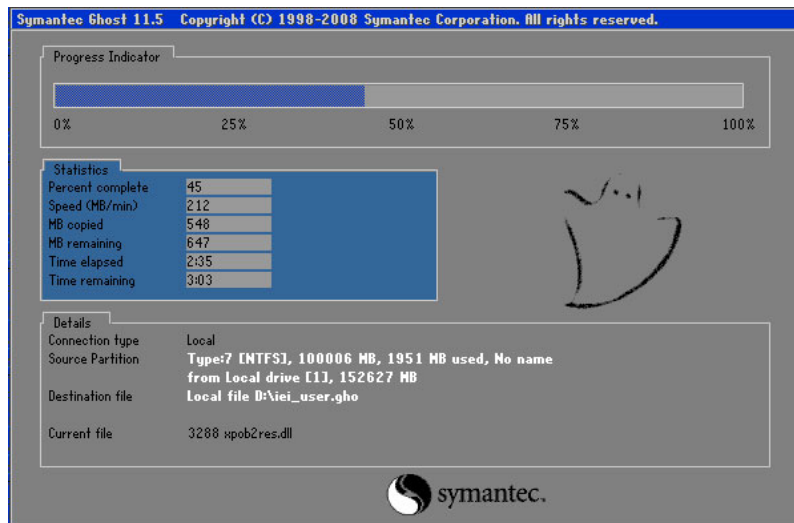

Figure C-37: Backup System

Step 3: The screen shown in **Figure C-38** appears when system backup is complete. Press any key to reboot the system.

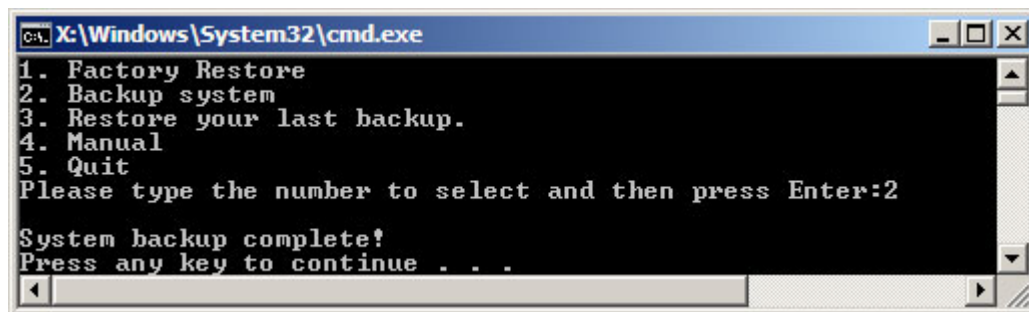

Figure C-38: System Backup Complete Window

AFL2-10A-N28 Panel PC

C.5.3 Restore Your Last Backup

To restore the last system backup, please follow the steps below.

Step 1: Type <3> and press <Enter> in the main menu.

Step 2: The Symantec Ghost window appears and starts to restore the last backup image (iei_user.GHO).

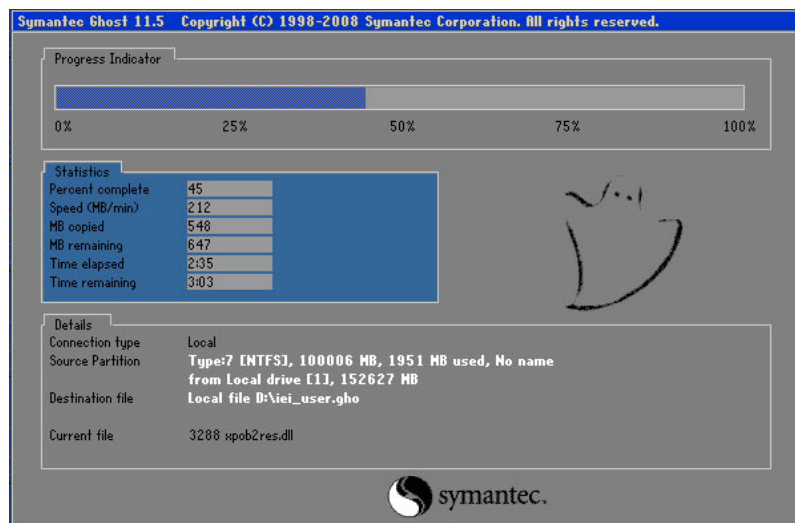

Figure C-39: Restore Backup

Step 3: The screen shown in **Figure C-40** appears when backup recovery is complete. Press any key to reboot the system.

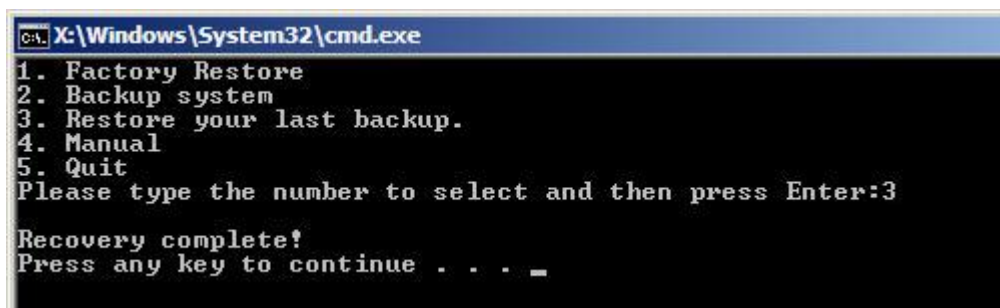

Figure C-40: Restore System Backup Complete Window

C.5.4 Manual

To restore the last system backup, please follow the steps below.

Step 1: Type <4> and press <Enter> in the main menu.

Step 2: The Symantec Ghost window appears. Use the Ghost program to backup or recover the system manually.

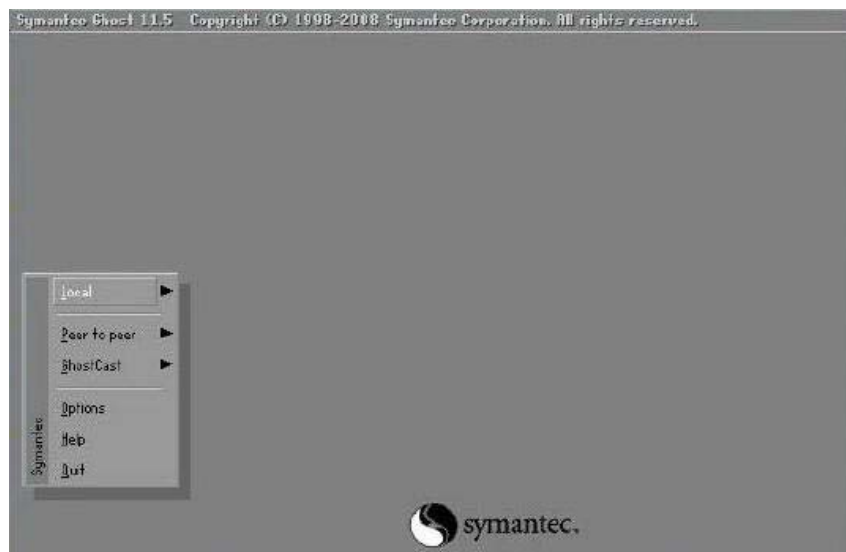
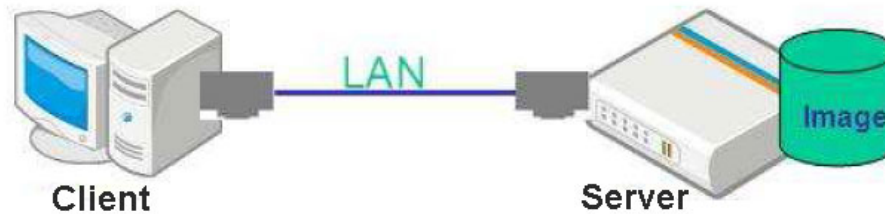

Figure C-41: Symantec Ghost Window

Step 3: When backup or recovery is completed, press any key to reboot the system.

C.6 Restore Systems from a Linux Server through LAN

The One Key Recovery allows a client system to automatically restore to a factory default image saved in a Linux system (the server) through LAN connectivity after encountering a Blue Screen of Death (BSOD) or a hang for around 10 minutes. To be able to use this function, the client system and the Linux system MUST reside in the same domain.



CAUTION:

The supported client OS includes:

- Windows 2000
- Windows XP
- Windows Vista
- Windows 7
- Windows XP Embedded
- Windows Embedded Standard 7

Prior to restoring client systems from a Linux server, a few setup procedures are required.

Step 1: Configure DHCP server settings

Step 2: Configure TFTP settings

Step 3: Configure One Key Recovery server settings

Step 4: Start DHCP, TFTP and HTTP

Step 5: Create a shared directory

Step 6: Setup a client system for auto recovery

The detailed descriptions are described in the following sections. In this document, two types of Linux OS are used as examples to explain the configuration process – CentOS 5.5 (Kernel 2.6.18) and Debian 5.0.7 (Kernel 2.6.26).

C.6.1 Configure DHCP Server Settings

Step 1: Install the DHCP

`#yum install dhcp` (CentOS, commands marked in red)

`#apt-get install dhcp3-server` (Debian, commands marked in blue)

Step 2: Confirm the operating system default settings: dhcpd.conf.

CentOS

Use the following command to show the DHCP server sample location:

`#vi /etc/dhcpd.conf`

The DHCP server sample location is shown as below:

```
# DHCP Server Configuration file.
# see /usr/share/doc/dhcp*/dhcpd.conf.sample
```

Use the following command to copy the DHCP server sample to etc/dhcpd.conf:

`#cp /usr/share/doc/dhcp-3.0.5/dhcpd.conf.sample /etc/dhcpd.conf`

`#vi /etc/dhcpd.conf`

```
ddns-update-style interim;
ignore client-updates;

subnet 192.168.0.0 netmask 255.255.255.0 {
# --- default gateway
    option routers                192.168.0.2;
    option subnet-mask            255.255.255.0;

    option nis-domain             "domain.org";
    option domain-name            "domain.org";
    option domain-name-servers   192.168.0.1;
    next-server 192.168.0.6;
    filename "pxelinux.0";
    option time-offset            -18000; # Eastern Standard Time
    option ntp-servers            192.168.1.1;
}
```

Debian

`#vi /etc/dhcpd.conf`

Edit “/etc/dhcpd.conf” for your environment. For example, add

`next-server PXE server IP address;`

filename "pxelinux.0";

```
ddns-update-style interim;
ignore client-updates;

subnet 192.168.0.0 netmask 255.255.255.0 {
# --- default gateway
    option routers                192.168.0.2;
    option subnet-mask            255.255.255.0;

    option nis-domain             "domain.org";
    option domain-name            "domain.org";
    option domain-name-servers    192.168.0.1;
    next-server 192.168.0.6;
    filename "pxelinux.0";
    option time-offset             -18000; # Eastern Standard Time
    option ntp-servers             192.168.1.1;
}
```

C.6.2 Configure TFTP Settings

Step 1: Install the tftp, httpd and syslinux.

`#yum install tftp-server httpd syslinux` (CentOS)

`#apt-get install tftpd-hpa xinetd syslinux` (Debian)

Step 2: Enable the TFTP server by editing the `/etc/xinetd.d/tftp` file and make it use the remap file. The `-vvv` is optional but it could definitely help on getting more information while running the remap file. For example:

CentOS

`#vi /etc/xinetd.d/tftp`

Modify:

`disable = no`

`server_args = -s /tftpboot -m /tftpboot/tftpd.remap -vvv_`

```
socket_type      = dgram
protocol         = udp
wait            = yes
user            = root
server          = /usr/sbin/in.tftpd
server_args     = -s /tftpboot -m /tftpboot/tftpd.remap -vvv
disable         = no
per_source      = 11
cps             = 100 2
flags          = IPv4
```

Debian

Replace the TFTP settings from “inetd” to “xinetd” and annotate the “inetd” by adding “#”.

`#vi /etc/inetd.conf`

Modify: `#tftp dgram udp wait root /usr/sbin.....` (as shown below)

```
#:BOOT: TFTP service is provided primarily for booting. Most sites
# run this only on machines acting as "boot servers."
#tftp dgram udp wait root /usr/sbin/in.tftpd /usr/sbin/in.tftpd -s
/var/lib/tftpboot
```

`#vi /etc/xinetd.d/tftp`

```
socket_type = dgram
protocol = udp
wait = yes
user = root
server = /usr/sbin/in.tftpd
server_args = -s /tftpboot -n /tftpboot/tftpd.remap -vvv
disable = no
per_source = 11
cps = 100 2
flags = IPv4
```

C.6.3 Configure One Key Recovery Server Settings

Step 1: Copy the **Utility/RECOVERYR10.TAR.BZ2** package from the One Key Recovery CD to the system (server side).



Step 2: Extract the recovery package to /.

```
#cp RecoveryR10.tar.bz2 /
#cd /
#tar -xvjf RecoveryR10.tar.bz2
```

Step 3: Copy “pxelinux.0” from “syslinux” and install to “tftpboot”.

```
#cp /usr/lib/syslinux/pxelinux.0 /tftpboot/
```

AFL2-10A-N28 Panel PC

C.6.4 Start the DHCP, TFTP and HTTP

Start the DHCP, TFTP and HTTP. For example:

CentOS

```
#service xinetd restart
```

```
#service httpd restart
```

```
#service dhcpd restart
```

Debian

```
#/etc/init.d/xinetd reload
```

```
#/etc/init.d/xinetd restart
```

```
#/etc/init.d/dhcp3-server restart
```

C.6.5 Create Shared Directory

Step 1: Install the samba.

```
#yum install samba
```

Step 2: Create a shared directory for the factory default image.

```
#mkdir /share
```

```
#cd /share
```

```
#mkdir /image
```

```
#cp iei.gho /image
```



WARNING:

The file name of the factory default image must be **iei.gho**.

Step 3: Confirm the operating system default settings: smb.conf.

```
#vi /etc/samba/smb.conf
```

Modify:

[image]

comment = One Key Recovery

path = /share/image

browseable = yes

writable = yes

public = yes

create mask = 0644

directory mask = 0755

Step 4: Edit “/etc/samba/smb.conf” for your environment. For example:

```
# "security = user" is always a good idea. This will require a Unix account
# in this server for every user accessing the server. See
# /usr/share/doc/samba-doc/html/docs/Samba3-HOWTO/ServerType.html
# in the samba-doc package for details.
security = share
```

```
[image]
comment = One Key Recovery
path = /share/image
browseable = yes
writable = yes
public = yes
create mask = 0644
directory mask = 0755
```

Step 5: Modify the hostname

#vi /etc/hostname

Modify: RecoveryServer

```
RecoveryServer
```

C.6.6 Setup a Client System for Auto Recovery

Step 1: Disable the automatically restart function before creating the factory default image. Go to: My Computer → Properties → Advanced. Click the Settings button of Startup and Recovery. Deselect “Automatically restart”. Click OK to save the settings and exit. (See Figure C-23)

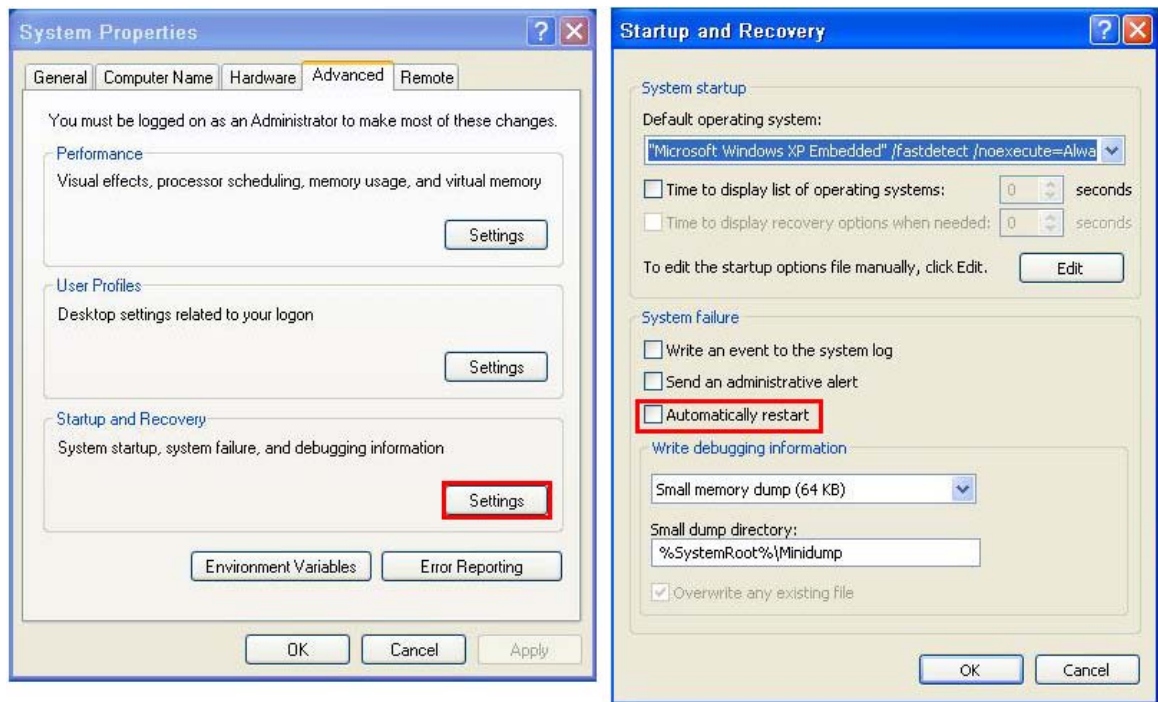

Figure C-42: Disable Automatically Restart

Step 2: Configure the following BIOS options of the client system.

Advanced → iEi Feature → Auto Recovery Function → **Enabled**

Advanced → iEi Feature → Recover from PXE → **Enabled**

Boot → Launch PXE OpROM → **Enabled**

Step 3: Continue to configure the **Boot Option Priorities** BIOS option of the client system:

Boot Option #1 → remain the default setting to boot from the original OS.

Boot Option #2 → select the boot from LAN option.

Step 4: Save changes and exit BIOS menu.

Exit → **Save Changes and Exit**

Step 5: Install the auto recovery utility into the system by double clicking the

Utility/AUTORECOVERY-SETUP.exe in the One Key Recovery CD. This utility

MUST be installed in the system, otherwise, the system will automatically restore from the factory default image every ten (10) minutes.



Step 6: Restart the client system from LAN. If the system encounters a Blue Screen of Death (BSoD) or a hang for around 10 minutes, it will automatically restore from the factory default image. The following screens will show when the system starts auto recovering.

```
Realtek PCIe GBE Family Controller Series v2.35 (06/14/10)
CLIENT MAC ADDR: 00 18 7D 13 E6 89  GUID: 00020003-0004-0005-0006-0007000000
DHCP.. /
```

```
My IP address seems to be C0A80009 192.168.0.9
ip=192.168.0.9:192.168.0.8:192.168.0.2:255.255.255.0
TFTP prefix:
Trying to load: pxelinux.cfg/00020003-0004-0005-0006-000700000009
Trying to load: pxelinux.cfg/01-00-18-7d-13-e6-89
Trying to load: pxelinux.cfg/C0A80009
Trying to load: pxelinux.cfg/C0A8000
Trying to load: pxelinux.cfg/C0A800
Trying to load: pxelinux.cfg/C0A80
Trying to load: pxelinux.cfg/C0A8
Trying to load: pxelinux.cfg/C0A
Trying to load: pxelinux.cfg/C0
Trying to load: pxelinux.cfg/C
Trying to load: pxelinux.cfg/default
boot:
```

```
Windows is loading files...
IP: 192.168.0.8, File: \Boot\WinPE.wim
```

AFL2-10A-N28 Panel PC

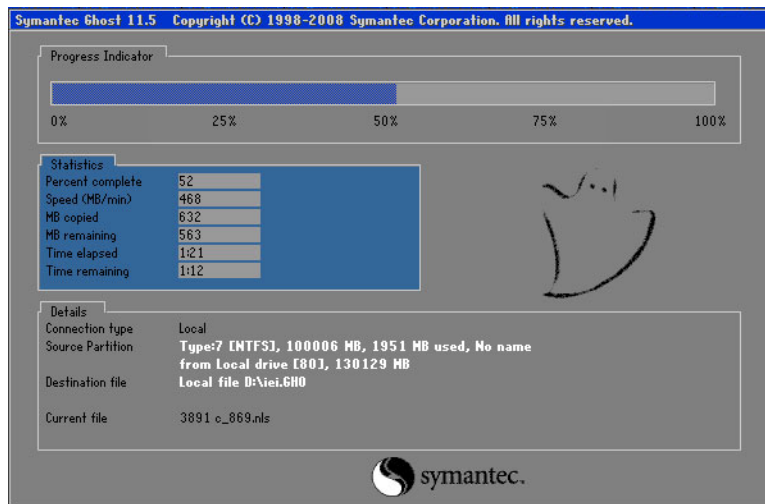

NOTE:

A firewall or a SELinux is not in use in the whole setup process described above. If there is a firewall or a SELinux protecting the system, modify the configuration information to accommodate them.

C.7 Other Information

C.7.1 Using AHCI Mode or ALi M5283 / VIA VT6421A Controller

When the system uses AHCI mode or some specific SATA controllers such as ALi M5283 or VIA VT6421A, the SATA RAID/AHCI driver must be installed before using one key recovery. Please follow the steps below to install the SATA RAID/AHCI driver.

- Step 1:** Copy the SATA RAID/AHCI driver to a floppy disk and insert the floppy disk into a USB floppy disk drive. The SATA RAID/AHCI driver must be especially designed for the on-board SATA controller.
- Step 2:** Connect the USB floppy disk drive to the system.
- Step 3:** Insert the One Key Recovery CD into the system and boot the system from the CD.
- Step 4:** When launching the recovery tool, press <F6>.

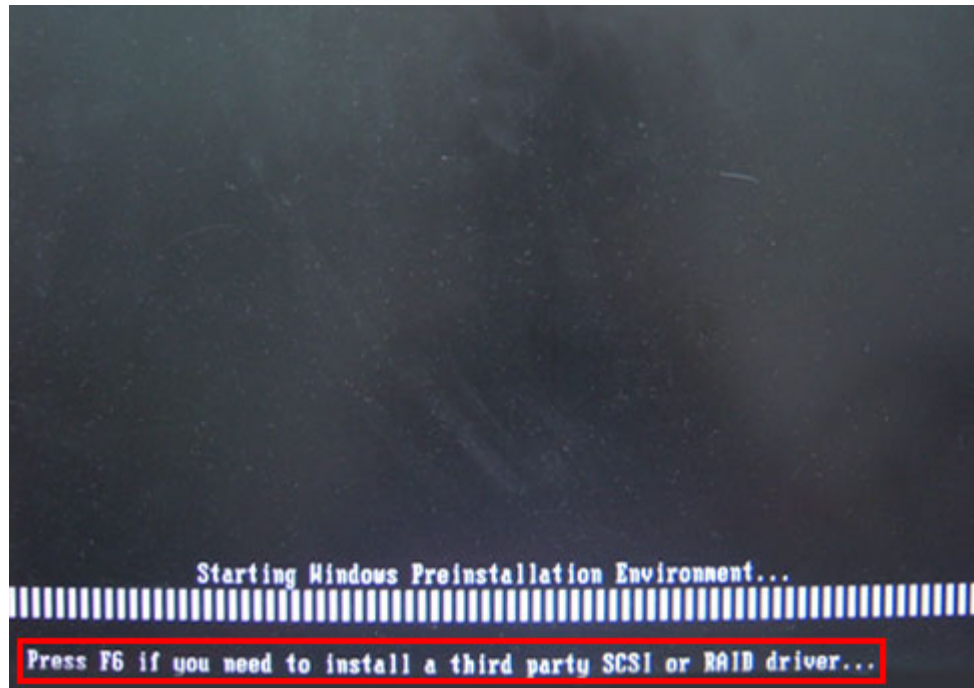

Step 5: When the following window appears, press <S> to select “Specify Additional Device”.

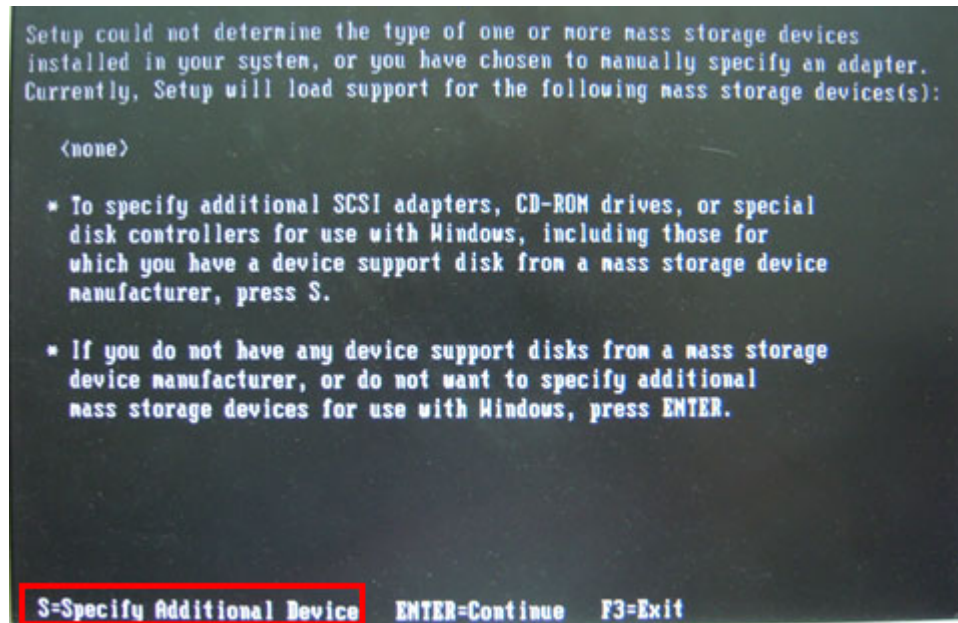

AFL2-10A-N28 Panel PC

Step 6: In the following window, select a SATA controller mode used in the system. Then press <Enter>. The user can now start using the SATA HDD.

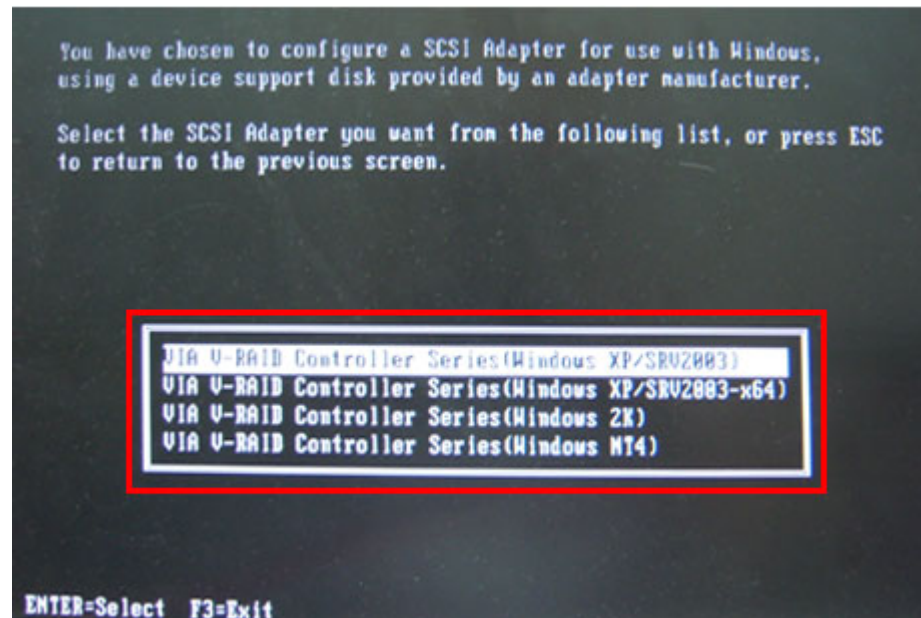

Step 7: After pressing <Enter>, the system will get into the recovery tool setup menu. Continue to follow the setup procedure from **Step 4** in **Section C.2.2 Create Partitions** to finish the whole setup process.

C.7.2 System Memory Requirement

To be able to access the recovery tool by pressing <F3> while booting up the system, please make sure to have enough system memory. The minimum memory requirement is listed below.

- **Using Award BIOS:** 128 MB system memory
- **Using AMI BIOS:** 512 MB system memory.

Appendix

D

Watchdog Timer



NOTE:

The following discussion applies to DOS. Contact IEI support or visit the IEI website for drivers for other operating systems.

The Watchdog Timer is a hardware-based timer that attempts to restart the system when it stops working. The system may stop working because of external EMI or software bugs. The Watchdog Timer ensures that standalone systems like ATMs will automatically attempt to restart in the case of system problems.

A BIOS function call (INT 15H) is used to control the Watchdog Timer.

INT 15H:

AH – 6FH Sub-function:	
AL – 2:	Sets the Watchdog Timer’s period.
BL:	Time-out value (Its unit-second is dependent on the item “Watchdog Timer unit select” in CMOS setup).

Table D-1: AH-6FH Sub-function

Call sub-function 2 to set the time-out period of Watchdog Timer first. If the time-out value is not zero, the Watchdog Timer starts counting down. When the timer value reaches zero, the system resets. To ensure that this reset condition does not occur, calling sub-function 2 must periodically refresh the Watchdog Timer. However, the watchdog timer is disabled if the time-out value is set to zero.

A tolerance of at least 10% must be maintained to avoid unknown routines within the operating system (DOS), such as disk I/O that can be very time-consuming.

NOTE:

The Watchdog Timer is activated through software. The software application that activates the Watchdog Timer must also deactivate it when closed. If the Watchdog Timer is not deactivated, the system will automatically restart after the Timer has finished its countdown.

EXAMPLE PROGRAM:

```
; INITIAL TIMER PERIOD COUNTER
```

```
;
```

```
W_LOOP:
```

```
;
```

```

MOV      AX, 6F02H      ;setting the time-out value
MOV      BL, 30         ;time-out value is 48 seconds
INT      15H

```

```
;
```

```
; ADD THE APPLICATION PROGRAM HERE
```

```
;
```

```

CMP      EXIT_AP, 1     ;is the application over?
JNE      W_LOOP        ;No, restart the application

```

```

MOV      AX, 6F02H      ;disable Watchdog Timer
MOV      BL, 0         ;
INT      15H

```

```
;
```

```
; EXIT ;
```

Appendix

E

Hazardous Materials Disclosure

E.1 Hazardous Material Disclosure Table for IPB Products Certified as RoHS Compliant Under 2002/95/EC Without Mercury

The details provided in this appendix are to ensure that the product is compliant with the Peoples Republic of China (China) RoHS standards. The table below acknowledges the presences of small quantities of certain materials in the product, and is applicable to China RoHS only.

A label will be placed on each product to indicate the estimated “Environmentally Friendly Use Period” (EFUP). This is an estimate of the number of years that these substances would “not leak out or undergo abrupt change.” This product may contain replaceable sub-assemblies/components which have a shorter EFUP such as batteries and lamps. These components will be separately marked.

Please refer to the table on the next page.

AFL2-10A-N28 Panel PC

Part Name	Toxic or Hazardous Substances and Elements					
	Lead (Pb)	Mercury (Hg)	Cadmium (Cd)	Hexavalent Chromium (CR(VI))	Polybrominated Biphenyls (PBB)	Polybrominated Diphenyl Ethers (PBDE)
Housing	X	O	O	O	O	X
Display	X	O	O	O	O	X
Printed Circuit Board	X	O	O	O	O	X
Metal Fasteners	X	O	O	O	O	O
Cable Assembly	X	O	O	O	O	X
Fan Assembly	X	O	O	O	O	X
Power Supply Assemblies	X	O	O	O	O	X
Battery	O	O	O	O	O	O

O: This toxic or hazardous substance is contained in all of the homogeneous materials for the part is below the limit requirement in SJ/T11363-2006

X: This toxic or hazardous substance is contained in at least one of the homogeneous materials for this part is above the limit requirement in SJ/T11363-2006

此附件旨在确保本产品符合中国 RoHS 标准。以下表格标示此产品中某有毒物质的含量符合中国 RoHS 标准规定的限量要求。

本产品上会附有“环境友好使用期限”的标签，此期限是估算这些物质“不会有泄漏或突变”的年限。本产品可能包含有较短的环境友好使用期限的可替换元件，像是电池或灯管，这些元件将会单独标示出来。

部件名称	有毒有害物质或元素					
	铅 (Pb)	汞 (Hg)	镉 (Cd)	六价铬 (CR(VI))	多溴联苯 (PBB)	多溴二苯醚 (PBDE)
壳体	X	○	○	○	○	X
显示	X	○	○	○	○	X
印刷电路板	X	○	○	○	○	X
金属螺帽	X	○	○	○	○	○
电缆组装	X	○	○	○	○	X
风扇组装	X	○	○	○	○	X
电力供应组装	X	○	○	○	○	X
电池	○	○	○	○	○	○

○: 表示该有毒有害物质在该部件所有物质材料中的含量均在 SJ/T11363-2006 标准规定的限量要求以下。
X: 表示该有毒有害物质至少在该部件的某一均质材料中的含量超出 SJ/T11363-2006 标准规定的限量要求。