

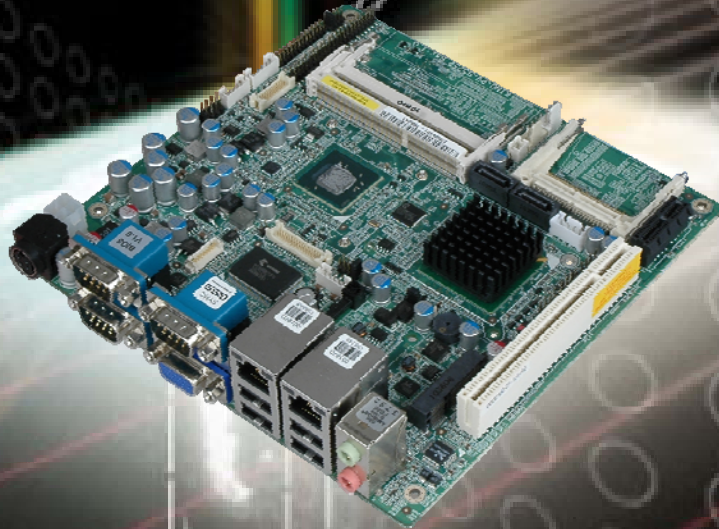

IEI Technology Corp.



MODEL:

KINO-PV-D5252/D4252

**Mini ITX SBC with Intel® Atom™ processor D425/D525, DDR3
VGA, Dual LVDS, Dual GbE LAN, USB 2.0, SATA 3Gb/s, RoHS**

User Manual

Rev. 1.02 – 17 January, 2012



Revision

Date	Version	Changes
17 January, 2012	1.02	Minor update to Figure 1.4 Data flow Block Diagram Minor update to Figure 3-1: Connector and Jumper Locations Updated Table D-1 Digital I/O Connector Pinouts
17 June, 2011	1.01	Added KEY1 connector. Minor update to J_VLVDS1 and J_VLVDS2 jumper settings.
24 March, 2011	1.00	Initial release

Copyright

COPYRIGHT NOTICE

The information in this document is subject to change without prior notice in order to improve reliability, design and function and does not represent a commitment on the part of the manufacturer.

In no event will the manufacturer be liable for direct, indirect, special, incidental, or consequential damages arising out of the use or inability to use the product or documentation, even if advised of the possibility of such damages.

This document contains proprietary information protected by copyright. All rights are reserved. No part of this manual may be reproduced by any mechanical, electronic, or other means in any form without prior written permission of the manufacturer.

TRADEMARKS

All registered trademarks and product names mentioned herein are used for identification purposes only and may be trademarks and/or registered trademarks of their respective owners.

Table of Contents

1 INTRODUCTION.....	1
1.1 INTRODUCTION.....	2
1.2 CONNECTORS	3
1.3 DIMENSIONS.....	4
1.4 DATA FLOW	5
1.5 TECHNICAL SPECIFICATIONS	6
2 UNPACKING	8
2.1 ANTI-STATIC PRECAUTIONS	9
2.2 UNPACKING PRECAUTIONS.....	9
2.3 PACKING LIST.....	10
2.3.1 <i>Optional Items</i>	11
3 CONNECTORS	12
3.1 PERIPHERAL INTERFACE CONNECTORS.....	13
3.1.1 <i>KINO-PV-D5252/D4252 Layout</i>	13
3.1.2 <i>Peripheral Interface Connectors</i>	14
3.1.3 <i>External Interface Panel Connectors</i>	15
3.2 INTERNAL PERIPHERAL CONNECTORS	15
3.2.1 <i>12V Power Connector</i>	15
3.2.2 <i>Battery Connector</i>	16
3.2.3 <i>CompactFlash® Slot</i>	17
3.2.4 <i>Digital I/O Connector</i>	19
3.2.5 <i>Fan Connector (CPU)</i>	20
3.2.6 <i>Fan Connector</i>	21
3.2.7 <i>Flash SPI ROM</i>	22
3.2.8 <i>Front Panel Connector</i>	23
3.2.9 <i>Keyboard/Mouse Connector</i>	24
3.2.10 <i>Keypad Connector</i>	24
3.2.11 <i>LVDS1 Connector (For Intel® Atom™ processor D525 dual LVDS only)</i> ...	25
3.2.12 <i>LVDS1 Backlight Inverter Connector</i>	27

KINO-PV-D5252/D4252 Mini ITX SBC

3.2.13 LVDS2 Connector	28
3.2.14 LVDS2 Backlight Inverter Connector	29
3.2.15 Parallel Port Connector	29
3.2.16 PCIe Mini Card Slot	31
3.2.17 SATA Drive Connectors	32
3.2.18 SATA Power Connector.....	33
3.2.19 Serial Port Connectors (RS-232).....	35
3.2.20 Serial Port Connector (RS-232).....	36
3.2.21 SMBus Connector	37
3.2.22 USB Connectors.....	38
3.3 EXTERNAL PERIPHERAL INTERFACE CONNECTOR PANEL	39
3.3.1 Audio Connector	40
3.3.2 Ethernet and USB Connector.....	40
3.3.3 Power Connector	42
3.3.4 Serial Port Connector.....	42
3.3.5 VGA Port Connector.....	43
4 INSTALLATION	45
4.1 ANTI-STATIC PRECAUTIONS	46
4.2 INSTALLATION CONSIDERATIONS.....	47
4.2.1 Installation Notices	47
4.3 UNPACKING.....	48
4.4 SO-DIMM INSTALLATION	48
4.4.1 SO-DIMM Installation.....	49
4.5 COMPACTFLASH® INSTALLATION	50
4.6 JUMPER SETTINGS	51
4.6.1 AT/ATX Power Select Jumper Settings	52
4.6.2 Clear CMOS Jumper.....	53
4.6.3 CompactFlash® Card Setup Jumper	54
4.6.4 LVDS1 Panel Resolution Type Select Jumper (For Intel® Atom™ processor D525 dual LVDS only).....	55
4.6.5 LVDS2 Panel Resolution Select Jumper	56
4.6.6 LVDS1 Voltage Select setting	57
4.6.7 LVDS2 Voltage Select setting	58
4.6.8 Serial Port Setting Jumper.....	59

4.7 CHASSIS INSTALLATION.....	60
4.7.1 Airflow.....	60
4.7.2 Motherboard Installation.....	60
4.8 INTERNAL PERIPHERAL DEVICE CONNECTIONS.....	61
4.8.1 AT/ATX Power Connection.....	61
4.8.2 Single RS-232 Cable with Slot Bracket.....	63
4.9 EXTERNAL PERIPHERAL INTERFACE CONNECTION.....	64
4.9.1 Audio Connector.....	65
4.9.2 LAN Connection (Dual Connector).....	66
4.9.3 Serial Device Connection.....	66
4.9.4 USB Connection (Quad Connector).....	67
4.9.5 VGA Monitor Connection.....	68
4.10 SOFTWARE INSTALLATION.....	69
5 BIOS SCREENS.....	72
5.1 INTRODUCTION.....	73
5.1.1 Starting Setup.....	73
5.1.2 Using Setup.....	73
5.1.3 Getting Help.....	74
5.1.4 Unable to Reboot After Configuration Changes.....	74
5.1.5 BIOS Menu Bar.....	74
5.2 MAIN.....	75
5.3 ADVANCED.....	76
5.3.1 ACPI Settings.....	77
5.3.2 Trusted Computing.....	78
5.3.3 CPU Configuration.....	79
5.3.4 IDE Configuration.....	80
5.3.5 USB Configuration.....	81
5.3.6 Super IO Configuration.....	82
5.3.6.1 Serial Port 0 Configuration.....	83
5.3.6.2 Parallel Port Configuration.....	86
5.3.7 H/W Monitor.....	88
5.3.8 Secondary Super IO Configuration.....	90
5.3.8.1 Serial Port 5 Configuration.....	90
5.3.8.2 Serial Port 6 Configuration.....	91

KINO-PV-D5252/D4252 Mini ITX SBC

5.3.9 Serial Port Console Redirection	92
5.4 CHIPSET	93
5.4.1 Host Bridge Configuration	94
5.4.1.1 Memory Frequency and Timing.....	95
5.4.1.2 OnChip VGA Configuration.....	96
5.4.2 South Bridge Configuration.....	97
5.4.3 Intel IGD SWSCI OpRegion.....	98
5.5 BOOT.....	101
5.6 SECURITY.....	102
5.7 EXIT	103
A BIOS OPTIONS	105
B ONE KEY RECOVERY	108
B.1 ONE KEY RECOVERY INTRODUCTION	109
B.1.1 System Requirement.....	110
B.1.2 Supported Operating System.....	111
B.2 SETUP PROCEDURE FOR WINDOWS	112
B.2.1 Hardware and BIOS Setup	112
B.2.2 Create Partitions	113
B.2.3 Install Operating System, Drivers and Applications.....	116
B.2.4 Build-up Recovery Partition.....	117
B.2.5 Create Factory Default Image.....	119
B.3 SETUP PROCEDURE FOR LINUX	124
B.4 RECOVERY TOOL FUNCTIONS	127
B.4.1 Factory Restore	129
B.4.2 Backup System.....	130
B.4.3 Restore Your Last Backup.....	131
B.4.4 Manual.....	132
B.5 OTHER INFORMATION	133
B.5.1 Using AHCI Mode or ALi M5283 / VIA VT6421A Controller.....	133
B.5.2 System Memory Requirement	135
C TERMINOLOGY	136
D DIGITAL I/O INTERFACE.....	140
D.1 INTRODUCTION.....	141

D.2 DIO CONNECTOR PINOUTS	141
D.3 ASSEMBLY LANGUAGE SAMPLES.....	142
<i>D.3.1 Enable the DIO Input Function</i>	<i>142</i>
<i>D.3.2 Enable the DIO Output Function.....</i>	<i>142</i>
E WATCHDOG TIMER.....	143
F HAZARDOUS MATERIALS DISCLOSURE.....	146
F.1 HAZARDOUS MATERIALS DISCLOSURE TABLE FOR IPB PRODUCTS CERTIFIED AS ROHS COMPLIANT UNDER 2002/95/EC WITHOUT MERCURY	147

List of Figures

Figure 1-1: KINO-PV-D5252/D4252.....	2
Figure 1-2: Connectors	3
Figure 1-3: KINO-PV-D5252/D4252 Dimensions (mm)	4
Figure 1-4: Data Flow Block Diagram.....	5
Figure 3-1: Connector and Jumper Locations.....	13
Figure 3-2: 12 V Power Connector Location.....	16
Figure 3-3: Battery Connector Location.....	17
Figure 3-4: CompactFlash® Slot Location.....	18
Figure 3-5: Digital I/O Connector Locations	19
Figure 3-6: CPU Fan Connector Location	20
Figure 3-7: Fan Connector Location.....	21
Figure 3-8: Flash SPI ROM Connector Location	22
Figure 3-9: Front Panel Connector Location	23
Figure 3-10: Keyboard/Mouse Connector Location.....	24
Figure 3-11: Keypad Connector Location	25
Figure 3-12: LVDS1 Connector Location	26
Figure 3-13: LVDS1 Backlight Inverter Connector Location.....	27
Figure 3-14: LVDS2 Connector Location	28
Figure 3-15: LVDS2 Backlight Inverter Connector Location.....	29
Figure 3-16: Parallel Port Connector Location.....	30
Figure 3-17: PCIe Mini Card Slot Location.....	31
Figure 3-18: SATA Drive Connector Locations	33
Figure 3-19: SATA Power Connector Locations	34
Figure 3-20: SATA Power Connector Locations	35
Figure 3-21: Serial Port (COM5 and COM6) Connector Pinout Locations.....	36
Figure 3-22: Serial Port (COM2) Connector Location	37
Figure 3-23: SMBus Connector Locations.....	38
Figure 3-24: USB Connector Pinout Locations	39
Figure 3-25: KINO-PV-D5252/D4252 External Peripheral Interface Connector	40
Figure 3-26: Audio Connector	40

Figure 3-27: RJ-45 Ethernet Connector	41
Figure 3-28: VGA Connector	43
Figure 4-1: SO-DIMM Installation	49
Figure 4-2: SO-DIMM Connector Location	49
Figure 4-3: CompactFlash® Card Installation	51
Figure 4-4: AT/ATX Power Select Jumper Location.....	53
Figure 4-5: Clear CMOS Jumper	54
Figure 4-6: CompactFlash® Setup Jumper Location	55
Figure 4-7: LVDS1 Panel Resolution Jumper Location	56
Figure 4-8: LVDS2 Panel Resolution Jumper Location	57
Figure 4-9: LVDS1 Voltage Select Jumper Location.....	58
Figure 4-10: LVDS2 Voltage Select Jumper Location.....	59
Figure 4-11: Serial Port Jumper Locations	60
Figure 4-12: Power Cable to Motherboard Connection	62
Figure 4-13: Connect Power Cable to Power Supply.....	63
Figure 4-14: Single RS-232 Cable Installation	64
Figure 4-15: Audio Connector	65
Figure 4-16: LAN Connection	66
Figure 4-17: Serial Device Connector.....	67
Figure 4-18: USB Connector.....	68
Figure 4-19: VGA Connector	69
Figure 4-20: Introduction Screen	70
Figure 4-21: Available Drivers	71
Figure B-1: IEI One Key Recovery Tool Menu	109
Figure B-2: Launching the Recovery Tool	113
Figure B-3: Recovery Tool Setup Menu	114
Figure B-4: Command Mode.....	114
Figure B-5: Partition Creation Commands.....	115
Figure B-6: Launching the Recovery Tool	117
Figure B-7: System Configuration for Windows	117
Figure B-8: Build-up Recovery Partition	118
Figure B-9: Press any key to continue	118
Figure B-10: Press F3 to Boot into Recovery Mode.....	119
Figure B-11: Recovery Tool Menu	119
Figure B-12: About Symantec Ghost Window.....	120

KINO-PV-D5252/D4252 Mini ITX SBC

Figure B-13: Symantec Ghost Path	120
Figure B-14: Select a Local Source Drive	121
Figure B-15: Select a Source Partition from Basic Drive	121
Figure B-16: File Name to Copy Image to	122
Figure B-17: Compress Image.....	122
Figure B-18: Image Creation Confirmation	123
Figure B-19: Image Creation Complete	123
Figure B-20: Image Creation Complete	123
Figure B-21: Press Any Key to Continue	124
Figure B-22: Partitions for Linux.....	125
Figure B-23: System Configuration for Linux.....	126
Figure B-24: Access menu.lst in Linux (Text Mode).....	126
Figure B-25: Recovery Tool Menu	127
Figure B-26: Recovery Tool Main Menu	128
Figure B-27: Restore Factory Default.....	129
Figure B-28: Recovery Complete Window	129
Figure B-29: Backup System.....	130
Figure B-30: System Backup Complete Window	130
Figure B-31: Restore Backup	131
Figure B-32: Restore System Backup Complete Window	131
Figure B-33: Symantec Ghost Window	132

List of Tables

Table 1-1: Technical Specifications.....	7
Table 3-1: Peripheral Interface Connectors.....	15
Table 3-2: Rear Panel Connectors.....	15
Table 3-3: 12 V Power Connector Pinouts.....	16
Table 3-4: Battery Connector Pinouts.....	17
Table 3-5: CompactFlash® Slot Pinouts.....	19
Table 3-6: Digital I/O Connector Pinouts.....	20
Table 3-7: CPU Fan Connector Pinouts.....	21
Table 3-8: Fan Connector Pinouts.....	22
Table 3-9: SPI Flash Connector Pinouts.....	22
Table 3-10: Front Panel Connector Pinouts.....	23
Table 3-11: Keyboard/Mouse Connector Pinouts.....	24
Table 3-12: Keypad Connector Pinouts.....	25
Table 3-13: LVDS1 Connector Pinouts.....	27
Table 3-14: LVDS1 Backlight Inverter Connector Pinouts.....	27
Table 3-15: LVDS2 Connector Pinouts.....	28
Table 3-16: LVDS2 Backlight Inverter Connector Pinouts.....	29
Table 3-17: Parallel Port Connector Pinouts.....	30
Table 3-18: PCIe Mini Card Slot Pinouts.....	32
Table 3-19: SATA Drive Connector Pinouts.....	33
Table 3-20: SATA Power Connector Pinouts.....	34
Table 3-21: SATA Power Connector Pinouts.....	35
Table 3-22: Serial Port Connector Pinouts.....	36
Table 3-23: Serial Port (COM2) Connector Pinouts.....	37
Table 3-24: SMBus Connector Pinouts.....	38
Table 3-25: USB Port Connector Pinouts.....	39
Table 3-26: LAN Pinouts.....	41
Table 3-27: RJ-45 Ethernet Connector LEDs.....	41
Table 3-28: USB Pinouts.....	42
Table 3-29: Power Connector Pinouts.....	42

KINO-PV-D5252/D4252 Mini ITX SBC

Table 3-30: Serial Port Pinouts.....	43
Table 3-31: VGA Connector Pinouts.....	44
Table 4-1: Jumpers	52
Table 4-2: AT/ATX Power Select Jumper Settings	52
Table 4-3: Clear CMOS Jumper Settings.....	54
Table 4-4: CompactFlash® Setup Jumper Settings	54
Table 4-5: LVDS1 Panel Resolution Jumper Settings.....	55
Table 4-6: LVDS2 Panel Resolution Jumper Settings.....	57
Table 4-7: LVDS1 Voltage Select Jumper Settings	57
Table 4-8: LVDS2 Voltage Select Jumper Settings	58
Table 4-9: Serial Port Jumper Settings.....	59
Table 5-1: BIOS Navigation Keys	74

BIOS Menus

BIOS Menu 1: Main	75
BIOS Menu 2: Advanced	76
BIOS Menu 3: ACPI Settings	77
BIOS Menu 4: TPM Configuration	78
BIOS Menu 5: CPU Configuration	79
BIOS Menu 6: IDE Configuration	80
BIOS Menu 7: USB Configuration	81
BIOS Menu 8: Super IO Configuration	82
BIOS Menu 9: Serial Port 0 Configuration Menu	83
BIOS Menu 10: Parallel Port Configuration Menu	86
BIOS Menu 11: Hardware Health Configuration	88
BIOS Menu 12: Secondary Super IO Configuration	90
BIOS Menu 13: Serial Port Console Redirection	92
BIOS Menu 14: Chipset	93
BIOS Menu 15: Host Bridge Chipset Configuration	94
BIOS Menu 16: Memory Frequency and Timing Configuration	95
BIOS Menu 17: OnChip VGA Configuration	96
BIOS Menu 18: South Bridge Chipset Configuration	97
BIOS Menu 19: Intel IGD SWSCI OpRegion	99
BIOS Menu 20: Boot	101
BIOS Menu 21: Security	102
BIOS Menu 22: Exit	103

Chapter

1

Introduction

1.1 Introduction

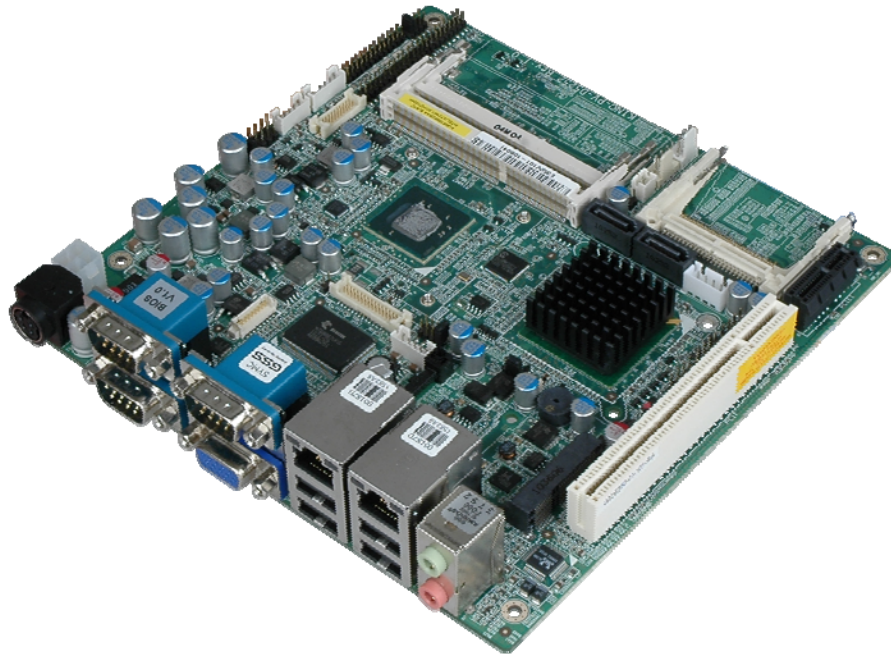

Figure 1-1: KINO-PV-D5252/D4252

The KINO-PV-D5252/D4252 Mini ITX motherboard is an Intel® Atom™ processor D525 or D425 platform. Up to two 4.0 GB 800 MHz DDR3 SDRAM SO-DIMMs are supported by the KINO-PV-D5252/D4252.

The integrated Intel® ICH8M Chipset supports two GbE LAN ports through two Realtek RTL8111E Ethernet controllers (with ASF 2.0 support on LAN1). The KINO-PV-D5252/D4252 also supports two SATA 3Gb/s drives and provides 5 V SATA power.

The KINO-PV-D5252/D4252 supports an integrated GMA 3150 graphics card with a graphic core speed of 400MHz. Eight USB 2.0 channels, one PCI slot, one PCIe Mini socket, one CompactFlash® connector and one PCIe x1 slot provide flexible expansion options. High Definition Audio (HDA) support ensures HDA devices can be easily implemented on the KINO-PV-D5252/D4252. Serial device connectivity is provided by three external RS-232 ports, two internal RS-232 ports and one internal RS-232/422/485 connector.

KINO-PV-D5252/D4252 Mini ITX SBC

1.2 Connectors

The connectors on the KINO-PV-D5252/D4252 are shown in the figure below.

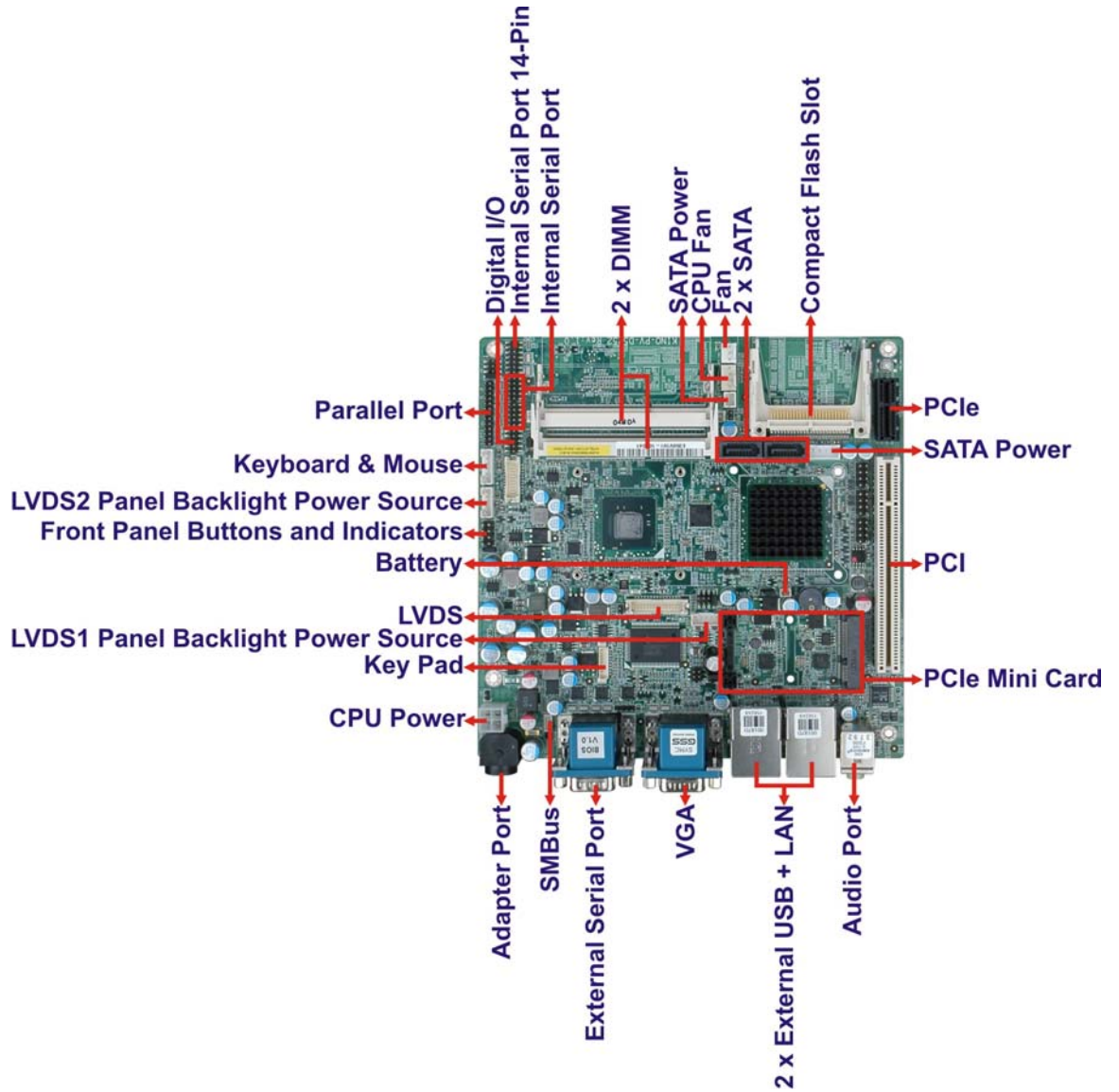

Figure 1-2: Connectors

1.3 Dimensions

The dimensions of the board are listed below:

- **Length:** 170 mm
- **Width:** 170 mm

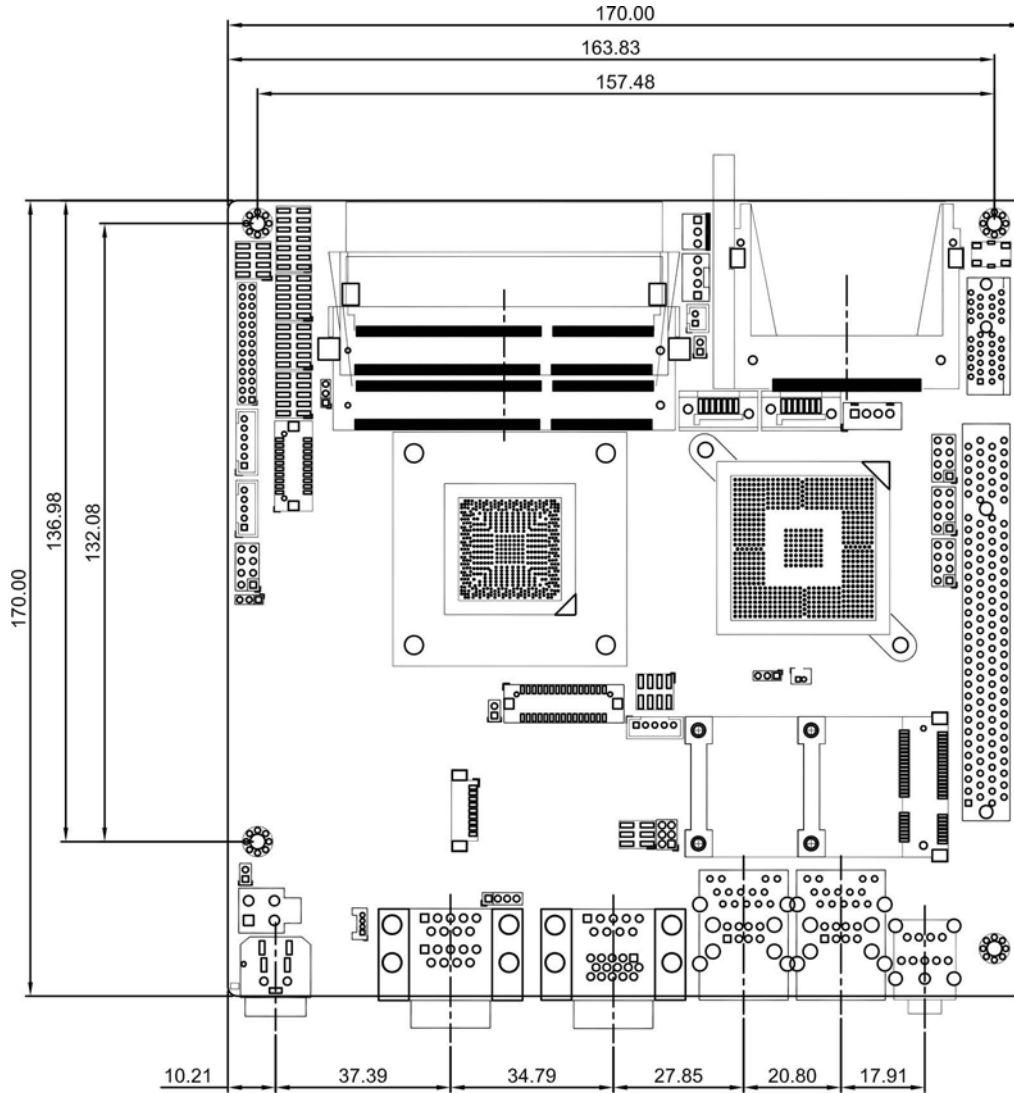

Figure 1-3: KINO-PV-D5252/D4252 Dimensions (mm)

KINO-PV-D5252/D4252 Mini ITX SBC

1.4 Data Flow

Figure 1-4 shows the data flow between the two on-board chipsets and other components installed on the motherboard and described in the following sections of this chapter.

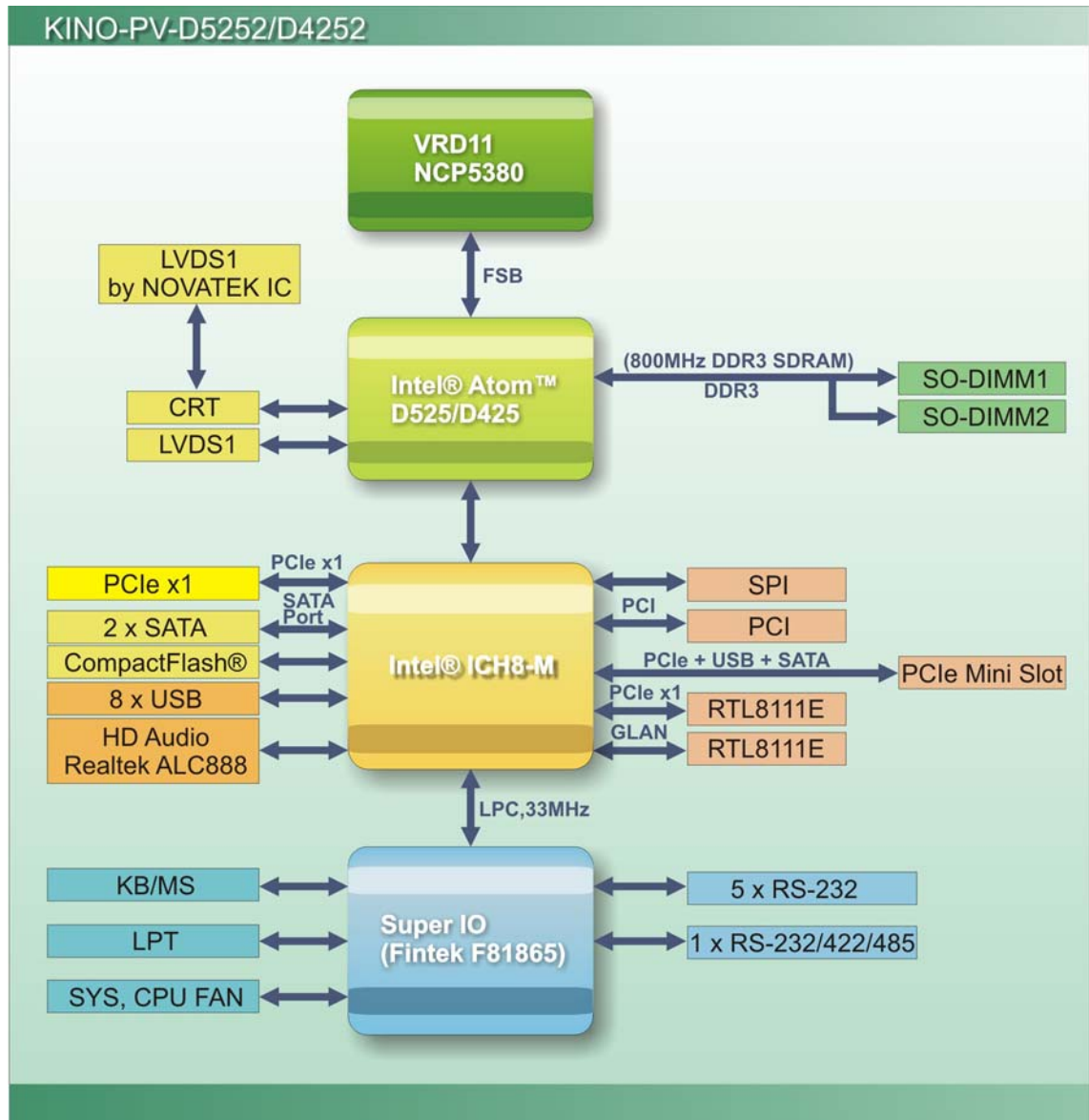

Figure 1-4: Data Flow Block Diagram

1.5 Technical Specifications

KINO-PV-D5252/D4252 technical specifications are listed in table below.

Specification	KINO-PV-D5252/D4252
Form Factor	Mini ITX
CPU Options	Intel® Atom™ processor D525, 1.8 GHz/1MB L2 cache Intel® Atom™ processor D425, 1.8 GHz/512KB L2 cache
Express Chipset	Intel® ICH8M
Graphics Engine	GMA 3150
Memory	Two 204-pin SO-DIMM sockets support 800 MHz 4.0 GB (max.) DDR3 SDRAM SO-DIMM
Audio	Realtek ALC888 HD audio codec
LAN	Two Realtek RTL8111E PCIe GbE controllers with ASF 2.0 support on LAN1
Super I/O	Fintek F81865
Digital I/O	8-bit, 4-bit input/4-bit output
BIOS	UEFI BIOS label
SMBus	One 4-pin wafer connector
Watchdog Timer	Software programmable supports 1~255 sec. system reset
Expansion	
PCIe	One PCIe Mini slot (PCIe + USB + SATA signal), One PCIe x1 slot
PCI	One PCI slot
I/O Interface Connectors	
Display Ports	Analog CRT, resolution support up to 2048x1536 CRT hot plug supported 18-bit single-channel LVDS, resolution support up to WXGA 1366x768 or XGA 1024x768 24-bit dual-channel LVDS by Novatek 68667UFG, resolution support up to 1920x1080

KINO-PV-D5252/D4252 Mini ITX SBC

Specification	KINO-PV-D5252/D4252
Ethernet	Two RJ-45 GbE ports by Realtek RTL8111E with ASF 2.0 support on LAN1
Serial Ports	Three RS-232 via Rear I/O Two RS-232 via four 10-pin headers One RS-232/422/485 via 14-pin header
USB 2.0/1.1 Ports	Four external USB ports Four internal USB ports via 8-pin headers
Parallel Ports	One LPT connector via 26-pin header
TPM	INFINEON SLB9635TT1.2 (Optional)
Storage	
Serial ATA	Two SATA 3.0 Gb/s connectors One 5 V SATA power connector One 5 V/12 V SATA power connector
Environmental and Power Specifications	
Power Supply	12 V only ATX and AT power supported
Power Connector	One external DIN 4-pin DC jack One internal 4-pin power connector
Power Consumption	12 V @ 1.95A (Intel® Atom™ D525 1.8GHz with DDR3 1GB*2)
Operating Temperature	-20°C ~ 60°C with free air, -20°C ~ 70°C with force air for D525 processor -20°C ~ 65°C with free air, -20°C ~ 70°C with force air for D425 processor
Humidity	5% ~ 95% (non-condensing)
Physical Specifications	
Dimensions	170 mm x 170 mm
Weight GW/NW	800 g / 340 g

Table 1-1: Technical Specifications



Chapter

2

Unpacking

KINO-PV-D5252/D4252 Mini ITX SBC

2.1 Anti-static Precautions



WARNING!

Static electricity can destroy certain electronics. Make sure to follow the ESD precautions to prevent damage to the product, and injury to the user.

Make sure to adhere to the following guidelines:

- **Wear an anti-static wristband:** Wearing an anti-static wristband can prevent electrostatic discharge.
- **Self-grounding:** Touch a grounded conductor every few minutes to discharge any excess static buildup.
- **Use an anti-static pad:** When configuring any circuit board, place it on an anti-static mat.
- **Only handle the edges of the PCB:** Don't touch the surface of the motherboard. Hold the motherboard by the edges when handling.

2.2 Unpacking Precautions

When the KINO-PV-D5252/D4252 is unpacked, please do the following:

- Follow the antistatic guidelines above.
- Make sure the packing box is facing upwards when opening.
- Make sure all the packing list items are present.







2.3 Packing List



NOTE:

If any of the components listed in the checklist below are missing, do not proceed with the installation. Contact the IEI reseller or vendor the KINO-PV-D5252/D4252 was purchased from or contact an IEI sales representative directly by sending an email to sales@iei.com.tw.

The KINO-PV-D5252/D4252 is shipped with the following components:







Quantity	Item and Part Number	Image
1	KINO-PV-D5252-L2-R11, KINO-PV-D5252T-L2-R11 (with TPM), KINO-PV-D4252-R11 or KINO-PV-D4252T-R11 (with TPM) single board computer	
1	SATA and 5 V power cable (P/N: 32801-000100-100-RS)	
1	RS-232 cable with bracket (P/N: 19800-000300-100-RS)	
1	I/O shielding (P/N: 45014-0024C0-01-RS)	
1	Mini jumper pack (2.0mm) (P/N: 33100-000033-RS)	
1	Utility CD	

KINO-PV-D5252/D4252 Mini ITX SBC

1	Quick Installation Guide	
---	--------------------------	---

2.3.1 Optional Items

The following are optional components which may be separately purchased:

Item and Part Number	Image
LPT cable (P/N: 32200-015100-RS)	
KB/MS PS/2 Y-cable (P/N: 32000-0023800-RS)	
Dual RS-232/422/485 cable with bracket (P/N: 19800-000110-RS)	
Dual port USB cable with bracket (P/N: CB-USB02-RS)	
CPU fan (P/N: 19FTS00032100-000001-RS)	
PCIe x1 riser card (P/N: PCIER-K101L-R10)	



Chapter

3

Connectors

KINO-PV-D5252/D4252 Mini ITX SBC

3.1 Peripheral Interface Connectors

This chapter details all the jumpers and connectors.

3.1.1 KINO-PV-D5252/D4252 Layout

The figures below show all the connectors and jumpers.

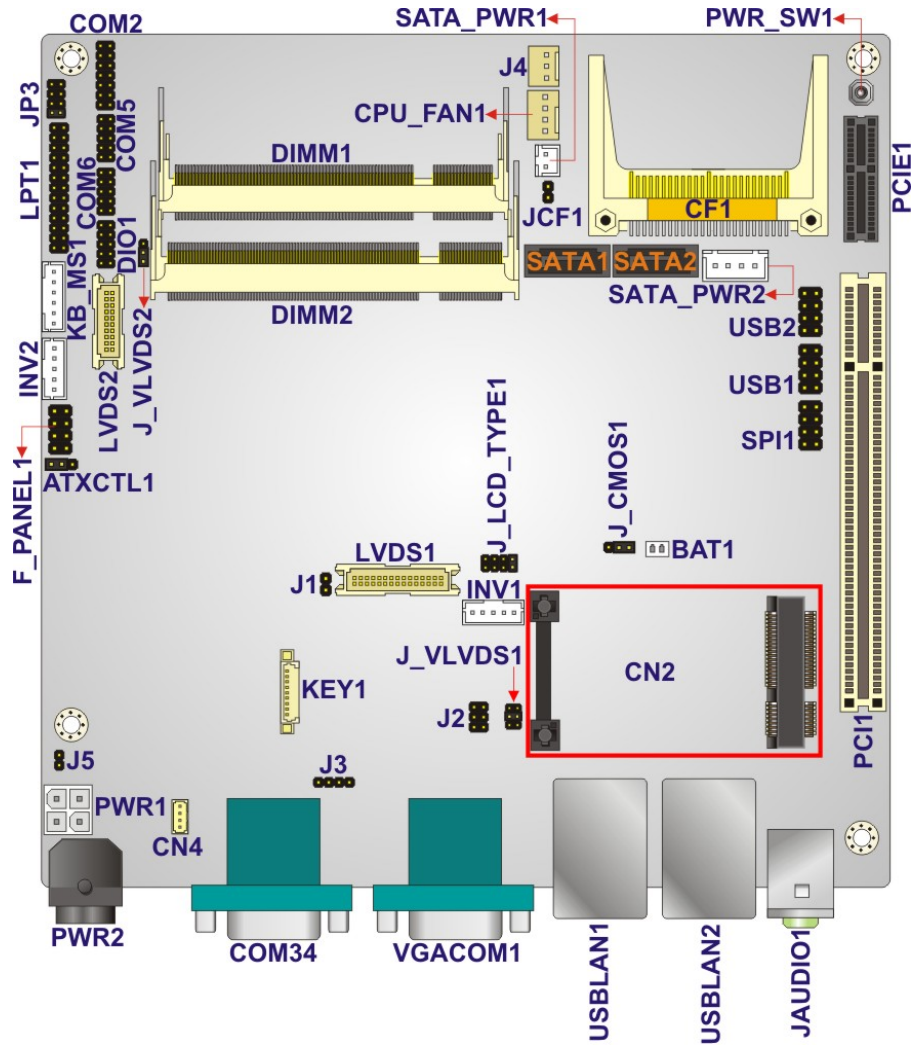

Figure 3-1: Connector and Jumper Locations

3.1.2 Peripheral Interface Connectors

The table below lists all the connectors on the board.

Connector	Type	Label
12 V Power connector	4-pin connector	PWR2
Battery connector	2-pin wafer	BAT1
CompactFlash® slot	50-pin header	CF1
Digital I/O connector	10-pin header	DIO1
Fan connector (CPU)	4-pin wafer	CPU_FAN1
Fan connector	3-pin header	J4
Flash SPI ROM	8-pin header	SPI1
Front panel connector	8-pin header	F_PANEL1
Keyboard and mouse connector	6-pin wafer	KB_MS1
Keypad connector	9-pin wafer	KEY1
LVDS1 connector	30-pin crimp	LVDS1
LVDS1 Backlight Inverter connector	5-pin wafer	INV1
LVDS2 connector	20-pin crimp	LVDS2
LVDS2 Backlight Inverter connector	5-pin wafer	INV2
Parallel port connector	26-pin header	LPT1
PCIe Mini card slot	PCIe Mini card slot	CN2
Serial ATA (SATA) drive connector	7-pin SATA	SATA1, SATA2
SATA power connector	2-pin wafer, 4-pin wafer	SATA_PWR1, SATA_PWR2
Serial port connector (RS-232)	10-pin header	COM5, COM6
Serial port connector (RS-232)	14-pin header	COM2
SMBus connector	4-pin wafer	CN4

KINO-PV-D5252/D4252 Mini ITX SBC

Connector	Type	Label
USB connector	8-pin header	USB1, USB2

Table 3-1: Peripheral Interface Connectors

3.1.3 External Interface Panel Connectors

The table below lists the connectors on the external I/O panel.

Connector	Type	Label
Audio connector	Line-out, Mic	JAUDIO1
Ethernet and USB connector	RJ-45	USBLAN1, USBLAN2
Power connector	5-pin connector	PWR1
Serial port connector	9-pin male	COM1, COM3, COM4
VGA port connector	15-pin connector	VGACOM1

Table 3-2: Rear Panel Connectors

3.2 Internal Peripheral Connectors

The section describes all of the connectors on the KINO-PV-D5252/D4252.

3.2.1 12V Power Connector

CN Label: PWR2

CN Type: 4-pin Molex power connector (1x4)

CN Location: See Figure 3-2

CN Pinouts: See Table 3-3

The connector supports the 12V power supply.

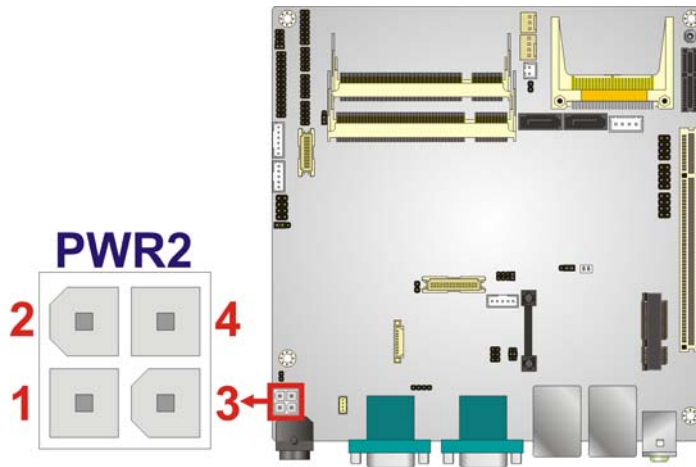

Figure 3-2: 12 V Power Connector Location

Pin	Description	Pin	Description
1	GND	2	GND
3	+12V	4	+12V

Table 3-3: 12 V Power Connector Pinouts

3.2.2 Battery Connector

- CN Label:** BAT1
- CN Type:** 2-pin wafer
- CN Location:** See **Figure 3-3**
- CN Pinouts:** See **Table 3-4**

This is connected to the system battery. The battery provides power to the system clock to retain the time when power is turned off.

KINO-PV-D5252/D4252 Mini ITX SBC

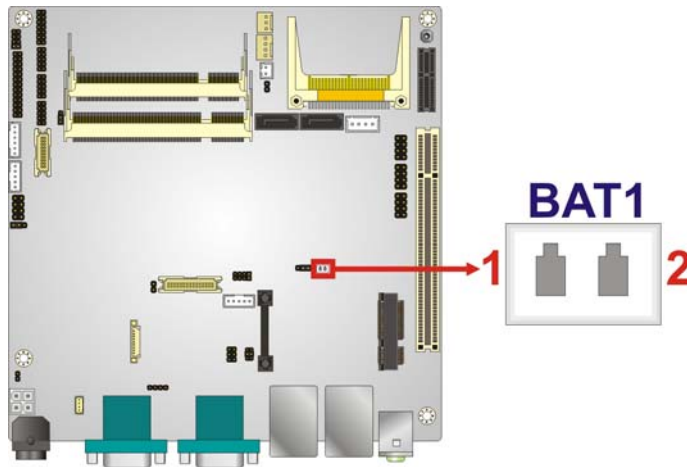

Figure 3-3: Battery Connector Location

Pin	Description
1	VCC_BAT
3	GND

Table 3-4: Battery Connector Pinouts

3.2.3 CompactFlash® Slot

- CN Label:** CF1
- CN Type:** CompactFlash® card slot
- CN Location:** See **Figure 3-4**
- CN Pinouts:** See **Table 3-5**

A CompactFlash® Type I/II card can be used in this slot.

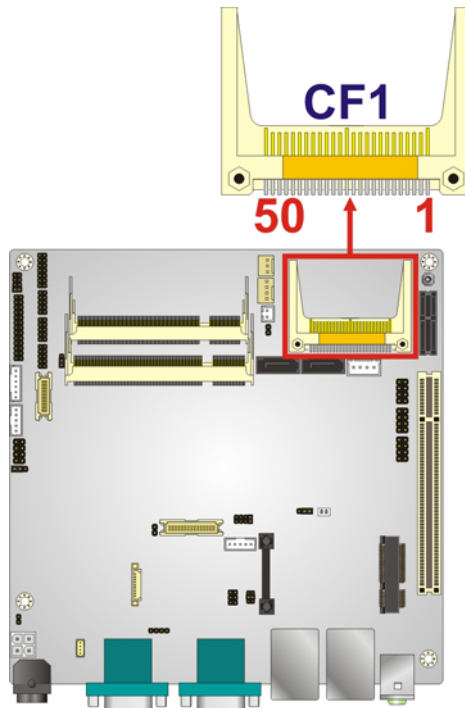
Figure 3-4: CompactFlash® Slot Location

Pin	Description	Pin	Description
1	GND	26	CD1#
2	D3	27	D11
3	D4	28	D12
4	D5	29	D13
5	D6	30	D14
6	D7	31	D15
7	CE#	32	CE2#
8	A10	33	VS1#
9	OE#	34	IOR#
10	A9	35	IOW#
11	A8	36	WE#
12	A7	37	IRQ
13	VCC	38	VCC
14	A6	39	CSEL#
15	A5	40	VS2#
16	A4	41	RESET#

KINO-PV-D5252/D4252 Mini ITX SBC

Pin	Description	Pin	Description
17	A3	42	WAIT#
18	A2	43	INPACK#
19	A1	44	REG#
20	A0	45	BVD2
21	D0	46	BVD1
22	D1	47	D8
23	D2	48	D9
24	IOCS16#	49	D10
25	CD2#	50	GND2

Table 3-5: CompactFlash® Slot Pinouts

3.2.4 Digital I/O Connector

- CN Label:** DIO1
- CN Type:** 10-pin header
- CN Location:** See **Figure 3-5**
- CN Pinouts:** See **Table 3-6**

The digital I/O connector provides programmable input and output for external devices. The digital I/O provides 4-bit output and 4-bit input.

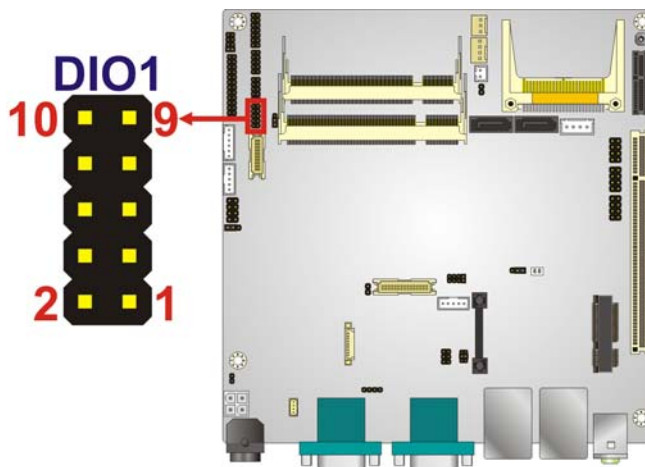

Figure 3-5: Digital I/O Connector Locations

Pin	Description	Pin	Description
1	Ground	2	VCC5
3	Output 3	4	Output 2
5	Output 1	6	Output 0
7	Input 3	8	Input 2
9	Input 1	10	Input 0

Table 3-6: Digital I/O Connector Pinouts

3.2.5 Fan Connector (CPU)

- CN Label:** CPU_FAN1
- CN Type:** 4-pin wafer
- CN Location:** See **Figure 3-6**
- CN Pinouts:** See **Table 3-7**

The fan connector attaches to a CPU cooling fan.

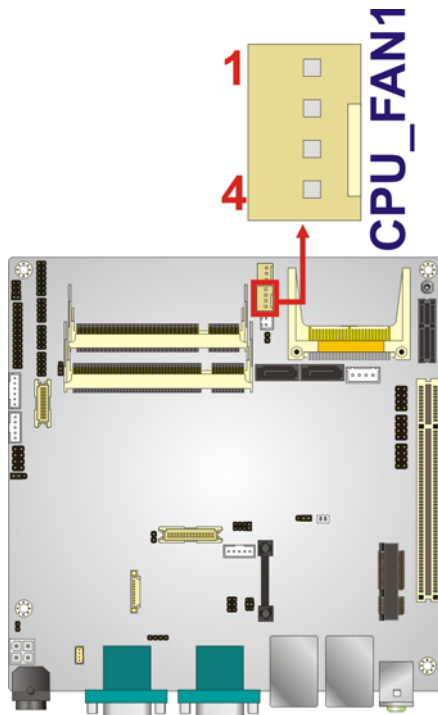

Figure 3-6: CPU Fan Connector Location

KINO-PV-D5252/D4252 Mini ITX SBC

Pin	Description
1	GND
2	VCC12
3	FANIN1
4	FANOUT1

Table 3-7: CPU Fan Connector Pinouts

3.2.6 Fan Connector

- CN Label:** J4
- CN Type:** 3-pin header
- CN Location:** See **Figure 3-7**
- CN Pinouts:** See **Table 3-8**

The fan connector attaches to a cooling fan.

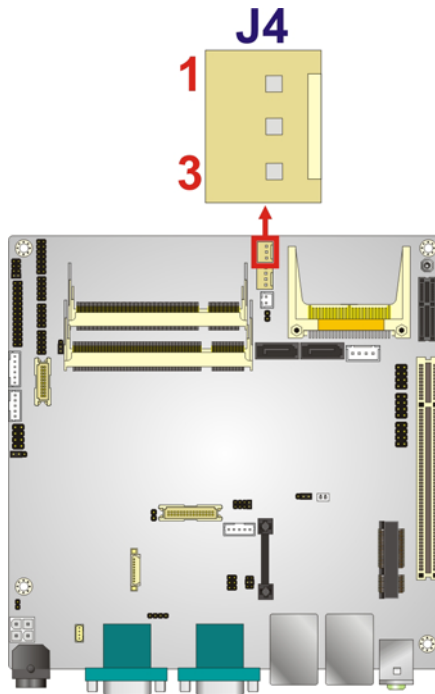

Figure 3-7: Fan Connector Location

Pin	Description
1	FANIO1

Pin	Description
2	+12V (PWM)
3	GND

Table 3-8: Fan Connector Pinouts

3.2.7 Flash SPI ROM

- CN Label:** SPI1
- CN Type:** 8-pin header
- CN Location:** See **Figure 3-8**
- CN Pinouts:** See **Table 3-9**

The connector provides a Flash SPI BIOS update.

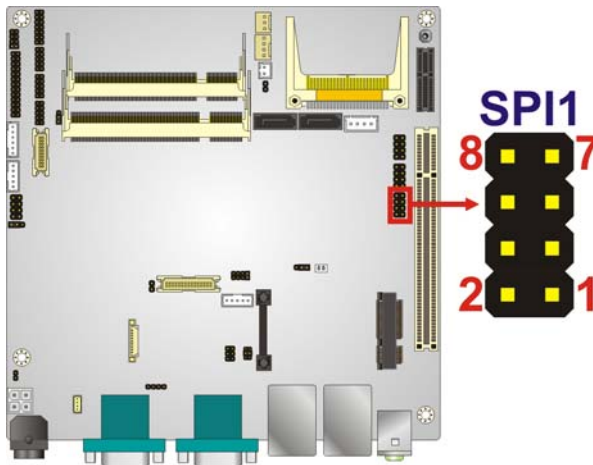
Figure 3-8: Flash SPI ROM Connector Location

Pin	Description	Pin	Description
1	SPI_VCC	2	GND
3	SPI_CS	4	SPI_CLK
5	SPI_SO	6	SPI_SI
7	NC	8	NC

Table 3-9: SPI Flash Connector Pinouts

KINO-PV-D5252/D4252 Mini ITX SBC

3.2.8 Front Panel Connector

CN Label:	F_PANEL1
CN Type:	8-pin header (2x4)
CN Location:	See Figure 3-9
CN Pinouts:	See Table 3-10

The front panel connector connects to external switches and indicators to monitor and controls the motherboard. These indicators and switches include:

- Power button
- Reset
- Power LED
- HDD LED

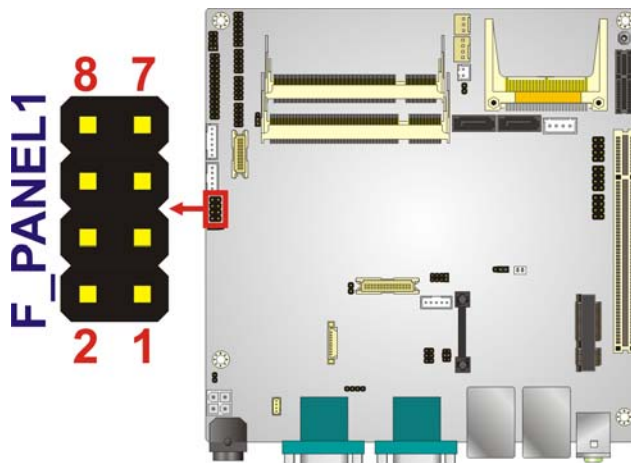

Figure 3-9: Front Panel Connector Location

FUNCTION	PIN	DESCRIPTION	FUNCTION	PIN	DESCRIPTION
Power Button	1	PWRBTSW-	Power LED	2	PWR_LED+
	3	GND		4	GND
HDD LED	5	VCC	Reset	6	PM_RESET
	7	-HDLED		8	GND

Table 3-10: Front Panel Connector Pinouts

3.2.9 Keyboard/Mouse Connector

- CN Label:** KB_MS1
- CN Type:** 6-pin wafer (1x6)
- CN Location:** See **Figure 3-10**
- CN Pinouts:** See **Table 3-11**

The keyboard/mouse connector connects to a PS/2 Y-cable that can be connected to a PS/2 keyboard and mouse.

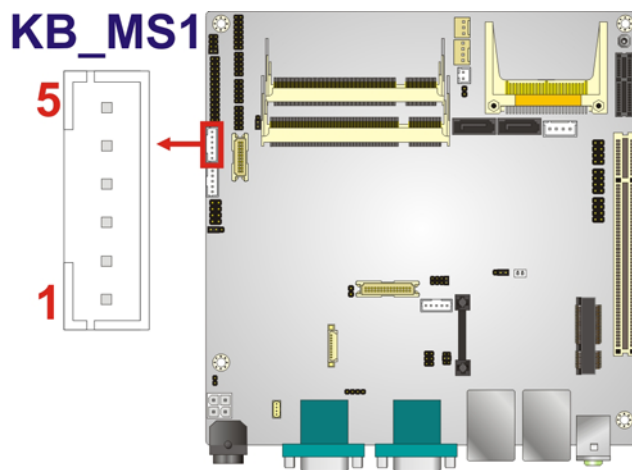

Figure 3-10: Keyboard/Mouse Connector Location

Pin	Description
1	VCC
2	Mouse Data
3	Mouse Clock
4	Keyboard Data
5	Keyboard Clock
6	GND

Table 3-11: Keyboard/Mouse Connector Pinouts

3.2.10 Keypad Connector

- CN Label:** KEY1
- CN Type:** 9-pin header

KINO-PV-D5252/D4252 Mini ITX SBC

CN Location: See Figure 3-11

CN Pinouts: See Table 3-12

The keypad connector can be used to install a numeric keypad.

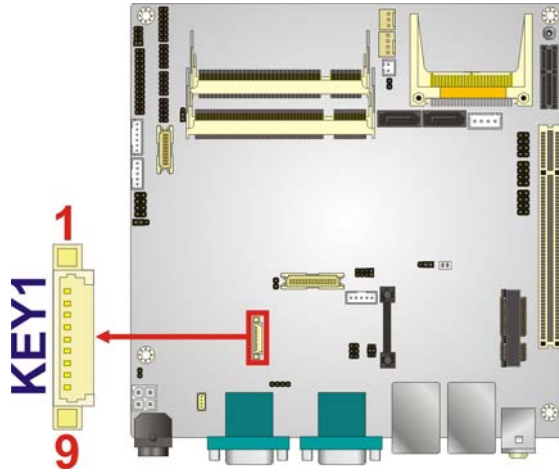

Figure 3-11: Keypad Connector Location

Pin	Description
1	Red LED
2	NC
3	Green LED
4	Menu/Enter
5	Up
6	Down
7	Auto/Exit
8	Power
9	Ground

Table 3-12: Keypad Connector Pinouts

3.2.11 LVDS1 Connector (For Intel® Atom™ processor D525 dual LVDS only)

CN Label: LVDS1

CN Type: 30-pin crimp

CN Location: See Figure 3-12

CN Pinouts: See Table 3-13

The LVDS connector is for an LCD panel connected to the board.

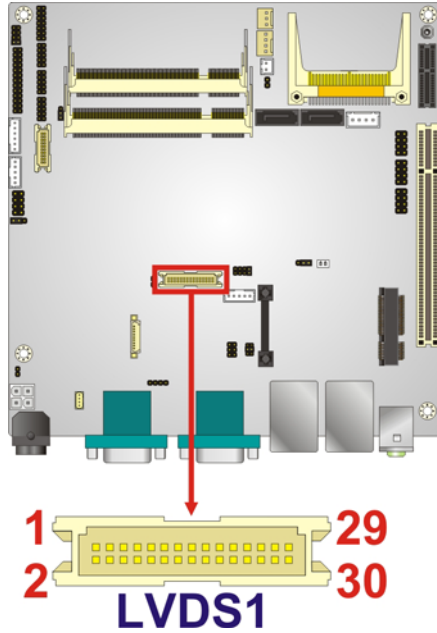

Figure 3-12: LVDS1 Connector Location

Pin	Description	Pin	Description
1	GND1	2	GND2
3	A_Y0	4	A_Y0#
5	A_Y1	6	A_Y1#
7	A_Y2	8	A_Y2#
9	A_CK	10	A_CK#
11	A_Y3	12	A_Y3#
13	GND3	14	GND4
15	B_Y0	16	B_Y0#
17	B_Y1	18	B_Y1#
19	B_Y2	20	B_Y2#
21	B_CK	22	B_CK#
23	B_Y3	24	B_Y3#
25	GND5	26	GND6

KINO-PV-D5252/D4252 Mini ITX SBC

Pin	Description	Pin	Description
27	VCC_LCD	28	VCC_LCD
29	VCC_LCD	30	VCC_LCD

Table 3-13: LVDS1 Connector Pinouts

3.2.12 LVDS1 Backlight Inverter Connector

- CN Label:** INV1
- CN Type:** 5-pin wafer
- CN Location:** See **Figure 3-13**
- CN Pinouts:** See **Table 3-14**

The backlight inverter connector provides power to an LCD panel.

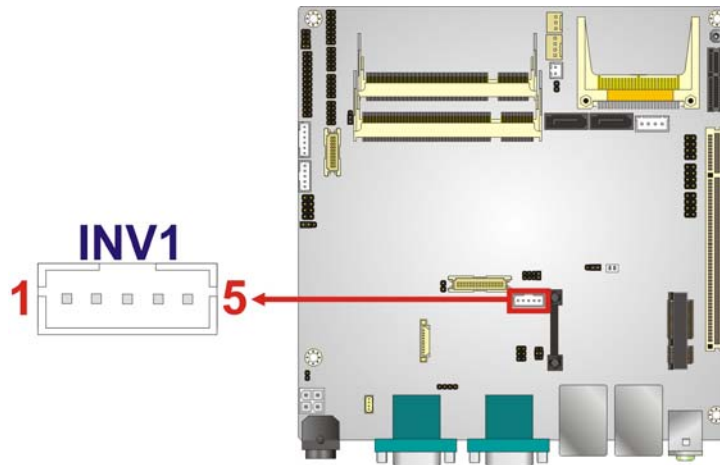

Figure 3-13: LVDS1 Backlight Inverter Connector Location

Pin	Description
1	LCD_BKLTCTL
2	GROUND
3	+12V
4	GROUND
5	BACKLIGHT ENABLE

Table 3-14: LVDS1 Backlight Inverter Connector Pinouts

3.2.13 LVDS2 Connector

- CN Label:** LVDS2
- CN Type:** 20-pin crimp
- CN Location:** See **Figure 3-12**
- CN Pinouts:** See **Table 3-13**

The LVDS connector is for an LCD panel connected to the board.

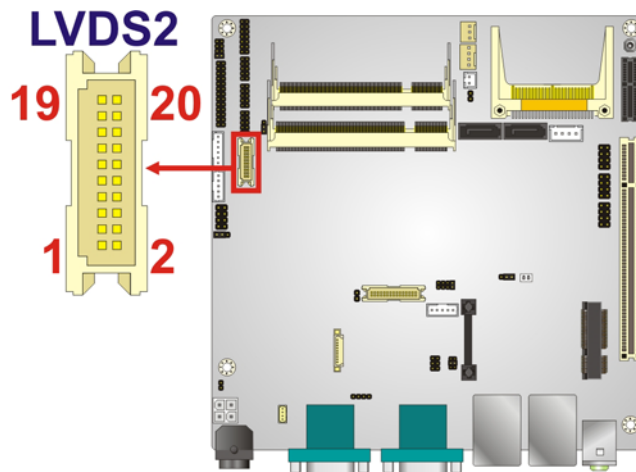

Figure 3-14: LVDS2 Connector Location

Pin	Description	Pin	Description
1	GND1	2	GND2
3	A_Y0	4	A_Y0#
5	A_Y1	6	A_Y1#
7	A_Y2	8	A_Y2#
9	A_CK	10	A_CK#
11	NC	12	NC
13	GND3	14	GND4
15	NC	16	NC
17	VCC_LCD	18	VCC_LCD
19	VCC_LCD	20	VCC_LCD

Table 3-15: LVDS2 Connector Pinouts

KINO-PV-D5252/D4252 Mini ITX SBC

3.2.14 LVDS2 Backlight Inverter Connector

CN Label:	INV2
CN Type:	5-pin wafer
CN Location:	See Figure 3-13
CN Pinouts:	See Table 3-14

The backlight inverter connector provides power to an LCD panel.

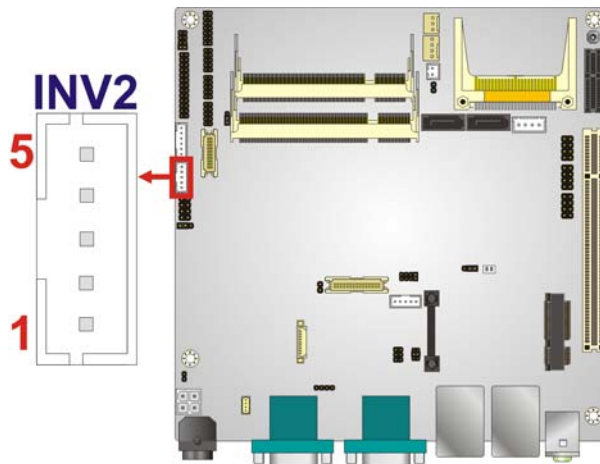

Figure 3-15: LVDS2 Backlight Inverter Connector Location

Pin	Description
1	LCD_BKLTCTL
2	GROUND
3	+12V
4	GROUND
5	BACKLIGHT ENABLE

Table 3-16: LVDS2 Backlight Inverter Connector Pinouts

3.2.15 Parallel Port Connector

CN Label:	LPT1
CN Type:	26-pin box header
CN Location:	See Figure 3-16

CN Pinouts: See **Table 3-17**

The parallel port connector connects to a parallel port connector interface or some other parallel port device such as a printer.

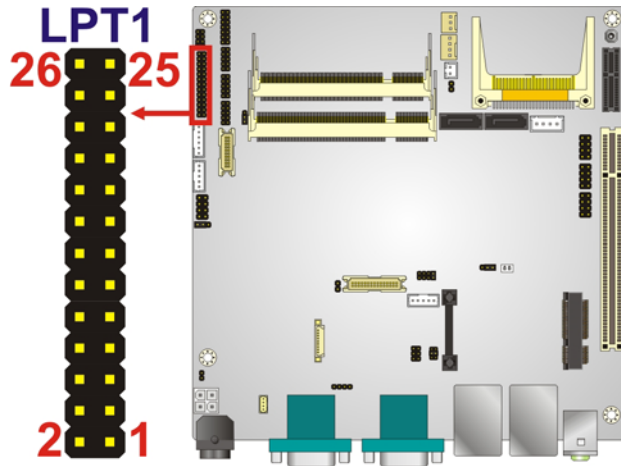

Figure 3-16: Parallel Port Connector Location

Pin	Description	Pin	Description
1	STROBE#	2	AUTO FORM FEED #
3	DATA0	4	ERROR#
5	DATA1	6	INITIALIZE#
7	DATA2	8	PRINTER SELECT LN#
9	DATA3	10	GND
11	DATA4	12	GND
13	DATA5	14	GND
15	DATA6	16	GND
17	DATA7	18	GND
19	ACKNOWLEDGE#	20	GND
21	BUSY	22	GND
23	PAPER EMPTY	24	GND
25	PRINTER SELECT	26	NC

Table 3-17: Parallel Port Connector Pinouts

KINO-PV-D5252/D4252 Mini ITX SBC

3.2.16 PCIe Mini Card Slot

- CN Label:** CN2
- CN Type:** PCIe Mini card slot
- CN Location:** See **Figure 3-17**
- CN Pinouts:** See **Table 3-18**

The PCIe Mini card slot is for installing PCIe Mini expansion cards.

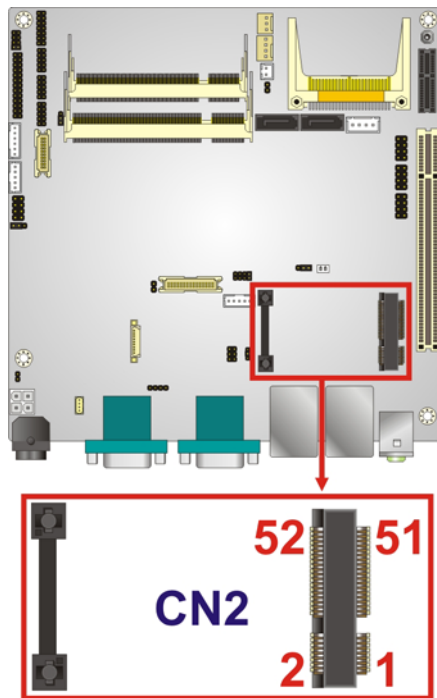

Figure 3-17: PCIe Mini Card Slot Location

Pin	Description	Pin	Description
1	PCIE_WAKE#	2	VCC3
3	N/C	4	GND
5	N/C	6	1.5 V
7	CLKREQ#	8	LFRAME#
9	GND	10	LAD3
11	CLK-	12	LAD2
13	CLK+	14	LAD1
15	GND	16	LAD0

Pin	Description	Pin	Description
17	PCIRST#	18	GND
19	LPC	20	VCC3
21	GND	22	PCIRST#
23	PERN2	24	3VDual
25	PERP2	26	GND
27	GND	28	1.5 V
29	GND	30	SMBCLK
31	PETN2	32	SMBDATA
33	PETP2	34	GND
35	GND	36	USB D-
37	GND	38	USB D+
39	SATARXP	40	GND
41	SATARXN	42	N/C
43	N/C	44	RF_LINK#
45	SATATXN	46	BLUELED#
47	SATATXP	48	1.5 V
49	GND	50	GND
51	N/C	52	VCC3

Table 3-18: PCIe Mini Card Slot Pinouts

3.2.17 SATA Drive Connectors

- CN Label:** SATA1, SATA2
- CN Type:** 7-pin SATA drive connectors
- CN Location:** See Figure 3-18
- CN Pinouts:** See Table 3-19

The two SATA 3Gb/s drive connectors are each connected to a SATA 3Gb/s drive. The SATA 3Gb/s drives transfer data at speeds as high as 3.0 Gb/s.

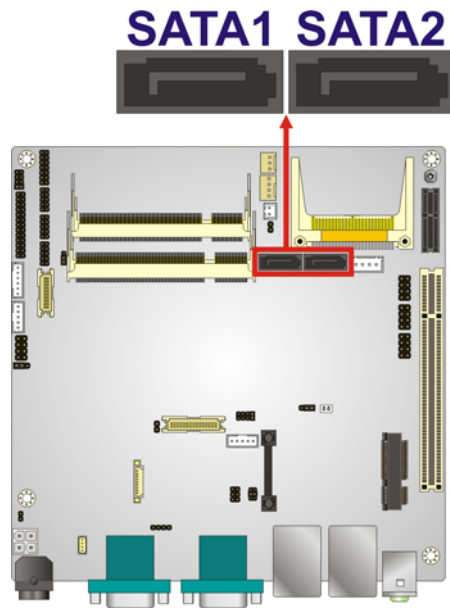

Figure 3-18: SATA Drive Connector Locations

Pin	Description
1	GND
2	TX+
3	TX-
4	GND
5	RX-
6	RX+
7	GND

Table 3-19: SATA Drive Connector Pinouts

3.2.18 SATA Power Connector

- CN Label:** SATA_PWR1
- CN Type:** 2-pin wafer
- CN Location:** See Figure 3-19
- CN Pinouts:** See Table 3-20

The SATA Power Connector provides power output to the SATA connectors.

SATA_PWR1

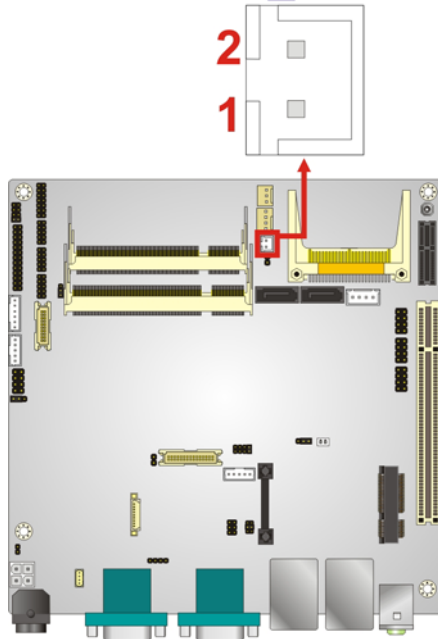

Figure 3-19: SATA Power Connector Locations

Pin	Description
1	+5V
2	GND

Table 3-20: SATA Power Connector Pinouts

- CN Label:** SATA_PWR2
- CN Type:** 4-pin wafer
- CN Location:** See **Figure 3-20**
- CN Pinouts:** See **Table 3-21**

The SATA Power Connector provides power output to the SATA connectors.

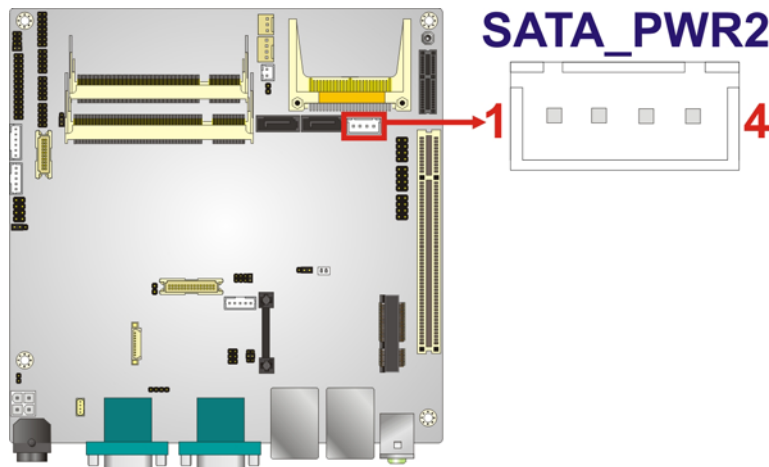

Figure 3-20: SATA Power Connector Locations

Pin	Description
1	12V
2	GND
3	GND
4	5V

Table 3-21: SATA Power Connector Pinouts

3.2.19 Serial Port Connectors (RS-232)

- CN Label:** COM5, COM6
- CN Type:** 10-pin header (2x5)
- CN Location:** See Figure 3-21
- CN Pinouts:** See Table 3-22

This connector provides RS-232 communications.

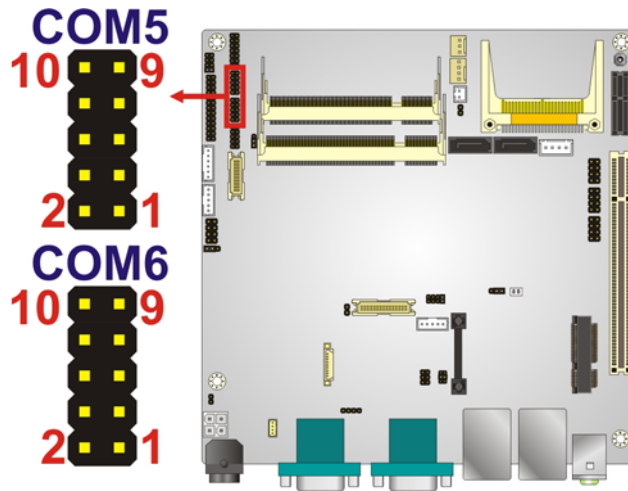

Figure 3-21: Serial Port (COM5 and COM6) Connector Pinout Locations

Pin	Description	Pin	Description
1	Data Carrier Direct (DCD)	2	Data Set Ready (DSR)
3	Receive Data (RXD)	4	Request To Send (RTS)
5	Transmit Data (TXD)	6	Clear To Send (CTS)
7	Data Terminal Ready (DTR)	8	Ring Indicator (RI)
9	Ground (GND)	10	Ground (GND)

Table 3-22: Serial Port Connector Pinouts

3.2.20 Serial Port Connector (RS-232)

- CN Label:** COM2
- CN Type:** 14-pin header (2x7)
- CN Location:** See Figure 3-22
- CN Pinouts:** See Table 3-23

Used for RS-232/422/485 communications.

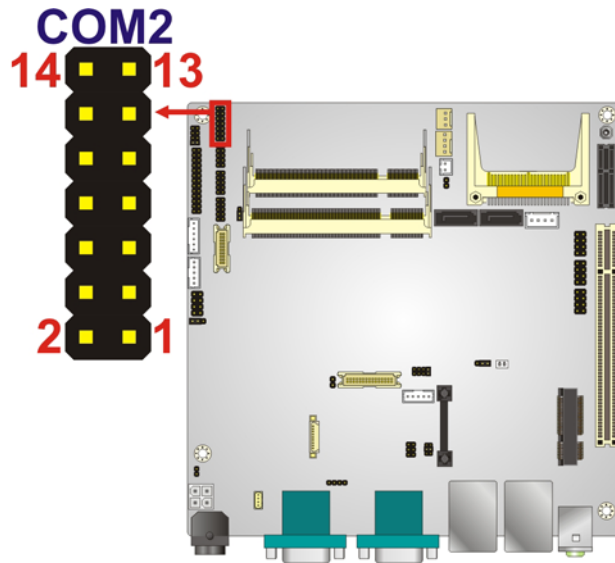

Figure 3-22: Serial Port (COM2) Connector Location

Pin	Description	Pin	Description
1	DCD	2	DSR
3	RXD	4	RTS
5	TXD	6	CTS
7	DTR	8	RI
9	GND	10	N/C
11	TXD485+	12	TXD485#
13	RXD485+	14	RXD485#

Table 3-23: Serial Port (COM2) Connector Pinouts

3.2.21 SMBus Connector

- CN Label:** CN4
- CN Type:** 4-pin wafer (1x4)
- CN Location:** See **Figure 3-23**
- CN Pinouts:** See **Table 3-24**

The SMBus Connector provides a connection to a SMBus (System Management Bus) device.

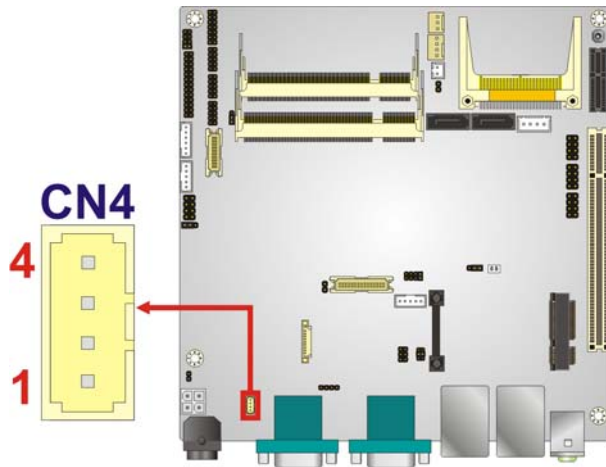

Figure 3-23: SMBus Connector Locations

Pin	Description
1	Ground
2	SMB_DATA
3	SMB_CLK
4	+5V

Table 3-24: SMBus Connector Pinouts

3.2.22 USB Connectors

- CN Label:** USB1, USB2
- CN Type:** 8-pin header (2x4)
- CN Location:** See **Figure 3-24**
- CN Pinouts:** See **Table 3-25**

The USB connectors connect to USB devices. Each pin header provides two USB ports.

KINO-PV-D5252/D4252 Mini ITX SBC

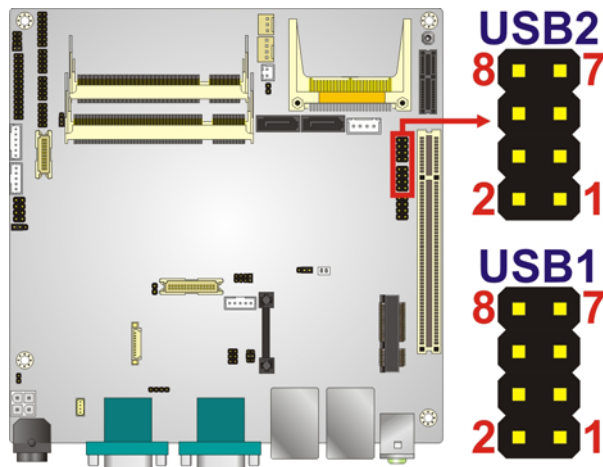

Figure 3-24: USB Connector Pinout Locations

Pin	Description	Pin	Description
1	VCC	2	GND
3	DATA-	4	DATA+
5	DATA+	6	DATA-
7	GND	8	VCC

Table 3-25: USB Port Connector Pinouts

3.3 External Peripheral Interface Connector Panel

Figure 3-25 shows the KINO-PV-D5252/D4252 external peripheral interface connector (EPIC) panel. The KINO-PV-D5252/D4252 EPIC panel consists of the following:

- 4 x USB connectors
- 2 x Ethernet connector
- 1 x Line-out
- 1x Microphone
- 1 x VGA
- 3 x Serial port (RS-232)
- 1 x 12 V DC input

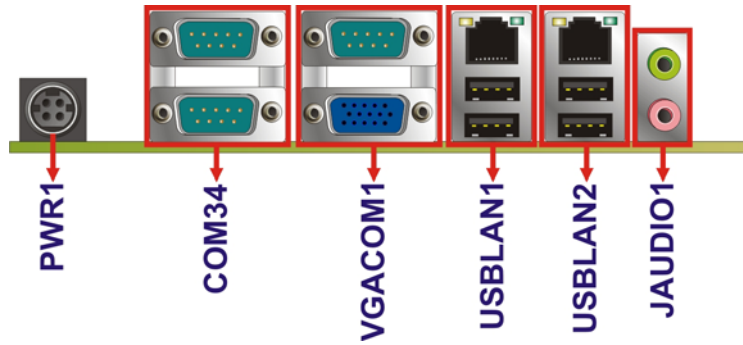

Figure 3-25: KINO-PV-D5252/D4252 External Peripheral Interface Connector

3.3.1 Audio Connector

- CN Label:** JAUDIO1
- CN Type:** Line-out, Mic
- CN Location:** See **Figure 3-25**

The audio jacks connect to external audio devices.

- **Line-out port (Lime):** Connects to a headphone or a speaker. With multi-channel configurations, this port can also connect to front speakers.
- **Microphone (Pink):** Connects a microphone.



Figure 3-26: Audio Connector

3.3.2 Ethernet and USB Connector

- CN Label:** USBLAN1, USBLAN2
- CN Type:** RJ-45 port, USB port
- CN Location:** See **Figure 3-25**
- CN Pinouts:** See **Table 3-26**, **Table 3-28**

KINO-PV-D5252/D4252 Mini ITX SBC

The KINO-PV-D5252/D4252 is equipped with two built-in RJ-45 Ethernet controllers. The controllers can connect to the LAN through the RJ-45 LAN connectors.

Pin	Description	Pin	Description
P1	3.3V supply	P2	LAN signal differential pair (0+)
P3	LAN signal differential pair (0-)	P4	LAN signal differential pair (1+)
P5	LAN signal differential pair (1-)	P6	LAN signal differential pair (2+)
P7	LAN signal differential pair (2-)	P8	LAN signal differential pair (3+)
P9	LAN signal differential pair (3-)	P10	GND
P11	Right LED signal(-)	P12	Right LED signal(+)
P13	Left LED signal(-)	P14	Left LED signal(+)
9	Chassis GND	10	Chassis GND
11	Chassis GND	12	Chassis GND
13	Chassis GND	14	Chassis GND
15	Chassis GND	16	Chassis GND

Table 3-26: LAN Pinouts

The RJ-45 Ethernet connectors have two status LEDs, one green and one yellow. The green LED indicates activity on the port and the yellow LED indicates the speed. See **Table 3-27**.

Speed LED		Activity/Link LED	
STATUS	DESCRIPTION	STATUS	DESCRIPTION
Off	10 Mbps connection	Off	No link
Green	100 Mbps connection	Yellow	Linked
Orange	Gbps connection	Blinking	TX/RX activity 1

Table 3-27: RJ-45 Ethernet Connector LEDs



Figure 3-27: RJ-45 Ethernet Connector

The USB connector can be connected to a USB device.

Pin	Description
1	VCC
2	DATA0-
3	DATA0+
4	GND
5	VCC
6	DATA1-
7	DATA1+
8	GND

Table 3-28: USB Pinouts

3.3.3 Power Connector

- CN Label:** PWR1
- CN Type:** 5-pin connector
- CN Location:** See **Figure 3-25**
- CN Pinouts:** See **Table 3-29**

The connector supports the 12V power adapter.

Pin	Description
1	12V
2	GND
3	12V
4	GND
5	GND

Table 3-29: Power Connector Pinouts

3.3.4 Serial Port Connector

- CN Label:** COM1, COM3, COM4
- CN Type:** 9-pin male
- CN Location:** **Figure 3-25**

KINO-PV-D5252/D4252 Mini ITX SBC

CN Pinouts: See **Table 3-30**

The serial port connects to a RS-232 serial communications device.

Pin	Description
1	DATA CARRIER DETECT (DCD)
2	DATA SET READY (DSR)
3	RECEIVE DATA (RXD)
4	REQUEST TO SEND (RTS)
5	TRANSMIT DATA (TXD)
6	CLEAR TO SEND (CTS)
7	DATA TERMINAL READY (DTR)
8	RING INDICATOR (RI)
9	GND (GND)
10	N/C

Table 3-30: Serial Port Pinouts

3.3.5 VGA Port Connector

CN Label: VGACOM1

CN Type: 15-pin Female VGA connector

CN Location: See **Figure 3-25**

CN Pinouts: See **Table 3-31**

The VGA port connects to a monitor that accepts a standard VGA input.

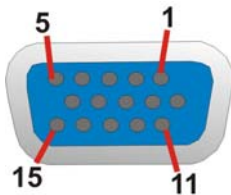

Figure 3-28: VGA Connector

Pin	Description	Pin	Description
1	RED	2	GREEN

Pin	Description	Pin	Description
3	BLUE	4	NC
5	GND	6	GND
7	GND	8	GND
9	CRT_VCC	10	Display_GND
11	NC	12	DDCDAT
13	HSYNC	14	VSYNC
15	DDCCLK		

Table 3-31: VGA Connector Pinouts

Chapter

4

Installation

4.1 Anti-static Precautions



WARNING:

Failure to take ESD precautions during the installation of the KINO-PV-D5252/D4252 may result in permanent damage to the KINO-PV-D5252/D4252 and severe injury to the user.

Electrostatic discharge (ESD) can cause serious damage to electronic components, including the KINO-PV-D5252/D4252. Dry climates are especially susceptible to ESD. It is therefore critical that whenever the KINO-PV-D5252/D4252 or any other electrical component is handled, the following anti-static precautions are strictly adhered to.

- **Wear an anti-static wristband:** Wearing a simple anti-static wristband can help to prevent ESD from damaging the board.
- **Self-grounding:** Before handling the board, touch any grounded conducting material. During the time the board is handled, frequently touch any conducting materials that are connected to the ground.
- **Use an anti-static pad:** When configuring the KINO-PV-D5252/D4252, place it on an anti-static pad. This reduces the possibility of ESD damaging the KINO-PV-D5252/D4252.
- **Only handle the edges of the PCB:** When handling the PCB, hold the PCB by the edges.

4.2 Installation Considerations



NOTE:

The following installation notices and installation considerations should be read and understood before the KINO-PV-D5252/D4252 is installed. All installation notices pertaining to the installation of the KINO-PV-D5252/D4252 should be strictly adhered to. Failing to adhere to these precautions may lead to severe damage of the KINO-PV-D5252/D4252 and injury to the person installing the motherboard.

4.2.1 Installation Notices



WARNING:

The installation instructions described in this manual should be carefully followed in order to prevent damage to the KINO-PV-D5252/D4252, KINO-PV-D5252/D4252 components and injury to the user.

Before and during the installation please **DO** the following:

- Read the user manual:
 - The user manual provides a complete description of the KINO-PV-D5252/D4252 installation instructions and configuration options.
- Wear an electrostatic discharge cuff (ESD):
 - Electronic components are easily damaged by ESD. Wearing an ESD cuff removes ESD from the body and helps prevent ESD damage.
- Place the KINO-PV-D5252/D4252 on an antistatic pad:
 - When installing or configuring the motherboard, place it on an antistatic pad. This helps to prevent potential ESD damage.

- Turn all power to the KINO-PV-D5252/D4252 off:
 - When working with the KINO-PV-D5252/D4252, make sure that it is disconnected from all power supplies and that no electricity is being fed into the system.

Before and during the installation of the KINO-PV-D5252/D4252 **DO NOT:**

- Remove any of the stickers on the PCB board. These stickers are required for warranty validation.
- Use the product before verifying all the cables and power connectors are properly connected.
- Allow screws to come in contact with the PCB circuit, connector pins, or its components.

4.3 Unpacking

When the KINO-PV-D5252/D4252 is unpacked, please check all the unpacking list items listed in Chapter 3 are indeed present. If any of the unpacking list items are not available please contact the KINO-PV-D5252/D4252 vendor reseller/vendor where the KINO-PV-D5252/D4252 was purchased or contact an IEI sales representative.

4.4 SO-DIMM Installation

SO-DIMM is a critical component of the KINO-PV-D5252/D4252. If it is not installed the KINO-PV-D5252/D4252 cannot run.

KINO-PV-D5252/D4252 Mini ITX SBC

4.4.1 SO-DIMM Installation

To install a SO-DIMM, please follow the steps below and refer to **Figure 4-1**.

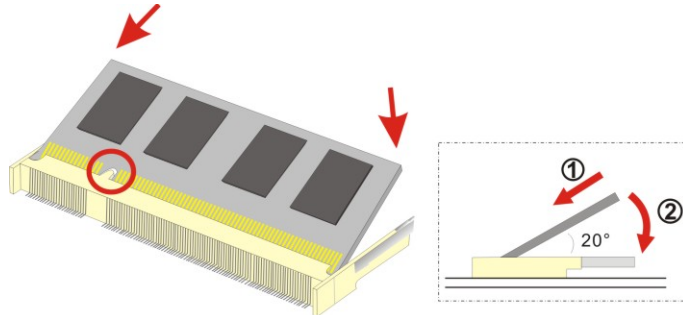

Figure 4-1: SO-DIMM Installation

Step 1: Locate the SO-DIMM socket on the board (See the figure below). Place the board on an anti-static mat.

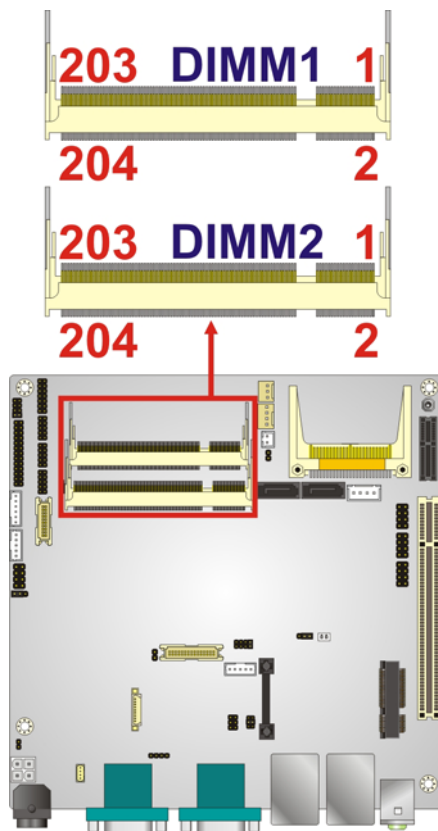

Figure 4-2: SO-DIMM Connector Location

- Step 2:** **Align the SO-DIMM with the socket.** Align the notch on the memory with the notch on the memory socket.
- Step 3:** **Insert the SO-DIMM.** Push the memory in at a 20° angle. (See **Figure 4-1**)
- Step 4:** **Seat the SO-DIMM.** Gently push downwards and the arms clip into place. (See **Figure 4-1**)

4.5 CompactFlash® Installation



NOTE:

Both CompactFlash® Type I and Type II cards are supported.

To install the CompactFlash® card, please follow the steps below.

- Step 1:** **Locate the CF card socket.** Locate the CompactFlash® slot.
- Step 2:** **Align the CF card.** Align the CompactFlash® card. The label side should be facing away from the board. The grooves on the CompactFlash® slot ensure that the card cannot be inserted the wrong way.
- Step 3:** **Insert the CF card.** Push until the CompactFlash® card is firmly seated in the slot. See **Figure 4-3**.

KINO-PV-D5252/D4252 Mini ITX SBC

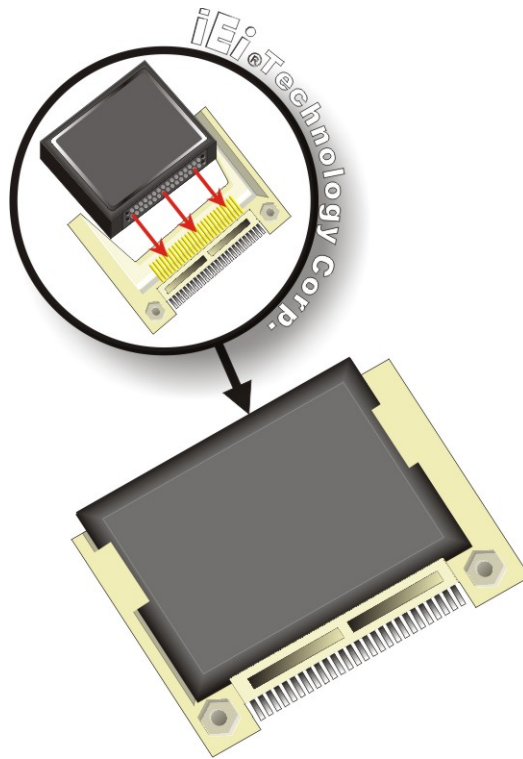

Figure 4-3: CompactFlash® Card Installation

4.6 Jumper Settings



NOTE:

A jumper is a metal bridge used to close an electrical circuit. It consists of two or three metal pins and a small metal clip (often protected by a plastic cover) that slides over the pins to connect them. To CLOSE/SHORT a jumper means connecting the pins of the jumper with the plastic clip and to OPEN a jumper means removing the plastic clip from a jumper.

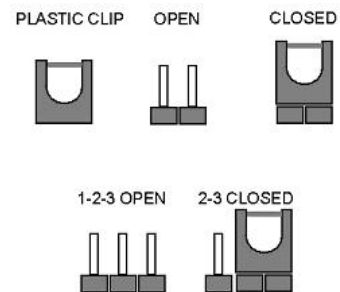

Before the KINO-PV-D5252/D4252 is installed in the system, the jumpers must be set in accordance with the desired configuration. The jumpers on the KINO-PV-D5252/D4252 are listed in **Table 4-1**.

Description	Type	Label
AT/ATX Power setting	3-pin wafer	ATXCTL1
Clear CMOS	3-pin header	J_CMOS1
CompactFlash® setting	2-pin header	JCF1
LVDS1 Panel Resolution Select setting	6-pin header	J2
LVDS2 Panel Resolution Select setting	6-pin header	J_LCD_TYPE1
LVDS1 Voltage Select setting	6-pin header	J_VLVDS1
LVDS2 Voltage Select setting	2-pin header	J_VLVDS2
Serial port setting	8-pin header	JP3

Table 4-1: Jumpers

4.6.1 AT/ATX Power Select Jumper Settings

- Jumper Label:** ATXCTL1
- Jumper Type:** 3-pin header (1x3)
- Jumper Settings:** See **Table 4-2**
- Jumper Location:** See **Figure 4-4**

The AT/ATX Power Select jumper specifies the systems power mode as AT or ATX. AT/ATX Power Select jumper settings are shown in **Table 4-2**.

AT Power Select	Description	
Short 1 - 2	Use ATX power	
Short 2 – 3	Use AT power	Default

Table 4-2: AT/ATX Power Select Jumper Settings

The location of the AT/ATX Power Select jumper is shown in **Figure 4-4** below.

KINO-PV-D5252/D4252 Mini ITX SBC



Figure 4-4: AT/ATX Power Select Jumper Location

4.6.2 Clear CMOS Jumper

Jumper Label:	J_CMOS1
Jumper Type:	3-pin header (1x3)
Jumper Settings:	See Table 4-3
Jumper Location:	See Figure 4-5

If the KINO-PV-D5252/D4252 fails to boot due to improper BIOS settings, the clear CMOS jumper clears the CMOS data and resets the system BIOS information. To do this, use the jumper cap to close pins 2 and 3 for a few seconds then reinstall the jumper clip back to pins 1 and 2.

If the “CMOS Settings Wrong” message is displayed during the boot up process, the fault may be corrected by pressing the F1 to enter the CMOS Setup menu. Do one of the following:

- Enter the correct CMOS setting
- Load Optimal Defaults
- Load Failsafe Defaults.

After having done one of the above, save the changes and exit the CMOS Setup menu.

The clear CMOS jumper settings are shown in **Table 4-3**.

Clear CMOS	Description	
Short 1 - 2	Keep CMOS Setup	Default
Short 2 - 3	Clear CMOS Setup	

Table 4-3: Clear CMOS Jumper Settings

The location of the clear CMOS jumper is shown in **Figure 4-5** below.

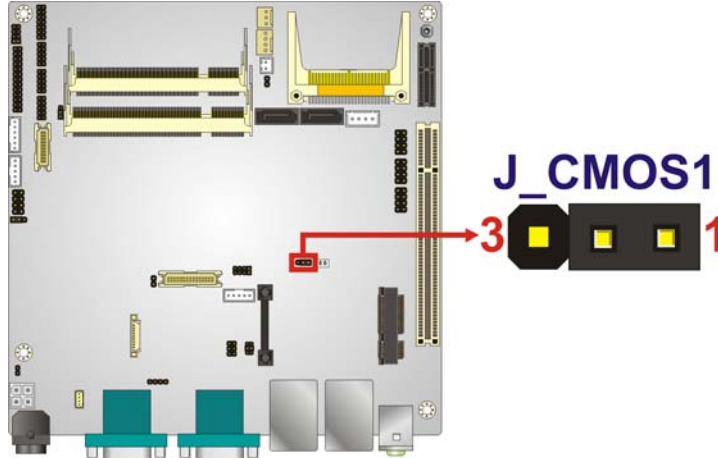

Figure 4-5: Clear CMOS Jumper

4.6.3 CompactFlash® Card Setup Jumper

- Jumper Label:** JCF1
- Jumper Type:** 2-pin header
- Jumper Settings:** See **Table 4-4**
- Jumper Location:** See **Figure 4-6**

The CompactFlash® slot is connected through an IDE connection. This jumper sets the CompactFlash® card as the master or slave IDE device.

Setting	Description
Open	Slave
Closed	Master

Table 4-4: CompactFlash® Setup Jumper Settings

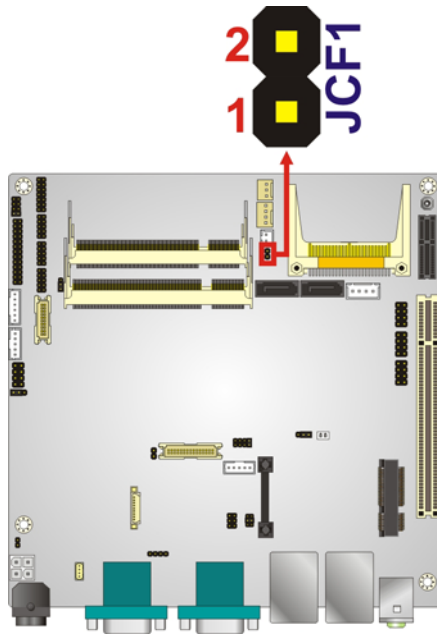

Figure 4-6: CompactFlash® Setup Jumper Location

4.6.4 LVDS1 Panel Resolution Type Select Jumper (For Intel® Atom™ processor D525 dual LVDS only)

- Jumper Label:** J2
- Jumper Type:** 6-pin header
- Jumper Settings:** See Table 4-6
- Jumper Location:** See Figure 4-8

The LVDS1 Panel Resolution jumper configures the resolution of the LVDS output. The LVDS1 Panel Resolution jumper settings are shown below.

Setting	Description
Short 1-2	800 x 600
Short 3-4	1024 x 768
Short 1-2 and 3-4 (Default)	1280 x 1024
Short 5-6	1366 x 768
Short 1-2 and 5-6	1920 x 1080

Table 4-5: LVDS1 Panel Resolution Jumper Settings

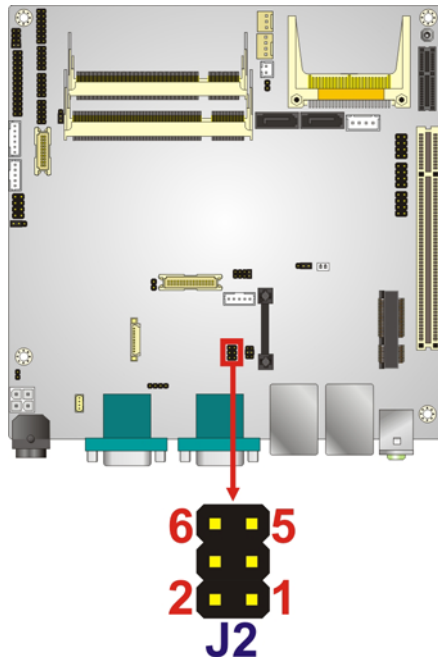

Figure 4-7: LVDS1 Panel Resolution Jumper Location

4.6.5 LVDS2 Panel Resolution Select Jumper

- Jumper Label:** J_LCD_TYPE1
- Jumper Type:** 6-pin header
- Jumper Settings:** See Table 4-6
- Jumper Location:** See Figure 4-8

The LVDS2 Panel Resolution jumper configures the resolution of the LVDS output. The LVDS2 Panel Resolution jumper settings are shown below.

Setting	Description
Open	640 x 480 (18 bit)
Short 1-2	800 x 400 (18 bit)
Short 3-4 (Default)	800 x 600 (18 bit)
Short 1-2 and 3-4	1024 x 768 (18 bit)
Short 5-6	1280 x 1024 (18 bit)
Short 1-2 and 5-6	1366 x 768 (18 bit)
Short 3-4 and 5-6	1280 x 800 (18 bit)

KINO-PV-D5252/D4252 Mini ITX SBC

Setting	Description
Short 1-2, 3-4 and 5-6	1280 x 600 (18 bit)

Table 4-6: LVDS2 Panel Resolution Jumper Settings

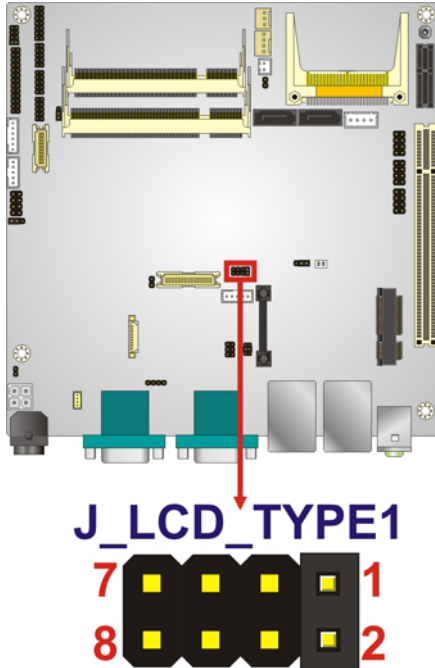

Figure 4-8: LVDS2 Panel Resolution Jumper Location

4.6.6 LVDS1 Voltage Select setting

Jumper Label:	J_VLVDS1
Jumper Type:	6-pin header
Jumper Settings:	See Table 4-8
Jumper Location:	See Figure 4-10

The voltage selection jumper sets the voltage of the power supplied to the LCD panel.

Setting	Description
Short 1-2	12 V
Short 3-4	5 V (Default)
Short 5-6	3.3 V

Table 4-7: LVDS1 Voltage Select Jumper Settings

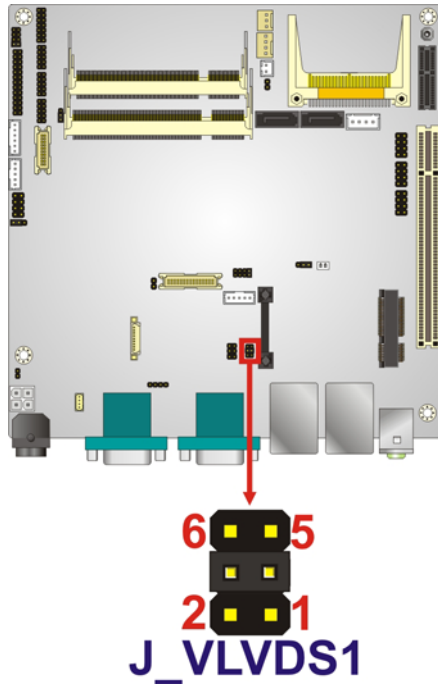

Figure 4-9: LVDS1 Voltage Select Jumper Location

4.6.7 LVDS2 Voltage Select setting

Jumper Label:	J_VLVDS2
Jumper Type:	2-pin header
Jumper Settings:	See Table 4-8
Jumper Location:	See Figure 4-10

The voltage selection jumper sets the voltage of the power supplied to the LCD panel.

Setting	Description
Short 1-2	3.3 V (Default)
Short 2-3	5 V

Table 4-8: LVDS2 Voltage Select Jumper Settings

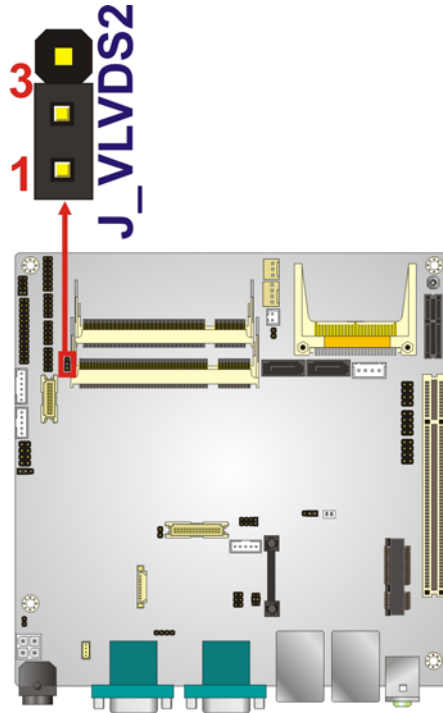

Figure 4-10: LVDS2 Voltage Select Jumper Location

4.6.8 Serial Port Setting Jumper

- Jumper Label:** JP3
- Jumper Type:** 8-pin header
- Jumper Settings:** See Table 4-9
- Jumper Location:** See Figure 4-11

Used for RS-232/422/485 communications.

Pin	Description
Short 1-2	RS-232 (Default)
Short 3-4	RS-422
Short 5-6	RS-485
Short 7-8	RS-485 use RTS Control

Table 4-9: Serial Port Jumper Settings

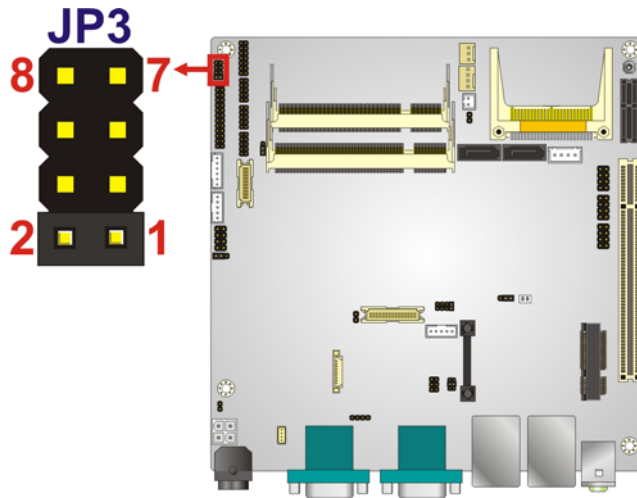

Figure 4-11: Serial Port Jumper Locations

4.7 Chassis Installation

4.7.1 Airflow



WARNING:

Airflow is critical to the cooling of the CPU and other onboard components. The chassis in which the KINO-PV-D5252/D4252 must have air vents to allow cool air to move into the system and hot air to move out.

The KINO-PV-D5252/D4252 must be installed in a chassis with ventilation holes on the sides allowing airflow to travel through the heat sink surface. In a system with an individual power supply unit, the cooling fan of a power supply can also help generate airflow through the board surface.

4.7.2 Motherboard Installation

To install the KINO-PV-D5252/D4252 motherboard into the chassis please refer to the reference material that came with the chassis.

4.8 Internal Peripheral Device Connections

This section outlines the installation of peripheral devices to the onboard connectors

4.8.1 AT/ATX Power Connection

Follow the instructions below to connect the KINO-PV-D5252/D4252 to an AT or ATX power supply.



WARNING:

Disconnect the power supply power cord from its AC power source to prevent a sudden power surge to the KINO-PV-D5252/D4252.

Step 1: Locate the power cable. The power cable is shown in the packing list in Chapter 3.

Step 2: Connect the Power Cable to the Motherboard. Connect the 4-pin (2x2) Molex type power cable connector to the AT/ATX power connector on the motherboard.

See Figure 4-12.

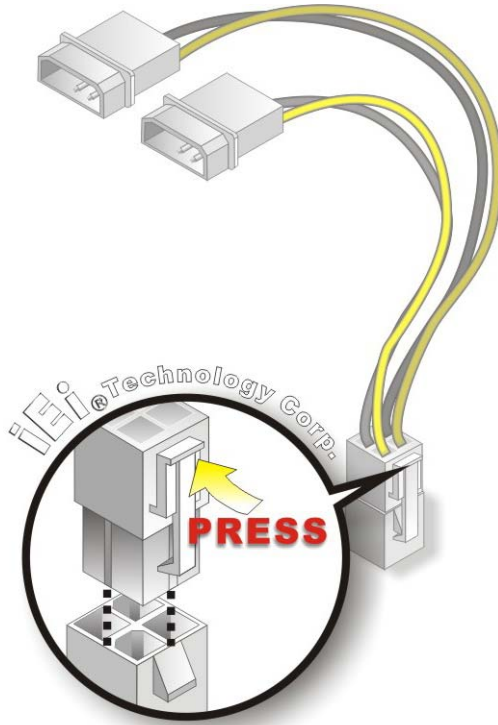

Figure 4-12: Power Cable to Motherboard Connection

Step 3: Connect Power Cable to Power Supply. Connect one of the 4-pin (1x4) Molex type power cable connectors to an AT/ATX power supply. See Figure 4-13.

KINO-PV-D5252/D4252 Mini ITX SBC

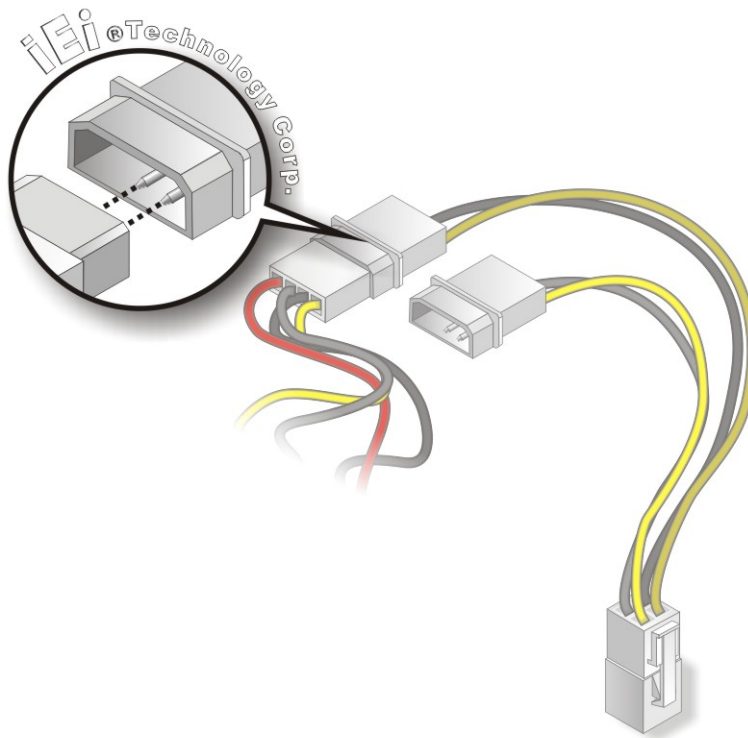

Figure 4-13: Connect Power Cable to Power Supply

4.8.2 Single RS-232 Cable with Slot Bracket

The single RS-232 cable consists of one serial port connectors attached to a serial communications cable that is then attached to a D-sub 9 male connector that is mounted onto a bracket. To install the single RS-232 cable, please follow the steps below.

- Step 1: Locate the connector.** The location of the RS-232 connector is shown in Chapter 3.
- Step 2: Insert the cable connector.** Insert the connector into the serial port box header. See Figure 4-14. A key on the front of the cable connectors ensures the connector can only be installed in one direction.

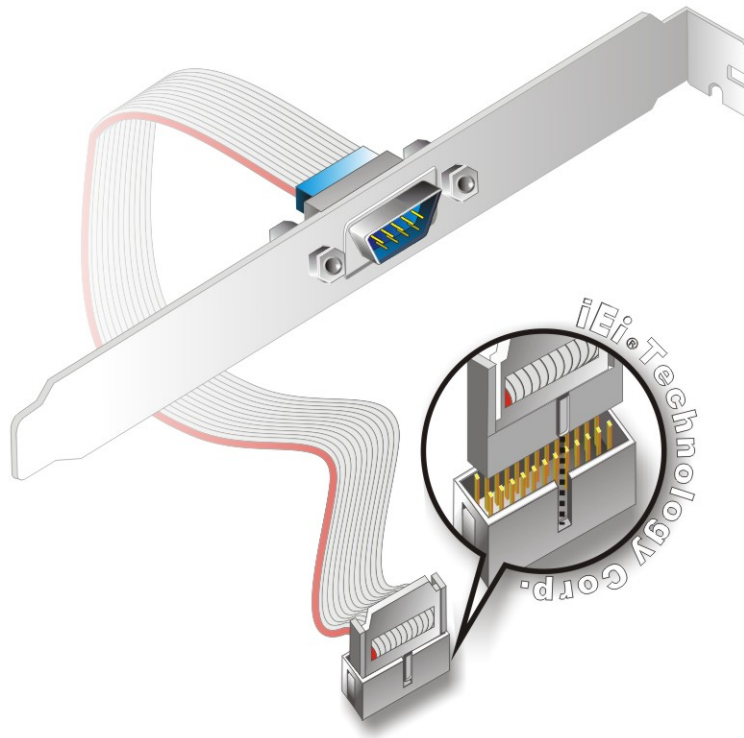

Figure 4-14: Single RS-232 Cable Installation

Step 3: Secure the bracket. The single RS-232 connector has one D-sub 9 male connector secured to a bracket. To secure the bracket to the chassis please refer to the reference material that came with the chassis

4.9 External Peripheral Interface Connection

The following external peripheral devices can be connected to the external peripheral interface connectors.

- RJ-45 Ethernet cable connector
- Serial devices
- USB devices
- VGA monitor
- DVI devices
- Audio devices

KINO-PV-D5252/D4252 Mini ITX SBC

To install these devices, connect the corresponding cable connector from the actual device to the corresponding KINO-PV-D5252/D4252 external peripheral interface connector making sure the pins are properly aligned.

4.9.1 Audio Connector

The audio jacks on the external audio connector enable the KINO-PV-D5252/D4252 to be connected to a stereo sound setup. To install the audio devices, follow the steps below.

Step 1: Identify the audio plugs. The plugs on your home theater system or speakers may not match the colors on the rear panel. If audio plugs are plugged into the wrong jacks, sound quality will be very bad.

Step 2: Plug the audio plugs into the audio jacks. Plug the audio plugs into the audio jacks. If the plugs on your speakers are different, an adapter will need to be used to plug them into the audio jacks.

- **Line-out port (Lime):** Connects to a headphone or a speaker.
- **Microphone (Pink):** Connects to a microphone.

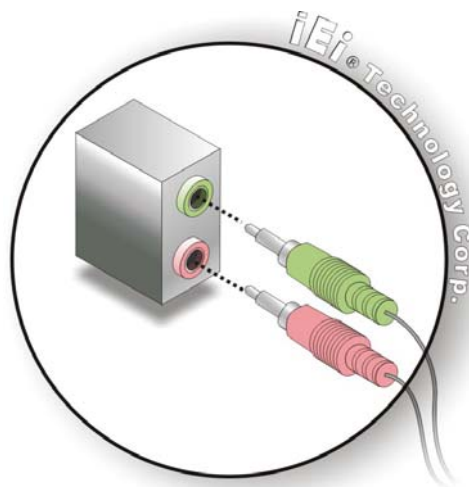

Figure 4-15: Audio Connector

Step 3: Check audio clarity. Check that the sound is coming through the right speakers by adjusting the balance front to rear and left to right.

4.9.2 LAN Connection (Dual Connector)

There are two external RJ-45 LAN connectors. The RJ-45 connector enables connection to an external network. To connect a LAN cable with an RJ-45 connector, please follow the instructions below.

Step 1: **Locate the RJ-45 connectors.** The location of the LAN connector is shown in Chapter 3.

Step 2: **Align the connectors.** Align the RJ-45 connector on the LAN cable with one of the RJ-45 connectors on the KINO-PV-D5252/D4252. See Figure 4-16.

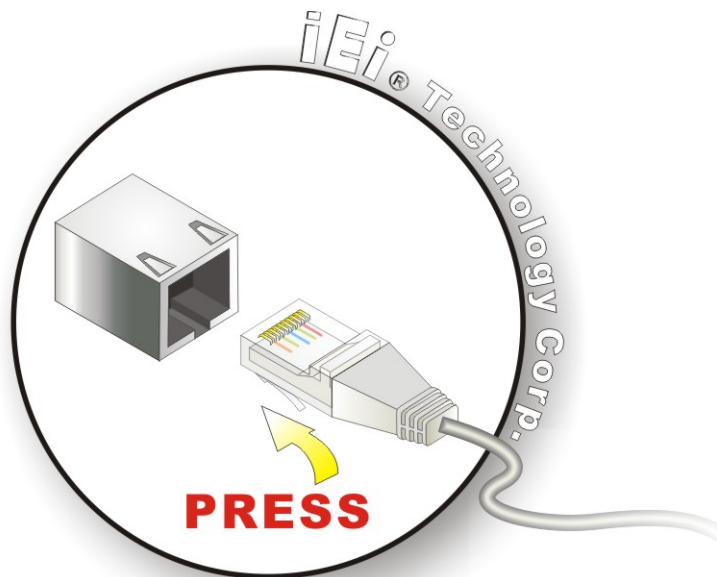

Figure 4-16: LAN Connection

Step 3: **Insert the LAN cable RJ-45 connector.** Once aligned, gently insert the LAN cable RJ-45 connector into the on-board RJ-45 connector.

4.9.3 Serial Device Connection

The KINO-PV-D5252/D4252 has a single female DB-9 connector on the external peripheral interface panel for a serial device. Follow the steps below to connect a serial device to the KINO-PV-D5252/D4252.

KINO-PV-D5252/D4252 Mini ITX SBC

Step 1: Locate the DB-9 connector. The location of the DB-9 connector is shown in Chapter 3.

Step 2: Insert the serial connector. Insert the DB-9 connector of a serial device into the DB-9 connector on the external peripheral interface. See Figure 4-17.

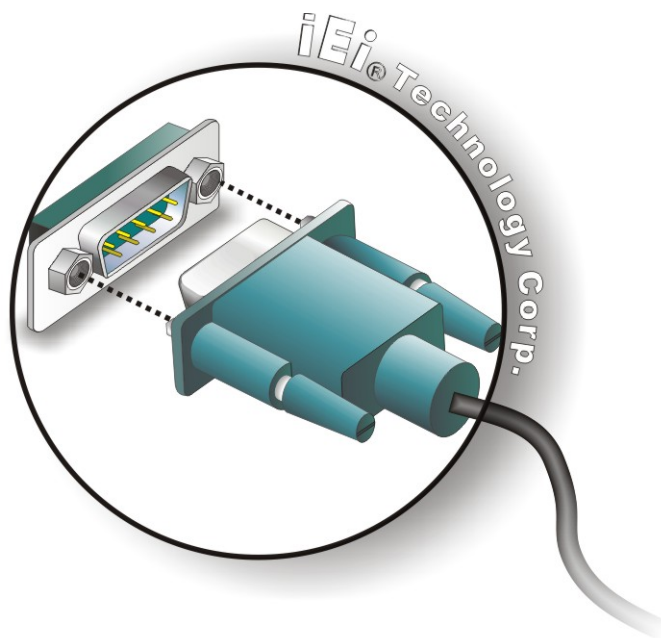

Figure 4-17: Serial Device Connector

Step 3: Secure the connector. Secure the serial device connector to the external interface by tightening the two retention screws on either side of the connector.

4.9.4 USB Connection (Quad Connector)

The external USB Series "A" receptacle connectors provide easier and quicker access to external USB devices. Follow the steps below to connect USB devices to the KINO-PV-D5252/D4252.

Step 1: Locate the USB Series "A" receptacle connectors. The location of the USB Series "A" receptacle connectors are shown in Chapter 3.

Step 2: Insert a **USB Series "A" plug**. Insert the USB Series "A" plug of a device into the USB Series "A" receptacle on the external peripheral interface. See Figure 4-18.

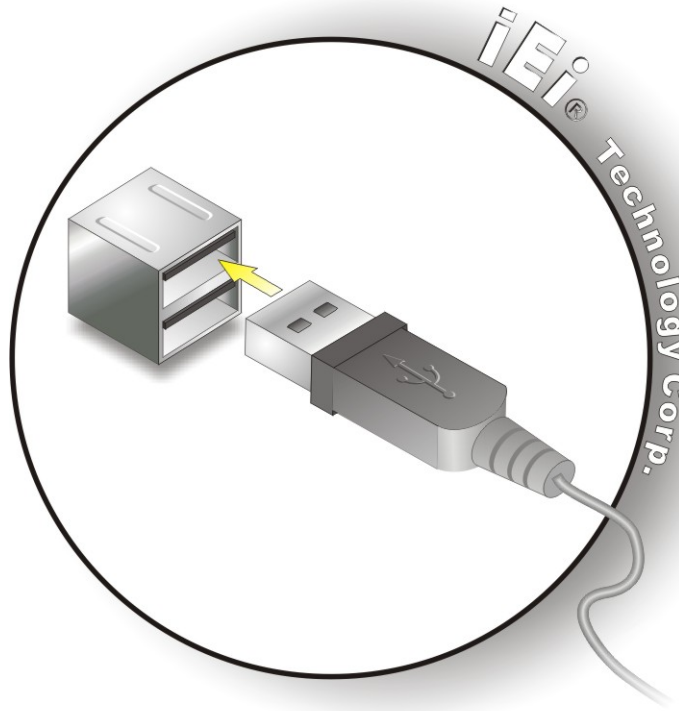

Figure 4-18: USB Connector

4.9.5 VGA Monitor Connection

The KINO-PV-D5252/D4252 has a single female DB-15 connector on the external peripheral interface panel. The DB-15 connector is connected to a CRT or VGA monitor. To connect a monitor to the KINO-PV-D5252/D4252, please follow the instructions below.

- Step 1:** **Locate the female DB-15 connector.** The location of the female DB-15 connector is shown in **Chapter 3**.
- Step 2:** **Align the VGA connector.** Align the male DB-15 connector on the VGA screen cable with the female DB-15 connector on the external peripheral interface.

KINO-PV-D5252/D4252 Mini ITX SBC

Step 3: Insert the VGA connector Once the connectors are properly aligned with the insert the male connector from the VGA screen into the female connector on the KINO-PV-D5252/D4252. See Figure 4-19.

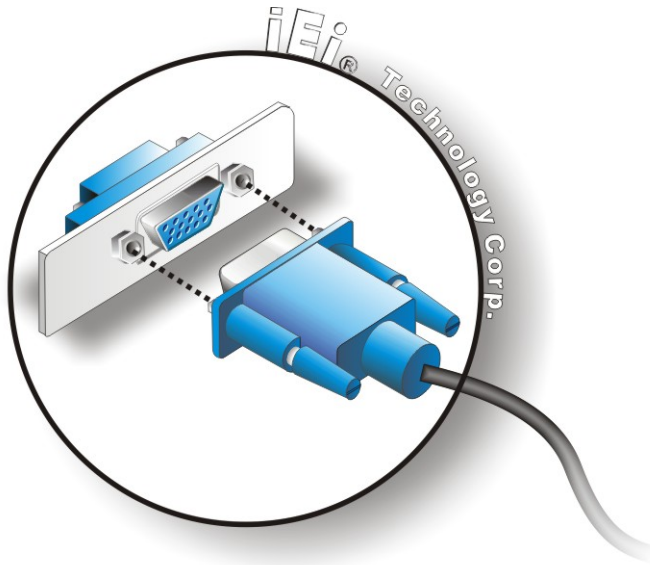

Figure 4-19: VGA Connector

Step 4: Secure the connector. Secure the DB-15 VGA connector from the VGA monitor to the external interface by tightening the two retention screws on either side of the connector.

4.10 Software Installation

All the drivers for the KINO-PV-D5252/D4252 are on the CD that came with the system. To install the drivers, please follow the steps below.

Step 1: Insert the CD into a CD drive connected to the system.



NOTE:

If the installation program doesn't start automatically:
Click "Start->My Computer->CD Drive->autorun.exe"

Step 2: The driver main menu appears (**Figure 4-20**).

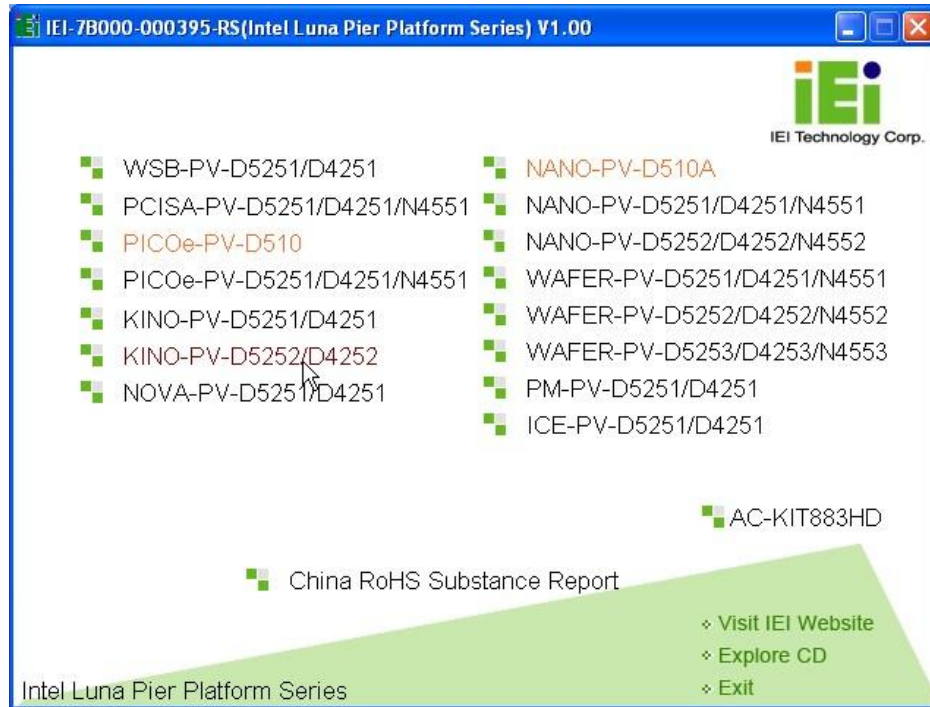

Figure 4-20: Introduction Screen

Step 3: Click **KINO-PV-D5252/D4252**.

Step 4: A new screen with a list of available drivers appears (**Figure 4-21**).

KINO-PV-D5252/D4252 Mini ITX SBC

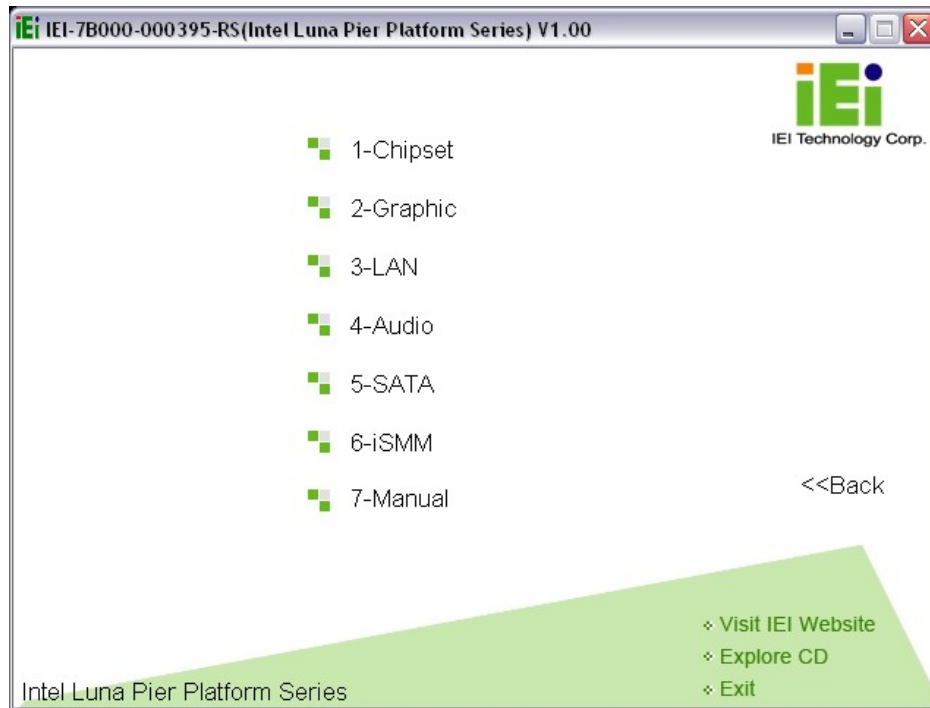

Figure 4-21: Available Drivers

Step 5: Install all of the necessary drivers in this menu.



Chapter

5

BIOS Screens

5.1 Introduction

The BIOS is programmed onto the BIOS chip. The BIOS setup program allows changes to certain system settings. This chapter outlines the options that can be changed.

5.1.1 Starting Setup

The UEFI BIOS is activated when the computer is turned on. The setup program can be activated in one of two ways.

1. Press the **F2** key as soon as the system is turned on or
2. Press the **F2** key when the “**Press F2 to enter SETUP**” message appears on the screen.

If the message disappears before the **F2** key is pressed, restart the computer and try again.

5.1.2 Using Setup

Use the arrow keys to highlight items, press **ENTER** to select, use the **PageUp** and **PageDown** keys to change entries, press **F1** for help and press **ESC** to quit. Navigation keys are shown in the following table.

Key	Function
Up arrow	Move to the item above
Down arrow	Move to item below
Left arrow	Move to the item on the left hand side
Right arrow	Move to the item on the right hand side
+	Increase the numeric value or make changes
-	Decrease the numeric value or make changes
Page up	Move to the next page
Page down	Move to the previous page

Key	Function
Esc	Main Menu – Quit and do not save changes into CMOS Status Page Setup Menu and Option Page Setup Menu -- Exit current page and return to Main Menu
F1	General help, only for Status Page Setup Menu and Option Page Setup Menu
F9	Load optimized defaults
F10	Save changes and Exit BIOS

Table 5-1: BIOS Navigation Keys

5.1.3 Getting Help

When **F1** is pressed a small help window describing the appropriate keys to use and the possible selections for the highlighted item appears. To exit the Help Window press **Esc** or the **F1** key again.

5.1.4 Unable to Reboot After Configuration Changes

If the computer cannot boot after changes to the system configuration is made, CMOS defaults. Use the jumper described in Chapter 4.

5.1.5 BIOS Menu Bar

The **menu bar** on top of the BIOS screen has the following main items:

- Main – Changes the basic system configuration.
- Advanced – Changes the advanced system settings.
- Chipset – Changes the chipset settings.
- Boot – Changes the system boot configuration.
- Security – Sets User and Supervisor Passwords.
- Save & Exit – Selects exit options and loads default settings

The following sections completely describe the configuration options found in the menu items at the top of the BIOS screen and listed above.

5.2 Main

The **Main** BIOS menu (**BIOS Menu 1**) appears when the **BIOS Setup** program is entered. The **Main** menu gives an overview of the basic system information.

```

Aptio Setup Utility - Copyright (C) 2010 American Megatrends, Inc.
Main  Advanced  Chipset  Boot  Security  Save & Exit

BIOS Information
BIOS Vendor                American Megatrends
Core Version               4.6.4.0 0.20
Compliancy                 UEFI 2.0
Project Version            E350AR12.ROM
Build Date                 01/05/2011 20:25:34

System Date                [Fri 04/16/2010]
System Time                [14:20:27]

Access Level               Administrator

<->: Select Screen
↑ ↓: Select Item
Enter>Select
+/-: Change Opt.
F1  General Help
F2  Previous Values
F3  Optimized Defaults
F4  Save & Exit
ESC Exit

Version 2.10.1208. Copyright (C) 2010 American Megatrends, Inc.

```

BIOS Menu 1: Main

→ BIOS Information

The **BIOS Information** lists a brief summary of the BIOS. The fields in **BIOS Information** cannot be changed. The items shown in the system overview include:

- **BIOS Vendor:** Installed BIOS vendor
- **Core Version:** Current BIOS version
- **Project Version:** The board version
- **Build Date and Time:** Date the current BIOS version was made

The System Overview field also has two user configurable fields:

→ System Date [xx/xx/xx]

Use the **System Date** option to set the system date. Manually enter the day, month and year.

→ **System Time [xx:xx:xx]**

Use the **System Time** option to set the system time. Manually enter the hours, minutes and seconds.

5.3 Advanced

Use the **Advanced** menu (**BIOS Menu 2**) to configure the CPU and peripheral devices through the following sub-menus:



WARNING!

Setting the wrong values in the sections below may cause the system to malfunction. Make sure that the settings made are compatible with the hardware.

```

Aptio Setup Utility - Copyright (C) 2010 American Megatrends, Inc.
Main  Advanced  Chipset  Boot  Security  Save & Exit
-----
> ACPI Settings
> Trusted Computing
> CPU Configuration
> IDE Configuration
> USB Configuration
> Super IO Configuration
> H/M Monitor
> Secondary Super IO Configuration
> Serial Port Console Redirection

                                  ←→: Select Screen
                                  ↑↓: Select Item
                                  EnterSelect
                                  +/-: Change Opt.
                                  F1  General Help
                                  F2  Previous Values
                                  F3  Optimized Defaults
                                  F4  Save & Exit
                                  ESC  Exit

Version 2.10.1208. Copyright (C) 2010 American Megatrends, Inc.
    
```

BIOS Menu 2: Advanced

KINO-PV-D5252/D4252 Mini ITX SBC

5.3.1 ACPI Settings

The **ACPI Settings** menu (**BIOS Menu 3**) configures the Advanced Configuration and Power Interface (ACPI) options.

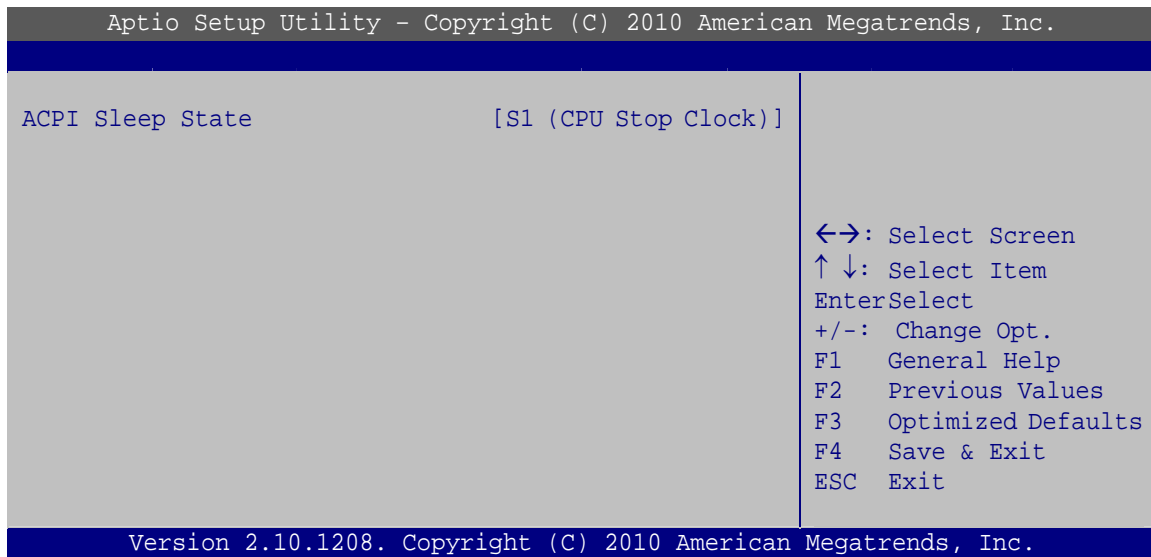

BIOS Menu 3: ACPI Settings

→ ACPI Sleep State [S1 (CPU Stop Clock)]

Use the **ACPI Sleep State** option to specify the sleep state the system enters when it is not being used.

- **S1 (CPU Stop Clock)** **DEFAULT** The system enters S1(POS) sleep state. The system appears off. The CPU is stopped; RAM is refreshed; the system is running in a low power mode.
- **S3 (Suspend to RAM)** The caches are flushed and the CPU is powered off. Power to the RAM is maintained. The computer returns slower to a working state, but more power is saved.

5.3.2 Trusted Computing

Use the **Trusted Computing** menu (**BIOS Menu 4**) to configure settings related to the Trusted Computing Group (TCG) Trusted Platform Module (TPM).

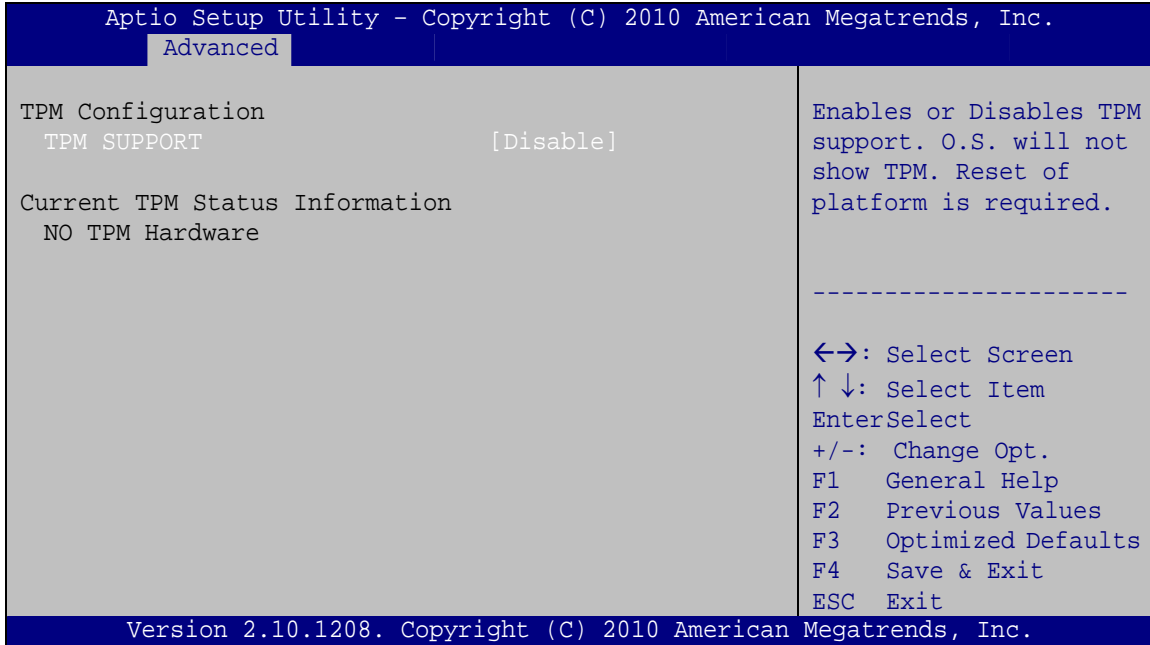

BIOS Menu 4: TPM Configuration

→ TPM Support [Disable]

Use the **TPM Support** option to configure support for the TPM.

- **Disable** **DEFAULT** TPM support is disabled.
- **Enable** TPM support is enabled.

KINO-PV-D5252/D4252 Mini ITX SBC

5.3.3 CPU Configuration

Use the **CPU Configuration** menu (**BIOS Menu 5**) to view detailed CPU specifications and configure the CPU.

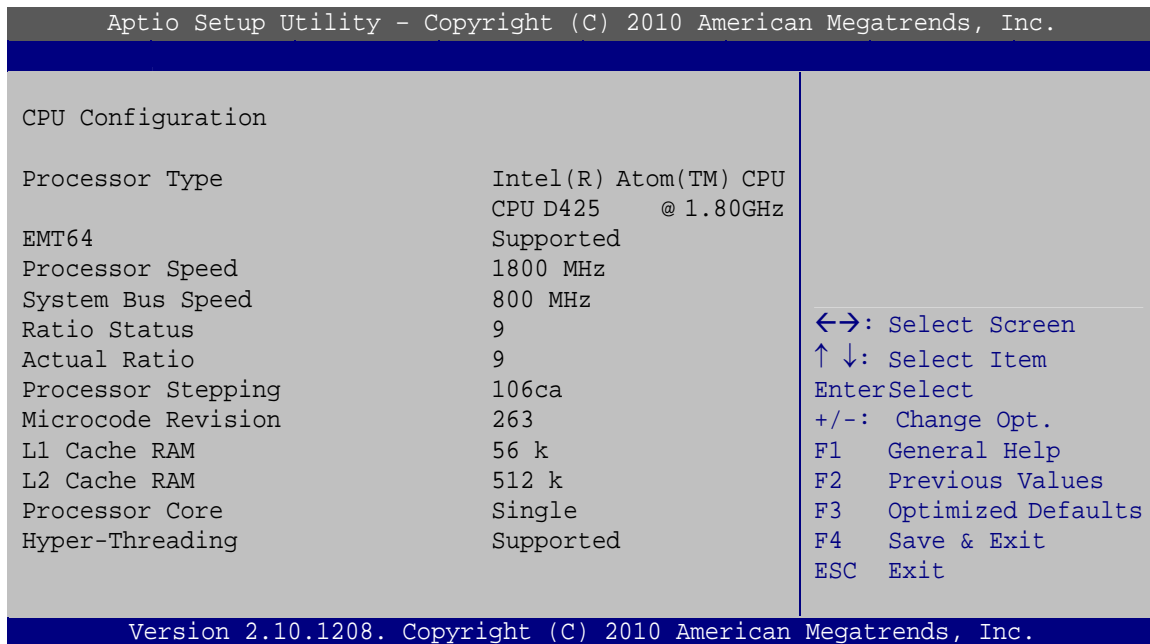

BIOS Menu 5: CPU Configuration

The CPU Configuration menu (**BIOS Menu 5**) lists the following CPU details:

- Processor Type: Lists the brand name of the CPU being used
- EMT64: Indicates if EM64T is supported by the CPU.
- Processor Speed: Lists the CPU processing speed
- System Bus: Lists the system bus
- Ratio Status: List the maximum FSB divisor
- Actual Ratio: Lists current FSB divisor
- Processor Stepping: Lists the CPU processing stepping
- Microcode Revision: Lists the microcode revision
- L1 Cache RAM: Lists the CPU L1 cache size
- L2 Cache RAM: Lists the CPU L2 cache size
- Processor Core: Lists the number of the processor core
- Hyper-Threading: Indicates if Intel Hyper-Threading Technology is supported by the CPU.

5.3.4 IDE Configuration

Use the **IDE Configuration** menu (**BIOS Menu 6**) to change and/or set the configuration of the ATA/IDE devices installed in the system.

```

Aptio Setup Utility - Copyright (C) 2010 American Megatrends, Inc.

PATA Master          Not Present
PATA Slave           Not Present

SATA Port0           Not Present
SATA Port1           Not Present
SATA Port2           Not Present
SATA Port3           Not Present

ATA/IDE Configuration [Enhanced]
  Configure SATA as   [IDE]

<->: Select Screen
↑ ↓: Select Item
Enter>Select
+/-: Change Opt.
F1  General Help
F2  Previous Values
F3  Optimized Defaults
F4  Save & Exit
ESC Exit

Version 2.10.1208. Copyright (C) 2010 American Megatrends, Inc.
  
```

BIOS Menu 6: IDE Configuration

→ ATA/IDE Configurations [Enhanced]

Use the **ATA/IDE Configurations** option to configure the ATA/IDE controller.

- **Disabled** Disables the on-board ATA/IDE controller.
- **Compatible** Configures the on-board ATA/IDE controller to be in compatible mode. In this mode, a SATA channel will replace one of the IDE channels. This mode supports up to 4 storage devices.
- **Enhanced DEFAULT** Configures the on-board ATA/IDE controller to be in Enhanced mode. In this mode, IDE channels and SATA channels are separated. This mode supports up to 6 storage devices. Some legacy OS do not support this mode.

KINO-PV-D5252/D4252 Mini ITX SBC

→ Configure SATA as [IDE]

Use the **Configure SATA as** option to configure SATA devices as normal IDE devices.

- **IDE** **DEFAULT** Configures SATA devices as normal IDE device.
- **AHCI** Configures SATA devices as AHCI device.

5.3.5 USB Configuration

Use the **USB Configuration** menu (**BIOS Menu 7**) to read USB configuration information and configure the USB settings.

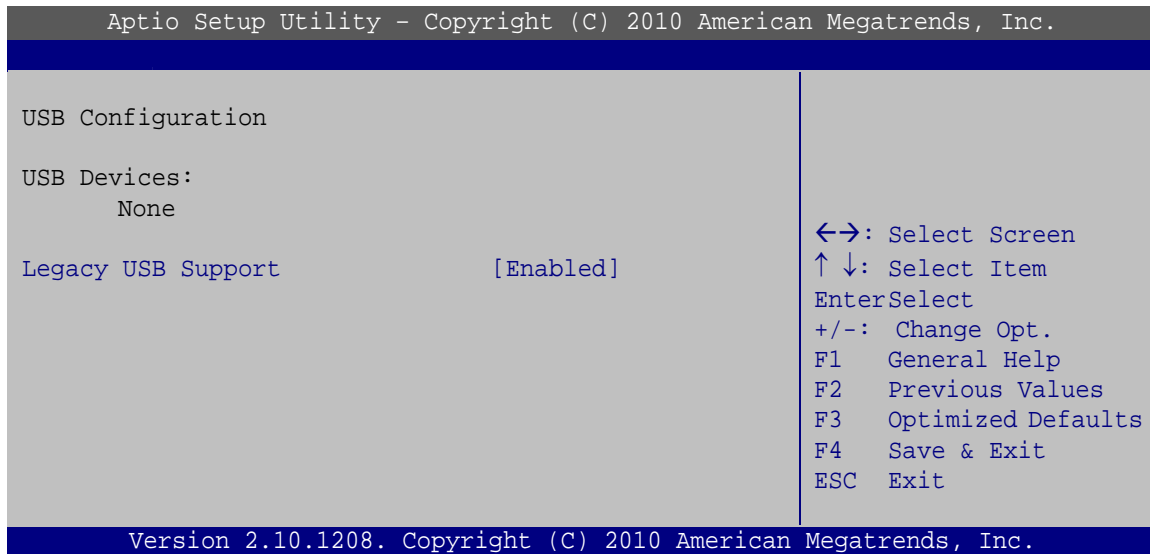

BIOS Menu 7: USB Configuration

→ USB Devices

The **USB Devices Enabled** field lists the USB devices that are enabled on the system

→ Legacy USB Support [Enabled]

Use the **Legacy USB Support** BIOS option to enable USB mouse and USB keyboard support. Normally if this option is not enabled, any attached USB mouse or USB keyboard does not become available until a USB compatible operating system is fully booted with all USB drivers loaded. When this option is enabled, any attached USB mouse or USB keyboard can control the system even when there is no USB driver loaded onto the system.

- ➔ **Enabled** **DEFAULT** Legacy USB support enabled
- ➔ **Disabled** Legacy USB support disabled
- ➔ **Auto** Legacy USB support disabled if no USB devices are connected

5.3.6 Super IO Configuration

Use the **Super IO Configuration** menu (**BIOS Menu 8**) to set or change the configurations for the FDD controllers, parallel ports and serial ports.

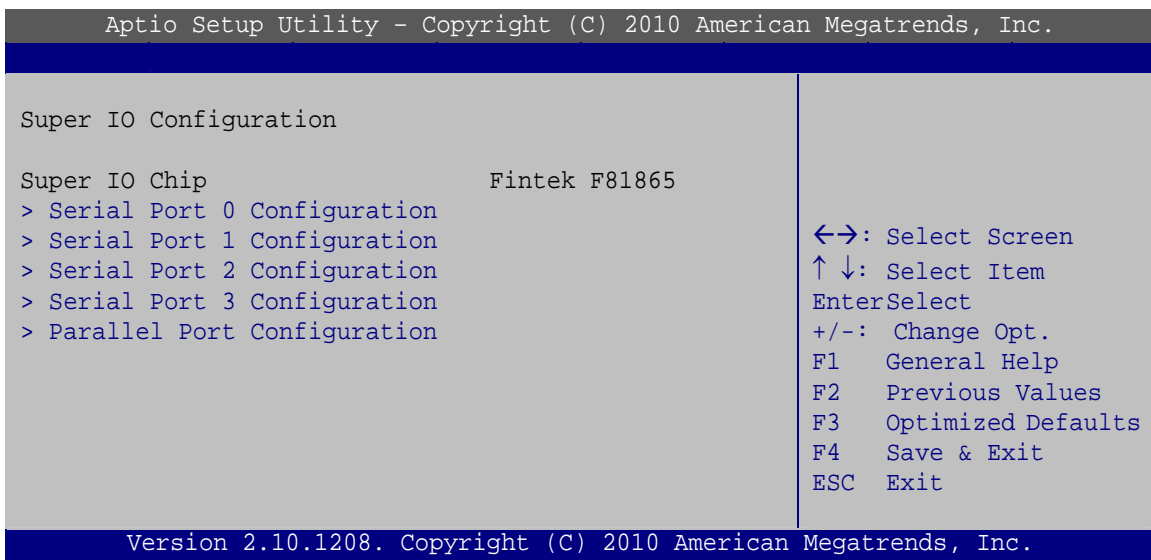

BIOS Menu 8: Super IO Configuration

KINO-PV-D5252/D4252 Mini ITX SBC

5.3.6.1 Serial Port 0 Configuration

Use the **Serial Port 0 Configuration** menu (**BIOS Menu 9**) to configure the serial port 0.

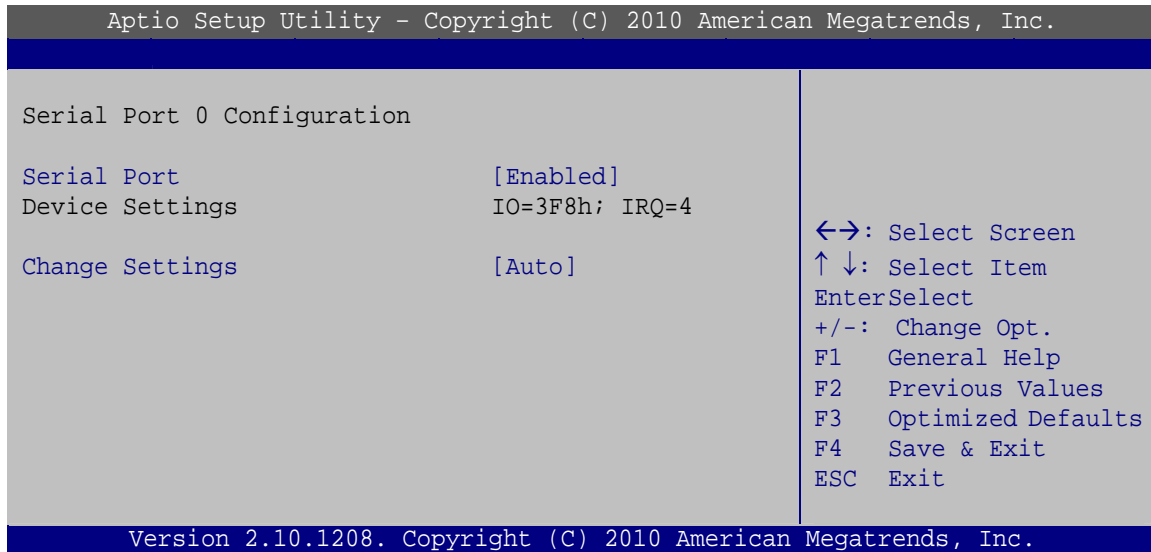

BIOS Menu 9: Serial Port 0 Configuration Menu

→ Serial Port [Enabled]

Use the **Serial Port** option to enable or disable the serial port.

- **Disabled** Disable the serial port
- **Enabled** **DEFAULT** Enable the serial port

→ Change Settings [Auto]

Use the **Change Settings** option to change the serial port IO port address and interrupt address.

- **Auto** **DEFAULT** The serial port IO port address and interrupt address are automatically detected.
- **IO=3F8h;**
IRQ=4 Serial Port I/O port address is 3F8h and the interrupt address is IRQ4
- **IO=3F8h;**
IRQ=3, 4 Serial Port I/O port address is 3F8h and the interrupt address is IRQ3 and IRQ4

- **IO=2F8h;**
IRQ=3, 4 Serial Port I/O port address is 2F8h and the interrupt address is IRQ3 and IRQ4

5.3.6.1.1 Serial Port 1 Configuration

→ Serial Port [Enabled]

Use the **Serial Port** option to enable or disable the serial port.

- **Disabled** Disable the serial port
- **Enabled** **DEFAULT** Enable the serial port

→ Device Mode

Use the **Device Mode** option to set the Serial Port 1 signaling mode.

- **RS232** **DEFAULT** Serial Port 1 signaling mode is RS-232
- **RS485** Serial Port 1 signaling mode is RS-422/RS-485

→ Change Settings [Auto]

Use the **Change Settings** option to change the serial port IO port address and interrupt address.

- **Auto** **DEFAULT** The serial port IO port address and interrupt address are automatically detected.
- **IO=2F8h;**
IRQ=3 Serial Port I/O port address is 2F8h and the interrupt address is IRQ3
- **IO=3F8h;**
IRQ=3, 4 Serial Port I/O port address is 3F8h and the interrupt address is IRQ3, 4
- **IO=2F8h;**
IRQ=3, 4 Serial Port I/O port address is 2F8h and the interrupt address is IRQ3, 4

KINO-PV-D5252/D4252 Mini ITX SBC

5.3.6.1.2 Serial Port 2 Configuration

→ Serial Port [Enabled]

Use the **Serial Port** option to enable or disable the serial port.

- **Disabled** Disable the serial port
- **Enabled** **DEFAULT** Enable the serial port

→ Change Settings [Auto]

Use the **Change Settings** option to change the serial port IO port address and interrupt address.

- **Auto** **DEFAULT** The serial port IO port address and interrupt address are automatically detected.
- **IO=3E8h;**
IRQ=11 Serial Port I/O port address is 3E8h and the interrupt address is IRQ11
- **IO=3E8h;**
IRQ=10, 11 Serial Port I/O port address is 3E8h and the interrupt address is IRQ10, 11
- **IO=2E8h;**
IRQ=10, 11 Serial Port I/O port address is 2E8h and the interrupt address is IRQ10, 11

5.3.6.1.3 Serial Port 3 Configuration

→ Serial Port [Enabled]

Use the **Serial Port** option to enable or disable the serial port.

- **Disabled** Disable the serial port
- **Enabled** **DEFAULT** Enable the serial port

→ Change Settings [Auto]

Use the **Change Settings** option to change the serial port IO port address and interrupt address.

- ➔ **Auto** **DEFAULT** The serial port IO port address and interrupt address are automatically detected.
- ➔ **IO=2E8h;**
IRQ=10 Serial Port I/O port address is 2E8h and the interrupt address is IRQ10
- ➔ **IO=3E8h;**
IRQ=10, 11 Serial Port I/O port address is 3E8h and the interrupt address is IRQ10, 11
- ➔ **IO=2E8h;**
IRQ=10, 11 Serial Port I/O port address is 2E8h and the interrupt address is IRQ10, 11

5.3.6.2 Parallel Port Configuration

Use the **Parallel Port Configuration** menu (**BIOS Menu 9**) to configure the serial port n.

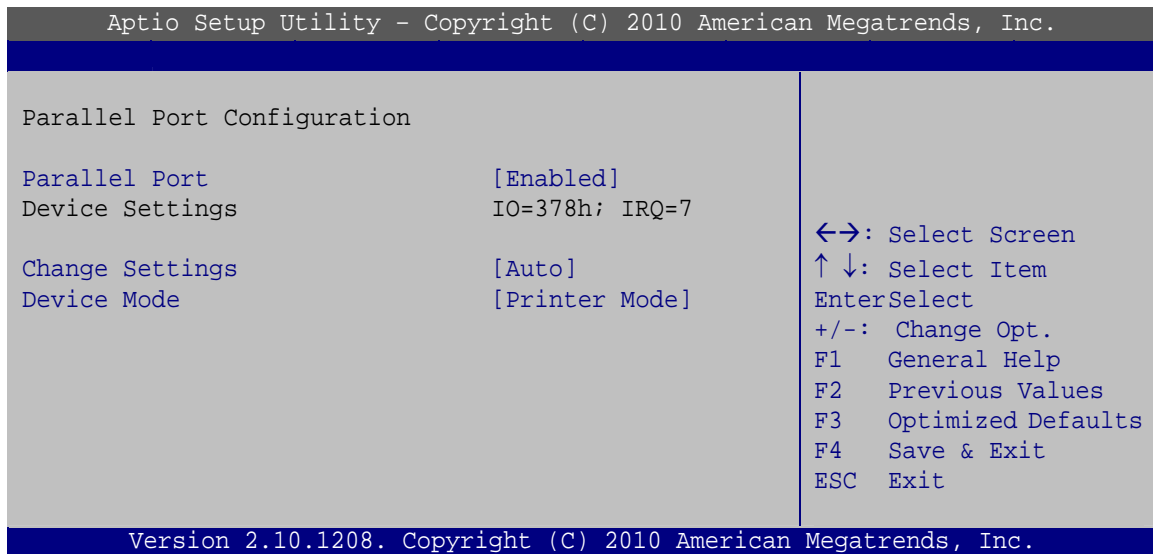

BIOS Menu 10: Parallel Port Configuration Menu

➔ **Parallel Port [Enabled]**

Use the **Parallel Port** option to enable or disable the parallel port.

- ➔ **Disabled** Disable the parallel port
- ➔ **Enabled** **DEFAULT** Enable the parallel port

KINO-PV-D5252/D4252 Mini ITX SBC

→ Change Settings [Auto]

Use the **Change Settings** option to change the parallel port IO port address and interrupt address.

- | | | | |
|---|---------------------------|----------------|---|
| → | Auto | DEFAULT | The parallel port IO port address and interrupt address are automatically detected. |
| → | IO=378h;
IRQ=7 | | Parallel Port I/O port address is 378h and the interrupt address is IRQ7 |
| → | IO=378h;
IRQ=7 | | Parallel Port I/O port address is 378h and the interrupt address is IRQ7 |
| → | IO=278h;
IRQ=7 | | Parallel Port I/O port address is 278h and the interrupt address is IRQ7 |
| → | IO=3BCh
IRQ=7 | | Parallel Port I/O port address is 3BCh and the interrupt address is IRQ7 |

→ Device Mode [Printer Mode]

Use the **Device Mode** option to select the mode the parallel port operates in. Configuration options are listed below.

- | | | |
|---|----------------------|----------------|
| ▪ | Printer Mode | Default |
| ▪ | SPP Mode | |
| ▪ | EPP-1.9 and SPP Mode | |
| ▪ | EPP-1.7 and SPP Mode | |
| ▪ | ECP Mode | |
| ▪ | ECP and EPP 1.9 Mode | |
| ▪ | ECP and EPP 1.7 Mode | |

5.3.7 H/W Monitor

The H/W Monitor menu (**BIOS Menu 11**) shows the operating temperature, fan speeds and system voltages.

```

Aptio Setup Utility - Copyright (C) 2010 American Megatrends, Inc.

PC Health Status

CPU Temperature           :+39 C
SYS Temperature          :+40 C
CPU FAN Speed            :4950 RPM
SYS FAN Speed            :2762 RPM
VCC3V                    :+3.312 V
V_core                   :+1.104 V
Vcc                      :+4.961 V
Vcc12                    :+11.176 V
V1_5VDDR                 :+1.776 V
VSB3V                    :+3.312 V
VBAT                     :+3.232 V
CPU Smart Fan control    [Auto Mode]
Temperature Bound1      60
Temperature Bound2      50
Temperature Bound3      40
Temperature Bound4      30
SYS Smart Fan control    [Auto Mode]
Temperature Bound1      60
Temperature Bound2      50
Temperature Bound3      40
Temperature Bound4      30

<->: Select Screen
↑ ↓: Select Item
Enter>Select
+/-: Change Opt.
F1   General Help
F2   Previous Values
F3   Optimized Defaults
F4   Save & Exit
ESC  Exit

Version 2.10.1208. Copyright (C) 2010 American Megatrends, Inc.
  
```

BIOS Menu 11: Hardware Health Configuration

→ PC Health Status

The following system parameters and values are shown. The system parameters that are monitored are:

- System Temperatures:
 - CPU Temperature
 - System Temperature
- Fan Speeds:
 - CPU Fan Speed
 - SYS Fan Speed

KINO-PV-D5252/D4252 Mini ITX SBC

- Voltages:
 - VCC3V
 - V_core
 - Vcc
 - Vcc12
 - Vcc1_5VDDR
 - VSB3V
 - VBAT

→ CPU Smart Fan control [Auto Mode]

Use the **CPU Smart Fan control** option to configure the CPU fan.

- **Auto Mode**

The fan adjusts its speed using these settings:

 - Temperature Bound 1
 - Temperature Bound 2
 - Temperature Bound 3
 - Temperature Bound 4
- **Manual Mode**

The fan spins at the speed set in:

 - Manual Duty Cycle Setting

→ SYS Smart Fan control [Auto Mode]

Use the **SYS Smart Fan control** option to configure the SYS fan.

- **Auto Mode**

The fan adjusts its speed using these settings:

 - Temperature Bound 1
 - Temperature Bound 2
 - Temperature Bound 3
 - Temperature Bound 4
- **Manual Mode**

The fan spins at the speed set in:

 - Manual Duty Cycle Setting

5.3.8 Secondary Super IO Configuration

The **Secondary Super IO Configuration (BIOS Menu 13)** displays IO chip type and the submenus for configuring the external SATA ports 5 and 6.

```

Aptio Setup Utility - Copyright (C) 2010 American Megatrends, Inc.

Secondary Super IO Configuration

Super IO Chip          Fintek F81216
> Serial Port 5 Configuration
> Serial Port 6 Configuration

<=>: Select Screen
↑↓: Select Item
Enter>Select
+/-: Change Opt.
F1  General Help
F2  Previous Values
F3  Optimized Defaults
F4  Save & Exit
ESC Exit

Version 2.10.1208. Copyright (C) 2010 American Megatrends, Inc.
    
```

BIOS Menu 12: Secondary Super IO Configuration

5.3.8.1 Serial Port 5 Configuration

➔ **Serial Port [Enabled]**

Use the **Serial Port** option to enable or disable the serial port.

- ➔ **Disabled** Disable the serial port
- ➔ **Enabled** **DEFAULT** Enable the serial port

➔ **Change Settings [Auto]**

Use the **Change Settings** option to change the serial port IO port address and interrupt address.

- ➔ **Auto** **DEFAULT** The serial port IO port address and interrupt address are automatically detected.

KINO-PV-D5252/D4252 Mini ITX SBC

- ➔ **IO=2C0h;**
IRQ=11 Serial Port I/O port address is 2C0h and the interrupt address is IRQ11
- ➔ **IO=2C0h;**
IRQ=10, 11 Serial Port I/O port address is 2C0h and the interrupt address is IRQ10, 11
- ➔ **IO=2C8h;**
IRQ=10, 11 Serial Port I/O port address is 2C8h and the interrupt address is IRQ10, 11
- ➔ **IO=2D0h;**
IRQ=10, 11 Serial Port I/O port address is 2D0h and the interrupt address is IRQ10, 11
- ➔ **IO=2D8h;**
IRQ=10, 11 Serial Port I/O port address is 2D8h and the interrupt address is IRQ10, 11
- ➔ **IO=2E0h;**
IRQ=10, 11 Serial Port I/O port address is 2E0h and the interrupt address is IRQ10, 11

5.3.8.2 Serial Port 6 Configuration

➔ Serial Port [Enabled]

Use the **Serial Port** option to enable or disable the serial port.

- ➔ **Disabled** Disable the serial port
- ➔ **Enabled** **DEFAULT** Enable the serial port

➔ Change Settings [Auto]

Use the **Change Settings** option to change the serial port IO port address and interrupt address.

- ➔ **Auto** **DEFAULT** The serial port IO port address and interrupt address are automatically detected.
- ➔ **IO=2E0h;**
IRQ=10 Serial Port I/O port address is 2E0h and the interrupt address is IRQ10
- ➔ **IO=2C0h;**
IRQ=10, 11 Serial Port I/O port address is 2C0h and the interrupt address is IRQ10, 11

- ➔ **IO=2C8h;** Serial Port I/O port address is 2C8h and the interrupt address is IRQ10, 11
IRQ=10, 11
- ➔ **IO=2D0h;** Serial Port I/O port address is 2D0h and the interrupt address is IRQ10, 11
IRQ=10, 11
- ➔ **IO=2D8h;** Serial Port I/O port address is 2D8h and the interrupt address is IRQ10, 11
IRQ=10, 11
- ➔ **IO=2E0h;** Serial Port I/O port address is 2E0h and the interrupt address is IRQ10, 11
IRQ=10, 11

5.3.9 Serial Port Console Redirection

The **Serial Port Console Redirection** menu (**BIOS Menu 13**) allows the console redirection options to be configured. Console redirection allows users to maintain a system remotely by re-directing keyboard input and text output through the serial port.

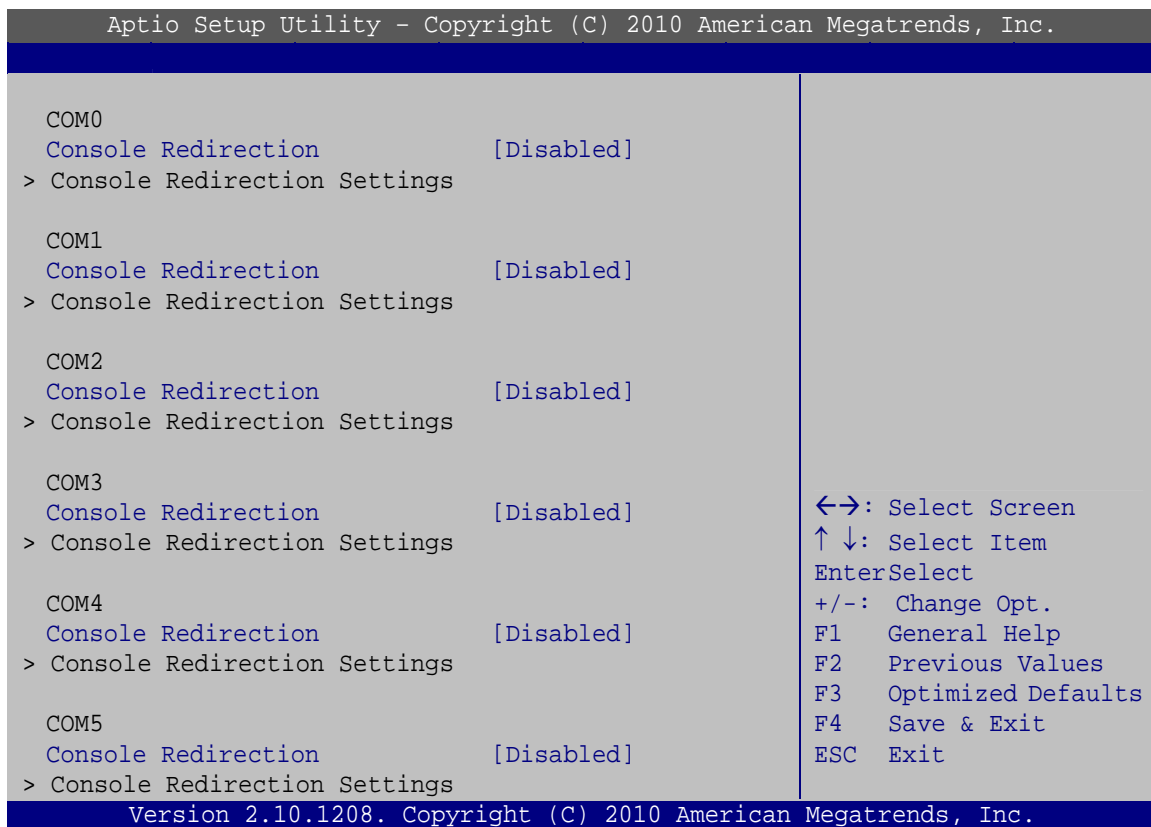

BIOS Menu 13: Serial Port Console Redirection

KINO-PV-D5252/D4252 Mini ITX SBC

→ Console Redirection [Disabled]

Use **Console Redirection** option to enable or disable the console redirection function.

- **Disabled** **DEFAULT** Disabled the console redirection function
- **Enabled** Enabled the console redirection function

5.4 Chipset

Use the **Chipset** menu (**BIOS Menu 14**) to access the Northbridge and Southbridge configuration menus



WARNING!

Setting the wrong values for the Chipset BIOS selections in the Chipset BIOS menu may cause the system to malfunction.

```

Aptio Setup Utility - Copyright (C) 2010 American Megatrends, Inc.
Main   Advanced  Chipset  Boot   Security  Save & Exit
-----
> Host Bridge
> South Bridge
> Intel ICD SWSCI OpRegion

                                  ←→: Select Screen
                                  ↑↓: Select Item
                                  EnterSelect
                                  +/-: Change Opt.
                                  F1   General Help
                                  F2   Previous Values
                                  F3   Optimized Defaults
                                  F4   Save & Exit
                                  ESC  Exit

Version 2.10.1208. Copyright (C) 2010 American Megatrends, Inc.
    
```

BIOS Menu 14: Chipset

5.4.1 Host Bridge Configuration

Use the **Host Bridge Configuration** menu (**BIOS Menu 15**) to configure the Northbridge chipset.

```

Aptio Setup Utility - Copyright (C) 2010 American Megatrends, Inc.
Chipset
> Memory Frequency and Timing
> OnChip VGA Configuration
  MMIO Size                [AUTO]

  Initate Graphic Adapter  [IGD]

***** Memory Information *****
Memory Frequency          800 Mhz
Total Memory              2048 MB
DIMM#0                   2048 MB
DIMM#1                   Not Present

<=>: Select Screen
↑↓: Select Item
Enter>Select
+/-: Change Opt.
F1  General Help
F2  Previous Values
F3  Optimized Defaults
F4  Save & Exit
ESC Exit

Version 2.10.1208. Copyright (C) 2010 American Megatrends, Inc.
  
```

BIOS Menu 15: Host Bridge Chipset Configuration

➔ MMIO Size

Use the **MMIO Size** option to set the MMIO reserve memory size.

- ➔ **AUTO** **DEFAULT**
- ➔ **1GB** Enables ION graphics controller.
- ➔ **2GB** Enables PCI/PEG graphics controller.

➔ Initate Graphic Adapter [IGD]

Use **Initate Graphic Adapter** option to select which graphics controller to use as the primary boot device. Select either an ION graphics controller or a combination of PCI graphics controller and PCI express (PEG) controller. Configuration options are listed in the table below:

KINO-PV-D5252/D4252 Mini ITX SBC

- ➔ **ION** **DEFAULT** Enables ION graphics controller.
- ➔ **PCI/PEG** Enables PCI/PEG graphics controller.

5.4.1.1 Memory Frequency and Timing

Use the **Memory Frequency and Timing** submenu (**BIOS Menu 16**) to configure memory frequency and timing settings.

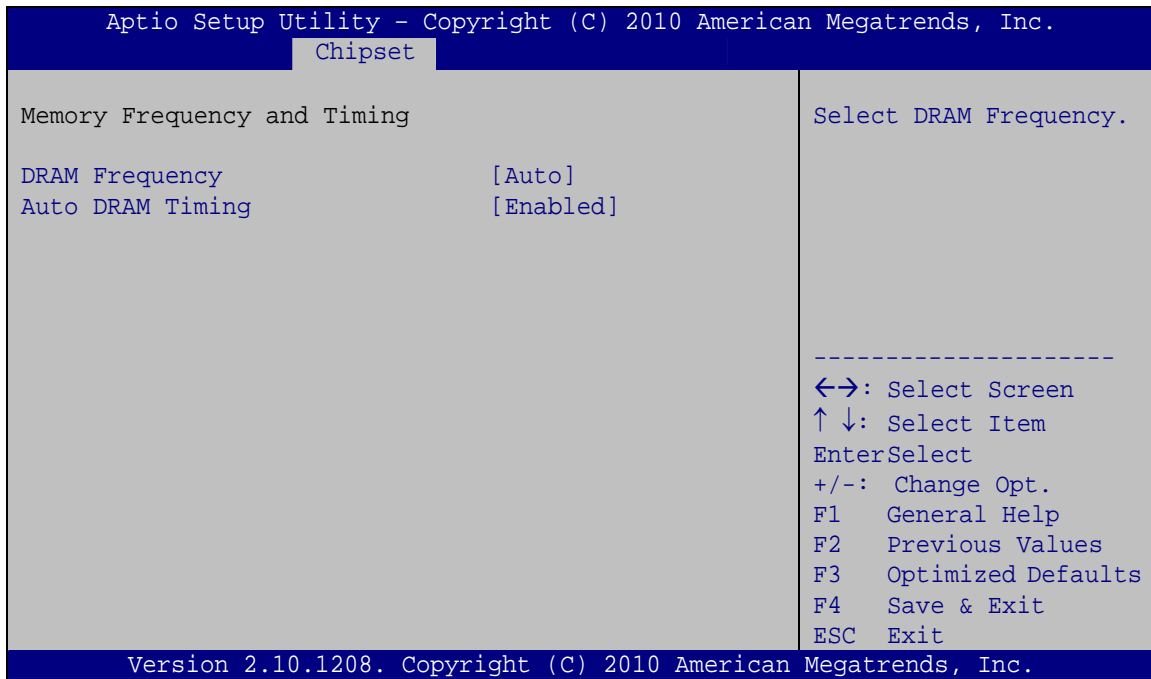

BIOS Menu 16: Memory Frequency and Timing Configuration

➔ **DRAM Frequency**

The **DRAM Frequency** option sets the DRAM Frequency.

- ➔ **Auto** **DEFAULT**
- ➔ **667 Mhz** Sets DRAM Frequency to 667 Mhz
- ➔ **800 Mhz** Sets DRAM Frequency to 800 Mhz

➔ **Auto DRAM Timing**

The **Auto DRAM Timing** option enables or disables DRAM Timing by SPD.

- ➔ **Enabled** **DEFAULT** Enables DRAM Timing.
- ➔ **Disabled** Disables DRAM Timing.

5.4.1.2 OnChip VGA Configuration

Use the **OnChip VGA Configuration** submenu (**BIOS Menu 16**) to configure the OnChip VGA.

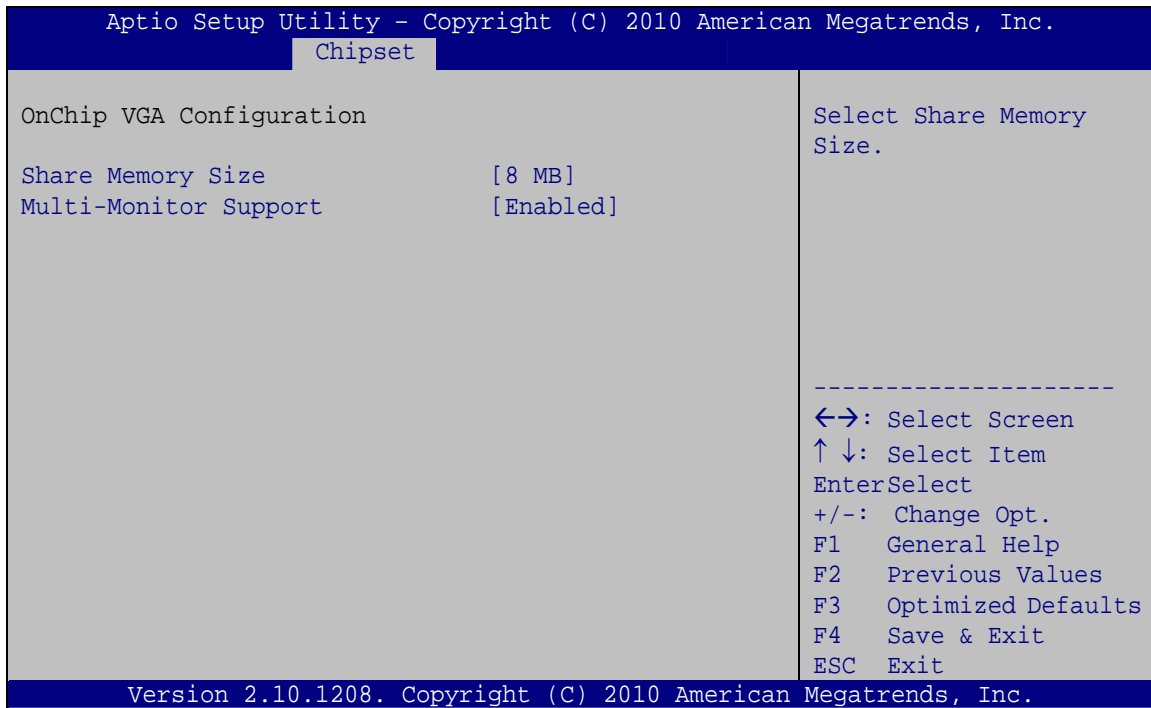

BIOS Menu 17: OnChip VGA Configuration

➔ **Share Memory Size [8 MB]**

Use the **Share Memory Size** option to set the amount of system memory allocated to the integrated graphics processor when the system boots. The system memory allocated can then only be used as graphics memory, and is no longer available to applications or the operating system. Configuration options are listed below:

- Disabled
- 1 MB
- 8 MB **Default**

KINO-PV-D5252/D4252 Mini ITX SBC

→ Multi-Monitor Support [Enabled]

Use **Multi-Monitor Support** option to enable or disable the multi-monitor function.

- **Disabled** Disabled the multi-monitor function
- **Enabled** **DEFAULT** Enabled the multi-monitor function

5.4.2 South Bridge Configuration

Use the **South Bridge Configuration** menu (**BIOS Menu 18**) to configure the Southbridge chipset.

```

Aptio Setup Utility - Copyright (C) 2010 American Megatrends, Inc.

Auto Power Button Function      [Disabled]
Restore AC Power Loss           [Last State]
High Definition Audio Controller [Enabled]
USB Function                     [Enabled]
USB 2.0(EHCI) Support           [Enabled]
Set Spread Spectrum function     [Disabled]

←→: Select Screen
↑↓: Select Item
Enter>Select
+/-: Change Opt.
F1   General Help
F2   Previous Values
F3   Optimized Defaults
F4   Save & Exit
ESC  Exit

Version 2.10.1208. Copyright (C) 2010 American Megatrends, Inc.

```

BIOS Menu 18: South Bridge Chipset Configuration

→ Restore AC Power Loss [Last State]

Use the **Restore AC Power Loss** to select which AC power state is applied after power failure.

- **Power Off** Restores the system to power off.
- **Power On** Restores the system to power on.
- **Last State** **DEFAULT** Restores the system to last power state.

→ **HD Audio Controller [Enabled]**

Use the **HD Audio Controller** option to enable or disable the High Definition Audio controller.

→ **Enabled** **DEFAULT** The onboard High Definition Audio controller automatically detected and enabled

→ **Disabled** The onboard High Definition Audio controller is disabled

→ **USB Function [Enabled]**

Use the **USB Function** BIOS option to enable or disable USB function support.

→ **Disabled** USB function support disabled

→ **Enabled** **DEFAULT** USB function support enabled

→ **USB 2.0 (EHCI) Support [Enabled]**

Use the **USB 2.0 (EHCI) Support** BIOS option to enable or disable USB 2.0 support.

→ **Enabled** **DEFAULT** USB 2.0 (EHCI) support enabled

→ **Disabled** USB 2.0 (EHCI) support disabled

→ **Set Spread Spectrum Function [Disabled]**

The **Set Spread Spectrum Function** option can help to improve CPU EMI issues.

→ **Disabled** **DEFAULT** The spread spectrum mode is disabled

→ **Enabled** The spread spectrum mode is enabled

5.4.3 Intel IGD SWSCI OpRegion

Use the **Intel IGD SWSCI OpRegion** menu (**BIOS Menu 19**) to configure the video device connected to the system.

KINO-PV-D5252/D4252 Mini ITX SBC

```

Aptio Setup Utility - Copyright (C) 2010 American Megatrends, Inc.
Chipset
-----
Intel IGD SWSCI OpRegion Configuration
DVMT Mode Select          [DVMT Mode]
DVMT/FIXED Memory        [Maximum]
IGD - Boot Type          [VBIOS Default]
LCD Panel Type           [Select by Panel ID]
Panel ID Resolution      800x600 18bit

Select DVMT Mode/Fixed Mode
-----
<->: Select Screen
↑ ↓: Select Item
Enter>Select
+/-: Change Opt.
F1  General Help
F2  Previous Values
F3  Optimized Defaults
F4  Save & Exit
ESC Exit

Version 2.10.1208. Copyright (C) 2010 American Megatrends, Inc.

```

BIOS Menu 19: Intel IGD SWSCI OpRegion

➔ DVMT Mode Select [DVMT Mode]

Use the **DVMT Mode Select** option to select the Intel Dynamic Video Memory Technology (DVMT) operating mode.

- ➔ **Fixed Mode** A fixed portion of graphics memory is reserved as graphics memory.
- ➔ **DVMT Mode DEFAULT** Graphics memory is dynamically allocated according to the system and graphics needs.

➔ DVMT/FIXED Memory [Maximum]

Use the **DVMT/FIXED Memory** option to specify the maximum amount of memory that can be allocated as graphics memory. Configuration options are listed below.

- 128 MB
- 256 MB
- Maximum **Default**

➔ IGD - Boot Type [VBIOS Default]

Use the **IGD - Boot Type** option to select the display device used by the system when it boots. Configuration options are listed below.

- VBIOS Default **DEFAULT**
- CRT
- LFP
- CRT + LFP

→ **LCD Panel Type [VBIOS Default]**

Use the **LCD Panel Type** option to select the type of flat panel connected to the system. Configuration options are listed below.

- Select by Panel ID **DEFAULT**
- 640x480 18bit
- 800x480 18bit
- 800x600 18bit
- 1024x768 18bit
- 1280x1024 18bit
- 1366x768 18bit
- 1280x800 18bit
- 1280x600 18bit

5.5 Boot

Use the **Boot** menu (**BIOS Menu 20**) to configure system boot options.

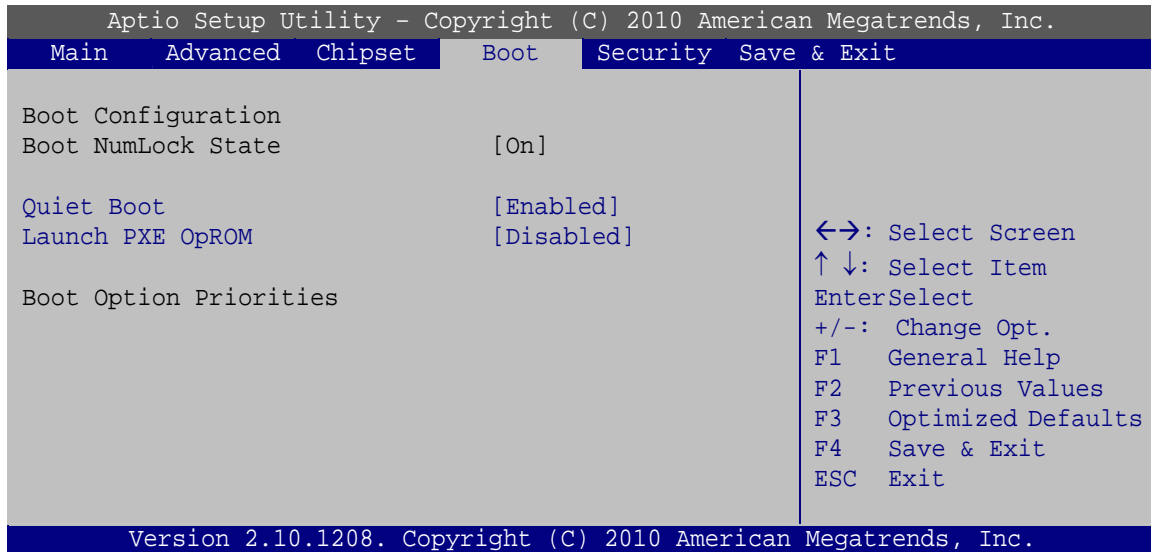

BIOS Menu 20: Boot

→ Bootup NumLock State [On]

Use the **Bootup NumLock State** BIOS option to specify if the number lock setting must be modified during boot up.

→ **On** **DEFAULT** Allows the Number Lock on the keyboard to be enabled automatically when the computer system boots up. This allows the immediate use of the 10-key numeric keypad located on the right side of the keyboard. To confirm this, the Number Lock LED light on the keyboard is lit.

→ **Off** Does not enable the keyboard Number Lock automatically. To use the 10-keys on the keyboard, press the Number Lock key located on the upper left-hand corner of the 10-key pad. The Number Lock LED on the keyboard lights up when the Number Lock is engaged.

→ Quiet Boot [Enabled]

Use the **Quiet Boot** BIOS option to select the screen display when the system boots.

- **Disabled** Normal POST messages displayed
- **Enabled** **DEFAULT** OEM Logo displayed instead of POST messages

→ Launch PXE OpROM [Disabled]

Use the **Launch PXE OpROM** option to enable or disable boot option for legacy network devices.

- **Disabled** **DEFAULT** Ignore all PXE Option ROMs
- **Enabled** Load PXE Option ROMs.

5.6 Security

Use the **Security** menu (**BIOS Menu 21**) to set system and user passwords.

```

Aptio Setup Utility - Copyright (C) 2010 American Megatrends, Inc.
Main  Advanced  Chipset  Boot  Security  Save & Exit
-----
Password Description

If ONLY the Administrator's password is set,
then this only limits access to Setup and is
only asked for when entering Setup.
If ONLY the User's password is set, then this
is a power on password and must be entered to
boot or enter Setup. In Setup the User will
have Administrator rights.
The password must be 3 to 20 characters long.

Administrator Password
User Password

←→: Select Screen
↑ ↓: Select Item
Enter>Select
+/-: Change Opt.
F1  General Help
F2  Previous Values
F3  Optimized Defaults
F4  Save & Exit
ESC Exit

Version 2.10.1208. Copyright (C) 2010 American Megatrends, Inc.

```

BIOS Menu 21: Security
→ Administrator Password

Use the **Administrator Password** option to set or change an administrator password.

KINO-PV-D5252/D4252 Mini ITX SBC

→ User Password

Use the **User Password** option to set or change a user password.

5.7 Exit

Use the **Exit** menu (**BIOS Menu 22**) to load default BIOS values, optimal failsafe values and to save configuration changes.

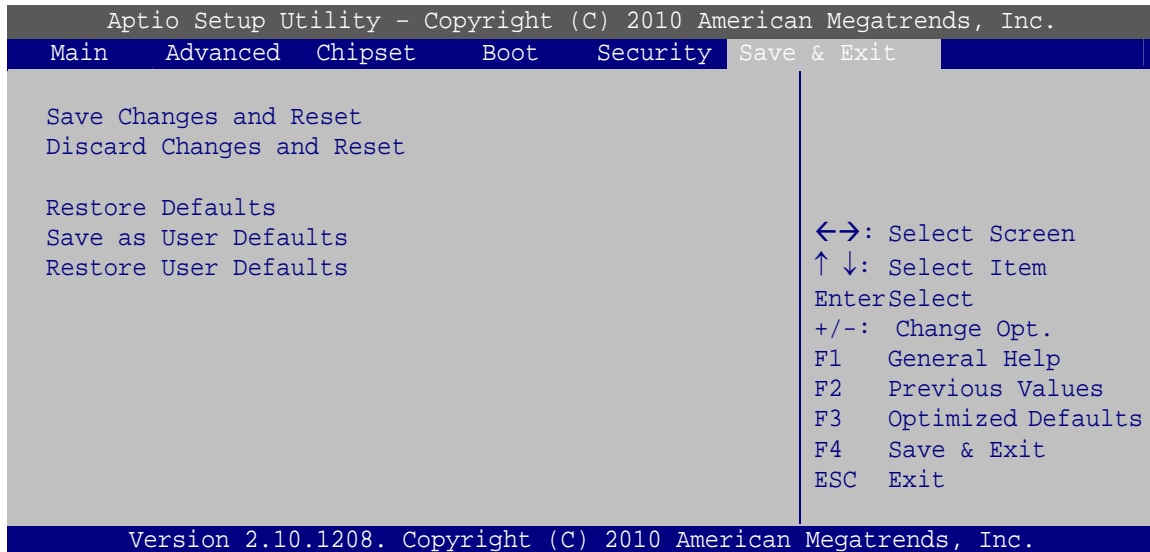

BIOS Menu 22: Exit

→ Save Changes and Reset

Use the **Save Changes and Reset** option to save the changes made to the BIOS options and to exit the BIOS configuration setup program.

→ Discard Changes and Reset

Use the **Discard Changes and Reset** option to exit the system without saving the changes made to the BIOS configuration setup program.

→ Restore Defaults

Use the **Restore Defaults** option to load the optimal default values for each of the parameters on the Setup menus. **F3 key can be used for this operation.**

→ **Save as User Defaults**

Use the **Save as User Defaults** option to save the changes done so far as user defaults.

→ **Restore User Defaults**

Use the **Restore User Defaults** option to restore the user defaults to all the setup options.

Appendix

A

BIOS Options

Below is a list of BIOS configuration options in the BIOS chapter.

BIOS Information	75
System Date [xx/xx/xx]	75
System Time [xx:xx:xx]	76
ACPI Sleep State [S1 (CPU Stop Clock)]	77
TPM Support [Disable]	78
ATA/IDE Configurations [Enhanced]	80
Configure SATA as [IDE]	81
USB Devices	81
Legacy USB Support [Enabled]	81
Serial Port [Enabled]	83
Change Settings [Auto]	83
Serial Port [Enabled]	84
Device Mode	84
Change Settings [Auto]	84
Serial Port [Enabled]	85
Change Settings [Auto]	85
Serial Port [Enabled]	85
Change Settings [Auto]	85
Parallel Port [Enabled]	86
Change Settings [Auto]	87
Device Mode [Printer Mode]	87
PC Health Status	88
CPU Smart Fan control [Auto Mode]	89
SYS Smart Fan control [Auto Mode]	89
Serial Port [Enabled]	90
Change Settings [Auto]	90
Serial Port [Enabled]	91
Change Settings [Auto]	91
Console Redirection [Disabled]	93
MMIO Size	94
Initate Graphic Adapter [IGD]	94
DRAM Frequency	95
Auto DRAM Timing	95

KINO-PV-D5252/D4252 Mini ITX SBC

Share Memory Size [8 MB].....	96
Multi-Monitor Support [Enabled].....	97
Restore AC Power Loss [Last State]	97
HD Audio Controller [Enabled].....	98
USB Function [Enabled].....	98
USB 2.0 (EHCI) Support [Enabled].....	98
Set Spread Spectrum Function [Disabled].....	98
DVMT Mode Select [DVMT Mode].....	99
DVMT/FIXED Memory [Maximum]	99
IGD - Boot Type [VBIOS Default].....	99
LCD Panel Type [VBIOS Default].....	100
Bootup NumLock State [On].....	101
Quiet Boot [Enabled]	102
Launch PXE OpROM [Disabled].....	102
Administrator Password	102
User Password	103
Save Changes and Reset	103
Discard Changes and Reset	103
Restore Defaults	103
Save as User Defaults	104
Restore User Defaults	104

Appendix

B

One Key Recovery

B.1 One Key Recovery Introduction

The IEI one key recovery is an easy-to-use front end for the Norton Ghost system backup and recovery tool. The one key recovery provides quick and easy shortcuts for creating a backup and reverting to that backup or for reverting to the factory default settings.

The IEI One Key Recovery tool menu is shown below.

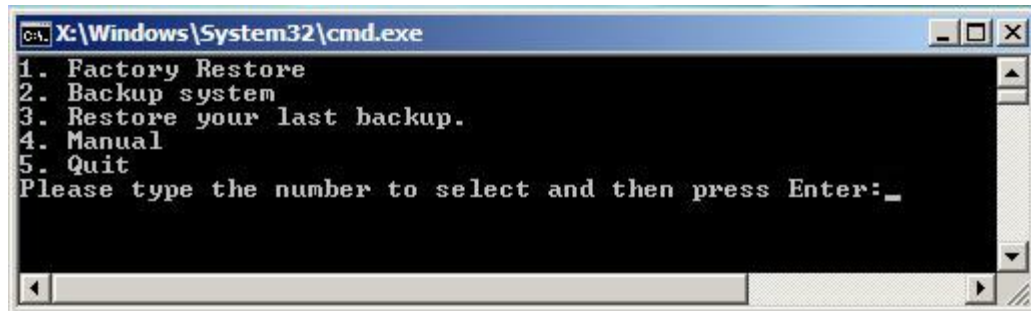

Figure B-1: IEI One Key Recovery Tool Menu

Prior to using the IEI One Key Recovery tool (as shown in **Figure B-1**) to backup or restore Windows system, five setup procedures are required.

1. Hardware and BIOS setup (see **Section B.2.1**)
2. Create partitions (see **Section B.2.2**)
3. Install operating system, drivers and system applications (see **Section B.2.3**)
4. Build-up recovery partition (see **Section B.2.4**)
5. Create factory default image (see **Section B.2.5**)

After completing the five initial setup procedures as described above, users can access the recovery tool by pressing <F3> while booting up the system. The detailed information of each function is described in **Section B.4**.



NOTE:

The initial setup procedures for Linux system are described in Section B.3.

B.1.1 System Requirement



NOTE:

The recovery CD can only be used with IEI products. The software will fail to run and a warning message will appear when used on non-IEI hardware.

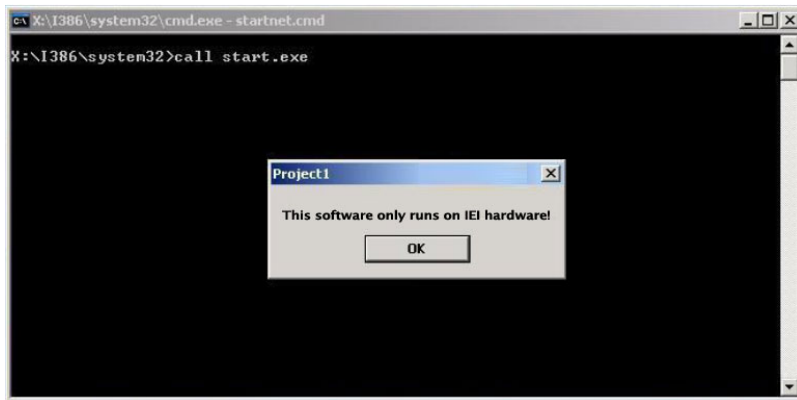

To create the system backup, the main storage device must be split into two partitions (three partitions for Linux). The first partition will be for the operating system, while the second partition will be invisible to the operating system and contain the backup made by the one key recovery software.

The partition created for recovery images must be big enough to contain both the factory default image and the user backup image. The size must be calculated before creating the partitions. Please take the following table as a reference when calculating the size of the partition.

	OS	OS IMAGE AFTER GHOST	COMPRESSION RATIO
WINDOWS® 7	7 GB	5 GB	70%
WINDOWS® XPE	776 MB	560 MB	70%
WINDOWS® CE 6.0	36 MB	28 MB	77%

**NOTE:**

Specialized tools are required to change the partition size if the operating system is already installed.

B.1.2 Supported Operating System

The recovery CD is compatible with both Microsoft Windows and Linux operating system (OS). The supported OS versions are listed below.

- Microsoft Windows
 - Windows XP (Service Pack 2 or 3 required)
 - Windows Vista
 - Windows 7
 - Windows CE 5.0
 - Windows CE 6.0
 - Windows XP Embedded
- Linux
 - Fedora Core 12 (Constantine)
 - Fedora Core 11 (Leonidas)
 - Fedora Core 10 (Cambridge)
 - Fedora Core 8 (Werewolf)
 - Fedora Core 7 (Moonshine)
 - RedHat RHEL-5.4
 - RedHat 9 (Ghirke)
 - Ubuntu 8.10 (Intrepid)
 - Ubuntu 7.10 (Gutsy)
 - Ubuntu 6.10 (Edgy)
 - Debian 5.0 (Lenny)
 - Debian 4.0 (Etch)
 - SuSe 11.2
 - SuSe 10.3

**NOTE:**

Installing unsupported OS versions may cause the recovery tool to fail.

B.2 Setup Procedure for Windows

Prior to using the recovery tool to backup or restore Windows system, a few setup procedures are required.

Step 1: Hardware and BIOS setup (see **Section B.2.1**)

Step 2: Create partitions (see **Section B.2.2**)

Step 3: Install operating system, drivers and system applications (see **Section B.2.3**)

Step 4: Build-up recovery partition (see **Section B.2.4**)

Step 5: Create factory default image (see **Section B.2.5**)

The detailed descriptions are described in the following sections.

**NOTE:**

The setup procedures described below are for Microsoft Windows operating system users. For Linux system, most setup procedures are the same with Microsoft Windows except for several steps described in Section B.3.

B.2.1 Hardware and BIOS Setup

Step 1: Make sure the system is powered off and unplugged.

Step 2: Install a hard drive or SSD in the system. An unformatted and unpartitioned disk is recommended.

Step 3: Connect an optical disk drive to the system and insert the recovery CD.

KINO-PV-D5252/D4252 Mini ITX SBC

- Step 4:** Turn on the system.
- Step 5:** Press the <F2> key as soon as the system is turned on to enter the BIOS.
- Step 6:** Select the connected optical disk drive as the 1st boot device. (**Boot → Boot Device Priority → 1st Boot Device**).
- Step 7:** Save changes and restart the computer. Continue to the next section for instructions on partitioning the internal storage.

B.2.2 Create Partitions

To create the system backup, the main storage device must be split into two partitions (three partitions for Linux). The first partition will be for the operating system, while the second partition will be invisible to the operating system and contain the backup made by the one key recovery software.

- Step 1:** Put the recovery CD in the optical drive of the system.
- Step 2:** **Boot the system from recovery CD.** When prompted, press any key to boot from the recovery CD. It will take a while to launch the recovery tool. Please be patient!

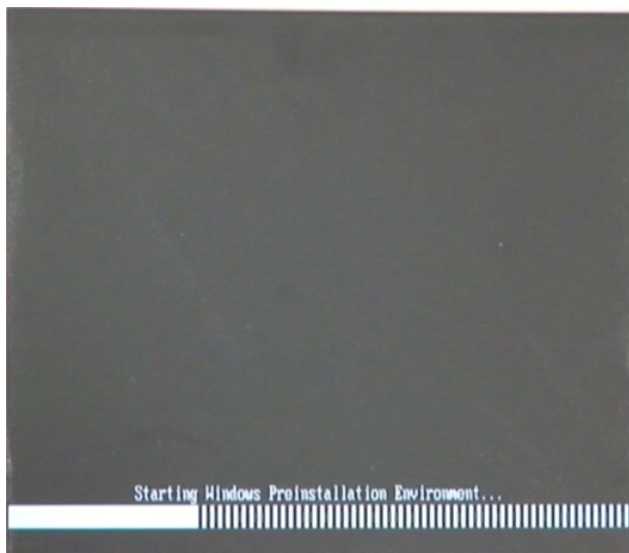
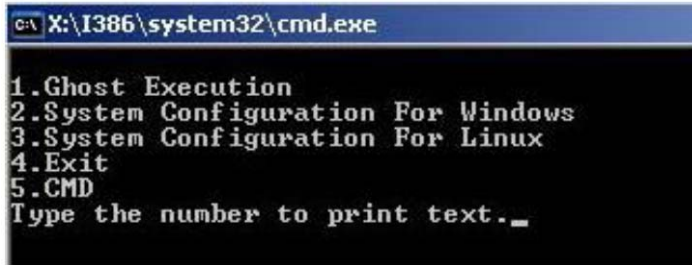

Figure B-2: Launching the Recovery Tool

Step 3: The recovery tool setup menu is shown as below.



```

C:\X:\I386\system32\cmd.exe
1.Ghost Execution
2.System Configuration For Windows
3.System Configuration For Linux
4.Exit
5.CMD
Type the number to print text._
  
```

Figure B-3: Recovery Tool Setup Menu

Step 4: Press <5> then <Enter>.

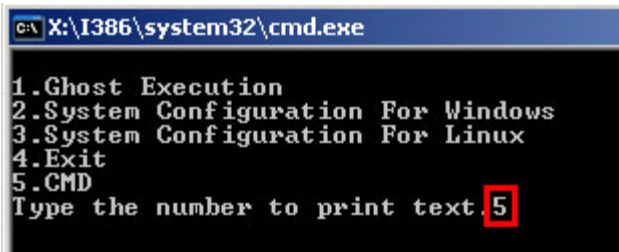

```

C:\X:\I386\system32\cmd.exe
1.Ghost Execution
2.System Configuration For Windows
3.System Configuration For Linux
4.Exit
5.CMD
Type the number to print text. 5
  
```

Figure B-4: Command Mode

Step 5: The command prompt window appears. Type the following commands (marked in red) to create two partitions. One is for the OS installation; the other is for saving recovery files and images which will be an invisible partition.

(Press <Enter> after entering each line below)

```

system32>diskpart
DISKPART>list vol
DISKPART>sel disk 0
DISKPART>create part pri size= ____
DISKPART>assign letter=N
DISKPART>create part pri size= ____
DISKPART>assign letter=F
DISKPART>exit
system32>format N: /fs:ntfs /q /y
  
```

system32>format F: /fs:ntfs /q /v:Recovery /y

system32>exit

```

C:\X:\I386\system32\CMD.EXE
X:\I386\SYSTEM32>diskpart → Starts the Microsoft disk partitioning tool.
Microsoft DiskPart version 5.2.3790.1830
Copyright (C) 1999-2001 Microsoft Corporation.
On computer: MININT-JUC
DISKPART> list vol → Show partition information
Volume ### Ltr Label Fs Type Size Status Info
-----
Volume 0 X CD_ROM GDFS DUD-ROM 405 MB Healthy Boot
Volume 1 D FAT32 Removeable 3854 MB Healthy
DISKPART> sel disk 0 → Select a disk
Disk 0 is now the selected disk.
DISKPART> create part pri size=2000 → Create partition 1 and assign a size.
This partition is for OS installation.
DiskPart succeeded in creating the specified partition.
DISKPART> assign letter=N → Assign partition 1 a code name (N).
DiskPart successfully assigned the drive letter or mount point.
DISKPART> create part pri size=1800 → Create partition 2 and assign a size.
This partition is for recovery images.
DiskPart succeeded in creating the specified partition.
DISKPART> assign letter=F → Assign partition 2 a code name (F).
DiskPart successfully assigned the drive letter or mount point.
DISKPART> exit → Exit diskpart
X:\I386\SYSTEM32>format n: /fs:ntfs /q /y → Format partition 1 (N) as NTFS format.
The type of the file system is ntw.
The new file system is NTFS.
QuickFormatting 2000M
Creating file system structures.
Format complete.
2048254 KB total disk space.
2035620 KB are available.
X:\I386\SYSTEM32>format f: /fs:ntfs /q /v:Recovery /y → Formate partition 2 (F) as NTFS formate and
name it as "Recovery".
The type of the file system is ntw.
The new file system is NTFS.
QuickFormatting 1804M
Creating file system structures.
Format complete.
1847474 KB total disk space.
1835860 KB are available.
X:\I386\SYSTEM32>exit → Exit Windows PE
  
```

Figure B-5: Partition Creation Commands

NOTE:

Use the following commands to check if the partitions were created successfully.

```

X:\I386\SYSTEM32>diskpart
Microsoft DiskPart version 5.2.3790.1830
Copyright (C) 1999-2001 Microsoft Corporation.
On computer: MININT-JUC

DISKPART> sel disk 0
Disk 0 is now the selected disk.

DISKPART> list part

   Partition ###   Type              Size              Offset
-----
   Partition 1     Primary           2000 MB           32 KB
   Partition 2     Primary           1804 MB          2000 MB

DISKPART> exit
  
```

Step 6: Press any key to exit the recovery tool and automatically reboot the system.

Please continue to the following procedure: Build-up Recovery Partition.

B.2.3 Install Operating System, Drivers and Applications

Install the operating system onto the unlabelled partition. The partition labeled as "Recovery" is for use by the system recovery tool and should not be used for installing the operating system or any applications.

NOTE:

The operating system installation program may offer to reformat the chosen partition. DO NOT format the partition again. The partition has already been formatted and is ready for installing the new operating system.

To install the operating system, insert the operating system installation CD into the optical drive. Restart the computer and follow the installation instructions.

KINO-PV-D5252/D4252 Mini ITX SBC

B.2.4 Build-up Recovery Partition

- Step 1:** Put the recover CD in the optical drive.
- Step 2:** Start the system.
- Step 3:** **Boot the system from recovery CD.** When prompted, press any key to boot from the recovery CD. It will take a while to launch the recovery tool. Please be patient!

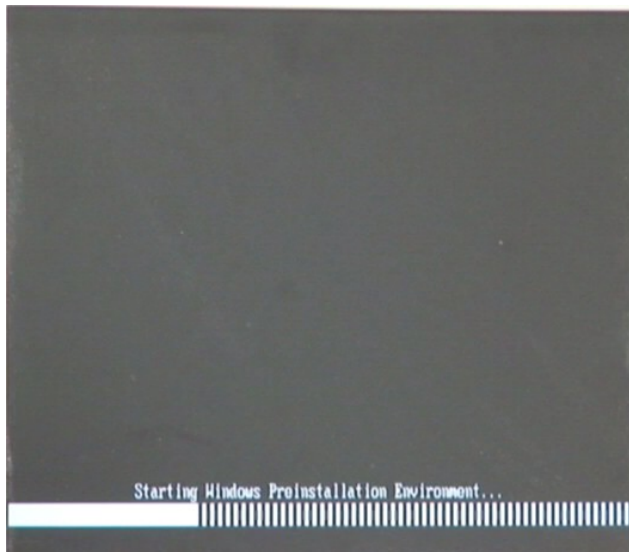

Figure B-6: Launching the Recovery Tool

- Step 4:** When the recovery tool setup menu appears, press <2> then <Enter>.

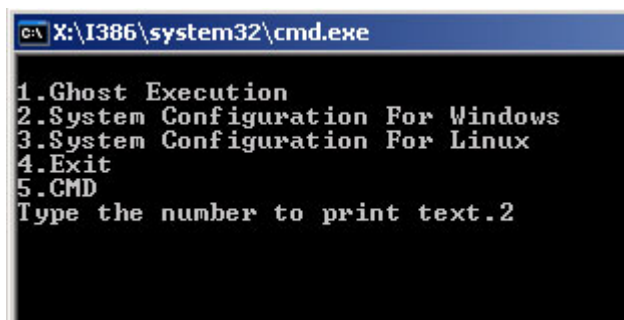

Figure B-7: System Configuration for Windows

- Step 5:** The Symantec Ghost window appears and starts configuring the system to build-up a recovery partition. In this process, the partition which is created for

recovery files in **Section B.2.2** is hidden and the recovery tool is saved in this partition.

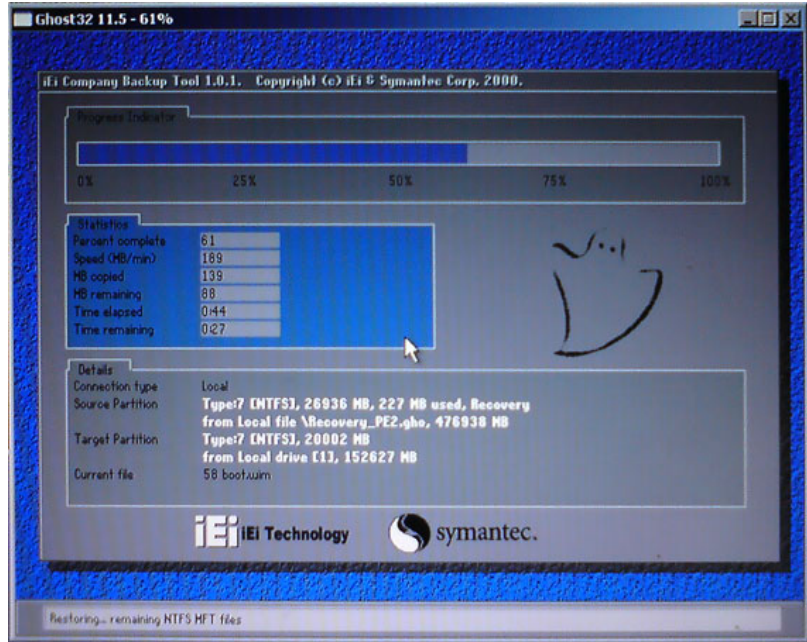

Figure B-8: Build-up Recovery Partition

Step 6: After completing the system configuration, press any key in the following window to reboot the system.

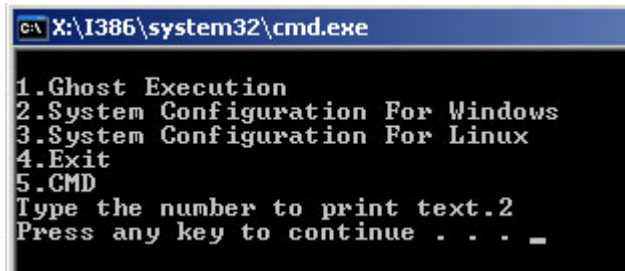

Figure B-9: Press any key to continue

Step 7: Eject the recovery CD.

B.2.5 Create Factory Default Image



NOTE:

Before creating the factory default image, please configure the system to a factory default environment, including driver and application installations.

To create a factory default image, please follow the steps below.

Step 1: Turn on the system. When the following screen displays (**Figure B-10**), press the <F3> key to access the recovery tool. The message will display for 10 seconds, please press F3 before the system boots into the operating system.

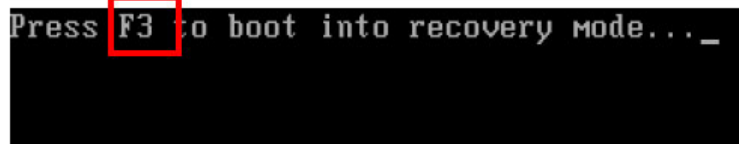

```
Press F3 to boot into recovery mode... _
```

Figure B-10: Press F3 to Boot into Recovery Mode

Step 2: The recovery tool menu appears. Type <4> and press <Enter>. (**Figure B-11**)

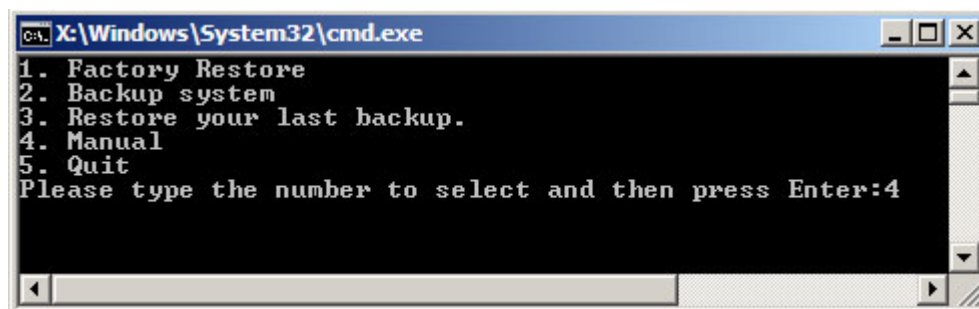

Figure B-11: Recovery Tool Menu

Step 3: The About Symantec Ghost window appears. Click **OK** button to continue.

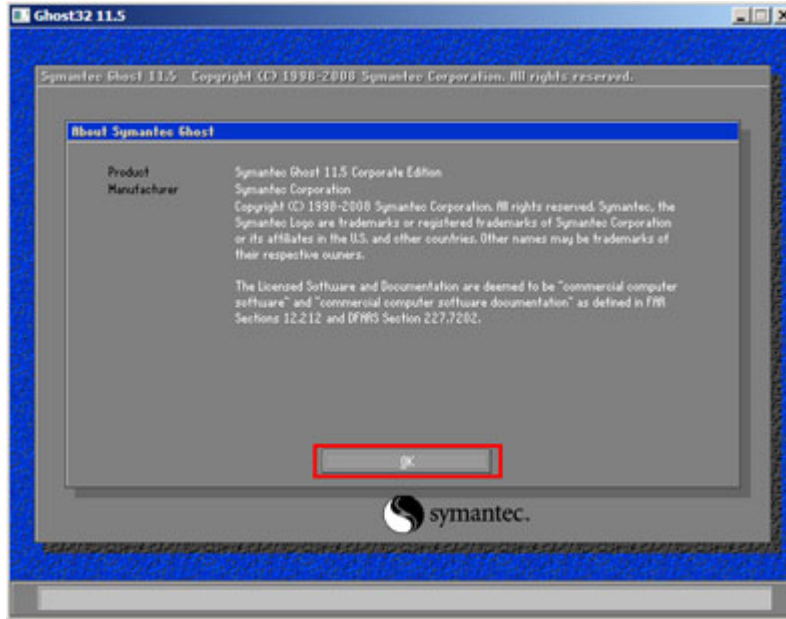

Figure B-12: About Symantec Ghost Window

Step 4: Use mouse to navigate to the option shown below (Figure B-13).

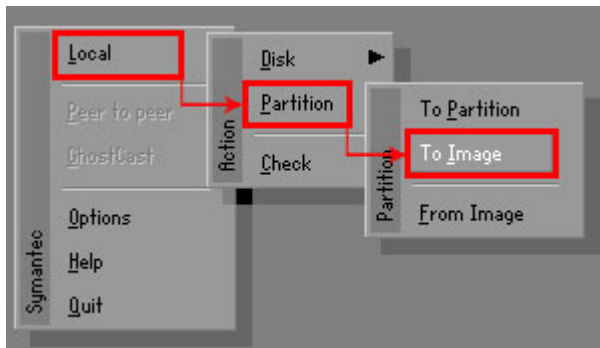

Figure B-13: Symantec Ghost Path

Step 5: Select the local source drive (Drive 1) as shown in Figure B-14. Then click OK.

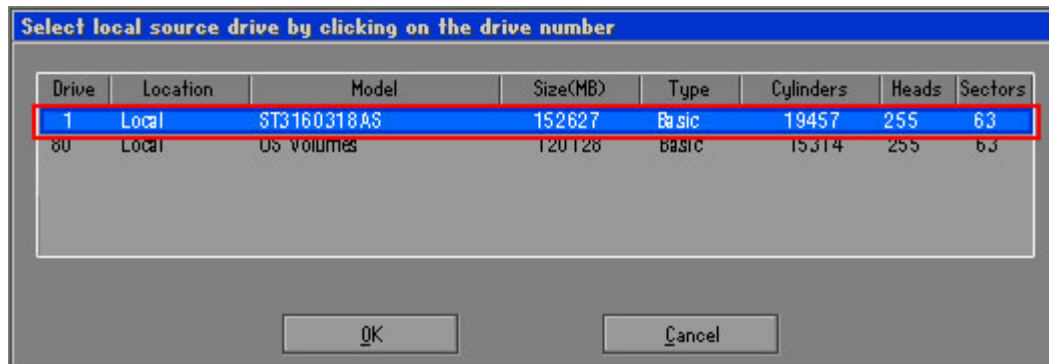

Figure B-14: Select a Local Source Drive

Step 6: Select a source partition (Part 1) from basic drive as shown in **Figure B-15**.

Then click OK.

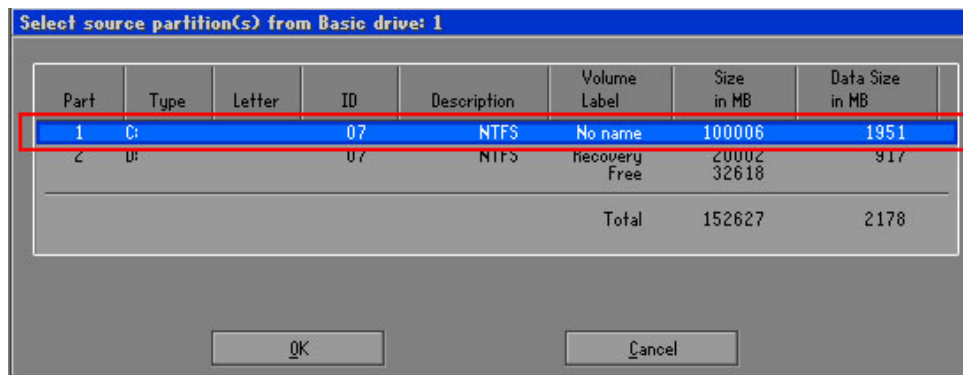

Figure B-15: Select a Source Partition from Basic Drive

Step 7: Select 1.2: **[Recovery] NTFS drive** and enter a file name called **iei** (**Figure B-16**). Click **Save**. The factory default image will then be saved in the selected recovery drive and named **IEI.GHO**.



WARNING:

The file name of the factory default image must be **iei.GHO**.

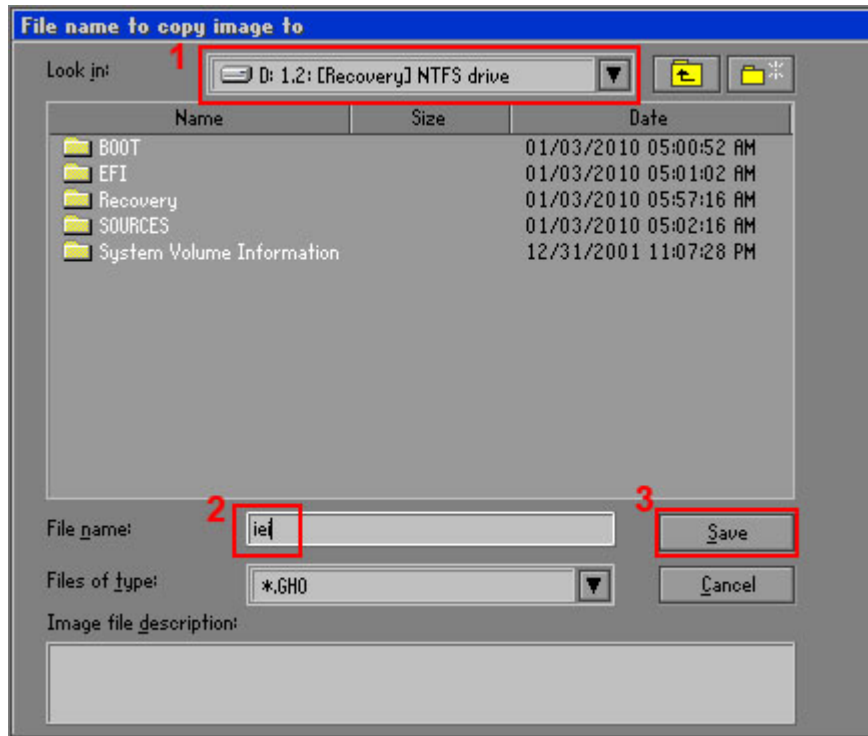

Figure B-16: File Name to Copy Image to

Step 8: When the Compress Image screen in **Figure B-17** prompts, click **High** to make the image file smaller.

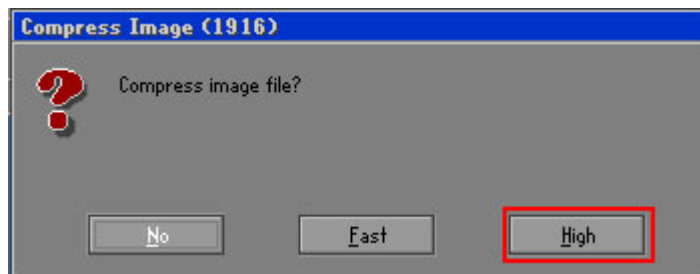

Figure B-17: Compress Image

KINO-PV-D5252/D4252 Mini ITX SBC

Step 9: The Proceed with partition image creation window appears, click **Yes** to continue.

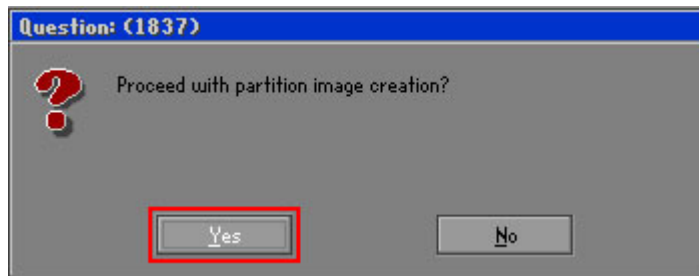

Figure B-18: Image Creation Confirmation

Step 10: The Symantec Ghost starts to create the factory default image (**Figure B-19**).

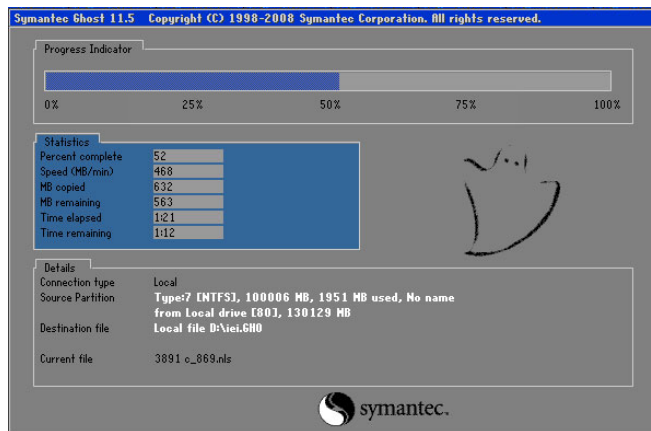

Figure B-19: Image Creation Complete

Step 11: When the image creation completes, a screen prompts as shown in **Figure B-20**.

Click **Continue** and close the Ghost window to exit the program.

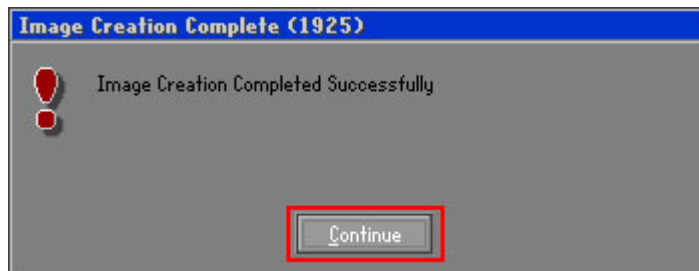
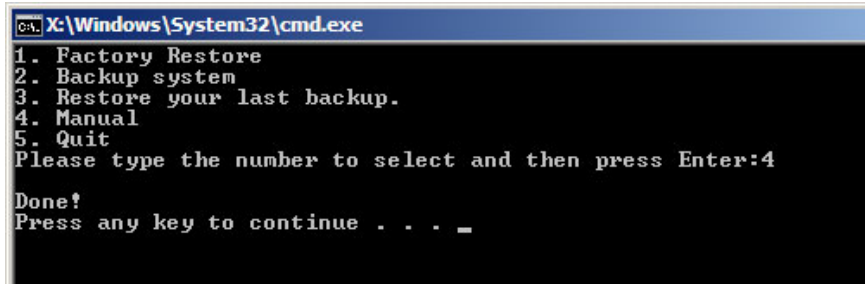

Figure B-20: Image Creation Complete

Step 12: The recovery tool main menu window is shown as below. Press any key to reboot the system.



```

C:\Windows\System32\cmd.exe
1. Factory Restore
2. Backup system
3. Restore your last backup.
4. Manual
5. Quit
Please type the number to select and then press Enter:4
Done!
Press any key to continue . . . _
  
```

Figure B-21: Press Any Key to Continue

B.3 Setup Procedure for Linux

The initial setup procedures for a Linux system are mostly the same with the procedure for Microsoft Windows. Please follow the steps below to setup the recovery tool for Linux OS.

Step 1: Hardware and BIOS setup. Refer to **Section B.2.1**.

Step 2: Install Linux operating system. Make sure to install GRUB (v0.97 or earlier) MBR type and Ext3 partition type. Leave enough space on the hard drive to create the recover partition later.



NOTE:

If the Linux OS is not installed with GRUB (v0.97 or earlier) and Ext3, the Symantec Ghost may not function properly.

While installing Linux OS, please create two partitions:

- Partition 1: /
- Partition 2: **SWAP**



NOTE:

Please reserve enough space for partition 3 for saving recovery images.

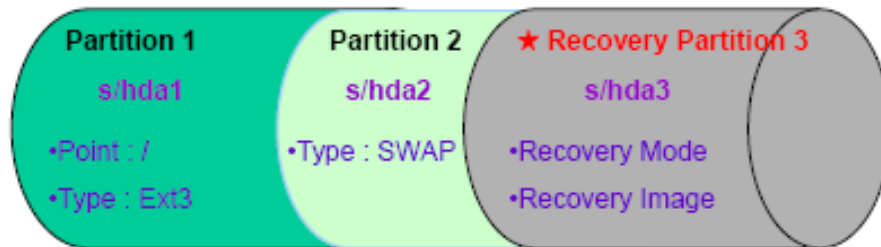

Figure B-22: Partitions for Linux

Step 3: Create a recovery partition. Insert the recovery CD into the optical disk drive.

Follow **Step 1 ~ Step 3** described in **Section B.2.2**. Then type the following commands (marked in red) to create a partition for recovery images.

```
system32>diskpart
DISKPART>list vol
DISKPART>sel disk 0
DISKPART>create part pri size= ____
DISKPART>assign letter=N
DISKPART>exit
system32>format N: /fs:ntfs /q /v:Recovery /y
system32>exit
```

Step 4: Build-up recovery partition. Press any key to boot from the recovery CD. It will take a while to launch the recovery tool. Please be patient. When the recovery tool setup menu appears, type <3> and press <Enter> (**Figure B-23**). The Symantec Ghost window appears and starts configuring the system to build-up a recovery partition. After completing the system configuration, press any key to reboot the system. Eject the recovery CD.

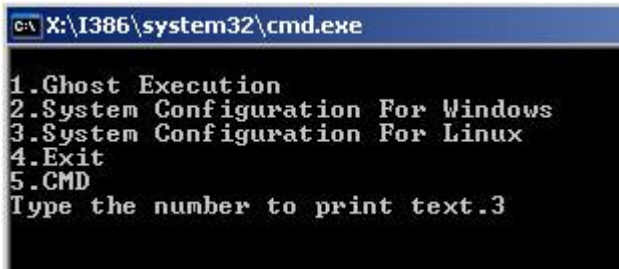

```
C:\X:\I386\system32\cmd.exe
1.Ghost Execution
2.System Configuration For Windows
3.System Configuration For Linux
4.Exit
5.CMD
Type the number to print text.3
```

Figure B-23: System Configuration for Linux

Step 5: Access the recovery tool main menu by modifying the “menu.lst”. To first access the recovery tool main menu, the menu.lst must be modified. In Linux system, enter Administrator (root). When prompt appears, type:

cd /boot/grub

vi menu.lst

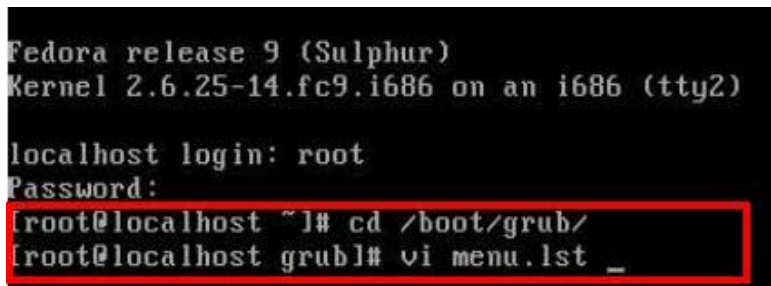

```
Fedora release 9 (Sulphur)
Kernel 2.6.25-14.fc9.i686 on an i686 (tty2)

localhost login: root
Password:
[root@localhost ~]# cd /boot/grub/
[root@localhost grub]# vi menu.lst _
```

Figure B-24: Access menu.lst in Linux (Text Mode)

Step 6: Modify the menu.lst as shown below.

```
#boot=/dev/sda
default=0
timeout=10 ← Modify timeout=10
splashimage=(hd0,8)/grub/splash.xpm.gz
hiddenmenu
title Fedora (2.6.25-14.fc9.i686)
    root (hd0,0)
    kernel /vmlinuz-2.6.25-14.fc9.i686 ro root=UUID=10f1acd
ac38b5c78910 rhgb quiet
    initrd /initrd-2.6.25-14.fc9.i686.img

title Recovery Partition
root (hd0,2)
makeactive ← Type command
chainloader +1
```

- Type command:
title Recovery Partition
root (hd0,2)
makeactive
chainloader +1

Step 7: The recovery tool menu appears. (Figure B-25)

```
1. Factory Restore
2. Backup system
3. Restore your last backup.
4. Manual
5. Quit
Please type the number to select and then press Enter:
```

Figure B-25: Recovery Tool Menu

Step 8: Create a factory default image. Follow **Step 2 ~ Step 12** described in **Section B.2.5** to create a factory default image.

B.4 Recovery Tool Functions

After completing the initial setup procedures as described above, users can access the recovery tool by pressing **<F3>** while booting up the system. The main menu of the recovery tool is shown below.

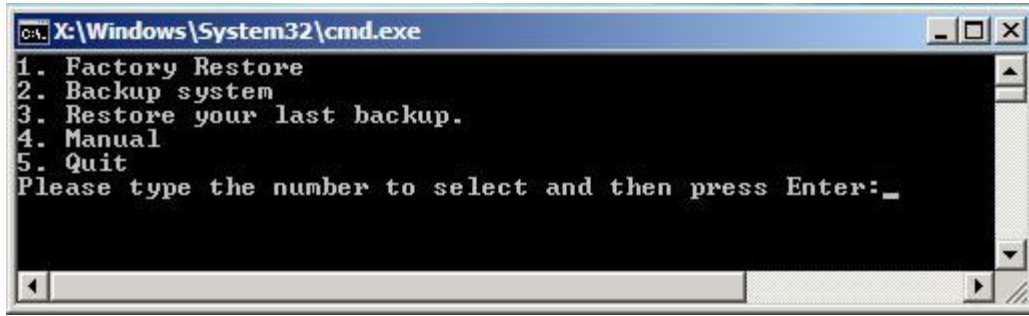

Figure B-26: Recovery Tool Main Menu

The recovery tool has several functions including:

1. **Factory Restore:** Restore the factory default image (iei.GHO) created in Section B.2.5.
2. **Backup system:** Create a system backup image (iei_user.GHO) which will be saved in the hidden partition.
3. **Restore your last backup:** Restore the last system backup image
4. **Manual:** Enter the Symantec Ghost window to configure manually.
5. **Quit:** Exit the recovery tool and restart the system.



WARNING:

Please do not turn off the system power during the process of system recovery or backup.



WARNING:

All data in the system will be deleted during the system recovery. Please backup the system files before restoring the system (either Factory Restore or Restore Backup).

KINO-PV-D5252/D4252 Mini ITX SBC

B.4.1 Factory Restore

To restore the factory default image, please follow the steps below.

Step 1: Type <1> and press <Enter> in the main menu.

Step 2: The Symantec Ghost window appears and starts to restore the factory default. A factory default image called **iei.GHO** is created in the hidden Recovery partition.

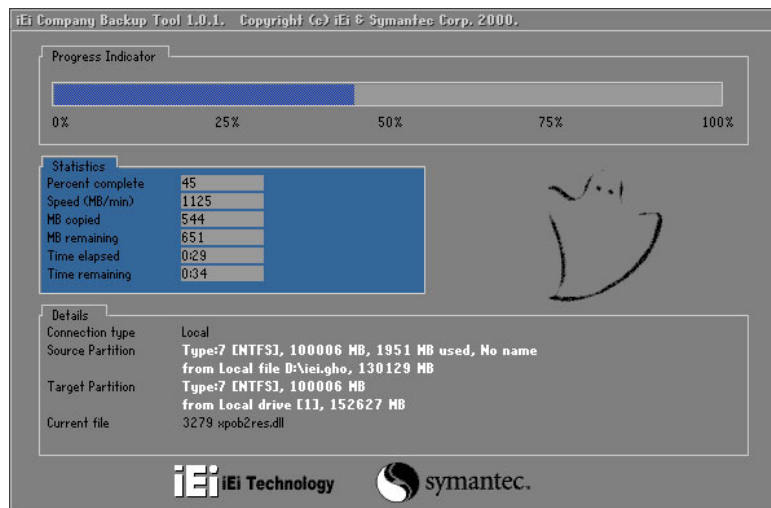

Figure B-27: Restore Factory Default

Step 3: The screen is shown as in **Figure B-28** when completed. Press any key to reboot the system.

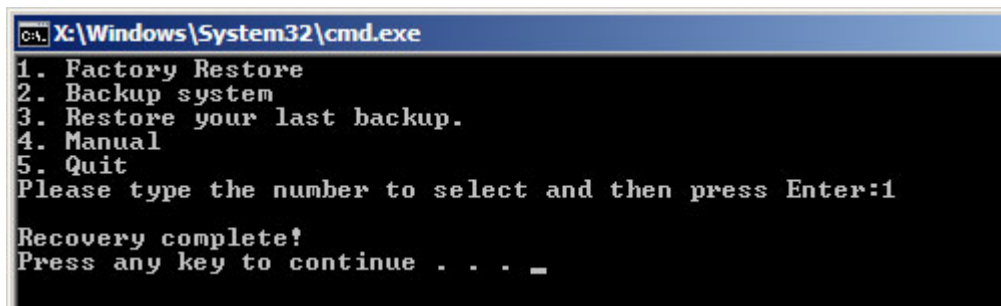

Figure B-28: Recovery Complete Window

B.4.2 Backup System

To backup the system, please follow the steps below.

Step 1: Type <2> and press <Enter> in the main menu.

Step 2: The Symantec Ghost window appears and starts to backup the system. A backup image called `iei_user.GHO` is created in the hidden Recovery partition.

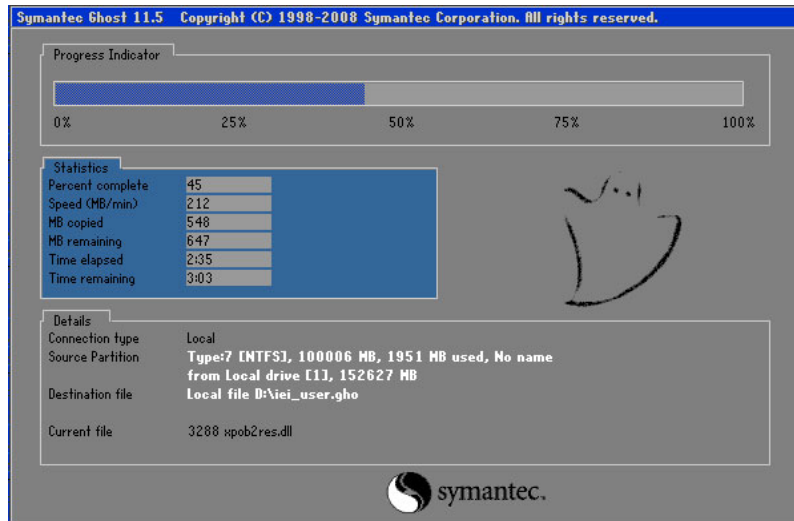

Figure B-29: Backup System

Step 3: The screen is shown as in **Figure B-30** when system backup is completed.

Press any key to reboot the system.

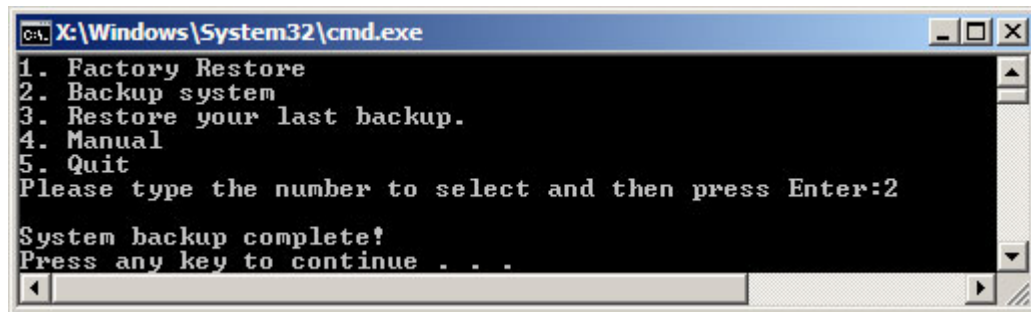

Figure B-30: System Backup Complete Window

B.4.3 Restore Your Last Backup

To restore the last system backup, please follow the steps below.

Step 1: Type <3> and press <Enter> in the main menu.

Step 2: The Symantec Ghost window appears and starts to restore the last backup image (iei_user.GHO).

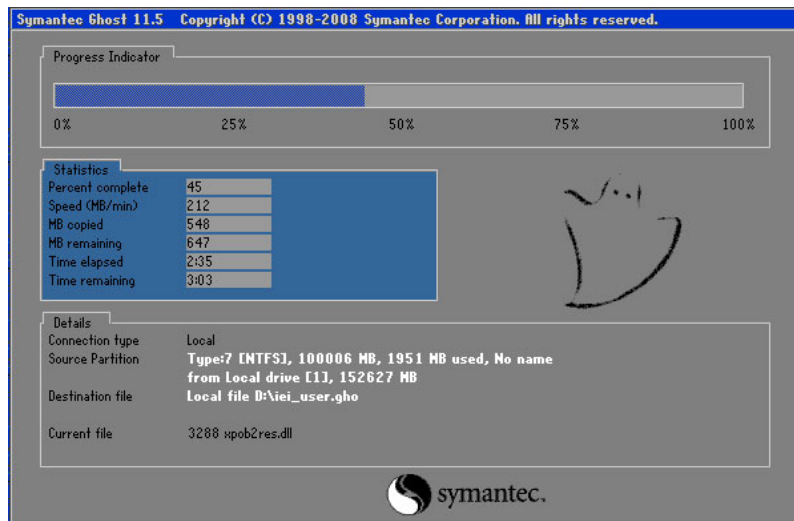

Figure B-31: Restore Backup

Step 3: The screen is shown as in **Figure B-32** when backup recovery is completed. Press any key to reboot the system.

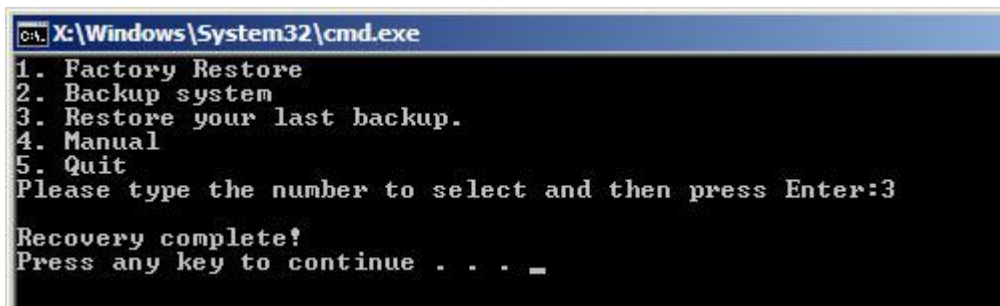

Figure B-32: Restore System Backup Complete Window

B.4.4 Manual

To restore the last system backup, please follow the steps below.

Step 1: Type <4> and press <Enter> in the main menu.

Step 2: The Symantec Ghost window appears. Use the Ghost program to backup or recover the system manually.

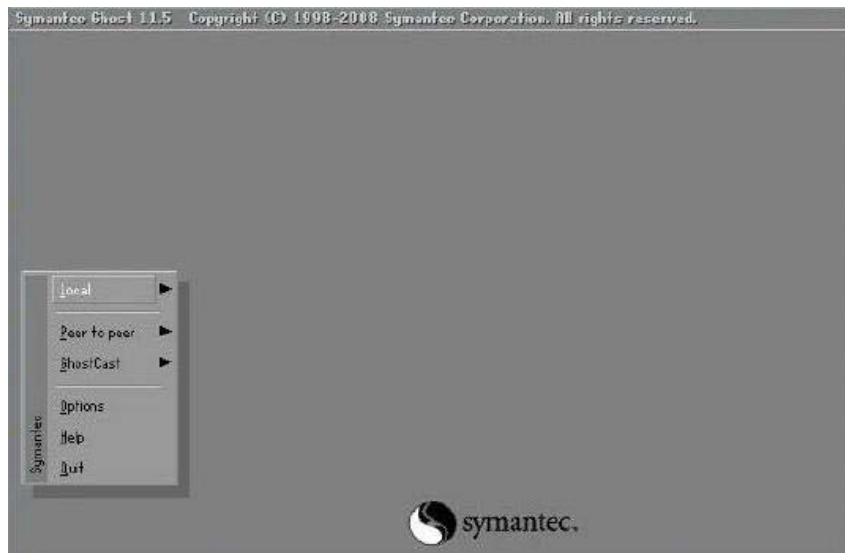

Figure B-33: Symantec Ghost Window

Step 3: When backup or recovery is completed, press any key to reboot the system.

B.5 Other Information

B.5.1 Using AHCI Mode or ALi M5283 / VIA VT6421A Controller

When the system uses AHCI mode or some specific SATA controllers such as ALi M5283 or VIA VT6421A, the SATA RAID/AHCI driver must be installed before using one key recovery. Please follow the steps below to install the SATA RAID/AHCI driver.

Step 1: Copy the SATA RAID/AHCI driver to a floppy disk and insert the floppy disk into a USB floppy disk drive. The SATA RAID/AHCI driver must be especially designed for the on-board SATA controller.

Step 2: Connect the USB floppy disk drive to the system.

Step 3: Insert the One Key Recovery CD into the system and boot the system from the CD.

Step 4: When launching the recovery tool, press <F6>.

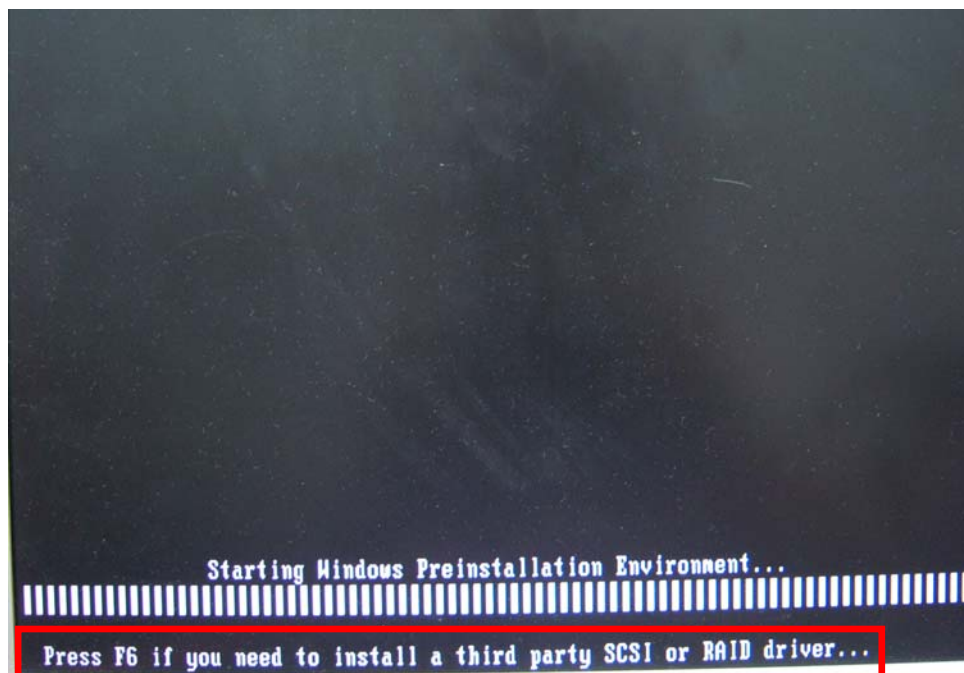

Step 5: When the following window appears, press <S> to select “Specify Additional Device”.

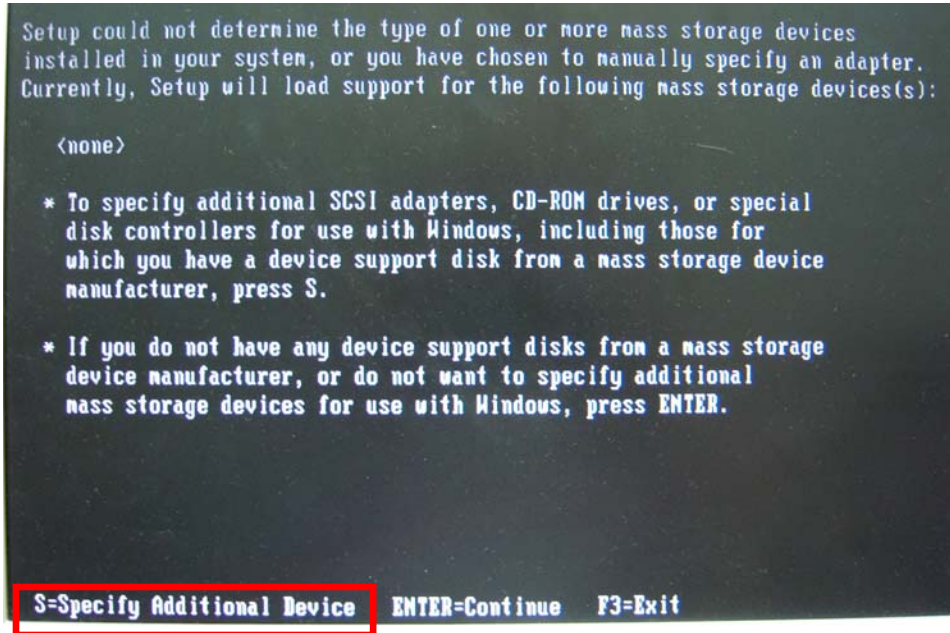

Step 6: In the following window, select a SATA controller mode used in the system. Then press <Enter>. The user can now start using the SATA HDD.

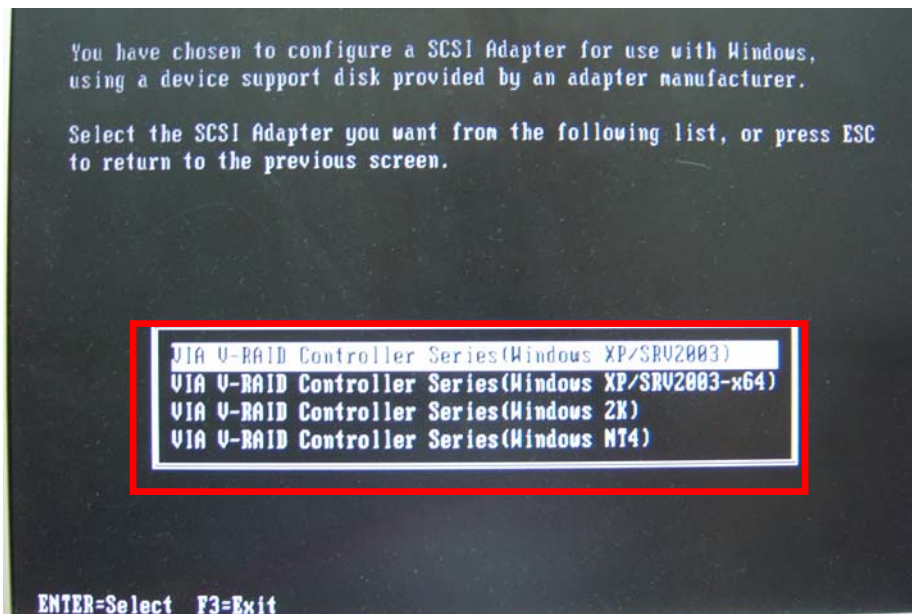

KINO-PV-D5252/D4252 Mini ITX SBC

Step 7: After pressing <Enter>, the system will get into the recovery tool setup menu.

Continue to follow the setup procedure from **Step 4** in **Section B.2.2 Create Partitions** to finish the whole setup process.

B.5.2 System Memory Requirement

To be able to access the recovery tool by pressing <F3> while booting up the system, please make sure to have enough system memory. The minimum memory requirement is listed below.

- **Using Award BIOS:** 128 MB system memory
- **Using AMI BIOS:** 512 MB system memory.

Appendix

C

Terminology

KINO-PV-D5252/D4252 Mini ITX SBC

AC '97	Audio Codec 97 (AC'97) refers to a codec standard developed by Intel® in 1997.
ACPI	Advanced Configuration and Power Interface (ACPI) is an OS-directed configuration, power management, and thermal management interface.
AHCI	Advanced Host Controller Interface (AHCI) is a SATA Host controller register-level interface.
ATA	The Advanced Technology Attachment (ATA) interface connects storage devices including hard disks and CD-ROM drives to a computer.
ARMD	An ATAPI Removable Media Device (ARMD) is any ATAPI device that supports removable media, besides CD and DVD drives.
ASKIR	Amplitude Shift Keyed Infrared (ASKIR) is a form of modulation that represents a digital signal by varying the amplitude (“volume”) of the signal. A low amplitude signal represents a binary 0, while a high amplitude signal represents a binary 1.
BIOS	The Basic Input/Output System (BIOS) is firmware that is first run when the computer is turned on and can be configured by the end user
CODEC	The Compressor-Decompressor (CODEC) encodes and decodes digital audio data on the system.
CompactFlash®	CompactFlash® is a solid-state storage device. CompactFlash® devices use flash memory in a standard size enclosure. Type II is thicker than Type I, but a Type II slot can support both types.
CMOS	Complimentary metal-oxide-conductor is an integrated circuit used in chips like static RAM and microprocessors.
COM	COM refers to serial ports. Serial ports offer serial communication to expansion devices. The serial port on a personal computer is usually a male DB-9 connector.
DAC	The Digital-to-Analog Converter (DAC) converts digital signals to analog signals.
DDR	Double Data Rate refers to a data bus transferring data on both the rising and falling edges of the clock signal.

DMA	Direct Memory Access (DMA) enables some peripheral devices to bypass the system processor and communicate directly with the system memory.
DIMM	Dual Inline Memory Modules are a type of RAM that offer a 64-bit data bus and have separate electrical contacts on each side of the module.
DIO	The digital inputs and digital outputs are general control signals that control the on/off circuit of external devices or TTL devices. Data can be read or written to the selected address to enable the DIO functions.
EHCI	The Enhanced Host Controller Interface (EHCI) specification is a register-level interface description for USB 2.0 Host Controllers.
EIDE	Enhanced IDE (EIDE) is a newer IDE interface standard that has data transfer rates between 4.0 MBps and 16.6 MBps.
EIST	Enhanced Intel® SpeedStep Technology (EIST) allows users to modify the power consumption levels and processor performance through application software. The application software changes the bus-to-core frequency ratio and the processor core voltage.
FSB	The Front Side Bus (FSB) is the bi-directional communication channel between the processor and the Northbridge chipset.
GbE	Gigabit Ethernet (GbE) is an Ethernet version that transfers data at 1.0 Gbps and complies with the IEEE 802.3-2005 standard.
GPIO	General purpose input
HDD	Hard disk drive (HDD) is a type of magnetic, non-volatile computer storage device that stores digitally encoded data.
ICH	The Input/Output Control Hub (ICH) is an Intel® Southbridge chipset.
IrDA	Infrared Data Association (IrDA) specify infrared data transmission protocols used to enable electronic devices to wirelessly communicate with each other.
L1 Cache	The Level 1 Cache (L1 Cache) is a small memory cache built into the system processor.
L2 Cache	The Level 2 Cache (L2 Cache) is an external processor memory cache.

KINO-PV-D5252/D4252 Mini ITX SBC

LCD	Liquid crystal display (LCD) is a flat, low-power display device that consists of two polarizing plates with a liquid crystal panel in between.
LVDS	Low-voltage differential signaling (LVDS) is a dual-wire, high-speed differential electrical signaling system commonly used to connect LCD displays to a computer.
POST	The Power-on Self Test (POST) is the pre-boot actions the system performs when the system is turned-on.
RAM	Random Access Memory (RAM) is volatile memory that loses data when power is lost. RAM has very fast data transfer rates compared to other storage like hard drives.
SATA	Serial ATA (SATA) is a serial communications bus designed for data transfers between storage devices and the computer chipsets. The SATA bus has transfer speeds up to 1.5 Gbps and the SATA II bus has data transfer speeds of up to 3.0 Gbps.
S.M.A.R.T	Self Monitoring Analysis and Reporting Technology (S.M.A.R.T) refers to automatic status checking technology implemented on hard disk drives.
UART	Universal Asynchronous Receiver-transmitter (UART) is responsible for asynchronous communications on the system and manages the system's serial communication (COM) ports.
UHCI	The Universal Host Controller Interface (UHCI) specification is a register-level interface description for USB 1.1 Host Controllers.
USB	The Universal Serial Bus (USB) is an external bus standard for interfacing devices. USB 1.1 supports 12Mbps data transfer rates and USB 2.0 supports 480Mbps data transfer rates.
VGA	The Video Graphics Array (VGA) is a graphics display system developed by IBM.

Appendix

D

Digital I/O Interface

D.1 Introduction

The DIO connector on the KINO-PV-D5252/D4252 is interfaced to GPIO ports on the Super I/O chipset. The DIO has both 4-bit digital inputs and 4-bit digital outputs. The digital inputs and digital outputs are generally control signals that control the on/off circuit of external devices or TTL devices. Data can be read or written to the selected address to enable the DIO functions.



NOTE:

For further information, please refer to the datasheet for the Super I/O chipset.

D.2 DIO Connector Pinouts

The following table describes how the DIO connector pins are connected to the Super I/O GPIO port 1.

Pin	Description	Pin	Description
1	Ground	N/A	N/A
2	VCC	N/A	N/A
3	Output 3	GP27	General purpose I/O port 5 bit 7.
4	Output 2	GP26	General purpose I/O port 5 bit 6.
5	Output 1	GP25	General purpose I/O port 5 bit 5.
6	Output 0	GP24	General purpose I/O port 5 bit 4.
7	Input 3	GP23	General purpose I/O port 5 bit 3.
8	Input 2	GP22	General purpose I/O port 5 bit 2.
9	Input 1	GP21	General purpose I/O port 5 bit 1.
10	Input 0	GP20	General purpose I/O port 5 bit 0.

Table D-1: Digital I/O Connector Pinouts

D.3 Assembly Language Samples

D.3.1 Enable the DIO Input Function

The BIOS interrupt call INT 15H controls the digital I/O. An assembly program to enable digital I/O input functions is listed below.

MOV	AX, 6F08H	Sets the digital port as input
INT	15H	Initiates the INT 15H BIOS call

D.3.2 Enable the DIO Output Function

The BIOS interrupt call INT 15H controls the digital I/O. An assembly program to enable digital I/O output functions is listed below.

MOV	AX, 6F09H	Sets the digital port as output
MOV	BL, 09H	
INT	15H	Initiates the INT 15H BIOS call

Appendix

E

Watchdog Timer

**NOTE:**

The following discussion applies to DOS. Contact IEI support or visit the IEI website for drivers for other operating systems.

The Watchdog Timer is a hardware-based timer that attempts to restart the system when it stops working. The system may stop working because of external EMI or software bugs. The Watchdog Timer ensures that standalone systems like ATMs will automatically attempt to restart in the case of system problems.

A BIOS function call (INT 15H) is used to control the Watchdog Timer.

INT 15H:

AH – 6FH Sub-function:

AL – 2:	Sets the Watchdog Timer's period.
---------	-----------------------------------

AH – 6FH Sub-function:	
BL:	Time-out value (Its unit-second is dependent on the item “Watchdog Timer unit select” in CMOS setup).

Table E-1: AH-6FH Sub-function

Call sub-function 2 to set the time-out period of Watchdog Timer first. If the time-out value is not zero, the Watchdog Timer starts counting down. When the timer value reaches zero, the system resets. To ensure that this reset condition does not occur, calling sub-function 2 must periodically refresh the Watchdog Timer. However, the watchdog timer is disabled if the time-out value is set to zero.

A tolerance of at least 10% must be maintained to avoid unknown routines within the operating system (DOS), such as disk I/O that can be very time-consuming.

NOTE:

The Watchdog Timer is activated through software. The software application that activates the Watchdog Timer must also deactivate it when closed. If the Watchdog Timer is not deactivated, the system will automatically restart after the Timer has finished its countdown.

EXAMPLE PROGRAM:

```
; INITIAL TIMER PERIOD COUNTER
```

```
;
```

```
W_LOOP:
```

```
;
```

```

MOV      AX, 6F02H      ;setting the time-out value
MOV      BL, 30         ;time-out value is 48 seconds
INT      15H

```

```
;
```

```
; ADD THE APPLICATION PROGRAM HERE
```

```
;
```

KINO-PV-D5252/D4252 Mini ITX SBC

```
    CMP     EXIT_AP, 1      ;is the application over?
    JNE     W_LOOP         ;No, restart the application

    MOV     AX, 6F02H      ;disable Watchdog Timer
    MOV     BL, 0          ;
    INT     15H

;
; EXIT ;
```



Appendix

F

Hazardous Materials Disclosure

F.1 Hazardous Materials Disclosure Table for IPB Products Certified as RoHS Compliant Under 2002/95/EC Without Mercury

The details provided in this appendix are to ensure that the product is compliant with the Peoples Republic of China (China) RoHS standards. The table below acknowledges the presences of small quantities of certain materials in the product, and is applicable to China RoHS only.

A label will be placed on each product to indicate the estimated “Environmentally Friendly Use Period” (EFUP). This is an estimate of the number of years that these substances would “not leak out or undergo abrupt change.” This product may contain replaceable sub-assemblies/components which have a shorter EFUP such as batteries and lamps. These components will be separately marked.

Please refer to the table on the next page.

Part Name	Toxic or Hazardous Substances and Elements					
	Lead (Pb)	Mercury (Hg)	Cadmium (Cd)	Hexavalent Chromium (CR(VI))	Polybrominated Biphenyls (PBB)	Polybrominated Diphenyl Ethers (PBDE)
Housing	X	O	O	O	O	X
Display	X	O	O	O	O	X
Printed Circuit Board	X	O	O	O	O	X
Metal Fasteners	X	O	O	O	O	O
Cable Assembly	X	O	O	O	O	X
Fan Assembly	X	O	O	O	O	X
Power Supply Assemblies	X	O	O	O	O	X
Battery	O	O	O	O	O	O

O: This toxic or hazardous substance is contained in all of the homogeneous materials for the part is below the limit requirement in SJ/T11363-2006

X: This toxic or hazardous substance is contained in at least one of the homogeneous materials for this part is above the limit requirement in SJ/T11363-2006

KINO-PV-D5252/D4252 Mini ITX SBC

此附件旨在确保本产品符合中国 RoHS 标准。以下表格标示此产品中某有毒物质的含量符合中国 RoHS 标准规定的限量要求。

本产品上会附有“环境友好使用期限”的标签，此期限是估算这些物质“不会有泄漏或突变”的年限。本产品可能包含有较短的环境友好使用期限的可替换元件，像是电池或灯管，这些元件将会单独标示出来。

部件名称	有毒有害物质或元素					
	铅 (Pb)	汞 (Hg)	镉 (Cd)	六价铬 (CR(VI))	多溴联苯 (PBB)	多溴二苯 醚 (PBDE)
壳体	XXXX	O	O	O	O	XXXX
显示	X	O	O	O	O	X
印刷电路板	X	O	O	O	O	X
金属螺帽	X	O	O	O	O	O
电缆组装	X	O	O	O	O	X
风扇组装	X	O	O	O	O	X
电力供应组装	X	O	O	O	O	X
电池	O	O	O	O	O	O
<p>O: 表示该有毒有害物质在该部件所有物质材料中的含量均在 SJ/T11363-2006 标准规定的限量要求以下。</p> <p>X: 表示该有毒有害物质至少在该部件的某一均质材料中的含量超出 SJ/T11363-2006 标准规定的限量要求。</p>						