

**MODEL:
tKINO-BW**

Mini-ITX SBC with 14nm Intel® Pentium® or Celeron® On-board SoC, VGA, LVDS, HDMI/DP, Dual PCIe GbE, USB 3.0, PCIe Mini, mSATA, PCIe x1, SATA 6Gb/s, RS-232/422/485, Audio, TPM and RoHS

User Manual

Revision

Date	Version	Changes
August 17, 2016	1.01	Changed supported power input voltage from 12 V to 9 V~30V. Added notes regarding the DDR3L 1333 MHz memory module in Section 1.7 and Section 4.3 .
March 18, 2016	1.00	Initial release

Copyright

COPYRIGHT NOTICE

The information in this document is subject to change without prior notice in order to improve reliability, design and function and does not represent a commitment on the part of the manufacturer.

In no event will the manufacturer be liable for direct, indirect, special, incidental, or consequential damages arising out of the use or inability to use the product or documentation, even if advised of the possibility of such damages.

This document contains proprietary information protected by copyright. All rights are reserved. No part of this manual may be reproduced by any mechanical, electronic, or other means in any form without prior written permission of the manufacturer.

TRADEMARKS

All registered trademarks and product names mentioned herein are used for identification purposes only and may be trademarks and/or registered trademarks of their respective owners.

Manual Conventions



WARNING

Warnings appear where overlooked details may cause damage to the equipment or result in personal injury. Warnings should be taken seriously.



CAUTION

Cautionary messages should be heeded to help reduce the chance of losing data or damaging the product.



NOTE

These messages inform the reader of essential but non-critical information. These messages should be read carefully as any directions or instructions contained therein can help avoid making mistakes.



HOT SURFACE

This symbol indicates a hot surface that should not be touched without taking care.

Table of Contents

1 INTRODUCTION.....	1
1.1 INTRODUCTION.....	2
1.2 MODEL VARIATIONS	3
1.3 FEATURES.....	3
1.4 CONNECTORS	4
1.5 DIMENSIONS.....	5
1.6 DATA FLOW	6
1.7 TECHNICAL SPECIFICATIONS	7
2 UNPACKING	10
2.1 ANTI-STATIC PRECAUTIONS	11
2.2 UNPACKING PRECAUTIONS.....	11
2.3 PACKING LIST.....	12
2.4 OPTIONAL ITEMS	13
3 CONNECTORS	14
3.1 PERIPHERAL INTERFACE CONNECTORS.....	15
3.1.1 <i>tKINO-BW Layout</i>	15
3.1.2 <i>Peripheral Interface Connectors</i>	16
3.1.3 <i>External Interface Panel Connectors</i>	17
3.2 INTERNAL PERIPHERAL CONNECTORS	18
3.2.1 <i>9 V~ 30 V DC-IN Power Connector</i>	18
3.2.2 <i>Audio Connector</i>	18
3.2.3 <i>Battery Connector</i>	19
3.2.4 <i>Chassis Intrusion Connector</i>	20
3.2.5 <i>Digital I/O Connector</i>	21
3.2.6 <i>Fan Connectors</i>	22
3.2.7 <i>Front Panel Connector</i>	23
3.2.8 <i>I²C Connector</i>	24
3.2.9 <i>Keyboard and Mouse Connector</i>	24
3.2.10 <i>LVDS Backlight Inverter Connector</i>	25

3.2.11 LVDS LCD Connector.....	26
3.2.12 LAN LED Connectors	27
3.2.13 microSD Slot	28
3.2.14 mSATA Module Slot.....	29
3.2.15 PCIe Mini Card Slot	31
3.2.16 PCIe x1 Card Slot	32
3.2.17 RS-232 Serial Port Connector	34
3.2.18 RS-232/422/485 Serial Port Connector.....	35
3.2.19 SATA 6Gb/s Drive Connectors.....	36
3.2.20 SATA Power Connectors	37
3.2.21 SMBus Connector	38
3.2.22 SPI Flash Connector, BIOS.....	38
3.2.23 SPI Flash Connector, EC	39
3.2.24 TPM Connector.....	40
3.2.25 USB Connector	41
3.3 EXTERNAL PERIPHERAL INTERFACE CONNECTOR PANEL	42
3.3.1 Audio Line-out Connector.....	43
3.3.2 HDMI Connector	43
3.3.3 LAN Connectors.....	44
3.3.4 USB Connectors.....	45
3.3.5 VGA Connector	46
4 INSTALLATION	47
4.1 ANTI-STATIC PRECAUTIONS	48
4.2 INSTALLATION CONSIDERATIONS.....	48
4.3 SO-DIMM INSTALLATION	50
4.4 MICROSD CARD INSTALLATION.....	51
4.5 mSATA MODULE INSTALLATION	52
4.5.1 Full-size mSATA Module Installation	52
4.5.2 Half-size mSATA Module Installation.....	54
4.6 PCIe MINI CARD INSTALLATION	56
4.6.1 Full-size PCIe Mini Card Installation	56
4.6.2 Half-size PCIe Mini Card Installation.....	58
4.7 SYSTEM CONFIGURATION.....	60
4.7.1 AT/ATX Mode Select Switch.....	60

tKINO-BW SBC

4.7.2	<i>Clear CMOS Button</i>	61
4.7.3	<i>HDMI/DP Select Switch</i>	62
4.7.4	<i>LVDS Panel Resolution Select Switch</i>	63
4.7.5	<i>LVDS Voltage Select Jumper</i>	64
4.7.6	<i>mSATA and SATA2 Select Jumper</i>	65
4.8	CHASSIS INSTALLATION.....	66
4.8.1	<i>Airflow</i>	66
4.8.2	<i>Motherboard Installation</i>	66
4.9	SATA DRIVE CONNECTION	67
5	BIOS	68
5.1	INTRODUCTION.....	69
5.1.1	<i>Starting Setup</i>	69
5.1.2	<i>Using Setup</i>	69
5.1.3	<i>Getting Help</i>	70
5.1.4	<i>Unable to Reboot after Configuration Changes</i>	70
5.1.5	<i>BIOS Menu Bar</i>	70
5.2	MAIN.....	71
5.3	ADVANCED.....	72
5.3.1	<i>ACPI Settings</i>	73
5.3.2	<i>RTC Wake Settings</i>	74
5.3.3	<i>Trusted Computing</i>	75
5.3.4	<i>CPU Configuration</i>	76
5.3.5	<i>SATA Configuration</i>	77
5.3.6	<i>USB Configuration</i>	78
5.3.7	<i>NVMe Configuration</i>	79
5.3.8	<i>F81866 Super IO Configuration</i>	80
5.3.8.1	<i>Serial Port n Configuration</i>	80
5.3.8.1.1	<i>Serial Port 1 Configuration</i>	81
5.3.8.1.2	<i>Serial Port 2 Configuration</i>	82
5.3.8.1.3	<i>Serial Port 3 Configuration</i>	83
5.3.8.1.4	<i>Serial Port 4 Configuration</i>	84
5.3.8.1.5	<i>Serial Port 5 Configuration</i>	85
5.3.8.1.6	<i>Serial Port 6 Configuration</i>	86
5.3.9	<i>iWDD H/W Monitor</i>	87

5.3.9.1 Smart Fan Mode Configuration	88
5.3.10 Serial Port Console Redirection	91
5.3.10.1 Console Redirection Settings	92
5.3.11 IEI Feature	94
5.4 CHIPSET	95
5.4.1 North Bridge Configuration.....	96
5.4.1.1 Intel IGD Configuration.....	96
5.4.2 South Bridge Configuration.....	99
5.4.2.1 PCI Express Configuration	100
5.5 SECURITY.....	101
5.6 BOOT.....	102
5.7 EXIT	104
6 SOFTWARE DRIVERS	106
6.1 SOFTWARE INSTALLATION	107
6.2 AVAILABLE SOFTWARE DRIVERS	109
A REGULATORY COMPLIANCE	110
B BIOS MENU OPTIONS	112
C TERMINOLOGY	115
D DIGITAL I/O INTERFACE.....	120
D.1 INTRODUCTION.....	121
D.2 ASSEMBLY LANGUAGE SAMPLE 1.....	122
D.3 ASSEMBLY LANGUAGE SAMPLE 2.....	122
E WATCHDOG TIMER.....	123
F HAZARDOUS MATERIALS DISCLOSURE.....	126
F.1 HAZARDOUS MATERIAL DISCLOSURE TABLE FOR IPB PRODUCTS CERTIFIED AS ROHS COMPLIANT UNDER 2002/95/EC WITHOUT MERCURY	127

List of Figures

Figure 1-1: tKINO-BW	2
Figure 1-2: Connectors	4
Figure 1-3: Dimensions (mm)	5
Figure 1-4: Data Flow Diagram	6
Figure 3-1: Connector and Jumper Locations (Front)	15
Figure 3-2: DC-IN Power Connector Location	18
Figure 3-3: Audio Connector Location	19
Figure 3-4: Battery Connector Location	20
Figure 3-5: Chassis Intrusion Connector Location	21
Figure 3-6: Digital I/O Connector Location	21
Figure 3-7: Fan Connector Locations	22
Figure 3-8: Front Panel Connector Location	23
Figure 3-9: I ² C Connector Location	24
Figure 3-10: Keyboard and Mouse Connector Location	25
Figure 3-11: Backlight Inverter Connector Location	26
Figure 3-12: LVDS Connector Location	27
Figure 3-13: LAN LED Connector Locations	28
Figure 3-14: microSD Card Slot Location	29
Figure 3-15: mSATA Module Slot Location	30
Figure 3-16: PCIe Mini Card Slot Location	31
Figure 3-17: PCIe x1 Slot Location	33
Figure 3-18: RS-232 Serial Port Connector Locations	34
Figure 3-19: RS-232/422/485 Connector Locations	35
Figure 3-20: SATA 6Gb/s Drive Connectors Locations	36
Figure 3-21: SATA Power Connector Locations	37
Figure 3-22: SMBUS Connector Location	38
Figure 3-23: SPI Flash Connector Location	39
Figure 3-24: SPI Flash Connector Location	40
Figure 3-25: TPM Connector Location	41
Figure 3-26: USB Connector Location	42
Figure 3-27: External Peripheral Interface Connector	43

Figure 3-28: Audio Line-out Connector.....	43
Figure 3-29: DP/HDMI Connector Pinout Locations.....	44
Figure 3-30: LAN Connector.....	45
Figure 3-31: VGA Connector.....	46
Figure 4-1: SO-DIMM Installation.....	50
Figure 4-2: microSD Card Installation.....	51
Figure 4-3: Removing the Retention Screw.....	52
Figure 4-4: Inserting the Full-size mSATA Module into the Slot at an Angle.....	53
Figure 4-5: Securing the mSATA Module.....	53
Figure 4-6: Removing the Retention Screw.....	54
Figure 4-7: Removing the Standoff.....	54
Figure 4-8: Installing the Standoff.....	55
Figure 4-9: Inserting the Half-size mSATA Module into the Slot at an Angle.....	55
Figure 4-10: Securing the Half-size mSATA Module.....	56
Figure 4-11: Removing the Retention Screws.....	56
Figure 4-12: Inserting the Full-size PCIe Mini Card into the Slot at an Angle.....	57
Figure 4-13: Securing the Full-size PCIe Mini Card.....	57
Figure 4-14: Removing Retention Screw and Standoff.....	58
Figure 4-15: Installing the Standoff.....	59
Figure 4-16: Inserting the Half-size PCIe Mini Card into the Slot at an Angle.....	59
Figure 4-17: Securing the Half-size PCIe Mini Card.....	60
Figure 4-18: AT/ATX Mode Select Switch Location.....	61
Figure 4-19: Clear CMOS Button Location.....	61
Figure 4-20: HDMI/DP Select Switch Location.....	62
Figure 4-21: LVDS Panel Resolution Select Switch Location.....	64
Figure 4-22: LVDS Voltage Select Jumper Location.....	65
Figure 4-23: mSATA and SATA2 Select Jumper Location.....	66
Figure 4-24: SATA Drive Cable Connection.....	67
Figure 6-1: Driver CD Main Menu.....	108
Figure 6-2: Available Drivers.....	108

List of Tables

Table 1-1: tKINO-BW Model Variations.....	3
Table 1-2: Technical Specifications.....	9
Table 3-1: Peripheral Interface Connectors.....	17
Table 3-2: Rear Panel Connectors.....	17
Table 3-3: DC-IN Power Connector Pinouts.....	18
Table 3-4: Audio Connector Pinouts.....	19
Table 3-5: Battery Connector Pinouts.....	20
Table 3-6: Chassis Intrusion Connector Pinouts.....	21
Table 3-7: Digital I/O Connector Pinouts.....	22
Table 3-8: Fan Connector Pinouts.....	22
Table 3-9: Front Panel Connector Pinouts.....	23
Table 3-10: I ² C Connector Pinouts.....	24
Table 3-11: Keyboard and Mouse Connector Pinouts.....	25
Table 3-12: Backlight Inverter Connector Pinouts.....	26
Table 3-13: LVDS Connector Pinouts.....	27
Table 3-14: LAN LED Connector Pinouts.....	28
Table 3-15: mSATA Module Slot Pinouts.....	31
Table 3-16: PCIe Mini Card Slot Pinouts.....	32
Table 3-17: PCIe x1 Slot Pinouts.....	33
Table 3-18: RS-232 Serial Port Connector Pinouts.....	34
Table 3-19: RS-232/422/485 Connector Pinouts.....	35
Table 3-20: DB-9 RS-422/485 Pinouts.....	36
Table 3-21: SATA Power Connector Pinouts.....	37
Table 3-22: SMBUS Connector Pinouts.....	38
Table 3-23: SPI Flash Connector Pinouts.....	39
Table 3-24: SPI Flash Connector Pinouts.....	40
Table 3-25: TPM Connector Pinouts.....	41
Table 3-26: USB Connector Pinouts.....	42
Table 3-27: DP/HDMI Connector Pinouts.....	44
Table 3-28: LAN Pinouts.....	45
Table 3-29: USB 3.0 Port Pinouts.....	45

Table 3-30: VGA Connector Pinouts.....	46
Table 4-1: AT/ATX Mode Select Switch Settings.....	60
Table 4-2: HDMI/DP Select Switch Settings.....	62
Table 4-3: LVDS Panel Resolution Selection.....	63
Table 4-4: LVDS Voltage Select Jumper Settings.....	64
Table 4-5: mSATA and SATA2 Select Jumper Settings.....	65
Table 5-1: BIOS Navigation Keys.....	70

List of BIOS Menus

BIOS Menu 1: Main	71
BIOS Menu 2: Advanced	72
BIOS Menu 3: ACPI Settings	73
BIOS Menu 4: RTC Wake Settings	74
BIOS Menu 5: Trusted Computing	75
BIOS Menu 6: CPU Configuration	76
BIOS Menu 7: SATA Configuration	77
BIOS Menu 8: USB Configuration	78
BIOS Menu 9: NVMe Configuration.....	79
BIOS Menu 10: F81866 Super IO Configuration	80
BIOS Menu 11: Serial Port n Configuration	80
BIOS Menu 12: iWDD H/W Monitor	87
BIOS Menu 13: Smart Fan Mode Configuration	88
BIOS Menu 14: Serial Port Console Redirection	91
BIOS Menu 15: Console Redirection Settings.....	92
BIOS Menu 16: IEI Feature	94
BIOS Menu 17: Chipset	95
BIOS Menu 18: North Bridge Configuration	96
BIOS Menu 19: Intel IGD Configuration.....	97
BIOS Menu 20: South Bridge Configuration.....	99
BIOS Menu 21: PCI Express Configuration	100
BIOS Menu 22: Security	101
BIOS Menu 23: Boot	102
BIOS Menu 24: Exit.....	104

Chapter

1

Introduction

1.1 Introduction

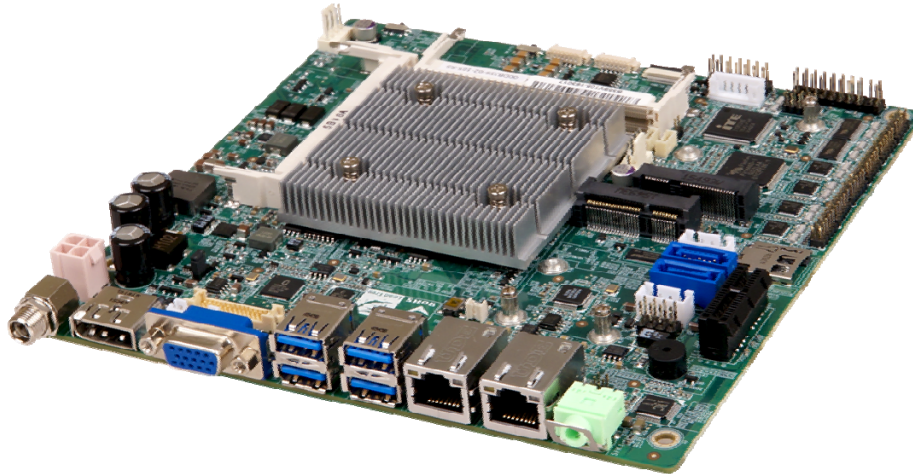

Figure 1-1: tKINO-BW

The tKINO-BW series is a Mini-ITX form factor single board computer. It has an on-board 14nm Intel® Pentium® or Celeron® processor, and supports two 204-pin 1600/1333 MHz single-channel unbuffered DDR3 Low Voltage (DDR3L) SDRAM SO-DIMM slots with up to 8.0 GB of memory.

The tKINO-BW series includes a VGA connector, a HDMI/DisplayPort connector and an 18-/24-bit LVDS connector for triple independent display.

Expansion and I/O include one PCIe x1 slot, one PCIe Mini slot supporting mSATA modules, one PCIe Mini slot for expansion, four USB 3.0 connectors on the rear panel, two USB 2.0 connectors by pin header and two SATA 6Gb/s connectors. Serial device connectivity is provided by four internal RS-232 connectors and two internal RS-232/422/485 connectors. Two RJ-45 GbE connectors provide the system with smooth connections to an external LAN.

1.2 Model Variations

The model variations of the tKINO-BW series are listed below.

Model No.	SoC
tKINO-BW-N4-R10	Intel® Pentium® N3710 on-board SoC (2.56 GHz, quad-core, 2 MB cache, TDP=6 W)
tKINO-BW-N3-R10	Intel® Celeron® N3160 on-board SoC (2.24 GHz, quad-core, 2 MB cache, TDP=6 W)
tKINO-BW-N2-R10	Intel® Celeron® N3060 on-board SoC (2.48 GHz, dual-core, 2 MB cache, TDP=6 W)
tKINO-BW-N1-R10*	Intel® Celeron® N3010 on-board SoC (2.24 GHz, dual-core, 2 MB cache, TDP=4 W)
*By order production, MOQ 100	

Table 1-1: tKINO-BW Model Variations

1.3 Features

Some of the tKINO-BW motherboard features are listed below:

- Thin Mini-ITX motherboard supports 14nm Intel® Pentium®/Celeron® on-board SoC
- Triple independent display supporting 4K resolution
- Two 1600/1333 MHz DDR3L SO-DIMM slots support up to 8 GB of memory
- Two SATA 6Gb/s connectors with 5 V / 12 V power output
- 9 V ~ 30 V wide voltage power input
- Four USB 3.0 external connectors
- Four RS-232 connectors and two RS-232/422/485 connectors
- One microSD card socket on board
- Full-size/half-size PCIe Mini card slots for expansion
- Support mSATA modules
- IEI One Key Recovery solution allows you to create rapid OS backup and recovery

1.4 Connectors

The connectors on the tKINO-BW are shown in the figure below.

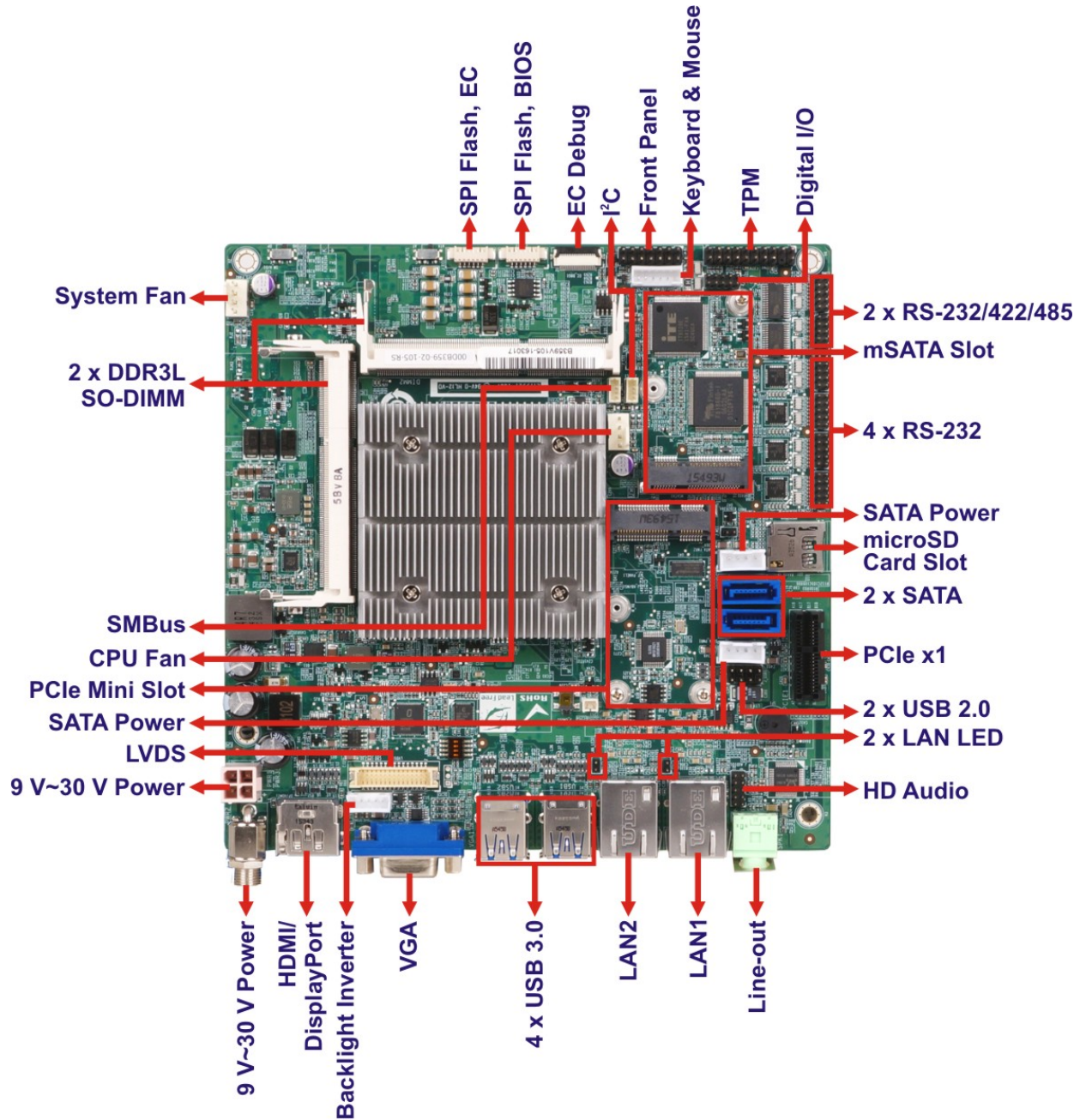

Figure 1-2: Connectors

tKINO-BW SBC

1.5 Dimensions

The dimensions of the board are listed below:

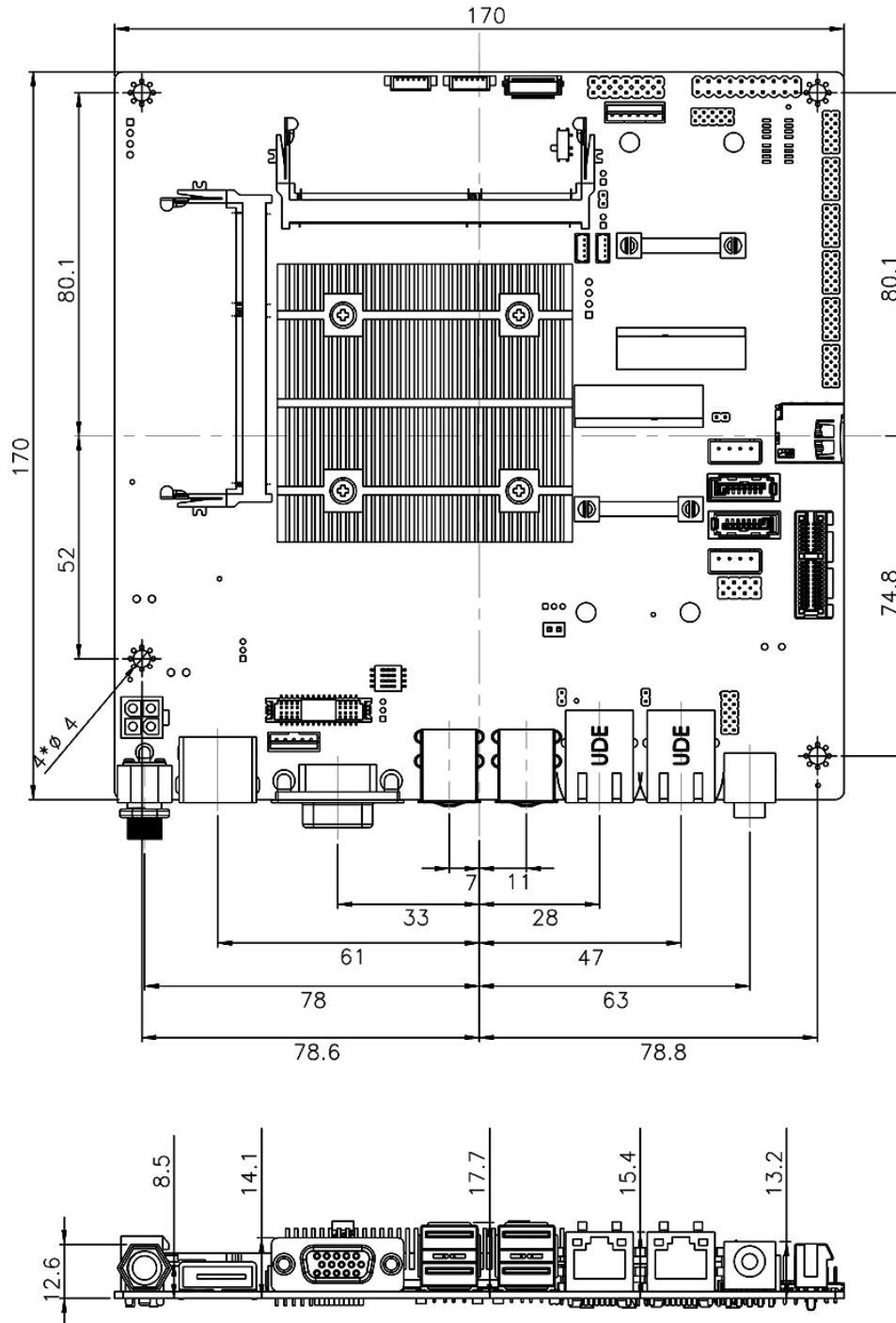

Figure 1-3: Dimensions (mm)

1.6 Data Flow

Figure 1-4 shows the data flow between the system chipset, the CPU and other components installed on the motherboard.

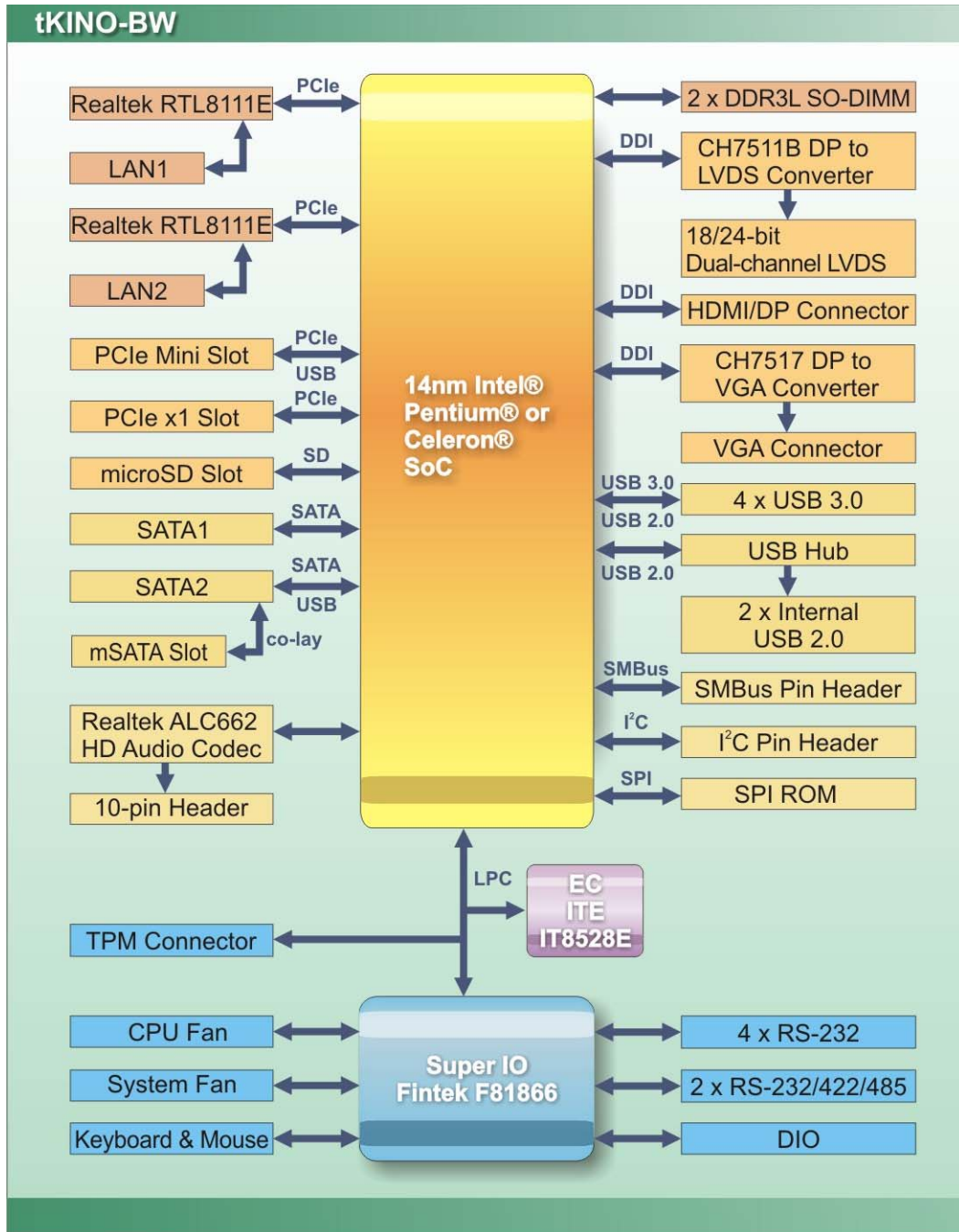

Figure 1-4: Data Flow Diagram

1.7 Technical Specifications

tKINO-BW technical specifications are listed below.

Specification	tKINO-BW
SoC	<p>Intel® Pentium® N3710 on-board SoC (2.56 GHz, quad-core, 2 MB cache, TDP=6 W)</p> <p>Intel® Celeron® N3160 on-board SoC (2.24 GHz, quad-core, 2 MB cache, TDP=6 W)</p> <p>Intel® Celeron® N3060 on-board SoC (2.48 GHz, dual-core, 2 MB cache, TDP=6 W)</p> <p>Intel® Celeron® N3010 on-board SoC (2.24 GHz, dual-core, 2 MB cache, TDP=4 W)</p>
BIOS	AMI UEFI BIOS
Memory	<p>Two 204-pin 1600/1333* MHz single-channel DDR3L SDRAM unbuffered SO-DIMM slots (system max. 8 GB)</p> <p><i>* DDR3L 1333 MHz operation will be downgraded to 1066 MHz due to Intel® SoC limitation.</i></p>
Graphics	8 th generation Intel® HD Graphics with 16 low-power execution units, supporting DX11.1, OpenGL 4.2 and OpenCL1.2
Display Output	<p>Triple independent display</p> <p>1 x HDMI/DisplayPort (up to 3840x2160 @ 30Hz)</p> <p>1 x 18/24-bit dual-channel LVDS by CH7511B DP to LVDS converter (up to 1920x1200 @ 60Hz)</p> <p>1 x VGA by CH7517 DP to VGA converter (up to 1920x1200 @ 60Hz)</p>
Ethernet	Dual Realtek RTL8111E PCIe GbE controller
Digital I/O	8-bit digital I/O by 10-pin (2x5) header
Super IO	Fintek F81866D-I
Embedded Controller	ITE IT8528E

Specification	tKINO-BW
Audio	Realtek ALC662 HD codec
Watchdog Timer	Software programmable support 1~255 sec. system reset
I/O Interface	
Audio Connector	1 x Audio line-out jack 1 x Analog audio by 10-pin (2x5) header
Ethernet	2 x RJ-45 GbE port
Keyboard/Mouse	1 x KB/MS by 6-pin (1x6) wafer
Serial Ports	2 x RS-232/422/485 by 10-pin (2x5) header 4 x RS-232 by 10-pin (2x5) header
USB Ports	4 x USB 3.0 on rear I/O 2 x USB 2.0 by 8-pin (2x4) header
Front Panel	1 x Front panel connector by 14-pin (2x7) header for power LED, HDD LED, speaker, power button and reset button
LAN LED	2 x LAN link LED connector by 2-pin header
Fan	1 x CPU smart fan connector by 4-pin (1x4) wafer 1 x System smart fan connector by 4-pin (1x4) wafer
SMBus	1 x SMBus connector by 4-pin (1x4) wafer
I²C	1 x I ² C connector by 4-pin (1x4) wafer
TPM	1 x TPM connector by 20-pin (2x10) header
Storage	2 x SATA 6Gb/s with 5 V / 12 V SATA power connectors 1 x mSATA slot (full-size/half-size PCIe Mini) colay SATA2 1 x microSD socket
Expansion	1 x Full-size/Half-size PCIe Mini card slot 1 x PCIe x1 slot
Environmental and Power Specifications	
Power Supply	9 V ~ 30 V DC input (AT/ATX support)
Power Connector	1 x External DC power jack (ø5.5 mm) 1 x Internal power connector by 4-pin (2x2) connector

tKINO-BW SBC

Specification	tKINO-BW
Power Consumption	+12 V @ 1.33 A (Intel® Celeron® processor N3060 with 4 GB 1600 MHz DDR3L memory)
Operating Temperature	-20°C ~ 60°C
Storage Temperature	-30°C ~ 70°C
Humidity	5% ~ 95%, non-condensing
Physical Specifications	
Dimensions	170 mm x 170 mm
Weight GW/NW	900 g / 400 g

Table 1-2: Technical Specifications

Chapter

2

Unpacking

2.1 Anti-static Precautions



WARNING!

Static electricity can destroy certain electronics. Make sure to follow the ESD precautions to prevent damage to the product, and injury to the user.

Make sure to adhere to the following guidelines:

- **Wear an anti-static wristband:** Wearing an anti-static wristband can prevent electrostatic discharge.
- **Self-grounding:** Touch a grounded conductor every few minutes to discharge any excess static buildup.
- **Use an anti-static pad:** When configuring any circuit board, place it on an anti-static mat.
- **Only handle the edges of the PCB:** Don't touch the surface of the motherboard. Hold the motherboard by the edges when handling.

2.2 Unpacking Precautions

When the tKINO-BW is unpacked, please do the following:

- Follow the antistatic guidelines above.
- Make sure the packing box is facing upwards when opening.
- Make sure all the packing list items are present.







2.3 Packing List

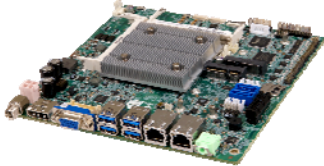

NOTE:



If any of the components listed in the checklist below are missing, do not proceed with the installation. Contact the IEI reseller or vendor the tKINO-BW was purchased from or contact an IEI sales representative directly by sending an email to sales@ieiworld.com.

The tKINO-BW is shipped with the following components:

Quantity	Item and Part Number	Image
1	tKINO-BW single board computer	
1	SATA with 5V/12V output cable kit (P/N: 32801-000100-300-RS)	
1	I/O shielding (P/N: 45014-0058C0-00-RS)	
1	Utility CD	
1	One Key Recovery CD	
1	Quick Installation Guide	

2.4 Optional Items

The following are optional components which may be separately purchased:

Item and Part Number	Image
RS-232 cable, 200mm, P=2.0 (P/N: 32205-002700-100-RS)	
RS-232 & RS-422/485 cable, 230mm, P=2.0 (P/N: 32205-003700-100-RS)	
Infineon TPM module, 20-pin, firmware v3.17 (P/N: TPM-IN01-R11)	

Chapter

3

Connectors

tKINO-BW SBC

3.1 Peripheral Interface Connectors

This chapter details all the jumpers and connectors.

3.1.1 tKINO-BW Layout

The figures below show all the connectors and jumpers.

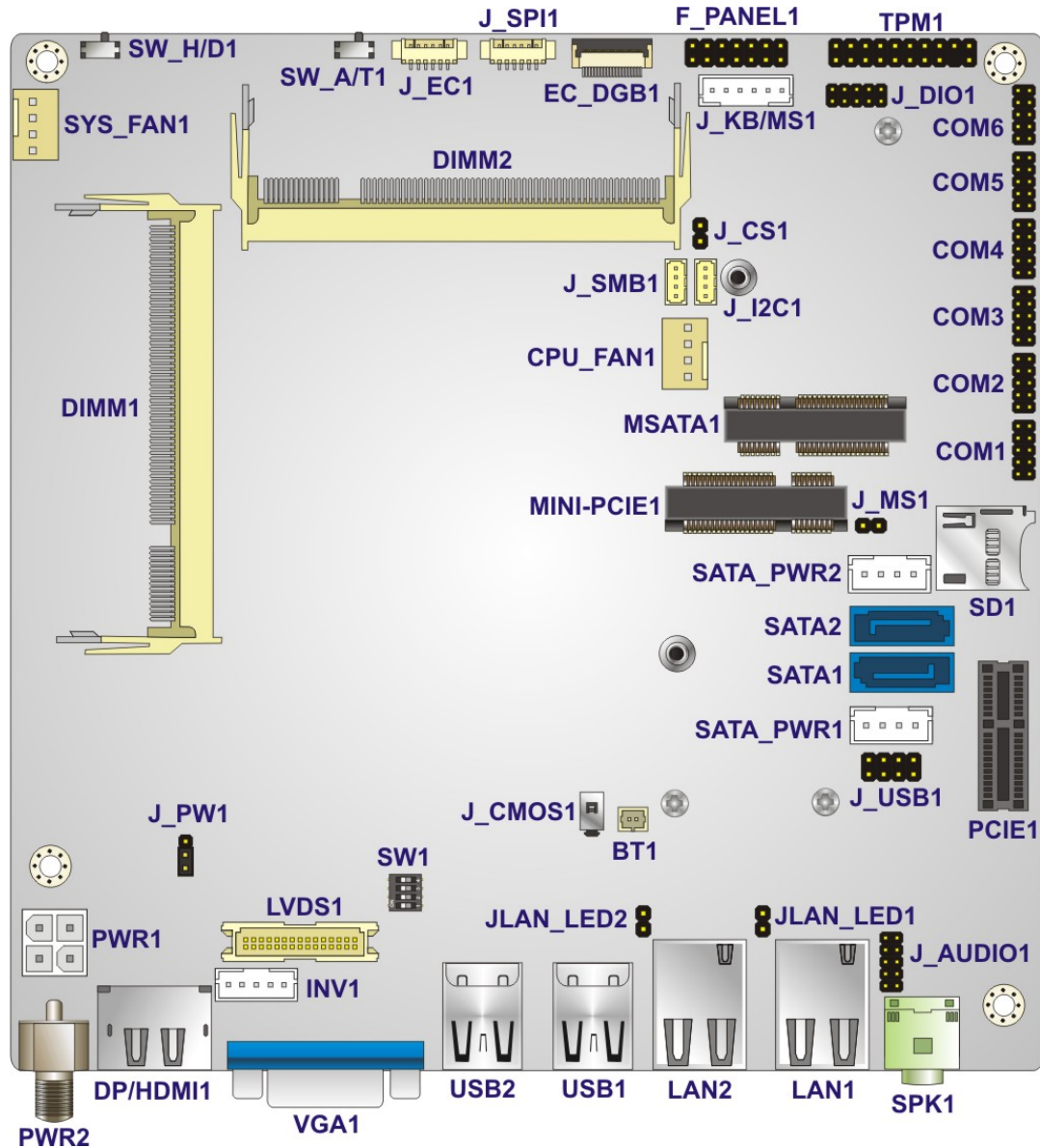

Figure 3-1: Connector and Jumper Locations (Front)

3.1.2 Peripheral Interface Connectors

The table below lists all the connectors on the board.

Connector	Type	Label
9 V~ 30 V DC-IN power connector	4-pin Molex	PWR1
Audio connector	10-pin header	J_AUDIO1
Battery connector	2-pin wafer	BT1
Chassis intrusion connector	2-pin header	J_CS1
Digital I/O connector	10-pin header	J_DIO1
EC debug card connector	20-pin FPC	EC_DBG1
Fan connector, CPU	4-pin wafer	CPU_FAN1
Fan connector, system	4-pin wafer	SYS_FAN1
Front panel connector	14-pin header	F_PANEL1
I ² C connector	4-pin wafer	J_I2C1
Keyboard & mouse connector	6-pin wafer	J_KB/MS1
LCD backlight inverter connector	5-pin wafer	INV1
LVDS LCD connector	30-pin crimp	LVDS1
LAN LED connectors	2-pin header	JLAN_LED1, JLAN_LED2
Memory slot	204-pin DDR3L SO-DIMM	DIMM1, DIMM2
microSD slot	microSD slot	SD1
mSATA module slot	PCIe Mini slot	MSATA1
PCIe Mini card slot	PCIe Mini slot	MINI-PCIE1
PCIe x1 slot	PCIe x1 slot	PCIE1

tKINO-BW SBC

RS-232 serial port connectors	10-pin header	COM1, COM2, COM3, COM4
RS-232/422/485 serial port connectors	10-pin header	COM5, COM6
SATA 6Gb/s drive connectors	7-pin SATA connector	SATA1, SATA2
SATA power connectors	4-pin wafer	SATA_PWR1, SATA_PWR2
SMBus connector	4-pin wafer	J_SMB1
SPI flash connector, BIOS	6-pin wafer	J_SPI1
SPI flash connector, EC	6-pin wafer	J_EC1
TPM connector	20-pin header	TPM1
USB 2.0 connector	8-pin header	J_USB1

Table 3-1: Peripheral Interface Connectors

3.1.3 External Interface Panel Connectors

The table below lists the connectors on the external I/O panel.

Connector	Type	Label
9 V~ 30 V DC-IN power jack	Power jack	PWR2
Audio line-out connector	Audio jack	SPK1
LAN connectors	RJ-45	LAN1, LAN2
HDMI and DisplayPort connector	HDMI	DP/HDMI1
USB 3.0 connectors	USB 3.0	USB1, USB2
VGA Connector	15-pin female	VGA1

Table 3-2: Rear Panel Connectors

3.2 Internal Peripheral Connectors

The section describes all of the connectors on the tKINO-BW.

3.2.1 9 V~ 30 V DC-IN Power Connector

- CN Label:** PWR1
- CN Type:** 4-pin Molex, p=4.2 mm
- CN Location:** See **Figure 3-2**
- CN Pinouts:** See **Table 3-3**

The connector supports the 9 V ~ 30 V power supply.

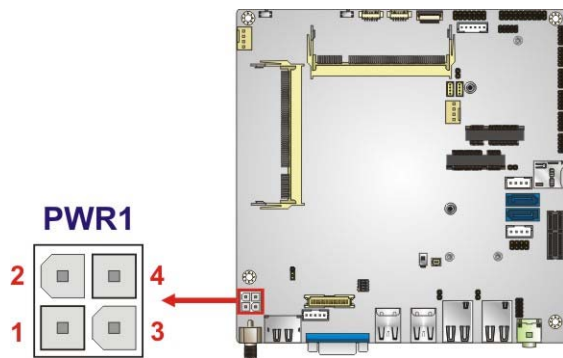

Figure 3-2: DC-IN Power Connector Location

PIN NO.	DESCRIPTION	PIN NO.	DESCRIPTION
1	GND	2	GND
3	VCC	4	VCC

Table 3-3: DC-IN Power Connector Pinouts

3.2.2 Audio Connector

- CN Label:** J_AUDIO1
- CN Type:** 10-pin header, p=2.00 mm
- CN Location:** See **Figure 3-3**
- CN Pinouts:** See **Table 3-4**

tKINO-BW SBC

The audio connector is connected to external audio devices including speakers and microphones for the input and output of audio signals to and from the system.

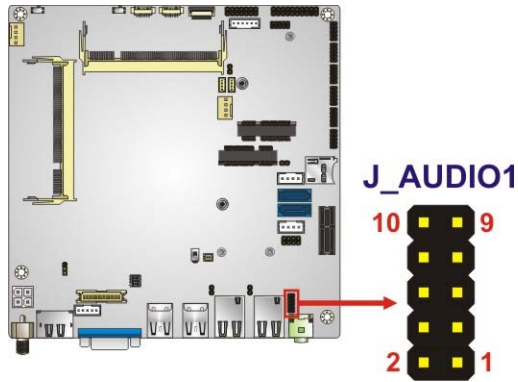

Figure 3-3: Audio Connector Location

PIN NO.	DESCRIPTION	PIN NO.	DESCRIPTION
1	LINEOUT1R	2	LINEIN-R
3	GND	4	GND
5	LINEOUT1L	6	LINEIN-L
7	GND	8	GND
9	MIC-R	10	MIC-L

Table 3-4: Audio Connector Pinouts

3.2.3 Battery Connector



CAUTION:

Risk of explosion if battery is replaced by an incorrect type. Only certified engineers should replace the on-board battery.

Dispose of used batteries according to instructions and local regulations.

- CN Label:** BT1
- CN Type:** 2-pin wafer, p=1.25 mm
- CN Location:** See **Figure 3-4**
- CN Pinouts:** See **Table 3-5**

The battery connector is connected to the system battery. The battery provides power to the system clock to retain the time when power is turned off.

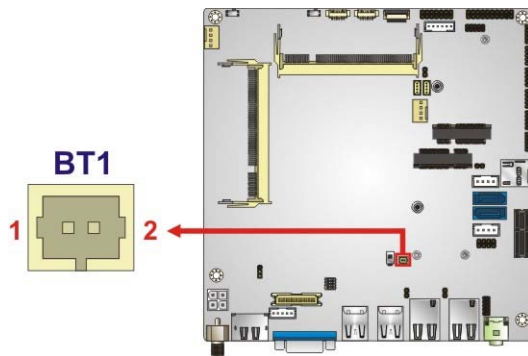

Figure 3-4: Battery Connector Location

Pin	Description
1	VBAT+
2	GND

Table 3-5: Battery Connector Pinouts

3.2.4 Chassis Intrusion Connector

- CN Label:** J_CS1
- CN Type:** 2-pin header, p=2.00 mm
- CN Location:** See **Figure 3-5**
- CN Pinouts:** See **Table 3-6**

The chassis intrusion connector is for a chassis intrusion detection sensor or switch that detects if a chassis component is removed or replaced.

tKINO-BW SBC

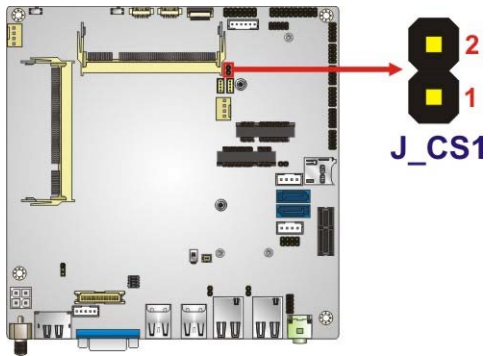

Figure 3-5: Chassis Intrusion Connector Location

Pin	Description
1	+V3.3A_EC
2	CHASSIS_EC

Table 3-6: Chassis Intrusion Connector Pinouts

3.2.5 Digital I/O Connector

- CN Label:** J_DIO1
- CN Type:** 10-pin header, p=2.00 mm
- CN Location:** See Figure 3-6
- CN Pinouts:** See Table 3-7

The 8-bit digital I/O connector provides programmable input and output for external devices.

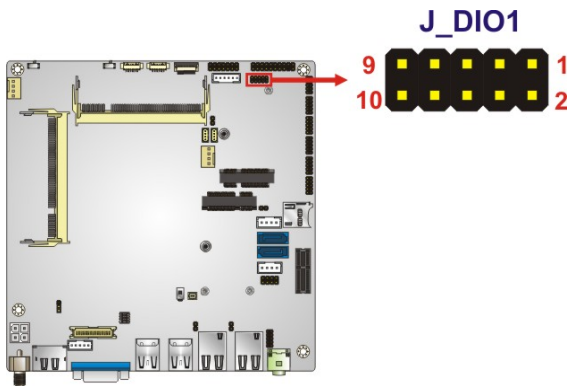

Figure 3-6: Digital I/O Connector Location

PIN NO.	DESCRIPTION	PIN NO.	DESCRIPTION
1	GND	2	VCC5V
3	DOUT3	4	DOUT2
5	DOUT1	6	DOUT0
7	DIN3	8	DIN2
9	DIN1	10	DINO

Table 3-7: Digital I/O Connector Pinouts

3.2.6 Fan Connectors

CN Label: CPU_FAN1, SYS_FAN1

CN Type: 4-pin wafer, p=2.54 mm

CN Location: See **Figure 3-7**

CN Pinouts: See **Table 3-8**

The fan connector attaches to a cooling fan.

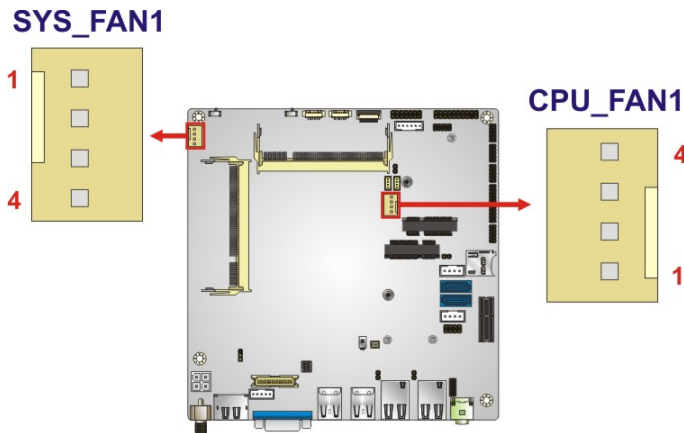

Figure 3-7: Fan Connector Locations

Pin	Description
1	GND
2	VCC12V
3	FANIO
4	PWM

Table 3-8: Fan Connector Pinouts

tKINO-BW SBC

3.2.7 Front Panel Connector

- CN Label:** F_PANEL1
- CN Type:** 14-pin header, p=2.54 mm
- CN Location:** See Figure 3-8
- CN Pinouts:** See Table 3-9

The front panel connector connects to the indicator LEDs, buttons and speaker on the system front panel.

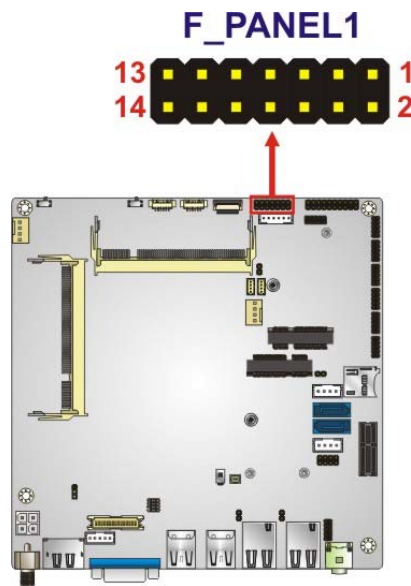

Figure 3-8: Front Panel Connector Location

PIN NO.	DESCRIPTION	PIN NO.	DESCRIPTION
1	PWR_LED+	2	SPKR+
3	NC	4	NC
5	PWR_LED-	6	NC
7	PWR_BTN+	8	SPKR-
9	PWR_BTN-	10	NC
11	HDD_LED+	12	RESET+
13	HDD_LED-	14	RESET-

Table 3-9: Front Panel Connector Pinouts

3.2.8 I²C Connector

- CN Label:** J_I2C1
- CN Type:** 4-pin wafer, p=1.25 mm
- CN Location:** See **Figure 3-9**
- CN Pinouts:** See **Table 3-10**

The I²C connector is used to connect I²C-bus devices to the main board.

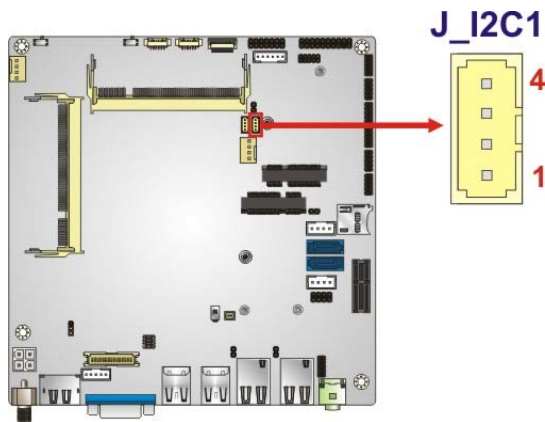

Figure 3-9: I²C Connector Location

Pin	Description
1	GND
2	I ² C _DATA
3	I ² C _CLK
4	+5V

Table 3-10: I²C Connector Pinouts

3.2.9 Keyboard and Mouse Connector

- CN Label:** J_KB/MS1
- CN Type:** 6-pin wafer, p=2.00 mm
- CN Location:** See **Figure 3-10**
- CN Pinouts:** See **Table 3-11**

tKINO-BW SBC

The keyboard/mouse connector connects to a PS/2 Y-cable that can be connected to a PS/2 keyboard and mouse.

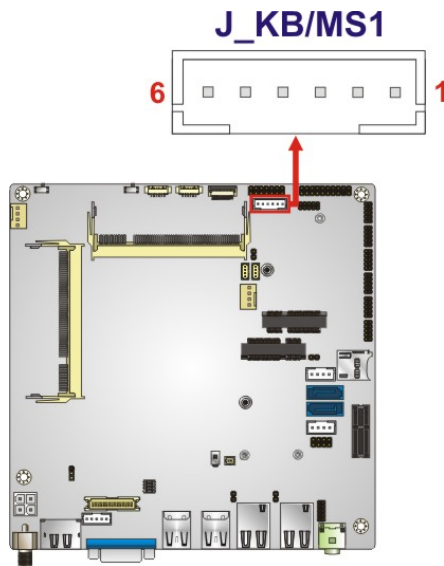

Figure 3-10: Keyboard and Mouse Connector Location

Pin	Description
1	VCC5V
2	Mouse Data
3	Mouse Clock
4	Keyboard Data
5	Keyboard Clock
6	GND

Table 3-11: Keyboard and Mouse Connector Pinouts

3.2.10 LVDS Backlight Inverter Connector

- CN Label:** INV1
- CN Type:** 5-pin wafer, p=2.00 mm
- CN Location:** See Figure 3-11
- CN Pinouts:** See Table 3-12

The backlight inverter connector provides power to an LCD panel.

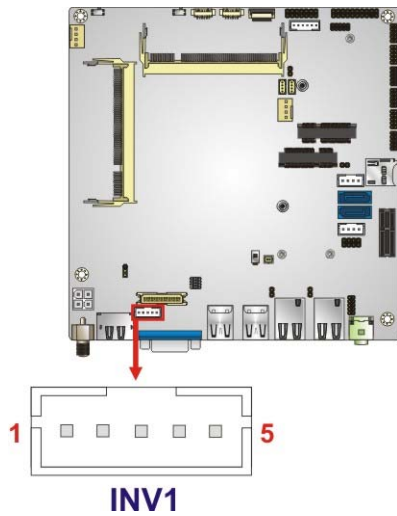

Figure 3-11: Backlight Inverter Connector Location

Pin	Description
1	LCD_ADJ
2	GND
3	VCC12V
4	GND
5	BL_ON/OFF

Table 3-12: Backlight Inverter Connector Pinouts

3.2.11 LVDS LCD Connector

- CN Label:** LVDS1
- CN Type:** 30-pin crimp, p=1.25 mm
- CN Location:** See **Figure 3-12**
- CN Pinouts:** See **Table 3-13**

The LVDS connector is for an LCD panel connected to the board.

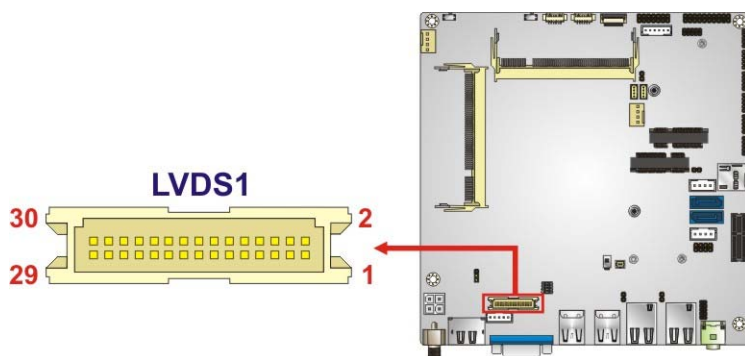

Figure 3-12: LVDS Connector Location

Pin	Description	Pin	Description
1	GROUND	2	GROUND
3	LVDS_A_TX0-P	4	LVDS_A_TX0-N
5	LVDS_A_TX1-P	6	LVDS_A_TX1-N
7	LVDS_A_TX2-P	8	LVDS_A_TX2-N
9	LVDS_A_TXCLK-P	10	LVDS_A_TXCLK-N
11	LVDS_A_TX3-P	12	LVDS_A_TX3-N
13	GROUND	14	GROUND
15	LVDS_B_TX0-P	16	LVDS_B_TX0-N
17	LVDS_B_TX1-P	18	LVDS_B_TX1-N
19	LVDS_B_TX2-P	20	LVDS_B_TX2-N
21	LVDS_B_TXCLK-P	22	LVDS_B_TXCLK-N
23	LVDS_B_TX3-P	24	LVDS_B_TX3-N
25	GROUND	26	GROUND
27	+LCD VCC	28	+LCD VCC
29	+LCD VCC	30	+LCD VCC

Table 3-13: LVDS Connector Pinouts

3.2.12 LAN LED Connectors

CN Label: JLAN_LED1, JLAN_LED2

CN Type: 2-pin header, p=2.00 mm

CN Location: See Figure 3-13

CN Pinouts: See Table 3-14

The LAN LED connectors connect to the LAN link LEDs on the system.

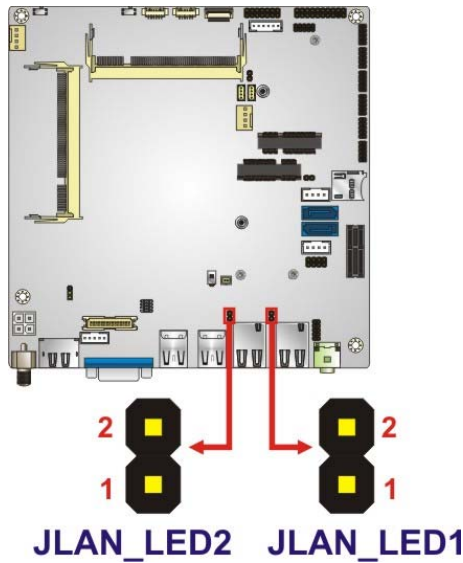

Figure 3-13: LAN LED Connector Locations

Pin	Description
1	+3.3VLAN
2	LAN_LED_LINK#

Table 3-14: LAN LED Connector Pinouts

3.2.13 microSD Slot

- CN Label:** SD1
- CN Type:** microSD card slot
- CN Location:** See **Figure 3-14**

The microSD card slot accepts a microSD card for storage.

tKINO-BW SBC

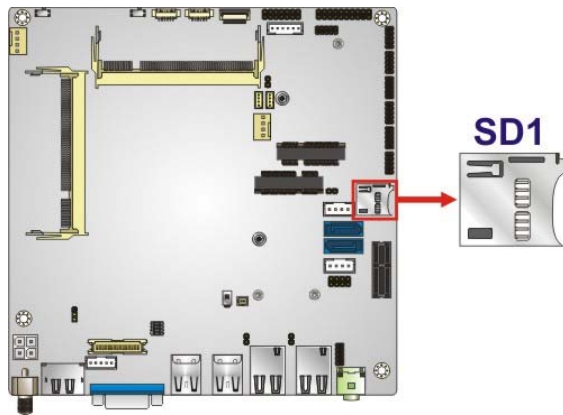

Figure 3-14: microSD Card Slot Location

3.2.14 mSATA Module Slot



CAUTION:

If an mSATA module is installed in the mSATA slot (MSATA1), the SATA port 2 (SATA2) will be disabled. Choose either the SATA2 connector or the mSATA module for storage.

CN Label:	MSATA1
CN Type:	Half-size/Full-size PCIe Mini card slot
CN Location:	See Figure 3-15
CN Pinouts:	See Table 3-15

The PCIe Mini card slot supports mSATA modules or PCIe Mini cards with USB interface.

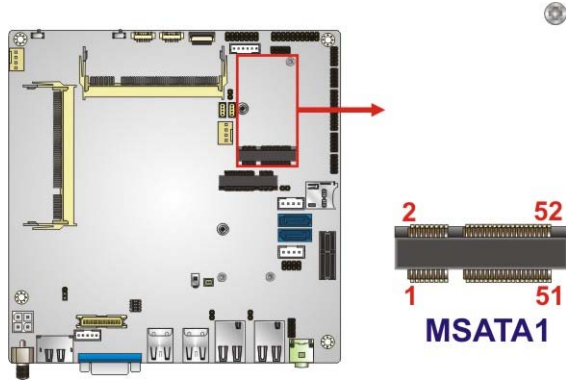

Figure 3-15: mSATA Module Slot Location

Pin	Description	Pin	Description
1	N/C	2	VCC3
3	N/C	4	GND
5	N/C	6	1.5 V
7	N/C	8	N/C
9	GND	10	N/C
11	N/C	12	N/C
13	N/C	14	N/C
15	GND	16	N/C
17	N/C	18	GND
19	N/C	20	VCC3
21	GND	22	BUF_PLT_RST#
23	SATARXP1	24	N/C
25	SATARXN1	26	GND
27	GND	28	1.5V
29	GND	30	SMBCLK
31	SATATXN1	32	SMBDATA
33	SATATXP1	34	GND
35	GND	36	USB4-_GL850
37	N/C	38	USB4+_GL850
39	VCC3	40	GND
41	VCC3	42	N/C
43	GND	44	N/C
45	N/C	46	N/C

tKINO-BW SBC

Pin	Description	Pin	Description
47	N/C	48	1.5 V
49	N/C	50	GND
51	M-SATADET	52	VCC3

Table 3-15: mSATA Module Slot Pinouts

3.2.15 PCIe Mini Card Slot

CN Label: MINI-PCIE1

CN Type: Half-size/Full-size PCIe Mini card slot

CN Location: See **Figure 3-16**

CN Pinouts: See **Table 3-16**

The PCIe Mini card slot is for installing a PCIe Mini expansion card.

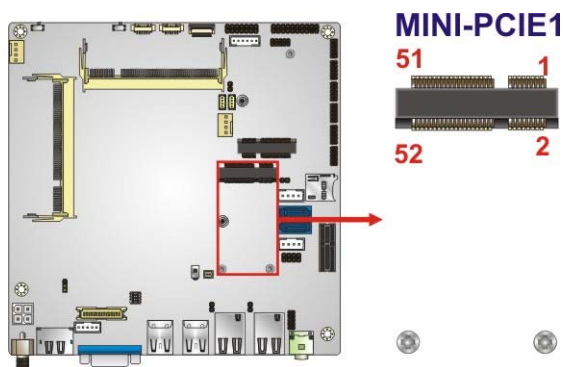

Figure 3-16: PCIe Mini Card Slot Location

Pin	Description	Pin	Description
1	PCIE_WAKE#	2	VCC3
3	N/C	4	GND
5	N/C	6	1.5 V
7	N/C	8	N/C
9	GND	10	N/C
11	CLK-	12	N/C
13	CLK+	14	N/C
15	GND	16	N/C

Pin	Description	Pin	Description
17	N/C	18	GND
19	N/C	20	WLAN_EN
21	GND	22	BUF_PLT_RST#
23	PCIE_RXN0	24	VCC3A
25	PCIE_RXP0	26	GND
27	GND	28	1.5 V
29	GND	30	SMBCLK
31	PCIE_TXN0	32	SMBDATA
33	PCIE_TXP0	34	GND
35	GND	36	USB3-_GL850
37	N/C	38	USB3+_GL850
39	N/C	40	GND
41	N/C	42	N/C
43	N/C	44	N/C
45	N/C	46	N/C
47	N/C	48	1.5 V
49	N/C	50	GND
51	N/C	52	VCC3

Table 3-16: PCIe Mini Card Slot Pinouts

3.2.16 PCIe x1 Card Slot

- CN Label:** PCIE1
- CN Type:** PCIe x1 slot
- CN Location:** See **Figure 3-17**
- CN Pinouts:** See **Table 3-17**

The PCIe x1 slot is for PCIe x1 expansion cards.

tKINO-BW SBC

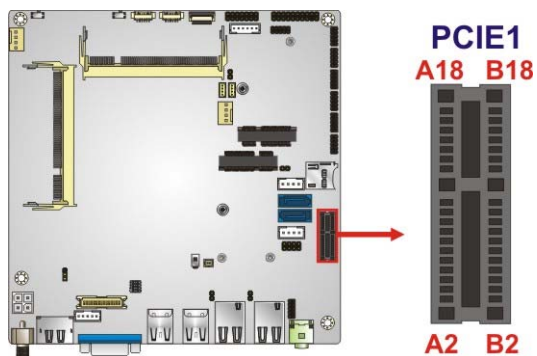

Figure 3-17: PCIe x1 Slot Location

Pin	Description	Pin	Description
A1	+12v	B1	PRSNT#1
A2	+12v	B2	+12v
A3	RSVD	B3	+12v
A4	GND	B4	GND
A5	SMCLK	B5	JTAG2
A6	SMDAT	B6	JTAG3
A7	GND	B7	JTAG4
A8	+3.3v	B8	JTAG5
A9	JTAG1	B9	+3.3v
A10	3.3 Vaux	B10	+3.3v
A11	WAKE#	B11	PWRGD
A12	RSVD	B12	GND
A13	GND	B13	REFCLK+
A14	HSOp(0)	B14	REFCLK-
A15	HSOn(0)	B15	GND
A16	GND	B16	HSIp(0)
A17	PRSNT#2	B17	HSIn(0)
A18	GND	B18	GND

Table 3-17: PCIe x1 Slot Pinouts

3.2.17 RS-232 Serial Port Connector

CN Label: COM1, COM2, COM3, COM4

CN Type: 10-pin header, p=2.00 mm

CN Location: See **Figure 3-18**

CN Pinouts: See **Table 3-18**

The serial connector provides RS-232 connection.

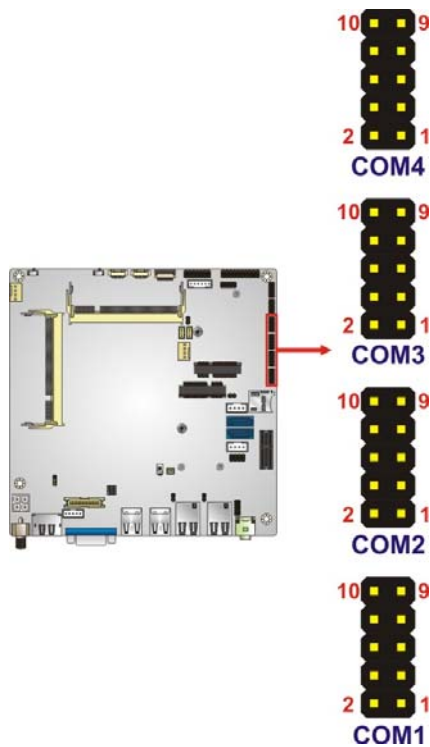

Figure 3-18: RS-232 Serial Port Connector Locations

PIN NO.	DESCRIPTION	PIN NO.	DESCRIPTION
1	DCD	2	DSR
3	RX	4	RTS
5	TX	6	CTS
7	DTR	8	RI
9	GND	10	GND

Table 3-18: RS-232 Serial Port Connector Pinouts

tKINO-BW SBC

3.2.18 RS-232/422/485 Serial Port Connector

- CN Label:** COM5, COM6
- CN Type:** 10-pin header, p=2.00 mm
- CN Location:** See **Figure 3-19**
- CN Pinouts:** See **Table 3-19**

These two connectors provide RS-232, RS-422 or RS-485 communications. The default mode is set to RS-232 in BIOS. To configure the connectors as RS-422 or RS-485, please refer to **Section 5.3.8.1.5** and **Section 5.3.8.1.6**.

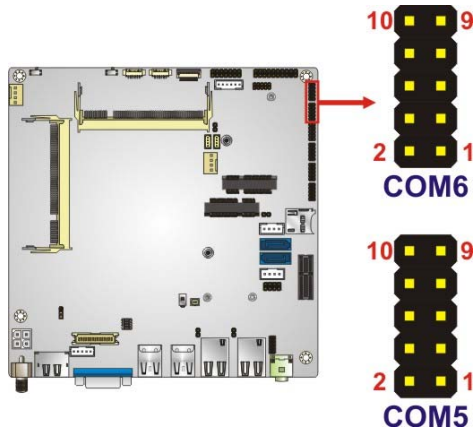

Figure 3-19: RS-232/422/485 Connector Locations

Pin	RS-232	RS-422	RS-485
1	DCD	TX-	D-
2	DSR		
3	RX	TX+	D+
4	RTS		
5	TX	RX+	
6	CTS		
7	DTR	RX-	
8	RI		
9	GND		
10	GND		

Table 3-19: RS-232/422/485 Connector Pinouts

Use the optional RS-422/485 cable to connect to a serial device. The pinouts of the DB-9 connector are listed below.

RS-422 Pinouts	RS-485 Pinouts

Table 3-20: DB-9 RS-422/485 Pinouts

3.2.19 SATA 6Gb/s Drive Connectors

- CN Label:** SATA1, SATA2
- CN Type:** 7-pin SATA connector
- CN Location:** See **Figure 3-20**

The SATA 6Gb/s drive connector is connected to a SATA 6Gb/s drive. The SATA 6Gb/s drive transfers data at speeds as high as 6Gb/s.

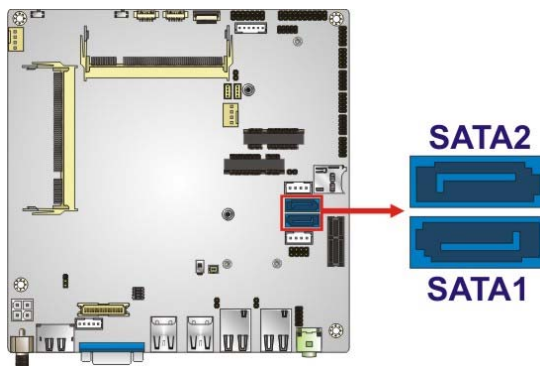

Figure 3-20: SATA 6Gb/s Drive Connectors Locations



CAUTION:

If an mSATA module is installed in the mSATA slot (MSATA1), the SATA port 2 (SATA2) will be disabled. Choose either the SATA2 connector or the mSATA module for storage.

3.2.20 SATA Power Connectors

CN Label: SATA_PWR1, SATA_PWR2

CN Type: 4-pin wafer, p=2.54 mm

CN Location: See **Figure 3-21**

CN Pinouts: See **Table 3-21**

The SATA power connector provides +5 V and +12 V power output to the SATA connector.

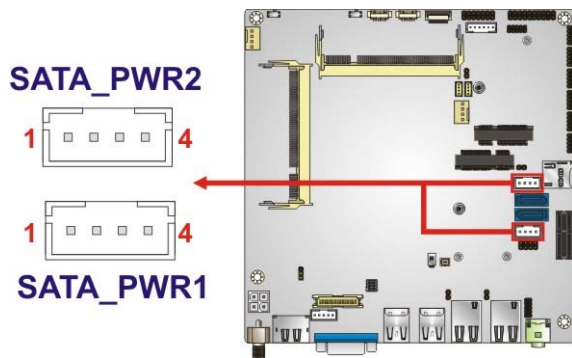

Figure 3-21: SATA Power Connector Locations

Pin	Description
1	+12V
2	GND
3	GND
4	+5V

Table 3-21: SATA Power Connector Pinouts

3.2.21 SMBus Connector

- CN Label:** J_SMB1
- CN Type:** 4-pin wafer, p=1.25 mm
- CN Location:** See **Figure 3-22**
- CN Pinouts:** See **Table 3-22**

The SMBUS (System Management Bus) connector provides low-speed system management communications.

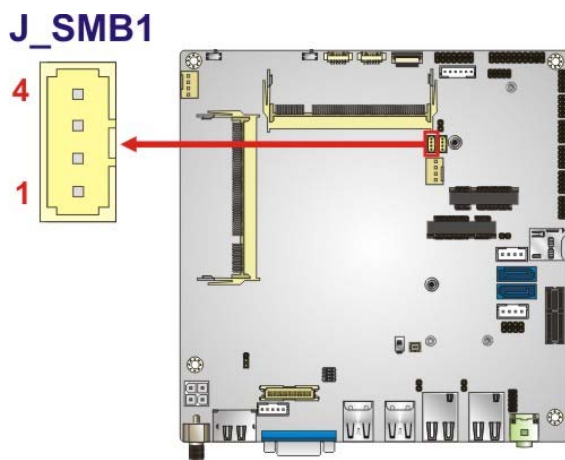

Figure 3-22: SMBUS Connector Location

Pin	Description
1	GND
2	SMB_DATA
3	SMB_CLK
4	+5V

Table 3-22: SMBUS Connector Pinouts

3.2.22 SPI Flash Connector, BIOS

- CN Label:** J_SPI1
- CN Type:** 6-pin wafer, p=1.25 mm

tKINO-BW SBC

CN Location: See Figure 3-23

CN Pinouts: See Table 3-23

The 6-pin SPI Flash connector is used to flash the BIOS.

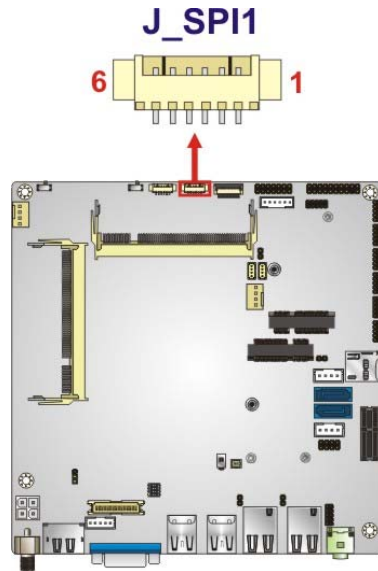

Figure 3-23: SPI Flash Connector Location

Pin	Description
1	+1.8VA
2	SPI_CS
3	SPI_SO_SW
4	SPI_CLK_SW
5	SPI_SI_SW
6	GND

Table 3-23: SPI Flash Connector Pinouts

3.2.23 SPI Flash Connector, EC

CN Label: J_EC1

CN Type: 6-pin wafer, p=1.25 mm

CN Location: See Figure 3-24

CN Pinouts: See **Table 3-24**

The 6-pin SPI Flash connector is used to flash the embedded controller.

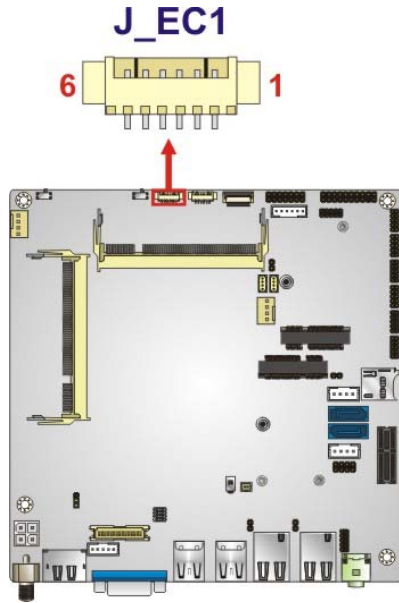

Figure 3-24: SPI Flash Connector Location

Pin	Description
1	+3.3VA
2	CS
3	MISO
4	CLK
5	MOSI
6	GND

Table 3-24: SPI Flash Connector Pinouts

3.2.24 TPM Connector

CN Label: TPM1

CN Type: 20-pin header, p=2.54 mm

CN Location: See **Figure 3-25**

CN Pinouts: See **Table 3-25**

tKINO-BW SBC

The Trusted Platform Module (TPM) connector secures the system on bootup.

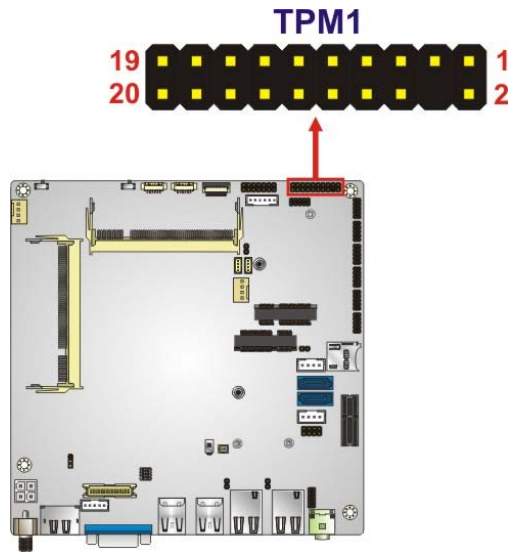

Figure 3-25: TPM Connector Location

PIN NO.	DESCRIPTION	PIN NO.	DESCRIPTION
1	CLOCK	2	GND
3	FRAME	4	KEY/NC
5	RESET	6	VCC5V
7	LAD3	8	LAD2
9	VCC3V	10	LAD1
11	LAD0	12	GND
13	SMB_CLK	14	SMB_DATA
15	SB3V	16	SERIRQ
17	GND	18	CLKRUN
19	LPCPD	20	DRQ

Table 3-25: TPM Connector Pinouts

3.2.25 USB Connector

- CN Label:** J_USB1
- CN Type:** 8-pin header, p=2.54 mm
- CN Location:** See Figure 3-26

CN Pinouts: See **Table 3-26**

The USB connectors provide four USB 2.0 ports by dual-port USB cable.

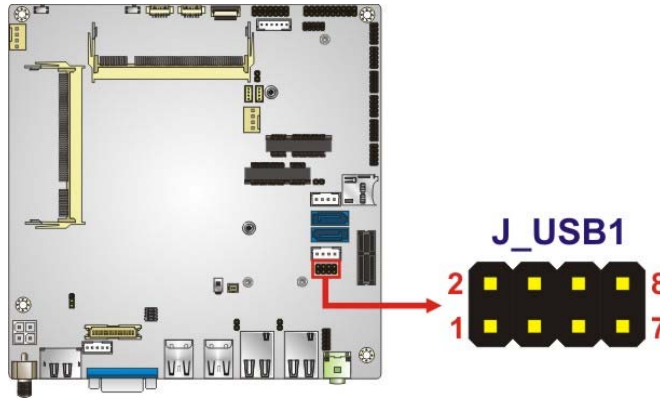

Figure 3-26: USB Connector Location

PIN NO.	DESCRIPTION	PIN NO.	DESCRIPTION
1	+5V	2	GND
3	DATA-	4	DATA+
5	DATA+	6	DATA-
7	GND	8	+5V

Table 3-26: USB Connector Pinouts

3.3 External Peripheral Interface Connector Panel

Figure 3-27 shows the tKINO-BW external peripheral interface connector (EPIC) panel.

The EPIC panel consists of the following:

- 1 x Audio line-out connector
- 1 x DC-in power jack
- 2 x GbE connector
- 1 x HDMI/DisplayPort connector
- 4 x USB 3.0 connector
- 1 x VGA connector

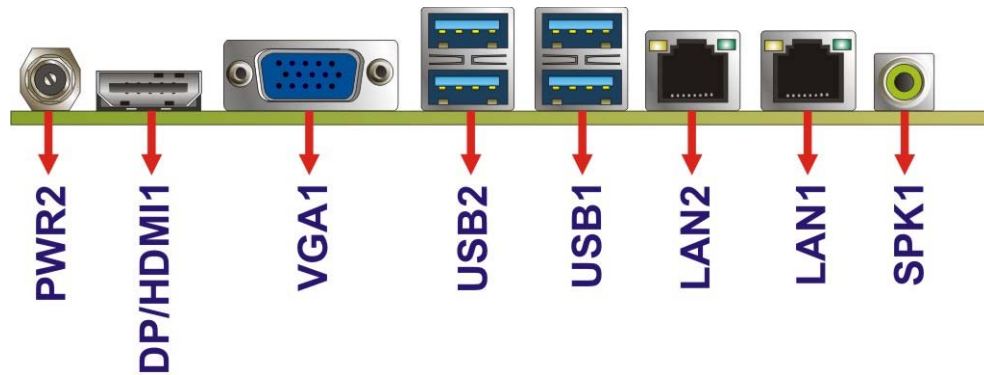

Figure 3-27: External Peripheral Interface Connector

3.3.1 Audio Line-out Connector

CN Label:	SPK1
CN Type:	Audio jack
CN Location:	See Figure 3-27

The audio line-out port (Lime) connects to a headphone or a speaker. With multi-channel configurations, this port can also connect to front speakers.



Figure 3-28: Audio Line-out Connector

3.3.2 HDMI Connector

CN Label:	DP/HDMI1
CN Type:	DisplayPort and HDMI combo connector
CN Location:	See Figure 3-27
CN Pinouts:	See Table 3-27

The DisplayPort and HDMI combo connector can connect to an HDMI or DisplayPort device. The selection is made through a switch (SW_H/D1) on the board. Please refer to **Section 4.7.3** for detailed information.

Pin	Description	Pin	Description
1	HDMI_DP_DATA0	2	GND
3	HDMI_DP_DATA0#	4	HDMI_DP_DATA1
5	GND	6	HDMI_DP_DATA1#
7	HDMI_DP_DATA2	8	GND
9	HDMI_DP_DATA2#	10	HDMI_DP_DATA3
11	GND	12	HDMI_DP_DATA3#
13	HDPMI_DP_EN	14	HDPMI_DP_P14
15	HDPMI_DP_AUP	16	HDPMI_DP_P16
17	HDPMI_DP_AUN	18	HDMI_VCC
19	HDPMI_DP_P19	20	DP_VCC

Table 3-27: DP/HDMI Connector Pinouts

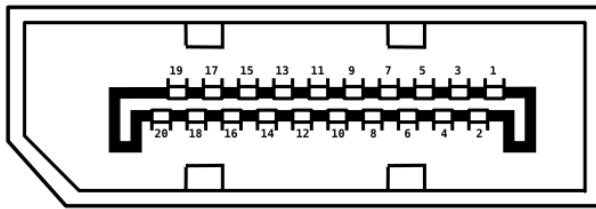

Figure 3-29: DP/HDMI Connector Pinout Locations

3.3.3 LAN Connectors

- CN Label:** LAN1, LAN2
- CN Type:** RJ-45
- CN Location:** See **Figure 3-27**
- CN Pinouts:** See **Figure 3-30** and **Table 3-28**

The LAN connector connects to a local network.

tKINO-BW SBC

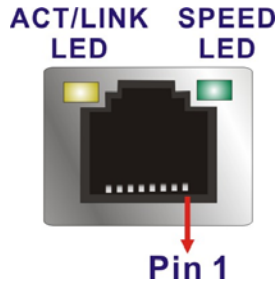

Figure 3-30: LAN Connector

Pin	Description	Pin	Description
1	TRD0+	5	TRD2+
2	TRD0-	6	TRD2-
3	TRD1+	7	TRD3+
4	TRD1-	8	TRD3-

Table 3-28: LAN Pinouts

3.3.4 USB Connectors

CN Label: USB1, USB2

CN Type: USB 3.0 ports

CN Location: See **Figure 3-27**

CN Pinouts: See **Table 3-29**

The tKINO-BW has four external USB 3.0 ports. The USB connector can be connected to a USB 2.0 or USB 3.0 device. The pinouts of USB 3.0 connectors are shown below.

Pin	Description	Pin	Description
1	+5V	2	USB2P0-
3	USB2P0+	4	GND
5	USB3P0_RXDN1	6	USB3P0_RXDP1
7	GND	8	USB3P0_TXDN1
9	USB3P0_TXDP1		

Table 3-29: USB 3.0 Port Pinouts

3.3.5 VGA Connector

- CN Label:** VGA1
- CN Type:** 15-pin female D-sub
- CN Location:** See **Figure 3-27**
- CN Pinouts:** See **Figure 3-31** and **Table 3-30**

The VGA port connects to a monitor that accepts a standard VGA input.

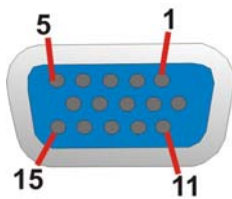

Figure 3-31: VGA Connector

Pin	Description	Pin	Description
1	Red	2	Green
3	Blue	4	NC
5	GND	6	HOTPLUG
7	GND	8	GND
9	VGAVCC	10	GND
11	NC	12	DDCDAT
13	HSYNC	14	VSYNC
15	DDCCLK		

Table 3-30: VGA Connector Pinouts

Chapter

4

Installation

4.1 Anti-static Precautions



WARNING:

Failure to take ESD precautions during the installation of the tKINO-BW may result in permanent damage to the tKINO-BW and severe injury to the user.

Electrostatic discharge (ESD) can cause serious damage to electronic components, including the tKINO-BW. Dry climates are especially susceptible to ESD. It is therefore critical that whenever the tKINO-BW or any other electrical component is handled, the following anti-static precautions are strictly adhered to.

- **Wear an anti-static wristband:** Wearing a simple anti-static wristband can help to prevent ESD from damaging the board.
- **Self-grounding** Before handling the board, touch any grounded conducting material. During the time the board is handled, frequently touch any conducting materials that are connected to the ground.
- **Use an anti-static pad:** When configuring the tKINO-BW, place it on an anti-static pad. This reduces the possibility of ESD damaging the tKINO-BW.
- **Only handle the edges of the PCB:** When handling the PCB, hold the PCB by the edges.

4.2 Installation Considerations



NOTE:

The following installation notices and installation considerations should be read and understood before installation. All installation notices must be strictly adhered to. Failing to adhere to these precautions may lead to severe damage and injury to the person performing the installation.

**WARNING:**

The installation instructions described in this manual should be carefully followed in order to prevent damage to the tKINO-BW, tKINO-BW components and injury to the user.

Before and during the installation please **DO** the following:

- Read the user manual:
 - The user manual provides a complete description of the tKINO-BW installation instructions and configuration options.
- Wear an electrostatic discharge cuff (ESD):
 - Electronic components are easily damaged by ESD. Wearing an ESD cuff removes ESD from the body and helps prevent ESD damage.
- Place the tKINO-BW on an antistatic pad:
 - When installing or configuring the motherboard, place it on an antistatic pad. This helps to prevent potential ESD damage.
- Turn all power to the tKINO-BW off:
 - When working with the tKINO-BW, make sure that it is disconnected from all power supplies and that no electricity is being fed into the system.

Before and during the installation of the tKINO-BW **DO NOT**:

- Remove any of the stickers on the PCB board. These stickers are required for warranty validation.
- Use the product before verifying all the cables and power connectors are properly connected.
- Allow screws to come in contact with the PCB circuit, connector pins, or its components.

4.3 SO-DIMM Installation



CAUTION:

1. DDR3L 1333 MHz operation will be downgraded to 1066 MHz due to Intel® SoC limitation.
2. In some cases, the tKINO-BW with DDR3L 1333 MHz memory module installed may take a longer time to boot up.

To install an SO-DIMM, please follow the steps below and refer to **Figure 4-1**.

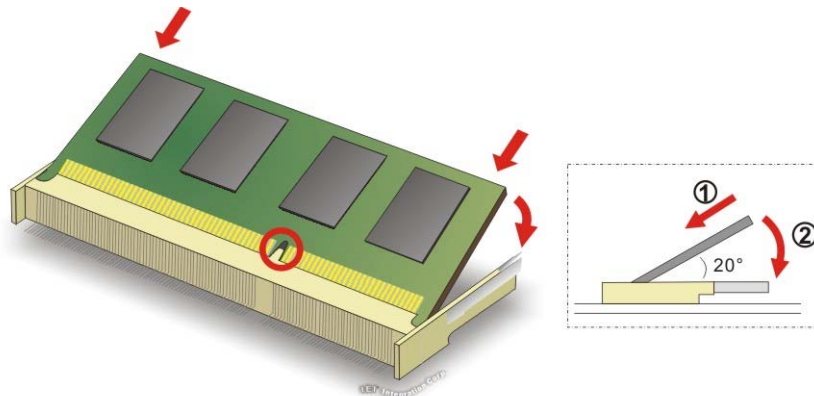

Figure 4-1: SO-DIMM Installation

- Step 1:** Locate the SO-DIMM socket. Place the board on an anti-static mat.
- Step 2:** Align the SO-DIMM with the socket. Align the notch on the memory with the notch on the memory socket.
- Step 3:** Insert the SO-DIMM. Push the memory in at a 20° angle. (See **Figure 4-1**)
- Step 4:** Seat the SO-DIMM. Gently push downwards and the arms clip into place. (See **Figure 4-1**)

4.4 microSD Card Installation

To install the microSD card, please follow the steps below.

Step 1: Locate the microSD slot. See **Figure 4-2**.

Step 2: Align the microSD card. The label side should be facing away from the board.

The grooves on the microSD slot ensure that the card cannot be inserted the wrong way.

Step 3: Insert the microSD card. Push until the microSD card is firmly seated in the slot. See **Figure 4-2**.

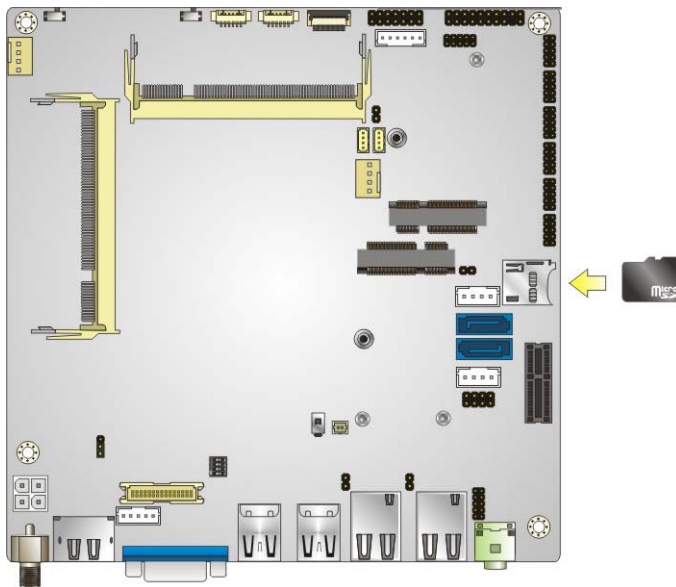

Figure 4-2: microSD Card Installation

4.5 mSATA Module Installation



CAUTION:

If an mSATA module is installed in the mSATA slot (MSATA1), the SATA port 2 (SATA2) will be disabled. Choose either the SATA2 connector or the mSATA module for storage.

The full-size/half-size PCIe Mini card slot (MSATA1) allows installation of an mSATA module. To install an mSATA module, please follow the steps below.

4.5.1 Full-size mSATA Module Installation

To install a full-size mSATA module, please follow the steps below.

Step 1: Locate the PCIe Mini slot (MSATA1). See Chapter 3.

Step 2: Remove the retention screw. Remove the retention screw as shown in Figure 4-3.

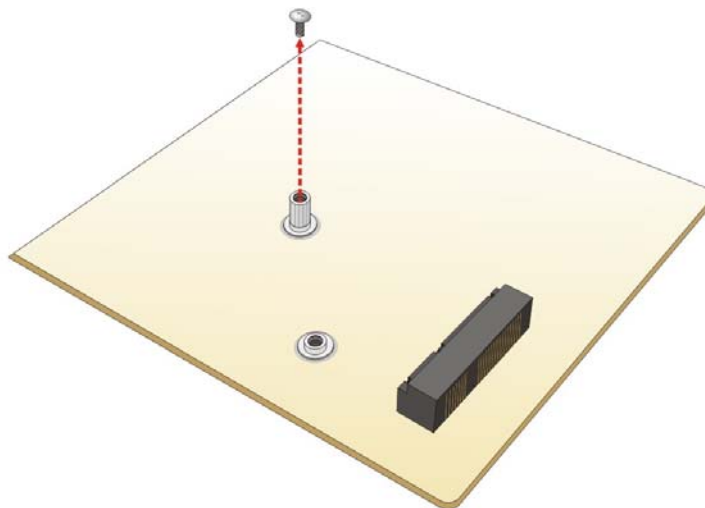

Figure 4-3: Removing the Retention Screw

tKINO-BW SBC

Step 3: Insert into the socket at an angle. Line up the notch on the mSATA module with the notch on the slot. Slide the mSATA module into the socket at an angle of about 20° (Figure 4-4).

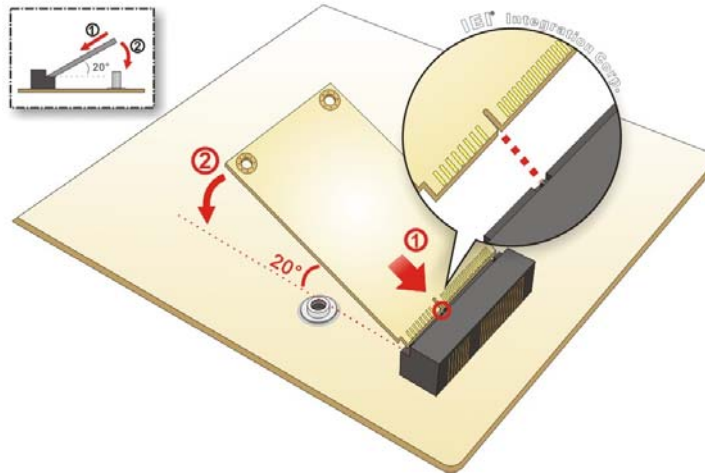

Figure 4-4: Inserting the Full-size mSATA Module into the Slot at an Angle

Step 4: Secure the mSATA module. Secure the mSATA module with the retention screw previously removed (Figure 4-5).

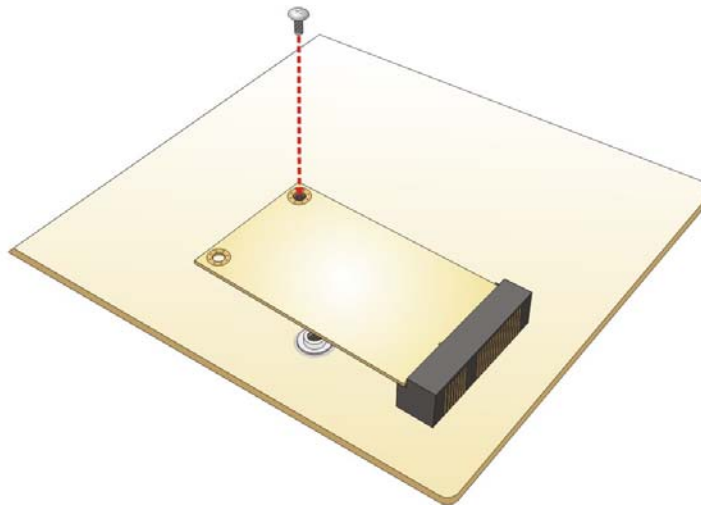

Figure 4-5: Securing the mSATA Module

4.5.2 Half-size mSATA Module Installation

To install a half-size mSATA module, please follow the steps below.

Step 1: Locate the PCIe Mini card slot (MSATA1). See Chapter 3.

Step 2: Remove the retention screw. Remove the retention screw as shown in Figure 4-6.

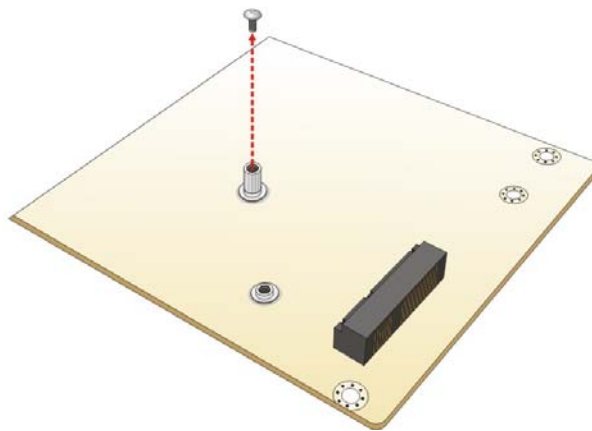

Figure 4-6: Removing the Retention Screw

Step 3: Remove the standoff. Unscrew and remove the standoff secured on the motherboard as shown in Figure 4-7.

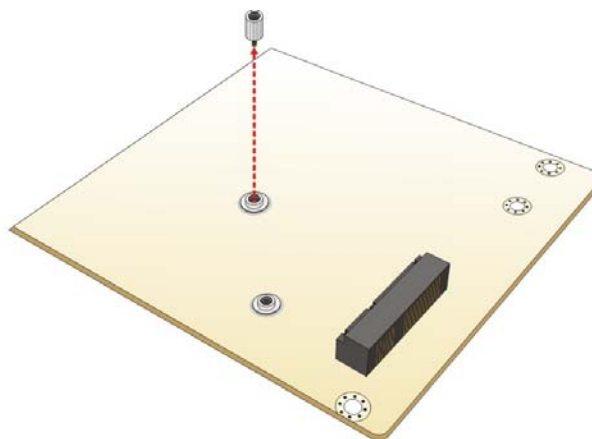

Figure 4-7: Removing the Standoff

Step 4: Install the standoff to the screw hole for the half-size mSATA module. Install the previously removed standoff to the screw hole for the half-size mSATA module (Figure 4-8).

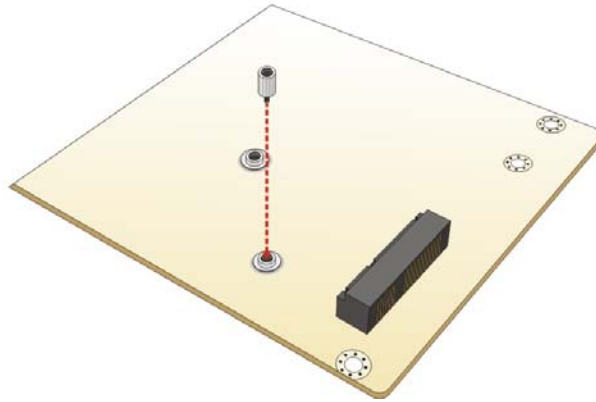

Figure 4-8: Installing the Standoff

Step 5: Insert into the socket at an angle. Line up the notch on the card with the notch on the slot. Slide the mSATA module into the slot at an angle of about 20° (Figure 4-9).

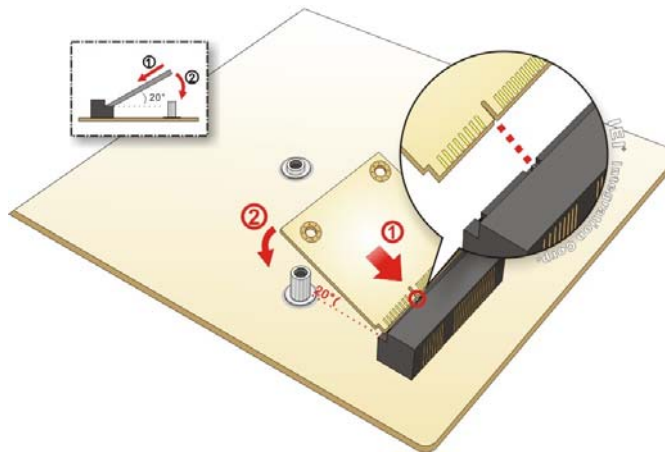

Figure 4-9: Inserting the Half-size mSATA Module into the Slot at an Angle

Step 6: Secure the half-size mSATA module. Secure the half-size mSATA module with the retention screw previously removed (Figure 4-10).

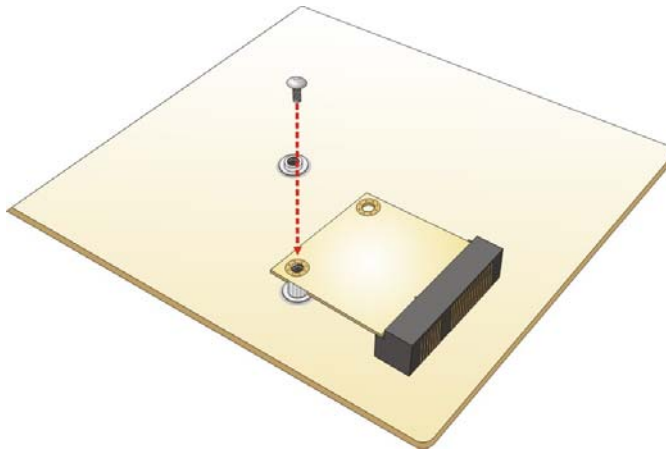

Figure 4-10: Securing the Half-size mSATA Module

4.6 PCIe Mini Card Installation

4.6.1 Full-size PCIe Mini Card Installation

The PCIe Mini card slot allows installation of either a full-size or half-size PCIe Mini card. To install a full-size PCIe Mini card, please follow the steps below.

Step 1: Locate the PCIe Mini card slot. See Chapter 3.

Step 2: Remove the retention screws. Remove the two retention screws as shown in

Figure 4-11.

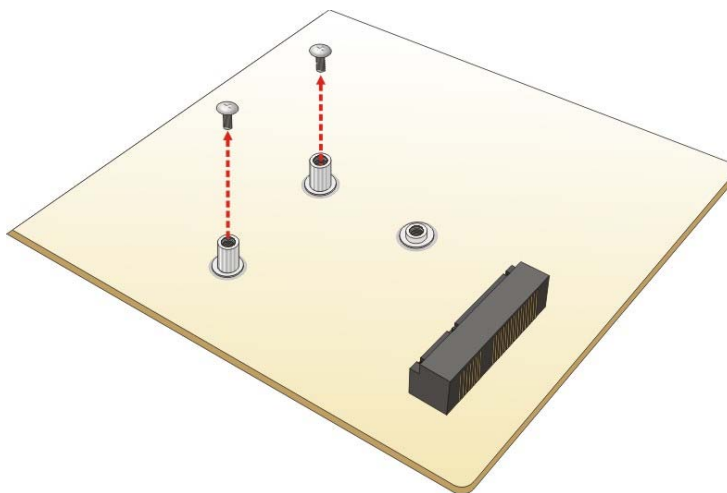

Figure 4-11: Removing the Retention Screws

tKINO-BW SBC

Step 3: Insert into the socket at an angle. Line up the notch on the card with the notch on the slot. Slide the PCIe Mini card into the socket at an angle of about 20° (Figure 4-12).

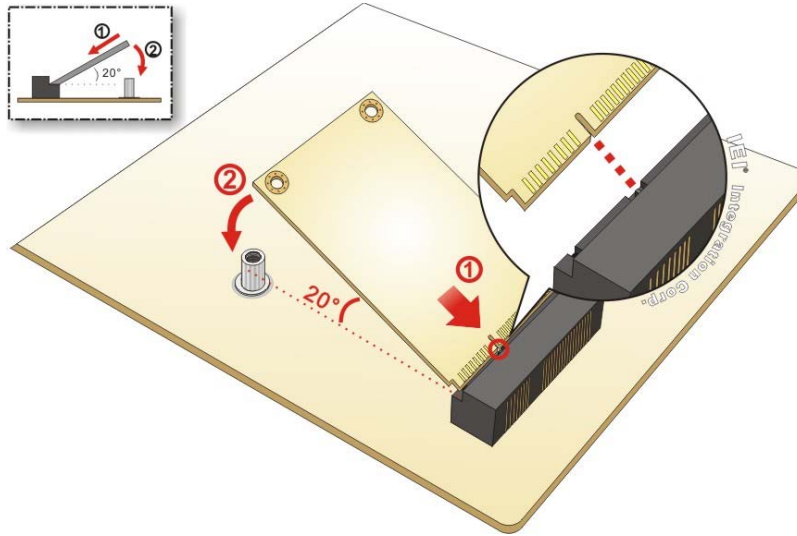

Figure 4-12: Inserting the Full-size PCIe Mini Card into the Slot at an Angle

Step 4: Secure the full-size PCIe Mini card. Secure the full-size PCIe Mini card with the retention screws previously removed (Figure 4-13).

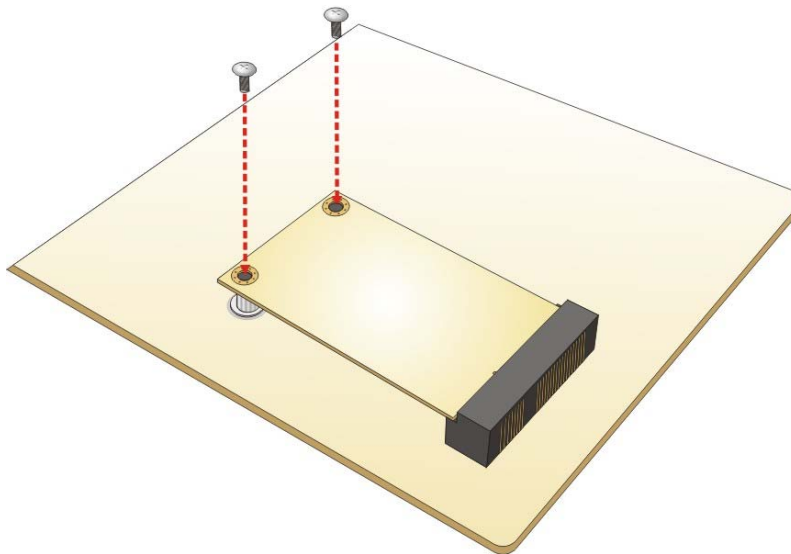

Figure 4-13: Securing the Full-size PCIe Mini Card

4.6.2 Half-size PCIe Mini Card Installation

The PCIe Mini card slot allows installation of either a full-size or half-size PCIe Mini card. To install a half-size PCIe Mini card, please follow the steps below.

Step 1: Locate the PCIe Mini card slot. See Chapter 3.

Step 2: Remove the retention screw and the standoff. Remove the retention screw first, then unscrew and remove the standoff secured on the motherboard. See Figure 4-14.

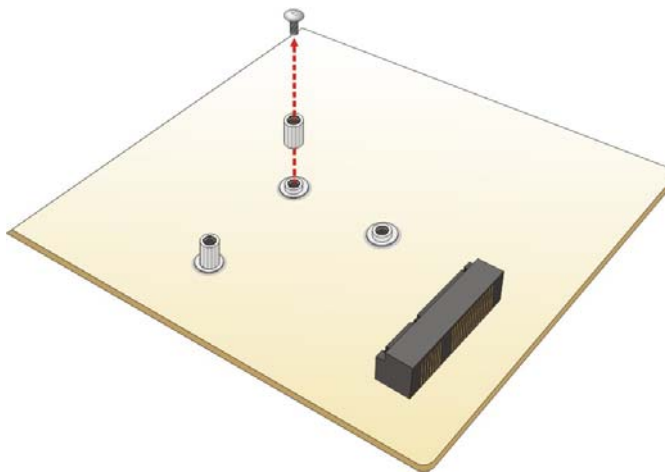

Figure 4-14: Removing Retention Screw and Standoff

Step 3: Install the standoff to the screw hole for the half-size PCIe Mini card. Install the previously removed standoff to the screw hole for the half-size PCIe Mini card (Figure 4-15).

tKINO-BW SBC

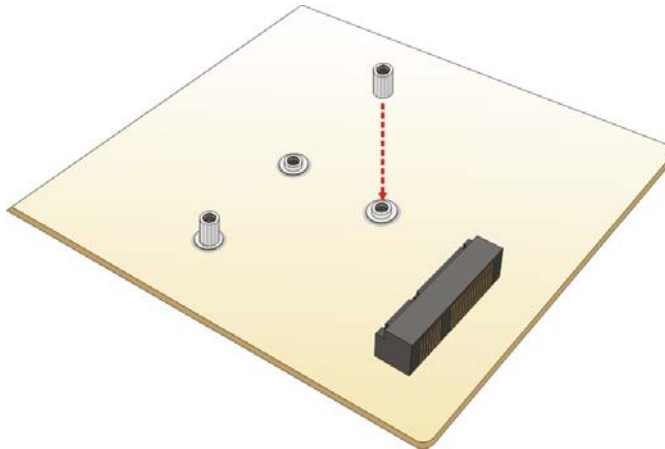

Figure 4-15: Installing the Standoff

Step 4: Insert into the socket at an angle. Line up the notch on the card with the notch on the slot. Slide the PCIe Mini card into the slot at an angle of about 20° (Figure 4-16).

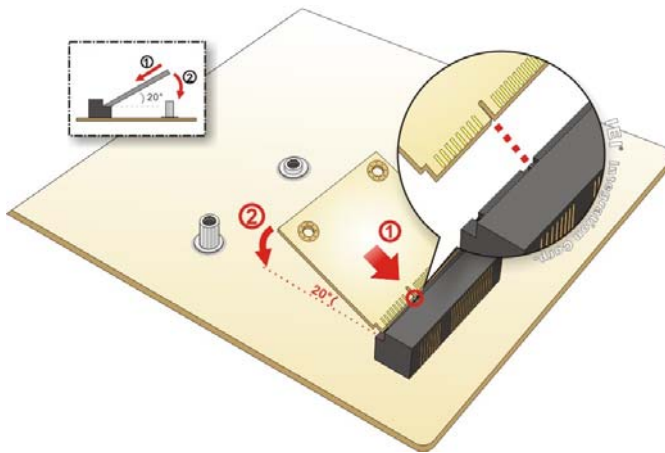

Figure 4-16: Inserting the Half-size PCIe Mini Card into the Slot at an Angle

Step 5: Secure the half-size PCIe Mini card. Secure the half-size PCIe Mini card with the retention screw previously removed (Figure 4-17).

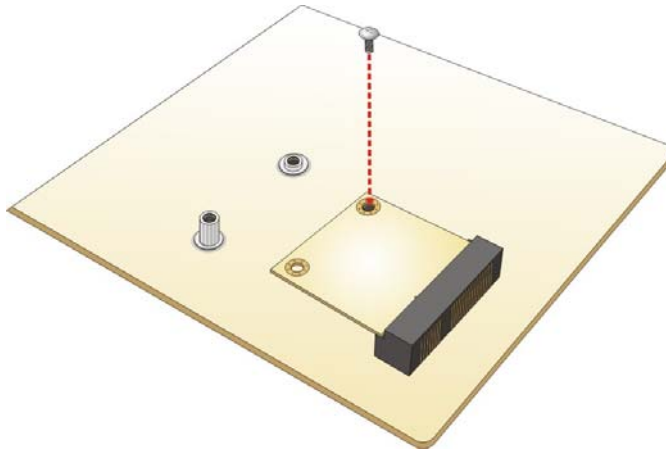

Figure 4-17: Securing the Half-size PCIe Mini Card

4.7 System Configuration

The system configuration is controlled by buttons, jumpers and switches. The system configuration should be performed before installation.

4.7.1 AT/ATX Mode Select Switch

CN Label:	SW_A/T1
CN Type:	Switch
CN Location:	See Figure 4-18
CN Settings:	See Table 4-1

The AT/ATX mode select switch specifies the systems power mode as AT or ATX. AT/ATX mode select switch settings are shown in **Table 4-1**.

Setting	Description
Short A-B	ATX Mode (Default)
Short B-C	AT Mode

Table 4-1: AT/ATX Mode Select Switch Settings

The location of the AT/ATX mode select switch is shown in **Figure 4-18** below.

tKINO-BW SBC

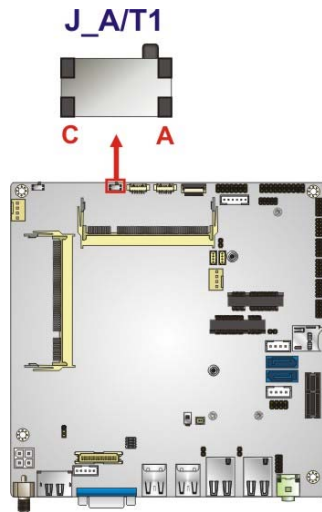

Figure 4-18: AT/ATX Mode Select Switch Location

4.7.2 Clear CMOS Button

CN Label:	J_CMOS1
CN Type:	Button
CN Location:	See Figure 4-19

If the tKINO-BW fails to boot due to improper BIOS settings, use the button to clear the CMOS data and reset the system BIOS information.

The location of the clear CMOS button is shown in **Figure 4-19**

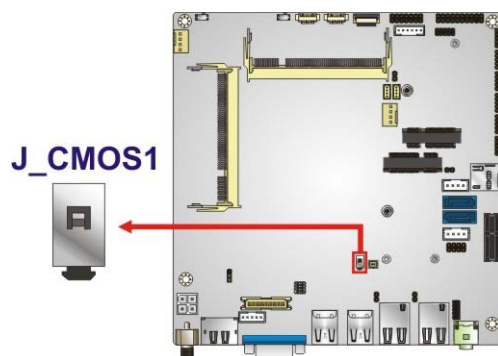

Figure 4-19: Clear CMOS Button Location

4.7.3 HDMI/DP Select Switch

- CN Label:** SW_H/D1
- CN Type:** Switch
- CN Location:** See **Figure 4-20**
- CN Settings:** See **Table 4-2**

The HDMI/DP select switch specifies the external HDMI/DP connector as HDMI or DisplayPort. HDMI/DP select switch settings are shown in **Table 4-2**.

Setting	Description
Short A-B	HDMI (Default)
Short B-C	DisplayPort

Table 4-2: HDMI/DP Select Switch Settings

The location of the HDMI/DP select switch is shown in **Figure 4-18** below.

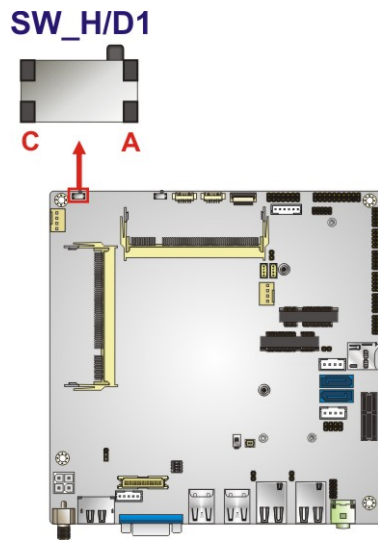

Figure 4-20: HDMI/DP Select Switch Location

tKINO-BW SBC

4.7.4 LVDS Panel Resolution Select Switch

Jumper Label:	SW1
Jumper Type:	DIP switch
Jumper Settings:	See Table 4-3
Jumper Location:	See Figure 4-21

Selects the resolution of the LCD panel connected to the LVDS connector.

* ON=0, OFF=1; Single=S, Dual=D

SW1 (4-3-2-1)	Description
0000	800x600 18-bit S (default)
0001	1024x768 18-bit S
0010	1024x768 24-bit S
0011	1280x768 18-bit S
0100	1280x800 18-bit S
0101	1280x960 18-bit S
0110	1280x1024 24-bit D
0111	1366x768 18-bit S
1000	1366x768 24-bit S
1001	1440x960 24-bit D
1010	1400x1050 24-bit D
1011	1600x900 24-bit D
1100	1680x1050 24-bit D
1101	1600x1200 24-bit D
1110	1920x1080 24-bit D
1111	1920x1200 24-bit D

Table 4-3: LVDS Panel Resolution Selection

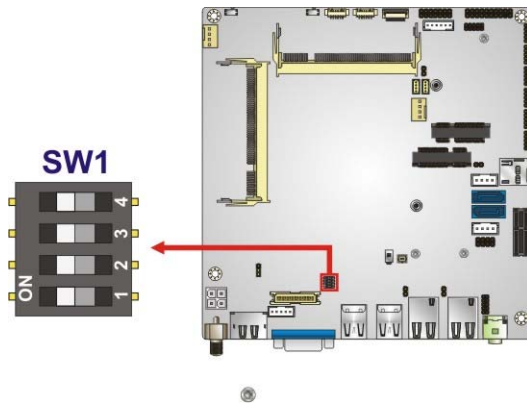

Figure 4-21: LVDS Panel Resolution Select Switch Location

4.7.5 LVDS Voltage Select Jumper



WARNING:

Permanent damage to the screen and tKINO-BW may occur if the wrong voltage is selected with this jumper. Please refer to the user guide that came with the monitor to select the correct voltage.

- Jumper Label:** J_PW1
- Jumper Type:** 3-pin header, p=2.0 mm
- Jumper Settings:** See Table 4-4
- Jumper Location:** See Figure 4-22

The LVDS voltage selection jumper allows setting the voltage provided to the monitor connected to the LVDS connector.

Setting	Description
Short 1-2	+3.3 V (Default)
Short 2-3	+5 V

Table 4-4: LVDS Voltage Select Jumper Settings

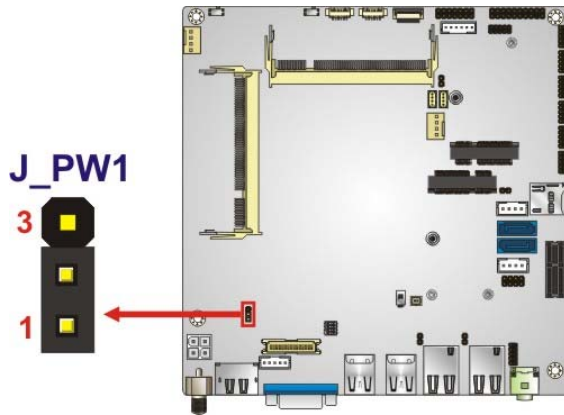

Figure 4-22: LVDS Voltage Select Jumper Location

4.7.6 mSATA and SATA2 Select Jumper

- CN Label:** J_MS1
- CN Type:** 2-pin header, p=2.54 mm
- CN Location:** See Figure 4-23
- CN Settings:** See Table 4-5

Use the mSATA and SATA2 select jumper to set the priority of MSATA1 and SATA2 connectors since the MSATA1 slot is co-lay with the SATA2 connector. The mSATA and SATA2 select jumper settings are shown in **Table 4-5**.

Setting	Description
Open	MSATA1 as the priority (Default) (SATA2 will be disabled if an mSATA module is installed in the MSATA1 slot.)
Short	MSATA1 is enabled and SATA2 is disabled.

Table 4-5: mSATA and SATA2 Select Jumper Settings

The location of the mSATA and SATA2 select jumper is shown in **Figure 4-23** below.

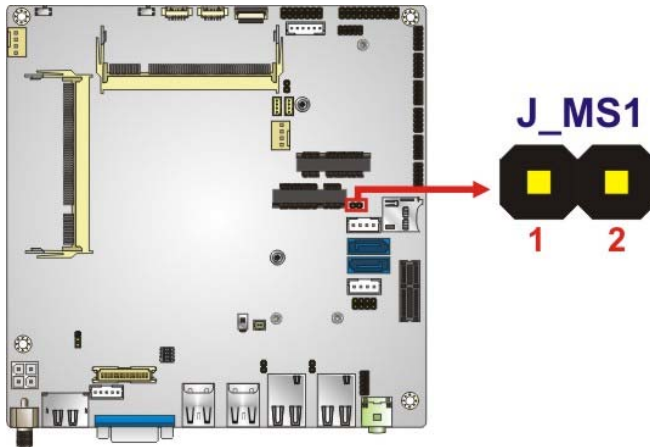

Figure 4-23: mSATA and SATA2 Select Jumper Location

4.8 Chassis Installation

4.8.1 Airflow



WARNING:

Airflow is critical for keeping components within recommended operating temperatures. The chassis should have fans and vents as necessary to keep things cool.

The tKINO-BW must be installed in a chassis with ventilation holes on the sides allowing airflow to travel through the heat sink surface. In a system with an individual power supply unit, the cooling fan of a power supply can also help generate airflow through the board surface.

4.8.2 Motherboard Installation

To install the tKINO-BW motherboard into the chassis please refer to the reference material that came with the chassis.

4.9 SATA Drive Connection

The tKINO-BW is shipped with a SATA drive cable. To connect the SATA drive to the connector, please follow the steps below.

Step 1: Locate the SATA connector and the SATA power connector. The locations of the connectors are shown in **Chapter 3**.

Step 2: Insert the cable connector. Insert the cable connector into the on-board SATA drive connector and the SATA power connector. See **Figure 4-24**.

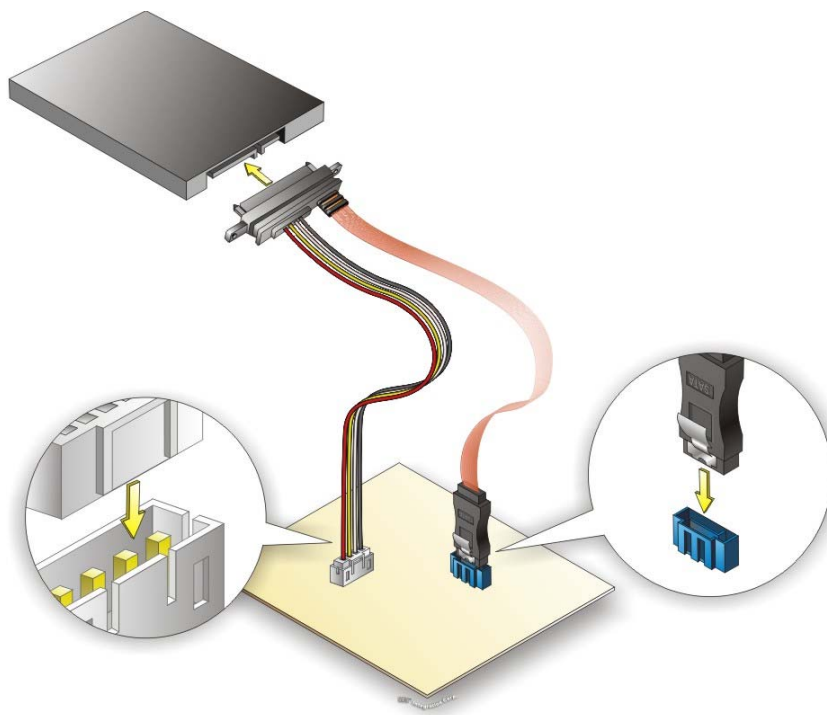

Figure 4-24: SATA Drive Cable Connection

Step 3: Connect the cable to the SATA disk. Connect the connector on the other end of the cable to the connector at the back of the SATA drive. See **Figure 4-24**.

Step 4: To remove the SATA cable from the SATA connector, press the clip on the connector at the end of the cable.

Chapter

5

BIOS

5.1 Introduction

The BIOS is programmed onto the BIOS chip. The BIOS setup program allows changes to certain system settings. This chapter outlines the options that can be changed.



NOTE:

Some of the BIOS options may vary throughout the life cycle of the product and are subject to change without prior notice.

5.1.1 Starting Setup

The UEFI BIOS is activated when the computer is turned on. The setup program can be activated in one of two ways.

1. Press the **DELETE** or **F2** key as soon as the system is turned on or
2. Press the **DELETE** or **F2** key when the “**Press Del to enter SETUP**” message appears on the screen.

If the message disappears before the **DELETE** or **F2** key is pressed, restart the computer and try again.

5.1.2 Using Setup

Use the arrow keys to highlight items, press **ENTER** to select, use the PageUp and PageDown keys to change entries, press **F1** for help and press **ESC** to quit. Navigation keys are shown in.

Key	Function
Up arrow	Move to previous item
Down arrow	Move to next item
Left arrow	Move to the item on the left hand side
Right arrow	Move to the item on the right hand side
+	Increase the numeric value or make changes

Key	Function
-	Decrease the numeric value or make changes
F1 key	General help, only for Status Page Setup Menu and Option Page Setup Menu
F2 key	Load previous values.
F3 key	Load optimized defaults
F4 key	Save changes and Exit BIOS
Esc key	Main Menu – Quit and not save changes into CMOS Status Page Setup Menu and Option Page Setup Menu -- Exit current page and return to Main Menu

Table 5-1: BIOS Navigation Keys

5.1.3 Getting Help

When **F1** is pressed a small help window describing the appropriate keys to use and the possible selections for the highlighted item appears. To exit the Help Window press **Esc** or the **F1** key again.

5.1.4 Unable to Reboot after Configuration Changes

If the computer cannot boot after changes to the system configuration is made, CMOS defaults. Use the jumper described in **Section 4.7.2**.

5.1.5 BIOS Menu Bar

The **menu bar** on top of the BIOS screen has the following main items:

- Main – Changes the basic system configuration.
- Advanced – Changes the advanced system settings.
- Chipset – Changes the chipset settings.
- Security – Sets User and Supervisor Passwords.
- Boot – Changes the system boot configuration.
- Save & Exit – Selects exit options and loads default settings

tKINO-BW SBC

The following sections completely describe the configuration options found in the menu items at the top of the BIOS screen and listed above.

5.2 Main

The **Main** BIOS menu (**BIOS Menu 1**) appears when the **BIOS Setup** program is entered. The **Main** menu gives an overview of the basic system information.

Aptio Setup Utility - Copyright (C) 2016 American Megatrends, Inc.		
Main	Advanced	Chipset Security Boot Save & Exit
BIOS Information		Set the Date. Use Tab to switch between Data elements.
BIOS Vendor	American Megatrends	
Core Version	5.11	
Compliancy	UEFI 2.4; PI 1.3	
Project Version	B359AR13.ROM	
Build Date and Time	02/17/2016 15:52:12	
iWDD Vendor	iEi	
iWDD Version	B359ER13.bin	
Access Level	Administrator	
Memory Information		
Total Memory	2048 MB(LPDDR3)	
TXE Information		
Sec RC Version	00.05.00.00	←→: Select Screen
TXE FW Version	02.00.02.2092	↑ ↓: Select Item
CPU Configuration		EnterSelect
Microcode Patch	403	+/-: Change Opt.
System Date	[Fri 01/01/2010]	F1: General Help
System Time	[00:18:35]	F2: Previous Values
		F3: Optimized Defaults
		F4: Save & Exit
		ESC: Exit
Version 2.17.1249. Copyright (C) 2016 American Megatrends, Inc.		

BIOS Menu 1: Main

The Main menu lists the following system details:

- BIOS Information
- iWDD Information
- Memory Information
- TXE Information
- CPU Configuration

The System Overview field also has two user configurable fields:

➔ **System Date [xx/xx/xx]**

Use the **System Date** option to set the system date. Manually enter the day, month and year.

➔ **System Time [xx:xx:xx]**

Use the **System Time** option to set the system time. Manually enter the hours, minutes and seconds.

5.3 Advanced

Use the **Advanced** menu (**BIOS Menu 2**) to configure the CPU and peripheral devices through the following sub-menus:



WARNING!

Setting the wrong values in the sections below may cause the system to malfunction. Make sure that the settings made are compatible with the hardware.

```

Aptio Setup Utility - Copyright (C) 2016 American Megatrends, Inc.
Main  Advanced  Chipset  Security  Boot  Save & Exit
-----
> ACPI Settings
> RTC Wake Settings
> Trusted Computing
> CPU Configuration
> SATA Configuration
> USB Configuration
> NVMe Configuration
> F81866 Super IO Configuration
> iWDD H/W Monitor
> Serial Port Console Redirection
> iEi Feature

System ACPI Parameters.
-----
<=>: Select Screen
↑ ↓: Select Item
Enter>Select
F1  General Help
F2  Previous Values
F3  Optimized Defaults
F4  Save
ESC Exit

Version 2.17.1249. Copyright (C) 2016 American Megatrends, Inc.
    
```

BIOS Menu 2: Advanced

5.3.1 ACPI Settings

The **ACPI Settings** menu (**BIOS Menu 3**) configures the Advanced Configuration and Power Interface (ACPI) options.

```
Aptio Setup Utility - Copyright (C) 2016 American Megatrends, Inc.
Advanced
ACPI Settings
ACPI Sleep State          [S3 (Suspend to RAM)]
-----
<=>: Select Screen
↑↓: Select Item
EnterSelect
+/-: Change Opt.
F1: General Help
F2: Previous Values
F3: Optimized Defaults
F4: Save & Exit
ESC: Exit
Version 2.17.1249. Copyright (C) 2016 American Megatrends, Inc.
```

BIOS Menu 3: ACPI Settings

5.3.2 RTC Wake Settings

The **RTC Wake Settings** menu (**BIOS Menu 4**) configures RTC wake event.

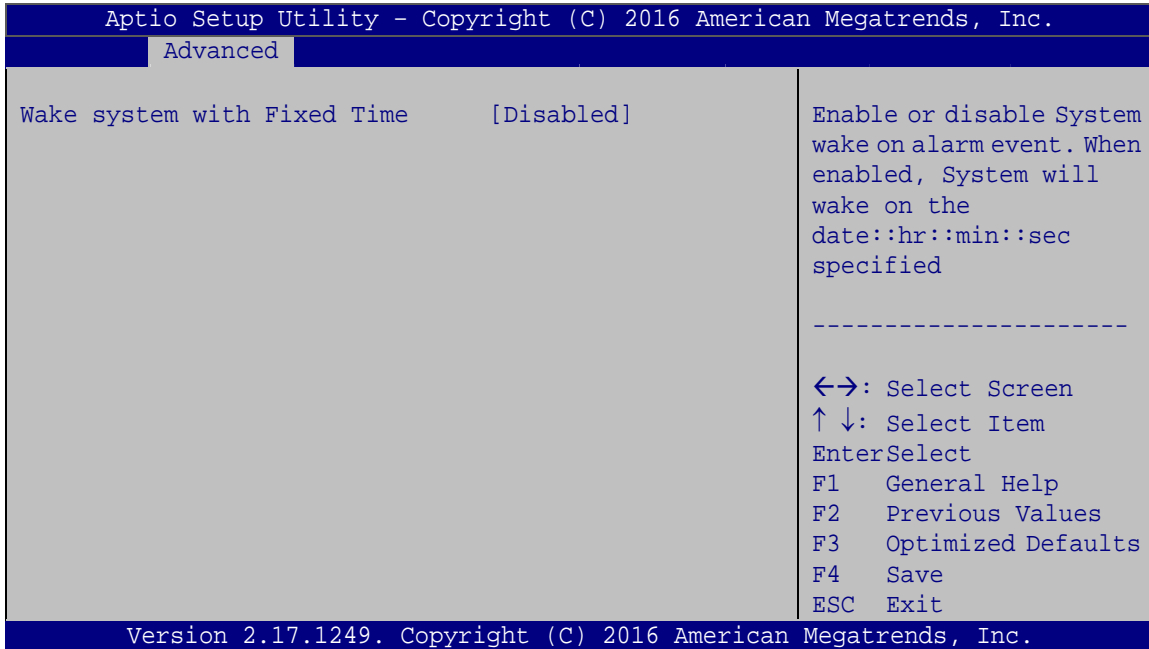

BIOS Menu 4: RTC Wake Settings

→ Wake system with Fixed Time [Disabled]

Use the **Wake system with Fixed Time** option to enable or disable the system wake on alarm event.

→ **Disabled** **DEFAULT** The real time clock (RTC) cannot generate a wake event

→ **Enabled** If selected, the **Wake up every day** option appears allowing you to enable to disable the system to wake every day at the specified time. Besides, the following options appear with values that can be selected:

Wake up date

Wake up hour

Wake up minute

Wake up second

After setting the alarm, the computer turns itself on from a suspend state when the alarm goes off.

5.3.3 Trusted Computing

Use the **Trusted Computing** menu (**BIOS Menu 5**) to configure settings related to the Trusted Computing Group (TCG) Trusted Platform Module (TPM).

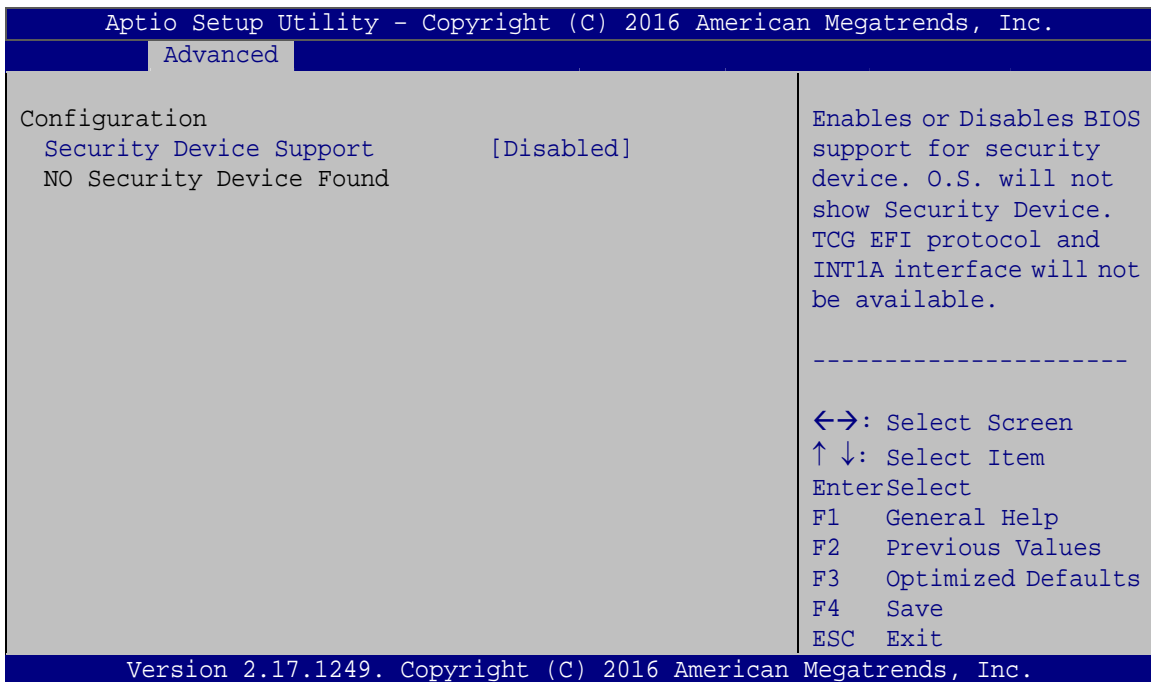

BIOS Menu 5: Trusted Computing

→ Security Device Support [Disabled]

Use the **Security Device Support** option to configure support for the security device.

- **Disabled** **DEFAULT** Security device support is disabled.
- **Enabled** Security device support is enabled.

5.3.4 CPU Configuration

Use the **CPU Configuration** menu (**BIOS Menu 6**) to view detailed CPU specifications and configure the CPU.

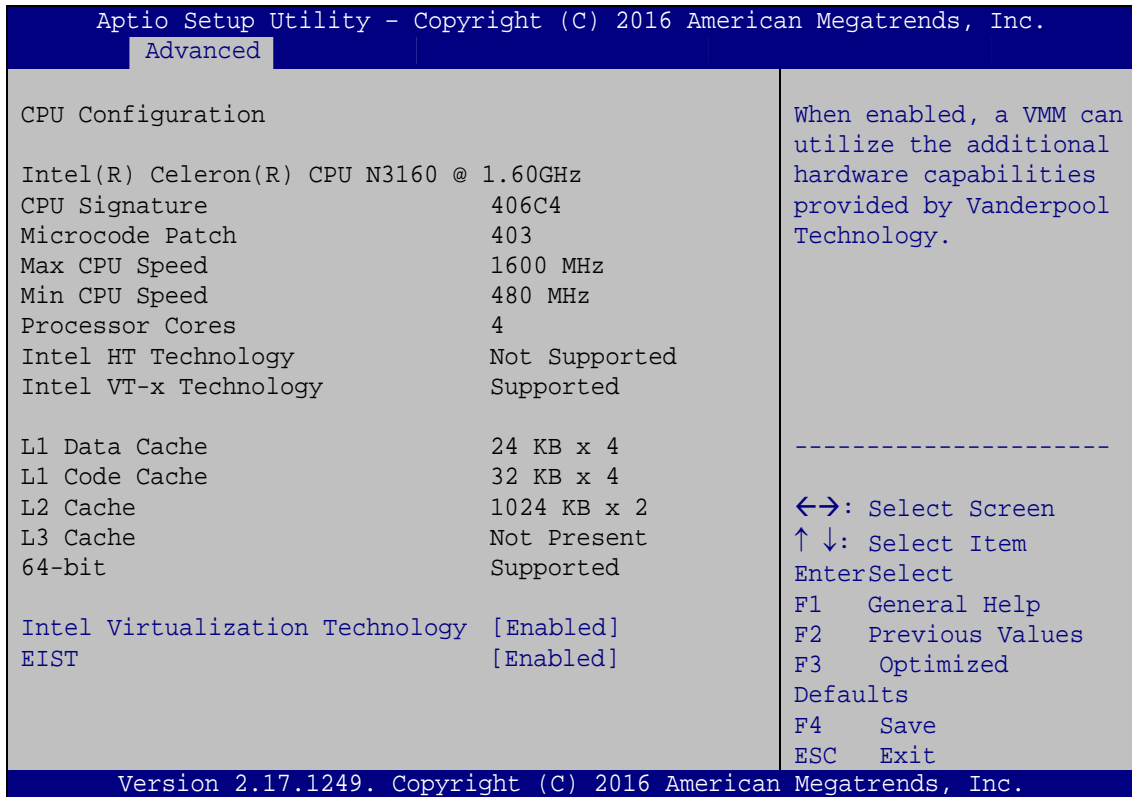

BIOS Menu 6: CPU Configuration

→ Intel® Virtualization Technology [Enabled]

Use the **Intel® Virtualization Technology** option to enable or disable virtualization on the system. When combined with third party software, Intel® Virtualization technology allows several OSs to run on the same system at the same time.

- **Disabled** Disables Intel® Virtualization Technology.
- **Enabled** **DEFAULT** Enables Intel® Virtualization Technology.

tKINO-BW SBC

→ EIST [Enabled]

Use the **EIST** option to enable or disable the Intel® Speed Step Technology.

- **Disabled** Disables the Intel® Speed Step Technology.
- **Enabled** **DEFAULT** Enables the Intel® Speed Step Technology.

5.3.5 SATA Configuration

Use the **SATA Configuration** menu (**BIOS Menu 7**) to change and/or set the configuration of the SATA devices installed in the system.

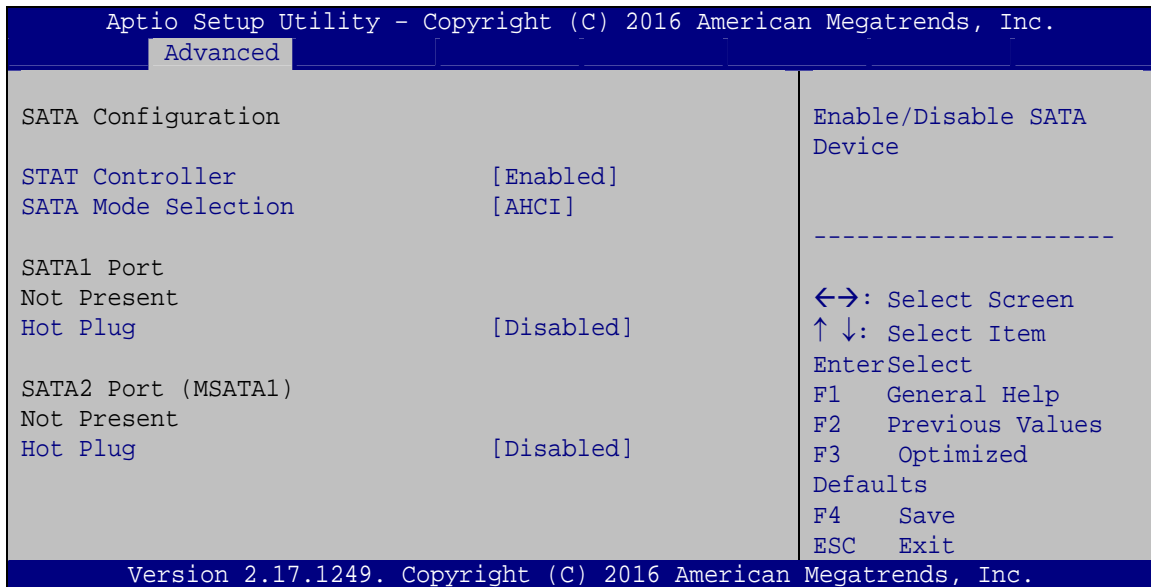

BIOS Menu 7: SATA Configuration

→ STAT Configuration [Enabled]

Use the **STAT Configuration** option to enable or disable the SATA device.

- **Enabled** **DEFAULT** Enables the SATA device.
- **Disabled** Disables the SATA device.

➔ **SATA Mode Selection [AHCI]**

Use the **SATA Mode Selection** option to configure SATA devices as AHCI devices.

➔ **AHCI** **DEFAULT** Configures SATA devices as AHCI device.

➔ **Hot Plug [Disabled]**

Use the **Hot Plug** option to enable or disable the SATA device hot plug.

➔ **Enabled** Enables the SATA device hot plug

➔ **Disabled** **DEFAULT** Disables the SATA device hot plug.

5.3.6 USB Configuration

Use the **USB Configuration** menu (**BIOS Menu 8**) to read USB configuration information and configure the USB settings.

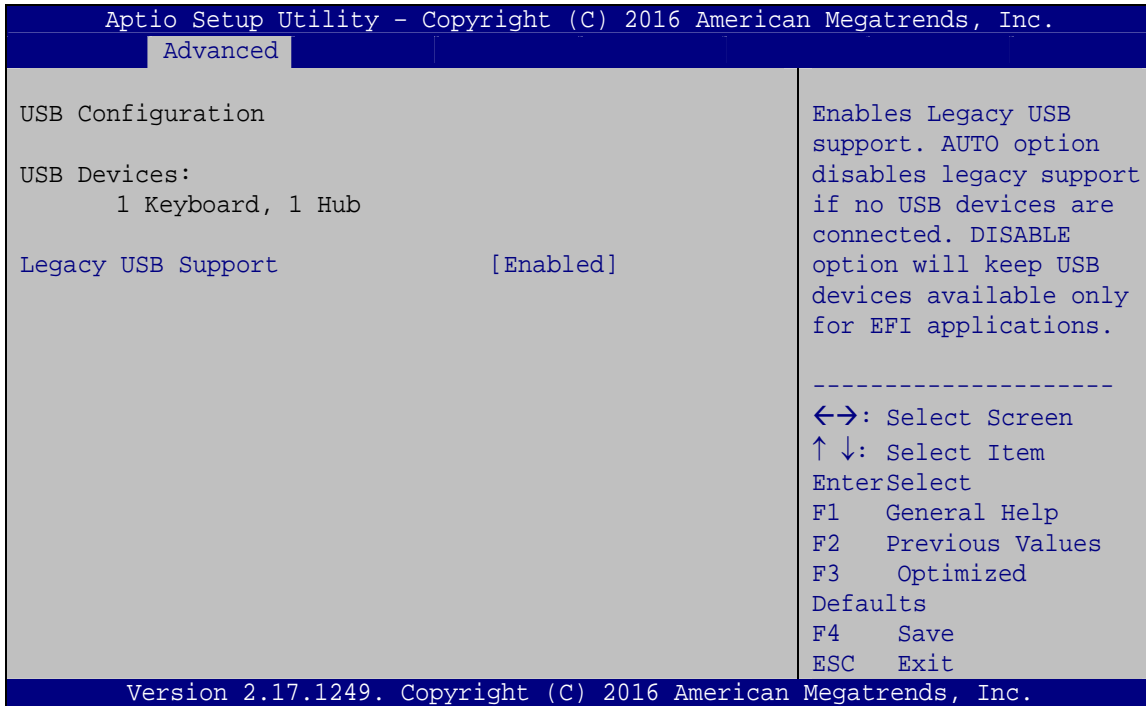

BIOS Menu 8: USB Configuration

tKINO-BW SBC

→ USB Devices

The **USB Devices Enabled** field lists the USB devices that are enabled on the system

→ Legacy USB Support [Enabled]

Use the **Legacy USB Support** BIOS option to enable USB mouse and USB keyboard support. Normally if this option is not enabled, any attached USB mouse or USB keyboard does not become available until a USB compatible operating system is fully booted with all USB drivers loaded. When this option is enabled, any attached USB mouse or USB keyboard can control the system even when there is no USB driver loaded onto the system.

- **Enabled** **DEFAULT** Legacy USB support enabled
- **Disabled** Legacy USB support disabled
- **Auto** Legacy USB support disabled if no USB devices are connected

5.3.7 NVMe Configuration

Use the **NVMe Configuration** menu (**BIOS Menu 9**) to change and/or set the configuration of the NVMe devices installed in the system.

```

Aptio Setup Utility - Copyright (C) 2016 American Megatrends, Inc.
  Advanced
-----
NVMe Controller and Drive information
No NVME Device Found

-----
←→: Select Screen
↑↓: Select Item
Enter>Select
F1  General Help
F2  Previous Values
F3  Optimized
Defaults
F4  Save
ESC Exit

Version 2.17.1249. Copyright (C) 2016 American Megatrends, Inc.
    
```

BIOS Menu 9: NVMe Configuration

5.3.8 F81866 Super IO Configuration

Use the **F81866 Super IO Configuration** menu (**BIOS Menu 10**) to set or change the configurations for the serial ports.

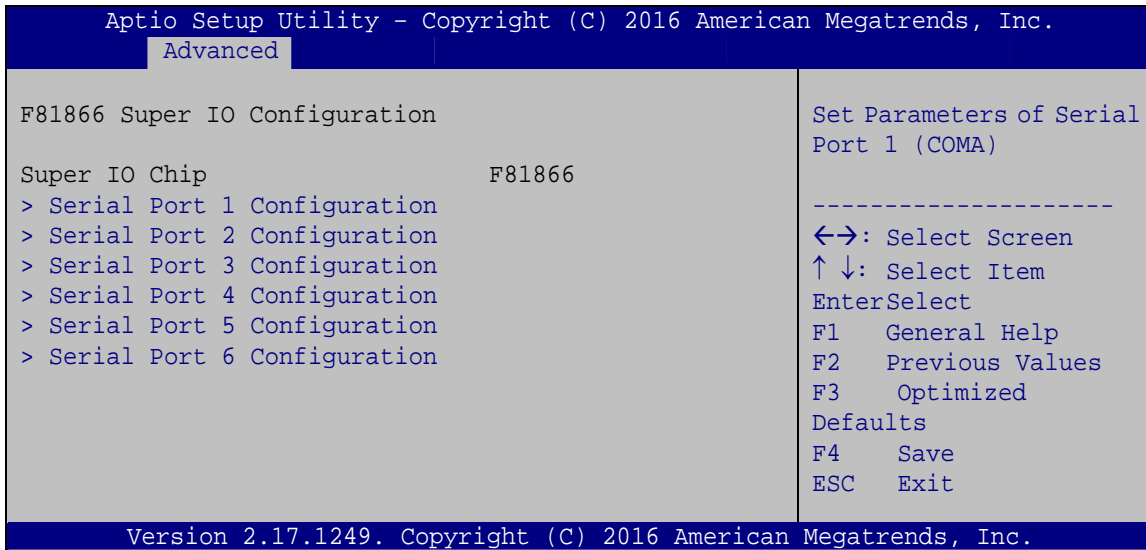

BIOS Menu 10: F81866 Super IO Configuration

5.3.8.1 Serial Port n Configuration

Use the **Serial Port n Configuration** menu (**BIOS Menu 11**) to configure the serial port n.

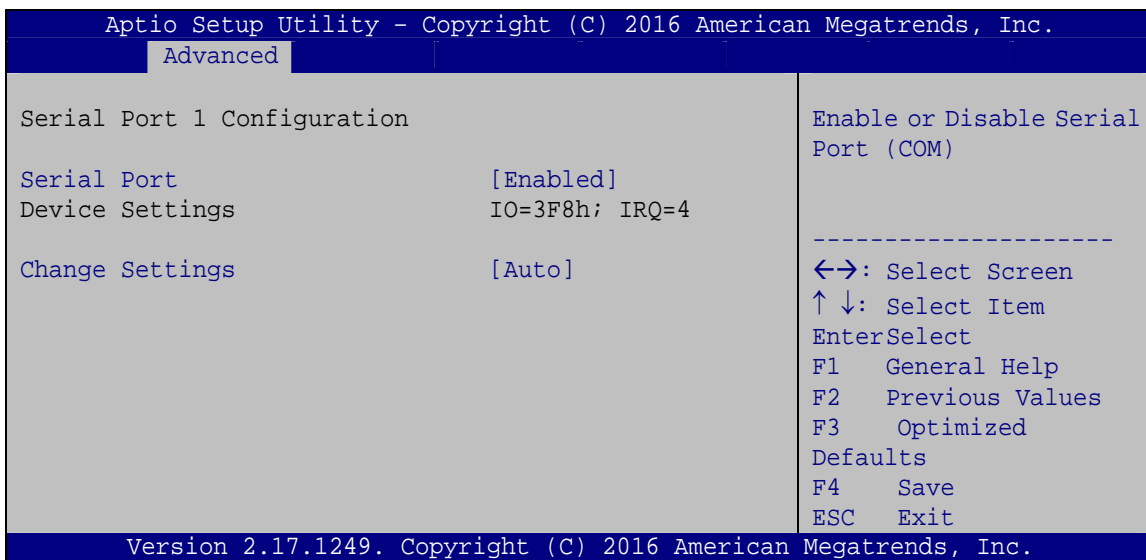

BIOS Menu 11: Serial Port n Configuration

5.3.8.1.1 Serial Port 1 Configuration

→ Serial Port [Enabled]

Use the **Serial Port** option to enable or disable the serial port.

- **Disabled** Disable the serial port
- **Enabled** **DEFAULT** Enable the serial port

→ Change Settings [Auto]

Use the **Change Settings** option to change the serial port IO port address and interrupt address.

- **Auto** **DEFAULT** The serial port IO port address and interrupt address are automatically detected.
- **IO=3F8h; IRQ=4** Serial Port I/O port address is 3F8h and the interrupt address is IRQ4
- **IO=3F8h; IRQ=3, 4,5,6,7,9,10,11,12** Serial Port I/O port address is 3F8h and the interrupt address is IRQ3,4,5,6,7,9,10,11,12
- **IO=2F8h; IRQ=3, 4,5,6,7,9,10,11,12** Serial Port I/O port address is 2F8h and the interrupt address is IRQ3,4,5,6,7,9,10,11,12
- **IO=3E8h; IRQ=3, 4,5,6,7,9,10,11,12** Serial Port I/O port address is 3E8h and the interrupt address is IRQ3,4,5,6,7,9,10,11,12
- **IO=2E8h; IRQ=3, 4,5,6,7,9,10,11,12** Serial Port I/O port address is 2E8h and the interrupt address is IRQ3,4,5,6,7,9,10,11,12

5.3.8.1.3 Serial Port 3 Configuration

→ Serial Port [Enabled]

Use the **Serial Port** option to enable or disable the serial port.

- **Disabled** Disable the serial port
- **Enabled** **DEFAULT** Enable the serial port

→ Change Settings [Auto]

Use the **Change Settings** option to change the serial port IO port address and interrupt address.

- **Auto** **DEFAULT** The serial port IO port address and interrupt address are automatically detected.
- **IO=3E8h; IRQ=10** Serial Port I/O port address is 3E8h and the interrupt address is IRQ10
- **IO=3E8h;
IRQ=10,11** Serial Port I/O port address is 3E8h and the interrupt address is IRQ10,11
- **IO=2E8h;
IRQ=10,11** Serial Port I/O port address is 2E8h and the interrupt address is IRQ10,11
- **IO=2D0h;
IRQ=10,11** Serial Port I/O port address is 2D0h and the interrupt address is IRQ10,11
- **IO=2E0h;
IRQ=10,11** Serial Port I/O port address is 2E0h and the interrupt address is IRQ10,11

5.3.8.1.4 Serial Port 4 Configuration

→ Serial Port [Enabled]

Use the **Serial Port** option to enable or disable the serial port.

- **Disabled** Disable the serial port
- **Enabled** **DEFAULT** Enable the serial port

→ Change Settings [Auto]

Use the **Change Settings** option to change the serial port IO port address and interrupt address.

- **Auto** **DEFAULT** The serial port IO port address and interrupt address are automatically detected.
- **IO=2E8h; IRQ=10** Serial Port I/O port address is 2E8h and the interrupt address is IRQ10
- **IO=3E8h;
IRQ=10,11** Serial Port I/O port address is 3E8h and the interrupt address is IRQ10,11
- **IO=2E8h;
IRQ=10,11** Serial Port I/O port address is 2E8h and the interrupt address is IRQ10,11
- **IO=2D0h;
IRQ=10,11** Serial Port I/O port address is 2D0h and the interrupt address is IRQ10,11
- **IO=2E0h;
IRQ=10,11** Serial Port I/O port address is 2E0h and the interrupt address is IRQ10,11

5.3.8.1.5 Serial Port 5 Configuration

➔ **Serial Port [Enabled]**

Use the **Serial Port** option to enable or disable the serial port.

- ➔ **Disabled** Disable the serial port
- ➔ **Enabled** **DEFAULT** Enable the serial port

➔ **Change Settings [Auto]**

Use the **Change Settings** option to change the serial port IO port address and interrupt address.

- ➔ **Auto** **DEFAULT** The serial port IO port address and interrupt address are automatically detected.
- ➔ **IO=2D0h; IRQ=11** Serial Port I/O port address is 2D0h and the interrupt address is IRQ11
- ➔ **IO=3E8h;
IRQ=10,11** Serial Port I/O port address is 3E8h and the interrupt address is IRQ10,11
- ➔ **IO=2E8h;
IRQ=10,11** Serial Port I/O port address is 2E8h and the interrupt address is IRQ10,11
- ➔ **IO=2D0h;
IRQ=10,11** Serial Port I/O port address is 2D0h and the interrupt address is IRQ10,11
- ➔ **IO=2E0h;
IRQ=10,11** Serial Port I/O port address is 2E0h and the interrupt address is IRQ10,11

➔ **Serial Port Mode [RS232]**

Use the **Serial Port Mode** option to select the Serial Port 5 signaling mode.

- ➔ **RS232** **DEFAULT** Serial Port 5 signaling mode is RS-232
- ➔ **RS485** Serial Port 5 signaling mode is RS-485
- ➔ **RS422** Serial Port 5 signaling mode is RS-422

5.3.8.1.6 Serial Port 6 Configuration

→ **Serial Port [Enabled]**

Use the **Serial Port** option to enable or disable the serial port.

- **Disabled** Disable the serial port
- **Enabled DEFAULT** Enable the serial port

→ **Change Settings [Auto]**

Use the **Change Settings** option to change the serial port IO port address and interrupt address.

- **Auto DEFAULT** The serial port IO port address and interrupt address are automatically detected.
- **IO=2E0h; IRQ=11** Serial Port I/O port address is 2E0h and the interrupt address is IRQ11
- **IO=3E8h;
IRQ=10,11** Serial Port I/O port address is 3E8h and the interrupt address is IRQ10,11
- **IO=2E8h;
IRQ=10,11** Serial Port I/O port address is 2E8h and the interrupt address is IRQ10,11
- **IO=2D0h;
IRQ=10,11** Serial Port I/O port address is 2D0h and the interrupt address is IRQ10,11
- **IO=2E0h;
IRQ=10,11** Serial Port I/O port address is 2E0h and the interrupt address is IRQ10,11

→ **Serial Port Mode [RS232]**

Use the **Serial Port Mode** option to select the Serial Port 6 signaling mode.

- **RS232 DEFAULT** Serial Port 6 signaling mode is RS-232
- **RS485** Serial Port 6 signaling mode is RS-485
- **RS422** Serial Port 6 signaling mode is RS-422

tKINO-BW SBC

5.3.9 iWDD H/W Monitor

The **iWDD H/W Monitor** menu (**BIOS Menu 12**) contains the fan configuration submenus and displays operating temperature, fan speeds and system voltages.

```

Aptio Setup Utility - Copyright (C) 2016 American Megatrends, Inc.
Advanced
PC Health Status
CPU temperature           :+49 °C
System temperature       :+33 °C

CPU_FAN1 Speed           :N/A
SYS_FAN1 Speed           :N/A

CPU_CORE                  :+1.266 V
+5V                       :+5.070 V
+12V                      :+11.967 V
+DDR                      :+1.357 V
+5VSB                     :+5.085 V
+3.3V                     :+3.310 V
+3.3VSB                   :+3.217 V

> Smart Fan Mode Configuration

Smart Fan Mode Select

-----
<->: Select Screen
↑ ↓: Select Item
EnterSelect
+ - Change Opt.
F1  General Help
F2  Previous Values
F3  Optimized Defaults
F4  Save & Exit
ESC Exit

Version 2.17.1249. Copyright (C) 2016 American Megatrends, Inc.

```

BIOS Menu 12: iWDD H/W Monitor**→ PC Health Status**

The following system parameters and values are shown. The system parameters that are monitored are:

- System Temperatures:
 - CPU Temperature
 - System temperature
- Fan Speed:
 - CPU Fan Speed
 - System Fan Speed
- Voltages
 - CPU_CORE
 - +5V
 - +12V

- +DDR
- +5VSB
- +3.3V
- +3.3VSB

5.3.9.1 Smart Fan Mode Configuration

Use the **Smart Fan Mode Configuration** submenu (**BIOS Menu 13**) to configure fan temperature and speed settings.

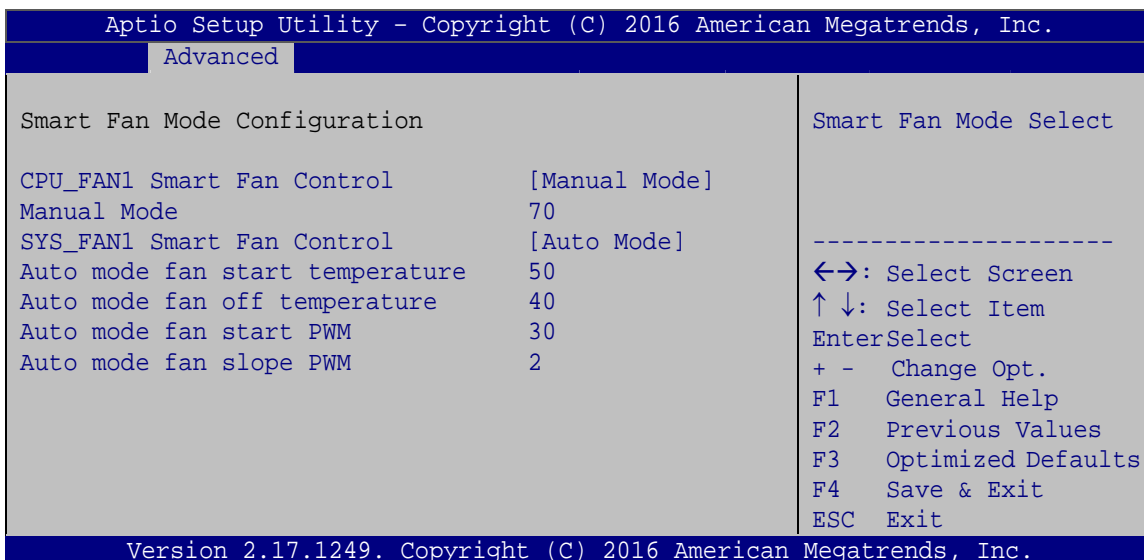

BIOS Menu 13: Smart Fan Mode Configuration

→ CPU_FAN1 Smart Fan Control [Manual Mode]

Use the **CPU_FAN1 Smart Fan Control** BIOS option to configure the CPU Smart Fan.

→ **Manual Mode** **DEFAULT** The fan spins at the speed set in the Manual Mode option

→ Manual Mode

Use the + or – key to change the fan **Manual Mode** value. Enter a decimal number between 1 and 100.

tKINO-BW SBC

→ **SYS_FAN1 Smart Fan Control [Auto Mode]**

Use the **SYS_FAN1 Smart Fan Control** BIOS option to configure the system smart fan.

- | | | | |
|---|--------------------|----------------|---|
| → | Manual Mode | | The fan spins at the speed set in the Manual Mode option |
| → | Auto Mode | DEFAULT | The fan adjusts its speed using these settings:
Auto mode fan start temperature
Auto mode fan off temperature
Auto mode fan start PWM
Auto mode fan slope PWM |

→ **Auto mode fan start temperature [50]****WARNING:**

Setting this value too high may cause the fan to rotate at full speed only when the CPU is at a very high temperature and therefore cause the system to be damaged.

The **Auto mode fan start temperature** option can only be set if the **SYS_FAN1 Smart Fan Control** option is set to **Auto Mode**. If the system temperature is between **Start Temperature** and **Off Temperature**, the fan speed change to be **Start PWM**. To set a value, select the **Auto mode fan start temperature** option and enter a decimal number between 1 and 100. The temperature range is specified below.

- Minimum Value: 1°C
- Maximum Value: 100°C

→ **Auto mode fan off temperature [40]**



WARNING:

Setting this value too high may cause the fan to speed up only when the CPU is at a very high temperature and therefore cause the system to be damaged.

The **Auto mode fan off temperature** option can only be set if the **SYS_FAN1 Smart Fan control** option is set to **Auto Mode**. If the system temperature is lower than **Auto mode fan off temperature**, the fan speed change to be lowest. To set a value, select the **Auto mode fan off temperature** option and enter a decimal number between 1 and 100. The temperature range is specified below.

- Minimum Value: 1°C
- Maximum Value: 100°C

→ **Auto mode fan start PWM [30]**

The **Auto mode fan start PWM** option can only be set if the **SYS_FAN1 Smart Fan control** option is set to **Auto Mode**. Use the **Auto mode fan start PWM** option to set the PWM start value. To set a value, select the **Auto mode fan start PWM** option and enter a decimal number between 1 and 100. The temperature range is specified below.

- Minimum Value: 1
- Maximum Value: 100

→ **Auto mode fan slope PWM [2]**

The **Auto mode fan slope PWM** option can only be set if the **SYS_FAN1 Smart Fan control** option is set to **Auto Mode**. Use the **Auto mode fan slope PWM** option to select the linear rate at which the PWM mode increases with respect to an increase in temperature. To set a value, select the **Auto mode fan slope PWM** option and enter a decimal number between 1 and 8.

5.3.10 Serial Port Console Redirection

The **Serial Port Console Redirection** menu (**BIOS Menu 14**) allows the console redirection options to be configured. Console redirection allows users to maintain a system remotely by re-directing keyboard input and text output through the serial port.

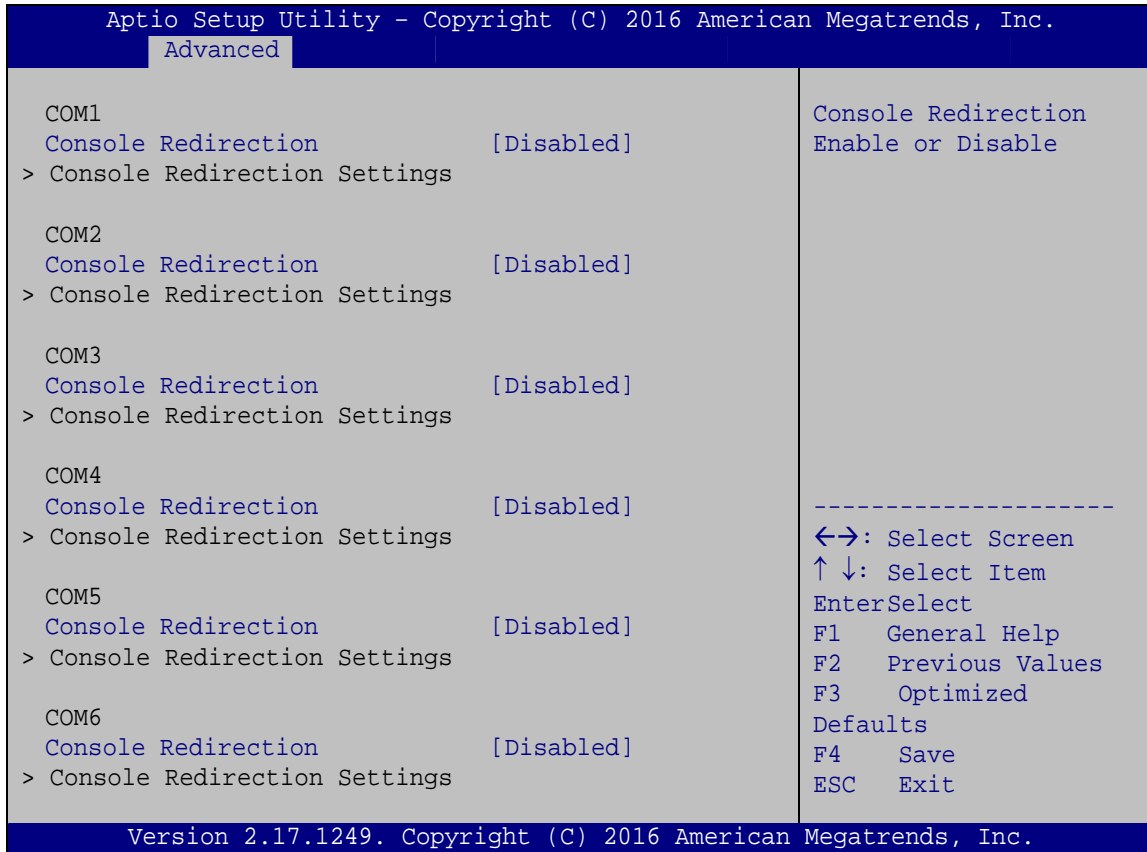

BIOS Menu 14: Serial Port Console Redirection

➔ **Console Redirection [Disabled]**

Use **Console Redirection** option to enable or disable the console redirection function.

- ➔ **Disabled** **DEFAULT** Disabled the console redirection function
- ➔ **Enabled** Enabled the console redirection function

5.3.10.1 Console Redirection Settings

The **Console Redirection Settings** menu (**BIOS Menu 15**) allows the console redirection options to be configured. The option is active when Console Redirection option is enabled.

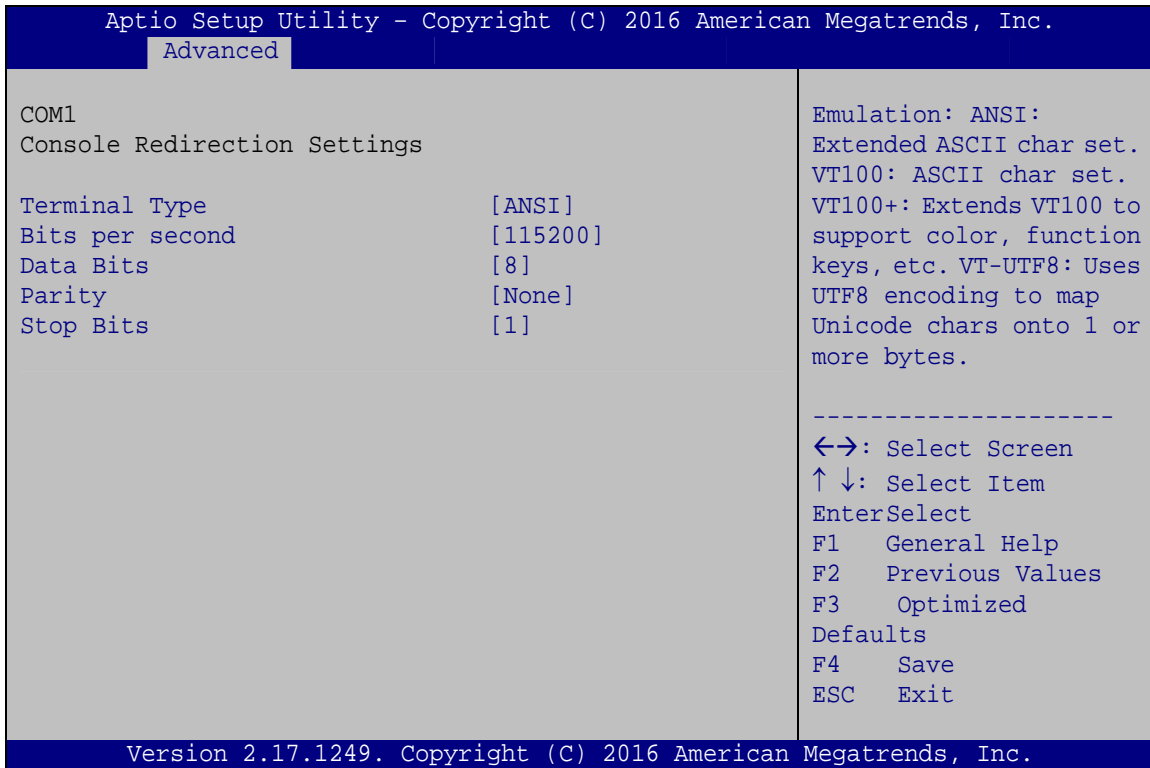

BIOS Menu 15: Console Redirection Settings

→ Terminal Type [ANSI]

Use the **Terminal Type** option to specify the remote terminal type.

- **VT100** The target terminal type is VT100
- **VT100+** The target terminal type is VT100+
- **VT-UTF8** The target terminal type is VT-UTF8
- **ANSI** **DEFAULT** The target terminal type is ANSI

tKINO-BW SBC**→ Bits per second [115200]**

Use the **Bits per second** option to specify the serial port transmission speed. The speed must match the other side. Long or noisy lines may require lower speeds.

- 9600** Sets the serial port transmission speed at 9600.
- 19200** Sets the serial port transmission speed at 19200.
- 38400** Sets the serial port transmission speed at 38400.
- 57600** Sets the serial port transmission speed at 57600.
- 115200** **DEFAULT** Sets the serial port transmission speed at 115200.

→ Data Bits [8]

Use the **Data Bits** option to specify the number of data bits.

- 7** Sets the data bits at 7.
- 8** **DEFAULT** Sets the data bits at 8.

→ Parity [None]

Use the **Parity** option to specify the parity bit that can be sent with the data bits for detecting the transmission errors.

- None** **DEFAULT** No parity bit is sent with the data bits.
- Even** The parity bit is 0 if the number of ones in the data bits is even.
- Odd** The parity bit is 0 if the number of ones in the data bits is odd.
- Mark** The parity bit is always 1. This option does not provide error detection.
- Space** The parity bit is always 0. This option does not provide error detection.

➔ **Stop Bits [1]**

Use the **Stop Bits** option to specify the number of stop bits used to indicate the end of a serial data packet. Communication with slow devices may require more than 1 stop bit.

- ➔ **1** **DEFAULT** Sets the number of stop bits at 1.
- ➔ **2** Sets the number of stop bits at 2.

5.3.11 IEI Feature

Use the **IEI Feature** menu (**BIOS Menu 16**) to configure One Key Recovery function.

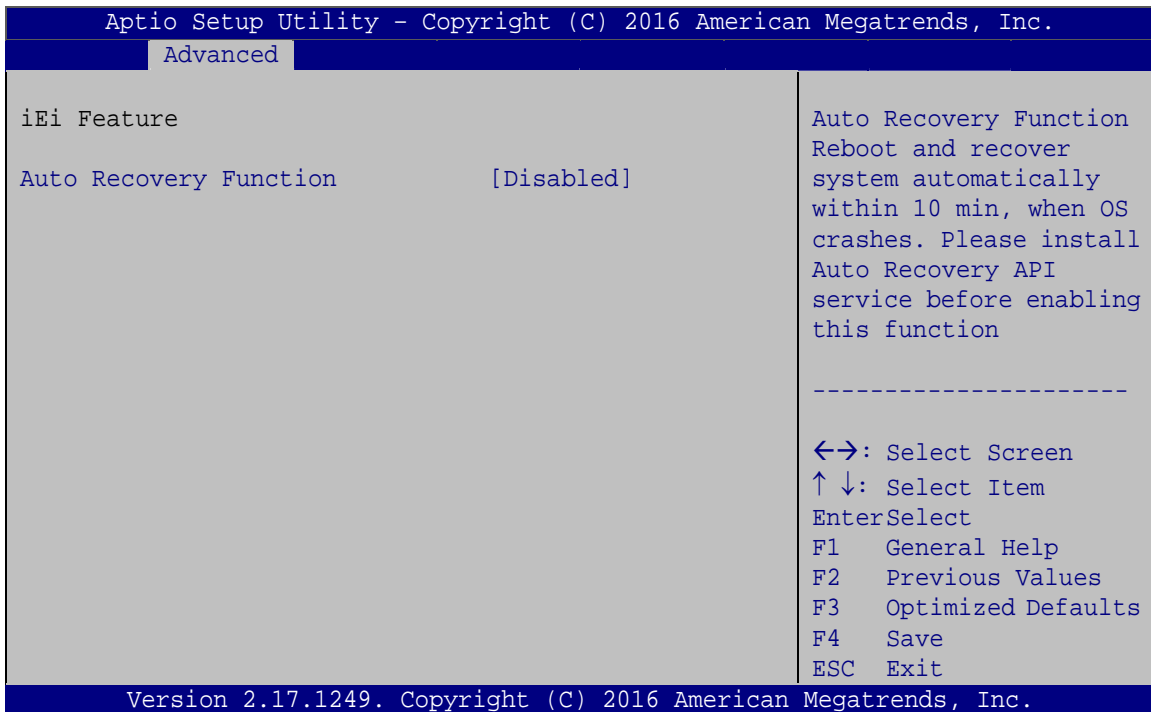

BIOS Menu 16: IEI Feature

➔ **Auto Recovery Function [Disabled]**

Use the **Auto Recovery Function** BIOS option to enable or disable the auto recovery function of the IEI One Key Recovery.

- ➔ **Disabled** **DEFAULT** Auto recovery function disabled
- ➔ **Enabled** Auto recovery function enabled

5.4 Chipset

Use the **Chipset** menu (**BIOS Menu 17**) to access the north bridge and south bridge configuration menus



WARNING!

Setting the wrong values for the Chipset BIOS selections in the Chipset BIOS menu may cause the system to malfunction.

```

Aptio Setup Utility - Copyright (C) 2016 American Megatrends, Inc.
Main   Advanced  Chipset  Security  Boot   Save & Exit
-----
> North Bridge
> South Bridge

North Bridge Parameters
-----
<->: Select Screen
↑ ↓: Select Item
Enter>Select
+/-: Change Opt.
F1   General Help
F2   Previous Values
F3   Optimized Defaults
F4   Save & Exit
ESC  Exit
    
```

BIOS Menu 17: Chipset

5.4.1 North Bridge Configuration

Use the **North Bridge Configuration** menu (**BIOS Menu 18**) to configure the Intel IGD settings.

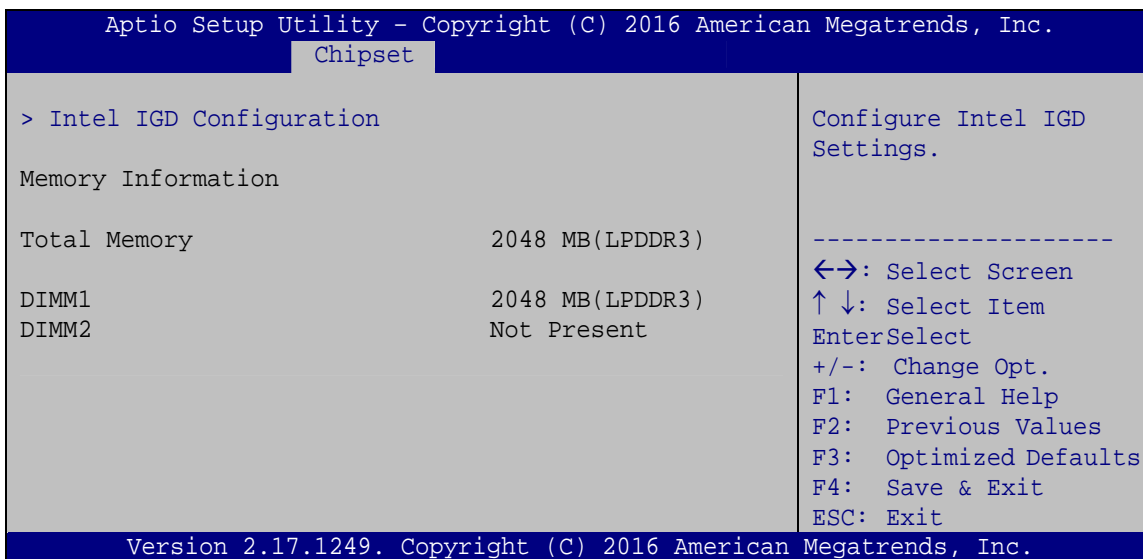

BIOS Menu 18: North Bridge Configuration

→ Memory Information

The **Memory Information** lists a brief summary of the on-board memory. The fields in **Memory Information** cannot be changed.

5.4.1.1 Intel IGD Configuration

Use the **Intel IGD Configuration** menu (**BIOS Menu 19**) to configure the video device connected to the system.

tKINO-BW SBC

```

Aptio Setup Utility - Copyright (C) 2016 American Megatrends, Inc.
Chipset
Intel IGD Configuration
Primary Display [Auto]
Primary IGFX Boot Display [Auto]
DVMT Pre-Allocated [256M]
DVMT Total Gfx Mem [Max]
On board LVDS [Enabled]
Backlight Control Mode [CCFL]
Backlight Control Type [PWM]
Select which of IGD/PCI Graphics device should be Primary Display.
-----
<->: Select Screen
^ v: Select Item
Enter>Select
+/-: Change Opt.
F1: General Help
F2: Previous Values
F3: Optimized Defaults
F4: Save & Exit
ESC: Exit
Version 2.17.1249. Copyright (C) 2016 American Megatrends, Inc.
  
```

BIOS Menu 19: Intel IGD Configuration

→ Primary Display [Auto]

Use the **Primary Display** option to select the graphics controller used as the primary boot device. Select either an integrated graphics controller (IGD) or a PCI express (PEG) controller. Configuration options are listed below:

- Auto **DEFAULT**
- IGD
- PCIe

→ Primary IGFX Boot Display [Auto]

Use the **Primary IGFX Boot Display** option to select the display device used by the system when it boots.

- Auto **DEFAULT**
- CRT
- LVDS
- DP/HDMI1

→ DVMT Pre-Allocated [256MB]

Use the **DVMT Pre-Allocated** option to set the amount of system memory allocated to the integrated graphics processor when the system boots. The system memory allocated can then only be used as graphics memory, and is no longer available to applications or the operating system. Configuration options are listed below:

- 64M
- 128M
- 256M **DEFAULT**
- 512M

→ DVMT Total Gfx Mem [Max]

Use the **DVMT Total Gfx Mem** option to select DVMT5.0 total graphic memory size used by the internal graphic device. The following options are available:

- 128M
- 256M
- Max **DEFAULT**

→ On board LVDS [Enabled]

Use the **On board LVDS** option enables or disables the on-board LVDS connector.

- Disabled** The on-board LVDS connector is disabled.
- Enabled** **DEFAULT** The on-board LVDS connector is disabled.

→ Backlight Control Mode [CCFL]

Use the **Backlight Control Mode** option to specify the backlight control mode. Configuration options are listed below.

- LED
- CCFL **DEFAULT**

tKINO-BW SBC

→ Backlight Control Type [PWM]

Use the **Backlight Control Type** option to specify the backlight control type. Configuration options are listed below.

- PWM **DEFAULT**
- DC

5.4.2 South Bridge Configuration

Use the **South Bridge Configuration** menu (**BIOS Menu 20**) to configure the south bridge chipset.

```

Aptio Setup Utility - Copyright (C) 2016 American Megatrends, Inc.
Chipset
Auto Power Button Function      [Disabled (ATX)]
Restore AC Power Loss           [Last State]
Audio Controller                [Enabled]
> PCI Express Configuration

-----
<=>: Select Screen
↑ ↓: Select Item
EnterSelect
+/-: Change Opt.
F1:  General Help
F2:  Previous Values
F3:  Optimized Defaults
F4:  Save & Exit
ESC: Exit

Version 2.17.1249. Copyright (C) 2016 American Megatrends, Inc.
    
```

BIOS Menu 20: South Bridge Configuration

→ Restore on AC Power Loss [Last State]

Use the **Restore on AC Power Loss** BIOS option to specify what state the system returns to if there is a sudden loss of power to the system.

- **Power Off** The system remains turned off
- **Power On** The system turns on
- **Last State** **DEFAULT** The system returns to its previous state. If it was on, it turns itself on. If it was off, it remains off.

➔ **Audio Controller [Enabled]**

Use the **Audio Controller** option to enable or disable the High Definition Audio controller.

- ➔ **Disabled** The onboard High Definition Audio controller is disabled
- ➔ **Enabled DEFAULT** The onboard High Definition Audio controller is detected automatically and enabled

5.4.2.1 PCI Express Configuration

Use the **PCI Express Configuration** menu (**BIOS Menu 21**) to configure the PCI Express.

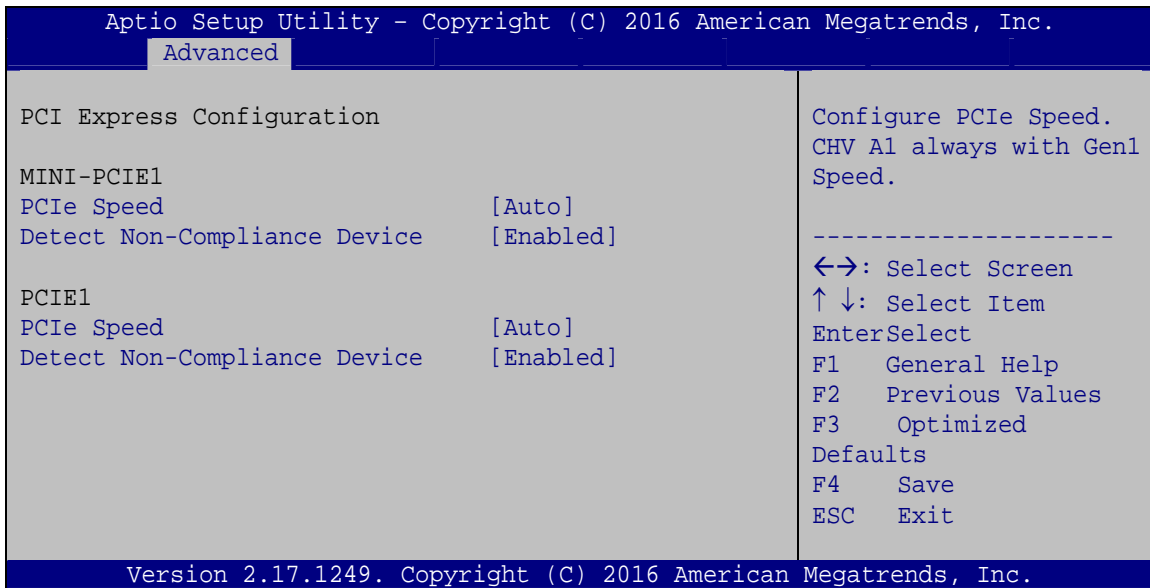

BIOS Menu 21: PCI Express Configuration

➔ **PCIe Speed [Auto]**

Use the **PCIe Speed** option to configure PCIe port speed.

- ➔ **Auto DEFAULT** Configure PCIe port speed to auto
- ➔ **Gen 2** Configure PCIe port speed to Gen2
- ➔ **Gen 1** Configure PCIe port speed to Gen1

tKINO-BW SBC

→ Detect Non-Compliance Device [Disabled]

Use the **Detect Non-Compliance Device** option to enable or disable the Non-compliant PCIe device detection function.

- **Disabled** **DEFAULT** Disables non-compliant PCIe device detection.
- **Enabled** Enables non-compliant PCIe device detection.

5.5 Security

Use the **Security** menu (**BIOS Menu 22**) to set system and user passwords.

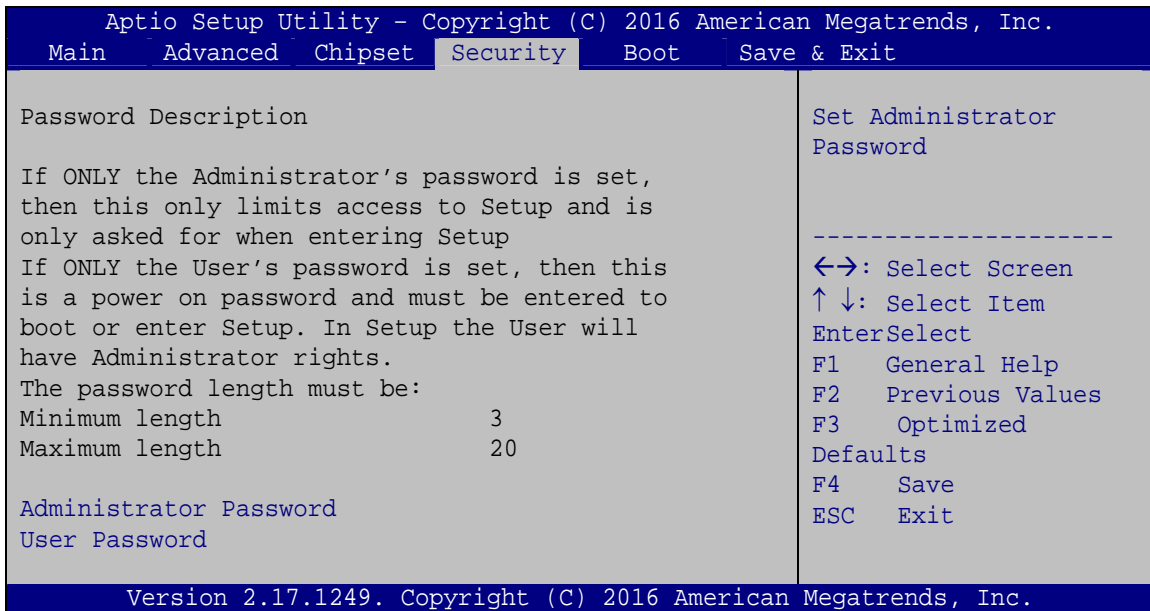

BIOS Menu 22: Security

→ Administrator Password

Use the **Administrator Password** to set or change a administrator password.

→ User Password

Use the **User Password** to set or change a user password.

5.6 Boot

Use the **Boot** menu (**BIOS Menu 23**) to configure system boot options.

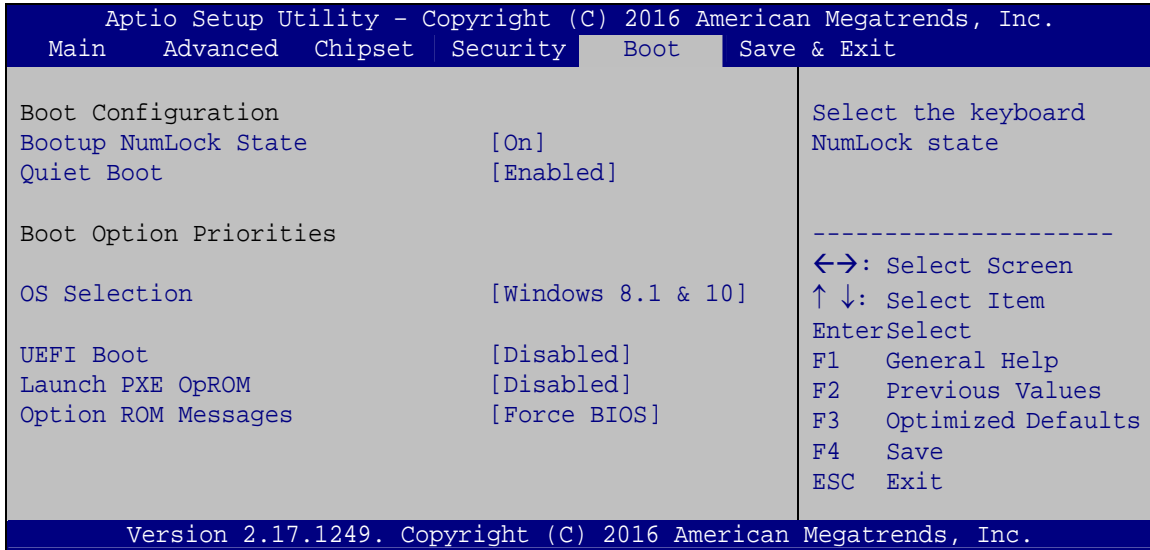

BIOS Menu 23: Boot

→ Bootup NumLock State [On]

Use the **Bootup NumLock State** BIOS option to specify if the number lock setting must be modified during boot up.

- **On** **DEFAULT** Allows the Number Lock on the keyboard to be enabled automatically when the computer system boots up. This allows the immediate use of the 10-key numeric keypad located on the right side of the keyboard. To confirm this, the Number Lock LED light on the keyboard is lit.
- **Off** Does not enable the keyboard Number Lock automatically. To use the 10-keys on the keyboard, press the Number Lock key located on the upper left-hand corner of the 10-key pad. The Number Lock LED on the keyboard lights up when the Number Lock is engaged.

tKINO-BW SBC

→ Quiet Boot [Enabled]

Use the **Quiet Boot** BIOS option to select the screen display when the system boots.

- **Disabled** Normal POST messages displayed
- **Enabled** **DEFAULT** OEM Logo displayed instead of POST messages

→ OS Selection [Windows 8.1 & 10]

Use the **OS Selection** BIOS option to select an operating system (OS) before installing OS.

- **Windows 8.1 & 10** **DEFAULT** The system will be installed with Windows 8.1 or Windows 10 operating system.
- **Windows 7** The system will be installed with Windows 7 operating system.
- **Linux** The system will be installed with Linux operating system.

→ UEFI Boot [Disabled]

Use the **UEFI Boot** option to enable or disable to boot from the UEFI devices.

- **Enabled** Boot from UEFI devices is enabled.
- **Disabled** **DEFAULT** Boot from UEFI devices is disabled.

→ Launch PXE OpROM [Disabled]

Use the **Launch PXE OpROM** option to enable or disable boot option for legacy network devices.

- **Disabled** **DEFAULT** Ignore all PXE Option ROMs
- **Enabled** Load PXE Option ROMs.

➔ **Option ROM Messages [Keep Current]**

Use the **Option ROM Messages** option to set the Option ROM display mode.

- ➔ **Force BIOS** Sets display mode to force BIOS.
- ➔ **Keep DEFAULT Current** Sets display mode to current.

➔ **Boot Option Priority**

Use the **Boot Option Priority** function to set the system boot sequence from the available devices. The drive sequence also depends on the boot sequence in the individual device section.

5.7 Exit

Use the **Exit** menu (**BIOS Menu 24**) to load default BIOS values, optimal failsafe values and to save configuration changes.

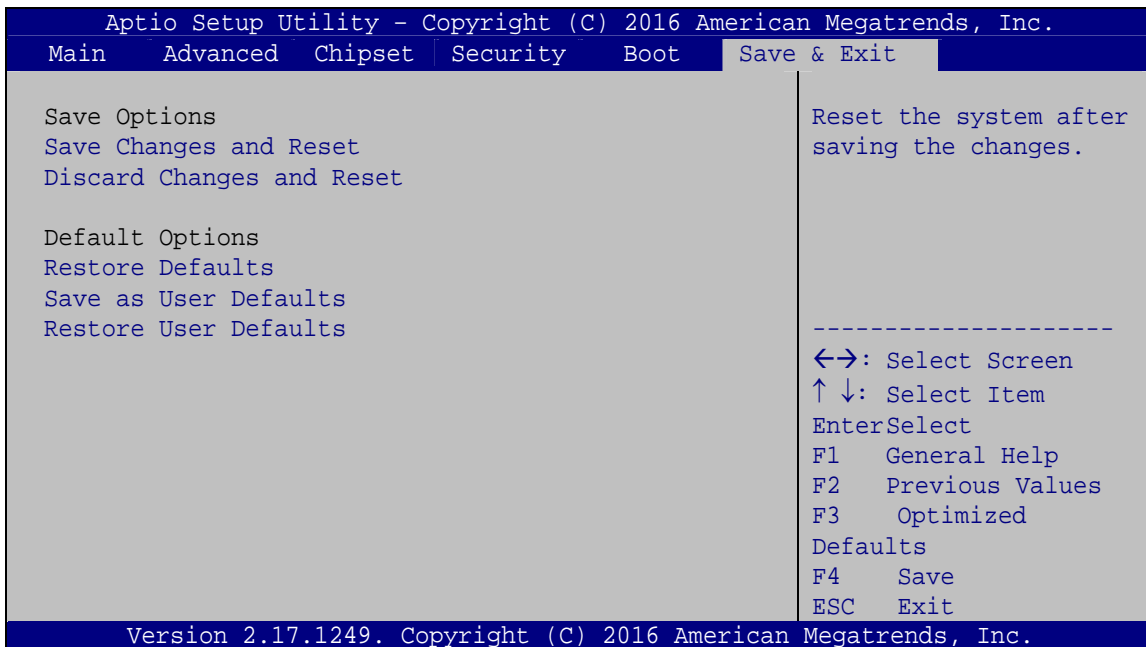

BIOS Menu 24: Exit

tKINO-BW SBC

→ **Save Changes and Reset**

Use the **Save Changes and Reset** option to save the changes made to the BIOS options and to exit the BIOS configuration setup program.

→ **Discard Changes and Reset**

Use the **Discard Changes and Reset** option to exit the system without saving the changes made to the BIOS configuration setup program.

→ **Restore Defaults**

Use the **Restore Defaults** option to load the optimal default values for each of the parameters on the Setup menus. **F3 key can be used for this operation.**

→ **Save as User Defaults**

Use the **Save as User Defaults** option to save the changes done so far as user defaults.

→ **Restore User Defaults**

Use the **Restore User Defaults** option to restore the user defaults to all the setup options.

Chapter

6

Software Drivers

tKINO-BW SBC



NOTE:

The content of the CD may vary throughout the life cycle of the product and is subject to change without prior notice. Visit the IEI website or contact technical support for the latest updates.

6.1 Software Installation

All the drivers for the tKINO-BW are on the CD that came with the system. To install the drivers, please follow the steps below.

Step 1: Insert the CD into a CD drive connected to the system.



NOTE:

If the installation program doesn't start automatically:
Click "Start->My Computer->CD Drive->autorun.exe"

Step 2: The driver main menu appears (**Figure 6-1**).

Step 3: Click **tKINO-BW**.



Figure 6-1: Driver CD Main Menu

Step 4: A new screen with a list of available drivers appears (Figure 6-2).



Figure 6-2: Available Drivers

Step 5: Install all of the necessary drivers in the menu.

6.2 Available Software Drivers

All the drivers for the tKINO-BW are on the utility CD that came with the system. The utility CD contains drivers for Windows 7, Windows 8 and Windows 10 operating systems. If the drivers are not installed automatically, please install the following drivers manually.

The following drivers can be installed on the **tKINO-BW**:

- Chipset
- Graphics
- Audio
- LAN
- USB 3.0
- Serial I/O
- TXE



NOTE:

The Intel TXE requires that Microsoft's "Kernel-Mode Driver Framework (KMDf) version 1.11 update for Windows 7" must be installed first on Windows 7 OS. If the KMDf is not installed, either error 37 or error 28 may appear on the Intel TXE device in Device Manager.

Please find the KMDf version 1.11 update for Windows 7 in the TXE driver folder in the driver CD or click the following link to download it.

<http://www.microsoft.com/en-us/download/details.aspx?id=38423>

Appendix

A

Regulatory Compliance

DECLARATION OF CONFORMITY



This equipment has been tested and found to comply with specifications for CE marking. If the user modifies and/or installs other devices in the equipment, the CE conformity declaration may no longer apply.

FCC WARNING



This equipment complies with Part 15 of the FCC Rules. Operation is subject to the following two conditions:

- This device may not cause harmful interference, and
- This device must accept any interference received, including interference that may cause undesired operation.

This equipment has been tested and found to comply with the limits for a Class A digital device, pursuant to part 15 of the FCC Rules. These limits are designed to provide reasonable protection against harmful interference when the equipment is operated in a commercial environment. This equipment generates, uses, and can radiate radio frequency energy and, if not installed and used in accordance with the instruction manual, may cause harmful interference to radio communications. Operation of this equipment in a residential area is likely to cause harmful interference in which case the user will be required to correct the interference at his own expense.

Appendix

B

BIOS Menu Options

System Date [xx/xx/xx]	72
System Time [xx:xx:xx]	72
Wake system with Fixed Time [Disabled].....	74
Security Device Support [Disabled].....	75
Intel® Virtualization Technology [Enabled]	76
EIST [Enabled].....	77
STAT Configuration [Enabled].....	77
SATA Mode Selection [AHCI].....	78
Hot Plug [Disabled].....	78
USB Devices	79
Legacy USB Support [Enabled].....	79
Serial Port [Enabled].....	81
Change Settings [Auto]	81
Serial Port [Enabled].....	82
Change Settings [Auto]	82
Serial Port [Enabled].....	83
Change Settings [Auto]	83
Serial Port [Enabled].....	84
Change Settings [Auto]	84
Serial Port [Enabled].....	85
Change Settings [Auto]	85
Serial Port Mode [RS232]	85
Serial Port [Enabled].....	86
Change Settings [Auto]	86
Serial Port Mode [RS232]	86
PC Health Status	87
CPU_FAN1 Smart Fan Control [Manual Mode]	88
Manual Mode	88
SYS_FAN1 Smart Fan Control [Auto Mode].....	89
Auto mode fan start temperature [50].....	89
Auto mode fan off temperature [40].....	90
Auto mode fan start PWM [30].....	90
Auto mode fan slope PWM [2]	90
Console Redirection [Disabled]	91

Terminal Type [ANSI].....	92
Bits per second [115200].....	93
Data Bits [8]	93
Parity [None].....	93
Stop Bits [1].....	94
Auto Recovery Function [Disabled].....	94
Memory Information	96
Primary Display [Auto]	97
Primary IGFX Boot Display [Auto]	97
DVMT Pre-Allocated [256MB].....	98
DVMT Total Gfx Mem [Max].....	98
On board LVDS [Enabled]	98
Backlight Control Mode [CCFL].....	98
Backlight Control Type [PWM]	99
Restore on AC Power Loss [Last State]	99
Audio Controller [Enabled]	100
PCIe Speed [Auto].....	100
Detect Non-Compliance Device [Disabled]	101
Administrator Password	101
User Password	101
Bootup NumLock State [On].....	102
Quiet Boot [Enabled]	103
OS Selection [Windows 8.1 & 10].....	103
UEFI Boot [Disabled]	103
Launch PXE OpROM [Disabled]	103
Option ROM Messages [Keep Current]	104
Boot Option Priority.....	104
Save Changes and Reset	105
Discard Changes and Reset	105
Restore Defaults	105
Save as User Defaults	105
Restore User Defaults	105

Appendix

C

Terminology

AC '97	Audio Codec 97 (AC'97) refers to a codec standard developed by Intel® in 1997.
ACPI	Advanced Configuration and Power Interface (ACPI) is an OS-directed configuration, power management, and thermal management interface.
AHCI	Advanced Host Controller Interface (AHCI) is a SATA Host controller register-level interface.
ATA	The Advanced Technology Attachment (ATA) interface connects storage devices including hard disks and CD-ROM drives to a computer.
APM	The Advanced Power Management (APM) application program interface (API) enables the inclusion of power management in the BIOS.
ARMD	An ATAPI Removable Media Device (ARMD) is any ATAPI device that supports removable media, besides CD and DVD drives.
ASKIR	Amplitude Shift Keyed Infrared (ASKIR) is a form of modulation that represents a digital signal by varying the amplitude (“volume”) of the signal. A low amplitude signal represents a binary 0, while a high amplitude signal represents a binary 1.
BIOS	The Basic Input/Output System (BIOS) is firmware that is first run when the computer is turned on and can be configured by the end user
CODEC	The Compressor-Decompressor (CODEC) encodes and decodes digital audio data on the system.
CMOS	Complimentary metal-oxide-conductor is a type of integrated circuit used in chips like static RAM and microprocessors.
COM	COM is used to refer to serial ports. Serial ports offer serial communication to expansion devices. The serial port on a personal

	computer is usually a male DE-9 connector.
DAC	The Digital-to-Analog Converter (DAC) converts digital signals to analog signals.
DDR	Double Data Rate refers to a data bus transferring data on both the rising and falling edges of the clock signal.
DMA	Direct Memory Access (DMA) enables some peripheral devices to bypass the system processor and communicate directly with the system memory.
DIMM	Dual Inline Memory Modules are a type of RAM that offer a 64-bit data bus and have separate electrical contacts on each side of the module.
EHCI	The Enhanced Host Controller Interface (EHCI) specification is a register-level interface description for USB 2.0 Host Controllers.
GbE	Gigabit Ethernet (GbE) is an Ethernet version that transfers data at 1.0 Gbps and complies with the IEEE 802.3-2005 standard.
GPIO	General purpose input
IrDA	Infrared Data Association (IrDA) specify infrared data transmission protocols used to enable electronic devices to wirelessly communicate with each other.
L1 Cache	The Level 1 Cache (L1 Cache) is a small memory cache built into the system processor.
L2 Cache	The Level 2 Cache (L2 Cache) is an external processor memory cache.
LVDS	Low-voltage differential signaling (LVDS) is a dual-wire, high-speed differential electrical signaling system commonly used to connect LCD displays to a computer.
MAC	The Media Access Control (MAC) protocol enables several terminals or network nodes to communicate in a LAN, or other multipoint networks.

PCIe	PCI Express (PCIe) is a communications bus that uses dual data lines for full-duplex (two-way) serial (point-to-point) communications between the SBC components and/or expansion cards and the SBC chipsets. Each line has a 2.5 Gbps data transmission rate and a 250 MBps sustained data transfer rate.
POST	The Power-on Self Test (POST) is the pre-boot actions the system performs when the system is turned-on.
QVGA	Quarter Video Graphics Array (QVGA) refers to a display with a resolution of 320 x 240 pixels.
RAM	Random Access Memory (RAM) is a form of storage used in computer. RAM is volatile memory, so it loses its data when power is lost. RAM has very fast data transfer rates compared to other storage like hard drives.
SATA	Serial ATA (SATA) is a serial communications bus designed for data transfers between storage devices and the computer chipsets. The SATA bus has transfer speeds up to 1.5 Gbps and the SATA 3Gb/s bus has data transfer speeds of up to 3.0 Gbps.
S.M.A.R.T	Self Monitoring Analysis and Reporting Technology (S.M.A.R.T) refers to automatic status checking technology implemented on hard disk drives.
UART	Universal Asynchronous Receiver-transmitter (UART) is responsible for asynchronous communications on the system and manages the system's serial communication (COM) ports.
UHCI	The Universal Host Controller Interface (UHCI) specification is a register-level interface description for USB 1.1 Host Controllers.
USB	The Universal Serial Bus (USB) is an external bus standard for interfacing devices. USB 1.1 supports 12Mbps data transfer rates, while

tKINO-BW SBC

USB 2.0 supports 480Mbps data transfer rates.

VGA

The Video Graphics Array (VGA) is a graphics display system developed by IBM.

Appendix

D

Digital I/O Interface

D.1 Introduction

The DIO connector on the tKINO-BW is interfaced to GPIO ports on the Super I/O chipset. The DIO has both 8-bit digital inputs and 8-bit digital outputs. The digital inputs and digital outputs are generally control signals that control the on/off circuit of external devices or TTL devices. Data can be read or written to the selected address to enable the DIO functions.



NOTE:

For further information, please refer to the datasheet for the Super I/O chipset.

The BIOS interrupt call **INT 15H** controls the digital I/O.

INT 15H:

AH – 6FH	
<u>Sub-function:</u>	
AL – 8	: Set the digital port as INPUT
AL	: Digital I/O input value

D.2 Assembly Language Sample 1

```
MOV     AX, 6F08H      ;setting the digital port as input
INT     15H            ;
```

AL low byte = value

AH – 6FH	
<u>Sub-function:</u>	
AL – 9	:Set the digital port as OUTPUT
BL	:Digital I/O input value

D.3 Assembly Language Sample 2

```
MOV     AX, 6F09H      ;setting the digital port as output
MOV     BL, 09H        ;digital value is 09H
INT     15H            ;
```

Digital Output is 1001b

Appendix

E

Watchdog Timer



NOTE:

The following discussion applies to DOS. Contact IEI support or visit the IEI website for drivers for other operating systems.

The Watchdog Timer is a hardware-based timer that attempts to restart the system when it stops working. The system may stop working because of external EMI or software bugs. The Watchdog Timer ensures that standalone systems like ATMs will automatically attempt to restart in the case of system problems.

A BIOS function call (INT 15H) is used to control the Watchdog Timer.

INT 15H:

AH – 6FH Sub-function:	
AL – 2:	Sets the Watchdog Timer's period.
BL:	Time-out value (Its unit-second is dependent on the item "Watchdog Timer unit select" in CMOS setup).

Table E-1: AH-6FH Sub-function

Call sub-function 2 to set the time-out period of Watchdog Timer first. If the time-out value is not zero, the Watchdog Timer starts counting down. When the timer value reaches zero, the system resets. To ensure that this reset condition does not occur, calling sub-function 2 must periodically refresh the Watchdog Timer. However, the watchdog timer is disabled if the time-out value is set to zero.

A tolerance of at least 10% must be maintained to avoid unknown routines within the operating system (DOS), such as disk I/O that can be very time-consuming.

**NOTE:**

The Watchdog Timer is activated through software. The software application that activates the Watchdog Timer must also deactivate it when closed. If the Watchdog Timer is not deactivated, the system will automatically restart after the Timer has finished its countdown.

EXAMPLE PROGRAM:

; INITIAL TIMER PERIOD COUNTER

;

W_LOOP:

;

```

MOV      AX, 6F02H      ;setting the time-out value
MOV      BL, 30         ;time-out value is 48 seconds
INT      15H

```

;

; ADD THE APPLICATION PROGRAM HERE

;

```

CMP      EXIT_AP, 1     ;is the application over?
JNE      W_LOOP        ;No, restart the application

```

```

MOV      AX, 6F02H     ;disable Watchdog Timer
MOV      BL, 0         ;
INT      15H

```

;

; EXIT ;

Appendix

F

Hazardous Materials Disclosure

F.1 Hazardous Material Disclosure Table for IPB Products Certified as RoHS Compliant Under 2002/95/EC Without Mercury

The details provided in this appendix are to ensure that the product is compliant with the Peoples Republic of China (China) RoHS standards. The table below acknowledges the presences of small quantities of certain materials in the product, and is applicable to China RoHS only.

A label will be placed on each product to indicate the estimated “Environmentally Friendly Use Period” (EFUP). This is an estimate of the number of years that these substances would “not leak out or undergo abrupt change.” This product may contain replaceable sub-assemblies/components which have a shorter EFUP such as batteries and lamps. These components will be separately marked.

Please refer to the table on the next page.

Part Name	Toxic or Hazardous Substances and Elements					
	Lead (Pb)	Mercury (Hg)	Cadmium (Cd)	Hexavalent Chromium (CR(VI))	Polybrominated Biphenyls (PBB)	Polybrominated Diphenyl Ethers (PBDE)
Housing	O	O	O	O	O	O
Display	O	O	O	O	O	O
Printed Circuit Board	O	O	O	O	O	O
Metal Fasteners	O	O	O	O	O	O
Cable Assembly	O	O	O	O	O	O
Fan Assembly	O	O	O	O	O	O
Power Supply Assemblies	O	O	O	O	O	O
Battery	O	O	O	O	O	O

O: This toxic or hazardous substance is contained in all of the homogeneous materials for the part is below the limit requirement in SJ/T11363-2006

X: This toxic or hazardous substance is contained in at least one of the homogeneous materials for this part is above the limit requirement in SJ/T11363-2006

tKINO-BW SBC

此附件旨在确保本产品符合中国 RoHS 标准。以下表格标示此产品中某有毒物质的含量符合中国 RoHS 标准规定的限量要求。

本产品上会附有“环境友好使用期限”的标签，此期限是估算这些物质“不会有泄漏或突变”的年限。本产品可能包含有较短的环境友好使用期限的可替换元件，像是电池或灯管，这些元件将会单独标示出来。

部件名称	有毒有害物质或元素					
	铅 (Pb)	汞 (Hg)	镉 (Cd)	六价铬 (CR(VI))	多溴联苯 (PBB)	多溴二苯醚 (PBDE)
壳体	○	○	○	○	○	○
显示	○	○	○	○	○	○
印刷电路板	○	○	○	○	○	○
金属螺帽	○	○	○	○	○	○
电缆组装	○	○	○	○	○	○
风扇组装	○	○	○	○	○	○
电力供应组装	○	○	○	○	○	○
电池	○	○	○	○	○	○

○: 表示该有毒有害物质在该部件所有物质材料中的含量均在 SJ/T11363-2006 标准规定的限量要求以下。
 X: 表示该有毒有害物质至少在该部件的某一均质材料中的含量超出 SJ/T11363-2006 标准规定的限量要求。