

MODEL:  
**PPC-37xxA-N26**

**Panel PC with Intel® Atom™ N2600 CPU, DDR3, Touchscreen, USB 3.0, Dual GbE, HDMI, VGA, mSATA, SATA 3Gb/s, Audio, RS-232/422/485, IP 65 Compliant Front Panel and RoHS Compliant**

# User Manual

# Revision

---

Date	Version	Changes
12 March, 2014	1.10	Updated for R11 version Updated Section 6.8: Touchscreen Driver Installation Added touchscreen type selection jumper in Section 3.6.2
24 December, 2012	1.00	Initial release

# Copyright

---

## **COPYRIGHT NOTICE**

The information in this document is subject to change without prior notice in order to improve reliability, design and function and does not represent a commitment on the part of the manufacturer.

In no event will the manufacturer be liable for direct, indirect, special, incidental, or consequential damages arising out of the use or inability to use the product or documentation, even if advised of the possibility of such damages.

This document contains proprietary information protected by copyright. All rights are reserved. No part of this manual may be reproduced by any mechanical, electronic, or other means in any form without prior written permission of the manufacturer.

## **TRADEMARKS**

All registered trademarks and product names mentioned herein are used for identification purposes only and may be trademarks and/or registered trademarks of their respective owners.

# Table of Contents

<b>1 INTRODUCTION.....</b>	<b>1</b>
1.1 OVERVIEW.....	2
1.2 MODEL VARIATIONS .....	3
1.3 FEATURES.....	3
1.4 EXTERNAL OVERVIEW.....	4
1.4.1 <i>Front Panel</i> .....	4
1.4.2 <i>Rear Panel</i> .....	4
1.4.3 <i>Bottom Panel</i> .....	5
1.4.4 <i>Side Panels</i> .....	6
1.4.5 <i>Frame</i> .....	7
1.5 DIMENSIONS.....	8
1.5.1 <i>PPC-3708A-N26 Dimensions</i> .....	8
1.5.2 <i>PPC-3710A-N26 Dimensions</i> .....	9
1.5.3 <i>PPC-3712A-N26 Dimensions</i> .....	10
1.6 SPECIFICATIONS .....	11
<b>2 UNPACKING .....</b>	<b>13</b>
2.1 UNPACKING.....	14
2.2 PACKING LIST.....	15
2.3 OPTIONAL ITEMS .....	16
<b>3 INSTALLATION .....</b>	<b>18</b>
3.1 ANTI-STATIC PRECAUTIONS .....	19
3.2 INSTALLATION PRECAUTIONS .....	19
3.3 PREINSTALLED COMPONENTS.....	20
3.4 INSTALLATION AND CONFIGURATION STEPS .....	20
3.5 REMOVING THE BACK COVER .....	21
3.6 JUMPER SETTINGS .....	22
3.6.1 <i>Access the Jumpers</i> .....	23
3.6.2 <i>Preconfigured Jumpers</i> .....	23
3.6.3 <i>AT/ATX Power Selection Jumper</i> .....	24

## PPC-37xxA-N26 Panel PC

3.6.4	<i>Clear CMOS Jumper</i> .....	25
3.6.5	<i>mSATA/PCIe Mini Mode Selection</i> .....	26
3.7	<b>mSATA SSD INSTALLATION</b> .....	26
3.8	<b>HDD INSTALLATION</b> .....	28
3.8.1	<i>PPC-3708A-N26 HDD Installation</i> .....	28
3.8.2	<i>PPC-3710A-N26 HDD Installation</i> .....	31
3.8.3	<i>PPC-3712A-N26 HDD Installation</i> .....	32
3.9	<b>OPTICAL DISK DRIVE INSTALLATION (PPC-3712A-N26 ONLY)</b> .....	33
3.10	<b>MOUNTING THE SYSTEM</b> .....	36
3.10.1	<i>Wall Mounting</i> .....	36
3.10.2	<i>Panel Mounting</i> .....	39
3.10.2.1	<i>PPC-3708A-N26 and PPC-3710A-N26</i> .....	39
3.10.2.2	<i>PPC-3712A-N26</i> .....	41
3.10.3	<i>Cabinet and Rack Installation</i> .....	43
3.10.3.1	<i>PPC-3708A-N26</i> .....	43
3.10.3.2	<i>PPC-3710A-N26 and PPC-3712A -N26</i> .....	45
3.10.4	<i>Arm Mounting</i> .....	46
3.10.5	<i>Stand Mounting</i> .....	48
3.11	<b>BOTTOM PANEL CONNECTORS</b> .....	49
3.11.1	<i>Audio Connectors</i> .....	49
3.11.2	<i>HDMI Connector</i> .....	49
3.11.3	<i>Power Input Connector</i> .....	50
3.11.4	<i>RJ-45 LAN Connectors</i> .....	50
3.11.5	<i>RS-232 Serial Ports</i> .....	52
3.11.6	<i>RS-422/485 Serial Port</i> .....	52
3.11.7	<i>USB 2.0 Connectors</i> .....	53
3.11.8	<i>USB 3.0 Connectors</i> .....	54
3.11.9	<i>VGA Connector</i> .....	54
<b>4</b>	<b>SYSTEM MAINTENANCE</b> .....	<b>56</b>
4.1	<b>SYSTEM MAINTENANCE INTRODUCTION</b> .....	<b>57</b>
4.2	<b>MOTHERBOARD REPLACEMENT</b> .....	<b>57</b>
4.3	<b>BACK COVER REMOVAL</b> .....	<b>57</b>
4.4	<b>SO-DIMM REPLACEMENT</b> .....	<b>58</b>
<b>5</b>	<b>BIOS SETUP</b> .....	<b>60</b>

5.1 INTRODUCTION.....	61
5.1.1 Starting Setup.....	61
5.1.2 Using Setup.....	61
5.1.3 Getting Help.....	62
5.1.4 Unable to Reboot after Configuration Changes.....	62
5.1.5 BIOS Menu Bar.....	62
5.2 MAIN.....	63
5.3 ADVANCED.....	64
5.3.1 ACPI Settings.....	64
5.3.2 RTC Wake Settings.....	65
5.3.3 CPU Configuration.....	67
5.3.4 IDE Configuration.....	68
5.3.5 USB Configuration.....	69
5.3.6 F81866 Super IO Configuration.....	72
5.3.6.1 Serial Port n Configuration.....	72
5.3.7 F81866 H/W Monitor.....	76
5.3.7.1 Smart Fan Mode Configuration.....	78
5.3.8 Serial Port Console Redirection.....	79
5.3.8.1 Console Redirection Settings.....	79
5.3.9 iEi Feature.....	82
5.4 CHIPSET.....	83
5.4.1 Host Bridge Configuration.....	84
5.4.1.1 Intel IGD Configuration.....	84
5.4.2 South Bridge Configuration.....	85
5.5 BOOT.....	86
5.6 SECURITY.....	88
5.7 SAVE & EXIT.....	88
<b>6 DRIVER INSTALLATION.....</b>	<b>90</b>
6.1 AVAILABLE SOFTWARE DRIVERS.....	91
6.2 STARTING THE DRIVER PROGRAM.....	91
6.3 CHIPSET DRIVER INSTALLATION.....	92
6.4 VGA DRIVER INSTALLATION.....	96
6.5 LAN DRIVER INSTALLATION.....	100
6.6 AUDIO DRIVER INSTALLATION.....	102

## PPC-37xxA-N26 Panel PC

6.7 USB 3.0 DRIVER INSTALLATION .....	104
6.7.1 <i>Installing USB 3.0 Driver during Windows® 7 OS Installation</i> .....	107
6.8 TOUCHSCREEN DRIVER INSTALLATION.....	111
6.8.1 <i>Calibrating the Touchscreen</i> .....	114
<b>7 INTERFACE CONNECTORS .....</b>	<b>117</b>
7.1 PERIPHERAL INTERFACE CONNECTORS.....	118
7.2 INTERNAL PERIPHERAL CONNECTORS .....	119
7.2.1 <i>5 V SATA Power Connectors (SATA_PWR1/SATA_PWR2)</i> .....	120
7.2.2 <i>Audio Connector (AUDIO1)</i> .....	120
7.2.3 <i>Backlight Inverter Connector (INV1)</i> .....	121
7.2.4 <i>Battery Connector (BAT1)</i> .....	121
7.2.5 <i>Buzzer Connector (SPI)</i> .....	121
7.2.6 <i>Digital Input/Output Connector (DIO1)</i> .....	121
7.2.7 <i>Fan Connector (CPU_FAN1)</i> .....	122
7.2.8 <i>Front Panel Connector (F_PANEL1)</i> .....	122
7.2.9 <i>Keyboard/Mouse Connector (KB_MS1)</i> .....	122
7.2.10 <i>LVDS Connector (LVDS1)</i> .....	123
7.2.11 <i>PCIe Mini Card Slot (M_PCIE1)</i> .....	123
7.2.12 <i>Power Connector (9V~28V) (CN2)</i> .....	124
7.2.13 <i>RS-232 Serial Port Connectors (COM1/COM2/COM3)</i> .....	124
7.2.14 <i>RS-422/485 Serial Port Connector (COM4)</i> .....	125
7.2.15 <i>SATA 3Gb/s Connectors (SATA1/SATA2)</i> .....	125
7.2.16 <i>USB 2.0 Connector (USB4)</i> .....	125
7.3 EXTERNAL INTERFACE PANEL CONNECTORS .....	126
7.3.1 <i>HDMI Connector (HDMI1)</i> .....	126
7.3.2 <i>RJ-45 LAN Connectors (LAN1/LAN2)</i> .....	127
7.3.3 <i>USB 2.0 Connectors (USB_CON2)</i> .....	127
7.3.4 <i>USB 3.0 Connectors (USB_CON1)</i> .....	127
7.3.5 <i>VGA Connector (VGA1)</i> .....	128
<b>A BIOS CONFIGURATION OPTIONS.....</b>	<b>129</b>
A.1 BIOS CONFIGURATION OPTIONS .....	130
<b>B ONE KEY RECOVERY .....</b>	<b>132</b>
B.1 ONE KEY RECOVERY INTRODUCTION .....	133

<i>B.1.1 System Requirement</i> .....	134
<i>B.1.2 Supported Operating System</i> .....	135
<b>B.2 SETUP PROCEDURE FOR WINDOWS</b> .....	136
<i>B.2.1 Hardware and BIOS Setup</i> .....	137
<i>B.2.2 Create Partitions</i> .....	137
<i>B.2.3 Install Operating System, Drivers and Applications</i> .....	141
<i>B.2.4 Building the Recovery Partition</i> .....	142
<i>B.2.5 Create Factory Default Image</i> .....	144
<b>B.3 AUTO RECOVERY SETUP PROCEDURE</b> .....	149
<b>B.4 SETUP PROCEDURE FOR LINUX</b> .....	153
<b>B.5 RECOVERY TOOL FUNCTIONS</b> .....	157
<i>B.5.1 Factory Restore</i> .....	158
<i>B.5.2 Backup System</i> .....	159
<i>B.5.3 Restore Your Last Backup</i> .....	160
<i>B.5.4 Manual</i> .....	161
<b>B.6 RESTORE SYSTEMS FROM A LINUX SERVER THROUGH LAN</b> .....	162
<i>B.6.1 Configure DHCP Server Settings</i> .....	163
<i>B.6.2 Configure TFTP Settings</i> .....	164
<i>B.6.3 Configure One Key Recovery Server Settings</i> .....	165
<i>B.6.4 Start the DHCP, TFTP and HTTP</i> .....	166
<i>B.6.5 Create Shared Directory</i> .....	166
<i>B.6.6 Setup a Client System for Auto Recovery</i> .....	167
<b>B.7 OTHER INFORMATION</b> .....	170
<i>B.7.1 Using AHCI Mode or ALi M5283 / VIA VT6421A Controller</i> .....	170
<i>B.7.2 System Memory Requirement</i> .....	172
<b>C SAFETY PRECAUTIONS</b> .....	<b>173</b>
<b>C.1 SAFETY PRECAUTIONS</b> .....	174
<i>C.1.1 General Safety Precautions</i> .....	174
<i>C.1.2 Anti-static Precautions</i> .....	175
<i>C.1.3 Product Disposal</i> .....	175
<b>C.2 MAINTENANCE AND CLEANING PRECAUTIONS</b> .....	176
<i>C.2.1 Maintenance and Cleaning</i> .....	176
<i>C.2.2 Cleaning Tools</i> .....	177
<b>D WATCHDOG TIMER</b> .....	<b>178</b>



<b>E HAZARDOUS MATERIALS DISCLOSURE .....</b>	<b>181</b>
E.1 HAZARDOUS MATERIAL DISCLOSURE TABLE FOR IPB PRODUCTS CERTIFIED AS ROHS COMPLIANT UNDER 2002/95/EC WITHOUT MERCURY .....	182

# List of Figures

---

Figure 1-1: PPC-37xxA-N26 Panel PC.....	2
Figure 1-2: Front View .....	4
Figure 1-3: Rear View .....	5
Figure 1-4: Bottom View .....	6
Figure 1-5: PPC-3712A-N26 Left View .....	6
Figure 1-6: PPC-3710A-N26 Frame Rear View .....	7
Figure 1-7: PPC-3712A-N26 Frame Rear View .....	7
Figure 1-8: PPC-3708A-N26 Dimensions (mm).....	8
Figure 1-9: PPC-3710A-N26 Dimensions (mm).....	9
Figure 1-10: PPC-3712A-N26 Dimensions (mm).....	10
Figure 3-1: PPC-3708A-N26 Back Cover Retention Screws.....	21
Figure 3-2: PPC-3710A-N26 Back Cover Retention Screws.....	21
Figure 3-3: PPC-3712A-N26 Back Cover Retention Screws.....	22
Figure 3-4: Touchscreen Type Selection Jumper Location .....	24
Figure 3-5: AT/ATX Power Selection Jumper Location .....	25
Figure 3-6: Clear CMOS Jumper Location .....	25
Figure 3-7: mSATA/PCIe Mini Mode Selection Jumper Location .....	26
Figure 3-8: Hex Nuts on the Bottom Panel .....	27
Figure 3-9: Retention Screws on the Motherboard .....	27
Figure 3-10: PCIe Mini Slot Location .....	27
Figure 3-11: PCIe Mini Card Installation.....	28
Figure 3-12: PPC-3708A-N26 HDD Bracket Retention Screws (Tope Panel).....	29
Figure 3-13: PPC-3708A-N26 HDD Bracket Retention Screws (Inside).....	29
Figure 3-14: PPC-3708A-N26 HDD Retention Screws.....	30
Figure 3-15: Replacing the PPC-3708A-N26 HDD Bracket .....	30
Figure 3-16: PPC-3710A-N26 HDD Bracket Retention Screws.....	31
Figure 3-17: PPC-3710A-N26 HDD Retention Screws.....	32
Figure 3-18: Replacing the PPC-3710A-N26 HDD Bracket .....	32
Figure 3-19: Optical Drive Bracket Retention Screws .....	33
Figure 3-20: Optical Drive Blank Plate Assembly .....	34
Figure 3-21: Optical Drive Screws .....	34

## PPC-37xxA-N26 Panel PC

Figure 3-22: Optical Drive SATA Cable .....	35
Figure 3-23: Replacing the Optical Drive Bracket .....	35
Figure 3-24: Wall-mounting Bracket .....	37
Figure 3-25: Mount the Chassis .....	38
Figure 3-26: Secure the Chassis .....	39
Figure 3-27: PPC-3708A-N26 Panel Cutout Dimensions .....	40
Figure 3-28: PPC-3710A-N26 Panel Cutout Dimensions .....	40
Figure 3-29: Tighten the Panel Mounting Clamp Screws .....	41
Figure 3-30: Panel Mounting Kit.....	41
Figure 3-31: PPC-3712A-N26 Panel Cutout Dimensions .....	42
Figure 3-32: Tighten the Panel Mounting Clamp Screws .....	43
Figure 3-33: The Rack/Cabinet Bracket.....	43
Figure 3-34: Securing the PPC-3708A-N26 Rack/Cabinet Bracket .....	44
Figure 3-35: Installing into a Rack/Cabinet.....	45
Figure 3-36: Securing the Rack/Cabinet Bracket .....	46
Figure 3-37: Arm Mounting Retention Screw Holes.....	47
Figure 3-38: Arm Mounting .....	48
Figure 3-39: Stand Mounting Retention Screw Holes.....	48
Figure 3-40: HDMI Connection .....	50
Figure 3-41: RJ-45 LAN Connector .....	51
Figure 3-42: LAN Connection .....	51
Figure 3-43: RS-232 Serial Device Connector .....	52
Figure 3-44: RS-422/485 Serial Device Connector .....	53
Figure 3-45: USB Device Connection .....	54
Figure 3-46: VGA Connector .....	55
Figure 4-1: SO-DIMM Module Location.....	58
Figure 4-2: SO-DIMM Module Installation.....	59
Figure 6-1: Drivers .....	92
Figure 6-2: Chipset Driver Screen.....	93
Figure 6-3: Chipset Driver Welcome Screen.....	93
Figure 6-4: Chipset Driver License Agreement .....	94
Figure 6-5: Chipset Driver Read Me File .....	95
Figure 6-6: Chipset Driver Setup Operations .....	95
Figure 6-7: Chipset Driver Installation Finish Screen.....	96
Figure 6-8: VGA Driver Welcome Screen .....	97

Figure 6-9: VGA Driver License Agreement.....	98
Figure 6-10: VGA Driver Read Me File.....	98
Figure 6-11: VGA Driver Setup Operations.....	99
Figure 6-12: VGA Driver Installation Finish Screen.....	99
Figure 6-13: LAN Driver Welcome Screen.....	100
Figure 6-14: LAN Driver Installation.....	101
Figure 6-15: LAN Driver Installation Complete.....	101
Figure 6-16: Audio Driver Installation File Extraction.....	102
Figure 6-17: Audio Driver Welcome Screen.....	103
Figure 6-18: Audio Driver Installation.....	103
Figure 6-19: Audio Driver Installation Complete.....	104
Figure 6-20: USB 3.0 Driver Welcome Screen.....	105
Figure 6-21: USB 3.0 Driver License Agreement.....	106
Figure 6-22: USB 3.0 Driver Setup Operations.....	106
Figure 6-23: USB 3.0 Driver Installation Finish Screen.....	107
Figure 6-24: Install Now.....	108
Figure 6-25: Load Driver.....	108
Figure 6-26: Browse for Folder.....	109
Figure 6-27: Select the ASMedia XHCI Controller Driver.....	109
Figure 6-28: Confirm the Driver File.....	110
Figure 6-29: Select the USB Root Hub Driver.....	110
Figure 6-30: Welcome Screen.....	111
Figure 6-31: Touchscreen Driver License Agreement.....	112
Figure 6-32: Choose Destination Folder.....	112
Figure 6-33: Setup Status.....	113
Figure 6-34: Touchscreen Driver Installation Finish Screen.....	113
Figure 6-35: Select Control Panel.....	114
Figure 6-36: Touchscreen Control Panel.....	114
Figure 6-37: Select Calibration Type.....	115
Figure 6-38: Calibration Window.....	116
Figure 7-1: Main Board Layout Diagram (Front Side).....	118
Figure 7-2: Main Board Layout Diagram (Solder Side).....	119
Figure B-1: IEI One Key Recovery Tool Menu.....	133
Figure B-2: Launching the Recovery Tool.....	138
Figure B-3: Recovery Tool Setup Menu.....	138

## PPC-37xxA-N26 Panel PC

Figure B-4: Command Prompt .....	139
Figure B-5: Partition Creation Commands.....	140
Figure B-6: Launching the Recovery Tool .....	142
Figure B-7: Manual Recovery Environment for Windows .....	142
Figure B-8: Building the Recovery Partition.....	143
Figure B-9: Press Any Key to Continue .....	143
Figure B-10: Press F3 to Boot into Recovery Mode.....	144
Figure B-11: Recovery Tool Menu .....	144
Figure B-12: About Symantec Ghost Window.....	145
Figure B-13: Symantec Ghost Path .....	145
Figure B-14: Select a Local Source Drive .....	146
Figure B-15: Select a Source Partition from Basic Drive .....	146
Figure B-16: File Name to Copy Image to .....	147
Figure B-17: Compress Image.....	147
Figure B-18: Image Creation Confirmation .....	148
Figure B-19: Image Creation Complete .....	148
Figure B-20: Image Creation Complete .....	148
Figure B-21: Press Any Key to Continue .....	149
Figure B-22: Auto Recovery Utility .....	150
Figure B-23: Launching the Recovery Tool .....	150
Figure B-24: Auto Recovery Environment for Windows .....	150
Figure B-25: Building the Auto Recovery Partition.....	151
Figure B-26: Factory Default Image Confirmation .....	151
Figure B-27: Image Creation Complete .....	152
Figure B-28: Press any key to continue .....	152
Figure B-29: Partitions for Linux.....	154
Figure B-30: Manual Recovery Environment for Linux .....	155
Figure B-31: Access menu.lst in Linux (Text Mode).....	156
Figure B-32: Recovery Tool Menu .....	156
Figure B-33: Recovery Tool Main Menu .....	157
Figure B-34: Restore Factory Default.....	158
Figure B-35: Recovery Complete Window .....	159
Figure B-36: Backup System.....	159
Figure B-37: System Backup Complete Window .....	160
Figure B-38: Restore Backup .....	160

**Figure B-39: Restore System Backup Complete Window ..... 161**  
**Figure B-40: Symantec Ghost Window ..... 161**

# List of Tables

Table 1-1: Model Variations .....	3
Table 1-2: System Specifications.....	12
Table 2-1: Packing List.....	16
Table 2-2: Optional Items .....	17
Table 3-1: Jumpers .....	23
Table 3-2: Preconfigured Jumpers .....	23
Table 3-3: LVDS Voltage Selection Jumper Settings.....	23
Table 3-4: Touchscreen Type Selection Jumper Settings.....	24
Table 3-5: AT/ATX Power Selection Jumper Settings.....	24
Table 3-6: Clear CMOS Jumper Settings.....	25
Table 3-7: mSATA/PCIe Mini Mode Selection Jumper Settings.....	26
Table 3-8: LAN Pinouts .....	50
Table 3-9: RJ-45 LAN Connector LEDs .....	51
Table 5-1: BIOS Navigation Keys .....	62
Table 7-1: Peripheral Interface Connectors .....	120
Table 7-2: 5 V SATA Power Connectors Pinouts .....	120
Table 7-3: Audio Connector (AUDIO1) Pinouts .....	120
Table 7-4: Backlight Inverter Connector (INV1) Pinouts.....	121
Table 7-5: Battery Connector (BAT1) Pinouts .....	121
Table 7-6: Buzzer Connector (SP1) Pinouts .....	121
Table 7-7: Digital Input/Output Connector (DIO1) Pinouts.....	121
Table 7-8: Fan Connector (CPU_FAN1) Pinouts.....	122
Table 7-9: Front Panel Connector (F_PANEL1) Pinouts.....	122
Table 7-10: Keyboard/Mouse Connector (KB_MS1) Pinouts .....	122
Table 7-11: LVDS Connector (LVDS1) Pinouts.....	123
Table 7-12: PCIe Mini Card Slot (M_PCIE1) Pinouts .....	124
Table 7-13: Power Connector (9V~28V) (CN2) Pinouts.....	124
Table 7-14: RS-232 Serial Port Connector Pinouts .....	124
Table 7-15: RS-422/485 Serial Port Connector (COM4) Pinouts .....	125
Table 7-16: SATA 3Gb/s Connectors (SATA1/SATA2) Pinouts .....	125
Table 7-17: USB 2.0 Connector (USB4) Pinouts.....	125

<b>Table 7-18: Rear Panel Connectors .....</b>	<b>126</b>
<b>Table 7-19: HDMI Connector (HDMI1) Pinouts.....</b>	<b>126</b>
<b>Table 7-20: RJ-45 LAN Connector Pinouts .....</b>	<b>127</b>
<b>Table 7-21: USB 2.0 Connectors (USB_CON2) Pinouts.....</b>	<b>127</b>
<b>Table 7-22: USB 3.0 Connectors (USB_CON1) Pinouts.....</b>	<b>127</b>
<b>Table 7-23: VGA Connector (VGA1) Pinouts .....</b>	<b>128</b>



Chapter

1

# Introduction

---

## 1.1 Overview



**Figure 1-1: PPC-37xxA-N26 Panel PC**

The PPC-37xxA-N26 is an industrial flat panel PC. The PPC-37xxA-N26 can be used for machine control, production lines, kiosks and information stations. The PPC-37xxA-N26 is preinstalled with an Intel® Atom™ N2600 CPU for applications where more computing power is needed.

The PPC-37xxA-N26 supports a second monitor for presenting information to customers or extending the display area. The second monitor can show different information to the main screen, or duplicate the main screen content.

The PPC-37xxA-N26 can be installed in a rack, on a VESA clamp or in a custom enclosure with a hole of the correct size. Storage options include a 2.5" hard drive and optional mSATA, allowing for flexibility in choosing solid state drives or traditional hard drives.

## PPC-37xxA-N26 Panel PC

### 1.2 Model Variations

The model numbers and model variations are listed below.

Model	CPU	Memory	Screen
PPC-3708A-N26/R/2G-R11	1.6 GHz Intel® Atom™ N2600	2 GB DDR3	8.4"
PPC-3710A-N26/R/2G-R11	1.6 GHz Intel® Atom™ N2600	2 GB DDR3	10.4"
PPC-3712A-N26/R/2G-R11	1.6 GHz Intel® Atom™ N2600	2 GB DDR3	12.1"

**Table 1-1: Model Variations**

### 1.3 Features

Some of the features of the PPC-37xxA-N26 panel PC include:

- 1.6 GHz Intel® Atom™ N2600 processor
- Preinstalled 2 GB DDR3 SO-DIMM memory module
- Multiple storage options: 2.5" SATA HDD and mSATA SSD
- Optional PCIe Mini 802.11b/g/n wireless module
- Dual video output: HDMI and VGA
- Dual GbE
- Supports slim type optical disk drive (PPC-3712A-N26 only)
- Supports 9 V ~ 28 V DC power input (default: 12 V)
- IP 65 compliant front panel
- RoHS compliant

## 1.4 External Overview

The PPC-37xxA-N26 panel PC is comprised of an LCD screen, aluminum front panel and heavy duty steel rear and side panels. The rear panel provides screw holes for wall and an arm mounting. The bottom panel provides access to external interface connectors that include GbE, USB 3.0, USB 2.0, audio, serial port connectors, VGA port and HDMI port.

### 1.4.1 Front Panel

The front panel of the PPC-37xxA-N26 (**Figure 1-2**) is a flat panel TFT LCD screen surrounded by an aluminum frame.

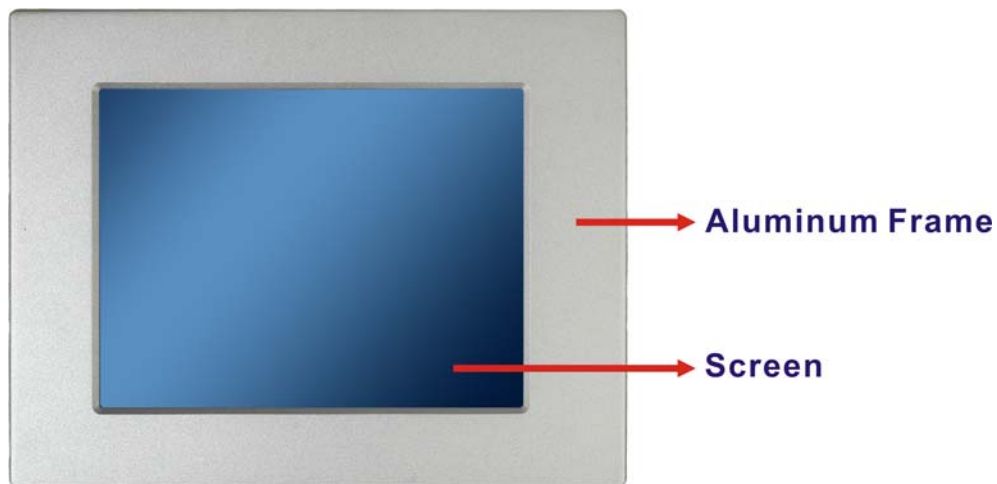

**Figure 1-2: Front View**

### 1.4.2 Rear Panel

The rear panel contains some vents for ventilation, four VESA standard mounting holes and several retention screw holes. The VESA mounting holes are circled in **Figure 1-3**.

## PPC-37xxA-N26 Panel PC



Figure 1-3: Rear View

### 1.4.3 Bottom Panel

The bottom panel has the following interfaces:

- 1 x 12 V DC power input connector
- 1 x Power switch
- 2 x USB 3.0 connectors
- 2 x USB 2.0 connectors
- 2 x RJ-45 GbE connectors
- 2 x RS-232 connectors
- 1 x RS-422/485 connector
- 1 x Line-out jack
- 1 x Line-in jack
- 1 x Mic-in jack
- 1 x VGA connector
- 1 x HDMI connector

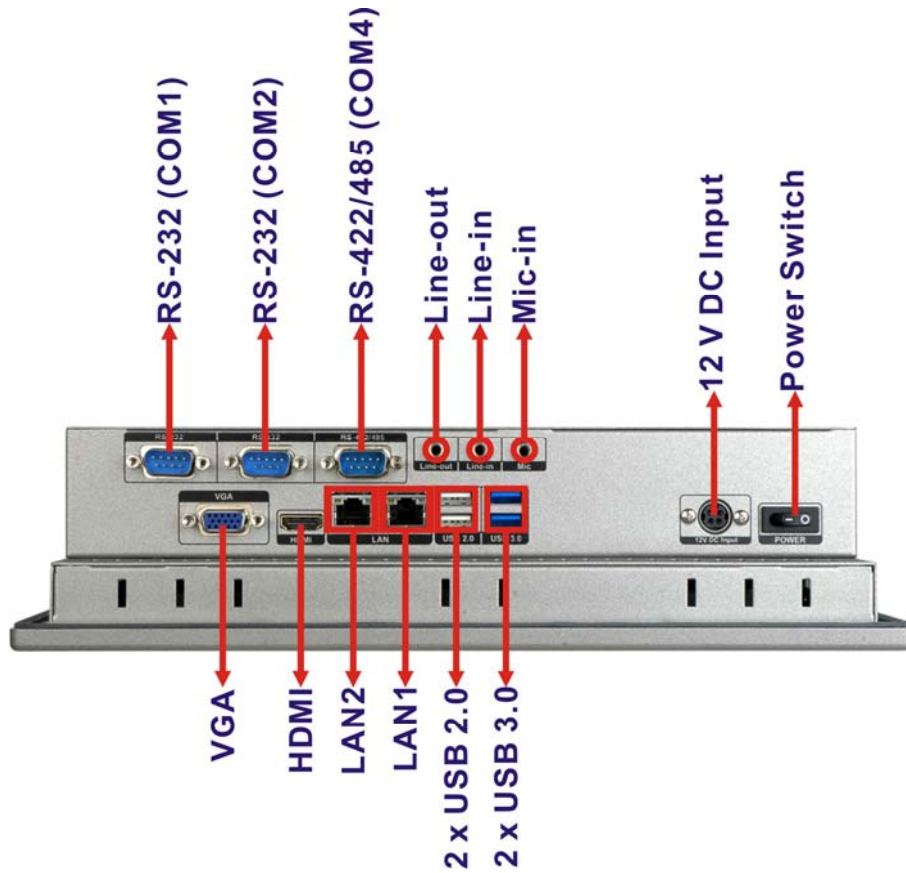

Figure 1-4: Bottom View

#### 1.4.4 Side Panels

The both sides panel of the panel PC contain some vents for ventilation. The left side panel of PPC-3712A-N26 provides access to the slim type optical disk drive bay.

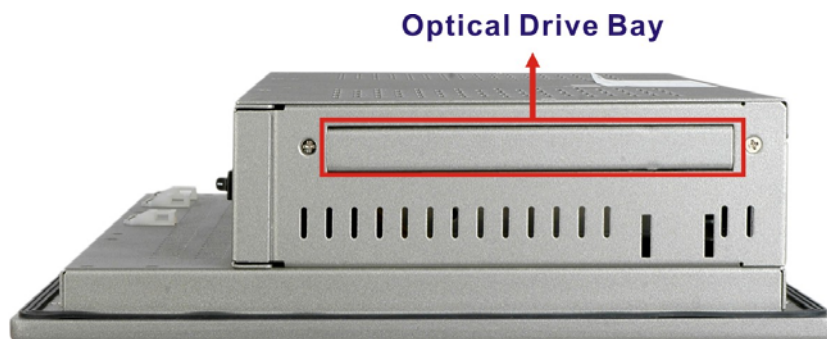

Figure 1-5: PPC-3712A-N26 Left View

## PPC-37xxA-N26 Panel PC

### 1.4.5 Frame

An aluminum frame surrounds the LCD screen. The aluminum frames of the PPC-3710A-N26 and PPC-3712A-N26 have small screw holes that are used when the flat panel PC is mounted into a rack or cabinet. These screws are circled in **Figure 1-7** and **Figure 1-7**.



Figure 1-6: PPC-3710A-N26 Frame Rear View



Figure 1-7: PPC-3712A-N26 Frame Rear View

## 1.5 Dimensions

### 1.5.1 PPC-3708A-N26 Dimensions

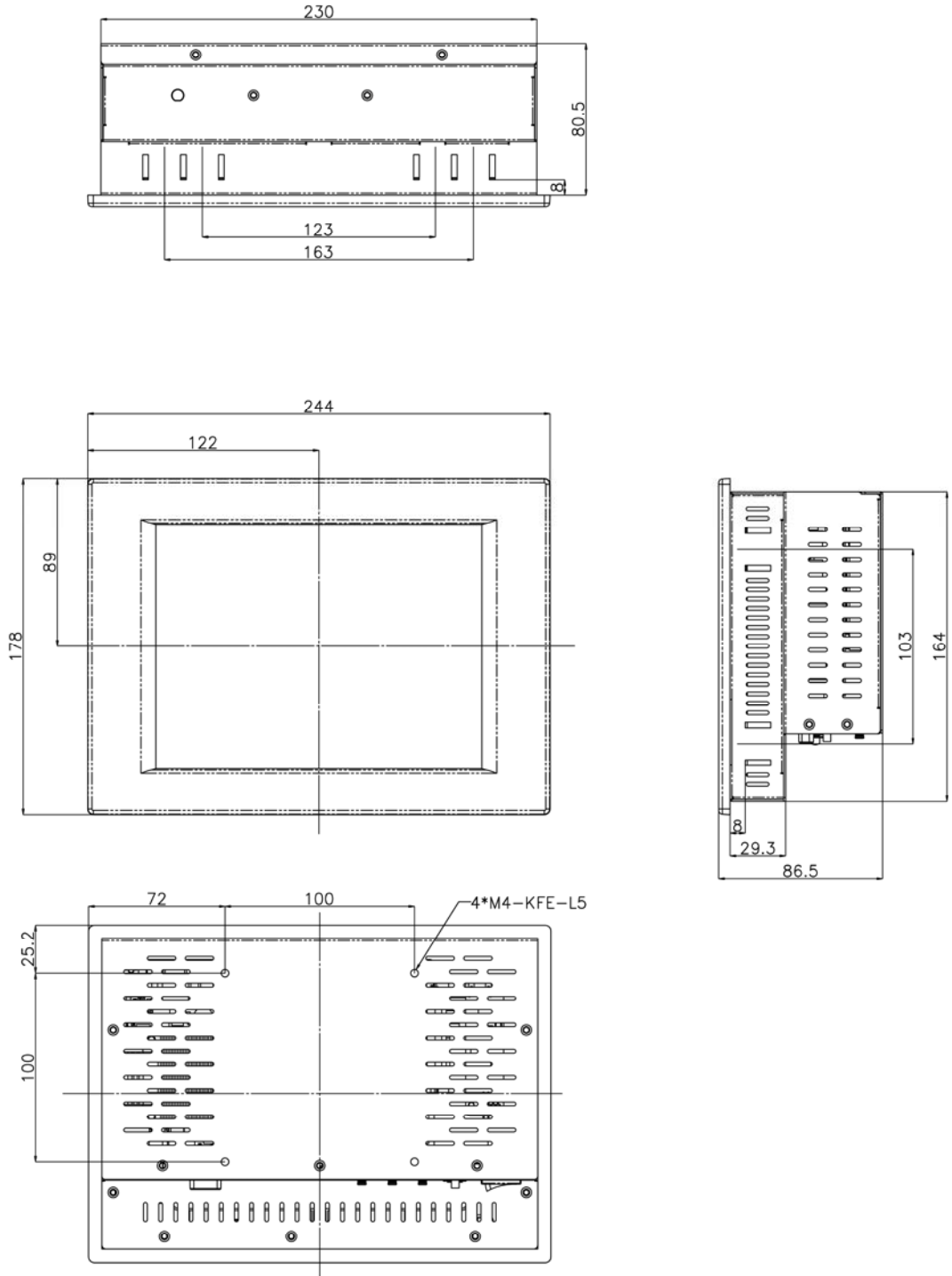
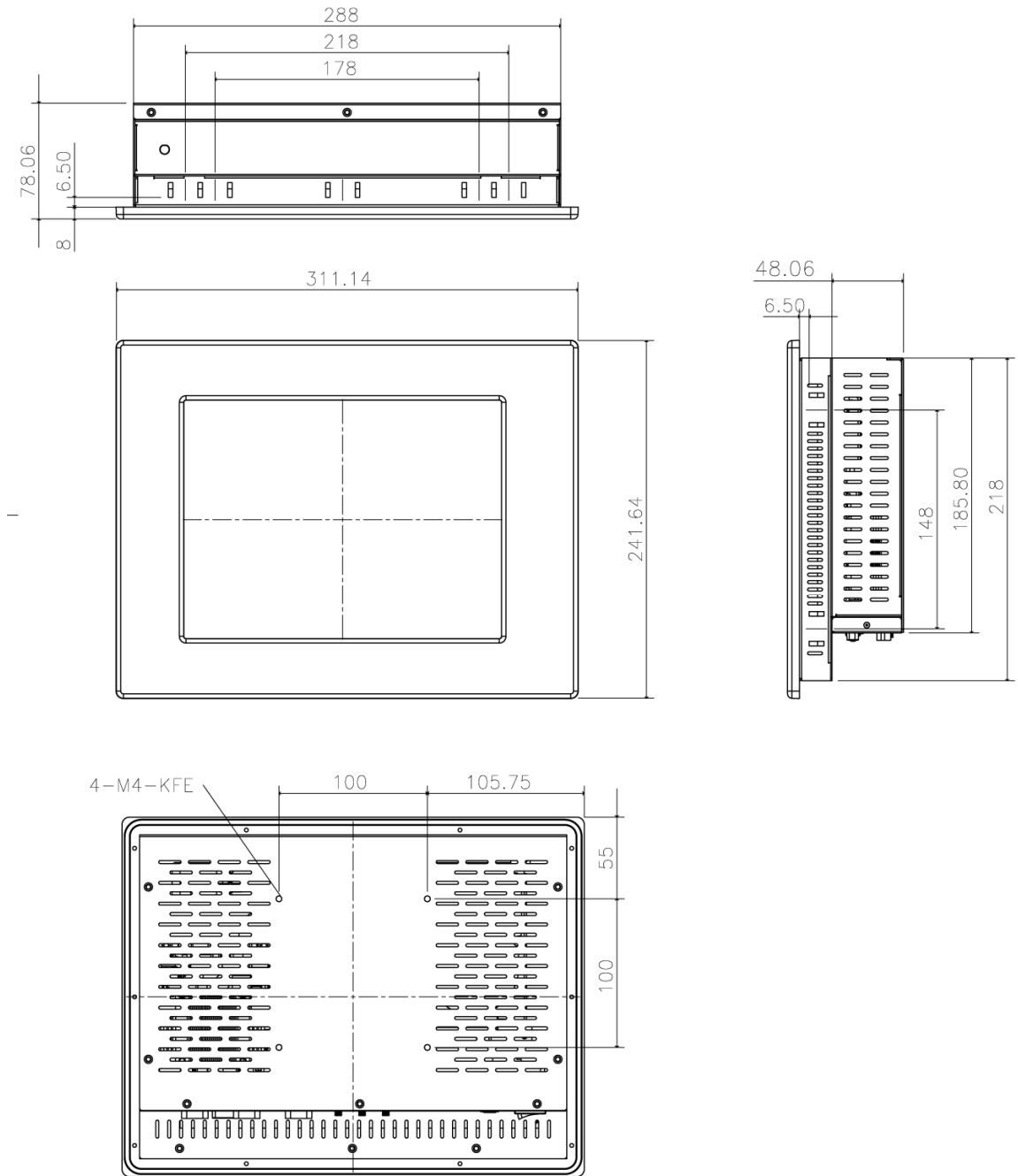

Figure 1-8: PPC-3708A-N26 Dimensions (mm)



**PPC-37xxA-N26 Panel PC**

**1.5.2 PPC-3710A-N26 Dimensions**



**Figure 1-9: PPC-3710A-N26 Dimensions (mm)**

**1.5.3 PPC-3712A-N26 Dimensions**

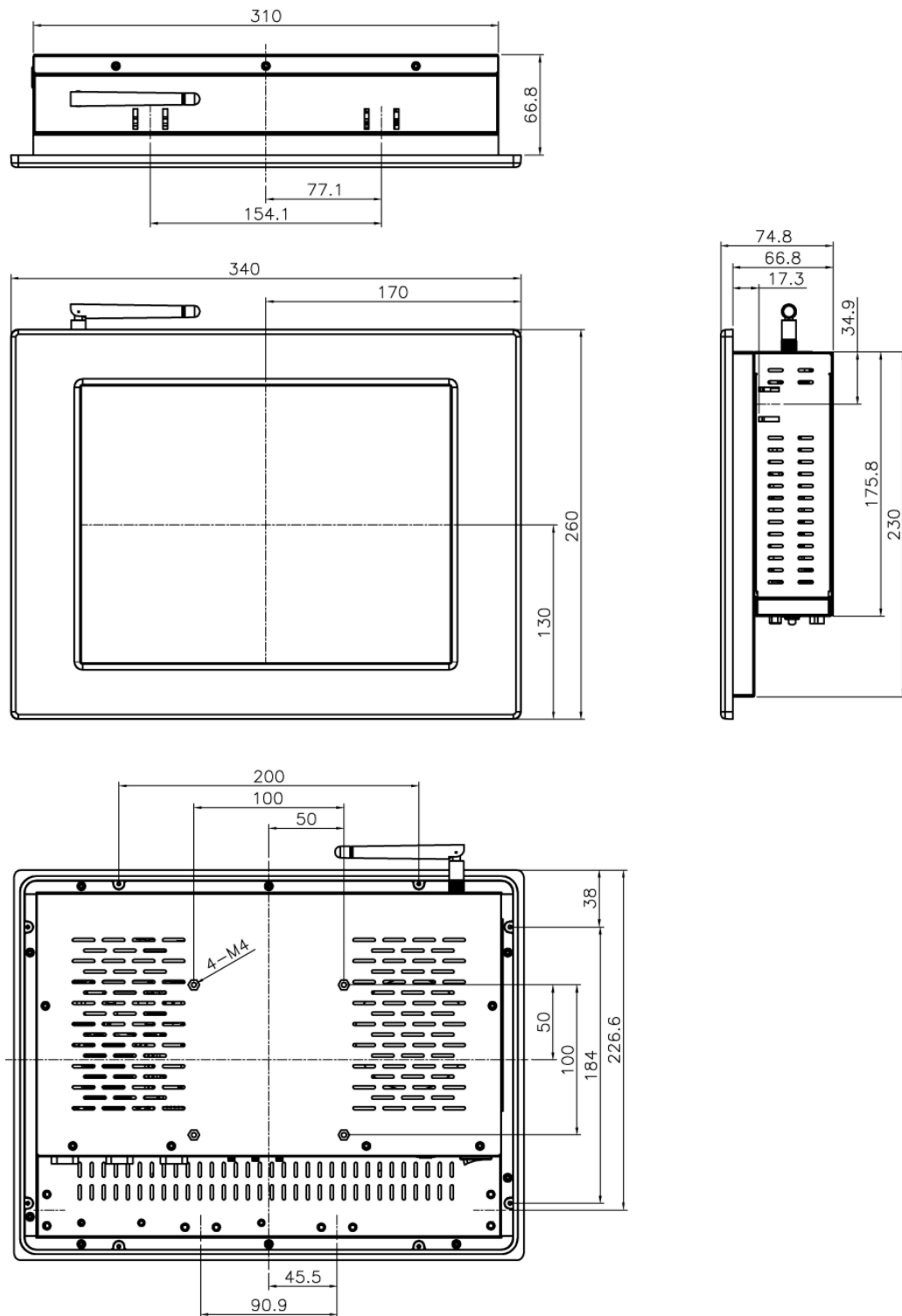

**Figure 1-10: PPC-3712A-N26 Dimensions (mm)**

## PPC-37xxA-N26 Panel PC

### 1.6 Specifications

The technical specifications for the PPC-37xxA-N26 system are listed in **Table 1-2**.

	PPC-3708A-N26	PPC-3710A-N26	PPC-3712A-N26
<b>LCD Size</b>	8.4"	10.4"	12.1"
<b>Max. Resolution</b>	800 (W) x 600 (H)	800 (W) x 600 (H)	1024 (W) x 768 (H)
<b>Brightness</b>	450 cd/m <sup>2</sup>	400 cd/m <sup>2</sup>	500 cd/m <sup>2</sup>
<b>Contrast Ratio</b>	600:1	700:1	700:1
<b>Pixel Pitch (mm)</b>	0.213 (H) x 0.213 (V)	0.264 (H) x 0.264 (V)	0.3075 (H)x0.3075 (V)
<b>Viewing Angle (V-H)</b>	140/160	140/160	160/160
<b>LCD Color</b>	262K	262K	262K
<b>Backlight MTBF</b>	50,000 hours (LED backlight)		
<b>SBC Model</b>	NANO-CV-N26001-R10		
<b>CPU</b>	1.6 GHz Intel® Atom™ N2600 dual-core CPU		
<b>Chipset</b>	Intel® NM10		
<b>Memory</b>	One 204-pin 800 MHz DDR3 SO-DIMM slot (up to 2 GB)		
<b>Ethernet</b>	Two Realtek RTL8111E PCIe GbE controllers (LAN1 with ASF 2.0 support)		
<b>Audio</b>	Realtek ALC662 HD Audio codec		
<b>Solid State Drive (SSD)</b>	mSATA (optional)		
<b>Drive Bays</b>	One 2.5" SATA HDD bay		
	One slim type optical disk drive bay (PPC-3712A-N26 only)		
<b>Expansion Slots</b>	One PCIe Mini card slot with mSATA support		
<b>Touchscreen</b>	4-wire resistive type with USB interface	5-wire resistive type with USB interface	5-wire resistive type with USB interface
<b>Wireless LAN</b>	IEEE 802.11b/g/n 2T2R mode WLAN via internal PCIe Mini card (optional)		
<b>Mounting</b>	VESA 100 mm x 100 mm Panel, wall, rack, stand and arm		

	PPC-3708A-N26	PPC-3710A-N26	PPC-3712A-N26
<b>Power Requirement</b>	9 V ~ 28 V DC		
<b>Power Adapter</b>	P/N: 63040-010060-050-RS 60 W Input: 90 V AC ~ 264 V AC, 50/60 Hz Output: 12 V DC		
<b>I/O Ports and Switches</b>	2 x USB 3.0 2 x USB 2.0 2 x RS-232 1 x RS-422/485 1 x HDMI connector 1 x VGA connector 2 x RJ-45 LAN connectors 3 x Audio jacks (Line-in, Line-out and Mic-in) 1 x Power switch 1 x 12 V DC power input connector		
<b>Chassis Construction</b>	Heavy-duty steel (SECC)		
<b>Front Panel Construction</b>	Aluminum die-casting		
<b>Front Panel Color</b>	Silver (PANTONE 8001C)		
<b>Vibration</b>	5 Hz ~ 17 Hz 0.1" double amplitude displacement 17 Hz ~ 640 Hz 1.5G acceleration peak to peak		
<b>Shock</b>	10G acceleration part to part (11 ms)		
<b>Humidity</b>	10% ~ 95%, non-condensing		
<b>Operating Temperature (Ambient with air flow)</b>	-10°C ~ 50°C		
<b>Storage Temperature</b>	-20°C ~ 60°C		
<b>Net/Gross Weight</b>	2.2 kg/4.4 kg	3.4 kg/5.8 kg	6 kg/8 kg
<b>Dimensions (W x H x D) (mm)</b>	244 x 175 x 86.5	311 x 242 x 77.8	340 x 260 x 74.8

Table 1-2: System Specifications

Chapter

2

# Unpacking

---

## 2.1 Unpacking

To unpack the panel PC, follow the steps below:



### **WARNING!**

The front side LCD screen has a protective plastic cover stuck to the screen. Only remove the plastic cover after the panel PC has been properly installed. This ensures the screen is protected during the installation process.

---

- Step 1:** Use box cutters, a knife or a sharp pair of scissors that seals the top side of the external (second) box.
- Step 2:** Open the external (second) box.
- Step 3:** Use box cutters, a knife or a sharp pair of scissors that seals the top side of the internal (first) box.
- Step 4:** Lift the monitor out of the boxes.
- Step 5:** Remove both polystyrene ends, one from each side.
- Step 6:** Pull the plastic cover off the panel PC.
- Step 7:** Make sure all the components listed in the packing list are present.

## PPC-37xxA-N26 Panel PC

### 2.2 Packing List

The PPC-37xxA-N26 panel PC is shipped with the following components:

Quantity	Item	Image
1	PPC-37xxA-N26	
1	Power adapter (P/N: 63040-010060-050-RS)	
1	Power cord (P/N: 32702-000200-100-RS)	
1	Screw kit (P/N: 19600-000205-RS)	
1	Touch pen (P/N: 43125-0002C0-00-RS)	
1	Panel mounting kit (P/N: 19Z00-000026-RS)	
1	Wall mounting kit (P/N: 41020-016102-00-RS, 41014-057602-00-RS)	
1	User manual and driver CD	



Quantity	Item	Image
1	One Key Recovery CD	

**Table 2-1: Packing List**

If any of the above items are missing or damaged, contact the distributor or sales representative immediately.

### 2.3 Optional Items

The following items are optional accessories for the PPC-37xxA-N26:

Item	Image
Slim type SATA DVD-ROM (PPC-3712A-N26 only) (P/N: 73400-AD7760H01-RS)	
Arm (P/N: ARM-11-RS)	
Stand (P/N: STAND-100-RS)	
Rack mounting kit (P/N: RK-084MS-R10 RK-104MS-R10 RK-121MS-R10)	



## PPC-37xxA-N26 Panel PC

Item	Image
Wi-Fi module with RF cable and antenna, 2T2R, 802.11b/g/n (P/N: PPC-WL-KIT02-R10)	

**Table 2-2: Optional Items**

Chapter

**3**

# Installation

---

### 3.1 Anti-static Precautions

---

**WARNING:**

Failure to take ESD precautions during the maintenance of the EP series may result in permanent damage to the EP series and severe injury to the user.

---

Electrostatic discharge (ESD) can cause serious damage to electronic components, including the PPC-37xxA-N26. Dry climates are especially susceptible to ESD. It is therefore critical that whenever the PPC-37xxA-N26 is accessed internally, or any other electrical component is handled, the following anti-static precautions are strictly adhered to.

- **Wear an anti-static wristband:** - Wearing a simple anti-static wristband can help to prevent ESD from damaging the board.
- **Self-grounding:** - Before handling the board touch any grounded conducting material. During the time the board is handled, frequently touch any conducting materials that are connected to the ground.
- **Use an anti-static pad:** - When configuring the PPC-37xxA-N26, place it on an anti-static pad. This reduces the possibility of ESD damaging the PPC-37xxA-N26.
- **Only handle the edges of the PCB:** - When handling the PCB, hold the PCB by the edges.

### 3.2 Installation Precautions

When installing the panel PC, please follow the precautions listed below:

- **Power turned off:** When installing the panel PC, make sure the power is off. Failing to turn off the power may cause severe injury to the body and/or damage to the system.
- **Certified Engineers:** Only certified engineers should install and modify onboard functionalities.

- **Anti-static Discharge:** If a user open the rear panel of the panel PC, to configure the jumpers or plug in added peripheral devices, ground themselves first and wear an anti-static wristband.

### 3.3 Preinstalled Components

The following components are all preinstalled.

- Motherboard
- DDR3 memory module
- TFT LCD
- Touchscreen

Preinstalled OEM customizations may include the following.

- HDD
- Wi-Fi module
- Optical disk drive (PPC-3712A-N26 only)

### 3.4 Installation and Configuration Steps

The following installation steps must be followed.

**Step 1:** Unpack the PPC-37xxA-N26.

**Step 2:** Set the jumper settings (not usually necessary).

**Step 3:** Install the mSATA SSD, HDD and optical disk drive.

**Step 4:** Mount the PPC-37xxA-N26 panel PC.

**Step 5:** Connect peripheral devices to the bottom panel of the PPC-37xxA-N26.

**Step 6:** Configure the system.

## PPC-37xxA-N26 Panel PC

### 3.5 Removing the Back Cover

Remove all the retention screws on the back cover. Lift the cover up to remove.



**Figure 3-1: PPC-3708A-N26 Back Cover Retention Screws**

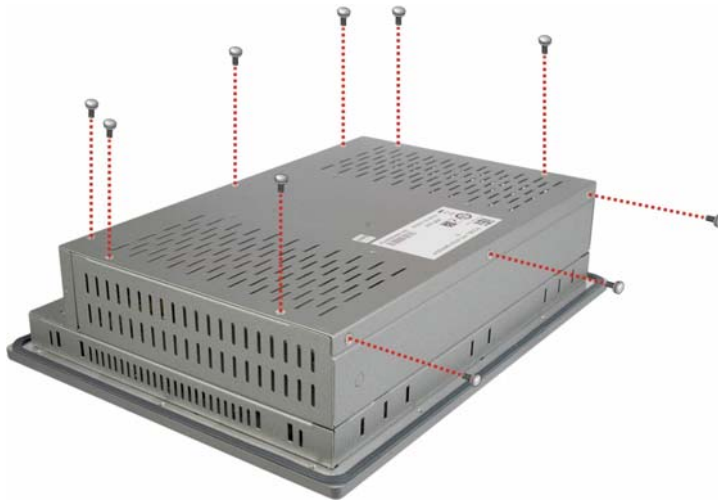

**Figure 3-2: PPC-3710A-N26 Back Cover Retention Screws**



**Figure 3-3: PPC-3712A-N26 Back Cover Retention Screws**

### 3.6 Jumper Settings



**NOTE:**

A jumper is a metal bridge used to close an electrical circuit. It consists of two or three metal pins and a small metal clip (often protected by a plastic cover) that slides over the pins to connect them. To CLOSE/SHORT a jumper means connecting the pins of the jumper with the plastic clip and to OPEN a jumper means removing the plastic clip from a jumper.

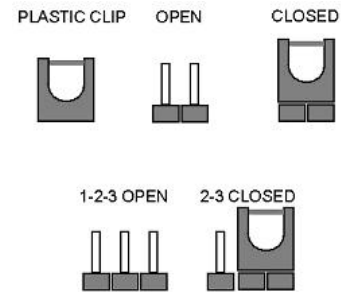

The following jumpers can be found on the motherboard installed in the PPC-37xxA-N26. Before the PPC-37xxA-N26 is installed, the jumpers must be set in accordance with the desired configuration. The jumpers on the PPC-37xxA-N26 motherboard are listed in **Table 3-1**.

## PPC-37xxA-N26 Panel PC

Description	Label	Type
AT/ATX power selection	JP3	2-pin header
Clear CMOS	JP1	3-pin header
mSATA/PCIe Mini mode selection	MSATA_SW1	2-pin header

**Table 3-1: Jumpers**

### 3.6.1 Access the Jumpers

To access the jumpers, remove the back cover. To remove the back cover, please refer to **Section 3.5**.

### 3.6.2 Preconfigured Jumpers



**WARNING:**

Do not change the settings on the jumpers described here. Doing so may disable or damage the system

The following jumpers are preconfigured for the PPC-37xxA-N26. Users should not change these jumpers.

Jumper Name	Label	Type
LVDS voltage selection	JP5	3-pin header
Touchscreen type selection	J_WIRE1	Switch

**Table 3-2: Preconfigured Jumpers**

Setting	Description
Short 1-2	+3.3V LVDS (Default)
Short 2-3	+5V LVDS

**Table 3-3: LVDS Voltage Selection Jumper Settings**

Setting	Description
A	5-wire resistive touch (for PPC-3710A-N26 and PPC-3712A-N26)
B	4-wire resistive touch (for PPC-3708A-N26)

**Table 3-4: Touchscreen Type Selection Jumper Settings**

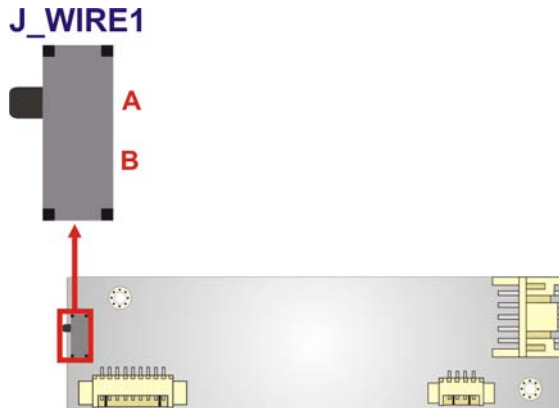

**Figure 3-4: Touchscreen Type Selection Jumper Location**

### 3.6.3 AT/ATX Power Selection Jumper

- Jumper Label:** JP3
- Jumper Type:** 2-pin header
- Jumper Settings:** See Table 3-5
- Jumper Location:** See Figure 3-5

The AT/ATX power selection jumper specifies the system power mode as AT or ATX.

Setting	Description
Short 1-2	Use ATX power (Default)
Off	Use AT power

**Table 3-5: AT/ATX Power Selection Jumper Settings**



PPC-37xxA-N26 Panel PC

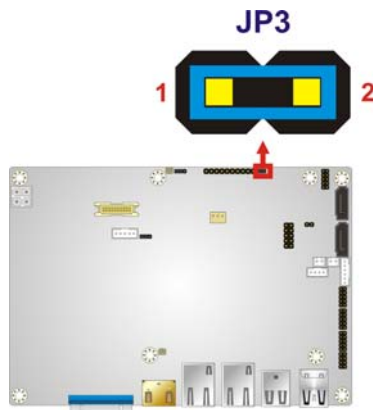

Figure 3-5: AT/ATX Power Selection Jumper Location

3.6.4 Clear CMOS Jumper

- Jumper Label:** JP1
- Jumper Type:** 3-pin header
- Jumper Settings:** See Table 3-6
- Jumper Location:** See Figure 3-6

To reset the BIOS, move the jumper to the "Clear BIOS" position for 3 seconds or more, and then move back to the default position.

Setting	Description
Short 1-2	Normal (Default)
Short 2-3	Clear BIOS

Table 3-6: Clear CMOS Jumper Settings

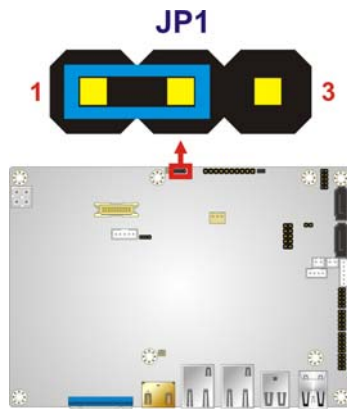

Figure 3-6: Clear CMOS Jumper Location

### 3.6.5 mSATA/PCIe Mini Mode Selection

- Jumper Label:** MSATA\_SW1
- Jumper Type:** 2-pin header
- Jumper Settings:** See **Table 3-7**
- Jumper Location:** See **Figure 3-7**

The jumper configures the PCIe Mini slot (M\_PCIE1) to automatically detect mSATA device or to force mSATA to be enabled.

Setting	Description
Short 1-2	Auto-detect mSATA device (Default)
Off	Enable mSATA

**Table 3-7: mSATA/PCIe Mini Mode Selection Jumper Settings**

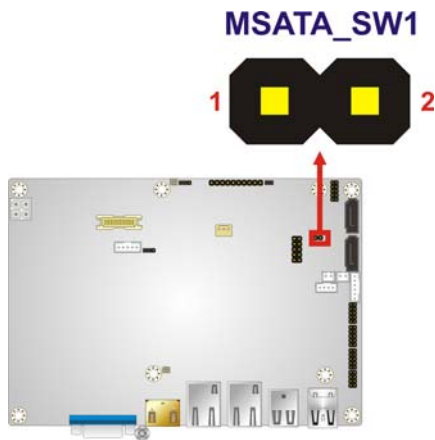

**Figure 3-7: mSATA/PCIe Mini Mode Selection Jumper Location**

### 3.7 mSATA SSD Installation

The PPC-37xxA-N26 has one PCIe Mini slot on the solder side of the motherboard for mSATA SSD installation. To install the mSATA SSD, follow the instructions below.

- Step 1:** Remove the back cover (**Section 3.5**).
- Step 2:** Remove the two hex nuts on the bottom panel (**Figure 3-8**).

PPC-37xxA-N26 Panel PC



Figure 3-8: Hex Nuts on the Bottom Panel

**Step 3:** Remove all the cables connected to the motherboard.

**Step 4:** Release the motherboard from the panel PC by removing the four retention screws (Figure 3-9).

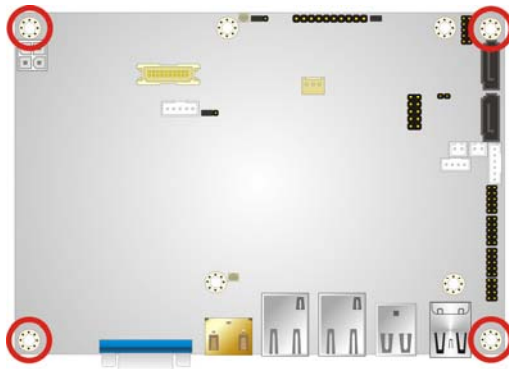

Figure 3-9: Retention Screws on the Motherboard

**Step 5:** Locate the PCIe Mini slot on the solder side of the motherboard (Figure 3-10).

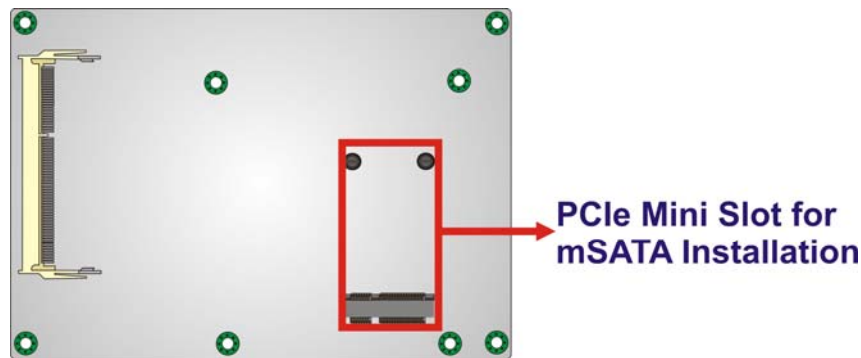

Figure 3-10: PCIe Mini Slot Location

**Step 6:** Insert into the socket at an angle. Line up the notch on the card with the notch on the connector. Slide the PCIe Mini card into the socket at an angle of about 20° (Figure 3-11).

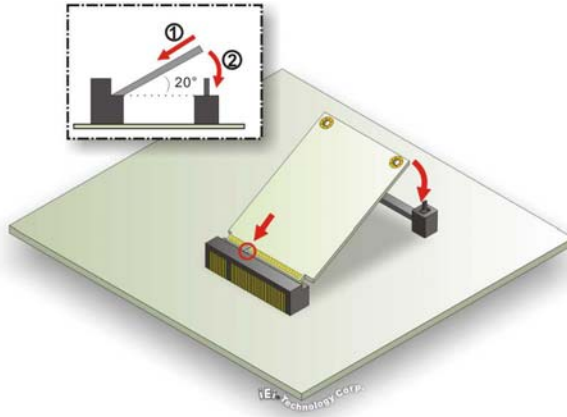

Figure 3-11: PCIe Mini Card Installation

**Step 7:** Push down until the card clips into place. Push the other end of the card down until it clips into place on the plastic connector (Figure 3-11).

**Step 8:** Reassemble the whole system.

## 3.8 HDD Installation

### 3.8.1 PPC-3708A-N26 HDD Installation

To install the HDD into the PPC-3708A-N26, please follow the steps below:

**Step 1:** Remove the back cover. Refer to Section 3.5.

**Step 2:** Remove the HDD bracket from the PPC-3708A-N26. The HDD bracket is attached on the PPC-3708A-N26 with four retention screws, two on the top panel (Figure 3-12) and two inside the chassis (Figure 3-13). Remove the four retention screws and lift the bracket off the panel PC.

## PPC-37xxA-N26 Panel PC



Figure 3-12: PPC-3708A-N26 HDD Bracket Retention Screws (Top Panel)

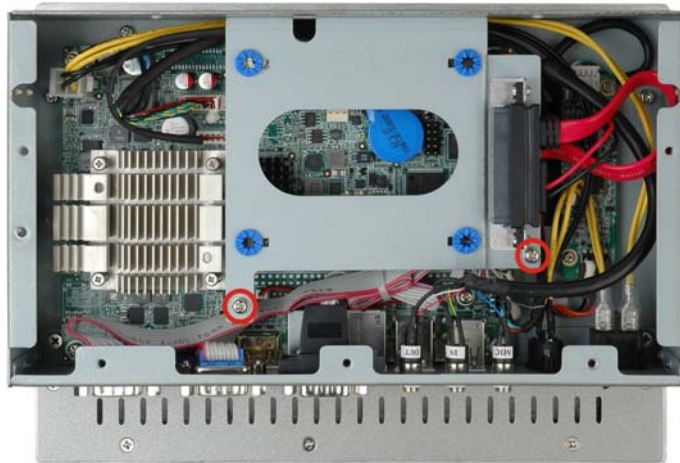

Figure 3-13: PPC-3708A-N26 HDD Bracket Retention Screws (Inside)

- Step 3:** Attach the HDD to the HDD bracket. To do this, align the four retention screw holes in the HDD bracket with the retention screw holes on the bottom of the HDD. Insert four retention screws into the HDD bracket and fasten them. (Figure 3-14).



Figure 3-14: PPC-3708A-N26 HDD Retention Screws

**Step 4:** Install the HDD bracket (with hard drive and SATA cable attached) into the PPC-3708A-N26 and fasten the four HDD bracket screws. **(Figure 3-15.)**

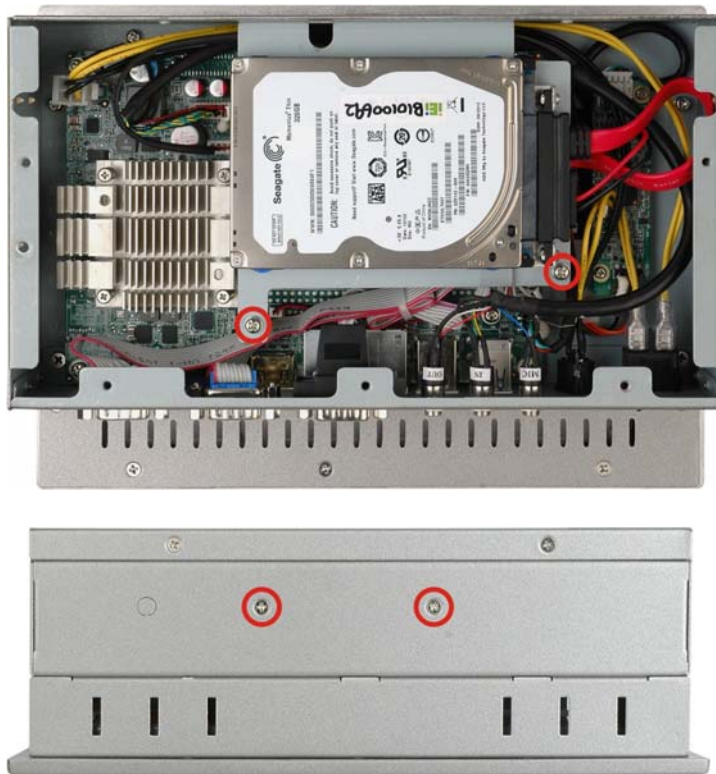

Figure 3-15: Replacing the PPC-3708A-N26 HDD Bracket

## PPC-37xxA-N26 Panel PC

### 3.8.2 PPC-3710A-N26 HDD Installation

To install the HDD into the PPC-3710A-N26, please follow the steps below:

**Step 1:** Remove the back cover. See **Section 3.5**.

**Step 2:** Remove the HDD bracket from the PPC-3710A-N26. The HDD bracket is attached on the panel PC with four retention screws inside the chassis (**Figure 3-16**). Remove the four retention screws and lift the bracket off the panel PC.

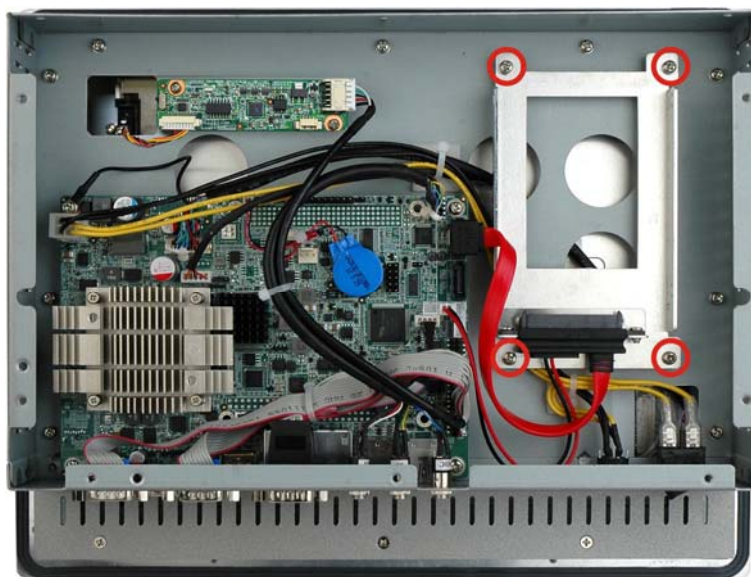

**Figure 3-16: PPC-3710A-N26 HDD Bracket Retention Screws**

**Step 3:** Attach the hard drive in the bracket. To do this, slide the hard drive onto the bracket until it connects with the SATA connector at the back. Fasten the four retention screws on the sides (**Figure 3-17**).



**Figure 3-17: PPC-3710A-N26 HDD Retention Screws**

**Step 4:** Install the hard drive bracket (with hard drive and SATA cable attached) into the panel PC and fasten the four hard drive bracket screws.

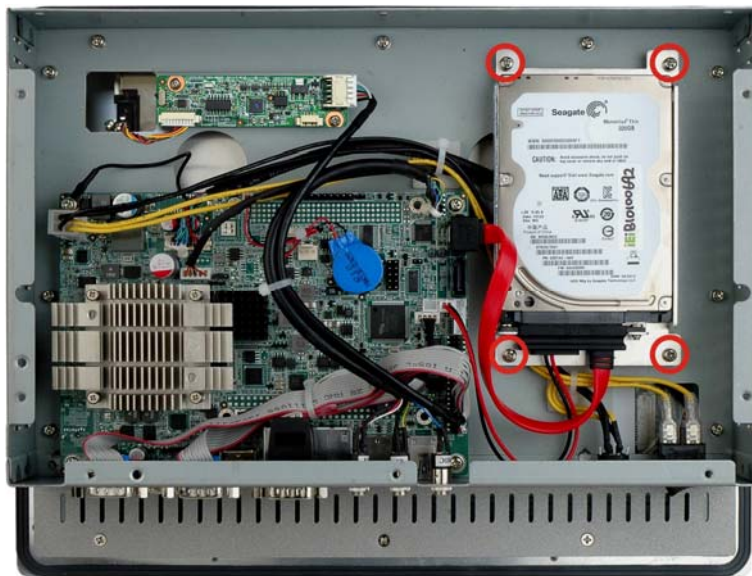

**Figure 3-18: Replacing the PPC-3710A-N26 HDD Bracket**

### **3.8.3 PPC-3712A-N26 HDD Installation**

To install the HDD into the PPC-3712A-N26, please follow the steps below:

**Step 1:** Remove the back cover. See **Section 3.5**.

**Step 2:** Remove the optical drive bracket. Undo the optical drive bracket screws and remove the optical drive bracket. See **Figure 3-19**.



## PPC-37xxA-N26 Panel PC

**Step 3:** Follow **Steps 2 ~ 4** in **Section 3.8.2** to install a hard disk drive to the panel PC.

**Step 4:** Replace the optical drive bracket.

### 3.9 Optical Disk Drive Installation (PPC-3712A-N26 Only)

To install an optical disk drive, please follow the steps below.

**Step 1:** Remove the back cover. See **Section 3.5**.

**Step 2:** Remove the optical drive bracket from the PPC-3712A-N26. To do this, remove four retention screws, two on the side panel and two inside the panel PC (**Figure 3-19**).

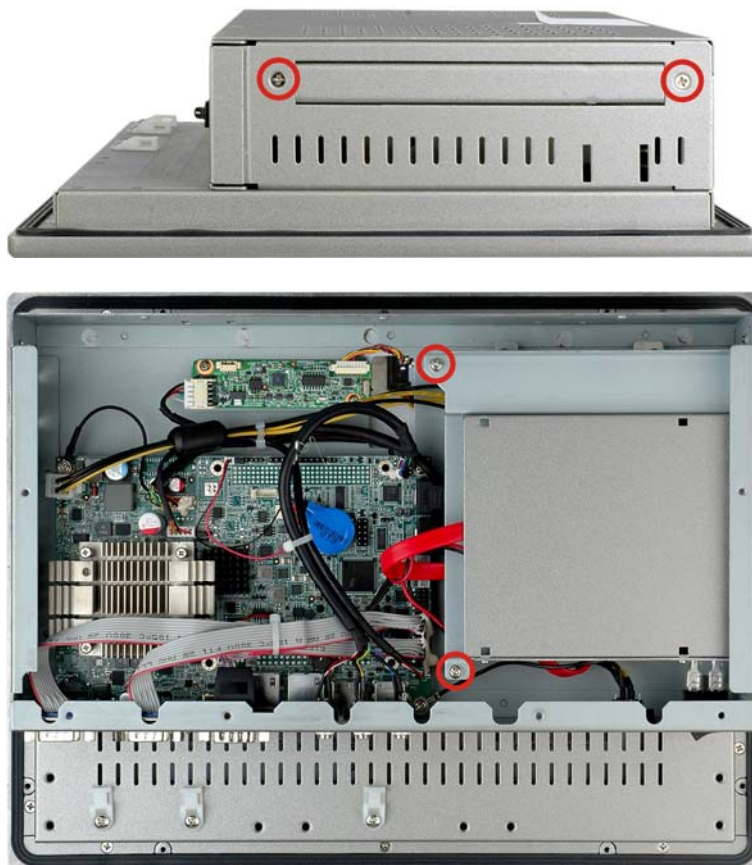

**Figure 3-19: Optical Drive Bracket Retention Screws**

- Step 3:** Remove the four screws from the optical drive bracket assembly (**Figure 3-20**).  
Remove the blank drive plate.

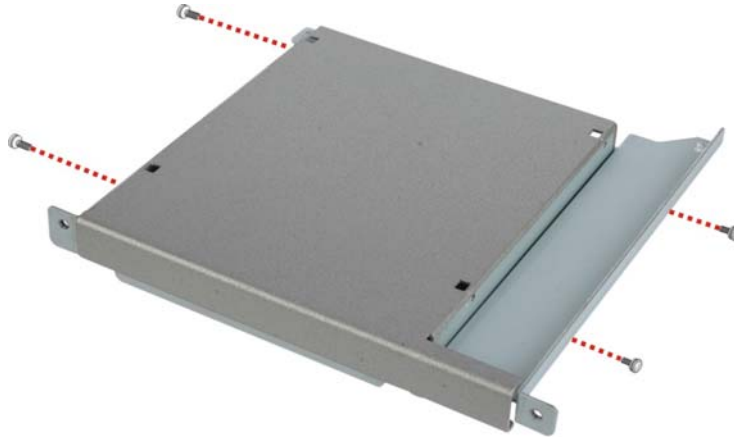

**Figure 3-20: Optical Drive Blank Plate Assembly**

- Step 4:** Install the optical drive in the same position as the previously removed blank optical drive plate. Fasten the same four screws to attach the optical drive to the bracket.



**Figure 3-21: Optical Drive Screws**

- Step 5:** Attach the SATA cable to the back of the optical drive.

## PPC-37xxA-N26 Panel PC



Figure 3-22: Optical Drive SATA Cable

**Step 6:** Reinstall the optical drive bracket into the PPC-3712A-N26 and fasten the optical bracket screws.

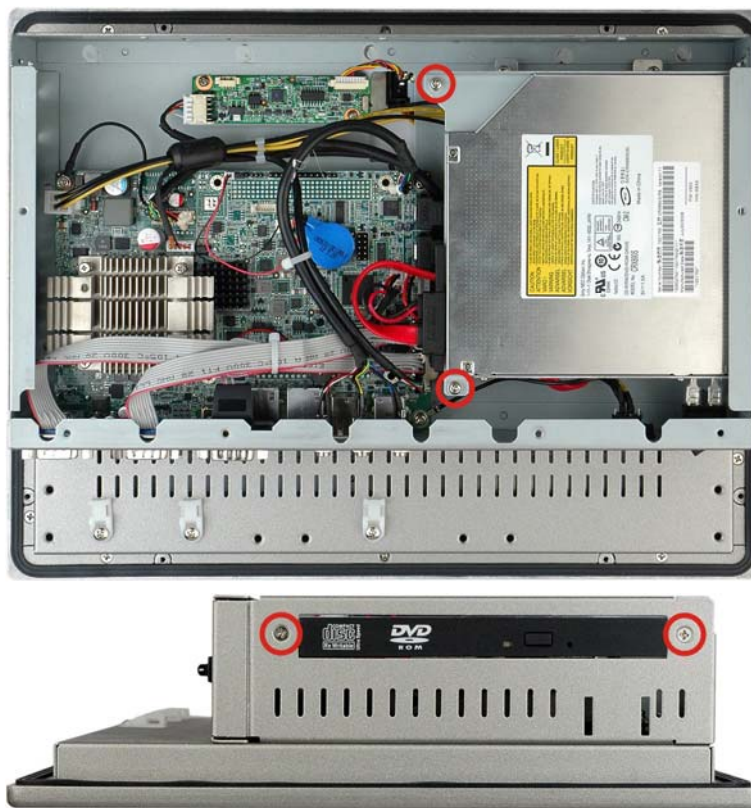

Figure 3-23: Replacing the Optical Drive Bracket

## 3.10 Mounting the System

---



### WARNING!

When mounting the PPC-37xxA-N26 panel PC, it is advisable to have more than one person help with the installation to prevent accidental damage to the panel and avoid personal injury.

---

The methods of mounting the PPC-37xxA-N26 are:

- Wall mounting
- Panel mounting
- Arm mounting
- Stand mounting
- Rack mounting

The mounting methods are described in the following sections.

### 3.10.1 Wall Mounting

To mount the PPC-37xxA-N26 panel PC onto a wall, please follow the steps below.

- Step 1:** Select the location on the wall for the wall-mounting bracket.
- Step 2:** Carefully mark the locations of the four bracket screw holes on the wall.
- Step 3:** Drill four pilot holes at the marked locations on the wall for the bracket retention screws.
- Step 4:** Align the wall-mounting bracket screw holes with the pilot holes.
- Step 5:** Secure the mounting bracket to the wall by inserting the retention screws into the four pilot holes and tightening them (**Figure 3-24**).

## PPC-37xxA-N26 Panel PC

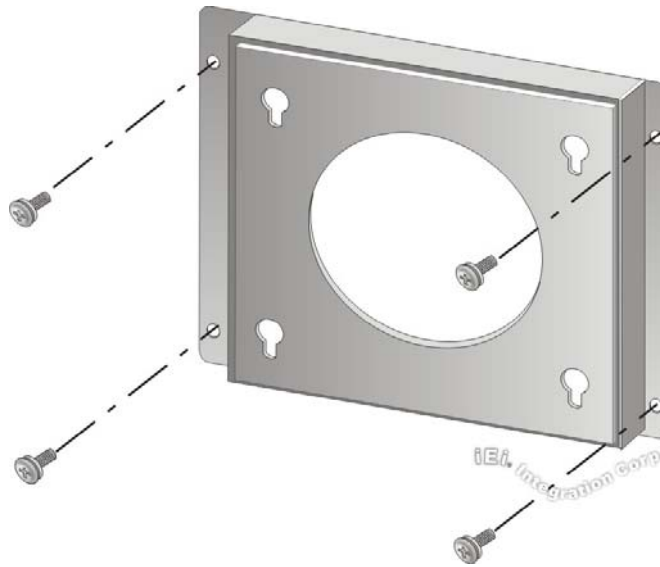

**Figure 3-24: Wall-mounting Bracket**

- Step 6:** Insert the four monitor mounting screws provided in the wall mounting kit into the four screw holes on the rear panel of the monitor and tighten until the screw shank is secured against the rear panel (**Figure 3-25**).
- Step 7:** Align the mounting screws on the monitor rear panel with the mounting holes on the bracket.
- Step 8:** Carefully insert the screws through the holes and gently pull the monitor downwards until the monitor rests securely in the slotted holes (**Figure 3-25**). Ensure that all four of the mounting screws fit snugly into their respective slotted holes.



**NOTE:**

In the diagram below the bracket is already installed on the wall.

---

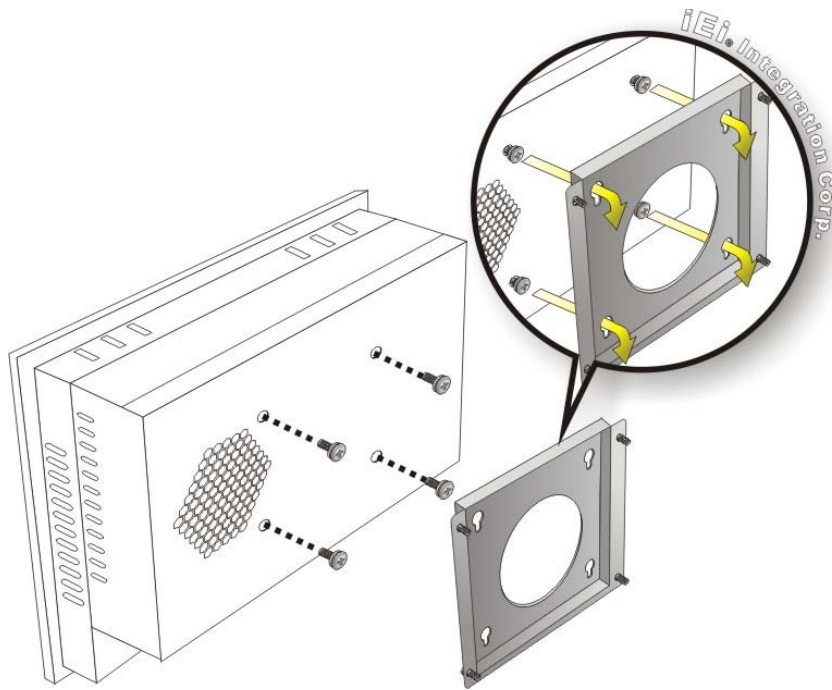

**Figure 3-25: Mount the Chassis**

**Step 9:** Secure the panel PC with the wall-mounting kit. To do this, stick the protective cushion to the wall-mounting kit first. Then, put the wall-mounting kit on the top panel of the panel PC. Carefully mark the location of the wall-mounting kit screw holes on the wall. Drill a pilot hole at the marked location on the wall. Secure the wall-mounting kit to the wall by inserting a retention screw into the pilot hole on the wall (**Figure 3-26**). This step is to avoid the panel PC being pushed apart from the wall-mounting bracket accidentally.

## PPC-37xxA-N26 Panel PC

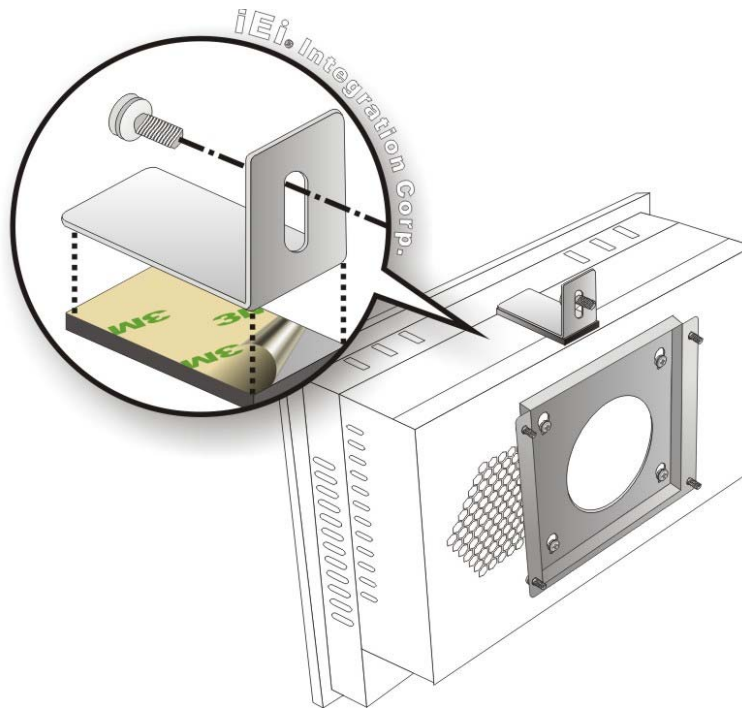

Figure 3-26: Secure the Chassis

### 3.10.2 Panel Mounting

#### 3.10.2.1 PPC-3708A-N26 and PPC-3710A-N26

To mount the PPC-3708A-N26 or PPC-3710A-N26 panel PC into a panel, please follow the steps below.

- Step 1:** Select the position on the panel to mount the PPC-37xxA-N26.
- Step 2:** Cut out a section of the panel that corresponds to the rear panel dimensions of the panel PC. The recommended cutout sizes are shown below (**Figure 3-27** and **Figure 3-28**).

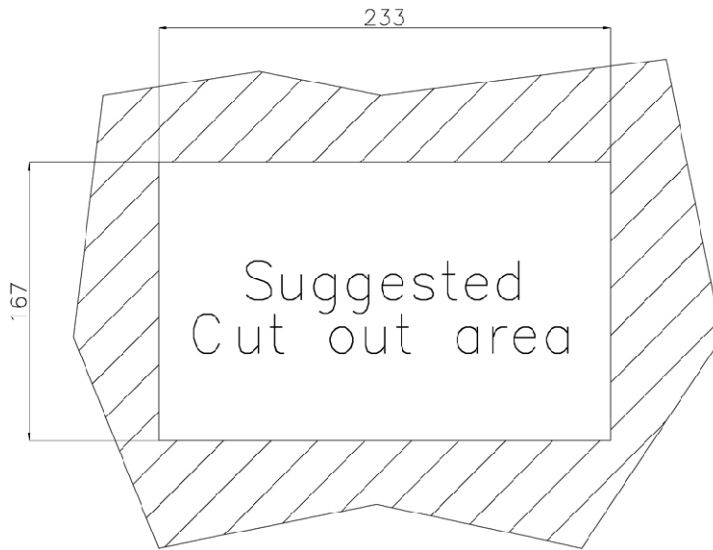

**Figure 3-27: PPC-3708A-N26 Panel Cutout Dimensions**

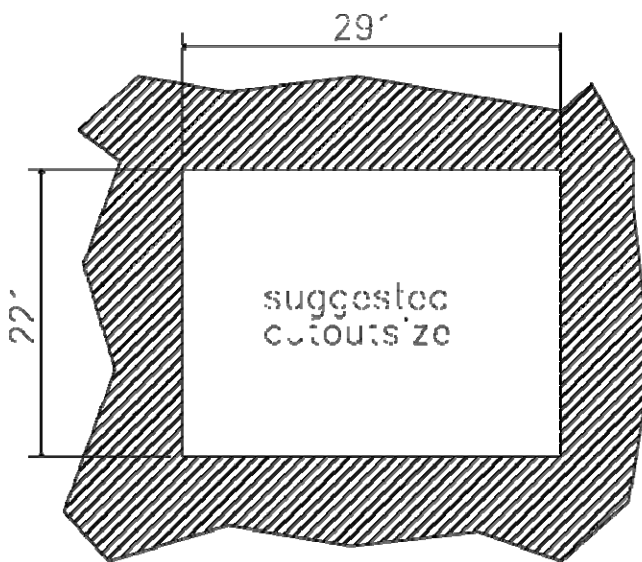

**Figure 3-28: PPC-3710A-N26 Panel Cutout Dimensions**

- Step 3:** Slide the panel PC through the hole until the aluminum frame is flush against the panel.
- Step 4:** Insert the panel mounting clamps into the pre-formed holes along the edges of the panel PC, behind the aluminum frame (**Figure 3-29**). There are a total of 8 panel mounting clamps for PPC-3708A-N26 and 10 clamps for PPC-3710A-N26.



## PPC-37xxA-N26 Panel PC

**Step 5:** Tighten the screws that pass through the panel mounting clamps until the plastic caps at the front of all the screws are firmly secured to the panel (**Figure 3-29**).

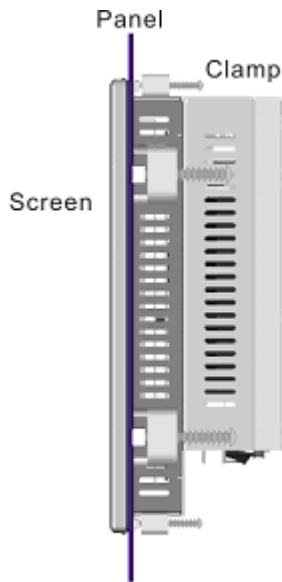
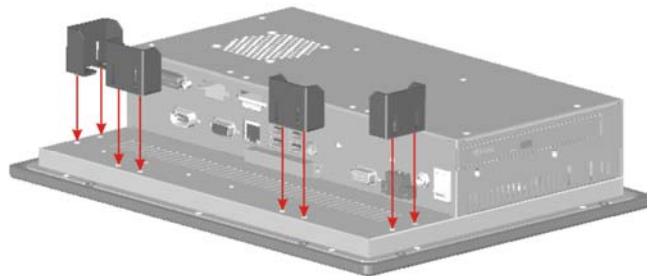

**Figure 3-29: Tighten the Panel Mounting Clamp Screws**

### 3.10.2.2 PPC-3712A-N26

To mount the PPC-3712A-N26 panel PC into a panel, please follow the steps below.

**Step 1:** Install the panel mounting kit onto the real panel (**Figure 3-30**).



**Figure 3-30: Panel Mounting Kit**

**Step 2:** Select the position in the panel to mount the PPC-3712A-N26.

- Step 3:** Cut out a section from the panel that corresponds to the dimensions of the flat panel PC chassis. The panel section that is cut out must be smaller than the size of the aluminum frame that surrounds the 12.1" TFT LCD panel but just large enough for the chassis to fit through (**Figure 3-31**).

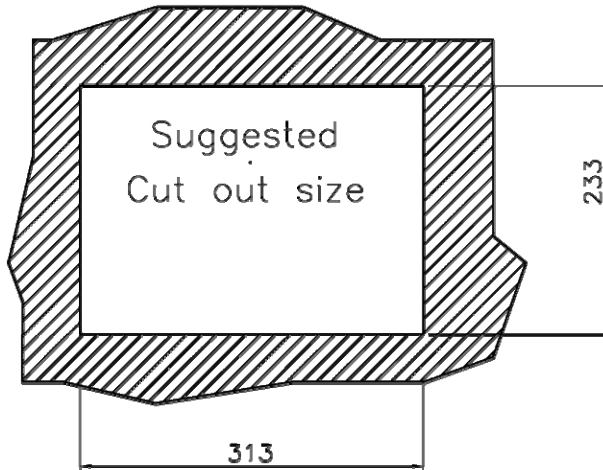

**Figure 3-31: PPC-3712A-N26 Panel Cutout Dimensions**

- Step 4:** Slide the panel PC through the hole until the aluminum frame is flush against the panel.
- Step 5:** Insert the panel mounting clamps into the pre-formed holes along the edges of the chassis, behind the aluminum frame. There are a total of 8 panel mounting clamps.
- Step 6:** Tighten the screws that pass through the panel mounting clamps until the plastic caps at the front of all the screws are firmly secured to the panel (**Figure 3-32**).

PPC-37xxA-N26 Panel PC

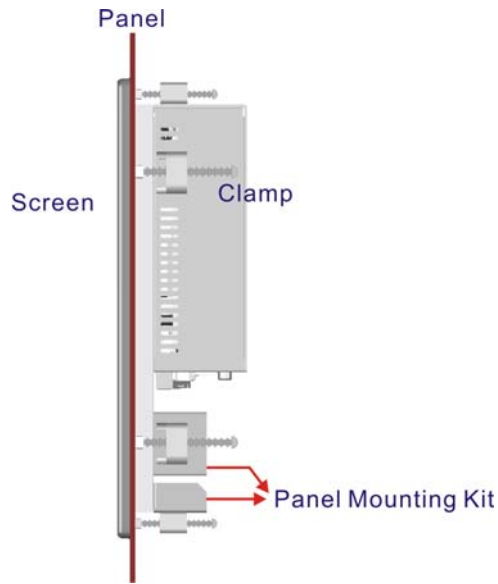

Figure 3-32: Tighten the Panel Mounting Clamp Screws

3.10.3 Cabinet and Rack Installation

The PPC-37xxA-N26 panel PC can be installed into a cabinet or rack. To do this, please follow the steps below.

3.10.3.1 PPC-3708A-N26

**Step 1:** Slide the rear chassis of the PPC-3708A-N26 panel PC through the rack/cabinet bracket until the aluminum frame is flush against the front of the bracket (Figure 3-33).

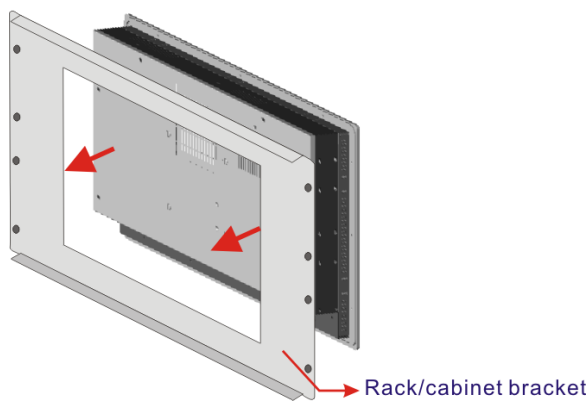
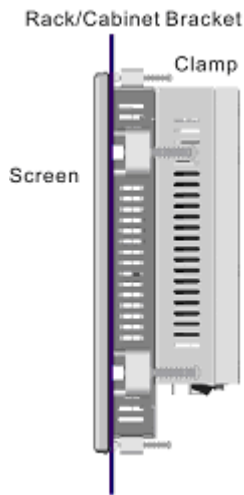

Figure 3-33: The Rack/Cabinet Bracket

**Step 2:** Insert the rack mounting clamps into the pre-formed holes along the edges of the PPC-3708A-N26, behind the aluminum frame. The required number of mounting clamps should be eight.

**Step 3:** Tighten the screws that pass through the rack mounting clamps until the plastic caps at the front of all the screws are firmly secured to the bracket

(**Figure 3-34**).



**Figure 3-34: Securing the PPC-3708A-N26 Rack/Cabinet Bracket**

**Step 4:** Slide the PPC-3708A-N26 panel PC with the attached rack/cabinet bracket into a rack or cabinet (**Figure 3-35**).

## PPC-37xxA-N26 Panel PC

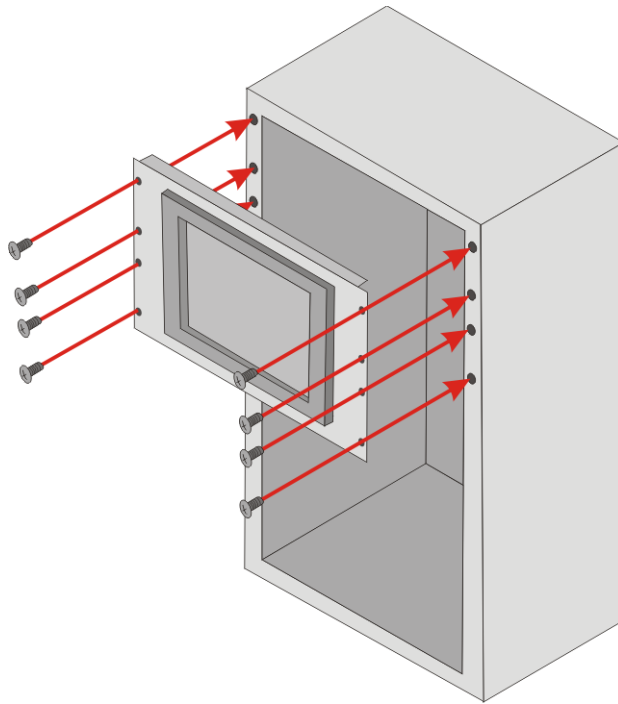

**Figure 3-35: Installing into a Rack/Cabinet**

**Step 5:** Once the panel PC with the attached rack/cabinet bracket has been properly inserted into the rack or cabinet, secure the front of the rack/cabinet bracket to the front of the rack or cabinet (**Figure 3-35**).

### 3.10.3.2 PPC-3710A-N26 and PPC-3712A -N26

**Step 1:** The back of the aluminum frame surrounding the LCD screen has retention screw holes (PPC-3710A-N26 has 10 holes and PPC-3712A -N26 has 8 holes) for a cabinet/rack installation bracket.



**NOTE:**

When purchasing the cabinet/rack installation bracket, make sure it is compatible with both the panel PC and the rack/cabinet into which the panel PC is installed.

---

- Step 2:** Slide the rear chassis through the rack/cabinet bracket until the rear side of the LCD screen frame is flush against the front of the bracket.
- Step 3:** Make sure the retention screw holes at the rear of the LCD screen are aligned with the retention screw holes in the rack/cabinet bracket.
- Step 4:** Secure the rack/cabinet bracket to the panel PC by inserting the retention screws (**Figure 3-36**).

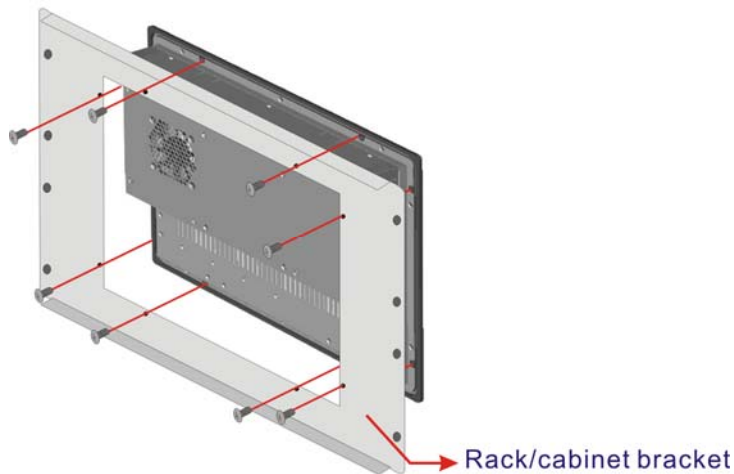

**Figure 3-36: Securing the Rack/Cabinet Bracket**

- Step 5:** Follow **Step 4** and **Step 5** of the PPC-3708A-N26 Cabinet and Rack Installation procedures to complete the whole installation process.

### 3.10.4 Arm Mounting

The PPC-37xxA-N26 is VESA (Video Electronics Standards Association) compliant and can be mounted on an arm with a 100 mm interface pad. To mount the PPC-37xxA-N26 on an arm, please follow the steps below.

- Step 1:** The arm is a separately purchased item. Please correctly mount the arm onto the surface it uses as a base. To do this, refer to the installation documentation that came with the mounting arm.

## PPC-37xxA-N26 Panel PC

**NOTE:**

When purchasing the arm please ensure that it is VESA compliant and that the arm has a 100 mm interface pad. If the mounting arm is not VESA compliant, it cannot be used to support the PPC-37xxA-N26 panel PC.

**Step 2:** Once the mounting arm has been firmly attached to its surface, lift the PPC-37xxA-N26 panel PC onto the interface pad of the mounting arm.

**Step 3:** Align the retention screw holes on the mounting arm interface with those in the PPC-37xxA-N26 panel PC. The arm mounting retention screw holes of the PPC-37xxA-N26 panel PC are shown in **Figure 3-37**.

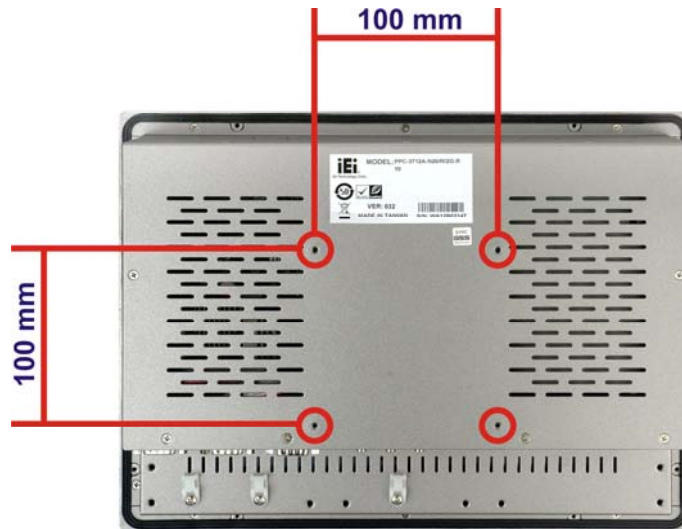

**Figure 3-37: Arm Mounting Retention Screw Holes**

**Step 4:** Secure the PPC-37xxA-N26 to the interface pad by inserting four retention screws through the mounting arm interface pad and into the PPC-37xxA-N26 panel PC.

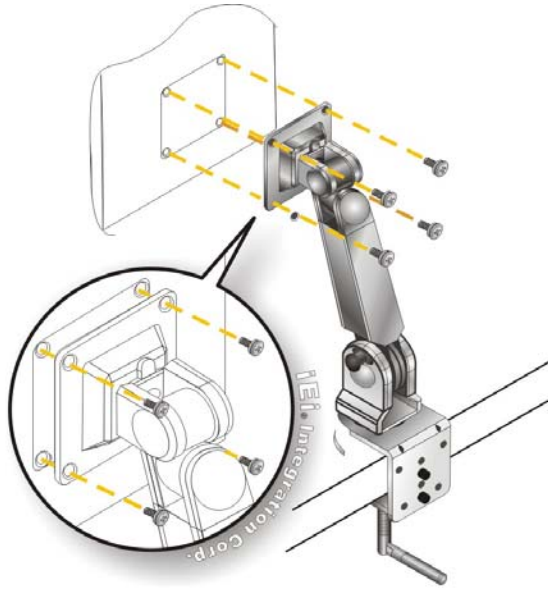
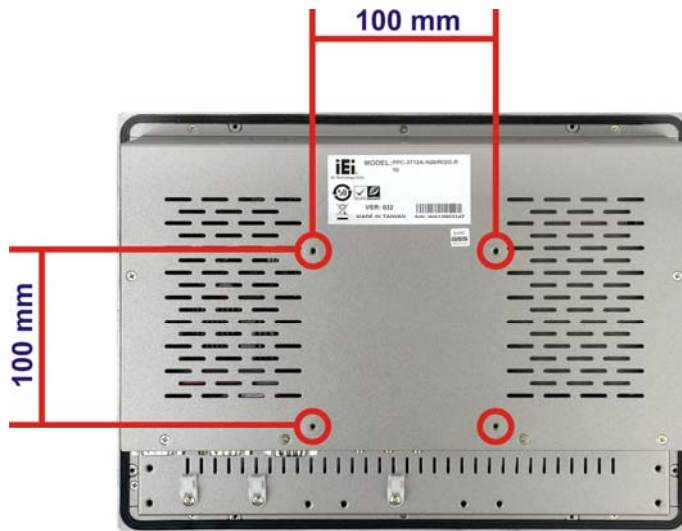

**Figure 3-38: Arm Mounting**

### 3.10.5 Stand Mounting

To mount the PPC-37xxA-N26 using the stand mounting kit, please follow the steps below.

**Step 1:** Locate the screw holes on the rear of the PPC-37xxA-N26. This is where the bracket will be attached.



**Figure 3-39: Stand Mounting Retention Screw Holes**



## PPC-37xxA-N26 Panel PC

**Step 2:** Align the bracket with the screw holes.

**Step 3:** To secure the bracket to the PPC-37xxA-N26, insert the retention screws into the screw holes and tighten them.

### 3.11 Bottom Panel Connectors

The bottom panel of the PPC-37xxA-N26 contains I/O connectors, power connector and power switch. Detailed descriptions of the connectors can be found in the subsections below.

#### 3.11.1 Audio Connectors

The audio jacks connect to external audio devices.

- **Mic:** Connects to a microphone.
- **Line-in:** Connects to a player or other audio sources.
- **Line-out:** Connects to a headphone or a speaker. With multi-channel configurations, this port can also connect to front speakers.

#### 3.11.2 HDMI Connector

The HDMI connector transmits a digital signal to compatible HDMI display devices such as a TV or computer screen. To connect the HDMI cable to the PPC-37xxA-N26, follow the steps below.

**Step 1:** **Locate the HDMI connector.** The location is shown in **Figure 1-4**.

**Step 2:** **Align the connector.** Align the HDMI connector with the HDMI port. Make sure the orientation of the connector is correct.

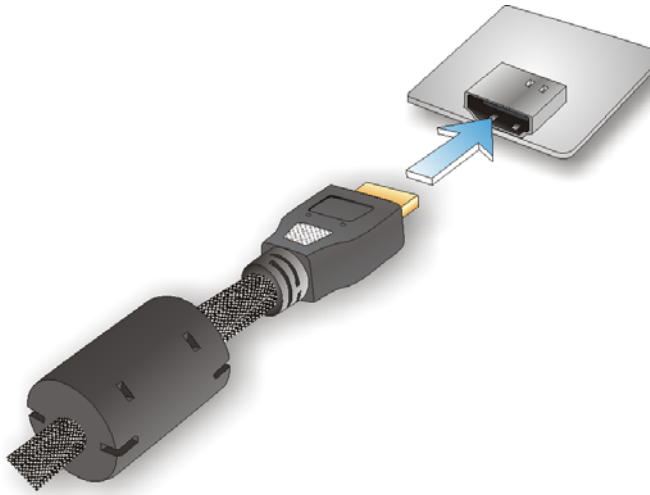

**Figure 3-40: HDMI Connection**

**Step 3: Insert the HDMI connector.** Gently insert the HDMI connector. The connector should engage with a gentle push. If the connector does not insert easily, check again that the connector is aligned correctly, and that the connector is being inserted with the right way up.

### 3.11.3 Power Input Connector

The standard system is shipped with a 90 V to 264 V AC power adapter that has a maximum power output of 60 W. The power adapter has a 12 V DC output connector. The PPC-37xxA-N26 has one 12 V power input connector on the bottom panel. The location of the power connector is shown in **Figure 1-4**.

### 3.11.4 RJ-45 LAN Connectors

The RJ-45 LAN connectors allow connections to external networks. The pinouts of the RJ-45 LAN connector is shown below.

Pin	Description	Pin	Description
1	MD10+	5	MD12+
2	MD10-	6	MD12-
3	MD11+	7	MD13+
4	MD11-	8	MD13-

**Table 3-8: LAN Pinouts**

PPC-37xxA-N26 Panel PC

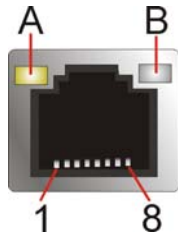

Figure 3-41: RJ-45 LAN Connector

Each RJ-45 LAN connector has two status LEDs. See **Figure 3-41**.

LED	Description	LED	Description
A	on: linked blinking: data is being sent/received	B	off: 10 Mb/s green: 100 Mb/s orange: 1000 Mb/s

Table 3-9: RJ-45 LAN Connector LEDs

To connect the PPC-37xxA-N26 to a network through the RJ-45 LAN connectors, follow the steps below.

**Step 1:** **Locate the RJ-45 connectors.** The locations of the RJ-45 connectors are shown in **Figure 1-4**.

**Step 2:** **Align the connectors.** Align the RJ-45 connector on the LAN cable with one of the RJ-45 connectors on the PPC-37xxA-N26. See **Figure 3-42**.

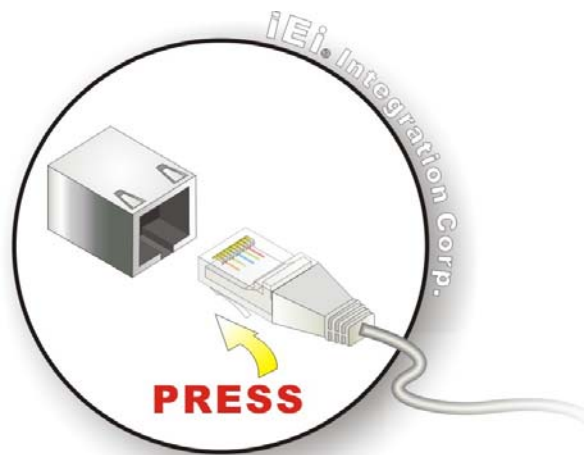

Figure 3-42: LAN Connection

**Step 3:** Insert the LAN cable RJ-45 connector. Once aligned, gently insert the LAN cable RJ-45 connector into the on-board RJ-45 connector.

### 3.11.5 RS-232 Serial Ports

An RS-232 device can be connected to the RS-232 serial port on the bottom panel. To install the RS-232 devices, follow the steps below.

**Step 1:** Locate the DB-9 connector. The locations of the DB-9 connectors are shown in **Figure 1-4**.

**Step 2:** Insert the serial connector. Insert the DB-9 connector of a serial device into the DB-9 connector on the external peripheral interface. See **Figure 3-43**

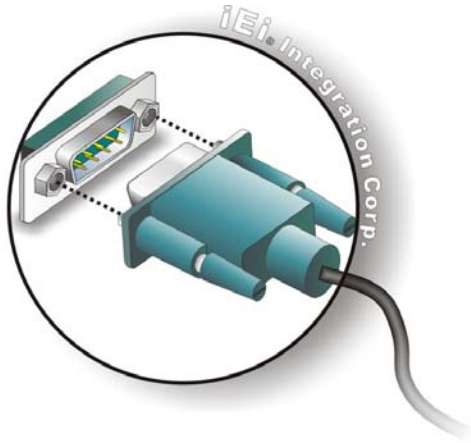

**Figure 3-43: RS-232 Serial Device Connector**

**Step 3:** Secure the connector. Secure the serial device connector to the external interface by tightening the two retention screws on either side of the connector

### 3.11.6 RS-422/485 Serial Port

To install the RS-422/485 device, follow the steps below.

**Step 1:** Locate the DB-9 connector. The location of the DB-9 connector is shown in **Figure 1-4**.

## PPC-37xxA-N26 Panel PC

**Step 2: Insert the serial connector.** Insert the DB-9 connector of a serial device into the DB-9 connector on the external peripheral interface. See **Figure 3-44**

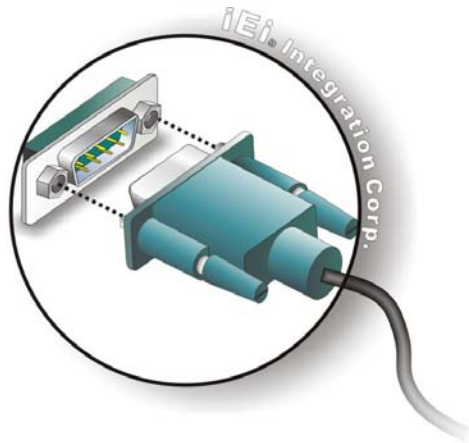

**Figure 3-44: RS-422/485 Serial Device Connector**

**Step 3: Secure the connector.** Secure the serial device connector to the external interface by tightening the two retention screws on either side of the connector

### 3.11.7 USB 2.0 Connectors

The USB 2.0 ports are for attaching USB 2.0/1.1 peripheral devices to the system. To connect a USB 2.0 or USB 1.1 device, please follow the instructions below.

**Step 1: Located the USB connectors.** The locations of the USB connectors are shown in **Figure 1-4**.

**Step 2: Align the connectors.** Align the USB device connector with one of the connectors on the bottom panel. See **Figure 3-45**.

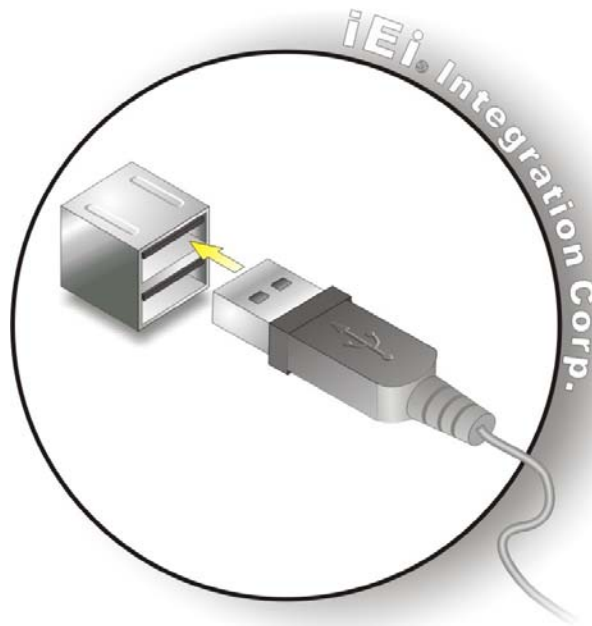

**Figure 3-45: USB Device Connection**

**Step 3:** **Insert the device connector.** Once aligned, gently insert the USB device connector into the onboard connector.

### 3.11.8 USB 3.0 Connectors

The USB 3.0 ports are for attaching USB 3.0 peripheral devices to the system. Follow the instructions in the previous section to connect the USB devices to the USB 3.0 ports.



**NOTE:**

If installing the Windows® 7 OS by using the USB 3.0 ports, loading the USB 3.0 driver during OS installation is necessary. Refer to **Section 6.7.1** for detailed installation procedure.

### 3.11.9 VGA Connector

The VGA connector connects to a monitor that accepts VGA video input. To connect the PPC-37xxA-N26 to a second display via the VGA connector, follow the steps below,

## PPC-37xxA-N26 Panel PC

- Step 1:** **Locate the female DB-15 connector.** The location of the female DB-15 connector is shown in **Figure 1-4**.
- Step 2:** **Align the VGA connector.** Align the male DB-15 connector on the VGA screen cable with the female DB-15 connector on the external peripheral interface.
- Step 3:** **Insert the VGA connector.** Once the connectors are properly aligned with the insert the male connector from the VGA screen into the female connector on the PPC-37xxA-N26. See **Figure 3-46**

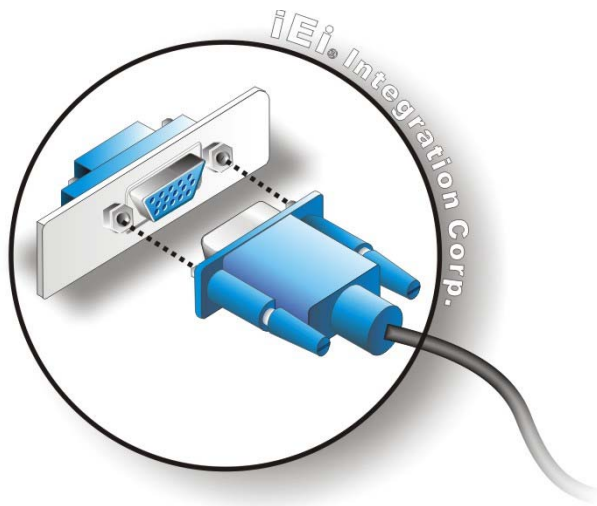

**Figure 3-46: VGA Connector**

Chapter

4

# System Maintenance

---



## PPC-37xxA-N26 Panel PC

### 4.1 System Maintenance Introduction

The following system components may require maintenance.

- Motherboard
- SO-DIMM module

If these components fail, they must be replaced. Please contact the system reseller or vendor to purchase replacement parts. Replacement instructions for the above listed components are described below.

### 4.2 Motherboard Replacement

A user cannot replace a motherboard. If the motherboard fails it must be shipped back to IEI to be replaced. If the system motherboard has failed, please contact the system vendor, reseller or an IEI sales person directly.

### 4.3 Back Cover Removal



#### **WARNING!**

Before removing the back cover, make sure all power to the system has been disconnected. Failing to do so may cause severe damage to the PPC-37xxA-N26 and injury to the user.

---

---



#### **WARNING!**

Please take antistatic precautions when working with the internal components. The interior of the PPC-37xxA-N26 contains very sensitive electronic components. These components are easily damaged by electrostatic discharge (ESD). Before working with the internal components, make sure all anti-static precautions described earlier have been observed.

---

To access the panel PC internal components, the back cover must be removed. To remove the back cover, please refer to **Section 3.5** for back cover removal instructions.

## 4.4 SO-DIMM Replacement

Please read the warnings at the beginning of the previous section before attempting to access any PPC-37xxA-N26 internal components.

To install/replace the SO-DIMM modules, please follow the steps below.

**Step 1:** Remove the back cover (**Section 3.5**).

**Step 2:** Follow **Steps 2 ~ 4** in **Section 3.7** to release the motherboard from the panel PC.

**Step 3:** Locate the SO-DIMM module on the solder side of the motherboard.

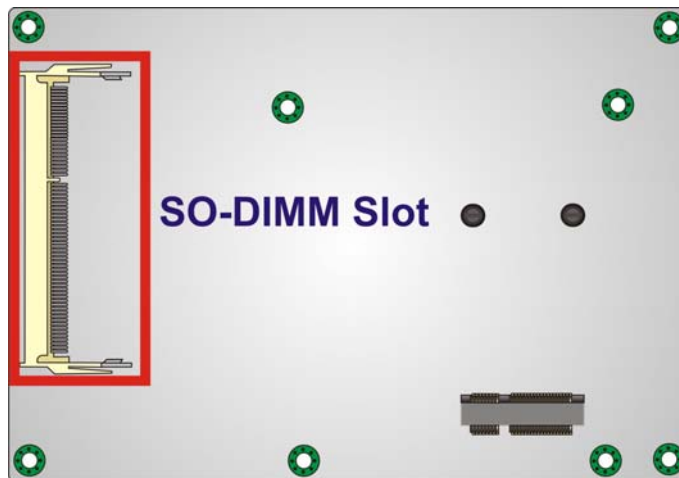

**Figure 4-1: SO-DIMM Module Location**

**Step 4:** Release the SO-DIMM module by pulling both the spring retainer clips outward from the socket.

**Step 5:** Grasp the SO-DIMM module by the edges and carefully pull it out of the socket.

**Step 6:** Install the new SO-DIMM module by pushing it into the socket at an angle (**Figure 4-2**).

## PPC-37xxA-N26 Panel PC

**Step 7:** Gently push the rear of the SO-DIMM module down (**Figure 4-2**). The spring retainer clips clip into place and secure the SO-DIMM module in the socket.

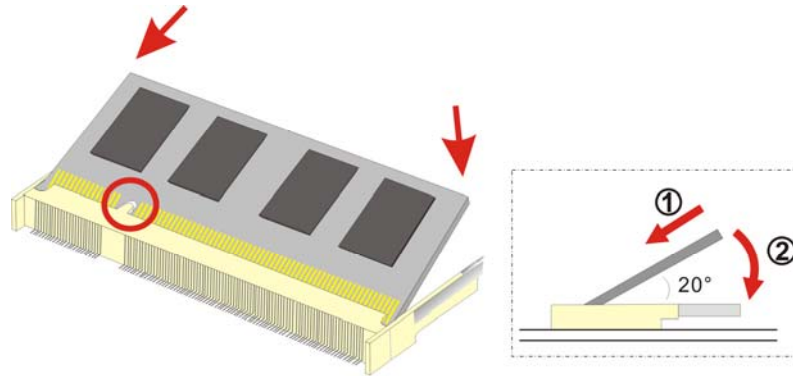

**Figure 4-2: SO-DIMM Module Installation**

**Step 8:** Push the new DIMM module until it engages and the white plastic end clips click into place. Make sure the end clips are fully secured after installation.

Chapter

**5**

# BIOS Setup

---

## 5.1 Introduction

The BIOS is programmed onto the BIOS chip. The BIOS setup program allows changes to certain system settings. This chapter outlines the options that can be changed.

### 5.1.1 Starting Setup

The UEFI BIOS is activated when the computer is turned on. The setup program can be activated in one of two ways.

1. Press the **DELETE** or **F2** key as soon as the system is turned on or
2. Press the **DELETE** or **F2** key when the “**Press DELETE or F2 to enter SETUP**” message appears on the screen.

If the message disappears before the **DELETE** or **F2** key is pressed, restart the computer and try again.

### 5.1.2 Using Setup

Use the arrow keys to highlight items, press **ENTER** to select, use the PageUp and PageDown keys to change entries, press **F1** for help and press **Esc** to quit. Navigation keys are shown in the following table.

Key	Function
Up arrow	Move to the item above
Down arrow	Move to the item below
Left arrow	Move to the item on the left hand side
Right arrow	Move to the item on the right hand side
+	Increase the numeric value or make changes
-	Decrease the numeric value or make changes
Page up	Move to the next page
Page down	Move to the previous page

Key	Function
Esc	Main Menu – Quit and do not save changes into CMOS Status Page Setup Menu and Option Page Setup Menu -- Exit current page and return to Main Menu
F1	General help, only for Status Page Setup Menu and Option Page Setup Menu
F2	Load previous values
F3	Load optimized defaults
F4	Save changes and Exit BIOS

**Table 5-1: BIOS Navigation Keys**

### 5.1.3 Getting Help

When **F1** is pressed a small help window describing the appropriate keys to use and the possible selections for the highlighted item appears. To exit the Help Window press **Esc** or the **F1** key again.

### 5.1.4 Unable to Reboot after Configuration Changes

If the computer cannot boot after changes to the system configuration are made, press the CMOS button on the bottom panel to clear the CMOS data and reset the system BIOS information. The location of the CMOS button is shown in **Section 3.6.4**.

### 5.1.5 BIOS Menu Bar

The **menu bar** on top of the BIOS screen has the following main items:

- Main – Changes the basic system configuration.
- Advanced – Changes the advanced system settings.
- Chipset – Changes the chipset settings.
- Boot – Changes the system boot configuration.
- Security – Sets User and Supervisor Passwords.
- Save & Exit – Selects exit options and loads default settings

The following sections completely describe the configuration options found in the menu items at the top of the BIOS screen and listed above.

## PPC-37xxA-N26 Panel PC

### 5.2 Main

The **Main** BIOS menu (**BIOS Menu 1**) appears when the **BIOS Setup** program is entered. The **Main** menu gives an overview of the basic system information.

```

Aptio Setup Utility - Copyright (C) 2011 American Megatrends, Inc.
Main  Advanced  Chipset  Boot  Security  Save & Exit

BIOS Information
BIOS Vendor                American Megatrends
Core Version               4.6.5.3.0.16
Compliancy                 UEFI 2.3; PI 1.2
Project Version            H730AR12.ROM
Build Date and Time       10/26/2012 11:46:29

System Date                [Tue 12/18/2012]
System Time                [14:20:27]

Access Level               Administrator

Set the Date. Use Tab to
switch between Data
elements.

-----

-><: Select Screen
↑↓: Select Item
Enter: Select
+/-: Change Opt.
F1: General Help
F2: Previous Values
F3: Optimized Defaults
F4: Save & Exit
ESC: Exit

Version 2.14.1219. Copyright (C) 2011 American Megatrends, Inc.
  
```

#### BIOS Menu 1: Main

##### → BIOS Information

The **BIOS Information** lists a brief summary of the BIOS. The fields in **BIOS Information** cannot be changed. The items shown in the system overview include:

- **BIOS Vendor:** Installed BIOS vendor
- **Core Version:** Current BIOS version
- **Compliancy:** compliant UEFI specification version
- **Project Version:** the board version
- **Build Date and Time:** Date and time the current BIOS version was made

##### → System Date [xx/xx/xx]

Use the **System Date** option to set the system date. Manually enter the day, month and year.

→ **System Time [xx:xx:xx]**

Use the **System Time** option to set the system time. Manually enter the hours, minutes and seconds.

### 5.3 Advanced

Use the **Advanced** menu (**BIOS Menu 2**) to configure the CPU and peripheral devices through the following sub-menus:



**WARNING!**

Setting the wrong values in the sections below may cause the system to malfunction. Make sure that the settings made are compatible with the hardware.

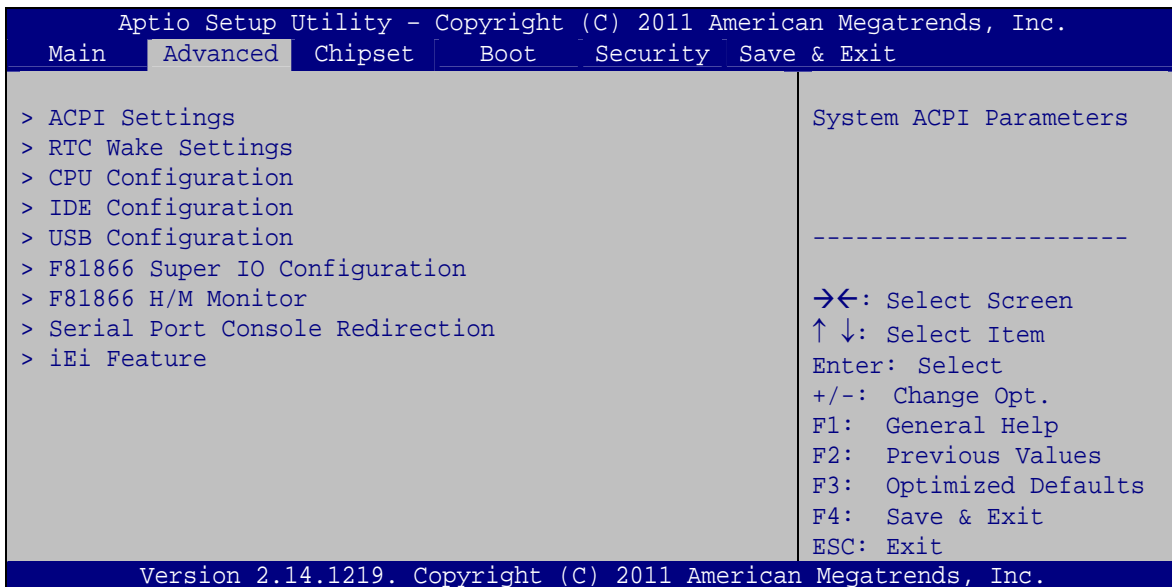

**BIOS Menu 2: Advanced**

#### 5.3.1 ACPI Settings

The **ACPI Settings** menu (**BIOS Menu 3**) configures the Advanced Configuration and Power Interface (ACPI) options.



## PPC-37xxA-N26 Panel PC

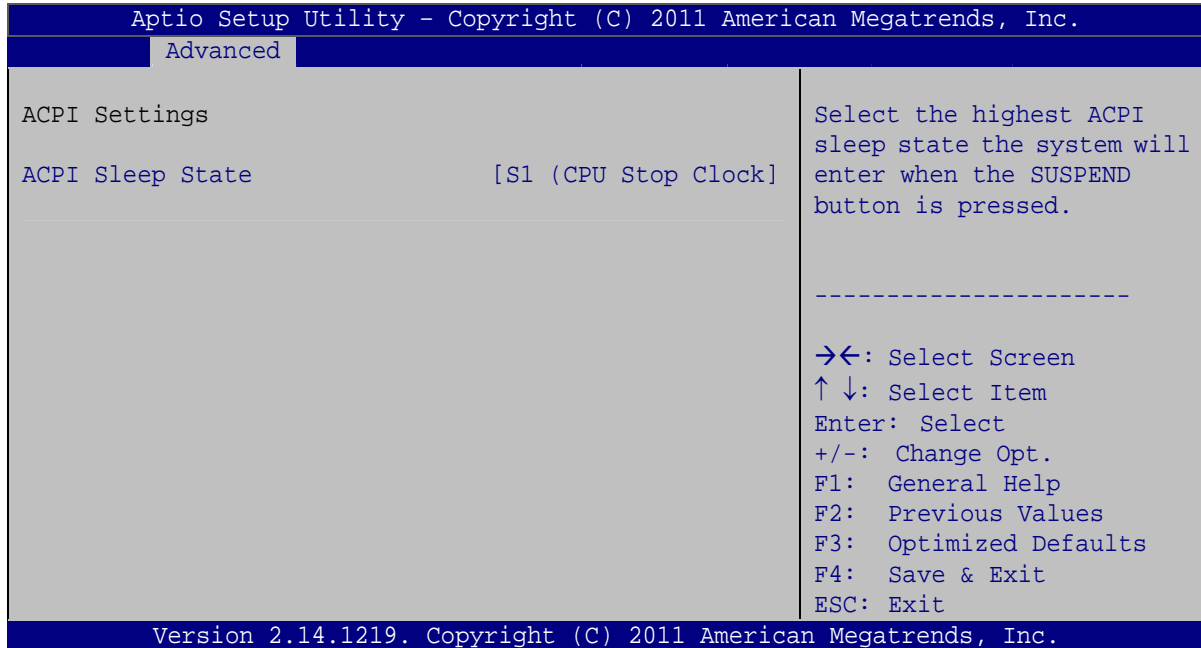

### BIOS Menu 3: ACPI Settings

#### → ACPI Sleep State [S1 (CPU Stop Clock)]

Use the **ACPI Sleep State** option to specify the sleep state the system enters when it is not being used.

- **S1 (CPU Stop Clock)** **DEFAULT** The system enters S1(POS) sleep state. The system appears off. The CPU is stopped; RAM is refreshed; the system is running in a low power mode.
- **S3 (Suspend to RAM)** The caches are flushed and the CPU is powered off. Power to the RAM is maintained. The computer returns slower to a working state, but more power is saved.

### 5.3.2 RTC Wake Settings

The **RTC Wake Settings** menu (**BIOS Menu 4**) enables the system to wake at the specified time.

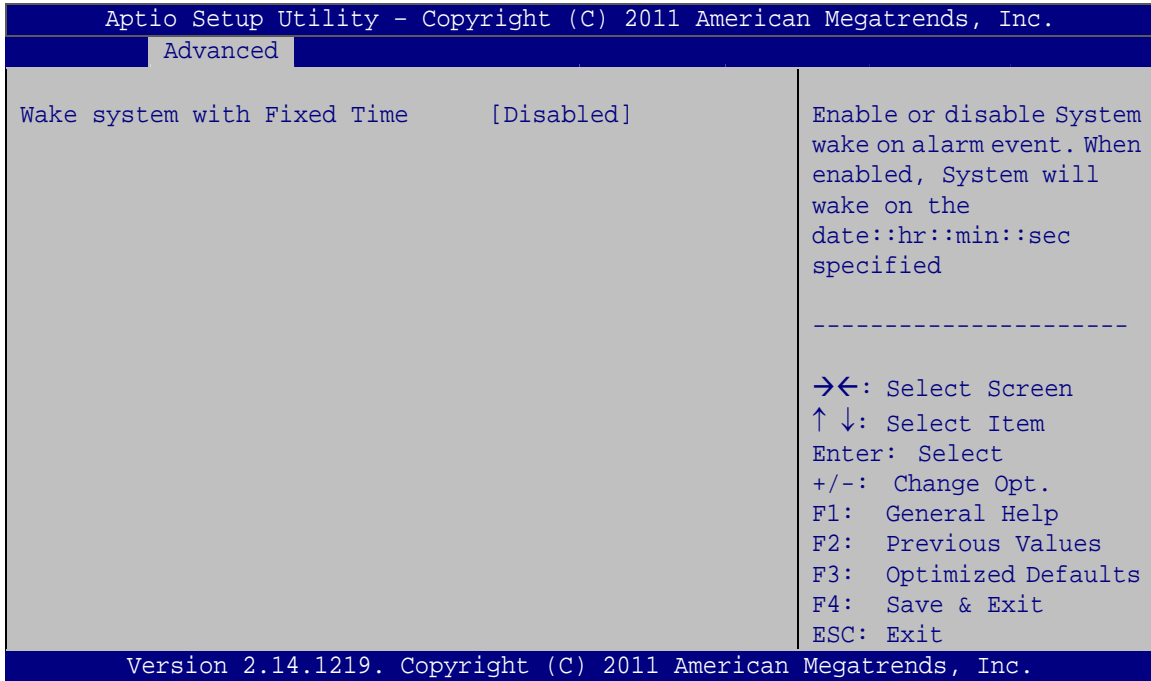

**BIOS Menu 4: RTC Wake Settings**

→ **Wake system with Fixed Time [Disabled]**

Use the **Wake system with Fixed Time** option to enable or disable the system wake on alarm event.

→ **Disabled**      **DEFAULT**      The real time clock (RTC) cannot generate a wake event

→ **Enabled**      If selected, the **Wake up every day** option appears allowing you to enable to disable the system to wake every day at the specified time. Besides, the following options appear with values that can be selected:

Wake up date

Wake up hour

Wake up minute

Wake up second

After setting the alarm, the computer turns itself on from a suspend state when the alarm goes off.

## PPC-37xxA-N26 Panel PC

### 5.3.3 CPU Configuration

Use the **CPU Configuration** menu (**BIOS Menu 5**) to view detailed CPU specifications and configure the CPU.

Aptio Setup Utility - Copyright (C) 2011 American Megatrends, Inc.		
Advanced		
CPU Configuration		Enabled for Windows XP and Linux (OS optimized for Hyper-Threading Technology) and Disabled for other OS (OS not optimized for Hyper-Threading Technology)
Processor Type	Intel(R) Atom(TM) CPU N2600 @ 1.60GHz	
EMT64	Supported	
Processor Speed	1600 MHz	
System Bus Speed	400 MHz	
Ratio Status	16	
Actual Ratio	16	
System Bus Speed	400 MHz	
Processor Stepping	30661	
Microcode Revision	269	
L1 Cache RAM	2x56 k	
L2 Cache RAM	2x512 k	
Processor Core	Dual	
Hyper-Threading	Supported	
Hyper-Threading	[Enabled]	
		-----
		→←: Select Screen
		↑ ↓: Select Item
		Enter: Select
		+/-: Change Opt.
		F1: General Help
		F2: Previous Values
		F3: Optimized Defaults
		F4: Save & Exit
		ESC: Exit
Version 2.14.1219. Copyright (C) 2011 American Megatrends, Inc.		

#### BIOS Menu 5: CPU Configuration

The CPU Configuration menu (**BIOS Menu 5**) lists the following CPU details:

- **Processor Type:** Lists the brand name of the CPU being used.
- **EMT64:** Indicates if EMT64 is supported by the CPU.
- **Processor Speed:** Lists the CPU processing speed.
- **System Bus Speed:** Lists the system bus speed.
- **Ratio Status:** Lists the ratio status.
- **Actual Ratio:** Lists the ratio of the frequency to the clock speed.
- **Processor Stepping:** Lists the CPU ID.
- **Microcode Revision:** Lists the microcode revision.
- **L1 Cache RAM:** Lists the CPU L1 cache size.
- **L2 Cache RAM:** Lists the CPU L2 cache size.
- **Processor Core:** Lists the number of the processor core.
- **Hyper-Threading:** Indicates if Intel HT Technology is supported by the CPU.

➔ **Hyper-Threading [Enabled]**

Use the **Hyper-Threading** BIOS option to enable or disable the Intel Hyper-Threading Technology.

- ➔ **Disabled** Disables the Intel Hyper-Threading Technology.
- ➔ **Enabled** **DEFAULT** Enables the Intel Hyper-Threading Technology.

### 5.3.4 IDE Configuration

Use the **IDE Configuration** menu (**BIOS Menu 6**) to change and/or set the configuration of the SATA devices installed in the system.

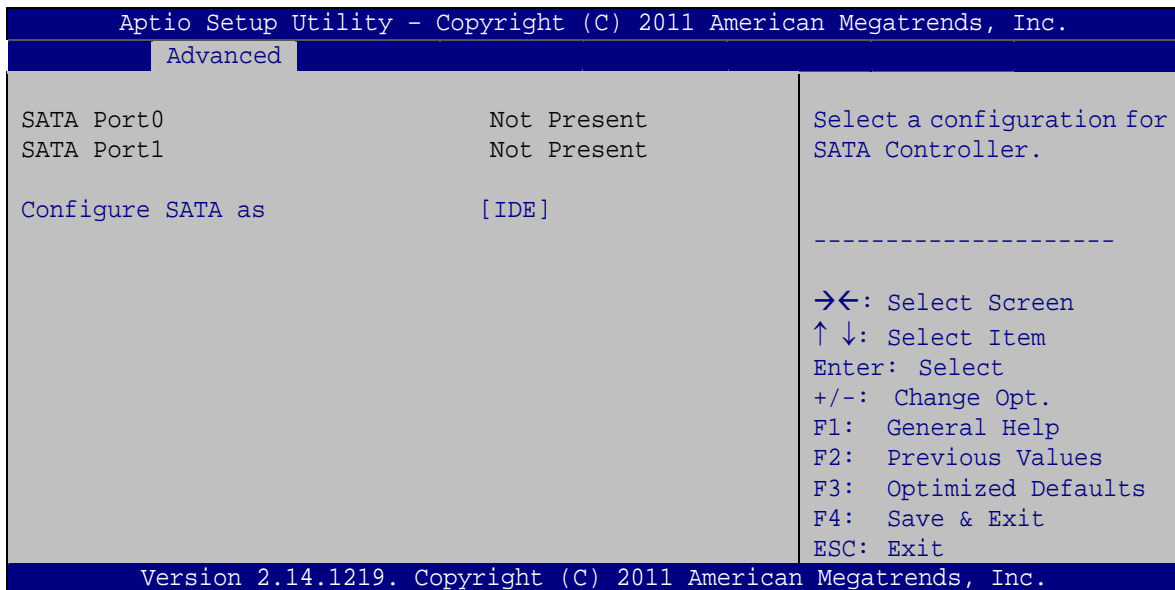

**BIOS Menu 6: SATA Configuration**

➔ **Configure SATA as [IDE]**

Use the **Configure SATA as** option to configure SATA devices as normal IDE or AHCI devices.

- ➔ **IDE** **DEFAULT** Configures SATA devices as normal IDE device.
- ➔ **AHCI** Configures SATA devices as AHCI device.

## PPC-37xxA-N26 Panel PC

### 5.3.5 USB Configuration

Use the **USB Configuration** menu (**BIOS Menu 7**) to read USB configuration information and configure the USB settings.

```

Aptio Setup Utility - Copyright (C) 2011 American Megatrends, Inc.
  Advanced
-----
USB Configuration
USB Devices:
  1 Keyboard

Legacy USB Support          [Enabled]
USB3.0 Support              [Enabled]
XHCI Hand-off               [Enabled]
EHCI Hand-off               [Disabled]
USB Mass Storage Driver Support [Enabled]

USB hardware delays and time-outs:
USB transfer time-out       [20 sec]
Device reset time-out      [20 sec]
Device power-up delay      [Auto]

-----
-><: Select Screen
↑↓: Select Item
Enter: Select
+/-: Change Opt.
F1: General Help
F2: Previous Values
F3: Optimized Defaults
F4: Save & Exit
ESC: Exit

Version 2.14.1219. Copyright (C) 2011 American Megatrends, Inc.
  
```

#### BIOS Menu 7: USB Configuration

##### ➔ USB Devices

The **USB Devices** field lists the USB devices that are enabled on the system

##### ➔ Legacy USB Support [Enabled]

Use the **Legacy USB Support** BIOS option to enable USB mouse and USB keyboard support. Normally if this option is not enabled, any attached USB mouse or USB keyboard does not become available until a USB compatible operating system is fully booted with all USB drivers loaded. When this option is enabled, any attached USB mouse or USB keyboard can control the system even when there is no USB driver loaded onto the system.

➔ **Enabled**      **DEFAULT**      Legacy USB support enabled

- ➔ Disabled Legacy USB support disabled
- ➔ Auto Legacy USB support disabled if no USB devices are connected

➔ **USB3.0 Support [Enabled]**

Use the **USB3.0 Support** BIOS option to enable or disable the USB 3.0 controller.

- ➔ Enabled **DEFAULT** Enables the USB 3.0 support
- ➔ Disabled Disables the USB 3.0 support

➔ **XHCI Hand-off [Enabled]**

Use the **XHCI Hand-off** BIOS option to enable the support for operating systems without an XHCI hand-off feature. The XHCI ownership change should be claimed by XHCI driver.

- ➔ Enabled **DEFAULT** Enables the support for operating systems without an XHCI hand-off feature
- ➔ Disabled Disables the XHCI hand-off support

➔ **EHCI Hand-off [Disabled]**

Use the **EHCI Hand-off** BIOS option to enable the support for operating systems without an EHCI hand-off feature. The EHCI ownership change should be claimed by EHCI driver.

- ➔ Enabled Enables the support for operating systems without an EHCI hand-off feature
- ➔ Disabled **DEFAULT** Disables the EHCI hand-off support

➔ **USB Mass Storage Driver Support [Enabled]**

Use the **USB Mass Storage Driver Support** BIOS option to enable or disable the USB mass storage driver support.

- ➔ Enabled **DEFAULT** Enables the USB mass storage driver support
- ➔ Disabled Disables the USB mass storage driver support

## PPC-37xxA-N26 Panel PC

### → USB transfer time-out [20 sec]

Use the **USB transfer time-out** option to set the time-out value for Control, Bulk and Interrupt transfers.

- 1 sec
- 5 sec
- 10 sec
- 20 sec           **DEFAULT**

### → Device reset time-out [20 sec]

Use the **Device reset time-out** option to set the number of seconds that the Power-On Self Test will wait for a USB mass storage device to start.

- 10 sec
- 20 sec           **DEFAULT**
- 30 sec
- 40 sec

### → Device power-up delay [Auto]

Use the **Device power-up delay** BIOS option to set the maximum time a USB device will take before it properly reports itself to the Host Controller.

- **Auto**           **DEFAULT**           Uses the default values.  
For a Root port: 100 ms delay.  
For a Hub port: Uses the delay from Hub descriptor
- **Manual**           Allows setting the delay ranging from 1 to 40 seconds.

### 5.3.6 F81866 Super IO Configuration

Use the **F81866 Super IO Configuration** menu (**BIOS Menu 8**) to set or change the configurations for the serial ports.

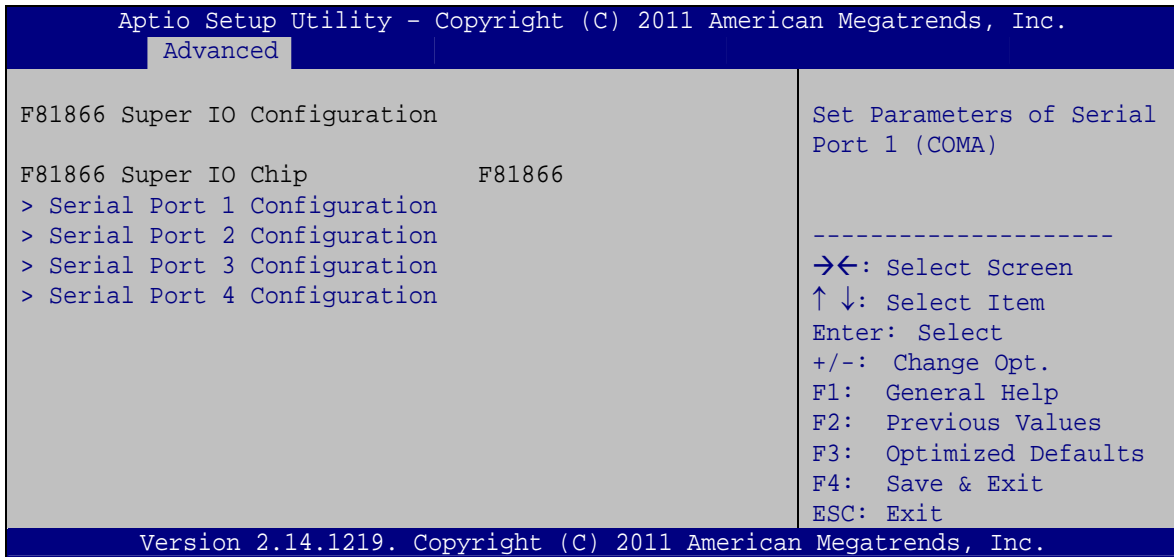

**BIOS Menu 8: F81866 Super IO Configuration**

#### 5.3.6.1 Serial Port n Configuration

Use the **Serial Port n Configuration** menu (**BIOS Menu 9**) to configure the serial port n.

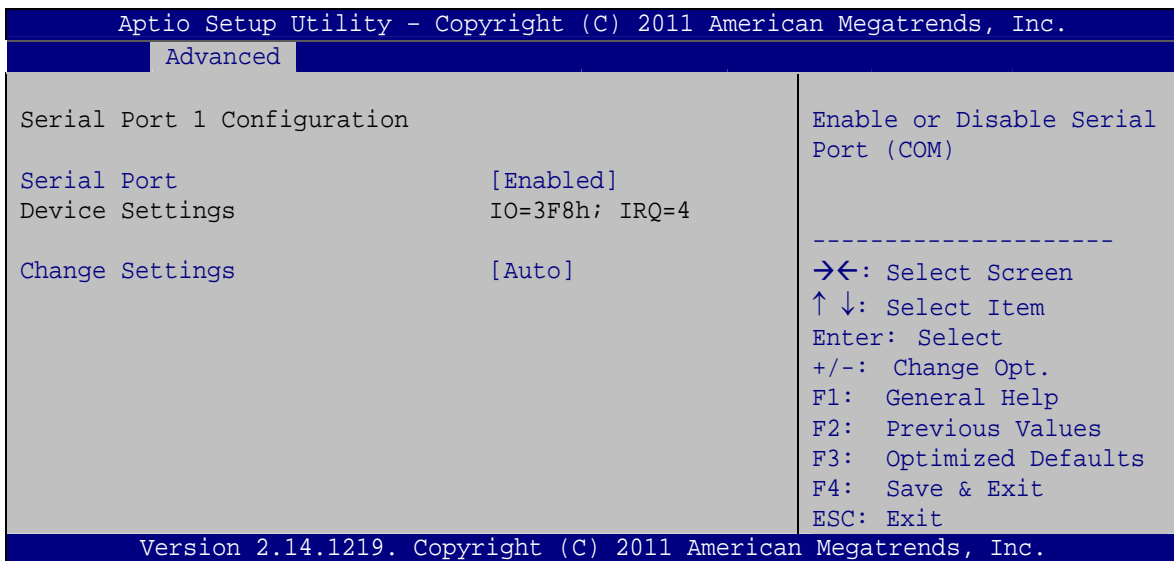

**BIOS Menu 9: Serial Port n Configuration Menu**



## PPC-37xxA-N26 Panel PC

### 5.3.6.1.1 Serial Port 1 Configuration

#### → Serial Port [Enabled]

Use the **Serial Port** option to enable or disable the serial port.

- **Disabled**                      Disable the serial port
- **Enabled**      **DEFAULT**      Enable the serial port

#### → Change Settings [Auto]

Use the **Change Settings** option to change the serial port IO port address and interrupt address.

- **Auto**              **DEFAULT**      The serial port IO port address and interrupt address are automatically detected.
- **IO=3F8h;**  
**IRQ=4**                      Serial Port I/O port address is 3F8h and the interrupt address is IRQ4
- **IO=3F8h;**  
**IRQ=3, 4**                      Serial Port I/O port address is 3F8h and the interrupt address is IRQ3, 4
- **IO=2F8h;**  
**IRQ=3, 4**                      Serial Port I/O port address is 2F8h and the interrupt address is IRQ3, 4
- **IO=3E8h;**  
**IRQ=3, 4**                      Serial Port I/O port address is 3E8h and the interrupt address is IRQ3, 4
- **IO=2E8h;**  
**IRQ=3, 4**                      Serial Port I/O port address is 2E8h and the interrupt address is IRQ3, 4

### 5.3.6.1.2 Serial Port 2 Configuration

#### → Serial Port [Enabled]

Use the **Serial Port** option to enable or disable the serial port.

- **Disabled**                      Disable the serial port
- **Enabled**      **DEFAULT**      Enable the serial port

→ **Change Settings [Auto]**

Use the **Change Settings** option to change the serial port IO port address and interrupt address.

- **Auto**                      **DEFAULT**                      The serial port IO port address and interrupt address are automatically detected.
- **IO=2F8h;**  
**IRQ=3**                      Serial Port I/O port address is 2F8h and the interrupt address is IRQ3
- **IO=3F8h;**  
**IRQ=3, 4**                      Serial Port I/O port address is 3F8h and the interrupt address is IRQ3, 4
- **IO=2F8h;**  
**IRQ=3, 4**                      Serial Port I/O port address is 2F8h and the interrupt address is IRQ3, 4
- **IO=3E8h;**  
**IRQ=3, 4**                      Serial Port I/O port address is 3E8h and the interrupt address is IRQ3, 4
- **IO=2E8h;**  
**IRQ=3, 4**                      Serial Port I/O port address is 2E8h and the interrupt address is IRQ3, 4

**5.3.6.1.3 Serial Port 3 Configuration**

→ **Serial Port [Enabled]**

Use the **Serial Port** option to enable or disable the serial port.

- **Disabled**                      Disable the serial port
- **Enabled**                      **DEFAULT**                      Enable the serial port

→ **Change Settings [Auto]**

Use the **Change Settings** option to change the serial port IO port address and interrupt address.

## PPC-37xxA-N26 Panel PC

→	<b>Auto</b>	<b>DEFAULT</b>	The serial port IO port address and interrupt address are automatically detected.
→	<b>IO=3E8h; IRQ=10</b>		Serial Port I/O port address is 3E8h and the interrupt address is IRQ10
→	<b>IO=3F8h; IRQ=10, 11</b>		Serial Port I/O port address is 3F8h and the interrupt address is IRQ10, 11
→	<b>IO=2F8h; IRQ=10, 11</b>		Serial Port I/O port address is 2F8h and the interrupt address is IRQ10, 11
→	<b>IO=3E8h; IRQ=10, 11</b>		Serial Port I/O port address is 3E8h and the interrupt address is IRQ10, 11
→	<b>IO=2E8h; IRQ=10, 11</b>		Serial Port I/O port address is 2E8h and the interrupt address is IRQ10, 11
→	<b>IO=250h; IRQ=10, 11</b>		Serial Port I/O port address is 250h and the interrupt address is IRQ10, 11
→	<b>IO=2E0h; IRQ=10, 11</b>		Serial Port I/O port address is 2E0h and the interrupt address is IRQ10, 11

### 5.3.6.1.4 Serial Port 4 Configuration

#### → Serial Port [Enabled]

Use the **Serial Port** option to enable or disable the serial port.

→	<b>Disabled</b>		Disable the serial port
→	<b>Enabled</b>	<b>DEFAULT</b>	Enable the serial port

#### → Change Settings [Auto]

Use the **Change Settings** option to change the serial port IO port address and interrupt address.

→	Auto	DEFAULT	The serial port IO port address and interrupt address are automatically detected.
→	IO=2E8h; IRQ=10		Serial Port I/O port address is 2E8h and the interrupt address is IRQ10
→	IO=3F8h; IRQ=10, 11		Serial Port I/O port address is 3F8h and the interrupt address is IRQ10, 11
→	IO=2F8h; IRQ=10, 11		Serial Port I/O port address is 2F8h and the interrupt address is IRQ10, 11
→	IO=3E8h; IRQ=10, 11		Serial Port I/O port address is 3E8h and the interrupt address is IRQ10, 11
→	IO=2E8h; IRQ=10, 11		Serial Port I/O port address is 2E8h and the interrupt address is IRQ10, 11
→	IO=250h; IRQ=10, 11		Serial Port I/O port address is 250h and the interrupt address is IRQ10, 11
→	IO=2E0h; IRQ=10, 11		Serial Port I/O port address is 2E0h and the interrupt address is IRQ10, 11

### 5.3.7 F81866 H/W Monitor

The F81866 H/W Monitor menu (**BIOS Menu 10**) contains the fan configuration submenu and displays system temperature, voltages, and fan speeds.

## PPC-37xxA-N26 Panel PC

```

Aptio Setup Utility - Copyright (C) 2011 American Megatrends, Inc.
Advanced
PC Health Status
Smart Fan Mode Select

> Smart Fan Mode Configuration
System Temperature      : +55 C
CPU_FAN1 Speed         : N/A
SYS_FAN1 Speed         : N/A
+VCC_CPU               : +0.968 V
+VCC_GFX               : +1.680 V
+V1.05S               : +1.072 V
+1.5_DDR3              : +1.536 V
VSB5V                  : +4.992 V
+V3.3S                 : +3.360 V
VSB3V                  : +3.376 V
VBAT                   : +3.312 V

-----
-><: Select Screen
↑↓: Select Item
Enter: Select
+/-: Change Opt.
F1: General Help
F2: Previous Values
F3: Optimized Defaults
F4: Save & Exit
ESC: Exit

Version 2.14.1219. Copyright (C) 2011 American Megatrends, Inc.
  
```

### BIOS Menu 10: F81866 H/W Monitor

#### → PC Health Status

The following system parameters and values are shown. The system parameters that are monitored are:

- System Temperatures:
  - System Temperature
- Fan Speeds:
  - CPU\_FAN1 Speed
  - SYS\_FAN1 Speed
- Voltages:
  - +VCC\_CPU
  - +VCC\_GFX
  - +V1.05S
  - +1.5\_DDR3
  - VSB5V
  - +V3.3S
  - VSB3V
  - VBAT

### 5.3.7.1 Smart Fan Mode Configuration

Use the **Smart Fan Mode Configuration** submenu (**BIOS Menu 11**) to configure the fan temperature and speed settings.

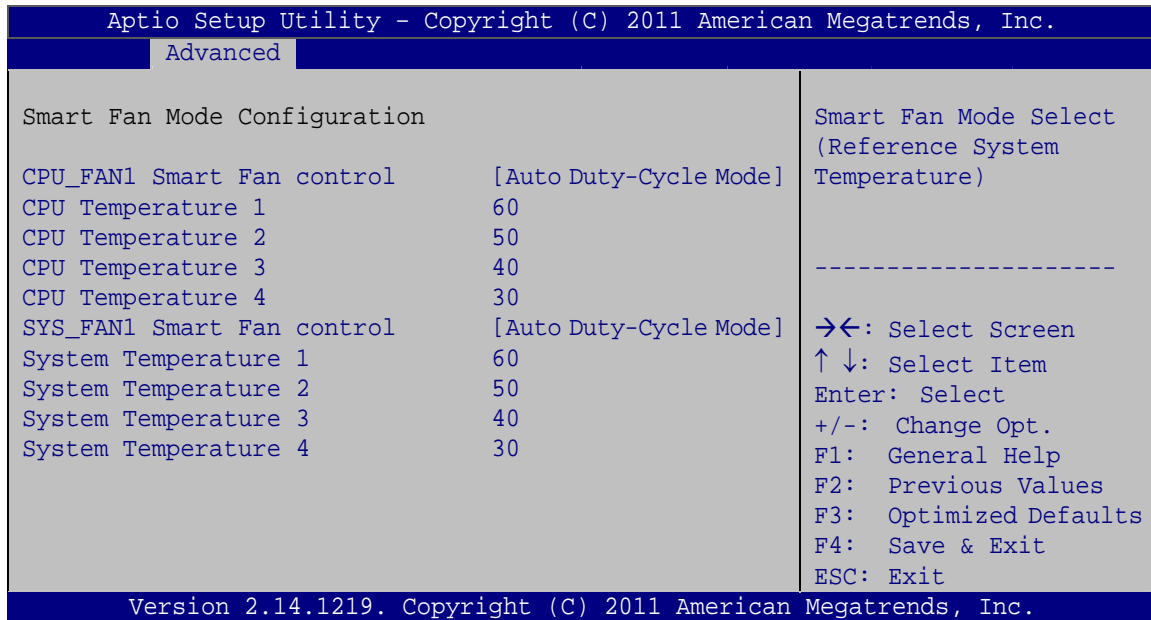

#### BIOS Menu 11: Smart Fan Mode Configuration

##### → CPU\_FAN1/SYS\_FAN1 Smart Fan Control [Auto Duty-Cycle Mode]

Use the **CPU\_FAN1/SYS\_FAN1 Smart Fan Control** option to configure the smart fans.

- **Manual Duty Mode**                      The fan spins at the speed set in Manual Duty Mode settings.
- **Auto Duty-Cycle Mode**                      **DEFAULT**      The fan adjusts its speed using Auto Duty-Cycle Mode settings.

##### → CPU Temperature n/System Temperature n

Use the + or – key to change the temperature value. Enter a decimal number between 1 and 100.

## PPC-37xxA-N26 Panel PC

### 5.3.8 Serial Port Console Redirection

The **Serial Port Console Redirection** menu (**BIOS Menu 12**) allows the console redirection options to be configured. Console redirection allows users to maintain a system remotely by re-directing keyboard input and text output through the serial port.

```

Aptio Setup Utility - Copyright (C) 2011 American Megatrends, Inc.
  Advanced
COM1
Console Redirection          [Disabled]      Console Redirection
> Console Redirection Settings      Enable or Disable

COM2
Console Redirection          [Disabled]      -----
> Console Redirection Settings      →←: Select Screen
                                     ↑↓: Select Item
                                     Enter: Select
                                     +/-: Change Opt.
                                     F1:  General Help
                                     F2:  Previous Values
                                     F3:  Optimized Defaults
                                     F4:  Save & Exit
                                     ESC: Exit

COM3
Console Redirection          [Disabled]
> Console Redirection Settings

Version 2.14.1219. Copyright (C) 2011 American Megatrends, Inc.
  
```

#### BIOS Menu 12: Serial Port Console Redirection

##### → Console Redirection [Disabled]

Use **Console Redirection** option to enable or disable the console redirection function.

- **Disabled**    **DEFAULT**    Disabled the console redirection function
- **Enabled**                    Enabled the console redirection function

#### 5.3.8.1 Console Redirection Settings

Use the **Console Redirection Settings** menu (**BIOS Menu 13**) to configure console redirection settings of the specified serial port. This menu appears only when the Console Redirection is enabled.

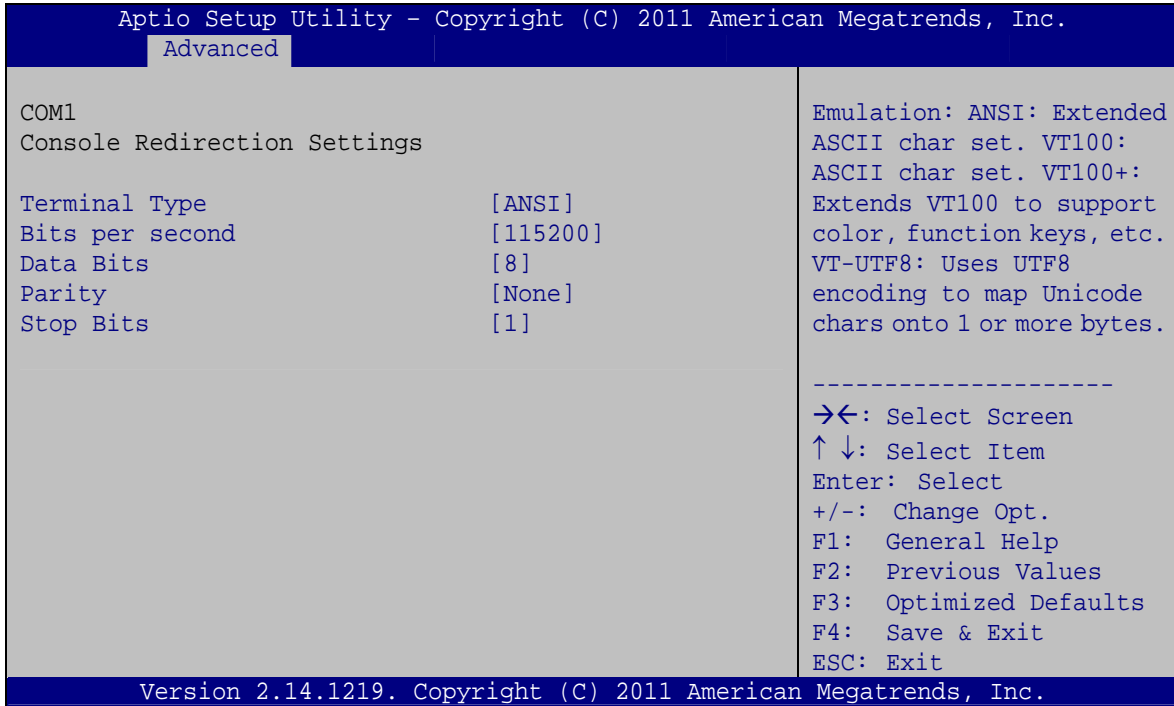

**BIOS Menu 13: Console Redirection Settings**

→ **Terminal Type [ANSI]**

Use the **Terminal Type** option to specify the remote terminal type.

- **VT100**                      The target terminal type is VT100
- **VT100+**                    The target terminal type is VT100+
- **VT-UTF8**                    The target terminal type is VT-UTF8
- **ANSI**                      **DEFAULT**                    The target terminal type is ANSI

→ **Bits per second [115200]**

Use the **Bits per second** option to specify the serial port transmission speed. The speed must match the other side. Long or noisy lines may require lower speeds.

- **9600**                        Sets the serial port transmission speed at 9600.
- **19200**                      Sets the serial port transmission speed at 19200.
- **38400**                      Sets the serial port transmission speed at 38400.



## PPC-37xxA-N26 Panel PC

- **57600** Sets the serial port transmission speed at 57600.
- **115200**      **DEFAULT** Sets the serial port transmission speed at 115200.

→ **Data Bits [8]**

Use the **Data Bits** option to specify the number of data bits.

- **7** Sets the data bits at 7.
- **8**      **DEFAULT** Sets the data bits at 8.

→ **Parity [None]**

Use the **Parity** option to specify the parity bit that can be sent with the data bits for detecting the transmission errors.

- **None**      **DEFAULT** No parity bit is sent with the data bits.
- **Even** The parity bit is 0 if the number of ones in the data bits is even.
- **Odd** The parity bit is 0 if the number of ones in the data bits is odd.
- **Mark** The parity bit is always 1. This option does not provide error detection.
- **Space** The parity bit is always 0. This option does not provide error detection.

→ **Stop Bits [1]**

Use the **Stop Bits** option to specify the number of stop bits used to indicate the end of a serial data packet. Communication with slow devices may require more than 1 stop bit.

- **1**      **DEFAULT** Sets the number of stop bits at 1.
- **2** Sets the number of stop bits at 2.

### 5.3.9 iEi Feature

Use the **iEi Feature** menu (**BIOS Menu 13**) to configure One Key Recovery function.

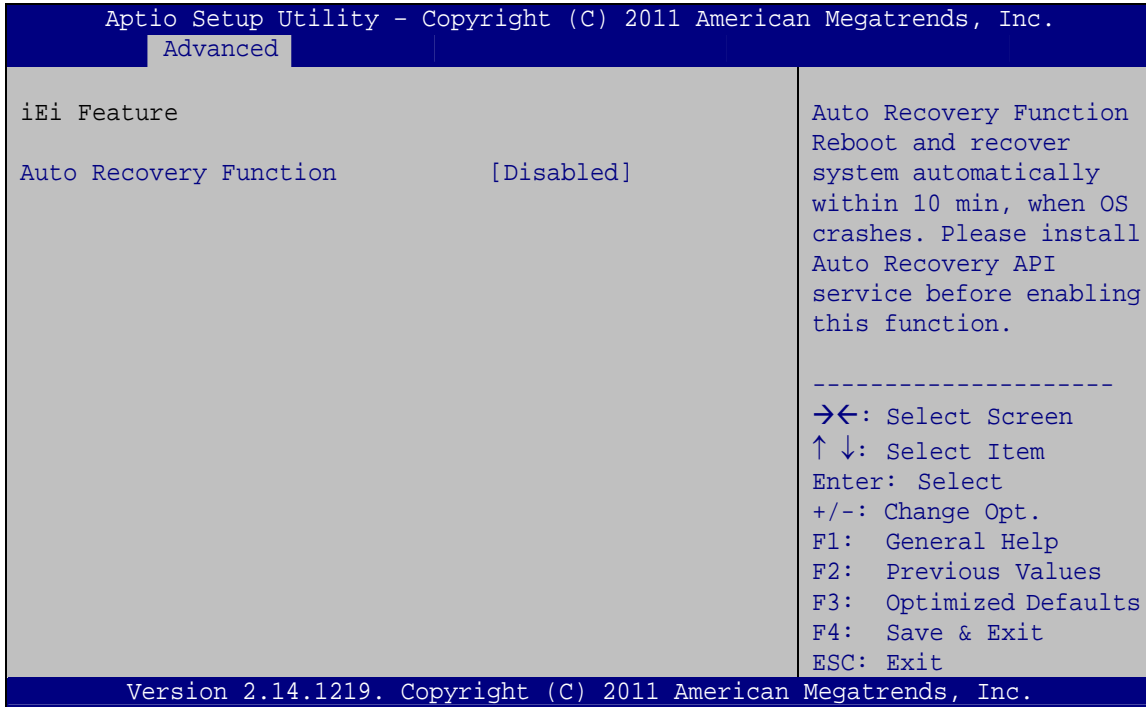

#### BIOS Menu 14: iEi Feature

##### → Auto Recovery Function [Disabled]

Use the **Auto Recovery Function** BIOS option to enable or disable the auto recovery function of the IEI One Key Recovery.

- **Disabled**      **DEFAULT**      Auto recovery function disabled
- **Enabled**        Auto recovery function enabled

## PPC-37xxA-N26 Panel PC

### 5.4 Chipset

Use the **Chipset** menu (**BIOS Menu 15**) to access the Host Bridge and Southbridge configuration menus.



#### **WARNING!**

Setting the wrong values for the Chipset BIOS selections in the Chipset BIOS menu may cause the system to malfunction.

```

Aptio Setup Utility - Copyright (C) 2011 American Megatrends, Inc.
Main   Advanced  Chipset  Boot   Security  Save & Exit
-----
> Host Bridge
> South Bridge

Host Bridge Parameters

-----
-><: Select Screen
↑↓: Select Item
Enter: Select
+/-: Change Opt.
F1: General Help
F2: Previous Values
F3: Optimized Defaults
F4: Save & Exit
ESC: Exit

Version 2.14.1219. Copyright (C) 2011 American Megatrends, Inc.
    
```

**BIOS Menu 15: Chipset**

### 5.4.1 Host Bridge Configuration

Use the **Host Bridge Configuration** menu (**BIOS Menu 16**) to configure Intel IGD Configuration and display the memory information.

```

Aptio Setup Utility - Copyright (C) 2011 American Megatrends, Inc.
  Chipset
> Intel IGD Configuration
***** Memory Information *****
Memory Frequency           800 MHz(DDR3)
Total Memory                2048 MB
DIMM#1                     2048 MB

Config Intel IGD Settings
-----
-><: Select Screen
↑↓: Select Item
Enter: Select
+/-: Change Opt.
F1: General Help
F2: Previous Values
F3: Optimized Defaults
F4: Save & Exit
ESC: Exit

Version 2.14.1219. Copyright (C) 2011 American Megatrends, Inc.
    
```

**BIOS Menu 16: Host Bridge Configuration**

#### 5.4.1.1 Intel IGD Configuration

Use the **Intel IGD Configuration** submenu (**BIOS Menu 17**) to configure the video device connected to the system.

```

Aptio Setup Utility - Copyright (C) 2011 American Megatrends, Inc.
  Advanced
Intel IGD Configuration
IGFX - Boot Type           [LVDS1]
LVDS1 Panel Type          [1024x768 LVDS]
Backlight Control         [Normal]
Fixed Graphics Memory Size [128MB]

Enable/Disable LVDS1.
-----
-><: Select Screen
↑↓: Select Item
Enter: Select
+/-: Change Opt.
F1: General Help
F2: Previous Values
F3: Optimized Defaults
F4: Save & Exit
ESC: Exit

Version 2.14.1219. Copyright (C) 2011 American Megatrends, Inc.
    
```

**BIOS Menu 17: Intel IGD Configuration**

## PPC-37xxA-N26 Panel PC

### → Fixed Graphics Memory Size [128MB]

Use the **Fixed Graphics Memory Size** option to specify the maximum amount of memory that can be allocated as graphics memory. Configuration options are listed below.

- 128MB      **DEFAULT**
- 256MB

## 5.4.2 South Bridge Configuration

Use the **South Bridge Configuration** menu (**BIOS Menu 18**) to configure the Southbridge chipset.

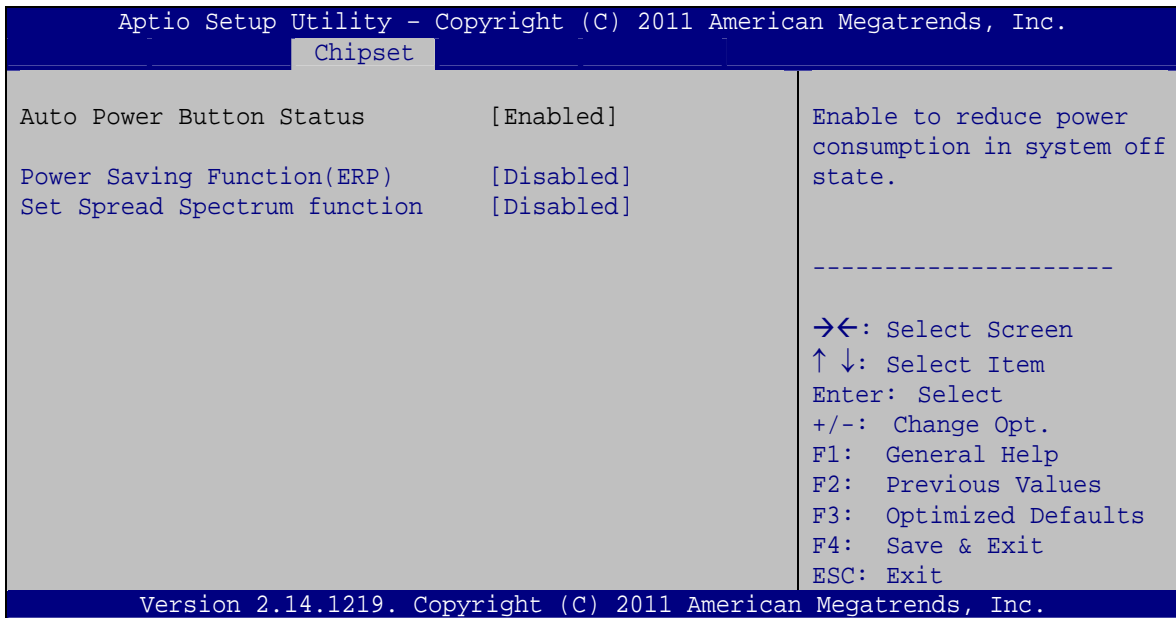

### BIOS Menu 18: Southbridge Configuration

#### → Power Saving Function(ERP) [Disabled]

Use the **Power Saving Function(ERP)** option to enable or disable the power saving function.

- **Disabled**      **DEFAULT**      Disables the power saving function.
- **Enabled**                      Enables the power saving function.

➔ **Set Spread Spectrum function [Disabled]**

The **Set Spread Spectrum Function** option can help to improve CPU EMI issues.

- ➔ **Disabled**      **DEFAULT**      The spread spectrum mode is disabled
- ➔ **Enabled**                      The spread spectrum mode is enabled

## 5.5 Boot

Use the **Boot** menu (**BIOS Menu 19**) to configure system boot options.

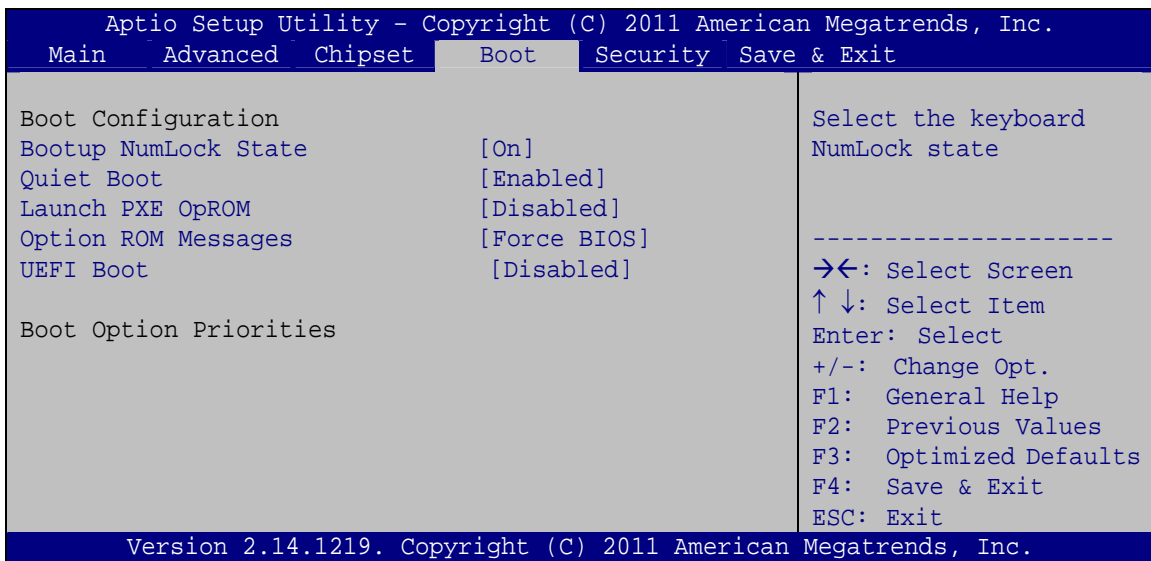

**BIOS Menu 19: Boot**

➔ **Bootup NumLock State [On]**

Use the **Bootup NumLock State** BIOS option to specify if the number lock setting must be modified during boot up.

- ➔ **On**                      **DEFAULT**      Allows the Number Lock on the keyboard to be enabled automatically when the computer system boots up. This allows the immediate use of the 10-key numeric keypad located on the right side of the keyboard. To confirm this, the Number Lock LED light on the keyboard is lit.

## PPC-37xxA-N26 Panel PC

- **Off** Does not enable the keyboard Number Lock automatically. To use the 10-keys on the keyboard, press the Number Lock key located on the upper left-hand corner of the 10-key pad. The Number Lock LED on the keyboard lights up when the Number Lock is engaged.

### → **Quiet Boot [Enabled]**

Use the **Quiet Boot** BIOS option to select the screen display when the system boots.

- **Disabled** Normal POST messages displayed
- **Enabled** **DEFAULT** OEM Logo displayed instead of POST messages

### → **Launch PXE OpROM [Disabled]**

Use the **Launch PXE OpROM** option to enable or disable boot option for legacy network devices.

- **Disabled** **DEFAULT** Ignore all PXE Option ROMs
- **Enabled** Load PXE Option ROMs

### → **Option ROM Messages [Force BIOS]**

Use the **Option ROM Messages** option to set the Option ROM display mode.

- **Force BIOS** **DEFAULT** Sets display mode to force BIOS.
- **Keep Current** Sets display mode to current.

### → **UEFI Boot [Disabled]**

Use the **UEFI Boot** BIOS option to allow the system to boot from the UEFI devices.

- **Disabled** **DEFAULT** Disables to boot from the UEFI devices.
- **Enabled** Enables to boot from the UEFI devices.

## 5.6 Security

Use the **Security** menu (**BIOS Menu 20**) to set system and user passwords.

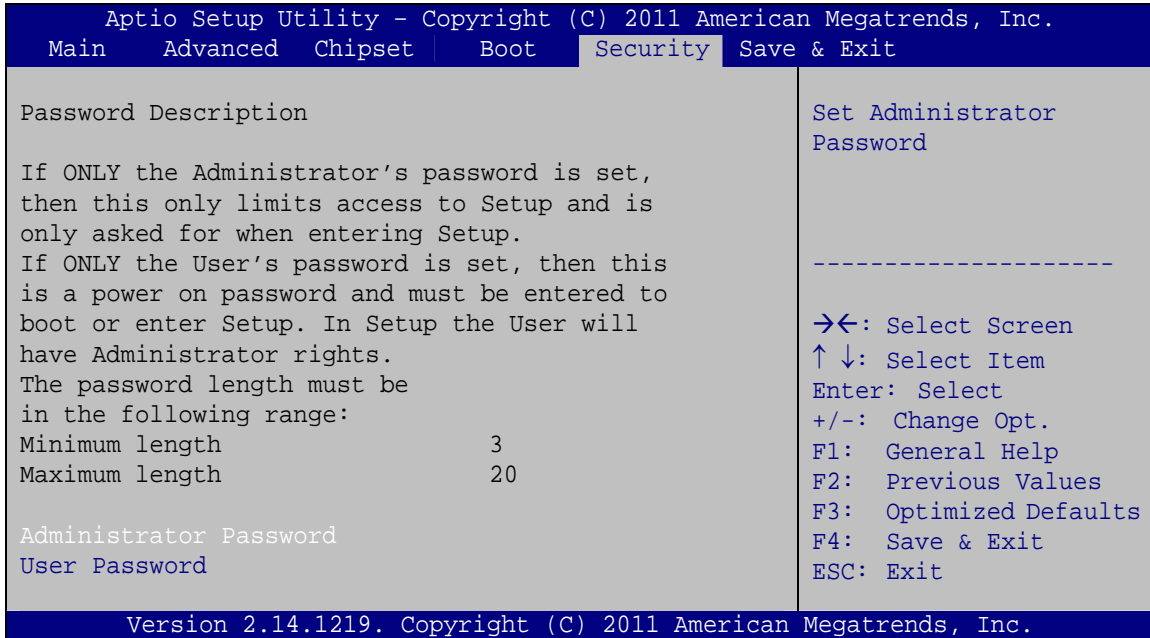

### BIOS Menu 20: Security

#### → Administrator Password

Use the **Administrator Password** to set or change an administrator password.

#### → User Password

Use the **User Password** to set or change a user password.

## 5.7 Save & Exit

Use the **Save & Exit** menu (**BIOS Menu 21**) to load default BIOS values, optimal failsafe values and to save configuration changes.

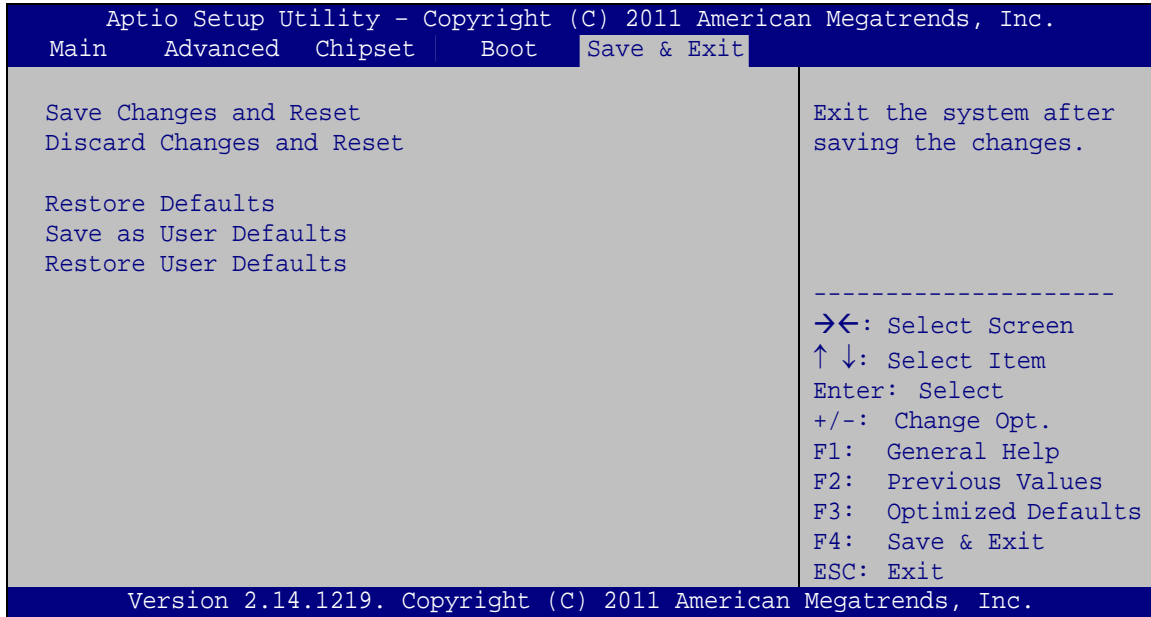

## PPC-37xxA-N26 Panel PC

**BIOS Menu 21: Save & Exit****→ Save Changes and Reset**

Use the **Save Changes and Reset** option to save the changes made to the BIOS options and reset the system.

**→ Discard Changes and Reset**

Use the **Discard Changes and Reset** option to exit the system without saving the changes made to the BIOS configuration setup program.

**→ Restore Defaults**

Use the **Restore Defaults** option to load the optimal default values for each of the parameters on the Setup menus. **F3 key can be used for this operation.**

**→ Save as User Defaults**

Use the **Save as User Defaults** option to save the changes done so far as user defaults.

**→ Restore User Defaults**

Use the **Restore User Defaults** option to restore the user defaults to all the setup options.

Chapter

**6**

# Driver Installation

---

## 6.1 Available Software Drivers

---

**NOTE:**

The content of the CD may vary throughout the life cycle of the product and is subject to change without prior notice. Visit the IEI website or contact technical support for the latest updates.

---

The following drivers can be installed on the system:

- Chipset
- VGA
- LAN
- Audio
- USB 3.0
- Touchscreen

Installation instructions for the drivers are given in the following sections.

## 6.2 Starting the Driver Program

To access the driver installation programs, please do the following.

**Step 1:** Insert the CD that came with the system into an optical disk drive connected to the system.

---

**NOTE:**

If the installation program doesn't start automatically:  
Click "Start->Computer->CD Drive->autorun.exe"

---

**Step 2:** The list of drivers in **Figure 6-1** appears.



Figure 6-1: Drivers

### 6.3 Chipset Driver Installation

To install the chipset driver, please do the following.

- Step 1:** Access the driver list. (See **Section 6.2**)
- Step 2:** Click “**CHIPSET**”.
- Step 3:** Go to the 32-bit or 64-bit folder that corresponds to your OS version.
- Step 4:** Open the **Intel Chipset Software Installation Utility** folder.
- Step 5:** Double click the **infinst\_autol** icon.
- Step 6:** The setup files are extracted as shown in **Figure 6-2**.

## PPC-37xxA-N26 Panel PC

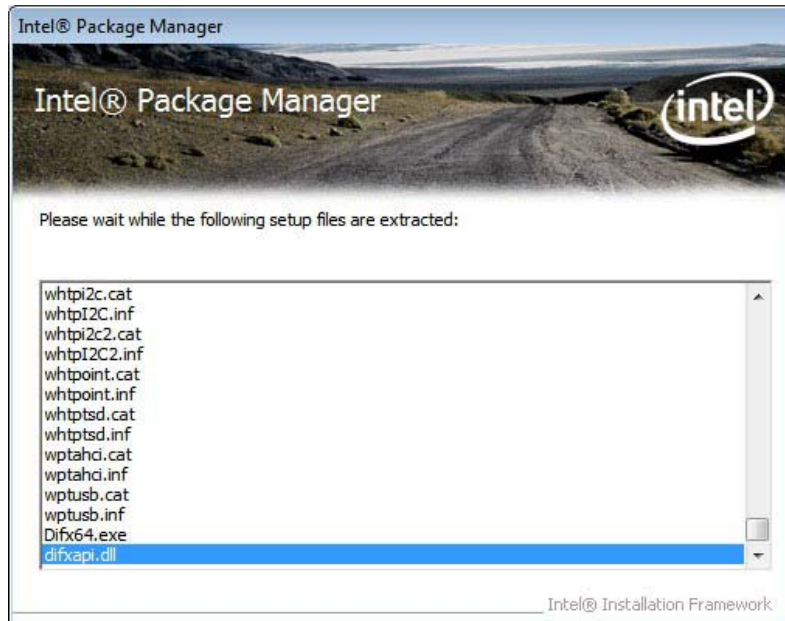

Figure 6-2: Chipset Driver Screen

**Step 7:** When the setup files are completely extracted, the **Welcome Screen** in **Figure 6-3** appears.

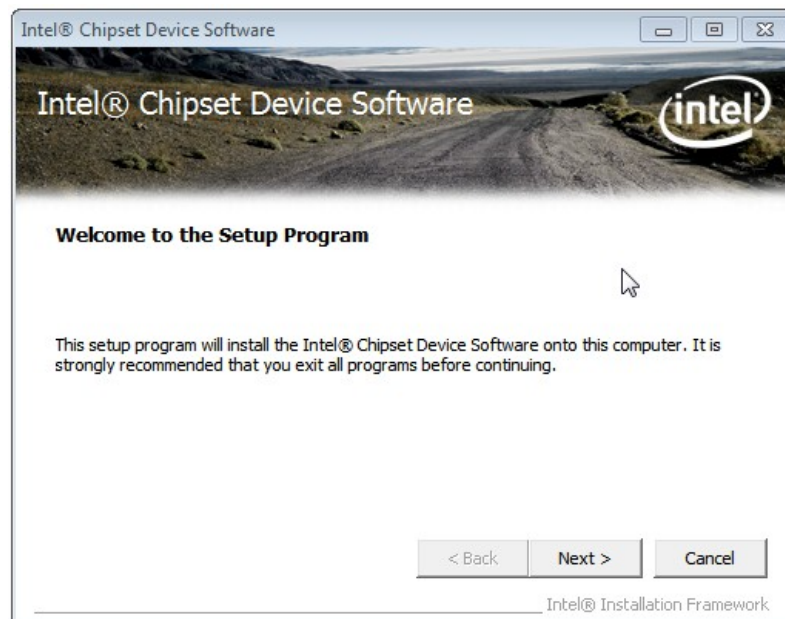

Figure 6-3: Chipset Driver Welcome Screen

**Step 8:** Click **Next** to continue.

**Step 9:** The license agreement in **Figure 6-4** appears.

**Step 10:** Read the **License Agreement**.

**Step 11:** Click **Yes** to continue.



**Figure 6-4: Chipset Driver License Agreement**

**Step 12:** The Read Me file in **Figure 6-5** appears.

**Step 13:** Click **Next** to continue.

PPC-37xxA-N26 Panel PC



Figure 6-5: Chipset Driver Read Me File

**Step 14:** Setup Operations are performed as shown in Figure 6-6.

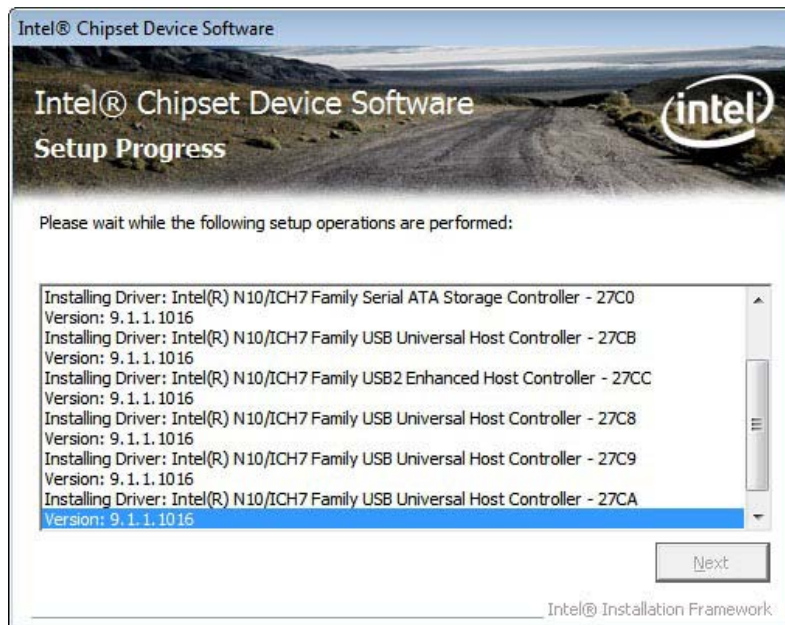

Figure 6-6: Chipset Driver Setup Operations

**Step 15:** Once the Setup Operations are complete, click Next to continue.

**Step 16:** The Finish screen appears.

**Step 17:** Select “Yes, I want to restart the computer now” and click the **Finish** icon.

See **Figure 6-7**.



**Figure 6-7: Chipset Driver Installation Finish Screen**

## 6.4 VGA Driver Installation



### NOTE:

Due to Intel® GMA driver limitation, the monitor connected to the VGA connector may become extended desktop or not have signal to it after restarting from the graphics driver installation. To work out this limitation, press the Ctrl+Alt+F1 hotkey to switch the primary display to CRT mode.

To install the VGA driver, please do the following.

**Step 1:** Access the driver list. (See **Section 6.2**)

**Step 2:** Click “VGA”.



## PPC-37xxA-N26 Panel PC

**Step 3:** Open the 32-bit or 64-bit folder that corresponds to your OS version.

**Step 4:** Double click the **Setup** icon.

**Step 5:** The **Welcome Screen** in **Figure 6-8** appears.



**Figure 6-8: VGA Driver Welcome Screen**

**Step 6:** Click **Next** to continue.

**Step 7:** The license agreement in **Figure 6-9** appears.

**Step 8:** Read the **License Agreement**.

**Step 9:** Click **Yes** to continue.

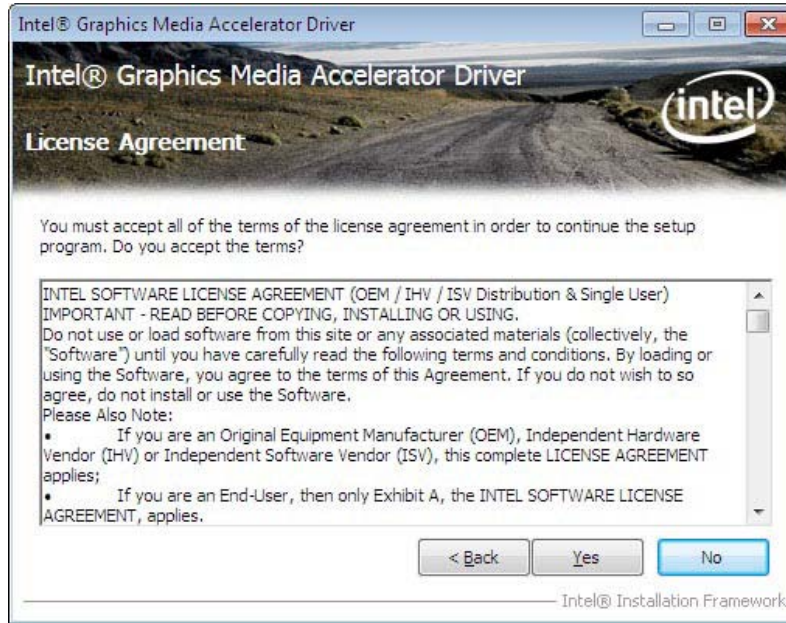

Figure 6-9: VGA Driver License Agreement

**Step 10:** The Read Me file in **Figure 6-10** appears.

**Step 11:** Click **Next** to continue.

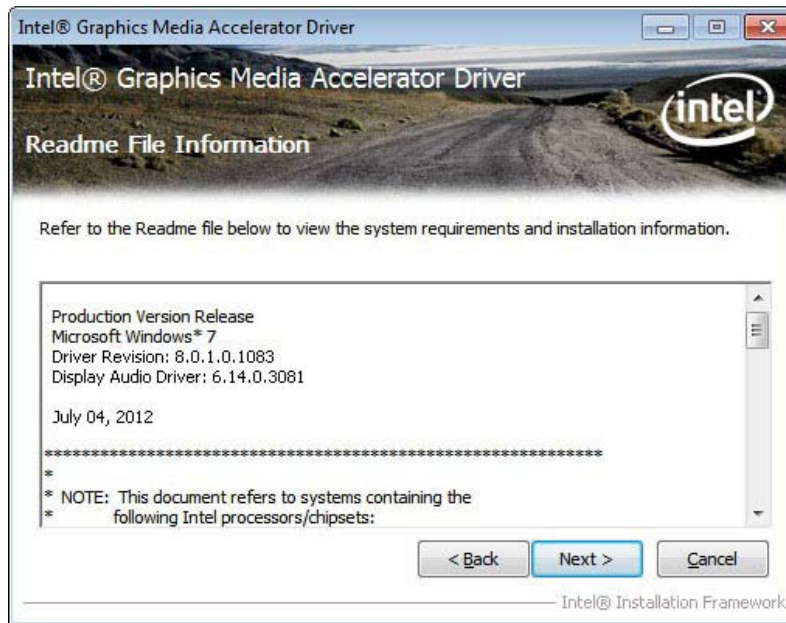

Figure 6-10: VGA Driver Read Me File

**Step 12:** Setup Operations are performed as shown in **Figure 6-11**.

## PPC-37xxA-N26 Panel PC

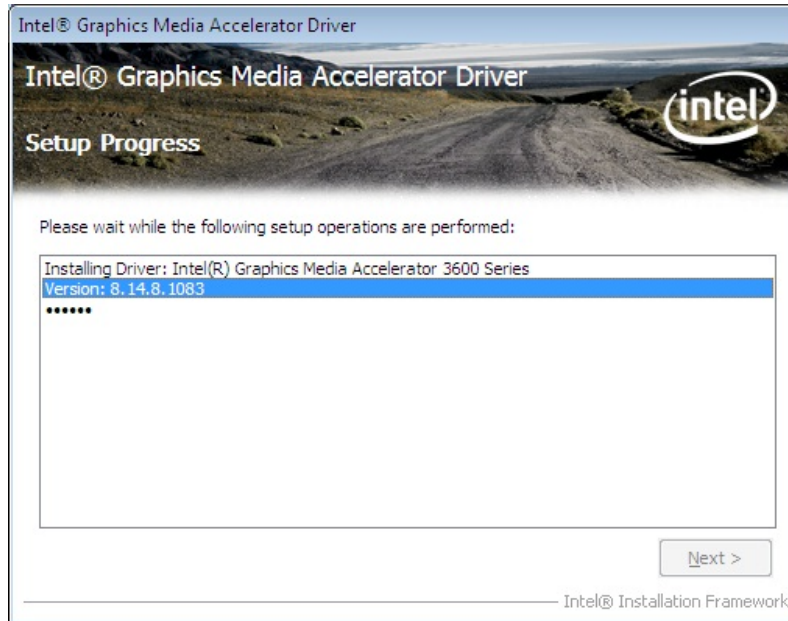

Figure 6-11: VGA Driver Setup Operations

**Step 13:** Once the **Setup Operations** are complete, click the **Next** icon to continue.

**Step 14:** The **Finish** screen appears.

**Step 15:** Select “**Yes, I want to restart the computer now**” and click the **Finish** icon.

See **Figure 6-12**.



Figure 6-12: VGA Driver Installation Finish Screen

## 6.5 LAN Driver Installation

To install the LAN driver, please do the following.

**Step 1:** Access the driver list. (See **Section 6.2**)

**Step 2:** Click “LAN”.

**Step 3:** Go to the **Realtek > Install\_Win7\_7048\_09162011** folder.

**Step 4:** Double click the **setup** icon.

**Step 5:** The **Welcome** screen in **Figure 6-13** appears.

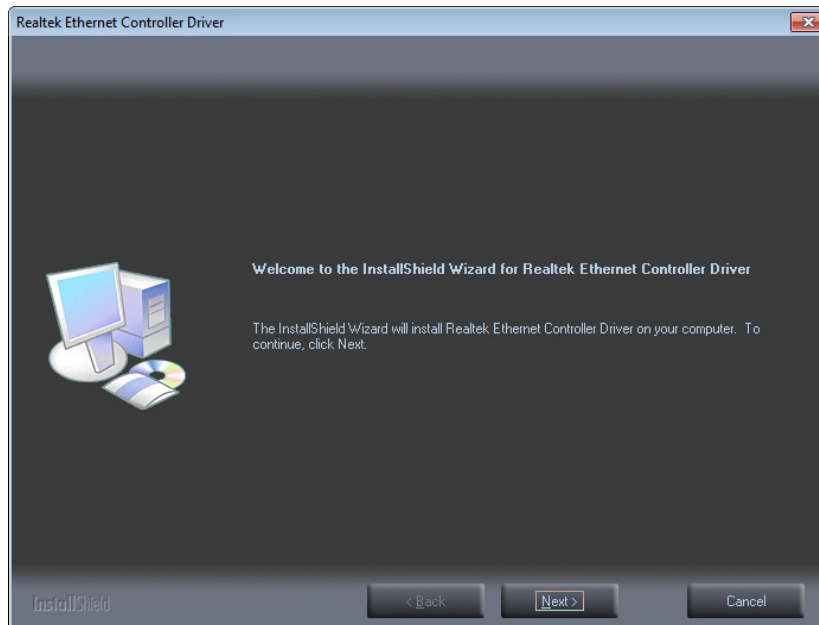

**Figure 6-13: LAN Driver Welcome Screen**

**Step 6:** Click **Next** to continue.

**Step 7:** The **Ready to Install** screen in **Figure 6-14** appears.

**Step 8:** Click **Install** to proceed with the installation.

## PPC-37xxA-N26 Panel PC

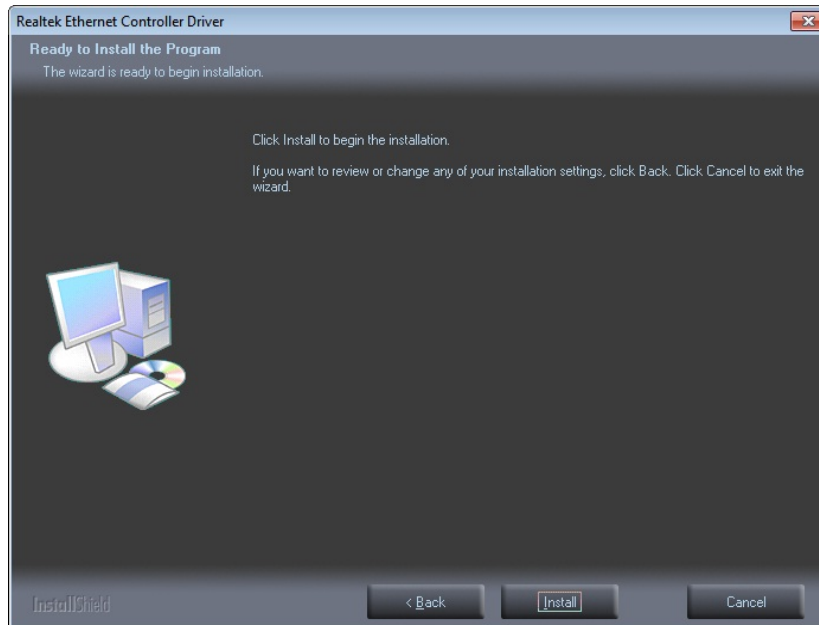
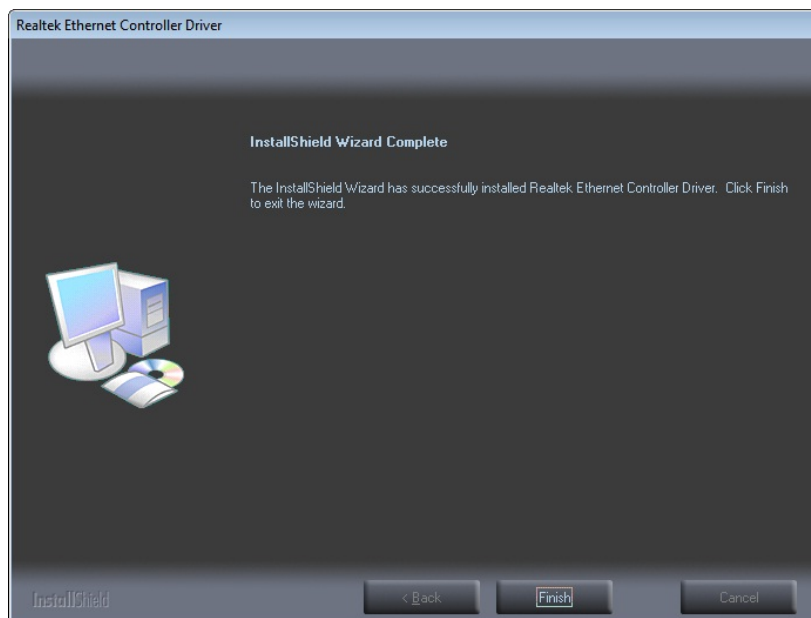

**Figure 6-14: LAN Driver Installation**

**Step 9:** The program begins to install.

**Step 10:** When the driver installation is complete, the screen in **Figure 6-15** appears.

**Step 11:** Click **Finish** to exit.



**Figure 6-15: LAN Driver Installation Complete**

## 6.6 Audio Driver Installation

To install the Audio driver, please do the following.

**Step 1:** Access the driver list. (See **Section 6.2**)

**Step 2:** Click “**AUDIO**”.

**Step 3:** Open the **Win7** folder.

**Step 4:** Double click the **Vista\_Win7\_R263** icon.

**Step 5:** The installation files are extracted as shown in **Figure 6-16**.

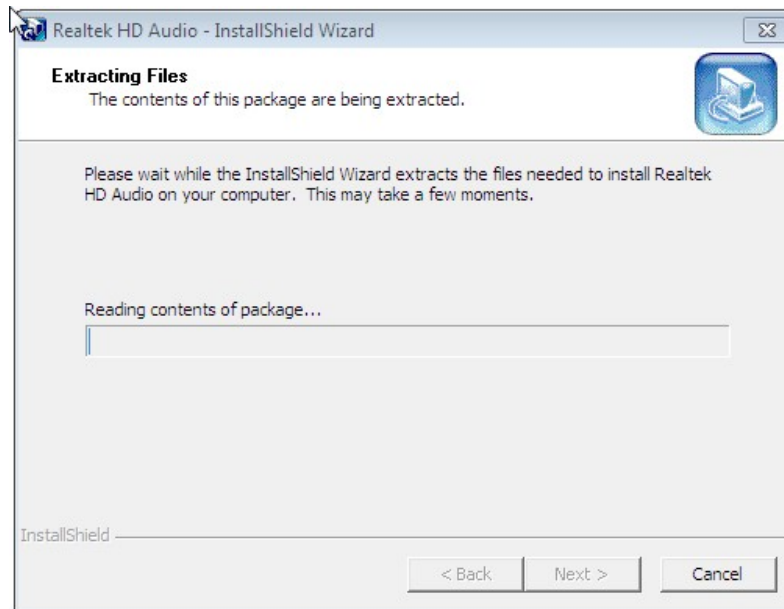

**Figure 6-16: Audio Driver Installation File Extraction**

**Step 6:** The **Welcome** screen in **Figure 6-17** appears.

## PPC-37xxA-N26 Panel PC

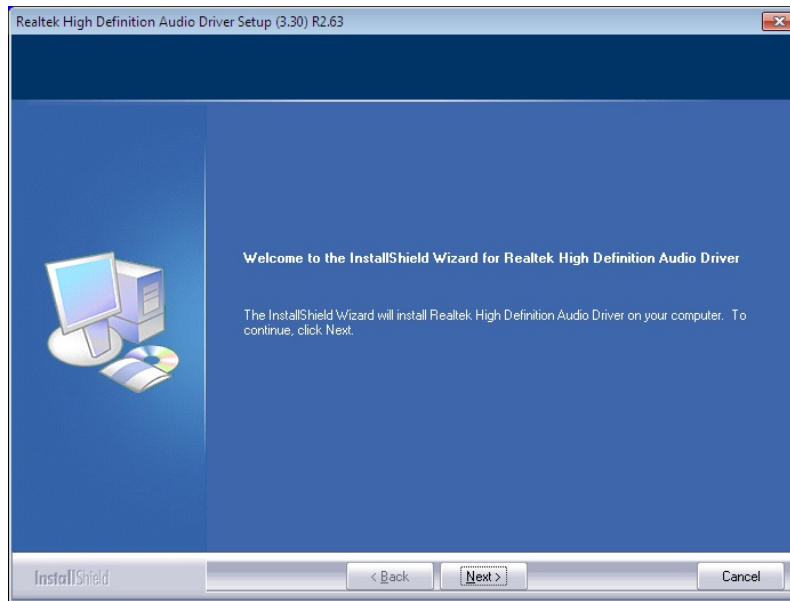
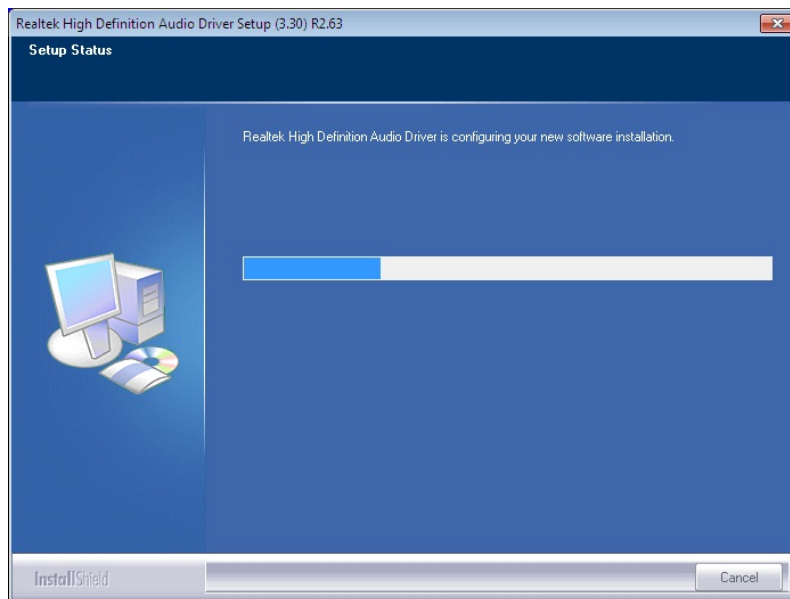

**Figure 6-17: Audio Driver Welcome Screen**

**Step 7:** Click **Next** to continue.

**Step 8:** The program begins to install.

**Step 9:** The installation progress can be monitored in the progress bar shown in **Figure 6-18**.



**Figure 6-18: Audio Driver Installation**

**Step 10:** When the driver installation is complete, the screen in **Figure 6-19** appears.

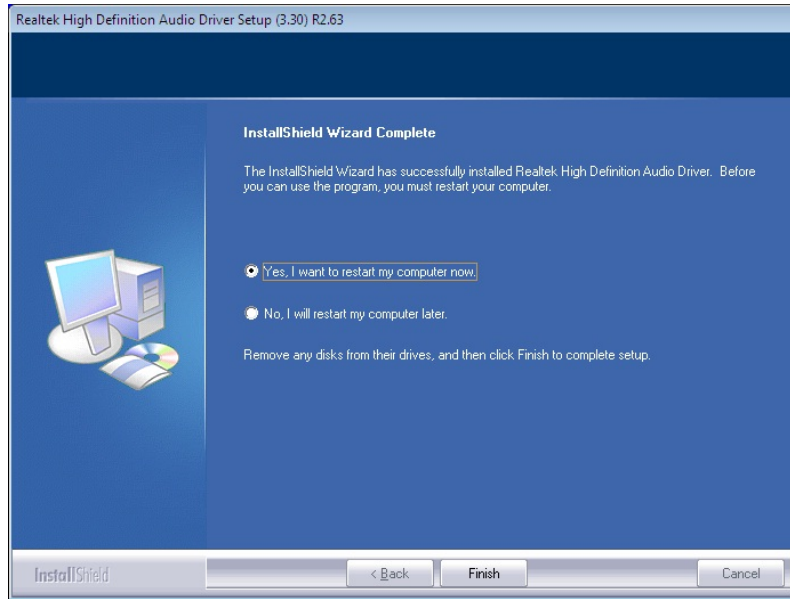

**Figure 6-19: Audio Driver Installation Complete**

**Step 11:** Select “**Yes, I want to restart my computer now**” and click **Finish**.

**Step 12:** The system reboots.

## 6.7 USB 3.0 Driver Installation



### **WARNING:**

Do not run this driver’s installer (Setup.exe) from a USB storage device (ie. external USB hard drive or USB thumb drive). For proper installation, please copy driver files to a local hard drive folder and run from there.

To install the USB 3.0 driver, please follow the steps below.

**Step 1:** Access the driver list. (See **Section 6.2**)

**Step 2:** Click “USB 3.0”.



## PPC-37xxA-N26 Panel PC

- Step 3:** Locate the setup file and double click on it.
- Step 4:** The **Welcome Screen** in **Figure 6-20** appears.
- Step 5:** Click **Next** to continue.

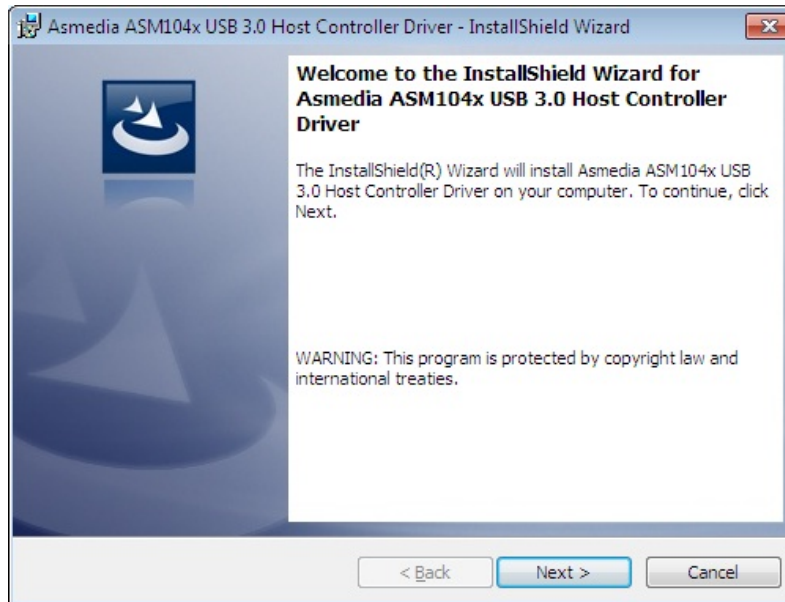

**Figure 6-20: USB 3.0 Driver Welcome Screen**

- Step 6:** The license agreement in **Figure 6-21** appears.
- Step 7:** Read the **License Agreement**.
- Step 8:** Check **I accept the terms in the license agreement**, and then click **Next** to continue.

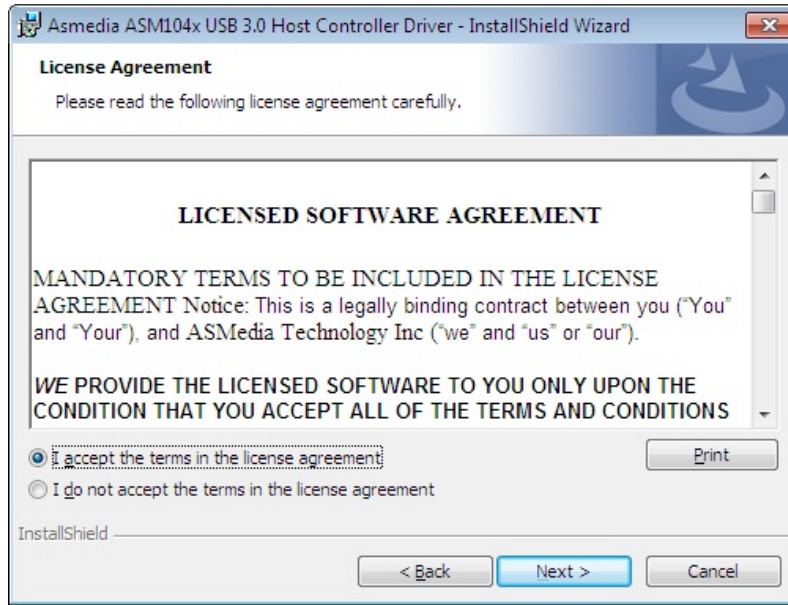

**Figure 6-21: USB 3.0 Driver License Agreement**

**Step 9:** The installation progress can be monitored in the progress bar shown in **Figure 6-22**.

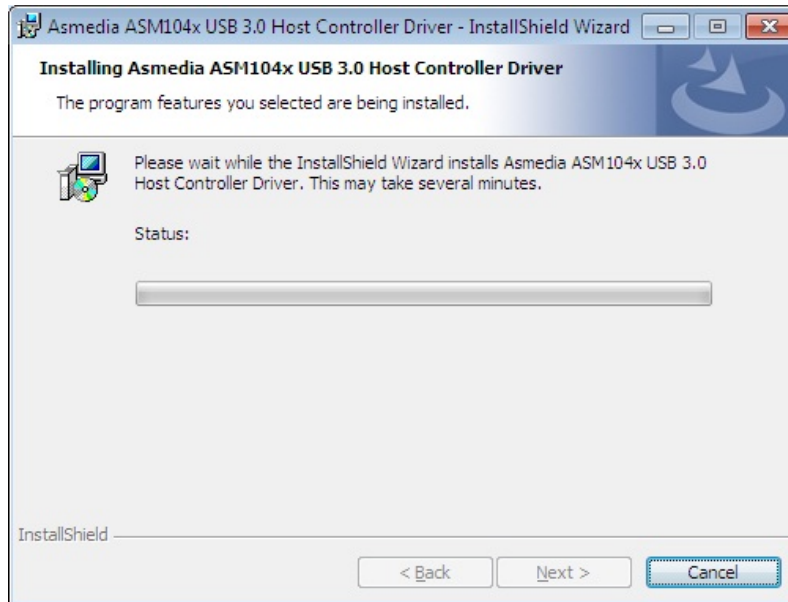

**Figure 6-22: USB 3.0 Driver Setup Operations**

**Step 10:** When the driver installation is complete, the screen in **Figure 6-23** appears

**Step 11:** Click **Finish** to exit.

## PPC-37xxA-N26 Panel PC

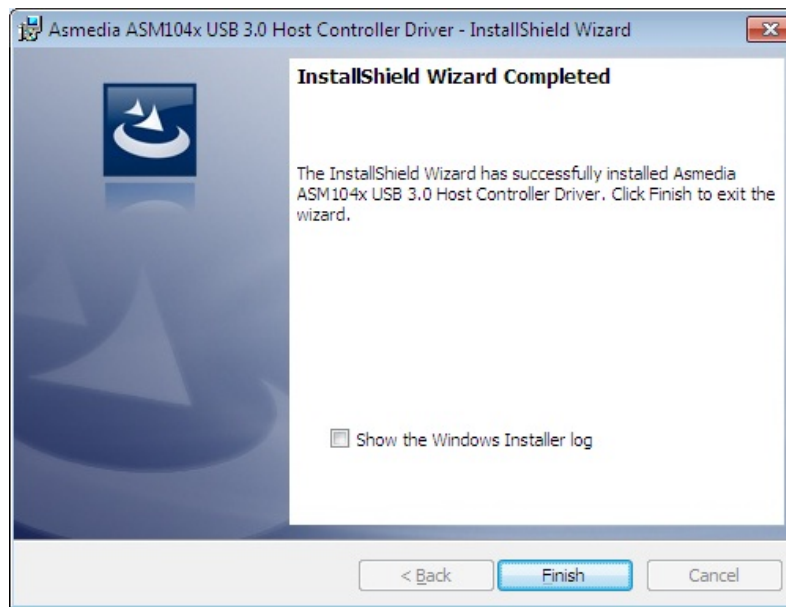

Figure 6-23: USB 3.0 Driver Installation Finish Screen

### 6.7.1 Installing USB 3.0 Driver during Windows® 7 OS Installation

If installing the Windows® 7 OS by using the USB 3.0 ports, loading the USB 3.0 driver during the OS installation is necessary. Follow the instructions below to complete the task.

- Step 1:** Insert the USB flash drive containing the USB 3.0 driver into one of the USB 2.0 ports on the PPC-37xxA-N26.
- Step 2:** After clicking the **Install now** button during the OS installation (**Figure 6-24**), the Load Driver screen appears (**Figure 6-25**). Click **Browse**.



**Figure 6-24: Install Now**

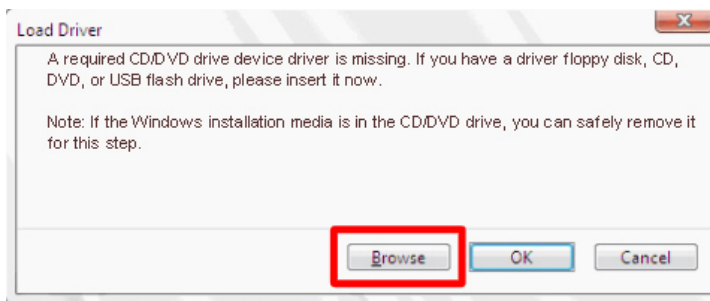

**Figure 6-25: Load Driver**

**Step 3:** Locate the USB 3.0 driver folder, select **Driver**, and then click **OK** (Figure 6-26).

## PPC-37xxA-N26 Panel PC

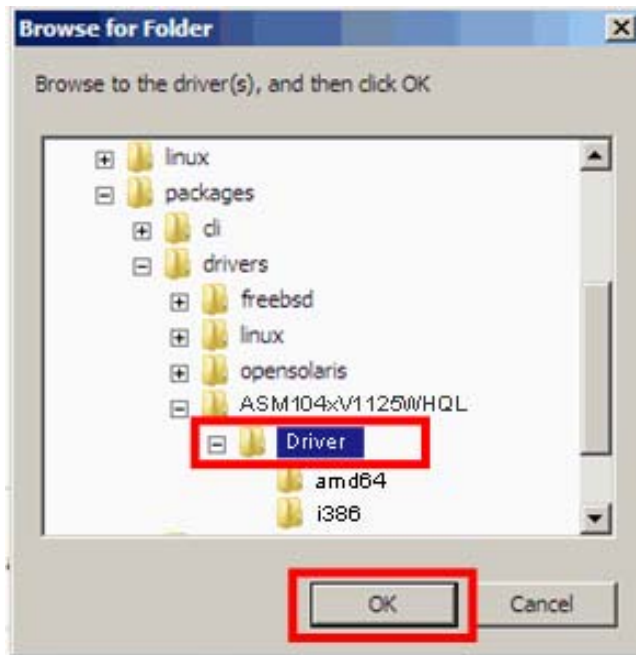

Figure 6-26: Browse for Folder

**Step 4:** Make sure the **ASMedia XHCI Controller** driver is selected, and then click **Next**.

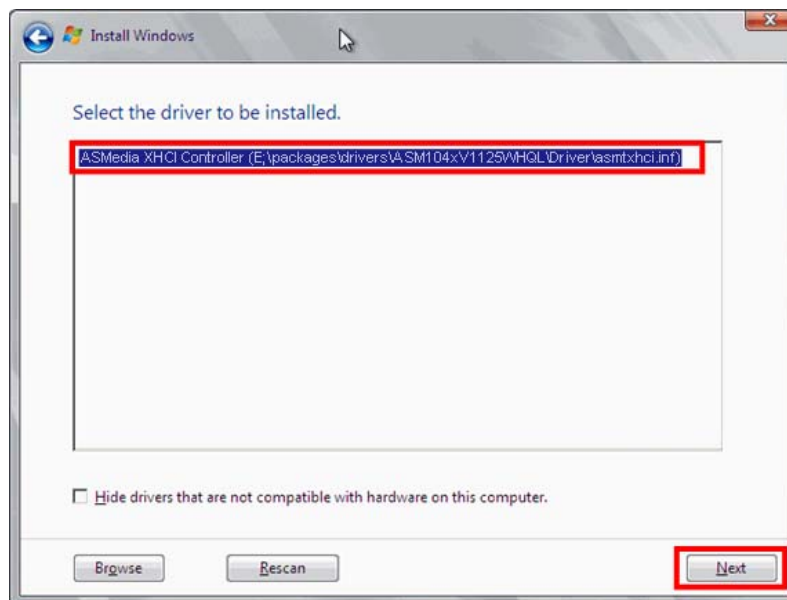
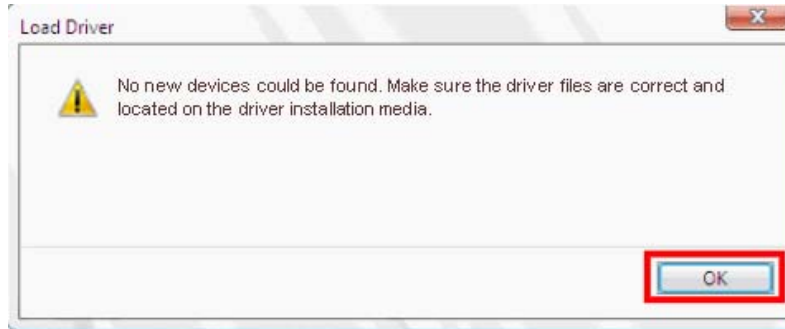

Figure 6-27: Select the ASMedia XHCI Controller Driver

**Step 5:** Click **OK** to continue (Figure 6-28).



**Figure 6-28: Confirm the Driver File**

**Step 6:** Make sure the **Driver** subfolder inside the USB 3.0 driver folder is selected, and then click **OK** (Figure 6-26).

**Step 7:** Select the **USB Root Hub** driver and click **Next**.

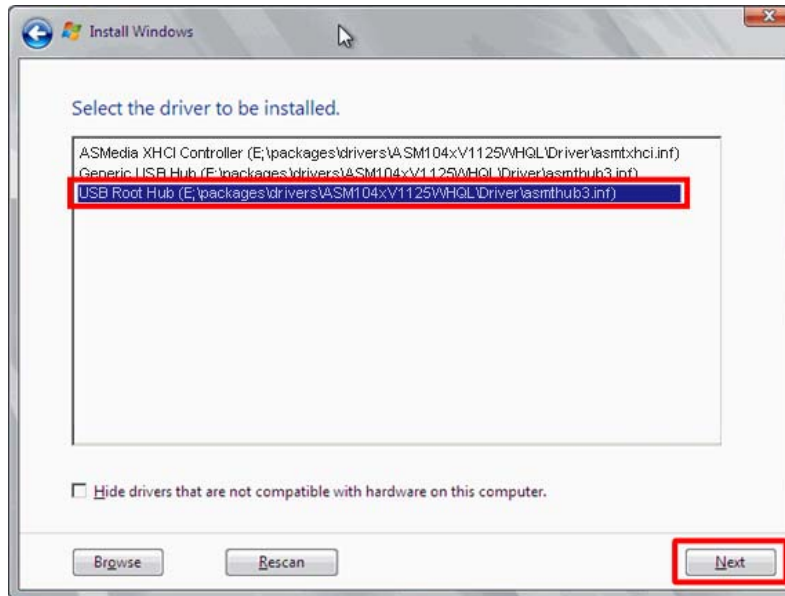

**Figure 6-29: Select the USB Root Hub Driver**

**Step 8:** Follow the on-screen instructions of the Windows setup wizard to complete the OS installation.

## PPC-37xxA-N26 Panel PC

## 6.8 Touchscreen Driver Installation

To install the touchscreen driver, please follow the steps below.

**Step 1:** Access the driver list. (See **Section 6.2**)

**Step 2:** Click “Touch”.

**Step 3:** Double click the **setup** icon.

**Step 4:** The Welcome screen in **Figure 6-30** appears. Click **Next** to continue.

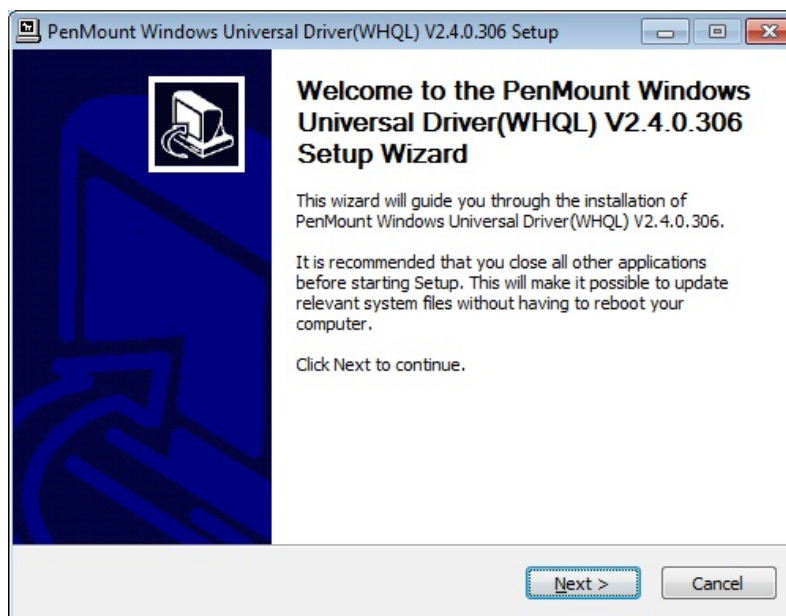
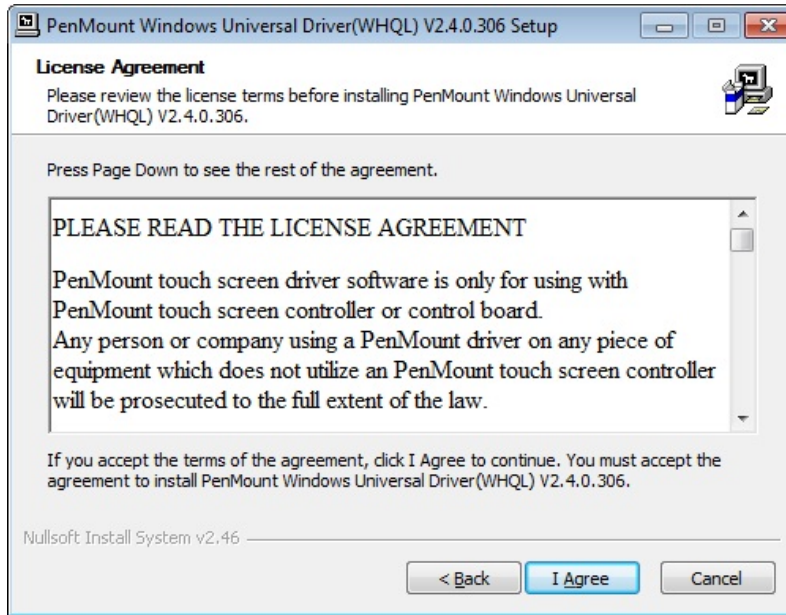

**Figure 6-30: Welcome Screen**

**Step 5:** The license agreement in **Figure 6-31** appears.

**Step 6:** Read the **License Agreement**.

**Step 7:** Click **I Agree** to continue.



**Figure 6-31: Touchscreen Driver License Agreement**

**Step 8:** Select the destination folder where the setup files will be copied to (**Figure 6-32**).

**Step 9:** Click **Install** to start installation.

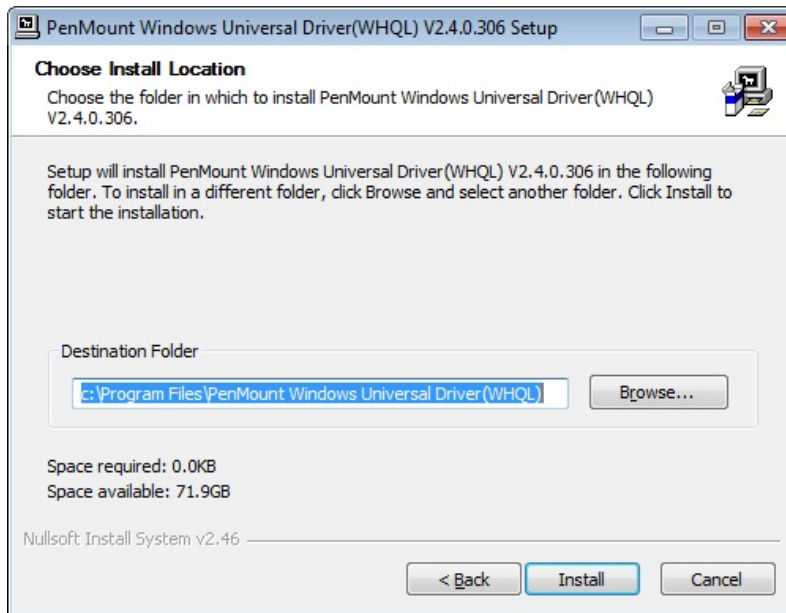
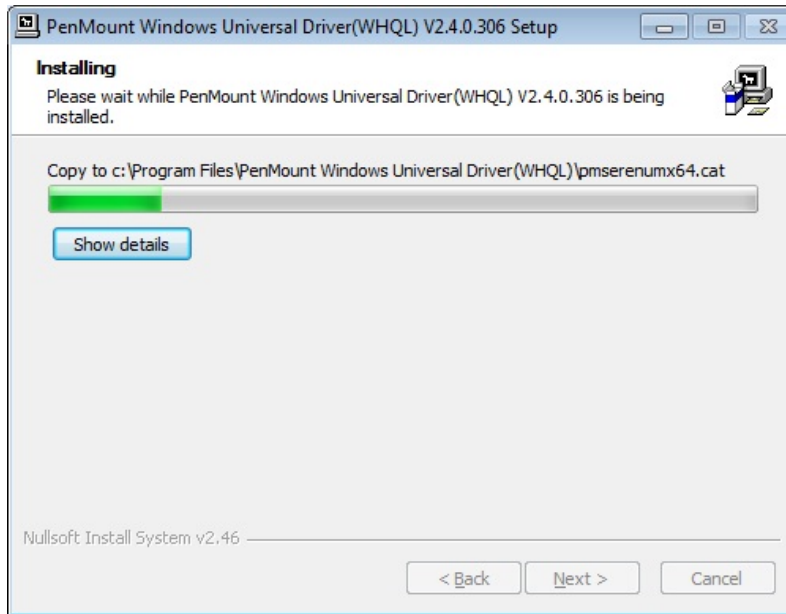

**Figure 6-32: Choose Destination Folder**



**PPC-37xxA-N26 Panel PC**

**Step 10:** The installation begins. See **Figure 6-33**.



**Figure 6-33: Setup Status**

**Step 11:** When the installation is complete, the screen in **Figure 6-34** appears. Click **Finish** to close the setup wizard.

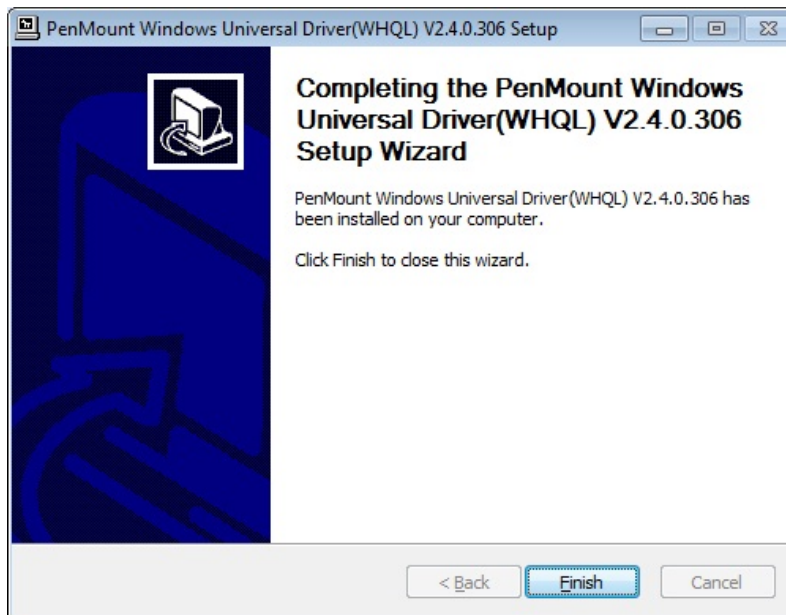

**Figure 6-34: Touchscreen Driver Installation Finish Screen**

### 6.8.1 Calibrating the Touchscreen

To calibrate the touchscreen, please follow the steps below.

**Step 1:** Click the  icon on the Windows taskbar.

**Step 2:** Click **Control Panel** from the menu (**Figure 6-35**).

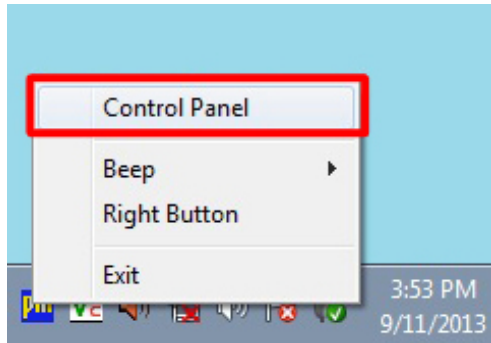

**Figure 6-35: Select Control Panel**

**Step 3:** The touchscreen control panel appears (**Figure 6-36**). Click **Configure**.

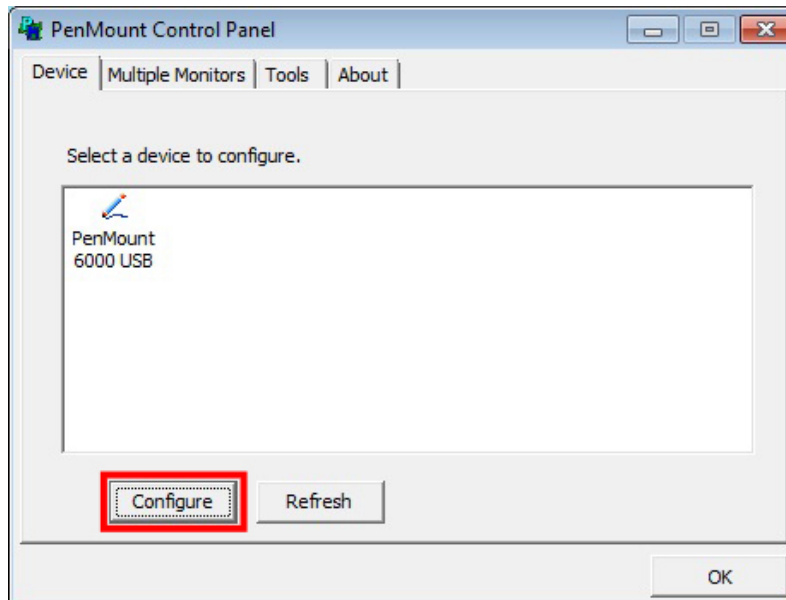

**Figure 6-36: Touchscreen Control Panel**

## PPC-37xxA-N26 Panel PC

**Step 4:** The user can click **Standard Calibration** or **Advanced Calibration** to proceed with standard or advanced calibration.

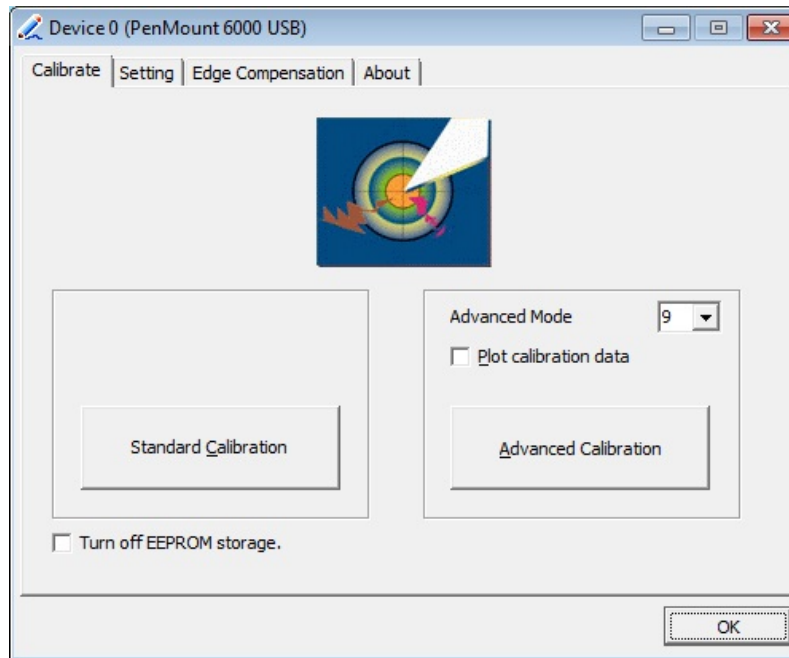

**Figure 6-37: Select Calibration Type**

**Step 5:** The calibration window in **Figure 6-38** appears. The user is asked to touch the screen at five specified points, if Standard Calibration is selected. Follow the screen guide to touch and hold each red square in the calibration window until it shows “Lift off to proceed”.

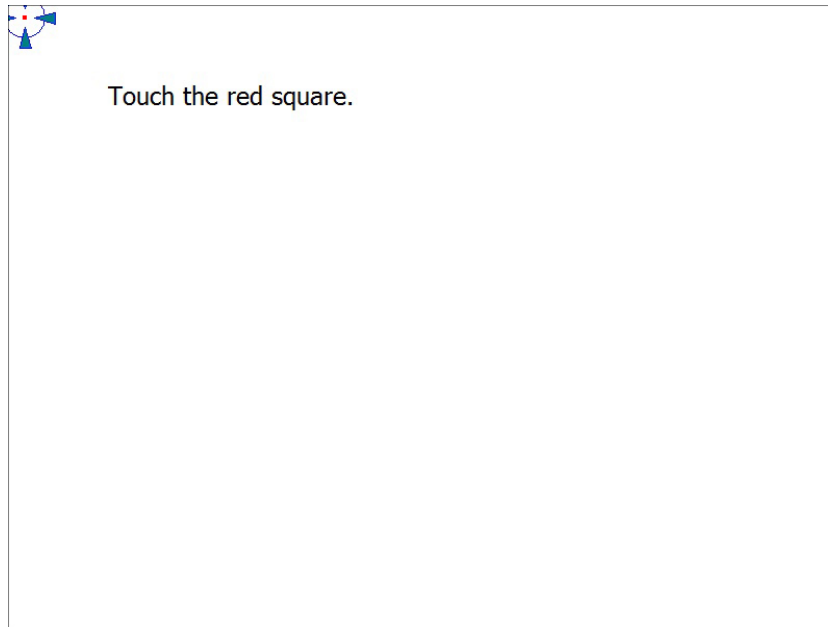

**Figure 6-38: Calibration Window**

- Step 6:** When the calibration is complete, the setup returns to the control panel. Click **OK** to exit.

Chapter

7

# Interface Connectors

---

## 7.1 Peripheral Interface Connectors

The PPC-37xxA-N26 panel PC motherboard comes with a number of peripheral interface connectors and configuration jumpers. The connector locations are shown in **Figure 6-1** and **Figure 6-2**. The Pin 1 locations of the on-board connectors are also indicated in the diagrams. The connector pinouts for these connectors are listed in the following sections.

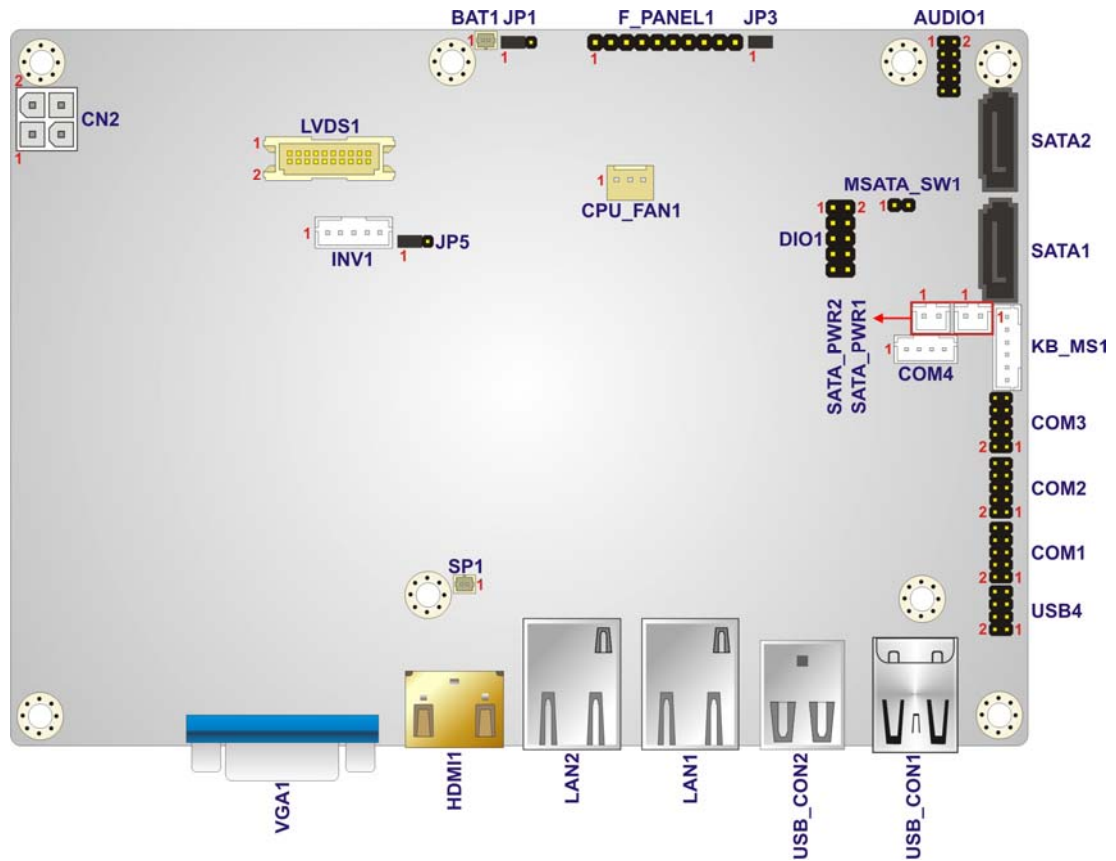

**Figure 7-1: Main Board Layout Diagram (Front Side)**

PPC-37xxA-N26 Panel PC

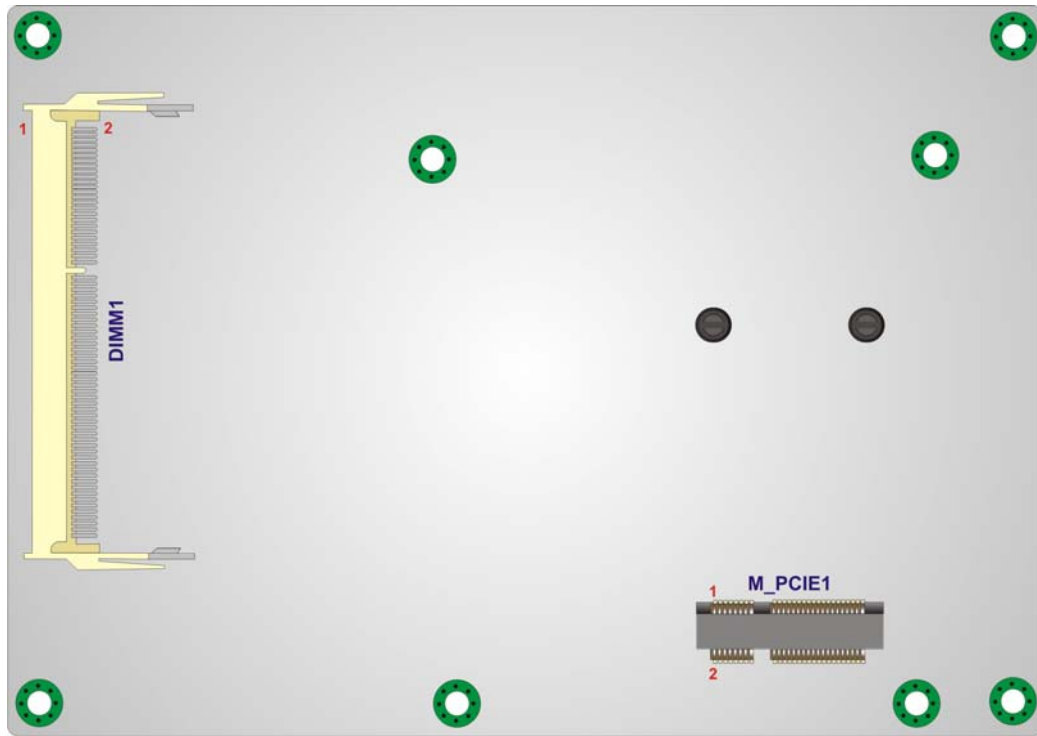

Figure 7-2: Main Board Layout Diagram (Solder Side)

## 7.2 Internal Peripheral Connectors

Internal peripheral connectors are found on the motherboard and are only accessible when the motherboard is outside of the chassis. The table below shows a list of the peripheral interface connectors on the PPC-37xxA-N26 motherboard. Pinouts of these connectors can be found in the following sections.

Connector	Type	Label
5 V SATA power connectors	2-pin wafer	SATA_PWR1, SATA_PWR2
Audio connector	10-pin header	AUDIO1
Backlight inverter connector	5-pin wafer	INV1
Battery connector	2-pin wafer	BAT1
Buzzer connector	2-pin wafer	SP1
Digital Input/Output (DIO) connector	10-pin header	DIO1

Connector	Type	Label
Fan connector	3-pin wafer	CPU_FAN1
Front panel connector	10-pin header	F_PANEL1
Keyboard and mouse connector	6-pin wafer	KB_MS1
LVDS connector	20-pin crimp	LVDS1
PCIe Mini card slot	52-pin PCIe Mini	M_PCIE1
Power connector (9V~28V)	4-pin connector	CN2
RS-232 serial port connectors	10-pin header	COM1, COM2, COM3
RS-422/485 serial port connector	4-pin wafer	COM4
Serial ATA (SATA) drive connectors	7-pin SATA	SATA1, SATA2
SO-DIMM connector	SO-DIMM connector	DIMM1
USB 2.0 connector	8-pin header	USB4

**Table 7-1: Peripheral Interface Connectors**

### 7.2.1 5 V SATA Power Connectors (SATA\_PWR1/SATA\_PWR2)

PIN NO.	DESCRIPTION
1	GND
2	GND

**Table 7-2: 5 V SATA Power Connectors Pinouts**

### 7.2.2 Audio Connector (AUDIO1)

PIN NO.	DESCRIPTION	PIN NO.	DESCRIPTION
1	SPK_R	2	LINE1_R
3	AUD_GND	4	AUD_GND
5	SPK_L	6	LINE1_L
7	AUD_GND	8	AUD_GND
9	MIC1_R	10	MIC1_L

**Table 7-3: Audio Connector (AUDIO1) Pinouts**



### 7.2.3 Backlight Inverter Connector (INV1)

PIN NO.	DESCRIPTION
1	LCD_BKLTCTL
2	GROUND
3	+12V
4	GROUND
5	BACKLIGHT ENABLE

**Table 7-4: Backlight Inverter Connector (INV1) Pinouts**

### 7.2.4 Battery Connector (BAT1)

PIN NO.	DESCRIPTION
1	Battery+
2	GND

**Table 7-5: Battery Connector (BAT1) Pinouts**

### 7.2.5 Buzzer Connector (SP1)

PIN NO.	DESCRIPTION
1	+V5S
2	GND

**Table 7-6: Buzzer Connector (SP1) Pinouts**

### 7.2.6 Digital Input/Output Connector (DIO1)

PIN NO.	DESCRIPTION	PIN NO.	DESCRIPTION
1	GND	2	VCC
3	Output 3	4	Output 2
5	Output 1	6	Output 0
7	Input 3	8	Input 2
9	Input 1	10	Input 0

**Table 7-7: Digital Input/Output Connector (DIO1) Pinouts**

### 7.2.7 Fan Connector (CPU\_FAN1)

PIN NO.	DESCRIPTION
1	FANIO
2	+12V (PWM)
3	Ground

**Table 7-8: Fan Connector (CPU\_FAN1) Pinouts**

### 7.2.8 Front Panel Connector (F\_PANEL1)

FUNCTION	PIN NO.	DESCRIPTION	FUNCTION	PIN NO.	DESCRIPTION
	1	NC	Power LED	6	PWRLED
Power Button	2	PWRBTSW#		7	PWRLED
	3	GND		8	GND
HDD LED	4	+V5S	Reset Button	9	RESET+
	5	HDD_LED-		10	GND

**Table 7-9: Front Panel Connector (F\_PANEL1) Pinouts**

### 7.2.9 Keyboard/Mouse Connector (KB\_MS1)

PIN NO.	DESCRIPTION
1	VCC
2	Mouse Data
3	Mouse Clock
4	Keyboard Data
5	Keyboard Clock
6	GND

**Table 7-10: Keyboard/Mouse Connector (KB\_MS1) Pinouts**

### 7.2.10 LVDS Connector (LVDS1)

PIN NO.	DESCRIPTION	PIN NO.	DESCRIPTION
1	GND	2	GND
3	LVDS_DATA0	4	LVDS_DATA0#
5	LVDS_DATA1	6	LVDS_DATA1#
7	LVDS_DATA2	8	LVDS_DATA2#
9	LVDS_CLK	10	LVDS_CLK#
11	NC	12	NC
13	GND	14	GND
15	LDDC_DATA	16	LDDC_CLK
17	VCC_LCD	18	VCC_LCD
19	VCC_LCD	20	VCC_LCD

Table 7-11: LVDS Connector (LVDS1) Pinouts

### 7.2.11 PCIe Mini Card Slot (M\_PCIE1)

PIN NO.	DESCRIPTION	PIN NO.	DESCRIPTION
1	PCIE_WAKE#	2	VCC3
3	N/C	4	GND
5	N/C	6	1.5V
7	N/C	8	N/C
9	GND	10	N/C
11	PCIE_CLK#	12	N/C
13	PCIE_CLK	14	N/C
15	GND	16	N/C
17	N/C	18	GND
19	N/C	20	N/C
21	GND	22	PCIRST#
23	PCIE_RXN	24	VCC3
25	PCIE_RXP	26	GND
27	GND	28	1.5V
29	GND	30	SMBCLK

PIN NO.	DESCRIPTION	PIN NO.	DESCRIPTION
31	PCIE_TXN	32	SMBDATA
33	PCIE_TXP	34	GND
35	GND	36	USBD-
37	GND	38	USBD+
39	VCC3	40	GND
41	VCC3	42	N/C
43	GND	44	N/C
45	N/C	46	N/C
47	N/C	48	1.5V
49	N/C	50	GND
51	M-SATA Detect	52	VCC3

**Table 7-12: PCIe Mini Card Slot (M\_PCIE1) Pinouts**

### 7.2.12 Power Connector (9V~28V) (CN2)

PIN NO.	DESCRIPTION	PIN NO.	DESCRIPTION
1	GND	2	GND
3	PWR	4	PWR

**Table 7-13: Power Connector (9V~28V) (CN2) Pinouts**

### 7.2.13 RS-232 Serial Port Connectors (COM1/COM2/COM3)

PIN NO.	DESCRIPTION	PIN NO.	DESCRIPTION
1	DCD	2	DSR
3	RXD	4	RTS
5	TXD	6	CTS
7	DTR	8	RI
9	GND	10	GND

**Table 7-14: RS-232 Serial Port Connector Pinouts**

### 7.2.14 RS-422/485 Serial Port Connector (COM4)

PIN NO.	DESCRIPTION	PIN NO.	DESCRIPTION
1	RXD422-	3	TXD422+/TXD485+
2	RXD422+	4	TXD422-/TXD485-

**Table 7-15: RS-422/485 Serial Port Connector (COM4) Pinouts**

### 7.2.15 SATA 3Gb/s Connectors (SATA1/SATA2)

PIN NO.	DESCRIPTION
1	GND
2	TX+
3	TX-
4	GND
5	RX-
6	RX+
7	GND

**Table 7-16: SATA 3Gb/s Connectors (SATA1/SATA2) Pinouts**

### 7.2.16 USB 2.0 Connector (USB4)

PIN NO.	DESCRIPTION	PIN NO.	DESCRIPTION
1	USB_VCC	2	GND
3	DATA-	4	DATA+
5	DATA+	6	DATA-
7	GND	8	USB_VCC

**Table 7-17: USB 2.0 Connector (USB4) Pinouts**

### 7.3 External Interface Panel Connectors

The table below lists the rear panel connectors on the PPC-37xxA-N26 motherboard. Pinouts of these connectors can be found in the following sections.

Connector	Type	Label
HDMI connector	HDMI	HDMI1
RJ-45 LAN connectors	RJ-45	LAN1/LAN2
USB 2.0 connectors	USB 2.0 port	USB_CON2
USB 3.0 connectors	USB 3.0 port	USB_CON1
VGA connector	15-pin female	VGA1

**Table 7-18: Rear Panel Connectors**

#### 7.3.1 HDMI Connector (HDMI1)

PIN NO.	DESCRIPTION	PIN NO.	DESCRIPTION
1	HDMI_DATA2	13	N/C
2	GND	14	N/C
3	HDMI_DATA2#	15	HDMI_SCL
4	HDMI_DATA1	16	HDMI_SDA
5	GND	17	GND
6	HDMI_DATA1#	18	+5V
7	HDMI_DATA0	19	HDMI_HPD
8	GND	20	HDMI_GND
9	HDMI_DATA0#	21	HDMI_GND
10	HDMI_CLK	22	HDMI_GND
11	GND	23	HDMI_GND
12	HDMI_CLK#		

**Table 7-19: HDMI Connector (HDMI1) Pinouts**

### 7.3.2 RJ-45 LAN Connectors (LAN1/LAN2)

PIN NO.	DESCRIPTION	PIN NO.	DESCRIPTION
1	MDI0+	5	MDI2+
2	MDI0-	6	MDI2-
3	MDI1+	7	MDI3+
4	MDI1-	8	MDI3-

**Table 7-20: RJ-45 LAN Connector Pinouts**

### 7.3.3 USB 2.0 Connectors (USB\_CON2)

PIN NO.	DESCRIPTION
1	VCC
2	DATA-
3	DATA+
4	GND

**Table 7-21: USB 2.0 Connectors (USB\_CON2) Pinouts**

### 7.3.4 USB 3.0 Connectors (USB\_CON1)

PIN NO.	DESCRIPTION	PIN NO.	DESCRIPTION
1	VCC	2	D-
3	D+	4	GND
5	RX-	6	RX+
7	GND	8	TX-
9	TX+		

**Table 7-22: USB 3.0 Connectors (USB\_CON1) Pinouts**

### 7.3.5 VGA Connector (VGA1)

PIN NO.	DESCRIPTION	PIN NO.	DESCRIPTION
1	RED	9	VCC
2	GREEN	10	GROUND
3	BLUE	11	NC
4	NC	12	DDCDAT
5	GROUND	13	HSYNC
6	GROUND	14	VSYNC
7	GROUND	15	DDCCLK
8	GROUND		

**Table 7-23: VGA Connector (VGA1) Pinouts**



Appendix

**A**

# BIOS Configuration Options

---

## A.1 BIOS Configuration Options

Below is a list of BIOS configuration options described in **Chapter 0**.

BIOS Information .....	63
System Date [xx/xx/xx] .....	63
System Time [xx:xx:xx] .....	64
ACPI Sleep State [S1 (CPU Stop Clock)] .....	65
Wake system with Fixed Time [Disabled].....	66
Hyper-Threading [Enabled].....	68
Configure SATA as [IDE].....	68
USB Devices .....	69
Legacy USB Support [Enabled].....	69
USB3.0 Support [Enabled] .....	70
XHCI Hand-off [Enabled] .....	70
EHCI Hand-off [Disabled] .....	70
USB Mass Storage Driver Support [Enabled] .....	70
USB transfer time-out [20 sec] .....	71
Device reset time-out [20 sec] .....	71
Device power-up delay [Auto] .....	71
Serial Port [Enabled].....	73
Change Settings [Auto] .....	73
Serial Port [Enabled].....	73
Change Settings [Auto] .....	74
Serial Port [Enabled].....	74
Change Settings [Auto] .....	74
Serial Port [Enabled].....	75
Change Settings [Auto] .....	75
PC Health Status .....	77
CPU_FAN1/SYS_FAN1 Smart Fan Control [Auto Duty-Cycle Mode].....	78
CPU Temperature n/System Temperature n .....	78
Console Redirection [Disabled] .....	79
Terminal Type [ANSI].....	80
Bits per second [115200].....	80
Data Bits [8] .....	81

## PPC-37xxA-N26 Panel PC

Parity [None].....	81
Stop Bits [1].....	81
Auto Recovery Function [Disabled].....	82
Fixed Graphics Memory Size [128MB].....	85
Power Saving Function(ERP) [Disabled].....	85
Set Spread Spectrum function [Disabled].....	86
Bootup NumLock State [On].....	86
Quiet Boot [Enabled] .....	87
Launch PXE OpROM [Disabled].....	87
Option ROM Messages [Force BIOS].....	87
UEFI Boot [Disabled] .....	87
Administrator Password .....	88
User Password .....	88
Save Changes and Reset .....	89
Discard Changes and Reset .....	89
Restore Defaults .....	89
Save as User Defaults .....	89
Restore User Defaults .....	89

Appendix

**B**

# One Key Recovery

---

## B.1 One Key Recovery Introduction

The IEI one key recovery is an easy-to-use front end for the Norton Ghost system backup and recovery tool. This tool provides quick and easy shortcuts for creating a backup and reverting to that backup or reverting to the factory default settings.



### NOTE:

The latest One Key Recovery software provides an auto recovery function that allows a system running Microsoft Windows OS to automatically restore from the factory default image after encountering a Blue Screen of Death (BSoD) or a hang for around 10 minutes. Please refer to Section B.3 for the detailed setup procedure.

---

The IEI One Key Recovery tool menu is shown below.

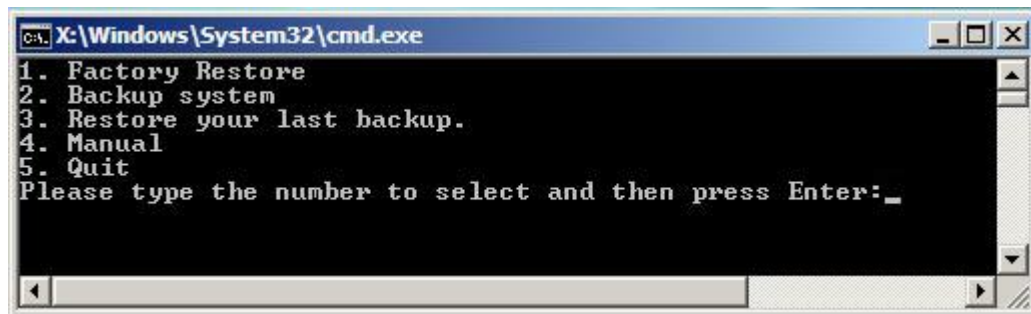

Figure B-1: IEI One Key Recovery Tool Menu

Prior to using the IEI One Key Recovery tool (as shown in **Figure B-1**) to backup or restore Windows system, five setup procedures are required.

1. Hardware and BIOS setup (see **Section B.2.1**)
2. Create partitions (see **Section B.2.2**)
3. Install operating system, drivers and system applications (see **Section B.2.3**)
4. Build the recovery partition (see **Section B.2.4**)
5. Create factory default image (see **Section B.2.5**)

After completing the five initial setup procedures as described above, users can access the recovery tool by pressing <F3> while booting up the system. The detailed information of each function is described in **Section B.5**.

**NOTE:**

The initial setup procedures for Linux system are described in **Section B.3**.

---

### B.1.1 System Requirement

---

**NOTE:**

The recovery CD can only be used with IEI products. The software will fail to run and a warning message will appear when used on non-IEI hardware.

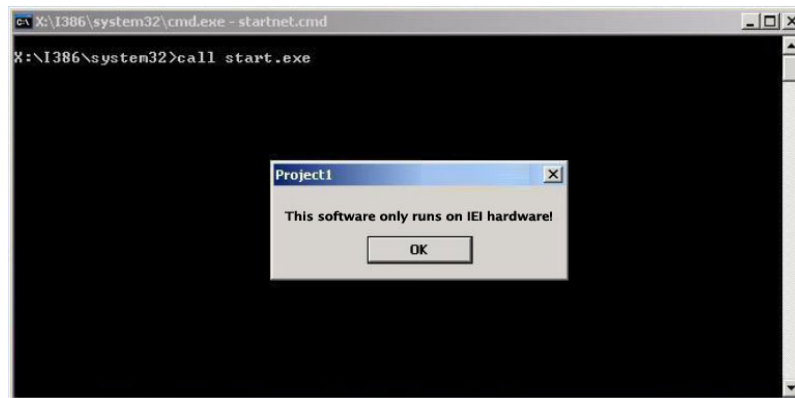

To create the system backup, the main storage device must be split into two partitions (three partitions for Linux). The first partition will be for the operating system, while the second partition will be invisible to the operating system and contain the backup made by the one key recovery software.

The partition created for recovery images must be big enough to contain both the factory default image and the user backup image. The size must be calculated before creating the

## PPC-37xxA-N26 Panel PC

partitions. Please take the following table as a reference when calculating the size of the partition.

	OS	OS Image after Ghost	Compression Ratio
<b>Windows® 7</b>	7 GB	5 GB	70%
<b>Windows® XPE</b>	776 MB	560 MB	70%
<b>Windows® CE 6.0</b>	36 MB	28 MB	77%



### NOTE:

Specialized tools are required to change the partition size if the operating system is already installed.

### B.1.2 Supported Operating System

The recovery CD is compatible with both Microsoft Windows and Linux operating systems (OS). The supported OS versions are listed below.

- Microsoft Windows
  - Windows XP (Service Pack 2 or 3 required)
  - Windows Vista
  - Windows 7
  - Windows CE 5.0
  - Windows CE 6.0
  - Windows XP Embedded
- Linux
  - Fedora Core 12 (Constantine)
  - Fedora Core 11 (Leonidas)
  - Fedora Core 10 (Cambridge)
  - Fedora Core 8 (Werewolf)
  - Fedora Core 7 (Moonshine)
  - RedHat RHEL-5.4
  - RedHat 9 (Ghirke)

- Ubuntu 8.10 (Intrepid)
- Ubuntu 7.10 (Gutsy)
- Ubuntu 6.10 (Edgy)
- Debian 5.0 (Lenny)
- Debian 4.0 (Etch)
- SuSe 11.2
- SuSe 10.3

**NOTE:**

Installing unsupported OS versions may cause the recovery tool to fail.

---

## B.2 Setup Procedure for Windows

Prior to using the recovery tool to backup or restore, a few setup procedures are required.

- Step 1:** Hardware and BIOS setup (see **Section B.2.1**)
- Step 2:** Create partitions (see **Section B.2.2**)
- Step 3:** Install operating system, drivers and system applications (see **Section B.2.3**)
- Step 4:** Build the recovery partition (see **Section B.2.4**) or build the auto recovery partition (see **Section B.3**)
- Step 5:** Create factory default image (see **Section B.2.5**)

The detailed descriptions are described in the following sections.

---

**NOTE:**

The setup procedures described below are for Microsoft Windows operating system users. For Linux, most of the setup procedures are the same except for several steps described in **Section B.3**.

---



## PPC-37xxA-N26 Panel PC

### B.2.1 Hardware and BIOS Setup

- Step 1:** Make sure the system is powered off and unplugged.
- Step 2:** Install a hard drive or SSD in the system. An unformatted and unpartitioned disk is recommended.
- Step 3:** Connect an optical disk drive to the system and insert the recovery CD.
- Step 4:** Turn on the system.
- Step 5:** Press the <DELETE> key as soon as the system is turned on to enter the BIOS.
- Step 6:** Select the connected optical disk drive as the 1<sup>st</sup> boot device. (**Boot** → **Boot Device Priority** → **1<sup>st</sup> Boot Device**).
- Step 7:** Save changes and restart the computer. Continue to the next section for instructions on partitioning the internal storage.

### B.2.2 Create Partitions

To create the system backup, the main storage device must be split into two partitions (three partitions for Linux). The first partition will be for the operating system, while the second partition will be invisible to the operating system and contain the backup made by the one key recovery software.

- Step 1:** Put the recovery CD in the optical drive of the system.
- Step 2:** **Boot the system from recovery CD.** When prompted, press any key to boot from the recovery CD. It will take a while to launch the recovery tool. Please be patient!

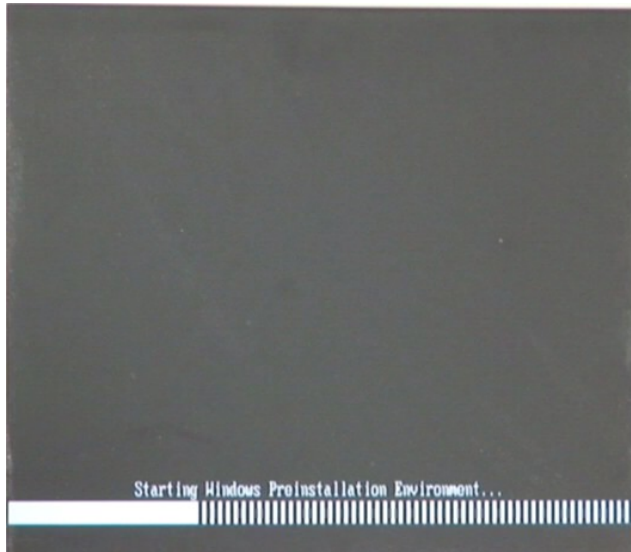

**Figure B-2: Launching the Recovery Tool**

**Step 3:** The recovery tool setup menu is shown as below.

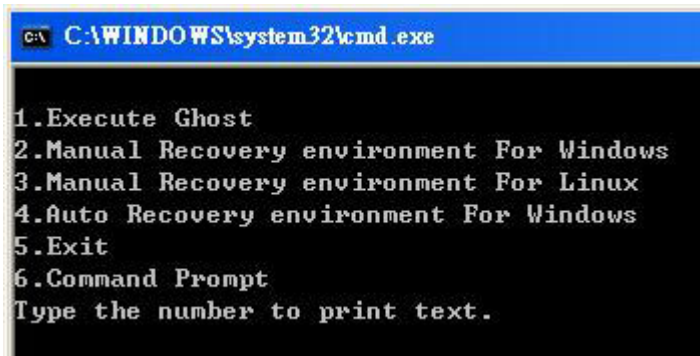

**Figure B-3: Recovery Tool Setup Menu**

**Step 4:** Press <6> then <Enter>.

## PPC-37xxA-N26 Panel PC

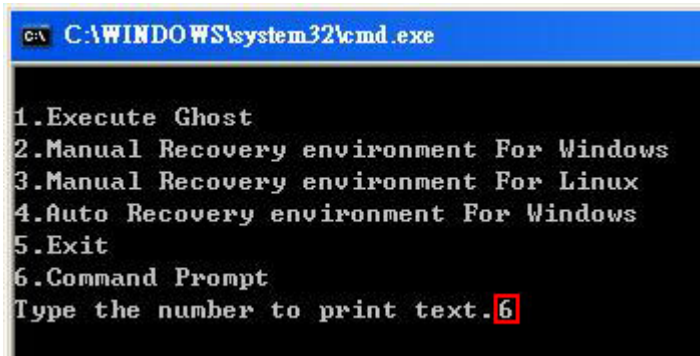

```
C:\WINDOWS\system32\cmd.exe

1.Execute Ghost
2.Manual Recovery environment For Windows
3.Manual Recovery environment For Linux
4.Auto Recovery environment For Windows
5.Exit
6.Command Prompt
Type the number to print text. 6
```

Figure B-4: Command Prompt

**Step 5:** The command prompt window appears. Type the following commands (marked in red) to create two partitions. One is for the OS installation; the other is for saving recovery files and images which will be an invisible partition. (Press <Enter> after entering each line below)

```
system32>diskpart
DISKPART>list vol
DISKPART>sel disk 0
DISKPART>create part pri size= ____
DISKPART>assign letter=N
DISKPART>create part pri size= ____
DISKPART>assign letter=F
DISKPART>exit
system32>format N: /fs:ntfs /q /y
system32>format F: /fs:ntfs /q /v:Recovery /y
system32>exit
```

```

X:\I386\SYSTEM32\CMD.EXE
X:\I386\SYSTEM32>diskpart → Starts the Microsoft disk partitioning tool.
Microsoft DiskPart version 5.2.3790.1830
Copyright (C) 1999-2001 Microsoft Corporation.
On computer: MININT-JUC

DISKPART> list vol → Show partition information

Volume ### Ltr Label Fs Type Size Status Info
-----
Volume 0 X CD_ROM CDFS DUD-ROM 405 MB Healthy Boot
Volume 1 D FAT32 Removeable 3854 MB Healthy

DISKPART> sel disk 0 → Select a disk
Disk 0 is now the selected disk.

DISKPART> create part pri size=2000 → Create partition 1 and assign a size.
This partition is for OS installation.
DiskPart succeeded in creating the specified partition.

DISKPART> assign letter=N → Assign partition 1 a code name (N).
DiskPart successfully assigned the drive letter or mount point.

DISKPART> create part pri size=1800 → Create partition 2 and assign a size.
This partition is for recovery images.
DiskPart succeeded in creating the specified partition.

DISKPART> assign letter=F → Assign partition 2 a code name (F).
DiskPart successfully assigned the drive letter or mount point.

DISKPART> exit → Exit diskpart
X:\I386\SYSTEM32>format n: /fs:ntfs /q /y → Format partition 1 (N) as NTFS format.
The type of the file system is RAW.
The new file system is NTFS.
QuickFormatting 2000M
Creating file system structures.
Format complete.
2048254 KB total disk space.
2035620 KB are available.

X:\I386\SYSTEM32>format f: /fs:ntfs /q /v:Recovery /y → Formate partition 2 (F) as NTFS formate and
name it as "Recovery".
The type of the file system is RAW.
The new file system is NTFS.
QuickFormatting 1804M
Creating file system structures.
Format complete.
1847474 KB total disk space.
1835860 KB are available.

X:\I386\SYSTEM32>exit → Exit Windows PE
  
```

Figure B-5: Partition Creation Commands

## PPC-37xxA-N26 Panel PC

**NOTE:**

Use the following commands to check if the partitions were created successfully.

```
X:\I386\SYSTEM32>diskpart
Microsoft DiskPart version 5.2.3790.1830
Copyright (C) 1999-2001 Microsoft Corporation.
On computer: MININT-JUC

DISKPART> sel disk 0
Disk 0 is now the selected disk.

DISKPART> list part

   Partition ###   Type              Size              Offset
-----
   Partition 1     Primary           2000 MB           32 KB
   Partition 2     Primary           1804 MB          2000 MB

DISKPART> exit
```

**Step 6:** Press any key to exit the recovery tool and automatically reboot the system.

Please continue to the following procedure: Build the Recovery Partition.

### B.2.3 Install Operating System, Drivers and Applications

Install the operating system onto the unlabelled partition. The partition labeled "Recovery" is for use by the system recovery tool and should not be used for installing the operating system or any applications.

**NOTE:**

The operating system installation program may offer to reformat the chosen partition. DO NOT format the partition again. The partition has already been formatted and is ready for installing the new operating system.

To install the operating system, insert the operating system installation CD into the optical drive. Restart the computer and follow the installation instructions.

### B.2.4 Building the Recovery Partition

- Step 1:** Put the recover CD in the optical drive.
- Step 2:** Start the system.
- Step 3:** **Boot the system from the recovery CD.** When prompted, press any key to boot from the recovery CD. It will take a while to launch the recovery tool. Please be patient!

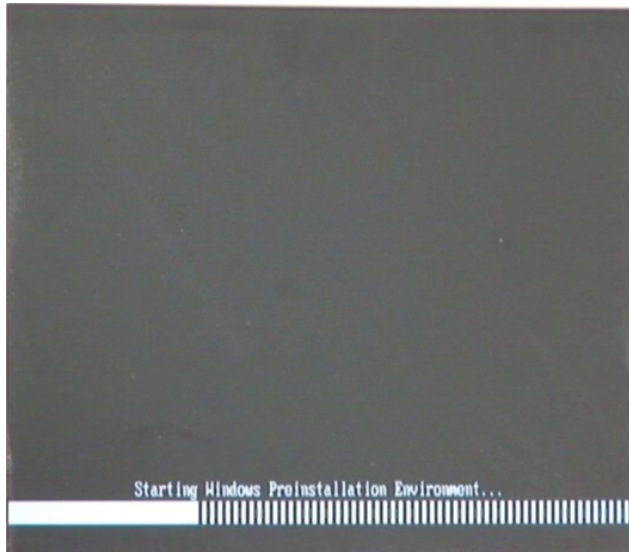

Figure B-6: Launching the Recovery Tool

- Step 4:** When the recovery tool setup menu appears, press <2> then <Enter>.

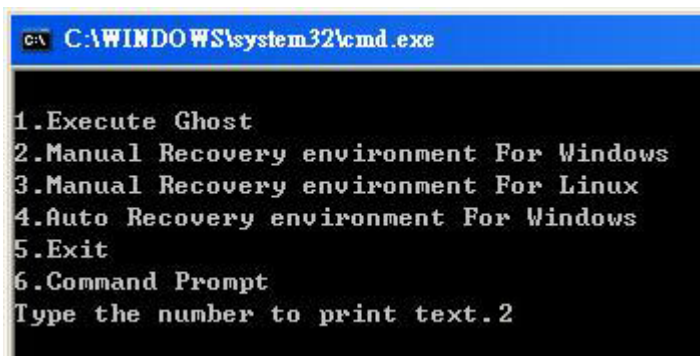

Figure B-7: Manual Recovery Environment for Windows

PPC-37xxA-N26 Panel PC

**Step 5:** The Symantec Ghost window appears and starts configuring the system to build a recovery partition. In this process the partition created for recovery files in **Section B.2.2** is hidden and the recovery tool is saved in this partition.

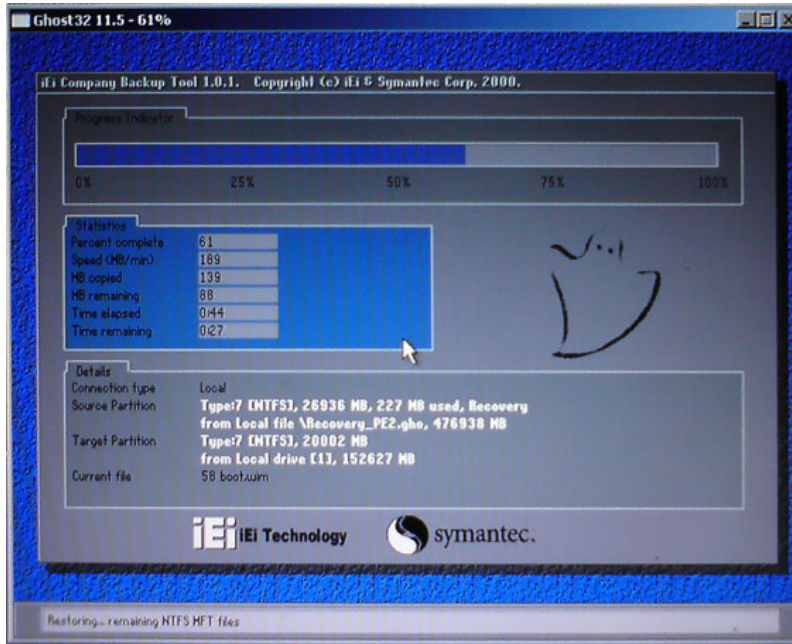

Figure B-8: Building the Recovery Partition

**Step 6:** After completing the system configuration, press any key in the following window to reboot the system.

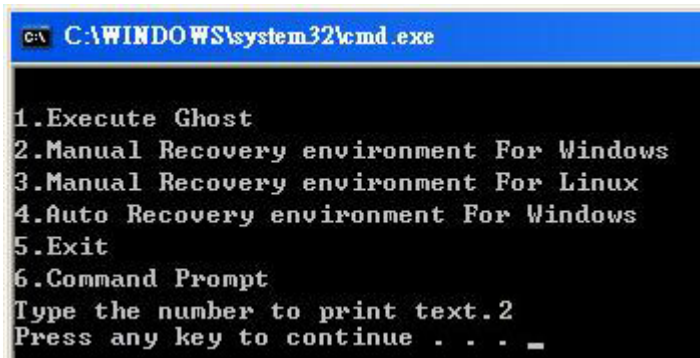

Figure B-9: Press Any Key to Continue

**Step 7:** Eject the recovery CD.

## B.2.5 Create Factory Default Image



### NOTE:

Before creating the factory default image, please configure the system to a factory default environment, including driver and application installations.

To create a factory default image, please follow the steps below.

**Step 1:** Turn on the system. When the following screen displays (**Figure B-10**), press the <F3> key to access the recovery tool. The message will display for 10 seconds, please press F3 before the system boots into the operating system.

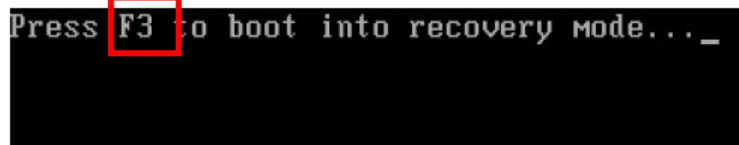

Figure B-10: Press F3 to Boot into Recovery Mode

**Step 2:** The recovery tool menu appears. Type <4> and press <Enter>. (**Figure B-11**)

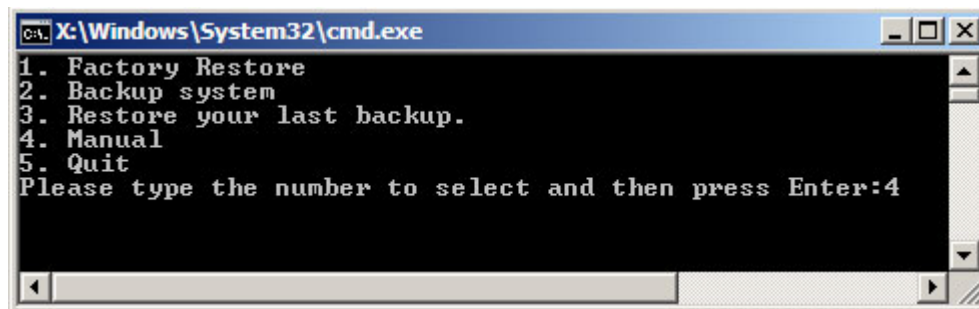

Figure B-11: Recovery Tool Menu

**Step 3:** The About Symantec Ghost window appears. Click **OK** button to continue.



PPC-37xxA-N26 Panel PC

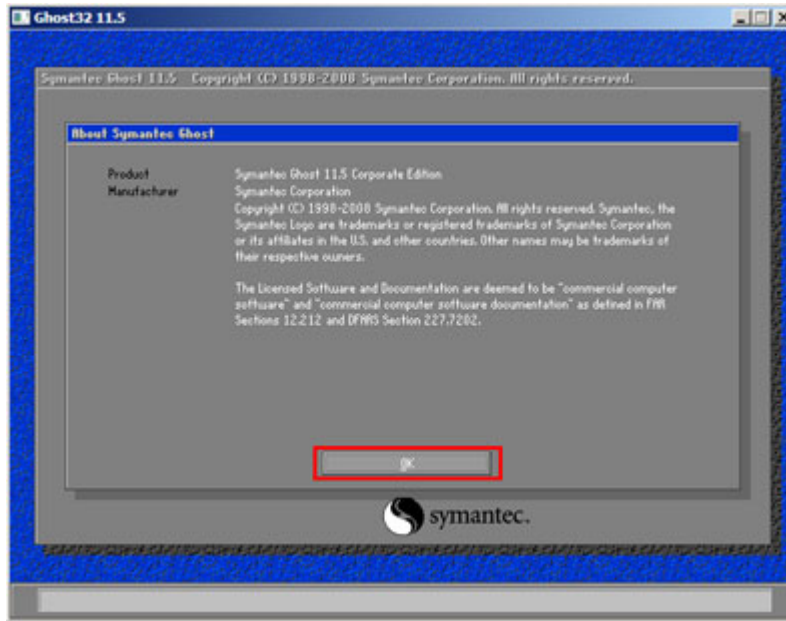

Figure B-12: About Symantec Ghost Window

**Step 4:** Use mouse to navigate to the option shown below (Figure B-13).

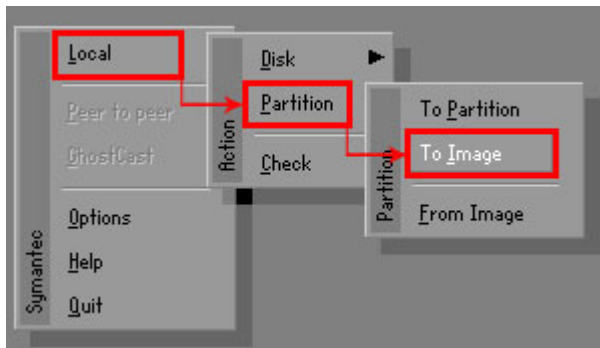
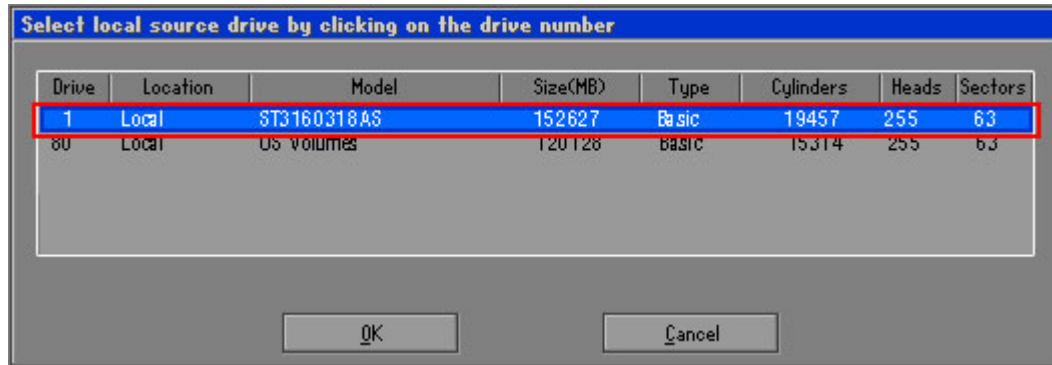

Figure B-13: Symantec Ghost Path

**Step 5:** Select the local source drive (Drive 1) as shown in Figure B-14. Then click OK.



**Figure B-14: Select a Local Source Drive**

**Step 6:** Select a source partition (Part 1) from basic drive as shown in **Figure B-15**. Then click OK.

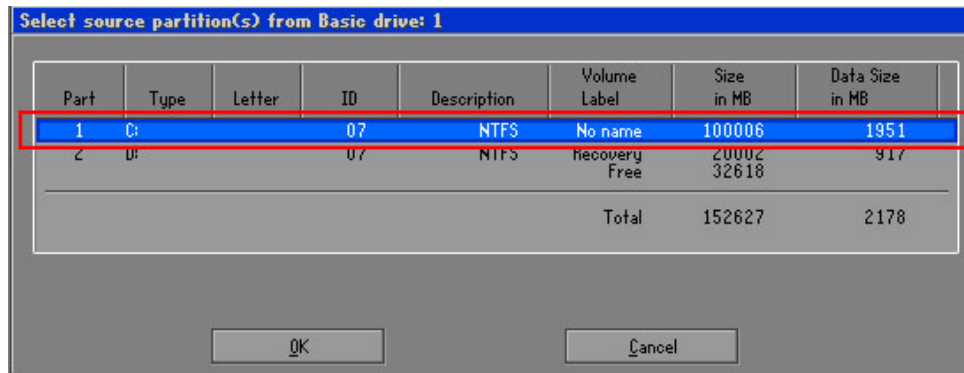

**Figure B-15: Select a Source Partition from Basic Drive**

**Step 7:** Select **1.2: [Recovery] NTFS drive** and enter a file name called **iei** (**Figure B-16**). Click **Save**. The factory default image will then be saved in the selected recovery drive and named **IEI.GHO**.



**WARNING:**

The file name of the factory default image must be **iei.GHO**.

## PPC-37xxA-N26 Panel PC

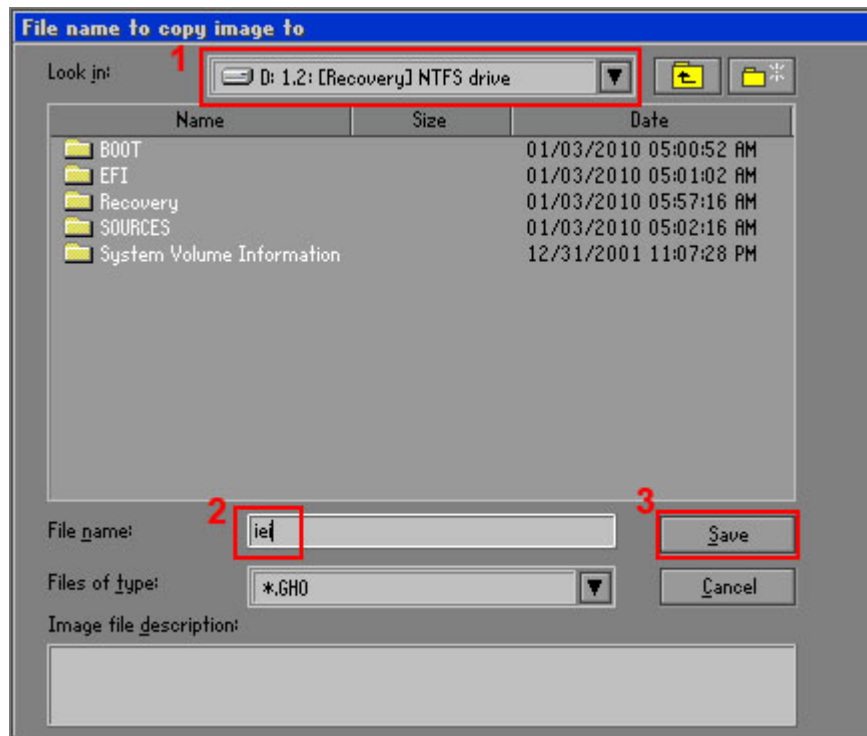

Figure B-16: File Name to Copy Image to

**Step 8:** When the Compress Image screen in **Figure B-17** prompts, click **High** to make the image file smaller.

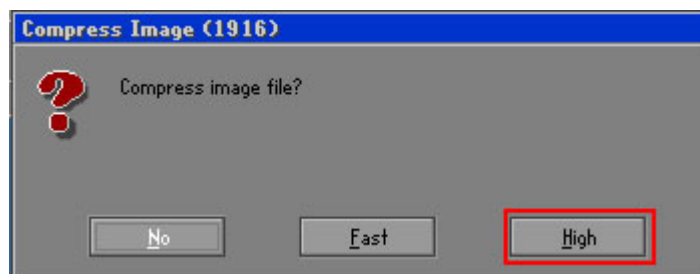
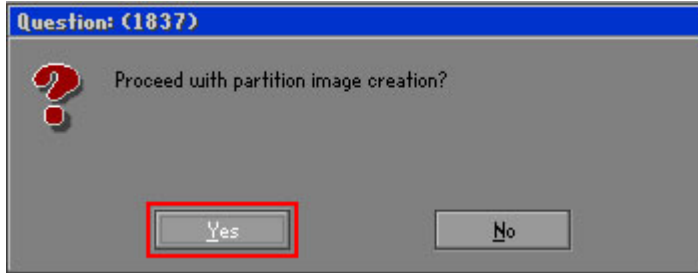

Figure B-17: Compress Image

**Step 9:** The Proceed with partition image creation window appears, click **Yes** to continue.



**Figure B-18: Image Creation Confirmation**

**Step 10:** The Symantec Ghost starts to create the factory default image (**Figure B-19**).

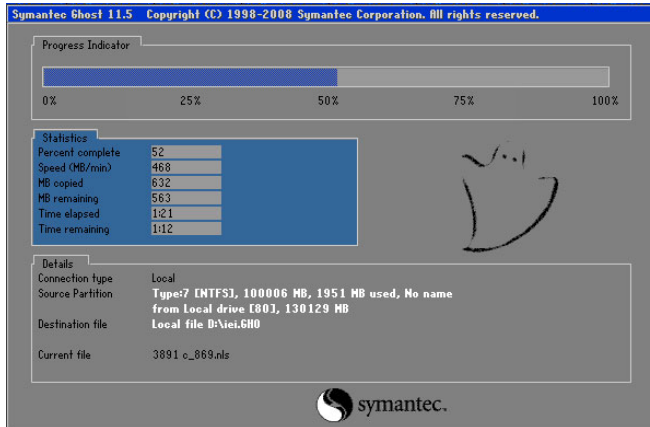

**Figure B-19: Image Creation Complete**

**Step 11:** When the image creation completes, a screen prompts as shown in **Figure B-20**. Click **Continue** and close the Ghost window to exit the program.

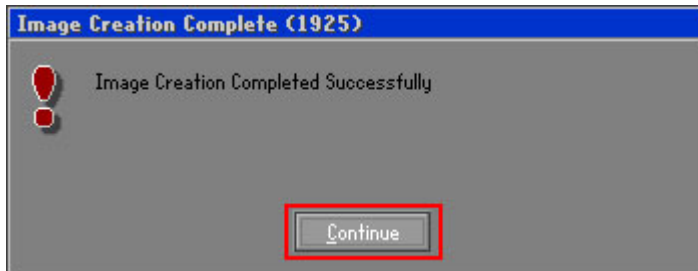

**Figure B-20: Image Creation Complete**

## PPC-37xxA-N26 Panel PC

**Step 12:** The recovery tool main menu window is shown as below. Press any key to reboot the system.

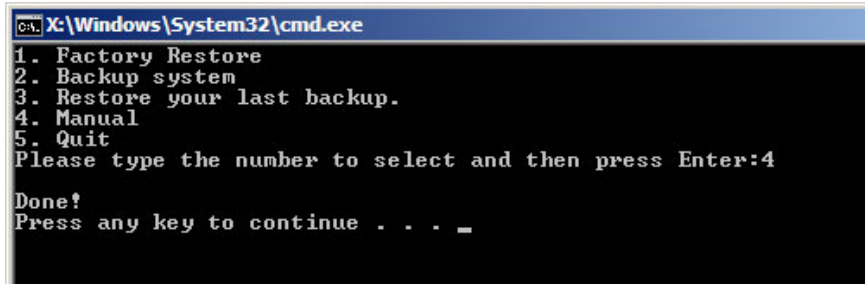

```
C:\Windows\System32\cmd.exe
1. Factory Restore
2. Backup system
3. Restore your last backup.
4. Manual
5. Quit
Please type the number to select and then press Enter:4
Done!
Press any key to continue . . . _
```

Figure B-21: Press Any Key to Continue

### B.3 Auto Recovery Setup Procedure

The auto recovery function allows a system to automatically restore from the factory default image after encountering a Blue Screen of Death (BSoD) or a hang for around 10 minutes. To use the auto recovery function, follow the steps described in the following sections.



#### CAUTION:

The setup procedure may include a step to create a factory default image. It is suggested to configure the system to a factory default environment before the configuration, including driver and application installations.

---

**Step 1:** Follow the steps described in **Section B.2.1 ~ Section B.2.3** to setup BIOS, create partitions and install operating system.

**Step 2:** Install the auto recovery utility into the system by double clicking the **Utility/AUTORECOVERY-SETUP.exe** in the One Key Recovery CD. This utility **MUST** be installed in the system, otherwise, the system will automatically restore from the factory default image every ten (10) minutes.



Figure B-22: Auto Recovery Utility

**Step 3:** Reboot the system from the recovery CD. When prompted, press any key to boot from the recovery CD. It will take a while to launch the recovery tool. Please be patient!

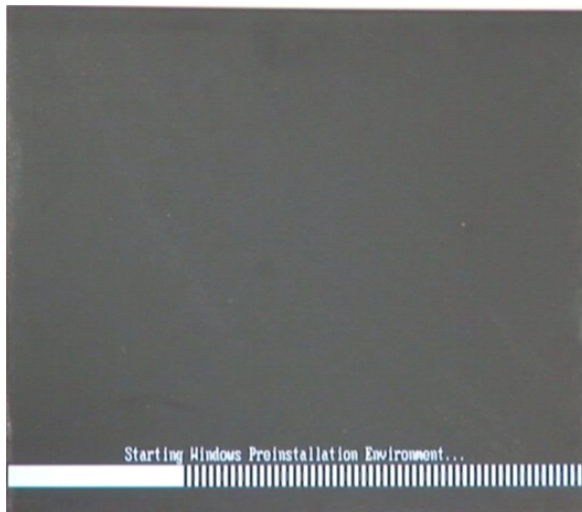

Figure B-23: Launching the Recovery Tool

**Step 4:** When the recovery tool setup menu appears, press <4> then <Enter>.

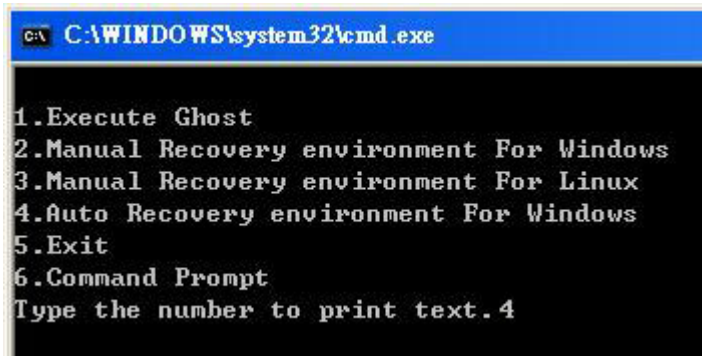

Figure B-24: Auto Recovery Environment for Windows

PPC-37xxA-N26 Panel PC

**Step 5:** The Symantec Ghost window appears and starts configuring the system to build an auto recovery partition. In this process the partition created for recovery files in **Section B.2.2** is hidden and the auto recovery tool is saved in this partition.

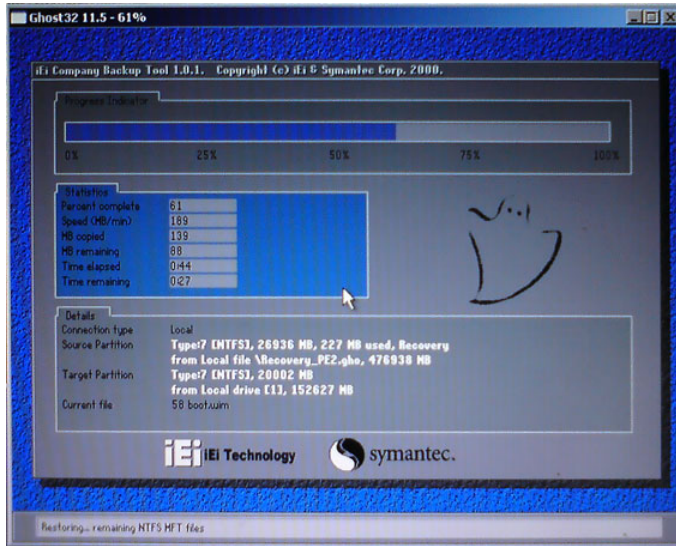

Figure B-25: Building the Auto Recovery Partition

**Step 6:** After completing the system configuration, the following message prompts to confirm whether to create a factory default image. Type **Y** to have the system create a factory default image automatically. Type **N** within 6 seconds to skip this process (The default option is YES). It is suggested to choose YES for this option.



Figure B-26: Factory Default Image Confirmation

**Step 7:** The Symantec Ghost starts to create the factory default image (Figure B-27).

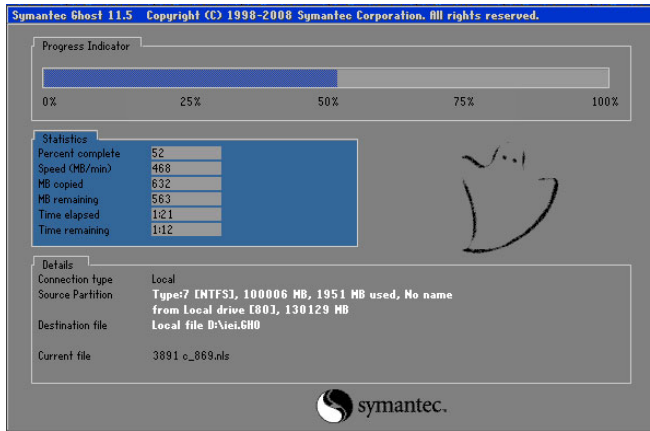

**Figure B-27: Image Creation Complete**

**Step 8:** After completing the system configuration, press any key in the following window to restart the system.

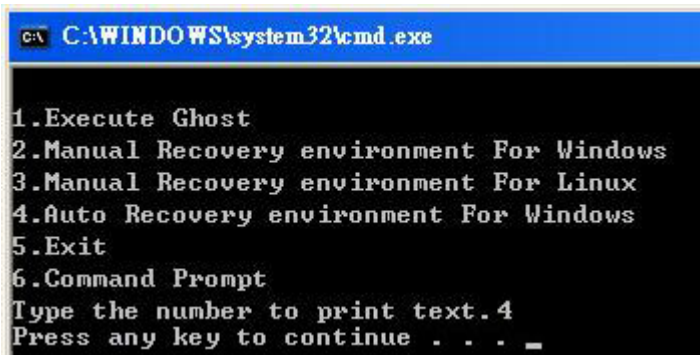

**Figure B-28: Press any key to continue**

**Step 9:** Eject the One Key Recovery CD and restart the system.

**Step 10:** Press the <DELETE> key as soon as the system is turned on to enter the BIOS.

**Step 11:** Enable the Auto Recovery Function option (**Advanced** → **iEi Feature** → **Auto Recovery Function**).

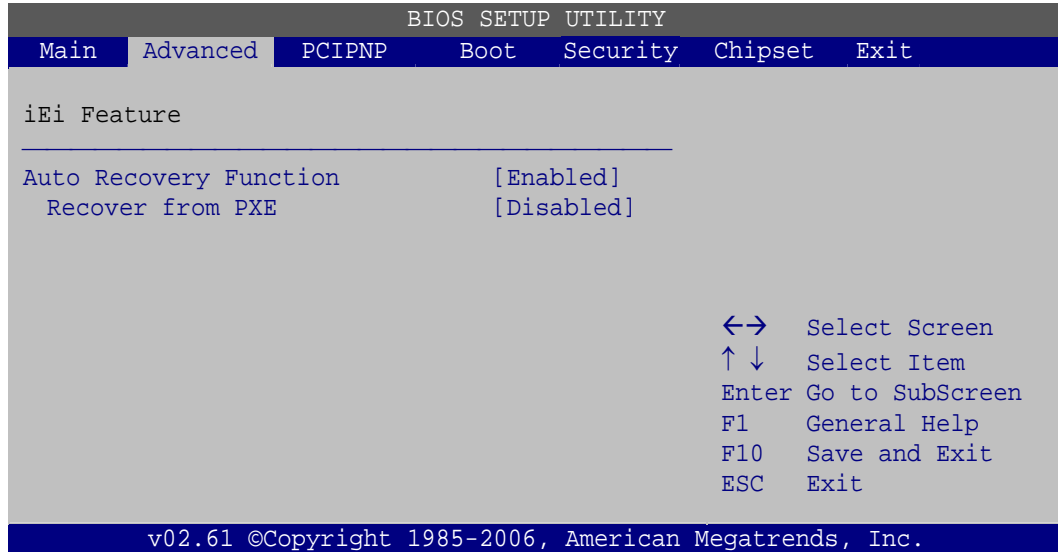

## PPC-37xxA-N26 Panel PC

**BIOS Menu 22: IEI Feature**

**Step 12:** Save changes and restart the system. If the system encounters a Blue Screen of Death (BSoD) or a hang for around 10 minutes, it will automatically restore from the factory default image.

**CAUTION:**

The auto recovery function can only apply on a Microsoft Windows system running the following OS versions:

- Windows XP
- Windows Vista
- Windows 7

**B.4 Setup Procedure for Linux**

The initial setup procedure for Linux system is mostly the same with the procedure for Microsoft Windows. Please follow the steps below to setup recovery tool for Linux OS.

**Step 1:** **Hardware and BIOS setup.** Refer to **Section B.2.1.**

**Step 2: Install Linux operating system.** Make sure to install GRUB (v0.97 or earlier) MBR type and Ext3 partition type. Leave enough space on the hard drive to create the recover partition later.

**NOTE:**

If the Linux OS is not installed with GRUB (v0.97 or earlier) and Ext3, the Symantec Ghost may not function properly.

---

While installing Linux OS, please create two partitions:

- Partition 1: /
- Partition 2: **SWAP**

**NOTE:**

Please reserve enough space for partition 3 for saving recovery images.

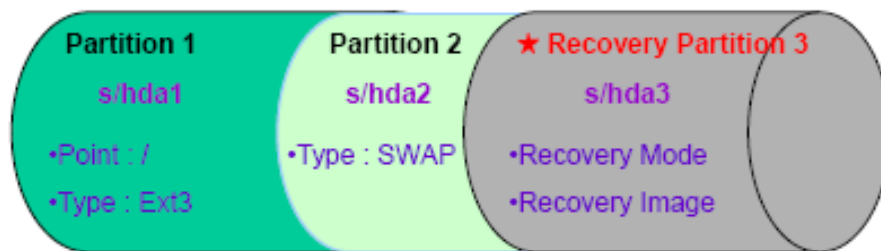

Figure B-29: Partitions for Linux

**Step 3: Create a recovery partition.** Insert the recovery CD into the optical disk drive. Follow **Step 1 ~ Step 3** described in **Section B.2.2**. Then type the following commands (marked in red) to create a partition for recovery images.

```
system32>diskpart
```

```
DISKPART>list vol
```

```
DISKPART>sel disk 0
```

## PPC-37xxA-N26 Panel PC

```
DISKPART>create part pri size= ____  
DISKPART>assign letter=N  
DISKPART>exit  
system32>format N: /fs:ntfs /q /v:Recovery /y  
system32>exit
```

**Step 4:** Build the recovery partition. Press any key to boot from the recovery CD. It will take a while to launch the recovery tool. Please be patient. When the recovery tool setup menu appears, type <3> and press <Enter> (Figure B-30). The Symantec Ghost window appears and starts configuring the system to build a recovery partition. After completing the system configuration, press any key to reboot the system. Eject the recovery CD.

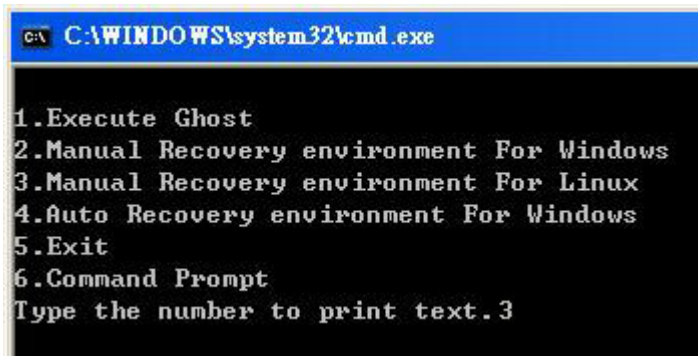
A screenshot of a Windows command prompt window. The title bar reads "C:\WINDOWS\system32\cmd.exe". The command prompt displays a menu with the following options:  
1. Execute Ghost  
2. Manual Recovery environment For Windows  
3. Manual Recovery environment For Linux  
4. Auto Recovery environment For Windows  
5. Exit  
6. Command Prompt  
Below the menu, it says "Type the number to print text.3".

```
C:\WINDOWS\system32\cmd.exe  
1. Execute Ghost  
2. Manual Recovery environment For Windows  
3. Manual Recovery environment For Linux  
4. Auto Recovery environment For Windows  
5. Exit  
6. Command Prompt  
Type the number to print text.3
```

Figure B-30: Manual Recovery Environment for Linux

**Step 5:** Access the recovery tool main menu by modifying the “menu.lst”. To first access the recovery tool main menu, the menu.lst must be modified. In Linux, enter Administrator (root). When prompt appears, type:

```
cd /boot/grub  
vi menu.lst
```

```
Fedora release 9 (Sulphur)
Kernel 2.6.25-14.fc9.i686 on an i686 (tty2)

localhost login: root
Password:
[root@localhost ~]# cd /boot/grub/
[root@localhost grub]# vi menu.lst _
```

Figure B-31: Access menu.lst in Linux (Text Mode)

**Step 6:** Modify the menu.lst as shown below.

```
#boot=/dev/sda
default=0
timeout=10 ← Modify timeout=10
splashimage=(hd0,0)/grub/splash.xpm.gz
hiddenmenu
title Fedora (2.6.25-14.fc9.i686)
    root (hd0,0)
    kernel /vmlinuz-2.6.25-14.fc9.i686 ro root=UUID=10f1acd
ac38b5c78910 rhgb quiet
    initrd /initrd-2.6.25-14.fc9.i686.img

title Recovery Partition
root (hd0,2) ← Type command
makeactive
chainloader +1
```

- **Type command:**  
**title Recovery Partition**  
**root (hd0,2)**  
**makeactive**  
**chainloader +1**

**Step 7:** The recovery tool menu appears. (Figure B-32)

```
1. Factory Restore
2. Backup system
3. Restore your last backup.
4. Manual
5. Quit
Please type the number to select and then press Enter:
```

Figure B-32: Recovery Tool Menu

**Step 8:** Create a factory default image. Follow **Step 2 ~ Step 12** described in **Section B.2.5** to create a factory default image.

## B.5 Recovery Tool Functions

After completing the initial setup procedures as described above, users can access the recovery tool by pressing <F3> while booting up the system. However, if the setup procedure in Section B.3 has been completed and the auto recovery function is enabled, the system will automatically restore from the factory default image without pressing the F3 key. The recovery tool main menu is shown below.

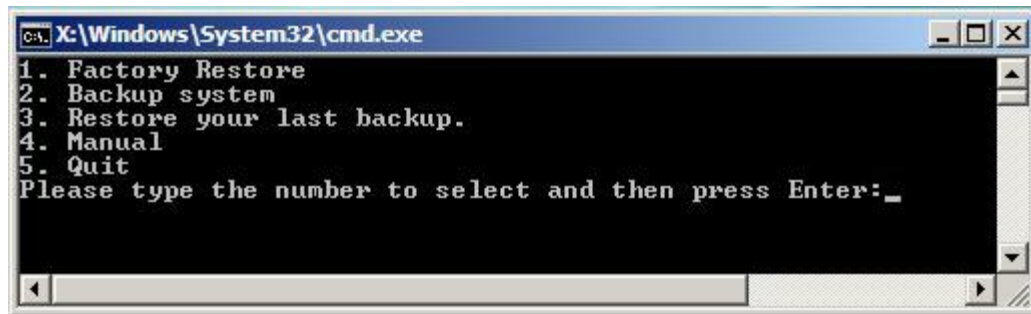

Figure B-33: Recovery Tool Main Menu

The recovery tool has several functions including:

1. **Factory Restore:** Restore the factory default image (iei.GHO) created in Section B.2.5.
2. **Backup system:** Create a system backup image (iei\_user.GHO) which will be saved in the hidden partition.
3. **Restore your last backup:** Restore the last system backup image
4. **Manual:** Enter the Symantec Ghost window to configure manually.
5. **Quit:** Exit the recovery tool and restart the system.



### WARNING:

Please do not turn off the system power during the process of system recovery or backup.

**WARNING:**

All data in the system will be deleted during the system recovery. Please backup the system files before restoring the system (either Factory Restore or Restore Backup).

### B.5.1 Factory Restore

To restore the factory default image, please follow the steps below.

**Step 1:** Type <1> and press <Enter> in the main menu.

**Step 2:** The Symantec Ghost window appears and starts to restore the factory default. A factory default image called **iei.GHO** is created in the hidden Recovery partition.

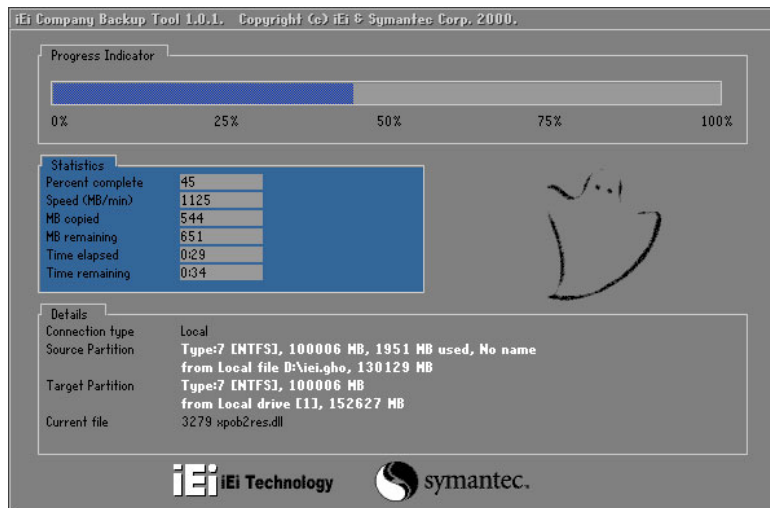

**Figure B-34: Restore Factory Default**

**Step 3:** The screen shown in **Figure B-35** appears when completed. Press any key to reboot the system.

## PPC-37xxA-N26 Panel PC

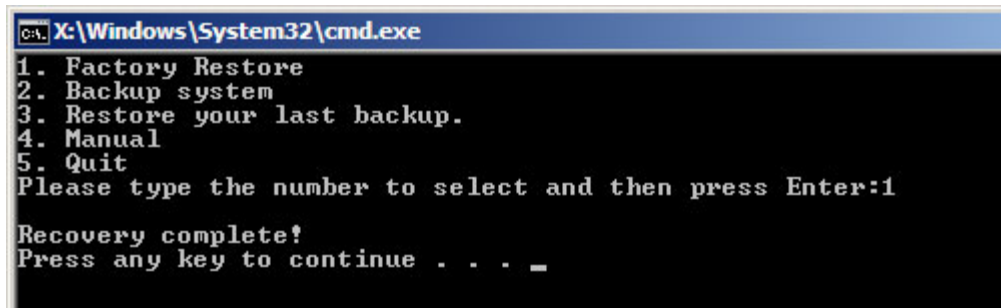

```

C:\X:\Windows\System32\cmd.exe
1. Factory Restore
2. Backup system
3. Restore your last backup.
4. Manual
5. Quit
Please type the number to select and then press Enter:1

Recovery complete!
Press any key to continue . . . _

```

Figure B-35: Recovery Complete Window

## B.5.2 Backup System

To backup the system, please follow the steps below.

**Step 1:** Type <2> and press <Enter> in the main menu.

**Step 2:** The Symantec Ghost window appears and starts to backup the system. A backup image called `iei_user.GHO` is created in the hidden Recovery partition.

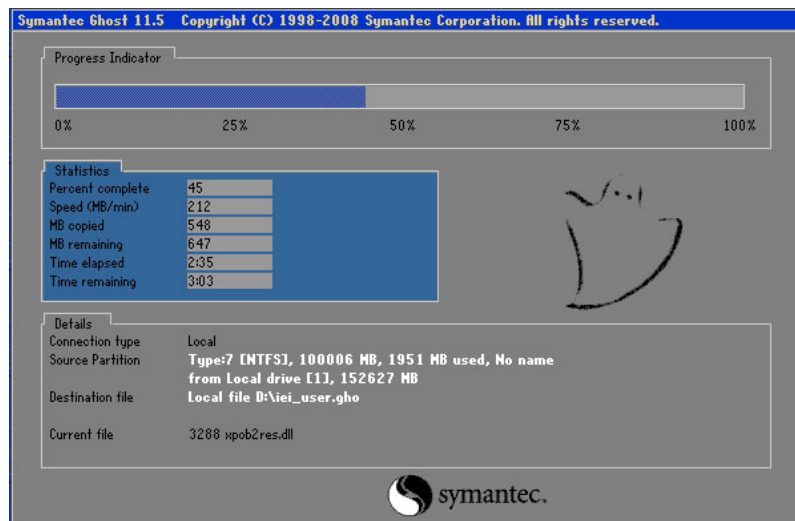

Figure B-36: Backup System

**Step 3:** The screen shown in **Figure B-37** appears when system backup is complete. Press any key to reboot the system.

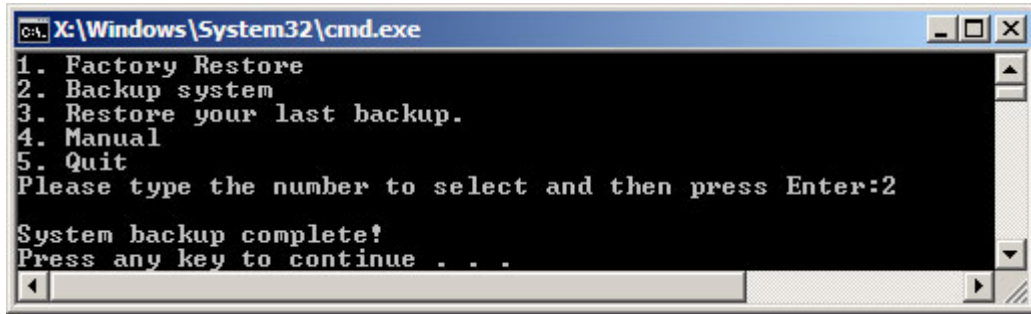

Figure B-37: System Backup Complete Window

### B.5.3 Restore Your Last Backup

To restore the last system backup, please follow the steps below.

**Step 1:** Type <3> and press <Enter> in the main menu.

**Step 2:** The Symantec Ghost window appears and starts to restore the last backup image (iei\_user.GHO).

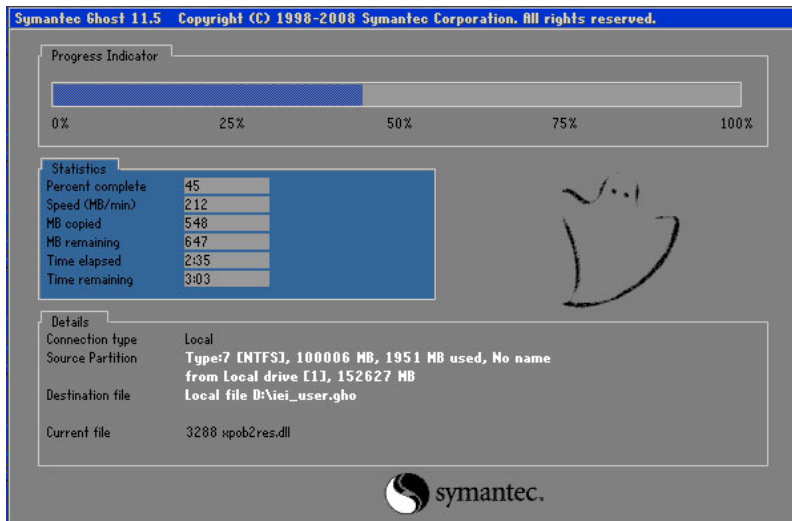
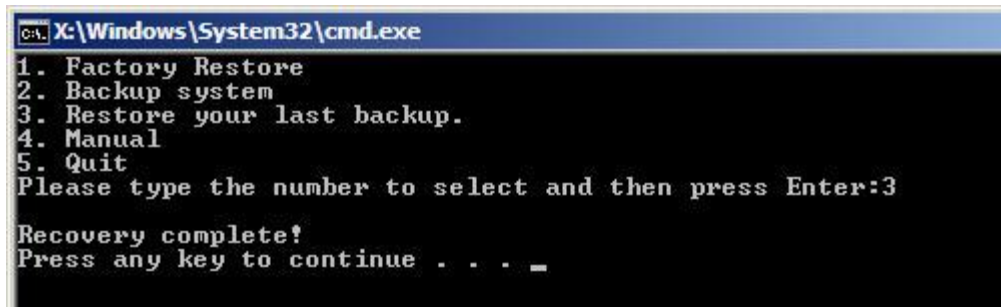

Figure B-38: Restore Backup

**Step 3:** The screen shown in **Figure B-39** appears when backup recovery is complete. Press any key to reboot the system.



## PPC-37xxA-N26 Panel PC



```
C:\X:\Windows\System32\cmd.exe
1. Factory Restore
2. Backup system
3. Restore your last backup.
4. Manual
5. Quit
Please type the number to select and then press Enter:3
Recovery complete!
Press any key to continue . . . _
```

Figure B-39: Restore System Backup Complete Window

### B.5.4 Manual

To restore the last system backup, please follow the steps below.

**Step 1:** Type <4> and press <Enter> in the main menu.

**Step 2:** The Symantec Ghost window appears. Use the Ghost program to backup or recover the system manually.

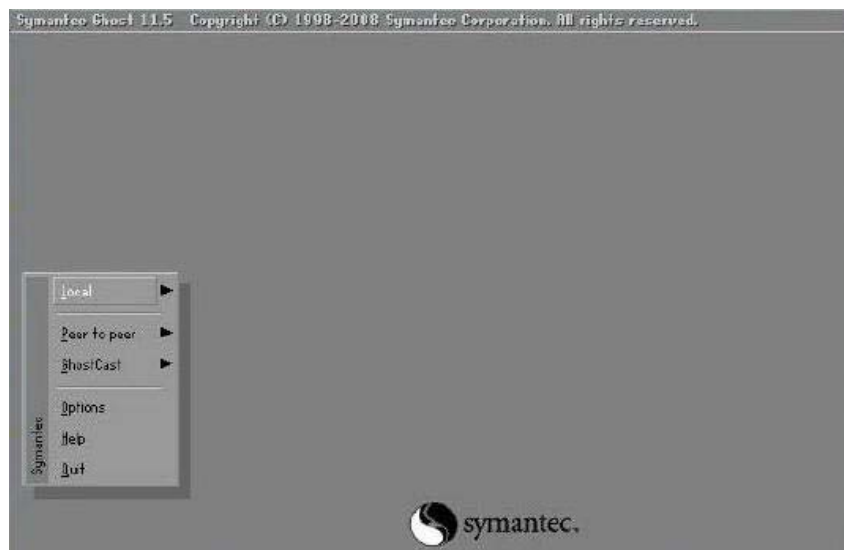
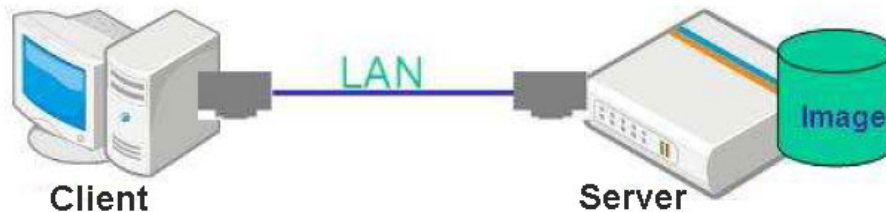

Figure B-40: Symantec Ghost Window

**Step 3:** When backup or recovery is completed, press any key to reboot the system.

## B.6 Restore Systems from a Linux Server through LAN

The One Key Recovery allows a client system to automatically restore to a factory default image saved in a Linux system (the server) through LAN connectivity after encountering a Blue Screen of Death (BSOD) or a hang for around 10 minutes. To be able to use this function, the client system and the Linux system MUST reside in the same domain.



### NOTE:

The supported client OS includes:

- Windows 2000
- Windows XP
- Windows Vista
- Windows 7
- Windows CE
- Windows XP Embedded

Prior to restoring client systems from a Linux server, a few setup procedures are required.

**Step 1:** Configure DHCP server settings

**Step 2:** Configure TFTP settings

**Step 3:** Configure One Key Recovery server settings

**Step 4:** Start DHCP, TFTP and HTTP

**Step 5:** Create a shared directory

**Step 6:** Setup a client system for auto recovery

The detailed descriptions are described in the following sections. In this document, two types of Linux OS are used as examples to explain the configuration process – CentOS 5.5 (Kernel 2.6.18) and Debian 5.0.7 (Kernel 2.6.26).

## PPC-37xxA-N26 Panel PC

## B.6.1 Configure DHCP Server Settings

**Step 1:** Install the DHCP

`#yum install dhcp` (CentOS, commands marked in red)

`#apt-get install dhcp3-server` (Debian, commands marked in blue)

**Step 2:** Confirm the operating system default settings: dhcpd.conf.

### CentOS

Use the following command to show the DHCP server sample location:

`#vi /etc/dhcpd.conf`

The DHCP server sample location is shown as below:

```
# DHCP Server Configuration file.
# see /usr/share/doc/dhcp*/dhcpd.conf.sample
```

Use the following command to copy the DHCP server sample to etc/dhcpd.conf:

`#cp /usr/share/doc/dhcp-3.0.5/dhcpd.conf.sample /etc/dhcpd.conf`

`#vi /etc/dhcpd.conf`

```
ddns-update-style interim;
ignore client-updates;

subnet 192.168.0.0 netmask 255.255.255.0 {
# --- default gateway
    option routers                192.168.0.2;
    option subnet-mask            255.255.255.0;

    option nis-domain             "domain.org";
    option domain-name            "domain.org";
    option domain-name-servers   192.168.0.1;
    next-server 192.168.0.6;
    filename "pxelinux.0";
    option time-offset            -18000; # Eastern Standard Time
    option ntp-servers            192.168.1.1;
    option bootfile-name          "pxelinux.0";
}
```

### Debian

`#vi /etc/dhcpd.conf`

Edit “/etc/dhcpd.conf” for your environment. For example, add

`next-server PXE server IP address;`

```
filename "pxelinux.0";
```

```
ddns-update-style interim;
ignore client-updates;

subnet 192.168.0.0 netmask 255.255.255.0 {
# --- default gateway
    option routers                192.168.0.2;
    option subnet-mask            255.255.255.0;

    option nis-domain             "domain.org";
    option domain-name            "domain.org";
    option domain-name-servers   192.168.0.1;
    next-server 192.168.0.6;
    filename "pxelinux.0";
    option time-offset            -18000; # Eastern Standard Time
    option ntp-servers            192.168.1.1;
}
```

## B.6.2 Configure TFTP Settings

**Step 1:** Install the tftp, httpd and syslinux.

```
#yum install tftp-server httpd syslinux (CentOS)
```

```
#apt-get install tftpd-hpa xinetd syslinux (Debian)
```

**Step 2:** Enable the TFTP server by editing the "/etc/xinetd.d/tftp" file and make it use the remap file. The "-vvv" is optional but it could definitely help on getting more information while running the remap file. For example:

### CentOS

```
#vi /etc/xinetd.d/tftp
```

Modify:

```
disable = no
```

```
server_args = -s /tftpboot -m /tftpboot/tftpd.remap -vvv_
```

```
socket_type      = dgram
protocol         = udp
wait            = yes
user            = root
server          = /usr/sbin/in.tftpd
server_args     = -s /tftpboot -m /tftpboot/tftpd.remap -vvv
disable         = no
per_source      = 11
cps             = 100 2
flags           = IPv4
```

## PPC-37xxA-N26 Panel PC

**Debian**

Replace the TFTP settings from “inetd” to “xinetd” and annotate the “inetd” by adding “#”.

`#vi /etc/inetd.conf`

Modify: `#tftp dgram udp wait root /usr/sbin/.....` (as shown below)

```
#:BOOT: TFTP service is provided primarily for booting. Most sites
# run this only on machines acting as "boot servers."
#tftp dgram udp wait root /usr/sbin/in.tftpd /usr/sbin/in.tftpd -s
/var/lib/tftpboot
```

`#vi /etc/xinetd.d/tftp`

```
socket_type      = dgram
protocol        = udp
wait            = yes
user            = root
server          = /usr/sbin/in.tftpd
server_args     = -s /tftpboot -n /tftpboot/tftpd.remap -vvv
disable         = no
per_source      = 11
cps             = 100 2
flags           = IPv4
```

**B.6.3 Configure One Key Recovery Server Settings**

**Step 1:** Copy the **Utility/RECOVERYR10.TAR.BZ2** package from the One Key Recovery CD to the system (server side).



**Step 2:** Extract the recovery package to /.

```
#cp RecoveryR10.tar.bz2 /
#cd /
#tar -xvjf RecoveryR10.tar.bz2
```

**Step 3:** Copy “pxelinux.0” from “syslinux” and install to “/tftpboot”.

```
#cp /usr/lib/syslinux/pxelinux.0 /tftpboot/
```

### B.6.4 Start the DHCP, TFTP and HTTP

Start the DHCP, TFTP and HTTP. For example:

#### CentOS

```
#service xinetd restart
```

```
#service httpd restart
```

```
#service dhcpd restart
```

#### Debian

```
#/etc/init.d/xinetd reload
```

```
#/etc/init.d/xinetd restart
```

```
#/etc/init.d/dhcp3-server restart
```

### B.6.5 Create Shared Directory

**Step 1:** Install the samba.

```
#yum install samba
```

**Step 2:** Create a shared directory for the factory default image.

```
#mkdir /share
```

```
#cd /share
```

```
#mkdir /image
```

```
#cp iei.gho /image
```



#### **WARNING:**

The file name of the factory default image must be **iei.gho**.

---

**Step 3:** Confirm the operating system default settings: smb.conf.

```
#vi /etc/samba/smb.conf
```

## PPC-37xxA-N26 Panel PC

Modify:

[image]

comment = One Key Recovery

path = /share/image

browseable = yes

writable = yes

public = yes

create mask = 0644

directory mask = 0755

**Step 4:** Edit "/etc/samba/smb.conf" for your environment. For example:

```
# "security = user" is always a good idea. This will require a Unix account
# in this server for every user accessing the server. See
# /usr/share/doc/samba-doc/htmldocs/Samba3-HOWTO/ServerType.html
# in the samba-doc package for details.
security = share
```

```
[image]
comment = One Key Recovery
path = /share/image
browseable = yes
writable = yes
public = yes
create mask = 0644
directory mask = 0755
```

**Step 5:** Modify the hostname

```
#vi /etc/hostname
```

Modify: RecoveryServer

```
RecoveryServer
```

## B.6.6 Setup a Client System for Auto Recovery

**Step 1:** Configure the following BIOS options of the client system.

Advanced → iEi Feature → Auto Recovery Function → **Enabled**

Advanced → iEi Feature → Recover from PXE → **Enabled**

Boot → Launch PXE OpROM → **Enabled**

**Step 2:** Continue to configure the **Boot Option Priorities** BIOS option of the client system:

Boot Option #1 → remain the default setting to boot from the original OS.

Boot Option #2 → select the boot from LAN option.

**Step 3:** Save changes and exit BIOS menu.

Exit → **Save Changes and Exit**

**Step 4:** Install the auto recovery utility into the system by double clicking the **Utility/AUTORECOVERY-SETUP.exe** in the One Key Recovery CD. This utility **MUST** be installed in the system, otherwise, the system will automatically restore from the factory default image every ten (10) minutes.



**Step 5:** Restart the client system from LAN. If the system encounters a Blue Screen of Death (BSoD) or a hang for around 10 minutes, it will automatically restore from the factory default image. The following screens will show when the system starts auto recovering.

```
Realtek PCIe GBE Family Controller Series v2.35 (06/14/10)
CLIENT MAC ADDR: 00 18 7D 13 E6 89  GUID: 00020003-0004-0005-0006-0007000000
DHCP . . /
```



## PPC-37xxA-N26 Panel PC

```

My IP address seems to be C0A80009 192.168.0.9
ip=192.168.0.9:192.168.0.8:192.168.0.2:255.255.255.0
TFTP prefix:
Trying to load: pxelinux.cfg/00020003-0004-0005-0006-000700080009
Trying to load: pxelinux.cfg/01-00-10-7d-13-e6-89
Trying to load: pxelinux.cfg/C0A80009
Trying to load: pxelinux.cfg/C0A8000
Trying to load: pxelinux.cfg/C0A800
Trying to load: pxelinux.cfg/C0A80
Trying to load: pxelinux.cfg/C0A8
Trying to load: pxelinux.cfg/C0A
Trying to load: pxelinux.cfg/C0
Trying to load: pxelinux.cfg/C
Trying to load: pxelinux.cfg/default
boot:
    
```

Windows is loading files...

IP: 192.168.0.8, File: \Boot\WinPE.wim

Symantec Ghost 11.5 Copyright (C) 1998-2008 Symantec Corporation. All rights reserved.

Progress Indicator

0% 25% 50% 75% 100%

Statistics

Percent complete	52
Speed (MB/min)	468
MB copied	632
MB remaining	563
Time elapsed	1:21
Time remaining	1:12

Details

Connection type	Local
Source Partition	Type:7 [NTFS], 100006 MB, 1951 MB used, No name from Local drive [80], 130129 MB
Destination file	Local file D:\iei.GHO
Current file	3891_e_869.nls

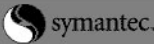
 symantec.



### NOTE:

A firewall or a SELinux is not in use in the whole setup process. If there is a firewall or a SELinux protecting the system, modify the configuration information to accommodate them.

## B.7 Other Information

### B.7.1 Using AHCI Mode or ALi M5283 / VIA VT6421A Controller

When the system uses AHCI mode or some specific SATA controllers such as ALi M5283 or VIA VT6421A, the SATA RAID/AHCI driver must be installed before using one key recovery. Please follow the steps below to install the SATA RAID/AHCI driver.

- Step 1:** Copy the SATA RAID/AHCI driver to a floppy disk and insert the floppy disk into a USB floppy disk drive. The SATA RAID/AHCI driver must be especially designed for the on-board SATA controller.
- Step 2:** Connect the USB floppy disk drive to the system.
- Step 3:** Insert the One Key Recovery CD into the system and boot the system from the CD.
- Step 4:** When launching the recovery tool, press <F6>.

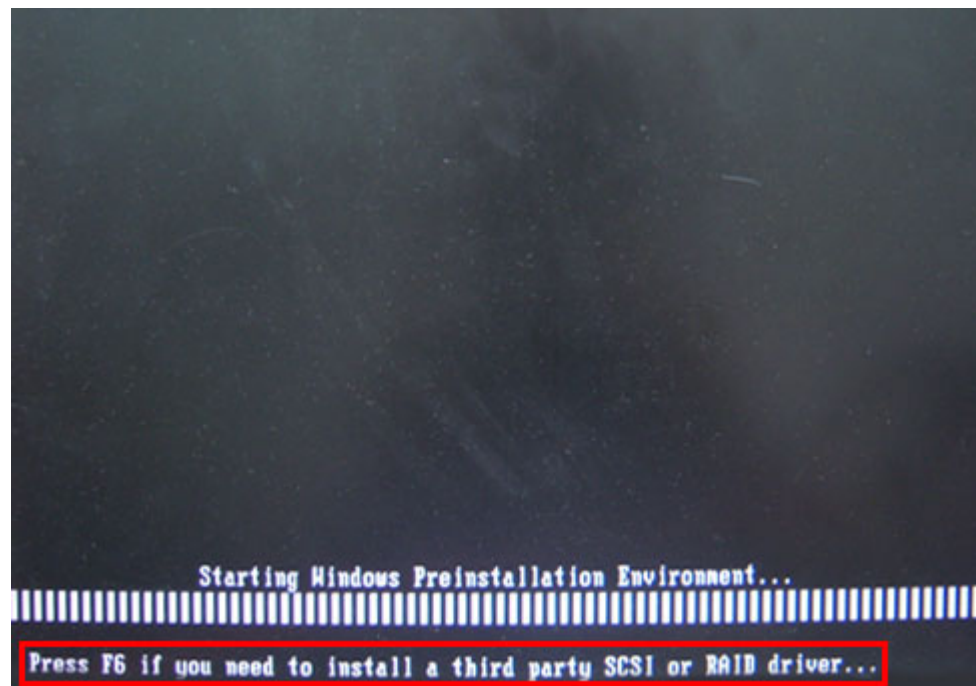

## PPC-37xxA-N26 Panel PC

**Step 5:** When the following window appears, press <S> to select “Specify Additional Device”.

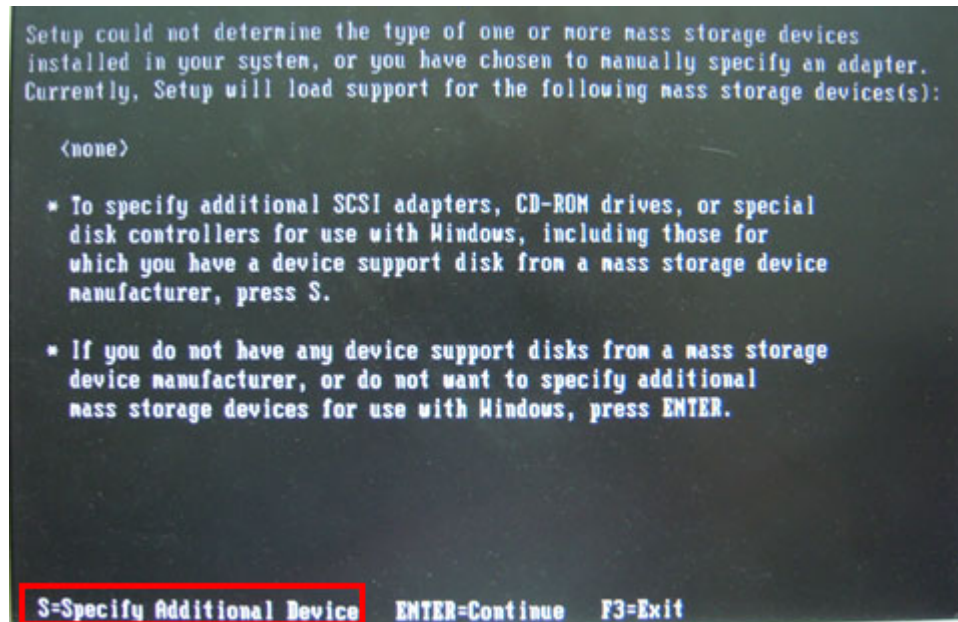

**Step 6:** In the following window, select a SATA controller mode used in the system. Then press <Enter>. The user can now start using the SATA HDD.

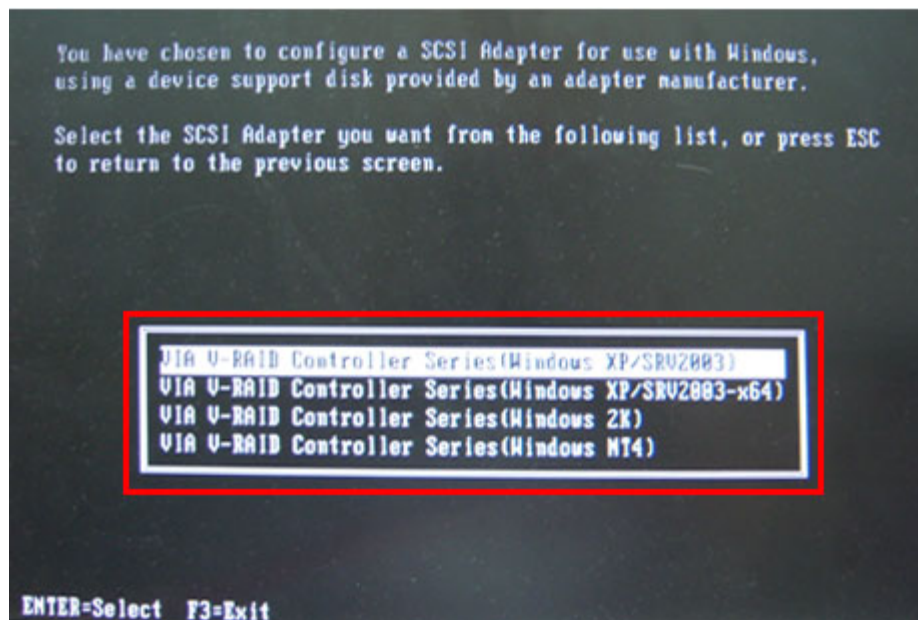

**Step 7:** After pressing <Enter>, the system will get into the recovery tool setup menu.

Continue to follow the setup procedure from **Step 4** in **Section B.2.2 Create Partitions** to finish the whole setup process.

## B.7.2 System Memory Requirement

To be able to access the recovery tool by pressing <F3> while booting up the system, please make sure to have enough system memory. The minimum memory requirement is listed below.

- Using Award BIOS: 128 MB system memory
- Using AMI BIOS: 512 MB system memory.

Appendix

C

# Safety Precautions

---

**WARNING:**

The precautions outlined in this chapter should be strictly followed. Failure to follow these precautions may result in permanent damage to the EP series.

## C.1 Safety Precautions

Please follow the safety precautions outlined in the sections that follow:

### C.1.1 General Safety Precautions

Please ensure the following safety precautions are adhered to at all times.

- **Follow the electrostatic precautions** outlined below whenever the EP series is opened.
- **Make sure the power is turned off and the power cord is disconnected** whenever the EP series is being installed, moved or modified.
- **Do not apply voltage levels that exceed the specified voltage range.** Doing so may cause fire and/or an electrical shock.
- **Electric shocks can occur** if the EP series chassis is opened when the EP series is running.
- **Do not drop or insert any objects** into the ventilation openings of the EP series.
- **If considerable amounts of dust, water, or fluids enter the EP series**, turn off the power supply immediately, unplug the power cord, and contact the EP series vendor.
- **DO NOT:**
  - Drop the EP series against a hard surface.
  - Strike or exert excessive force onto the LCD panel.
  - Touch any of the LCD panels with a sharp object
  - In a site where the ambient temperature exceeds the rated temperature

### C.1.2 Anti-static Precautions

---



#### WARNING:

Failure to take ESD precautions during the installation of the EP series may result in permanent damage to the EP series and severe injury to the user.

---

Electrostatic discharge (ESD) can cause serious damage to electronic components, including the EP series. Dry climates are especially susceptible to ESD. It is therefore critical that whenever the EP series is opened and any of the electrical components are handled, the following anti-static precautions are strictly adhered to.

- ***Wear an anti-static wristband:*** Wearing a simple anti-static wristband can help to prevent ESD from damaging any electrical component.
- ***Self-grounding:*** Before handling any electrical component, touch any grounded conducting material. During the time the electrical component is handled, frequently touch any conducting materials that are connected to the ground.
- ***Use an anti-static pad:*** When configuring or working with an electrical component, place it on an anti-static pad. This reduces the possibility of ESD damage.
- ***Only handle the edges of the electrical component:*** When handling the electrical component, hold the electrical component by its edges.

### C.1.3 Product Disposal

---



#### CAUTION:

Risk of explosion if battery is replaced by an incorrect type. Only certified engineers should replace the on-board battery.

Dispose of used batteries according to instructions and local regulations.

---

- Outside the European Union - If you wish to dispose of used electrical and electronic products outside the European Union, please contact your local authority so as to comply with the correct disposal method.
- Within the European Union:

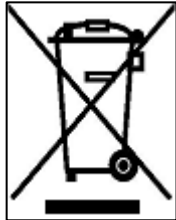

EU-wide legislation, as implemented in each Member State, requires that waste electrical and electronic products carrying the mark (left) must be disposed of separately from normal household waste. This includes monitors and electrical accessories, such as signal cables or power cords. When you need to dispose of your display products, please follow the guidance of your local authority, or ask the shop where you purchased the product. The mark on electrical and electronic products only applies to the current European Union Member States.

Please follow the national guidelines for electrical and electronic product disposal.

## **C.2 Maintenance and Cleaning Precautions**

When maintaining or cleaning the EP series, please follow the guidelines below.

### **C.2.1 Maintenance and Cleaning**

Prior to cleaning any part or component of the EP series, please read the details below.

- Except for the LCD panel, never spray or squirt liquids directly onto any other components. To clean the LCD panel, gently wipe it with a piece of soft dry cloth or a slightly moistened cloth.
- The interior of the EP series does not require cleaning. Keep fluids away from the EP series interior.
- Be cautious of all small removable components when vacuuming the EP series.
- Turn the EP series off before cleaning the EP series.
- Never drop any objects or liquids through the openings of the EP series.
- Be cautious of any possible allergic reactions to solvents or chemicals used when cleaning the EP series.
- Avoid eating, drinking and smoking within vicinity of the EP series.



### C.2.2 Cleaning Tools

Some components in the EP series may only be cleaned using a product specifically designed for the purpose. In such case, the product will be explicitly mentioned in the cleaning tips. Below is a list of items to use when cleaning the EP series.

- **Cloth** – Although paper towels or tissues can be used, a soft, clean piece of cloth is recommended when cleaning the EP series.
- **Water or rubbing alcohol** – A cloth moistened with water or rubbing alcohol can be used to clean the EP series.
- **Using solvents** – The use of solvents is not recommended when cleaning the EP series as they may damage the plastic parts.
- **Vacuum cleaner** – Using a vacuum specifically designed for computers is one of the best methods of cleaning the EP series. Dust and dirt can restrict the airflow in the EP series and cause its circuitry to corrode.
- **Cotton swabs** - Cotton swaps moistened with rubbing alcohol or water are excellent tools for wiping hard to reach areas.
- **Foam swabs** - Whenever possible, it is best to use lint free swabs such as foam swabs for cleaning.

Appendix

**D**

# Watchdog Timer

---

**NOTE:**

The following discussion applies to DOS environment. IEI support is contacted or the IEI website visited for specific drivers for more sophisticated operating systems, e.g., Windows and Linux.

The Watchdog Timer is provided to ensure that standalone systems can always recover from catastrophic conditions that cause the CPU to crash. This condition may have occurred by external EMI or a software bug. When the CPU stops working correctly, Watchdog Timer either performs a hardware reset (cold boot) or a Non-Maskable Interrupt (NMI) to bring the system back to a known state.

A BIOS function call (INT 15H) is used to control the Watchdog Timer:

**INT 15H:**

<b>AH – 6FH Sub-function:</b>	
AL – 2:	Sets the Watchdog Timer's period.
BL:	Time-out value (Its unit-second is dependent on the item "Watchdog Timer unit select" in CMOS setup).

**Table D-1: AH-6FH Sub-function**

Call sub-function 2 to set the time-out period of Watchdog Timer first. If the time-out value is not zero, the Watchdog Timer starts counting down. While the timer value reaches zero, the system resets. To ensure that this reset condition does not occur, calling sub-function 2 must periodically refresh the Watchdog Timer. However, the Watchdog timer is disabled if the time-out value is set to zero.

A tolerance of at least 10% must be maintained to avoid unknown routines within the operating system (DOS), such as disk I/O that can be very time-consuming.

**NOTE:**

When exiting a program it is necessary to disable the Watchdog Timer, otherwise the system resets.

**Example program:**

```
; INITIAL TIMER PERIOD COUNTER
;
W_LOOP:

    MOV    AX, 6F02H    ;setting the time-out value
    MOV    BX, 05      ;time-out value is 5 seconds
    INT    15H

;
; ADD THE APPLICATION PROGRAM HERE
;

    CMP    EXIT_AP, 1    ;is the application over?
    JNE    W_LOOP      ;No, restart the application

    MOV    AX, 6F02H    ;disable Watchdog Timer
    MOV    BX, 0        ;
    INT    15H

;
; EXIT ;
```

Appendix

**E**

# Hazardous Materials Disclosure

---

## **E.1 Hazardous Material Disclosure Table for IPB Products Certified as RoHS Compliant Under 2002/95/EC Without Mercury**

The details provided in this appendix are to ensure that the product is compliant with the Peoples Republic of China (China) RoHS standards. The table below acknowledges the presences of small quantities of certain materials in the product, and is applicable to China RoHS only.

A label will be placed on each product to indicate the estimated “Environmentally Friendly Use Period” (EFUP). This is an estimate of the number of years that these substances would “not leak out or undergo abrupt change.” This product may contain replaceable sub-assemblies/components which have a shorter EFUP such as batteries and lamps. These components will be separately marked.

Please refer to the table on the next page.

## PPC-37xxA-N26 Panel PC

Part Name	Toxic or Hazardous Substances and Elements					
	Lead (Pb)	Mercury (Hg)	Cadmium (Cd)	Hexavalent Chromium (CR(VI))	Polybrominated Biphenyls (PBB)	Polybrominated Diphenyl Ethers (PBDE)
Housing	O	O	O	O	O	O
Display	O	O	O	O	O	O
Printed Circuit Board	O	O	O	O	O	O
Metal Fasteners	O	O	O	O	O	O
Cable Assembly	O	O	O	O	O	O
Fan Assembly	O	O	O	O	O	O
Power Supply Assemblies	O	O	O	O	O	O
Battery	O	O	O	O	O	O

O: This toxic or hazardous substance is contained in all of the homogeneous materials for the part is below the limit requirement in SJ/T11363-2006

X: This toxic or hazardous substance is contained in at least one of the homogeneous materials for this part is above the limit requirement in SJ/T11363-2006

此附件旨在确保本产品符合中国 RoHS 标准。以下表格标示此产品中某有毒物质的含量符合中国 RoHS 标准规定的限量要求。

本产品上会附有“环境友好使用期限”的标签，此期限是估算这些物质“不会有泄漏或突变”的年限。本产品可能包含有较短的环境友好使用期限的可替换元件，像是电池或灯管，这些元件将会单独标示出来。

部件名称	有毒有害物质或元素					
	铅 (Pb)	汞 (Hg)	镉 (Cd)	六价铬 (CR(VI))	多溴联苯 (PBB)	多溴二苯醚 (PBDE)
壳体	O	O	O	O	O	O
显示	O	O	O	O	O	O
印刷电路板	O	O	O	O	O	O
金属螺帽	O	O	O	O	O	O
电缆组装	O	O	O	O	O	O
风扇组装	O	O	O	O	O	O
电力供应组装	O	O	O	O	O	O
电池	O	O	O	O	O	O

O: 表示该有毒有害物质在该部件所有物质材料中的含量均在 SJ/T11363-2006 标准规定的限量要求以下。  
X: 表示该有毒有害物质至少在该部件的某一均质材料中的含量超出 SJ/T11363-2006 标准规定的限量要求。