



IEI Technology Corp .



MODEL:  
**AFL-xxA-N270**

**Fanless All-in-one Panel PC with 1.6 GHz Intel® Atom™ Processor  
TFT LCD, Wireless LAN, Touch Screen,  
RS-232/422/485 and IP 64 Protection**

# User Manual

Rev. 2.30 - 6 February, 2013



# Revision

Date	Version	Changes
6 February, 2013	2.30	Updated for R23 version: Updated audio codec spec Added Section 5: Interface Connectors Added Appendix D: ALC892 Digital Microphone Configuration
22 February, 2012	2.20	Updated for R22 version (optional Bluetooth support)
14 February, 2012	2.11	Modified Section 2.7.3: Power Connector
13 July, 2011	2.10	Updated for R21 version
3 September, 2010	2.00	Updated for R20 version
17 March, 2010	1.04	Added standard compliance statement
12 November, 2009	1.03	Added wall mount screw warning in page 45
5 October, 2009	1.02	Added back cover screw torque warning
19 March, 2009	1.01	Changed model name
25 February, 2009	1.00	Initial release

# Copyright

---

## **COPYRIGHT NOTICE**

The information in this document is subject to change without prior notice in order to improve reliability, design and function and does not represent a commitment on the part of the manufacturer.

In no event will the manufacturer be liable for direct, indirect, special, incidental, or consequential damages arising out of the use or inability to use the product or documentation, even if advised of the possibility of such damages.

This document contains proprietary information protected by copyright. All rights are reserved. No part of this manual may be reproduced by any mechanical, electronic, or other means in any form without prior written permission of the manufacturer.

## **TRADEMARKS**

All registered trademarks and product names mentioned herein are used for identification purposes only and may be trademarks and/or registered trademarks of their respective owners.

**WARNING:**

This equipment has been tested and found to comply with the limits for a Class A and Class B digital device, pursuant to part 15 of the FCC Rules. These limits are designed to provide reasonable protection against harmful interference in a residential installation.

This equipment generates, uses and can radiate radio frequency energy and, if not installed and used in accordance with the instructions, may cause harmful interference to radio communications.

However, there is no guarantee that interference will not occur in a particular installation. If this equipment does cause harmful interference to radio or television reception, which can be determined by turning the equipment off and on, the user is encouraged to try to correct the interference by one or more of the following measures:

- Reorient or relocate the receiving antenna.
- Increase the separation between the equipment and receiver.
- Connect the equipment into an outlet on a circuit different from that to which the receiver is connected.
- Consult the dealer or an experienced radio/TV technician for help.

You are cautioned that any change or modifications to the equipment not expressly approve by the party responsible for compliance could void your authority to operate such equipment.

# Packing List



## NOTE:

If any of the components listed in the checklist below are missing, please do not proceed with the installation. Contact the IEI reseller or vendor you purchased the AFOLUX AFL-xxA-N270 series from or contact an IEI sales representative directly. To contact an IEI sales representative, please send an email to [sales@iei.com.tw](mailto:sales@iei.com.tw).

The items listed below should all be included in the AFOLUX AFL-xxA-N270 series package.

- 1 x AFOLUX AFL-xxA-N270 series flat panel PC
- 1 x Power adapter
- 1 x Power cord
- 1 x Screw kit
- 1 x User manual CD and driver CD
- 1 x Touch pen

Images of the above items are shown in **Chapter 3** on **page 24**.

# Table of Contents

<b>1 INTRODUCTION.....</b>	<b>1</b>
1.1 OVERVIEW.....	2
1.1.1 Features and Model Variations.....	2
1.1.2 Applications .....	3
1.2 EXTERNAL OVERVIEW.....	3
1.2.1 General Description.....	3
1.2.2 Front Panel .....	4
1.2.3 Rear Panel .....	4
1.2.4 I/O Interface Panel .....	5
1.2.5 Top Panel and Side Panels.....	6
1.3 INTERNAL OVERVIEW.....	6
1.4 SYSTEM SPECIFICATIONS.....	7
<b>2 DETAILED SPECIFICATIONS .....</b>	<b>9</b>
2.1 DIMENSIONS.....	10
2.1.1 AFL-07A-N270 Dimensions.....	10
2.1.2 AFL-08AH-N270 Dimensions.....	11
2.1.3 AFL-10A-N270 Dimensions.....	12
2.1.4 AFL-12A-N270 Dimensions.....	13
2.2 INTEL® ATOM™ PROCESSOR.....	14
2.3 MOTHERBOARD COMPONENTS.....	14
2.3.1 Memory Support.....	14
2.3.1.1 Installed Memory .....	14
2.3.1.2 Additional Memory.....	15
2.3.2 Storage Capacity.....	15
2.4 EXTERNAL PERIPHERAL INTERFACE CONNECTORS.....	15
2.4.1 Serial Port Connectors .....	15
2.4.2 LAN Connectivity.....	16
2.4.3 External USB Connectors.....	17
2.5 AFOLUX AFL-xxA-N270 FRONT SIDE.....	17
2.5.1 Monitor .....	17

## AFL-xxA-N270 Series Panel PC

2.5.2 <i>Touch-Screen Module</i> .....	18
2.6 AUDIO .....	18
2.6.1 <i>HD Audio Codec Controller</i> .....	18
2.6.2 <i>Stereo Speakers</i> .....	19
2.7 SYSTEM POWER .....	19
2.7.1 <i>Power Mode</i> .....	19
2.7.1.1 <i>ATX Power Mode (Default)</i> .....	19
2.7.1.2 <i>AT Power Mode</i> .....	20
2.7.2 <i>Power Adapter</i> .....	20
2.7.3 <i>Power Connector</i> .....	20
2.8 WIRELESS CONNECTIONS.....	21
2.8.1 <i>Wireless Ethernet</i> .....	21
<b>3 UNPACKING .....</b>	<b>22</b>
3.1 UNPACKING.....	23
3.1.1 <i>Packing List</i> .....	24
<b>4 INSTALLATION .....</b>	<b>26</b>
4.1 ANTI-STATIC PRECAUTIONS .....	27
4.2 INSTALLATION PRECAUTIONS .....	27
4.3 PREINSTALLED COMPONENTS.....	28
4.4 INSTALLATION AND CONFIGURATION STEPS .....	28
4.5 REMOVING THE BACK COVER .....	29
4.6 CF CARD INSTALLATION .....	30
4.7 HDD INSTALLATION (AF-12A-N270 ONLY).....	31
4.8 AT/ATX MODE SELECTION.....	32
4.8.1 <i>AT Power Mode</i> .....	32
4.8.2 <i>ATX Power Mode</i> .....	33
4.9 JUMPER SETTINGS .....	33
4.9.1 <i>Access the Jumpers</i> .....	34
4.9.2 <i>Preconfigured Jumpers</i> .....	34
4.9.3 <i>Clear CMOS Jumper</i> .....	35
4.9.4 <i>COM Port Pin 9 Select</i> .....	36
4.9.4.1 <i>COM3 RS-422 and RS-485 Pinouts</i> .....	37
4.9.5 <i>COM3 RX Function Select Jumper</i> .....	37

4.9.6 COM3 TX Function Select Jumper .....	38
4.9.7 COM3 RS-232/422/485 Serial Port Select Jumper .....	39
4.9.8 CompactFlash® Setup .....	40
<b>4.10 MOUNTING THE SYSTEM .....</b>	<b>41</b>
4.10.1 Wall Mounting .....	42
4.10.2 Panel Mounting .....	45
4.10.3 Arm Mounting .....	47
4.10.4 Cabinet and Rack Installation .....	49
<b>4.11 BOTTOM PANEL CONNECTORS .....</b>	<b>51</b>
4.11.1 LAN Connection .....	51
4.11.2 Serial Device Connection .....	52
4.11.3 USB Device Connection .....	54
<b>5 SYSTEM MAINTENANCE .....</b>	<b>55</b>
5.1 SYSTEM MAINTENANCE INTRODUCTION .....	56
5.2 ANTI-STATIC PRECAUTIONS .....	56
5.3 TURN OFF THE POWER .....	57
5.4 OPENING THE SYSTEM .....	57
5.4.1 Removing the Back Cover .....	57
5.4.2 AFL-xxA-N270 Series Internal Aluminum Cover Removal .....	58
5.5 REPLACING COMPONENTS .....	59
5.5.1 Memory Module Replacement .....	59
5.5.2 CF Card Replacement .....	60
5.6 REINSTALLING THE COVERS .....	61
<b>6 AMI BIOS SETUP .....</b>	<b>62</b>
6.1 INTRODUCTION .....	64
6.1.1 Starting Setup .....	64
6.1.2 Using Setup .....	64
6.1.3 Getting Help .....	65
6.1.4 Unable to Reboot After Configuration Changes .....	65
6.1.5 BIOS Menu Bar .....	65
6.2 MAIN .....	66
6.3 ADVANCED .....	67
6.3.1 CPU Configuration .....	68



## AFL-xxA-N270 Series Panel PC

6.3.2 IDE Configuration .....	69
6.3.2.1 IDE Master, IDE Slave .....	70
6.3.3 Super IO Configuration .....	74
6.3.4 Hardware Health Configuration.....	76
6.3.5 Power Configuration.....	76
6.3.5.1 ACPI Configuration .....	77
6.3.5.2 APM Configuration.....	78
6.3.6 Remote Access Configuration .....	80
6.3.7 USB Configuration.....	82
6.4 PCI/PNP.....	84
6.5 BOOT.....	87
6.5.1 Boot Settings Configuration.....	87
6.6 SECURITY.....	90
6.7 CHIPSET .....	91
6.7.1 North Bridge Configuration.....	92
6.7.2 South Bridge Configuration.....	94
6.8 EXIT .....	95
<b>7 SOFTWARE DRIVERS .....</b>	<b>97</b>
7.1 AVAILABLE SOFTWARE DRIVERS .....	98
7.2 STARTING THE DRIVER PROGRAM .....	98
7.3 CHIPSET DRIVER INSTALLATION.....	99
7.4 VGA DRIVER INSTALLATION.....	104
7.5 LAN DRIVER INSTALLATION .....	109
7.6 TOUCH SCREEN DRIVER.....	111
7.7 AUDIO DRIVER INSTALLATION .....	114
7.8 WIRELESS DRIVER .....	117
7.9 BLUETOOTH DRIVER (OPTIONAL) .....	120
<b>8 INTERFACE CONNECTORS .....</b>	<b>125</b>
8.1 PERIPHERAL INTERFACE CONNECTORS.....	126
8.2 INTERNAL PERIPHERAL CONNECTORS .....	127
8.2.1 Audio Line-out Connector (CN8).....	128
8.2.2 Audio Speaker-out Connector (CN3).....	129
8.2.3 Audio MIC-in Connector (MIC1) .....	129

8.2.4 Audio DMIC-in Connector (DMIC1).....	129
8.2.5 Battery Connector (BT1).....	129
8.2.6 CompactFlash® Type II Slot (CF1).....	130
8.2.7 CRT Connector (CN4) .....	131
8.2.8 DIO Connector (DIO1).....	131
8.2.9 HDD Power Connector (CN1).....	131
8.2.10 LED Indicator and Button Connector (JP2).....	132
8.2.11 LVDS Backlight Connector (INVERTER1).....	132
8.2.12 MCU Connector (JP7).....	132
8.2.13 MCU Connector (TS2).....	133
8.2.14 PCIe Mini Slot (CN2).....	133
8.2.15 RFID Connector (JP8).....	134
8.2.16 SATA Connector (SATA1).....	134
8.2.17 Touch Panel Connector (TS1).....	135
8.2.18 TTL Panel Connector (CN7).....	135
8.2.19 JUSB Connector (JUSB1).....	136
8.2.20 USB Connector (USB1) .....	136
8.2.21 USB Connector (USB2) .....	136
8.2.22 USB Connector (USB4) .....	137
8.3 EXTERNAL INTERFACE PANEL CONNECTORS .....	137
8.3.1 Ethernet Connector (LAN1, LAN2).....	138
8.3.2 Power Connector (CN5) .....	138
8.3.3 RS-232 Serial Ports (COM1).....	138
8.3.4 RS-422/485 Serial Port (COM3) .....	139
8.3.5 SATA Connector (SATA2).....	139
8.3.6 USB 2.0 Connectors (USB3).....	140
8.4 PRECONFIGURED JUMPER SETTINGS.....	140
8.4.1 Backlight Voltage Selection Jumper (J_BLI).....	140
8.4.2 Inverter Power Selection Jumper (JP12).....	141
8.4.3 LVDS Panel Voltage Selection Jumper (J_VLVDS1).....	141
8.4.4 MCU LCD Type Selection Jumper (JP14).....	141
8.4.5 MCU PWM Power Selection Jumper (JP13).....	141
8.4.6 Panel Type Selection Jumper (J_LCD_TYPE1).....	141
8.4.7 Touchscreen Selection Jumper (J1).....	142
8.4.8 USB2 and USB4 Power Selection Jumper (JP15).....	142

## AFL-xxA-N270 Series Panel PC

<b>A SYSTEM SPECIFICATIONS.....</b>	<b>143</b>
A.1 MOTHERBOARD SPECIFICATIONS.....	144
A.2 PROCESSOR SPECIFICATIONS .....	144
A.3 SCREEN SPECIFICATIONS .....	145
A.4 TOUCH SCREEN SPECIFICATIONS .....	146
<b>B SAFETY PRECAUTIONS .....</b>	<b>147</b>
B.1 SAFETY PRECAUTIONS.....	148
<i>B.1.1 General Safety Precautions .....</i>	<i>148</i>
<i>B.1.2 Anti-static Precautions .....</i>	<i>149</i>
<i>B.1.3 Product Disposal .....</i>	<i>150</i>
B.2 MAINTENANCE AND CLEANING PRECAUTIONS .....	150
<i>B.2.1 Maintenance and Cleaning.....</i>	<i>150</i>
<i>B.2.2 Cleaning Tools.....</i>	<i>151</i>
<b>C BIOS CONFIGURATION OPTIONS.....</b>	<b>153</b>
C.1 BIOS CONFIGURATION OPTIONS .....	154
<b>D ALC892 DIGITAL MICROPHONE CONFIGURATION.....</b>	<b>156</b>
D.1 ALC892 DIGITAL MICROPHONE CONFIGURATION.....	157
<b>E WATCHDOG TIMER.....</b>	<b>160</b>
<b>F HAZARDOUS MATERIALS DISCLOSURE.....</b>	<b>163</b>
F.1 HAZARDOUS MATERIAL DISCLOSURE TABLE FOR IPB PRODUCTS CERTIFIED AS ROHS COMPLIANT UNDER 2002/95/EC WITHOUT MERCURY .....	164

# List of Figures

Figure 1-1: AFOLUX AFL-xxA-N270 Flat Panel PC.....	2
Figure 1-2: AFL-xxA-N270 Front View .....	4
Figure 1-3: AFL-xxA-N270 Rear View .....	4
Figure 1-4: AFL-xxA-N270 I/O Interface Connector Panel .....	5
Figure 1-5: AFL-xxA-N270 Top View .....	6
Figure 1-6: AFL-10A-N270 Side View .....	6
Figure 2-1: AFL-07A-N270 Dimensions (mm) .....	10
Figure 2-2: AFL-08AH-N270 Dimensions (mm).....	11
Figure 2-3: AFL-10A-N270 Top and Bottom Panel Dimensions (mm).....	12
Figure 2-4: AFL-12A-N270 Top and Bottom Panel Dimensions (mm).....	13
Figure 2-5: Preinstalled DDR2 SO-DIMM .....	15
Figure 2-6: COM Ports.....	16
Figure 2-7: RJ-45 Ethernet Connectors.....	16
Figure 2-8: External USB Ports .....	17
Figure 2-9: LCD Screen .....	18
Figure 2-10: Audio Jack.....	18
Figure 2-11: Stereo Speakers .....	19
Figure 2-12: Power Connector .....	20
Figure 2-13: PIFA Antenna and Wireless Module.....	21
Figure 4-1: Back Cover Retention Screws .....	29
Figure 4-2: AFL-xxA-N270 Plastic Back Cover Removal .....	29
Figure 4-3: CF Card Location .....	30
Figure 4-4: AFL-08AH-N270 Plastic Back Cover Replacement.....	30
Figure 4-5: AF-12A-N270 HDD Retention Screws.....	31
Figure 4-6: AT/ATX Switch Location.....	32
Figure 4-7: Clear CMOS Jumper .....	36
Figure 4-8: COM1 and COM3 Pin 9 Setting Jumper Locations.....	37
Figure 4-9: COM3 RX Function Select Jumper Location.....	38
Figure 4-10: COM3 TX Function Select Jumper Pinout Locations.....	39
Figure 4-11: COM3 RS-232/422/485 Serial Port Select Jumper Location.....	40
Figure 4-12: CompactFlash® Setup Jumper Location .....	41

## AFL-xxA-N270 Series Panel PC

Figure 4-13: Wall-mounting Bracket .....	42
Figure 4-14: Chassis Support Screws .....	44
Figure 4-15: Secure the Panel PC .....	44
Figure 4-16: AFL-07A-N270 Panel Opening .....	45
Figure 4-17: AFL-08AH-N270 Panel Opening.....	45
Figure 4-18: AFL-10A-N270 Panel Opening .....	46
Figure 4-19: AFL-12A-N270 Panel Opening .....	46
Figure 4-20: Tighten the Panel Mounting Clamp Screws .....	47
Figure 4-21: AFL-07A-N270/AFL-08AH-N270 Arm Mounting Retention Screw Holes .....	48
Figure 4-22: AFL-10A-N270/AFL-12A-N270 Arm Mounting Retention Screw Holes .....	48
Figure 4-23: The Rack/Cabinet Bracket.....	49
Figure 4-24: Secure the Rack/Cabinet Bracket (AFL-10A-N270/AFL-12A-N270).....	50
Figure 4-25: Install into a Rack/Cabinet .....	51
Figure 4-26: LAN Connection .....	52
Figure 4-27: Serial Device Connector.....	53
Figure 4-28: USB Device Connection .....	54
Figure 5-1: Back Cover Retention Screws .....	58
Figure 5-2: AFL-xxA-N270 Plastic Back Cover Removal .....	58
Figure 5-3: AFL-10A-N270 Aluminum Back Cover Retention Screws.....	59
Figure 5-4: AFL-10A-N270 SO-DIMM Socket Location.....	59
Figure 5-5: DDR SO-DIMM Module Installation.....	60
Figure 7-1: Drivers .....	99
Figure 7-2: Chipset Driver Screen.....	100
Figure 7-3: Chipset Driver Welcome Screen.....	100
Figure 7-4: Chipset Driver License Agreement .....	101
Figure 7-5: Chipset Driver Read Me File .....	102
Figure 7-6: Chipset Driver Setup Operations .....	103
Figure 7-7: Chipset Driver Installation Finish Screen.....	104
Figure 7-8: VGA Driver Read Me File.....	105
Figure 7-9: VGA Driver Setup Files Extracted .....	105
Figure 7-10: VGA Driver Welcome Screen .....	106
Figure 7-11: VGA Driver License Agreement.....	107
Figure 7-12: VGA Driver Read Me File.....	107
Figure 7-13: VGA Driver Setup Operations .....	108
Figure 7-14: VGA Driver Installation Finish Screen .....	108

Figure 7-15: LAN Driver Welcome Screen .....	109
Figure 7-16: LAN Driver Welcome Screen .....	110
Figure 7-17: LAN Driver Installation .....	110
Figure 7-18: LAN Driver Installation Complete.....	111
Figure 7-19: Welcome Screen .....	112
Figure 7-20: License Agreement .....	112
Figure 7-21: Ready to Install the Program .....	113
Figure 7-22: Installing PenMount DMC9000.....	113
Figure 7-23: Reboot the Computer .....	114
Figure 7-24: The InstallShield Wizard Starts .....	114
Figure 7-25: Preparing Setup Screen .....	115
Figure 7-26: InstallShield Wizard Welcome Screen .....	115
Figure 7-27: Audio Driver Software Configuration.....	116
Figure 7-28: Restart the Computer .....	116
Figure 7-29: Wireless Driver Folders.....	117
Figure 7-30: Wireless Driver License Agreement.....	118
Figure 7-31: Wireless Driver Configuration Tool Options .....	118
Figure 7-32: Wireless Mode Select Window .....	119
Figure 7-33: Wireless Driver Installation .....	120
Figure 7-34: Welcome Screen .....	121
Figure 7-35: License Agreement .....	121
Figure 7-36: Bluetooth Driver Setup Options .....	122
Figure 7-37: Bluetooth Driver Destination Folder .....	122
Figure 7-38: Ready to Install the Program .....	123
Figure 7-39: Installing BlueSoleil .....	123
Figure 7-40: Bluetooth Driver Complete Installation Screen .....	124
Figure 7-41: Reboot the Computer .....	124
Figure 8-1: Main Board Layout Diagram (Front Side).....	126
Figure 8-2: Main Board Layout Diagram (Solder Side).....	127
Figure D-1: Realtek HD Audio Manager Icon [Task Bar] .....	157
Figure D-2: Realtek HD Audio Manager.....	157
Figure D-3: Mixer Screen .....	158
Figure D-4: Mixer ToolBox Screen.....	158
Figure D-5: Enabling the Digital Microphone Function .....	159

# List of Tables

<b>Table 1-1: Model Variations .....</b>	<b>3</b>
<b>Table 1-2: AFL-xxA-N270 Series System Specifications .....</b>	<b>8</b>
<b>Table 4-1: Jumpers .....</b>	<b>34</b>
<b>Table 4-2: Preconfigured Jumpers .....</b>	<b>35</b>
<b>Table 4-3: Clear CMOS Jumper Settings.....</b>	<b>35</b>
<b>Table 4-4: COM1 Pin 9 Setting Jumper Settings .....</b>	<b>36</b>
<b>Table 4-5: COM3 Pin 9 Setting Jumper Settings .....</b>	<b>36</b>
<b>Table 4-6: RS-422 Pinouts .....</b>	<b>37</b>
<b>Table 4-7: RS-485 Pinouts .....</b>	<b>37</b>
<b>Table 4-8: COM3 RX Function Select Jumper Settings .....</b>	<b>38</b>
<b>Table 4-9: COM3 TX Function Select Jumper Settings.....</b>	<b>39</b>
<b>Table 4-10: COM3 RS-232/422/485 Serial Port Select Jumper Settings .....</b>	<b>40</b>
<b>Table 4-11: CompactFlash® Setup Jumper Settings.....</b>	<b>41</b>
<b>Table 6-1: BIOS Navigation Keys .....</b>	<b>65</b>
<b>Table 8-1: Peripheral Interface Connectors .....</b>	<b>128</b>
<b>Table 8-2: Audio Line-out Connector (CN8) Pinouts .....</b>	<b>128</b>
<b>Table 8-3: Audio Speaker-out Connector (CN3) Pinouts.....</b>	<b>129</b>
<b>Table 8-4: Audio MIC-in Connector (MIC1) Pinouts .....</b>	<b>129</b>
<b>Table 8-5: Audio DMIC-in Connector (DMIC1) Pinouts.....</b>	<b>129</b>
<b>Table 8-6: Battery Connector (BT1) Pinouts.....</b>	<b>129</b>
<b>Table 8-7: CompactFlash® Slot (CF1) Pinouts.....</b>	<b>130</b>
<b>Table 8-8: CRT Connector (CN4) Pinouts .....</b>	<b>131</b>
<b>Table 8-9: DIO Connector (DIO1) Pinouts .....</b>	<b>131</b>
<b>Table 8-10: HDD Power Connector (CN1) Pinouts .....</b>	<b>131</b>
<b>Table 8-11: LED Indicator and Button Connector (JP2) Pinouts .....</b>	<b>132</b>
<b>Table 8-12: LVDS Backlight Connector (INVERTER1) Pinouts.....</b>	<b>132</b>
<b>Table 8-13: MCU Connector (JP7) Pinouts .....</b>	<b>132</b>
<b>Table 8-14: MCU Connector (TS2) Pinouts .....</b>	<b>133</b>
<b>Table 8-15: PCIe Mini Card Slot (CN2) Pinouts.....</b>	<b>134</b>
<b>Table 8-16: RFID Connector (JP8) Pinouts .....</b>	<b>134</b>
<b>Table 8-17: SATA Connector (SATA1) Pinouts .....</b>	<b>134</b>

Table 8-18: Touch Panel Connector (TS1) Pinouts .....	135
Table 8-19: TTL Panel Connector (CN7) Pinouts.....	136
Table 8-20: JUSB Connector (JUSB1) Pinouts.....	136
Table 8-21: USB Connector (USB1) Pinouts .....	136
Table 8-22: USB Connector (USB2) Pinouts .....	136
Table 8-23: USB Connector (USB4) Pinouts .....	137
Table 8-24: Rear Panel Connectors .....	137
Table 8-25: Ethernet Connector (LAN1, LAN2) Pinouts.....	138
Table 8-26: Power Connector (CN5) Pinouts .....	138
Table 8-27: RS-232 Serial Ports (COM1) Pinouts .....	138
Table 8-28: COM3 Connector Pinouts .....	139
Table 8-29: SATA Connector (SATA2) Pinouts .....	139
Table 8-30: USB 2.0 Connectors (USB3) Pinouts.....	140
Table 8-31: Preconfigured Jumpers .....	140
Table 8-32: Backlight Voltage Selection Jumper (J_BL1) Settings.....	140
Table 8-33: Inverter Power Selection Jumper (JP12) Settings .....	141
Table 8-34: LVDS Voltage Selection Jumper (J_VLVDS1) Settings .....	141
Table 8-35: MCU LCD Type Selection Jumper (JP14) Settings .....	141
Table 8-36: MCU PWM Power Selection Jumper (JP13) Settings.....	141
Table 8-37: Panel Type Selection Jumper (J_LCD_TYPE1) Settings .....	142
Table 8-38: Touchscreen Selection Jumper (J1) Settings .....	142
Table 8-39: USB2 and USB4 Power Selection Jumper (JP15) Settings .....	142



Chapter

1

# Introduction

---

## 1.1 Overview



**Figure 1-1: AFOLUX AFL-xxA-N270 Flat Panel PC**

The AFL-xxA-N270 series is Intel® Atom™ powered flat panel PCs with a rich variety of functions and peripherals. All AFL-xxA-N270 models are designed for easy and simplified integration in to kiosk and point-of-sales (POS) applications.

An Intel® 945GSE graphics memory controller hub (GMCH) coupled with an Intel® ICH7-M input/output controller hub ensures optimal memory, graphics, and peripheral I/O support. The system comes with 1.0 GB of preinstalled DDR2 SDRAM and supports a maximum of 2.0 GB of DDR2 SDRAM ensuring smooth data throughputs with reduced bottlenecks and fast system access.

Two serial ports and two external USB 2.0 ports ensure simplified connectivity to a variety of external peripheral devices. Wi-Fi capabilities and an RJ-45 Ethernet connector ensure smooth connection of the system to an external LAN.

### 1.1.1 Features and Model Variations

There are four models in the AFL-xxA-N270 series. Both models feature the following:

- Intel® Atom™ processor
- Intel® 945GSE chipset
- 1GB 533 MHz DDR2 SDRAM preinstalled

## AFL-xxA-N270 Series Panel PC

- 802.11 b/g/n wireless module
- Two USB 2.0 ports
- Watchdog timer that triggers a system reset if the system hangs for some reason
- IP 64 compliant front panel
- AT or ATX power mode
- Touch screen
- RoHS compliance

There are four kinds of panel size of the AFL-xxA-N270 series. The model numbers and model variations are listed below.

Model	Size	Brightness	Resolution	HSUPA
<b>AFL-07A-N270/R/1G-R22</b>	7"	400 cd/m <sup>2</sup>	800 x 480	No
<b>AFL-08AH-N270/R/1G-R22</b>	8.4"	450 cd/m <sup>2</sup>	800 x 600	No
<b>AFL-10A-N270/R/1G-R22</b>	10.4"	400 cd/m <sup>2</sup>	800 x 600	No
<b>AFL-12A-N270/R/1G-R22</b>	12.1"	500 cd/m <sup>2</sup>	1024 x 768	No

**Table 1-1: Model Variations**

### 1.1.2 Applications

The AFL-xxA-N270 panel PCs are elegant yet sophisticated systems that are easily implemented in commercial environments, industrial environments and corporate environments.

## 1.2 External Overview

### 1.2.1 General Description

The stylish AFL-xxA-N270 panel PC comprises of a screen, rear panel, top panel, bottom panel and two side panels (left and right). An ABS/PC plastic front frame surrounds the front screen. The rear panel provides screw holes for a wall-mounting bracket compliant with VESA FDMI standard. An I/O interface panel on the bottom panel of the

AFL-xxA-N270 provides access to external interface connectors that include LAN, USB 2.0, serial port, reset button, power connector and power switch.

### 1.2.2 Front Panel

The front side of the AFOLUX AFL-xxA-N270 series is a flat panel TFT LCD screen with LED backlight surrounded by an ABS/PC plastic frame. The top of the front panel has a power LED.

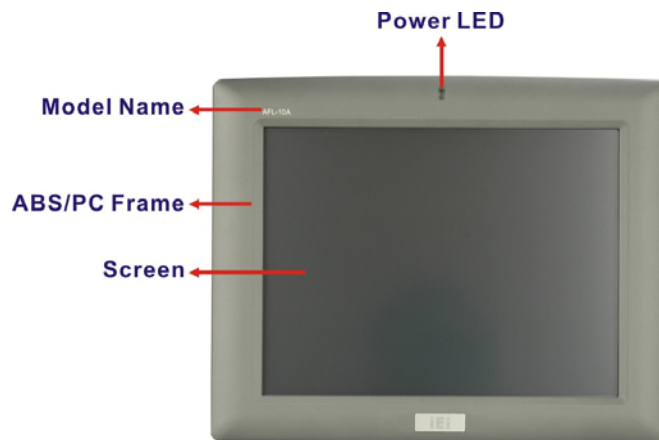

Figure 1-2: AFL-xxA-N270 Front View

### 1.2.3 Rear Panel

The rear panel provides access to retention screw holes that support the wall mounting. Refer to **Figure 1-3**.

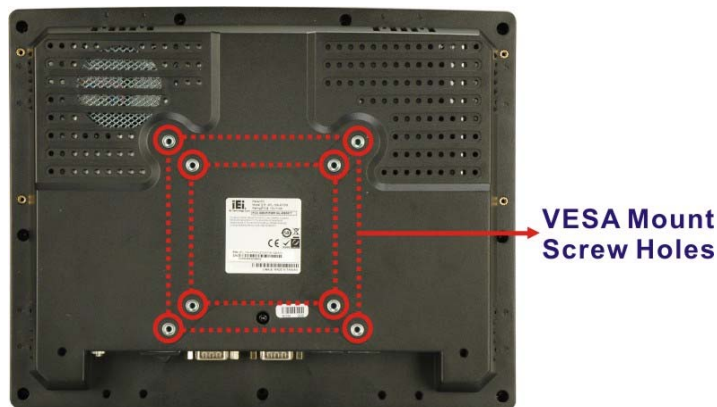

Figure 1-3: AFL-xxA-N270 Rear View

## AFL-xxA-N270 Series Panel PC

### 1.2.4 I/O Interface Panel

The I/O interface panel located on the bottom of the AFL-xxA-N270 has the following I/O interface connectors:

- 1 x Audio line-out connector
- 1 x 12 V DC In connector
- 1 x External SATA connector
- 1 x RS-232 connector
- 1 x RS-232/422/485 connector
- 2 x LAN connectors
- 2 x USB 2.0 connectors
- 1 x Power switch
- 1 x Reset button

The external I/O interface connector panel is shown in **Figure 1-4**.

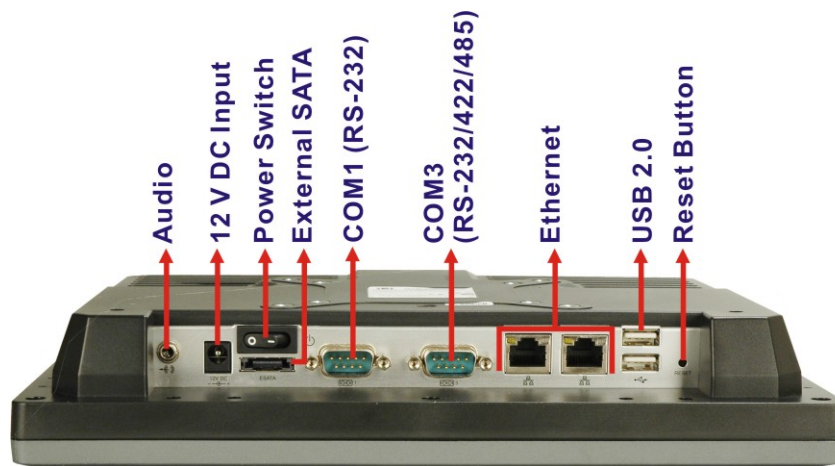

**Figure 1-4: AFL-xxA-N270 I/O Interface Connector Panel**

### 1.2.5 Top Panel and Side Panels

The top panel and side panels of AFOLUX AFL-xxA-N270 series provides access to slots that support panel mount and rack mount (**Figure 1-5**).



Figure 1-5: AFL-xxA-N270 Top View



Figure 1-6: AFL-10A-N270 Side View

### 1.3 Internal Overview

The AFOLUX AFL-xxA-N270 has the following components installed internally:

- 1 x Motherboard
- 1 x 1.0 GB 533 MHz DDR2 SDRAM SO-DIMM
- 1 x Wireless module

## AFL-xxA-N270 Series Panel PC

### 1.4 System Specifications

The technical specifications for the AFOLUX AFL-xxA-N270 series systems are listed in **Table 1-2.**

Specification	AFL-07A-N270	AFL-08AH-N270	AFL-10A-N270	AFL-12A-N270
<b>LCD Size</b>	7"	8.4"	10.4"	12.1"
<b>Max. Resolution</b>	800 x 480	800 x 600	800 x 600	1024 x 768
<b>Contrast Ratio</b>	400:1	600:1	700:1	700:1
<b>Brightness (cd/m<sup>2</sup>)</b>	400	450	400	500
<b>LCD Color</b>	262K	262K	262K	262K
<b>Pixel Pitch (H x V) (mm)</b>	0.0635 x 0.1905	0.213 x 0.213	0.264 x 0.264	0.3057 x 0.3057
<b>Viewing Angle (H-V)</b>	140 / 110	160 / 140	160 / 140	160 / 160
<b>Backlight</b>	LED backlight	LED backlight	LED backlight	LED backlight
<b>SBC Model</b>	AFLMB-945GSE			
<b>CPU</b>	1.6 GHz Intel® Atom™ N270 processor			
<b>GMCH</b>	Intel® 945GSE			
<b>Memory</b>	One 1.0 GB 533 MHz DDR2 SDRAM SO-DIMM pre-installed (Supports up to 2 GB 533/400 MHz DDR2 SDRAM)			
<b>SSD</b>	CF Type II slot			
<b>Watchdog Timer</b>	Software Programmable supports 1 sec. ~ 255 sec. system reset			
<b>Audio</b>	Realtek ALC892 audio codec AMP 1.5 W + AMP 1.5 W (built-in stereo speakers)			
<b>Expansion</b>	1 x PCIe mini card (wireless LAN 802.11 b/g/n module)			
	1 x Optional Bluetooth module (USB interface, Bluetooth v 2.0)			
<b>HDD Drive Bay</b>	1 x 2.5" SATA HDD bay or HSDPA module (AFL-12A-N270 Only)			
<b>Construction Material</b>	ABS + PC plastic front frame			
<b>Mounting</b>	Panel Wall Stand Arm (VESA 75 mm x 75 mm or 100 mm x 100 mm)			
<b>Front Panel Color</b>	Gray 7539U			
<b>Dimensions (W x H x D) (mm)</b>	226 x 140 x 40.18	234 x 184 x 41.09	276 x 227 x 50.7	304 x 246 x 49.5

<b>Operation Temperature</b>	-10°C ~ 50°C with CF card			-10°C ~ 50°C with CF card 0°C ~ 40°C with HDD
<b>Storage Temperature</b>	-20°C ~ 60°C			
<b>Net weight</b>	0.6 kg	0.8 kg	1.4 kg	1.8 kg
<b>IP level (front panel)</b>	IP 64			
<b>EMC</b>	CE, FCC and CCC			
<b>Safety</b>	CB			
<b>Touch Screen</b>	Resistive Type 4-wire (touch controller is on board)		Resistive Type 5-wire (touch controller is on board)	
<b>Power Adapter</b>	36 W		50 W	
	Input: 90 VAC ~ 264 VAC @ 50 Hz / 60 Hz			
	Output: 12 V DC			
<b>Power Consumption</b>	23 W	25 W	28 W	32 W
<b>I/O Ports and Switches</b>	1 x 12 V DC input jack			
	1 x Audio line-out connector			
	1 x RS-232 COM port connectors			
	1 x RS-232/422/485 COM port connector			
	2 x RJ-45 for LAN			
	2 x USB 2.0 ports			
	1 x Power switch			
	1 x Reset button			

**Table 1-2: AFL-xxA-N270 Series System Specifications**



Chapter

2

# Detailed Specifications

---

## 2.1 Dimensions

The following sections provide detailed schematics and information on the dimensions of the AFL-xxA-N270 series.

### 2.1.1 AFL-07A-N270 Dimensions

The AFL-07A-N270 dimensions are shown in **Figure 2-1** and listed below.

- **Width:** 226.00 mm
- **Height:** 140.00 mm
- **Depth:** 40.18 mm

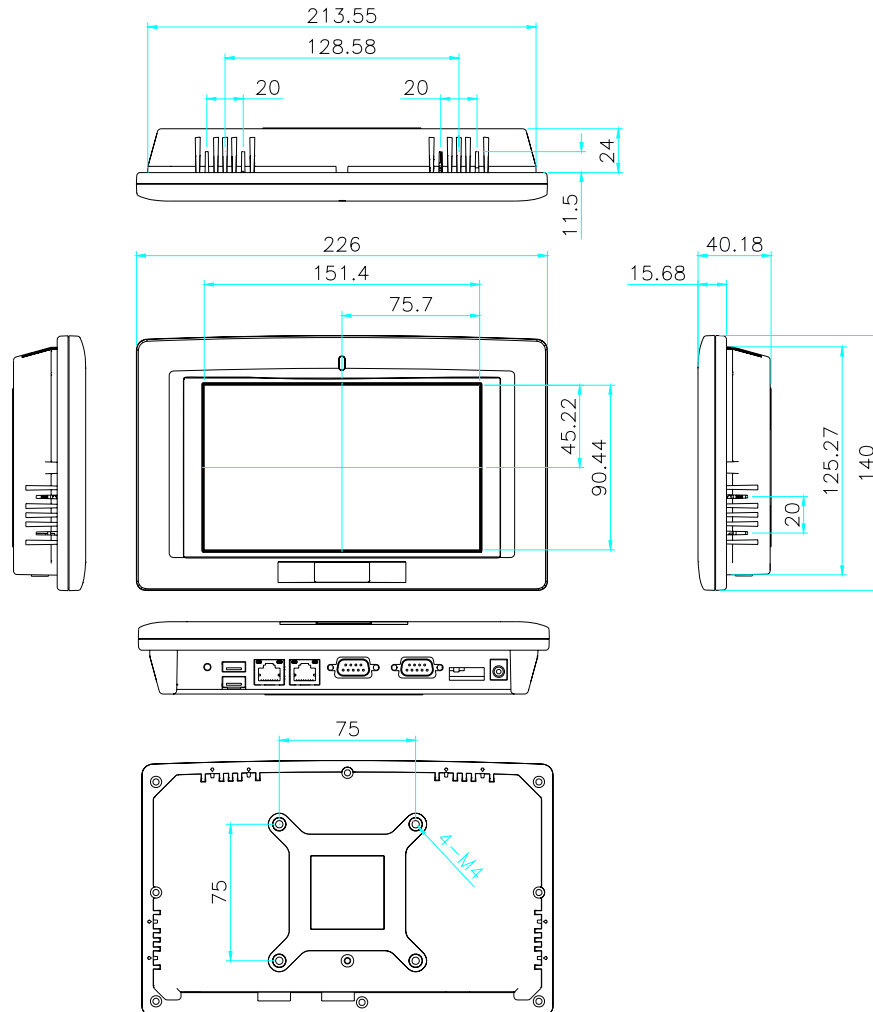

Figure 2-1: AFL-07A-N270 Dimensions (mm)

## AFL-xxA-N270 Series Panel PC

### 2.1.2 AFL-08AH-N270 Dimensions

The AFL-08AH-N270 dimensions are shown in **Figure 2-2** and listed below.

- **Width:** 233.86 mm
- **Height:** 183.86 mm
- **Depth:** 41.09 mm

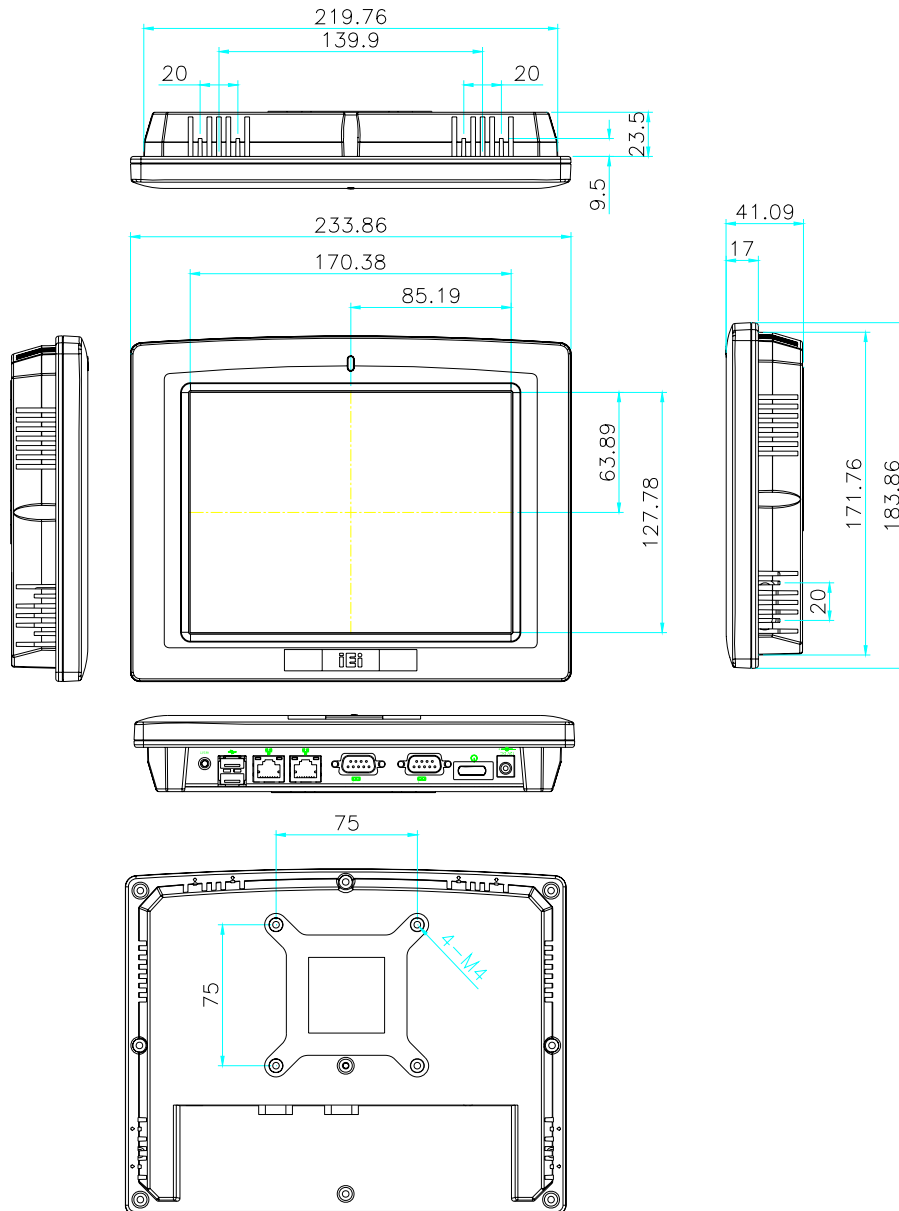
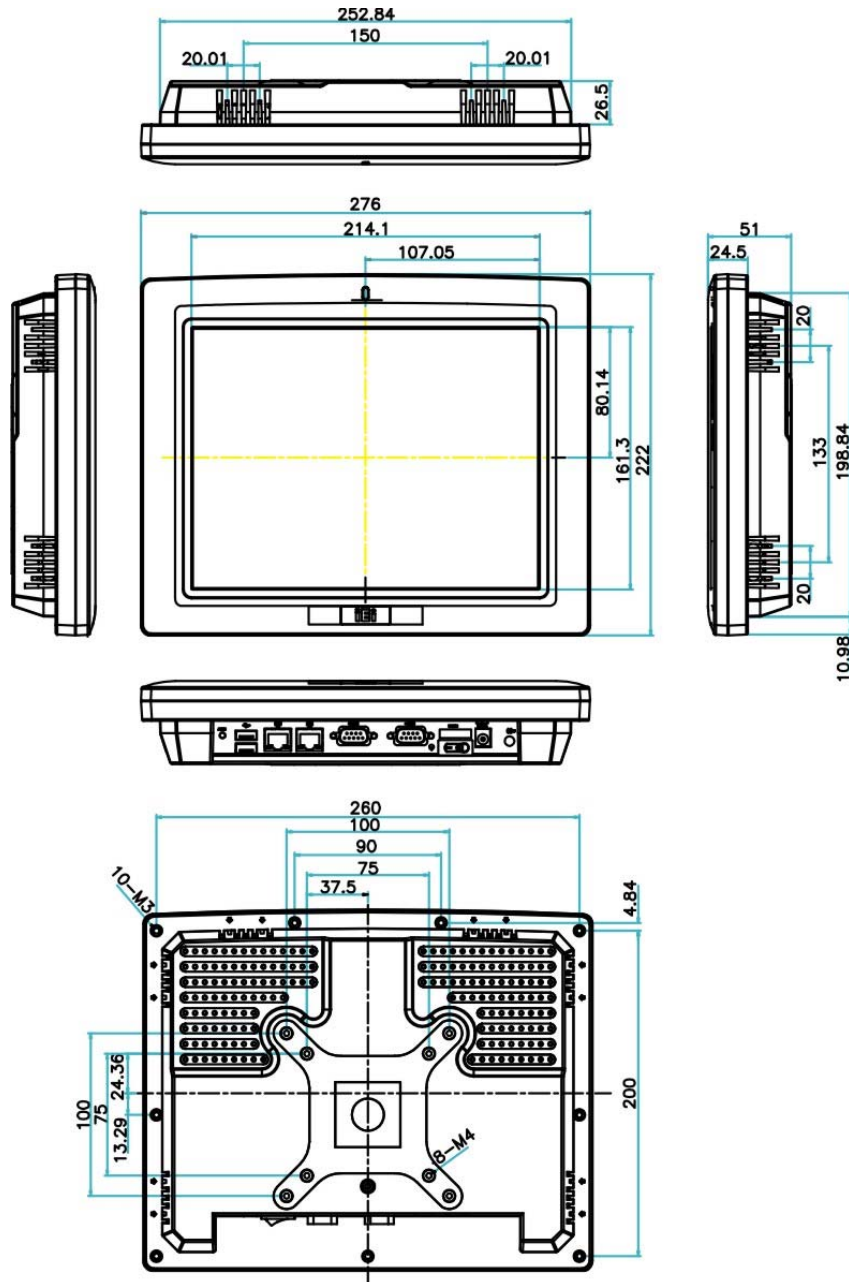

**Figure 2-2: AFL-08AH-N270 Dimensions (mm)**

### 2.1.3 AFL-10A-N270 Dimensions

The AFL-10A-N270 dimensions are shown in **Figure 2-3** and listed below.

- **Width:** 276.0 mm
- **Height:** 222.0 mm
- **Depth:** 51.0 mm



**Figure 2-3: AFL-10A-N270 Top and Bottom Panel Dimensions (mm)**

## AFL-xxA-N270 Series Panel PC

### 2.1.4 AFL-12A-N270 Dimensions

The AFL-12A-N270 dimensions are shown in **Figure 2-3** and listed below.

- **Width:** 304.0 mm
- **Height:** 246.0 mm
- **Depth:** 49.5 mm

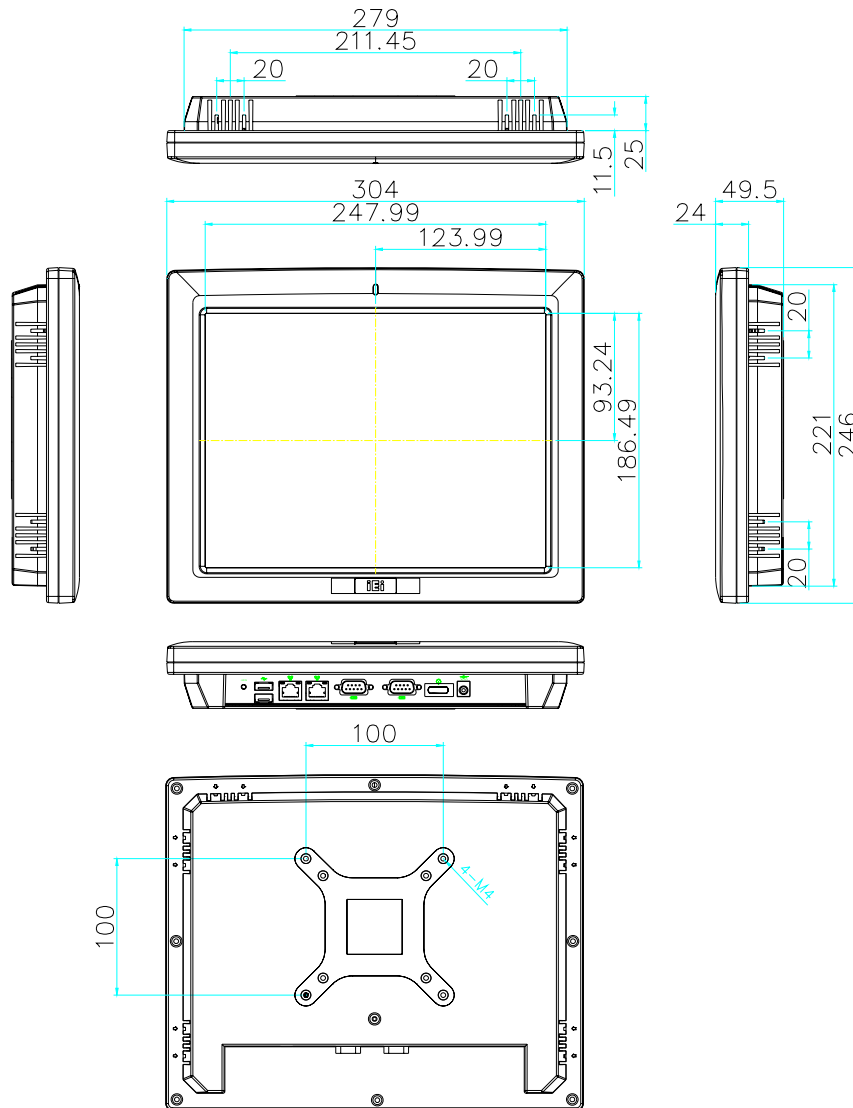

**Figure 2-4: AFL-12A-N270 Top and Bottom Panel Dimensions (mm)**

## 2.2 Intel® Atom™ Processor

A 45nm N270 Intel® Atom™ processor is installed in the system. The processor has a CPU speed of 1.6 GHz and a 533 MHz front side bus (FSB). The processor also comes with a 512 KB L2 cache and a 1.6 GHz L2 cache speed. Some of the features of the Intel® Atom™ processor N270 are listed below:

- On-die, primary 32-kB instructions cache and 24-kB write-back data cache
- 533-MHz source-synchronous front side bus (FSB)
- 2-Threads support
- On-die 512-kB, 8-way L2 cache
- Support for IA 32-bit architecture
- Intel® Streaming SIMD Extensions-2 and -3 (Intel® SSE2 and Intel® SSE3) support and Supplemental Streaming SIMD Extension 3 (SSSE3) support
- Micro-FCBGA8 packaging technologies
- Thermal management support via Intel® Thermal Monitor 1 and Intel Thermal Monitor 2
- FSB Lane Reversal for flexible routing
- Supports C0/C1(e)/C2(e)/C4(e)
- L2 Dynamic Cache Sizing
- Advanced power management features including Enhanced Intel SpeedStep® Technology
- Execute Disable Bit support for enhanced security

## 2.3 Motherboard Components

The following sections describe some of the features on the motherboard.

### 2.3.1 Memory Support

#### 2.3.1.1 Installed Memory

One 200-pin 1.0 GB 533 MHz DDR2 SDRAM SO-DIMM is installed in the AFL-xxA-N270 and controlled by the Intel® 945GSE GMCH installed on the internal motherboard.

## AFL-xxA-N270 Series Panel PC

### Preinstalled 1.0 GB 533 MHz DDR2 SO-DIMM

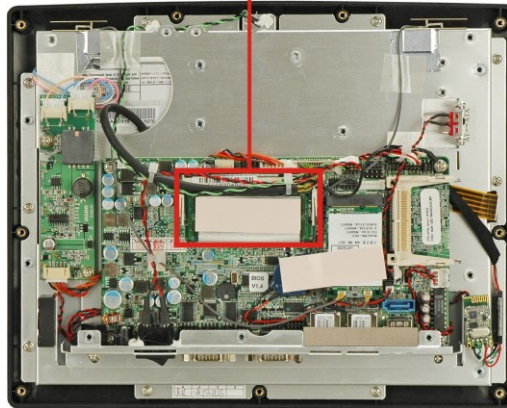

**Figure 2-5: Preinstalled DDR2 SO-DIMM**

### 2.3.1.2 Additional Memory

The Intel® 945GSE is capable of supporting one 200-pin 2.0 GB (max.) 533 MHz or 400 MHz DDR2 SDRAM SO-DIMM. If additional memory is required, please contact an IEI sales representative and discuss the necessary system requirement.

### 2.3.2 Storage Capacity

The AFL-xxA-N270 series supports an easily installed CompactFlash® Type II (CF Type II) memory disk. The AFL-xxA-N270 also supports a SATA drive through the external SATA connector on the bottom panel.

The AFL-12A-N270 model can also support either an internal 2.5" SATA hard disk drive or a HSDPA module.

## 2.4 External Peripheral Interface Connectors

The following section describes the external peripheral interface connectors on the bottom panel of the subsystem.

### 2.4.1 Serial Port Connectors

The AFL-xxA-N270 has two serial ports. One of these ports (COM1) is RS-232 only port. The other serial port (COM3) can be configured as a RS-232, RS-422 or an RS-485 serial port. Pin 9 on both ports can be set as the normal ring (RI) signal or can be designated as

a 5 V or 12 V power supply. Enabling COM devices to be powered through the COM port eliminates unnecessary and messy cabling.

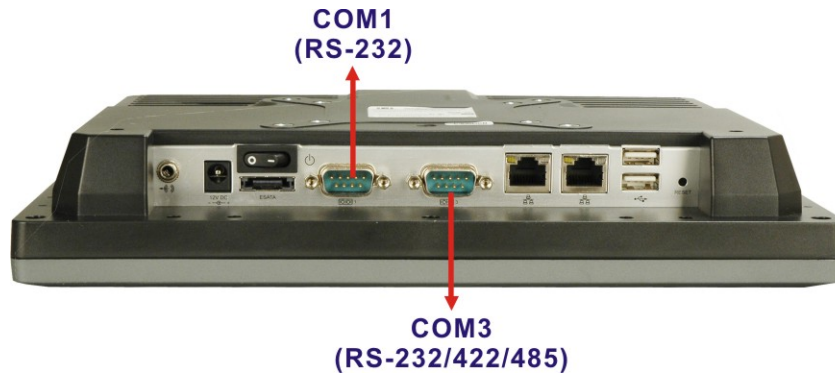

**Figure 2-6: COM Ports**

## 2.4.2 LAN Connectivity

The AFL-xxA-N270 has two RJ-45 LAN connectors on the bottom panel.



**Figure 2-7: RJ-45 Ethernet Connectors**

The PCIe lane from the Intel® ICH7 chipset of the AFL-xxA-N270 is interfaced to the Realtek RTL8111CP PCIe gigabit Ethernet (GbE) controllers. The RTL8111CP controllers are then connected directly to the RJ-45 connectors on the bottom panel and provides external GbE connectivity. Some of the RTL8111CP controller features are listed below:

- Integrated 10/100/1000 transceiver
- Supports PCI Express™ 1.1
- Fully compliant with IEEE 802.3, IEEE 802.3u, IEEE 802.3ab
- Supports IEEE 802.1P Layer 2 Priority Encoding



## AFL-xxA-N270 Series Panel PC

- Supports IEEE 802.1Q VLAN tagging
- Serial EEPROM
- Transmit/Receive on-chip buffer support
- 64-pin QFN package (Green package)

### 2.4.3 External USB Connectors

There are two USB 2.0 connectors on the bottom panel of the AFL-xxA-N270. Both USB 2.0 connectors are interfaced directly to the USB controllers on the ICH7-M southbridge. These USB connectors are fully compliant with USB specification Revision 2.0 and USB specification Revision 1.1 and can be interfaced to both USB 1.1 and USB 2.0 compliant devices.

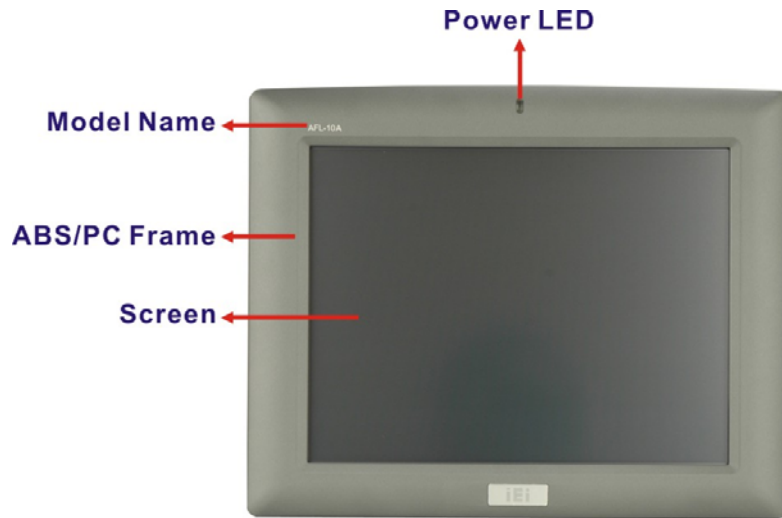

Figure 2-8: External USB Ports

## 2.5 AFOLUX AFL-xxA-N270 Front Side

### 2.5.1 Monitor

A LCD screen is installed on the front of the AFOLUX AFL-xxA-N270 series. The monitor maximum resolution is varied in different AFL-xxA-N270 models. The screen is shown in **Figure 2-9** below.



**Figure 2-9: LCD Screen**

## 2.5.2 Touch-Screen Module

A controller for the 4-wire/5-wire resistive touch screen is installed on the motherboard. The sensitive touch screen is accurate, reliable and durable.

## 2.6 Audio

### 2.6.1 HD Audio Codec Controller

The integrated HD Audio compliant audio controller on the Intel® ICH7M Southbridge is integrated to a RealTek ALC892 audio codec. The RealTek ALC892 is connected to an external audio jack, which is then connected to compliant audio devices. The audio connector is shown in **Figure 2-10**.



**Figure 2-10: Audio Jack**

## AFL-xxA-N270 Series Panel PC

### 2.6.2 Stereo Speakers

Two internal 1.5 W stereo speakers on the sides of the AFL-xxA-N270 are interfaced to the system through a Philips TDA1517p integrated class-B dual output amplifier.



Figure 2-11: Stereo Speakers

## 2.7 System Power

### 2.7.1 Power Mode

The system can be run in the AT power mode or the ATX power mode. Both these power modes are described below.

#### 2.7.1.1 ATX Power Mode (Default)

With the ATX mode selected, the AFOLUX AFL-xxA-N270 panel PC goes in a standby mode when it is turned off. The panel PC can be easily turned on via network or a power switch in standby mode. Remote power control is perfect for advertising applications since the broadcasting time for each panel PC can be set individually and controlled remotely. Other possible application includes

- Security surveillance
- Point-of-Sale (POS)
- Advertising terminal

### 2.7.1.2 AT Power Mode

With the AT mode selected, the power is controlled by a central power unit rather than a power switch. The AFOLUX AFL-xxA-N270 panel PC turns on automatically when the power is connected. The AT mode benefits a production line to control multiple panel PCs from a central management center and other applications including:

- ATM
- Self-service kiosk
- Plant environment monitoring system
- Factory automation platform
- Manufacturing shop flow

### 2.7.2 Power Adapter

The system is shipped with a 90 V to 264 V AC power adapter that has a maximum power output of 36 W (the AFL-12A-N270 comes with a 50 W power adapter). The power adapter has a 12 V DC output connector.

### 2.7.3 Power Connector

There is one 12 V power input connector on the bottom panel. The power connector is shown in **Figure 2-12** below.

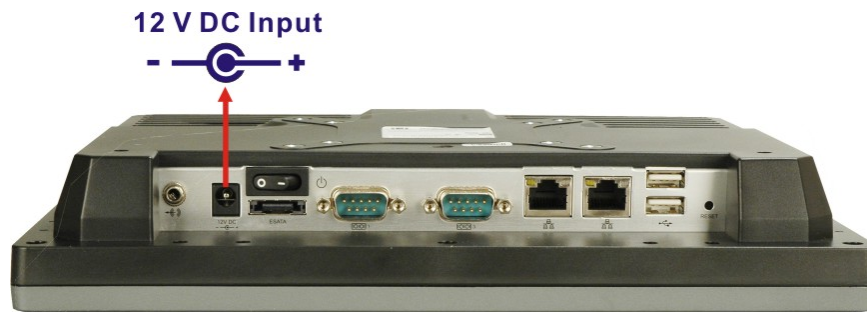

**Figure 2-12: Power Connector**

## AFL-xxA-N270 Series Panel PC

### 2.8 Wireless Connections

The following section describes the wireless modules on the circuit.

#### 2.8.1 Wireless Ethernet

An integrate PIFA antenna on the AFOLUX AFL-xxA-N270 ensures an uninterrupted wireless connection. PIFA antennas can receive high-quality, uniform signals in any location from all directions without any signal degradation or impedance and are the most efficient antennas on the market.

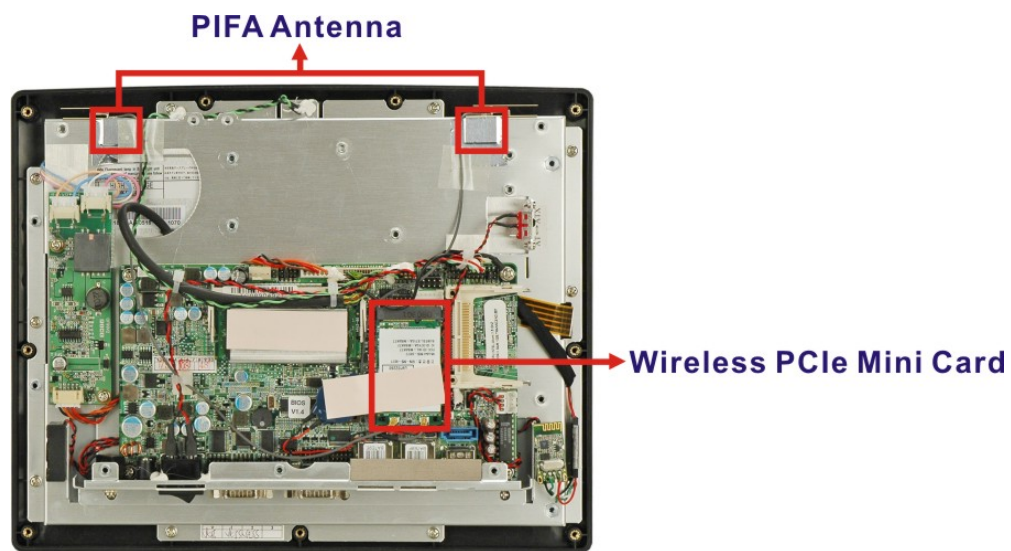

Figure 2-13: PIFA Antenna and Wireless Module

Chapter

3

# Unpacking

---

### 3.1 Unpacking

To unpack the flat panel PC, follow the steps below:



#### **WARNING!**







The front side LCD screen has a protective plastic cover stuck to the screen. Only remove the plastic cover after the flat panel PC has been properly installed. This ensures the screen is protected during the installation process.

---

- Step 1:** Use box cutters, a knife or a sharp pair of scissors that seals the top side of the external (second) box.
- Step 2:** Open the external (second) box.
- Step 3:** Use box cutters, a knife or a sharp pair of scissors that seals the top side of the internal (first) box.
- Step 4:** Lift the monitor out of the boxes.
- Step 5:** Remove both polystyrene ends, one from each side.
- Step 6:** Pull the plastic cover off the flat panel PC.
- Step 7:** Make sure all the components listed in the packing list are present.

### 3.1.1 Packing List

The AFL-xxA-N270 flat panel PC is shipped with the following components:

Quantity	Item	Image
<b>Standard</b>		
1	AFOLUX AFL-xxA-N270 series	
1	Power adapter	
1	Power cord	
4	Screw kit (M3*4)	
1	User manual CD and driver CD	
1	Touch pen	
<b>Optional</b>		
	Panel mounting kit (P/N: AFLPK-12)	



## AFL-xxA-N270 Series Panel PC

<p>Wall mounting kit (P/N: AFLWK-12)</p>	
<p>Stand (P/N: STAND-A12)</p>	
<p>Stand (P/N: STAND-100-RS)</p>	
<p>Arm (P/N: ARM-11-RS)</p>	
<p>Arm (P/N: ARM-31-RS)</p>	
<p>VSTAND: (P/N: VSTAND-A10)</p>	

If any of these items are missing or damaged, contact the distributor or sales representative immediately.

Chapter

4

# Installation

---

## AFL-xxA-N270 Series Panel PC

### 4.1 Anti-static Precautions

---



#### **WARNING:**

Failure to take ESD precautions during the maintenance of the AFL-xxA-N270 may result in permanent damage to the AFL-xxA-N270 and severe injury to the user.

---

Electrostatic discharge (ESD) can cause serious damage to electronic components, including the AFL-xxA-N270. Dry climates are especially susceptible to ESD. It is therefore critical that whenever the AFL-xxA-N270 is accessed internally, or any other electrical component is handled, the following anti-static precautions are strictly adhered to.

- **Wear an anti-static wristband:** - Wearing a simple anti-static wristband can help to prevent ESD from damaging the board.
- **Self-grounding:** - Before handling the board touch any grounded conducting material. During the time the board is handled, frequently touch any conducting materials that are connected to the ground.
- **Use an anti-static pad:** - When configuring the AFL-xxA-N270, place it on an anti-static pad. This reduces the possibility of ESD damaging the AFL-xxA-N270.
- **Only handle the edges of the PCB:** - When handling the PCB, hold the PCB by the edges.

### 4.2 Installation Precautions

When installing the flat panel PC, please follow the precautions listed below:

- **Power turned off:** When installing the flat panel PC, make sure the power is off. Failing to turn off the power may cause severe injury to the body and/or damage to the system.
- **Certified Engineers:** Only certified engineers should install and modify onboard functionalities.

- **Anti-static Discharge:** If a user open the rear panel of the flat panel PC, to configure the jumpers or plug in added peripheral devices, ground themselves first and wear an anti-static wristband.

### 4.3 Preinstalled Components

The following components are all preinstalled.

- Motherboard
- TFT LCD screen
- 1.0 GB DDR2 memory module
- Resistive type touch screen
- Wireless LAN module
- AT/ATX power switch
- Hard disk drive (HDD)

Preinstalled customizations may include the following.

- Different DDR2 memory module
- Hard disk drive (AFL-12A-N270 only)

Component installation is described in **the following sections**.

### 4.4 Installation and Configuration Steps

The following installation steps must be followed.

**Step 1:** Unpack the flat panel PC

**Step 2:** Install a CF card

**Step 3:** Install a HDD (AFL-12A-N270 only)

**Step 4:** Configure the system

**Step 5:** Connect peripheral devices to the bottom panel of the flat panel PC

**Step 6:** Mount the flat panel PC

## AFL-xxA-N270 Series Panel PC

### 4.5 Removing the Back Cover



#### WARNING:

Over-tightening back cover screws will crack the plastic frame.  
Maximum torque for cover screws is 5 kg-cm (0.36 lb-ft/0.49 Nm).

To access the AFL-xxA-N270 internally the back cover must be removed. To remove the back cover, please follow the steps below.

**Step 1:** Remove the retention screws (**Figure 4-1**) and lift the cover off the flat panel PC.



**Figure 4-1: Back Cover Retention Screws**

**Step 2:** Lift the cover off and pull down the cover a bit to make it possible to lift the cover further more after removing the retention screws (**Figure 4-2**). More strength is required to separate the cover from the chassis.

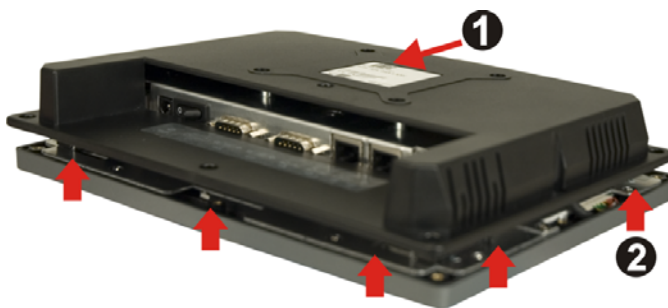

**Figure 4-2: AFL-xxA-N270 Plastic Back Cover Removal**

## 4.6 CF Card Installation

The AFL-xxA-N270 series has one CF Type II slot inside the rear panel. To install the CF card, follow the instructions below.

**Step 1:** Locate the CF slot. Insert a CF card into the slot (**Figure 4-3**).

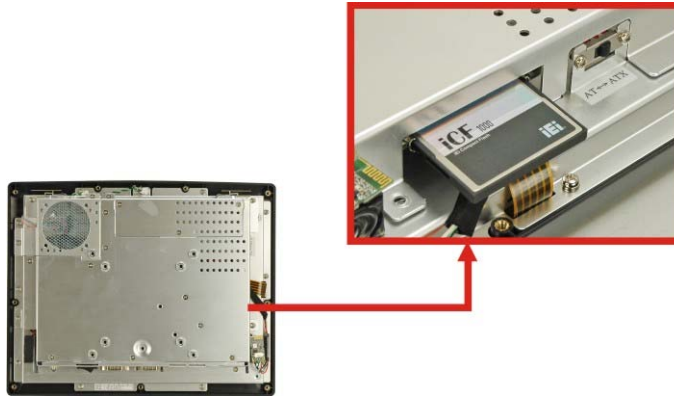

Figure 4-3: CF Card Location

**Step 2:** Replace the plastic back cover. For AFL-08AH-N270, more strength is required when pushing the bottom part of the cover down to the chassis (**Figure 4-4**).

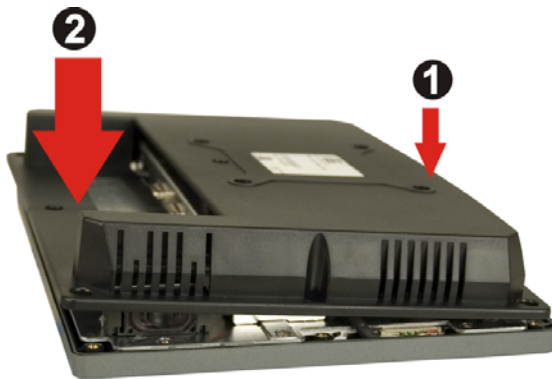

Figure 4-4: AFL-08AH-N270 Plastic Back Cover Replacement

**Step 3:** Once replaced reinsert the nine previously removed retention screws.

## AFL-xxA-N270 Series Panel PC

### 4.7 HDD Installation (AF-12A-N270 Only)

To install the HDD into the AF-12A-N270, please follow the steps below:

- Step 1:** Remove the plastic back cover. See **Section 4.5** above.
- Step 2:** Remove the aluminum cover. See **Section 5.4.2**.
- Step 3:** Remove the four HDD bracket retention screws and lift the HDD bracket off the panel PC.
- Step 4:** Attach the HDD brackets to the HDD. To do this, align the four retention screw holes in the both sides of the HDD bracket with the retention screw holes on the sides of the HDD. Insert four retention screws into the HDD bracket (**Figure 4-5**).

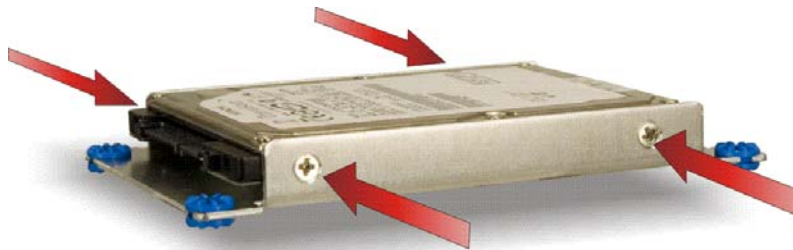

**Figure 4-5: AF-12A-N270 HDD Retention Screws**

- Step 5:** Connect the SATA cable to the rear of HDD and the SATA connector on the motherboard.
- Step 6:** Install the HDD into the AF-12A-N270 by aligning the retention screw holes in the HDD brackets with the retention screw holes on the chassis. Insert the four retention screws.
- Step 7:** Replace the aluminum back cover to the chassis.
- Step 8:** Replace the plastic back cover.

**WARNING:**

Over-tightening back cover screws will crack the plastic frame.  
Maximum torque for cover screws is 5 kg-cm (0.36 lb-ft/0.49 Nm).

## 4.8 AT/ATX Mode Selection

AT and ATX power modes can both be used on the AFL-xxA-N270 series. The selection is made through an AT/ATX switch on the aluminum chassis inside the plastic back cover (Figure 4-6). To select AT mode or ATX mode, follow the steps below.

**Step 1:** Remove the plastic back cover. See **Section 4.5** above.

**Step 2:** Locate the AT/ATX switch on the aluminum chassis (**Figure 4-6**).

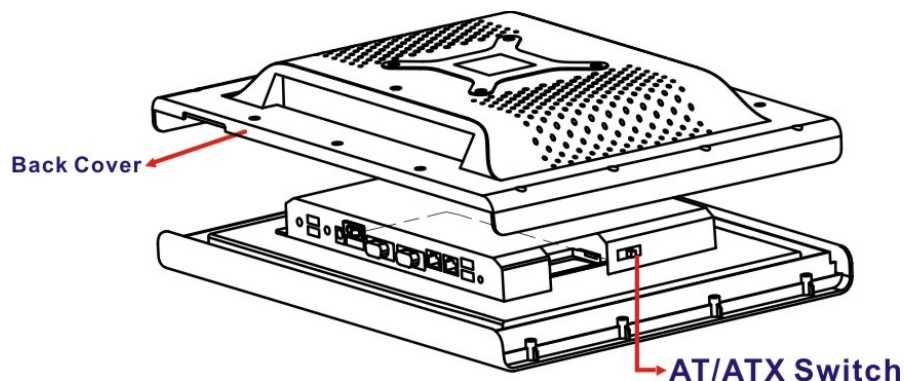

Figure 4-6: AT/ATX Switch Location

**Step 3:** Adjust the AT/ATX switch.

### 4.8.1 AT Power Mode

With the AT mode selected, the power is controlled by a central power unit rather than a power switch. The AFL-xxA-N270 panel PC turns on automatically when the power is connected. The AT mode benefits a production line to control multiple panel PCs from a central management center and other applications including:



## AFL-xxA-N270 Series Panel PC

- ATM
- Self-service kiosk
- Plant environment monitoring system
- Factory automation platform
- Manufacturing shop flow

### 4.8.2 ATX Power Mode

With the ATX mode selected, the AFL-xxA-N270 panel PC goes in a standby mode when it is turned off. The panel PC can be easily turned on via network or a power switch in standby mode. Remote power control is perfect for advertising applications since the broadcasting time for each panel PC can be set individually and controlled remotely. Other possible application includes

- Security surveillance
- Point-of-Sale (POS)
- Advertising terminal

## 4.9 Jumper Settings



### NOTE:

A jumper is a metal bridge used to close an electrical circuit. It consists of two or three metal pins and a small metal clip (often protected by a plastic cover) that slides over the pins to connect them. To CLOSE/SHORT a jumper means connecting the pins of the jumper with the plastic clip and to OPEN a jumper means removing the plastic clip from a jumper.

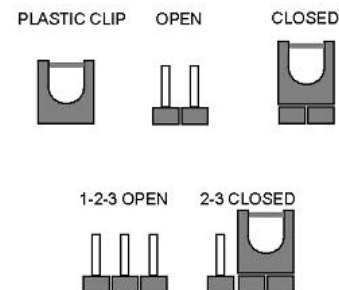

The following jumpers can be found on the motherboard installed in the AFL-xxA-N270. Before the AFL-xxA-N270 is installed, the jumpers must be set in accordance with the desired configuration. The jumpers on the AFL-xxA-N270 motherboard are listed in **Table 4-1**.

Description	Label	Type
Clear CMOS	J_COMS1	2-pin header
COM1 Pin 9 setting	JP8	10-pin header
COM3 Pin 9 setting	JP10	6-pin header
COM3 RX RS-232/422/485 select	JP9	8-pin header
COM3 TX RS-422/485 select	JP11	6-pin header
COM3 RS-232/422/485 select	JP6	12-pin header
CompactFlash® setup	JCF1	2-pin header

**Table 4-1: Jumpers**

#### 4.9.1 Access the Jumpers

To access the jumpers, remove the back cover. To remove the back cover, please refer to **Section 4.7 Step 1 ~ Step 4**.

#### 4.9.2 Preconfigured Jumpers

**WARNING:**

Do not change the settings on the jumpers in described here. Doing so may disable or damage the system.

The following jumpers are preconfigured for the AFL-xxA-N270. Users should no change these jumpers (**Table 4-2**).

Jumper Name	Label	Type
Backlight voltage selection	J_BL1	3-pin header
Inverter power selection	JP12	6-pin header
LVDS voltage selection	J_VLVDS1	3-pin header
MCU LCD type selection	JP14	4-pin header
MCU PWM power selection	JP13	3-pin header

## AFL-xxA-N270 Series Panel PC

Panel type and resolution	J_LCD_TYPE1	10-pin header
Touchscreen selection	J1	4-pin header
USB2 and USB4 power selection	JP15	6-pin header

**Table 4-2: Preconfigured Jumpers**

### 4.9.3 Clear CMOS Jumper

<b>Jumper Label:</b>	<b>J_CMOS1</b>
<b>Jumper Type:</b>	2-pin header
<b>Jumper Settings:</b>	See <b>Table 4-3</b>
<b>Jumper Location:</b>	See <b>Figure 4-7</b>

If the AFL-xxA-N270 fails to boot due to improper BIOS settings, the clear CMOS jumper clears the CMOS data and resets the system BIOS information. To do this, use the jumper cap to close the pins for a few seconds then remove the jumper clip.

If the “CMOS Settings Wrong” message is displayed during the boot up process, the fault may be corrected by pressing the F1 to enter the CMOS Setup menu. Do one of the following:

- Enter the correct CMOS setting
- Load Optimal Defaults
- Load Failsafe Defaults.

After having done one of the above, save the changes and exit the CMOS Setup menu.

The clear CMOS jumper settings are shown in **Table 4-3**.

Clear CMOS	Description	
Short 1 - 2	Keep CMOS Setup	Default
Short 2 - 3	Clear CMOS Setup	

**Table 4-3: Clear CMOS Jumper Settings**

The location of the clear CMOS jumper is shown in **Figure 4-7** below.

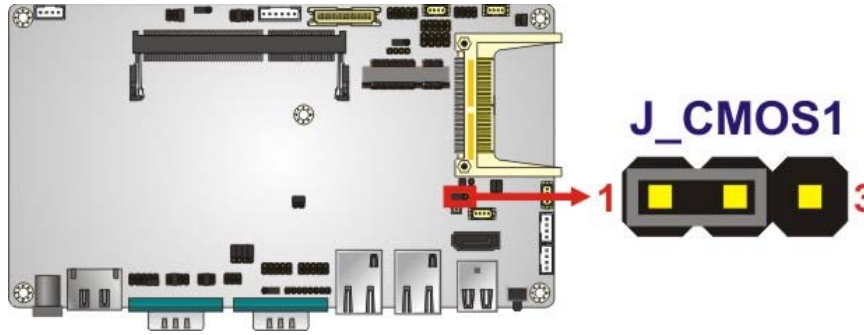

Figure 4-7: Clear CMOS Jumper

#### 4.9.4 COM Port Pin 9 Select

- Jumper Label:** JP8 and JP10
- Jumper Settings:** See Table 4-4
- Jumper Location:** See Figure 4-8

Two jumpers (JP8 and JP10) configure pin 9 on COM1 and COM3 DB-9 connectors. Pin 9 on the COM1 and the COM3 DB-9 connectors can be set as the ring (RI) signal, +5 V or +12 V. The COM1 and COM3 Pin 9 Setting jumper selection options are shown in Table 4-4.

JP8	Description	
Short 1-3	COM1 RI Pin use +12 V	
Short 3-5	COM1 RI Pin use +5 V	
Short 7-9	COM1 RI Pin use RI	Default

Table 4-4: COM1 Pin 9 Setting Jumper Settings

JP10	Description	
Short 1-2	COM3 RI Pin use +12 V	
Short 3-4	COM3 RI Pin use RI	Default
Short 5-6	COM3 RI Pin use +5 V	

Table 4-5: COM3 Pin 9 Setting Jumper Settings

The COM1 and COM3 Pin 9 Setting jumper locations are shown in Figure 4-8 below.

## AFL-xxA-N270 Series Panel PC

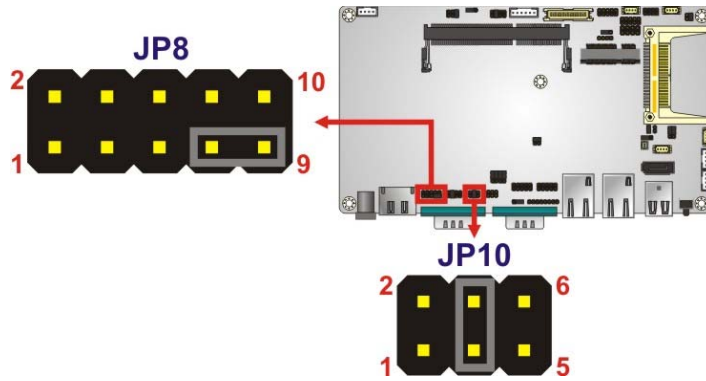

Figure 4-8: COM1 and COM3 Pin 9 Setting Jumper Locations

### 4.9.4.1 COM3 RS-422 and RS-485 Pinouts

The pinouts for RS-422 and RS-485 operation of external serial port COM 3 are detailed below.

COM 3	RS-422 Description
Pin 1	TX-
Pin 2	TX+
Pin 6	RX-
Pin 7	RX+

Table 4-6: RS-422 Pinouts

COM 3	RS-485 Description
Pin 1	Data-
Pin 2	Data+

Table 4-7: RS-485 Pinouts

### 4.9.5 COM3 RX Function Select Jumper

<b>Jumper Label:</b>	<b>JP9</b>
<b>Jumper Type:</b>	8-pin header
<b>Jumper Settings:</b>	See Table 4-8
<b>Jumper Location:</b>	See Figure 4-9

The COM3 RX Function Select jumper sets the communication protocol used by the RX serial communications port COM3 as RS-232, RS-422 or RS-485. The COM3 RX Function Select jumper settings are shown in **Table 4-8**.

COM3 RX Function Select	Description	
Short 1-2	DET BIOS RS-232/422/485	
Short 3-4	RS-232	Default
Short 5-6	RS-422	
Short 7-8	RS-485	

**Table 4-8: COM3 RX Function Select Jumper Settings**

The COM3 RX Function Select jumper location is shown in **Figure 4-9**.

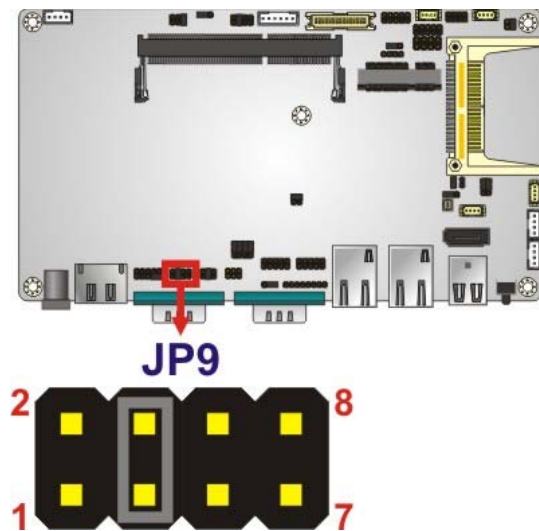

**Figure 4-9: COM3 RX Function Select Jumper Location**

#### 4.9.6 COM3 TX Function Select Jumper

<b>Jumper Label:</b>	<b>JP11</b>
<b>Jumper Type:</b>	6-pin header
<b>Jumper Settings:</b>	See <b>Table 4-9</b>
<b>Jumper Location:</b>	See <b>Figure 4-10</b>

## AFL-xxA-N270 Series Panel PC

The COM3 TX Function Select jumper configures the TX pin on COM3 serial port connector as RS-422 as an RS-485. The COM3 TX Function Select jumper selection options are shown in **Table 4-9**.

COM3 TX Function Select	Description
Short 1 – 3	RS-422 TX-
Short 2 – 4	RS-422 TX+
Short 3 – 5	RS-485 D-
Short 4 – 6	RS-485 D+

**Table 4-9: COM3 TX Function Select Jumper Settings**

The COM3 TX Function Select jumper location is shown in **Figure 4-10** below.

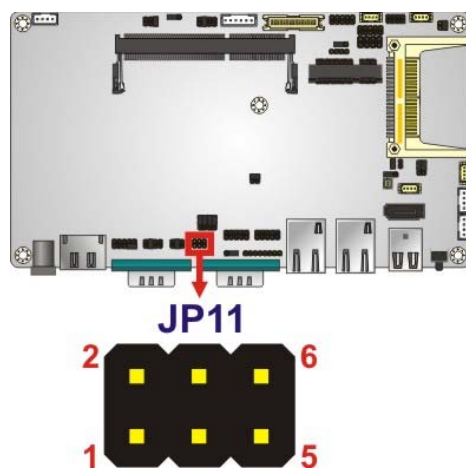

**Figure 4-10: COM3 TX Function Select Jumper Pinout Locations**

### 4.9.7 COM3 RS-232/422/485 Serial Port Select Jumper

<b>Jumper Label:</b>	<b>JP6</b>
<b>Jumper Type:</b>	12-pin header (four 3-pin headers combined)
<b>Jumper Settings:</b>	See <b>Table 4-10</b>
<b>Jumper Location:</b>	See <b>Figure 4-11</b>

The COM3 RS-232/422/485 Serial Port Select jumper sets the communication protocol used by the second serial communications port (COM3) as RS-232, RS-422 or RS-485. The COM3 RS-232/422/485 Serial Port Select settings are shown in **Table 4-10**.

RS-232/485 Select	Description	
Short 1-2	RS-232	Default
Short 4-5	RS-232	Default
Short 7-8	RS-232	Default
Short 10-11	RS-232	Default
Short 2-3	RS-422/485	
Short 5-6	RS-422/485	
Short 8-9	RS-422/485	
Short 11-12	RS-422/485	

**Table 4-10: COM3 RS-232/422/485 Serial Port Select Jumper Settings**

The COM3 RS-232/422/485 Serial Port Select jumper location is shown in **Figure 4-11**.

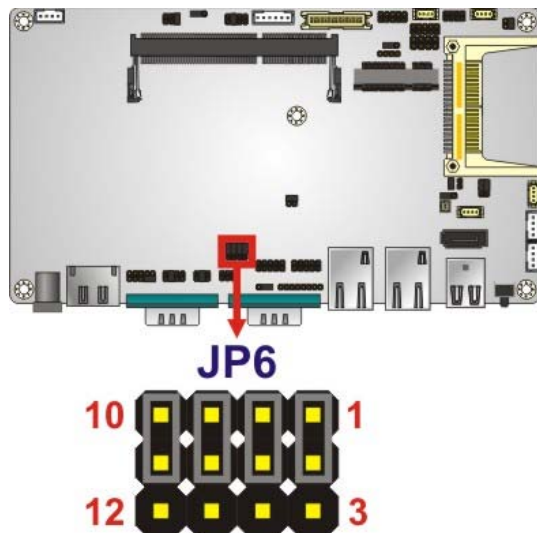

**Figure 4-11: COM3 RS-232/422/485 Serial Port Select Jumper Location**

#### 4.9.8 CompactFlash® Setup

Jumper Label: JCF1  
 Jumper Type: 2-pin header



## AFL-xxA-N270 Series Panel PC

**Jumper Settings:** See Table 4-11

**Jumper Location:** See Figure 4-12

The CompactFlash® slot is connected through an IDE connection. This jumper sets the CompactFlash® card as the master or slave IDE device.

Setting	Description
Open	Master (Default)
Short	Slave

**Table 4-11: CompactFlash® Setup Jumper Settings**

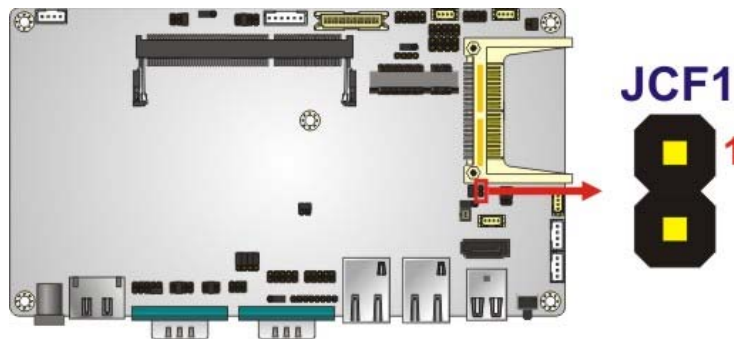

**Figure 4-12: CompactFlash® Setup Jumper Location**

### 4.10 Mounting the System



#### **WARNING!**

When mounting the flat panel PC onto an arm, onto the wall or onto a panel, it is better to have more than one person to help with the installation to make sure the panel PC does not fall down and get damaged.

The four methods of mounting the AFOLUX AFL-xxA-N270 are listed below.

- Wall mounting
- Panel mounting
- Arm mounting
- Rack mounting

The four mounting methods are described below.

### 4.10.1 Wall Mounting

To mount the flat panel PC onto the wall, please follow the steps below.

- Step 1:** Select the location on the wall for the wall-mounting bracket.
- Step 2:** Carefully mark the locations of the four screw holes in the bracket on the wall.
- Step 3:** Drill four pilot holes at the marked locations on the wall for the bracket retention screws.
- Step 4:** Align the wall-mounting bracket screw holes with the pilot holes.
- Step 5:** Secure the mounting-bracket to the wall by inserting the retention screws into the four pilot holes and tightening them (**Figure 4-13**).

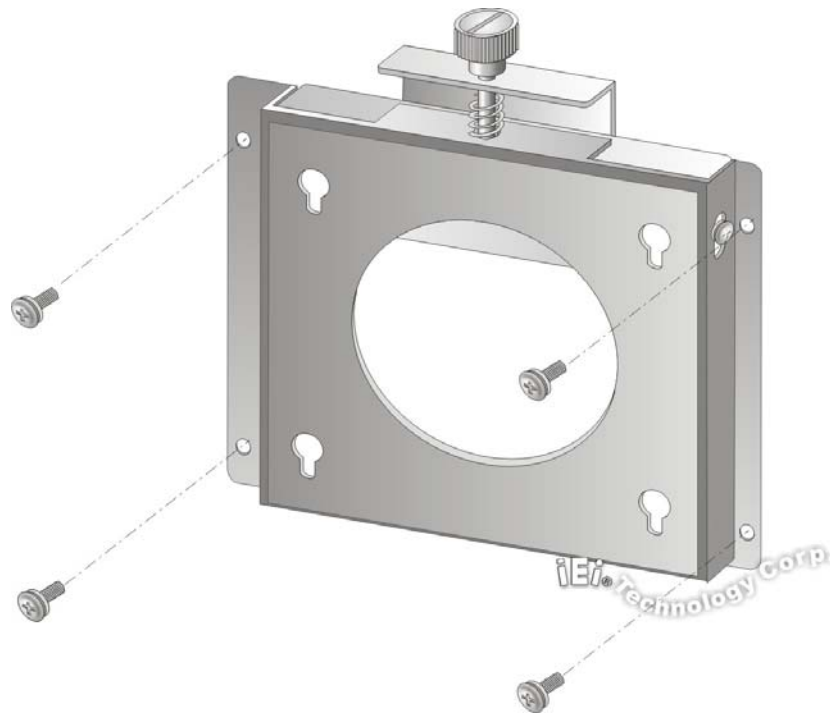

**Figure 4-13: Wall-mounting Bracket**

## AFL-xxA-N270 Series Panel PC

**Step 6:** Insert the four monitor mounting screws provided in the wall mount kit into the four screw holes on the rear panel of the flat panel PC and tighten until the screw shank is secured against the rear panel (**Figure 4-14**).



### WARNING:

Please use the M4 screws provided in the wall mount kit for the rear panel. If the screw is missing, the thread depth of the replacement screw should be not more than 4 mm.

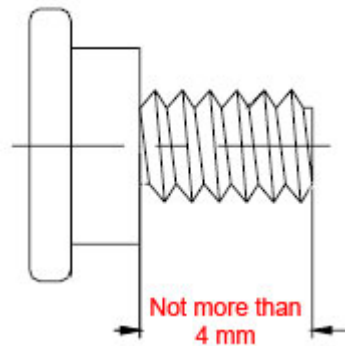

**Step 7:** Align the mounting screws on the monitor rear panel with the mounting holes on the bracket.

**Step 8:** Carefully insert the screws through the holes and gently pull the monitor downwards until the monitor rests securely in the slotted holes (**Figure 4-14**). Ensure that all four of the mounting screws fit snugly into their respective slotted holes.



### NOTE:

In the diagram below the bracket is already installed on the wall.

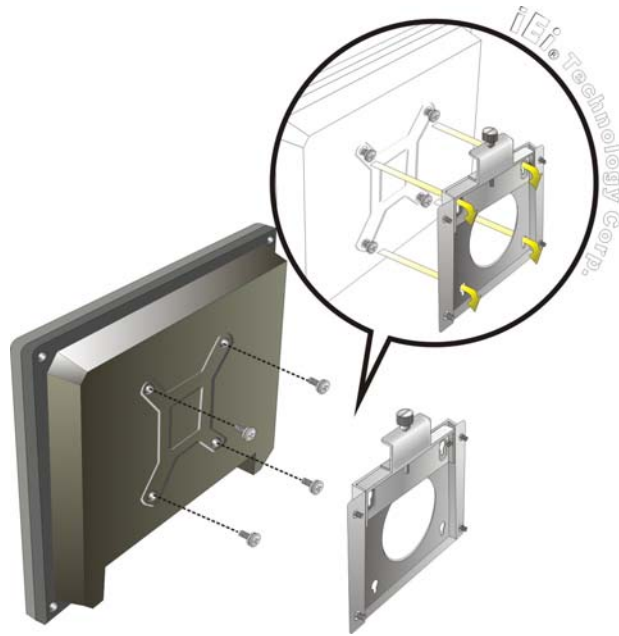

**Figure 4-14: Chassis Support Screws**

**Step 9:** Secure the panel PC by fastening the retention screw of the wall-mounting bracket. (Figure 4-15).

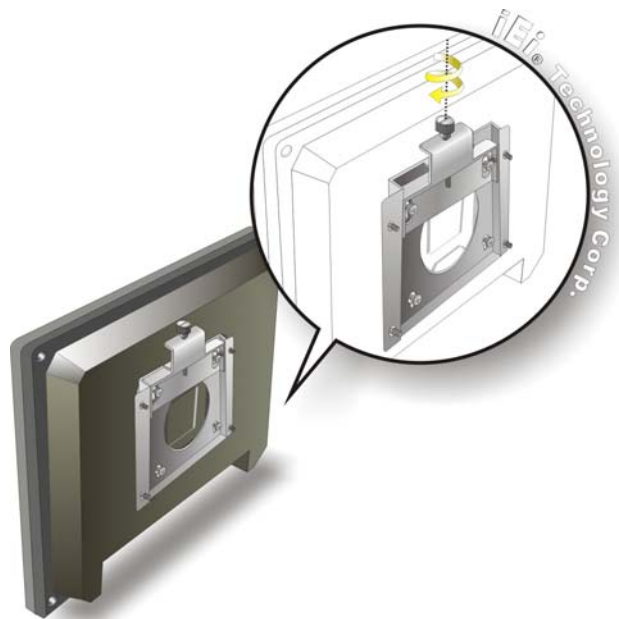

**Figure 4-15: Secure the Panel PC**

## AFL-xxA-N270 Series Panel PC

### 4.10.2 Panel Mounting

To mount the AFOLUX AFL-xxA-N270 series flat panel PC into a panel, please follow the steps below.

- Step 1:** Select the position on the panel to mount the flat panel PC.
- Step 2:** Cut out a section from the panel that corresponds to the rear panel dimensions of the flat panel PC. Take care that the panel section that is cut out is smaller than the overall size of the frame that surrounds the flat panel PC but just large enough for the rear panel of the flat panel PC to fit through (see **Figure 4-16**, **Figure 4-17**, **Figure 4-18** and **Figure 4-19**).

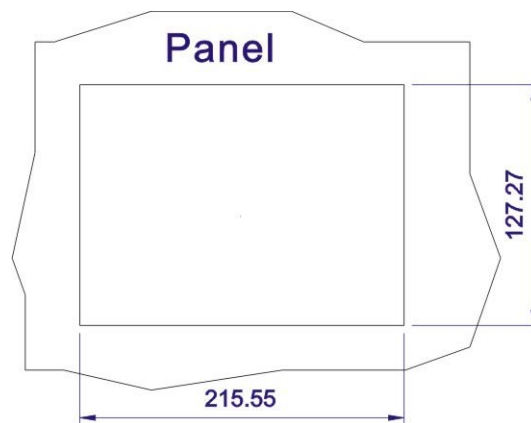

Figure 4-16: AFL-07A-N270 Panel Opening

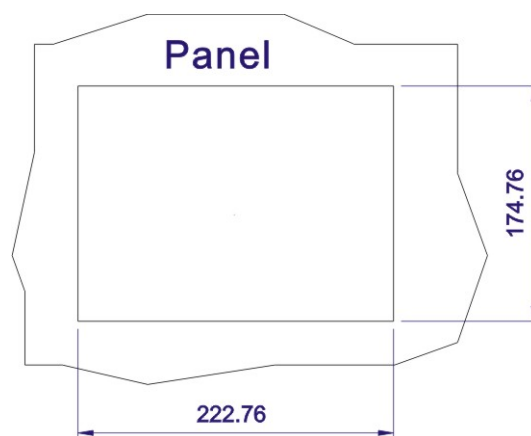

Figure 4-17: AFL-08AH-N270 Panel Opening

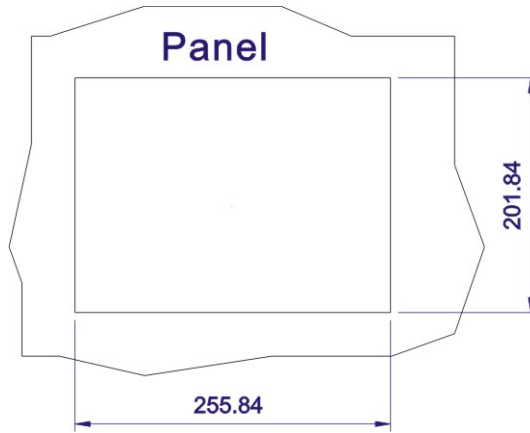

Figure 4-18: AFL-10A-N270 Panel Opening

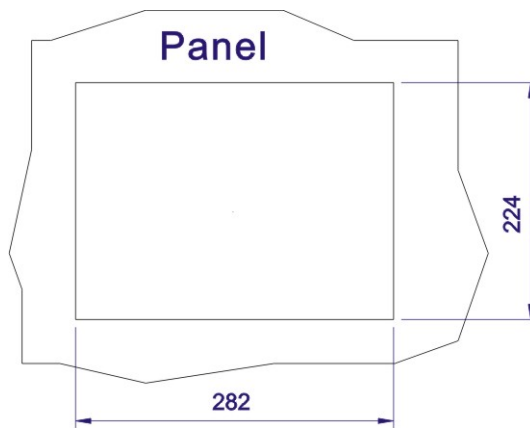

Figure 4-19: AFL-12A-N270 Panel Opening

- Step 3:** Slide the flat panel PC through the hole until the frame is flush against the panel.
- Step 4:** Insert the panel mounting clamps into the pre-formed holes along the edges of the chassis, behind the frame.
- Step 5:** Tighten the screws that pass through the panel mounting clamps until the plastic caps at the front of all the screws are firmly secured to the panel (**Figure 4-20**).

## AFL-xxA-N270 Series Panel PC

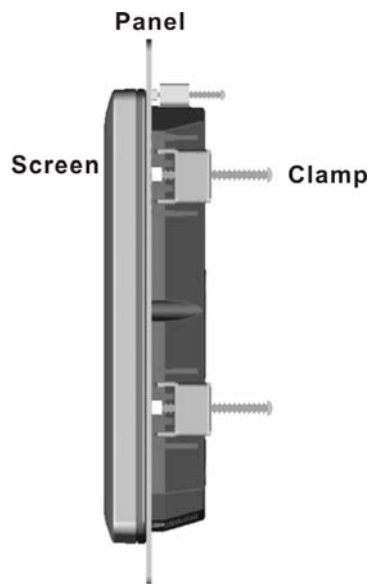

Figure 4-20: Tighten the Panel Mounting Clamp Screws

### 4.10.3 Arm Mounting

The AFL-xxA-N270 series is VESA (Video Electronics Standards Association) compliant and can be mounted on an arm with a 75mm or 100mm interface pad. To mount the AFL-xxA-N270 series on an arm, please follow the steps below.

**Step 1:** The arm is a separately purchased item. Please correctly mount the arm onto the surface it uses as a base. To do this, refer to the installation documentation that came with the mounting arm.



#### NOTE:

When purchasing the arm please ensure that it is VESA compliant and that the arm has a 75 mm interface pad. If the mounting arm is not VESA compliant it cannot be used to support the AFL-xxA-N270 series flat panel PC. The AFL-10A-N270 and AFL-12A-N270 also support VESA MIS-D 100.

---

**Step 2:** Once the mounting arm has been firmly attached to the surface, lift the flat panel PC onto the interface pad of the mounting arm.

**Step 3:** Align the retention screw holes on the mounting arm interface with those in the flat panel PC. The AFL-07A-N270/ AFL-08AH-N270 arm mount retention screw holes are shown in **Figure 4-21** and the AFL-10A-N270 /AFL-12A-N270 are shown in **Figure 4-22**.

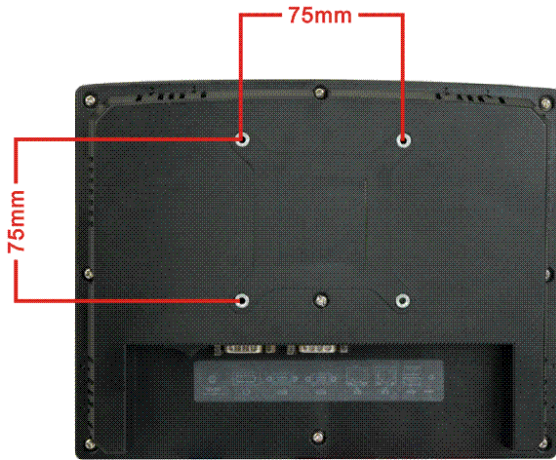

**Figure 4-21: AFL-07A-N270/AFL-08AH-N270 Arm Mounting Retention Screw Holes**

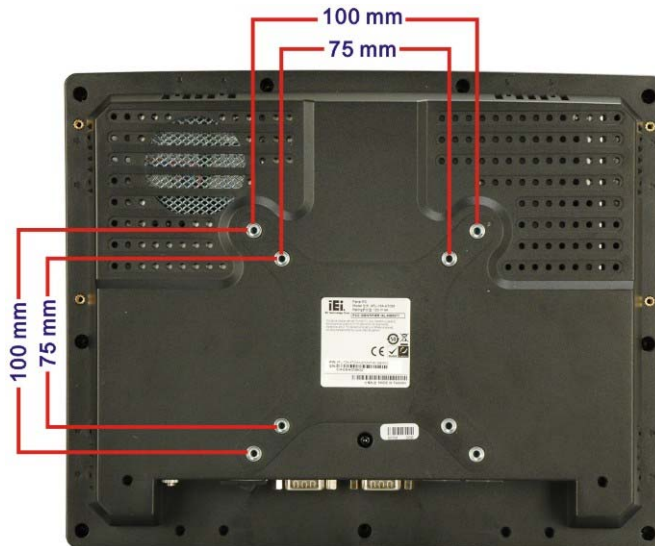

**Figure 4-22: AFL-10A-N270/AFL-12A-N270 Arm Mounting Retention Screw Holes**



## AFL-xxA-N270 Series Panel PC

**Step 4:** Secure the flat panel PC to the interface pad by inserting four retention screws through the bottom of the mounting arm interface pad and into the flat panel PC.

### 4.10.4 Cabinet and Rack Installation

The AFL-xxA-N270 series flat panel PC can be installed into a cabinet or rack. The installation procedures are similar to the panel mounting installation. To do this, please follow the steps below:



#### NOTE:

When purchasing the cabinet/rack installation bracket, make sure it is compatible with both the AFL-xxA-N270 series flat panel PC and the rack/cabinet into which the AFL-xxA-N270 series is installed.

---

**Step 1:** Slide the rear chassis of the AFL-xxA-N270 series flat panel PC through the rack/cabinet bracket until the aluminum frame is flush against the front of the bracket (**Figure 4-23**).

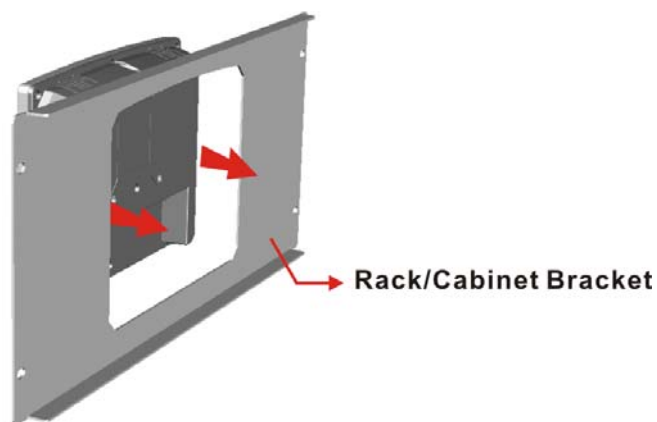
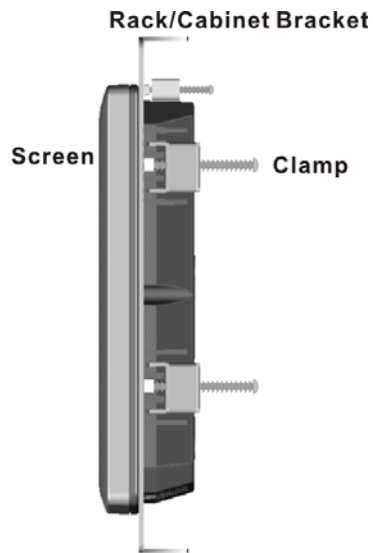

**Figure 4-23: The Rack/Cabinet Bracket**

**Step 2:** Insert the rack mounting clamps into the pre-formed holes along the edges of the flat panel PC, behind the ABS/PC plastic frame. There are a total of 4 rack

mounting clamps for AFL-07A-N270/ AFL-08AH-N270 and 6 rack mounting clamps for AFL-10A-N270/AFL-12A-N270.

**Step 3:** Tighten the screws that pass through the rack mounting clamps until the plastic caps at the front of all the screws are firmly secured to the bracket (**Figure 4-24**).



**Figure 4-24: Secure the Rack/Cabinet Bracket (AFL-10A-N270/AFL-12A-N270)**

**Step 4:** Slide the flat panel PC with the attached rack/cabinet bracket into a rack or cabinet (**Figure 4-25**).

## AFL-xxA-N270 Series Panel PC

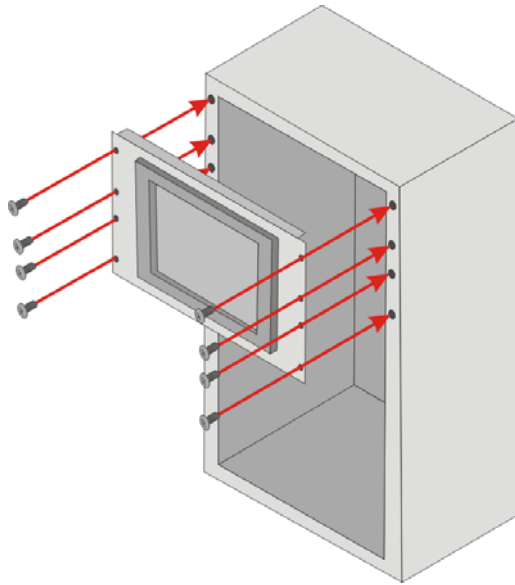

**Figure 4-25: Install into a Rack/Cabinet**

**Step 5:** Once the flat panel PC with the attached rack/cabinet bracket has been properly inserted into the rack or cabinet, secure the front of the rack/cabinet bracket to the front of the rack or cabinet (**Figure 4-25**).

## 4.11 Bottom Panel Connectors

### 4.11.1 LAN Connection

There are two external RJ-45 LAN connectors. The RJ-45 connector enables connection to an external network. To connect a LAN cable with an RJ-45 connector, please follow the instructions below.

**Step 1: Locate the RJ-45 connectors** on the bottom panel of the AFOLUX AFL-xxA-N270 Series.

**Step 2: Align the connectors.** Align the RJ-45 connector on the LAN cable with one of the RJ-45 connectors on the bottom panel of the AFOLUX AFL-xxA-N270 Series. See **Figure 4-26**.

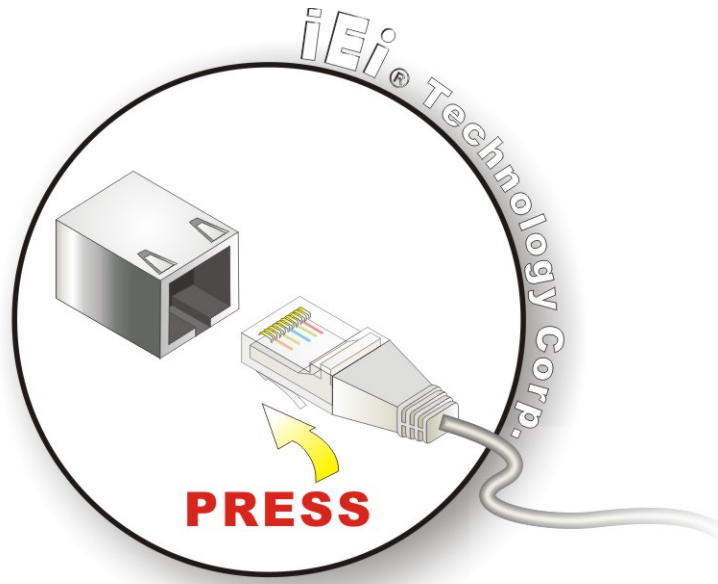

Figure 4-26: LAN Connection

**Step 3:** Insert the LAN cable RJ-45 connector. Once aligned, gently insert the LAN cable RJ-45 connector into the onboard RJ-45 connector.

#### 4.11.2 Serial Device Connection

The AFOLUX AFL-xxA-N270 Series has two male DB-9 connectors on the bottom panel for serial devices to be connected. Follow the steps below to connect a serial device to the AFOLUX AFL-xxA-N270 Series panel PC.

**Step 1:** Locate the DB-9 connector. The location of the DB-9 connector is shown in Chapter 2.

**Step 2:** Insert the serial connector. Insert the DB-9 connector of a serial device into the DB-9 connector on the bottom panel. See Figure 4-27.

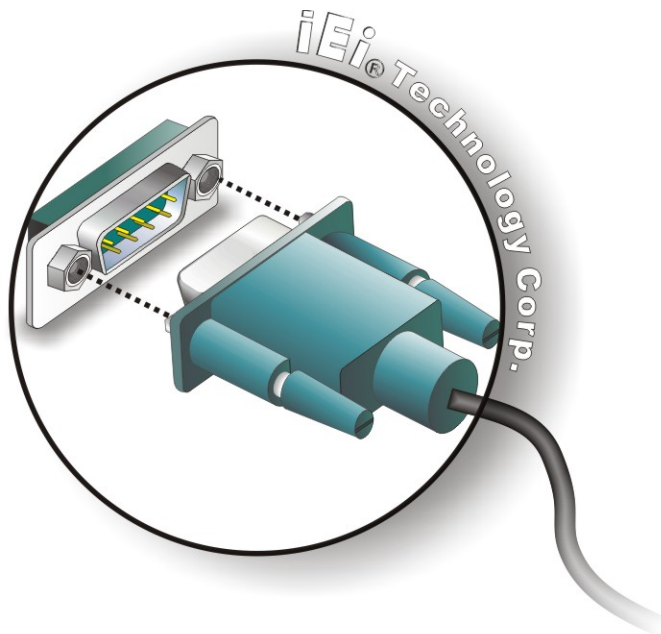

Figure 4-27: Serial Device Connector

**Step 3: Secure the connector.** Secure the serial device connector to the external interface by tightening the two retention screws on either side of the connector.

### 4.11.3 USB Device Connection

There are two external USB 2.0 connectors. To connect a USB 2.0 or USB 1.1 device, please follow the instructions below.

**Step 1:** Located the USB connectors. The locations of the USB connectors are shown in **Chapter 2**.

**Step 2:** Align the connectors. Align the USB device connector with one of the connectors on the bottom panel. See **Figure 4-28**.

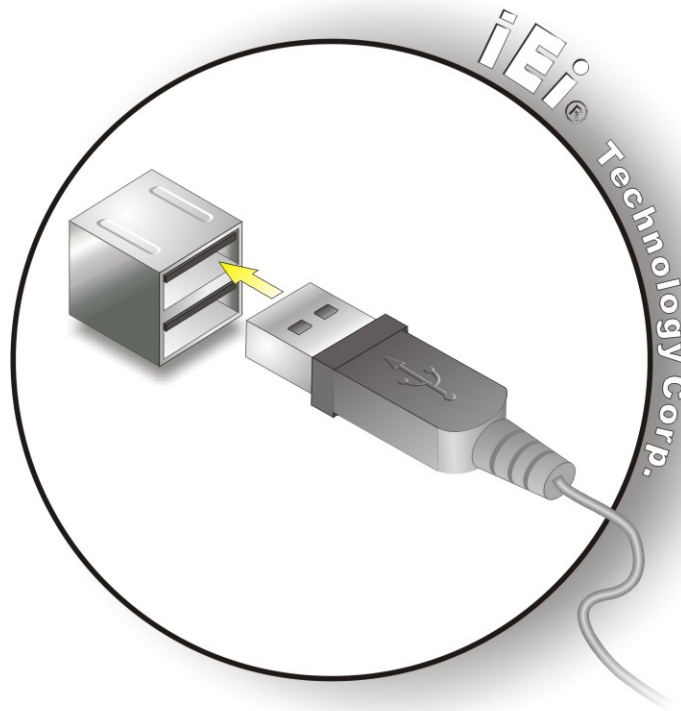

Figure 4-28: USB Device Connection

**Step 3:** Insert the device connector. Once aligned, gently insert the USB device connector into the onboard connector.

Chapter

5

# System Maintenance

---

## 5.1 System Maintenance Introduction

If the components of the AFOLUX AFL-xxA-N270 series fail they must be replaced.

Components that can be replaced include:

- CF Module
- Wireless LAN module
- SO-DIMM module

Please contact the system reseller or vendor to purchase the replacement parts. Back cover removal instructions for the AFOLUX AFL-xxA-N270 series are described below.

## 5.2 Anti-static Precautions



### WARNING:

Failure to take ESD precautions during the maintenance of the AFL-xxA-N270 may result in permanent damage to the AFL-xxA-N270 and severe injury to the user.

---

Electrostatic discharge (ESD) can cause serious damage to electronic components, including the AFL-xxA-N270. Dry climates are especially susceptible to ESD. It is therefore critical that whenever the AFL-xxA-N270 is accessed internally, or any other electrical component is handled, the following anti-static precautions are strictly adhered to.

- ***Wear an anti-static wristband:*** - Wearing a simple anti-static wristband can help to prevent ESD from damaging the board.
- ***Self-grounding:*** - Before handling the board touch any grounded conducting material. During the time the board is handled, frequently touch any conducting materials that are connected to the ground.
- ***Use an anti-static pad:*** - When configuring the AFL-xxA-N270, place it on an anti-static pad. This reduces the possibility of ESD damaging the AFL-xxA-N270.



## AFL-xxA-N270 Series Panel PC

- **Only handle the edges of the PCB:** - When handling the PCB, hold the PCB by the edges.

### 5.3 Turn off the Power

---



#### **WARNING:**

Failing to turn off the system before opening it can cause permanent damage to the system and serious or fatal injury to the user.

---

Before any maintenance procedures are carried out on the system, make sure the system is turned off.

### 5.4 Opening the System

#### 5.4.1 Removing the Back Cover

---



#### **WARNING:**

Over-tightening back cover screws will crack the plastic frame. Maximum torque for cover screws is 5 kg-cm (0.36 lb-ft/0.49 Nm).

---

To access the AFL-xxA-N270 internally the back cover must be removed. To remove the back cover, please follow the steps below.

**Step 1:** Follow all anti-static procedures. See **Section 5.2**.

**Step 2:** Turn off the power. See **Section 5.3**.

**Step 3:** Remove the retention screws on the back. Remove the retention screws (Figure 5-1) from the back cover.



**Figure 5-1: Back Cover Retention Screws**

**Step 4:** Lift the cover off and pull down the cover a bit to make it possible to lift the cover further more after removing the retention screws (**Figure 4-2**). More strength is required to separate the cover from the chassis.

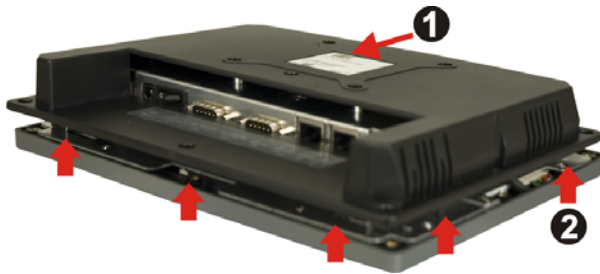

**Figure 5-2: AFL-xxA-N270 Plastic Back Cover Removal**

#### 5.4.2 AFL-xxA-N270 Series Internal Aluminum Cover Removal

To remove the internal aluminum cover, follow the steps below.

**Step 1:** Remove the retention screws securing the internal aluminum cover. The screw numbers are varied in different models. **Figure 5-3** shows the aluminum cover retention screws of the AFL-10A-N270.

## AFL-xxA-N270 Series Panel PC

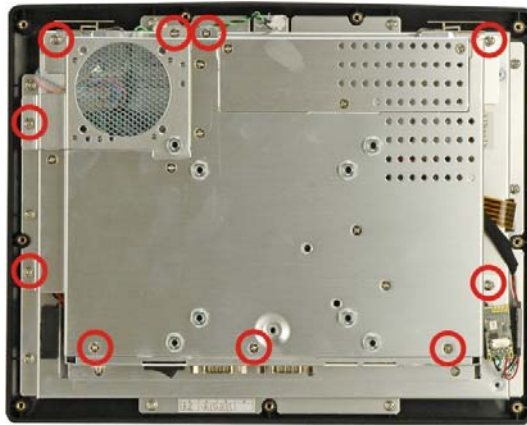

Figure 5-3: AFL-10A-N270 Aluminum Back Cover Retention Screws

**Step 2:** Lift the aluminum cover off the AFL-xxA-N270 series.

## 5.5 Replacing Components

### 5.5.1 Memory Module Replacement

The flat panel PC is preinstalled with a 1 GB DDR2 memory module. If the memory module is fail, follow the instructions below to replace the memory module.

**Step 1:** Remove the back cover. See **Section 5.4.1** above.

**Step 2:** Remove the internal aluminum back cover. See **Section 5.4.2** above.

**Step 3:** Locate the DDR2 SO-DIMM on the motherboard (**Figure 5-4**).

**Preinstalled 1.0 GB 533 MHz DDR2 SO-DIMM**

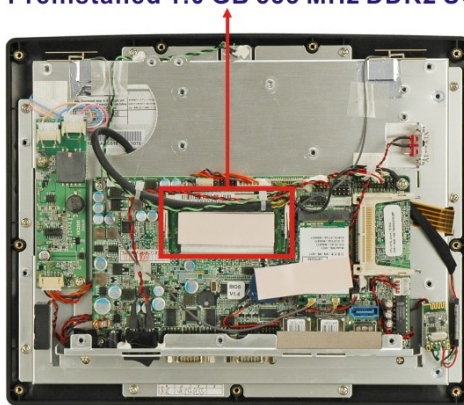
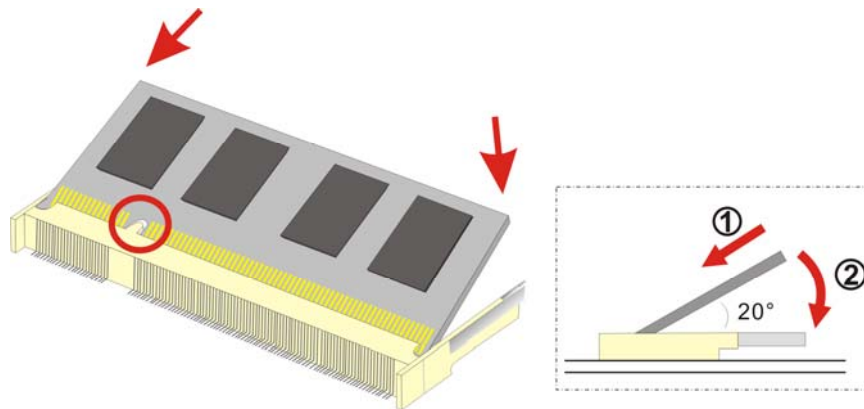

Figure 5-4: AFL-10A-N270 SO-DIMM Socket Location

- Step 4:** Remove the DDR memory module by pulling both the spring retainer clips outward from the socket.
- Step 5:** Grasp the DDR memory module by the edges and carefully pull it out of the socket.
- Step 6:** Install the new DDR memory module by pushing it into the socket at an angle (**Figure 5-5**).
- Step 7:** Gently pull the spring retainer clips of the SO-DIMM socket out and push the rear of the DDR memory module down (**Figure 5-5**).
- Step 8:** Release the spring retainer clips on the SO-DIMM socket. They clip into place and secure the DDR memory module in the socket.



**Figure 5-5: DDR SO-DIMM Module Installation**

### 5.5.2 CF Card Replacement

The AFOLUX AFL-xxA-N270 series has one CF Type II slot. To replace the CF card, follow the instructions below.

- Step 1:** Follow all anti-static procedures. See **Section 5.2**.
- Step 2:** Turn off the power. See **Section 5.3**.
- Step 3:** Remove the back cover. See **Section 5.4.1**.
- Step 4:** Follow the instruction listed in **Section 4.6** to replace the CF card.

## 5.6 Reinstalling the Covers

---

**WARNING:**

Failing to reinstall the covers may result in permanent damage to the system. Please make sure all coverings are properly installed.

---

When maintenance procedures are complete, please make sure all the covers are replaced, including the following:

- Aluminum cover
- Plastic cover



Chapter

6

# AMI BIOS Setup

---



## 6.1 Introduction

A licensed copy of AMI BIOS is preprogrammed into the ROM BIOS. The BIOS setup program allows users to modify the basic system configuration. This chapter describes how to access the BIOS setup program and the configuration options that may be changed.

### 6.1.1 Starting Setup

The AMI BIOS is activated when the computer is turned on. The setup program can be activated in one of two ways.

1. Press the **DELETE** key as soon as the system is turned on or
2. Press the **DELETE** key when the “**Press Del to enter SETUP**” message appears on the screen.

If the message disappears before the **DELETE** key is pressed, restart the computer and try again.

### 6.1.2 Using Setup

Use the arrow keys to highlight items, press **ENTER** to select, use the PageUp and PageDown keys to change entries, press **F1** for help and press **Esc** to quit. Navigation keys are shown in.

Key	Function
Up arrow	Move to previous item
Down arrow	Move to next item
Left arrow	Move to the item on the left hand side
Right arrow	Move to the item on the right hand side
Esc key	Main Menu – Quit and not save changes into CMOS Status Page Setup Menu and Option Page Setup Menu -- Exit current page and return to Main Menu
Page Up key	Increase the numeric value or make changes
Page Dn key	Decrease the numeric value or make changes



## AFL-xxA-N270 Series Panel PC

F1 key	General help, only for Status Page Setup Menu and Option Page Setup Menu
F2 /F3 key	Change color from total 16 colors. F2 to select color forward.
F10 key	Save all the CMOS changes, only for Main Menu

**Table 6-1: BIOS Navigation Keys**

### 6.1.3 Getting Help

When **F1** is pressed a small help window describing the appropriate keys to use and the possible selections for the highlighted item appears. To exit the Help Window press **Esc** or the **F1** key again.

### 6.1.4 Unable to Reboot After Configuration Changes

If the computer cannot boot after changes to the system configuration is made, CMOS defaults. Use the jumper described in **Chapter 5**.

### 6.1.5 BIOS Menu Bar

The **menu bar** on top of the BIOS screen has the following main items:

- **Main** Changes the basic system configuration.
- **Advanced** Changes the advanced system settings.
- **PCIPnP** Changes the advanced PCI/PnP Settings
- **Boot** Changes the system boot configuration.
- **Security** Sets User and Supervisor Passwords.
- **Chipset** Changes the chipset settings.
- **Exit** Selects exit options and loads default settings

The following sections completely describe the configuration options found in the menu items at the top of the BIOS screen and listed above.

## 6.2 Main

The **Main** menu gives an overview of the basic system information.

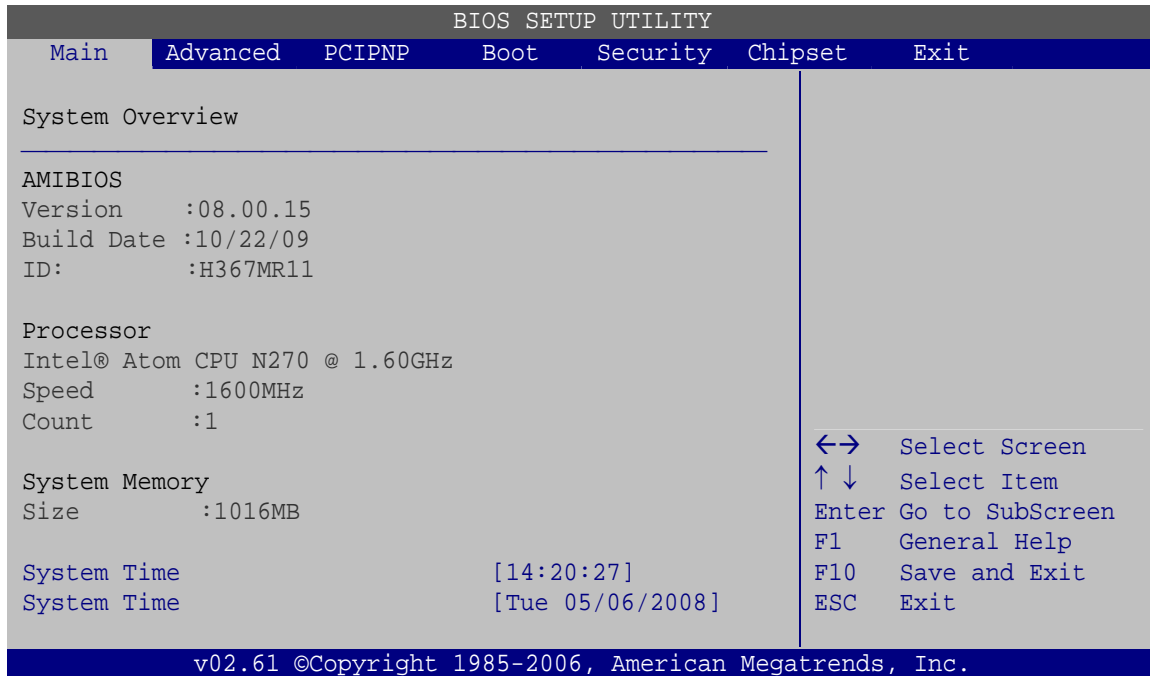

### BIOS Menu 1: Main

#### → System Overview

The **System Overview** lists a brief summary of different system components. The fields in **System Overview** cannot be changed. The items shown in the system overview include:

- AMI BIOS: Displays auto-detected BIOS information
  - **Version:** Current BIOS version
  - **Build Date:** Date the current BIOS version was made
  - **ID:** Installed BIOS ID
- Processor: Displays auto-detected CPU specifications
  - **Type:** Names the currently installed processor
  - **Speed:** Lists the processor speed
  - **Count:** The number of CPUs on the motherboard
- System Memory: Displays the auto-detected system memory.
  - **Size:** Lists memory size

## AFL-xxA-N270 Series Panel PC

The System Overview field also has two user configurable fields:

→ **System Time [xx:xx:xx]**

Use the **System Time** option to set the system time. Manually enter the hours, minutes and seconds.

→ **System Date [xx/xx/xx]**

Use the **System Date** option to set the system date. Manually enter the day, month and year.

### 6.3 Advanced

Use the **Advanced** menu to configure the CPU and peripheral devices through the following sub-menus:



#### **WARNING!**

Setting the wrong values in the sections below may cause the system to malfunction. Make sure that the settings made are compatible with the hardware.

---

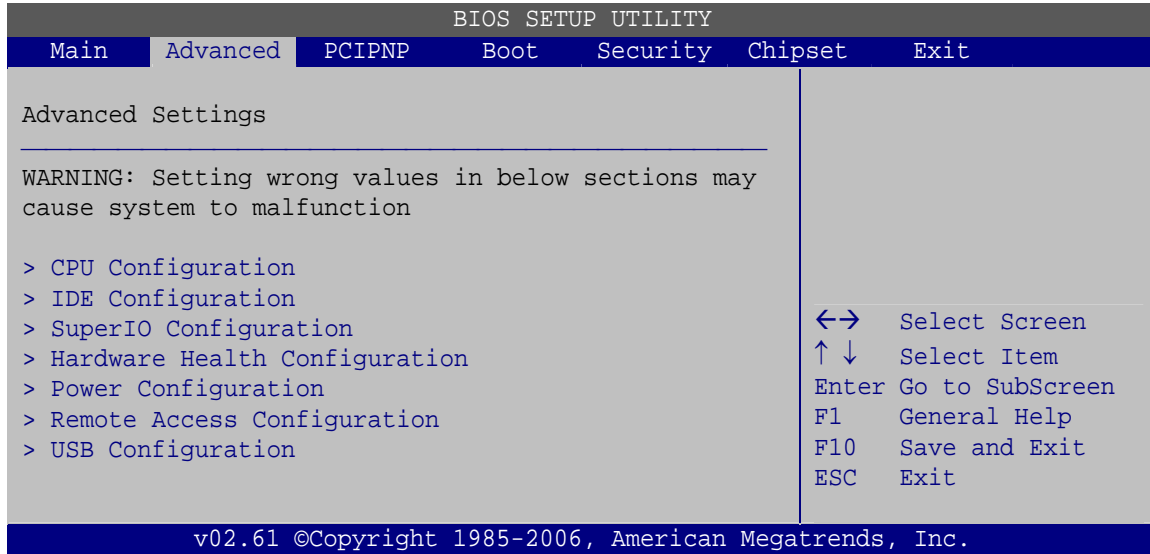

### BIOS Menu 2: Advanced

#### 6.3.1 CPU Configuration

Use the **CPU Configuration** menu to view detailed CPU specifications and configure the CPU.

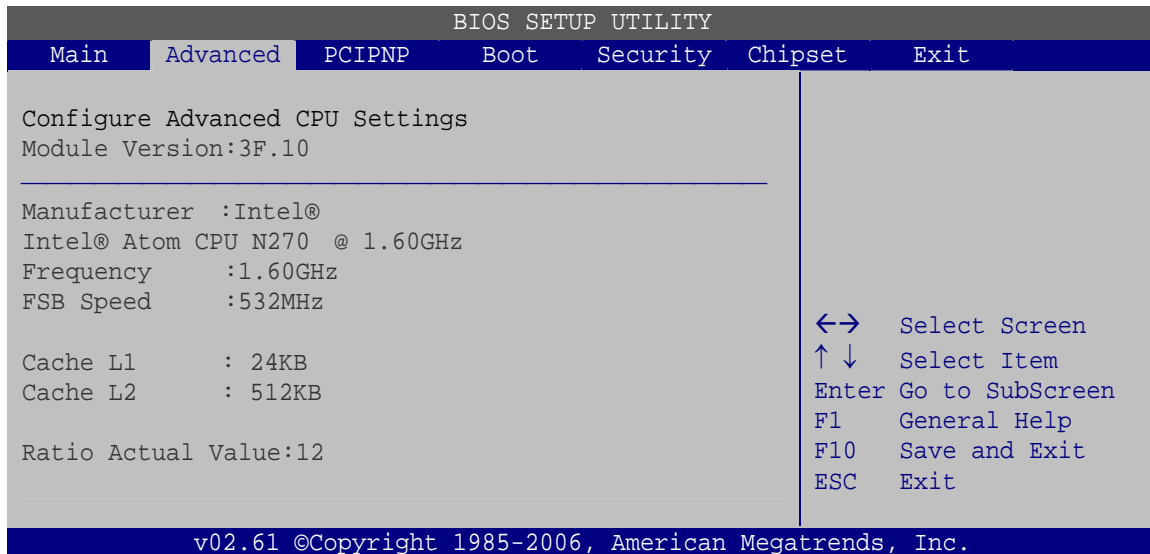

### BIOS Menu 3: CPU Configuration

The CPU Configuration menu lists the following CPU details:

- Manufacturer: Lists the name of the CPU manufacturer

## AFL-xxA-N270 Series Panel PC

- Brand String: Lists the brand name of the CPU being used
- Frequency: Lists the CPU processing speed
- FSB Speed: Lists the FSB speed
- Cache L1: Lists the CPU L1 cache size
- Cache L2: Lists the CPU L2 cache size
- Ratio Actual Value: the clock multiplier

### 6.3.2 IDE Configuration

Use the **IDE Configuration** menu to change and/or set the configuration of the IDE devices installed in the system.

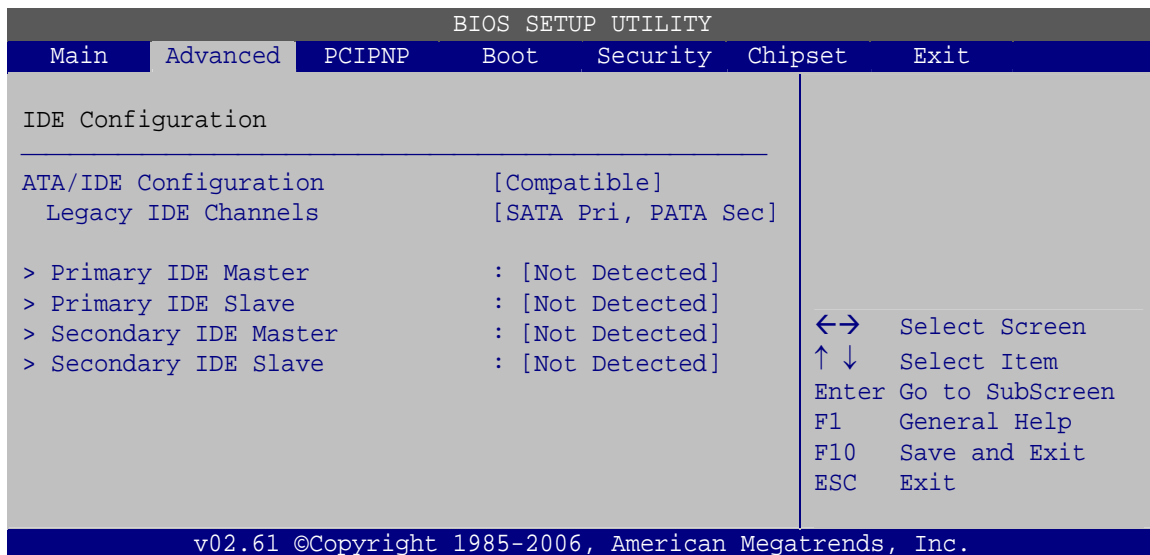

#### BIOS Menu 4: IDE Configuration

##### ➔ ATA/IDE Configurations [Compatible]

Use the **ATA/IDE Configurations** option to configure the ATA/IDE controller.

- ➔ **Disabled** Disables the on-board ATA/IDE controller.
- ➔ **Compatible** **DEFAULT** Configures the on-board ATA/IDE controller to be in compatible mode. In this mode, a SATA channel will replace one of the IDE channels. This mode supports up to 4 storage devices.

→ **Enhanced** Configures the on-board ATA/IDE controller to be in Enhanced mode. In this mode, IDE channels and SATA channels are separated. This mode supports up to 6 storage devices. Some legacy OS do not support this mode.

→ **Legacy IDE Channels [SATA Pri, PATA Sec]**

→ **SATA Only** Only the SATA drives are enabled.

→ **SATA Pri, PATA Sec** **DEFAULT** The SATA drives are enabled on the primary IDE channel, traditional IDE devices are enabled on the secondary channel

→ **PATA Only** Only the IDE devices are enabled

→ **IDE Master and IDE Slave**

When entering setup, BIOS auto detects the presence of IDE devices. BIOS displays the status of the auto detected IDE devices. The following IDE devices are detected and are shown in the **IDE Configuration** menu:

- Primary IDE Master
- Primary IDE Slave
- Secondary IDE Master
- Secondary IDE Slave

The **IDE Configuration** menu allows changes to the configurations for the IDE devices installed in the system. If an IDE device is detected, and one of the above listed four BIOS configuration options are selected, the IDE configuration options are shown.

### 6.3.2.1 IDE Master, IDE Slave

Use the **IDE Master** and **IDE Slave** configuration menu to view both primary and secondary IDE device details and configure the IDE devices connected to the system. Almost all settings are set to auto-detect, which will work for all modern drives.

## AFL-xxA-N270 Series Panel PC

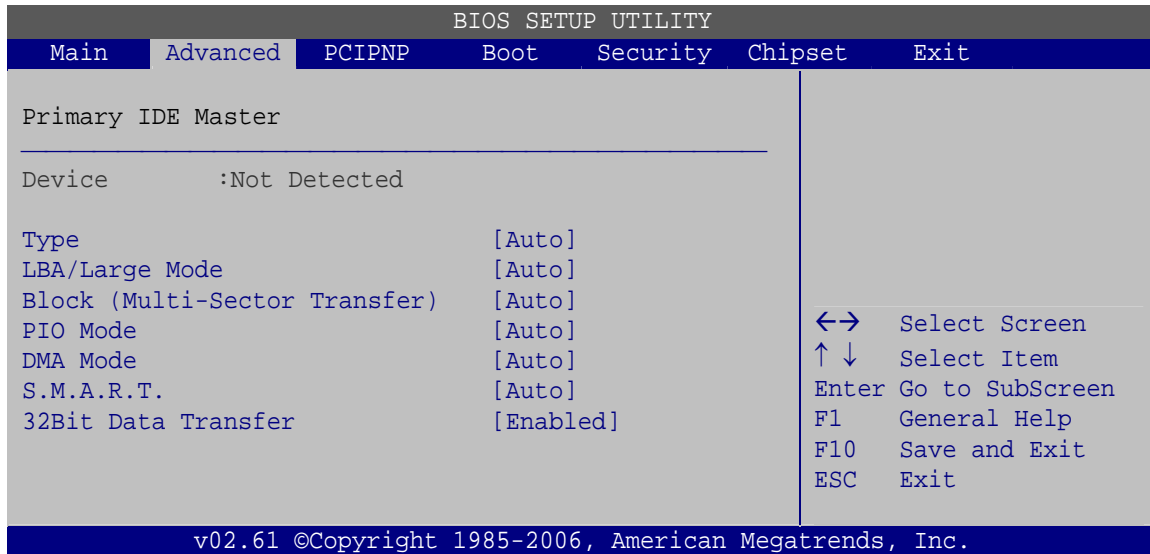

### BIOS Menu 5: IDE Master and IDE Slave Configuration

#### → Auto-Detected Drive Parameters

The “grayed-out” items in the left frame are IDE disk drive parameters automatically detected from the firmware of the selected IDE disk drive. The drive parameters are listed as follows:

- Device: Lists the device type (e.g. hard disk, CD-ROM etc.)
- Type: Indicates the type of devices a user can manually select
- LBA Mode: Indicates whether the LBA (Logical Block Addressing) is a method of addressing data on a disk drive is supported or not.
- Block Mode: Block mode boosts IDE drive performance by increasing the amount of data transferred. Only 512 bytes of data can be transferred per interrupt if block mode is not used. Block mode allows transfers of up to 64 KB per interrupt.
- PIO Mode: Indicates the PIO mode of the installed device.
- DMA: Indicates the DMA Mode that is supported.
- S.M.A.R.T.: Indicates whether or not the Self-Monitoring Analysis and Reporting Technology protocol is supported.
- 32Bit Data Transfer: Enables 32-bit data transfer.

**→ Type [Auto]**

Use the **Type** BIOS option select the type of device the AMIBIOS attempts to boot from after the Power-On Self-Test (POST) is complete.

- Not Installed** BIOS is prevented from searching for an IDE disk drive on the specified channel.
- Auto**      **DEFAULT** The BIOS auto detects the IDE disk drive type attached to the specified channel. This setting should be used if an IDE hard disk drive is attached to the specified channel.
- CD/DVD** The CD/DVD option specifies that an IDE CD-ROM drive is attached to the specified IDE channel. The BIOS does not attempt to search for other types of IDE disk drives on the specified channel.
- ARMD** This option specifies an ATAPI Removable Media Device. These include, but are not limited to:
  - ZIP
  - LS-120

**→ LBA/Large Mode [Auto]**

Use the **LBA/Large Mode** option to disable or enable BIOS to auto detects LBA (Logical Block Addressing). LBA is a method of addressing data on a disk drive. In LBA mode, the maximum drive capacity is 137 GB.

- Disabled** BIOS is prevented from using the LBA mode control on the specified channel.
- Auto**      **DEFAULT** BIOS auto detects the LBA mode control on the specified channel.

**→ Block (Multi Sector Transfer) [Auto]**

Use the **Block (Multi Sector Transfer)** to disable or enable BIOS to auto detect if the device supports multi-sector transfers.



## AFL-xxA-N270 Series Panel PC

- **Disabled** BIOS is prevented from using Multi-Sector Transfer on the specified channel. The data to and from the device occurs one sector at a time.
- **Auto** **DEFAULT** BIOS auto detects Multi-Sector Transfer support on the drive on the specified channel. If supported the data transfer to and from the device occurs multiple sectors at a time.

### → **PIO Mode [Auto]**

Use the **PIO Mode** option to select the IDE PIO (Programmable I/O) mode program timing cycles between the IDE drive and the programmable IDE controller. As the PIO mode increases, the cycle time decreases.

- **Auto** **DEFAULT** BIOS auto detects the PIO mode. Use this value if the IDE disk drive support cannot be determined.
- **0** PIO mode 0 selected with a maximum transfer rate of 3.3 MB/s
- **1** PIO mode 1 selected with a maximum transfer rate of 5.2 MB/s
- **2** PIO mode 2 selected with a maximum transfer rate of 8.3 MB/s
- **3** PIO mode 3 selected with a maximum transfer rate of 11.1 MB/s
- **4** PIO mode 4 selected with a maximum transfer rate of 16.6 MB/s  
(This setting generally works with all hard disk drives manufactured after 1999. For other disk drives, such as IDE CD-ROM drives, check the specifications of the drive.)

### → **DMA Mode [Auto]**

Use the **DMA Mode** BIOS selection to adjust the DMA mode options.

- **Auto** **DEFAULT** BIOS auto detects the DMA mode. Use this value if the IDE disk drive support cannot be determined.

**→ S.M.A.R.T [Auto]**

Use the **S.M.A.R.T** option to auto-detect, disable or enable Self-Monitoring Analysis and Reporting Technology (SMART) on the drive on the specified channel. **S.M.A.R.T** predicts impending drive failures. The **S.M.A.R.T** BIOS option enables or disables this function.

- **Auto**      **DEFAULT**      BIOS auto detects HDD SMART support.
- **Disabled**                      Prevents BIOS from using the HDD SMART feature.
- **Enabled**                      Allows BIOS to use the HDD SMART feature

**→ 32Bit Data Transfer [Enabled]**

Use the **32Bit Data Transfer** BIOS option to enables or disable 32-bit data transfers.

- **Disabled**                      Prevents the BIOS from using 32-bit data transfers.
- **Enabled**      **DEFAULT**      Allows BIOS to use 32-bit data transfers on supported hard disk drives.

### 6.3.3 Super IO Configuration

Use the **Super IO Configuration** menu to set or change the configurations for the FDD controllers, parallel ports and serial ports.

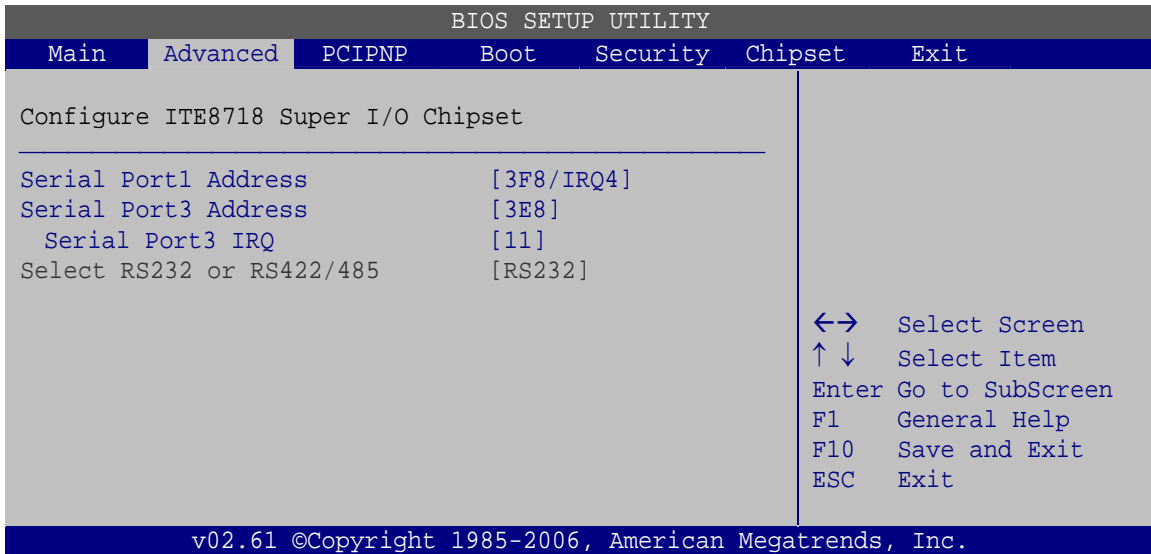

**BIOS Menu 6: Super IO Configuration**

## AFL-xxA-N270 Series Panel PC

### → Serial Port 1 Address [3F8/IRQ4]

Sets the port address and IRQ of serial port 1.

- Disabled
- 3F8/IRQ4      **DEFAULT**
- 2F8/IRQ3
- 3E8/IRQ4
- 2E8/IRQ3

### → Serial Port 3 Address [3E8]

Sets the port address of serial port 3.

- Disabled
- 3E8            **DEFAULT**
- 2E8
- 2F0
- 2E0

### → Serial Port 3 IRQ [IRQ4]

Sets the interrupt address of serial port 3.

- 10
- 11            **DEFAULT**

### → Select RS232 or RS422/RS485 [RS232]

Sets the communications protocol for serial port 3. This is set using a hardware jumper inside the system. This option can only be changed if the jumper setting is set to allow it.

- RS232        **DEFAULT**
- RS422/RS485

### 6.3.4 Hardware Health Configuration

The **Hardware Health Configuration** menu shows the operating temperature, fan speeds and system voltages.

BIOS SETUP UTILITY	
Main	Advanced
PCIPNP    Boot    Security    Chipset    Exit	
Hardware Health Event Monitoring	
CPU Temperature	:43°C/109°F
System Temperature	:40°C/104°F
CPU Core	:1.088 V
+1.05V	:1.024 V
+3.30V	:3.312 V
+5.00V	:5.026 V
+12.0V	:12.160V
+1.50V	:1.504 V
+1.80V	:1.776 V
5VSB	:5.026 V
VBAT	:3.232 V
←→ Select Screen ↑↓ Select Item Enter Go to SubScreen F1 General Help F10 Save and Exit ESC Exit	
v02.61 ©Copyright 1985-2006, American Megatrends, Inc.	

**BIOS Menu 7: Hardware Health Configuration**

### 6.3.5 Power Configuration

The **Power Configuration** menu configures the power related settings.

## AFL-xxA-N270 Series Panel PC

```

BIOS SETUP UTILITY
Main  Advanced  PCIPNP  Boot  Security  Chipset  Exit
-----
Auto Power Button Status      [Disabled]

> ACPI Configuration
> APM Configuration

                                  ←→  Select Screen
                                  ↑↓  Select Item
                                  Enter Go to SubScreen
                                  F1   General Help
                                  F10  Save and Exit
                                  ESC  Exit

v02.61 ©Copyright 1985-2006, American Megatrends, Inc.
  
```

### BIOS Menu 8: Power Configuration

#### 6.3.5.1 ACPI Configuration

Use the **ACPI Configuration** menu (**BIOS Menu 9**) to select the ACPI state when the system is suspended.

```

BIOS SETUP UTILITY
Main  Advanced  PCIPNP  Boot  Security  Chipset  Exit
-----
ACPI Settings
-----
Suspend mode      [S1 (POS)]

                                  ←→  Select Screen
                                  ↑↓  Select Item
                                  Enter Go to SubScreen
                                  F1   General Help
                                  F10  Save and Exit
                                  ESC  Exit

v02.61 ©Copyright 1985-2006, American Megatrends, Inc.
  
```

### BIOS Menu 9: General ACPI Configuration

➔ **Suspend Mode [S1(POS)]**

Use the **Suspend Mode** option to specify the sleep state the system enters when it is not being used.

- ➔ **S1 (POS) DEFAULT** System appears off. The CPU is stopped. RAM is refreshed.
- ➔ **S3 (STR)** System appears off. The CPU has no power. RAM in slow refresh. Power supply in reduced power mode.

### 6.3.5.2 APM Configuration

The **APM Configuration** menu allows the advanced power management options to be configured.

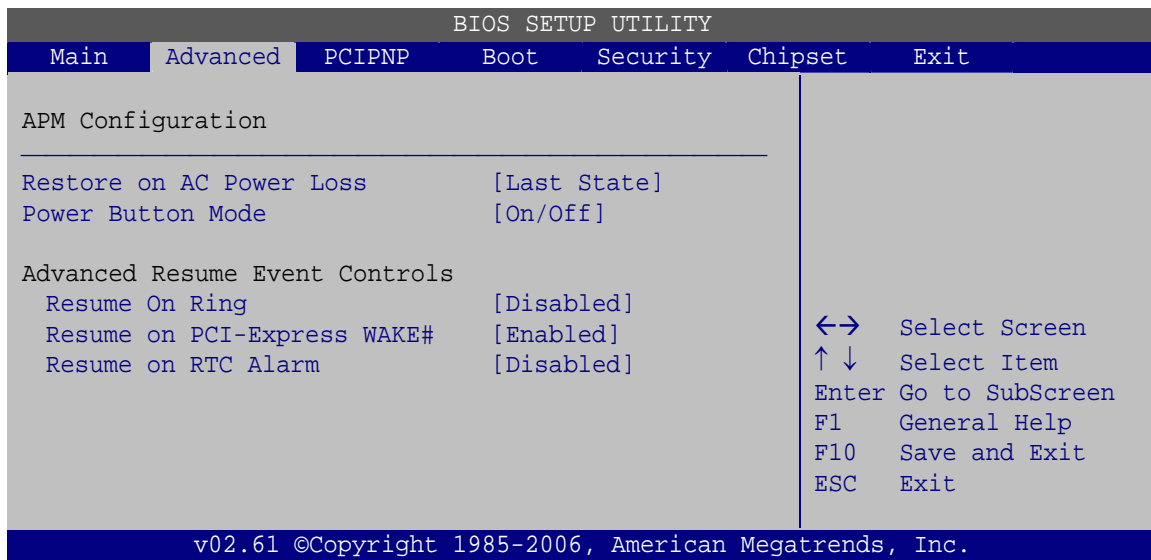

**BIOS Menu 10: APM Configuration**

➔ **Restore on AC Power Loss [Last State]**

Use the **Restore on AC Power Loss** BIOS option to specify what state the system returns to if there is a sudden loss of power to the system.

- ➔ **Power Off** The system remains turned off
- ➔ **Power On** The system turns on

## AFL-xxA-N270 Series Panel PC

- **Last State**    **DEFAULT**    The system returns to its previous state. If it was on, it turns itself on. If it was off, it remains off.

### → **Power Button Mode [On/Off]**

Use the **Power Button Mode** BIOS to specify how the power button functions.

- **On/Off**    **DEFAULT**    When the power button is pressed the system is either turned on or off
- **Suspend**          When the power button is pressed the system goes into suspend mode

### → **Resume on Ring [Disabled]**

Use the **Resume on Ring** BIOS option to enable activity on the RI (ring in) modem line to rouse the system from a suspend or standby state. That is, the system will be roused by an incoming call on a modem.

- **Disabled**    **DEFAULT**    Wake event not generated by an incoming call
- **Enabled**          Wake event generated by an incoming call

### → **Resume on PCI-Express WAKE# [Enabled]**

The **Resume on PCI-Express WAKE#** BIOS option specifies if the system is roused from a suspended or standby state when there is activity on the PCI-Express bus.

- **Disabled**          Wake event not generated by PCI-Express activity
- **Enabled**    **DEFAULT**    Wake event generated by PCI-Express activity

### → **Resume On RTC Alarm [Disabled]**

Use the **Resume On RTC Alarm** option to specify the time the system should be roused from a suspended state.

- **Disabled**    **DEFAULT**    The real time clock (RTC) cannot generate a wake event

➔ **Enabled**

If selected, the following appears with values that can be selected:

RTC Alarm Date (Days)

System Time

After setting the alarm, the computer turns itself on from a suspend state when the alarm goes off.

### 6.3.6 Remote Access Configuration

Use the **Remote Access Configuration** menu to configure remote access parameters. The **Remote Access Configuration** is an AMIBIOS feature and allows a remote host running a terminal program to display and configure the BIOS settings.

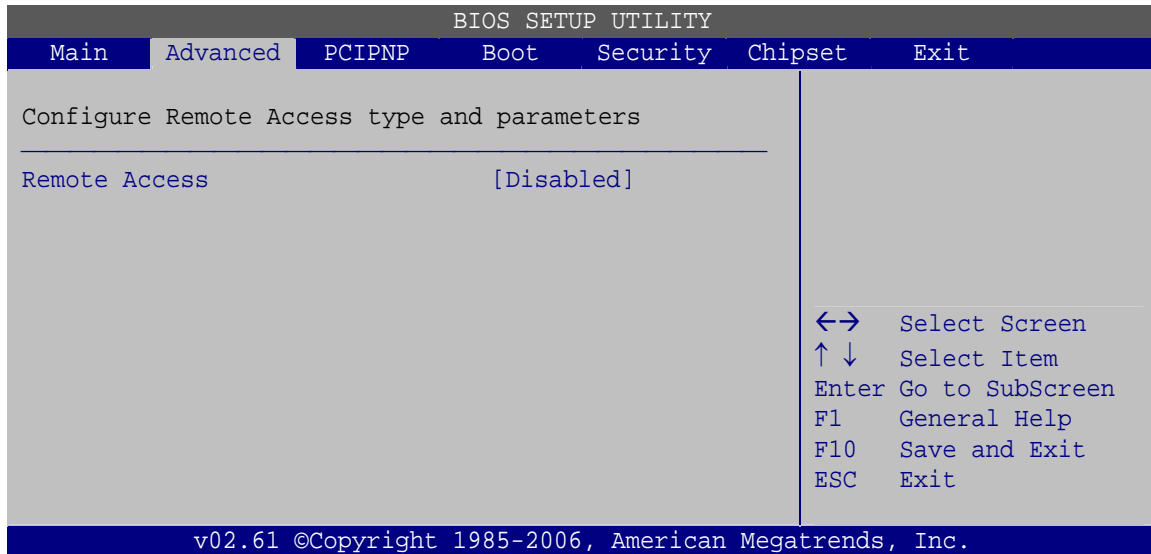

**BIOS Menu 11: Remote Access Configuration**

➔ **Remote Access [Disabled]**

Use the **Remote Access** option to enable or disable access to the remote functionalities of the system.

➔ **Disabled**      **DEFAULT**      Remote access is disabled.



## AFL-xxA-N270 Series Panel PC

### → Enabled

Remote access configuration options shown below appear:

Serial Port Number

Serial Port Mode

Redirection after BIOS POST

Terminal Type

These configuration options are discussed below.

### → Serial Port Number [COM1]

Use the **Serial Port Number** option allows to select the serial port used for remote access.

→ **COM1**    **DEFAULT**    System is remotely accessed through COM1

→ **COM3**    System is remotely accessed through COM3

**NOTE:** Make sure the selected COM port is enabled through the Super I/O configuration menu.

### → Base Address, IRQ [3F8h,4]

The **Base Address, IRQ** option cannot be configured and only shows the interrupt address of the serial port listed above.

### → Serial Port Mode [115200 8,n,1]

Use the **Serial Port Mode** option to select baud rate through which the console redirection is made. The following configuration options are available

- 115200 8,n,1    **DEFAULT**
- 57600 8,n,1
- 38400 8,n,1
- 19200 8,n,1
- 09600 8,n,1

**NOTE:**

Identical baud rate setting must be set on the host (a management computer running a terminal software) and the slave

**→ Redirection After BIOS POST [Always]**

Use the **Redirection After BIOS POST** option to specify when console redirection should occur.

- |   |                    |                |  |
|---|--------------------|----------------|--|
| → | <b>Disabled</b>    |                | The console is not redirected after POST                               |
| → | <b>Boot Loader</b> |                | Redirection is active during POST and during Boot Loader               |
| → | <b>Always</b>      | <b>DEFAULT</b> | Redirection is always active (Some Oses may not work if set to Always) |

**→ Terminal Type [ANSI]**

Use the **Terminal Type** BIOS option to specify the remote terminal type.

- |   |                |                |                                     |
|---|----------------|----------------|-------------------------------------|
| → | <b>ANSI</b>    | <b>DEFAULT</b> | The target terminal type is ANSI    |
| → | <b>VT100</b>   |                | The target terminal type is VT100   |
| → | <b>VT-UTF8</b> |                | The target terminal type is VT-UTF8 |

**6.3.7 USB Configuration**

Use the **USB Configuration** menu to read USB configuration information and configure the USB settings.

## AFL-xxA-N270 Series Panel PC

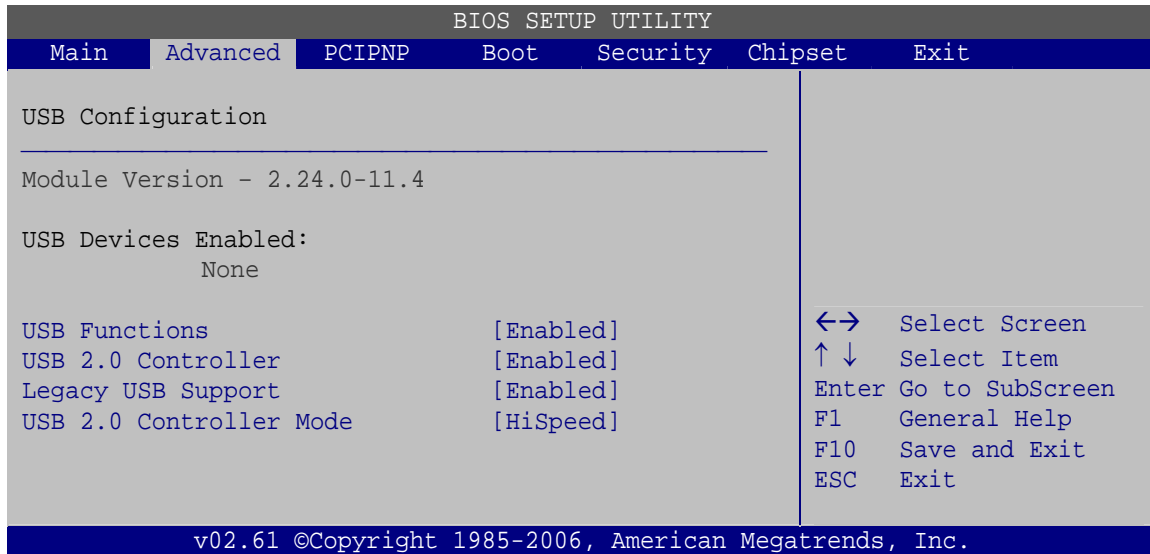

### BIOS Menu 12: USB Configuration

#### → USB Function [Enabled]

Use the **USB Function** BIOS option to enable or disable USB function support.

- **Disabled**                      USB function support disabled
- **Enabled**      **DEFAULT**      USB function support enabled

#### → USB 2.0 Controller [Enabled]

Use the **USB 2.0 Controller** BIOS option to enable or disable the USB 2.0 controller

- **Enabled**      **DEFAULT**      USB 2.0 controller enabled
- **Disabled**                      USB 2.0 controller disabled

#### → Legacy USB Support [Enabled]

Use the **Legacy USB Support** BIOS option to enable USB mouse and USB keyboard support.

Normally if this option is not enabled, any attached USB mouse or USB keyboard does not become available until a USB compatible operating system is fully booted with all USB

drivers loaded. When this option is enabled, any attached USB mouse or USB keyboard can control the system even when there is no USB driver loaded onto the system.

- ➔ **Disabled** Legacy USB support disabled
- ➔ **Enabled**     **DEFAULT** Legacy USB support enabled
- ➔ **Auto** Legacy USB support disabled if no USB devices are connected

➔ **USB2.0 Controller Mode [HiSpeed]**

Use the **USB2.0 Controller Mode** option to set the speed of the USB2.0 controller.

- ➔ **FullSpeed** The controller is capable of operating at 12 Mb/s
- ➔ **HiSpeed**     **DEFAULT** The controller is capable of operating at 480 Mb/s

## 6.4 PCI/PnP

Use the **PCI/PnP** menu (**BIOS Menu 13**) to configure advanced PCI and PnP settings.



**WARNING!**

Setting wrong values for the BIOS selections in the PCIPnP BIOS menu may cause the system to malfunction.

---

## AFL-xxA-N270 Series Panel PC

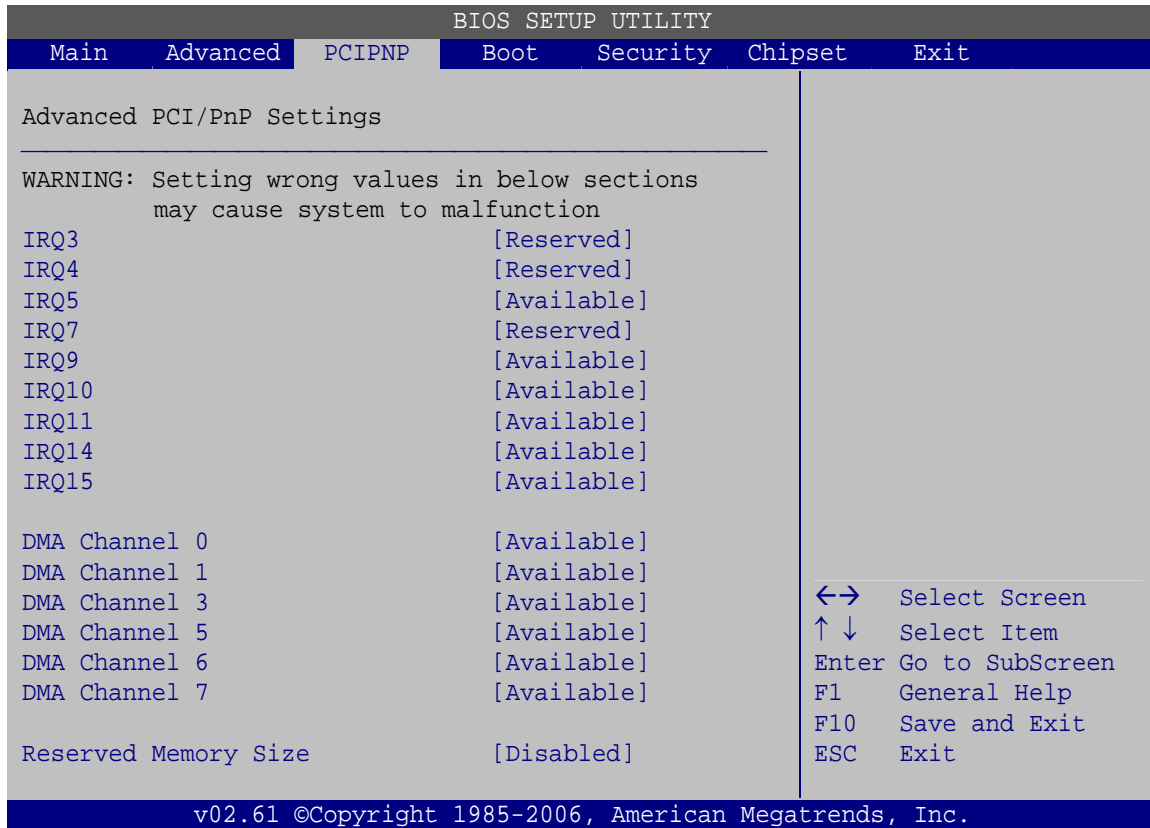

### BIOS Menu 13: PCI/PnP Configuration

#### → IRQ#

Use the **IRQ#** address to specify what IRQs can be assigned to a particular peripheral device.

→ **Available**                      The specified IRQ is available to be used by PCI/PnP devices

→ **Reserved**                        The specified IRQ is reserved for use by Legacy ISA devices

Available IRQ addresses are:

- IRQ3
- IRQ4
- IRQ5
- IRQ7

- IRQ9
- IRQ10
- IRQ 11
- IRQ 14
- IRQ 15

➔ **DMA Channel# [Available]**

Use the **DMA Channel#** option to assign a specific DMA channel to a particular PCI/PnP device.

- ➔ **Available**     **DEFAULT**     The specified DMA is available to be used by PCI/PnP devices
- ➔ **Reserved**                     The specified DMA is reserved for use by Legacy ISA devices

Available DMA Channels are:

- DM Channel 0
- DM Channel 1
- DM Channel 3
- DM Channel 5
- DM Channel 6
- DM Channel 7

➔ **Reserved Memory Size [Disabled]**

Use the **Reserved Memory Size** BIOS option to specify the amount of memory that should be reserved for legacy ISA devices.

- ➔ **Disabled**     **DEFAULT**     No memory block reserved for legacy ISA devices
- ➔ **16K**                             16 KB reserved for legacy ISA devices
- ➔ **32K**                             32 KB reserved for legacy ISA devices
- ➔ **64K**                             64 KB reserved for legacy ISA devices

## AFL-xxA-N270 Series Panel PC

### 6.5 Boot

Use the **Boot** menu to configure system boot options.

```

BIOS SETUP UTILITY
Main  Advanced  PCIPNP  Boot  Security  Chipset  Exit
-----
Boot Settings
-----
> Boot Settings Configuration

                                  ←→  Select Screen
                                  ↑↓  Select Item
                                  Enter Go to SubScreen
                                  F1   General Help
                                  F10  Save and Exit
                                  ESC  Exit

v02.61 ©Copyright 1985-2006, American Megatrends, Inc.
  
```

**BIOS Menu 14: Boot**

#### 6.5.1 Boot Settings Configuration

Use the **Boot Settings Configuration** menu (**BIOS Menu 15**) to configure advanced system boot options.

```

BIOS SETUP UTILITY
Main  Advanced  PCIPNP  Boot  Security  Chipset  Exit
-----
Boot Settings Configuration
-----
Quick Boot                [Enabled]
Quiet Boot                [Enabled]
AddOn ROM Display Mode   [Force BIOS]
Bootup Num-Lock          [On]
Boot From LAN Support     [Disabled]
Spread Spectrum Function  [Disabled]

                                  ←→  Select Screen
                                  ↑↓  Select Item
                                  Enter Go to SubScreen
                                  F1   General Help
                                  F10  Save and Exit
                                  ESC  Exit

v02.61 ©Copyright 1985-2006, American Megatrends, Inc.
  
```

**BIOS Menu 15: Boot Settings Configuration**

**→ Quick Boot [Enabled]**

Use the **Quick Boot** BIOS option to make the computer speed up the boot process.

- **Disabled** No POST procedures are skipped
- **Enabled** **DEFAULT** Some POST procedures are skipped to decrease the system boot time

**→ Quiet Boot [Enabled]**

Use the **Quiet Boot** BIOS option to select the screen display when the system boots.

- **Disabled** Normal POST messages displayed
- **Enabled** **DEFAULT** OEM Logo displayed instead of POST messages

**→ AddOn ROM Display Mode [Force BIOS]**

Use the **AddOn ROM Display Mode** option to allow add-on ROM (read-only memory) messages to be displayed.

- **Force BIOS** **DEFAULT** The system forces third party BIOS to display during system boot.
- **Keep Current** The system displays normal information during system boot.

**→ Bootup Num-Lock [On]**

Use the **Bootup Num-Lock** BIOS option to specify if the number lock setting must be modified during boot up.

- **Off** Does not enable the keyboard Number Lock automatically. To use the 10-keys on the keyboard, press the Number Lock key located on the upper left-hand corner of the 10-key pad. The Number Lock LED on the keyboard lights up when the Number Lock is engaged.



## AFL-xxA-N270 Series Panel PC

- **On**    **DEFAULT**    Allows the Number Lock on the keyboard to be enabled automatically when the computer system boots up. This allows the immediate use of the 10-key numeric keypad located on the right side of the keyboard. To confirm this, the Number Lock LED light on the keyboard is lit.

### → **Boot From LAN Support [Disabled]**

Use the **BOOT From LAN Support** option to enable the system to be booted from a remote system.

- **Enabled**                                    Can be booted from a remote system through the LAN
- **Disabled**    **DEFAULT**                Cannot be booted from a remote system through the LAN

### → **Spread Spectrum Function [Disabled]**

The **Spread Spectrum Function** option can help to improve CPU EMI issues.

- **Disabled**    **DEFAULT**                The spread spectrum mode is disabled
- **Enabled**                                    The spread spectrum mode is enabled

## 6.6 Security

Use the **Security** menu to set system and user passwords.

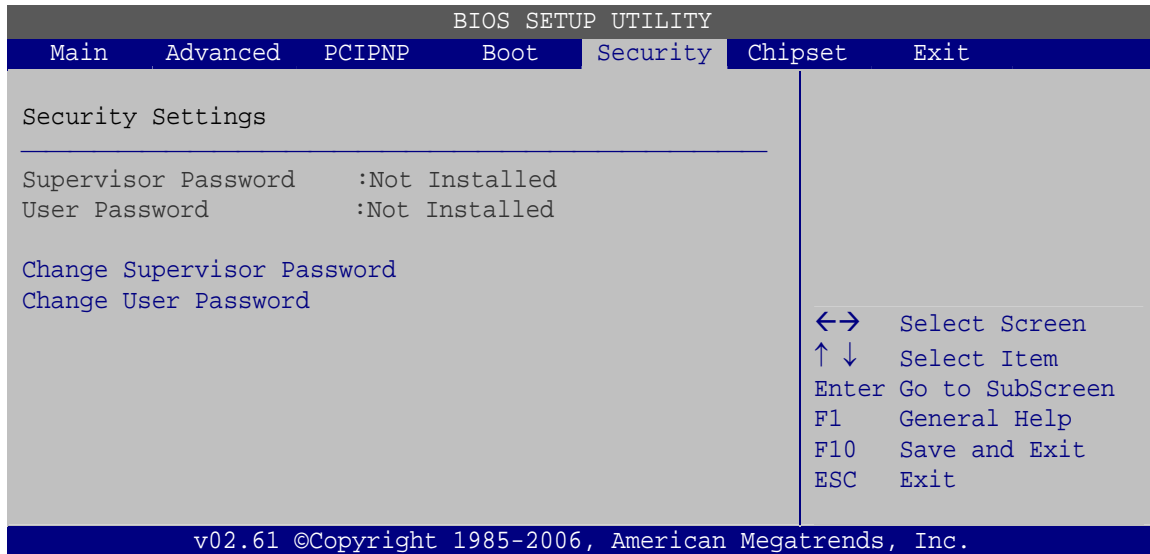

### BIOS Menu 16: Security

#### → Change Supervisor Password

Use the **Change Supervisor Password** to set or change a supervisor password. The default for this option is **Not Installed**. If a supervisor password must be installed, select this field and enter the password. After the password has been added, **Install** appears next to **Change Supervisor Password**.

#### → Change User Password

Use the **Change User Password** to set or change a user password. The default for this option is **Not Installed**. If a user password must be installed, select this field and enter the password. After the password has been added, **Install** appears next to **Change User Password**.

## 6.7 Chipset

Use the **Chipset** menu to access the Northbridge and Southbridge configuration menus



### WARNING!

Setting the wrong values for the Chipset BIOS selections in the Chipset BIOS menu may cause the system to malfunction.

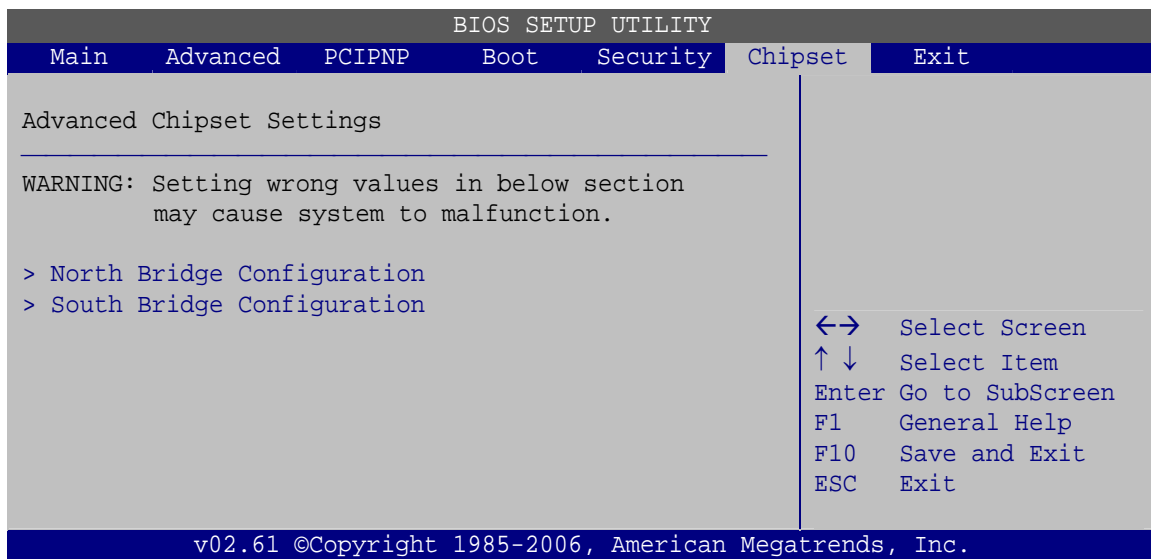

**BIOS Menu 17: Chipset**

### 6.7.1 North Bridge Configuration

Use the **North Bridge Chipset Configuration** menu (**BIOS Menu 18**) to configure the Northbridge chipset.

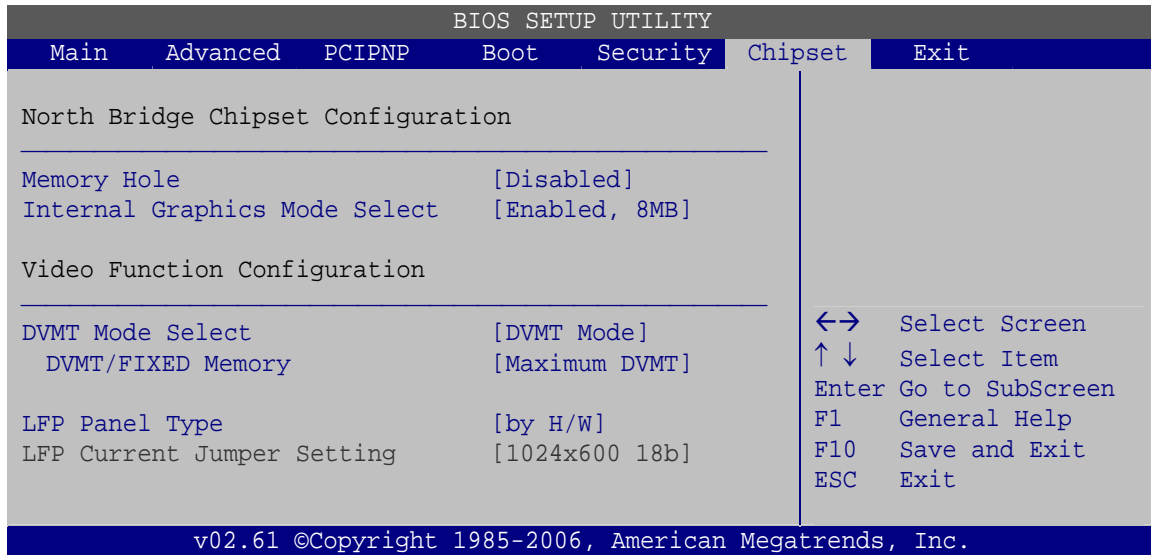

#### BIOS Menu 18:Northbridge Chipset Configuration

##### → Memory Hole [Disabled]

Use the **Memory Hole** option to reserve memory space between 15 MB and 16 MB for ISA expansion cards that require a specified area of memory to work properly. If an older ISA expansion card is used, please refer to the documentation that came with the card to see if it is necessary to reserve the space.

- **Disabled**      **DEFAULT**      Memory is not reserved for ISA expansion cards
- **15 MB–16 MB**      Between 15 MB and 16 MB of memory is reserved for ISA expansion cards

##### → Internal Graphics Mode Select [Enable, 8 MB]

Use the **Internal Graphic Mode Select** option to specify the amount of system memory that can be used by the Internal graphics device.

- **Disable**

## AFL-xxA-N270 Series Panel PC

- ➔ **Enable, 1 MB** 1 MB of memory used by internal graphics device
- ➔ **Enable, 8 MB** **DEFAULT** 8 MB of memory used by internal graphics device

### ➔ **DVMT Mode Select [DVMT Mode]**

Use the **DVMT Mode Select** option to select the Intel Dynamic Video Memory Technology (DVMT) operating mode.

- ➔ **Fixed Mode** A fixed portion of graphics memory is reserved as graphics memory.
- ➔ **DVMT Mode** **DEFAULT** Graphics memory is dynamically allocated according to the system and graphics needs.
- ➔ **Combo Mode** A fixed portion of graphics memory is reserved as graphics memory. If more memory is needed, graphics memory is dynamically allocated according to the system and graphics needs.

### ➔ **DVMT/FIXED Memory [Maximum DVMT]**

Use the **DVMT/FIXED Memory** option to specify the maximum amount of memory that can be allocated as graphics memory. This option can only be configured for if **DVMT Mode** or **Fixed Mode** is selected in the **DVMT Mode Select** option. If **Combo Mode** is selected, the maximum amount of graphics memory is 128 MB. Configuration options are listed below.

- 64 MB
- 128 MB
- **Maximum DVMT** **DEFAULT**

### ➔ **LFP Panel Type [by H/W]**

Use the **LFP Panel Type** to determine the LCD panel resolution. Configuration options are listed below:

- 640x480 18b
- 800x480 18b

- 800x600 18b
- 1024x768 18b
- 1280x1024 36b
- 1400x1050 36b
- 1440x900 36b
- 1600x1200 36b
- 1024x600 18b
- by H/W

➔ **LFP Current Jumper Setting [1024x600 18b]**

Displays the resolution setting of the LFP port by the on-board jumper.

### 6.7.2 South Bridge Configuration

The **South Bridge Configuration** menu the Southbridge chipset to be configured.

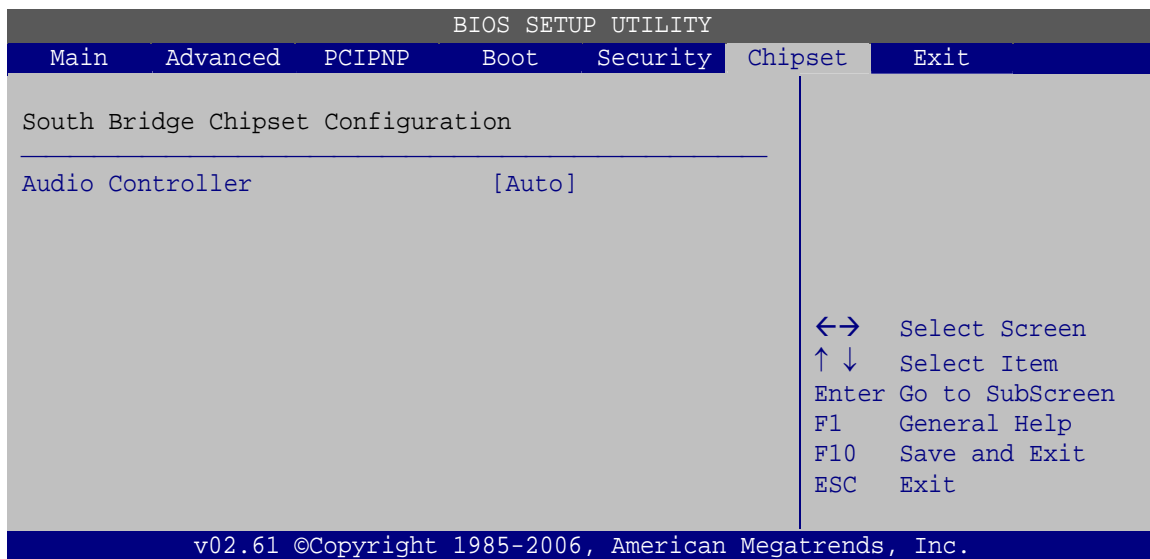

#### BIOS Menu 19:South Bridge Chipset Configuration

➔ **Audio Controller [Auto]**

Use the **Audio Controller** option to enable or disable the onboard audio.

- ➔ **Auto**      **DEFAULT**      The audio chip is activated if detected

## AFL-xxA-N270 Series Panel PC

➔ **All Disabled**                      The audio chip is disabled

### 6.8 Exit

Use the **Exit** menu to load default BIOS values, optimal failsafe values and to save configuration changes.

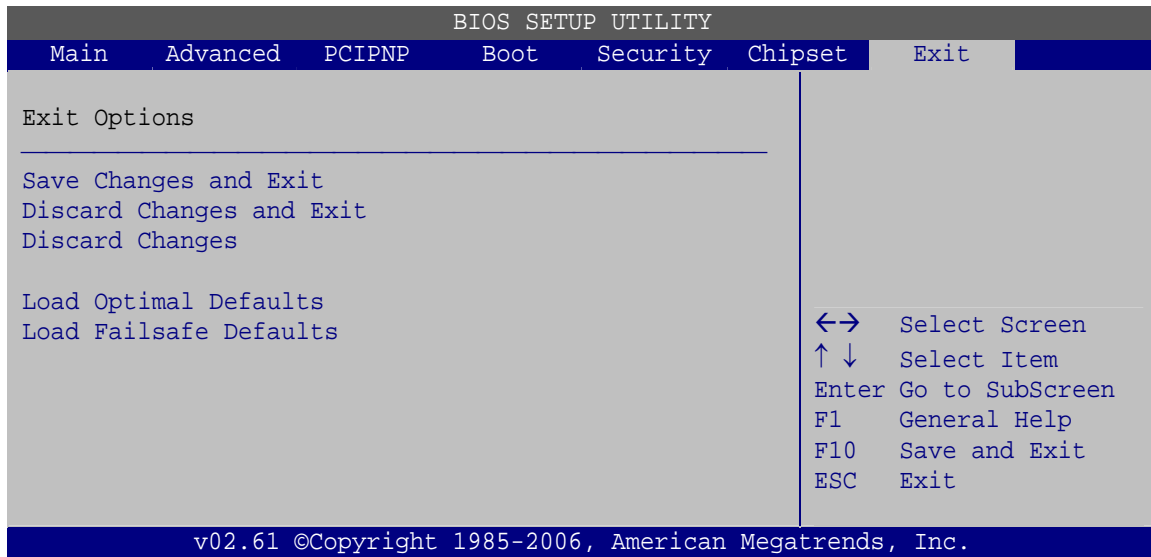

#### BIOS Menu 20:Exit

##### ➔ **Save Changes and Exit**

Use the **Save Changes and Exit** option to save the changes made to the BIOS options and to exit the BIOS configuration setup program.

##### ➔ **Discard Changes and Exit**

Use the **Discard Changes and Exit** option to exit the BIOS configuration setup program without saving the changes made to the system.

##### ➔ **Discard Changes**

Use the **Discard Changes** option to discard the changes and remain in the BIOS configuration setup program.

→ **Load Optimal Defaults**

Use the **Load Optimal Defaults** option to load the optimal default values for each of the parameters on the Setup menus. **F9 key can be used for this operation.**

→ **Load Failsafe Defaults**

Use the **Load Failsafe Defaults** option to load failsafe default values for each of the parameters on the Setup menus. **F8 key can be used for this operation.**



Chapter

7

# Software Drivers

---

## 7.1 Available Software Drivers

---



### NOTE:

The content of the CD may vary throughout the life cycle of the product and is subject to change without prior notice. Visit the IEI website or contact technical support for the latest updates.

---

The following drivers can be installed on the system:

- Chipset
- VGA
- LAN
- Touch screen
- Audio
- Wireless
- Bluetooth (optional)

Installation instructions are given below.

## 7.2 Starting the Driver Program

To access the driver installation programs, please do the following.

**Step 1:** Insert the CD-ROM that came with the system into a CD-ROM drive attached to the system.

**Step 2:** Click **AFLMB-945GSE-N270-R10 Driver**.

**Step 3:** The list of drivers in **Figure 7-1** appears.



Figure 7-1: Drivers

### 7.3 Chipset Driver Installation

To install the chipset driver, please do the following.

**Step 1:** Access the driver list shown in **Figure 7-1** (See **Section 7.2**). Click “Chipset”.

**Step 2:** The setup files are extracted as shown in **Figure 7-2**.

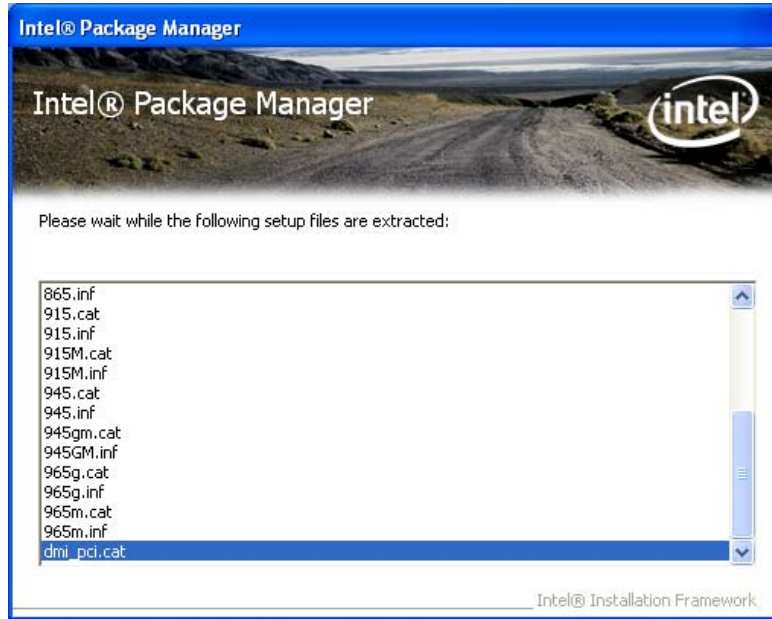

Figure 7-2: Chipset Driver Screen

**Step 3:** When the setup files are completely extracted the **Welcome Screen** in **Figure 7-3** appears.



Figure 7-3: Chipset Driver Welcome Screen

**Step 4:** Click **Next** to continue.

## AFL-xxA-N270 Series Panel PC

**Step 5:** The license agreement in **Figure 7-4** appears.

**Step 6:** Read the **License Agreement**.

**Step 7:** Click the **Yes** icon to continue.



**Figure 7-4: Chipset Driver License Agreement**

**Step 8:** The Read Me file in **Figure 7-5** appears.

**Step 9:** Click **Next** to continue.



Figure 7-5: Chipset Driver Read Me File

**Step 10: Setup Operations** are performed as shown in Figure 7-6.



**Figure 7-6: Chipset Driver Setup Operations**

**Step 11:** Once the **Setup Operations** are complete, click the **Next** icon to continue.

**Step 12:** The **Finish** screen appears.

**Step 13:** Select “**Yes, I want to restart the computer now**” and click the **Finish** icon.

See **Figure 7-7**.



Figure 7-7: Chipset Driver Installation Finish Screen

## 7.4 VGA Driver Installation

To install the VGA driver, please do the following.

- Step 1:** Access the driver list shown in **Figure 7-1** (See **Section 7.2**). Click **“VGA”**.
- Step 2:** The VGA Read Me file in **Figure 7-8** appears.
- Step 3:** Click **Next** to continue.



**AFL-xxA-N270 Series Panel PC**

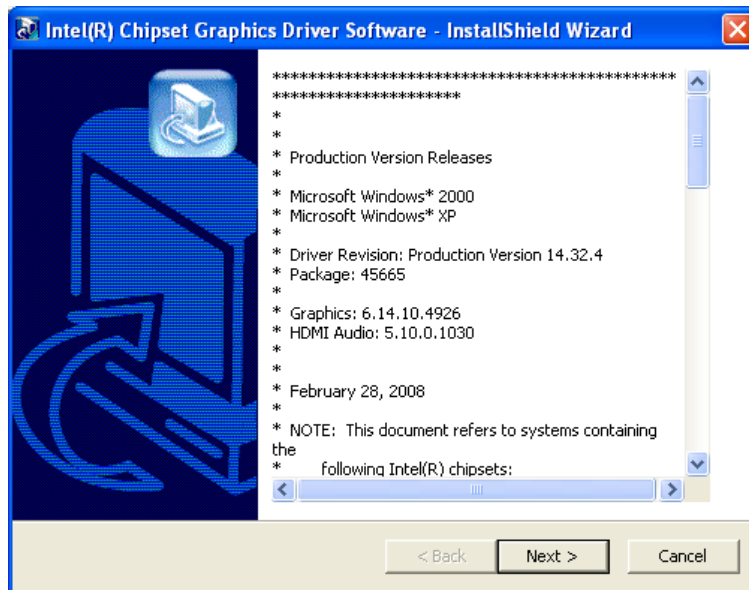

**Figure 7-8: VGA Driver Read Me File**

**Step 4:** The installation files are extracted. See **Figure 7-9**.

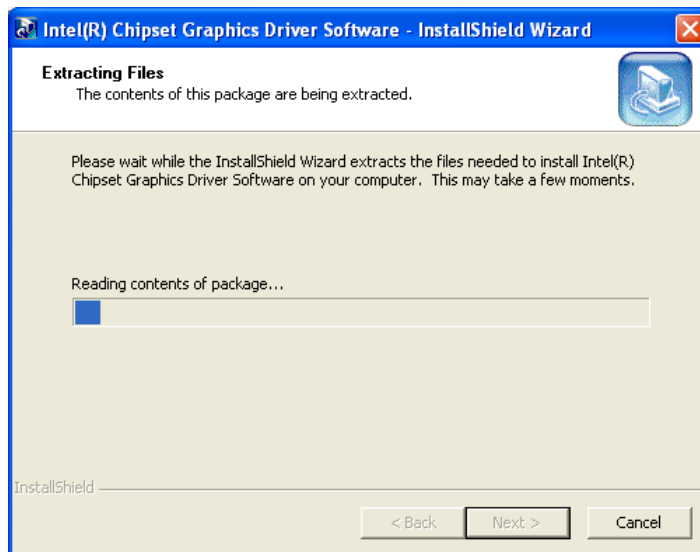

**Figure 7-9: VGA Driver Setup Files Extracted**

**Step 5:** The **Welcome Screen** in **Figure 7-10** appears.



**Figure 7-10: VGA Driver Welcome Screen**

- Step 6:** Click **Next** to continue.
- Step 7:** The license agreement in **Figure 7-11** appears.
- Step 8:** Read the **License Agreement**.
- Step 9:** Click the **Yes** icon to continue.

**AFL-xxA-N270 Series Panel PC**

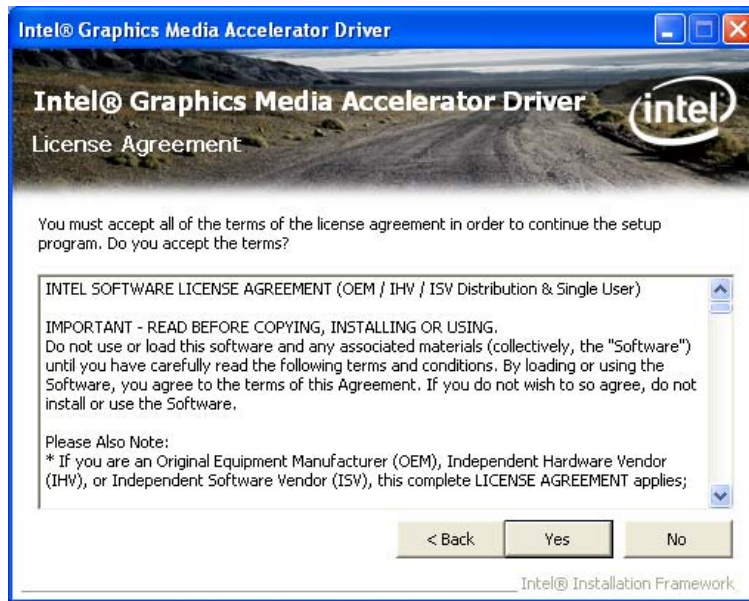

**Figure 7-11: VGA Driver License Agreement**

**Step 10:** The Read Me file in **Figure 7-12** appears.

**Step 11:** Click **Next** to continue.

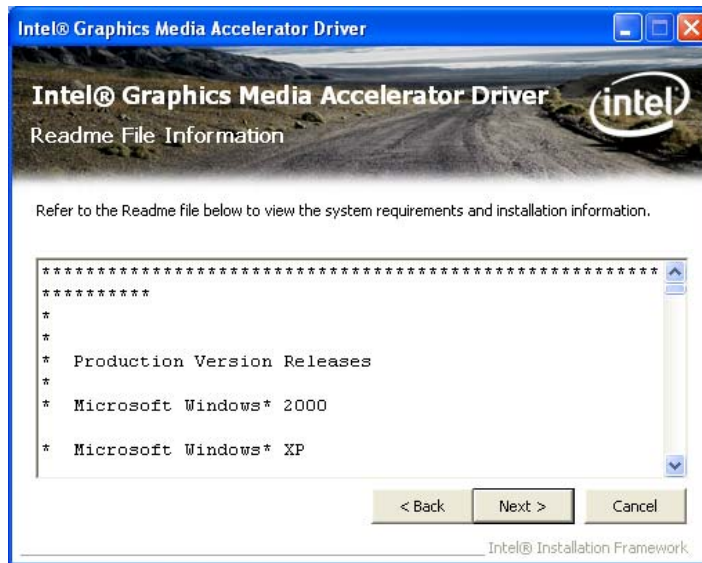

**Figure 7-12: VGA Driver Read Me File**

**Step 12:** Setup Operations are performed as shown in **Figure 7-13**.

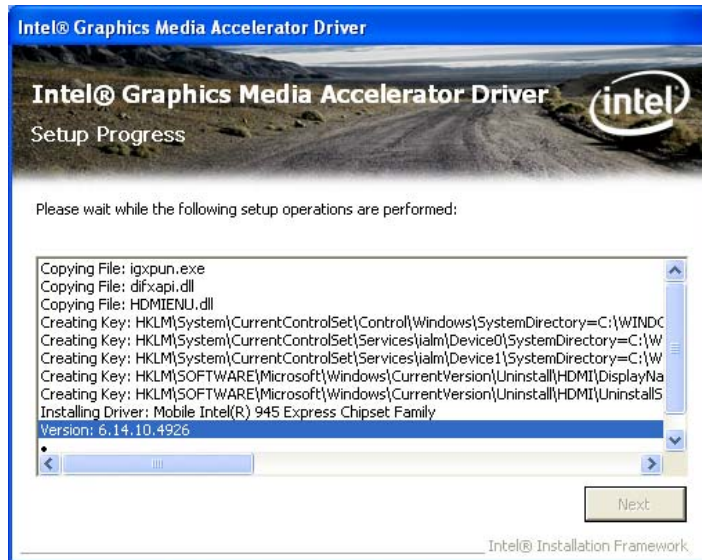

**Figure 7-13: VGA Driver Setup Operations**

**Step 13:** Once the **Setup Operations** are complete, click the **Next** icon to continue.

**Step 14:** The **Finish** screen appears.

**Step 15:** Select “**Yes, I want to restart the computer now**” and click the **Finish** icon.

See **Figure 7-14**.

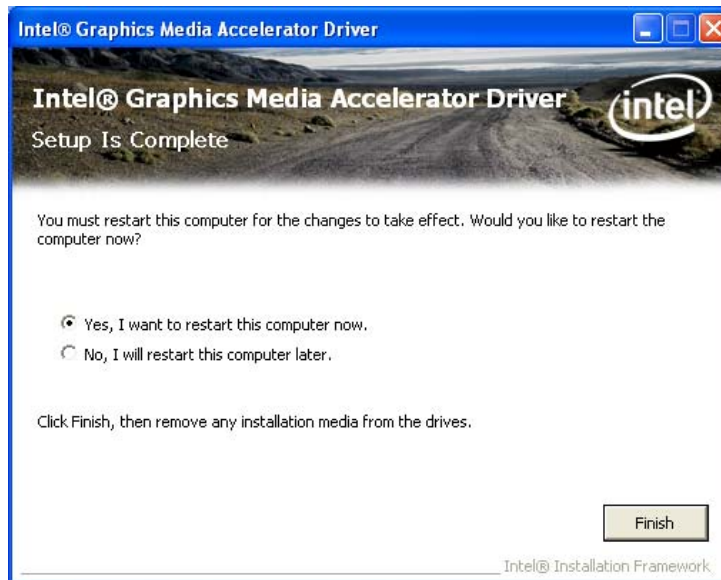

**Figure 7-14: VGA Driver Installation Finish Screen**

## AFL-xxA-N270 Series Panel PC

### 7.5 LAN Driver Installation

To install the LAN driver, please do the following.

**Step 1:** Access the driver list shown in **Figure 7-1** (See **Section 7.2**). Click “LAN”.

**Step 2:** The **Welcome** screen in **Figure 7-15** appears.

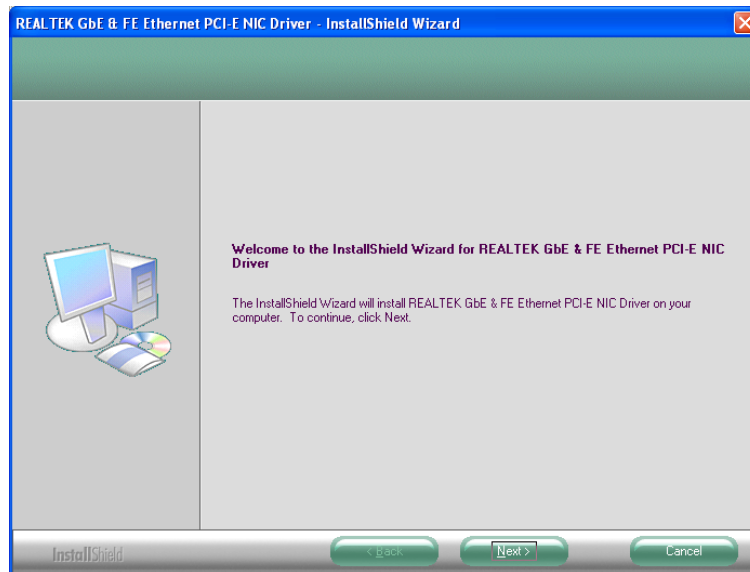

**Figure 7-15: LAN Driver Welcome Screen**

**Step 3:** Click **Next** to continue.

**Step 4:** The **Ready to Install** screen in **Figure 7-16** appears.

**Step 5:** Click **Next** to proceed with the installation.

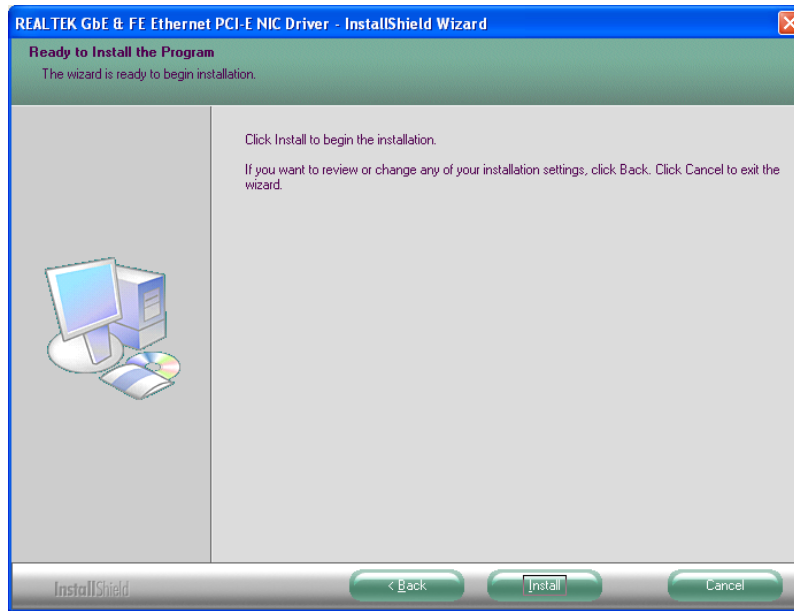

Figure 7-16: LAN Driver Welcome Screen

**Step 6:** The program begins to install.

**Step 7:** The installation progress can be monitored in the progress bar shown in **Figure 7-17**.

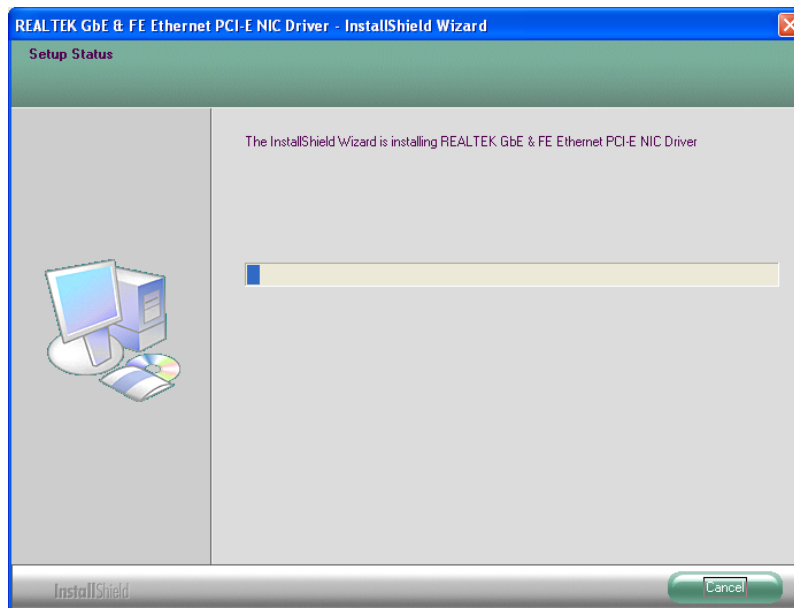
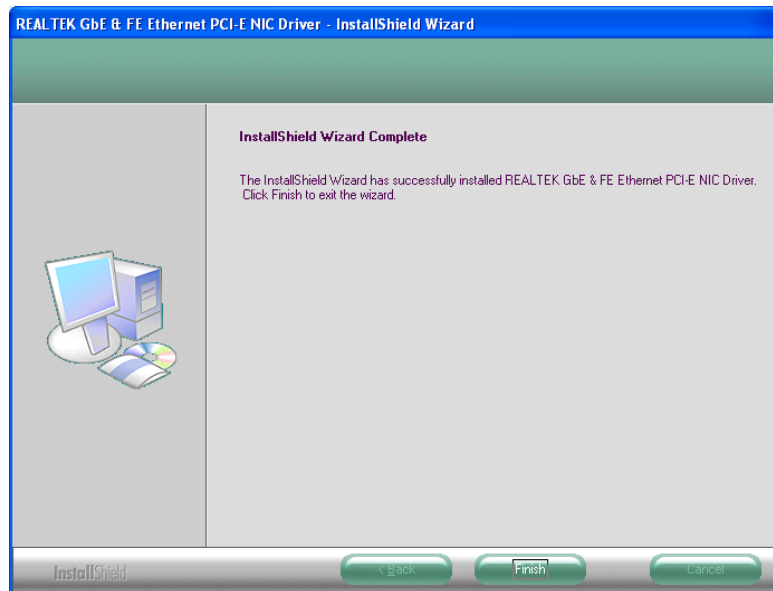

Figure 7-17: LAN Driver Installation

## AFL-xxA-N270 Series Panel PC

**Step 8:** When the driver installation is complete, the screen in **Figure 7-18** appears.

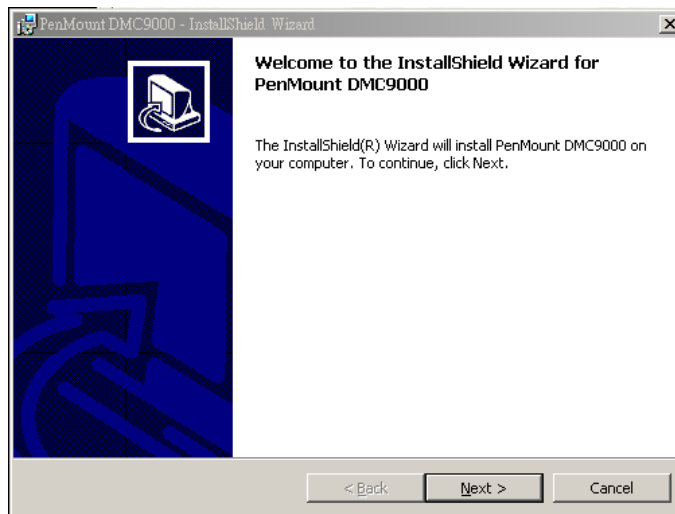

**Figure 7-18: LAN Driver Installation Complete**

## 7.6 Touch Screen Driver

To install the touch panel software driver, please follow the steps below.

- Step 1:** Access the driver list shown in **Figure 7-1** (See **Section 7.2**). Click “**Touch Screen**”.
- Step 2:** A welcome screen appears (**Figure 7-19**). To continue the installation process click **NEXT**.



**Figure 7-19: Welcome Screen**

**Step 3:** The license agreement shown in Figure 7-20 appears. Agree to the license by selecting “I accept the terms in the license agreement”.

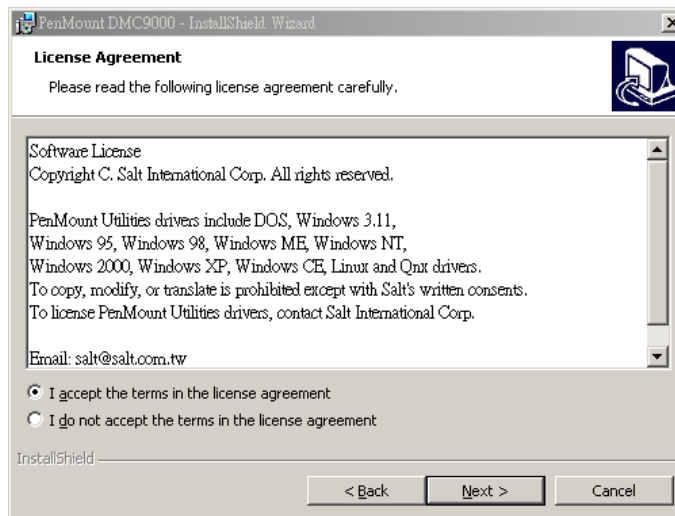
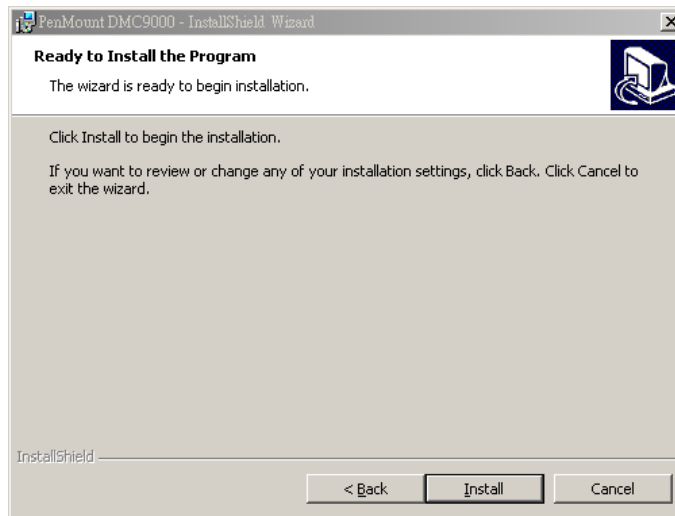

**Figure 7-20: License Agreement**

**Step 4:** Click **NEXT** and the Installshield Wizard is ready to install the program (Figure 7-21).



## AFL-xxA-N270 Series Panel PC



**Figure 7-21: Ready to Install the Program**

**Step 5:** Click **INSTALL** to continue. The Installing PenMount DMC9000 screen appears as the program is installed (Figure 7-22).

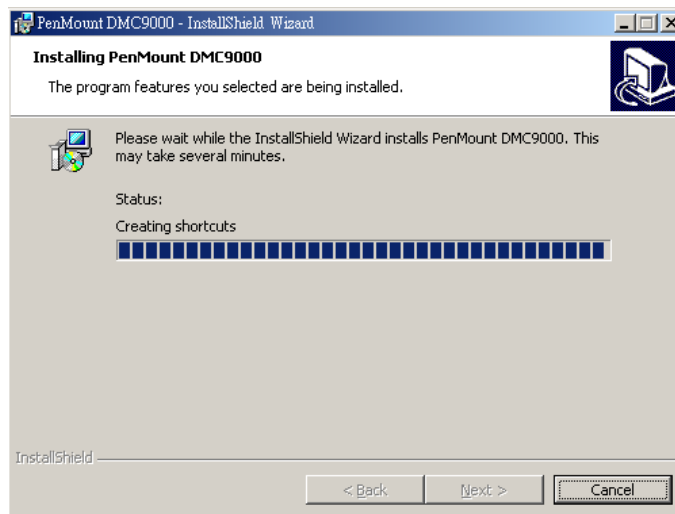

**Figure 7-22: Installing PenMount DMC9000**

**Step 6:** The user is then prompted to select to restart the computer now or later (Figure 7-23). For the settings to take effect, the computer must be restarted. Click **Yes** to restart the computer.

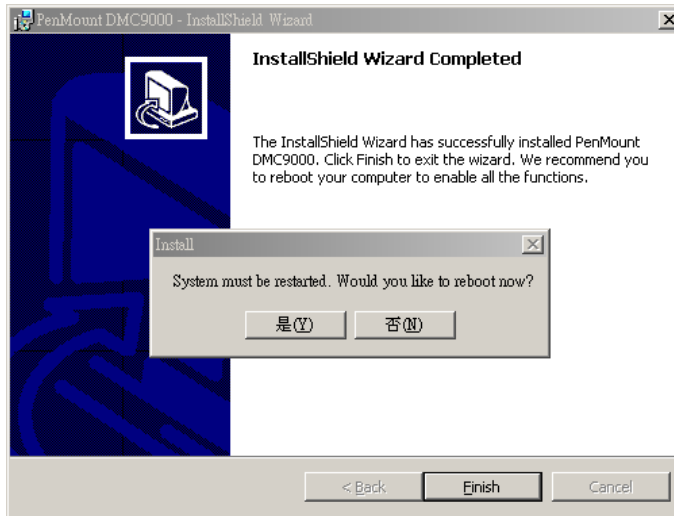

Figure 7-23: Reboot the Computer

## 7.7 Audio Driver Installation

To install the audio driver, please do the following.

**Step 1:** Access the driver list shown in **Figure 7-1** (See **Section 7.2**). Click “**Audio**”.

**Step 2:** Double click the setup file.

**Step 3:** The **InstallShield Wizard** starts (**Figure 7-24**).

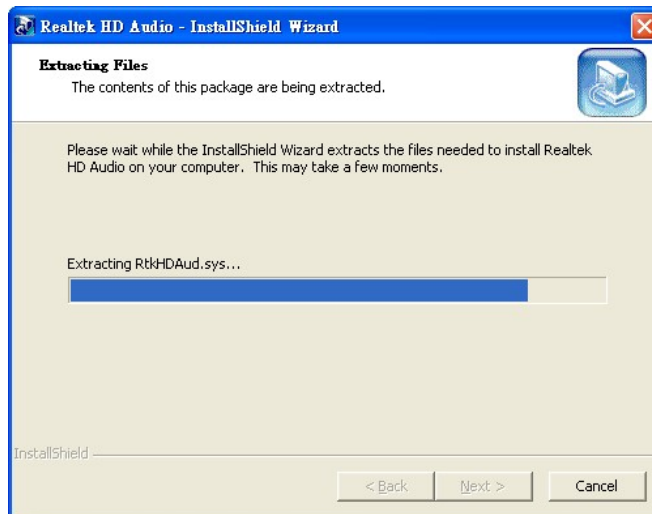
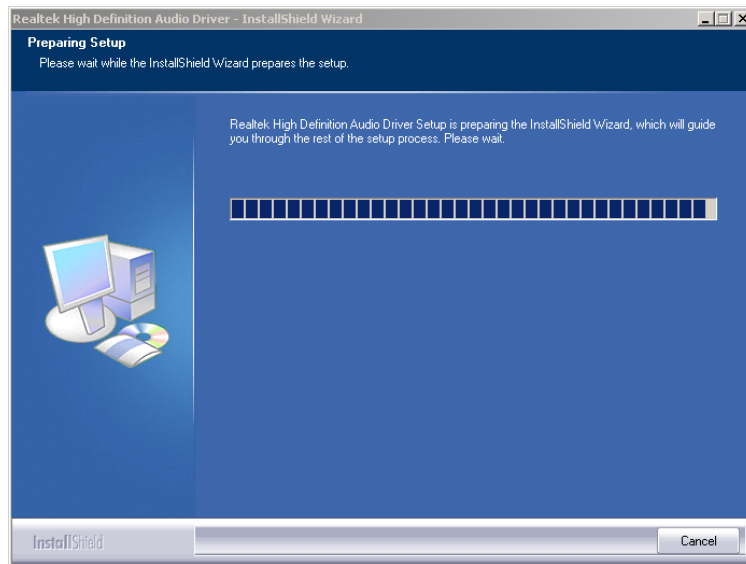

Figure 7-24: The InstallShield Wizard Starts

## AFL-xxA-N270 Series Panel PC

**Step 4:** The **InstallShield Wizard** is prepared to guide the user through the rest of the process (**Figure 7-25**).



**Figure 7-25: Preparing Setup Screen**

**Step 5:** Once initialized, the **InstallShield Wizard** welcome screen appears (**Figure 7-26**).

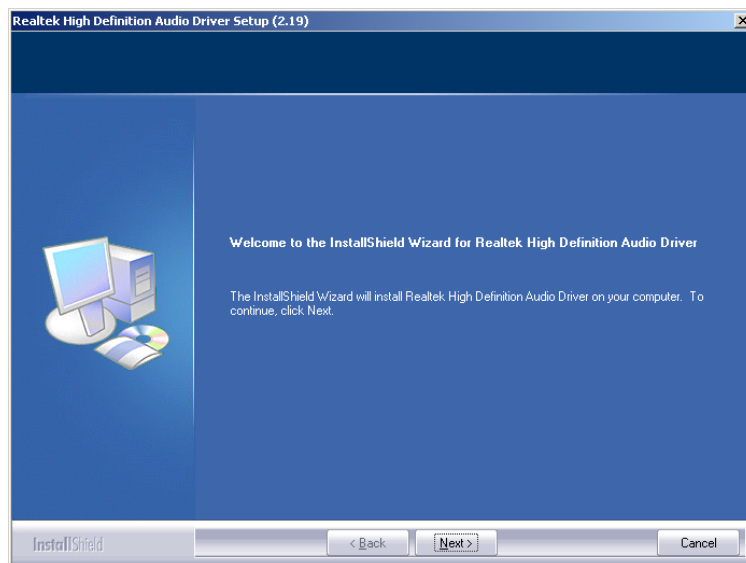

**Figure 7-26: InstallShield Wizard Welcome Screen**

**Step 6:** Click **NEXT** to continue the installation.

**Step 7:** InstallShield starts to install the new software as shown in **Figure 7-27**.

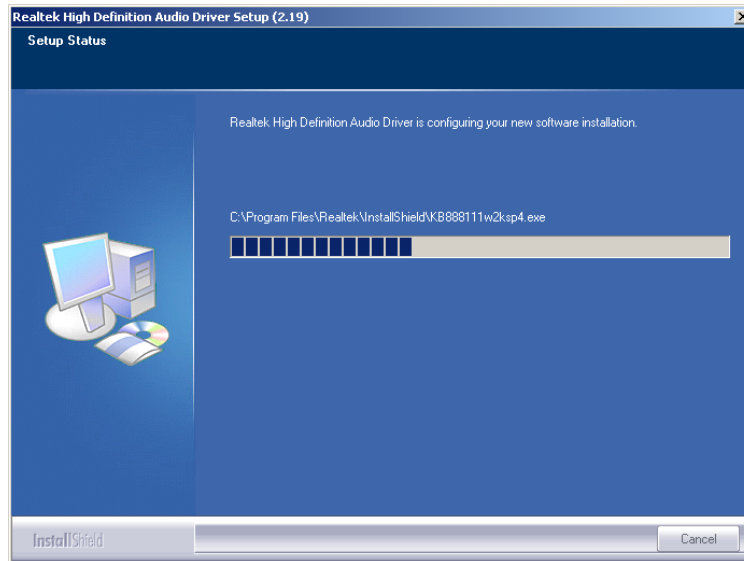

**Figure 7-27: Audio Driver Software Configuration**

**Step 8:** After the driver installation process is complete, a confirmation screen appears (**Figure 7-28**).

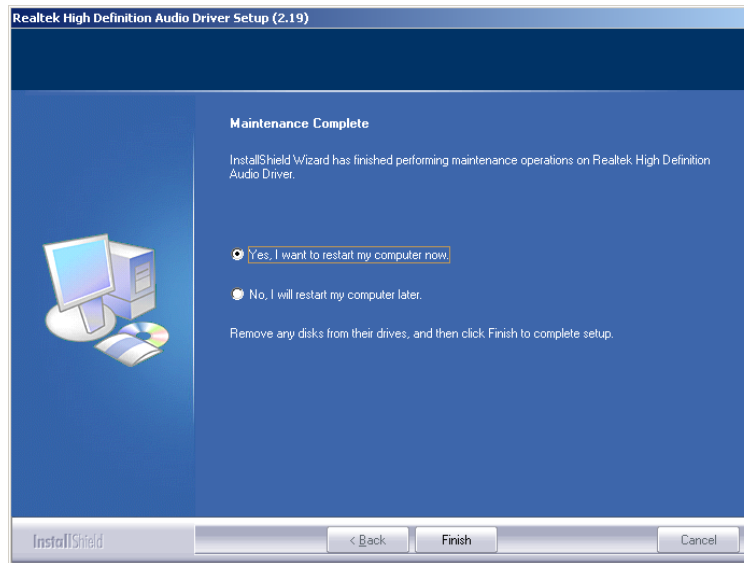

**Figure 7-28: Restart the Computer**

## AFL-xxA-N270 Series Panel PC

**Step 9:** The confirmation screen offers the option of restarting the computer now or later. For the settings to take effect, the computer must be restarted. Click **FINISH** to restart the computer.

### 7.8 Wireless Driver

To install the wireless driver, please follow the steps below.

**Step 1:** Select **Wireless** from the list in **Figure 7-1**.

**Step 2:** A new window opens (**Figure 7-29**). Select the **RT3090** folder. Double click the .exe file to install the wireless LAN driver.

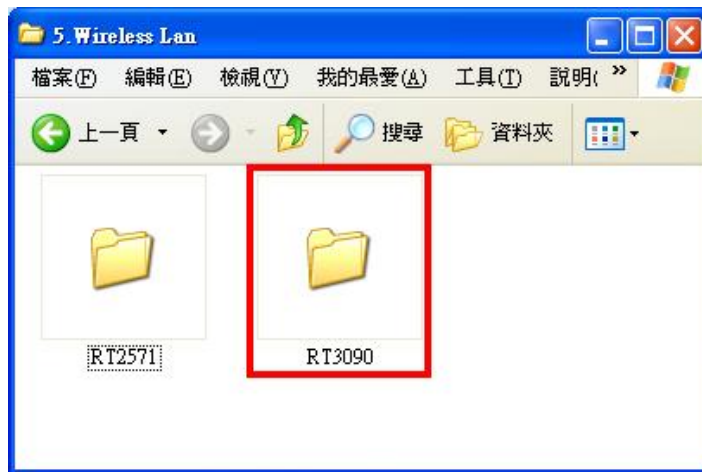

**Figure 7-29: Wireless Driver Folders**

**Step 3:** The license agreement in **Figure 7-30** appears.

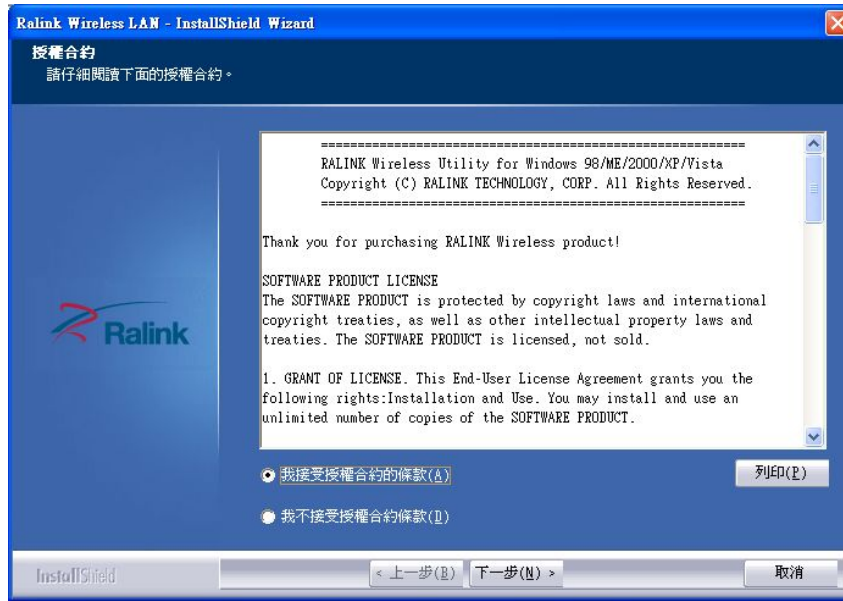

**Figure 7-30: Wireless Driver License Agreement**

**Step 4:** Accept the conditions of the license agreement and click **NEXT** to continue.

**Step 5:** The **Configuration Tool Options** screen in **Figure 7-31** appears next.



**Figure 7-31: Wireless Driver Configuration Tool Options**

**Step 6:** Select configuration tool in **Figure 7-31** and click **NEXT** to continue.

## AFL-xxA-N270 Series Panel PC

**Step 7:** The **Wireless Mode Options** window in **Figure 7-32** appears.



**Figure 7-32: Wireless Mode Select Window**

**Step 8:** Click **NEXT** in **Figure 7-32**.

**Step 9:** Click **INSTALL** in **Figure 7-33** to start to install the driver.

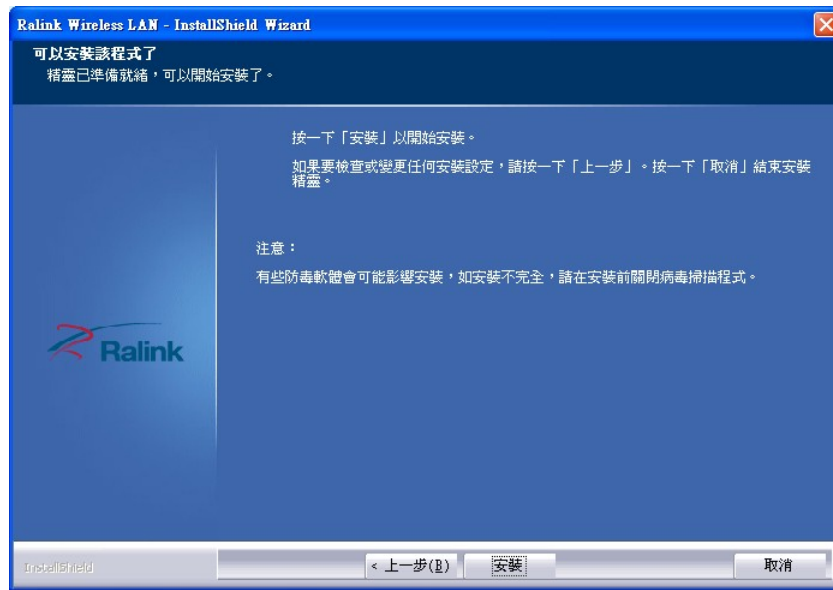

**Figure 7-33: Wireless Driver Installation**

**Step 10:** When the installation is finished. Click **FINISH** in the termination screen.

## 7.9 Bluetooth Driver (Optional)

To install the Bluetooth software driver, please follow the steps below.

**Step 1:** Select **Bluetooth** from the list in **Figure 7-1**.

**Step 2:** A welcome screen appears (**Figure 7-34**). To continue the installation process click **NEXT**.



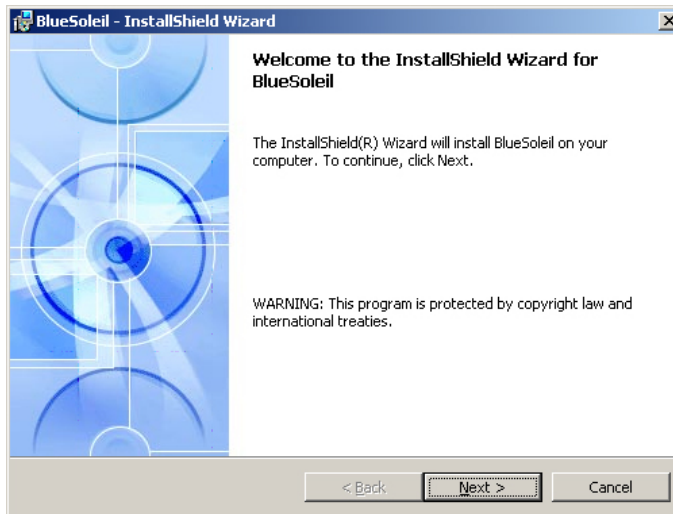

**Figure 7-34: Welcome Screen**

**Step 3:** The license agreement shown in **Figure 7-35** appears. Agree to the license by selecting “I accept the terms in the license agreement”.

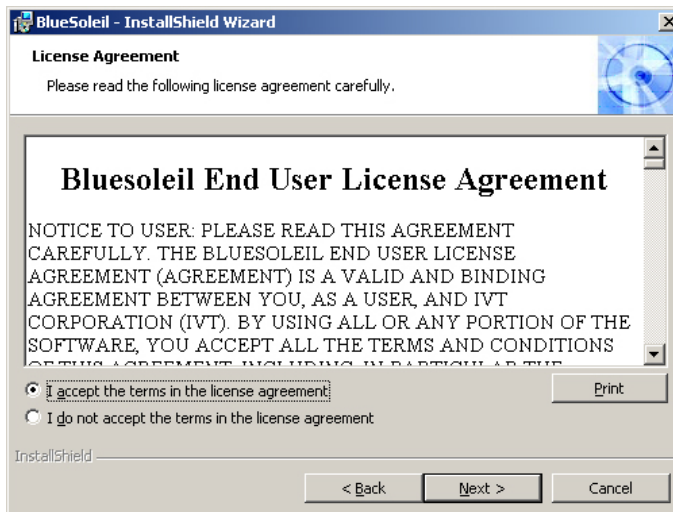

**Figure 7-35: License Agreement**

**Step 4:** The **Custom Settings** screen in **Figure 7-36** appears next.

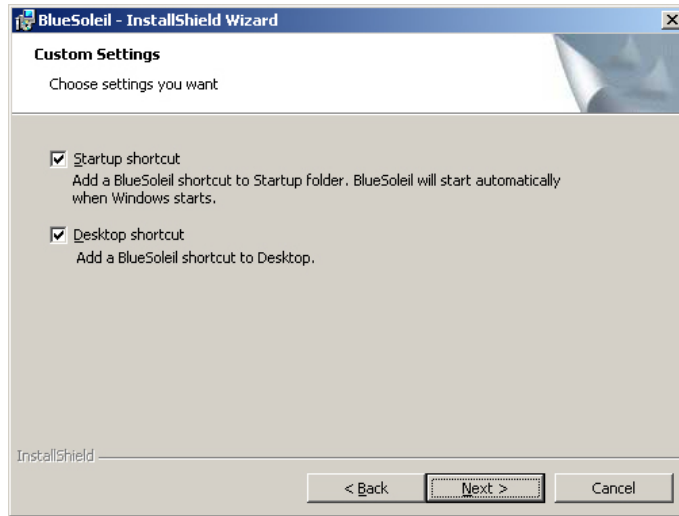

Figure 7-36: Bluetooth Driver Setup Options

**Step 5:** Select the required installation configuration in **Figure 7-36** and click **NEXT** to continue.

**Step 6:** The **Destination Folder** screen in **Figure 7-37** appears next. Confirm the destination folder to install the Bluetooth driver.

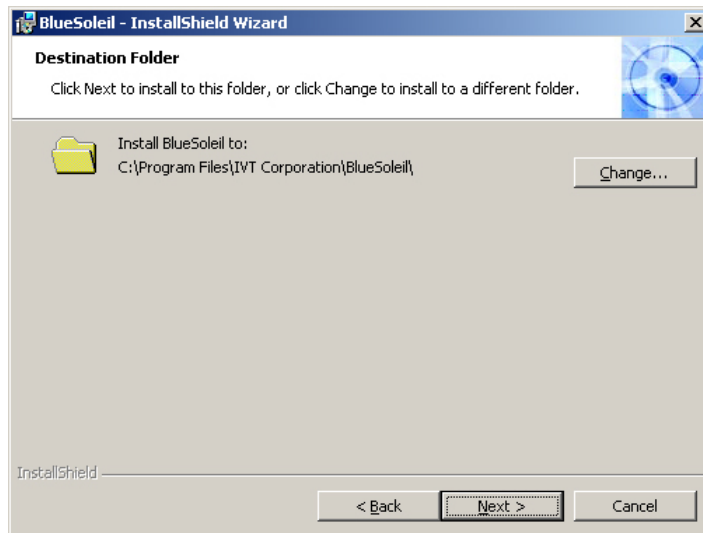
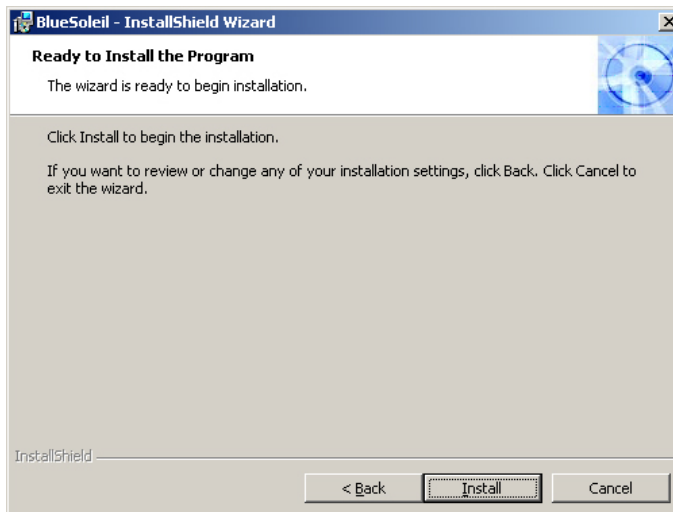

Figure 7-37: Bluetooth Driver Destination Folder

## AFL-xxA-N270 Series Panel PC

**Step 7:** Click **NEXT** and the InstallShield Wizard is ready to install the program (**Figure 7-38**).



**Figure 7-38: Ready to Install the Program**

**Step 8:** Click **INSTALL** to continue. The Installing BlueSoleil screen appears as the program is installed (**Figure 7-39**).

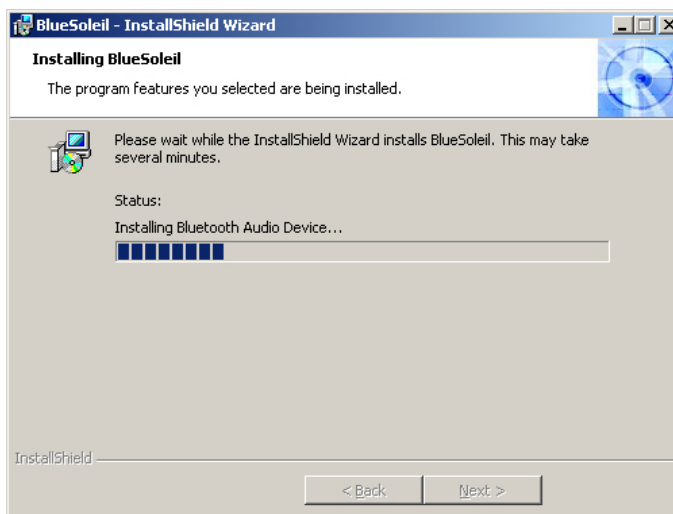

**Figure 7-39: Installing BlueSoleil**

**Step 9:** When the installation process is complete, the Setup Complete screen appears. See **Figure 7-40**.

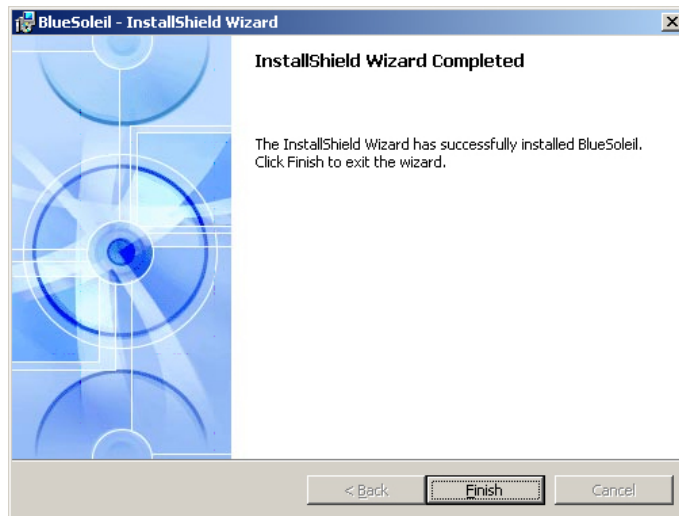

Figure 7-40: Bluetooth Driver Complete Installation Screen

**Step 10:** To complete the chipset driver installation, click **FINISH**. The user is then prompted to select to restart the computer now or later (**Figure 7-41**). For the settings to take effect, the computer must be restarted. Click **Yes** to restart the computer.

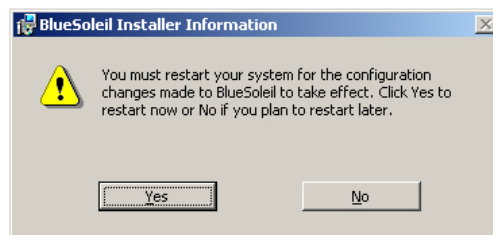

Figure 7-41: Reboot the Computer

Chapter

8

# Interface Connectors

---

## 8.1 Peripheral Interface Connectors

The AFL-xxA-N270 panel PC motherboard comes with a number of peripheral interface connectors and configuration jumpers. The connector locations are shown in **Figure 6-1**. The Pin 1 locations of the on-board connectors are also indicated in the diagram below. The connector pinouts for these connectors are listed in the following sections.

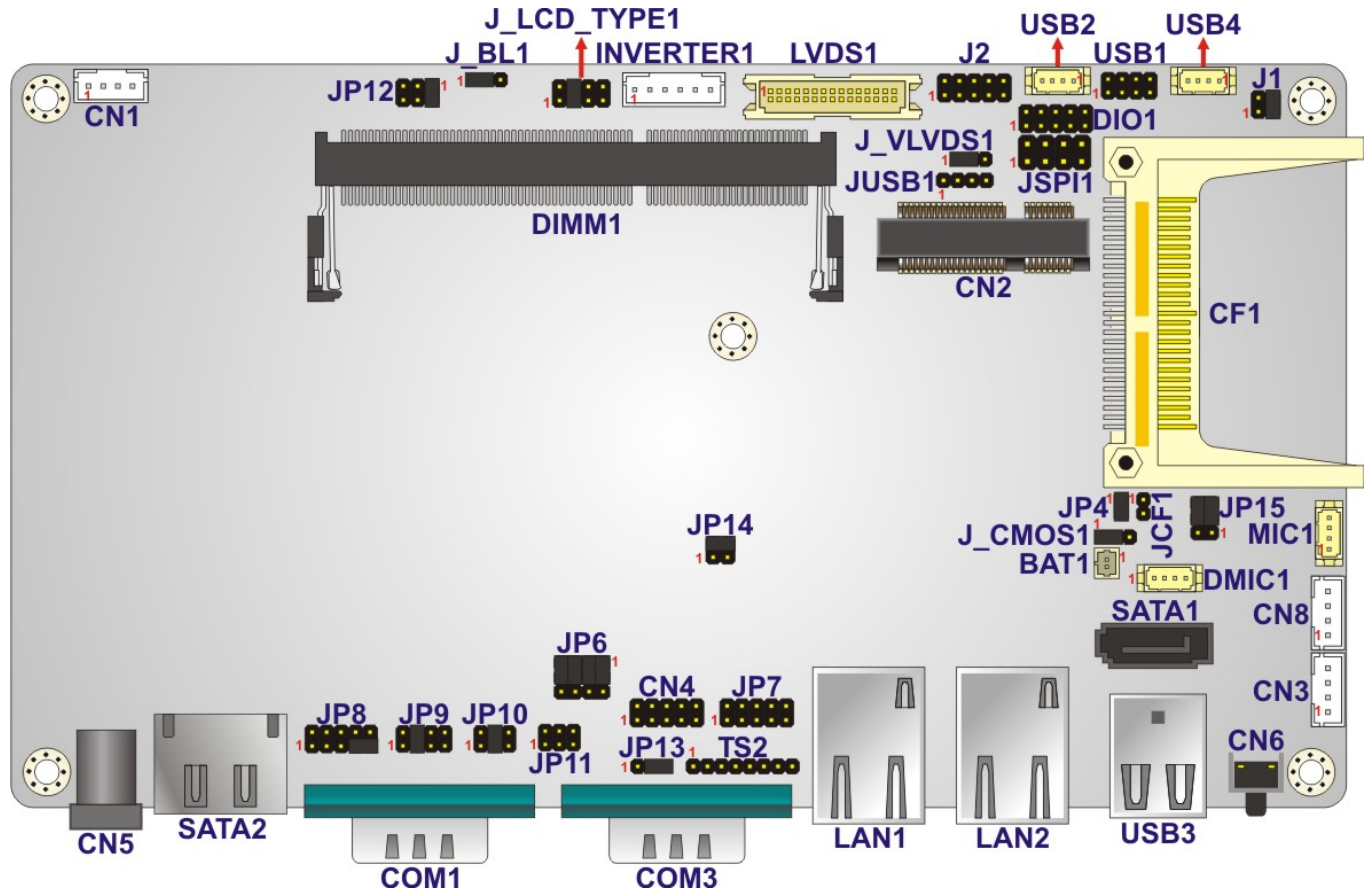

Figure 8-1: Main Board Layout Diagram (Front Side)



**Figure 8-2: Main Board Layout Diagram (Solder Side)**

## 8.2 Internal Peripheral Connectors

Internal peripheral connectors are found on the motherboard and are only accessible when the motherboard is outside of the chassis. The table below shows a list of the peripheral interface connectors on the AFL-xxA-N270 motherboard. Pinouts of these connectors can be found in the following sections.

Connector	Type	Label
AT/ATX switch connector	2-pin header	JP4
Audio line-out connector	4-pin wafer	CN8
Audio speaker connector	4-pin wafer	CN3
Audio MIC-in connector	4-pin wafer	MIC1
Audio DMIC-in connector	4-pin wafer	DMIC1
Battery connector	2-pin wafer	BT1
CF slot	CF slot	CF1

Connector	Type	Label
CRT connector	10-pin header	CN4
DIO connector	10-pin header	DIO1
HDD power connector	4-pin wafer	CN1
LED indicator and button connector	10-pin header	JP2
LVDS backlight connector	6-pin wafer	INVERTER1
MCU connector	8-pin header 10-pin header	TS2 JP7
PCIe Mini card slot	PCIe Mini card slot	CN2
RFID connector	10-pin header	JP8
SATA connector	SATA connector	SATA1
SO-DIMM connector	SO-DIMM connector	DIMM1
SPI Flash connector	8-pin header	JSPI1
Touch panel connector (solder side)	9-pin wafer	TS1
TTL panel connector (solder side)	40-pin FPC connector	CN7
JUSB connector	4-pin header	JUSB1
USB connector	8-pin header	USB1
USB connector	4-pin wafer	USB2
USB connector	4-pin wafer	USB4

**Table 8-1: Peripheral Interface Connectors**

### 8.2.1 Audio Line-out Connector (CN8)

PIN NO.	DESCRIPTION
1	SPK_R
2	AMP_R
3	AMP_L
4	SPK_L

**Table 8-2: Audio Line-out Connector (CN8) Pinouts**



**8.2.2 Audio Speaker-out Connector (CN3)**

PIN NO.	DESCRIPTION
1	AMP_L+
2	AMP_L-
3	AMP_R-
4	AMP_R+

**Table 8-3: Audio Speaker-out Connector (CN3) Pinouts**

**8.2.3 Audio MIC-in Connector (MIC1)**

PIN NO.	DESCRIPTION
1	MIC_IN_L
2	AGND_AMP
3	MIC_JD
4	MIC1_IN_R

**Table 8-4: Audio MIC-in Connector (MIC1) Pinouts**

**8.2.4 Audio DMIC-in Connector (DMIC1)**

PIN NO.	DESCRIPTION
1	DMIC_CLK
2	DMIC_DATA
3	+3.3V
4	GND

**Table 8-5: Audio DMIC-in Connector (DMIC1) Pinouts**

**8.2.5 Battery Connector (BT1)**

PIN NO.	DESCRIPTION
1	Battery +3.3V
2	GND

**Table 8-6: Battery Connector (BT1) Pinouts**

**8.2.6 CompactFlash® Type II Slot (CF1)**

PIN NO.	DESCRIPTION	PIN NO.	DESCRIPTION
1	GROUND1	26	CD1
2	DATA 3	27	DATA 11
3	DATA 4	28	DATA 12
4	DATA 5	29	DATA 13
5	DATA 6	30	DATA 14
6	DATA 7	31	DATA 15
7	CE	32	CE2
8	A10	33	VS1
9	OE	34	IOR
10	A9	35	IOW
11	A8	36	WE
12	A7	37	IRQ
13	VCC1	38	VCC2
14	A6	39	CSEL
15	A5	40	VS2
16	A4	41	RESET
17	A3	42	WAIT
18	A2	43	INPACK
19	A1	44	REG
20	A0	45	BVD2
21	DATA 0	46	BVD1
22	DATA 1	47	DATA 8
23	DATA 2	48	DATA 9
24	IOCS16	49	DATA 10
25	CD2	50	GROUND2

**Table 8-7: CompactFlash® Slot (CF1) Pinouts**

**8.2.7 CRT Connector (CN4)**

PIN NO.	DESCRIPTION	PIN NO.	DESCRIPTION
1	DACR_RED	2	SPD2
3	DACG_GREEN	4	SPCLK2
5	DACB_BLUE	6	V_GND
7	H_SYNC	8	V_GND
9	V_SYNC	10	V_GND

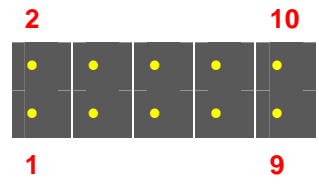

**Table 8-8: CRT Connector (CN4) Pinouts**

**8.2.8 DIO Connector (DIO1)**

PIN NO.	DESCRIPTION	PIN NO.	DESCRIPTION
1	GND	2	VCC_+5V
3	DGPO3	4	DGPO2
5	DGPO1	6	DGPO0
7	DGPI3	8	DGPI2
9	DGPI1	10	DGPI0

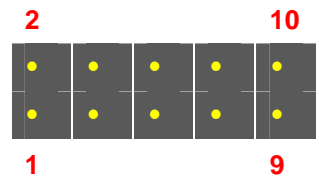

**Table 8-9: DIO Connector (DIO1) Pinouts**

**8.2.9 HDD Power Connector (CN1)**

PIN NO.	DESCRIPTION
1	+5V
2	GND
3	GND
4	+12V

**Table 8-10: HDD Power Connector (CN1) Pinouts**

### 8.2.10 LED Indicator and Button Connector (JP2)

PIN NO.	DESCRIPTION	PIN NO.	DESCRIPTION
1	PW_LED +5V	2	+5V
3	GND	4	HD_LED
5	SUS PW LED +5V	6	RST_SW
7	GND	8	GND
9	PW_BN	10	GND

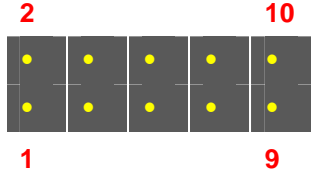

**Table 8-11: LED Indicator and Button Connector (JP2) Pinouts**

### 8.2.11 LVDS Backlight Connector (INVERTER1)

PIN NO.	DESCRIPTION
1	+12V
2	+12V
3	BLON
4	BRIGHTNESS
5	GND
6	GND

**Table 8-12: LVDS Backlight Connector (INVERTER1) Pinouts**

### 8.2.12 MCU Connector (JP7)

PIN NO.	DESCRIPTION	PIN NO.	DESCRIPTION
1	MCLR	2	+5V
3	+5V	4	MCU_IR
5	ICSPCLK	6	AUTO_CLK
7	ICSPDAT	8	AUTO_DATA
9	GND	10	GND

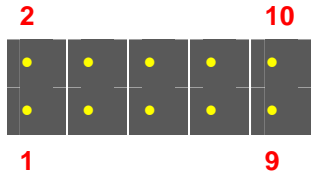

**Table 8-13: MCU Connector (JP7) Pinouts**

**8.2.13 MCU Connector (TS2)**

PIN NO.	DESCRIPTION
1	AUTO_DIMMING
2	LOCK_BUTTON
3	VOL+
4	VOL-
5	BRIGHT+
6	BRIGHT-
7	LCD_ON_OFF
8	GND

**Table 8-14: MCU Connector (TS2) Pinouts**

**8.2.14 PCIe Mini Slot (CN2)**

PIN NO.	DESCRIPTION	PIN NO.	DESCRIPTION
1	PCIE_WAKE#	2	VCC3
3	RESERVED	4	GND
5	RESERVED	6	1.5 V
7	CLKREQ#	8	N/C
9	GND	10	N/C
11	REFCLK-	12	N/C
13	REFCLK+	14	N/C
15	GND	16	N/C
17	N/C	18	GND
19	N/C	20	N/C
21	GND	22	PERST#
23	PERn0	24	VCC3_AUX
25	PERp0	26	GND
27	GND	28	1.5 V
29	GND	30	SMBCLK
31	PETn0	32	SMBDATA
33	PETp0	34	GND

PIN NO.	DESCRIPTION	PIN NO.	DESCRIPTION
35	GND	36	USBD-
37	RESERVED	38	USBD+
39	RESERVED	40	GND
41	RESERVED	42	LED_WWAN#
43	RESERVED	44	LED_WLAN#
45	RESERVED	46	LED_WPAN#
47	RESERVED	48	1.5 V
49	RESERVED	50	GND
51	RESERVED	52	VCC3

**Table 8-15: PCIe Mini Card Slot (CN2) Pinouts**

### 8.2.15 RFID Connector (JP8)

PIN NO.	DESCRIPTION	PIN NO.	DESCRIPTION
1	For COM1 Pin 9 setting	2	+5V
3		4	GND
5		6	RX2
7		8	TD2
9		10	RFID_INT

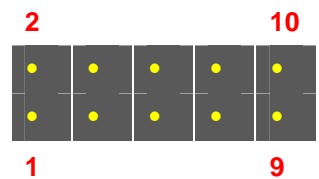
**Table 8-16: RFID Connector (JP8) Pinouts**

### 8.2.16 SATA Connector (SATA1)

PIN NO.	DESCRIPTION
1	GND
2	TX+
3	TX-
4	GND
5	RX-
6	RX+
7	GND

**Table 8-17: SATA Connector (SATA1) Pinouts**

**8.2.17 Touch Panel Connector (TS1)**

PIN NO.	8-Wire	4-Wire	5-Wire
1	Right Sense	N/A	N/A
2	Left Sense	N/A	N/A
3	Bottom Sense	N/A	N/A
4	Top Sense	N/A	Sense (S)
5	Right Excite	Right	LR (X)
6	Left Excite	Left	LL (L)
7	Bottom Excite	Bottom	UR (Y)
8	Top Excite	Top	UL (Y)
9	GND	GND	GND

**Table 8-18: Touch Panel Connector (TS1) Pinouts**

**8.2.18 TTL Panel Connector (CN7)**

PIN NO.	DESCRIPTION	PIN NO.	DESCRIPTION
1	GND	21	TFT_G5
2	GND	22	TFT_G4
3	TTL_VSYNC	23	TFT_G3
4	TTL_VCC3	24	GND
5	TTL_VCC3	25	TFT_G2
6	TTL_VCC3	26	TFT_G1
7	TTL_VCC3	27	TFT_G0
8	TTL_HSYNC	28	GND
9	LCD_EN	29	TFT_R5
10	GND	30	TFT_R4
11	GND	31	TFT_R3
12	GND	32	GND
13	TFT_B5	33	TFT_R2
14	TFT_B4	34	TFT_R1
15	TFT_B3	35	TFT_R0
16	GND	36	GND

17	TFT_B2	37	GND
18	TFT_B1	38	DOTCLK
19	TFT_B0	39	GND
20	GND	40	GND

**Table 8-19: TTL Panel Connector (CN7) Pinouts**

### 8.2.19 JUSB Connector (JUSB1)

PIN NO.	DESCRIPTION
1	+5Vsus
2	D6F-
3	D6F+
4	GND

**Table 8-20: JUSB Connector (JUSB1) Pinouts**

### 8.2.20 USB Connector (USB1)

PIN NO.	DESCRIPTION	PIN NO.	DESCRIPTION
1	+5Vsus	2	GND
3	D0F-	4	D0F+
5	D0F+	6	D0F-
7	GND	8	+5Vsus

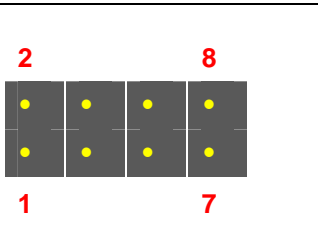
**Table 8-21: USB Connector (USB1) Pinouts**

### 8.2.21 USB Connector (USB2)

PIN NO.	DESCRIPTION
1	USB Power (selected by JP15)
2	D2F-
3	D2F+
4	GND

**Table 8-22: USB Connector (USB2) Pinouts**



## AFL-xxA-N270 Series Panel PC

### 8.2.22 USB Connector (USB4)

PIN NO.	DESCRIPTION
1	USB Power (selected by JP15)
2	D3F-
3	D3F+
4	GND

**Table 8-23: USB Connector (USB4) Pinouts**

## 8.3 External Interface Panel Connectors

The table below lists the rear panel connectors on the AFL-xxA-N270 motherboard. Pinouts of these connectors can be found in the following sections.

Connector	Type	Label
Ethernet connector	RJ-45	LAN1, LAN2
Power connector	DIN	CN5
Reset button	Push button	CN6
RS-232 serial ports	DB-9	COM1
RS-232/422/485 serial port	DB-9	COM3
SATA connector	SATA connector	SATA2
USB 2.0 connectors	USB 2.0 port	USB3

**Table 8-24: Rear Panel Connectors**

### 8.3.1 Ethernet Connector (LAN1, LAN2)

PIN NO.	DESCRIPTION	PIN NO.	DESCRIPTION
1	LAN1_MDIO+	2	LAN1_MDIO-
3	LAN1_MDI1+	4	LAN1_MDI1-
5	N/A	6	N/A
7	LAN1_MDI2+	8	LAN1_MDI2-
9	LAN1_MDI3+	10	LAN1_MDI3-
11	+3.3Vsus	12	ACT-1
13	LAN1_LINK1000 +3.3Vsus	14	LAN1_LINK100 +3.3Vsus
15	GND	16	GND
17	N/A	18	N/A

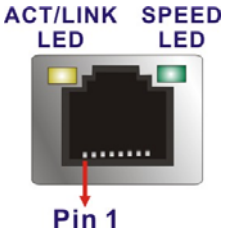

**Table 8-25: Ethernet Connector (LAN1, LAN2) Pinouts**

### 8.3.2 Power Connector (CN5)

PIN NO.	DESCRIPTION
1	GND
2	GND
3	VCC12_IN

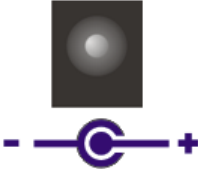

**Table 8-26: Power Connector (CN5) Pinouts**

### 8.3.3 RS-232 Serial Ports (COM1)

PIN NO.	DESCRIPTION	PIN NO.	DESCRIPTION
1	NDCD1	2	NRX1
3	NTX1	4	NDTR1
5	GND	6	NDSR1
7	NRTS1	8	NCTS1
9	COM_RI1	10	GND

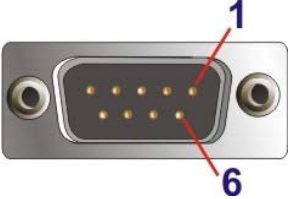

**Table 8-27: RS-232 Serial Ports (COM1) Pinouts**

## AFL-xxA-N270 Series Panel PC

### 8.3.4 RS-422/485 Serial Port (COM3)

PIN NO.	RS-232	RS-422	RS-485
1	NDCDB	TX-	D-
2	NRXDB	TX+	D+
3	NTX3		
4	NDTR3		
5	GND		
6	NDSRB	RX-	
7	NRTSB	RX+	
8	NCTS3		
9	COM_RI3		
10	GND		



**Table 8-28: COM3 Connector Pinouts**

### 8.3.5 SATA Connector (SATA2)

PIN NO.	DESCRIPTION
1	GND
2	STXP_0
3	STXN_0
4	GND
5	SRXN_0
6	SRXP_0
7	GND
8	GND
9	GND

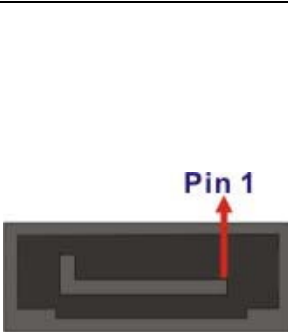

**Table 8-29: SATA Connector (SATA2) Pinouts**

### 8.3.6 USB 2.0 Connectors (USB3)

PIN NO.	DESCRIPTION	PIN NO.	DESCRIPTION
1	+5Vsus	5	+5Vsus
2	D4F-	6	D5F-
3	D4F+	7	D5F+
4	GND	8	GND



**Table 8-30: USB 2.0 Connectors (USB3) Pinouts**

## 8.4 Preconfigured Jumper Settings

The following jumpers are preconfigured for the AFL-xxA-N270. Users should not change these jumpers (**Table 8-31**). It is only for reference.

Jumper Name	Label	Type
Backlight voltage selection	J_BL1	3-pin header
Inverter power selection	JP12	6-pin header
LVDS voltage selection	J_VLVDS1	3-pin header
MCU LCD type selection	JP14	4-pin header
MCU PWM power selection	JP13	3-pin header
Panel type selection	J_LCD_TYPE1	10-pin header
Touchscreen selection	J1	4-pin header
USB2 and USB4 power selection	JP15	6-pin header

**Table 8-31: Preconfigured Jumpers**

### 8.4.1 Backlight Voltage Selection Jumper (J\_BL1)

Pin	Description
Short 1-2	+3.3 V (Default)
Short 2-3	+5 V

**Table 8-32: Backlight Voltage Selection Jumper (J\_BL1) Settings**

### 8.4.2 Inverter Power Selection Jumper (JP12)

Pin	Description
Short 1-2	+12 V (Default)
Short 3-4	+5 V
Short 5-6	+3.3 V

**Table 8-33: Inverter Power Selection Jumper (JP12) Settings**

### 8.4.3 LVDS Panel Voltage Selection Jumper (J\_VLVDS1)

Pin	Description
Short 1-2	+3.3 V (Default)
Short 2-3	+5 V

**Table 8-34: LVDS Voltage Selection Jumper (J\_VLVDS1) Settings**

### 8.4.4 MCU LCD Type Selection Jumper (JP14)

Pin	Description
Short 1-3	LCD Panel (Default)
Short 2-4	LED Panel

**Table 8-35: MCU LCD Type Selection Jumper (JP14) Settings**

### 8.4.5 MCU PWM Power Selection Jumper (JP13)

Pin	Description
Short 1-2	+5V (Default)
Short 2-3	+3.3V

**Table 8-36: MCU PWM Power Selection Jumper (JP13) Settings**

### 8.4.6 Panel Type Selection Jumper (J\_LCD\_TYPE1)

Pin	Description	Pin	Description
1	PA_DGPI0	2	GND
3	PA_DGPI1	4	GND

5	PA_DGPI2	6	GND
7	PA_DGPI3	8	GND

**Table 8-37: Panel Type Selection Jumper (J\_LCD\_TYPE1) Settings**

### 8.4.7 Touchscreen Selection Jumper (J1)

Pin	Description
Short 1-2	5-wire (Default)
Short 3-4	4-wire

**Table 8-38: Touchscreen Selection Jumper (J1) Settings**

### 8.4.8 USB2 and USB4 Power Selection Jumper (JP15)

Pin	Description
Short 1-3	USB4 +3.3V
Short 3-5	USB4 +5V (Default)
Short 2-4	USB2 +3.3V
Short 4-6	USB2 +5V (Default)

**Table 8-39: USB2 and USB4 Power Selection Jumper (JP15) Settings**

Appendix

A

# System Specifications

---

## A.1 Motherboard Specifications

The system comes with an IEI AFLMB-945GSE motherboard. The detailed specifications for the motherboard are listed below.

Specification	AFLMB-945GSE
<b>Northbridge</b>	Intel® 945GSE
<b>Southbridge</b>	Intel® ICH7M
<b>Processor</b>	1.6 GHz Intel® Atom™ N270 processor
<b>FSB Speed</b>	533 MHz
<b>Supported Memory</b>	One 200-pin 2.0 GB (max.) 533 MHz or 400 MHz DDR2 SDRAM SO-DIMM (system max. 2.0 GB)
<b>System BIOS</b>	AMI BIOS
<b>Hard disk drives</b>	Two SATA drives
<b>VGA</b>	Integrated in the Intel® 945GSE
<b>LAN</b>	Realtek RTL8111CP PCIe GbE Controllers
<b>Expansion Options</b>	One PCIe Mini
<b>Super I/O</b>	ITE IT8718F
<b>Audio Codec</b>	RealTek ALC892
<b>Audio Amplifier</b>	NXP TDA1517P
<b>USB</b>	Two external USB 2.0 ports Two internal pin headers
<b>RS-232</b>	Fintek
<b>FAN connector</b>	One 4-pin CPU fan connector

## A.2 Processor Specifications

The N270 Intel® Atom™ processor specifications are given below.

Parameter	Specifications
<b>CPU Speed</b>	1.6 GHz
<b>Bus Speed</b>	533 MHz
<b>L2 Cache Size</b>	512 KB
<b>L2 Cache Speed</b>	1.6 GHz
<b>Manufacturing Technology</b>	45 nm



## AFL-xxA-N270 Series Panel PC

<b>L1 Cache</b>	32 KB instruction cache 24 KB write-back data cache
<b>Thermal Design Power</b>	2.5 W
<b>Tjunction</b>	0 to 90°C

### A.3 Screen Specifications

The AFL-xxA-N270 comes with a TFT LCD monitor at the front of the flat panel PC. Specifications for the screens are shown below.

SPECIFICATION	AFL-07A-N270	AFL-08AH-N270	AFL-10A-N270	AFL-12A-N270
<b>Size</b>	7"	8.4"	10.4"	12.1"
<b>Resolution</b>	800 x 480 (VGA)	800 x 600 (SVGA)	800 x 600 (SVGA)	1024 x 768 (XGA)
<b>Pixel Pitch (mm)</b>	0.0635 x 0.1905	0.213 x 0.213	0.264 x 0.264	0.3057 x 0.3057
<b>LCD Color</b>	Native 262K colors	Native 262K colors	Native 262K colors	Native 262K colors
<b>View Angel (H/V)</b>	140/110	160/140	160/140	160/160
<b>Brightness (cd/m<sup>2</sup>)</b>	400	450	400	500
<b>Contrast Ratio</b>	400:1	600:1	700:1	700:1
<b>Backlight</b>	LED	LED	LED	LED
<b>RGB Bit</b>	6-bit	6-bit	6-bit	6-bit

## A.4 Touch Screen Specifications

The AFL-xxA-N270 series comes with an analog resistive type touch panel. The touch panel specifications are listed below.

SPECIFICATION	AFL-07A-N270	AFL-08AH-N270	AFL-10A-N270	AFL-12A-N270
<b>Model</b>	PANJIT 1070404C	PANJIT 1084403B	PANJIT 1104502A	PANJIT 1121505B
<b>Type</b>	Analog Resistive Type Touch Panel			
<b>Wire Type</b>	4-wire	4-wire	5-wire	5-wire
<b>Viewing Area (mm)</b>	154.90 x 93.94	130.75 x 173.38	219.8 x 166.8	188.0 x 250.0
<b>Active Area (mm)</b>	152.40 x 91.44	127.78 x 170.38	212.1 x 159.3	185.0 x 246.0
<b>Total Transmission</b>	78%			
<b>Maximum Voltage</b>	DC7V			
<b>Connector Type</b>	FPC.			
<b>Operating Temperature</b>	-10°C ~ 60°C	-10°C ~ 40°C	-10°C ~ 50°C	
<b>Operating Humidity</b>	20% ~ 90% RH			
<b>Storage Temperature</b>	-20°C ~ 70°C			
<b>Storage Humidity</b>	20% ~ 90% RH			
<b>Dimensions</b>	165 x 104 x 1.4	145.5 x 188 x 2.1	238.8x 188.7 x 2.6	204 x 268 x 2.1

Appendix

**B**

# Safety Precautions

---

**WARNING:**

The precautions outlined in this chapter should be strictly followed. Failure to follow these precautions may result in permanent damage to the AFOLUX AFL-xxA-N270 series.

## B.1 Safety Precautions

Please follow the safety precautions outlined in the sections that follow:

### B.1.1 General Safety Precautions

Please ensure the following safety precautions are adhered to at all times.

- **Follow the electrostatic precautions** outlined below whenever the AFOLUX AFL-xxA-N270 series is opened.
- **Make sure the power is turned off and the power cord is disconnected** whenever the AFOLUX AFL-xxA-N270 series is being installed, moved or modified.
- **Do not apply voltage levels that exceed the specified voltage range.** Doing so may cause fire and/or an electrical shock.
- **Electric shocks can occur** if the AFOLUX AFL-xxA-N270 series chassis is opened when the AFOLUX AFL-xxA-N270 series is running.
- **Do not drop or insert any objects** into the ventilation openings of the AFOLUX AFL-xxA-N270 series.
- **If considerable amounts of dust, water, or fluids enter the AFOLUX AFL-xxA-N270 series**, turn off the power supply immediately, unplug the power cord, and contact the AFOLUX AFL-xxA-N270series vendor.
- **DO NOT:**
  - Drop the AFOLUX AFL-xxA-N270 series against a hard surface.
  - Strike or exert excessive force onto the LCD panel.
  - Touch any of the LCD panels with a sharp object
  - In a site where the ambient temperature exceeds the rated temperature

## AFL-xxA-N270 Series Panel PC

### B.1.2 Anti-static Precautions

---



#### **WARNING:**

Failure to take ESD precautions during the installation of the AFOLUX AFL-xxA-N270 series may result in permanent damage to the AFOLUX AFL-xxA-N270 series and severe injury to the user.

---

Electrostatic discharge (ESD) can cause serious damage to electronic components, including the AFOLUX AFL-xxA-N270 series. Dry climates are especially susceptible to ESD. It is therefore critical that whenever the AFOLUX AFL-xxA-N270 series is opened and any of the electrical components are handled, the following anti-static precautions are strictly adhered to.

- ***Wear an anti-static wristband:*** Wearing a simple anti-static wristband can help to prevent ESD from damaging any electrical component.
- ***Self-grounding:*** Before handling any electrical component, touch any grounded conducting material. During the time the electrical component is handled, frequently touch any conducting materials that are connected to the ground.
- ***Use an anti-static pad:*** When configuring or working with an electrical component, place it on an anti-static pad. This reduces the possibility of ESD damage.
- ***Only handle the edges of the electrical component:*** When handling the electrical component, hold the electrical component by its edges.

### B.1.3 Product Disposal

---



#### **CAUTION:**

Risk of explosion if battery is replaced by and incorrect type. Only certified engineers should replace the on-board battery.

Dispose of used batteries according to instructions and local regulations.

---

- Outside the European Union - If you wish to dispose of used electrical and electronic products outside the European Union, please contact your local authority so as to comply with the correct disposal method.
- Within the European Union:

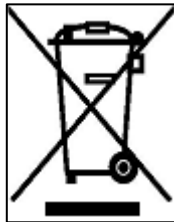

EU-wide legislation, as implemented in each Member State, requires that waste electrical and electronic products carrying the mark (left) must be disposed of separately from normal household waste. This includes monitors and electrical accessories, such as signal cables or power cords.

When you need to dispose of your display products, please follow the guidance of your local authority, or ask the shop where you purchased the product. The mark on electrical and electronic products only applies to the current European Union Member States.

Please follow the national guidelines for electrical and electronic product disposal.

## B.2 Maintenance and Cleaning Precautions

When maintaining or cleaning the AFOLUX AFL-xxA-N270 series, please follow the guidelines below.

### B.2.1 Maintenance and Cleaning

Prior to cleaning any part or component of the AFOLUX AFL-xxA-N270 series, please read the details below.

## AFL-xxA-N270 Series Panel PC

- Except for the LCD panel, never spray or squirt liquids directly onto any other components. To clean the LCD panel, gently wipe it with a piece of soft dry cloth or a slightly moistened cloth.
- The interior of the AFOLUX AFL-xxA-N270X series does not require cleaning. Keep fluids away from the AFOLUX AFL-xxA-N270 series interior.
- Be cautious of all small removable components when vacuuming the AFOLUX AFL-xxA-N270 series.
- Turn the AFOLUX AFL-xxA-N270 series off before cleaning the AFOLUX AFL-xxA-N270 series.
- Never drop any objects or liquids through the openings of the AFOLUX AFL-xxA-N270 series.
- Be cautious of any possible allergic reactions to solvents or chemicals used when cleaning the AFOLUX AFL-xxA-N270 series.
- Avoid eating, drinking and smoking within vicinity of the AFOLUX AFL-xxA-N270 series.

### B.2.2 Cleaning Tools

Some components in the AFOLUX AFL-xxA-N270 series may only be cleaned using a product specifically designed for the purpose. In such case, the product will be explicitly mentioned in the cleaning tips. Below is a list of items to use when cleaning the AFOLUX AFL-xxA-N270 series.

- **Cloth** – Although paper towels or tissues can be used, a soft, clean piece of cloth is recommended when cleaning the AFOLUX AFL-xxA-N270 series.
- **Water or rubbing alcohol** – A cloth moistened with water or rubbing alcohol can be used to clean the AFOLUX AFL-xxA-N270 series.
- **Using solvents** – The use of solvents is not recommended when cleaning the AFOLUX AFL-xxA-N270 series as they may damage the plastic parts.
- **Vacuum cleaner** – Using a vacuum specifically designed for computers is one of the best methods of cleaning the AFOLUX AFL-xxA-N270 series. Dust and dirt can restrict the airflow in the AFOLUX AFL-xxA-N270 series and cause its circuitry to corrode.
- **Cotton swabs** - Cotton swabs moistened with rubbing alcohol or water are excellent tools for wiping hard to reach areas.



- **Foam swabs** - Whenever possible, it is best to use lint free swabs such as foam swabs for cleaning.



Appendix

C

# BIOS Configuration Options

---

## C.1 BIOS Configuration Options

Below is a list of BIOS configuration options described in **Chapter 6**.

System Overview .....	66
System Time [xx:xx:xx] .....	67
System Date [xx/xx/xx] .....	67
ATA/IDE Configurations [Compatible] .....	69
Legacy IDE Channels [SATA Pri, PATA Sec] .....	70
IDE Master and IDE Slave .....	70
Auto-Detected Drive Parameters .....	71
Type [Auto] .....	72
LBA/Large Mode [Auto] .....	72
Block (Multi Sector Transfer) [Auto] .....	72
PIO Mode [Auto] .....	73
DMA Mode [Auto] .....	73
S.M.A.R.T [Auto] .....	74
32Bit Data Transfer [Enabled] .....	74
Serial Port 1 Address [3F8/IRQ4] .....	75
Serial Port 3 Address [3E8] .....	75
Serial Port 3 IRQ [IRQ4] .....	75
Select RS232 or RS422/RS485 [RS232] .....	75
Suspend Mode [S1(POS)] .....	78
Restore on AC Power Loss [Last State] .....	78
Power Button Mode [On/Off] .....	79
Resume on Ring [Disabled] .....	79
Resume on PCI-Express WAKE# [Enabled] .....	79
Resume On RTC Alarm [Disabled] .....	79
Remote Access [Disabled] .....	80
Serial Port Number [COM1] .....	81
Base Address, IRQ [3F8h,4] .....	81
Serial Port Mode [115200 8,n,1] .....	81
Redirection After BIOS POST [Always] .....	82
Terminal Type [ANSI] .....	82
USB Function [Enabled] .....	83

## AFL-xxA-N270 Series Panel PC

USB 2.0 Controller [Enabled].....	83
Legacy USB Support [Enabled].....	83
USB2.0 Controller Mode [HiSpeed].....	84
IRQ#.....	85
DMA Channel# [Available] .....	86
Reserved Memory Size [Disabled] .....	86
Quick Boot [Enabled] .....	88
Quiet Boot [Enabled] .....	88
AddOn ROM Display Mode [Force BIOS] .....	88
Bootup Num-Lock [On] .....	88
Boot From LAN Support [Disabled].....	89
Spread Spectrum Function [Disabled] .....	89
Change Supervisor Password.....	90
Change User Password.....	90
Memory Hole [Disabled].....	92
Internal Graphics Mode Select [Enable, 8 MB] .....	92
DVMT Mode Select [DVMT Mode].....	93
DVMT/FIXED Memory [Maximum DVMT] .....	93
LFP Panel Type [by H/W].....	93
LFP Current Jumper Setting [1024x600 18b].....	94
Audio Controller [Auto].....	94
Save Changes and Exit .....	95
Discard Changes and Exit.....	95
Discard Changes.....	95
Load Optimal Defaults.....	96
Load Failsafe Defaults.....	96

Appendix

D

# ALC892 Digital Microphone Configuration

---

## D.1 ALC892 Digital Microphone Configuration

To enable the ALC892 digital microphone function, follow the steps below.

**Step 1:** Make sure the Realtek ALC892 high definition audio driver has been installed on the system. If the audio driver has not been installed on the system, please refer to **Section 7.7**.

**Step 2:** To launch the Realtek ALC892 HD Audio Manager, double click either:

- The Realtek HD Audio Manager icon in the Notification Area of the system task bar (**Figure D-1**), or
- The Realtek HD Audio Manager icon in the Control Panel.

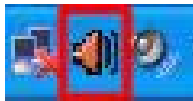

**Figure D-1: Realtek HD Audio Manager Icon [Task Bar]**

**Step 3:** The Realtek HD Audio Manager appears (**Figure D-2**).



**Figure D-2: Realtek HD Audio Manager**

**Step 4:** Click the **Mixer** tab.

**Step 5:** Click the **Mixer ToolBox** icon in the **Record** section (Figure D-3)



Figure D-3: Mixer Screen

**Step 6:** The following screen appears (Figure D-4). Check the **Enable recording multi-streaming** box, and then click **OK**.

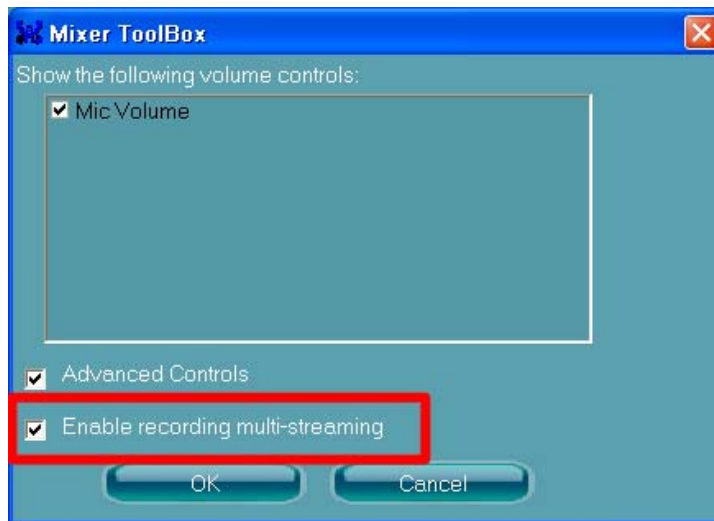

Figure D-4: Mixer ToolBox Screen

## AFL-xxA-N270 Series Panel PC

**Step 7:** From the dropdown list box in the **Record** section, select **Mic in at front panel (White)** (Figure D-5).

The digital microphone function is now enabled.



Figure D-5: Enabling the Digital Microphone Function

Appendix

E

# Watchdog Timer

---





**NOTE:**

The following discussion applies to DOS environment. IEI support is contacted or the IEI website visited for specific drivers for more sophisticated operating systems, e.g., Windows and Linux.

The Watchdog Timer is provided to ensure that standalone systems can always recover from catastrophic conditions that cause the CPU to crash. This condition may have occurred by external EMI or a software bug. When the CPU stops working correctly, Watchdog Timer either performs a hardware reset (cold boot) or a Non-Maskable Interrupt (NMI) to bring the system back to a known state.

A BIOS function call (INT 15H) is used to control the Watchdog Timer:

**INT 15H:**

<b>AH – 6FH Sub-function:</b>	
AL – 2:	Sets the Watchdog Timer's period.
BL:	Time-out value (Its unit-second is dependent on the item "Watchdog Timer unit select" in CMOS setup).

**Table E-1: AH-6FH Sub-function**

Call sub-function 2 to set the time-out period of Watchdog Timer first. If the time-out value is not zero, the Watchdog Timer starts counting down. While the timer value reaches zero, the system resets. To ensure that this reset condition does not occur, calling sub-function 2 must periodically refresh the Watchdog Timer. However, the Watchdog timer is disabled if the time-out value is set to zero.

A tolerance of at least 10% must be maintained to avoid unknown routines within the operating system (DOS), such as disk I/O that can be very time-consuming.

**NOTE:**

When exiting a program it is necessary to disable the Watchdog Timer, otherwise the system resets.

**Example program:**

```
; INITIAL TIMER PERIOD COUNTER
;
W_LOOP:

    MOV     AX, 6F02H      ;setting the time-out value
    MOV     BX, 05        ;time-out value is 5 seconds
    INT     15H

;
; ADD THE APPLICATION PROGRAM HERE
;

    CMP     EXIT_AP, 1    ;is the application over?
    JNE     W_LOOP       ;No, restart the application

    MOV     AX, 6F02H    ;disable Watchdog Timer
    MOV     BX, 0        ;
    INT     15H

;
; EXIT ;
```

Appendix

**F**

# Hazardous Materials Disclosure

---

## **F.1 Hazardous Material Disclosure Table for IPB Products Certified as RoHS Compliant Under 2002/95/EC Without Mercury**

The details provided in this appendix are to ensure that the product is compliant with the Peoples Republic of China (China) RoHS standards. The table below acknowledges the presences of small quantities of certain materials in the product, and is applicable to China RoHS only.

A label will be placed on each product to indicate the estimated “Environmentally Friendly Use Period” (EFUP). This is an estimate of the number of years that these substances would “not leak out or undergo abrupt change.” This product may contain replaceable sub-assemblies/components which have a shorter EFUP such as batteries and lamps. These components will be separately marked.

Please refer to the table on the next page.

## AFL-xxA-N270 Series Panel PC

Part Name	Toxic or Hazardous Substances and Elements					
	Lead (Pb)	Mercury (Hg)	Cadmium (Cd)	Hexavalent Chromium (CR(VI))	Polybrominated Biphenyls (PBB)	Polybrominated Diphenyl Ethers (PBDE)
Housing	X	O	O	O	O	X
Display	X	O	O	O	O	X
Printed Circuit Board	X	O	O	O	O	X
Metal Fasteners	X	O	O	O	O	O
Cable Assembly	X	O	O	O	O	X
Fan Assembly	X	O	O	O	O	X
Power Supply Assemblies	X	O	O	O	O	X
Battery	O	O	O	O	O	O

O: This toxic or hazardous substance is contained in all of the homogeneous materials for the part is below the limit requirement in SJ/T11363-2006

X: This toxic or hazardous substance is contained in at least one of the homogeneous materials for this part is above the limit requirement in SJ/T11363-2006

此附件旨在确保本产品符合中国 RoHS 标准。以下表格标示此产品中某有毒物质的含量符合中国 RoHS 标准规定的限量要求。

本产品上会附有“环境友好使用期限”的标签，此期限是估算这些物质“不会有泄漏或突变”的年限。本产品可能包含有较短的环境友好使用期限的可替换元件，像是电池或灯管，这些元件将会单独标示出来。

部件名称	有毒有害物质或元素					
	铅 (Pb)	汞 (Hg)	镉 (Cd)	六价铬 (CR(VI))	多溴联苯 (PBB)	多溴二苯醚 (PBDE)
壳体	X	O	O	O	O	X
显示	X	O	O	O	O	X
印刷电路板	X	O	O	O	O	X
金属螺帽	X	O	O	O	O	O
电缆组装	X	O	O	O	O	X
风扇组装	X	O	O	O	O	X
电力供应组装	X	O	O	O	O	X
电池	O	O	O	O	O	O

O: 表示该有毒有害物质在该部件所有物质材料中的含量均在 SJ/T11363-2006 标准规定的限量要求以下。  
X: 表示该有毒有害物质至少在该部件的某一均质材料中的含量超出 SJ/T11363-2006 标准规定的限量要求。