



MODEL:  
**TANK-801**

Fanless Embedded System with Intel® Celeron® J1900 processor,  
DVI-I, DisplayPort, Two Gigabit Ethernet, RS-232/422/485,  
Two USB 3.0, Two USB 2.0, RoHS Compliant

## User Manual

# Revision

---

Date	Version	Changes
6 November, 2014	1.00	Initial release

# Copyright

---

## COPYRIGHT NOTICE

The information in this document is subject to change without prior notice in order to improve reliability, design and function and does not represent a commitment on the part of the manufacturer.

In no event will the manufacturer be liable for direct, indirect, special, incidental, or consequential damages arising out of the use or inability to use the product or documentation, even if advised of the possibility of such damages.

This document contains proprietary information protected by copyright. All rights are reserved. No part of this manual may be reproduced by any mechanical, electronic, or other means in any form without prior written permission of the manufacturer.

## TRADEMARKS

All registered trademarks and product names mentioned herein are used for identification purposes only and may be trademarks and/or registered trademarks of their respective owners.

**WARNING**

This device complies with Part 15 of the FCC Rules. Operation is subject to the following two conditions:

(1) this device may not cause harmful interference, and(2) this device must accept any interference received, including interference that may cause undesired operation.

NOTE: This equipment has been tested and found to comply with the limits for a Class B digital device, pursuant to part 15 of the FCC Rules. These limits are designed to provide reasonable protection against harmful interference in a residential installation. This equipment generates, uses and can radiate radio frequency energy and, if not installed and used in accordance with the instructions, may cause harmful interference to radio communications.

However, there is no guarantee that interference will not occur in a particular installation. If this equipment does cause harmful interference to radio or television reception, which can be determined by turning the equipment off and on, the user is encouraged to try to correct the interference by one or more of the following measures:

- Reorient or relocate the receiving antenna.
- Increase the separation between the equipment and receiver.
- Connect the equipment into an outlet on a circuit different from that to which the receiver is connected.
- Consult the dealer or an experienced radio/ TV technician for help.

You are cautioned that any change or modifications to the equipment not expressly approve by the party responsible for compliance could void your authority to operate such equipment.

**IMPORTANT NOTE:**

FCC Radiation Exposure Statement:

This equipment complies with FCC radiation exposure limits set forth for an uncontrolled environment. This equipment should be installed and operated with minimum distance 20cm between the radiator & your body.

# Table of Contents

<b>1 INTRODUCTION.....</b>	<b>1</b>
1.1 OVERVIEW.....	2
1.2 MODEL VARIATIONS .....	3
1.3 FEATURES.....	3
1.4 TECHNICAL SPECIFICATIONS .....	4
1.5 CONNECTOR PANEL.....	6
1.6 LED INDICATORS .....	7
1.7 BACKPLANE OPTIONS .....	8
1.8 DIMENSIONS.....	10
<b>2 UNPACKING .....</b>	<b>11</b>
2.1 ANTI-STATIC PRECAUTIONS .....	12
2.2 UNPACKING PRECAUTIONS.....	12
2.3 UNPACKING CHECKLIST .....	13
<b>3 INSTALLATION .....</b>	<b>15</b>
3.1 INSTALLATION PRECAUTIONS .....	16
3.2 CFAST INSTALLATION.....	16
3.3 HARD DISK DRIVE (HDD) INSTALLATION.....	18
3.4 SYSTEM FAN INSTALLATION .....	20
3.5 PLUGGABLE DC-IN TERMINAL BLOCK INSTALLATION .....	21
3.6 MOUNTING THE SYSTEM WITH MOUNTING BRACKETS .....	22
3.7 EXTERNAL PERIPHERAL INTERFACE CONNECTORS.....	23
3.7.1 ACC Mode Selection .....	24
3.7.2 AT/ATX Power Mode Selection.....	24
3.7.3 Audio Connector .....	25
3.7.4 CFast Socket .....	25
3.7.5 Digital Input/Output Connector.....	25
3.7.6 DisplayPort Connector .....	26
3.7.7 DVI Connector.....	27
3.7.8 LAN Connectors.....	28

3.7.9	<i>Power Input, 3-pin Terminal Block</i> .....	30
3.7.10	<i>Power Input, 4-pin DIN Connector</i> .....	30
3.7.11	<i>RS-232/422/485 Serial Ports</i> .....	31
3.7.12	<i>RS-232 Serial Port Connectors</i> .....	33
3.7.13	<i>USB Connectors</i> .....	35
3.8	<b>POWERING ON/OFF THE SYSTEM</b> .....	36
<b>4</b>	<b>BIOS</b> .....	<b>38</b>
4.1	<b>INTRODUCTION</b> .....	39
4.1.1	<i>Starting Setup</i> .....	39
4.1.2	<i>Using Setup</i> .....	39
4.1.3	<i>Getting Help</i> .....	40
4.1.4	<i>Unable to Reboot after Configuration Changes</i> .....	40
4.1.5	<i>BIOS Menu Bar</i> .....	40
4.2	<b>MAIN</b> .....	41
4.3	<b>ADVANCED</b> .....	42
4.3.1	<i>ACPI Settings</i> .....	43
4.3.2	<i>Super IO Configuration</i> .....	44
4.3.2.1	<i>Serial Port n Configuration</i> .....	45
4.3.3	<i>Hardware Monitor</i> .....	49
4.3.3.1	<i>Smart Fan Mode Configuration</i> .....	50
4.3.4	<i>RTC Wake Settings</i> .....	53
4.3.5	<i>Serial Port Console Redirection</i> .....	54
4.3.6	<i>iEi Feature</i> .....	57
4.3.7	<i>CPU Configuration</i> .....	57
4.3.7.1	<i>Socket 0 CPU Information</i> .....	58
4.3.8	<i>IDE Configuration</i> .....	59
4.3.9	<i>Trusted Computing</i> .....	61
4.3.10	<i>USB Configuration</i> .....	62
4.4	<b>CHIPSET</b> .....	63
4.4.1	<i>North Bridge Configuration</i> .....	64
4.4.2	<i>South Bridge Configuration</i> .....	66
4.4.2.1	<i>Azalia HD Audio</i> .....	68
4.4.2.2	<i>PCI Express Configuration</i> .....	69
4.5	<b>SECURITY</b> .....	70

## TANK-801 Embedded System

4.6 BOOT.....	71
4.7 SAVE & EXIT .....	73
4.8 SERVER MGMT.....	74
4.8.1.1 System Event Log.....	75
4.8.1.2 BMC network configuration.....	76
<b>A SAFETY PRECAUTIONS .....</b>	<b>77</b>
A.1 SAFETY PRECAUTIONS .....	78
<i>A.1.1 General Safety Precautions</i> .....	78
<i>A.1.2 Anti-static Precautions</i> .....	78
<i>A.1.3 Product Disposal</i> .....	79
A.2 MAINTENANCE AND CLEANING PRECAUTIONS.....	80
<i>A.2.1 Maintenance and Cleaning</i> .....	80
<i>A.2.2 Cleaning Tools</i> .....	80
<b>B DIGITAL I/O INTERFACE .....</b>	<b>82</b>
B.1 INTRODUCTION .....	83
B.2 ASSEMBLY LANGUAGE SAMPLE 1 .....	84
B.3 ASSEMBLY LANGUAGE SAMPLE 2.....	84
<b>C HAZARDOUS MATERIALS DISCLOSURE .....</b>	<b>85</b>
C.1 HAZARDOUS MATERIALS DISCLOSURE TABLE FOR IPB PRODUCTS CERTIFIED AS ROHS COMPLIANT UNDER 2002/95/EC WITHOUT MERCURY.....	86

# List of Figures

Figure 1-1: TANK-801 .....	2
Figure 1-2: TANK-801 Peripheral Connectors .....	6
Figure 1-3: TANK-801 LED Indicators.....	7
Figure 1-4: 2P1E.....	8
Figure 1-5: 1P2E.....	8
Figure 1-6: 3P0E.....	8
Figure 1-7: Physical Dimensions (millimeters).....	10
Figure 3-1: CFast Socket .....	17
Figure 3-2: CFast Socket Cover .....	17
Figure 3-3: CF Card Installation .....	18
Figure 3-4: Unscrew the Cover.....	18
Figure 3-5: Remove the Cover from TANK-801 .....	19
Figure 3-6: HDD Installation .....	19
Figure 3-7: HDD Retention Screws .....	20
Figure 3-8: System Fan Installation .....	21
Figure 3-9: Pluggable DC-in Terminal Block Installation .....	22
Figure 3-10: Mounting Bracket Retention Screws .....	22
Figure 3-11: ACC Mode Switch .....	24
Figure 3-12: AT/ATX Power Mode Switch .....	24
Figure 3-13: Audio Connector .....	25
Figure 3-14: DIO Connector Pinout Location .....	26
Figure 3-15: RJ-45 to DB-9 Cable (P/N: 32005-000200-200-RS) .....	26
Figure 3-16: DisplayPort Connection .....	27
Figure 3-17: DVI Connector .....	28
Figure 3-18: LAN Connection .....	29
Figure 3-19: RJ-45 Ethernet Connector.....	29
Figure 3-20: 3-pin Terminal Block Pinout Location .....	30
Figure 3-21: Power Input Connector.....	31
Figure 3-22: Serial Device Connector.....	32
Figure 3-23: DB-9 Connector Pinout Location .....	32



## TANK-801 Embedded System

<b>Figure 3-24: Serial Device Connector</b> .....	<b>34</b>
<b>Figure 3-25: Serial Port Pinout Location</b> .....	<b>34</b>
<b>Figure 3-26: USB Device Connection</b> .....	<b>36</b>
<b>Figure 3-27: Power Button</b> .....	<b>37</b>

# List of Tables

---

<b>Table 1-1: TANK-801 Model Variations</b> .....	<b>3</b>
<b>Table 1-2: Technical Specifications</b> .....	<b>5</b>
<b>Table 1-3: Supported Signals</b> .....	<b>9</b>
<b>Table 1-4: Rated Voltage and Current</b> .....	<b>9</b>
<b>Table 3-1: DIO Connector Pinouts</b> .....	<b>26</b>
<b>Table 3-2: LAN Pinouts</b> .....	<b>29</b>
<b>Table 3-3: RJ-45 Ethernet Connector LEDs</b> .....	<b>30</b>
<b>Table 3-4: Power Input Pinouts</b> .....	<b>31</b>
<b>Table 3-5: RS-232/422/485 Connector Pinouts</b> .....	<b>33</b>
<b>Table 3-6: RS-232 Serial Port Pinouts</b> .....	<b>34</b>
<b>Table 3-7: USB Port Pinouts</b> .....	<b>36</b>
<b>Table 4-1: BIOS Navigation Keys</b> .....	<b>40</b>

Chapter

1

# Introduction

---

## 1.1 Overview



**Figure 1-1: TANK-801**

The TANK-801 Series embedded system is a fanless system for wide range temperature environments. It is powered by the Intel® Celeron® J1900 2.0GHz quad core processor and has 2.0 GB of DDR3L memory. The TANK-801 Series includes one DisplayPort, one DVI-I port, two PCIe GbE LAN, two USB 2.0 ports, two USB 3.0 ports and four COM ports.

## TANK-801 Embedded System

### 1.2 Model Variations

The model variations of the TANK-801 Series are listed below.

Model No.	CPU	Expansion Slots
TANK-801-BTi-J1/2G/3A-R10	Intel® Celeron® J1900 2.0GHz quad core	two PCI and one PCIe x 1
TANK-801-BTi-J1/2G/3B-R10	Intel® Celeron® J1900 2.0GHz quad core	one PCI and two PCIe x 1
TANK-801-BTi-J1/2G/3C-R10	Intel® Celeron® J1900 2.0GHz quad core	three PCI

**Table 1-1: TANK-801 Model Variations**

### 1.3 Features

The TANK-801 features are listed below:

- Intel® Celeron® J1900 2.0GHz quad core
- 2.0 GB DDR3L memory
- Redundant dual DC input
- Flexible PCI/PCIe expansion slots
- Two Gigabit Ethernet ports
- Two USB 2.0 ports
- Two USB 3.0 ports
- Two RS-232 serial ports
- Two RS-232/422/485 serial ports
- One DisplayPort
- One DVI-I port
- One Line-out and one Mic-in audio jacks
- AT/ATX power mode supported
- RoHS compliant

## 1.4 Technical Specifications

The TANK-801 technical specifications are listed in **Table 1-2**.

Specifications	
Fanless	Yes
Processor	Intel® Bay Trail-D J1900 22nm quad core Atom™ 2GHz processor TDP 10W
Memory	One 204-pin 1333 DDR3L Single-Channel SDRAM SODIMM (max capacity 8G)
IPMI	iRIS-2400 (Optional)
Ethernet	1 x RJ45 PCIe GbE by Intel I210 controller (LAN1) 1 x RJ45 PCIe GbE by Intel I211 controller (LAN2)
Super I/O	Fintek F81866
USB	2 x USB 2.0 (Front) 2 x USB 3.0 (Front) 1 x internal USB 2.0 connector
COM Port	2 x RS232 with DB9 2 x RS 232/422/485 with DB9 ( w/3KV isolation)
Display	DVI-I + DisplayPort
Max Resolution	2560 x 1600 MHz
Digital IO	2 x 8bit DIO(4 bit in , 4bit out ) by 2 x RJ45
Audio	1 x Line-out / 1 x Mic
Indicators	1.AT/ATX mode indicator 2.IPMI indicator 3.Power1 LED indicator 4.Power2 LED indicator 5,HDD indicator 6.CPU overheat indicator
Storage	1 x 2.5" SATA II 2.5" HDD/SSD 1 x CFast

## TANK-801 Embedded System

Specifications	
Interior Expansions	Mini PCIe slot x 1 , SO-DIMM for IPMI
Backplane	Follow TANK-800 BP (1)2 x PCI + 1 x PCIe ( by1 signal ) (2)1 x PCI + 2 x PCIe ( by1 signal ) (3)3 x PCI
Buttons	Power on, reset button
Antenna Port	2 antenna holes
Power Input	Dual Power input (1)Phenix 3 terminal port 9~36 V input (2)4 pin DC Jack-in 9~36 V input
Power Consumption	19 V@1.8 A (Intel® Celeron® J1900 with 2 GB DDR3 memory)
Chassis Construction	Extruded Aluminum Alloy for fanless support
Chassis Dimensions	247*191*136 (mm)
Operating Shock	Half-Sine Shock Test 5G/11ms, 3 shocks per axis
Operating Vibration	MIL-STD-810F 514.5 C-1(HDD),MIL-STD-810F 514.5 C-2(SSD)
Operation Temp.	From -20°C to 60°C (SATA SSD) with air flow
Storage Temp.	From -40°C to 85°C (SATA SSD) with air flow
Humidity	5% to 95% no condensation

**Table 1-2: Technical Specifications**

## 1.5 Connector Panel

All external peripheral interface connectors are located on the rear panel of the TANK-801. The peripheral interface connectors are shown in **Figure 1-2**.

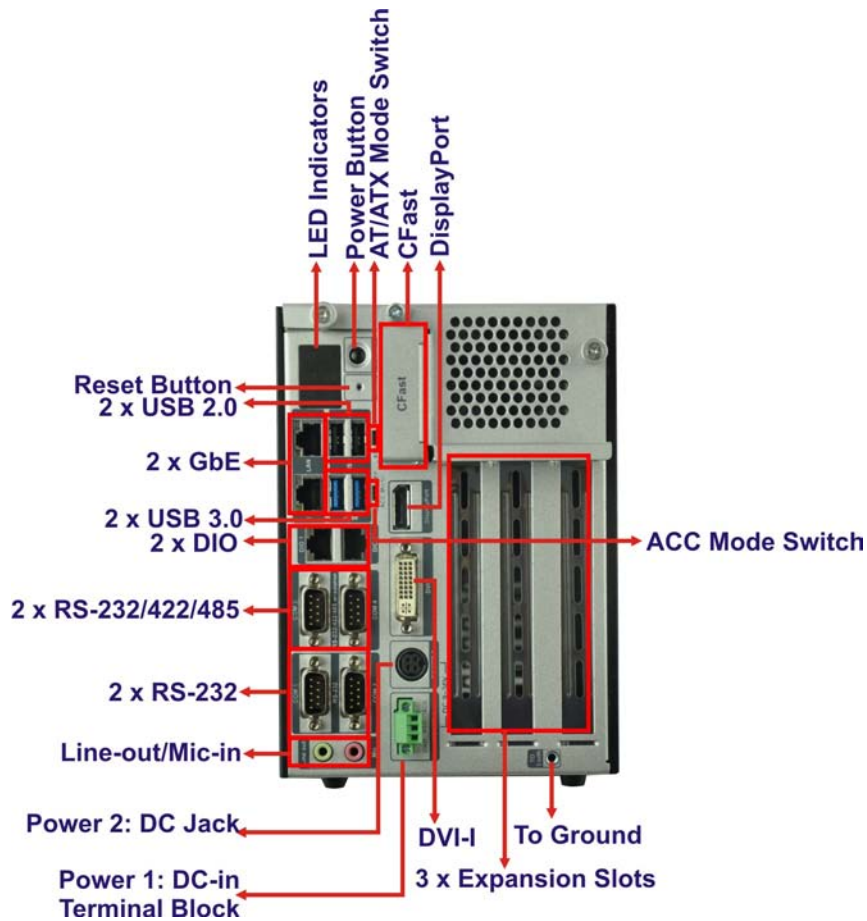

**Figure 1-2: TANK-801 Peripheral Connectors**

Connectors and buttons on the rear panel include the following.

- 1 x 4-pin power DC jack for 9V~ 36V power input
- 1 x Power terminal block for 9V ~ 36V power input
- 1 x Mic-in port (pink)
- 1 x Line-out port (green)
- 2 x DB-9 RS232 serial ports
- 2 x DB-9 RS 232/422/485 ( w/3KV isolation)
- 2 x Gigabit Ethernet ports
- 2 x USB 3.0 ports



## TANK-801 Embedded System

- 2 x USB 2.0 ports
- 1 x Reset button
- 6 x LED indicators (**Section 1.6**)
- 1 x Power button
- 1 x CFast
- 1 x DisplayPort
- 1 x DVI-I
- 1 x To earth
- 3 x Expansion slots
- 2 x DIO ports
- 1 x AT/ATX power mode switch
- 1 x ACC mode switch

### 1.6 LED Indicators

There are several indicators on the rear panel of the TANK-801 as shown in **Figure 1-3**.

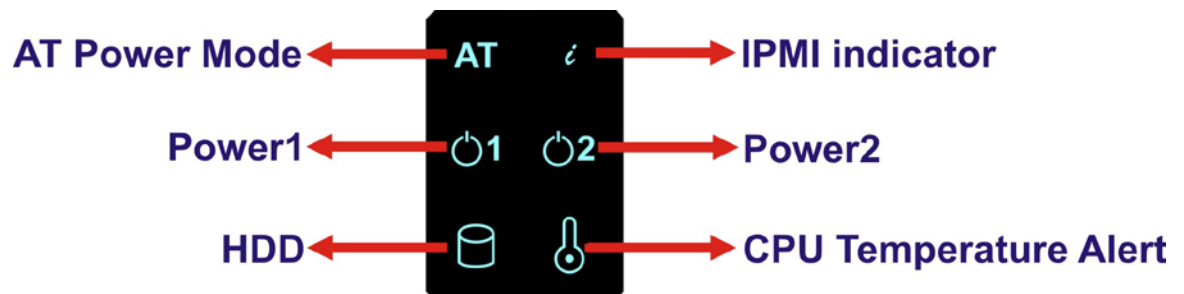

**Figure 1-3: TANK-801 LED Indicators**



#### WARNING:

The CPU Temperature Alert LED turns red when the CPU temperature is too high. If this situation occurs, lower the environment temperature or close some running applications to cool down the CPU.

### 1.7 Backplane Options

The backplane options of the TANK-801 are shown below.

#### 12V Power Input Connector

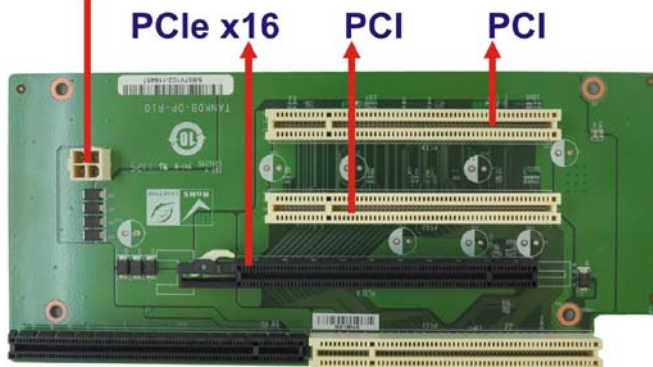

Figure 1-4: 2P1E

#### 12V Power Input Connector

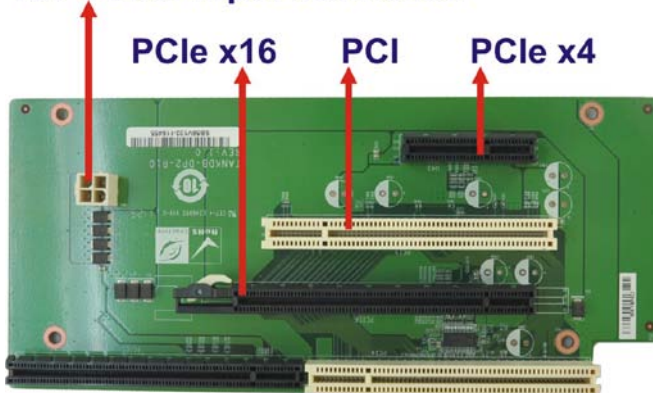

Figure 1-5: 1P2E

#### 12V Power Input Connector

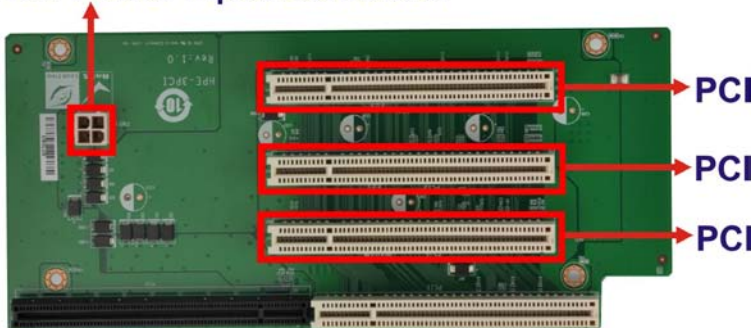

Figure 1-6: 3P0E

## TANK-801 Embedded System

The supported signals of the backplane slots are listed below.

Backplane	Slot	Signal
2P1E	PCI	PCI
	PCIe x16	PCIe x1
1P2E	PCI	PCI
	PCIe x4	PCIe x1
	PCIe x16	PCIe x1
3P0E	PCI	PCI

**Table 1-3: Supported Signals**

The rated voltage and current of the backplanes are listed below.

Rated Voltage	Rated Current
+5 V	7 A
+12 V	3.75 A
-12 V	0.1 A
+3.3 V	8 A

**Table 1-4: Rated Voltage and Current**



### **WARNING:**

The system default power is 96 W. The maximum total power of the backplane to support expansion cards is 45 W. The power of the selected expansion cards can not exceed the max. power (45 W), otherwise, the system may fail.

---



**NOTE:**

When using an expansion card with high power consumption, it is recommended to install an external power supply to the 12V power input connector on the backplane.

The maximum dimensions of the expansion card should be 190 mm in length and 111 mm in width.

### 1.8 Dimensions

The physical dimensions are shown below:

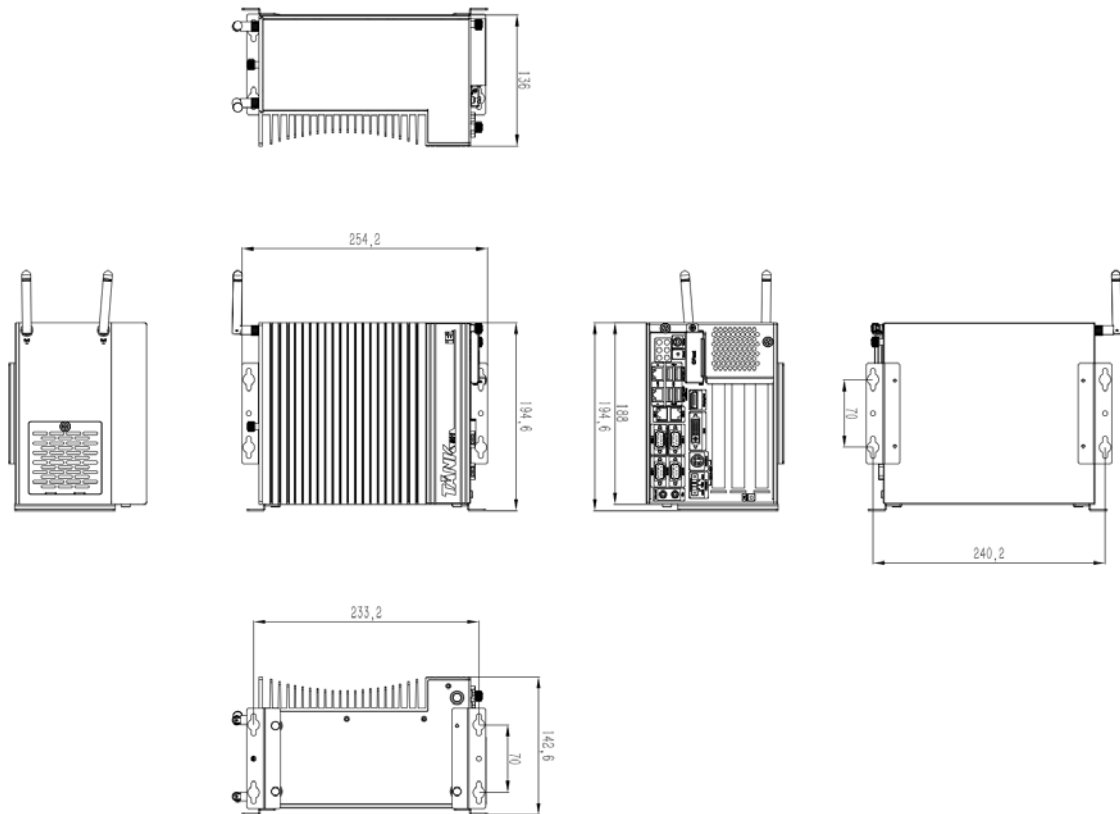

**Figure 1-7: Physical Dimensions (millimeters)**

Chapter

2

# Unpacking

---

## 2.1 Anti-static Precautions

---



### WARNING:

Failure to take ESD precautions during installation may result in permanent damage to the TANK-801 and severe injury to the user.

---

Electrostatic discharge (ESD) can cause serious damage to electronic components, including the TANK-801. Dry climates are especially susceptible to ESD. It is therefore critical that whenever the TANK-801 or any other electrical component is handled, the following anti-static precautions are strictly adhered to.

- **Wear an anti-static wristband:** Wearing a simple anti-static wristband can help to prevent ESD from damaging the board.
- **Self-grounding:** Before handling the board touch any grounded conducting material. During the time the board is handled, frequently touch any conducting materials that are connected to the ground.
- **Use an anti-static pad:** When configuring the TANK-801, place it on an anti-static pad. This reduces the possibility of ESD damaging the TANK-801.

## 2.2 Unpacking Precautions

When the TANK-801 is unpacked, please do the following:

- Follow the anti-static precautions outlined in **Section 2.1**.
- Make sure the packing box is facing upwards so the TANK-801 does not fall out of the box.
- Make sure all the components shown in **Section 2.3** are present.

## TANK-801 Embedded System





### 2.3 Unpacking Checklist







#### NOTE:

If some of the components listed in the checklist below are missing, please do not proceed with the installation. Contact the IEI reseller or vendor you purchased the TANK-801 from or contact an IEI sales representative directly. To contact an IEI sales representative, please send an email to [sales@iei.com.tw](mailto:sales@iei.com.tw).

The TANK-801 is shipped with the following components:

Quantity	Item and Part Number	Image
Standard		
1	TANK-801 Series	
1	Power adapter (P/N: 63040-010090-020-RS)	
1	Power cord	
2	Mounting bracket (P/N: 41020-0308C2-00-RS)	
4	Mounting bracket screw (P/N: 44033-040062-RS)	

Quantity	Item and Part Number	Image
Standard		
4	HDD screw (P/N: 44043-030051-RS)	
8	Rubber foot pad screw (P/N: 44005-030061-RS)	
1	One Key Recovery CD	
1	User manual and driver CD	



Chapter

3

# Installation

---

### 3.1 Installation Precautions

During installation, be aware of the precautions below:

- **Read the user manual:** The user manual provides a complete description of the TANK-801, installation instructions and configuration options.
- **DANGER! Disconnect Power:** Power to the TANK-801 must be disconnected during the installation process, or before any attempt is made to access the rear panel. Electric shock and personal injury might occur if the rear panel of the TANK-801 is opened while the power cord is still connected to an electrical outlet.
- **Qualified Personnel:** The TANK-801 must be installed and operated only by trained and qualified personnel. Maintenance, upgrades, or repairs may only be carried out by qualified personnel who are familiar with the associated dangers.
- **Air Circulation:** Make sure there is sufficient air circulation when installing the TANK-801. The TANK-801's cooling vents must not be obstructed by any objects. Blocking the vents can cause overheating of the TANK-801. Leave at least 5 cm of clearance around the TANK-801 to prevent overheating.
- **Grounding:** The TANK-801 should be properly grounded. The voltage feeds must not be overloaded. Adjust the cabling and provide external overcharge protection per the electrical values indicated on the label attached to the back of the TANK-801.

### 3.2 CFAST Installation

To install the CFAST card, please follow the steps below:

**Step 1:** Locate the CFAST socket, and then loosen the thumbscrew (**Figure 3-1**).

TANK-801 Embedded System



**Figure 3-1: CFast Socket**

**Step 2:** Open the CFast socket cover (Figure 3-2).

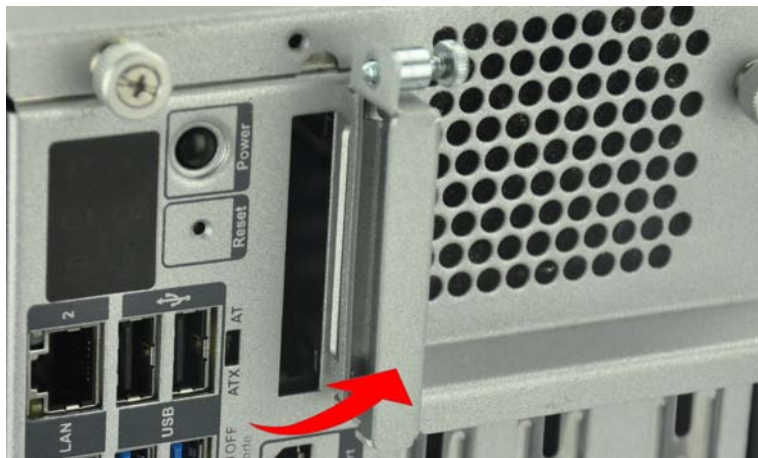

**Figure 3-2: CFast Socket Cover**

**Step 3:** Correctly align the CFast card with the socket and insert the CFast card into the socket.



**Figure 3-3: CF Card Installation**

**Step 4:** Reinstall the cover.

### 3.3 Hard Disk Drive (HDD) Installation

To install the hard drive, please follow the steps below:

**Step 1:** Loosen the thumbscrew, slide the cover inwards (**Figure 3-4**), and then lift the cover up gently.

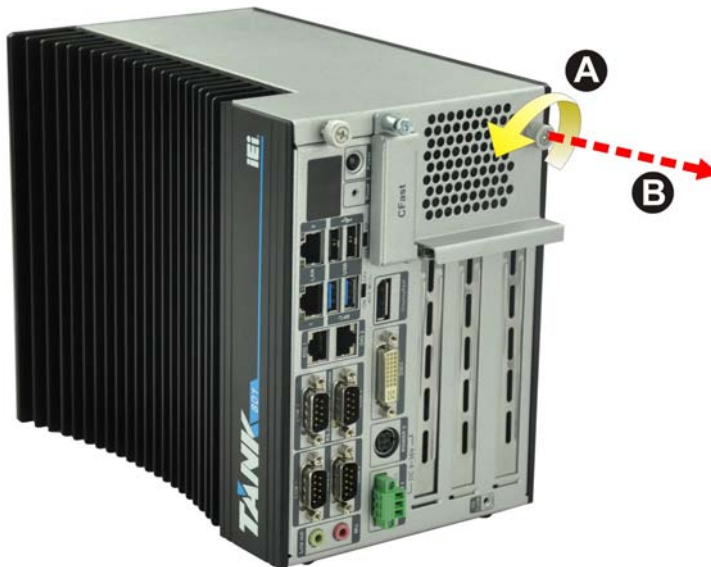

**Figure 3-4: Unscrew the Cover**

## TANK-801 Embedded System

**Step 2:** Unplug the SATA signal and power cables connected to the TANK-801, and then put the cover on a flat surface (**Figure 3-5**).

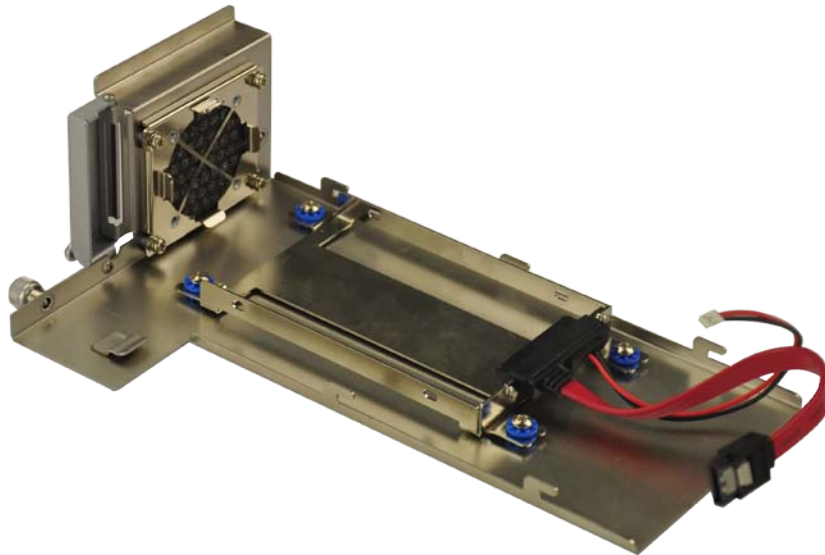

**Figure 3-5: Remove the Cover from TANK-801**

**Step 3:** Attach the HDD to the HDD bracket, and then slide the HDD to connect the HDD to the SATA connector (**Figure 3-6**).

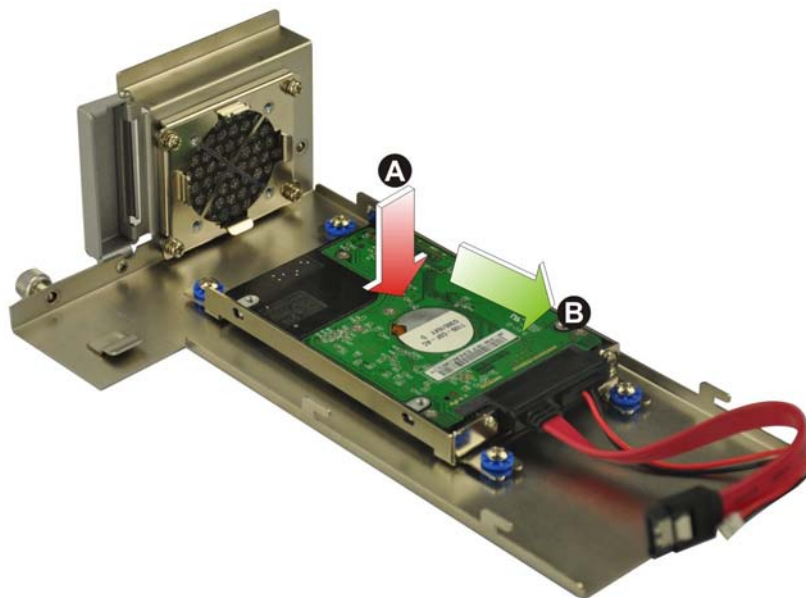

**Figure 3-6: HDD Installation**

**Step 4:** Secure the HDD with the HDD bracket by four retention screws (**Figure 3-7**).

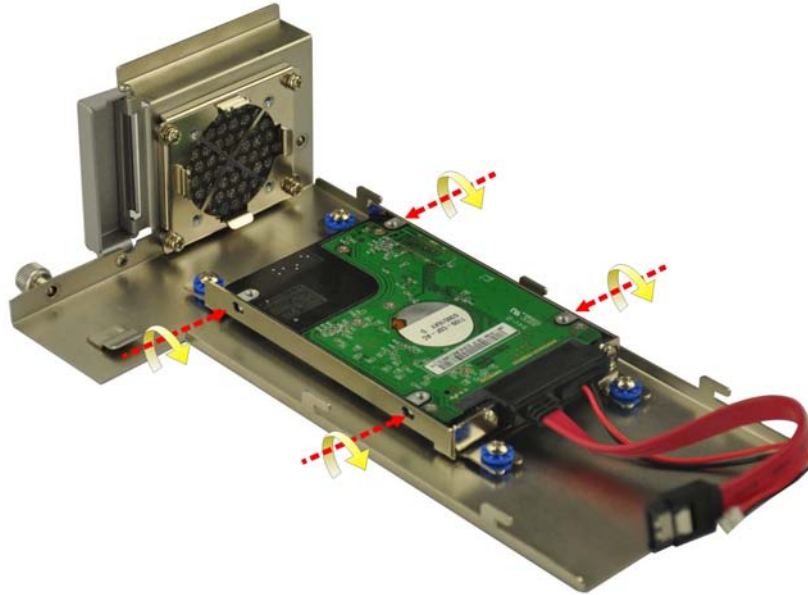

**Figure 3-7: HDD Retention Screws**

**Step 5:** Reconnect the SATA signal and power cables to the TANK-801.

**Step 6:** Reinstall the cover.

### 3.4 System Fan Installation

To install the optional system fan, please follow the steps below:

**Step 1:** Remove the two retention screws on the rear panel and loosen the two thumbscrews on the front panel, slide the cover inwards, and then lift the cover up gently (**Figure 3-4**).

**Step 2:** Unplug the SATA signal and power cables connected to the TANK-801, and then place the cover on a flat surface (**Figure 3-5**).

**Step 3:** Attach the system fan to the TANK-801 and secure it by four retention screws (**Figure 3-8**).

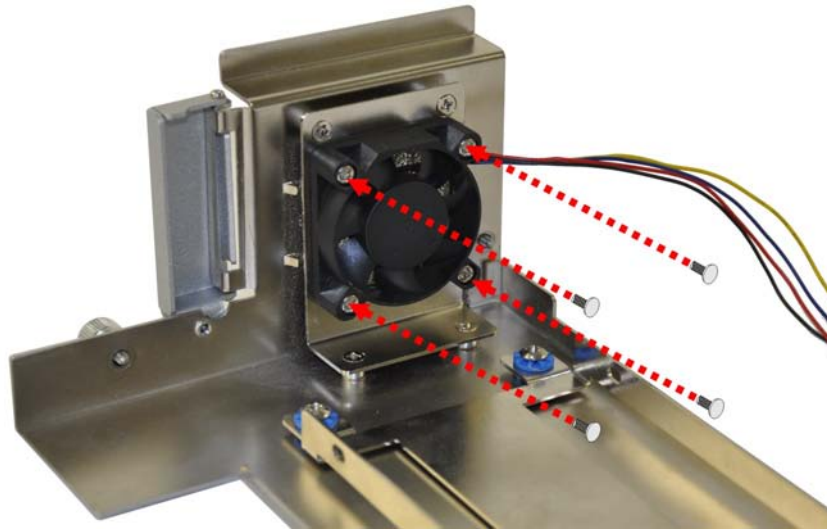

**Figure 3-8: System Fan Installation**

- Step 4:** Connect the system fan cable to the **CPU\_FAN** connector on the motherboard of TANK-801.
- Step 5:** Reconnect the SATA signal and power cables to the TANK-801.
- Step 6:** Reinstall the cover.

### 3.5 Pluggable DC-In Terminal Block Installation

To install the pluggable DC-in terminal block, please follow the steps below:

- Step 1:** Locate the DC-in terminal block connector. The location of the connector is shown in **Figure 1-2**.
- Step 2:** Align the pluggable DC-in terminal block with the DC-in terminal block connector on the TANK-801.
- Step 3:** Once aligned, insert the pluggable DC-in terminal block into the DC-in terminal block connector.
- Step 4:** Secure the pluggable DC-in terminal block to the external interface by tightening the two retention screws on either side of the terminal block (**Figure 3-9**).



**Figure 3-9: Pluggable DC-in Terminal Block Installation**

### 3.6 Mounting the System with Mounting Brackets

To mount the embedded system onto a wall or some other surface using the two mounting brackets, please follow the steps below.

- Step 1:** Turn the embedded system to the left side panel.
- Step 2:** Align the two retention screw holes in each bracket with the corresponding retention screw holes on the left side panel (**Figure 3-10**).

#### Left Side Panel



**Figure 3-10: Mounting Bracket Retention Screws**



## TANK-801 Embedded System

- Step 3:** Secure the brackets to the system by inserting two retention screws into each bracket (**Figure 3-10**).
- Step 4:** Drill holes in the intended installation surface.
- Step 5:** Align the mounting holes in the sides of the mounting brackets with the predrilled holes in the mounting surface.
- Step 6:** Insert four retention screws, two in each bracket, to secure the system to the wall.

### 3.7 External Peripheral Interface Connectors

The TANK-801 has the following connectors. Detailed descriptions of the connectors can be found in the subsections below.

- Audio
- CFast
- DIO
- DisplayPort
- DVI-I
- Ethernet
- Power button
- Power input
- Reset button
- RS-232
- RS-232/422/485
- USB

### 3.7.1 ACC Mode Selection

The TANK-801 allows turning the ACC mode on or off. The setting can be made through the ACC mode switch on the external peripheral interface panel as shown below.

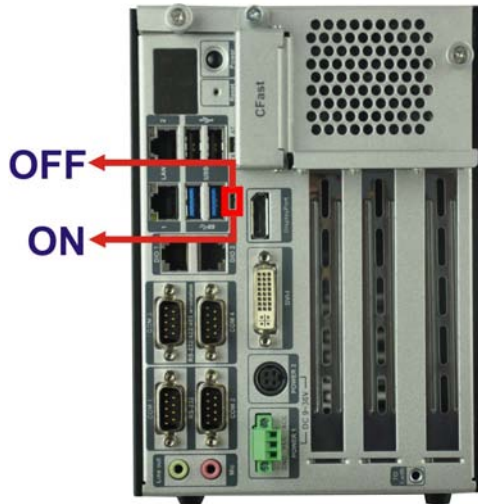

**Figure 3-11: ACC Mode Switch**

### 3.7.2 AT/ATX Power Mode Selection

The TANK-801 supports AT and ATX power modes. The setting can be made through the AT/ATX power mode switch on the external peripheral interface panel as shown below.

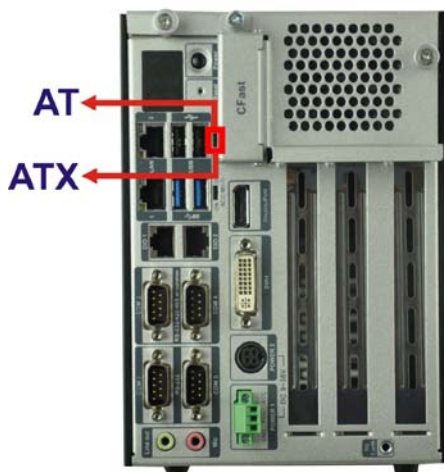

**Figure 3-12: AT/ATX Power Mode Switch**

## TANK-801 Embedded System

### 3.7.3 Audio Connector

CN Label:	Line out and Mic
CN Type:	Audio jack
CN Location:	See <b>Figure 1-2</b>

The audio jacks connect to external audio devices.

- **Line Out port (Green):** Connects to a headphone or a speaker. With multi-channel configurations, this port can also connect to front speakers.
- **Microphone (Pink):** Connects a microphone.



**Figure 3-13: Audio Connector**

### 3.7.4 CFast Socket

The TANK-801 has one CFast socket. The location of the socket is shown in **Figure 1-2**. To install the CFast card, refer to **Section 3.2**.

### 3.7.5 Digital Input/Output Connector

CN Label:	<b>DIO1, DIO2</b>
CN Type:	RJ-45
CN Location:	See <b>Figure 1-2</b>
CN Pinouts:	See <b>Table 3-1</b> and <b>Figure 3-14</b>

The digital I/O connector provides programmable input and output for external devices. The pinouts for the digital I/O connector are listed in the table below.

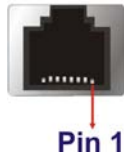

**Figure 3-14: DIO Connector Pinout Location**

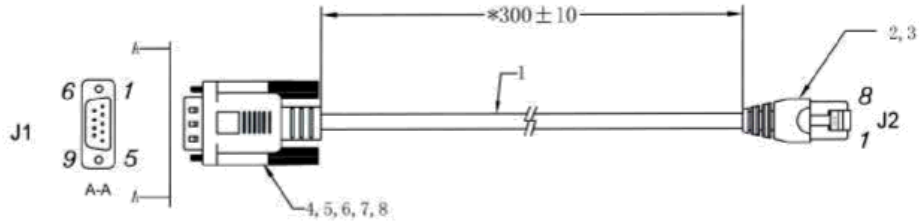

**Figure 3-15: RJ-45 to DB-9 Cable (P/N: 32005-000200-200-RS)**

Pin	Description (RJ-45)	Description (DB-9)
1	DOUT3	DIN0
2	DOUT2	DIN2
3	DOUT1	DOUT0
4	DOUT0	DOUT2
5	DIN3	N/A
6	DIN2	DIN1
7	DIN1	DIN3
8	DIN0	DOUT1
9	N/A	DOUT3

**Table 3-1: DIO Connector Pinouts**

### 3.7.6 DisplayPort Connector

The DisplayPort connector transmits a digital signal to compatible DisplayPort display devices such as a TV or computer screen. To connect the DisplayPort cable to the TANK-801, follow the steps below.

**Step 1: Locate the DisplayPort connector.** The location is shown in **Chapter 3**.

**Step 2: Align the connector.** Align the DisplayPort connector with the DisplayPort port. Make sure the orientation of the connector is correct.

## TANK-801 Embedded System

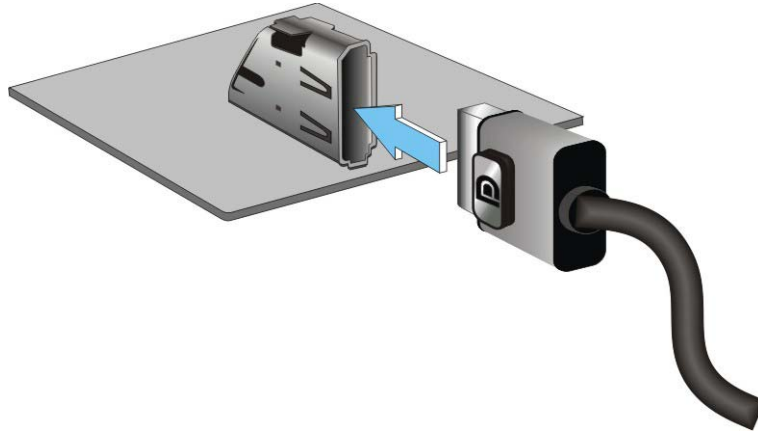

**Figure 3-16: DisplayPort Connection**

**Step 3: Insert the DisplayPort connector.** Gently insert the DisplayPort connector. The connector should engage with a gentle push. If the connector does not insert easily, check again that the connector is aligned correctly, and that the connector is being inserted with the right way up.

### 3.7.7 DVI Connector

The TANK-801 has one female DVI-I connector on the front panel. The DVI connectors are connected to digital display devices. To connect a digital display device to the TANK-801, please follow the instructions below.

**Step 1: Locate the DVI connector.** The location of the DVI connector is shown in **Chapter 1**.

**Step 2: Align the DVI connector.** Align the male DVI connector on the digital display device cable with the female DVI connector on the external peripheral interface.

**Step 3: Insert the DVI connector.** Once the connectors are properly aligned with the male connector, insert the male connector from the digital display device into the female connector on the TANK-801. See **Figure 3-17**.

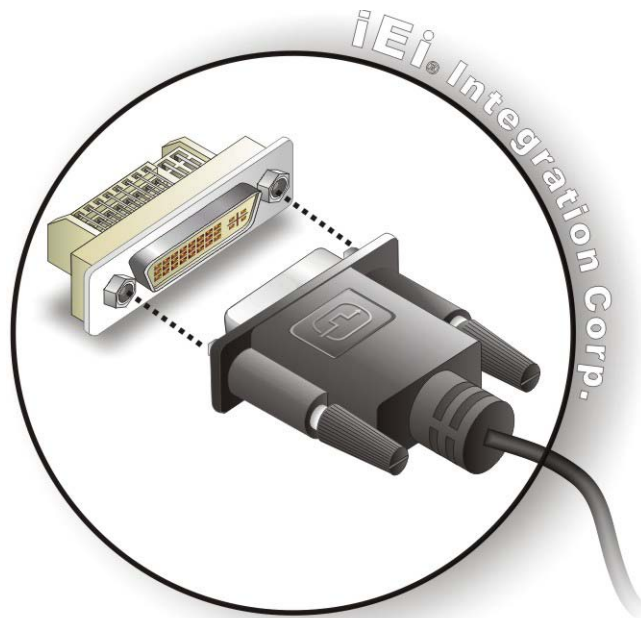

**Figure 3-17: DVI Connector**

**Step 4: Secure the connector.** Secure the DVI connector from the digital display device to the external interface by tightening the two retention screws on either side of the connector.

### 3.7.8 LAN Connectors

CN Label:	<b>LAN1, LAN2</b>
CN Type:	RJ-45
CN Location:	See <b>Figure 1-2</b>
CN Pinouts:	See <b>Table 3-2</b>

The LAN connectors allow connection to an external network.

**Step 1: Locate the RJ-45 connectors.** The locations of the RJ-45 connectors are shown in **Figure 1-2**.

**Step 2: Align the connectors.** Align the RJ-45 connector on the LAN cable with one of the RJ-45 connectors on the TANK-801. See **Figure 3-18**.

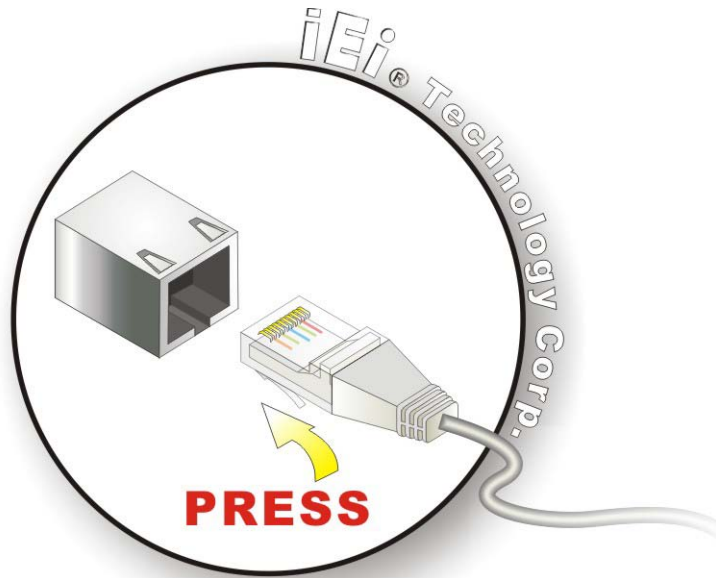

Figure 3-18: LAN Connection

**Step 3:** Insert the LAN cable RJ-45 connector. Once aligned, gently insert the LAN cable RJ-45 connector into the on-board RJ-45 connector.

Pin	Description	Pin	Description
1	TRD1P0	5	TRD1P2
2	TRD1N0	6	TRD1N2
3	TRD1P1	7	TRD1P3
4	TRD1N1	8	TRD1N3

Table 3-2: LAN Pinouts



Figure 3-19: RJ-45 Ethernet Connector

The RJ-45 Ethernet connector has two status LEDs, one green and one yellow. The green LED indicates activity on the port and the yellow LED indicates the port is linked. See **Table 3-3**.

Activity/Link LED		Speed LED	
STATUS	DESCRIPTION	STATUS	DESCRIPTION
Off	No link	Off	10 Mbps connection
Yellow	Linked	Green	100 Mbps connection
Blinking	TX/RX activity	Orange	1 Gbps connection

**Table 3-3: RJ-45 Ethernet Connector LEDs**

### 3.7.9 Power Input, 3-pin Terminal Block

- CN Label: **POWER 1**
- CN Type: 3-pin terminal block
- CN Location: See **Figure 1-2**
- CN Pinouts: See **Figure 3-20**

Connect the leads of a 9V~36V DC power supply into the terminal block. Make sure that the power and ground wires are attached to the correct sockets of the connector.

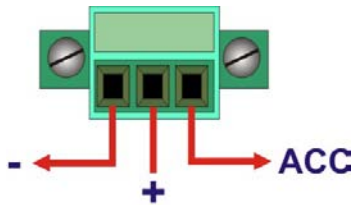

**Figure 3-20: 3-pin Terminal Block Pinout Location**

### 3.7.10 Power Input, 4-pin DIN Connector

- CN Label: POWER 2
- CN Type: 4-pin DIN connector
- CN Location: See **Figure 1-2**
- CN Pinouts: See **Table 3-4** and **Figure 3-21**

The power connector connects to the 9V ~36V DC power adapter.



## TANK-801 Embedded System



Figure 3-21: Power Input Connector

Pin	Description	Pin	Description
1	+12V	3	+12V
2	GND	4	GND

Table 3-4: Power Input Pinouts

## 3.7.11 RS-232/422/485 Serial Ports

- CN Label: **COM3, COM4**
- CN Type: DB-9 connectors
- CN Location: See **Figure 1-2**
- CN Pinouts: See **Figure 3-23 and Table 3-5**

RS-232/422/485 serial port devices can be attached to the DB-9 RS-232/422/485 ports on the rear panel.

**Step 1: Locate the DB-9 connector.** The locations of the DB-9 connectors are shown in **Figure 1-2**.

**Step 2: Insert the serial connector.** Insert the DB-9 connector of a serial device into the DB-9 connector on the external peripheral interface. See **Figure 3-24**.

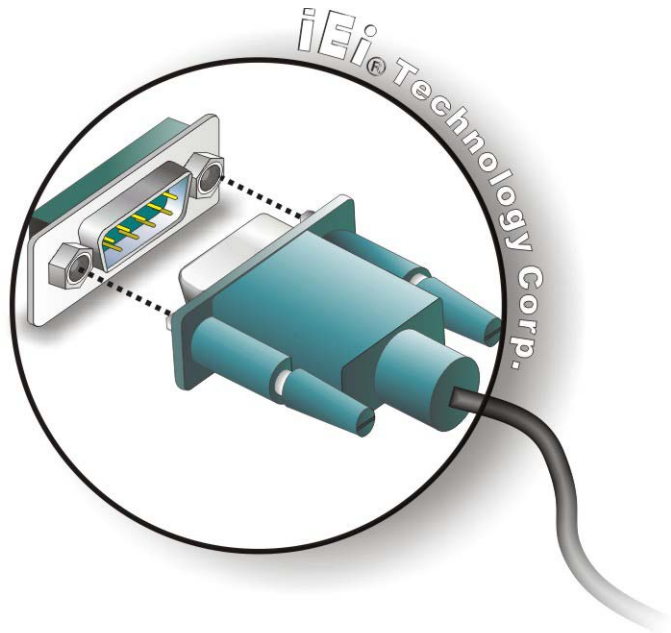

**Figure 3-22: Serial Device Connector**

**Step 3: Secure the connector.** Secure the serial device connector to the external interface by tightening the two retention screws on either side of the connector.

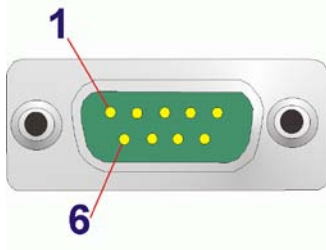

**Figure 3-23: DB-9 Connector Pinout Location**

Pin	Description (RS-232)	Description (RS-422)	Description (RS-485)
1	DCD	TXD422#	TXD485#
2	RX	TXD422+	TXD485+
3	TX	RXD422+	N/A
4	DTR	RXD422#	N/A
5	GND	N/A	N/A
6	DSR	N/A	N/A

## TANK-801 Embedded System

7	RTS	N/A	N/A
8	CTS	N/A	N/A
9	RI	N/A	N/A

**Table 3-5: RS-232/422/485 Connector Pinouts**

## 3.7.12 RS-232 Serial Port Connectors

CN Label:	<b>COM1, COM2</b>
CN Type:	DB-9 connectors
CN Location:	See <b>Figure 1-2</b>
CN Pinouts:	See <b>Table 3-6</b> and <b>Figure 3-25</b>

RS-232 serial port devices can be attached to the DB-9 RS-232 ports on the rear panel.

**Step 1: Locate the DB-9 connector.** The locations of the DB-9 connectors are shown in **Figure 1-2**.

**Step 2: Insert the serial connector.** Insert the DB-9 connector of a serial device into the DB-9 connector on the external peripheral interface. See **Figure 3-24**.

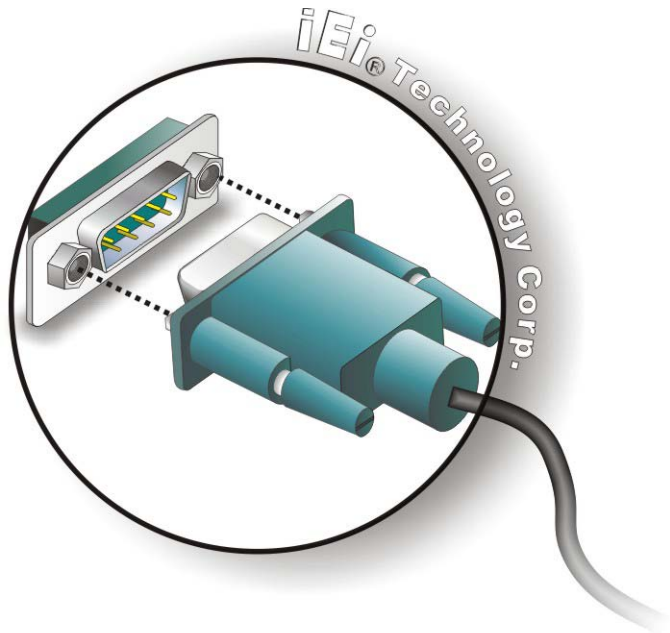

**Figure 3-24: Serial Device Connector**

**Step 3: Secure the connector.** Secure the serial device connector to the external interface by tightening the two retention screws on either side of the connector.

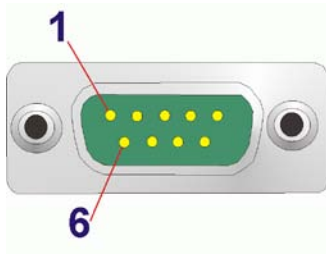

**Figure 3-25: Serial Port Pinout Location**

Pin	Description	Pin	Description
1	DCD	6	DSR
2	RX	7	RTS
3	TX	8	CTS
4	DTR	9	RI
5	GND		

**Table 3-6: RS-232 Serial Port Pinouts**

## TANK-801 Embedded System

## 3.7.13 USB Connectors

CN Label:	USB
CN Type:	USB port
CN Location:	See <b>Figure 1-2</b>
CN Pinouts:	See <b>Table 3-7</b>

**NOTE:**

User must install the USB 3.0 driver before connecting a USB device to the system or else the system may not recognize the connected device.

---

There are two USB 2.0 connectors and two USB 3.0 connectors on the TANK-801. To connect a USB device, please follow the instructions below.

**Step 1:** **Locate the USB connectors.** The locations of the USB connectors are shown in **Figure 1-2**.

**Step 2:** **Align the connectors.** Align the USB device connector with one of the connectors. See **Figure 3-26**.

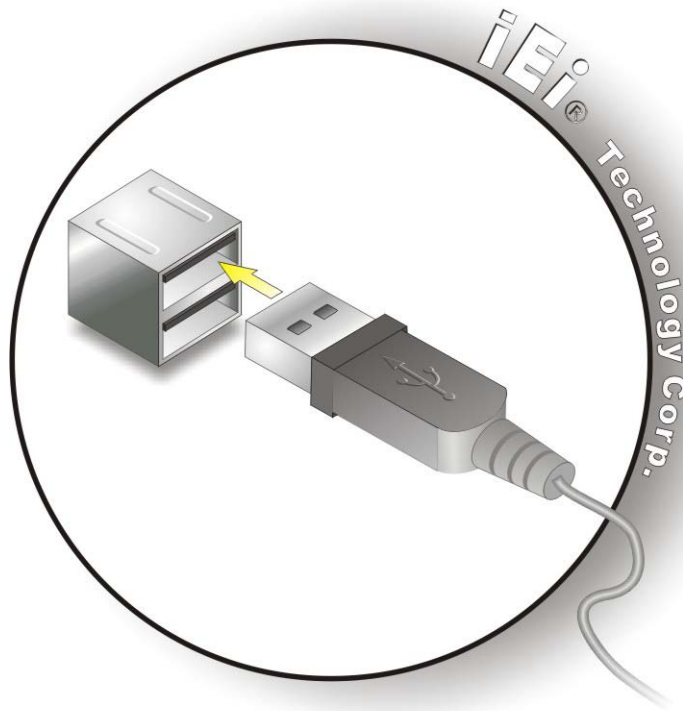

**Figure 3-26: USB Device Connection**

**Step 3:** **Insert the device connector.** Once aligned, gently insert the USB device connector into the on-board connector.

Pin	Description	Pin	Description
1	VCC	5	VCC
2	DATA-	6	DATA-
3	DATA+	7	DATA+
4	GROUND	8	GROUND

**Table 3-7: USB Port Pinouts**

### 3.8 Powering On/Off the System



**WARNING:**

Make sure a power supply with the correct input voltage is being fed into the system. Incorrect voltages applied to the system may cause damage to

## TANK-801 Embedded System

---

the internal electronic components and may also cause injury to the user.

---

- **Power on** the system: press the power button for 2 seconds
- **Power off** the system: press the power button for 5 seconds



Figure 3-27: Power Button

Chapter

4

**BIOS**

---



## 4.1 Introduction

The BIOS is programmed onto the BIOS chip. The BIOS setup program allows changes to certain system settings. This chapter outlines the options that can be changed.

### 4.1.1 Starting Setup

The UEFI BIOS is activated when the computer is turned on. The setup program can be activated in one of two ways.

1. Press the **DEL** or **F2** key as soon as the system is turned on or
2. Press the **DEL** or **F2** key when the “**Press DEL or F2 to enter SETUP**” message appears on the screen.

If the message disappears before the **DEL** or **F2** key is pressed, restart the computer and try again.

### 4.1.2 Using Setup

Use the arrow keys to highlight items, press **ENTER** to select, use the PageUp and PageDown keys to change entries, press **F1** for help and press **ESC** to quit. Navigation keys are shown in.

Key	Function
Up arrow	Move to previous item
Down arrow	Move to next item
Left arrow	Move to the item on the left hand side
Right arrow	Move to the item on the right hand side
+	Increase the numeric value or make changes
-	Decrease the numeric value or make changes
Page Up key	Increase the numeric value or make changes
Page Dn key	Decrease the numeric value or make changes

Key	Function
Esc key	Main Menu – Quit and not save changes into CMOS Status Page Setup Menu and Option Page Setup Menu -- Exit current page and return to Main Menu
F1	General help, only for Status Page Setup Menu and Option Page Setup Menu
F2	Previous values
F3	Load optimized defaults
F4	Save changes and Exit BIOS

**Table 4-1: BIOS Navigation Keys**

#### 4.1.3 Getting Help

When **F1** is pressed a small help window describing the appropriate keys to use and the possible selections for the highlighted item appears. To exit the Help Window press **Esc** or the **F1** key again.

#### 4.1.4 Unable to Reboot after Configuration Changes

If the computer cannot boot after changes to the system configuration is made, CMOS defaults. Use the jumper described in Chapter 3.

#### 4.1.5 BIOS Menu Bar

The **menu bar** on top of the BIOS screen has the following main items:

- Main – Changes the basic system configuration.
- Advanced – Changes the advanced system settings.
- Security – Sets User and Supervisor Passwords.
- Chipset – Changes the chipset settings.
- Boot – Changes the system boot configuration.
- Save & Exit – Selects exit options and loads default settings
- Server Mgmt – Access the server management menus.

## TANK-801 Embedded System

The following sections completely describe the configuration options found in the menu items at the top of the BIOS screen and listed above.

### 4.2 Main

The **Main** BIOS menu (**BIOS Menu 1**) appears when the **BIOS Setup** program is entered. The **Main** menu gives an overview of the basic system information.

Aptio Setup Utility - Copyright (C) 2013 American Megatrends, Inc.		
Main	Advanced	Chipset Security Boot Save & Exit Server Mgmt
BIOS Information		Set the Date. Use Tab to switch between Data elements.
BIOS Vendor	American Megatrends	
Core Version	5.009	
Compliancy	UEFI 2.3; PI 1.2	
Project Version	SEG6AM10.ROM	
Build Date and Time	10/16/2014 19:05:21	
iWDD Vendor	IEI	
iWDD Version	SEG6ER10.bin	
IPMI Module	N/A	
CPU Configuration		
Microcode Patch	809	
BayTrail Soc	Unknown	
KCS Version	N/A	
Memory Information		
Memory Frequency	1333 MHz	
Total Memory	2048 MB (LPDDR3)	
GDP Information		
Intel(R) GDP Driver	[N/A]	←→: Select Screen ↑ ↓: Select Item EnterSelect + - Change Opt. F1 General Help F2 Previous Values F3 Optimized Defaults F4 Save & Exit ESC Exit
TXE Information		
Sec RC Version	00.05.00.00	
TXE FW Version	01.00.02.1060	
System Date	[Tue 10/28/2014]	
System Time	[15:10:27]	
Access Level	Administrator	
Version 2.16.1242. Copyright (C) 2013 American Megatrends, Inc.		

#### BIOS Menu 1: Main

The Main menu lists the following system details:

- BIOS Information

- CPU Information
- Memory Information
- GDP Information
- TXE Information

The Main menu has two user configurable fields:

➔ System Date [xx/xx/xx]

Use the **System Date** option to set the system date. Manually enter the day, month and year.

➔ System Time [xx:xx:xx]

Use the **System Time** option to set the system time. Manually enter the hours, minutes and seconds.

### 4.3 Advanced

Use the **Advanced** menu (**BIOS Menu 2**) to configure the CPU and peripheral devices through the following sub-menus:



#### WARNING!

Setting the wrong values in the sections below may cause the system to malfunction. Make sure that the settings made are compatible with the hardware.

---

## TANK-801 Embedded System

```

Aptio Setup Utility - Copyright (C) 2013 American Megatrends, Inc.
Main  Advanced  Chipset  Boot  Security  Save & Exit

> ACPI Settings
> Super IO Configuration
> Hardware Monitor
> RTC Wake Settings
> Serial Port Console Redirection
> iEi Feature
> CPU Configuration
> IDE Configuration
> Trusted Computing
> USB Configuration

System ACPI Parameters
-----
<=>: Select Screen
↑↓: Select Item
EnterSelect
+ - Change Opt.
F1  General Help
F2  Previous Values
F3  Optimized Defaults
F4  Save & Exit
ESC Exit

Version 2.16.1242. Copyright (C) 2013 American Megatrends, Inc.
  
```

### BIOS Menu 2: Advanced

#### 4.3.1 ACPI Settings

The **ACPI Settings** menu (**BIOS Menu 3**) configures the Advanced Configuration and Power Interface (ACPI) options.

```

Aptio Setup Utility - Copyright (C) 2013 American Megatrends, Inc.
Advanced

ACPI Settings
ACPI Sleep State          [S3 (Suspend to RAM)]

Select the highest ACPI
sleep state the system
will enter when the
SUSPEND button is
pressed.

-----
<=>: Select Screen
↑↓: Select Item
EnterSelect
+ - Change Opt.
F1  General Help
F2  Previous Values
F3  Optimized Defaults
F4  Save & Exit
ESC Exit

Version 2.16.1242. Copyright (C) 2013 American Megatrends, Inc.
  
```

### BIOS Menu 3: ACPI Configuration

➔ ACPI Sleep State [S3 (Suspend to RAM)]

Use the **ACPI Sleep State** option to specify the sleep state the system enters when it is not being used.

➔ **Suspend Disabled**

➔ **S3 (Suspend to DEFAULT RAM)** The caches are flushed and the CPU is powered off. Power to the RAM is maintained. The computer returns slower to a working state, but more power is saved.

### 4.3.2 Super IO Configuration

Use the **Super IO Configuration** menu (**BIOS Menu 4**) to set or change the configurations for the serial ports.

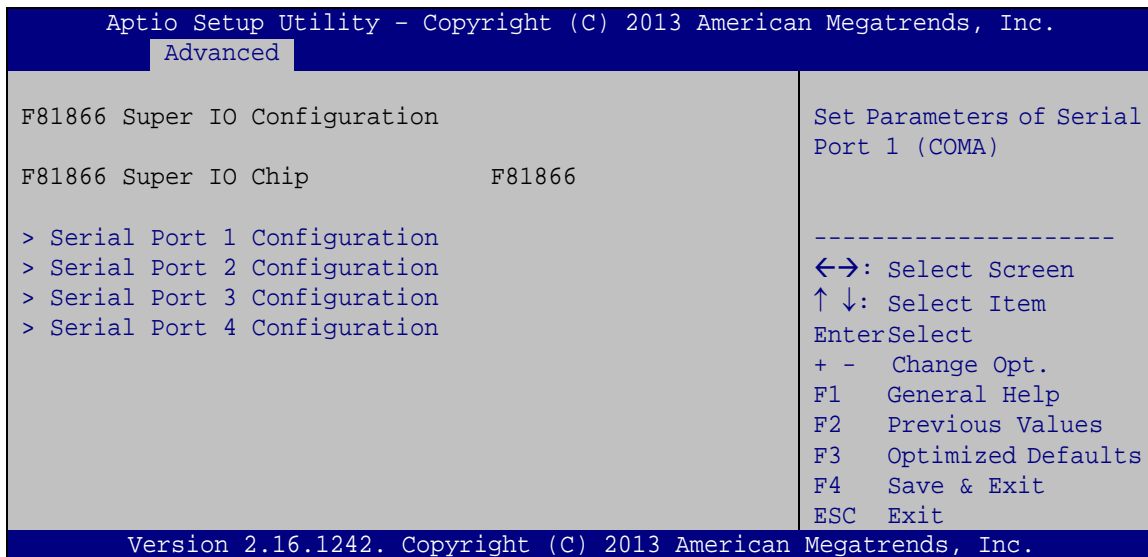

**BIOS Menu 4: Super IO Configuration**

## TANK-801 Embedded System

### 4.3.2.1 Serial Port n Configuration

Use the **Serial Port n Configuration** menu (**BIOS Menu 5**) to configure the serial port n.

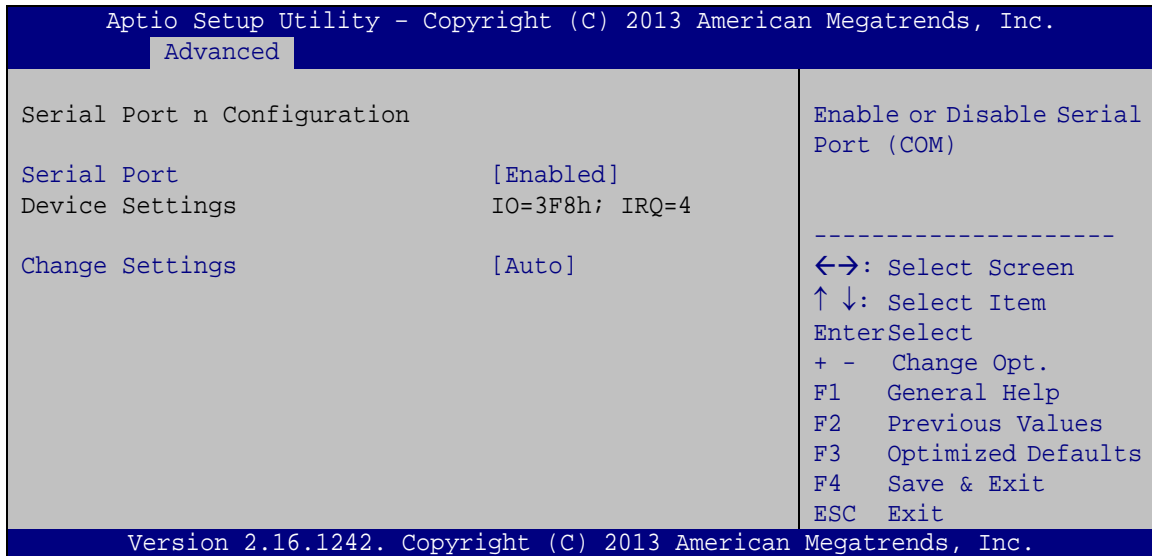

#### BIOS Menu 5: Serial Port n Configuration Menu

##### 4.3.2.1.1 Serial Port 1 Configuration

###### → Serial Port [Enabled]

Use the **Serial Port** option to enable or disable the serial port.

- **Disabled**                      Disable the serial port
- **Enabled**            **DEFAULT**      Enable the serial port

###### → Change Settings [Auto]

Use the **Change Settings** option to change the serial port IO port address and interrupt address.

- **Auto**                      **DEFAULT**      The serial port IO port address and interrupt address are automatically detected.
- **IO=3F8h; IRQ=4**                      Serial Port I/O port address is 3F8h and the interrupt address is IRQ4

- ➔ IO=3F8h; IRQ=3, 4,5,6,7,9,10,11,12      Serial Port I/O port address is 3F8h and the interrupt address is IRQ3,4,5,6,7,9,10,11,12
- ➔ IO=2F8h; IRQ=3, 4,5,6,7,9,10,11,12      Serial Port I/O port address is 2F8h and the interrupt address is IRQ3,4,5,6,7,9,10,11,12
- ➔ IO=3E8h; IRQ=3, 4,5,6,7,9,10,11,12      Serial Port I/O port address is 3E8h and the interrupt address is IRQ3,4,5,6,7,9,10,11,12
- ➔ IO=2E8h; IRQ=3, 4,5,6,7,9,10,11,12      Serial Port I/O port address is 2E8h and the interrupt address is IRQ3,4,5,6,7,9,10,11,12

#### 4.3.2.1.2 Serial Port 2 Configuration

##### ➔ Serial Port [Enabled]

Use the **Serial Port** option to enable or disable the serial port.

- ➔ **Disabled**      Disable the serial port
- ➔ **Enabled**      **DEFAULT**      Enable the serial port

##### ➔ Change Settings [Auto]

Use the **Change Settings** option to change the serial port IO port address and interrupt address.

- ➔ **Auto**      **DEFAULT**      The serial port IO port address and interrupt address are automatically detected.
- ➔ IO=2F8h; IRQ=3, 4,5,6,7,9,10,11,12      Serial Port I/O port address is 2F8h and the interrupt address is IRQ3,4,5,6,7,9,10,11,12
- ➔ IO=3F8h; IRQ=3, 4,5,6,7,9,10,11,12      Serial Port I/O port address is 3F8h and the interrupt address is IRQ3,4,5,6,7,9,10,11,12
- ➔ IO=2E8h; IRQ=3, 4,5,6,7,9,10,11,12      Serial Port I/O port address is 2E8h and the interrupt address is IRQ3,4,5,6,7,9,10,11,12
- ➔ IO=3E8h; IRQ=3, 4,5,6,7,9,10,11,12      Serial Port I/O port address is 3E8h and the interrupt address is IRQ3,4,5,6,7,9,10,11,12



## TANK-801 Embedded System

- ➔ **IO=2E8h; IRQ=3, 4,5,6,7,9,10,11,12**      Serial Port I/O port address is 2E8h and the interrupt address is IRQ3,4,5,6,7,9,10,11,12

### 4.3.2.1.3 Serial Port 3 Configuration

- ➔ Serial Port [Enabled]

Use the **Serial Port** option to enable or disable the serial port.

- ➔ **Disabled**      Disable the serial port
- ➔ **Enabled      DEFAULT**      Enable the serial port

- ➔ Change Settings [Auto]

Use the **Change Settings** option to change the serial port IO port address and interrupt address.

- ➔ **Auto      DEFAULT**      The serial port IO port address and interrupt address are automatically detected.
- ➔ **IO=3E8h; IRQ=10**      Serial Port I/O port address is 3E8h and the interrupt address is IRQ10
- ➔ **IO=3F8h; IRQ=3, 4,5,6,7,9,10,11,12**      Serial Port I/O port address is 3F8h and the interrupt address is IRQ3,4,5,6,7,9,10,11,12
- ➔ **IO=2F8h; IRQ=3, 4,5,6,7,9,10,11,12**      Serial Port I/O port address is 2F8h and the interrupt address is IRQ3,4,5,6,7,9,10,11,12
- ➔ **IO=3E8h; IRQ=3, 4,5,6,7,9,10,11,12**      Serial Port I/O port address is 3E8h and the interrupt address is IRQ3,4,5,6,7,9,10,11,12
- ➔ **IO=2E8h; IRQ=3, 4,5,6,7,9,10,11,12**      Serial Port I/O port address is 2E8h and the interrupt address is IRQ3,4,5,6,7,9,10,11,12
- ➔ **IO=2F0h; IRQ=3, 4,5,6,7,9,10,11,12**      Serial Port I/O port address is 2F0h and the interrupt address is IRQ3,4,5,6,7,9,10,11,12
- ➔ **IO=2E0h; IRQ=3, 4,5,6,7,9,10,11,12**      Serial Port I/O port address is 2E0h and the interrupt address is IRQ3,4,5,6,7,9,10,11,12

→ Device Mode [RS232]

Use the **Device Mode** option to enable or disable the serial port.

- **RS232**      **DEFAULT**      Enables serial port RS-232 support.
- **RS485**                      Enables serial port RS-485 support.
- **RS422**                      Enables serial port RS-422 support.

#### 4.3.2.1.4 Serial Port 4 Configuration

→ Serial Port [Enabled]

Use the **Serial Port** option to enable or disable the serial port.

- **Disabled**                      Disable the serial port
- **Enabled**      **DEFAULT**      Enable the serial port

→ Change Settings [Auto]

Use the **Change Settings** option to change the serial port IO port address and interrupt address.

- **Auto**                      **DEFAULT**      The serial port IO port address and interrupt address are automatically detected.
- **IO=2E8h; IRQ=10**                      Serial Port I/O port address is 2E8h and the interrupt address is IRQ3,4,5,6,7,9,10,11,12
- **IO=3F8h; IRQ=3, 4,5,6,7,9,10,11,12**                      Serial Port I/O port address is 3F8h and the interrupt address is IRQ3,4,5,6,7,9,10,11,12
- **IO=2F8h; IRQ=3, 4,5,6,7,9,10,11,12**                      Serial Port I/O port address is 2F8h and the interrupt address is IRQ3,4,5,6,7,9,10,11,12
- **IO=3E8h; IRQ=3, 4,5,6,7,9,10,11,12**                      Serial Port I/O port address is 3E8h and the interrupt address is IRQ3,4,5,6,7,9,10,11,12
- **IO=2E8h; IRQ=3, 4,5,6,7,9,10,11,12**                      Serial Port I/O port address is 2E8h and the interrupt address is IRQ3,4,5,6,7,9,10,11,12

## TANK-801 Embedded System

- ➔ **IO=2F0h; IRQ=3, 4,5,6,7,9,10,11,12**      Serial Port I/O port address is 2F0h and the interrupt address is IRQ3,4,5,6,7,9,10,11,12
- ➔ **IO=2E0h; IRQ=3, 4,5,6,7,9,10,11,12**      Serial Port I/O port address is 2E0h and the interrupt address is IRQ3,4,5,6,7,9,10,11,12

### ➔ Device Mode [RS232]

Use the **Device Mode** option to enable or disable the serial port.

- ➔ **RS232      DEFAULT**      Enables serial port RS-232 support.
- ➔ **RS485**                      Enables serial port RS-485 support.
- ➔ **RS422**                      Enables serial port RS-422 support.

### 4.3.3 Hardware Monitor

The **Hardware Monitor** menu (**BIOS Menu 6**) shows the operating temperature, fan speeds and system voltages.

```

Aptio Setup Utility - Copyright (C) 2013 American Megatrends, Inc.
  Advanced
PC Health Status
> Smart Fan Function
CPU Temperature           :+37 C
System Temperature       :+39 C
CPU Fan Speed             :N/A
Enable or Disable Smart Fan
-----
<->: Select Screen
↑ ↓: Select Item
Enter>Select
+/-: Change Opt.
F1:  General Help
F2:  Previous Values
F3:  Optimized
Defaults
F4:  Save & Exit
ESC: Exit
Version 2.16.1242. Copyright (C) 2013 American Megatrends, Inc.
  
```

**BIOS Menu 6: Hardware Health Configuration**

➔ PC Health Status

The following system parameters and values are shown. The system parameters that are monitored are:

- System Temperatures:
  - CPU Temperature
  - System Temperature
- Fan Speeds:
  - CPU Fan Speed

#### 4.3.3.1 Smart Fan Mode Configuration

Use the **Smart Fan Mode Configuration** submenu (**BIOS Menu 7**) to configure the smart fan temperature and speed settings.

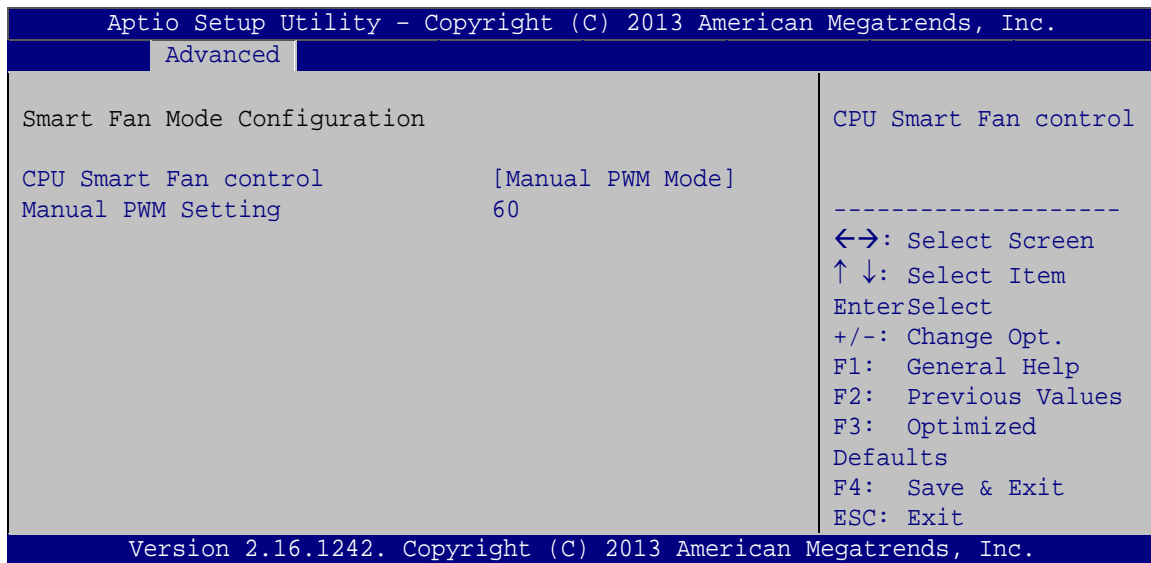

#### BIOS Menu 7: FAN Configuration

➔ Smart Fan control [Manual PWM Mode]

Use the **Smart Fan control** BIOS option to configure the CPU Smart Fan.

- ➔ **Manual PWM Mode**    **DEFAULT**    The fan spins at the speed set in the manual setting

## TANK-801 Embedded System

→ **Auto PWM Mode**

The fan adjusts its speed using these settings:

Temperature of Start

Temperature of Off

Start PWM

Slope (Duty Cycle)

→ **Manual PWM Setting**

Use the + or – key to change the **Manual PWM Setting** value. Enter a decimal number between 0 and 100.

→ **Temperature of Off [75]****WARNING:**

Setting this value too high may cause the fan to speed up only when the CPU is at a very high temperature and therefore cause the system to be damaged.

---

The **Temperature of Off** option can only be set if the **Smart Fan control** option is set to **Auto PWM Mode**. When the **CPU Temperature** is lower than **Temperature of Off**, the fan will be rotate at lowest speed. To set a value, select the **Temperature of Off** option and enter a decimal number between 0 and 127. The temperature range is specified below.

- Minimum Value: 0°C
- Maximum Value: 127°C

→ **Temperature of Start [80]****WARNING:**

---

Setting this value too high may cause the fan to rotate at full speed only when the CPU is at a very high temperature and therefore cause the system to be damaged.

---

The **Temperature of Start** option can only be set if the **Smart Fan control** option is set to **Auto PWM Mode**. Use the **Temperature of Start** option to set the CPU temperature at which the cooling fan starts to rotate using the starting pulse width modulation (PWM) specified in the **Start PWM** option below. To set a value, select the **Temperature of Start** option and enter a decimal number between 0 and 127. The temperature range is specified below.

- Minimum Value: 0°C
- Maximum Value: 127°C

→ Start PWM [30]

The **Start PWM** option can only be set if the **Smart Fan control** option is set to **Auto PWM Mode**. Use the **Start PWM** option to set the PWM start value. To set a value, select the **Start PWM** option and enter a decimal number between 0 and 100. The temperature range is specified below.

- Minimum Value: 0
- Maximum Value: 100

→ Slope (Duty Cycle) [4 (PWM)]

The **Slope (Duty Cycle)** option can only be set if the **Smart Fan control** option is set to **Auto PWM Mode**. Use the **Slope (Duty Cycle)** option to select the linear rate at which the PWM mode increases with respect to an increase in temperature. A list of available options is shown below:

- 0
- 1
- 2
- 4
- 8

## TANK-801 Embedded System

- 16

### 4.3.4 RTC Wake Settings

The **RTC Wake Settings** menu (**BIOS Menu 8**) configures RTC wake event.

```

Aptio Setup Utility - Copyright (C) 2013 American Megatrends, Inc.
-----
Advanced
-----
Wake system with Fixed Time      [Disabled]
-----
Enable or disable System
wake on alarm event. When
enabled, System will
wake on the date:: hr::
min::sec specified
-----
<=>: Select Screen
↑↓: Select Item
Enter>Select
+/-: Change Opt.
F1:  General Help
F2:  Previous Values
F3:  Optimized Defaults
F4:  Save & Exit
ESC: Exit
-----
Version 2.16.1242. Copyright (C) 2013 American Megatrends, Inc.

```

#### BIOS Menu 8: RTC Wake Settings

→ Wake System with Fixed Time [Disabled]

Use the **Wake System with Fixed Time** option to specify the time the system should be roused from a suspended state.

→ **Disabled**      **DEFAULT**      The real time clock (RTC) cannot generate a wake event

➔ **Enabled**

If selected, the following appears with values that can be selected:

- \*Wake up every day
- \*Wake up date
- \*Wake up hour
- \*Wake up minute
- \*Wake up second

After setting the alarm, the computer turns itself on from a suspend state when the alarm goes off.

### 4.3.5 Serial Port Console Redirection

The **Serial Port Console Redirection** menu (**BIOS Menu 9**) allows the console redirection options to be configured. Console redirection allows users to maintain a system remotely by re-directing keyboard input and text output through the serial port.

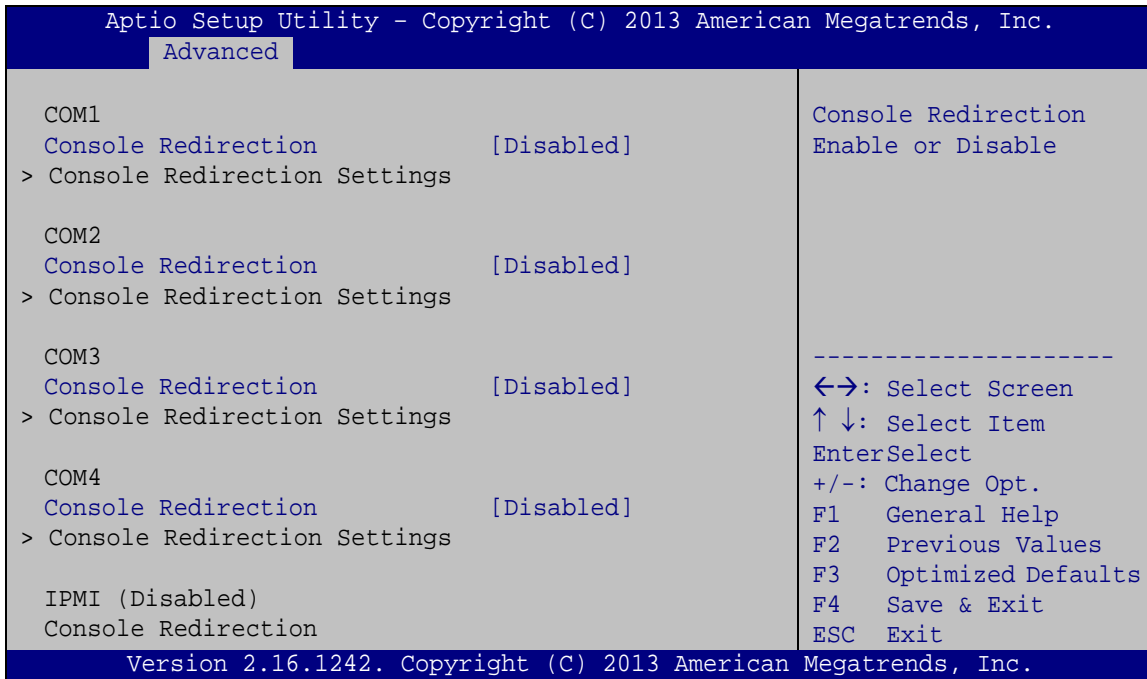

#### BIOS Menu 9: Serial Port Console Redirection

➔ Console Redirection [Disabled]

Use **Console Redirection** option to enable or disable the console redirection function.



## TANK-801 Embedded System

- ➔ **Disabled**      **DEFAULT**      Disabled the console redirection function
- ➔ **Enabled**                      Enabled the console redirection function

## ➔ Terminal Type [ANSI]

Use the **Terminal Type** option to specify the remote terminal type..

- ➔ **VT100**                      The target terminal type is VT100
- ➔ **VT100+**                      The target terminal type is VT100+
- ➔ **VT-UTF8**                      The target terminal type is VT-UTF8
- ➔ **ANSI**                      **DEFAULT**      The target terminal type is ANSI

## ➔ Bits per second [115200]

Use the **Bits per second** option to specify the transmission speed of the serial port.

- ➔ **9600**                      The transmission speed is 9600
- ➔ **19200**                      The transmission speed is 19200
- ➔ **38400**                      The transmission speed is 38400
- ➔ **57600**                      The transmission speed is 57600
- ➔ **115200**                      **DEFAULT**      The transmission speed is 115200

## ➔ Data Bits [8]

Use the **Data Bits** option to specify the number of data bits.

- ➔ **7**                      Sets the data bits at 7.
- ➔ **8**                      **DEFAULT**      Sets the data bits at 8.

## ➔ Parity [None]

Use the **Parity** option to specify the parity bit that can be sent with the data bits for detecting the transmission errors.

- |   |              |                |   |
|---|--------------|----------------|---|
| → | <b>None</b>  | <b>DEFAULT</b> | No parity bit is sent with the data bits.                                 |
| → | <b>Even</b>  |                | The parity bit is 0 if the number of ones in the data bits is even.       |
| → | <b>Odd</b>   |                | The parity bit is 0 if the number of ones in the data bits is odd.        |
| → | <b>Mark</b>  |                | The parity bit is always 1. This option does not provide error detection. |
| → | <b>Space</b> |                | The parity bit is always 0. This option does not provide error detection. |

→ Stop Bits [1]

Use the **Stop Bits** option to specify the number of stop bits used to indicate the end of a serial data packet. Communication with slow devices may require more than 1 stop bit.

- |   |          |                |                                    |
|---|----------|----------------|------------------------------------|
| → | <b>1</b> | <b>DEFAULT</b> | Sets the number of stop bits at 1. |
| → | <b>2</b> |                | Sets the number of stop bits at 2. |

## TANK-801 Embedded System

### 4.3.6 iEi Feature

Use the **iEi Feature** menu (**BIOS Menu 10**) to configure the iEi features.

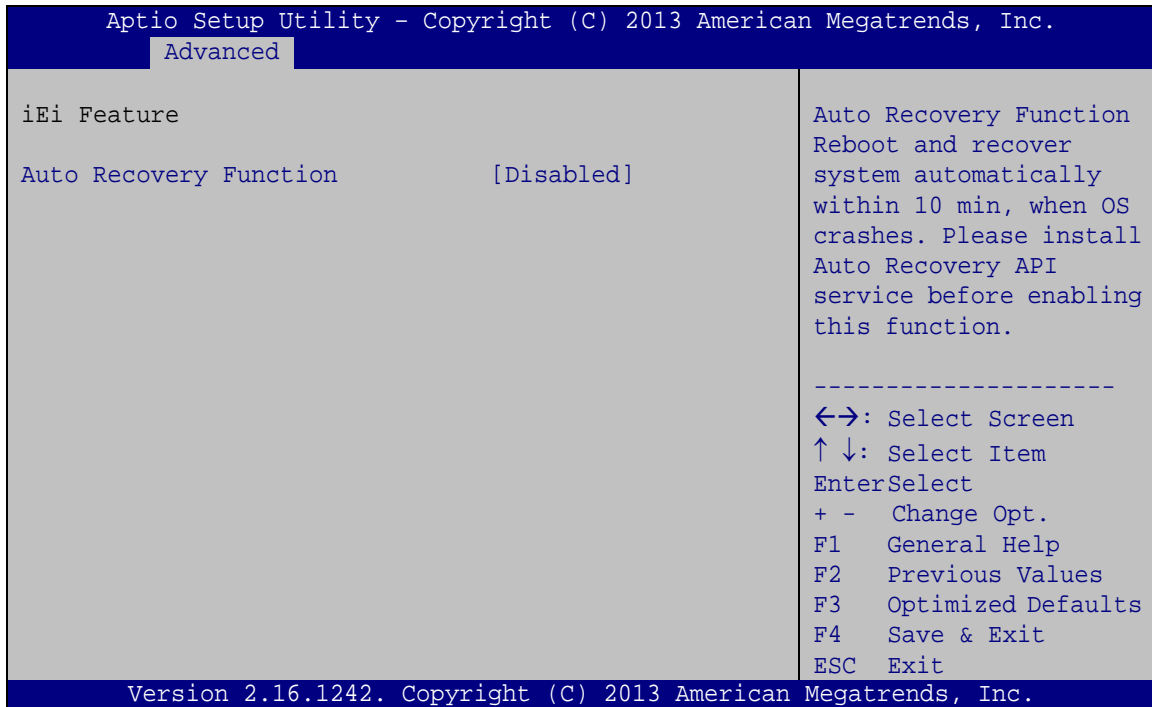

#### BIOS Menu 10: iEi Feature

➔ Auto Recovery Function [Disabled]

Use **Auto Recovery Function** option to enable or disable the auto recovery function.

➔ **Disabled**    **DEFAULT**    Disabled the auto recovery function

➔ **Enabled**                    Enabled the auto recovery function

### 4.3.7 CPU Configuration

Use the **CPU Configuration** menu (**BIOS Menu 11**) to enter the **CPU Information** submenu or enable Intel Virtualization Technology.

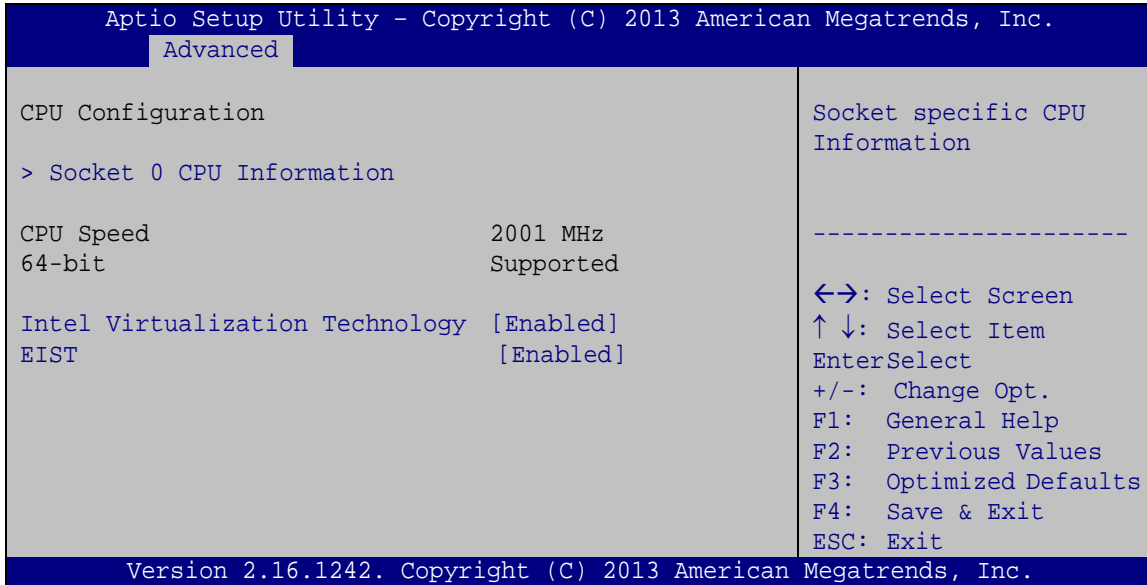

**BIOS Menu 11: CPU Configuration**

→ Intel Virtualization Technology [Enabled]

Use the **Intel Virtualization Technology** option to enable or disable virtualization on the system. When combined with third party software, Intel Virtualization technology allows several OSs to run on the same system at the same time.

→ **Disabled** Disables Intel Virtualization Technology.

→ **Enabled** **DEFAULT** Enables Intel Virtualization Technology.

→ EIST [Enabled]

Use the **EIST** option to enable or disable the Intel Speed Step Technology.

→ **Disabled** Disables the Intel Speed Step Technology.

→ **Enabled** **DEFAULT** Enables the Intel Speed Step Technology.

4.3.7.1 Socket 0 CPU Information

Use the **Socket 0 CPU Information** submenu (**BIOS Menu 12**) to view detailed CPU specifications and configure the CPU.

## TANK-801 Embedded System

```

Aptio Setup Utility - Copyright (C) 2013 American Megatrends, Inc.
  Advanced
Socket 0 CPU Information

Intel(R) Celeron(R) CPU J1900 @ 1.99GHz
CPU Signature           30678
Microcode Patch        809
Max CPU Speed          1990 MHz
Min CPU Speed          1334 MHz
Processor Cores        4
Intel HT Technology     Not Supported
Intel VT-x Technology   Supported

L1 Data Cache          24 kB x 4
L1 Code Cache          32 kB x 4
L2 Cache               1024 kB x 2
L3 Cache               Not Present

-----
<->: Select Screen
↑↓: Select Item
EnterSelect
+/-: Change Opt.
F1:  General Help
F2:  Previous Values
F3:  Optimized Defaults
F4:  Save & Exit
ESC: Exit

Version 2.16.1242. Copyright (C) 2013 American Megatrends, Inc.

```

**BIOS Menu 12: CPU Configuration**

The CPU Configuration menu (**BIOS Menu 12**) lists the following CPU details:

- Processor Type: Lists the brand name of the CPU being used
- CPU Signature: Lists the CPU signature value.
- Microcode Patch: Lists the microcode patch being used.
- Max CPU Speed: Lists the maximum CPU processing speed.
- Min CPU Speed: Lists the minimum CPU processing speed.
- Processor Cores: Lists the number of the processor core
- Intel HT Technology: Indicates if Intel HT Technology is supported by the CPU.
- Intel VT-x Technology: Indicates if Intel VT-x Technology is supported by the CPU.
- L1 Data Cache: Lists the amount of data storage space on the L1 cache.
- L1 Code Cache: Lists the amount of code storage space on the L1 cache.
- L2 Cache: Lists the amount of storage space on the L2 cache.
- L3 Cache: Lists the amount of storage space on the L3 cache.

#### 4.3.8 IDE Configuration

Use the **IDE Configuration** menu (**BIOS Menu 13**) to change and/or set the configuration of the SATA devices installed in the system.

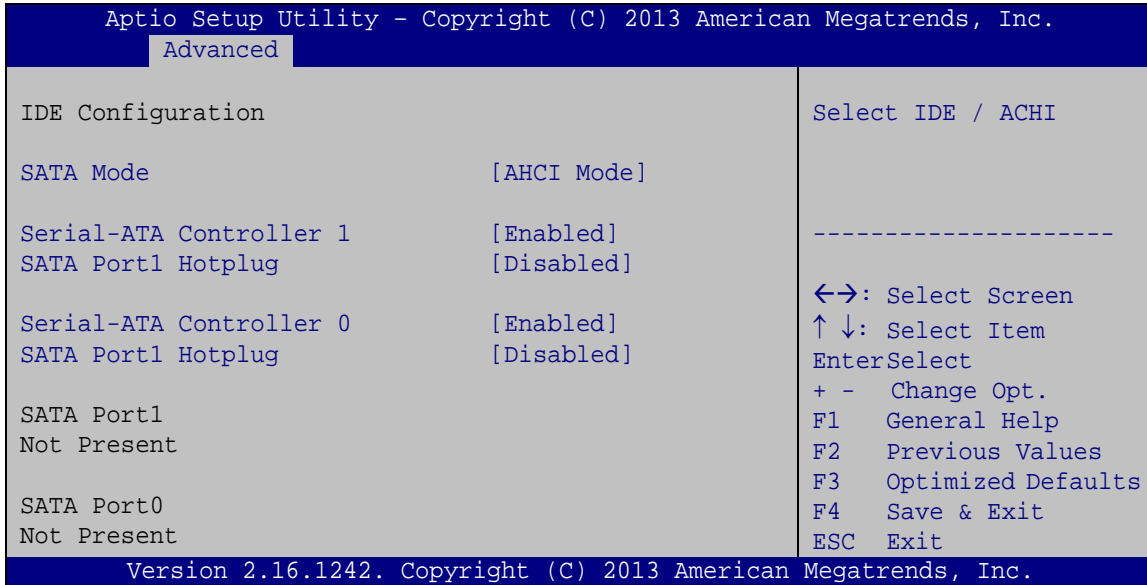

**BIOS Menu 13: IDE Configuration**

→ SATA Mode [IDE Mode]

Use the **SATA Mode** option to configure SATA devices as normal IDE devices.

- **IDE Mode**      **DEFAULT**      Configures SATA devices as normal IDE device.
- **AHCI Mode**                      Configures SATA devices as AHCI device.

→ Serial-ATA Controller 1/0 [Enabled]

Use the **Serial-ATA Controller 1/0** option to enable or disable the Serial-ATA controller.

- **Enabled**      **DEFAULT**      Enables Serial-ATA controller.
- **Disabled**                      Disables Serial-ATA controller.

→ SATA Port 1/0 Hotplug [Disabled]

Use the **SATA Port 1/0 Hotplug** option to configure SATA port as hot pluggable.

- **Enabled**                      Enables SATA port as hot pluggable.
- **Disabled**      **DEFAULT**      Disables SATA port as hot pluggable.

## TANK-801 Embedded System

### 4.3.9 Trusted Computing

Use the **Trusted Computing** menu (**BIOS Menu 14**) to configure settings related to the Trusted Computing Group (TCG) Trusted Platform Module (TPM).

```

Aptio Setup Utility - Copyright (C) 2013 American Megatrends, Inc.
  Advanced
Configuration
  Security Device Support          [Disable]
Current Status Information
  NO Security Device Found
-----
<->: Select Screen
↑ ↓: Select Item
EnterSelect
+/-: Change Opt.
F1:  General Help
F2:  Previous Values
F3:  Optimized Defaults
F4:  Save & Exit
ESC: Exit
Version 2.16.1242. Copyright (C) 2013 American Megatrends, Inc.
  
```

#### BIOS Menu 14: TPM Configuration

➔ Security Device Support [Disable]

Use the **Security Device Support** option to configure support for the security device.

- ➔ **Disable**    **DEFAULT**    Security device support is disabled.
- ➔ **Enable**                    Security device support is enabled.

#### 4.3.10 USB Configuration

Use the **USB Configuration** menu (**BIOS Menu 15**) to read USB configuration information and configure the USB settings.

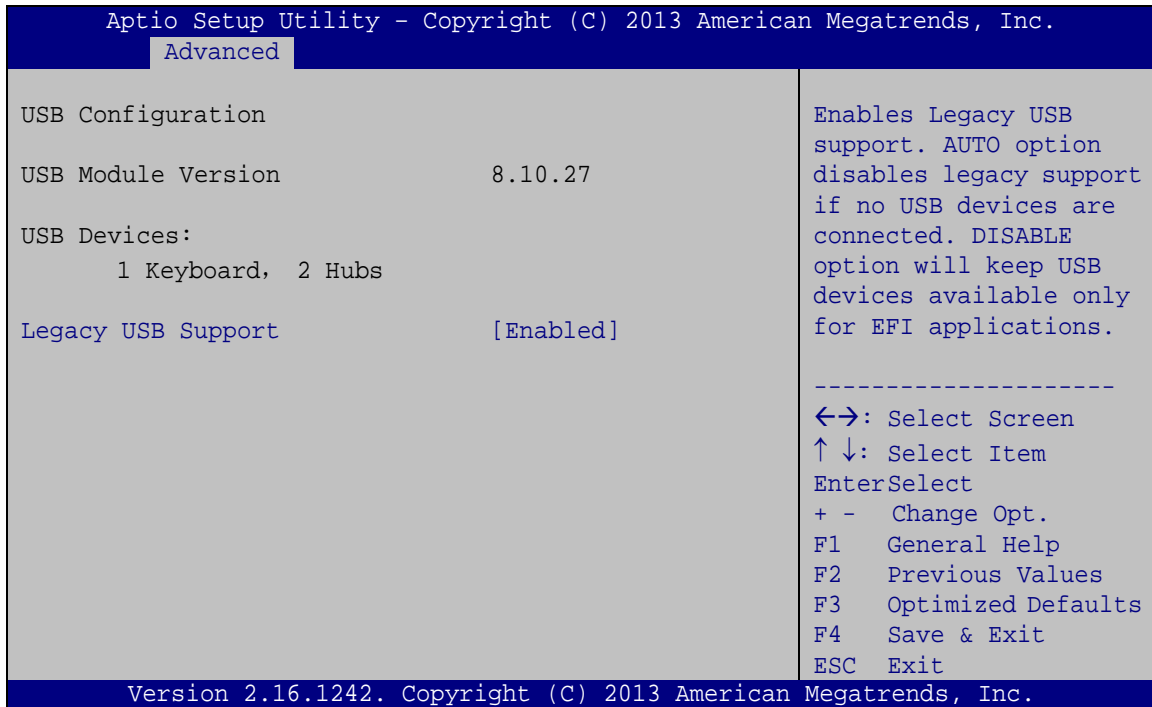

#### BIOS Menu 15: USB Configuration

##### ➔ USB Devices

The **USB Devices** field lists the USB devices that are enabled on the system

##### ➔ Legacy USB Support [Enabled]

Use the **Legacy USB Support** BIOS option to enable USB mouse and USB keyboard support. Normally if this option is not enabled, any attached USB mouse or USB keyboard does not become available until a USB compatible operating system is fully booted with all USB drivers loaded. When this option is enabled, any attached USB mouse or USB keyboard can control the system even when there is no USB driver loaded onto the system.

➔ **Enabled**      **DEFAULT**      Legacy USB support enabled



## TANK-801 Embedded System

- ➔ **Disabled** Legacy USB support disabled
- ➔ **Auto** Legacy USB support disabled if no USB devices are connected

### 4.4 Chipset

Use the **Chipset** menu (**BIOS Menu 16**) to access the Northbridge and Southbridge configuration menus.



#### WARNING!

Setting the wrong values for the Chipset BIOS selections in the Chipset BIOS menu may cause the system to malfunction.

```

Aptio Setup Utility - Copyright (C) 2013 American Megatrends, Inc.
  Chipset
-----
> North Bridge
> South Bridge

North Bridge Parameters
-----
<=>: Select Screen
↑ ↓: Select Item
EnterSelect
+ - Change Opt.
F1  General Help
F2  Previous Values
F3  Optimized Defaults
F4  Save & Exit
ESC Exit

Version 2.16.1242. Copyright (C) 2013 American Megatrends, Inc.
  
```

**BIOS Menu 16: Chipset**

#### 4.4.1 North Bridge Configuration

Use the **North Bridge** menu (**BIOS Menu 17**) to configure the North Bridge chipset.

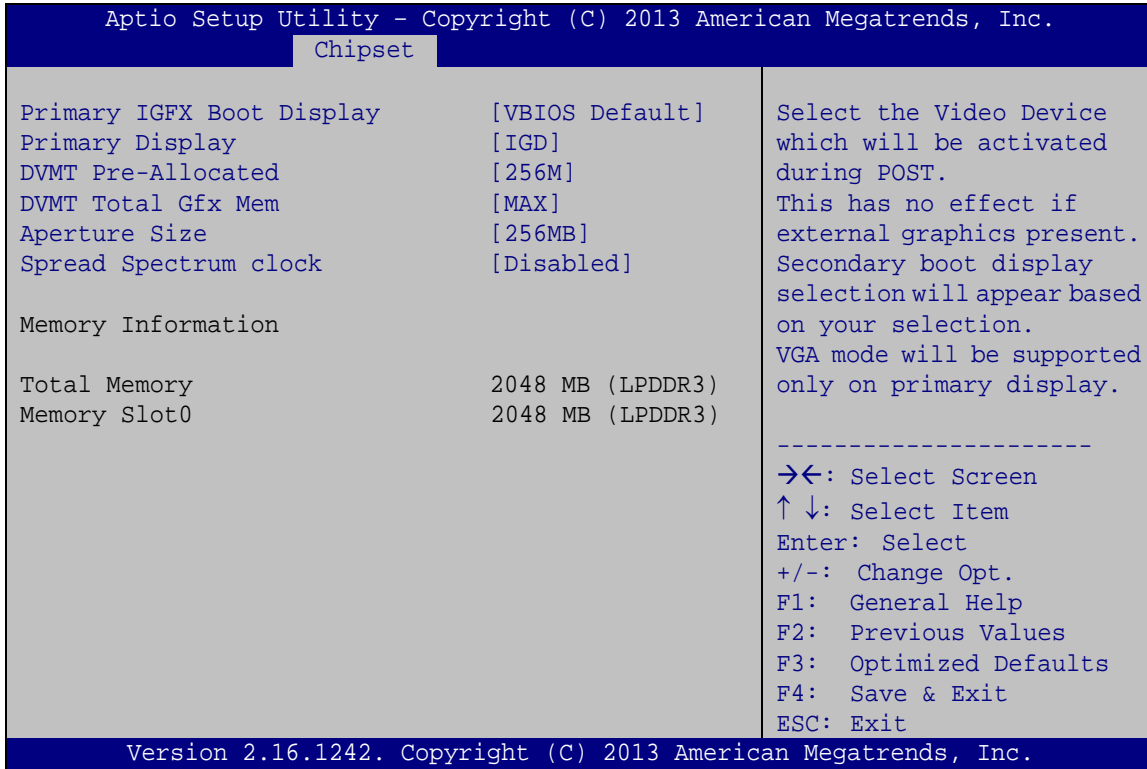

#### BIOS Menu 17: Graphics Configuration

##### → Primary IGFX Boot Display [VBIOS Default]

Use the **Primary IGFX Boot Display** option to select the display device used by the system when it boots. Configuration options are listed below.

- VBIOS Default      **DEFAULT**
- CRT
- Display port 1
- DVI

##### → Primary Display [IGD]

Use the **Primary Display** option to select the primary graphics controller the system uses.

The following options are available:

## TANK-801 Embedded System

- Auto
- IGD **Default**
- PCI
- SG

## ➔ DVMT Pre-Allocated [256M]

Use the **DVMT Pre-Allocated** option to set the amount of system memory allocated to the integrated graphics processor when the system boots. The system memory allocated can then only be used as graphics memory, and is no longer available to applications or the operating system. Configuration options are listed below:

- 64M
- 128M
- 256M **Default**
- 512M

## ➔ DVMT Total Gfx Mem [MAX]

Use the **DVMT Total Gfx Mem** option to select DVMT5.0 total graphic memory size used by the internal graphic device. The following options are available:

- 128M
- 256M
- MAX **Default**

## ➔ Aperture Size [256MB]

Use the **Aperture Size** option to select aperture size. The following options are available:

- 128MB
- 256MB **Default**
- 512MB

## ➔ Spread Spectrum clock [Disabled]

The **Spread Spectrum clock** option can help to improve CPU EMI issues.

- ➔ **Disabled** **DEFAULT** The spread spectrum mode is disabled

- ➔ **Enabled**                      The spread spectrum mode is enabled

#### 4.4.2 South Bridge Configuration

Use the **South Bridge Configuration** menu (**BIOS Menu 18**) to configure the Southbridge chipset.

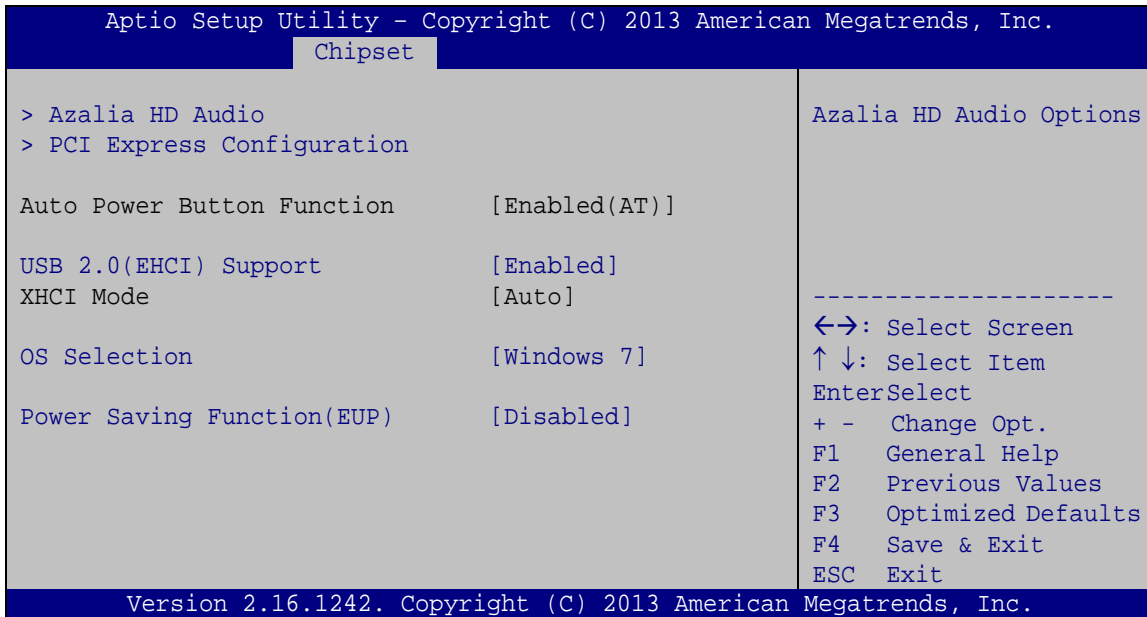

#### BIOS Menu 18: South Bridge Chipset Configuration

- ➔ HD Audio Controller [Enabled]

Use the **HD Audio Controller** option to enable or disable the High Definition Audio controller.

- ➔ **Enabled**    **DEFAULT**    The onboard High Definition Audio controller automatically detected and enabled
- ➔ **Disabled**                      The onboard High Definition Audio controller is disabled

- ➔ USB Function [Enabled]

Use the **USB Function** BIOS option to enable or disable USB function support.

- ➔ **Disabled**                      USB function support disabled

## TANK-801 Embedded System

➔ **Enabled**      **DEFAULT**      USB function support enabled

➔ USB 2.0 (EHCI) Support [Enabled]

Use the **USB 2.0 (EHCI) Support** BIOS option to enable or disable USB 2.0 support.

➔ **Enabled**      **DEFAULT**      USB 2.0 (EHCI) support enabled

➔ **Disabled**                      USB 2.0 (EHCI) support disabled

➔ OS Selection [Windows 7]

Use the **OS Selection** BIOS option to select the operating system.

➔ **Windows 8.X**                      Support Windows 8.X

➔ **Android**                              Support Android

➔ **Windows 7**      **DEFAULT**      Support Windows 7

➔ Power Saving Function [Disabled]

Use the **Power Saving Function** BIOS option to enable or disable the power saving function.

➔ **Disabled**      **DEFAULT**      Power saving function is disabled.

➔ **Enabled**                              Power saving function is enabled. It will reduce power consumption when the system is off.

#### 4.4.2.1 Azalia HD Audio

Use the **Azalia HD Audio** menu (**BIOS Menu 19**) to configure the Azalia HD audio settings.

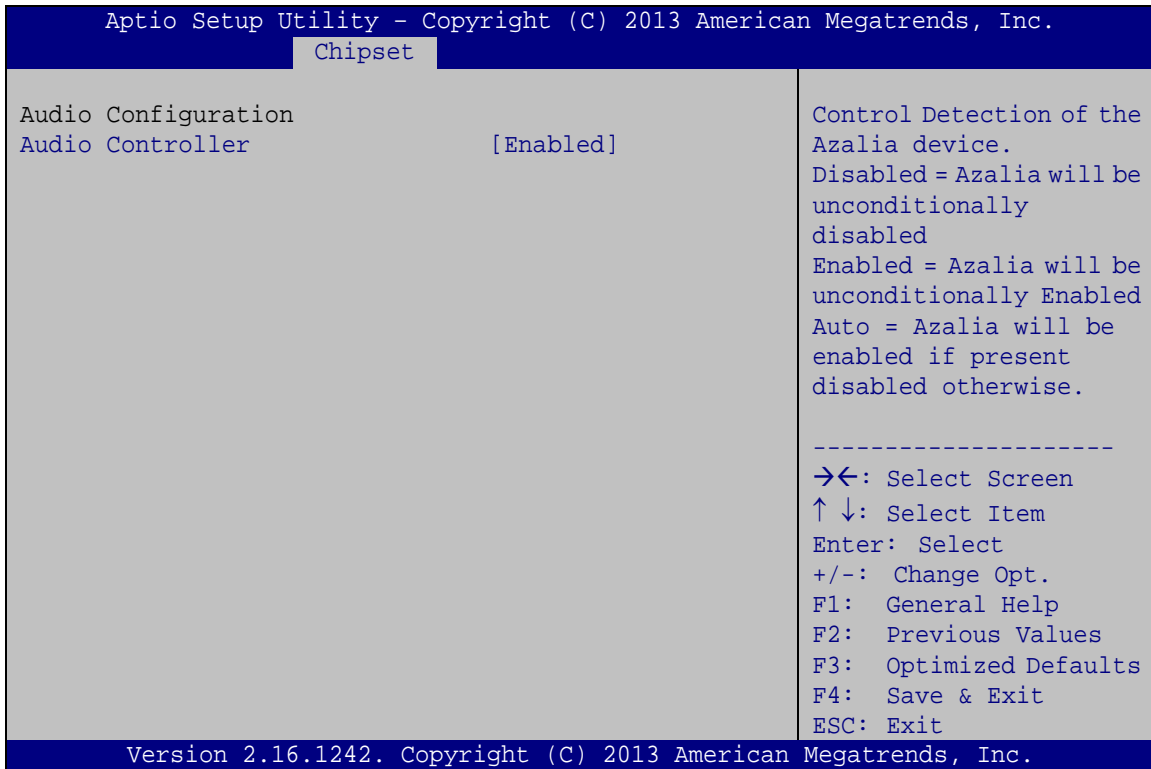

#### BIOS Menu 19: PCH Azalia Configuration Menu

→ Azalia HD Audio [Enabled]

Use the **Azalia** option to enable or disable the High Definition Audio controller.

- **Disabled**                      The onboard High Definition Audio controller is disabled
- **Enabled    DEFAULT**        The onboard High Definition Audio controller automatically detected and enabled

## TANK-801 Embedded System

### 4.4.2.2 PCI Express Configuration

Use the **PCI Express Configuration** menu (**BIOS Menu 20**) to select the support type of the PCIe Mini slot.

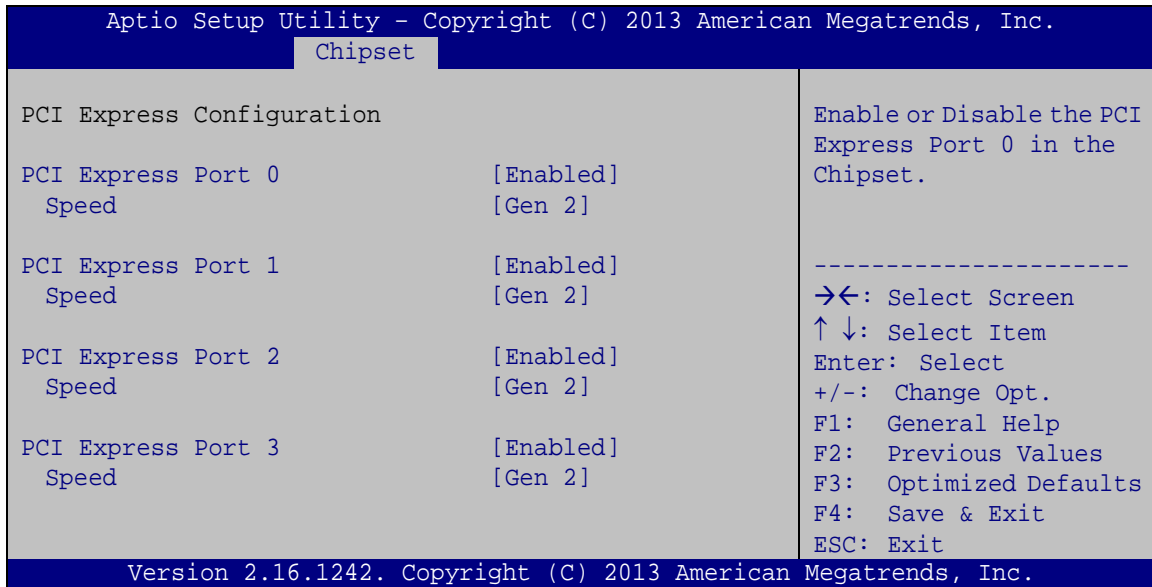

#### BIOS Menu 20: PCI Express Configuration

##### → PCI Express Port n [Enabled]

Use the **PCI Express Port n** option to enable or disable the PCI Express Port in the chipset.

→ **Enabled** **DEFAULT** Enables the PCI Express Port in the chipset.

→ **Disabled** Disables the PCI Express Port in the chipset.

##### → Speed

Use **Speed** option to select the speed type of the PCIe slot. The following options are available:

- Auto **Default**
- Gen2
- Gen1

## 4.5 Security

Use the **Security** menu (**BIOS Menu 21**) to set system and user passwords.

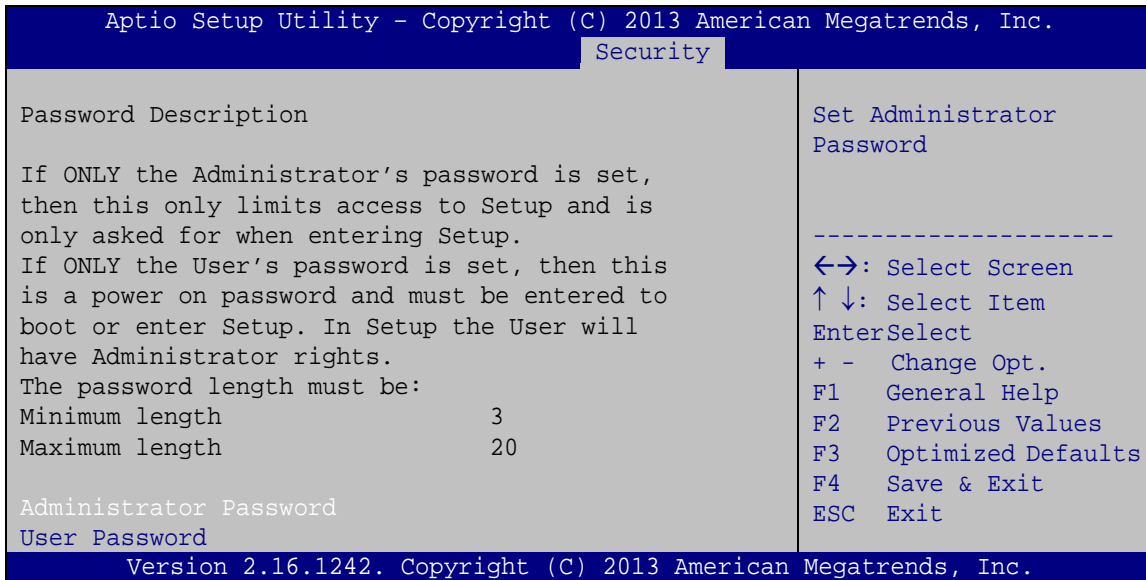

### BIOS Menu 21: Security

➔ Administrator Password

Use the **Administrator Password** to set or change an administrator password.

➔ User Password

Use the **User Password** to set or change a user password.



## 4.6 Boot

Use the **Boot** menu (**BIOS Menu 22**) to configure system boot options.

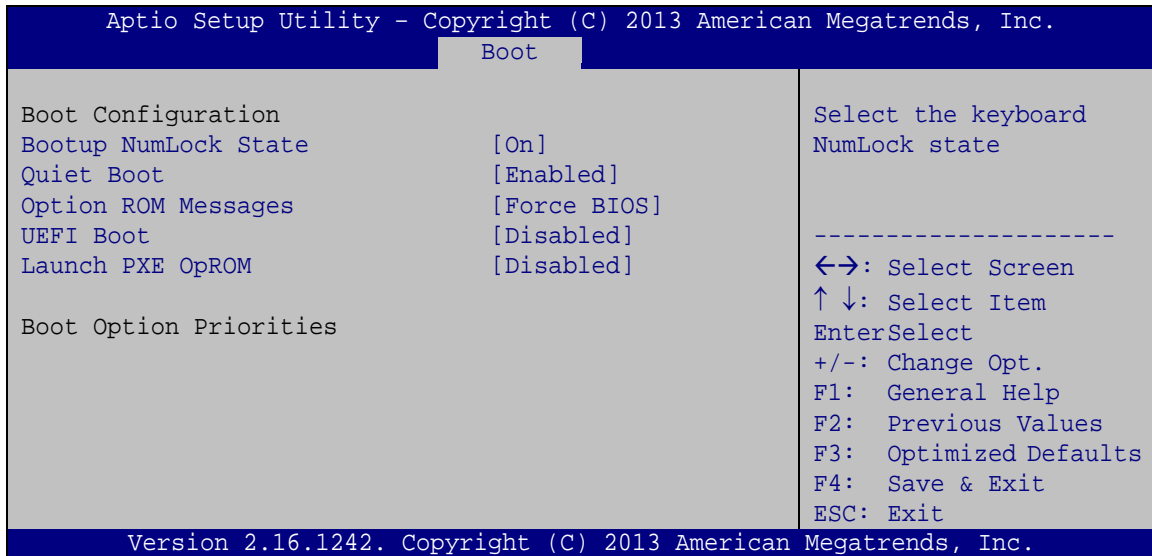

### BIOS Menu 22: Boot

#### → Bootup NumLock State [On]

Use the **Bootup NumLock State** BIOS option to specify if the number lock setting must be modified during boot up.

→ **On**                      **DEFAULT**                      Allows the Number Lock on the keyboard to be enabled automatically when the computer system boots up. This allows the immediate use of the 10-key numeric keypad located on the right side of the keyboard. To confirm this, the Number Lock LED light on the keyboard is lit.

→ **Off**    Does not enable the keyboard Number Lock automatically. To use the 10-keys on the keyboard, press the Number Lock key located on the upper left-hand corner of the 10-key pad. The Number Lock LED on the keyboard lights up when the Number Lock is engaged.

→ Quiet Boot [Enabled]

Use the **Quiet Boot** BIOS option to select the screen display when the system boots.

- **Disabled** Normal POST messages displayed
- **Enabled** **DEFAULT** OEM Logo displayed instead of POST messages

→ Option ROM Messages [Force BIOS]

Use the **Option ROM Messages** option to set the Option ROM display mode.

- **Force BIOS** **DEFAULT** Sets display mode to force BIOS.
- **Keep Current** Sets display mode to current.

→ UEFI Boot [Disabled]

Use the **UEFI Boot** option to enable or disable to boot from the UEFI devices.

- **Enabled** Boot from UEFI devices is enabled.
- **Disabled** **DEFAULT** Boot from UEFI devices is disabled.

→ Launch PXE OpROM [Disabled]

Use the **Launch PXE OpROM** option to enable or disable boot option for legacy network devices.

- **Disabled** **DEFAULT** Ignore all PXE Option ROMs
- **Enabled** Load PXE Option ROMs.

## TANK-801 Embedded System

## 4.7 Save &amp; Exit

Use the **Save & Exit** menu (**BIOS Menu 23**) to load default BIOS values, optimal failsafe values and to save configuration changes.

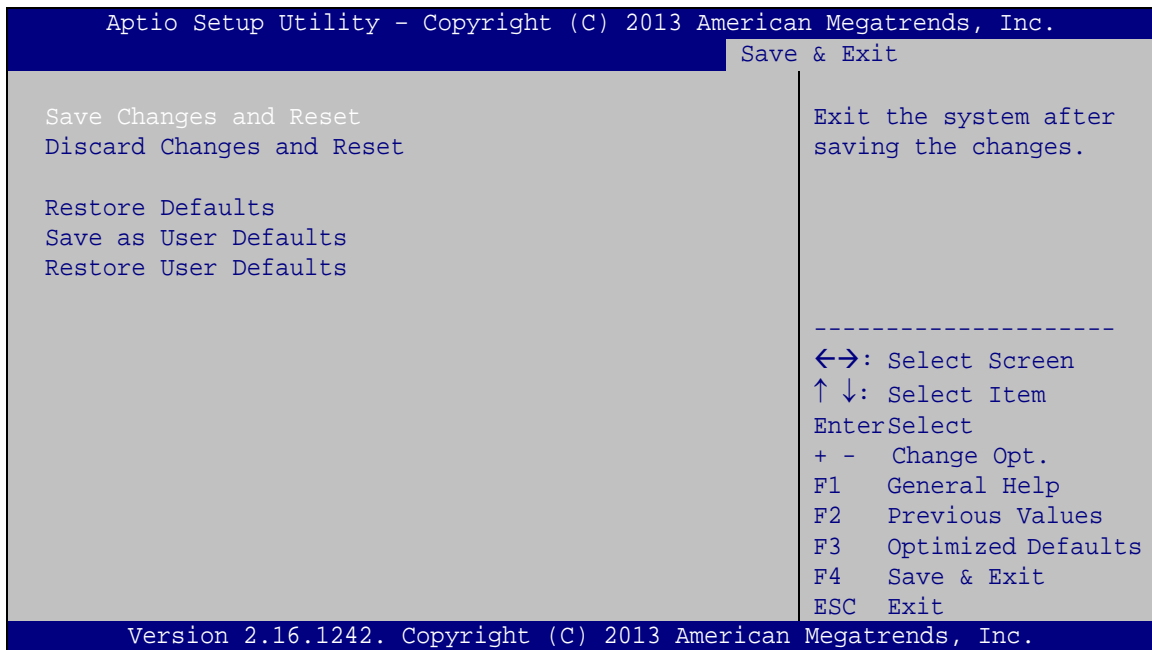
**BIOS Menu 23:Exit**

## → Save Changes and Reset

Use the **Save Changes and Reset** option to save the changes made to the BIOS options and to exit the BIOS configuration setup program.

## → Discard Changes and Reset

Use the **Discard Changes and Reset** option to exit the system without saving the changes made to the BIOS configuration setup program.

## → Restore Defaults

Use the **Restore Defaults** option to load the optimal default values for each of the parameters on the Setup menus. **F3 key can be used for this operation.**

➔ Save as User Defaults

Use the **Save as User Defaults** option to save the changes done so far as user defaults.

➔ Restore User Defaults

Use the **Restore User Defaults** option to restore the user defaults to all the setup options.

## 4.8 Server Mgmt

Use the **Server Mgmt** menu (**BIOS Menu 13**) to access the server management menus.

```

Aptio Setup Utility - Copyright (C) 2013 American Megatrends, Inc.
Server Mgmt
BMC Self Test Status          FAILED
BMC Firmware Revision        Unknown
> System Event Log
> BMC network configuration

-----
<=>: Select Screen
↑ ↓: Select Item
Enter>Select
+ - Change Opt.
F1 General Help
F2 Previous Values
F3 Optimized Defaults
F4 Save & Exit
ESC Exit

Version 2.16.1242. Copyright (C) 2013 American Megatrends, Inc.
    
```

**BIOS Menu 24: IDE Configuration**

## TANK-801 Embedded System

### 4.8.1.1 System Event Log

Use the **System Event Log** menu (**BIOS Menu 19**) to configure the event log.

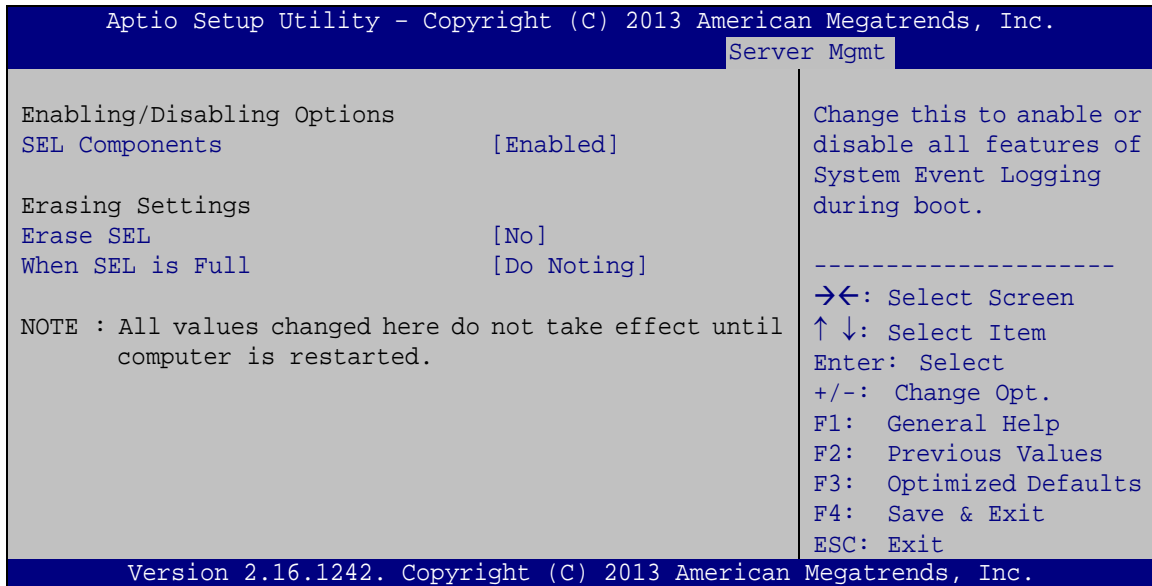

#### BIOS Menu 25: PCH Azalia Configuration Menu

##### → SEL Components [Enabled]

Use the **SEL Components** option to enable or disable all features of system event logging during boot.

→ **Disabled** Disables all features of system event logging during boot.

→ **Enabled** **DEFAULT** Enables all features of system event logging during boot.

##### → Erase SEL [No]

Use **Erase SEL** option to select options for erasing SEL. The following options are available:

- No **Default**
- Yes, On next reset
- Yes, On every reset

➔ When SEL is Full [Do Nothing]

Use **When SEL is FULL** option to select options for reactions to a full SEL. The following options are available:

- Do Nothing **Default**
- Erase Immediately

#### 4.8.1.2 BMC network configuration

Use the **BMC network configuration** menu (**BIOS Menu 19**) to configure BMC network parameters.

```

Aptio Setup Utility - Copyright (C) 2013 American Megatrends, Inc.
Server Mgmt
BMC network configuration
Lan channel 1
Configuration Address source [Unspecified]
Current Configuration Address source -
Station IP address -
Subnet mask -
Station MAC address -
Router IP address -
Router MAC address -
Select to configure LAN channel parameters statically or dynamically(by BIOS or BMC).Unspecified option will not modify any BMC network parameters during BIOS phase.
-----
-><: Select Screen
↑↓: Select Item
Enter: Select
+/-: Change Opt.
F1: General Help
F2: Previous Values
F3: Optimized Defaults
F4: Save & Exit
ESC: Exit
Version 2.16.1242. Copyright (C) 2013 American Megatrends, Inc.
    
```

#### BIOS Menu 26: PCH Azalia Configuration Menu

➔ Configuration Address source [Unspecified]

Use **Configuration Address source** option to configure LAN channel parameters. The following options are available:

- Unspecified **Default**
- Static
- DynamicBmcDhcp
- DynamicBmcNonDhcp

Appendix

A

# Safety Precautions

---

## A.1 Safety Precautions

---



### WARNING:

The precautions outlined in this appendix should be strictly followed. Failure to follow these precautions may result in permanent damage to the TANK-801.

---

Please follow the safety precautions outlined in the sections that follow:

### A.1.1 General Safety Precautions

Please ensure the following safety precautions are adhered to at all times.

- ***Make sure the power is turned off and the power cord is disconnected*** when moving, installing or modifying the system.
- ***Do not apply voltage levels that exceed the specified voltage range.*** Doing so may cause fire and/or an electrical shock.
- ***Electric shocks can occur*** if opened while still powered on.
- ***Do not drop or insert any objects*** into the ventilation openings.
- ***If considerable amounts of dust, water, or fluids enter the system***, turn off the power supply immediately, unplug the power cord, and contact the system vendor.
- **DO NOT:**
  - Drop the system against a hard surface.
  - In a site where the ambient temperature exceeds the rated temperature

### A.1.2 Anti-static Precautions

---



### WARNING:

Failure to take ESD precautions during the installation of the TANK-801 may result in permanent damage to the TANK-801 and severe injury to the user.

---



## TANK-801 Embedded System

Electrostatic discharge (ESD) can cause serious damage to electronic components, including the TANK-801. Dry climates are especially susceptible to ESD. It is therefore critical that whenever the TANK-801 is opened and any of the electrical components are handled, the following anti-static precautions are strictly adhered to.

- **Wear an anti-static wristband:** Wearing a simple anti-static wristband can help to prevent ESD from damaging any electrical component.
- **Self-grounding:** Before handling any electrical component, touch any grounded conducting material. During the time the electrical component is handled, frequently touch any conducting materials that are connected to the ground.
- **Use an anti-static pad:** When configuring or working with an electrical component, place it on an anti-static pad. This reduces the possibility of ESD damage.
- **Only handle the edges of the electrical component:** When handling the electrical component, hold the electrical component by its edges.

### A.1.3 Product Disposal



#### CAUTION:

Risk of explosion if battery is replaced by an incorrect type. Only certified engineers should replace the on-board battery.

Dispose of used batteries according to instructions and local regulations.

- 
- Outside the European Union - If you wish to dispose of used electrical and electronic products outside the European Union, please contact your local authority so as to comply with the correct disposal method.
  - Within the European Union:

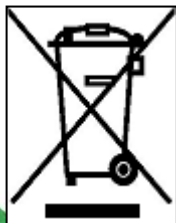

EU-wide legislation, as implemented in each Member State, requires that waste electrical and electronic products carrying the mark (left) must be disposed of separately from normal household waste. This includes

monitors and electrical accessories, such as signal cables or power cords. When you need to dispose of your display products, please follow the guidance of your local authority, or ask the shop where you purchased the product. The mark on electrical and electronic products only applies to the current European Union Member States.

Please follow the national guidelines for electrical and electronic product disposal.

## A.2 Maintenance and Cleaning Precautions

When maintaining or cleaning the TANK-801, please follow the guidelines below.

### A.2.1 Maintenance and Cleaning

Prior to cleaning any part or component of the TANK-801, please read the details below.

- The interior of the TANK-801 does not require cleaning. Keep fluids away from the TANK-801 interior.
- Be cautious of all small removable components when vacuuming the TANK-801.
- Turn the TANK-801 off before cleaning the TANK-801.
- Never drop any objects or liquids through the openings of the TANK-801.
- Be cautious of any possible allergic reactions to solvents or chemicals used when cleaning the TANK-801.
- Avoid eating, drinking and smoking within vicinity of the TANK-801.

### A.2.2 Cleaning Tools

Some components in the TANK-801 may only be cleaned using a product specifically designed for the purpose. In such case, the product will be explicitly mentioned in the cleaning tips. Below is a list of items to use when cleaning the TANK-801.

- **Cloth** – Although paper towels or tissues can be used, a soft, clean piece of cloth is recommended when cleaning the TANK-801.
- **Water or rubbing alcohol** – A cloth moistened with water or rubbing alcohol can be used to clean the TANK-801.
- **Using solvents** – The use of solvents is not recommended when cleaning the TANK-801 as they may damage the plastic parts.

## TANK-801 Embedded System

- **Vacuum cleaner** – Using a vacuum specifically designed for computers is one of the best methods of cleaning the TANK-801. Dust and dirt can restrict the airflow in the TANK-801 and cause its circuitry to corrode.
- **Cotton swabs** - Cotton swabs moistened with rubbing alcohol or water are excellent tools for wiping hard to reach areas.
- **Foam swabs** - Whenever possible, it is best to use lint free swabs such as foam swabs for cleaning.

Appendix

**B**

# Digital I/O Interface

---

## B.1 Introduction

The DIO connector on the TANK-801 is interfaced to GPIO ports on the Super I/O chipset. The DIO has both 4-bit digital inputs and 4-bit digital outputs. The digital inputs and digital outputs are generally control signals that control the on/off circuit of external devices or TTL devices. Data can be read or written to the selected address to enable the DIO functions.



### NOTE:

For further information, please refer to the datasheet for the Super I/O chipset.

---

The BIOS interrupt call **INT 15H** controls the digital I/O.

### INT 15H:

AH – 6FH
<u>Sub-function:</u>
AL – 8 : Set the digital port as INPUT
AL : Digital I/O input value

### B.2 Assembly Language Sample 1

```

MOV    AX, 6F08H    ;setting the digital port as input
INT    15H          ;
    
```

**AL low byte = value**

AH – 6FH
<u>Sub-function:</u>
AL – 9 : Set the digital port as OUTPUT
BL : Digital I/O input value

### B.3 Assembly Language Sample 2

```

MOV    AX, 6F09H    ;setting the digital port as output
MOV    BL, 09H      ;digital value is 09H
INT    15H          ;
    
```

**Digital Output is 1001b**

Appendix

C

# Hazardous Materials Disclosure

---

## C.1 Hazardous Materials Disclosure Table for IPB Products Certified as RoHS Compliant Under 2002/95/EC Without Mercury

The details provided in this appendix are to ensure that the product is compliant with the Peoples Republic of China (China) RoHS standards. The table below acknowledges the presences of small quantities of certain materials in the product, and is applicable to China RoHS only.

A label will be placed on each product to indicate the estimated “Environmentally Friendly Use Period” (EFUP). This is an estimate of the number of years that these substances would “not leak out or undergo abrupt change.” This product may contain replaceable sub-assemblies/components which have a shorter EFUP such as batteries and lamps. These components will be separately marked.

Please refer to the table on the next page.



## TANK-801 Embedded System

Part Name	Toxic or Hazardous Substances and Elements					
	Lead (Pb)	Mercury (Hg)	Cadmium (Cd)	Hexavalent Chromium (CR(VI))	Polybrominated Biphenyls (PBB)	Polybrominated Diphenyl Ethers (PBDE)
Housing	O	O	O	O	O	X
Display	O	O	O	O	O	X
Printed Circuit Board	O	O	O	O	O	X
Metal Fasteners	O	O	O	O	O	O
Cable Assembly	O	O	O	O	O	X
Fan Assembly	O	O	O	O	O	X
Power Supply Assemblies	O	O	O	O	O	X
Battery	O	O	O	O	O	O

O: This toxic or hazardous substance is contained in all of the homogeneous materials for the part is below the limit requirement in SJ/T11363-2006

X: This toxic or hazardous substance is contained in at least one of the homogeneous materials for this part is above the limit requirement in SJ/T11363-2006

此附件旨在确保本产品符合中国 RoHS 标准。以下表格标示此产品中某有毒物质的含量符合中国 RoHS 标准规定的限量要求。

本产品上会附有“环境友好使用期限”的标签，此期限是估算这些物质“不会有泄漏或突变”的年限。本产品可能包含有较短的环境友好使用期限的可替换元件，像是电池或灯管，这些元件将会单独标示出来。

部件名称	有毒有害物质或元素					
	铅 (Pb)	汞 (Hg)	镉 (Cd)	六价铬 (CR(VI))	多溴联苯 (PBB)	多溴二苯 醚 (PBDE)
壳体	O	O	O	O	O	X
显示	O	O	O	O	O	X
印刷电路板	O	O	O	O	O	X
金属螺帽	O	O	O	O	O	O
电缆组装	O	O	O	O	O	X
风扇组装	O	O	O	O	O	X
电力供应组装	O	O	O	O	O	X
电池	O	O	O	O	O	O

O: 表示该有毒有害物质在该部件所有物质材料中的含量均在 SJ/T11363-2006 标准规定的限量要求以下。  
X: 表示该有毒有害物质至少在该部件的某一均质材料中的含量超出 SJ/T11363-2006 标准规定的限量要求。