

# I-7550E PROFIBUS/Ethernet Converter

## User's Manual



High Quality, Industrial Data Acquisition, and Control Products

## **Warranty**

All products manufactured by ICP DAS are under warranty regarding defective materials for a period of one year from the date of delivery to the original purchaser.

## **Warning**

ICP DAS assumes no liability for damages resulting from the use of this product. ICP DAS reserves the right to change this manual at any time without notice. The information furnished by ICP DAS is believed to be accurate and reliable. However, no responsibility is assumed by ICP DAS for its use, or for any infringements of patents or other right of third parties resulting from its use.

## **Copyright**

Copyright 2014 by ICP DAS. All rights are reserved.

## **Trademark**

The names used for identification only may be registered trademarks of their respective companies.

## **List of Revision**

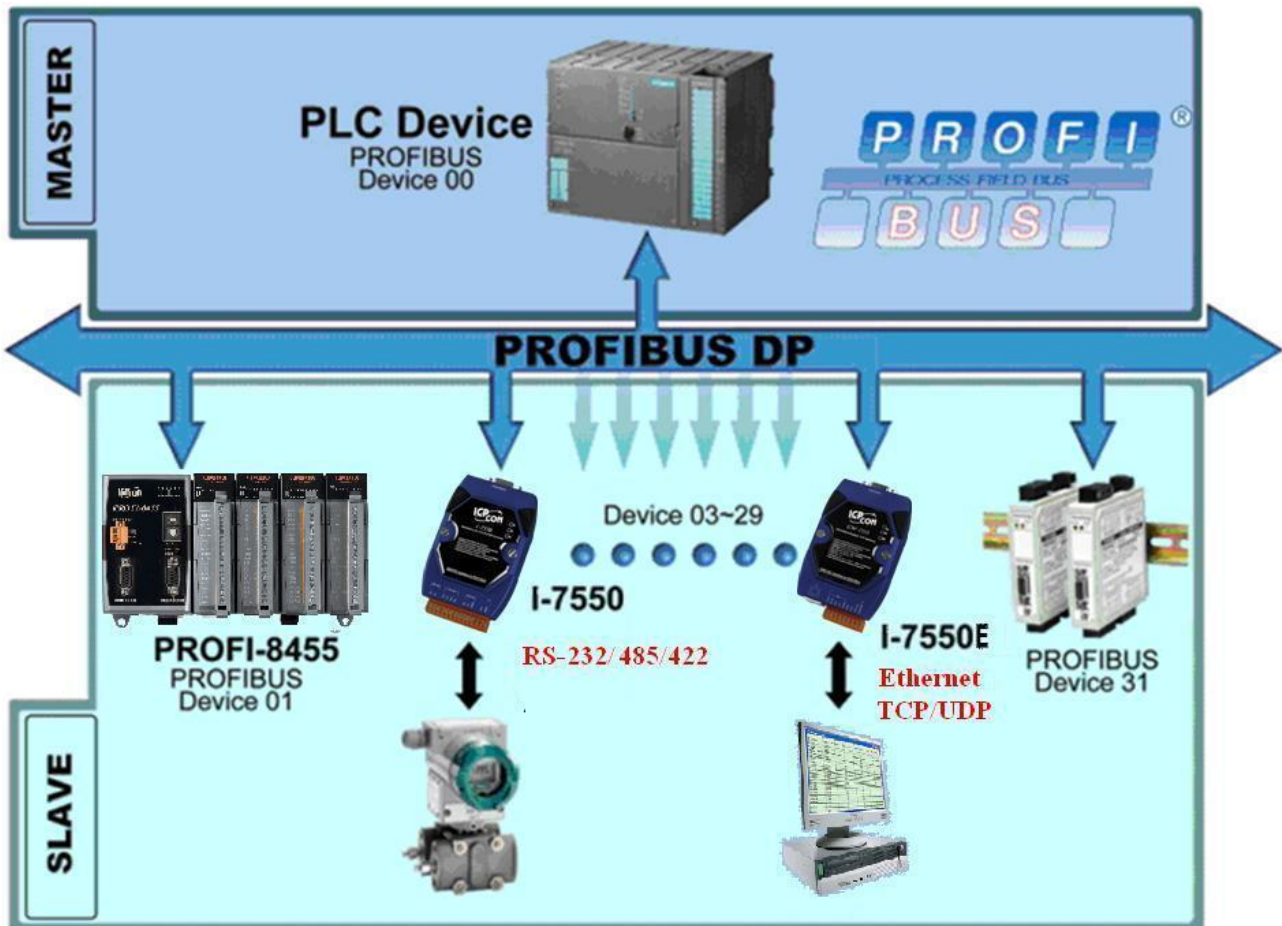
<b>Date</b>	<b>Author</b>	<b>Version</b>	<b>Revision</b>
<b>2014/06/10</b>	<b>Luke</b>	<b>1.00</b>	<b>Release</b>

# Table of Contents

<b>1. Introduction</b>	<b>4</b>
1.1 Features	4
1.2 Specification	5
<b>2. Hardware</b>	<b>7</b>
2.1 Block Diagram of I-7550E	7
2.2 Pin Assignment	7
2.3 Wiring	9
2.4 Setting the PROFIBUS Address	12
2.5 LED status indicator	13
2.6 Normal/Setting DIP switch	14
<b>3. Communication protocol transfer theorem</b>	<b>16</b>
3.1 PROFIBUS Data exchange mode	16
3.2 Ethernet Protocol	20
3.3 PROFIBUS I/O Data Area	23
3.4 Example for Output data of “System setting module”	30
3.5 Example for Input data of “System setting module”	32
<b>4. Communication</b>	<b>35</b>
4.1 Field of application	35
4.2 GSD file	36
4.3 The Configuration of the modules	39
4.4 Diagnostic messages	39
4.5 Establish connection with I-7550E	40
4.6 Data exchange example—I-7550E is as TCP server.	41
4.7 Data exchange example—I-7550E is as TCP Client	51
4.8 Data exchange example—I-7550E is as UDP Server	60
4.9 Data exchange example—I-7550E is as UDP Client	70
<b>5. Configuration with Web Browser</b>	<b>81</b>
5.1 Connecting to Web Server	81
5.2 Web Configuration—Function menu	82
5.3 Web Configuration—Setup page	83
<b>6. Virtual COM Port/VxComm Utility</b>	<b>92</b>
6.1 Install Utility	92
6.2 Setup Virtual COM Port	94
6.3 Remove Virtual COM Port	98
<b>7. Troubleshooting</b>	<b>100</b>
<b>8. Dimensions</b>	<b>101</b>

# 1. Introduction

PROFIBUS is one of famous protocols and is widely used in the fields of factory and process automation. Ethernet is a most popular computer networking technology for local area networks. The I-7550E is a PROFIBUS to Ethernet converter. By using this module, users can easily put the Ethernet devices into PROFIBUS network.



*Figure 1 Application architecture of the I-7550E module*

The I-7550E Converter is specially designed for the slave device of PROFIBUS DP protocol. In the Ethernet protocol application, the I-7550E support TCP/UDP protocol and it can be as server/client device. The Ethernet devices can exchange data with the PROFIBUS Master device via the I-7550E module.

The main features and specification of I-7550E are described as below:

## 1.1 Features

- 16-bit Microprocessor inside with 80MHz
- Profichip VPC3+C PROFIBUS controller

- Support PROFIBUS DP-V0 slave
- PROFIBUS transmission rate detect automatically
- Max transmission speed up to 12 Mbps for PROFIBUS
- Support TCP/UDP protocols
- Support TCP/UDP Server/Client
- Maximum length of Data for Ethernet is up to 1460 Bytes
- Max length of Data for PROFIBUS is 240/240 Bytes
- Ethernet Port: 10/100 Base-TX
- Support Virtual COM Port
- 2500Vrms High Speed iCoupler Isolation Protection for PROFIBUS network
- 3000V<sub>DC</sub> Isolation Protection on the PROFIBUS side
- Provide LED indicators
- Built-in Watchdog
- Mountable on DIN Rail

## 1.2 Specification

COM Port specs:

- Serial port - RS-232
- Serial port interface: screw terminal block
- Baud Rate : 115200 bps
- Feature: Support firmware update

PROFIBUS specs:

- PROFIBUS interface connector: D-Sub 9-pin female
- Baud Rate: 9.6k/19.2k/45.45k/93.75k/187.5k/500k/1.5M/3M/6M/12Mbps
- Address Setting: 0~126 (set by DIP switch or EEPROM)

Ethernet specs:

- 10/100Base-TX (Auto-negotiating, Auto\_MDIX, LED indicator)

Power requirement:

- Unregulated +10 ~ +30 V<sub>DC</sub>
- Power reverse protection, Over-Voltage brown-out protection
- Power consumption 2.5W

Module specs:

- Dimensions: 119mm x 72mm x 33mm
- Operating temperature: -25 ~ 75 °C
- Storage temperature: -30 ~ 85 °C
- Humidity : 5 ~ 95% RH, non-condensing

- LED Status Indicators(**Table 1**)

**Table 1** LED status indicator

PWR LED	– Show the power state
ERR LED	– Show error state
RUN LED	– Show communication state of PROFIBUS

## 2. Hardware

### 2.1 Block Diagram of I-7550E

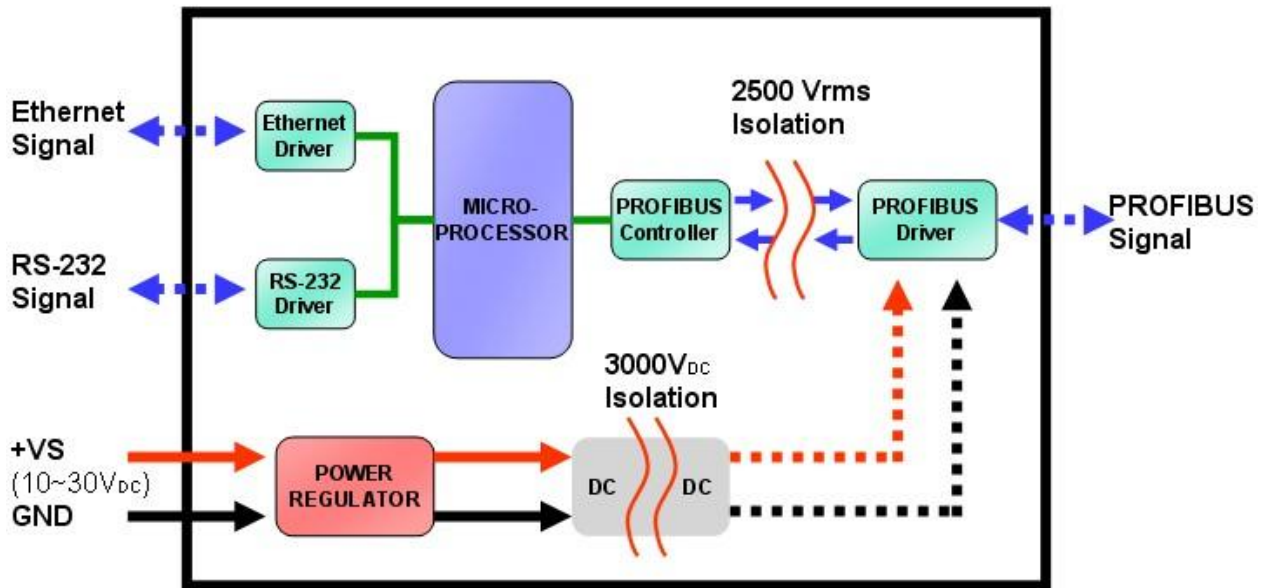


Figure 2 Block diagram of I-7550E

### 2.2 Pin Assignment



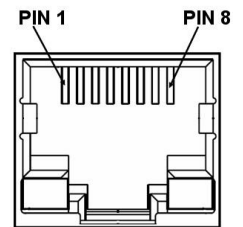
Figure 3 Pin assignment of I-7550E

**Table 2 9-pin screw terminal block**

Pin	Name	Description
1	CTS	Clear to Send of RS-232
2	RTS	Request to Send of RS-232
3	RX	Receive Data of RS-232
4	TX	Transmit Data of RS-232
5	GND	GND of RS-232
6	-	N/A
7	-	N/A
8	+VS	V+ of Power Supply(+10 ~ +30 VDC)
9	GND	GND of Power Supply

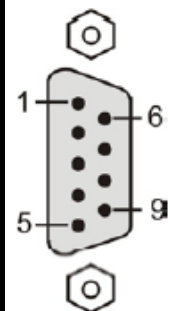
**Table 3 RJ-45 socket**

Pin	Name	Description
1	TX+	TX+ output
2	TX-	TX- output
3	RX+	RX+ input
4	-	N/A
5	-	N/A
6	RX-	RX- input
7	-	N/A
8	-	N/A



**Table 4 PROFIBUS DB9 Female Connector**

Pin	Name	Description
1	-	N/A
2	-	N/A
3	B	Non-inverting Bus Line
4	ISODE	Isolated DE output for use in PROFIBUS applications where the state of the isolated drive enable node needs to be monitored.
5	GND	Power supply ground for the first node and the last node
6	VP	+5V Power Supply for the first node and the last





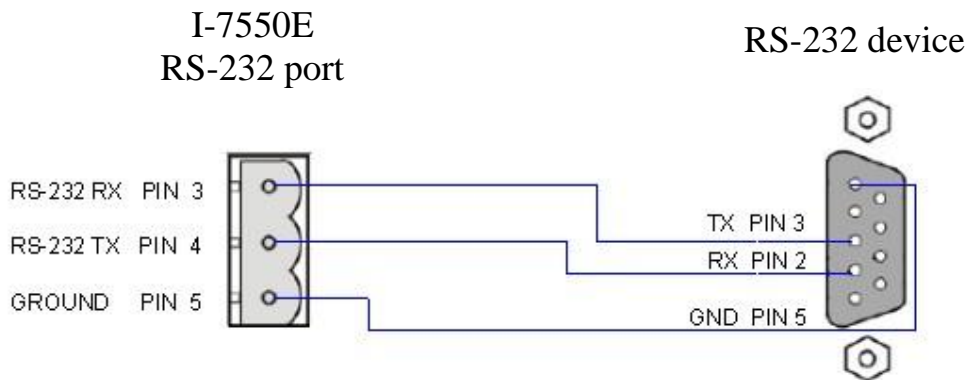
Pin	Name	Description
		node
7	-	N/A
8	A	Inverting Bus Line
9	-	N/A

## 2.3 Wiring

The I-7550E supports PROFIBUS to Ethernet communication and updating firmware via RS-232. The following section describes the connection interface of the I-7550E.

### 2.3.1 RS-232 connection

The RS-232 port of the I-7550E has got three pins. The wiring of the RS-232 device with the RS-232 port of the I-7550E is shown in *Figure 4*.



*Figure 4 RS-232 wiring diagram*

### 2.3.2 Ethernet connection

The user can connect I-7550E with the other device to the same sub network or same Ethernet Switch, as shown in *Figure 5*.



**Figure 5 Ethernet connection**

### 2.3.3 PROFIBUS Connection

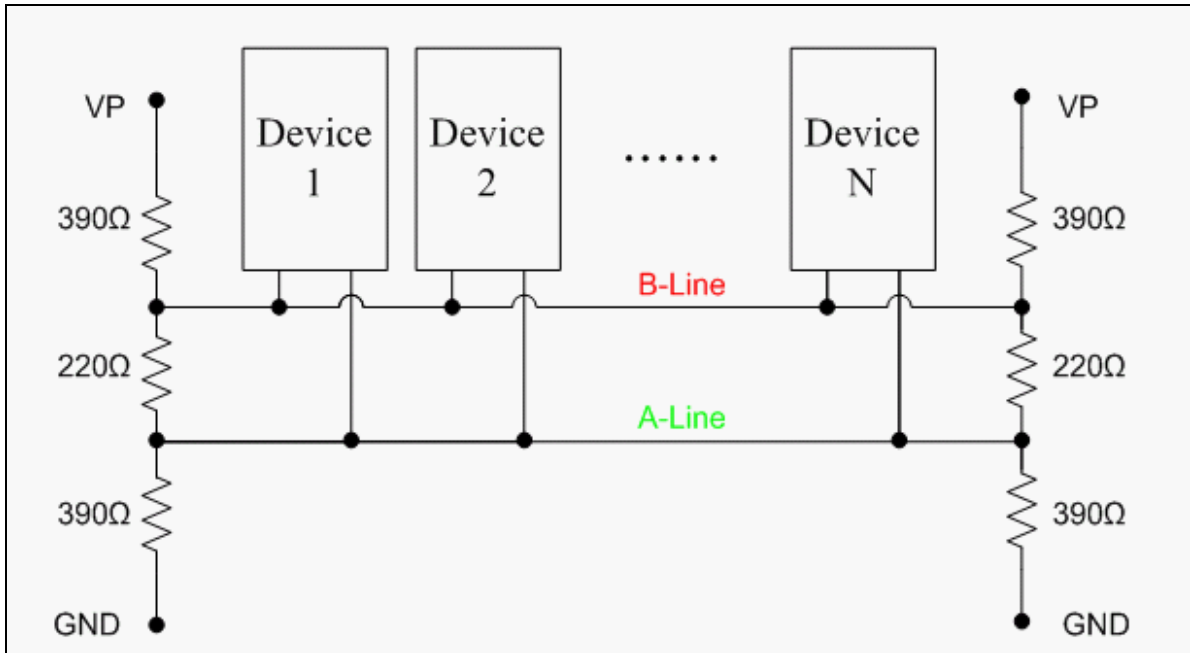
The PROFIBUS interface of the I-7550E is a DB9 female connector. The connector uses the standard PROFIBUS 9 pin assignment. It is recommended to use a standard PROFIBUS cable and connector (DB9 male). As with every serial bus the rate of safe data transmission in a PROFIBUS network decreases with increasing distance between Master and Slave. **Table 5** shows the transmission rate and range for a cable with the following properties:

1. Impedance :135~165  $\Omega$
2. Capacity : lower than 30 pF/m
3. Loop resistance : lower than 110  $\Omega$ /km
4. Wire diameter : greater than 0.65 mm
5. Core cross-section : greater than 0.34 mm<sup>2</sup>

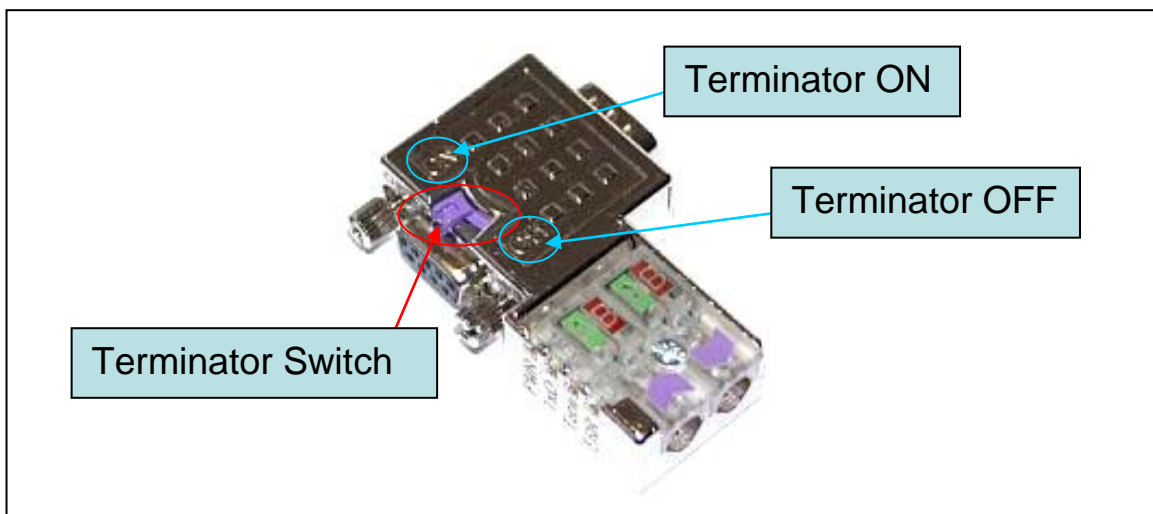
**Table 5 Transmission rate decreasing with increasing transmission distance**

Transmission Rate(kbps)	Transmission Distance per Segment (meter)
9.6, 19.2, 45.45,93.75	1200
187.5	1000
500	400
1500	200
3000, 6000, 12000	100

In order to minimize the reflection effect of signal transmission, both ends (first node and last node) of a PROFIBUS segment needs to be equipped with an active terminal resistor as shown in **Figure 6**. A standard PROFIBUS connector is usually already equipped with a terminal resistor. The user therefore only has to switch on the resistor of the devices stationed at the ends of a segment as shown in **Figure 7**.



**Figure 6** PROFIBUS connection



**Figure 7** PROFIBUS connector

The number of stations in a PROFIBUS network is restricted to 126. According to the PROFIBUS specification up to 32 stations are allowed per segment. A repeater has to be used to link the bus segments.

## 2.4 Setting the PROFIBUS Address

The station address of I-7550E can be set by using either the DIP switch or by writing it directly to the EEPROM. The DIP switch covers a range from 0 to 255. The valid address range of a PROFIBUS station spans from 0 to 126. **Table 6** shows three examples of setting the station address by using the DIP switch. The DIP switches are accessed by opening the modules housing (**Figure 8**). **Table 7** explains which address will be used by the module after power on, if the DIP switch address setting differs from the address stored in the EEPROM.

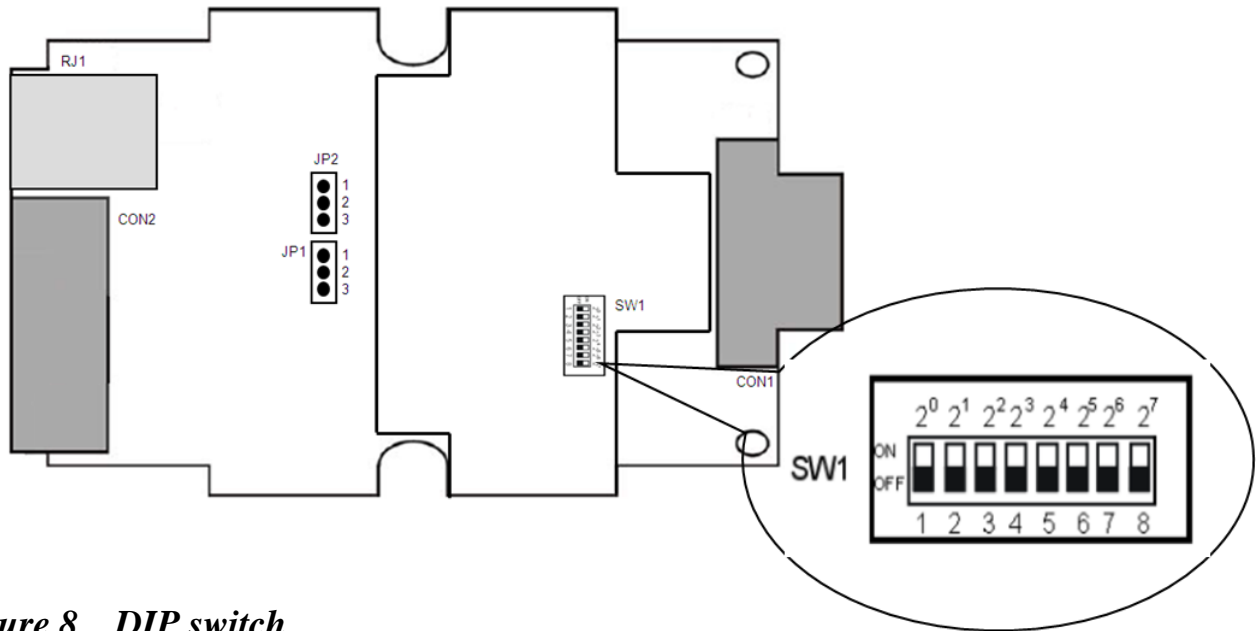
**Table 6** *DIP switch setting example*

Station address	DIP switch (SW1)							
	1	2	3	4	5	6	7	8
1	1	0	0	0	0	0	0	0
10	0	1	0	1	0	0	0	0
126	0	1	1	1	1	1	1	0

*Note: 1=>ON, 0=>OFF*

**Table 7** *The Address setting of the I-7550E*

DIP switch Setting	Description
0~125	<ol style="list-style-type: none"> <li>1. The address setting of the EEPROM is ignored.</li> <li>2. The address cannot be set by the PROFIBUS configuration tool.</li> </ol>
126-254	<ol style="list-style-type: none"> <li>1. The address setting of the DIP switch is ignored.</li> <li>2. If the address in the EEPROM is 126, the PROFIBUS configuration tool can set a new address and save it to the EEPROM.</li> </ol>
255	<ol style="list-style-type: none"> <li>1. Slave address in the EEPROM is set to 126.</li> </ol>



**Figure 8** *DIP switch*

Each Slave must have a unique valid address (1 to 125) in order to be able to communicate with the Master. To change the address by using the configuration tool it is necessary to first set the address stored in the EEPROM to 126. This is done by setting the DIP switch to 255 in the power off state. Switching the module on is forcing the module to change its address in the EEPROM to 126. In the next step switch the module off and change the DIP switch setting to any value from 126 to 254. This step is necessary in order to prevent the module to change its address in the EEPROM to 126 every time it is powered on. The configuration tool can now assign the Slave a new address.

## 2.5 LED status indicator

The I-7550E provides three LEDs to indicate the statuses of the I-7550E module. The position of LEDs and descriptions are shown in **Table 8** and **Figure 9**.

**Table 8** *LED status description*

LED Name	Status	Description
PWR	flash	When PWR led and ERR led are flashing at the same time, which means there is system error in the I-7550E. Please contact us for solution.
	on	Power supply is ok. The firmware has loaded.
	off	Power supply has failed.

LED Name	Status	Description
ERR	flash	When the I-7550E has diagnostic message, it will flash slowly (flash once about 220ms).
	on	– Connection error between PROFIBUS Master and Slave or PROFIBUS system has not been configured correctly.
	off	Normal operation PROFIBUS system has been configured correctly
RUN	on	Data exchange mode Normal operation.
	off	I-7550E module is not in a data exchange mode.

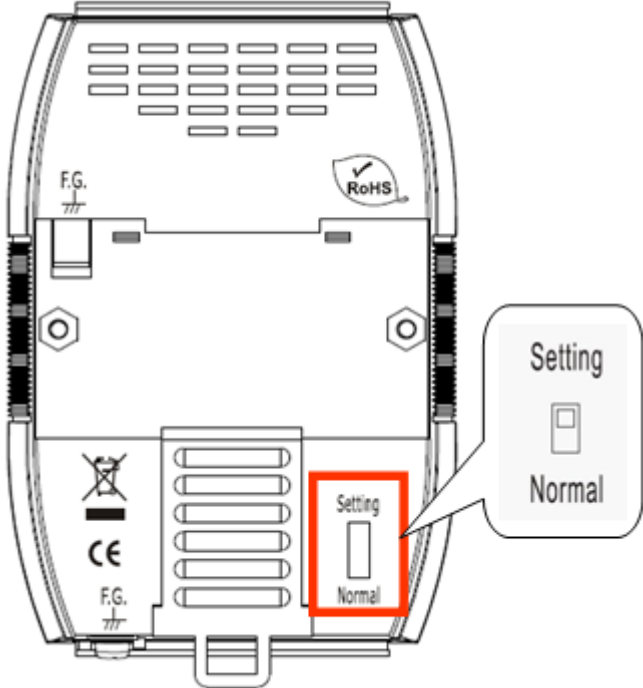


**Figure 9 LED position**

## 2.6 Normal/Setting DIP switch

There is a DIP switch on the back of the I-7550E module, as shown in **Figure 10**. The DIP switch is used to set the I-7550E module works in operation mode or setting mode. In the normal situation, it needs to set the DIP switch to the “Normal” position.

In this case, the I-7550E module can communicate with Ethernet devices. When the user sets the DIP switch to the “Setting” position, the I-7550E module will set the password of Web Configuration and local IP as default value temporarily. At this time, if user doesn’t change any local IP settings/Password and switch back to “Normal” position, the I-7550E will restore previous Local IP setting/Password. It provides the method to set I-7550E when the user forgets IP and Password.



**Figure 10** *DIP switch of the I-7550E*

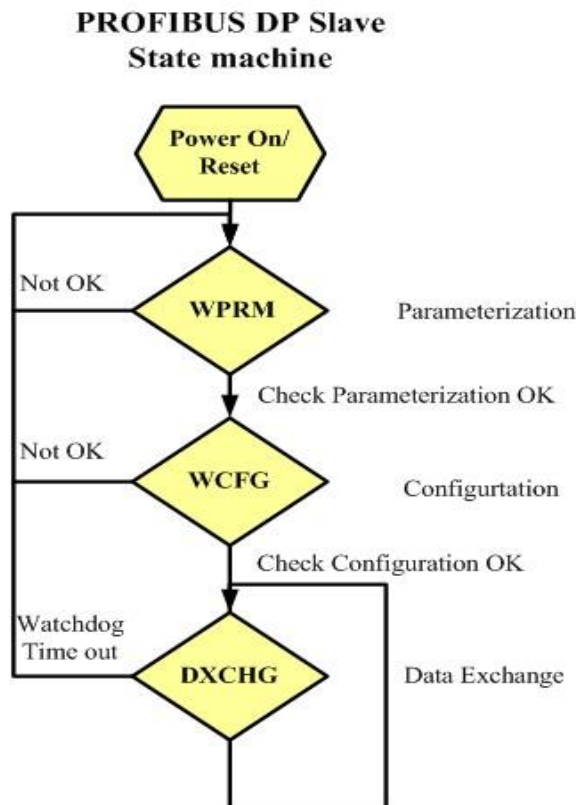
### 3. Communication protocol transfer theorem

Before a cyclic communication between a PROFIBUS Master and the converter can be established it is required to specify the number of input and output bytes that are to be exchanged in each telegram cycle with the PROFIBUS configuration program. Once the slave is an active station in the PROFIBUS network the configured input and output length cannot be changed. A new configuration of the slave is only possible when it is in an off-line mode.

The Maximum input/output length is 240 Bytes, but the first 20 Bytes of input/output are reserved for I-7550E(We call it as “System setting module”).The I-7550E supports the Maximum Ethernet data length is 1460 Bytes, so if the I-7550E receives the data that its length is greater than configured input length, the I-7550E will partition data into several sections according to configured input length. And the information of partition data will be put in input area of “System setting module”, the user can handle the data depending on the information.

#### 3.1 PROFIBUS Data exchange mode

The I-7550E is a PROFIBUS DP Slave device. The I-7550E is first parameterized then configured and finally it goes into the data exchange mode (*Figure 11*).

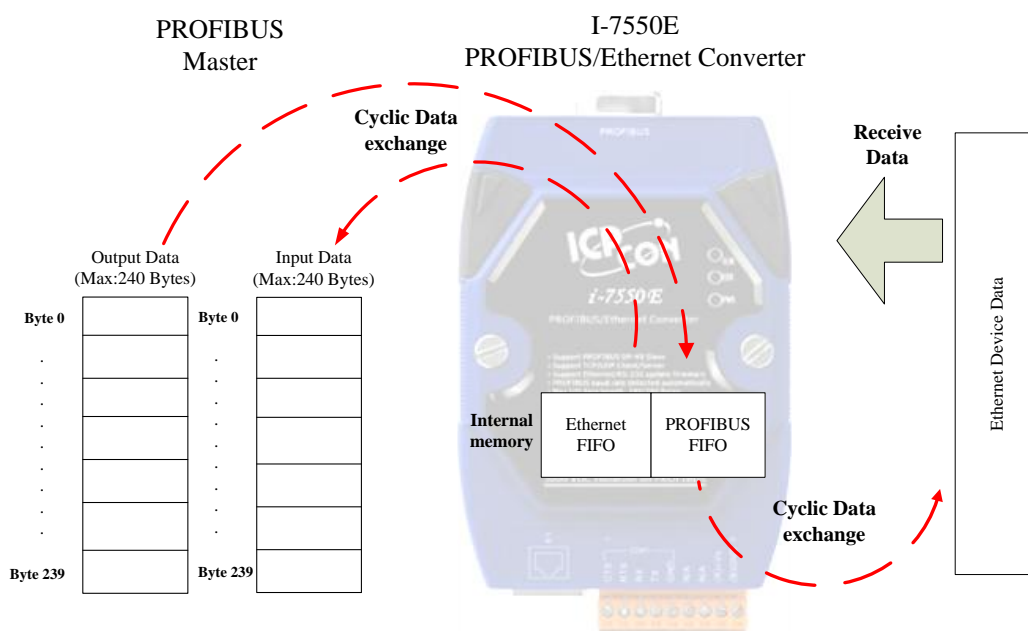


*Figure 11 State machine of PROFIBUS DP Slave device*

The I-7550E exchanges data cyclically between internal FIFO memory and



PROFIBUS Master Device in data exchange mode, and the I-7550E will start Ethernet service according to the setting of TCP/UDP(Please refer to section 5.2). When the I-7550E receives the data from PROFIBUS Master Device, data will be put in PROFIBUS FIFO buffer, and when receives data from Ethernet device it will be put in Ethernet FIFO buffer. In each cyclic communication the I-7550E will send data from PROFIBUS FIFO buffer to Ethernet Device and transfers data from Ethernet FIFO buffer to PROFIBUS Master Device, as shown in *Figure 12*.



**Figure 12** Data exchange between PROFIBUS Master and the I-7550E

● **System setting Module**

The I-7550E reserves the first 20 Bytes of Input/output data area for system control. So when the user configures the I/O length of PROFIBUS, the “System setting module” must be selected first. The user needs to fill these values of output area of system setting module, and the I-7550E will handle the data according to these values. When the I-7550E receives the data from Ethernet device, it will put the information in the input area of “System setting module”. Please refer to section 3.3.1 and 3.3.2 for more detail.

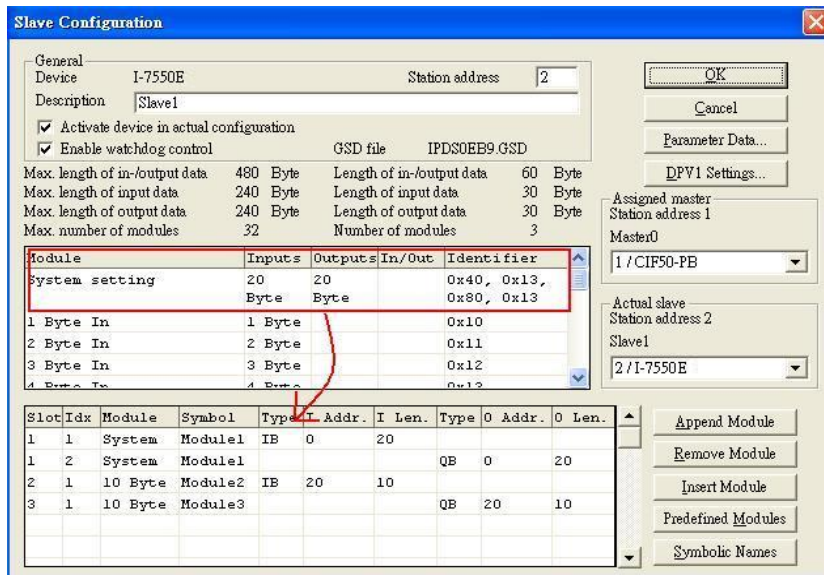


Figure 13 System setting module is selected first

- Set Operation Mode for transferring data between PROFIBUS Master and Ethernet device

In data exchange mode, the I-7550E will always receive data from Ethernet, and the data will be put in Ethernet FIFO (Please refer to section 3.2). But the data won't be transfer to PROFIBUS Master until the user sets the I-7550E in Read/Write mode (Set Byte 0 of output area in "System setting module" as 1). In the same time, the user needs to change the value of Trigger byte then the I-7550E will transfer data to Ethernet device (Please refer to section 3.3.1) as shown Figure 14.

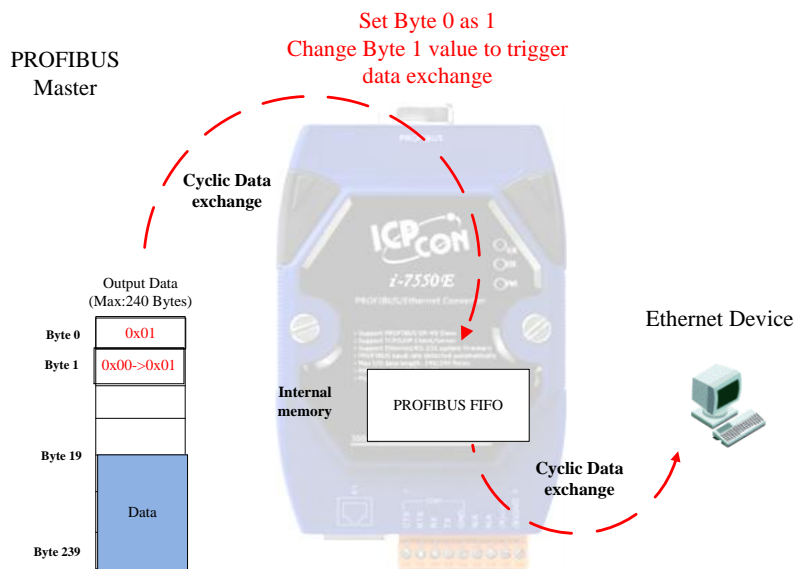
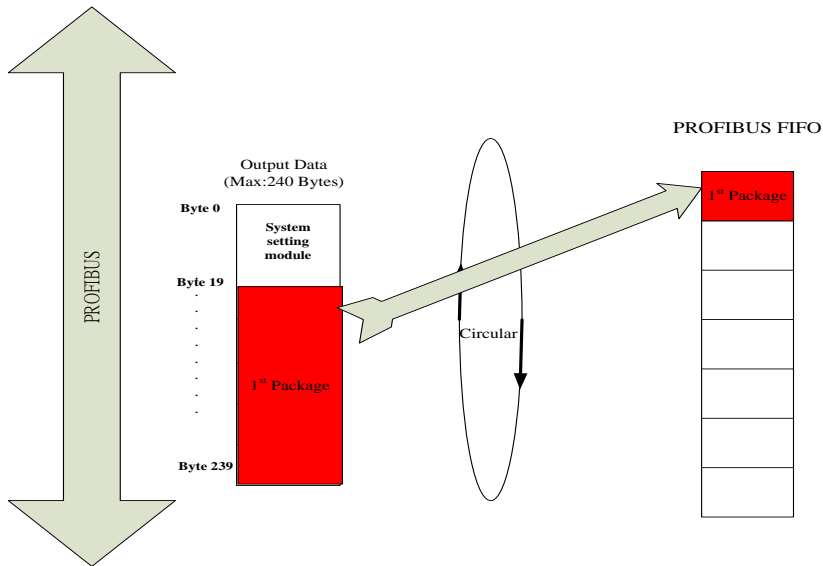


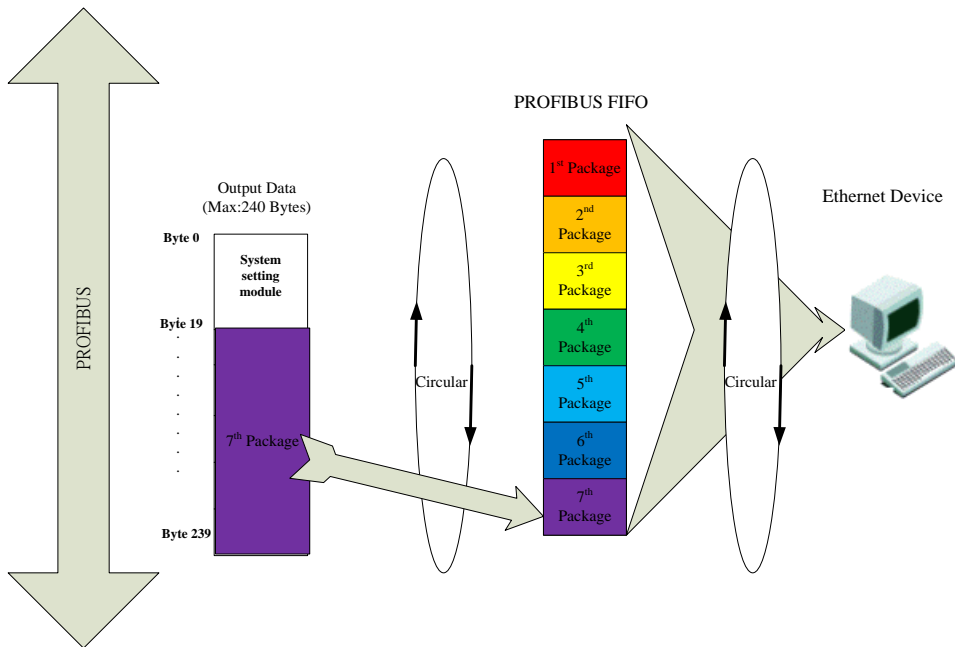
Figure 14 Read/Write Mode for transferring data.

● **Combined Method**

If the user wants to send the data that its length is over configured output length of PROFIBUS to Ethernet device, the I-7550E provides a method that helps the user to combine several packages to one. After receiving all package, the I-7550E combine them and transfers to Ethernet device as shown *Figure 15 and Figure 16*.

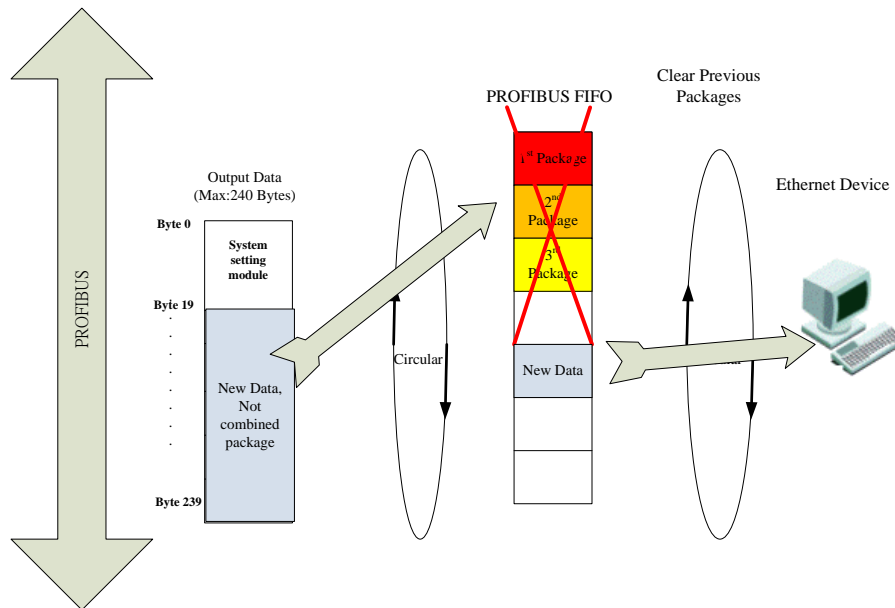


**Figure 15** Receive the 1<sup>st</sup> Package for combine method.



**Figure 16** Receive the last Package and transfer to Ethernet device.

During the Combined Method, if a data received from PROFIBUS Master Device is not correct combined method package, the I-7550E will clear previous combined method packages and diagnostic message will be sent to PROFIBUS Master as shown *Figure 17*.



**Figure 17** Receive new data during Combined Method

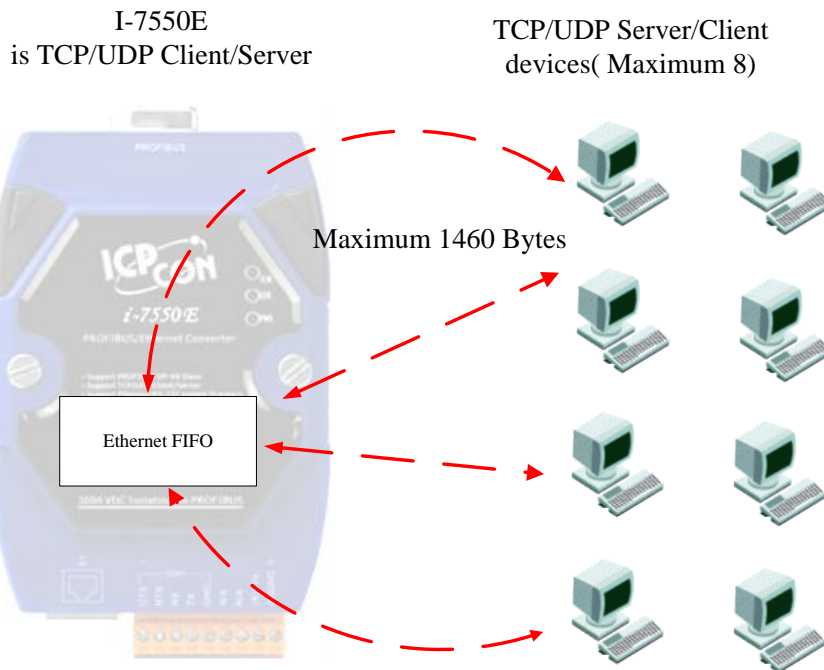
### 3.2 Ethernet Protocol

The I-7550E has below features for Ethernet:

- Maximum length of data is up to 1460 Bytes
- Can be as TCP/UDP server.
- Can be as TCP/UDP client.
- Maximum 8 allowing clients when the I-7550E is as server
- Maximum 8 targeting servers when the I-7550E is as client.

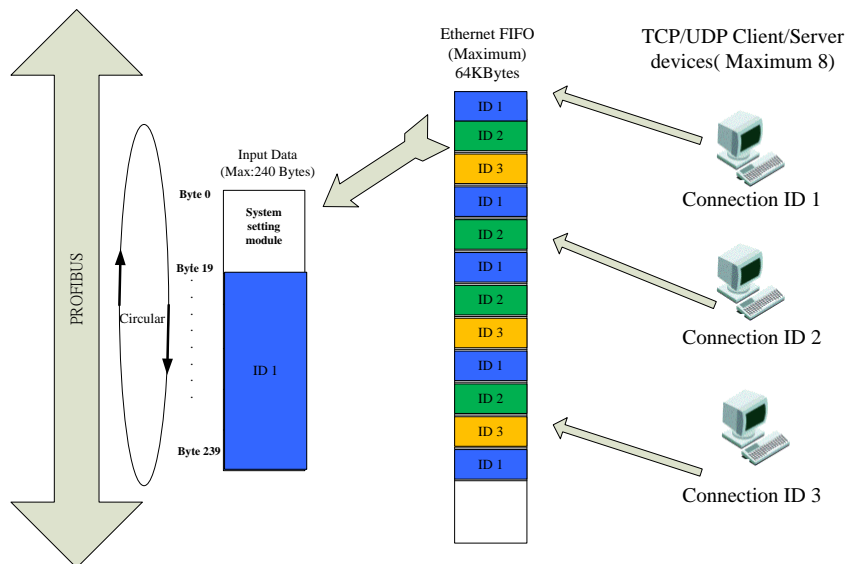
The I-7550E provides Web Configuration for the user to configure the settings of TCP/UDP via browser (Please refer to section 5.2).

The I-7550E supports TCP and UDP protocol and it can be as Server or Client. When the I-7550E is TCP/UDP server, it allows the maximum 8 connections from client devices. Also the I-7550E can be as TCP/UDP client and it can connect with the maximum 8 target server devices as shown *Figure 18*.

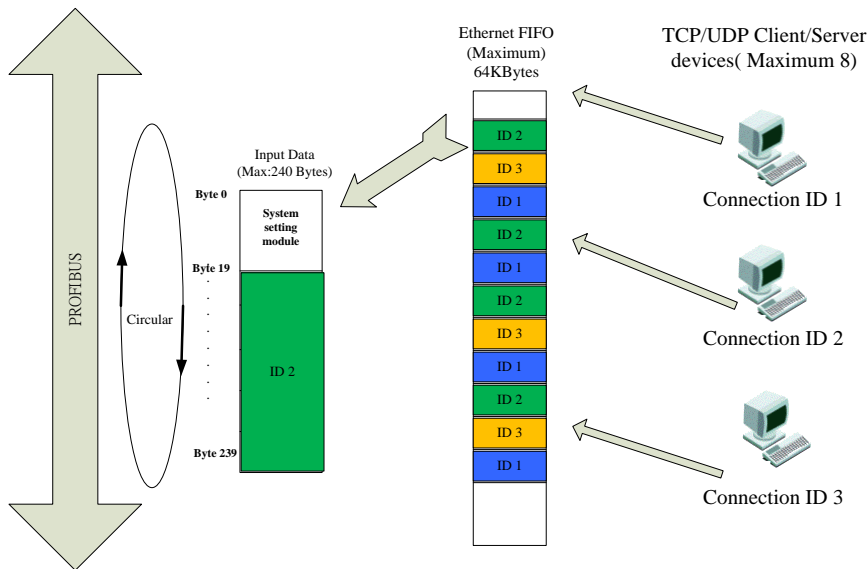


**Figure 18** The I-7550E is as TCP/UDP server/client

When the I-7550E receives data from Ethernet device, the data will be put in Ethernet FIFO buffer. In every Data exchange cycle, the I-7550E will move the first exiting data from FIFO to PROFIBUS Input Data area as shown **Figure 19** and **Figure 20**. The first 20 Bytes are reserved for the I-7550E that stored the information of the data from Ethernet device.



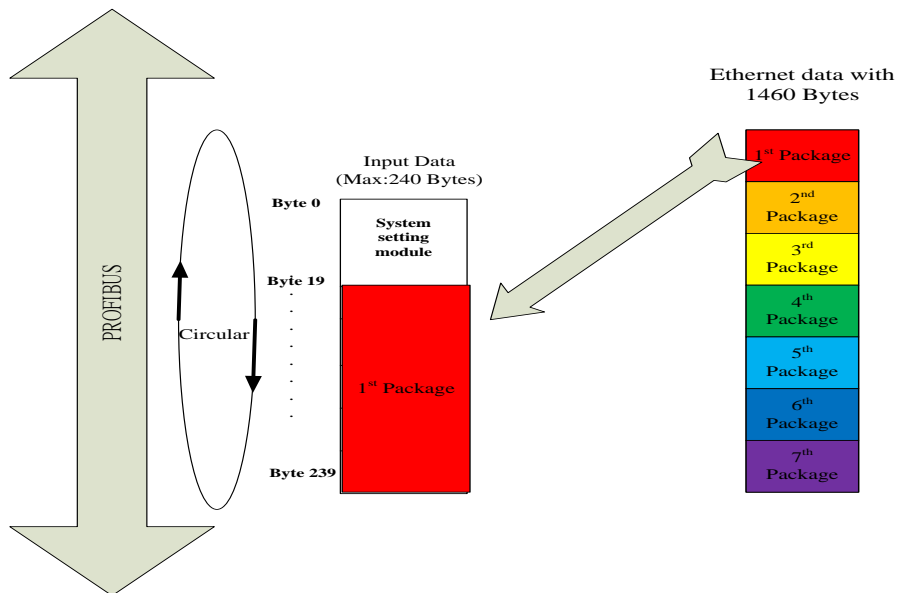
**Figure 19** Data flow of Ethernet (1)



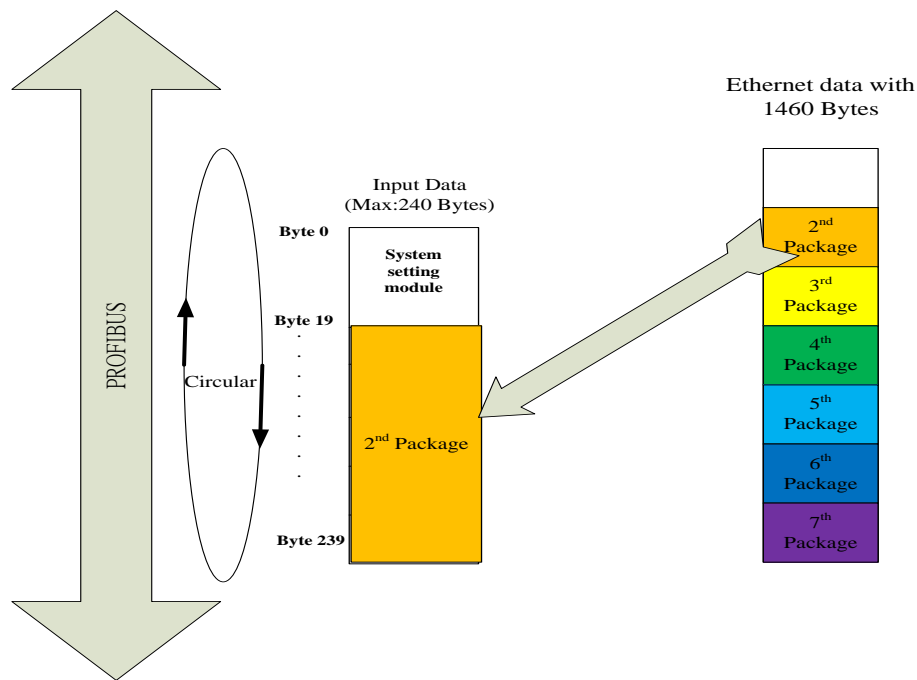
**Figure 20 Data flow of Ethernet (2)**

● **Partition Method**

When the size of data is over configured Input Data length, the I-7550E will partition this data into several packages. In every data exchange cycle, the I-7550E puts 1 partition package into PROFIBUS Input Data area. After all of the packages are done, the I-7550E will process next data from Ethernet device as shown **Figure 21 and Figure 22**.



**Figure 21 Partition Data of Ethernet device (1)**



**Figure 22 Partition Data of Ethernet device (2)**

The user can get the information of these packages in input data area of “System Setting module” (Please refer to section 3.3.2).

If the Ethernet devices transfer data too fast, it may cause FIFO overflow. When it happens, the I-7550E will send diagnostic message to the PROFIBUS Master (Please refer to section 4.4).

### 3.3 PROFIBUS I/O Data Area

The PROFIBUS Master sends and receives data in one telegram cycle. That is, the master sends output data to the slave (I-7550E module) and receives input data from the slave in a single cycle. The maximum length for each input and output data is 240 bytes.

When the PROFIBUS Master sends data to I-7550E, it must transmit the information of data to I-7550E e.g. data length, which Ethernet device will receive data etc. Meanwhile, when Ethernet sends data to I-7550E, it also need pass some information to I-7550E then the I-7550E could handle this data according to this information.

So the I-7550E reserves the first 20 Bytes of Input/output data area and designs the protocol of communication for data exchange. That means the user must arrange and configure the “System Setting Module” before arranging the input/output module. The user must add “System setting module” at the first

module before the other modules, else the I-7550E will send the diagnostic messages to PROFIBUS Master and the system will be abnormal. Section 3.3.1 and 3.3.2 will describe the property in detail.

### 3.3.1 Output Data Area

The I-7550E will handle the data from the PROFIBUS Master according to the first 20 Bytes of output data. There are three modes for I-7550E: Idle Mode、Read/Write Mode and System Control Mode, it depends on the value of the first Byte, as shown in *Table 9*、*Table 10*、*Table 11*.

**Table 9** *Output data area in Idle Mode (Byte 0 =0)*

	<i>Byte</i>	<i>Data type</i>	<i>Description</i>
System setting module	0	Byte	Operation mode
	1	Byte	Not available
	2	Byte	
	3	Byte	
	4	Word	
	6	Word	
	8	Byte	
	9	Byte	
	10	Byte	
	11~19	Byte	
Output module	20~239	Byte	

When the value of Byte 0 is zero (Idle Mode), the I-7550E won't transfer data from PROFIBUS Master to Ethernet device. But it still can receive data from Ethernet device and will put data into the Ethernet FIFO buffer.

**Table 10** *Output data area in Read/Write Mode (Byte 0 =1)*

	<i>Byte</i>	<i>Data type</i>	<i>Description</i>
System setting	0	Byte	Operation mode
	1	Byte	Trigger Byte



	<i>Byte</i>	<i>Data type</i>	<i>Description</i>
module	2	Byte	Control Byte
	3	Byte	Target's Connection ID
	4	Word	Write Message ID
	6	Word	Total length of Write Message
	8	Byte	Total numbers of Message Index
	9	Byte	The index of current Message
	10	Byte	The length of current Message
	11~19	Byte	Reserved
Output module	20~219	Byte	Output data to Ethernet Device

### **Byte 0: Operation Mode**

0: Idle mode. In this mode the I-7550E won't transfer any output data, but it still receive input data when Ethernet device transfers data to the I-7550E. The data from Ethernet will be stored in FIFO buffer.

1: Read/Write mode. This is normal operation mode of the I-7550E. When the user want to transfer data between PROFIBUS Master and Ethernet, it should be in this mode.

2: System control mode. In this mode the user can get/set the system information.

### **Byte 1: Trigger Byte**

When this byte is changed, PROFIBUS Master device will send data of output module to the Ethernet device.

The user must increase this byte in order (ex. 0->1, 1->2, ...255->0) or else the I-7550E will send a diagnostic message to the PROFIBUS Master (Please refer to section 4.4 Diagnostic messages.)

### **Byte 2: Control Byte**

Bit 0: When this bit is set (value =1), diagnostic message sent by the I-7550-E will all be cleared. And the error message will also be cleared.(Error message please refer to section 5.3)

Bit 1: When this bit is set, all data in PROFIBUS FIFO buffer will be cleared.

Bit 2: When this bit is set, all data in Ethernet FIFO buffer will be cleared.

Bit 3: When this bit is set, the Read message ID and total number of Message that have been written (Please refer to the description of Byte 1 and

Byte 3 in section 3.3.2 Input Data Area) will be clear as zero.

### **Byte 3: Connection ID**

The user must set this byte to let the I-7550E know which Ethernet device the data will be sent. This value is depended on “Server IP setting” and “Client IP setting” of Web Configuration (Please refer to section 5.2) as shown *Table 11*:

**Table 11 Connection ID**

Name	Connection ID	Name	Connection ID
S_IP1	1	C_IP9	9
S_IP2	2	C_IP10	10
S_IP3	3	C_IP11	11
S_IP4	4	C_IP12	12
S_IP5	5	C_IP13	13
S_IP6	6	C_IP14	14
S_IP7	7	C_IP15	15
S_IP8	8	C_IP16	16

The I-7550E support Virtual COM Port, and its connection ID is 17(Please refer to Chapter 6 for Virtual COM Port).

### **Byte 4~5: Write Message ID**

Write Message ID is big-endian byte order. The user can define it by himself. This property is not necessary if the user send single package data. When the user use “Combined Method” (Please refer to section 3.1), this property needs to be set.

### **Byte 6~7: Total length of Write Message**

Total length of Write Message is big-endian byte order. When the user sends single data from the PROFIBUS Master, this value will be the same as Byte 10: **The length of current Message.**

### **Byte 8: Total number of Message Index**

When the user sends single data from the PROFIBUS Master, this value will be set as 1. If the user uses “Combined method”, the I-7550E will combine data according to this value.

### **Byte 9: The Index of current Message**

When the user sends single data from the PROFIBUS Master, it needs to be set as 0. If the user uses “Combined Method”, this value needs starting from 0.

**Byte 10: The length of current Message**

The I-7550E will depend on this value to send data to Ethernet device. That means if the user set this property as zero, the I-7550E won’t send any data to Ethernet Device. If this value is bigger than configured output length, the I-7550E will only send the length of configured output, and the diagnostic message and error message will be written. (About error message, please refer to section 5.3).

**Table 12 Output data area in System Control Mode (Byte 0 =2)**

	<i>Byte</i>	<i>Data type</i>	<i>Description</i>
System setting module	0	Byte	Operation mode
	1	Byte	Reserved
	2	Byte	Control Byte
	3	Byte	Check Connection Status
	4~19	Byte	Reserved
Output module	20~219	Byte	Not available

**Byte 0/Byte 2:**

These two Bytes is the same with Read/Write Mode.

**Byte 3: Check Connection Status**

The user can check connection status by this property. For example, if the user wants to check the status of connection ID 7, he can set this value as 7 and the connection status will show in Input Data Area Byte 7 of System Control mode.

The I-7550E won’t transfer data from PROFIBUS Master to Ethernet device in this mode. But it still can receive data from Ethernet device and will put data into the Ethernet FIFO buffer.

**3.3.2 Input Data Area**

The first 20 Bytes of input data are reserved for the input data status as shown in *Table 13* 、*Table 14*. It depends on the “Operation mode”. The user can handle

received data depending on these values.

When the I-7550E is in “Idle Mode” (Byte 0 =0), the value of Input data area will be zero.

**Table 13** *Input data area of Read/Write Mode ((Byte 0 =1)*

	<i>Byte</i>	<i>Data type</i>	<i>Description</i>
System setting module	0	Byte	Operation mode
	1	Word	Read Message ID
	3	Word	Total number of written message
	5	Word	Numbers of message waiting to be written
	7	Byte	Connection ID
	8	Byte	Reserved
	9	Word	Reserved
	11	Byte	Total numbers of Message index
	12	Byte	The index of current message
	13	Word	Total length of message
	15	Byte	The length of current message
	16~19	Byte	Reserved
Input module	20~239	Byte	Receive data from Ethernet Device

**Byte 0: Operation Mode**

This Byte will show the current operation mode of the I-7550E.

**Byte 1~2: Read Message ID**

When the I-7550E receives data from Ethernet device, the I-7550E will assign an ID for this data. It will let the user know now the next data is available.

**Byte 3~4: Total number of written message**

This value is big-endian byte order. The I-7550E will count how many data has been sent to Ethernet device. When this value is 65535, the next value will be 1.

**Byte 5~6: Numbers of message waiting to be written**

This value is big-endian byte order. This property will inform the user how many data package in PROFIBUS FIFO buffer.

**Byte 7: Connection ID**

This value indicates this data is sent from which Ethernet device (Please refer to section 3.3.1 Byte 3).

**Byte 11: Total numbers of message index**

When the I-7550E receives the data that its length is over configured input length, the I-7550E will partition this data to several packages (Partition Method). This property will inform the user how many packages are the data partitioned.

If the data length is not over configured input length, this value is always 1.

**Byte 12: The index of current message**

If the data length is not over configured input length, this value is always 0. When the data is handled by “Partition Method”, this value indicates which number of package received. (This value starts from 0)

**Byte 13~14: Total length of message**

This value is big-endian byte order. If the data is not handled by “Partition method”, this value is the same with Byte 15.

**Byte 15: The length of current message**

This Byte will show the length of current data.

**Table 14** *Input data area of System Control Mode (Byte 0 =2)*

	<i>Byte</i>	<i>Data type</i>	<i>Description</i>
System setting module	0	Byte	Operation mode
	1	Byte	The usage percentage of PROFIBUS FIFO buffer
	2	Byte	The usage percentage of Ethernet FIFO buffer
	3	Byte	Numbers of Diagnostic message
	4	Byte	Diagnostic message length
	5	Byte	Diagnostic message
	6	Byte	Diagnostic description
	7	Byte	Connection Status
	8~19	Byte	Reserved
Input	20~219	Byte	Receive data from Ethernet

	<i>Byte</i>	<i>Data type</i>	<i>Description</i>
module			Device

**Byte 0: Operation Mode**

This Byte will show the current operation mode of the I-7550E.

**Byte 1: The usage percentage of PROFIBUS FIFO buffer**

This byte will show the total usage percentage of PROFIBUS FIFO.

**Byte 2: The usage percentage of Ethernet FIFO buffer**

This byte will show the total usage percentage of Ethernet FIFO.

**Byte 3: Numbers of Diagnostic message**

This byte will show how many diagnostic message existing.

**Byte 4: Diagnostic message length**

This Byte will always be 3 if there are diagnostic message existing.

**Byte 5: Diagnostic message**

Please refer to section 4.4.

**Byte 6: Diagnostic description**

Please refer to section 4.4.

**Byte 7: Connection Status**

When the user set Byte 2 as 1~17 in System Control Mode, this Byte will show the connection status of corresponding connection ID.

### 3.4 Example for Output data of “System setting module”

Now we have some examples to show the user how to set the value of output data area in “System setting module”. It will help the user easier to know the control method of the I-7550E. Please refer to 3.3.1 to know more detail about output data of “System setting module”.

#### 3.4.1 Single Output Data package

In this example, we assume the user wants to send 20 Bytes data to the Ethernet device with connection ID 7. In normal operation, the user only needs to set output data of “System setting module” as *Table 15*.

**Table 15** The value of output area of “System setting module”

<i>Module</i>	<i>Byte</i>	<i>Data type</i>	<i>Representation</i>	<i>Value</i>
System setting module	Output 0	Byte	Hex	0x01
	Output 1	Byte	Hex	0x00→ 0x01
	Output 2	Byte	Hex	0x00
	Output 3	Byte	Hex	0x07
	Output 4	Word	Hex	0x00
	Output 6	Word	Hex	0x14
	Output 8	Byte	Hex	0x01
	Output 9	Byte	Hex	0x00
	Output 10	Byte	Hex	0x14

### 3.4.2 Output data with Combine Method

The I-7550E provides “Combined Method” that can combine the data from PROFIBUS Master and sends to Ethernet device at once.

In this example, we assume the I-7550E is configured output data length as 220 Bytes, and the user wants to send 300 Bytes package to Ethernet device with connection ID 11. The PROFIBUS Master needs to send 2 packages to the I-7550E, and these 2 output data of “System setting module” are as shown **Table 16** and **Table 17**.

It is very import that Byte 3、Byte 4、Byte 6、Byte 8 must be the same in 2 package header. If there are different in these values, the I-7550E will ignore these data and sends diagnostic message to the PROFIBUS Master.

**Table 16** The value of output area for 1<sup>st</sup> package

<i>Module</i>	<i>Byte</i>	<i>Data type</i>	<i>Representation</i>	<i>Value</i>
System setting module	Output 0	Byte	Hex	0x01
	Output 1	Byte	Hex	0x00→ 0x01
	Output 2	Byte	Hex	0x00
	Output 3	Byte	Hex	0x0B
	Output 4	Word	Hex	0x01
	Output 6	Word	Hex	0x12C
	Output 8	Byte	Hex	0x02
	Output 9	Byte	Hex	0x00
	Output 10	Byte	Hex	0xDC

**Table 17 The value of output area for 2<sup>nd</sup> package**

<i>Module</i>	<i>Byte</i>	<i>Data type</i>	<i>Representation</i>	<i>Value</i>
System setting module	Output 0	Byte	Hex	0x01
	Output 1	Byte	Hex	0x00→ 0x01
	Output 2	Byte	Hex	0x00
	Output 3	Byte	Hex	0x0B
	Output 4	Word	Hex	0x01
	Output 6	Word	Hex	0x12C
	Output 8	Byte	Hex	0x02
	Output 9	Byte	Hex	0x01
	Output 10	Byte	Hex	0x64

### 3.5 Example for Input data of “System setting module”

#### 3.5.1 Single Package received

When the I-7550E receives the data from Ethernet Device, there is some information put in input data area of “System setting module”. In this example, the length of the data is in the range of configured input length and the user can see the information as shown **Table 18**. Please refer to 3.3.2 to know more detail about input data of “System setting module”.

**Table 18 Input data area of system setting module**

<i>Module</i>	<i>Byte</i>	<i>Data type</i>	<i>Representation</i>	<i>Value</i>
System setting module	Input 0	Byte	Hex	0x01
	Input 1	Word	Hex	0x00
	Input 3	Word	Hex	0x00
	Input 5	Word	Hex	0x00
	Input 7	Word	Hex	0x01
	Input 8	Byte	Hex	0x00
	Input 9	Word	Hex	0x00
	Input 11	Byte	Hex	0x01
	Input 12	Byte	Hex	0x00
	Input 13	Word	Hex	0x0A
	Input 15	Byte	Hex	0x0A



Byte 7 indicates this data is from which Ethernet Device, Byte 13 and Byte 15 is the length of the data received.

### 3.5.2 Package received with “Partition Method”

When the I-7550E receives the data that its length is over the configured input data length, the I-7550E will partition this data into several packages. The user can know the information of packages from input data area of “System setting module”.

In this example, we assume the input data length is configured as 220 Bytes and the I-7550E receives a data with 420 Bytes from connection ID 1. That means the I-7550E will partition this data into 2 packages. And these 2 input data of “System setting module” are as shown *Table 19* and *Table 20*.

Byte 1 is Read message ID and it will be the same in these 2 package headers. It will let the user know these 2 packages are actually the one data from Ethernet device. The user can handle these data depending on these values of input data area.

**Table 19** *The value of Input area for 1<sup>st</sup> package*

<i>Module</i>	<i>Byte</i>	<i>Data type</i>	<i>Representation</i>	<i>Value</i>
System setting module	Input 0	Byte	Hex	0x01
	Input 1	Word	Hex	0x00
	Input 3	Word	Hex	0x00
	Input 5	Word	Hex	0x00
	Input 7	Word	Hex	0x01
	Input 8	Byte	Hex	0x00
	Input 9	Word	Hex	0x00
	Input 11	Byte	Hex	0x02
	Input 12	Byte	Hex	0x00
	Input 13	Word	Hex	0x1A4
Input 15	Byte	Hex	0xDC	

**Table 20** *The value of Input area for 2<sup>nd</sup> package*

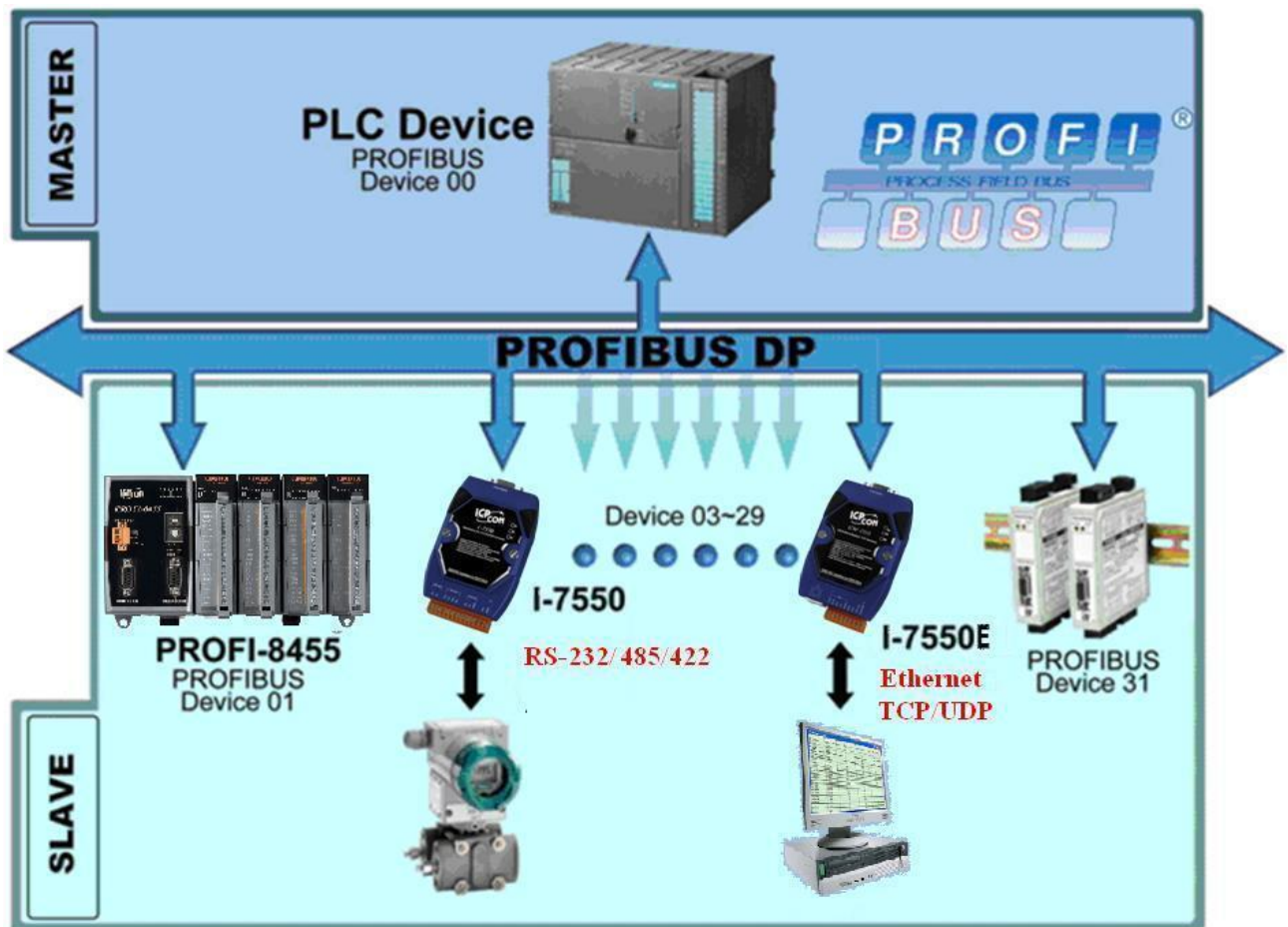
<i>Module</i>	<i>Byte</i>	<i>Data type</i>	<i>Representation</i>	<i>Value</i>
System setting module	Input 0	Byte	Hex	0x01
	Input 1	Word	Hex	0x00
	Input 3	Word	Hex	0x00

<i>Module</i>	<i>Byte</i>	<i>Data type</i>	<i>Representation</i>	<i>Value</i>
	Input 5	Word	Hex	0x00
	Input 7	Word	Hex	0x01
	Input 8	Byte	Hex	0x00
	Input 9	Word	Hex	0x00
	Input 11	Byte	Hex	0x02
	Input 12	Byte	Hex	0x01
	Input 13	Word	Hex	0x1A4
	Input 15	Byte	Hex	0xC8

## 4. Communication

### 4.1 Field of application

A master station can be a PLC, PC or any other smart device. The system can be a mono-master system (*Figure 23*) or a multi-master system (*Figure 24*). The I-7550E enables the integration of the Ethernet devices into a PROFIBUS DP network.



*Figure 23 Mono-master system*

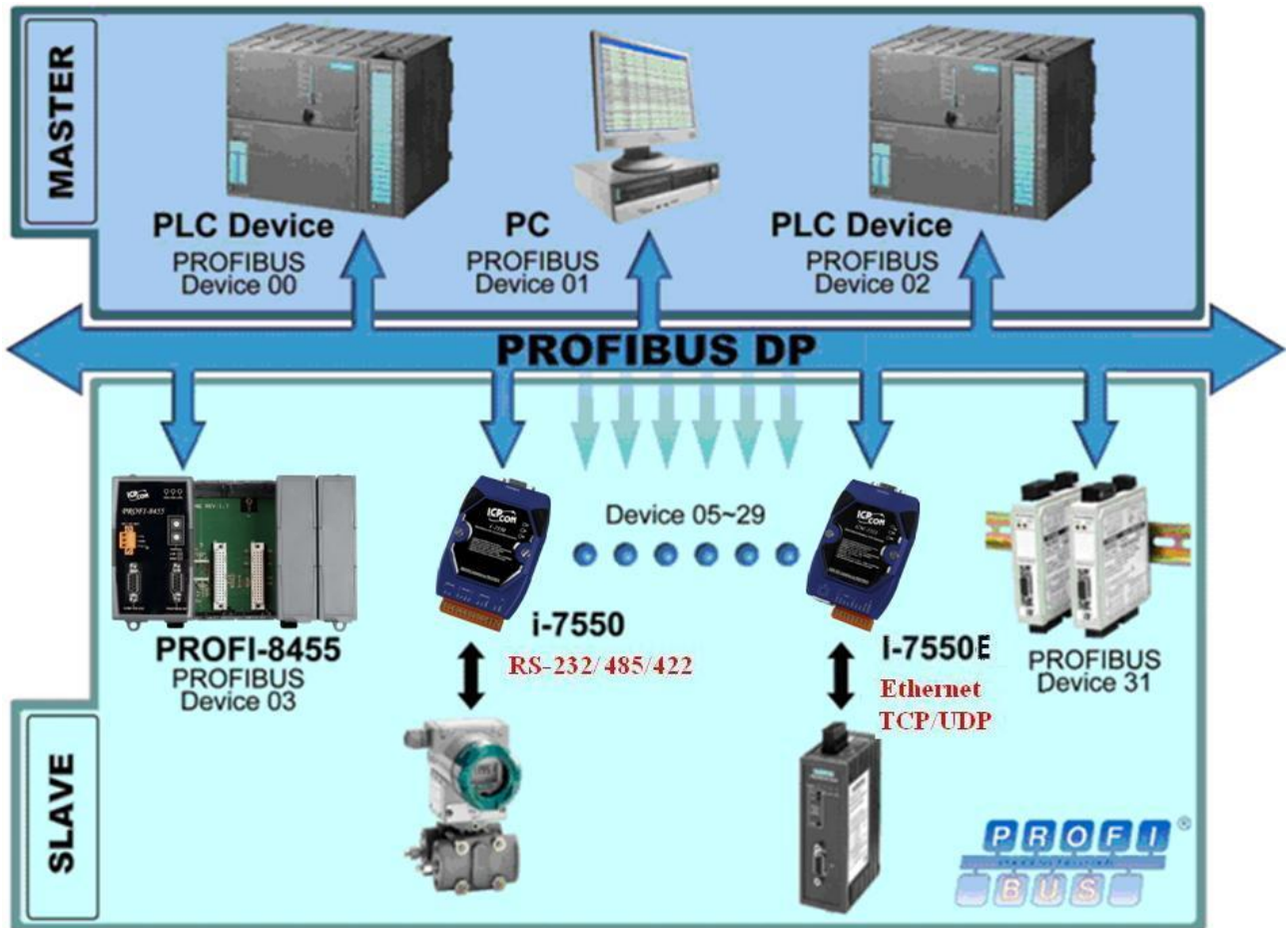


Figure 24 Multi-master system

## 4.2 GSD file

The characteristic (ex: baud rate, message length, number of input / output data.....) of each PROFIBUS DP device is described in the GSD file. The GSD file of the I-7550E is in the ICP DAS companion CD-ROM (PATH--> CD: \profibus\converter\I-7550E\gsd\). The user can copy GSD file (IPDS0EB9.gsd ) and the Bitmap file ( ICP7550E.bmp,i\_7550E.bmp ) to the PROFIBUS configuration tool.

### 4.2.1 The example of how to load GSD file

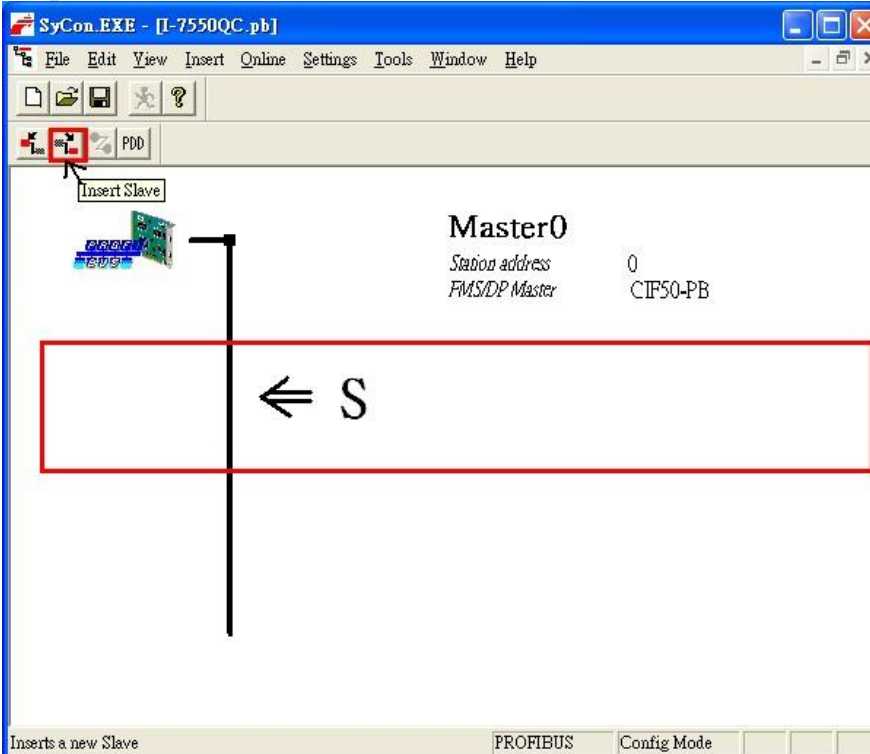
In the following examples the CIF50-PB PROFIBUS Master card from Hilscher is used. The configuration and communication is done by the program “SyCon” provided by Hilscher.

Step 1: Copy the GSD file (IPDS0EB9.gsd) and the Bitmap file (ICP7550E.bmp, i\_7550E.bmp) from CD of the I-7550E module into the PROFIBUS configuration tool.

**File->CopyGSD**

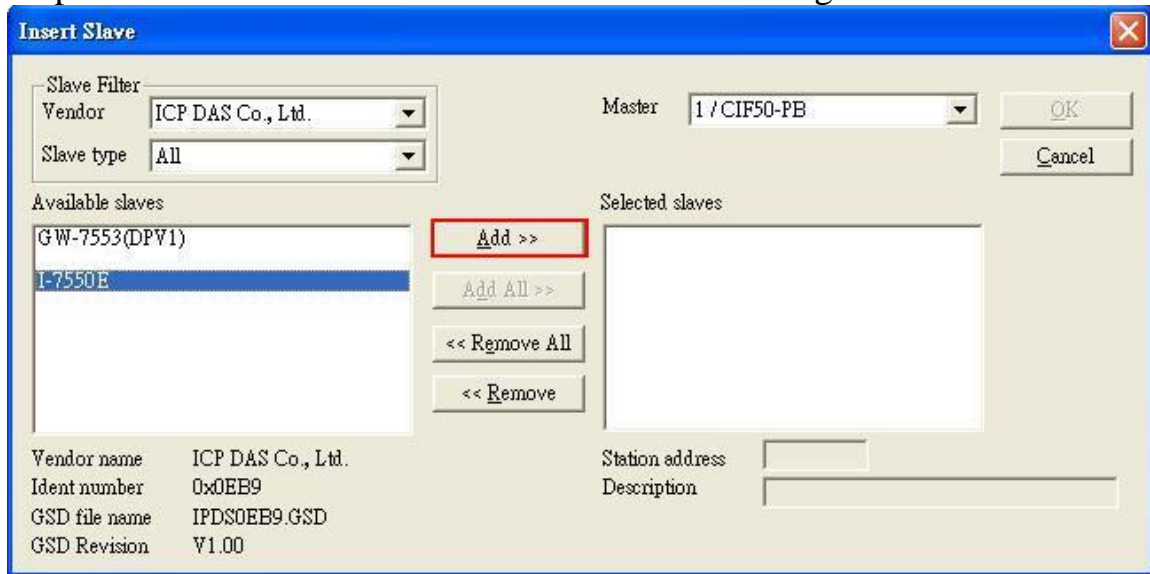
(Directory: --> CD: \profibus\converter\I-7550E\gsd\)

Step 2: Click “insert slave” button in the PROFIBUS configuration tool.



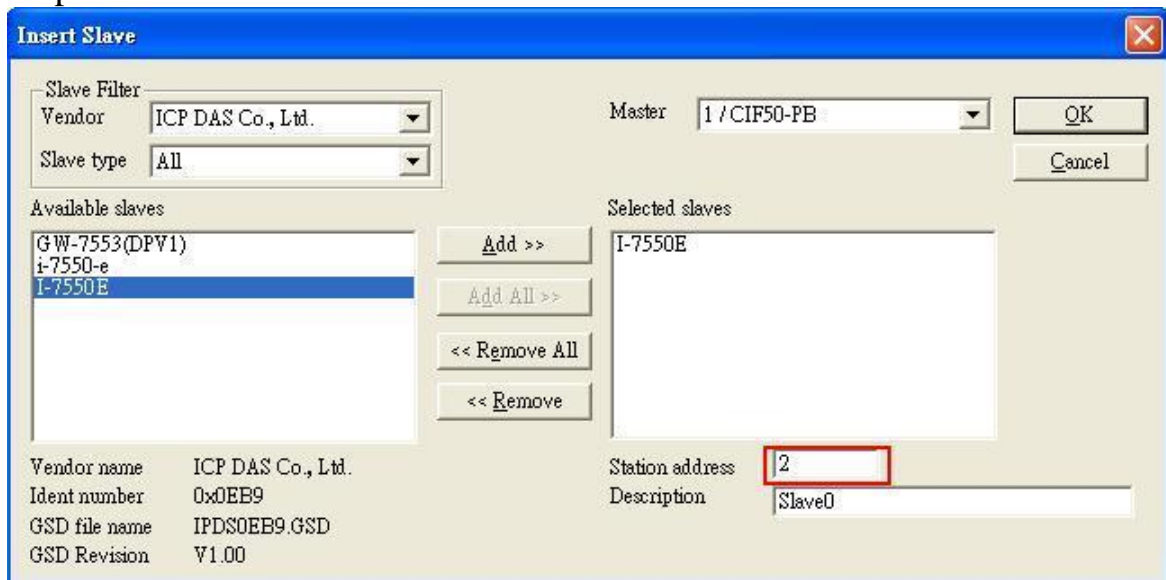
**Figure 25** Insert PROFIBUS Slave device

Step 3: Select I-7550E and click “Add” button to assign the I-7550E.



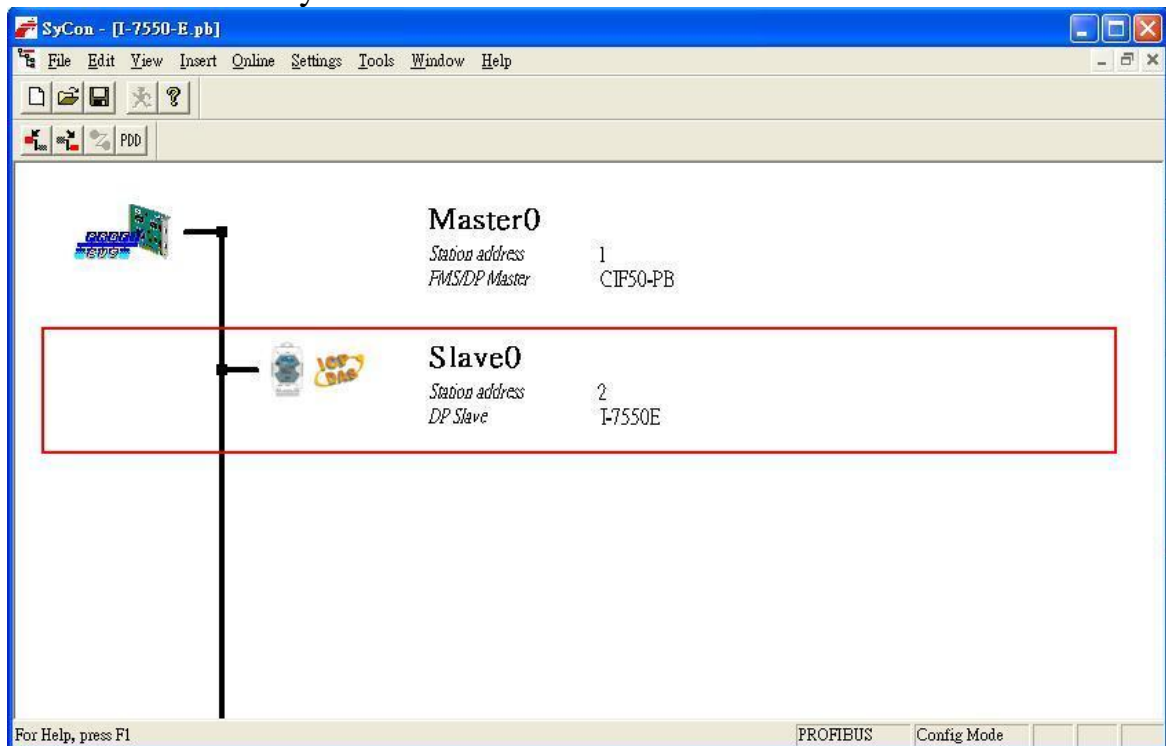
**Figure 26** Assign the I-7550E

Step 4: Set the address of the I-7550E and click “OK” button.



**Figure 27** Set the address of the I-7550E

Step 5: The I-7550E icon is shown in the window. It adds the I-7550E successfully in the software.



**Figure 28** Finish adding the I-7550E

### 4.3 The Configuration of the modules

The user can set the number and size of the I/O modules in the PROFIBUS configuration tool. The settings of the modules are described below.

- Max. I/O modules : 32 modules
- System setting module : 20 Bytes output , 20Bytes input
- Output module : 1~16 Bytes, 32Bytes, 64Bytes, 64 Words
- Input module : 1~16 Bytes, 32Bytes, 64Bytes, 64 Words
- Max. length of I/O data : 480 Bytes
- Output length : 0~240 Bytes
- Input length : 0~240 Bytes

Note:

The user must add “System setting module” at the first module before the other modules, else the I-7550E will send the diagnostic messages to PROFIBUS Master and the system will be abnormal.

#### **Example 1:**

The user wants to read data with Maximum length of 20Bytes from Ethernet device.

In this case, the user must select “System setting module” first, and can select two modules: “Input Register => 16Bytes” and “Input Register => 4Bytes”; or an “Input Register => 32Bytes”

#### **Example 2:**

The user wants to write data with maximum length of 10Bytes to Ethernet device.

In this case, the user must select “System setting module” first, and can select an : “Output Register => 10Bytes”.

The user can set I-7550E as TCP/UDP server or client. TCP/UDP server allows maximum 8 connections and I-7550E can have maximum 8 clients to communicate with other TCP/UDP server. The user can setup TCP/UDP settings form the web configuration of the I-7550E. For more TCP/UDP settings, please refer to Chapter 5.

### 4.4 Diagnostic messages

The I-7550E can record maximally 10 diagnostic messages at the same time. If the number of the diagnostic messages is bigger than 10, the I-7550E will not process other diagnostic message. The diagnostic messages have three types. They are “Connection ID Error”, “System Setting Module Error”, “Output data error” and



“Input Data Error”. The diagnostic messages are shown in *Table 21*.

**Table 21 Diagnostic messages**

Messages	Description	Note
Connection ID error (0x01-0x11)	Disconnected(0x01)	
	Receive Data Error(0x02)	
System setting module Error(0x82)	Not find System setting module.(0x3D)	
	Position is not correct!(0x3E)	
Output Data Error (0x83)	Output Header Error(0x3A)	
	Trigger Byte Error!(0x3B)	
	FIFO overflow(0x3E)	
	Data lose.(0x3F)	
Input Data Error (0x85)	FIFO overflow (0x60)	
	Data lose.(0x63)	

PS:

Diagnostic message will also be shown in input data area of System setting module (Please refer to section 3.3.2)

a. When the I-7550E receives a “data output command” (output byte 1) from system setting module, and this command didn’t increase in order (ex: 0->1, 1->2,..., 255->0), the I-7550E will think that it lose some output data of the PROFIBUS Master and a diagnostic message (“Trigger Byte Error”) will be sent by the I-7550E to the PROFIBUS Master.

b. When the FIFO is overflow, it means that the users send data from Ethernet to I-7550E fast. The user should adjust the timing of sending data.

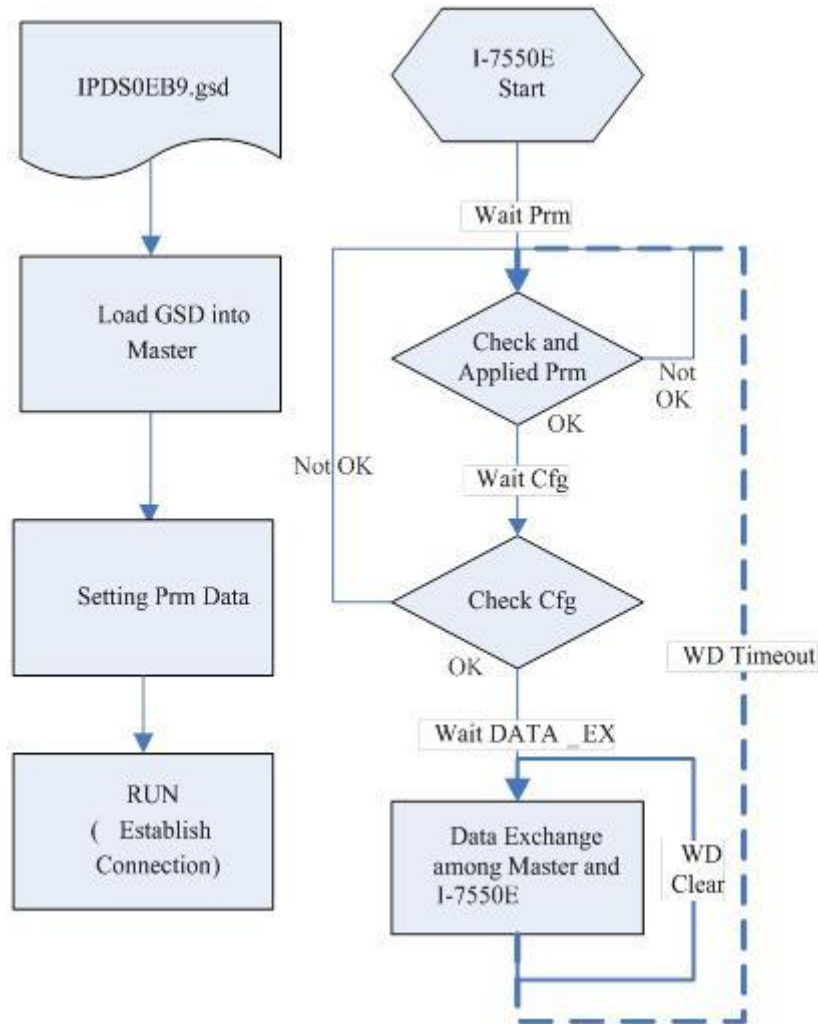
c. When the user set the wrong value of output data area of “System setting module”, it may not affect the communication but the I-7550E will send a diagnostic message to the PROFIBUS Master. Meanwhile, the user can check more detail error message by browser the web of the I-7550E. The user can check it on website “Information”->”ERROR\_MSG\_INFO”(Please refer to section 5.3, “F. Information”).

## 4.5 Establish connection with I-7550E

Before establishing a connection between the DP-Master and the I-7550E, user



should execute the following steps first.



**Figure 29 Establish connection with I-7550E**

First, users must load the electronic device description file (GSD file) of the I-7550E into the DP-Master, and then set the parameters. Finally change your DP-Master from Offline state to Operate state. While DP-Master changes to operate mode, I-7550E will initial the modules. Then I-7550E allocates the memory space and waits for Set\_Prm telegram. The next step is waiting for Check\_Cfg telegram in order. If there is no error occurs, I-7550E proceeds into data exchange state. Users can observe the status indicator LED to know the state of I-7550E. At the meantime, if there is any error occurs, I-7550E will return to wait parameterization.

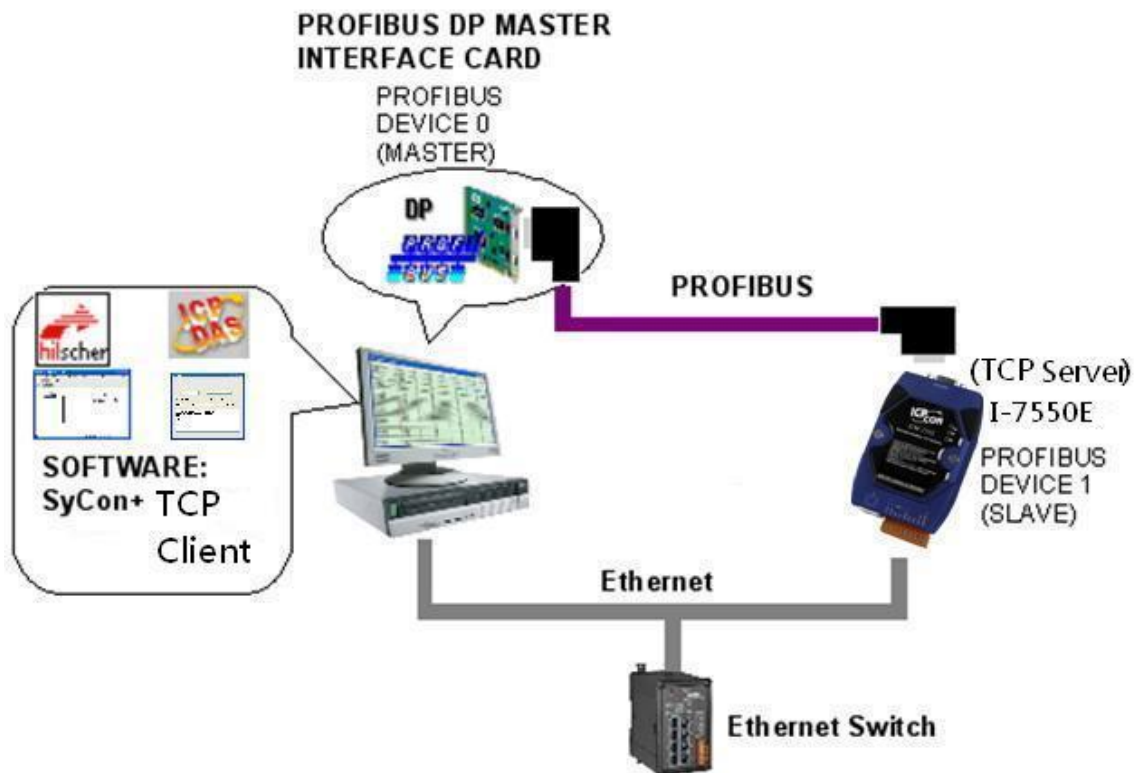
#### **4.6 Data exchange example—I-7550E is as TCP server.**

In this example a TCP client device simulated by a PC program sends data and

receives response message from a PROFIBUS Master via the I-7550E converter. In the following examples the CIF50-PB PROFIBUS Master card from Hilscher is used. The configuration and communication is done by the program “SyCon” provided by Hilscher.

Step 1: Copy the GSD file and assign the I-7550E a valid station address (Please refer to the section 4.2 GSD file).

Step 2: Connect I-7550E module to Ethernet and the PROFIBUS port to a PROFIBUS Master (*Figure 30*).



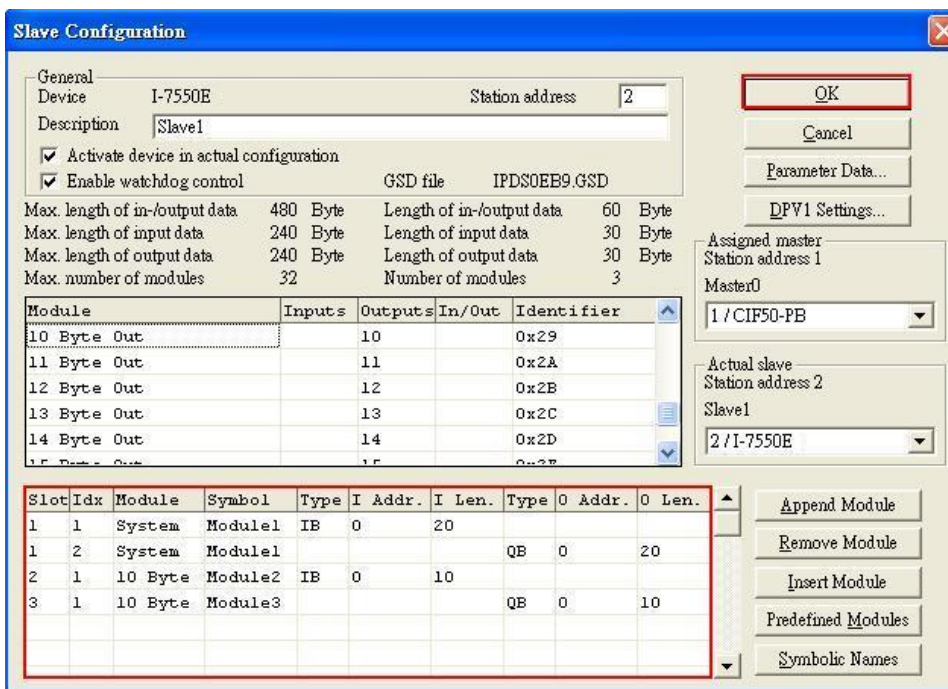
**Figure 30** Wiring diagram between PC and I-7550E

Step 3: Set the parameters of the I-7550E. We just need to configure the I/O length of Input/Output. The user can choose the I/O length depended on their requirement. In this example, we need 10 Bytes for Input/Output as shown *Figure 31* and *Figure 32*

- Select “System setting” module: “System setting” module always has to be selected otherwise no communication can be established between the converter and the Ethernet network.
- Select “10 Byte In” module and “10 Byte Out” module.



**Figure 31** Double click the I-7550E icon to open the “Slave configuration” window

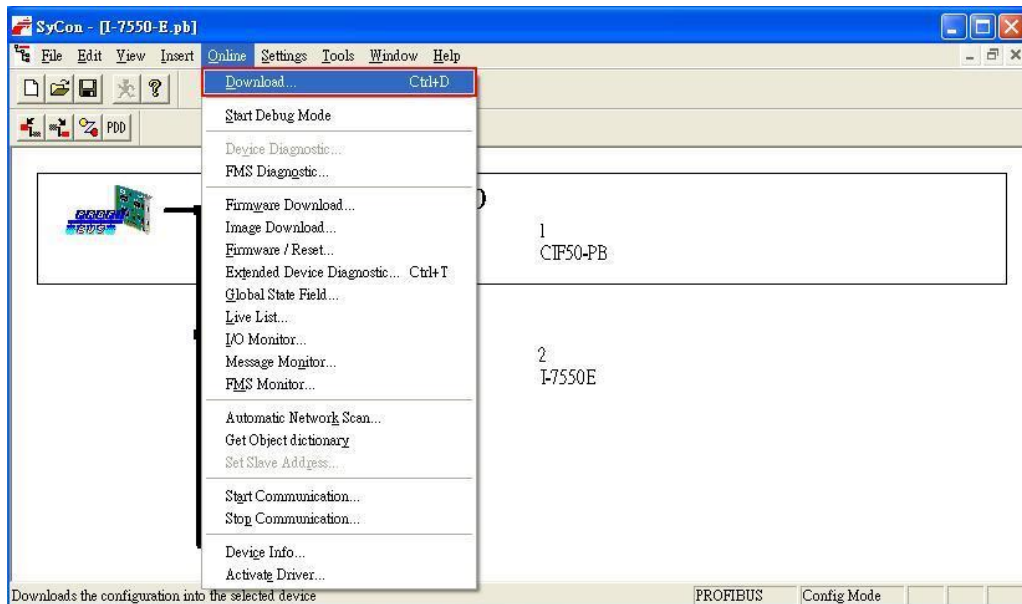


**Figure 32** Select modules for I/O length

Step 4: Close the “Slave Configuration” window by clicking the “OK” button

Step 5: Now the setting done by the configuration tool has to be downloaded to the PROFIBUS Master.

Click on the Master area in the graphic window then  
**Online -> Download...**



**Figure 33** Click “Online->Download” to download the setting into PROFIBUS Master

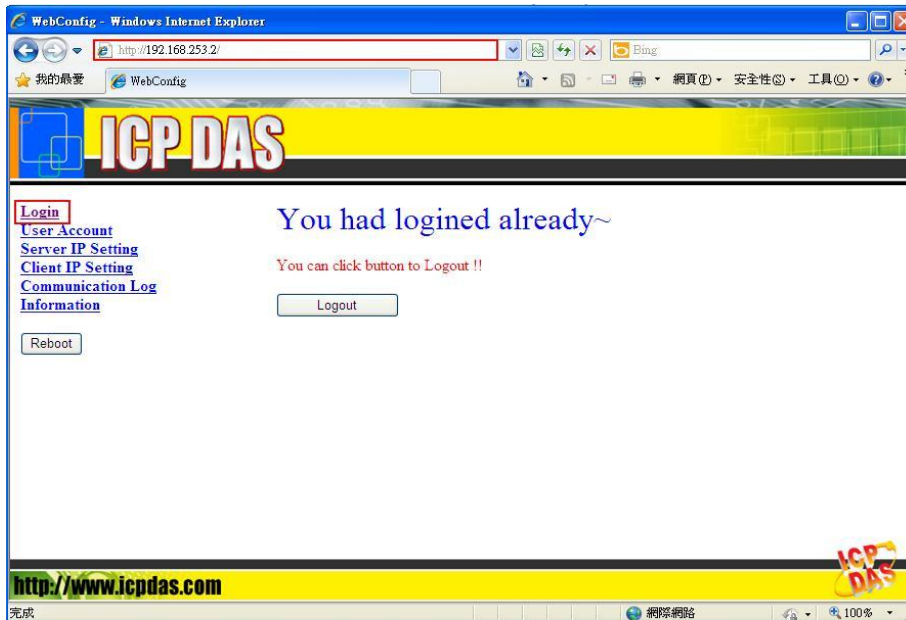
Step 6: Set the network of configuration of I-7550E as shown below:

- Open MiniOS7 utility and press “F12” to find IP address of the I-7550E. The default IP address is “192.168.255.1”.

Type	IP/Port	Name	Alias
TCP BroadCast	192.168.11.23	GRP-520	
TCP BroadCast	192.168.27.53	GRP-520	
TCP BroadCast	192.168.11.22	GRP-520	
TCP BroadCast	192.168.27.50	GRP-520	
TCP BroadCast	192.168.15.223	IR-712-MTCP	
TCP BroadCast	192.168.15.224	IR-712-MTCP	
TCP BroadCast	192.168.11.25	ET-7050	
TCP BroadCast	192.168.253.2	I-7550E	I-7550E
TCP BroadCast	192.168.34.34	7186E3	
TCP BroadCast	192.168.255.2	PFN-2060	PFN-2060v1.0
TCP BroadCast	192.168.255.2	7188E2	
TCP BroadCast	192.168.28.250	WP5231	Compact

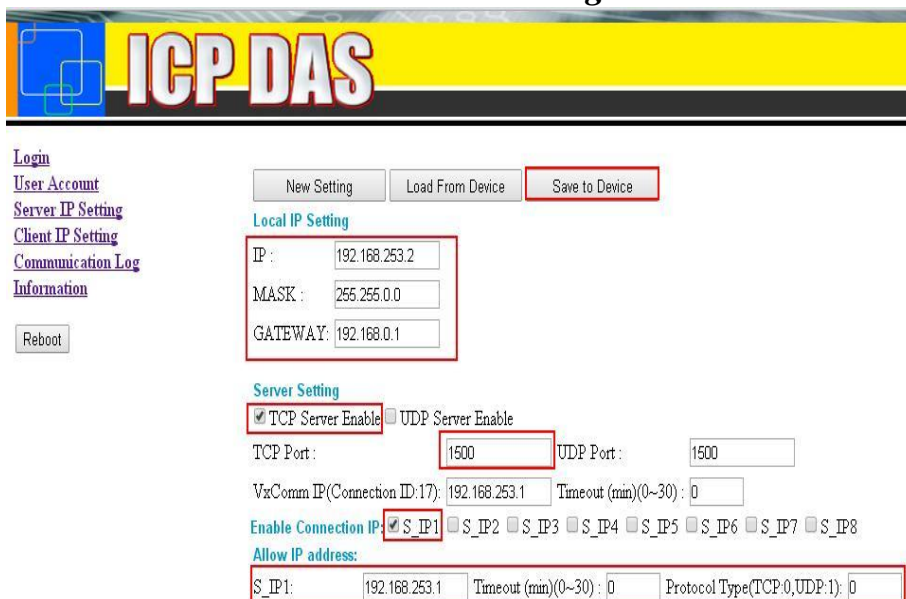
**Figure 34** Use MiniOS7 utility to find IP address of the I-7550E

- Open web browser (ex. IE). Enter IP address of the I-7550E in the Address field and press “**Enter**” to connect with I-7550E, and then enter default password (“icpdas”) to login to I-7550E in Login page as shown **Figure 35**



**Figure 35** Browser the Web of I-7550E and enter the default password to login.

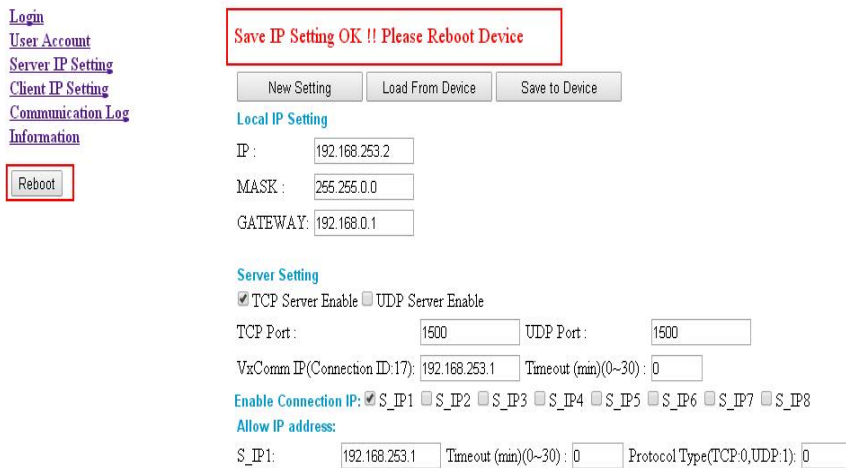
- Click “Server IP Setting” to set the network configuration of the I-7550E (please refer to user manual section 5.3). The network configuration of the I-7550E must have the same domain and different IP with the PC(TCP client Program) (ex: PC’s IP=192.168.253.1, MASK=255.255.0.0;and I-7550E’s IP=192.168.253.2, MASK=255.255.0.0) as shown **Figure 36**.
- Check “TCP Server Enable” and set TCP Port as 1500.
- In Allow IP address field, set S\_IP1 as 192.168.253.1, “Timeout “ values as 0 and “Protocol Type” as 0. Check “S-IP1” in Enable Connection IP field as shown **Figure 36**.



**Figure 36** Set the configuration of TCP server



- Press “Save to Device” to save settings to EEPROM of I-7550E and restart I-7550E. The user can power on I-7550E again or press “Reboot” button to restart the I-7550E as shown *Figure 37*

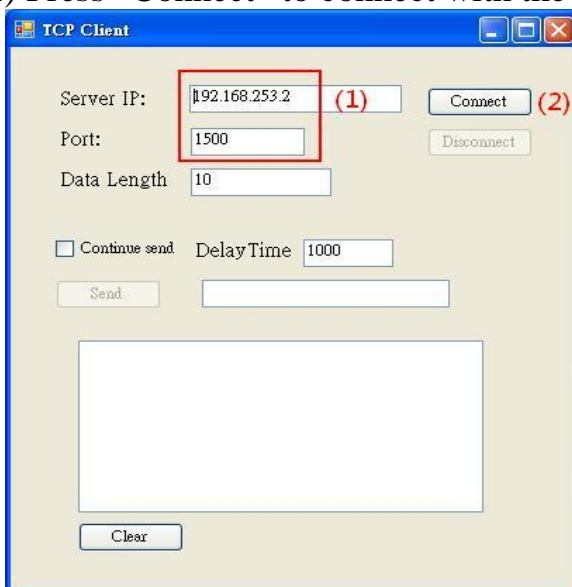


**Figure 37** Press “Save to Device” to save settings to the I-7550E, and restart the I-7550E.

#### 4.6.1 Sending data from a PC(TCP client) to PROFIBUS Master

- Start the test program “TCPClient” (*Figure 38*) on the PC.  
This program simulates a TCP client device and Users can get it from the ICP DAS companion CDROM(PATH:“CD: \PROFIBUS\Converter\I-7550E\utilities\TCPClient”).

- (1) Set the IP address to 192.168.253.2, the port to 1500.
- (2) Press “Connect” to connect with the I-7550E



**Figure 38** TCPClient test program

--Set the I-7550E in Read/Write mode.

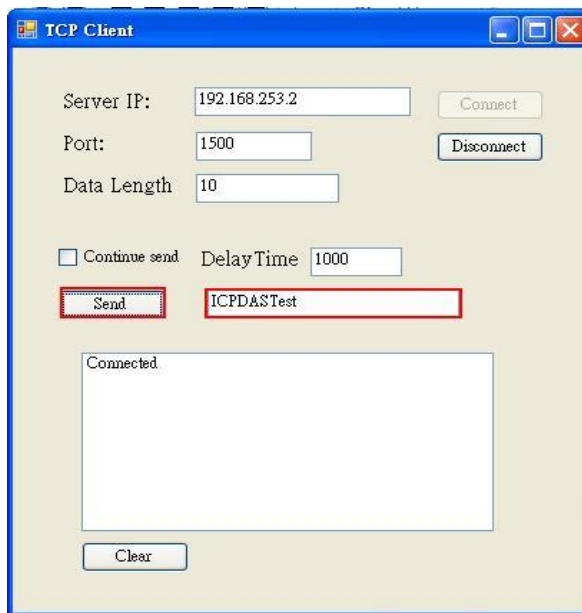
The user need to set the I-7550E in Read/Write mode(Please refer to section 3.3.1). We set Byte 0 of system setting module as 0x01 as shown **Figure 39**

Device	SymName	IEC-Address	Data-Type	Representation	Value
Slave1.Module1.SubModule002	Output001	0	Byte	Hex	01
Slave1.Module1.SubModule002	Output002	1	Byte	Hex	00
Slave1.Module1.SubModule002	Output003	2	Byte	Hex	00
Slave1.Module1.SubModule002	Output004	3	Byte	Hex	00
Slave1.Module1.SubModule002	Output005	4	Byte	Hex	00
Slave1.Module1.SubModule002	Output006	5	Byte	Hex	00
Slave1.Module1.SubModule002	Output007	6	Byte	Hex	00
Slave1.Module1.SubModule002	Output008	7	Byte	Hex	00
Slave1.Module1.SubModule002	Output009	8	Byte	Hex	00
Slave1.Module1.SubModule002	Output010	9	Byte	Hex	00
Slave1.Module1.SubModule002	Output011	10	Byte	Hex	00
Slave1.Module1.SubModule002	Output012	11	Byte	Hex	00
Slave1.Module1.SubModule002	Output013	12	Byte	Hex	00
Slave1.Module1.SubModule002	Output014	13	Byte	Hex	00
Slave1.Module1.SubModule002	Output015	14	Byte	Hex	00
Slave1.Module1.SubModule002	Output016	15	Byte	Hex	00
Slave1.Module1.SubModule002	Output017	16	Byte	Hex	00
Slave1.Module1.SubModule002	Output018	17	Byte	Hex	00
Slave1.Module1.SubModule002	Output019	18	Byte	Hex	00
Slave1.Module1.SubModule002	Output020	19	Byte	Hex	00

**Figure 39** Set Byte 0 of system setting module as 0x01 to let the I-7550E in Read/Write mode.

--Send Data to the PROFIBUS Master.

The user can input data in the text box of TCPClient and press “Send” button to send data to the PROFIBUS Master as shown **Figure 40** · **Figure 41** (The Hexadecimal of data are: 0x49, 0x43, 0x50, 0x44, 0x41, 0x53, 0x54, 0x65, 0x73, 0x74).



**Figure 40** Send Data (Data: ICPDASTest)

Device	SymName	IEC-Address	Data-Type	Representation	Value
Slave1.Module2	Input001	20	Byte	Hex	49
Slave1.Module2	Input002	21	Byte	Hex	43
Slave1.Module2	Input003	22	Byte	Hex	50
Slave1.Module2	Input004	23	Byte	Hex	44
Slave1.Module2	Input005	24	Byte	Hex	41
Slave1.Module2	Input006	25	Byte	Hex	53
Slave1.Module2	Input007	26	Byte	Hex	54
Slave1.Module2	Input008	27	Byte	Hex	65
Slave1.Module2	Input009	28	Byte	Hex	73
Slave1.Module2	Input010	29	Byte	Hex	74

**Figure 41** Receive “ICPDASTest” in the input data area

The user also can receive the information of Data in the input data area of “System setting module” (Please refer to section 3.3.2) as shown **Table 22**.

**Table 22** Receive the data in the input data area of system setting module

Module	Byte	Data type	Representation	Value
System setting module	Input 0	Byte	Hex	0x01
	Input 1	Word	Hex	0x00
	Input 3	Word	Hex	0x00
	Input 5	Word	Hex	0x00
	Input 7	Word	Hex	0x01
	Input 8	Byte	Hex	0x00
	Input 9	Word	Hex	0x00
	Input 11	Byte	Hex	0x01
	Input 12	Byte	Hex	0x00
	Input 13	Word	Hex	0x0A
	Input 15	Byte	Hex	0x0A

#### 4.6.2 The PROFIBUS Master sends data to TCPclient

-- Set the output data area of “System setting module”.

In section 4.6.1, we have already set Byte 0 of “System setting module” as 0x01. Now we need to set the necessary value in the output data area of “system setting module” and “Output module” for sending data to TCPClient as shown **Table 23**、**Table 24** and **Figure 42** .



**Table 23 The value of output area of “System setting module”**

<i>Module</i>	<i>Byte</i>	<i>Data type</i>	<i>Representation</i>	<i>Value</i>
System setting module	Output 0	Byte	Hex	0x01
	Output 1	Byte	Hex	0x00→ 0x01
	Output 2	Byte	Hex	0x00
	Output 3	Byte	Hex	0x01
	Output 4	Word	Hex	0x00
	Output 6	Word	Hex	0x0A
	Output 8	Byte	Hex	0x01
	Output 9	Byte	Hex	0x00
	Output 10	Byte	Hex	0x0A

**Table 24 The value of “Output module”**

<i>Module</i>	<i>Byte</i>	<i>Data type</i>	<i>Representation</i>	<i>Value</i>
Output module	Output 20	Byte	Hex	0x49
	Output 21	Byte	Hex	0x43
	Output 22	Byte	Hex	0x50
	Output 23	Byte	Hex	0x44
	Output 24	Byte	Hex	0x41
	Output 25	Byte	Hex	0x53
	Output 26	Byte	Hex	0x54
	Output 27	Byte	Hex	0x65
	Output 28	Byte	Hex	0x73
	Output 29	Byte	Hex	0x74

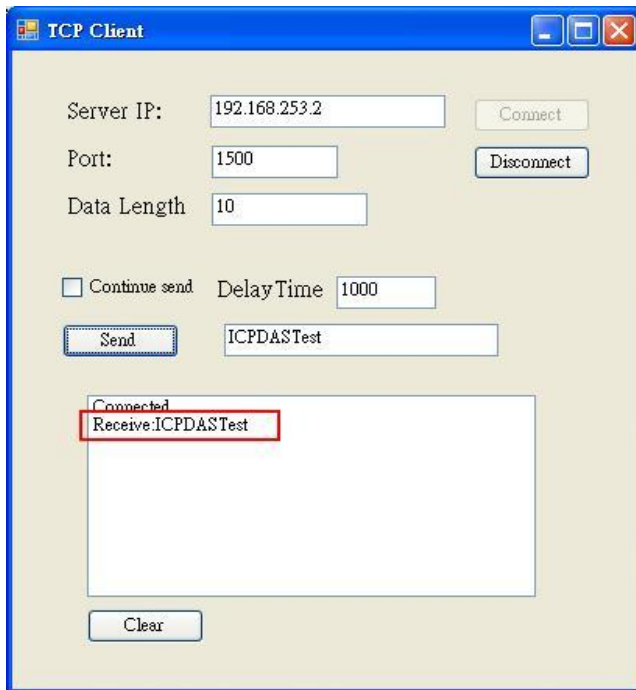
Device	SymName	IEC-Address	Data-Type	Representation	Value
Slave1.Module1.SubModule002	Output001	0	Byte	Hex	01
Slave1.Module1.SubModule002	Output002	1	Byte	Hex	00
Slave1.Module1.SubModule002	Output003	2	Byte	Hex	00
Slave1.Module1.SubModule002	Output004	3	Byte	Hex	01
Slave1.Module1.SubModule002	Output005	4	Byte	Hex	00
Slave1.Module1.SubModule002	Output006	5	Byte	Hex	00
Slave1.Module1.SubModule002	Output007	6	Byte	Hex	00
Slave1.Module1.SubModule002	Output008	7	Byte	Hex	0A
Slave1.Module1.SubModule002	Output009	8	Byte	Hex	01
Slave1.Module1.SubModule002	Output010	9	Byte	Hex	00
Slave1.Module1.SubModule002	Output011	10	Byte	Hex	0A
Slave1.Module1.SubModule002	Output012	11	Byte	Hex	00
Slave1.Module1.SubModule002	Output013	12	Byte	Hex	00
Slave1.Module1.SubModule002	Output014	13	Byte	Hex	00
Slave1.Module1.SubModule002	Output015	14	Byte	Hex	00
Slave1.Module1.SubModule002	Output016	15	Byte	Hex	00
Slave1.Module1.SubModule002	Output017	16	Byte	Hex	00
Slave1.Module1.SubModule002	Output018	17	Byte	Hex	00
Slave1.Module1.SubModule002	Output019	18	Byte	Hex	00
Slave1.Module1.SubModule002	Output020	19	Byte	Hex	00
Slave1.Module3	Output001	20	Byte	Hex	49
Slave1.Module3	Output002	21	Byte	Hex	43
Slave1.Module3	Output003	22	Byte	Hex	50
Slave1.Module3	Output004	23	Byte	Hex	44
Slave1.Module3	Output005	24	Byte	Hex	41
Slave1.Module3	Output006	25	Byte	Hex	53
Slave1.Module3	Output007	26	Byte	Hex	54
Slave1.Module3	Output008	27	Byte	Hex	65
Slave1.Module3	Output009	28	Byte	Hex	73
Slave1.Module3	Output010	29	Byte	Hex	74

Change from 0 to 1 after all value are set.

C:\Program Files\Hilscher\SyCon\Project\I-7550-E.pb

**Figure 42** The value of output data area

-- Set the Byte 1 of “System setting module” from 0 to 1  
 After setting all values, set the Byte 1 of “System setting module” from 0 to 1.  
 And it will trigger the I-7550E transfer data to TCPClient. TCPClient will receive data as shown **Figure 43**. About Trigger method, please refer to section 3.3.1.



**Figure 43** The value of output data area

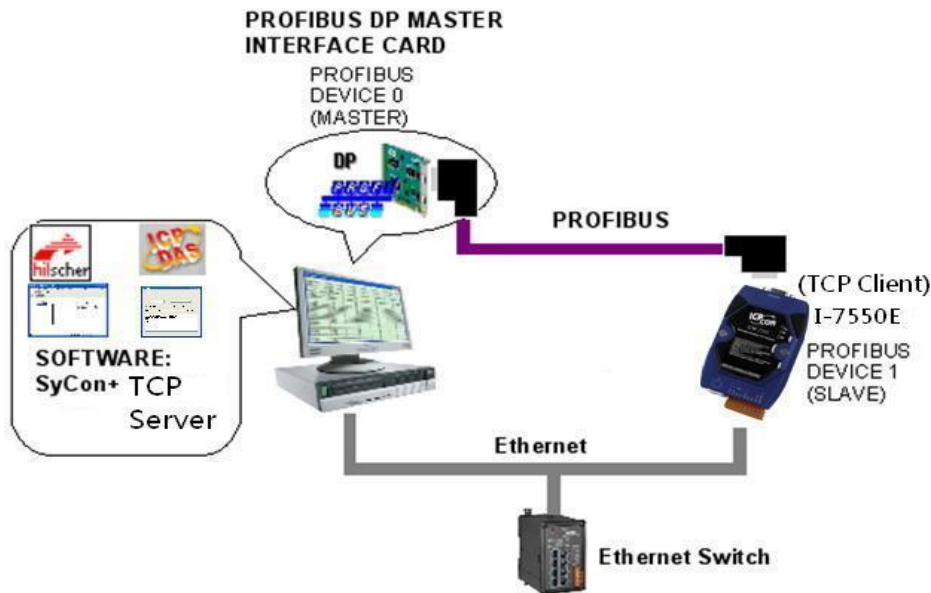
#### 4.7 Data exchange example—I-7550E is as TCP Client

In this example a TCP server device simulated by a PC program that receives data from a PROFIBUS Master and response data to it.

In the following examples the CIF50-PB PROFIBUS Master card from Hilscher is used. The configuration and communication is done by the program “SyCon” provided by Hilscher.

Step 1: Copy the GSD file and assign the I-7550E a valid station address (Please refer to the section 4.2 GSD file).

Step 2: Connect I-7550E and PC by **Figure 44**.



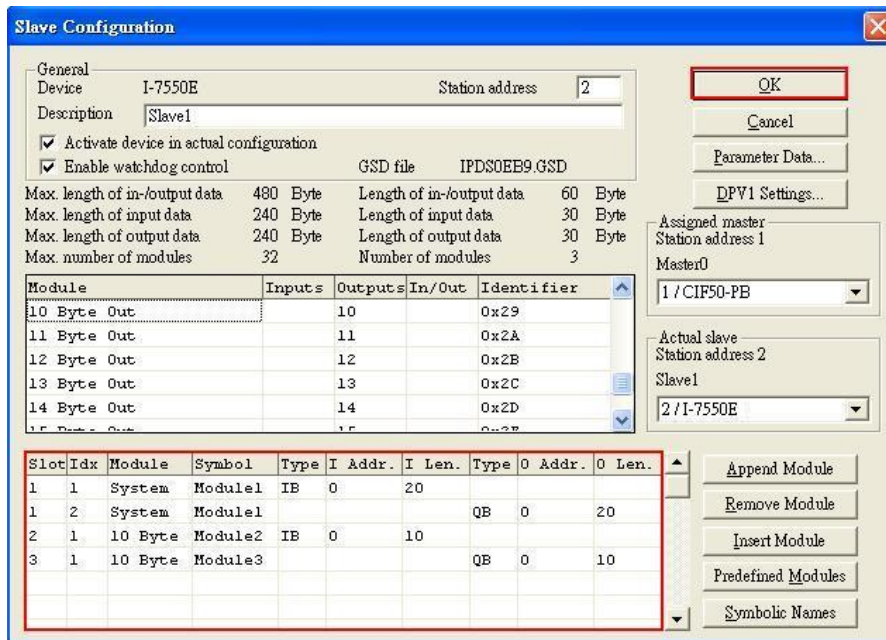
**Figure 44** Wiring diagram between PC and I-7550E

Step 3: Set the parameters of the I-7550E. We just need to configure the I/O length of Input/Output. The user can choose the I/O length depended on their requirement. In this example, we need 10 Bytes for Input/Output as shown **Figure 45** and **Figure 46**

- Select “System setting” module: “System setting” module always has to be selected otherwise no communication can be established between the converter and the Ethernet network.
- Select “10 Byte In” module and “10 Byte Out” module.



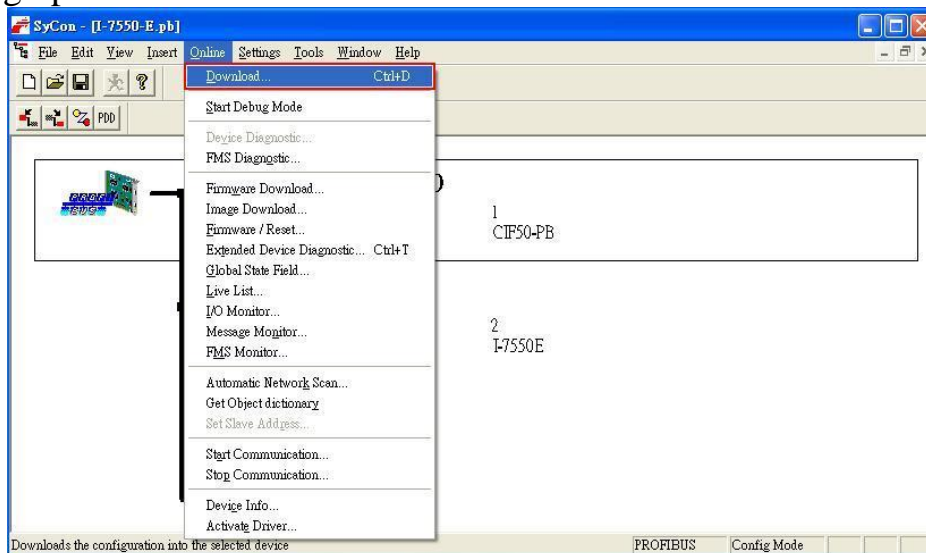
**Figure 45** Double click the I-7550E icon to open the “Slave configuration” window



**Figure 46** Click “Parameter Data...” button to open the “Parameter Data” window

Step 4: Close the “Slave Configuration” window by clicking the “OK” button

Step 5: Now the setting done by the configuration tool has to be downloaded to the PROFIBUS Master. Click on the Master area in the graphic window then **Online -> Download...**



**Figure 47** Click “Online->Download” to download the setting into PROFIBUS Master

Step 6: Set the network of configuration of I-7550E as shown below:

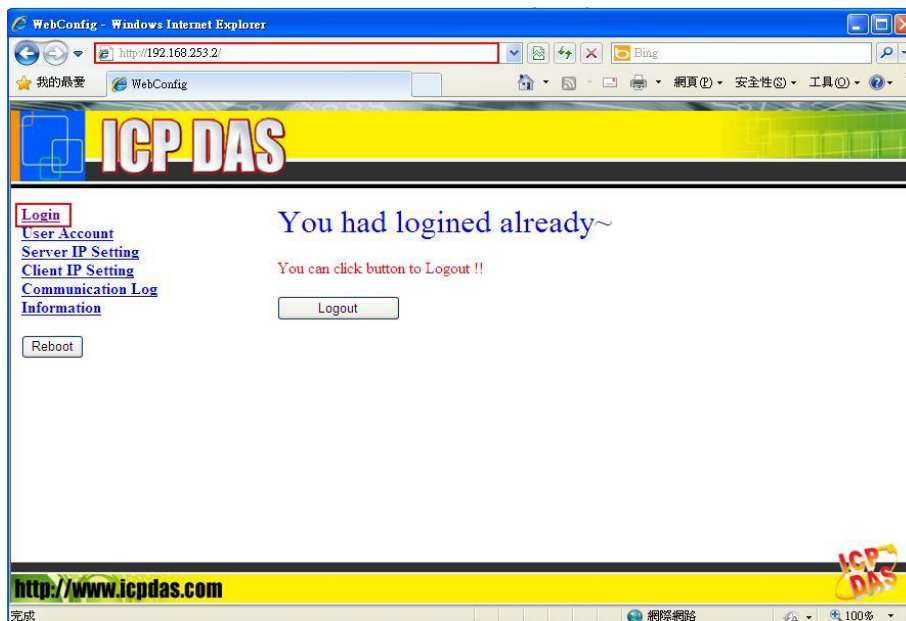
- Open MiniOS7 utility and press “F12” to find IP address of the I-7550E. The default IP address is “192.168.255.1”.



Type	IP/Port	Name	Alias
TCP BroadCast	192.168.11.23	GRP-520	
TCP BroadCast	192.168.27.53	GRP-520	
TCP BroadCast	192.168.11.22	GRP-520	
TCP BroadCast	192.168.27.50	GRP-520	
TCP BroadCast	192.168.15.223	IR-712-MTCP	
TCP BroadCast	192.168.15.224	IR-712-MTCP	
TCP BroadCast	192.168.11.25	ET-7050	
TCP BroadCast	192.168.253.2	I-7550E	I-7550E
TCP BroadCast	192.168.34.34	7186E3	
TCP BroadCast	192.168.255.2	PFN-2060	PFN-2060v1.0
TCP BroadCast	192.168.255.2	7188E2	
TCP BroadCast	192.168.28.250	WP5231	Compact

**Figure 48** Use MiniOS7 utility to find IP address of the I-7550E

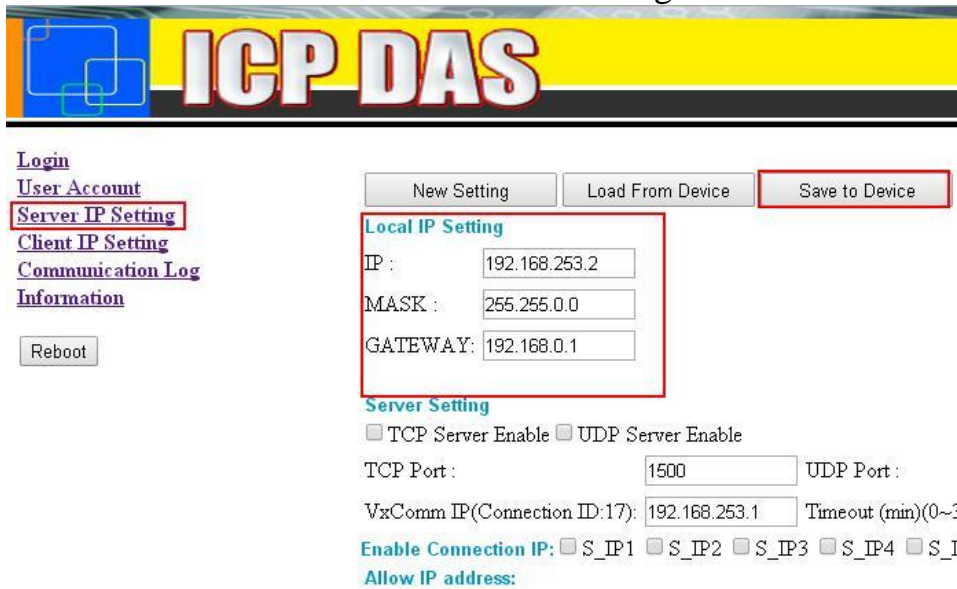
- Open web browser (ex. IE). Enter IP address of the I-7550E in the Address field and press “**Enter**” to connect with I-7550E, and then enter default password (“icpdas”) to login to I-7550E in Login page as shown **Figure 49**.



**Figure 49** Browser the Web of I-7550E and enter the default password to login.

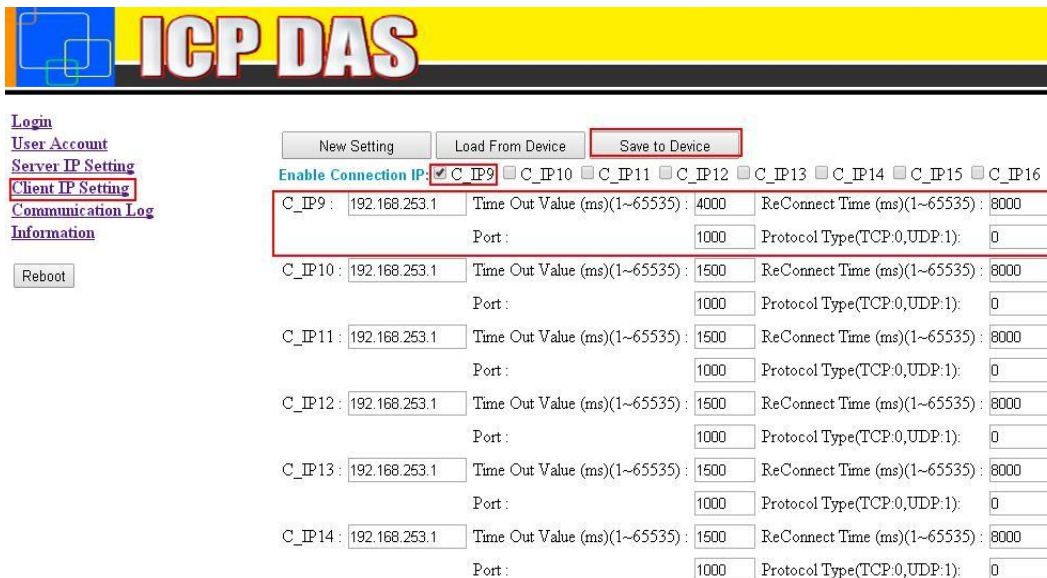
- Click “Server IP Setting” to set the network configuration of the I-7550E (please refer to user manual section 5.3). The network configuration of the I-7550E must have the same domain and different IP with the PC(TCP server Program) (ex: PC’s IP=192.168.253.1, MASK=255.255.0.0;and I-7550E’s IP=192.168.253.2, MASK=255.255.0.0) as shown **Figure50**

- Press “Save to Device” to save settings to EEPROM of I-7550E.



**Figure 50 Set the configuration of Local IP**

- Click “Client IP Setting” to set I-7550E as TCP Client. Set TCP server’s IP(192.168.253.1) in C\_IP9 field, and Time Out value as 4000, ReConnect Time as 8000, Port as 1000, and Protocol Type as 0.
- Check “C\_IP9” in Enable Connection IP field.
- Press “Save to Device” to save settings to EEPROM of I-7550E. And restart the I-7550E.



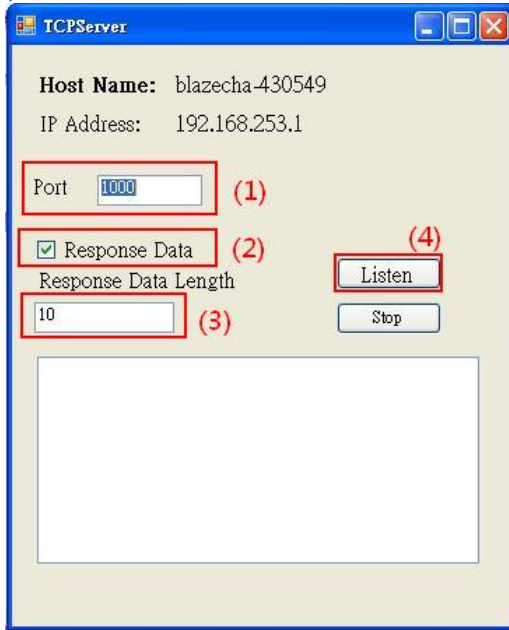
**Figure 51 Set the configuration of TCP Client.**

#### 4.7.1 Receiving data from PROFIBUS Master

- Start the test program “TCPServer” (**Figure 52**) on the PC.  
This program simulates a TCP server device and Users can get it from the ICP

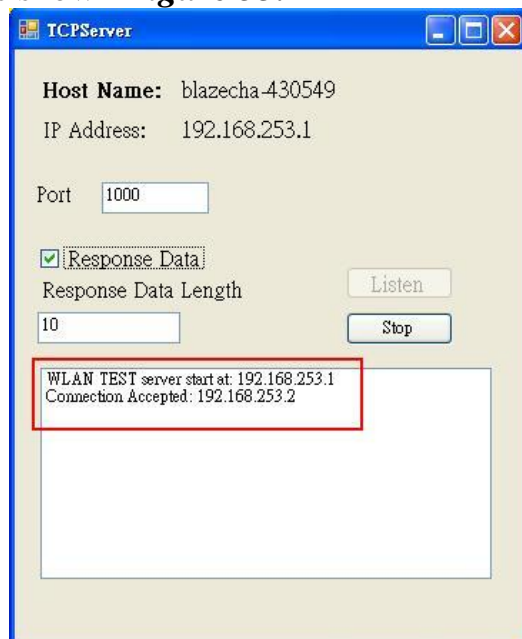
DAS companion CDROM(PATH:“CD: \PROFIBUS\Converter\I-7550E\utilities\TCPServer”).

- (1) Set the port value as 1000.
- (2) Check “Response Data”. TCPServer program will response data when it receives the data from PROFIBUS Master.
- (3) Set the length of response data.
- (4) Press “Listen” to start TCP server service.



**Figure 52 TCPServer Program**

(5)When the I-7550E is in data exchange mode, it will connect to TCPServer as shown **Figure 53**.



**Figure 53 TCPServer Program connect with I-7550E**



--Set the I-7550E in Read/Write mode.

The user need to set the I-7550E in Read/Write mode(Please refer to section 3.3.1). We set Byte 0 of system setting module as 0x01 as shown **Figure 54**

Device	SymName	IEC-Address	Data-Type	Representation	Value
Slave1.Module1.SubModule002	Output001	0	Byte	Hex	01
Slave1.Module1.SubModule002	Output002	1	Byte	Hex	00
Slave1.Module1.SubModule002	Output003	2	Byte	Hex	00
Slave1.Module1.SubModule002	Output004	3	Byte	Hex	00
Slave1.Module1.SubModule002	Output005	4	Byte	Hex	00
Slave1.Module1.SubModule002	Output006	5	Byte	Hex	00
Slave1.Module1.SubModule002	Output007	6	Byte	Hex	00
Slave1.Module1.SubModule002	Output008	7	Byte	Hex	00
Slave1.Module1.SubModule002	Output009	8	Byte	Hex	00
Slave1.Module1.SubModule002	Output010	9	Byte	Hex	00
Slave1.Module1.SubModule002	Output011	10	Byte	Hex	00
Slave1.Module1.SubModule002	Output012	11	Byte	Hex	00
Slave1.Module1.SubModule002	Output013	12	Byte	Hex	00
Slave1.Module1.SubModule002	Output014	13	Byte	Hex	00
Slave1.Module1.SubModule002	Output015	14	Byte	Hex	00
Slave1.Module1.SubModule002	Output016	15	Byte	Hex	00
Slave1.Module1.SubModule002	Output017	16	Byte	Hex	00
Slave1.Module1.SubModule002	Output018	17	Byte	Hex	00
Slave1.Module1.SubModule002	Output019	18	Byte	Hex	00
Slave1.Module1.SubModule002	Output020	19	Byte	Hex	00

**Figure 54** Set Byte 0 of system setting module as 0x01 to let the I-7550E in Read/Write mode.

-- Set the output data area of “System setting module”.

Now we need to set other the necessary value in the output data are of “system setting module” and “Output module” for sending data to TCP Server as shown **Table 25**、**Table 26** and **Figure 55**.

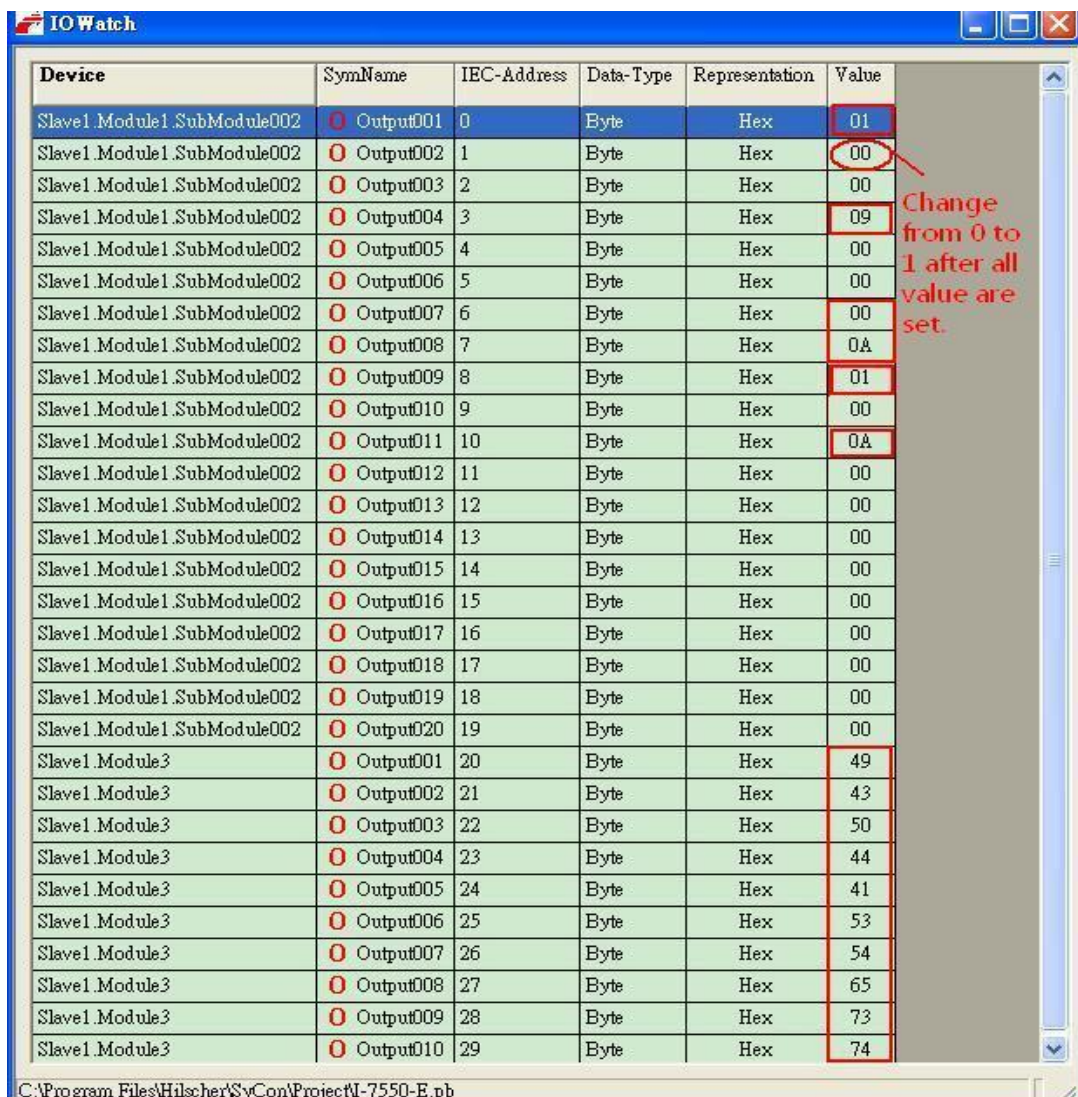
**Table 25** The value of output area of “System setting module”

Module	Byte	Data type	Representation	Value
System setting module	Output 0	Byte	Hex	0x01
	Output 1	Byte	Hex	0x00→ 0x01
	Output 2	Byte	Hex	0x00
	Output 3	Byte	Hex	0x09
	Output 4	Word	Hex	0x00
	Output 6	Word	Hex	0x0A
	Output 8	Byte	Hex	0x01
	Output 9	Byte	Hex	0x00
	Output 10	Byte	Hex	0x0A

**Table 26** The value of “Output module”

Module	Byte	Data type	Representation	Value
--------	------	-----------	----------------	-------

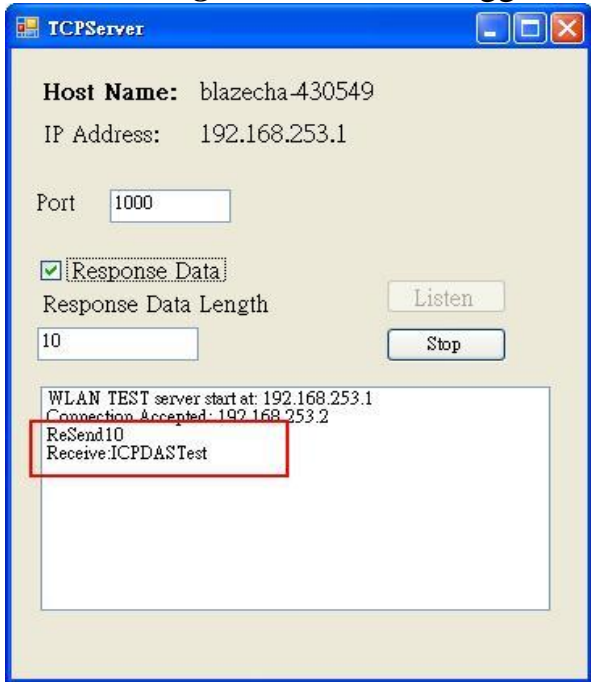
<i>Module</i>	<i>Byte</i>	<i>Data type</i>	<i>Representation</i>	<i>Value</i>
Output module	Output 20	Byte	Hex	0x49
	Output 21	Byte	Hex	0x43
	Output 22	Byte	Hex	0x50
	Output 23	Byte	Hex	0x44
	Output 24	Byte	Hex	0x41
	Output 25	Byte	Hex	0x53
	Output 26	Byte	Hex	0x54
	Output 27	Byte	Hex	0x65
	Output 28	Byte	Hex	0x73
	Output 29	Byte	Hex	0x74



**Figure 55** The value of output data area

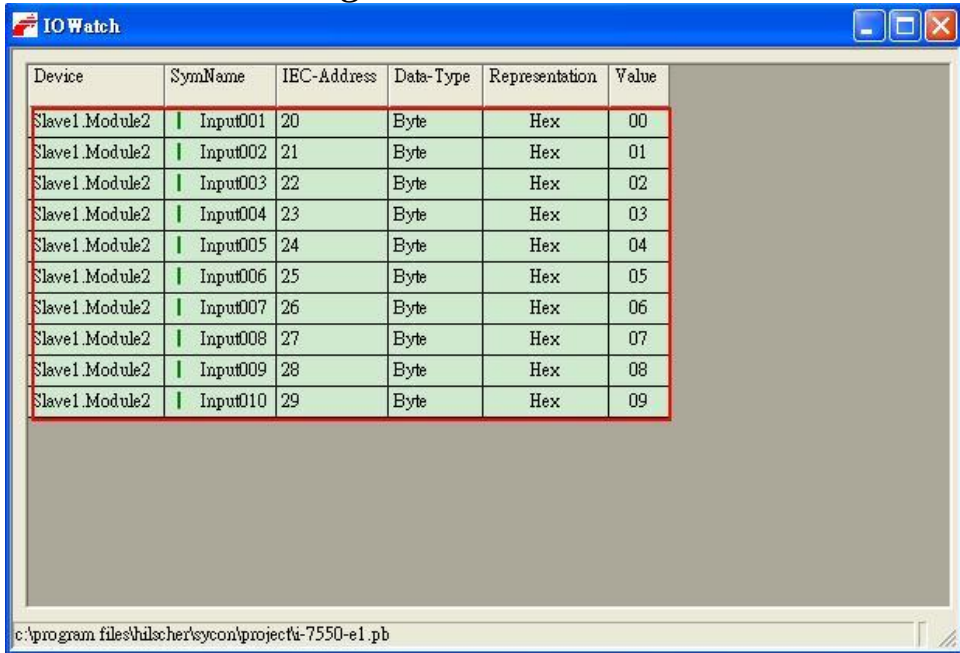
-- Set the Byte 1 of “System setting module” from 0 to 1

After setting all values, set the Byte 1 of “System setting module” from 0 to 1. And it will trigger the I-7550E transfer data to TCPServer. TCPServer will receive data as shown **Figure 56**. About Trigger method, please refer to section 3.3.1.



**Figure 56** TCPServer receives data and response data to PROFIBUS Master

-- PROFIBUS Master receives data from TCPServer.  
 TCPServer will response 10 Bytes data(0x00~0x09) to PROFIBUS Master as shown **Figure 57**.



**Figure 57** PROFIBUS Master receives data from TCPServer

The user also can receive the information of Data in the input data area of

“System setting module”(Please refer to section3.3.2) as shown **Table 27** .

**Table 27** *Receive the data in the input data area of system setting module*

<i>Module</i>	<i>Byte</i>	<i>Data type</i>	<i>Representation</i>	<i>Value</i>
System setting module	Input 0	Byte	Hex	0x01
	Input 1	Word	Hex	0x00
	Input 3	Word	Hex	0x01
	Input 5	Word	Hex	0x00
	Input 7	Word	Hex	0x09
	Input 8	Byte	Hex	0x00
	Input 9	Word	Hex	0x00
	Input 11	Byte	Hex	0x01
	Input 12	Byte	Hex	0x00
	Input 13	Word	Hex	0x0A
	Input 15	Byte	Hex	0x0A

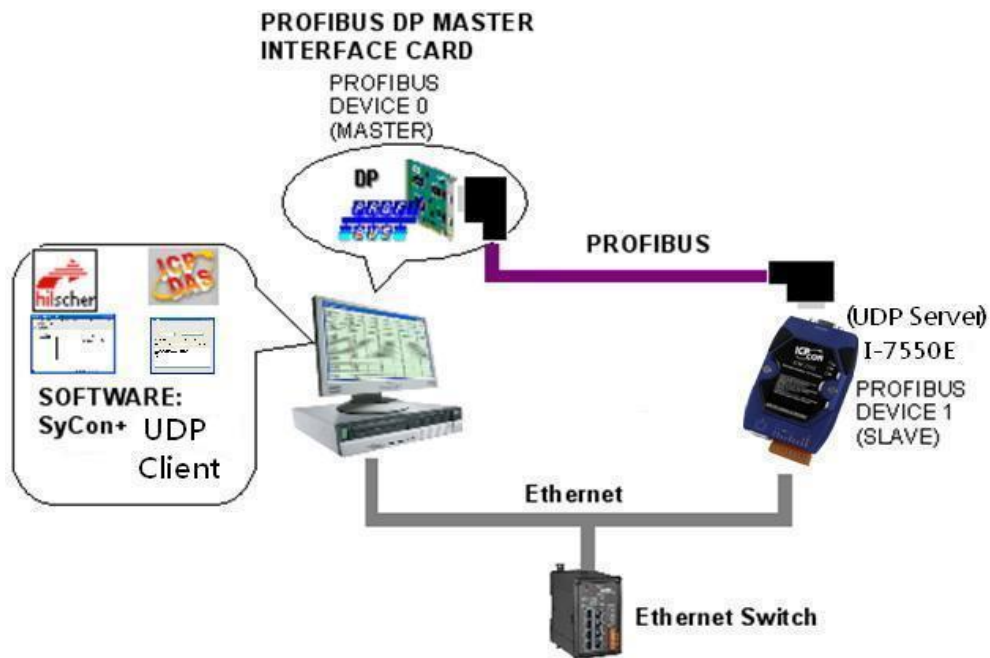
#### **4.8 Data exchange example—I-7550E is as UDP Server**

In this example an UDP Client device simulated by a PC program sends data and receives response message from a PROFIBUS Master via the I-7550E converter.

In the following examples the CIF50-PB PROFIBUS Master card from Hilscher is used. The configuration and communication is done by the program “SyCon” provided by Hilscher.

Step 1: Copy the GSD file and assign the I-7550E a valid station address (Please refer to the section 4.2 GSD file).

Step 2: Connect I-7550E module to Ethernet and the PROFIBUS port to a PROFIBUS Master (**Figure 58**).



**Figure 58** Wiring diagram between PC and I-7550E

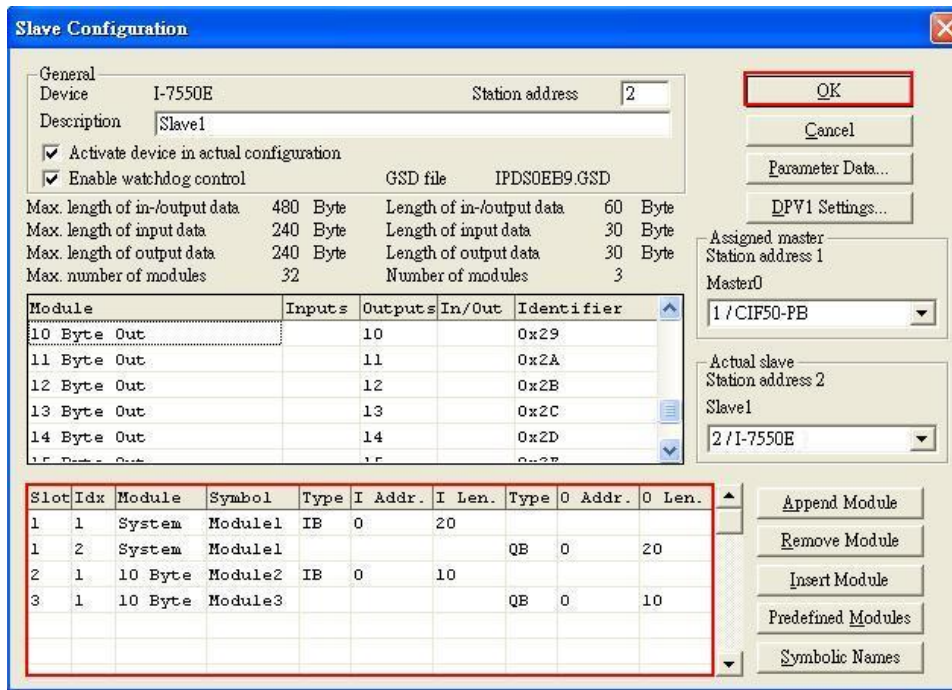
Step 3: Set the parameters of the I-7550E. We just need to configure the I/O length of Input/Output. The user can choose the I/O length depended on their requirement. In this example, we need 10 Bytes for Input/Output as shown **Figure 59** and **Figure 60**

- Select “System setting” module: “System setting” module always has to be selected otherwise no communication can be established between the converter and the Ethernet network.
- Select “10 Byte In” module and “10 Byte Out” module.



**Figure 59** Double click the I-7550E icon to open the “Slave configuration” window



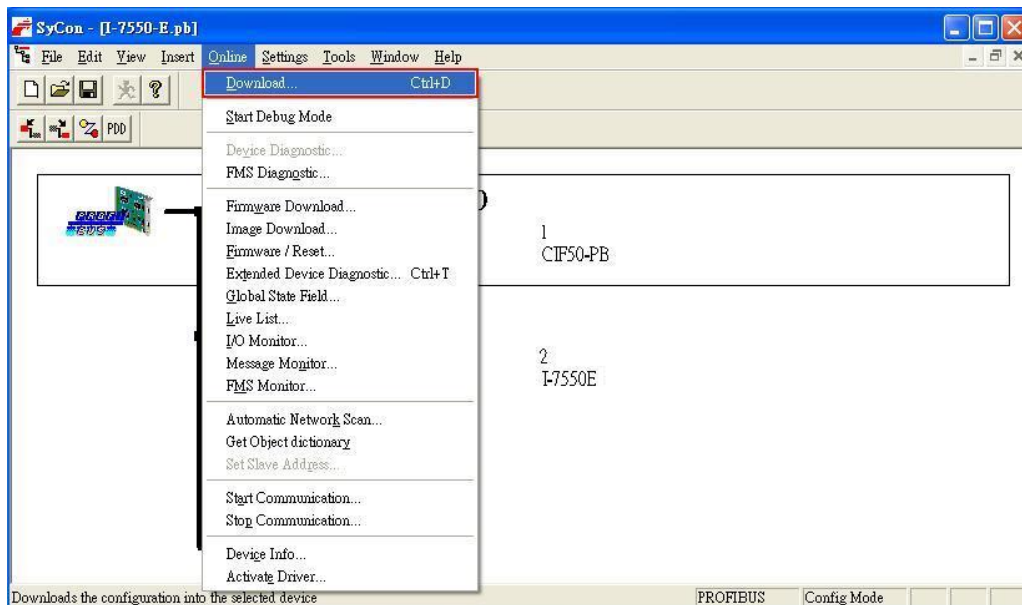


**Figure 60** Select modules for I/O length

Step 4: Close the “Slave Configuration” window by clicking the “OK” button

Step 5: Now the setting done by the configuration tool has to be downloaded to the PROFIBUS Master.

Click on the Master area in the graphic window then  
**Online -> Download...**

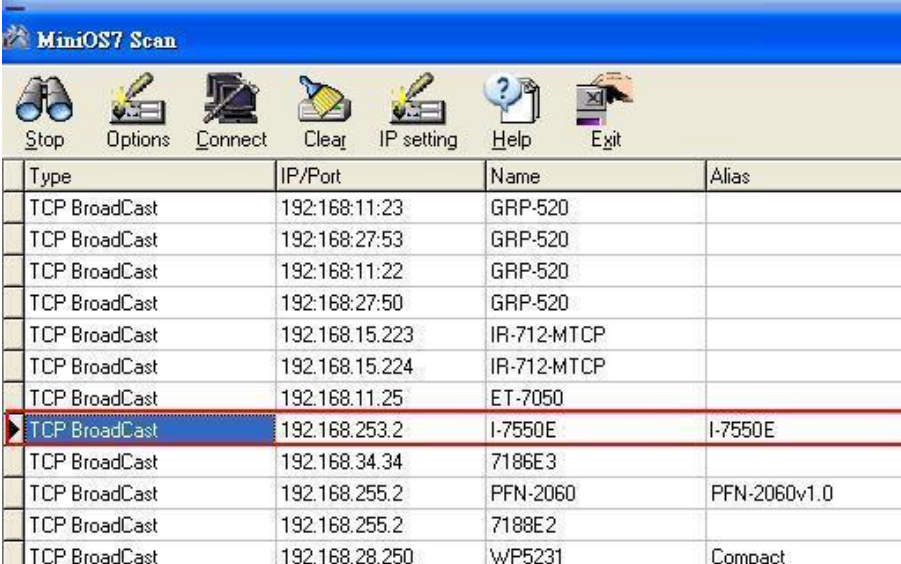


**Figure 61** Click “Online->Download” to download the setting into PROFIBUS Master

Step 6: Set the network of configuration of I-7550E as shown below:

- Open MiniOS7 utility and press “F12” to find IP address of the I-

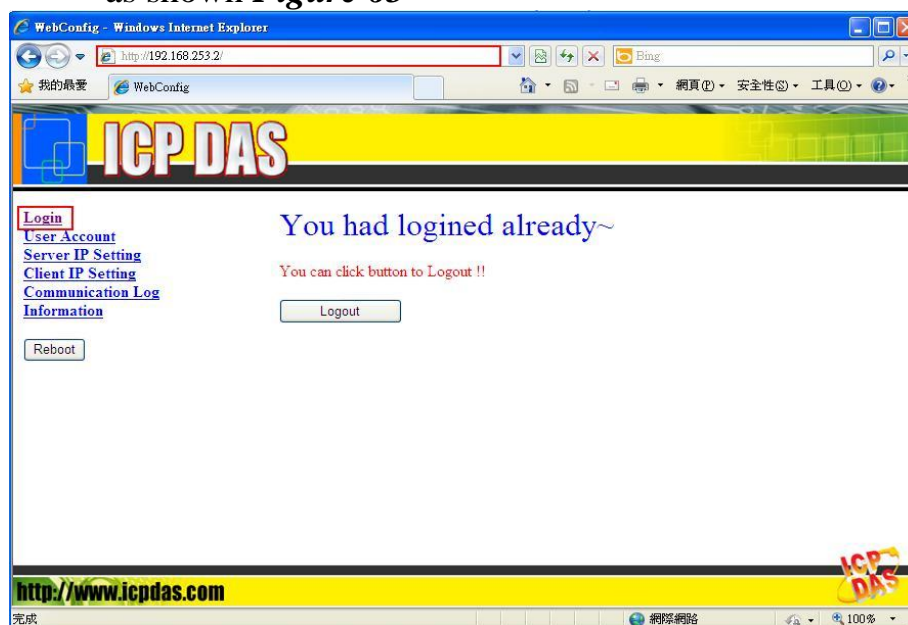
7550E. The default IP address is “192.168.255.1”.



Type	IP/Port	Name	Alias
TCP BroadCast	192.168.11.23	GRP-520	
TCP BroadCast	192.168.27.53	GRP-520	
TCP BroadCast	192.168.11.22	GRP-520	
TCP BroadCast	192.168.27.50	GRP-520	
TCP BroadCast	192.168.15.223	IR-712-MTCP	
TCP BroadCast	192.168.15.224	IR-712-MTCP	
TCP BroadCast	192.168.11.25	ET-7050	
TCP BroadCast	192.168.253.2	I-7550E	I-7550E
TCP BroadCast	192.168.34.34	7186E3	
TCP BroadCast	192.168.255.2	PFN-2060	PFN-2060v1.0
TCP BroadCast	192.168.255.2	7188E2	
TCP BroadCast	192.168.28.250	WP5231	Compact

**Figure 62** Use MiniOS7 utility to find IP address of the I-7550E

- Open web browser (ex. IE). Enter IP address of the I-7550E in the Address field and press “**Enter**” to connect with I-7550E, and then enter default password (“icpdas”) to login to I-7550E in Login page as shown **Figure 63**



**Figure 63** Browse the Web of I-7550E and enter the default password to login.

- Click “Server IP Setting” to set the network configuration of the I-7550E (please refer to user manual section 5.3). The network configuration of the I-7550E must have the same domain and different IP with the PC(UDP client Program) (ex: PC’s IP=192.168.253.1, MASK=255.255.0.0;and I-7550E’s IP=192.168.253.2, MASK=255.255.0.0) as shown **Figure 64**.

- Check “UDP Server Enable” and set UDP Port as 1000.
- In Allow IP address field, set S\_IP1 as 192.168.253.1, “Timeout “ values as 0 and “Protocol Type” as 1. Check “S-IP1” in Enable Connection IP field.

**ICP DAS**

[Login](#)  
[User Account](#)  
[Server IP Setting](#)  
[Client IP Setting](#)  
[Communication Log](#)  
[Information](#)

**Local IP Setting**

IP : 192.168.253.2  
 MASK : 255.255.0.0  
 GATEWAY: 192.168.0.1

**Server Setting**

TCP Server Enable
  **UDP Server Enable**

TCP Port : 1500      UDP Port : 1000

VxComm IP(Connection ID:17): 192.168.253.1      Timeout (min)(0-30) : 0

**Enable Connection IP:**
 S\_IP1
  S\_IP2
  S\_IP3
  S\_IP4
  S\_IP5
  S\_IP6
  S\_IP7
  S\_IP8

**Allow IP address:**

S\_IP1: 192.168.253.1      Timeout (min)(0-30) : 5      Protocol Type(TCP:0,UDP:1): 1

**Figure 64** Set the configuration of UDP server

- Press “Save to Device” to save settings to EEPROM of I-7550E and restart I-7550E. The user can power on I-7550E again or press “Reboot” button to restart the I-7550E.

[Login](#)  
[User Account](#)  
[Server IP Setting](#)  
[Client IP Setting](#)  
[Communication Log](#)  
[Information](#)

**Save IP Setting OK !! Please Reboot Device**

**Local IP Setting**

IP : 192.168.253.2  
 MASK : 255.255.0.0  
 GATEWAY: 192.168.0.1

**Server Setting**

TCP Server Enable
  UDP Server Enable

TCP Port : 1500      UDP Port : 1000

VxComm IP(Connection ID:17): 192.168.253.1      Timeout (min)(0-30) : 0

**Enable Connection IP:**
 S\_IP1
  S\_IP2
  S\_IP3
  S\_IP4
  S\_IP5
  S\_IP6
  S\_IP7
  S\_IP8

**Allow IP address:**

S\_IP1: 192.168.253.1      Timeout (min)(0-30) : 5      Protocol Type(TCP:0,UDP:1): 1

**Figure 65** Press “Save to Device” to save settings to the I-7550E, and restart the I-7550E.

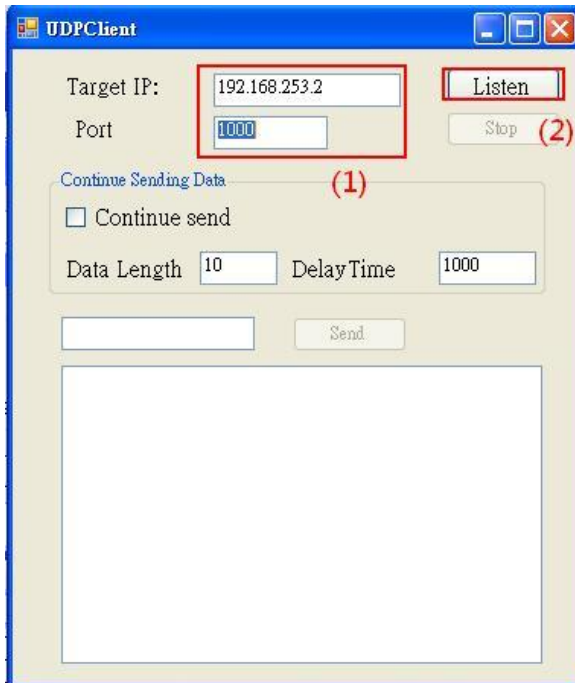


#### 4.8.1 Sending data from a PC(UDP client) to PROFIBUS Master

-- Start the test program “UDPClient” (**Figure 66**) on the PC.

This program simulates a TCP client device and Users can get it from the ICP DAS companion CDROM(PATH:“CD: \PROFIBUS\Converter\I-7550E\utilities\UDPClient”).

- (1) Set the IP address to 192.168.253.2, the port to 1000.
- (2) Press “Listen” to start UDP service.



**Figure 66 UDPClient test program**

--Set the I-7550E in Read/Write mode.

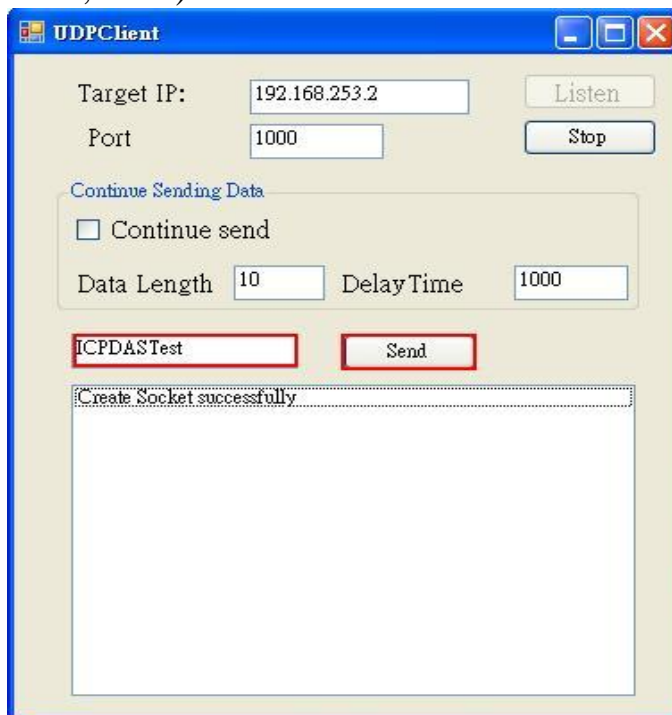
The user need to set the I-7550E in Read/Write mode(Please refer to section 3.3.1). We set Byte 0 of system setting module as 0x01 as shown **Figure 67**.

Device	SymName	IEC-Address	Data-Type	Representation	Value
Slave1.Module1.SubModule002	Output001	0	Byte	Hex	01
Slave1.Module1.SubModule002	Output002	1	Byte	Hex	00
Slave1.Module1.SubModule002	Output003	2	Byte	Hex	00
Slave1.Module1.SubModule002	Output004	3	Byte	Hex	00
Slave1.Module1.SubModule002	Output005	4	Byte	Hex	00
Slave1.Module1.SubModule002	Output006	5	Byte	Hex	00
Slave1.Module1.SubModule002	Output007	6	Byte	Hex	00
Slave1.Module1.SubModule002	Output008	7	Byte	Hex	00
Slave1.Module1.SubModule002	Output009	8	Byte	Hex	00
Slave1.Module1.SubModule002	Output010	9	Byte	Hex	00
Slave1.Module1.SubModule002	Output011	10	Byte	Hex	00
Slave1.Module1.SubModule002	Output012	11	Byte	Hex	00
Slave1.Module1.SubModule002	Output013	12	Byte	Hex	00
Slave1.Module1.SubModule002	Output014	13	Byte	Hex	00
Slave1.Module1.SubModule002	Output015	14	Byte	Hex	00
Slave1.Module1.SubModule002	Output016	15	Byte	Hex	00
Slave1.Module1.SubModule002	Output017	16	Byte	Hex	00
Slave1.Module1.SubModule002	Output018	17	Byte	Hex	00
Slave1.Module1.SubModule002	Output019	18	Byte	Hex	00
Slave1.Module1.SubModule002	Output020	19	Byte	Hex	00

**Figure 67** Set Byte 0 of system setting module as 0x01 to let the I-7550E in Read/Write mode.

--Send Data to the PROFIBUS Master.

The user can input data in the text box of UDPClient and press “Send” button to send data to the PROFIBUS Master as shown **Figure 68** · **Figure 69**. (The Hexadecimal of data is: 0x49, 0x43, 0x50, 0x44, 0x41, 0x53, 0x54, 0x65, 0x73, 0x74)



**Figure 68** Send Data(Data:ICPDASTest)

Device	SymName	IEC-Address	Data-Type	Representation	Value
Slave1.Module2	Input001	20	Byte	Hex	49
Slave1.Module2	Input002	21	Byte	Hex	43
Slave1.Module2	Input003	22	Byte	Hex	50
Slave1.Module2	Input004	23	Byte	Hex	44
Slave1.Module2	Input005	24	Byte	Hex	41
Slave1.Module2	Input006	25	Byte	Hex	53
Slave1.Module2	Input007	26	Byte	Hex	54
Slave1.Module2	Input008	27	Byte	Hex	65
Slave1.Module2	Input009	28	Byte	Hex	73
Slave1.Module2	Input010	29	Byte	Hex	74

**Figure 69** Receive “ICPDASTest” in the input data area

The user also can receive the information of Data in the input data area of “System setting module”(Please refer to section3.3.2) as shown **Table 28**.

**Table 28** Receive the data in the input data area of system setting module

Module	Byte	Data type	Representation	Value
System setting module	Input 0	Byte	Hex	0x01
	Input 1	Word	Hex	0x00
	Input 3	Word	Hex	0x00
	Input 5	Word	Hex	0x00
	Input 7	Word	Hex	0x01
	Input 8	Byte	Hex	0x00
	Input 9	Word	Hex	0x00
	Input 11	Byte	Hex	0x01
	Input 12	Byte	Hex	0x00
	Input 13	Word	Hex	0x0A
	Input 15	Byte	Hex	0x0A

#### 4.8.2 The PROFIBUS Master sends data to UDPclient

Note: If UDP client device never sent data to the I-7550E, the I-7550E is impossible to send (response) data to UDP client device.

-- Set the output data area of “System setting module”.

In section 4.8.1, we have already set Byte 0 of “System setting module” as

0x01. Now we need to set the necessary value in the output data are of “system setting module” and “Output module” for sending data to UDPCClient as shown *Table 29*、*Table 30* and *Figure 70*.

**Table 29** *The value of output area of “System setting module”*

<i>Module</i>	<i>Byte</i>	<i>Data type</i>	<i>Representation</i>	<i>Value</i>
System setting module	Output 0	Byte	Hex	0x01
	Output 1	Byte	Hex	0x00→0x01
	Output 2	Byte	Hex	0x00
	Output 3	Byte	Hex	0x01
	Output 4	Word	Hex	0x00
	Output 6	Word	Hex	0x0A
	Output 8	Byte	Hex	0x01
	Output 9	Byte	Hex	0x00
	Output 10	Byte	Hex	0x0A

**Table 30** *The value of “Output module”*

<i>Module</i>	<i>Byte</i>	<i>Data type</i>	<i>Representation</i>	<i>Value</i>
Output module	Output 20	Byte	Hex	0x49
	Output 21	Byte	Hex	0x43
	Output 22	Byte	Hex	0x50
	Output 23	Byte	Hex	0x44
	Output 24	Byte	Hex	0x41
	Output 25	Byte	Hex	0x53
	Output 26	Byte	Hex	0x54
	Output 27	Byte	Hex	0x65
	Output 28	Byte	Hex	0x73
	Output 29	Byte	Hex	0x74

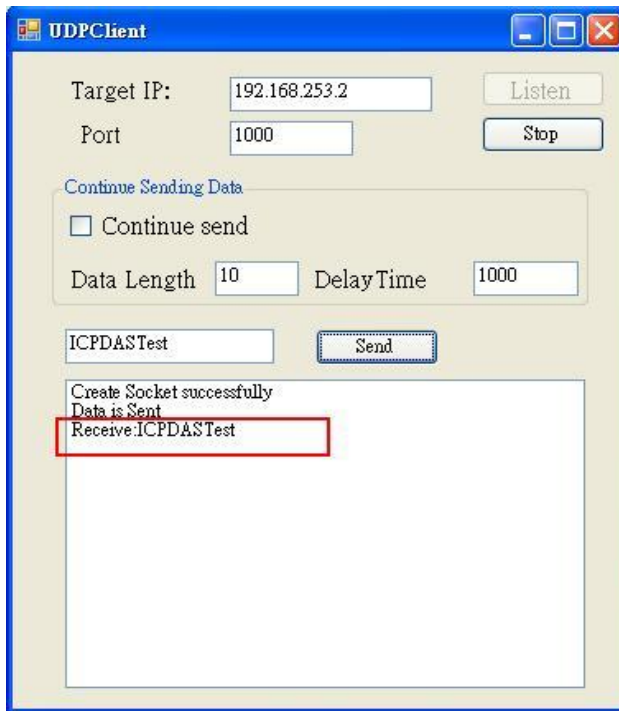
Device	SymName	IEC-Address	Data-Type	Representation	Value
Slave1.Module1.SubModule002	Output001	0	Byte	Hex	01
Slave1.Module1.SubModule002	Output002	1	Byte	Hex	00
Slave1.Module1.SubModule002	Output003	2	Byte	Hex	00
Slave1.Module1.SubModule002	Output004	3	Byte	Hex	01
Slave1.Module1.SubModule002	Output005	4	Byte	Hex	00
Slave1.Module1.SubModule002	Output006	5	Byte	Hex	00
Slave1.Module1.SubModule002	Output007	6	Byte	Hex	00
Slave1.Module1.SubModule002	Output008	7	Byte	Hex	0A
Slave1.Module1.SubModule002	Output009	8	Byte	Hex	01
Slave1.Module1.SubModule002	Output010	9	Byte	Hex	00
Slave1.Module1.SubModule002	Output011	10	Byte	Hex	0A
Slave1.Module1.SubModule002	Output012	11	Byte	Hex	00
Slave1.Module1.SubModule002	Output013	12	Byte	Hex	00
Slave1.Module1.SubModule002	Output014	13	Byte	Hex	00
Slave1.Module1.SubModule002	Output015	14	Byte	Hex	00
Slave1.Module1.SubModule002	Output016	15	Byte	Hex	00
Slave1.Module1.SubModule002	Output017	16	Byte	Hex	00
Slave1.Module1.SubModule002	Output018	17	Byte	Hex	00
Slave1.Module1.SubModule002	Output019	18	Byte	Hex	00
Slave1.Module1.SubModule002	Output020	19	Byte	Hex	00
Slave1.Module3	Output001	20	Byte	Hex	49
Slave1.Module3	Output002	21	Byte	Hex	43
Slave1.Module3	Output003	22	Byte	Hex	50
Slave1.Module3	Output004	23	Byte	Hex	44
Slave1.Module3	Output005	24	Byte	Hex	41
Slave1.Module3	Output006	25	Byte	Hex	53
Slave1.Module3	Output007	26	Byte	Hex	54
Slave1.Module3	Output008	27	Byte	Hex	65
Slave1.Module3	Output009	28	Byte	Hex	73
Slave1.Module3	Output010	29	Byte	Hex	74

Change from 0 to 1 after all value are set.

C:\Program Files\Hilscher\SyCon\Project\I-7550-E.pb

**Figure 70** The value of output data area

- Set the Byte 1 of “System setting module” from 0 to 1  
 After setting all values, set the Byte 1 of “System setting module” from 0 to 1. And it will trigger the I-7550E transfer data to UDPClient. UDPClient will receive data as shown **Figure 71**. About Trigger method, please refer to section 3.3.1.



**Figure 71** The value of output data area

#### 4.9 Data exchange example—I-7550E is as UDP Client

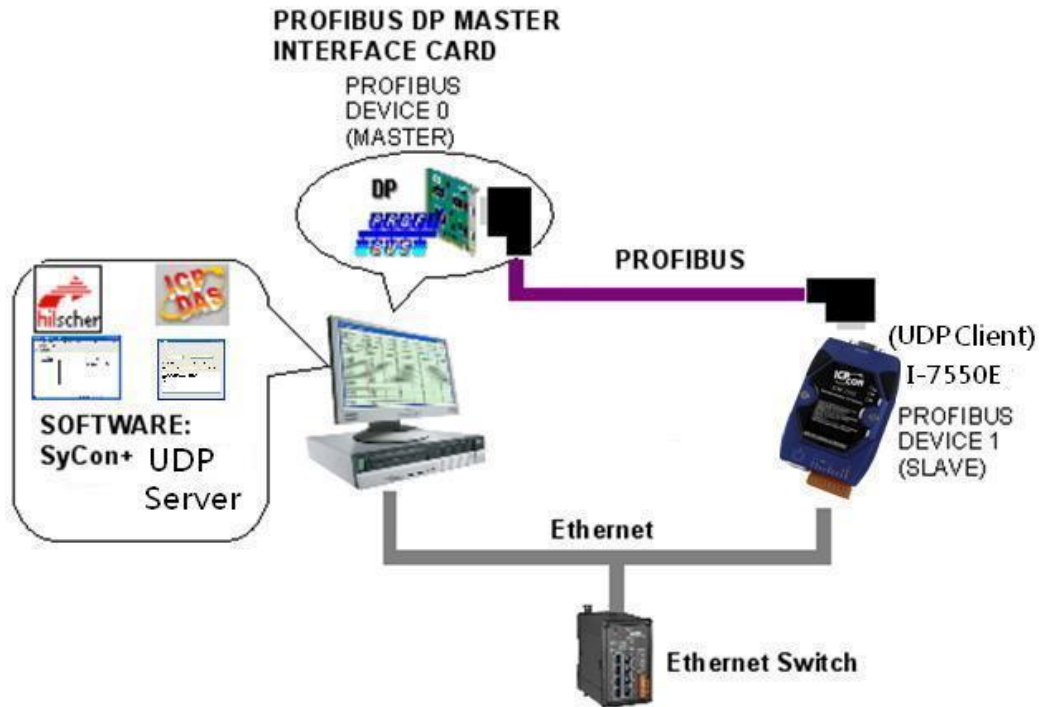
In this example an UDP server device simulated by a PC program that receives data from a PROFIBUS Master and response data to it.

In the following examples the CIF50-PB PROFIBUS Master card from Hilscher is used. The configuration and communication is done by the program “SyCon” provided by Hilscher.

Step 1: Copy the GSD file and assign the I-7550E a valid station address (Please refer to the section 4.2 GSD file).

Step 2: Connect I-7550E and PC by **Figure 72**.





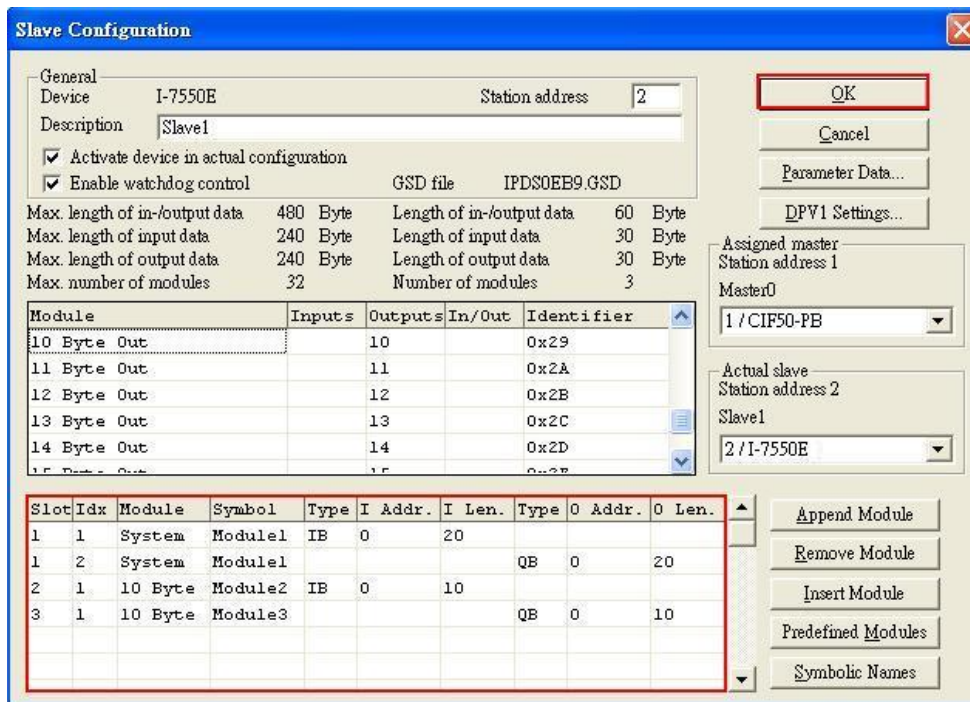
**Figure 72** Wiring diagram between PC and I-7550E

Step 3: Set the parameters of the I-7550E. We just need to configure the I/O length of Input/Output. The user can choose the I/O length depended on their requirement. In this example, we need 10 Bytes for Input/Output as shown **Figure 73** and **Figure 74**

- Select “System setting” module: “System setting” module always has to be selected otherwise no communication can be established between the converter and the Ethernet network.
- Select “10 Byte In” module and “10 Byte Out” module.



**Figure 73** Double click the I-7550E icon to open the “Slave configuration” window

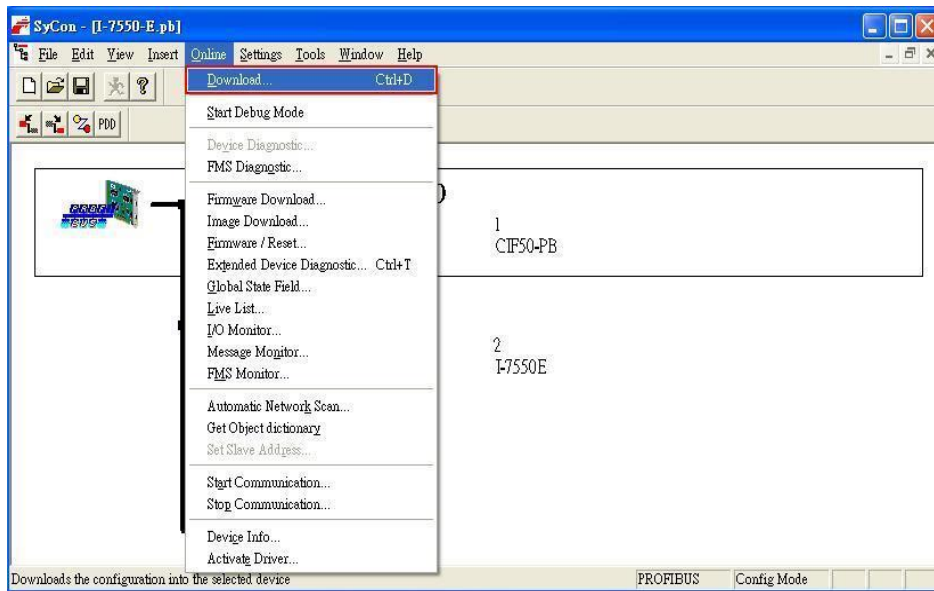


**Figure 74** Click “Parameter Data...” button to open the “Parameter Data” window

Step 4: Close the “Slave Configuration” window by clicking the “OK” button

Step 5: Now the setting done by the configuration tool has to be downloaded to the PROFIBUS Master. Click on the Master area in the graphic window then **Online -> Download...**





**Figure 75** Click “Online->Download” to download the setting into PROFIBUS Master

Step 6: Set the network of configuration of I-7550E as shown below:

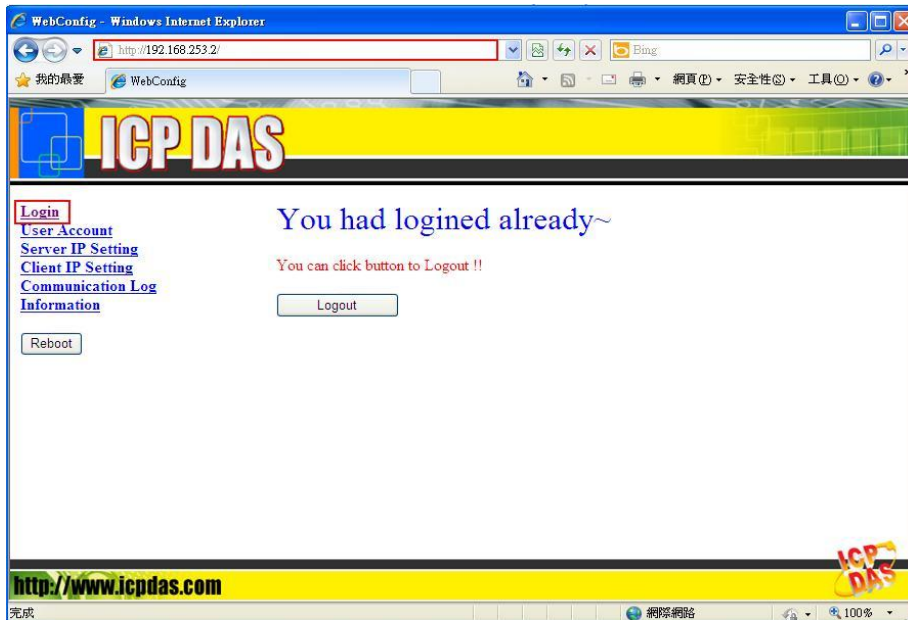
- Open MiniOS7 utility and press “F12” to find IP address of the I-7550E. The default IP address is “192.168.255.1”.

The screenshot shows the MiniOS7 Scan utility interface. It features a toolbar with icons for Stop, Options, Connect, Clear, IP setting, Help, and Exit. Below the toolbar is a table listing network devices. The entry for 'I-7550E' is highlighted with a red box.

Type	IP/Port	Name	Alias
TCP BroadCast	192.168.11.23	GRP-520	
TCP BroadCast	192.168.27.53	GRP-520	
TCP BroadCast	192.168.11.22	GRP-520	
TCP BroadCast	192.168.27.50	GRP-520	
TCP BroadCast	192.168.15.223	IR-712-MTCP	
TCP BroadCast	192.168.15.224	IR-712-MTCP	
TCP BroadCast	192.168.11.25	ET-7050	
TCP BroadCast	192.168.253.2	I-7550E	I-7550E
TCP BroadCast	192.168.34.34	7186E3	
TCP BroadCast	192.168.255.2	PFN-2060	PFN-2060v1.0
TCP BroadCast	192.168.255.2	7188E2	
TCP BroadCast	192.168.28.250	WP5231	Compact

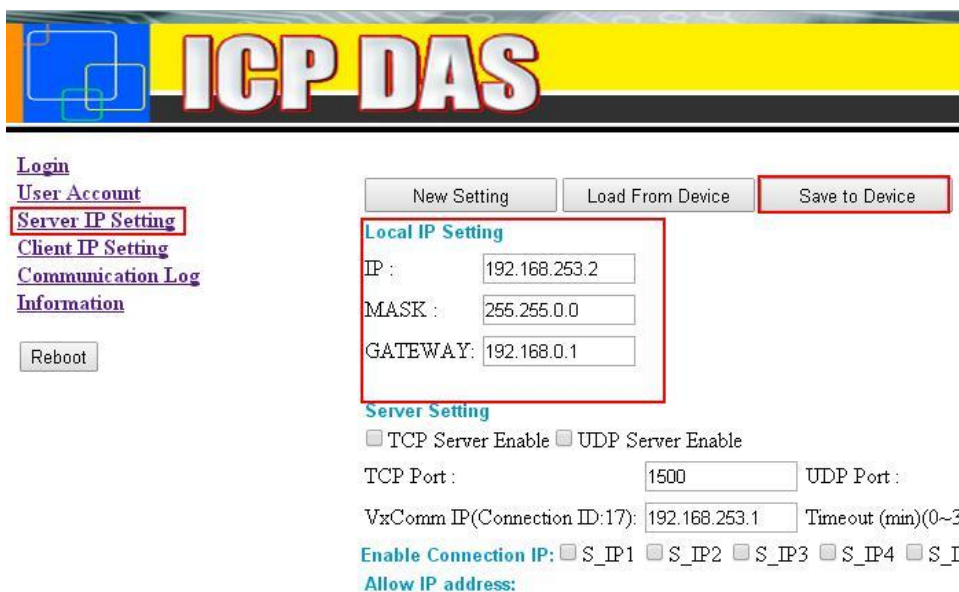
**Figure 76** Use MiniOS7 utility to find IP address of the I-7550E

- Open web browser (ex. IE). Enter IP address of the I-7550E in the Address field and press “Enter” to connect with I-7550E, and then enter default password (“icpdas”) to login to I-7550E in Login page as shown **Figure 77**.



**Figure 77** Browser the Web of I-7550E and enter the default password to login.

- Click “Server IP Setting” to set the network configuration of the I-7550E (please refer to user manual section 5.3). The network configuration of the I-7550E must have the same domain and different IP with the PC(UDP server Program) (ex: PC’s IP=192.168.253.1, MASK=255.255.0.0;and I-7550E’s IP=192.168.253.2, MASK=255.255.0.0) as shown **Figure 78**
- Press “Save to Device” to save settings to EEPROM of I-7550E.



**Figure 78** Set the configuration of Local IP

- Click “Client IP Setting” to set I-7550E as UDP Client. Set UDP

server's IP(192.168.253.1) in C\_IP9 field, and Protocol Type as 1. Please keep others value in default.

- Check "C\_IP9" in Enable Connection IP field.
- Press "Save to Device" to save settings to EEPROM of I-7550E. And restart the I-7550E.



**Figure 79 Set the configuration of TCP Client.**

#### 4.9.1 Receiving data from PROFIBUS Master

- Start the test program "UDPServer" (**Figure 80**) on the PC.  
 This program simulates a UDP server device and Users can get it from the ICP DAS companion CDROM(PATH:"CD: \PROFIBUS\Converter\I-7550E\utilities\UDPServer").
  - (1) Set the port value as 1000.
  - (2) Check "Echo Data". UDPServer program will response the data that it receives from UDP Client.
  - (3) Press "Listen" to start UDP Client service.



**Figure 80 TCPServer Program**

--Set the I-7550E in Read/Write mode.

The user need to set the I-7550E in Read/Write mode(Please refer to section 3.3.1). We set Byte 0 of system setting module as 0x01 as shown **Figure 81**.

Device	SymName	IEC-Address	Data-Type	Representation	Value
Slave1.Module1.SubModule002	Output001	0	Byte	Hex	01
Slave1.Module1.SubModule002	Output002	1	Byte	Hex	00
Slave1.Module1.SubModule002	Output003	2	Byte	Hex	00
Slave1.Module1.SubModule002	Output004	3	Byte	Hex	00
Slave1.Module1.SubModule002	Output005	4	Byte	Hex	00
Slave1.Module1.SubModule002	Output006	5	Byte	Hex	00
Slave1.Module1.SubModule002	Output007	6	Byte	Hex	00
Slave1.Module1.SubModule002	Output008	7	Byte	Hex	00
Slave1.Module1.SubModule002	Output009	8	Byte	Hex	00
Slave1.Module1.SubModule002	Output010	9	Byte	Hex	00
Slave1.Module1.SubModule002	Output011	10	Byte	Hex	00
Slave1.Module1.SubModule002	Output012	11	Byte	Hex	00
Slave1.Module1.SubModule002	Output013	12	Byte	Hex	00
Slave1.Module1.SubModule002	Output014	13	Byte	Hex	00
Slave1.Module1.SubModule002	Output015	14	Byte	Hex	00
Slave1.Module1.SubModule002	Output016	15	Byte	Hex	00
Slave1.Module1.SubModule002	Output017	16	Byte	Hex	00
Slave1.Module1.SubModule002	Output018	17	Byte	Hex	00
Slave1.Module1.SubModule002	Output019	18	Byte	Hex	00
Slave1.Module1.SubModule002	Output020	19	Byte	Hex	00

**Figure 81 Set Byte 0 of system setting module as 0x01to let the I-7550E in Read/Write mode.**

-- Set the output data area of “System setting module”.

Now we need to set other the necessary value in the output data are of “system setting module” and “Output module” for sending data to UDPServer as shown **Table 31**、**Table 32** and **Figure 82**.

**Table 31 The value of output area of “System setting module”**

<i>Module</i>	<i>Byte</i>	<i>Data type</i>	<i>Representation</i>	<i>Value</i>
System setting module	Output 0	Byte	Hex	0x01
	Output 1	Byte	Hex	0x00→ 0x01
	Output 2	Byte	Hex	0x00
	Output 3	Byte	Hex	0x09
	Output 4	Word	Hex	0x00
	Output 6	Word	Hex	0x0A
	Output 8	Byte	Hex	0x01
	Output 9	Byte	Hex	0x00
	Output 10	Byte	Hex	0x0A

**Table 32 The value of “Output module”**

<i>Module</i>	<i>Byte</i>	<i>Data type</i>	<i>Representation</i>	<i>Value</i>
Output module	Output 20	Byte	Hex	0x49
	Output 21	Byte	Hex	0x43
	Output 22	Byte	Hex	0x50
	Output 23	Byte	Hex	0x44
	Output 24	Byte	Hex	0x41
	Output 25	Byte	Hex	0x53
	Output 26	Byte	Hex	0x54
	Output 27	Byte	Hex	0x65
	Output 28	Byte	Hex	0x73
	Output 29	Byte	Hex	0x74



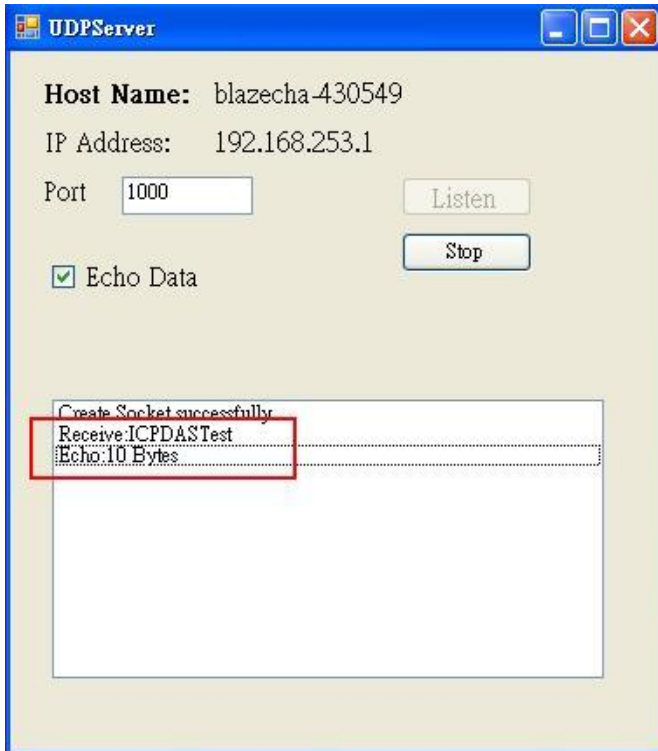
Device	SymName	IEC-Address	Data-Type	Representation	Value
Slave1.Module1.SubModule002	Output001	0	Byte	Hex	01
Slave1.Module1.SubModule002	Output002	1	Byte	Hex	00
Slave1.Module1.SubModule002	Output003	2	Byte	Hex	00
Slave1.Module1.SubModule002	Output004	3	Byte	Hex	09
Slave1.Module1.SubModule002	Output005	4	Byte	Hex	00
Slave1.Module1.SubModule002	Output006	5	Byte	Hex	00
Slave1.Module1.SubModule002	Output007	6	Byte	Hex	00
Slave1.Module1.SubModule002	Output008	7	Byte	Hex	0A
Slave1.Module1.SubModule002	Output009	8	Byte	Hex	01
Slave1.Module1.SubModule002	Output010	9	Byte	Hex	00
Slave1.Module1.SubModule002	Output011	10	Byte	Hex	0A
Slave1.Module1.SubModule002	Output012	11	Byte	Hex	00
Slave1.Module1.SubModule002	Output013	12	Byte	Hex	00
Slave1.Module1.SubModule002	Output014	13	Byte	Hex	00
Slave1.Module1.SubModule002	Output015	14	Byte	Hex	00
Slave1.Module1.SubModule002	Output016	15	Byte	Hex	00
Slave1.Module1.SubModule002	Output017	16	Byte	Hex	00
Slave1.Module1.SubModule002	Output018	17	Byte	Hex	00
Slave1.Module1.SubModule002	Output019	18	Byte	Hex	00
Slave1.Module1.SubModule002	Output020	19	Byte	Hex	00
Slave1.Module3	Output001	20	Byte	Hex	49
Slave1.Module3	Output002	21	Byte	Hex	43
Slave1.Module3	Output003	22	Byte	Hex	50
Slave1.Module3	Output004	23	Byte	Hex	44
Slave1.Module3	Output005	24	Byte	Hex	41
Slave1.Module3	Output006	25	Byte	Hex	53
Slave1.Module3	Output007	26	Byte	Hex	54
Slave1.Module3	Output008	27	Byte	Hex	65
Slave1.Module3	Output009	28	Byte	Hex	73
Slave1.Module3	Output010	29	Byte	Hex	74

Change from 0 to 1 after all value are set.

C:\Program Files\Hilscher\SyCon\Project\I-7550-E.pb

**Figure 82** The value of output data area

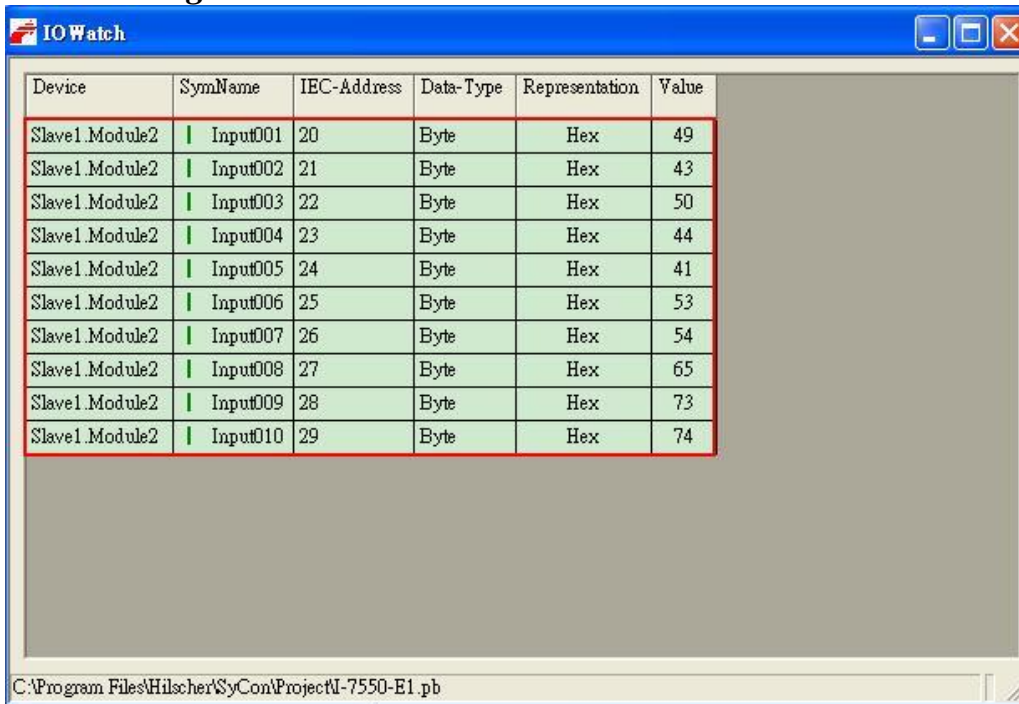
- Set the Byte 1 of “System setting module” from 0 to 1  
 After setting all values, set the Byte 1 of “System setting module” from 0 to 1. And it will trigger the I-7550E transfer data to UDPServer. UDPServer will receive data as shown **Figure 83**. About Trigger method, please refer to section 3.3.1.



**Figure 83 UDPServer receives data and response data to PROFIBUS Master**

-- PROFIBUS Master receives echo data from UDPServer.

UDPServer will response 10 Bytes data("ICPDASTest) to PROFIBUS Master as shown **Figure 84**.



**Figure 84 PROFIBUS Master receives data from TCPServer**



The user also can receive the information of Data in the input data area of “System setting module”(Please refer to section3.3.2) as shown **Table 33** .

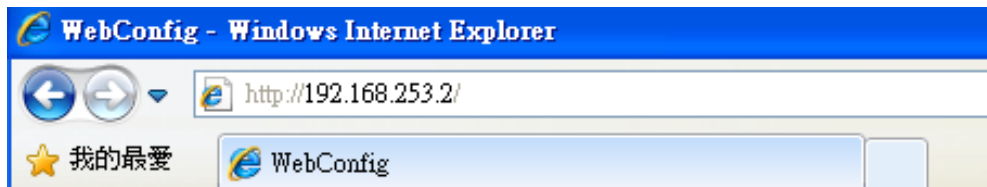
**Table 33** *Receive the data in the input data area of system setting module*

<i>Module</i>	<i>Byte</i>	<i>Data type</i>	<i>Representation</i>	<i>Value</i>
System setting module	Input 0	Byte	Hex	0x01
	Input 1	Word	Hex	0x00
	Input 3	Word	Hex	0x01
	Input 5	Word	Hex	0x00
	Input 7	Word	Hex	0x09
	Input 8	Byte	Hex	0x00
	Input 9	Word	Hex	0x00
	Input 11	Byte	Hex	0x01
	Input 12	Byte	Hex	0x00
	Input 13	Word	Hex	0x0A
	Input 15	Byte	Hex	0x0A

## 5. Configuration with Web Browser

### 5.1 Connecting to Web Server

Open web browser (ex. IE) and enter the IP address of the I-7550E module in the Address field and press “**Enter**” to connect to I-7550E module, as shown in *Figure 85*

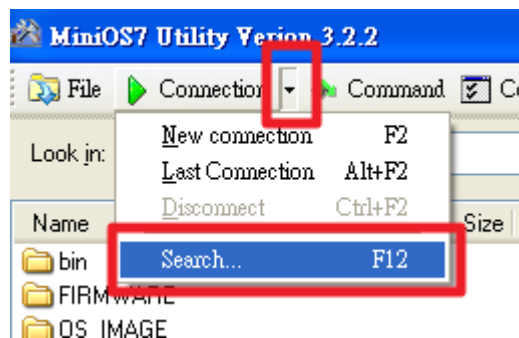


*Figure 85 Connecting to Web Server*

User can do the following steps to find the IP address of I-7550E:

Step 1: Open MiniOS7 Utility

- (1) The utility is on the web site in the following directory:  
[http://ftp.icpdas.com/pub/cd/8000cd/napdos/minios7/utility/minios7\\_utility/](http://ftp.icpdas.com/pub/cd/8000cd/napdos/minios7/utility/minios7_utility/)
- (2) Choose “Connection→Search” or “F12”, as shown in *Figure 86*.



*Figure 86 Search IP*

Step 2: User can find the IP address of I-7550E, as shown in *Figure 87*

Type	IP/Port	Name	Alias
TCP BroadCast	192.168.27.52	GRP-520	
TCP BroadCast	192.168.27.53	GRP-520	
TCP BroadCast	192.168.1.69	GRP-520	
TCP BroadCast	192.168.253.2	I-7550E	I-7550E

**Figure 87 IP address**

**Note:**

- The user can turn the switch on the back of the I-7550E to setting mode (Please refer to section 2.6), and then the IP address of I-7550E will become default value temporarily. The default IP address is 192.168.255.1

## 5.2 Web Configuration—Function menu



**Figure 88 Connecting to Web Server**

The left side is the function menu and the other is the setup page in the first page as shown **Figure 88**.

Function menu:

- Login
- User Account
- Server IP Setting
- Client IP Setting
- Communication Log
- Information

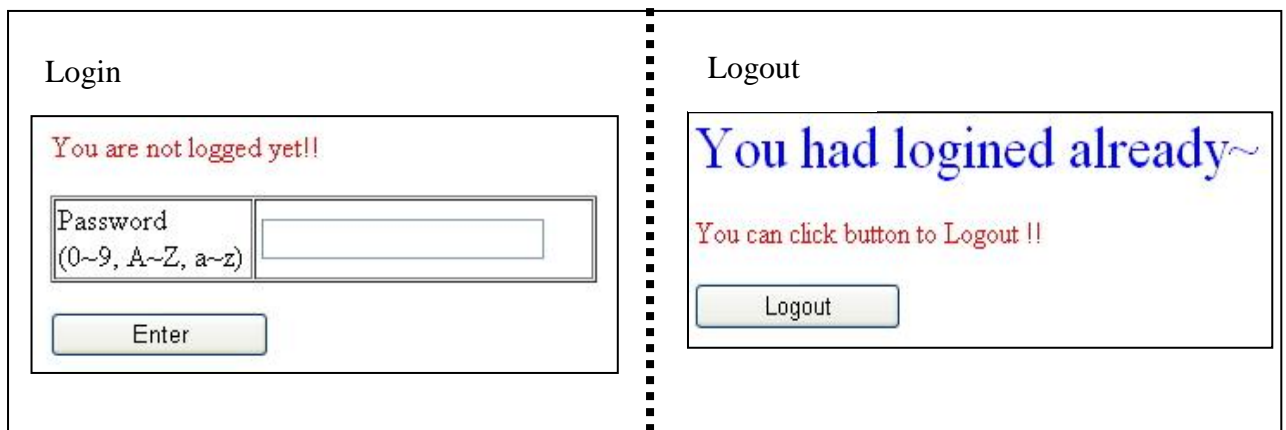
Reboot

The “Reboot” button provides the user to restart the I-7550E when user login successfully.

### 5.3 Web Configuration—Setup page

#### A. Login

The user login and logout interface, as shown in *Figure 89*



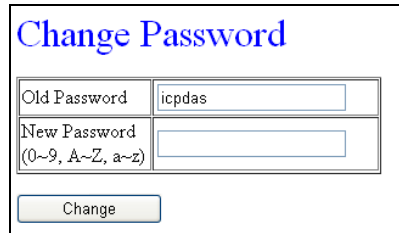
**Figure 89** Login

**Note:**

- The user can turn the switch on the back of the I-7550E to setting mode (Please refer to section 2.6) , and then user can login by using the default password of the I-7550E.
- The default password of the I-7550E is “icpdas”
- The idle time of web server is 5 minutes. If web server is idle more than 5 minutes, web server will logout automatically.

## B. User Account

The user can change password in this page, as shown in **Figure 90**. If the user forgets the password, the I-7550E provides the method that helps the user to login by using default password and IP (Please refer to section 2.6).



Change Password	
Old Password	<input type="text" value="icpdas"/>
New Password (0~9, A~Z, a~z)	<input type="text"/>
<input type="button" value="Change"/>	

**Figure 90** User Account

## C. Server IP Setting

The user can set Server IP setting in this page, as shown in **Figure 91**, if Server IP setting is ok, user needs to restart I-7550E to let new settings effective.

If there is any error message when the user press “Save to Device”, the I-7550E won’t save any data. That means the user needs to set correct value in all field.

The user can press “Load From Device” to check if the settings are set correctly.

- (1) New Setting : Open a new IP setting
- (2) Load From Device : Load the IP setting from I-7550E
- (3) Save to Device : Save the IP setting to EEPROM of I-7550E
- (4) Local IP Setting : The user can set local IP setting of I-7550E in this part.
- (5) TCP/UDP Server Enable : Enable TCP/UDP server.
- (6) TCP/UDP Port : The user can set port value for TCP/UDP server.
- (7) VxComm IP: The I-7550E supports VxComm Port, the user need to set which IP address will map to VxComm. If the I-7550E doesn’t receive any data during this time, the I-7550E will close this connection. When this value set as zero, the I-7550E won’t close this connection.
- (8) Enable Connection IP : When TCP/UDP server is enabled, it allows total maximum 8 connections, the user can set the numbers of allowing IPs.  
For TCP server, if any IP that is not allowed try to connect to I-7550E, it will be denied; For UDP server, the data will be ignored.
- (9) Allow IP Setting : The user can set IP address, time out value and TCP/UDP protocol in this part. When the I-7550E acts as a TCP/UDP Server and “Enable Connection IP” is enabled, these settings are effective.

Time out value: If the I-7550E doesn't receive any data during this time, the I-7550E will close this connection. When this value set as zero, the I-7550E won't close this connection.

Protocol Type: Set this connection as TCP/UDP protocol

(1) New Setting    Load From Device (2)    Save to Device (3)

**Local IP Setting (4)**

IP : 192.168.253.2  
 MASK : 255.255.0.0  
 GATEWAY: 192.168.0.1

**Server Setting (5)**

TCP Server Enable     UDP Server Enable

TCP Port : 1500    UDP Port : 1500 (6)

(7) VxComm IP(Connection ID:17): 0.0.0.0    Timeout (min)(0~30) : 0

(8) Enable Connection IP:  S\_IP1     S\_IP2     S\_IP3     S\_IP4     S\_IP5     S\_IP6     S\_IP7     S\_IP8

**Allow IP address: (9)**

S_IP	IP	Timeout (min)(0~30)	Protocol Type(TCP:0,UDP:1)
S_IP1:	0.0.0.0	0	0
S_IP2:	0.0.0.0	0	0
S_IP3:	0.0.0.0	0	0
S_IP4:	0.0.0.0	0	0
S_IP5:	0.0.0.0	0	0
S_IP6:	0.0.0.0	0	0
S_IP7:	0.0.0.0	0	0
S_IP8:	0.0.0.0	0	0

**Figure 91 Server IP Setting**

#### D. Client IP Setting

The user can set client IP setting when I-7550E as TCP/UDP client in this page, as shown in **Figure 92**. If Client IP setting is ok, user needs to restart I-7550E to let new settings effective.

If there is any error message when the user press “Save to Device”, the I-7550E won't save any data. That means the user needs to set all correct value in all field.

The user can press “Load From Device” to check if the settings are set correctly.

- (1) New Setting : Open a new Client IP setting
- (2) Load From Device : Load the IP setting from I-7550E
- (3) Save to Device : Save the IP setting to EEPROM of I-7550E

- (4) **Enable Connection IP** : When the user enable connection IP, I-7550E will try to connect to this IP during PROFIBUS is in Data exchange mode.  
**Time out Value**: the time that I-7550E tries to connect to TCP server.  
**ReConnect Time**: I-7550E will reconnect to TCP server if the connection is fail.  
 These two settings are only effective when the connection type is TCP.

The screenshot shows a configuration window with the following elements:

- Buttons: (1) New Setting, Load From Device (2), Save to Device (3)
- Enable Connection IP:  C\_IP9  C\_IP10  C\_IP11  C\_IP12  C\_IP13  C\_IP14  C\_IP15  C\_IP16 (4)
- Table of settings for C\_IP9 through C\_IP16:

Client IP	IP Address	Time Out Value (ms)	ReConnect Time (ms)	Port	Protocol Type
C_IP9	192.168.253.1	4000	8000	1000	0
C_IP10	192.168.253.1	4000	8000	1001	1
C_IP11	192.168.253.1	4000	8000	1002	1
C_IP12	192.168.253.1	1500	8000	1003	1
C_IP13	192.168.253.1	1500	8000	1004	1
C_IP14	192.168.253.1	1500	8000	1005	1
C_IP15	192.168.253.1	1500	8000	1006	1
C_IP16	192.168.253.1	1500	8000	1007	1

**Figure 92 Client IP Setting**

## E. Communication Log

The user can monitor communication between I-7550E and Ethernet devices in this page, it contains number of message、In or Out、Timestamp and maximum 20 Bytes of Data, as shown in **Figure 93**.



## Communication Log

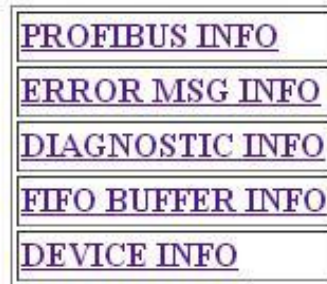
[No]	[In/Out]	[ID]	[Time (ms)]	[Frame]
[001]	Out	[05]	[0000000000]	30 31 32 33 34
[002]	In	[02]	[0000020280]	41 42 43 44 45
[003]	In	[02]	[0000046905]	41 42 43 44 45 46 47 48 49 4A 4B
[004]	In	[02]	[0000306375]	61 62 63 64 65 66 67 68 69 6A 6B 6C

Clear      Update

**Figure 93** Communication Log

## F. Information

Information is shown in **Figure 94**. This page has 5 parts, they are (1)PROFIBUS INFO、(2)ERROR MSG INFO、(3)DIAGNOSTIC INFO、(4)FIFO BUFFER INFO and (5)DEVICE INFO.



**Figure 94** Information

(1) PROFIBUS INFO :

PROFIBUS Status : This page shows PROFIBUS mode、PROFIBUS address and PROFIBUS baud rate.

## PROFIBUS STATUS

PROFIBUS Mode :

PROFIBUS Address :

PROFIBUS Baudrate :

[Back~](#)

### (2) ERROR MSG INFO :

The user can check Error message in this page as shown in *Figure 95*. The I-7550E will log some errors that are not affect communication. It will help the user to find out the issue of data communication. Most of Error message are about Output header format because I-7550E will follow Output header to send data. And sometimes the wrong setting of output header doesn't affect communication. Below is the Error message list and description:

Message	Description
Output length is zero	The Byte 10 of output header is zero. Data won't be sent.
Output length is too large	The Byte 10 of output header is over PROFIBUS output IO length when the Byte 8 is 1.
Total length Error!	The total length(Byte 5~6) is over 1460
Target ID is error!	The Byte 7 is error value.
Total Num Index Error!	The Byte 8 is zero.(this value should be 1 At least
Total/Current length diff!	The total length(Byte 5~6) is different from Byte 10 when the Byte 8 is 1.
Combine Header connectionID diff!	All of combined output data should be the same setting value of output header.
Combine Header MsgID diff!	Total length combined data is different from the length of data that I-7550E received.
Combine Header Index error!	
Combine Header Index error!	
Combine Total Length error!	
Combine Data 1st index error!	The index setting of the first combined data is error value.

	Byte 9 should be zero.
Input Total Index is too large!	When I-7550E receive the Ethernet data, and it can't be partitioned in 255. Please increase PROFIBUS input IO length or decrease data length.
Mode2:Check Connection ID error	In mode 2, the Byte 2 is error value.

### ERROR INFO

Number	Message
0	Output length is too large
1	Total/Current length diff!
2	Output length is too large
3	Total/Current length diff!

Update Clear

[Back~](#)

**Figure 95 Error Message INFO**

(3) DIAGNOSTIC INFO :

When PROFIBUS state is online, this page will shows the diagnostic messages of I-7550E, as shown in **Figure 96**.

### DIAGNOSTIC INFO

Diag Data	Message	Description
03 83 3B	Output Header Error !	Trigger Byte Error
03 84 3F	Output Data Error !	Data lost

Update

[Back~](#)

**Figure 96 Diagnostic info**

(4) FIFO BUFFER INFO :

This page shows the FIFO usage information as shown in **Figure 97**. It includes every connection ID FIFO usage status and PROFIBUS FIFO status. It also will show up the status of each connection.

## FIFO INFO

Update

PROFI FIFO Usage : 0 % Total Ethernet FIFO Usage : 0 %

Connection ID	The propotion of Ethernet FIFO	Connection Status
S_IP1	0 %	Disconnected
S_IP2	0 %	Disconnected
S_IP3	0 %	Disconnected
S_IP4	0 %	Disconnected
S_IP5	0 %	Disconnected
S_IP6	0 %	Disconnected
S_IP7	0 %	Disconnected
S_IP8	0 %	Disconnected
C_IP9	0 %	Connected
C_IP10	0 %	Disconnected
C_IP11	0 %	Disconnected
C_IP12	0 %	Disconnected
C_IP13	0 %	Disconnected
C_IP14	0 %	Disconnected
C_IP15	0 %	Disconnected
C_IP16	0 %	Disconnected

[Back~](#)

*Figure 97 Diagnostic info*

(5) DEVICE INFO :

This page shows the device information of I-7550E, as shown in *Figure 98*.

## DEVICE INFORMATION

Firmware Version :	V01
Current IP :	192.168.253.2
Subnet Mask :	255.255.0.0
Gateway:	192.168.0.1
Mac Address :	00:0D:E0:20:5B:1B

[Back~](#)

*Figure 98 Device info*

## 6. Virtual COM Port/VxComm Utility

I-7550E supports virtual COM Port. VxComm Utility provides the user the way that maps Ethernet to COM Port. Please notice that the IP address of PC must be set in “Server IP Setting” page in Web Configuration.(Please refer to section 5.3). The connection ID of Virtual COM Port is 17, the user need to set Byte 3 of output data area in “System setting module” when the user want to send data to the Virtual COM Port(Please refer to section 3.3.1 about output data of “System setting module”).

### 6.1 Install Utility

Step 1 :

Download the VxComm Utility setup file from the web site [ftp://ftp.icpdas.com/pub/cd/8000cd/napdos/driver/vxcomm\\_driver/2k/](ftp://ftp.icpdas.com/pub/cd/8000cd/napdos/driver/vxcomm_driver/2k/) and make sure the version of VxComm Utility is v2.12.08 or later.

Step 2 :

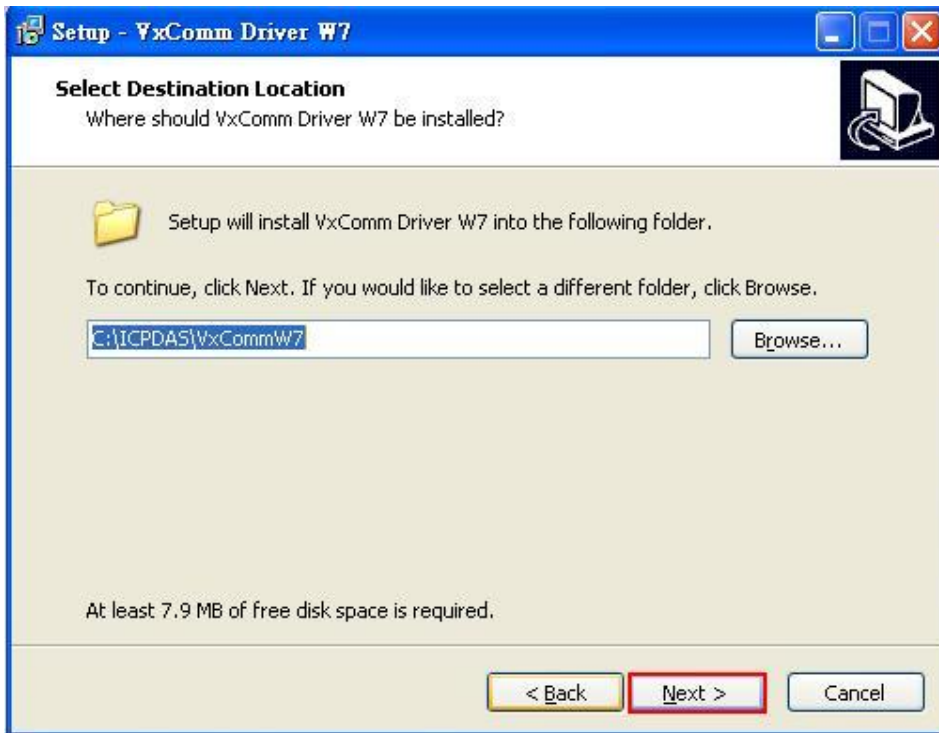
Execute setup executing file to install the VxComm Utility



*Figure 99 Install Process (1)*

Step 3 :

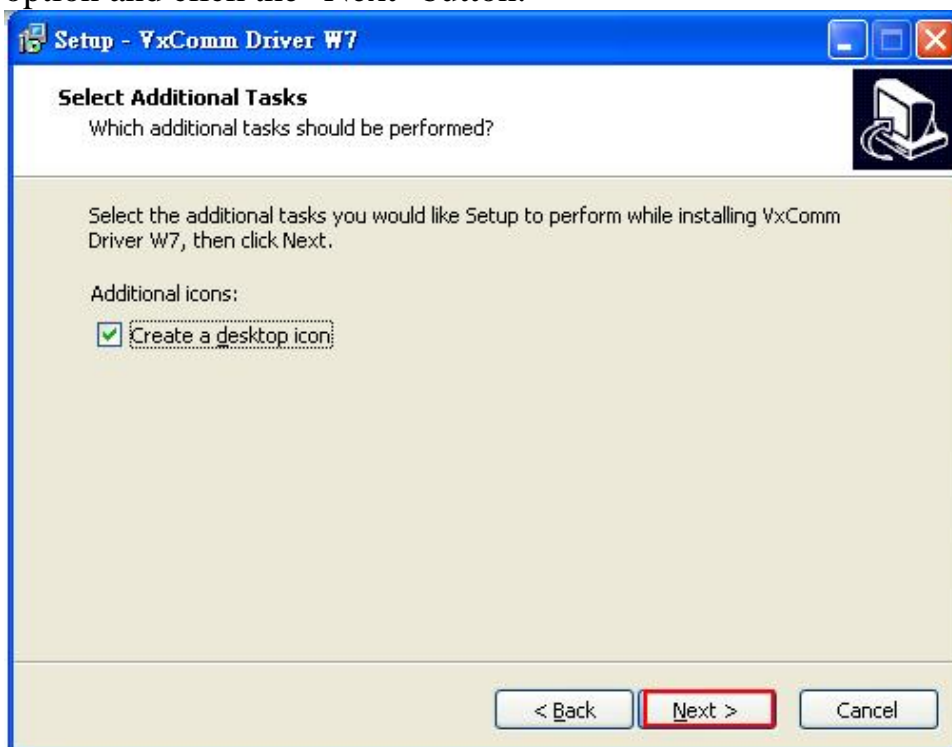
Click the “Next” button to continue. If you want to change the installation destination, click “Browse” button to set the installation path.



**Figure 100 Install Process (2)**

Step 4 :

When the “Select Additional Tasks” screen appears, select the appropriate option and click the "Next" button.

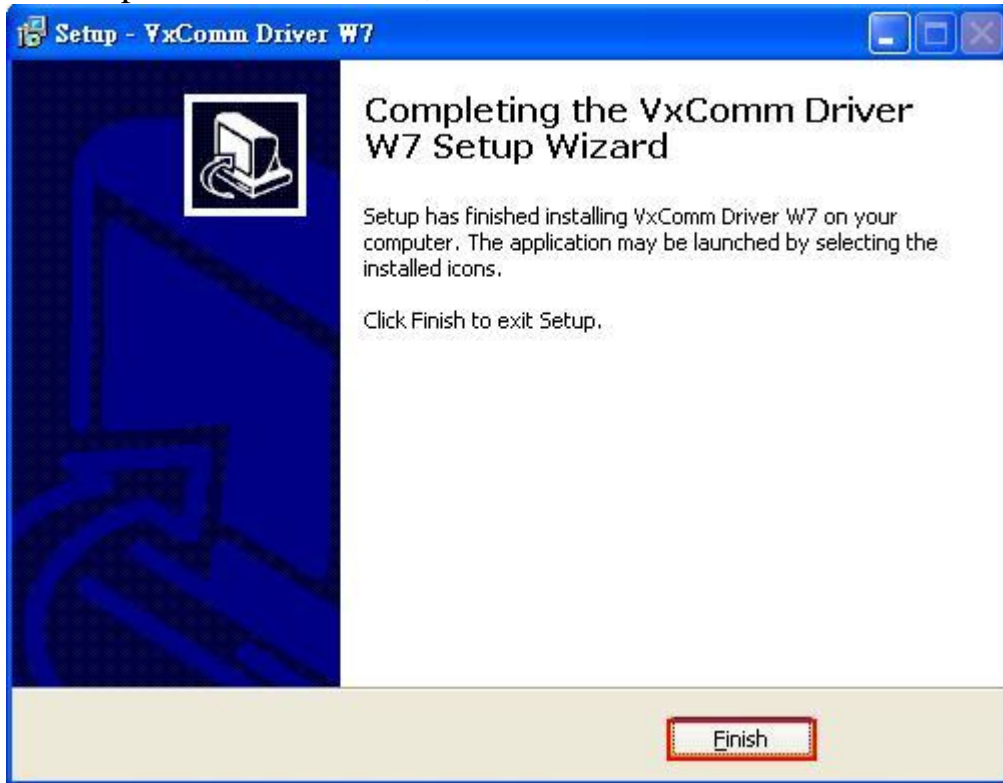


**Figure 101 Install Process (3)**



Step 5 :

To complete the installation, click the "Finish" button.



*Figure 102 Install Process (4)*

Step 6 :

After finishing the installation of the VxComm Utility, users can find the shortcut of Utility in Startup manual or on desktop as below icon.



## **6.2 Setup Virtual COM Port**

Now an I-7550E with an IP address 192.168.253.2 and a PC with an IP address 192.168.253.1 are used as an example.

Step 1 :

Brower the Web Configuration website and Click "Server IP Setting". Set VxComm IP as 192.168.253.1. If the user set "Timeout" value as zero, the I-7550E won't close connection.


[User Account](#)  
[Server IP Setting](#)  
[Client IP Setting](#)  
[Communication Log](#)  
[Information](#)

**Server Setting**  
 TCP Server Enable  UDP Server Enable  
 TCP Port :  UDP Port :   
 VxComm IP(Connection ID:17):  Timeout (min)(0~30) :   
 Enable Connection IP:  S\_IP1  S\_IP2  S\_IP3  S\_IP4  S\_IP5  S\_IP6  
 Allow IP address:  
 S\_IP1:  Timeout (min)(0~30) :  Protocol Type

**Figure 103 Setup Process (1)**

Step 2 :

Click “Save to Device” button and restart I-7550E.



[Login](#)  
[User Account](#)  
[Server IP Setting](#)  
[Client IP Setting](#)  
[Communication Log](#)  
[Information](#)

**Local IP Setting**  
 IP :   
 MASK :   
 GATEWAY:

**Figure 104 Setup Process (2)**

Step 3 :

Open VxComm Utility and click the “Search Servers” button, The VxComm Utility will then find I-7550E device.

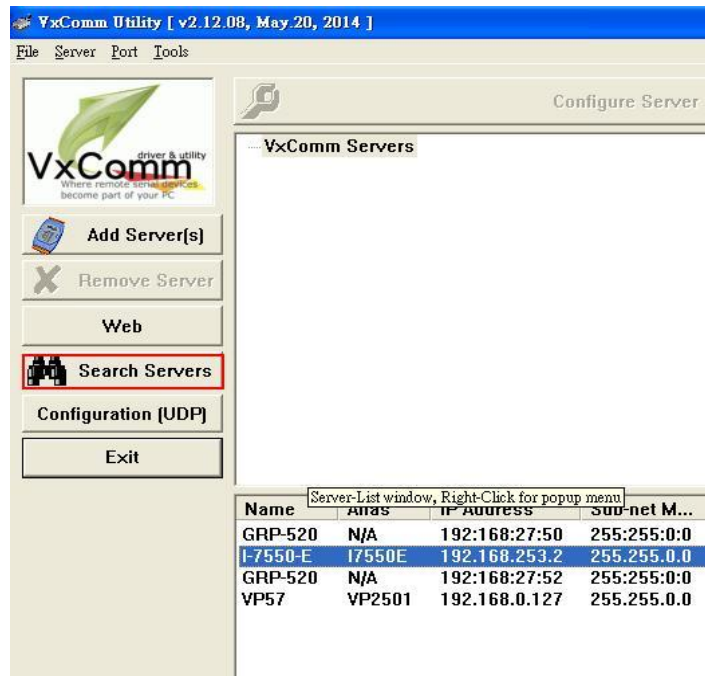


Figure 105 Setup Process (3)

Step 4 :

Right click on “I-7550E” in the list, and then select “Add Server(s)” from the popup menu

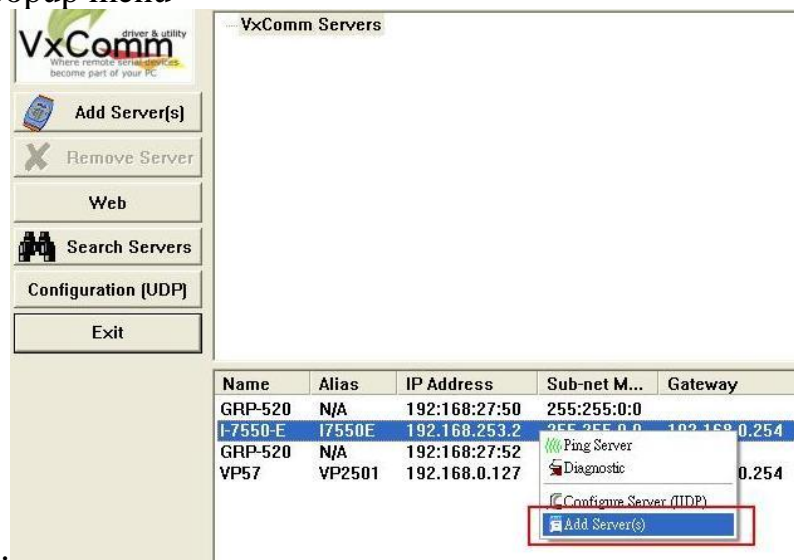
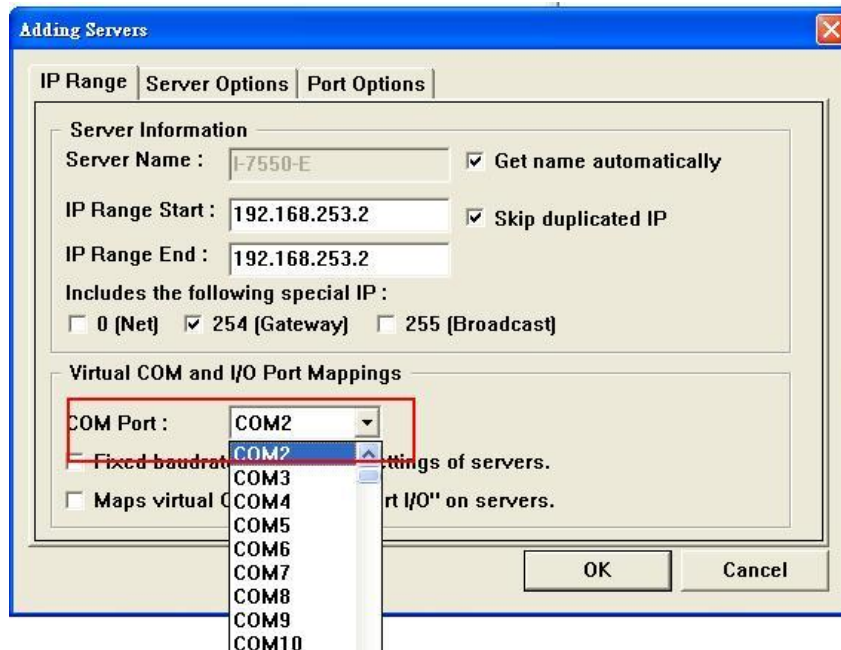


Figure 106 Setup Process (4)

Step 5 :

When the “Adding Servers” window is popped up, select a valid COM Port and click “OK” button.



*Figure 107 Setup Process (5)*

Step 6 :

Select “Restart Driver” from the “Tools” menu.



*Figure 108 Setup Process (6)*

Step 7 :

Click the “Restart Driver” button to save the settings and then exit the VxComm Utility. Now a virtual COM Port is available.

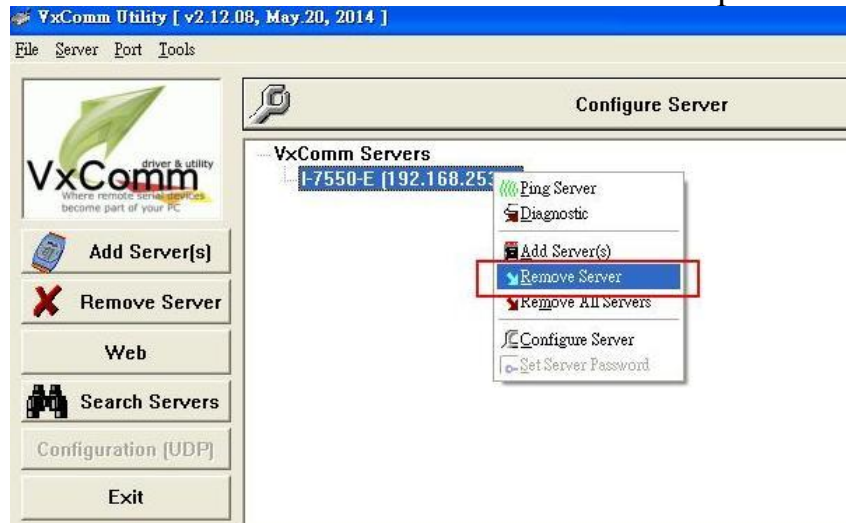


*Figure 109 Setup Process (7)*

### 6.3 Remove Virtual COM Port

Step 1 :

Execute **VxComm Utility** and right click on the name of the server that is to be removed and select “**Remove Server**” from the drop-down menu.



*Figure 110 Remove Process (1)*

Step 2 :

When the following alert is displayed, click the "Yes" button to confirm the removed of the server.



*Figure 111 Remove Process (2)*

Step 3 :

Select “Restart Driver” from the “Tools” menu.



*Figure 112 Remove Process (3)*

Step 4 :

Click the “Restart Driver” button to save the settings and then exit the VxComm Utility. Now a virtual COM Port is available.



*Figure 113 Remove Process (4)*



## 7. Troubleshooting

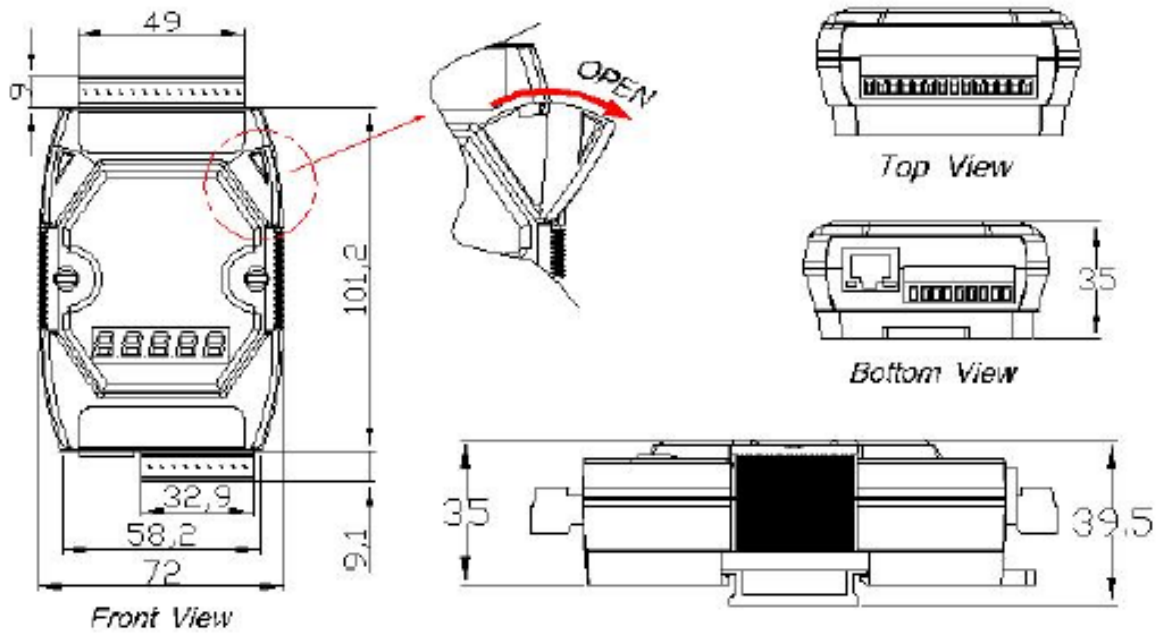
The troubleshooting list can help users to resolve the problems when using the I-7550E. If the problem still can't be solved, please contact with technical staff of ICP DAS.

**Table 34** *Errors and solutions*

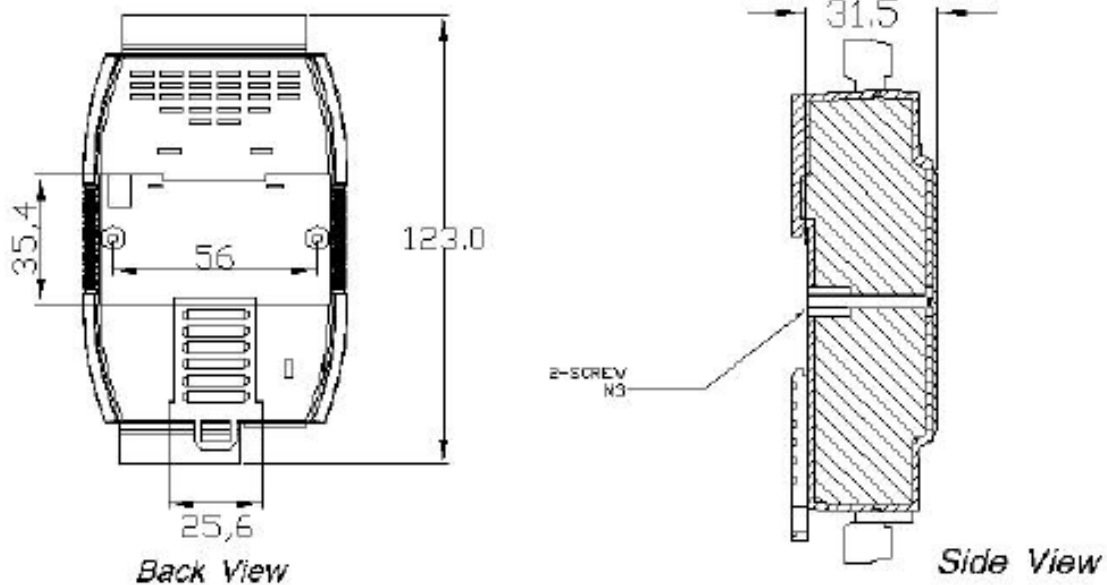
Item	Trouble state	Solution
1	'PWR' LED indication of the I-7550E is always turned off	The power supply of I-7550E has some problems. Please check the wire connection of the power and the voltage is between 10~30V <sub>DC</sub> .
2	'ERR' LED indication of the I-7550E is always turned on	That means the I-7550E isn't connecting to the PROFIBUS Master station. Please check the wire connection and the PROFIBUS Master station. The configuration and address of I-7550E in the PROFIBUS Master station are not correct.
3	'ERR' LED indication of the I-7550E is flashing fast	It means the I-7550E is in setting mode and connects with Utility. Please set the I-7550E to operation mode (please refer section 2.6 Normal/Setting DIP switch)
4	'ERR' LED indication of the I-7550E is flashing slow	It means the I-7550E has diagnostic messages. Please check diagnostic messages in the PROFIBUS Master station.
5	PROFIBUS Master station cannot communicate with the Ethernet device, when "RUN LED" of the I-7550E is light and "ERR LED" of the I-7550E is dark.	<ol style="list-style-type: none"> <li>Please confirm the connection between the I-7550E and Ethernet device.</li> <li>Please confirm Server IP setting (please refer section 5.3) or Client IP setting (please refer section 5.3) of the I-7550E is the same domain.</li> <li>Please confirm the Ethernet device is disconnected in unusual method.</li> <li>Please confirm the output data put in correct address and have changed value of byte 0 as 1. And please change byte 1 to trigger the output method. (Please refer section 3.4.1 Output data area and Operation mode/Trigger Byte).</li> </ol>



## 8. Dimensions



DIN-RAIL MOUNTING BRACKET



Unit : mm

