

**MODEL:**  
**KINO-DQM871**

**Mini-ITX SBC with 4th Generation 22nm Intel® Core™ CPU  
Up to 16.0 GB DDR3, HDMI, LVDS, DisplayPort, VGA  
Dual GbE, SATA 6Gb/s, USB 3.0, Dual PCIe Mini  
PCIe x16, Intel® AMT 9.0, RoHS**

# User Manual

# Revision

---

Date	Version	Changes
July 8, 2014	1.02	Updated Section 2.3: Packing List
April 22, 2014	1.01	Modified Table 3-32: LAN2 Pinouts and Table 3-35: LAN1 Pinouts
August 30, 2013	1.00	Initial release

# Copyright

---

## **COPYRIGHT NOTICE**

The information in this document is subject to change without prior notice in order to improve reliability, design and function and does not represent a commitment on the part of the manufacturer.

In no event will the manufacturer be liable for direct, indirect, special, incidental, or consequential damages arising out of the use or inability to use the product or documentation, even if advised of the possibility of such damages.

This document contains proprietary information protected by copyright. All rights are reserved. No part of this manual may be reproduced by any mechanical, electronic, or other means in any form without prior written permission of the manufacturer.

## **TRADEMARKS**

All registered trademarks and product names mentioned herein are used for identification purposes only and may be trademarks and/or registered trademarks of their respective owners.

# Table of Contents

<b>1 INTRODUCTION.....</b>	<b>1</b>
1.1 INTRODUCTION.....	2
1.2 BENEFITS .....	3
1.3 FEATURES.....	3
1.4 CONNECTORS .....	4
1.5 DIMENSIONS.....	5
1.6 DATA FLOW .....	6
1.7 TECHNICAL SPECIFICATIONS .....	7
<b>2 PACKING LIST.....</b>	<b>10</b>
2.1 ANTI-STATIC PRECAUTIONS .....	11
2.2 UNPACKING PRECAUTIONS.....	11
2.3 PACKING LIST.....	12
2.4 OPTIONAL ITEMS .....	13
<b>3 CONNECTOR PINOUTS.....</b>	<b>15</b>
3.1 PERIPHERAL INTERFACE CONNECTORS.....	16
3.1.1 <i>Layout</i> .....	16
3.1.2 <i>Peripheral Interface Connectors</i> .....	17
3.1.3 <i>External Interface Panel Connectors</i> .....	18
3.2 INTERNAL PERIPHERAL CONNECTORS .....	19
3.2.1 <i>ATX Power Signal Connector</i> .....	19
3.2.2 <i>Battery Connector</i> .....	20
3.2.3 <i>Digital I/O Connector</i> .....	21
3.2.4 <i>DisplayPort Connector</i> .....	22
3.2.5 <i>EC Debug Port</i> .....	23
3.2.6 <i>Fan Connector (CPU)</i> .....	24
3.2.7 <i>Fan Connector (System)</i> .....	24
3.2.8 <i>Front Panel Connector</i> .....	25
3.2.9 <i>Keyboard/Mouse Connector</i> .....	26
3.2.10 <i>LAN Active LED Connector</i> .....	27

## KINO-DQM871 Mini-ITX SBC

3.2.11 LVDS Connector.....	28
3.2.12 LVDS Backlight Connector.....	30
3.2.13 PCIe Mini Card Slot (Full-size).....	30
3.2.14 PCIe Mini Card Slot (Half-size).....	32
3.2.15 PCI Express x16 Slot.....	33
3.2.16 Power Button (On-board).....	36
3.2.17 Power Connector (12V).....	36
3.2.18 RS-232 Serial Port Connectors (COM2 ~ COM5).....	37
3.2.19 RS-422/485 Serial Port Connector (COM6).....	38
3.2.20 SATA 6Gb/s Drive Connectors.....	39
3.2.21 SATA 3Gb/s Drive Connectors.....	40
3.2.22 SATA Power Connectors.....	41
3.2.23 SMBus Connector.....	42
3.2.24 SO-DIMM Connectors.....	43
3.2.25 SPI Flash Connector.....	44
3.2.26 SPI Flash Connector (EC).....	45
3.2.27 TPM Connector.....	46
3.2.28 USB 2.0 Connectors.....	47
3.2.29 USB 3.0/2.0 Connector.....	48
<b>3.3 EXTERNAL INTERFACE CONNECTORS.....</b>	<b>49</b>
3.3.1 Audio Connector.....	49
3.3.2 Ethernet and USB 2.0 Connectors.....	50
3.3.3 Ethernet and USB 3.0 Connectors.....	51
3.3.4 HDMI Connectors.....	52
3.3.5 Power Connector (12 V, Power Adapter).....	53
3.3.6 Serial Port Connector (COM1).....	54
3.3.7 VGA Connector.....	54
<b>4 INSTALLATION.....</b>	<b>56</b>
4.1 ANTI-STATIC PRECAUTIONS.....	57
4.2 INSTALLATION CONSIDERATIONS.....	57
4.3 SO-DIMM INSTALLATION.....	59
4.4 PCIe MINI CARD INSTALLATION.....	59
4.5 JUMPER SETTINGS.....	60
4.5.1 AT/ATX Mode Selection.....	61

4.5.2 Clear CMOS.....	62
4.5.3 LVDS Voltage Selection.....	63
4.5.4 LVDS Resolution Selection .....	64
4.6 CHASSIS INSTALLATION.....	65
4.6.1 Airflow.....	65
4.6.2 Motherboard Installation.....	66
4.7 INTERNAL PERIPHERAL DEVICE CONNECTIONS.....	66
4.7.1 SATA Drive Connection .....	66
4.8 EXTERNAL PERIPHERAL INTERFACE CONNECTION .....	67
4.8.1 Audio Connector .....	67
4.8.2 HDMI Display Device Connection .....	68
4.8.3 LAN Connection (Single Connector).....	69
4.8.4 Serial Device Connection .....	70
4.8.5 USB Connection (Dual Connector).....	71
4.8.6 VGA Monitor Connection .....	72
4.9 INTEL® AMT SETUP PROCEDURE.....	73
<b>5 BIOS.....</b>	<b>75</b>
5.1 INTRODUCTION.....	76
5.1.1 Starting Setup.....	76
5.1.2 Using Setup .....	76
5.1.3 Getting Help.....	77
5.1.4 Unable to Reboot after Configuration Changes .....	77
5.1.5 BIOS Menu Bar.....	78
5.2 MAIN.....	79
5.3 ADVANCED.....	80
5.3.1 ACPI Settings.....	81
5.3.2 RTC Wake Settings .....	82
5.3.3 Trusted Computing.....	83
5.3.4 CPU Configuration.....	85
5.3.5 SATA Configuration .....	87
5.3.6 Intel(R) Rapid Start Technology.....	88
5.3.7 AMT Configuration .....	89
5.3.8 USB Configuration.....	90
5.3.9 iWDD H/W Monitor.....	91

**KINO-DQM871 Mini-ITX SBC**

5.3.9.1 Smart Fan Mode Configuration .....	91
5.3.10 F81866 Super IO Configuration .....	93
5.3.10.1 Serial Port n Configuration .....	93
5.3.11 F81866 H/W Monitor .....	99
5.3.11.1 Smart Fan Mode Configuration .....	100
5.3.12 Serial Port Console Redirection .....	101
5.3.13 iEi Feature .....	104
5.4 CHIPSET .....	105
5.4.1 System Agent (SA) Configuration .....	106
5.4.1.1 Graphics Configuration.....	106
5.4.1.2 NB PCIe Configuration.....	109
5.4.1.3 Memory Configuration .....	110
5.4.2 PCH-IO Configuration .....	111
5.4.2.1 PCI Express Configuration .....	112
5.5 BOOT.....	113
5.6 SECURITY.....	115
5.7 SAVE & EXIT .....	116
<b>6 SOFTWARE DRIVERS .....</b>	<b>118</b>
6.1 AVAILABLE SOFTWARE DRIVERS .....	119
6.2 STARTING THE DRIVER PROGRAM .....	119
6.3 CHIPSET DRIVER INSTALLATION.....	120
6.4 GRAPHICS DRIVER INSTALLATION .....	124
6.5 LAN DRIVER INSTALLATION .....	127
6.6 USB 3.0 DRIVER INSTALLATION .....	132
6.7 AUDIO DRIVER INSTALLATION .....	135
6.8 INTEL® AMT DRIVER INSTALLATION .....	137
<b>A BIOS OPTIONS .....</b>	<b>140</b>
<b>B TERMINOLOGY.....</b>	<b>143</b>
<b>C DIGITAL I/O INTERFACE.....</b>	<b>147</b>
C.1 INTRODUCTION .....	148
C.2 DIO CONNECTOR PINOUTS.....	148
C.3 ASSEMBLY LANGUAGE SAMPLES.....	149
C.3.1 Enable the DIO Input Function.....	149

<i>C.3.2 Enable the DIO Output Function .....</i>	<i>149</i>
<b>D HAZARDOUS MATERIALS DISCLOSURE .....</b>	<b>150</b>
D.1 HAZARDOUS MATERIALS DISCLOSURE TABLE FOR IPB PRODUCTS CERTIFIED AS ROHS COMPLIANT UNDER 2002/95/EC WITHOUT MERCURY .....	151



# List of Figures

Figure 1-1: KINO-DQM871 .....	2
Figure 1-2: Connectors .....	4
Figure 1-3: KINO-DQM871 Dimensions (mm) .....	5
Figure 1-4: Data Flow Diagram .....	6
Figure 3-1: Connector and Jumper Locations .....	16
Figure 3-2: ATX Power Signal Connector Location .....	19
Figure 3-3: Battery Connector Location .....	20
Figure 3-4: Digital I/O Connector Location .....	21
Figure 3-5: DisplayPort Connector Location .....	22
Figure 3-6: BIOS Debug Port Location .....	23
Figure 3-7: CPU Fan Connector Location .....	24
Figure 3-8: System Fan Connector Location .....	25
Figure 3-9: Front Panel Connector Location .....	26
Figure 3-10: Keyboard/Mouse Connector Location .....	27
Figure 3-11: LAN Active LED Connector Location .....	28
Figure 3-12: LVDS Connector Location .....	29
Figure 3-13: LVDS Backlight Inverter Connector .....	30
Figure 3-14: PCIe Mini Card Slot Location .....	31
Figure 3-15: PCIe Mini Card Slot Location .....	32
Figure 3-16: PCIe x16 Slot Location .....	34
Figure 3-17: On-board Power Button Location .....	36
Figure 3-18: Power Connector Location .....	37
Figure 3-19: RS-232 Serial Port Connector Location .....	38
Figure 3-20: RS-422/485 Serial Port Connector Location .....	39
Figure 3-21: SATA 6Gb/s Drive Connector Locations .....	40
Figure 3-22: SATA 3Gb/s Drive Connector Locations .....	41
Figure 3-23: SATA Power Connector Locations .....	42
Figure 3-24: SMBus Connector Location .....	43
Figure 3-25: SO-DIMM Connector Locations .....	44
Figure 3-26: SPI Flash Connector Location .....	44

Figure 3-27: EC SPI Flash Connector Location.....	45
Figure 3-28: TPM Connector Location.....	46
Figure 3-29: USB Connector Locations.....	47
Figure 3-30: USB 3.0/2.0 Connector Location .....	48
Figure 3-31: External Interface Connectors.....	49
Figure 3-32: Audio Jacks .....	50
Figure 3-33: Ethernet Connector.....	50
Figure 3-34: Ethernet Connector.....	52
Figure 3-35: HDMI Connector .....	53
Figure 3-36: 4-pin Power Mini-DIN Connection .....	53
Figure 3-37: Serial Port Pinouts .....	54
Figure 3-38: VGA Connector .....	55
Figure 4-1: SO-DIMM Installation .....	59
Figure 4-2: PCIe Mini Card Installation.....	60
Figure 4-3: AT/ATX Mode Selection Jumper Location.....	62
Figure 4-4: Clear CMOS Jumper Location .....	63
Figure 4-5: LVDS Voltage Selection Jumper Location .....	64
Figure 4-6: LVDS Resolution Selection Jumper Location.....	65
Figure 4-7: SATA Drive Cable Connection.....	66
Figure 4-8: Audio Connector .....	68
Figure 4-9: HDMI Connection .....	69
Figure 4-10: LAN Connection .....	70
Figure 4-11: Serial Device Connector.....	71
Figure 4-12: USB Connector.....	72
Figure 4-13: VGA Connector .....	73
Figure 6-1: Start Up Screen .....	120
Figure 6-2: Drivers .....	120
Figure 6-3: Chipset Driver Welcome Screen.....	121
Figure 6-4: Chipset Driver License Agreement .....	122
Figure 6-5: Chipset Driver Read Me File .....	122
Figure 6-6: Chipset Driver Setup Operations .....	123
Figure 6-7: Chipset Driver Installation Finish Screen.....	124
Figure 6-8: Graphics Driver Welcome Screen .....	125
Figure 6-9: Graphics Driver License Agreement.....	125
Figure 6-10: Graphics Driver Read Me File .....	126

## KINO-DQM871 Mini-ITX SBC

<b>Figure 6-11: Graphics Driver Setup Operations .....</b>	<b>126</b>
<b>Figure 6-12: Graphics Driver Installation Finish Screen .....</b>	<b>127</b>
<b>Figure 6-13: Windows Control Panel .....</b>	<b>128</b>
<b>Figure 6-14: System Control Panel .....</b>	<b>128</b>
<b>Figure 6-15: Device Manager List .....</b>	<b>129</b>
<b>Figure 6-16: Update Driver Software Window .....</b>	<b>130</b>
<b>Figure 6-17: Locate Driver Files .....</b>	<b>130</b>
<b>Figure 6-18: LAN Driver Installation .....</b>	<b>131</b>
<b>Figure 6-19: LAN Driver Installation Complete .....</b>	<b>131</b>
<b>Figure 6-20: USB 3.0 Driver Welcome Screen .....</b>	<b>132</b>
<b>Figure 6-21: USB 3.0 Driver License Agreement .....</b>	<b>133</b>
<b>Figure 6-22: USB 3.0 Driver Read Me File .....</b>	<b>133</b>
<b>Figure 6-23: USB 3.0 Driver Setup Operations .....</b>	<b>134</b>
<b>Figure 6-24: USB 3.0 Driver Installation Finish Screen .....</b>	<b>134</b>
<b>Figure 6-25: Audio Driver Welcome Screen .....</b>	<b>135</b>
<b>Figure 6-26: Audio Driver Installation .....</b>	<b>136</b>
<b>Figure 6-27: Audio Driver Installation Complete .....</b>	<b>136</b>
<b>Figure 6-28: Intel® ME Driver Welcome Screen .....</b>	<b>137</b>
<b>Figure 6-29: Intel® ME Driver License Agreement .....</b>	<b>138</b>
<b>Figure 6-30: Intel® ME Driver Setup Operations .....</b>	<b>138</b>
<b>Figure 6-31: Intel® ME Driver Installation Finish Screen .....</b>	<b>139</b>

# List of Tables

---

Table 1-1: Technical Specifications.....	9
Table 2-1: Packing List.....	13
Table 2-2: Optional Items.....	14
Table 3-1: Peripheral Interface Connectors.....	18
Table 3-2: Rear Panel Connectors.....	18
Table 3-3: ATX Power Signal Connector Pinouts.....	19
Table 3-4: Battery Connector Pinouts.....	21
Table 3-5: Digital I/O Connector Pinouts.....	21
Table 3-6: DisplayPort Connector Pinouts.....	22
Table 3-7: EC Debug Port Pinouts.....	23
Table 3-8: CPU Fan Connector Pinouts.....	24
Table 3-9: System Fan Connector Pinouts.....	25
Table 3-10: Front Panel Connector Pinouts.....	26
Table 3-11: Keyboard/Mouse Connector Pinouts.....	27
Table 3-12: LAN Active LED Connector Pinouts.....	28
Table 3-13: LVDS Connector Pinouts.....	29
Table 3-14: Backlight Inverter Connector Pinouts.....	30
Table 3-15: PCIe Mini Card Slot Pinouts.....	32
Table 3-16: PCIe Mini Card Slot Pinouts.....	33
Table 3-17: PCIe x16 Side A Pinouts.....	35
Table 3-18: PCIe x16 Side B Pinouts.....	36
Table 3-19: Power Connector Pinouts.....	37
Table 3-20: Serial Port Connector Pinouts.....	38
Table 3-21: RS-422/485 Serial Port Connector Pinouts.....	39
Table 3-22: D-sub 9 RS-422/485 Pinouts.....	39
Table 3-23: SATA 6Gb/s Drive Connector Pinouts.....	40
Table 3-24: SATA 3Gb/s Drive Connector Pinouts.....	41
Table 3-25: SATA Power Connector Pinouts.....	42
Table 3-26: SMBus Connector Pinouts.....	43
Table 3-27: SPI Flash Connector Pinouts.....	45

## KINO-DQM871 Mini-ITX SBC

Table 3-28: EC SPI Flash Connector Pinouts .....	46
Table 3-29: TPM Connector Pinouts .....	47
Table 3-30: USB Port Connector Pinouts.....	48
Table 3-31: USB 3.0/2.0 Connector Pinouts.....	49
Table 3-32: LAN2 Pinouts .....	50
Table 3-33: Connector LEDs.....	51
Table 3-34: External USB 2.0 Port Pinouts .....	51
Table 3-35: LAN1 Pinouts .....	51
Table 3-36: Connector LEDs.....	52
Table 3-37: External USB 3.0 Port Pinouts .....	52
Table 3-38: HDMI Connector Pinouts .....	53
Table 3-39: Serial Port Pinouts.....	54
Table 3-40: VGA Connector Pinouts.....	55
Table 4-1: Jumpers .....	61
Table 4-2: LVDS Voltage Selection Jumper Settings.....	63
Table 4-3: LVDS Resolution Selection Jumper Settings .....	65
Table 5-1: BIOS Navigation Keys .....	77
Table 6-1: Digital I/O Connector Pinouts.....	148

# BIOS Menus

---

BIOS Menu 1: Main .....	79
BIOS Menu 2: Advanced .....	81
BIOS Menu 3: ACPI Settings .....	81
BIOS Menu 4: RTC Wake Settings .....	82
BIOS Menu 5: Trusted Computing .....	84
BIOS Menu 6: CPU Configuration .....	85
BIOS Menu 7: SATA Configuration .....	87
BIOS Menu 8: Intel(R) Rapid Start Technology .....	88
BIOS Menu 9: AMT Configuration .....	89
BIOS Menu 10: USB Configuration .....	90
BIOS Menu 11: iWDD H/W Monitor .....	91
BIOS Menu 12: Smar Fan Mode Configuration.....	92
BIOS Menu 13: F81866 Super IO Configuration .....	93
BIOS Menu 14: Serial Port n Configuration Menu .....	93
BIOS Menu 15: F81866 H/W Monitor .....	99
BIOS Menu 16: Smart Fan Mode Configuration .....	100
BIOS Menu 17: Serial Port Console Redirection .....	101
BIOS Menu 18: iEi Feature .....	104
BIOS Menu 19: Chipset .....	105
BIOS Menu 20: System Agent (SA) Configuration .....	106
BIOS Menu 21: Graphics Configuration .....	107
BIOS Menu 22: NB PCIe Configuration .....	109
BIOS Menu 23: Memory Configuration.....	110
BIOS Menu 24: PCH-IO Configuration .....	111
BIOS Menu 25: PCI Express Configuration .....	112
BIOS Menu 26: Boot .....	113
BIOS Menu 27: Security .....	115
BIOS Menu 28: Save & Exit.....	116

Chapter

1

# Introduction

---

## 1.1 Introduction



**Figure 1-1: KINO-DQM871**

The KINO-DQM871 is a Mini-ITX SBC with a 4<sup>th</sup> generation 22nm Intel® Core™ or Celeron® processor and Intel® QM87 Express Chipset. Storage on the board is handled by two SATA 6Gb/s ports, two SATA 3Gb/s ports and one PCIe Mini socket for connecting a hard drive, optical drive or SSD.

The board has four types of graphics outputs that support triple independent display. A VGA output connects to a VGA monitor. One LVDS connector supports 18/24-bit dual-channel display. Two HDMI connectors support HDMI 1080p display and an internal DisplayPort connector supports DisplayPort displays.

Other slots and connectors include RS-232 ports, RS-422/485 port, Gigabit Ethernet, USB 3.0 ports, USB 2.0 ports, TPM, SMBus and digital I/O.



## KINO-DQM871 Mini-ITX SBC

### 1.2 Benefits

Some of the KINO-DQM871 motherboard benefits include:

- Low power consumption
- Wide range of I/O interfaces
- Triple independent display support

### 1.3 Features

Some of the KINO-DQM871 motherboard features are listed below:

- Mini-ITX form factor
- RoHS compliant
- 4th generation 22nm Intel® Core™ or Celeron® processor
- 1066/1333/1600MHz dual-channel DDR3 SDRAM
- Intel® AMT 9.0 support
- Dual GbE
- Supports VGA, HDMI, LVDS and DisplayPort interface for triple independent display (HDMI V1.4a compliant)
- 14 USB ports (ten USB 2.0, four USB 3.0)
- Five RS-232 serial ports and one RS-422/485 serial port
- Two PCIe Mini card slots
- One PCIe x16 slot

## 1.4 Connectors

The connectors on the KINO-DQM871 are shown in the figure below.

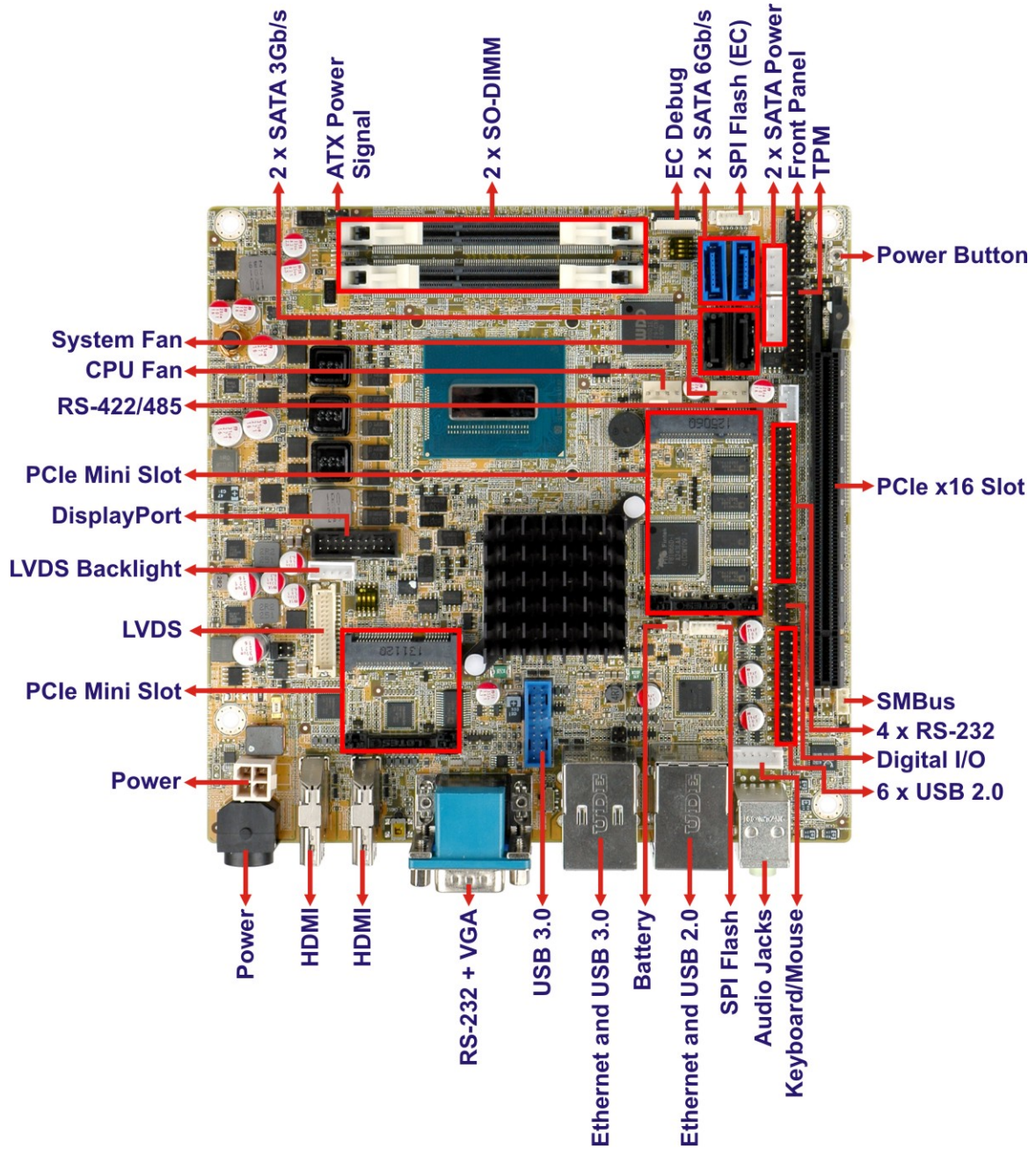
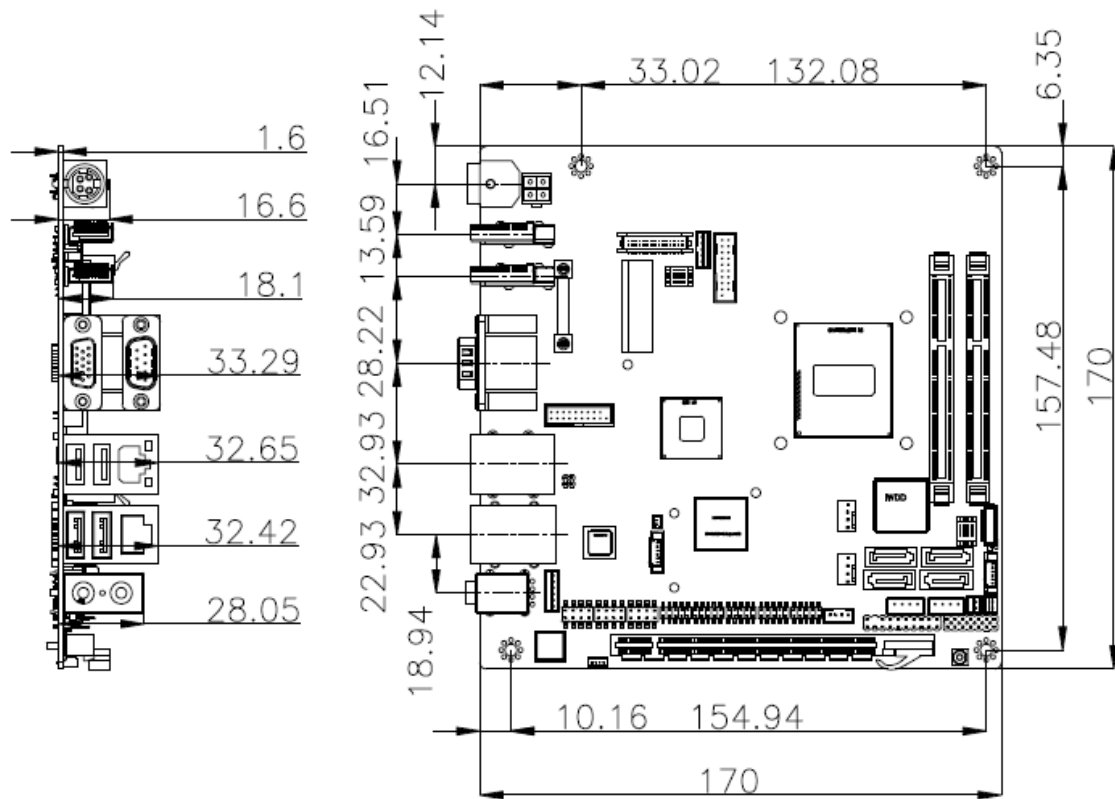

Figure 1-2: Connectors

**KINO-DQM871 Mini-ITX SBC**

**1.5 Dimensions**

The main dimensions of the KINO-DQM871 are shown in the diagram below.



**Figure 1-3: KINO-DQM871 Dimensions (mm)**

### 1.6 Data Flow

Figure 1-4 shows the data flow between the system chipset, the CPU and other components installed on the motherboard.

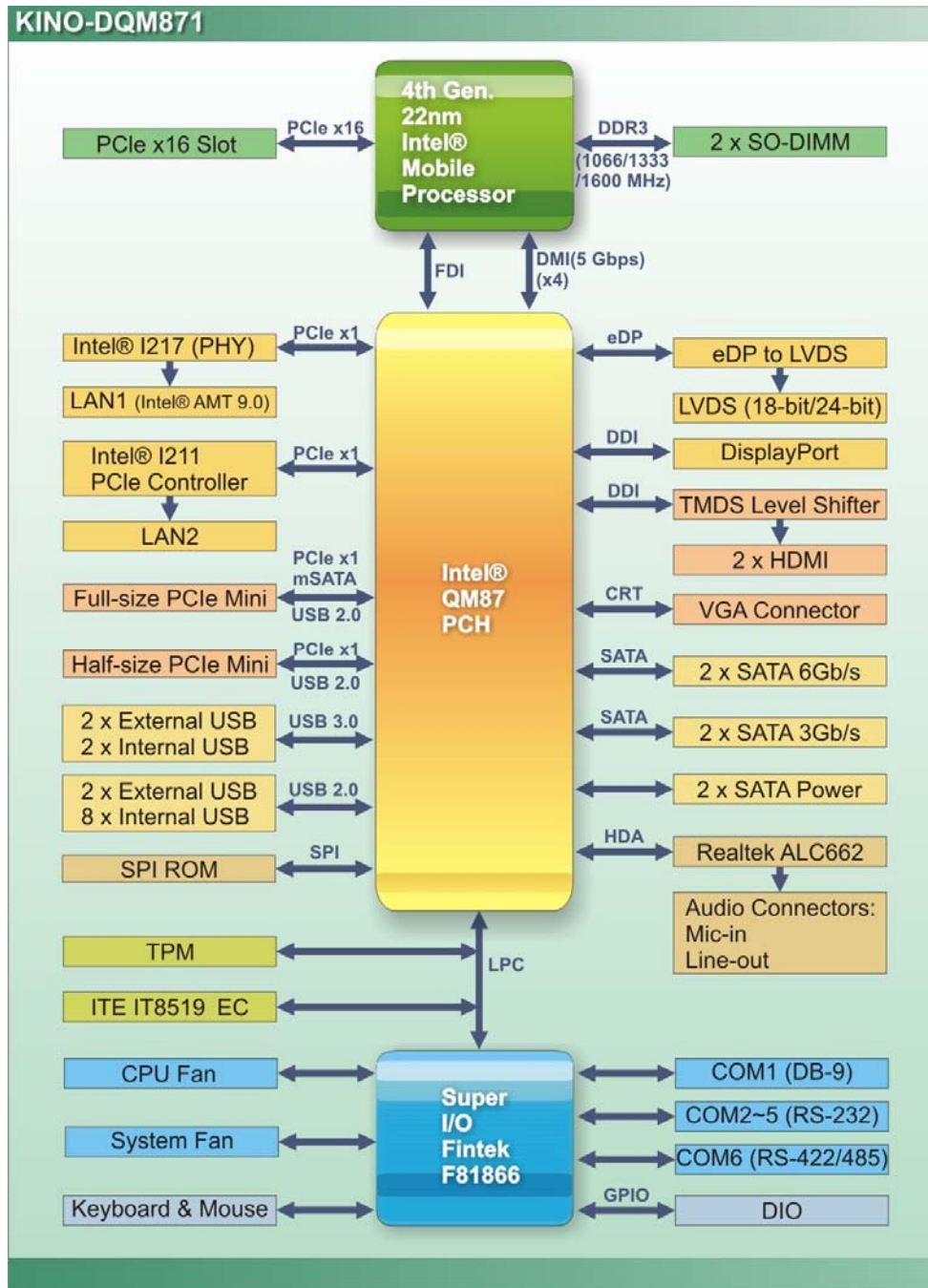

Figure 1-4: Data Flow Diagram

## KINO-DQM871 Mini-ITX SBC

### 1.7 Technical Specifications

KINO-DQM871 technical specifications are listed in Table 1-1.

Specification	KINO-DQM871
<b>Form Factor</b>	Mini-ITX
<b>On-board Processor</b>	Intel® Core™ i7-4700EQ processor with Intel® AMT 9.0 support (2.4 GHz, quad-core, 6 MB cache, 47 W TDP) Intel® Core™ i5-4402E processor with Intel® AMT 9.0 support (1.6 GHz, dual-core, 3 MB cache, 25 W TDP) Intel® Core™ i3-4102E processor (1.6 GHz, dual-core, 3 MB cache, 25 W TDP) Intel® Celeron® 2002E processor (1.5 GHz, dual-core, 2 MB cache, 25 W TDP)
<b>System Chipset</b>	Intel® QM87
<b>Memory</b>	Two 204-pin 1600/1333/1066 MHz DDR3 SO-DIMM supported (system max. 16.0 GB)
<b>Graphics Engine</b>	Supports DirectX 11.1, OpenGL 3.2, OpenCL 1.2, full MPEG2, VC1, AVC decode
<b>BIOS</b>	UEFI BIOS
<b>Ethernet Controllers</b>	<b>LAN1:</b> Intel® I217 PHY (through PCIe x1) with Intel® AMT 9.0 support <b>LAN2:</b> Intel® I211 PCIe Ethernet controller (through PCIe x1)
<b>Audio</b>	Realtek ALC662 HD Audio codec
<b>Super I/O Controller</b>	Fintek F81866
<b>EC</b>	ITE IT8519
<b>Digital I/O</b>	8-bit, 4-bit input/4-bit output
<b>Watchdog Timer</b>	Software programmable supports 1~255 sec. system reset
<b>Expansion</b>	1 x Full-size PCIe Mini slot (colay mSATA) 1 x Half-size PCIe Mini slot 1 x PCIe x16 slot

<b>I/O Interface Connectors</b>	
<b>Display Output Ports</b> (Triple Display Supported)	1 x VGA (up to 1920 x 1200 @ 60 Hz) 2 x HDMI (up to 2500 x 1600 @ 60 Hz) 1 x 18/24-bit dual-channel LVDS (up to 1920 x 1200 @ 60 Hz) 1 x DisplayPort via on-board box header supports HDMI, LVDS, VGA, DVI and DisplayPort (up to 3840 x 2160 @ 60 Hz)
<b>Fan connector</b>	One 4-pin wafer for CPU fan One 4-pin wafer for system fan
<b>Keyboard/Mouse</b>	One internal 6-pin wafer connector
<b>Serial Ports</b>	Five RS-232 COM connectors (four by pin header, one on rear side) One RS-422/485 COM connector (4-pin wafer)
<b>USB Ports</b>	Ten USB 2.0 ports (eight by 8-pin header, two on rear side ) Four USB 3.0 ports (two by pin header, two on rear side)
<b>SMBus</b>	One 4-pin wafer connector
<b>TPM</b>	One 20-pin header
<b>Storage</b>	
<b>SATA</b>	2 x SATA 6Gb/s 2 x SATA 3Gb/s with RAID 0/1/5/10 support
<b>Environmental and Power Specifications</b>	
<b>Power Supply</b>	12V only, AT/ATX support
<b>Power Connector</b>	1 x External 4-pin DIN DC jack 1 x Internal 4-pin (2x2) power connector
<b>Power Consumption</b>	12V@6.03A (2.4 GHz Intel® Core™ i7-4770EQ processor with two 4 GB 1333MHz DDR3 memory)
<b>Operating Temperature</b>	-20°C ~ 60°C (32°F ~ 140°F)
<b>Storage Temperature</b>	-30°C ~ 70°C
<b>Operating Humidity</b>	5% ~ 95% (non-condensing)
<b>Physical Specifications</b>	
<b>Dimensions</b>	170 mm x 170 mm

## KINO-DQM871 Mini-ITX SBC

<b>Weight GW/NW</b>	900 g/450 g
---------------------	-------------

**Table 1-1: Technical Specifications**

Chapter

**2**

# Packing List

---



## KINO-DQM871 Mini-ITX SBC

### 2.1 Anti-static Precautions

---



#### WARNING!

Static electricity can destroy certain electronics. Make sure to follow the ESD precautions to prevent damage to the product, and injury to the user.

---

Make sure to adhere to the following guidelines:

- **Wear an anti-static wristband:** - Wearing an anti-static wristband can prevent electrostatic discharge.
- **Self-grounding:**- Touch a grounded conductor every few minutes to discharge any excess static buildup.
- **Use an anti-static pad:** When configuring any circuit board, place it on an anti-static mat.
- **Only handle the edges of the PCB:**- Don't touch the surface of the motherboard. Hold the motherboard by the edges when handling.

### 2.2 Unpacking Precautions

When the KINO-DQM871 is unpacked, please do the following:

- Follow the antistatic guidelines above.
- Make sure the packing box is facing upwards when opening.
- Make sure all the packing list items are present.





## 2.3 Packing List



**NOTE:**

If any of the components listed in the checklist below are missing, do not proceed with the installation. Contact the IEI reseller or vendor the KINO-DQM871 was purchased from or contact an IEI sales representative directly by sending an email to [sales@ieiworld.com](mailto:sales@ieiworld.com).

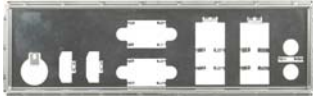
The KINO-DQM871 is shipped with the following components:

Quantity	Item and Part Number	Image
1	KINO-DQM871 SBC	
2	SATA and power cable (P/N: 32801-000100-300-RS)	
1	CPU cooler (preinstalled on the motherboard) (P/N: 19100-000176-00-RS)	
1	I/O shielding (P/N: 45014-0048C0-00-RS)	
1	Mini jumper pack (2.0mm) (P/N: 33101-000657-RS)	

## KINO-DQM871 Mini-ITX SBC















Quantity	Item and Part Number	Image
1	Utility CD	
1	One Key Recovery CD	
1	Quick installation guide	

Table 2-1: Packing List

## 2.4 Optional Items

These optional items are available.

Item and Part Number	Image
Dual RS-232 cable with Bracket (P/N:19800-000300-100-RS)	
RS-422/485 cable (P/N: 32205-003800-300-RS)	
Dual USB cable (w bracket) (P/N: 19800-003100-300-RS)	
Dual-port USB 3.0 cable with bracket (P/N: 19800-010500-100-RS)	

Item and Part Number	Image
KB/MS PS/2 Y-cable (P/N: 32000-023800-RS)	
Infineon TPM module (P/N: TPM-IN01-R11)	
DisplayPort to 24-bit dual channel LVDS converter board (For IEI IDP connector) (P/N: DP-LVDS-R10)	
DisplayPort to HDMI converter board (For IEI IDP connector) (P/N: DP-HDMI-R10)	
DisplayPort to DVI-D converter board (For IEI IDP connector) (P/N: DP-DVI-R10)	
DisplayPort to VGA converter board (For IEI IDP connector) (P/N: DP-VGA-R10)	
DisplayPort to DisplayPort converter board for iEi IDP connector (P/N: DP-DP-R10)	

**Table 2-2: Optional Items**

Chapter

**3**

# Connector Pinouts

---

### 3.1 Peripheral Interface Connectors

Section 3.1.1 shows peripheral interface connector locations. Section 3.1.2 lists all the peripheral interface connectors seen in Section 3.1.1.

#### 3.1.1 Layout

The figure below shows the on-board peripheral connectors, rear panel peripheral connectors and on-board jumpers.

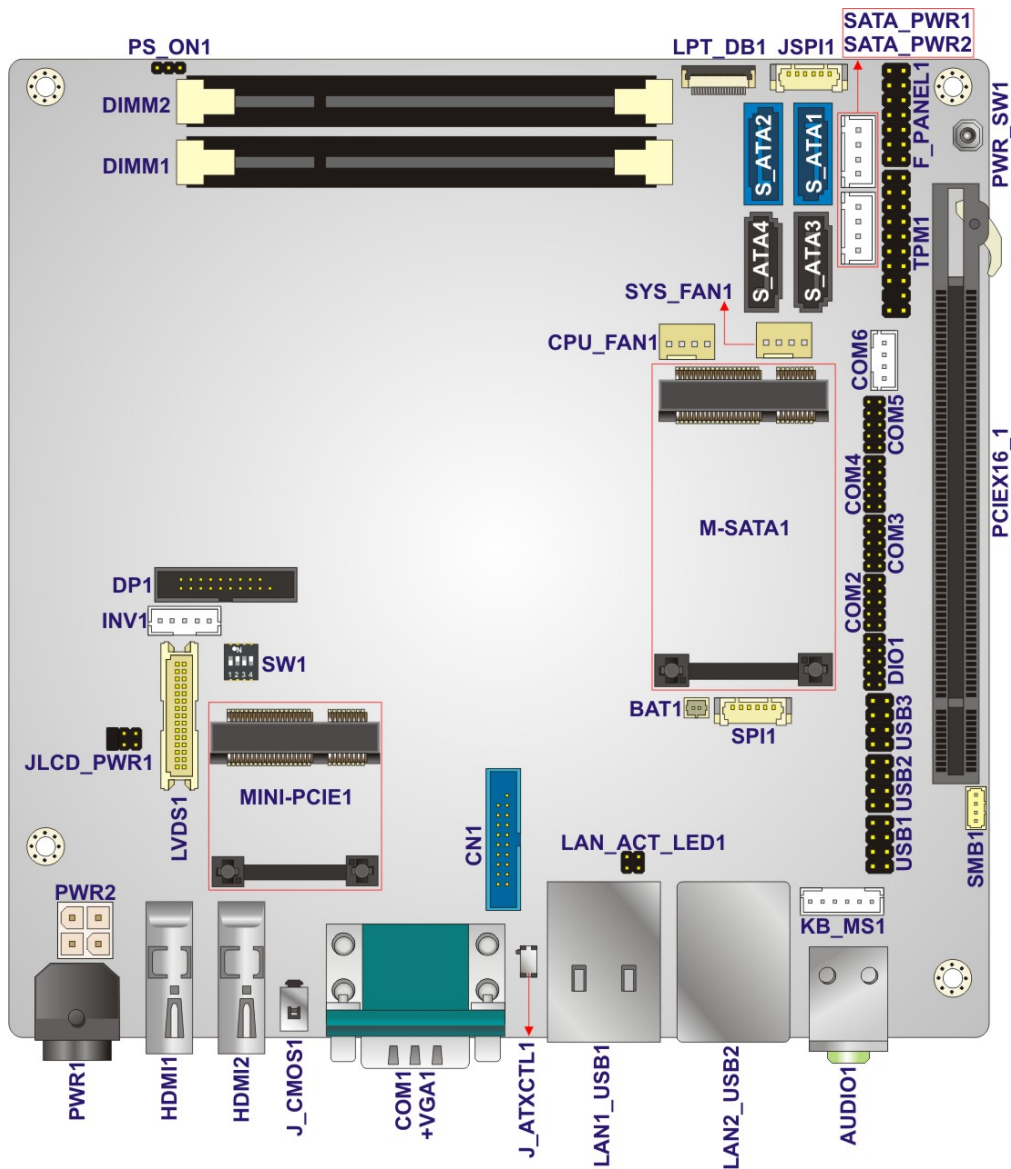

Figure 3-1: Connector and Jumper Locations

## KINO-DQM871 Mini-ITX SBC

### 3.1.2 Peripheral Interface Connectors

The table below shows a list of the peripheral interface connectors on the KINO-DQM871.

Detailed descriptions of these connectors can be found below.

Connector	Type	Label
ATX power signal connector	3-pin header	PS_ON1
Battery connector	2-pin wafer	BAT1
Digital I/O connector	10-pin header	DIO1
DisplayPort connector	20-pin box header	DP1
EC debug port	20-pin header	LPT_DB1
Fan connector (CPU)	4-pin wafer	CPU_FAN1
Fan connector (system)	4-pin wafer	SYS_FAN1
Front panel connector	14-pin header	F_PANEL1
Keyboard/mouse connector	6-pin wafer	KB_MS1
LAN active LED connector	4-pin header	LAN_ACT_LED1
LVDS connector	30-pin crimp	LVDS1
LVDS backlight connector	5-pin wafer	INV1
PCIe Mini card slot	Half-size PCIe Mini card slot	MINI-PCIE1
PCIe Mini card slot	Full-size PCIe Mini card slot	M-SATA1
PCIe x16 slot	PCIe x16 slot	PCIEX16_1
Power button (on-board)	Push button	PWR_SW1
Power connector (12V)	4-pin connector	PWR2
RS-232 serial ports	10-pin header	COM2, COM3, COM4, COM5
RS-422/485 serial port	4-pin wafer	COM6
SATA 3Gb/s connectors	SATA connector	S_ATA3, S_ATA4
SATA 6Gb/s connectors	SATA connector	S_ATA1, S_ATA2

Connector	Type	Label
SATA power connectors	4-pin wafer	SATA_PWR1, SATA_PWR2
SMBus connector	4-pin wafer	SMB1
SO-DIMM connectors	SO-DIMM connector	DIMM1, DIMM2
SPI Flash connector	6-pin wafer	SPI1
SPI Flash connector (EC)	6-pin header	JSPI1
TPM connector	20-pin header	TPM1
USB 2.0 connectors	8-pin header	USB1, USB2, USB3
USB 3.0/2.0 connector	20-pin box header	CN1

**Table 3-1: Peripheral Interface Connectors**

### 3.1.3 External Interface Panel Connectors

The table below lists the rear panel connectors on the KINO-DQM871. Detailed descriptions of these connectors can be found in a later section.

Connector	Type	Label
Audio jacks (mic-in, line-out)	Audio jack	AUDIO1
Ethernet and USB 2.0 connectors	RJ-45 and USB 2.0	LAN2_USB2
Ethernet and USB 3.0 connectors	RJ-45 and USB 3.0	LAN1_USB1
HDMI connectors	HDMI	HDMI1, HDMI2
Power connector	4-pin DIN	PWR1
RS-232 serial port	D-sub 9	COM1
VGA connector	D-sub 15	VGA1

**Table 3-2: Rear Panel Connectors**



## KINO-DQM871 Mini-ITX SBC

### 3.2 Internal Peripheral Connectors

Internal peripheral connectors are found on the motherboard and are only accessible when the motherboard is outside of the chassis. This section has complete descriptions of all the internal, peripheral connectors on the KINO-DQM871.

#### 3.2.1 ATX Power Signal Connector

- CN Label:** PS\_ON1
- CN Type:** 3-pin header
- CN Location:** See **Figure 3-2**
- CN Pinouts:** See **Table 3-3**

This connector provides power-on signal for ATX power mode. Users can use the power-on signal to work with devices that need to receive the PS\_ON signal in ATX mode.

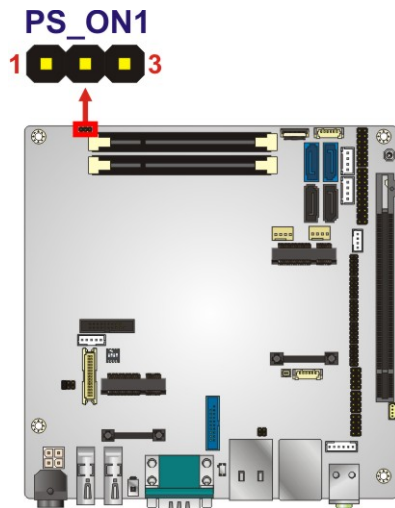

**Figure 3-2: ATX Power Signal Connector Location**

Pin	Description
1	5VSB
2	EC_PSON#
3	GND

**Table 3-3: ATX Power Signal Connector Pinouts**

### 3.2.2 Battery Connector



**CAUTION:**

Risk of explosion if battery is replaced by an incorrect type. Only certified engineers should replace the on-board battery.

Dispose of used batteries according to instructions and local regulations.

- CN Label:**        **BAT1**
- CN Type:**        2-pin wafer
- CN Location:**   See **Figure 3-3**
- CN Pinouts:**    See **Table 3-4**

This is connected to the system battery. The battery provides power to the system clock to retain the time when power is turned off.

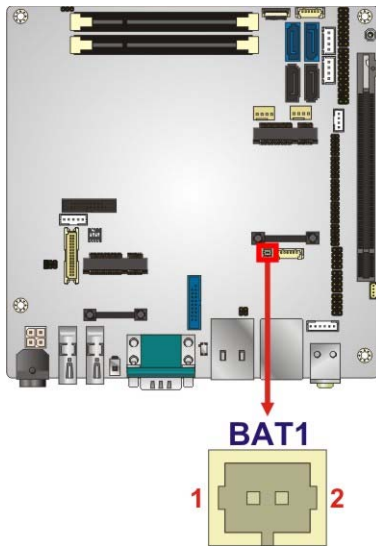

**Figure 3-3: Battery Connector Location**

## KINO-DQM871 Mini-ITX SBC

Pin	Description
1	Battery+
2	Ground

**Table 3-4: Battery Connector Pinouts**

### 3.2.3 Digital I/O Connector

- CN Label:** DIO1
- CN Type:** 10-pin header
- CN Location:** See **Figure 3-4**
- CN Pinouts:** See **Table 3-5**

The digital I/O connector provides programmable input and output for external devices. The digital I/O provides 4-bit output and 4-bit input.

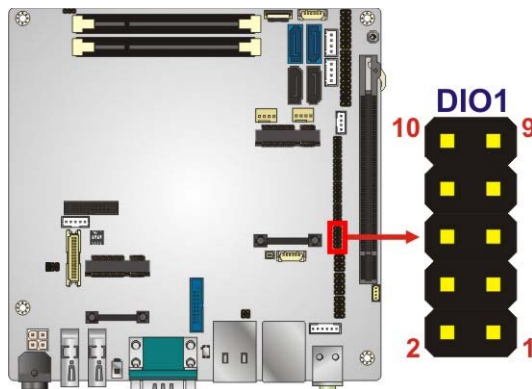

**Figure 3-4: Digital I/O Connector Location**

Pin	Description	Pin	Description
1	GND	2	+V5S
3	Output 3	4	Output 2
5	Output 1	6	Output 0
7	Input 3	8	Input 2
9	Input 1	10	Input 0

**Table 3-5: Digital I/O Connector Pinouts**

### 3.2.4 DisplayPort Connector

- CN Label:** DP1
- CN Type:** 20-pin box header
- CN Location:** See **Figure 3-5**
- CN Pinouts:** See **Table 3-6**

Connects to a monitor that accepts DisplayPort input.

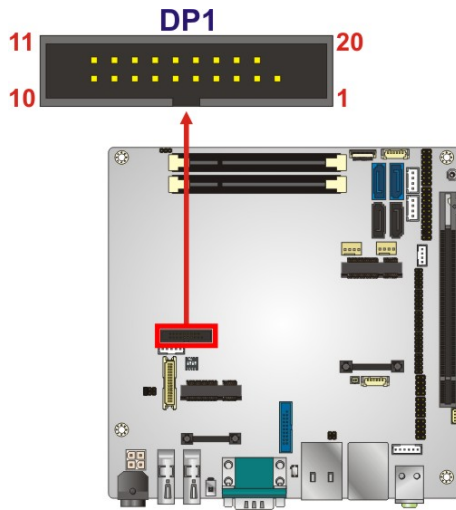

**Figure 3-5: DisplayPort Connector Location**

Pin	Description	Pin	Description
1	+5V	11	AUX_N2
2	DPB_OB_LANE1_N	12	AUX_P2
3	DPB_OB_LANE1_P	13	GND
4	GND	14	DPB_OB_LANE2_P
5	DPB_OB_LANE3_N	15	DPB_OB_LANE2_N
6	DPB_OB_LANE3_P	16	GND
7	GND	17	DPB_OB_LANE0_P
8	DP2_CFG1	18	DPB_OB_LANE0_N
9	GND	19	+3.3V
10	TMDS_B_HPD#		

**Table 3-6: DisplayPort Connector Pinouts**

## KINO-DQM871 Mini-ITX SBC

### 3.2.5 EC Debug Port

- CN Label:** LPT\_DB1
- CN Type:** 20-pin header
- CN Location:** See **Figure 3-6**
- CN Pinouts:** See **Table 3-7**

The connector is for EC debug only.

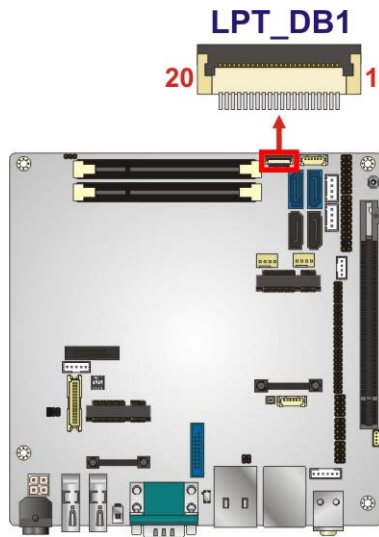

**Figure 3-6: BIOS Debug Port Location**

Pin	Description	Pin	Description
1	KS10	2	KSO0
3	KSO1	4	KSO2
5	KSO3	6	KSO4
7	KSO5	8	KSO6
9	KS07	10	KS08
11	KS09	12	KS010
13	KSO12	14	KS11
15	KSO11	16	KS12
17	KS13	18	GND
19	GND	20	GND

**Table 3-7: EC Debug Port Pinouts**

### 3.2.6 Fan Connector (CPU)

- CN Label:** CPU\_FAN1
- CN Type:** 4-pin wafer
- CN Location:** See **Figure 3-7**
- CN Pinouts:** See **Table 3-8**

The fan connector attaches to a CPU cooling fan.

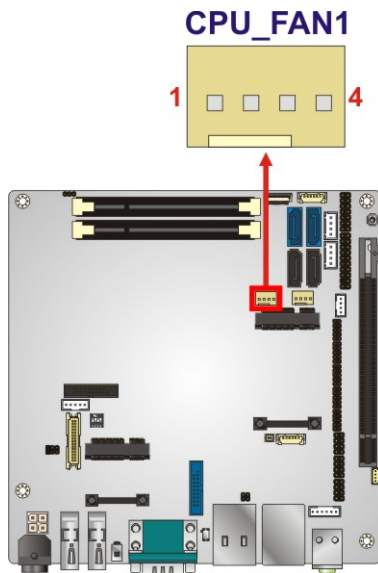

**Figure 3-7: CPU Fan Connector Location**

Pin	Description
1	GND
2	+V12S
3	Rotation Signal
4	PWM Control Signal

**Table 3-8: CPU Fan Connector Pinouts**

### 3.2.7 Fan Connector (System)

- CN Label:** SYS\_FAN1
- CN Type:** 4-pin wafer

## KINO-DQM871 Mini-ITX SBC

**CN Location:** See Figure 3-8

**CN Pinouts:** See Table 3-9

The fan connector attaches to a system cooling fan.

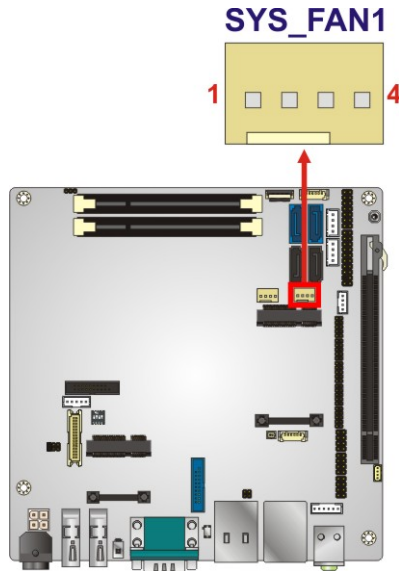

**Figure 3-8: System Fan Connector Location**

Pin	Description
1	GND
2	+V12S
3	Rotation Signal
4	PWM Control Signal

**Table 3-9: System Fan Connector Pinouts**

### 3.2.8 Front Panel Connector

**CN Label:** F\_PANEL1

**CN Type:** 14-pin header

**CN Location:** See Figure 3-9

**CN Pinouts:** See Table 3-10

The front panel connector connects to the indicator LEDs and buttons on the computer's front panel.

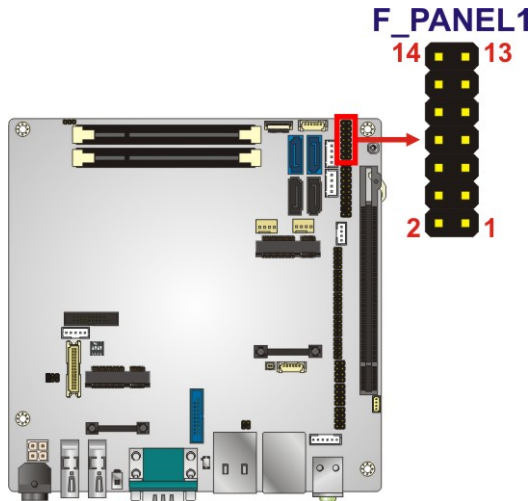

**Figure 3-9: Front Panel Connector Location**

	Pin	Description		Pin	Description
Power LED	1	PWR_LED+	Buzzer	2	BEEP_PWR
	3	NC		4	NC
	5	PWR_LED-		6	NC
Power Button	7	PWRBTN_SW#_C	8	PC_BEEP	
	9	GND	Reset	10	NC
HDD LED	11	HDD_LED+		12	EXTRST-
	13	HDD_LED-		14	GND

**Table 3-10: Front Panel Connector Pinouts**

### 3.2.9 Keyboard/Mouse Connector

- CN Label:** KB\_MS1
- CN Type:** 6-pin wafer
- CN Location:** See **Figure 3-10**
- CN Pinouts:** See **Table 3-11**



## KINO-DQM871 Mini-ITX SBC

The keyboard/mouse connector connects to a PS/2 Y-cable that can be connected to a PS/2 keyboard and mouse.

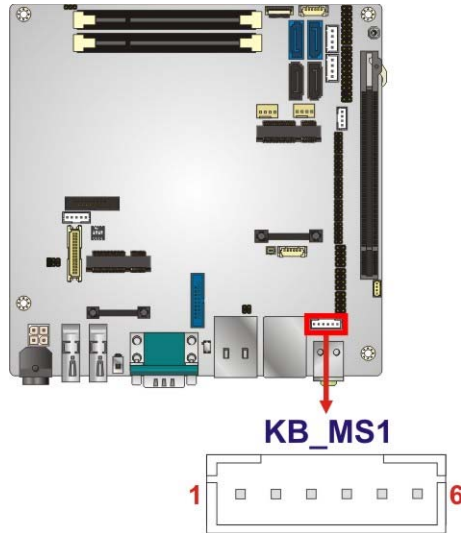

**Figure 3-10: Keyboard/Mouse Connector Location**

Pin	Description
1	VCC5_KBMS
2	Mouse Data
3	Mouse Clock
4	Keyboard Data
5	Keyboard Clock
6	GND

**Table 3-11: Keyboard/Mouse Connector Pinouts**

### 3.2.10 LAN Active LED Connector

**CN Label:** LAN\_ACT\_LED1

**CN Type:** 4-pin header

**CN Location:** See **Figure 3-11**

**CN Pinouts:** See **Table 3-12**

The connector is for active LED connection of the external LAN ports.

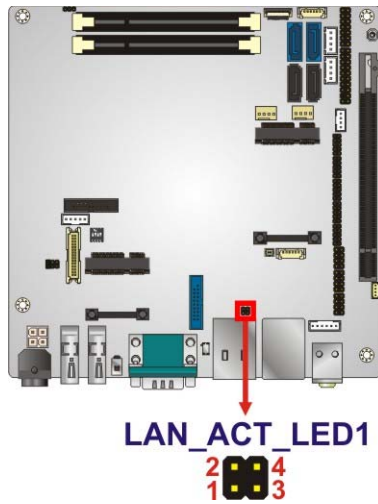

**Figure 3-11: LAN Active LED Connector Location**

Pin	Description	Pin	Description
1	LAN1_LINK_ACT-	2	V_3P3_LAN
3	LAN2_LINK_ACT-	4	+3.3A

**Table 3-12: LAN Active LED Connector Pinouts**

### 3.2.11 LVDS Connector

- CN Label:** LVDS1
- CN Type:** 30-pin crimp
- CN Location:** See **Figure 3-12**
- CN Pinouts:** See **Table 3-13**

The LVDS connector is for an LCD panel connected to the board.

KINO-DQM871 Mini-ITX SBC

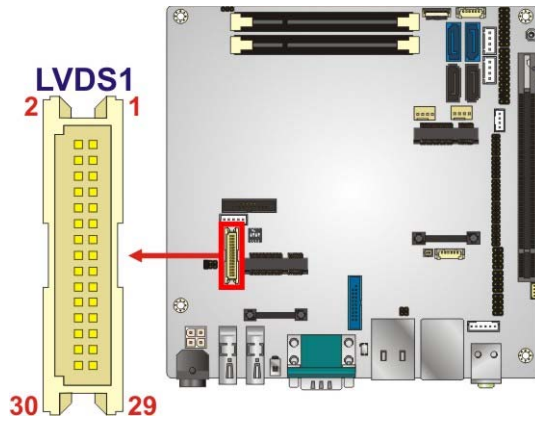

Figure 3-12: LVDS Connector Location

Pin	Description	Pin	Description
1	GND	2	GND
3	LVDS_A_TX0-P	4	LVDS_A_TX0-N
5	LVDS_A_TX1-P	6	LVDS_A_TX1-N
7	LVDS_A_TX2-P	8	LVDS_A_TX2-N
9	LVDS_A_TXCLK-P	10	LVDS_A_TXCLK-N
11	LVDS_A_TX3-P	12	LVDS_A_TX3-N
13	GND	14	GND
15	LVDS_B_TX0-P	16	LVDS_B_TX0-N
17	LVDS_B_TX1-P	18	LVDS_B_TX1-N
19	LVDS_B_TX2-P	20	LVDS_B_TX2-N
21	LVDS_B_TXCLK-P	22	LVDS_B_TXCLK-N
23	LVDS_B_TX3-P	24	LVDS_B_TX3-N
25	GND	26	GND
27	+LCD Vcc	28	+LCD Vcc
29	+LCD Vcc	30	+LCD Vcc

Table 3-13: LVDS Connector Pinouts

### 3.2.12 LVDS Backlight Connector

- CN Label:** INV1
- CN Type:** 5-pin wafer
- CN Location:** See **Figure 3-13**
- CN Pinouts:** See **Table 3-14**

The backlight inverter connectors provide power to LCD panels.

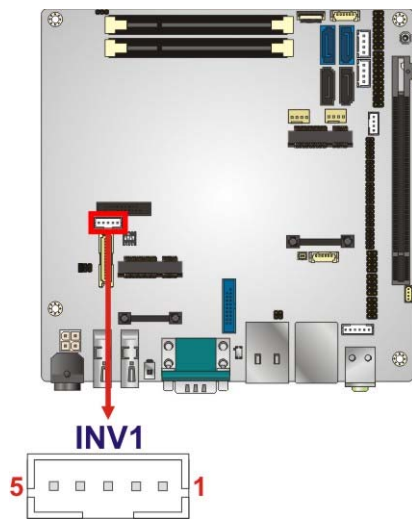

**Figure 3-13: LVDS Backlight Inverter Connector**

Pin	Description
1	BRIGHTNESS
2	GROUND
3	+12VS_LCD_BKL
4	GROUND
5	BACKLIGHT ENABLE

**Table 3-14: Backlight Inverter Connector Pinouts**

### 3.2.13 PCIe Mini Card Slot (Full-size)

- CN Label:** M-SATA1
- CN Type:** Full-size PCIe Mini card slot

## KINO-DQM871 Mini-ITX SBC

**CN Location:** See Figure 3-14

**CN Pinouts:** See Table 3-15

The PCIe Mini card slot enables a PCIe Mini card expansion module to be connected to the board. Cards supported include among others PCIe Mini cards and mSATA cards.

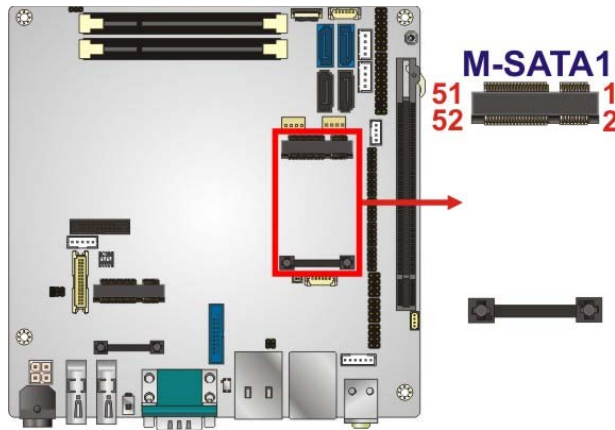

**Figure 3-14: PCIe Mini Card Slot Location**

Pin	Description	Pin	Description
1	PCIE_WAKE#	2	VCC3
3	N/C	4	GND
5	N/C	6	1.5V
7	N/C	8	N/C
9	GND	10	N/C
11	CLK-	12	N/C
13	CLK+	14	N/C
15	GND	16	N/C
17	PCIRST#	18	GND
19	N/C	20	VCC3
21	GND	22	PCIRST#
23	PERN2 (SATA_RX4+)	24	3VDual
25	PERP2 (SATA_RX4-)	26	GND
27	GND	28	1.5V
29	GND	30	SMBCLK
31	PETN2 (SATA_TX4-)	32	SMBDATA

Pin	Description	Pin	Description
33	PETP2 (SATA_TX4+)	34	GND
35	GND	36	USBD-
37	N/C	38	USBD+
39	N/C	40	GND
41	N/C	42	N/C
43	SATA_DET4_R_N	44	N/C
45	N/C	46	N/C
47	N/C	48	1.5V
49	N/C	50	GND
51	MSATA_SEL#	52	VCC3

**Table 3-15: PCIe Mini Card Slot Pinouts**

### 3.2.14 PCIe Mini Card Slot (Half-size)

- CN Label:** MINI\_PCIE1
- CN Type:** Half-size PCIe Mini card slot
- CN Location:** See **Figure 3-15**
- CN Pinouts:** See **Table 3-16**

The PCIe Mini card slot enables a PCIe Mini card expansion module to be connected to the board.

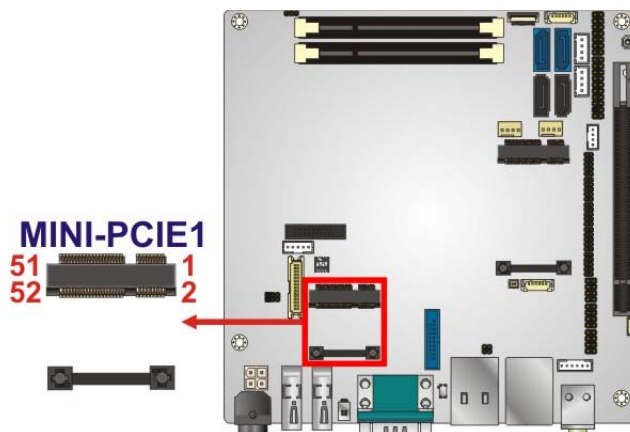

**Figure 3-15: PCIe Mini Card Slot Location**

## KINO-DQM871 Mini-ITX SBC

Pin	Description	Pin	Description
1	PCIE_WAKE#	2	VCC3
3	N/C	4	GND
5	N/C	6	1.5V
7	N/C	8	N/C
9	GND	10	N/C
11	CLK-	12	N/C
13	CLK+	14	N/C
15	GND	16	N/C
17	PCIRST#	18	GND
19	N/C	20	VCC3
21	GND	22	PCIRST#
23	PERN2	24	3VDual
25	PERP2	26	GND
27	GND	28	1.5V
29	GND	30	SMBCLK
31	PETN2	32	SMBDATA
33	PETP2	34	GND
35	GND	36	USB D-
37	N/C	38	USB D+
39	N/C	40	GND
41	N/C	42	N/C
43	SATA_DET4_R_N	44	N/C
45	N/C	46	N/C
47	N/C	48	1.5V
49	N/C	50	GND
51	MSATA_SEL#	52	VCC3

**Table 3-16: PCIe Mini Card Slot Pinouts**

### 3.2.15 PCI Express x16 Slot

**CN Label:** PCIEX16\_1

**CN Type:** PCIe x16 slot

**CN Location:** See Figure 3-16

**CN Pinouts:** See Table 3-17 (Side A) Table 3-18 (Side B)

The PCIe x16 expansion cards slot is for PCIe x16 expansion cards.

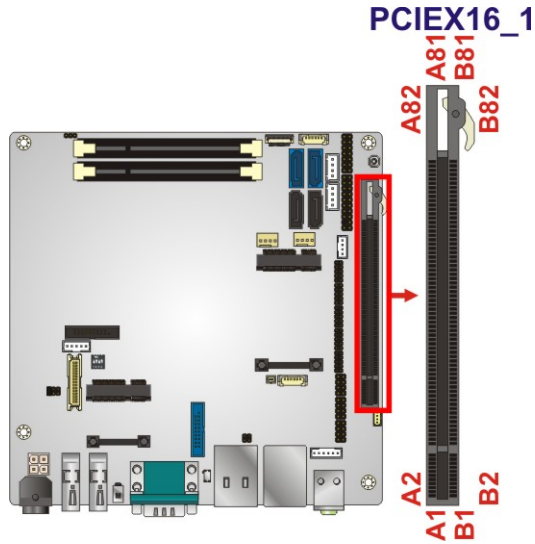

**Figure 3-16: PCIe x16 Slot Location**

Pin	Description	Pin	Description	Pin	Description	Pin	Description
A1	Name	A22	HSIn(1)	A43	HSIp(6)	A64	HSIp(11)
A2	PRSNT#1	A23	GND	A44	HSIn(6)	A65	HSIn(11)
A3	+12v	A24	GND	A45	GND	A66	GND
A4	+12v	A25	HSIp(2)	A46	GND	A67	GND
A5	GND	A26	HSIn(2)	A47	HSIp(7)	A68	HSIp(12)
A6	JTAG2	A27	GND	A48	HSIn(7)	A69	HSIn(12)
A7	JTAG3	A28	GND	A49	GND	A70	GND
A8	JTAG4	A29	HSIp(3)	A50	RSVD	A71	GND
A9	JTAG5	A30	HSIn(3)	A51	GND	A72	HSIp(13)
A10	+3.3v	A31	GND	A52	HSIp(8)	A73	HSIn(13)
A11	+3.3v	A32	RSVD	A53	HSIn(8)	A74	GND
A12	PWRGD	A33	RSVD	A54	GND	A75	GND
A13	GND	A34	GND	A55	GND	A76	HSIp(14)
A14	REFCLK+	A35	HSIp(4)	A56	HSIp(9)	A77	HSIn(14)



## KINO-DQM871 Mini-ITX SBC

Pin	Description	Pin	Description	Pin	Description	Pin	Description
A15	REFCLK-	A36	HSIn(4)	A57	HSIn(9)	A78	GND
A16	GND	A37	GND	A58	GND	A79	GND
A17	HSIp(0)	A38	GND	A59	GND	A80	HSIp(15)
A18	HSIn(0)	A39	HSIp(5)	A60	HSIp(10)	A81	HSIn(15)
A19	GND	A40	HSIn(5)	A61	HSIn(10)	A82	GND
A20	RSVD	A41	GND	A62	GND		
A21	GND	A42	GND	A63	GND		

**Table 3-17: PCIe x16 Side A Pinouts**

Pin	Description	Pin	Description	Pin	Description	Pin	Description
B1	+12v	B22	GND	B43	GND	B64	GND
B2	+12v	B23	HSOp(2)	B44	GND	B65	GND
B3	RSVD	B24	HSOn(2)	B45	HSOp(7)	B66	HSOp(12)
B4	GND	B25	GND	B46	HSOn(7)	B67	HSOn(12)
B5	SMCLK	B26	GND	B47	GND	B68	GND
B6	SMDAT	B27	HSOp(3)	B48	PRSNT#2	B69	GND
B7	GND	B28	HSOn(3)	B49	GND	B70	HSOp(13)
B8	+3.3v	B29	GND	B50	HSOp(8)	B71	HSOn(13)
B9	JTAG1	B30	RSVD	B51	HSOn(8)	B72	GND
B10	3.3 Vaux	B31	PRSNT#2	B52	GND	B73	GND
B11	WAKE#	B32	GND	B53	GND	B74	HSOp(14)
B12	RSVD	B33	HSOp(4)	B54	HSOp(9)	B75	HSOn(14)
B13	GND	B34	HSOn(4)	B55	HSOn(9)	B76	GND
B14	HSOp(0)	B35	GND	B56	GND	B77	GND
B15	HSOn(0)	B36	GND	B57	GND	B78	HSOp(15)
B16	GND	B37	HSOp(5)	B58	HSOp(10)	B79	HSOn(15)
B17	PRSNT#2	B38	HSOn(5)	B59	HSOn(10)	B80	GND
B18	GND	B39	GND	B60	GND	B81	PRSNT#2
B19	HSOp(1)	B40	GND	B61	GND	B82	RSVD#2
B20	HSOn(1)	B41	HSOp(6)	B62	HSOp(11)		

Pin	Description	Pin	Description	Pin	Description	Pin	Description
B21	GND	B42	HSOn(6)	B63	HSOn(11)		

**Table 3-18: PCIe x16 Side B Pinouts**

### 3.2.16 Power Button (On-board)

- CN Label:** PWR\_SW1
- CN Type:** Push button
- CN Location:** See **Figure 3-17**

Push the on-board power button to power on the KINO-DQM871.

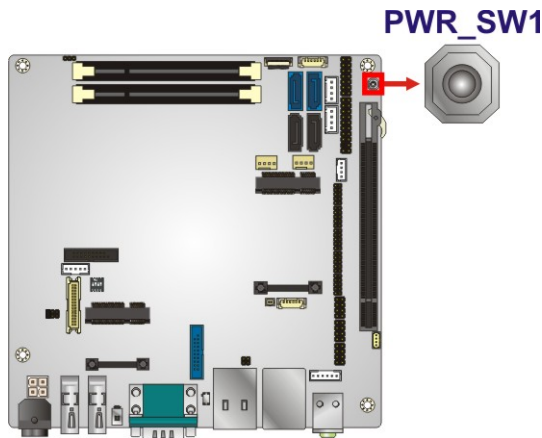

**Figure 3-17: On-board Power Button Location**

### 3.2.17 Power Connector (12V)

- CN Label:** PWR2
- CN Type:** 4-pin connector
- CN Location:** See **Figure 3-18**
- CN Pinouts:** See **Table 3-19**

The power connector is connected to an external power supply and supports 12V power input. Power is provided to the system, from the power supply through this connector.

**KINO-DQM871 Mini-ITX SBC**

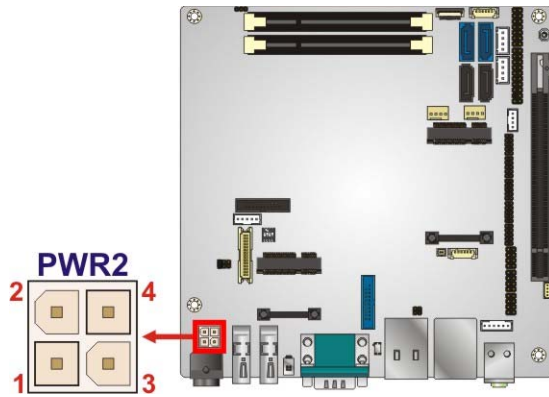

**Figure 3-18: Power Connector Location**

Pin	Description	Pin	Description
1	Ground	2	Ground
3	+12V	4	+12V

**Table 3-19: Power Connector Pinouts**

**3.2.18 RS-232 Serial Port Connectors (COM2 ~ COM5)**

**CN Label:** COM2, COM3, COM4, COM5

**CN Type:** 10-pin header

**CN Location:** See **Figure 3-19**

**CN Pinouts:** See **Table 3-20**

The 10-pin serial port connector provides one RS-232 serial communications channel. The COM serial port connector can be connected to an external RS-232 serial port device.

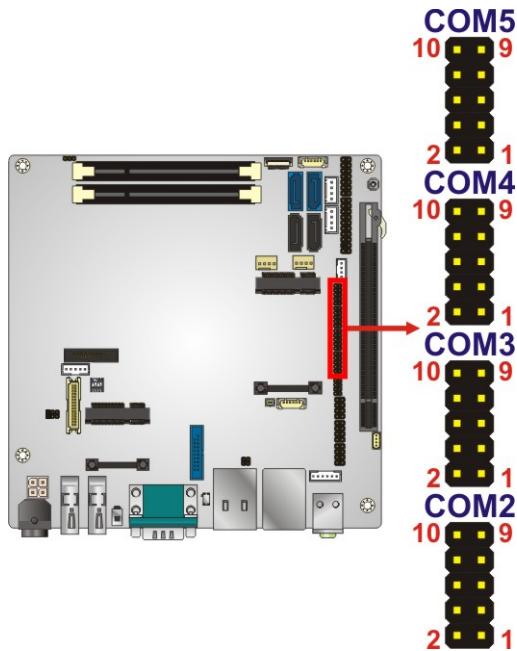

**Figure 3-19: RS-232 Serial Port Connector Location**

Pin	Description	Pin	Description
1	-ND CD	2	-NDSR
3	NSIN	4	-NRTS
5	NSOUT	6	-NCTS
7	-NDTR	8	-XRI
9	GND	10	GND

**Table 3-20: Serial Port Connector Pinouts**

### 3.2.19 RS-422/485 Serial Port Connector (COM6)

- CN Label:** COM6
- CN Type:** 4-pin wafer
- CN Location:** See **Figure 3-20**
- CN Pinouts:** See **Table 3-21**

This connector provides RS-422 or RS-485 communications.

## KINO-DQM871 Mini-ITX SBC

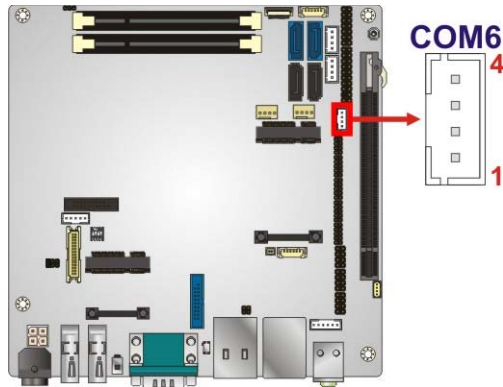

Figure 3-20: RS-422/485 Serial Port Connector Location

Pin	Description
1	RXD422-
2	RXD422+
3	TXD422+/TXD485+
4	TXD422-/TXD485-

Table 3-21: RS-422/485 Serial Port Connector Pinouts

Use the optional RS-422/485 cable to connect to a serial device. The pinouts of the D-sub 9 connector are listed below.

RS-422 Pinouts	RS-485 Pinouts

Table 3-22: D-sub 9 RS-422/485 Pinouts

### 3.2.20 SATA 6Gb/s Drive Connectors

- CN Label:** S\_ATA1, S\_ATA2
- CN Type:** 7-pin SATA drive connectors
- CN Location:** See Figure 3-21

**CN Pinouts:** See **Table 3-23**

The SATA connectors connect to SATA hard drives or optical drives with data transfer speeds as high as 6Gb/s.

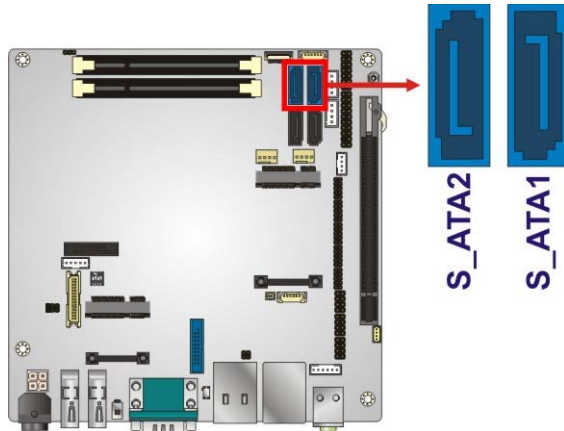

**Figure 3-21: SATA 6Gb/s Drive Connector Locations**

Pin	Description
1	GND
2	TX+
3	TX-
4	GND
5	RX-
6	RX+
7	GND

**Table 3-23: SATA 6Gb/s Drive Connector Pinouts**

### 3.2.21 SATA 3Gb/s Drive Connectors

**CN Label:** S\_ATA3, S\_ATA4

**CN Type:** 7-pin SATA drive connectors

**CN Location:** See **Figure 3-22**

**CN Pinouts:** See **Table 3-24**

## KINO-DQM871 Mini-ITX SBC

The SATA connectors connect to SATA hard drives or optical drives with data transfer speeds as high as 3Gb/s.

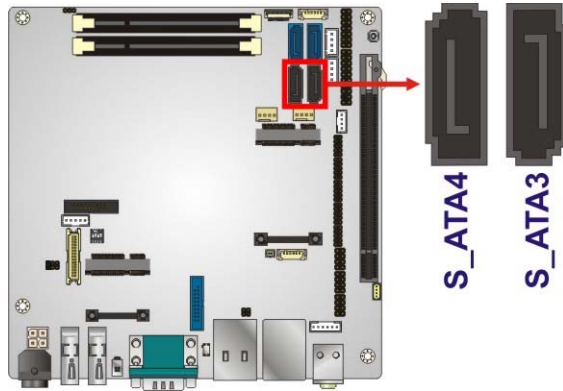

Figure 3-22: SATA 3Gb/s Drive Connector Locations

Pin	Description
1	GND
2	TX+
3	TX-
4	GND
5	RX-
6	RX+
7	GND

Table 3-24: SATA 3Gb/s Drive Connector Pinouts

### 3.2.22 SATA Power Connectors

**CN Label:** SATA\_PWR1, SATA\_PWR2

**CN Type:** 4-pin wafer

**CN Location:** See Figure 3-23

**CN Pinouts:** See Table 3-25

Use the SATA Power Connector to connect to SATA device power connections.

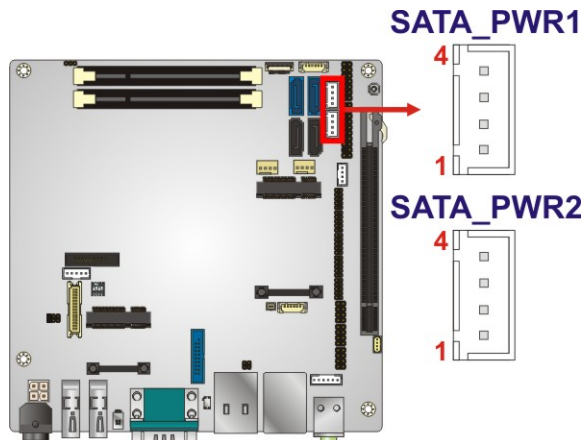

**Figure 3-23: SATA Power Connector Locations**

Pin	Description
1	+V12S
2	GND
3	GND
4	+V5S

**Table 3-25: SATA Power Connector Pinouts**

### 3.2.23 SMBus Connector

- CN Label:** SMB1
- CN Type:** 4-pin wafer
- CN Location:** See **Figure 3-24**
- CN Pinouts:** See **Table 3-26**

The SMBus (System Management Bus) connector provides low-speed system management communications.



**KINO-DQM871 Mini-ITX SBC**

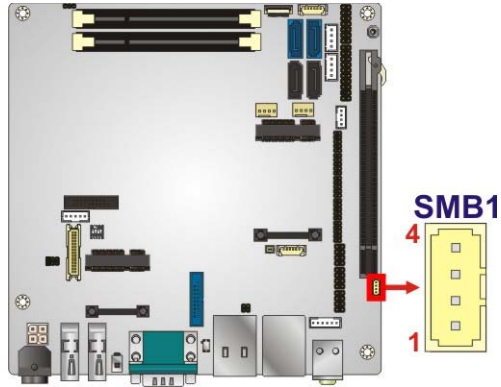

**Figure 3-24: SMBus Connector Location**

Pin	Description
1	GND
2	SMB_DATA
3	SMB_CLK
4	+V5S

**Table 3-26: SMBus Connector Pinouts**

**3.2.24 SO-DIMM Connectors**

**CN Label:** DIMM1, DIMM2

**CN Type:** 204-pin DDR3 SO-DIMM connector

**CN Location:** See **Figure 3-25**

The SO-DIMM connector is for installing memory on the system.

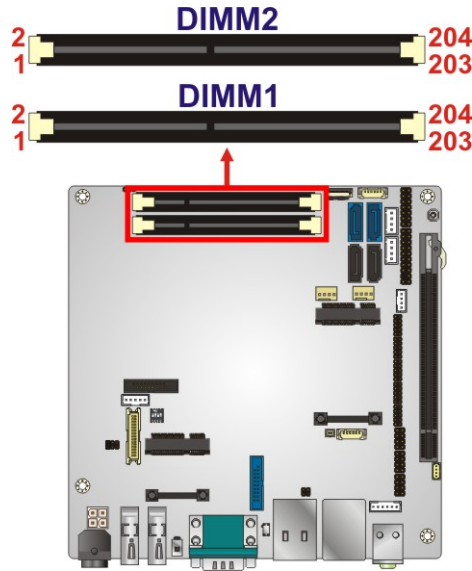
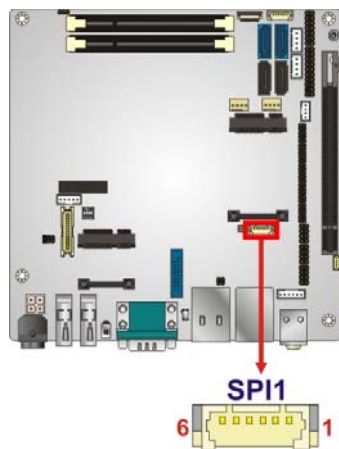

**Figure 3-25: SO-DIMM Connector Locations**

### 3.2.25 SPI Flash Connector

- CN Label:** SPI1
- CN Type:** 6-pin wafer
- CN Location:** See **Figure 3-26**
- CN Pinouts:** See **Table 3-27**

The 6-pin SPI Flash connector is used to flash the BIOS.



**Figure 3-26: SPI Flash Connector Location**

**KINO-DQM871 Mini-ITX SBC**

Pin	Description
1	+V3.3M_SPI_CON
2	SPI_CS#0_CN
3	SPI_SO_SW
4	SPI_CLK_SW
5	SPI_SI_SW
6	GND

**Table 3-27: SPI Flash Connector Pinouts**

**3.2.26 SPI Flash Connector (EC)**

- CN Label:** JSPI1
- CN Type:** 6-pin wafer
- CN Location:** See **Figure 3-27**
- CN Pinouts:** See **Table 3-28**

The 6-pin EC SPI Flash connector is used to flash the BIOS.

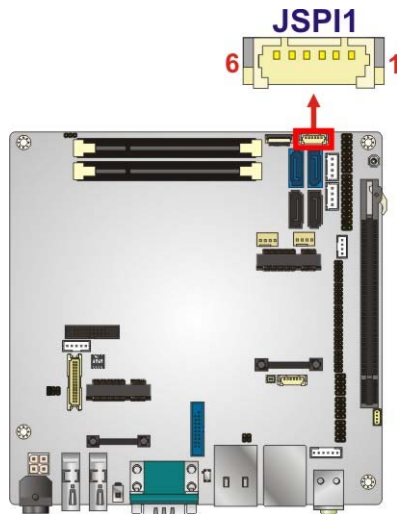

**Figure 3-27: EC SPI Flash Connector Location**

Pin	Description
1	+V3.3M_SPI_CON_EC
2	SPI_CS#0_CN_EC
3	SPI_SO_SW_EC
4	SPI_CLK_SW_EC
5	SPI_SI_SW_EC
6	GND

**Table 3-28: EC SPI Flash Connector Pinouts**

### 3.2.27 TPM Connector

- CN Label:** TPM1
- CN Type:** 20-pin header
- CN Location:** See **Figure 3-28**
- CN Pinouts:** See **Table 3-29**

The Trusted Platform Module (TPM) connector secures the system on bootup.

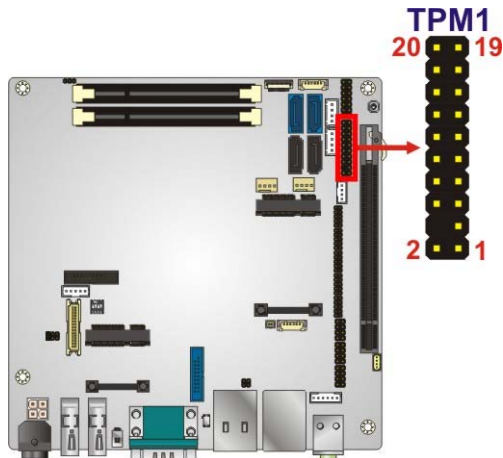

**Figure 3-28: TPM Connector Location**

Pin	Description	Pin	Description
1	LCLK	2	GND
3	LFRAME#	4	KEY

**KINO-DQM871 Mini-ITX SBC**

Pin	Description	Pin	Description
5	LRERST#	6	+5V
7	LAD3	8	LAD2
9	+3V	10	LAD1
11	LAD0	12	GND
13	SCL	14	SDA
15	SB3V	16	SERIRQ
17	GND	18	GLKRUN#
19	LPCPD#	20	LDRQ#

**Table 3-29: TPM Connector Pinouts**

**3.2.28 USB 2.0 Connectors**

**CN Label:** USB1, USB2, USB3

**CN Type:** 8-pin header

**CN Location:** See Figure 3-29

**CN Pinouts:** See Table 3-30

The USB header can connect to two USB devices.

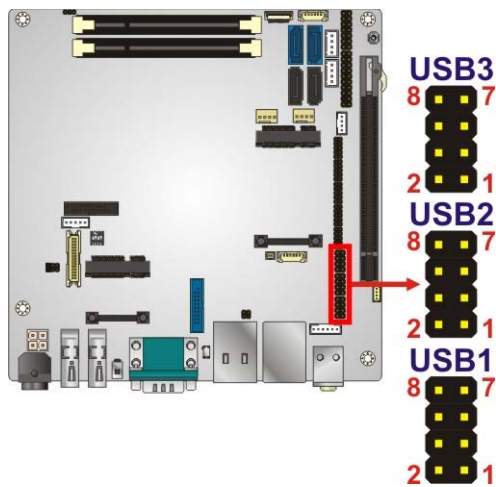

**Figure 3-29: USB Connector Locations**

Pin	Description	Pin	Description
1	VCC	2	GND

Pin	Description	Pin	Description
3	DATA-	4	DATA+
5	DATA+	6	DATA-
7	GND	8	VCC

**Table 3-30: USB Port Connector Pinouts**

### 3.2.29 USB 3.0/2.0 Connector

- CN Label:** CN1
- CN Type:** 20-pin box header
- CN Location:** See **Figure 3-30**
- CN Pinouts:** See **Table 3-31**

The connector supports two USB 3.0 ports and two USB 2.0 ports connection.

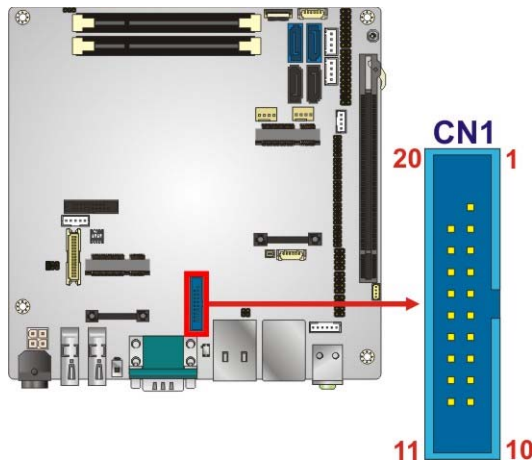

**Figure 3-30: USB 3.0/2.0 Connector Location**

Pin	Description	Pin	Description
1	+5V	11	USB2_DP2
2	USB3_RXDN5_C	12	USB2_DN2
3	USB3_RXDP5_C	13	GND
4	GND	14	USB3_TXDP4_C
5	USB3_TXDN5_C	15	USB3_TXDN4_C
6	USB3_TXDP5_C	16	GND

## KINO-DQM871 Mini-ITX SBC

Pin	Description	Pin	Description
7	GND	17	USB3_RXDP4_C
8	USB2_DN3	18	USB3_RXDN4_C
9	USB2_DP3	19	+5V
10	NC		

Table 3-31: USB 3.0/2.0 Connector Pinouts

### 3.3 External Interface Connectors

Figure 3-31 shows the KINO-DQM871 motherboard external interface connectors. The KINO-DQM871 on-board external interface connectors are shown in **Figure 3-31**.

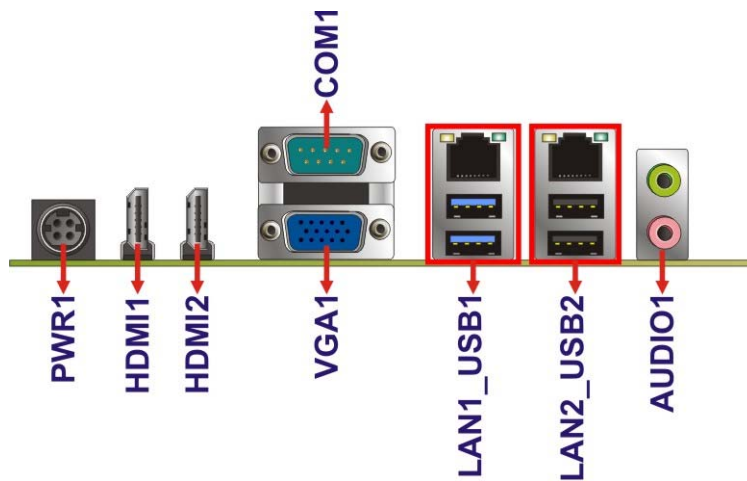

Figure 3-31: External Interface Connectors

#### 3.3.1 Audio Connector

**CN Label:** AUDIO1  
**CN Type:** Audio jack  
**CN Location:** See **Figure 3-31**

The audio jacks connect to external audio devices.

- **Line Out port (Lime):** Connects to a headphone or a speaker. With multi-channel configurations, this port can also connect to front speakers.
- **Microphone (Pink):** Connects a microphone.



**Figure 3-32: Audio Jacks**

### 3.3.2 Ethernet and USB 2.0 Connectors

- CN Label:** LAN2\_USB2
- CN Type:** RJ-45 and USB 2.0 combo connector
- CN Location:** See **Figure 3-31**
- CN Pinouts:** See **Table 3-32** and **Table 3-34**

The LAN connector connects to a local network.

PIN	DESCRIPTION	PIN	DESCRIPTION
1	MDIA0+	5	MDIA2-
2	MDIA0-	6	MDIA1-
3	MDIA1+	7	MDIA3+
4	MDIA2+	8	MDIA3-

**Table 3-32: LAN2 Pinouts**

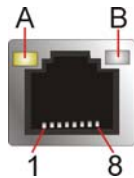

**Figure 3-33: Ethernet Connector**



## KINO-DQM871 Mini-ITX SBC

LED	Description	LED	Description
A	on: linked blinking: data is being sent/received	B	off: 10 Mb/s green: 100 Mb/s orange: 1000 Mb/s

**Table 3-33: Connector LEDs**

The USB 2.0 connector can be connected to a USB device.

Pin	Description
1	VBUS
2	D1-
3	D1+
4	GND

**Table 3-34: External USB 2.0 Port Pinouts**

### 3.3.3 Ethernet and USB 3.0 Connectors

**CN Label:** LAN1\_USB1

**CN Type:** RJ-45 and USB 3.0 combo connector

**CN Location:** See **Figure 3-31**

**CN Pinouts:** See **Table 3-35** and **Table 3-37**

The LAN connector connects to a local network. It supports Intel® AMT 9.0.

PIN	DESCRIPTION	PIN	DESCRIPTION
1	MDIA0+	5	MDIA2-
2	MDIA0-	6	MDIA1-
3	MDIA1+	7	MDIA3+
4	MDIA2+	8	MDIA3-

**Table 3-35: LAN1 Pinouts**

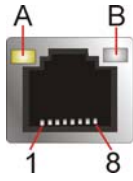

**Figure 3-34: Ethernet Connector**

LED	Description	LED	Description
A	on: linked blinking: data is being sent/received	B	off: 10 Mb/s green: 100 Mb/s orange: 1000 Mb/s

**Table 3-36: Connector LEDs**

The USB 3.0 connector can be connected to a USB device.

Pin	Description
1	VBUS
2	D1-
3	D1+
4	GND1
5	STDA_SSRX1_N
6	STDA_SSRX1_P
7	GND_DRAIN
8	STDA_SSTX1_N
9	STDA_SSTX1_P

**Table 3-37: External USB 3.0 Port Pinouts**

### 3.3.4 HDMI Connectors

- CN Label:** HDMI1, HDMI2
- CN Type:** HDMI connector
- CN Location:** See **Figure 3-31**
- CN Pinouts:** See **Table 3-38** and **Figure 3-35**

The HDMI connector connects to a display device with HDMI interface.

**KINO-DQM871 Mini-ITX SBC**

Pin	Description	Pin	Description
1	HDMI_DATA2	11	GND
2	GND	12	HDMI_CLK#
3	HDMI_DATA2#	13	N/C
4	HDMI_DATA1	14	N/C
5	GND	15	HDMI_SCL
6	HDMI_DATA1#	16	HDMI_SDA
7	HDMI_DATA0	17	GND
8	GND	18	+5V
9	HDMI_DATA0#	19	HDMI_HPD
10	HDMI_CLK+		

**Table 3-38: HDMI Connector Pinouts**

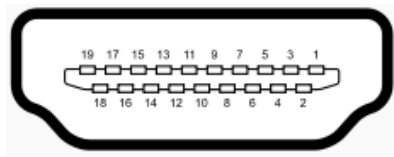
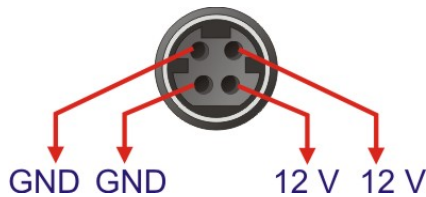

**Figure 3-35: HDMI Connector**

**3.3.5 Power Connector (12 V, Power Adapter)**

- CN Label:** PWR1
- CN Type:** 4-pin Mini-DIN
- CN Location:** See **Figure 3-31**
- CN Pinouts:** See **Figure 3-36**

The connector supports the 12V power adapter.



**Figure 3-36: 4-pin Power Mini-DIN Connection**

### 3.3.6 Serial Port Connector (COM1)

- CN Label:** COM1
- CN Type:** D-sub 9
- CN Location:** See **Figure 3-31**
- CN Pinouts:** See **Table 3-39**

The serial port connects to a RS-232 serial communications device.

PIN NO.	DESCRIPTION	PIN NO.	DESCRIPTION
1	DATA CARRIER DETECT (DCD1)	6	DATA SET READY (DSR1)
2	RECEIVE DATA (RXD1)	7	REQUEST TO SEND (RTS1)
3	TRANSMIT DATA (TXD1)	8	CLEAR TO SEND (CTS1)
4	DATA TERMINAL READY (DTR1)	9	RING INDICATOR (RI1)
5	GND		

**Table 3-39: Serial Port Pinouts**

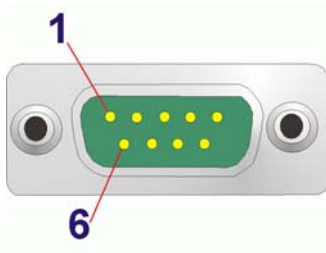

**Figure 3-37: Serial Port Pinouts**

### 3.3.7 VGA Connector

- CN Label:** VGA1
- CN Type:** 15-pin Female
- CN Location:** See **Figure 3-31**
- CN Pinouts:** See **Figure 3-38** and **Table 3-40**

Connects to a monitor that accepts a standard VGA input.

**KINO-DQM871 Mini-ITX SBC**

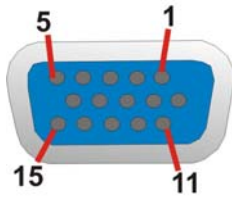

**Figure 3-38: VGA Connector**

Pin	Description	Pin	Description
1	RED	9	5V
2	GREEN	10	GROUND
3	BLUE	11	NC
4	NC	12	DDCDAT
5	GND	13	HSYNC
6	GND	14	VSYNC
7	GND	15	DDCCLK
8	GND		

**Table 3-40: VGA Connector Pinouts**

Chapter

4

# Installation

---

## KINO-DQM871 Mini-ITX SBC

### 4.1 Anti-static Precautions

---



#### **WARNING:**

Failure to take ESD precautions during installation may result in permanent damage to the product and severe injury to the user.

---

Electrostatic discharge (ESD) can cause serious damage to electronic components, including the KINO-DQM871. Dry climates are especially susceptible to ESD. It is therefore critical to strictly adhere to the following anti-static precautions whenever the KINO-DQM871, or any other electrical component, is handled.

- ***Wear an anti-static wristband:*** - Wearing a simple anti-static wristband can help to prevent ESD from damaging the board.
- ***Self-grounding:***- Before handling the board touch any grounded conducting material. During the time the board is handled, frequently touch any conducting materials that are connected to the ground.
- ***Use an anti-static pad:*** When configuring the KINO-DQM871, place it on an anti-static pad. This reduces the possibility of ESD damaging the KINO-DQM871.
- ***Only handle the edges of the PCB:-:*** When handling the PCB, hold it by the edges.

### 4.2 Installation Considerations

---



#### **NOTE:**

The following installation notices and installation considerations should be read and understood before the KINO-DQM871 is installed. All installation notices pertaining to the installation of KINO-DQM871 should be strictly adhered to. Failing to adhere to these precautions may lead to severe damage of the KINO-DQM871 and injury to the person installing the motherboard.

---

**WARNING:**

The installation instructions described in this manual should be carefully followed in order to prevent damage to the KINO-DQM871, KINO-DQM871 components and injury to the user.

Before and during the installation please **DO** the following:

- **Read the user manual:**
  - The user manual provides a complete description of the installation instructions and configuration options.
- **Wear an electrostatic discharge cuff (ESD):**
  - Electronic components are easily damaged by ESD. Wearing an ESD cuff removes ESD from the body and helps prevent ESD damage.
- **Place on an antistatic pad:**
  - When installing or configuring the motherboard, place it on an antistatic pad. This helps to prevent potential ESD damage.
- **Turn all power off:**
  - Make sure the product is disconnected from all power supplies and that no electricity is being fed into the system.

Before and during the installation of the KINO-DQM871 **DO NOT**:

- **DO NOT** remove any of the stickers on the PCB board. These stickers are required for warranty validation.
- **DO NOT** use the product before verifying all the cables and power connectors are properly connected.
- **DO NOT** allow screws to come in contact with the PCB circuit, connector pins, or its components.



## KINO-DQM871 Mini-ITX SBC

### 4.3 SO-DIMM Installation

To install a SO-DIMM, please follow the steps below and refer to **Figure 4-1**.

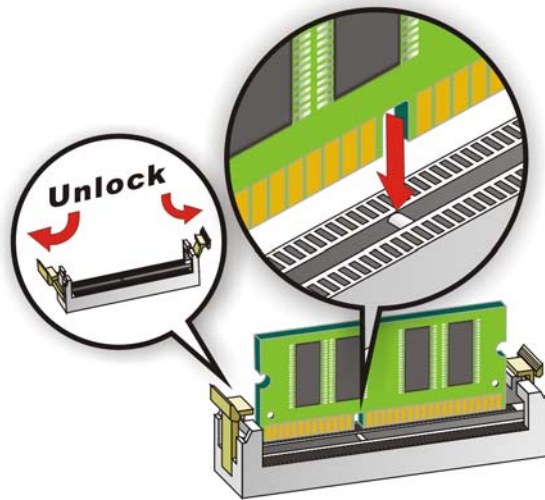
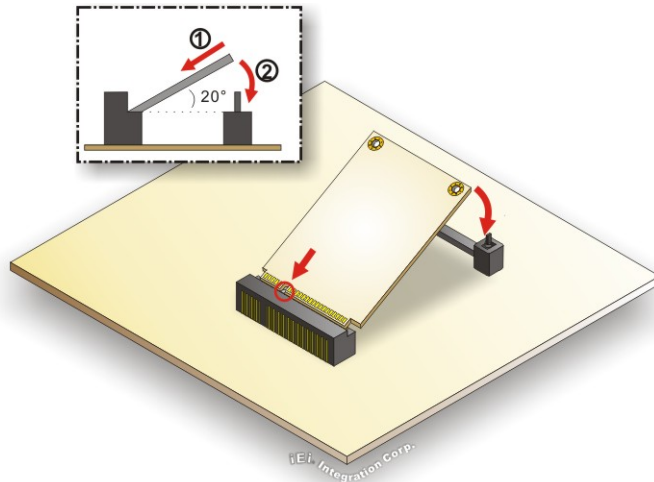

**Figure 4-1: SO-DIMM Installation**

- Step 1:** **Open the SO-DIMM socket handles.** Open the two handles outwards as far as they can. See **Figure 4-1**.
- Step 2:** **Align the SO-DIMM with the socket.** Align the SO-DIMM so the notch on the memory lines up with the notch on the memory socket. See **Figure 4-1**.
- Step 3:** **Insert the SO-DIMM.** Once aligned, press down until the SO-DIMM is properly seated. Clip the two handles into place. See **Figure 4-1**.
- Step 4:** **Removing a SO-DIMM.** To remove a SO-DIMM, push both handles outward. The memory module is ejected by a mechanism in the socket.

### 4.4 PCIe Mini Card Installation

Two PCIe Mini card slots are located on the KINO-DQM871. To install the PCIe Mini card, please refer to the diagram and instructions below.



**Figure 4-2: PCIe Mini Card Installation**

- Step 1:** **Insert into the socket at an angle.** Line up the notch on the card with the notch on the connector. Slide the PCIe Mini card into the socket at an angle of about 20°.
- Step 2:** **Push down until the card clips into place.** Push the other end of the card down until it clips into place on the plastic connector.

## 4.5 Jumper Settings



**NOTE:**

A jumper is a metal bridge that is used to close an electrical circuit. It consists of two metal pins and a small metal clip (often protected by a plastic cover) that slides over the pins to connect them. To CLOSE/SHORT a jumper means connecting the pins of the jumper with the plastic clip and to OPEN a jumper means removing the plastic clip from a jumper.

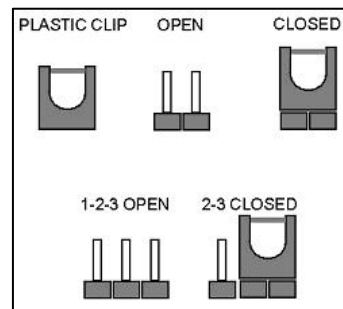

## KINO-DQM871 Mini-ITX SBC

Before the KINO-DQM871 is installed in the system, the jumpers must be set in accordance with the desired configuration. The jumpers on the KINO-DQM871 are listed in Table 4-1.

Description	Label	Type
AT/ATX mode selection	J_ATXCTL1	Switch
Clear CMOS	J_CMOS1	Push-button
LVDS voltage selection	JLCD_PWR1	6-pin header
LVDS resolution selection	SW1	DIP switch

**Table 4-1: Jumpers**

### 4.5.1 AT/ATX Mode Selection

<b>Jumper Label:</b>	<b>J_ATXCTL1</b>
<b>Jumper Type:</b>	Switch
<b>Jumper Settings:</b>	See <b>Figure 4-3</b>
<b>Jumper Location:</b>	See <b>Figure 4-3</b>

Set the switch to select AT or ATX power mode for the KINO-DQM871. AT power mode limits the system to on/off. ATX allows the system to use various power saving states and enter a standby state, so the system can be turned on remotely over a network. To configure, see the diagram below.

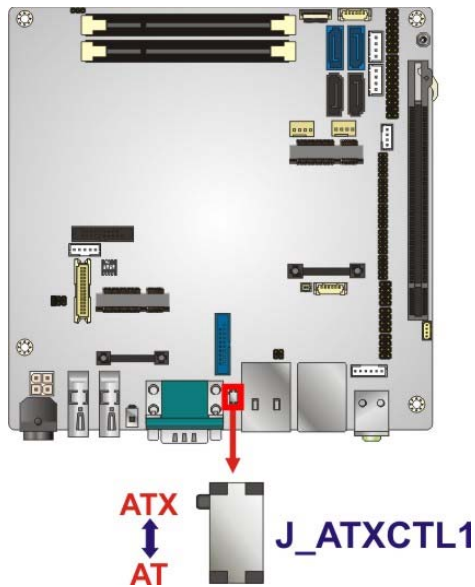

Figure 4-3: AT/ATX Mode Selection Jumper Location

#### 4.5.2 Clear CMOS

<b>Jumper Label:</b>	<b>J_CMOS1</b>
<b>Jumper Type:</b>	Push button
<b>Jumper Location:</b>	See <b>Figure 4-4</b>

If the KINO-DQM871 fails to boot due to improper BIOS settings, the clear CMOS jumper clears the CMOS data and resets the system BIOS information. To do this, push the clear CMOS button for three seconds, then restart the system.

If the “CMOS Settings Wrong” message is displayed during the boot up process, the fault may be corrected by pressing the F1 to enter the CMOS Setup menu. Do one of the following:

- Enter the correct CMOS setting
- Load Optimal Defaults
- Load Failsafe Defaults.

After having done one of the above, save the changes and exit the CMOS Setup menu.

**KINO-DQM871 Mini-ITX SBC**

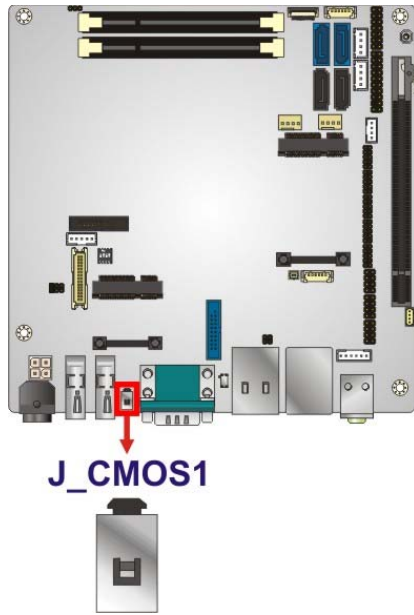

**Figure 4-4: Clear CMOS Jumper Location**

**4.5.3 LVDS Voltage Selection**

- Jumper Label:** JLCD\_PWR1
- Jumper Type:** 6-pin header
- Jumper Settings:** See Table 4-2
- Jumper Location:** See Figure 4-5

This jumper selects the voltage of the LVDS connector.

Pin	Description
Short 1-2	+3.3 V (Default)
Short 3-4	+5 V
Short 5-6	+12 V

**Table 4-2: LVDS Voltage Selection Jumper Settings**

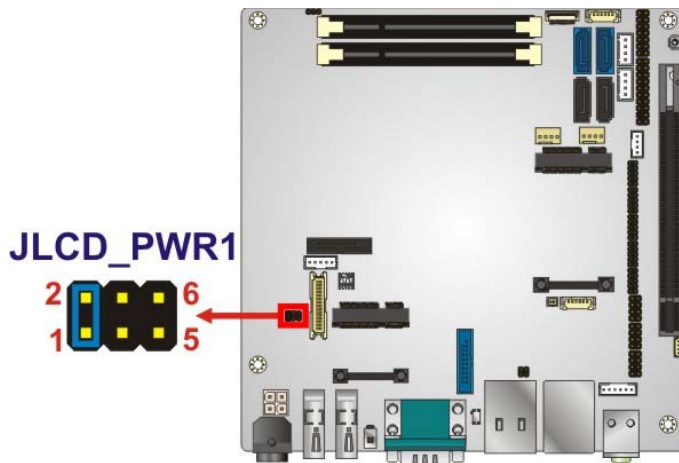

**Figure 4-5: LVDS Voltage Selection Jumper Location**

#### 4.5.4 LVDS Resolution Selection

- Jumper Label:** SW1
- Jumper Type:** DIP switch
- Jumper Settings:** See Table 4-3
- Jumper Location:** See Figure 4-6

This jumper selects the resolution of the LCD panel connected to the LVDS connector.

\* ON=0, OFF=1; Single=S, Dual=D

SW1 (4-3-2-1)	Description
0000	800x600 18bit S (default)
0001	1024x768 18bit S
0010	1024x768 24bit S
0011	1280x768 18bit S
0100	1280x800 18bit S
0101	1280x960 18bit S
0110	1280x1024 24bit D
0111	1366x768 18bit S
1000	1366x768 24bit S
1001	1440x960 24bit D

## KINO-DQM871 Mini-ITX SBC

SW1 (4-3-2-1)	Description
1010	1400x1050 24bit D
1011	1600x900 24bit D
1100	1680x1050 24bit D
1101	1600x1200 24bit D
1110	1920x1080 24bit D
1111	1920x1200 24bit D

**Table 4-3: LVDS Resolution Selection Jumper Settings**

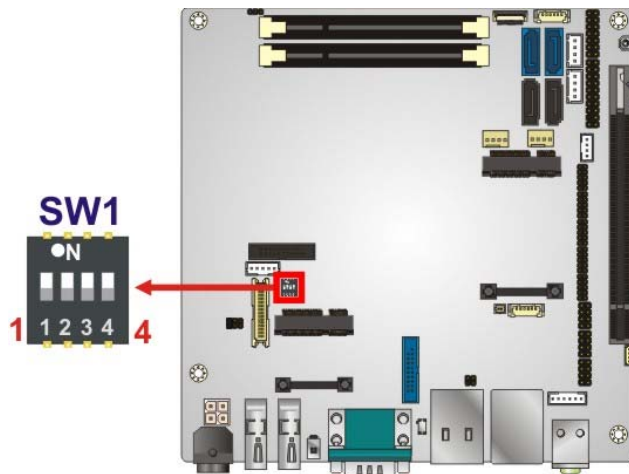

**Figure 4-6: LVDS Resolution Selection Jumper Location**

## 4.6 Chassis Installation

### 4.6.1 Airflow



**WARNING:**

Airflow is critical for keeping components within recommended operating temperatures. The chassis should have fans and vents as necessary to keep things cool.

The KINO-DQM871 must be installed in a chassis with ventilation holes on the sides allowing airflow to travel through the heat sink surface. In a system with an individual

power supply unit, the cooling fan of a power supply can also help generate airflow through the board surface.

## 4.6.2 Motherboard Installation

To install the KINO-DQM871 motherboard into the chassis please refer to the reference material that came with the chassis.

## 4.7 Internal Peripheral Device Connections

This section outlines the installation of peripheral devices to the onboard connectors.

### 4.7.1 SATA Drive Connection

The KINO-DQM871 is shipped with two SATA drive cable. To connect the SATA drive to the connector, please follow the steps below.

**Step 1:** Locate the SATA connector and the SATA power connector. The locations of the connectors are shown in **Chapter 3**.

**Step 2:** Insert the cable connector. Insert the cable connector into the on-board SATA drive connector and the SATA power connector. See **Figure 4-7**.

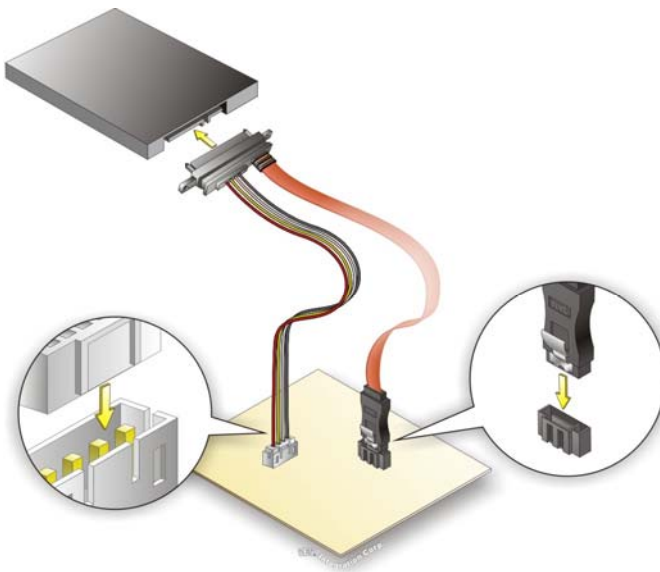

**Figure 4-7: SATA Drive Cable Connection**



## KINO-DQM871 Mini-ITX SBC

**Step 3:** **Connect the cable to the SATA disk.** Connect the connector on the other end of the cable to the connector at the back of the SATA drive. See **Figure 4-7**.

**Step 4:** To remove the SATA cable from the SATA connector, press the clip on the connector at the end of the cable.

## 4.8 External Peripheral Interface Connection

Devices can be connected to the external connectors. To install external devices, follow the directions in the subsections below.

### 4.8.1 Audio Connector

The audio jacks on the external audio connector enable the KINO-DQM871 to be connected to a stereo sound setup. To install the audio devices, follow the steps below.

**Step 1:** **Identify the audio plugs.** The plugs on your home theater system or speakers may not match the colors on the rear panel. If audio plugs are plugged into the wrong jacks, sound quality will be very bad.

**Step 2:** **Plug the audio plugs into the audio jacks.** Plug the audio plugs into the audio jacks. If the plugs on your speakers are different, an adapter will need to be used to plug them into the audio jacks.

- **Line Out port (Lime):** Connects to a headphone or a speaker.
- **Microphone (Pink):** Connects to a microphone.

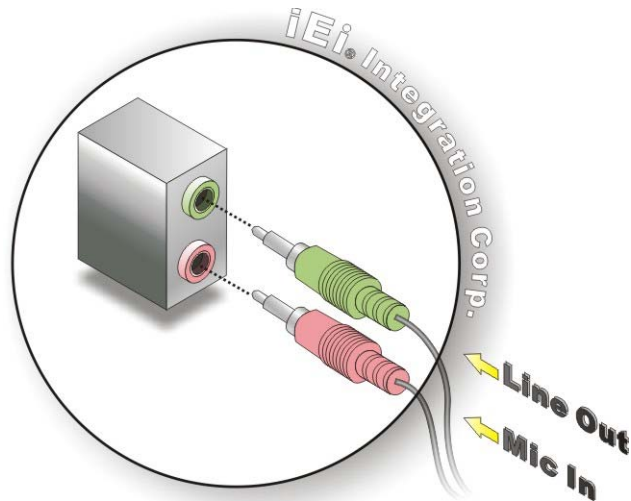

**Figure 4-8: Audio Connector**

**Step 3: Check audio clarity.** Check that the sound is coming through the right speakers by adjusting the balance front to rear and left to right.

#### **4.8.2 HDMI Display Device Connection**

The HDMI connector transmits a digital signal to compatible HDMI display devices such as a TV or computer screen. To connect the HDMI cable to the KINO-DQM871, follow the steps below.

**Step 1: Locate the HDMI connector.** The location is shown in **Chapter 3**.

**Step 2: Align the connector.** Align the HDMI connector with the HDMI port. Make sure the orientation of the connector is correct.

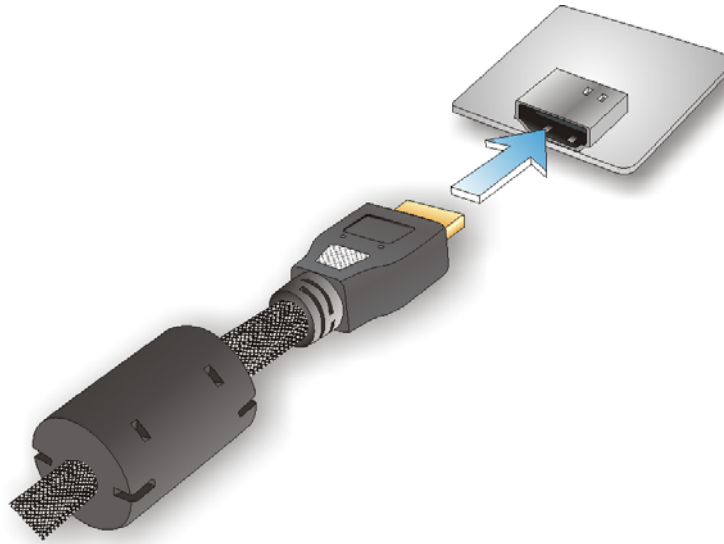

**Figure 4-9: HDMI Connection**

**Step 3: Insert the HDMI connector.** Gently insert the HDMI connector. The connector should engage with a gentle push. If the connector does not insert easily, check again that the connector is aligned correctly, and that the connector is being inserted with the right way up.

### 4.8.3 LAN Connection (Single Connector)

There are two external RJ-45 LAN connectors. The RJ-45 connectors enable connection to an external network. To connect a LAN cable with an RJ-45 connector, please follow the instructions below.

**Step 1: Locate the RJ-45 connectors.** The locations of the LAN connectors are shown in **Chapter 3**.

**Step 2: Align the connectors.** Align the RJ-45 connector on the LAN cable with one of the RJ-45 connectors on the KINO-DQM871. See Figure 4-10.

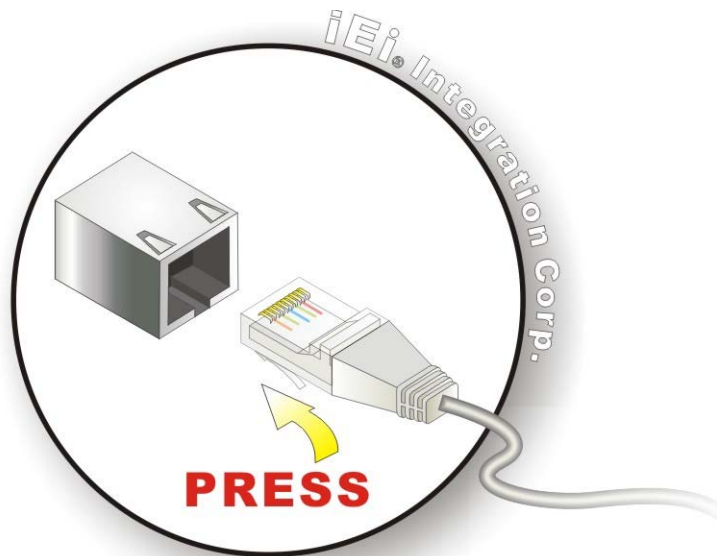

**Figure 4-10: LAN Connection**

**Step 3:** Insert the LAN cable RJ-45 connector. Once aligned, gently insert the LAN cable RJ-45 connector into the on-board RJ-45 connector.

#### **4.8.4 Serial Device Connection**

The KINO-DQM871 has a single male D-sub 9 connector on the external peripheral interface panel for a serial device. Follow the steps below to connect a serial device to the KINO-DQM871.

**Step 1:** Locate the D-sub 9 connector. The location of the D-sub 9 connector is shown in **Chapter 3**.

**Step 2:** Insert the serial connector. Insert the D-sub 9 connector of a serial device into the D-sub 9 connector on the external peripheral interface. See Figure 4-11.

## KINO-DQM871 Mini-ITX SBC

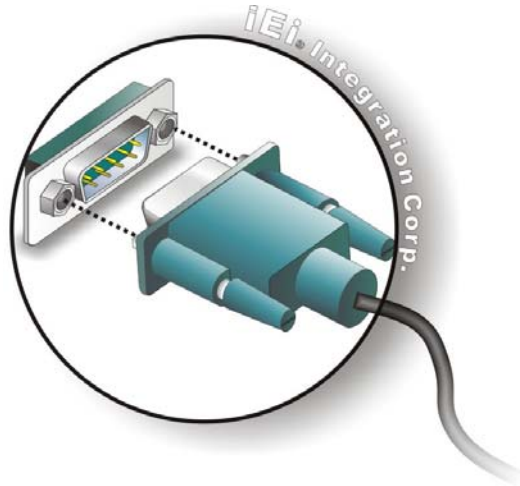

Figure 4-11: Serial Device Connector

**Step 3: Secure the connector.** Secure the serial device connector to the external interface by tightening the two retention screws on either side of the connector.

#### 4.8.5 USB Connection (Dual Connector)

The external USB 2.0/USB 3.0 connectors provide easier and quicker access to external USB devices. Follow the steps below to connect USB devices to the KINO-DQM871.

**Step 1: Locate the USB 2.0/USB 3.0 connectors.** The locations of the USB 2.0/USB 3.0 connectors are shown in **Chapter 3**.

**Step 2: Insert a USB 2.0/USB 3.0 plug.** Insert the USB 2.0/USB 3.0 plug of a device into the USB 2.0/3.0 on the external peripheral interface. See Figure 4-12.

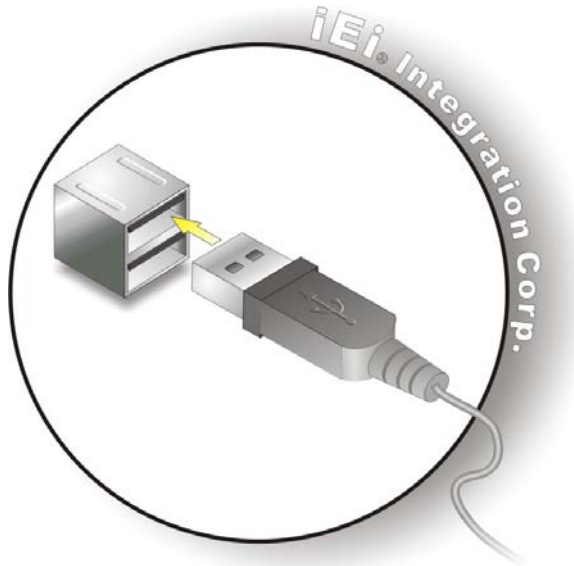

Figure 4-12: USB Connector

#### 4.8.6 VGA Monitor Connection

The KINO-DQM871 has a single female D-sub 15 connector on the external peripheral interface panel. The D-sub 15 connector is connected to a CRT or VGA monitor. To connect a monitor to the KINO-DQM871, please follow the instructions below.

- Step 1: Locate the female D-sub 15 connector.** The location of the female D-sub 15 connector is shown in **Chapter 3**.
- Step 2: Align the VGA connector.** Align the male D-sub 15 connector on the VGA screen cable with the female D-sub 15 connector on the external peripheral interface.
- Step 3: Insert the VGA connector** Once the connectors are properly aligned with the insert the male connector from the VGA screen into the female connector on the KINO-DQM871. See Figure 4-13.

## KINO-DQM871 Mini-ITX SBC

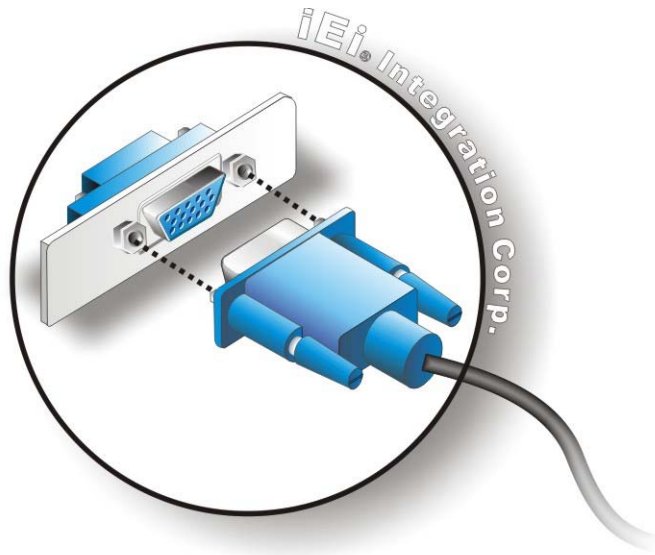

Figure 4-13: VGA Connector

**Step 4:** **Secure the connector.** Secure the D-sub 15 VGA connector from the VGA monitor to the external interface by tightening the two retention screws on either side of the connector.

## 4.9 Intel® AMT Setup Procedure

The KINO-DQM871 is featured with the Intel® Active Management Technology (AMT). To enable the Intel® AMT function, follow the steps below.

- Step 1:** Make sure the **DIMM1** socket is installed with one DDR3 SO-DIMM.
- Step 2:** Connect an Ethernet cable to the RJ-45 connector labeled **LAN1**.
- Step 3:** The AMI BIOS options regarding the Intel® ME or Intel® AMT must be enabled,
- Step 4:** Properly install the Intel® Management Engine Components drivers from the iAMT Driver & Utility directory in the driver CD. See **Section 6.8**.
- Step 5:** Configure the Intel® Management Engine BIOS extension (MEBx). To get into the Intel® MEBx settings, press <Ctrl+P> after a single beep during boot-up

process. Enter the Intel® current ME password as it requires (the Intel® default password is **admin**).

**NOTE:**

To change the password, enter a new password following the strong password rule (containing at least one upper case letter, one lower case letter, one digit and one special character, and be at least eight characters).

---



Chapter

5

# BIOS

---

## 5.1 Introduction

The BIOS is programmed onto the BIOS chip. The BIOS setup program allows changes to certain system settings. This chapter outlines the options that can be changed.



### NOTE:

Some of the BIOS options may vary throughout the life cycle of the product and are subject to change without prior notice.

---

### 5.1.1 Starting Setup

The UEFI BIOS is activated when the computer is turned on. The setup program can be activated in one of two ways.

1. Press the **DEL** or **F2** key as soon as the system is turned on or
2. Press the **DEL** or **F2** key when the “**Press DEL or F2 to enter SETUP**” message appears on the screen.

If the message disappears before the **DEL** or **F2** key is pressed, restart the computer and try again.

### 5.1.2 Using Setup

Use the arrow keys to highlight items, press **ENTER** to select, use the PageUp and PageDown keys to change entries, press **F1** for help and press **ESC** to quit. Navigation keys are shown in the following table.

Key	Function
Up arrow	Move to previous item
Down arrow	Move to next item

## KINO-DQM871 Mini-ITX SBC

Key	Function
Left arrow	Move to the item on the left hand side
Right arrow	Move to the item on the right hand side
+	Increase the numeric value or make changes
-	Decrease the numeric value or make changes
Page Up key	Move to the next page
Page Dn key	Move to the previous page
Esc key	Main Menu – Quit and not save changes into CMOS Status Page Setup Menu and Option Page Setup Menu -- Exit current page and return to Main Menu
F1	General help, only for Status Page Setup Menu and Option Page Setup Menu
F2	Load previous values
F3	Load optimized defaults
F4	Save changes and Exit BIOS

Table 5-1: BIOS Navigation Keys

### 5.1.3 Getting Help

When **F1** is pressed a small help window describing the appropriate keys to use and the possible selections for the highlighted item appears. To exit the Help Window press **Esc** or the **F1** key again.

### 5.1.4 Unable to Reboot after Configuration Changes

If the computer cannot boot after changes to the system configuration are made, CMOS defaults. Use the jumper described in **Chapter 4**.

### 5.1.5 BIOS Menu Bar

The **menu bar** on top of the BIOS screen has the following main items:

- Main – Changes the basic system configuration.
- Advanced – Changes the advanced system settings.
- Chipset – Changes the chipset settings.
- Boot – Changes the system boot configuration.
- Security – Sets User and Supervisor Passwords.
- Save & Exit – Selects exit options and loads default settings.

The following sections completely describe the configuration options found in the menu items at the top of the BIOS screen and listed above.

## KINO-DQM871 Mini-ITX SBC

### 5.2 Main

The **Main** BIOS menu (**BIOS Menu 1**) appears when the **BIOS Setup** program is entered.

The **Main** menu gives an overview of the basic system information.

Aptio Setup Utility - Copyright (C) 2012 American Megatrends, Inc.					
Main	Advanced	Chipset	Boot	Security	Save & Exit
BIOS Information					Set the Date. Use Tab to switch between Date elements.
BIOS Vendor		American Megatrends			
Core Version		4.6.5.4			
Compliance		UEFI 2.3.1; PI 1.2			
Project Version		E415AR05.ROM			
Build Date and Time		07/15/2013 14:08:15			
iWDD Vendor		ICP			
iWDD Version		B271ER15.bin			
Processor Information					
Name		Haswell			
Brand String		Intel(R) Core(TM) i5-			
Frequency		2600 MHz			
Processor ID		306c3			
Stepping		CO			
Number of Processors		2Core(s) / 4Thread(s)			
Microcode Revision		8			
GT Info		GT3 (800 MHz)			
IGFX VBIOS Version		2167			
Memory RC Version		1.0.0.0			
Total Memory		2048 MB (DDR3)			
Memory Frequency		1333 MHz			
PCH Information					
Name		LynxPoint			
PCH SKU		QM87			
Stepping		04/C1			
LAN PHY Revision		A3			
ME FW Version		9.0.10.1372			
ME Firmware SKU		5MB			
SPI Clock Frequency					
DOFR Support		Unsupported			
Read Status Clock Frequency		50 MHz			
Write Status Clock Frequency		50 MHz			
Fast Read Status Clock Frequency		50 MHz			
System Date		[Tue 12/25/2012]			
System Time		[15:10:27]			
Access Level		Administrator			
-----					
→←: Select Screen ↑↓: Select Item Enter: Select +/-: Change Opt. F1: General Help F2: Previous Values F3: Optimized Defaults F4: Save & Exit ESC: Exit					
Version 2.15.1236. Copyright (C) 2012 American Megatrends, Inc.					

**BIOS Menu 1: Main**

### → System Overview

The **BIOS Information** lists a brief summary of the BIOS. The fields in **BIOS Information** cannot be changed. The items shown in the system overview include:

- BIOS Information
- Processor Information
- Memory Information
- PCH Information
- SPI Clock Frequency

The System Overview field also has two user configurable fields:

### → System Date [xx/xx/xx]

Use the **System Date** option to set the system date. Manually enter the day, month and year.

### → System Time [xx:xx:xx]

Use the **System Time** option to set the system time. Manually enter the hours, minutes and seconds.

## 5.3 Advanced

Use the **Advanced** menu (**BIOS Menu 2**) to configure the CPU and peripheral devices through the following sub-menus:



### **WARNING:**

Setting the wrong values in the sections below may cause the system to malfunction. Make sure that the settings made are compatible with the hardware.

---

## KINO-DQM871 Mini-ITX SBC

```

Aptio Setup Utility - Copyright (C) 2012 American Megatrends, Inc.
Main  Advanced  Chipset  Boot  Security  Save & Exit
-----
> ACPI Settings
> RTC Wake Settings
> Trusted Computing
> CPU Configuration
> SATA Configuration
> Intel(R) Rapid Start Technology
> AMT Configuration
> USB Configuration
> iWDD H/W Monitor
> F81866 Super IO Configuration
> F81866 H/W Monitor
> Serial Port Console Redirection
> iEi Feature

System ACPI Parameters
-----
-><: Select Screen
↑↓: Select Item
Enter: Select
+/-: Change Opt.
F1: General Help
F2: Previous Values
F3: Optimized Defaults
F4: Save & Exit
ESC: Exit

Version 2.15.1236. Copyright (C) 2012 American Megatrends, Inc.
  
```

### BIOS Menu 2: Advanced

#### 5.3.1 ACPI Settings

The **ACPI Settings** menu (**BIOS Menu 3**) configures the Advanced Configuration and Power Interface (ACPI) options.

```

Aptio Setup Utility - Copyright (C) 2012 American Megatrends, Inc.
Advanced
-----
ACPI Settings
ACPI Sleep State          [S1 only(CPU Stop C1...)]

Select ACPI sleep state
the system will enter
when the SUSPEND button
is pressed.
-----
-><: Select Screen
↑↓: Select Item
Enter: Select
+/-: Change Opt.
F1: General Help
F2: Previous Values
F3: Optimized Defaults
F4: Save & Exit
ESC: Exit

Version 2.15.1236. Copyright (C) 2012 American Megatrends, Inc.
  
```

### BIOS Menu 3: ACPI Settings

➔ **ACPI Sleep State [S1 only (CPU Stop Clock)]**

Use the **ACPI Sleep State** option to specify the sleep state the system enters when it is not being used.

- ➔ **S1 only (CPU Stop Clock)** **DEFAULT** The system enters S1 (POS) sleep state. The system appears off. The CPU is stopped; RAM is refreshed; the system is running in a low power mode.
- ➔ **S3 only (Suspend to RAM)** The caches are flushed and the CPU is powered off. Power to the RAM is maintained. The computer returns slower to a working state, but more power is saved.

### 5.3.2 RTC Wake Settings

The **RTC Wake Settings** menu (**BIOS Menu 4**) enables the system to wake at the specified time.

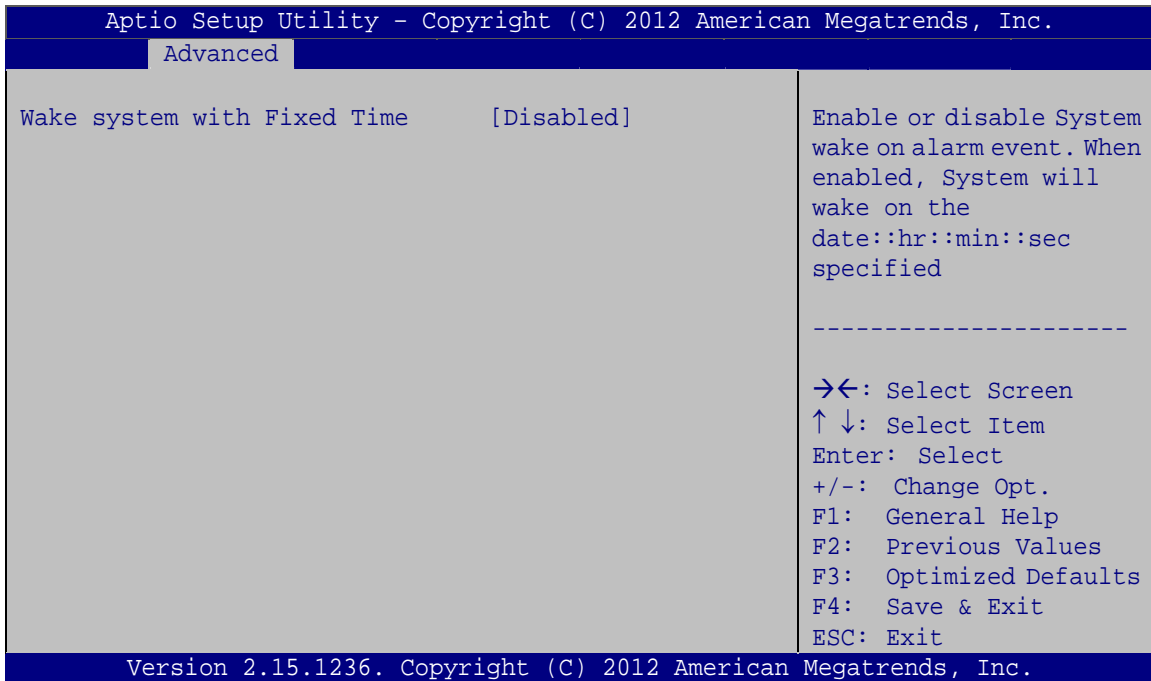

**BIOS Menu 4: RTC Wake Settings**



## KINO-DQM871 Mini-ITX SBC

### → Wake system with Fixed Time [Disabled]

Use the **Wake system with Fixed Time** option to enable or disable the system wake on alarm event.

→ **Disabled**      **DEFAULT**      The real time clock (RTC) cannot generate a wake event

→ **Enabled**      If selected, the **Wake up every day** option appears allowing you to enable to disable the system to wake every day at the specified time. Besides, the following options appear with values that can be selected:

Wake up every day

Wake up date

Wake up hour

Wake up minute

Wake up second

After setting the alarm, the computer turns itself on from a suspend state when the alarm goes off.

### 5.3.3 Trusted Computing

Use the **Trusted Computing** menu (**BIOS Menu 5**) to configure settings related to the Trusted Computing Group (TCG) Trusted Platform Module (TPM).

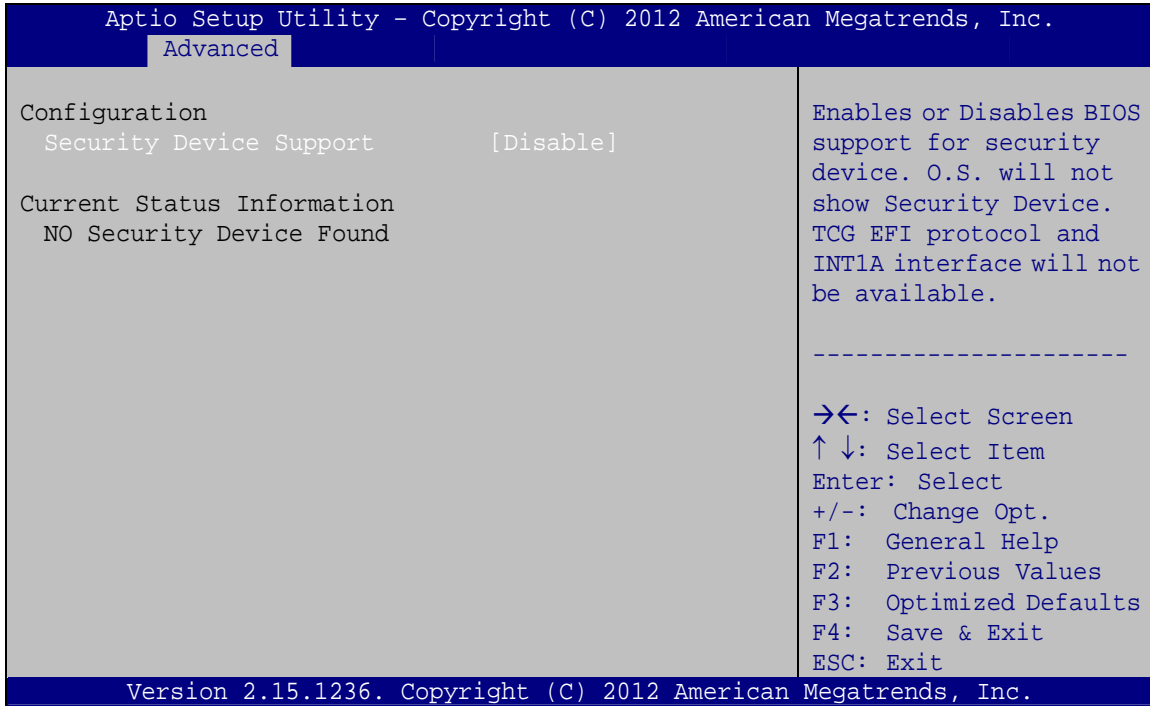

### BIOS Menu 5: Trusted Computing

#### → Security Device Support [Disable]

Use the **Security Device Support** option to configure support for the TPM.

- **Disable**    DEFAULT    TPM support is disabled.
- **Enable**                    TPM support is enabled.

## KINO-DQM871 Mini-ITX SBC

### 5.3.4 CPU Configuration

Use the **CPU Configuration** menu (**BIOS Menu 6**) to view detailed CPU specifications and configure the CPU.

```

Aptio Setup Utility - Copyright (C) 2012 American Megatrends, Inc.
  Advanced
CPU Configuration
Intel(R) Core(TM) i5-4402E CPU @ 1.60GHz
CPU Signature          306c3
Microcode Patch       8
Max CPU Speed         1600 MHz
Min CPU Speed         800 MHz
CPU Speed             2600 MHz
Processor Cores       2
Intel HT Technology   Supported
Intel VT-x Technology Supported
Intel SMX Technology Supported
64-bit               Supported
EIST Technology       Supported

L1 Data Cache        32 kB x 2
L1 Code Cache        32 kB x 2
L2 Cache             256 kB x 2
L3 Cache             3072 kB

Hyper-threading      [Enabled]
Intel Virtualization Technology [Disabled]
Intel TXT(LT) Support [Disabled]

-----
-><: Select Screen
↑↓: Select Item
Enter: Select
+/-: Change Opt.
F1: General Help
F2: Previous Values
F3: Optimized Defaults
F4: Save & Exit
ESC: Exit

Version 2.15.1236. Copyright (C) 2012 American Megatrends, Inc.
  
```

#### BIOS Menu 6: CPU Configuration

The CPU Configuration menu (**BIOS Menu 6**) lists the following CPU details:

- Processor Type: Lists the brand name of the CPU being used
- CPU Signature: Lists the CPU signature value.
- Microcode Patch: Lists the microcode patch being used.
- Max CPU Speed: Lists the maximum CPU processing speed.
- Min CPU Speed: Lists the minimum CPU processing speed.
- CPU Speed: Lists the CPU processing speed
- Processor Cores: Lists the number of the processor core
- Intel HT Technology: Indicates if Intel HT Technology is supported by the CPU.

- Intel VT-x Technology: Indicates if Intel VT-x Technology is supported by the CPU.
- Intel SMX Technology: Indicates if Intel SMX Technology is supported by the CPU.
- EIST Technology: Indicates if the Enhanced Intel SpeedStep® Technology (EIST) is supported by the CPU.
- 64-bit: Indicates if 64-bit is supported by the CPU.
- L1 Data Cache: Lists the amount of data storage space on the L1 cache.
- L1 Code Cache: Lists the amount of code storage space on the L1 cache.
- L2 Cache: Lists the amount of storage space on the L2 cache.
- L3 Cache: Lists the amount of storage space on the L3 cache.

#### ➔ **Hyper-threading [Enabled]**

Use the **Hyper-Threading** BIOS option to enable or disable the Intel Hyper-Threading Technology.

- ➔ **Disabled** Disables the Intel Hyper-Threading Technology.
- ➔ **Enabled** **DEFAULT** Enables the Intel Hyper-Threading Technology.

#### ➔ **Intel Virtualization Technology [Disabled]**

Use the **Intel Virtualization Technology** option to enable or disable virtualization on the system. When combined with third party software, Intel® Virtualization technology allows several OSs to run on the same system at the same time.

- ➔ **Disabled** **DEFAULT** Disables Intel Virtualization Technology.
- ➔ **Enabled** Enables Intel Virtualization Technology.

#### ➔ **Intel TXT(LT) Support [Disabled]**

Use the **Intel TXT(LT) Support** BIOS option to enable or disable the Intel Trusted Execution Technology.

- ➔ **Disabled** **DEFAULT** Disables the Intel Trusted Execution Technology.
- ➔ **Enabled** Enables the Intel Trusted Execution Technology.

## KINO-DQM871 Mini-ITX SBC

### 5.3.5 SATA Configuration

Use the **SATA Configuration** menu (**BIOS Menu 7**) to change and/or set the configuration of the SATA devices installed in the system.



#### BIOS Menu 7: SATA Configuration

##### → SATA Controller(s) [Enabled]

Use the **SATA Controller(s)** option to configure the SATA controller.

- **Enabled**      **DEFAULT**      Enable SATA controller.
- **Disabled**                      Disable SATA controller.

##### → SATA Mode Selection [IDE]

Use the **SATA Mode Selection** option to configure SATA devices.

- **IDE**              **DEFAULT**      Configures SATA devices as normal IDE device.
- **AHCI**                              Configures SATA devices as AHCI device.
- **RAID**                              Configures SATA devices as RAID device.



**NOTE:**

Before accessing the RAID configuration utility, ensure to set the **Option ROM Messages** BIOS option in the **Boot** menu to **Force BIOS**. This is to allow the “Press <CTRL+I> to enter Configuration Utility.....” message to appear during POST. Press Ctrl+I when prompted to enter the RAID configuration utility.

### 5.3.6 Intel(R) Rapid Start Technology

Use the **Intel(R) Rapid Start Technology (BIOS Menu 8)** menu to configure Intel® Rapid Start Technology support.

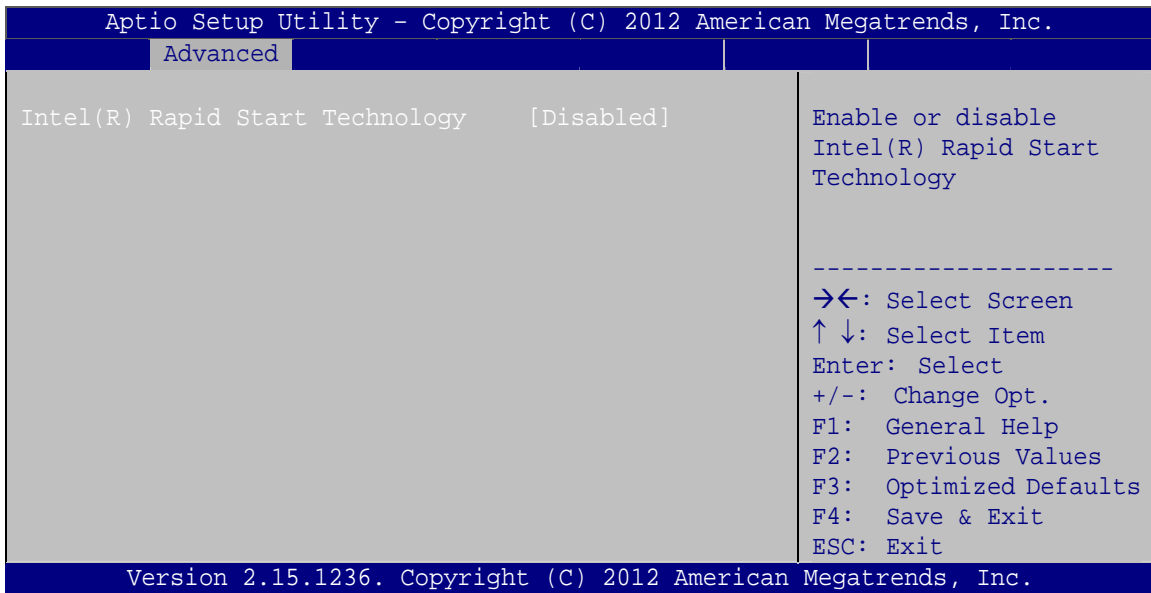

#### BIOS Menu 8: Intel(R) Rapid Start Technology

##### ➔ Intel(R) Rapid Start Technology [Disabled]

Use **Intel(R) Rapid Start Technology** option to enable or disable the Intel® Rapid Start Technology function.

- ➔ **Disabled**      **DEFAULT**      Intel® Rapid Start Technology is disabled
- ➔ **Enabled**                      Intel® Rapid Start Technology is enabled

## KINO-DQM871 Mini-ITX SBC

### 5.3.7 AMT Configuration

The **AMT Configuration** menu (**BIOS Menu 9**) allows the advanced power management options to be configured.

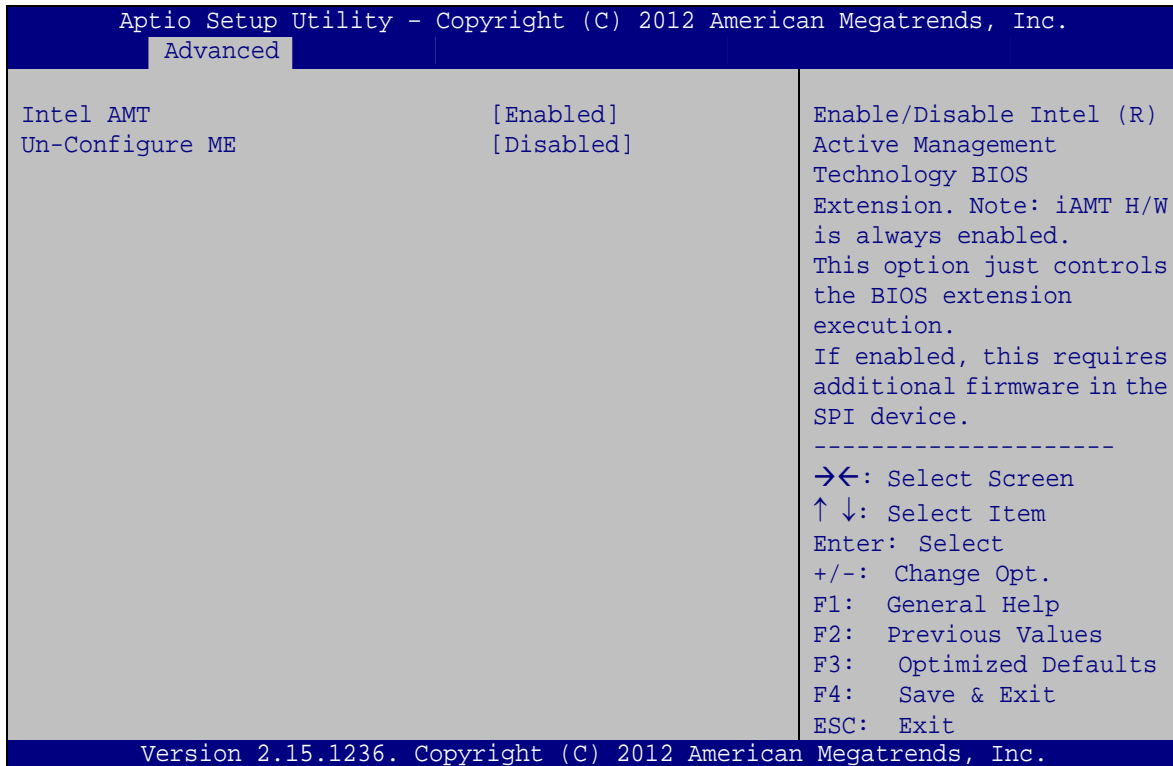

#### BIOS Menu 9: AMT Configuration

##### → Intel AMT [Enabled]

Use **Intel AMT** option to enable or disable the Intel® AMT function.

- **Disabled** Intel® AMT is disabled
- **Enabled** **DEFAULT** Intel® AMT is enabled

##### → Un-Configure ME [Disabled]

Use the **Un-Configure ME** option to perform ME unconfigure without password operation.

- **Disabled** **DEFAULT** Not perform ME unconfigure
- **Enabled** To perform ME unconfigure

### 5.3.8 USB Configuration

Use the **USB Configuration** menu (**BIOS Menu 10**) to read USB configuration information and configure the USB settings.

```

Aptio Setup Utility - Copyright (C) 2012 American Megatrends, Inc.
  Advanced
-----
USB Configuration                               Enables Legacy USB
                                                support. AUTO option
USB Devices:                                     disables legacy support
  1 Keyboard, 2 Hubs                             if no USB devices are
                                                connected. DISABLE
Legacy USB Support                               option will keep USB
                                                devices available only
                                                for EFI applications.
                                                -----
                                                →←: Select Screen
                                                ↑↓: Select Item
                                                Enter: Select
                                                +/-: Change Opt.
                                                F1:  General Help
                                                F2:  Previous Values
                                                F3:  Optimized Defaults
                                                F4:  Save & Exit
                                                ESC: Exit
-----
Version 2.15.1236. Copyright (C) 2012 American Megatrends, Inc.

```

#### BIOS Menu 10: USB Configuration

##### → USB Devices

The **USB Devices** field lists the USB devices that are enabled on the system

##### → Legacy USB Support [Enabled]

Use the **Legacy USB Support** BIOS option to enable USB mouse and USB keyboard support.

Normally if this option is not enabled, any attached USB mouse or USB keyboard does not become available until a USB compatible operating system is fully booted with all USB drivers loaded. When this option is enabled, any attached USB mouse or USB keyboard can control the system even when there is no USB driver loaded onto the system.



## KINO-DQM871 Mini-ITX SBC

- ➔ **Enabled**      **DEFAULT**      Legacy USB support enabled
- ➔ **Disabled**                      Legacy USB support disabled
- ➔ **Auto**                              Legacy USB support disabled if no USB devices are connected

### 5.3.9 iWDD H/W Monitor

The **iWDD H/W Monitor** menu (**BIOS Menu 11**) displays the CPU temperature and CPU fan speed, and contains the fan configuration submenu.

```

Aptio Setup Utility - Copyright (C) 2012 American Megatrends, Inc.
-----
Advanced
-----
PC Health Status
CPU temperature                : +68 C
> Smart Fan Mode Configuration

Smart Fan Mode Select

-----
-><: Select Screen
↑↓: Select Item
Enter: Select
+/-: Change Opt.
F1: General Help
F2: Previous Values
F3: Optimized Defaults
F4: Save & Exit
ESC: Exit

Version 2.15.1236. Copyright (C) 2012 American Megatrends, Inc.
  
```

#### BIOS Menu 11: iWDD H/W Monitor

##### ➔ PC Health Status

The following system parameters and values are shown. The system parameters that are monitored are:

- CPU Temperature

#### 5.3.9.1 Smart Fan Mode Configuration

Use the **Smart Fan Mode Configuration** submenu (**BIOS Menu 12**) to configure the smart fan temperature and speed settings.

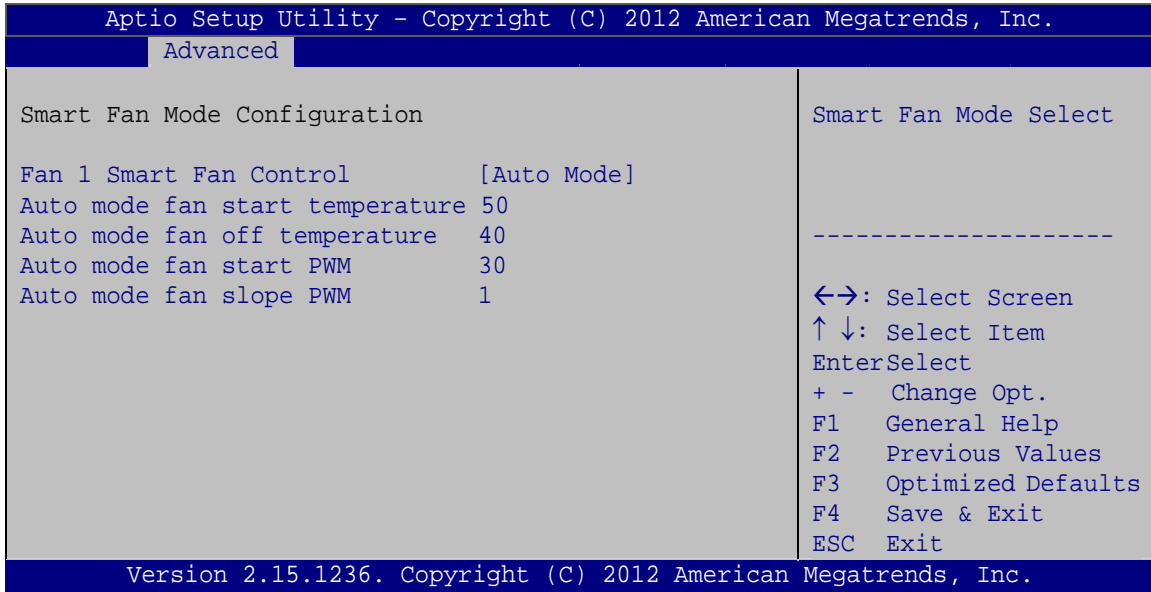

**BIOS Menu 12: Smar Fan Mode Configuration**

➔ **Fan 1 Smart Fan Control [Auto Mode]**

Use the **Fan 1 Smart Fan Control** option to configure the CPU Smart Fan.

➔ **Manual Mode** The fan spins at the speed set in Manual by Duty Cycle settings

➔ **Auto Mode** **DEFAULT** The fan adjusts its speed using Auto by Duty-Cycle settings

➔ **Auto mode fan start/off temperature**

Use the + or – key to change the **Auto mode fan start/off temperature** value. Enter a decimal number between 1 and 100.

➔ **Auto mode fan start PWM**

Use the + or – key to change the **Auto mode fan start PWM** value. Enter a decimal number between 1 and 128.

➔ **Auto mode fan slope PWM**

Use the + or – key to change the **Auto mode fan slope PWM** value. Enter a decimal number between 1 and 64.

## KINO-DQM871 Mini-ITX SBC

### 5.3.10 F81866 Super IO Configuration

Use the **F81866 Super IO Configuration** menu (**BIOS Menu 13**) to set or change the configurations for the serial ports.

```

Aptio Setup Utility - Copyright (C) 2012 American Megatrends, Inc.
  Advanced
F81866 Super IO Configuration                               Set Parameters of Serial
                                                           Port 1 (COMA)
F81866 Super IO Chip                                     F81866
> Serial Port 1 Configuration
> Serial Port 2 Configuration
> Serial Port 3 Configuration
> Serial Port 4 Configuration
> Serial Port 5 Configuration
> Serial Port 6 Configuration
                                                           -----
                                                           →←: Select Screen
                                                           ↑ ↓: Select Item
                                                           Enter: Select
                                                           +/-: Change Opt.
                                                           F1: General Help
                                                           F2: Previous Values
                                                           F3: Optimized Defaults
                                                           F4: Save & Exit
                                                           ESC: Exit
Version 2.15.1236. Copyright (C) 2012 American Megatrends, Inc.

```

**BIOS Menu 13: F81866 Super IO Configuration**

#### 5.3.10.1 Serial Port n Configuration

Use the **Serial Port n Configuration** menu (**BIOS Menu 14**) to configure the serial port n.

```

Aptio Setup Utility - Copyright (C) 2012 American Megatrends, Inc.
  Advanced
Serial Port n Configuration                               Enable or Disable Serial
                                                           Port (COM)
Serial Port                                             [Enabled]
Device Settings                                         IO=3F8h; IRQ=4
Change Settings                                         [Auto]
                                                           -----
                                                           →←: Select Screen
                                                           ↑ ↓: Select Item
                                                           Enter: Select
                                                           +/-: Change Opt.
                                                           F1: General Help
                                                           F2: Previous Values
                                                           F3: Optimized Defaults
                                                           F4: Save & Exit
                                                           ESC: Exit
Version 2.15.1236. Copyright (C) 2012 American Megatrends, Inc.

```

**BIOS Menu 14: Serial Port n Configuration Menu**

### 5.3.10.1.1 Serial Port 1 Configuration

➔ **Serial Port [Enabled]**

Use the **Serial Port** option to enable or disable the serial port.

- ➔ **Disabled**                                      Disable the serial port
- ➔ **Enabled**                      **DEFAULT**                      Enable the serial port

➔ **Change Settings [Auto]**

Use the **Change Settings** option to change the serial port IO port address and interrupt address.

- ➔ **Auto**                      **DEFAULT**                      The serial port IO port address and interrupt address are automatically detected.
- ➔ **IO=3F8h;**  
**IRQ=4**                                      Serial Port I/O port address is 3F8h and the interrupt address is IRQ4
- ➔ **IO=3F8h;**  
**IRQ=3, 4**                                      Serial Port I/O port address is 3F8h and the interrupt address is IRQ3, 4
- ➔ **IO=2F8h;**  
**IRQ=3, 4**                                      Serial Port I/O port address is 2F8h and the interrupt address is IRQ3, 4
- ➔ **IO=2C0h;**  
**IRQ=3, 4**                                      Serial Port I/O port address is 2C0h and the interrupt address is IRQ3, 4
- ➔ **IO=2C8h;**  
**IRQ=3, 4**                                      Serial Port I/O port address is 2C8h and the interrupt address is IRQ3, 4

### 5.3.10.1.2 Serial Port 2 Configuration

➔ **Serial Port [Enabled]**

Use the **Serial Port** option to enable or disable the serial port.

- ➔ **Disabled**                                      Disable the serial port
- ➔ **Enabled**                      **DEFAULT**                      Enable the serial port

## KINO-DQM871 Mini-ITX SBC

### → Change Settings [Auto]

Use the **Change Settings** option to change the serial port IO port address and interrupt address.

- |   |                              |                |   |
|---|------------------------------|----------------|---|
| → | <b>Auto</b>                  | <b>DEFAULT</b> | The serial port IO port address and interrupt address are automatically detected. |
| → | <b>IO=2F8h;<br/>IRQ=3</b>    |                | Serial Port I/O port address is 2F8h and the interrupt address is IRQ3            |
| → | <b>IO=3F8h;<br/>IRQ=3, 4</b> |                | Serial Port I/O port address is 3F8h and the interrupt address is IRQ3, 4         |
| → | <b>IO=2F8h;<br/>IRQ=3, 4</b> |                | Serial Port I/O port address is 2F8h and the interrupt address is IRQ3, 4         |
| → | <b>IO=2C0h;<br/>IRQ=3, 4</b> |                | Serial Port I/O port address is 2C0h and the interrupt address is IRQ3, 4         |
| → | <b>IO=2C8h;<br/>IRQ=3, 4</b> |                | Serial Port I/O port address is 2C8h and the interrupt address is IRQ3, 4         |

### 5.3.10.1.3 Serial Port 3 Configuration

#### → Serial Port [Enabled]

Use the **Serial Port** option to enable or disable the serial port.

- |   |                 |                |                         |
|---|-----------------|----------------|-------------------------|
| → | <b>Disabled</b> |                | Disable the serial port |
| → | <b>Enabled</b>  | <b>DEFAULT</b> | Enable the serial port  |

#### → Change Settings [Auto]

Use the **Change Settings** option to change the serial port IO port address and interrupt address.

- |   |             |                |   |
|---|-------------|----------------|---|
| → | <b>Auto</b> | <b>DEFAULT</b> | The serial port IO port address and interrupt address are automatically detected. |
|---|-------------|----------------|---|

- **IO=3E8h;**  
**IRQ=10**                      Serial Port I/O port address is 3E8h and the interrupt address is IRQ10
- **IO=3E8h;**  
**IRQ=10, 11**                      Serial Port I/O port address is 3E8h and the interrupt address is IRQ10, 11
- **IO=2E8h;**  
**IRQ=10, 11**                      Serial Port I/O port address is 2E8h and the interrupt address is IRQ10, 11
- **IO=2D0h;**  
**IRQ=10, 11**                      Serial Port I/O port address is 2D0h and the interrupt address is IRQ10, 11
- **IO=2D8h;**  
**IRQ=10, 11**                      Serial Port I/O port address is 2D8h and the interrupt address is IRQ10, 11

### 5.3.10.1.4 Serial Port 4 Configuration

#### → Serial Port [Enabled]

Use the **Serial Port** option to enable or disable the serial port.

- **Disabled**                      Disable the serial port
- **Enabled      DEFAULT**                      Enable the serial port

#### → Change Settings [Auto]

Use the **Change Settings** option to change the serial port IO port address and interrupt address.

- **Auto              DEFAULT**                      The serial port IO port address and interrupt address are automatically detected.
- **IO=2E8h;**  
**IRQ=10**                      Serial Port I/O port address is 2E8h and the interrupt address is IRQ10
- **IO=3E8h;**  
**IRQ=10, 11**                      Serial Port I/O port address is 3E8h and the interrupt address is IRQ10, 11
- **IO=2E8h;**  
**IRQ=10, 11**                      Serial Port I/O port address is 2E8h and the interrupt address is IRQ10, 11

## KINO-DQM871 Mini-ITX SBC

- ➔ **IO=2D0h;**  
**IRQ=10, 11**      Serial Port I/O port address is 2D0h and the interrupt address is IRQ10, 11
- ➔ **IO=2D8h;**  
**IRQ=10, 11**      Serial Port I/O port address is 2D8h and the interrupt address is IRQ10, 11

### 5.3.10.1.5 Serial Port 5 Configuration

#### ➔ Serial Port [Enabled]

Use the **Serial Port** option to enable or disable the serial port.

- ➔ **Disabled**      Disable the serial port
- ➔ **Enabled**      **DEFAULT**      Enable the serial port

#### ➔ Change Settings [Auto]

Use the **Change Settings** option to change the serial port IO port address and interrupt address.

- ➔ **Auto**      **DEFAULT**      The serial port IO port address and interrupt address are automatically detected.
- ➔ **IO=2D0h;**  
**IRQ=3**      Serial Port I/O port address is 2D0h and the interrupt address is IRQ10
- ➔ **IO=2C0h;**  
**IRQ=10, 11**      Serial Port I/O port address is 2C0h and the interrupt address is IRQ10, 11
- ➔ **IO=2C8h;**  
**IRQ=10, 11**      Serial Port I/O port address is 2C8h and the interrupt address is IRQ10, 11
- ➔ **IO=2D0h;**  
**IRQ=10, 11**      Serial Port I/O port address is 2D0h and the interrupt address is IRQ10, 11
- ➔ **IO=2D8h;**  
**IRQ=10, 11**      Serial Port I/O port address is 2D8h and the interrupt address is IRQ10, 11
- ➔ **IO=2E0h;**  
**IRQ=10, 11**      Serial Port I/O port address is 2E0h and the interrupt address is IRQ10, 11

### 5.3.10.1.6 Serial Port 6 Configuration

➔ **Serial Port [Enabled]**

Use the **Serial Port** option to enable or disable the serial port.

- ➔ **Disabled**                      Disable the serial port
- ➔ **Enabled**      **DEFAULT**      Enable the serial port

➔ **Change Settings [Auto]**

Use the **Change Settings** option to change the serial port IO port address and interrupt address.

- ➔ **Auto**              **DEFAULT**      The serial port IO port address and interrupt address are automatically detected.
- ➔ **IO=2D8h;**  
**IRQ=3**                      Serial Port I/O port address is 2D8h and the interrupt address is IRQ10
- ➔ **IO=2C0h;**  
**IRQ=10, 11**                      Serial Port I/O port address is 2C0h and the interrupt address is IRQ10, 11
- ➔ **IO=2C8h;**  
**IRQ=10, 11**                      Serial Port I/O port address is 2C8h and the interrupt address is IRQ10, 11
- ➔ **IO=2D0h;**  
**IRQ=10, 11**                      Serial Port I/O port address is 2D0h and the interrupt address is IRQ10, 11
- ➔ **IO=2D8h;**  
**IRQ=10, 11**                      Serial Port I/O port address is 2D8h and the interrupt address is IRQ10, 11
- ➔ **IO=2E0h;**  
**IRQ=10, 11**                      Serial Port I/O port address is 2E0h and the interrupt address is IRQ10, 11



## KINO-DQM871 Mini-ITX SBC

### 5.3.11 F81866 H/W Monitor

The **F81866 H/W Monitor** menu (**BIOS Menu 15**) contains the fan configuration submenu and displays the system fan speeds.

```

Aptio Setup Utility - Copyright (C) 2012 American Megatrends, Inc.
-----
Advanced
-----
PC Health Status
> Smart Fan Mode Configuration
System temperature      : +40 C
CPU_FAN1 Speed         : N/A
SYS_FAN1 Speed         : N/A
+VCC_CORE               : +1.720 V
+V5S                    : +5.087 V
+V12S                   : +12.056 V
+V1.5                   : +1.584 V
+V3.3S                  : +3.344 V
VSB3V                   : +3.344 V
VBAT                    : +3.024 V

Smart Fan Mode Select
-----
-><: Select Screen
↑↓: Select Item
Enter: Select
+/-: Change Opt.
F1: General Help
F2: Previous Values
F3: Optimized Defaults
F4: Save & Exit
ESC: Exit

Version 2.15.1236. Copyright (C) 2012 American Megatrends, Inc.
  
```

**BIOS Menu 15: F81866 H/W Monitor**

### 5.3.11.1 Smart Fan Mode Configuration

Use the **Smart Fan Mode Configuration** submenu (**BIOS Menu 16**) to configure fan temperature and speed settings.

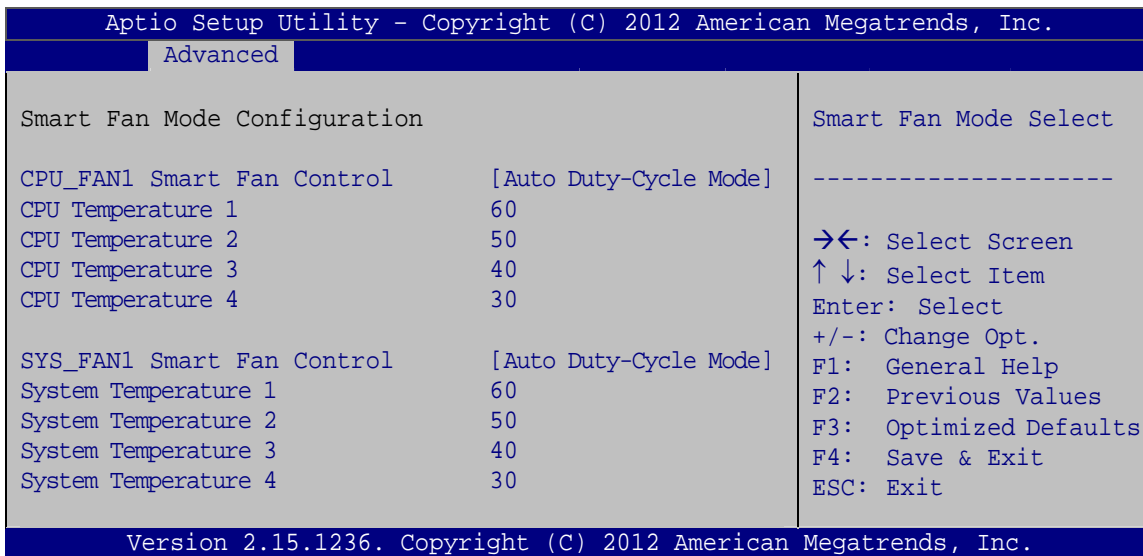

#### BIOS Menu 16: Smart Fan Mode Configuration

##### → CPU\_FAN1/SYS\_FAN1 Smart Fan Mode [Auto Duty-Cycle Mode]

Use the **FAN1/FAN2 Smart Fan Mode** option to configure the system smart fans.

- **Manual Duty Mode**                      The fan spins at the speed set in Manual Duty Mode settings (below option)
- **Auto by DEFAULT Duty-Cycle Mode**                      The fan adjusts its speed using Auto by Duty-Cycle settings

##### → CPU/System Temperature n

Enter a decimal number between 1 and 100 to change the fan **CPU/System Temperature n** value.

## KINO-DQM871 Mini-ITX SBC

### 5.3.12 Serial Port Console Redirection

The **Serial Port Console Redirection** menu (**BIOS Menu 17**) allows the console redirection options to be configured. Console redirection allows users to maintain a system remotely by re-directing keyboard input and text output through the serial port.

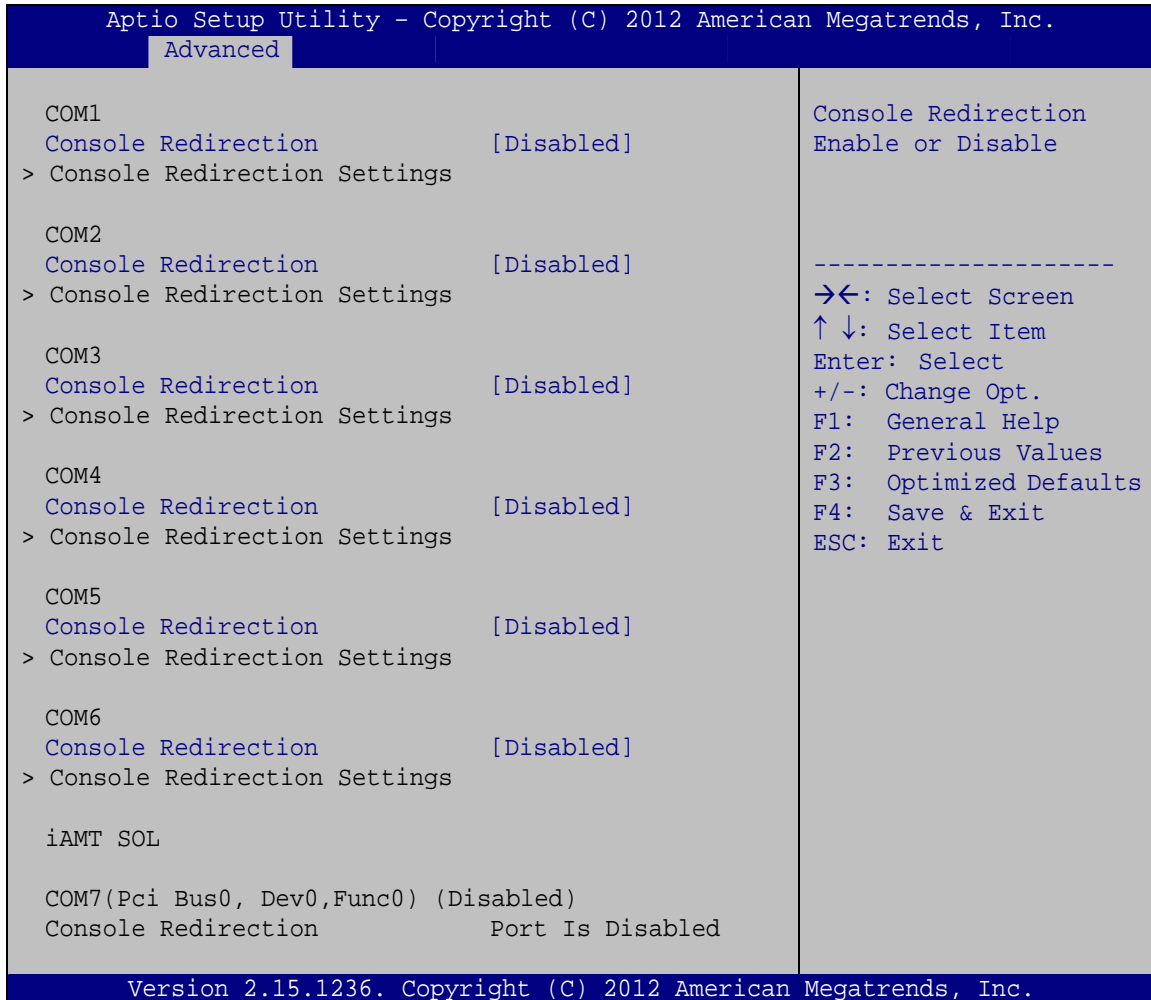

#### BIOS Menu 17: Serial Port Console Redirection

##### → Console Redirection [Disabled]

Use **Console Redirection** option to enable or disable the console redirection function.

- **Disabled**    **DEFAULT**    Disabled the console redirection function
- **Enabled**                    Enabled the console redirection function



**NOTE:**

The following five options appear when the **Console Redirection** option is enabled.

→ **Terminal Type [ANSI]**

Use the **Terminal Type** option to specify the remote terminal type.

- **VT100** The target terminal type is VT100
- **VT100+** The target terminal type is VT100+
- **VT-UTF8** The target terminal type is VT-UTF8
- **ANSI** **DEFAULT** The target terminal type is ANSI

→ **Bits per second [115200]**

Use the **Bits per second** option to specify the serial port transmission speed. The speed must match the other side. Long or noisy lines may require lower speeds.

- **9600** Sets the serial port transmission speed at 9600.
- **19200** Sets the serial port transmission speed at 19200.
- **38400** Sets the serial port transmission speed at 38400.
- **57600** Sets the serial port transmission speed at 57600.
- **115200** **DEFAULT** Sets the serial port transmission speed at 115200.

→ **Data Bits [8]**

Use the **Data Bits** option to specify the number of data bits.

- **7** Sets the data bits at 7.

## KINO-DQM871 Mini-ITX SBC

→ 8                      **DEFAULT**                      Sets the data bits at 8.

→ **Parity [None]**

Use the **Parity** option to specify the parity bit that can be sent with the data bits for detecting the transmission errors.

→ **None**                      **DEFAULT**                      No parity bit is sent with the data bits.

→ **Even**                      The parity bit is 0 if the number of ones in the data bits is even.

→ **Odd**                      The parity bit is 0 if the number of ones in the data bits is odd.

→ **Mark**                      The parity bit is always 1. This option does not provide error detection.

→ **Space**                      The parity bit is always 0. This option does not provide error detection.

→ **Stop Bits [1]**

Use the **Stop Bits** option to specify the number of stop bits used to indicate the end of a serial data packet. Communication with slow devices may require more than 1 stop bit.

→ 1                      **DEFAULT**                      Sets the number of stop bits at 1.

→ 2                      Sets the number of stop bits at 2.

### 5.3.13 iEi Feature

Use the **iEi Feature** menu (**BIOS Menu 18**) to configure One Key Recovery function.

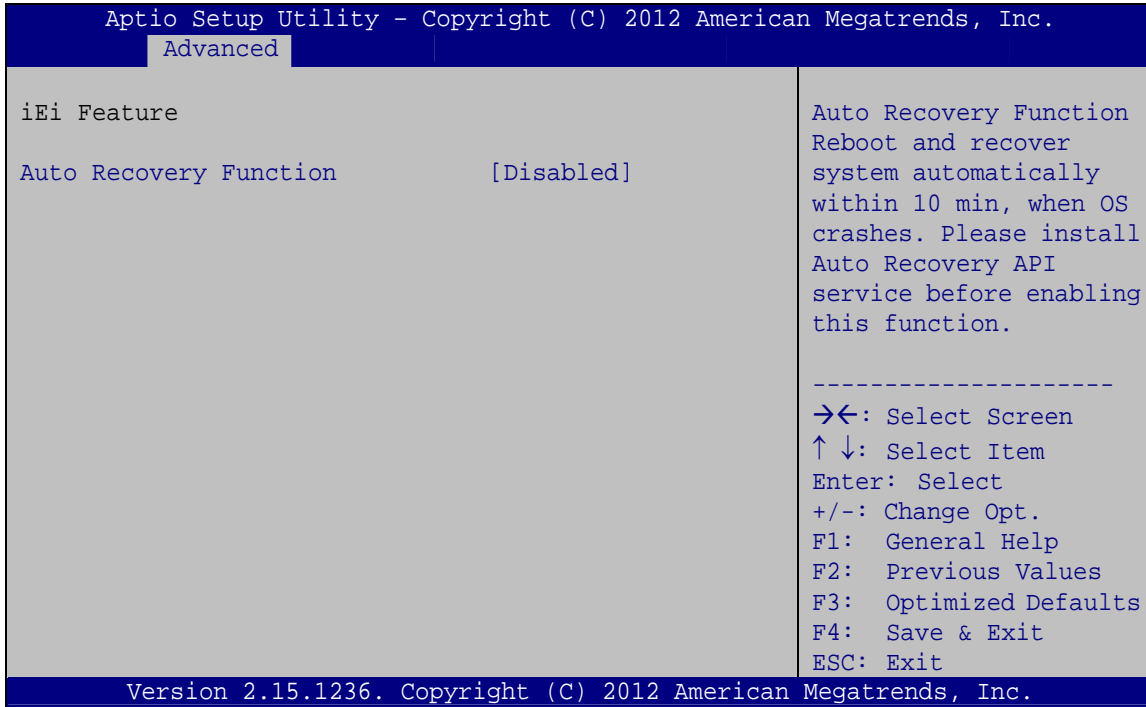

#### BIOS Menu 18: iEi Feature

##### ➔ Auto Recovery Function [Disabled]

Use the **Auto Recovery Function** BIOS option to enable or disable the auto recovery function of the IEI One Key Recovery.

- ➔ **Disabled**      **DEFAULT**      Auto recovery function disabled
- ➔ **Enabled**      Auto recovery function enabled

## KINO-DQM871 Mini-ITX SBC

## 5.4 Chipset

Use the **Chipset** menu (**BIOS Menu 19**) to access the PCH IO and System Agent (SA) configuration menus.



### WARNING!

Setting the wrong values for the Chipset BIOS selections in the Chipset BIOS menu may cause the system to malfunction.

```

Aptio Setup Utility - Copyright (C) 2012 American Megatrends, Inc.
Main   Advanced  Chipset  Boot   Security  Save & Exit
-----
> System Agent (SA) Configuration
> PCH-IO Configuration

System Agent (SA)
Parameters

-----
-><: Select Screen
↑ ↓: Select Item
Enter: Select
+/-: Change Opt.
F1: General Help
F2: Previous Values
F3: Optimized Defaults
F4: Save & Exit
ESC: Exit

Version 2.15.1236. Copyright (C) 2012 American Megatrends, Inc.

```

**BIOS Menu 19: Chipset**

### 5.4.1 System Agent (SA) Configuration

Use the **System Agent (SA) Configuration** menu (**BIOS Menu 20**) to configure the System Agent (SA) parameters.

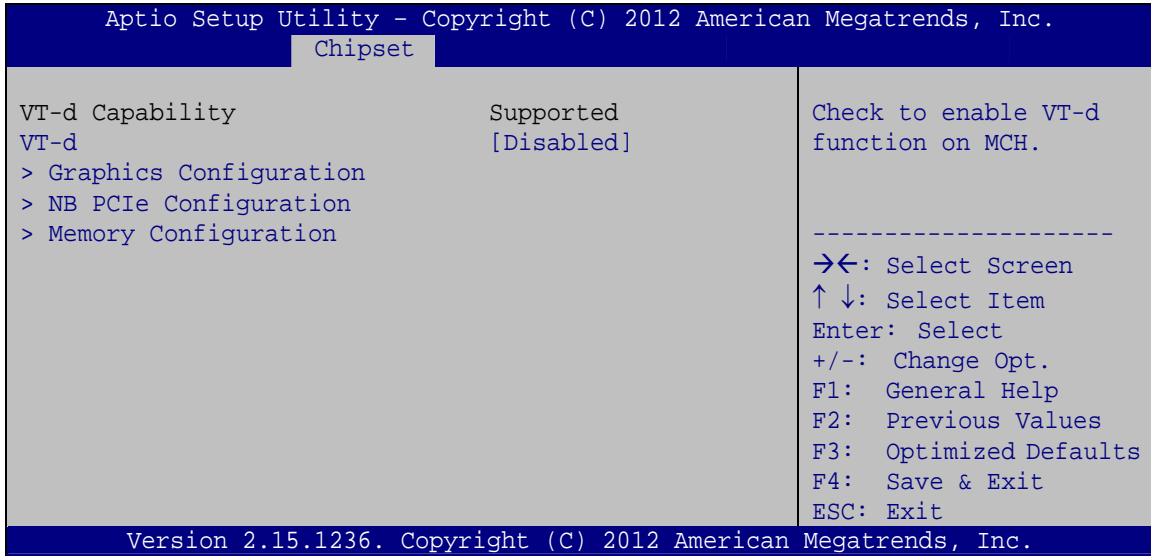

#### BIOS Menu 20: System Agent (SA) Configuration

##### ➔ VT-d [Disabled]

Use the **VT-d** option to enable or disable VT-d support.

- ➔ **Disabled**                      **DEFAULT**      Disables VT-d support.
- ➔ **Enabled**                                      Enables VT-d support.

#### 5.4.1.1 Graphics Configuration

Use the **Graphics Configuration (BIOS Menu 21)** menu to configure the video device connected to the system.



## KINO-DQM871 Mini-ITX SBC

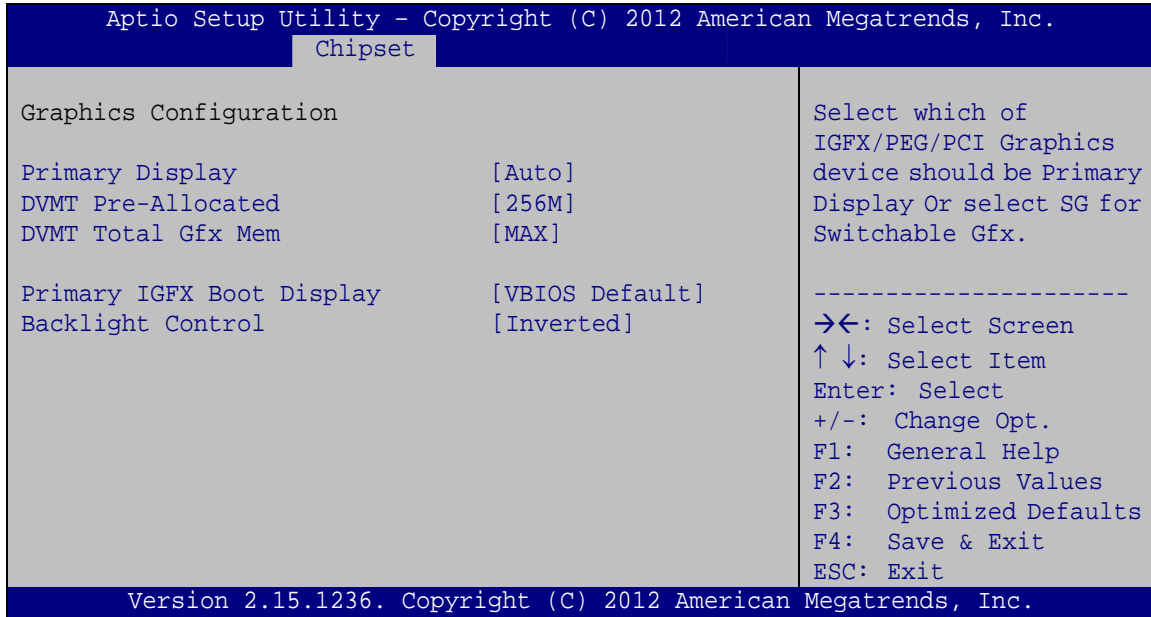

### BIOS Menu 21: Graphics Configuration

#### → Primary Display [Auto]

Use the **Primary Display** option to select the primary graphics controller the system uses.

The following options are available:

- Auto **Default**
- IGFX
- PEG
- PCIE

#### → DVMT Pre-Allocated [256M]

Use the **DVMT Pre-Allocated** option to set the amount of system memory allocated to the integrated graphics processor when the system boots. The system memory allocated can then only be used as graphics memory, and is no longer available to applications or the operating system. Configuration options are listed below:

- 32M
- 64M
- 128M
- 256M **Default**
- 512M

**→ DVMT Total Gfx Mem [MAX]**

Use the **DVMT Total Gfx Mem** option to select DVMT5.0 total graphic memory size used by the internal graphic device. The following options are available:

- 128M
- 256M
- MAX                      **Default**

**→ Primary IGFX Boot Display [VBIOS Default]**

Use the **Primary IGFX Boot Display** option to select the display device used by the system when it boots. Configuration options are listed below.

- VBIOS Default              **DEFAULT**
- CRT
- LVDS
- Display port 1
- HDMI 1
- HDMI 2

**→ Backlight Control [Inverted]**

Use the **Backlight Control** option to select the backlight control mode.

- Normal**                      The LVDS backlight is brighter at low voltage level.
- Inverted**                      **DEFAULT**      The LVDS backlight is brighter at high voltage level.

## KINO-DQM871 Mini-ITX SBC

## 5.4.1.2 NB PCIe Configuration

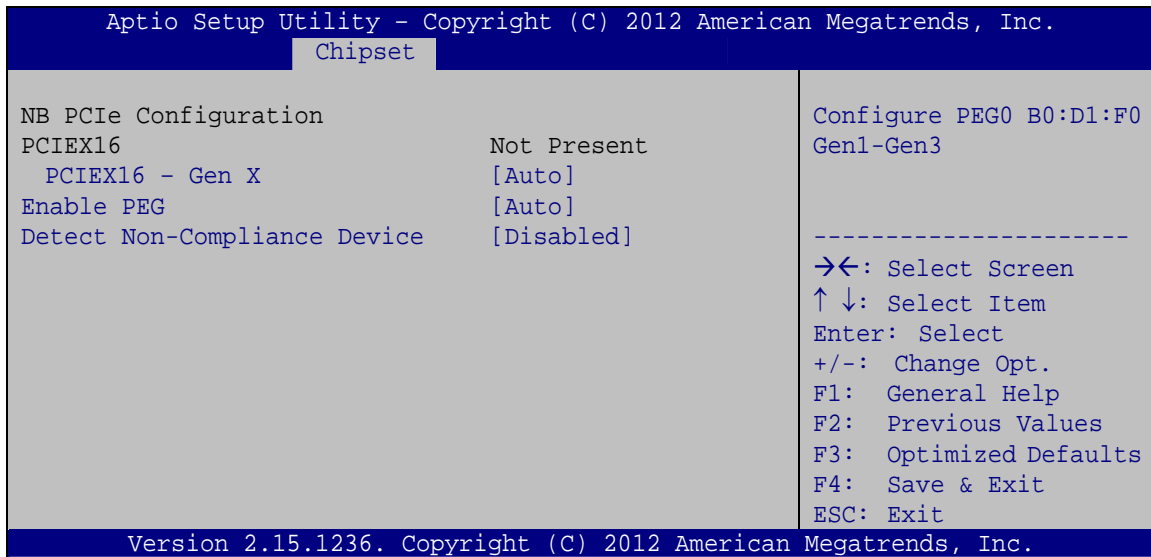

## BIOS Menu 22: NB PCIe Configuration

## ➔ PCIEX16 – Gen X [Auto]

Use the **PCIEX16 – Gen X** option to select the support type of the PCI Express x16 slot.

The following options are available:

- Auto           **Default**
- Gen1
- Gen2
- Gen3

## ➔ Enable PEG [Auto]

Use the **Enable PEG** option to enable or disable the PCI Express controller. The following options are available:

- Disabled
- Enabled
- Auto       **Default**

## ➔ Detect Non-Compliance Device [Disabled]

Use the **Detect Non-Compliance Device** option to enable or disable detecting a non-compliance PCI Express device in the PEG. The following options are available:

- Disabled      **Default**
- Enabled

### 5.4.1.3 Memory Configuration

Use the **Memory Configuration** submenu (**BIOS Menu 23**) to view memory information.

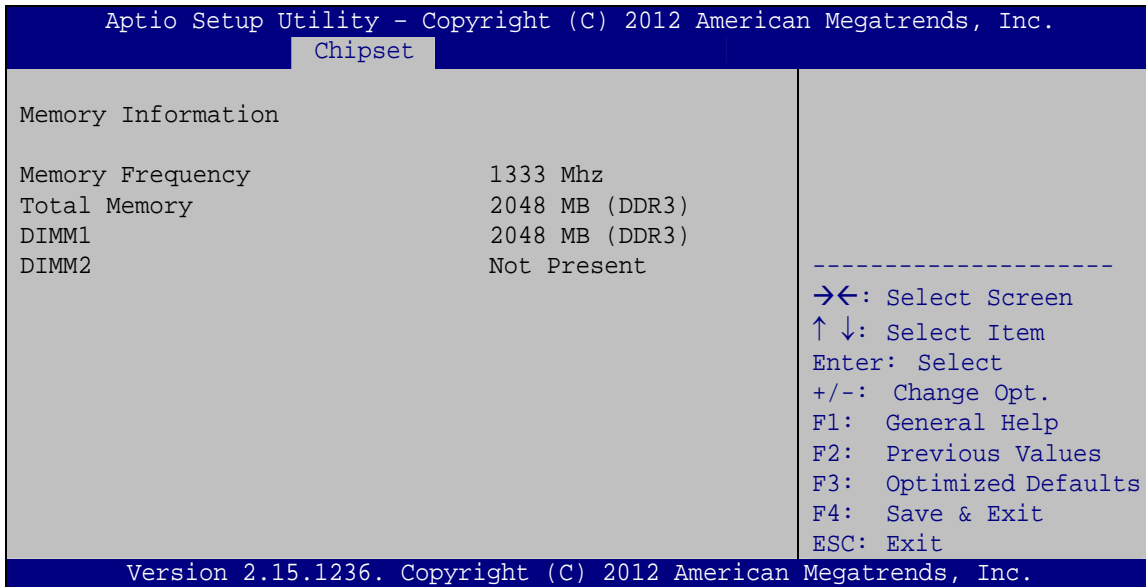

**BIOS Menu 23: Memory Configuration**

## KINO-DQM871 Mini-ITX SBC

### 5.4.2 PCH-IO Configuration

Use the **PCH-IO Configuration** menu (**BIOS Menu 24**) to configure the PCH parameters.

```

Aptio Setup Utility - Copyright (C) 2012 American Megatrends, Inc.
Chipset
Restore AC Power Loss      [Last State]
Azalia                     [Enabled]
Power Saving Function(ERP) [Disabled]

> PCI Express Configuration

-----
-><: Select Screen
↑↓: Select Item
Enter: Select
+/-: Change Opt.
F1: General Help
F2: Previous Values
F3: Optimized Defaults
F4: Save & Exit
ESC: Exit

Version 2.15.1236. Copyright (C) 2012 American Megatrends, Inc.
  
```

#### BIOS Menu 24: PCH-IO Configuration

##### ➔ Restore AC Power Loss [Last State]

Use the **Restore AC Power Loss** BIOS option to specify what state the system returns to if there is a sudden loss of power to the system.

- ➔ **Power Off**                      The system remains turned off
- ➔ **Power On**                        The system turns on
- ➔ **Last State**            **DEFAULT**    The system returns to its previous state. If it was on, it turns itself on. If it was off, it remains off.

##### ➔ Azalia [Enabled]

Use the **Azalia** option to enable or disable the High Definition Audio controller.

- ➔ **Disabled**                      The onboard High Definition Audio controller is disabled
- ➔ **Enabled**    **DEFAULT**      The onboard High Definition Audio controller automatically detected and enabled

### ➔ Power Saving Function [Disabled]

Use the **Power Saving Function** option to enable or disable power saving function.

- ➔ **Disabled**    **DEFAULT**      Power saving function is disabled
- ➔ **Enabled**                      Enable to reduce power consumption in system off state.

### 5.4.2.1 PCI Express Configuration

Use the **PCI Express Configuration** menu (**BIOS Menu 25**) to select the support type of the PCI Express or PCIe Mini slots.

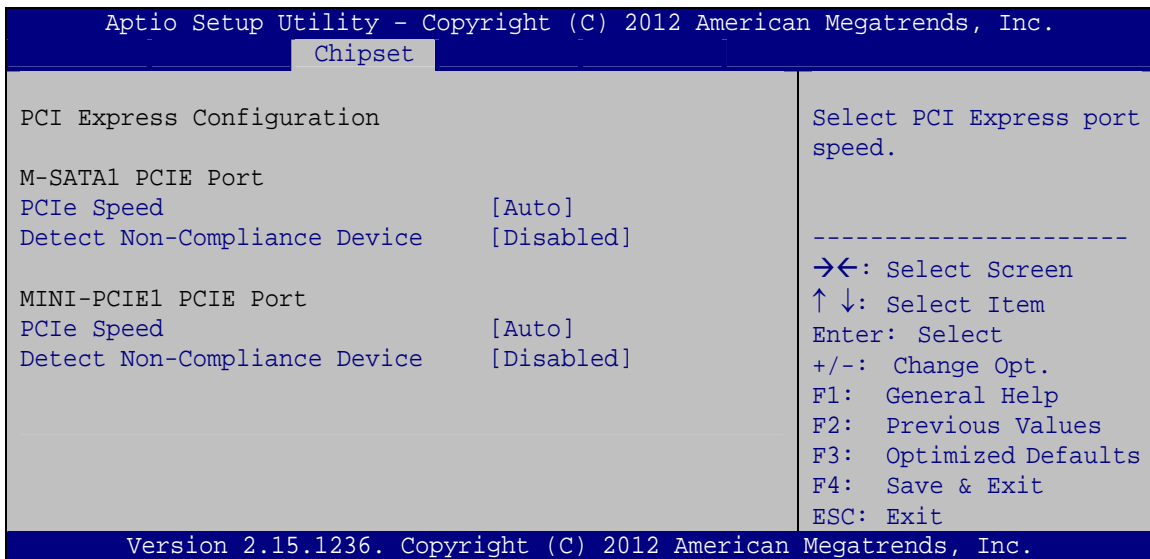

### BIOS Menu 25: PCI Express Configuration

#### ➔ PCIe Speed

Use PCIe Speed option to select the speed type of the PCI Express or PCIe Mini slots.

The following options are available:

- Auto                      **Default**
- Gen1

## KINO-DQM871 Mini-ITX SBC

- Gen2

### → Detect Non-Compliance Device [Disabled]

Use the **Detect Non-Compliance Device** option to enable or disable the “detect no-compliance PCIe device” function.

- **Disabled** **DEFAULT** Detect no-compliance PCIe device function is disabled
- **Enabled** Detect no-compliance PCIe device function is enabled. If will take more time at POST if it is enabled.

## 5.5 Boot

Use the **Boot menu (BIOS Menu 26)** to configure system boot options.

```

Aptio Setup Utility - Copyright (C) 2012 American Megatrends, Inc.
Main   Advanced  Chipset  Boot   Security  Save & Exit
-----
Boot Configuration
Bootup NumLock State      [On]
Quiet Boot                 [Enabled]
Option ROM Messages       [Force BIOS]
Launch PXE OpROM          [Disabled]
UEFI Boot                  [Disabled]

Boot Option Priorities

-----
→←: Select Screen
↑ ↓: Select Item
Enter: Select
+/-: Change Opt.
F1:  General Help
F2:  Previous Values
F3:  Optimized Defaults
F4:  Save & Exit
ESC: Exit

Version 2.15.1236. Copyright (C) 2012 American Megatrends, Inc.
  
```

### BIOS Menu 26: Boot

#### → Bootup NumLock State [On]

Use the **Bootup NumLock State** BIOS option to specify if the number lock setting must be modified during boot up.

- **On**                      **DEFAULT**                      Allows the Number Lock on the keyboard to be enabled automatically when the computer system boots up. This allows the immediate use of the 10-key numeric keypad located on the right side of the keyboard. To confirm this, the Number Lock LED light on the keyboard is lit.
  
- **Off**                                      Does not enable the keyboard Number Lock automatically. To use the 10-keys on the keyboard, press the Number Lock key located on the upper left-hand corner of the 10-key pad. The Number Lock LED on the keyboard lights up when the Number Lock is engaged.

### → **Quiet Boot [Enabled]**

Use the **Quiet Boot** BIOS option to select the screen display when the system boots.

- **Disabled**                                      Normal POST messages displayed
  
- **Enabled**                      **DEFAULT**                      OEM Logo displayed instead of POST messages

### → **Option ROM Messages [Force BIOS]**

Use the **Option ROM Messages** option to set the Option ROM display mode.

- **Force BIOS**                      **DEFAULT**                      Sets display mode to force BIOS.
  
- **Keep Current**                                      Sets display mode to current.

### → **Launch PXE OpROM [Disabled]**

Use the **Launch PXE OpROM** option to enable or disable boot option for legacy network devices.

- **Disabled**                      **DEFAULT**                      Ignore all PXE Option ROMs



## KINO-DQM871 Mini-ITX SBC

→ **Enabled** Load PXE Option ROMs.

### → **UEFI Boot [Disabled]**

Use the **UEFI Boot** BIOS option to allow the system to boot from the UEFI devices.

→ **Disabled** **DEFAULT** Disables to boot from the UEFI devices.

→ **Enabled** Enables to boot from the UEFI devices.

## 5.6 Security

Use the **Security** menu (**BIOS Menu 27**) to set system and user passwords.

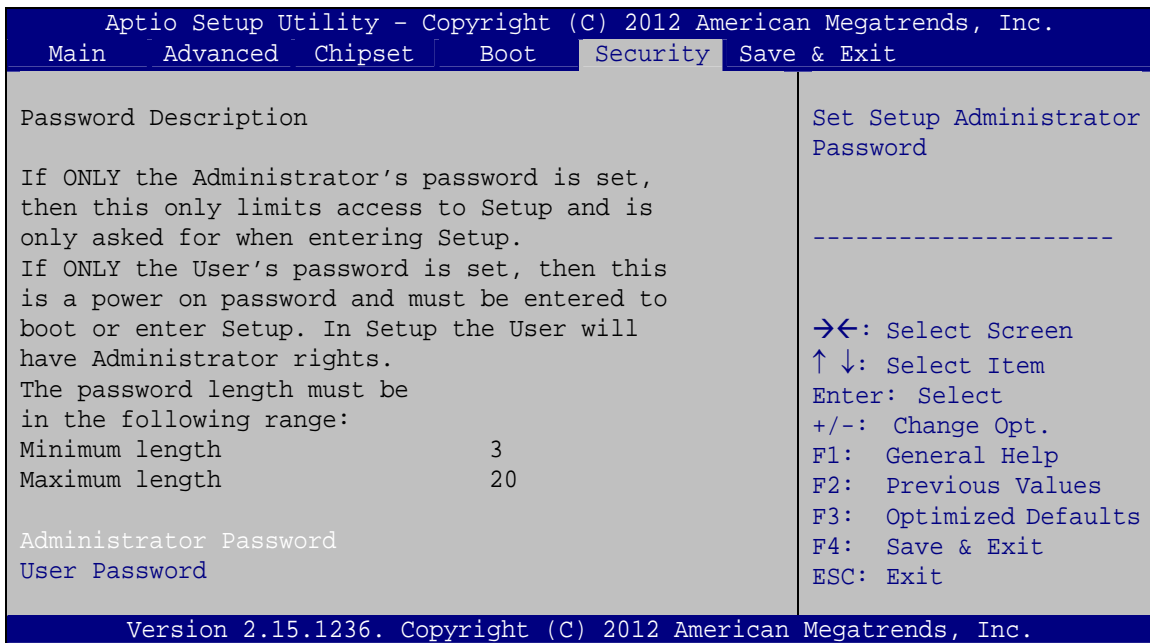

### **BIOS Menu 27: Security**

#### → **Administrator Password**

Use the **Administrator Password** to set or change an administrator password.

#### → **User Password**

Use the **User Password** to set or change a user password.

## 5.7 Save & Exit

Use the **Save & Exit** menu (**BIOS Menu 28**) to load default BIOS values, optimal failsafe values and to save configuration changes.

```
Aptio Setup Utility - Copyright (C) 2012 American Megatrends, Inc.
Main   Advanced  Chipset  Boot   Security  Save & Exit

Save Changes and Reset
Discard Changes and Reset

Restore Defaults
Save as User Defaults
Restore User Defaults

Reset the system after
saving the changes.

-----
-><: Select Screen
↑↓: Select Item
Enter: Select
+/-: Change Opt.
F1:  General Help
F2:  Previous Values
F3:  Optimized Defaults
F4:  Save & Exit
ESC: Exit

Version 2.15.1236. Copyright (C) 2012 American Megatrends, Inc.
```

### BIOS Menu 28: Save & Exit

#### → Save Changes and Reset

Use the **Save Changes and Reset** option to save the changes made to the BIOS options and reset the system.

#### → Discard Changes and Reset

Use the **Discard Changes and Reset** option to exit the system without saving the changes made to the BIOS configuration setup program.

#### → Restore Defaults

Use the **Restore Defaults** option to load the optimal default values for each of the parameters on the Setup menus. **F3 key can be used for this operation.**

#### → Save as User Defaults

Use the **Save as User Defaults** option to save the changes done so far as user defaults.

## KINO-DQM871 Mini-ITX SBC

### → Restore User Defaults

Use the **Restore User Defaults** option to restore the user defaults to all the setup options.

Chapter

**6**

# Software Drivers

---

## KINO-DQM871 Mini-ITX SBC

### 6.1 Available Software Drivers

---

**NOTE:**

The content of the CD may vary throughout the life cycle of the product and is subject to change without prior notice. Visit the IEI website or contact technical support for the latest updates.

---

The following drivers can be installed on the system:

- Chipset
- Graphics
- LAN
- USB 3.0
- Audio
- Intel® AMT

Installation instructions are given below.

### 6.2 Starting the Driver Program

To access the driver installation programs, please do the following.

**Step 1:** Insert the CD that came with the system into a CD drive connected to the system.

---

**NOTE:**

If the installation program doesn't start automatically:  
Click "Start->Computer->CD Drive->autorun.exe"

---

**Step 2:** The driver main menu appears (**Figure 6-1**).

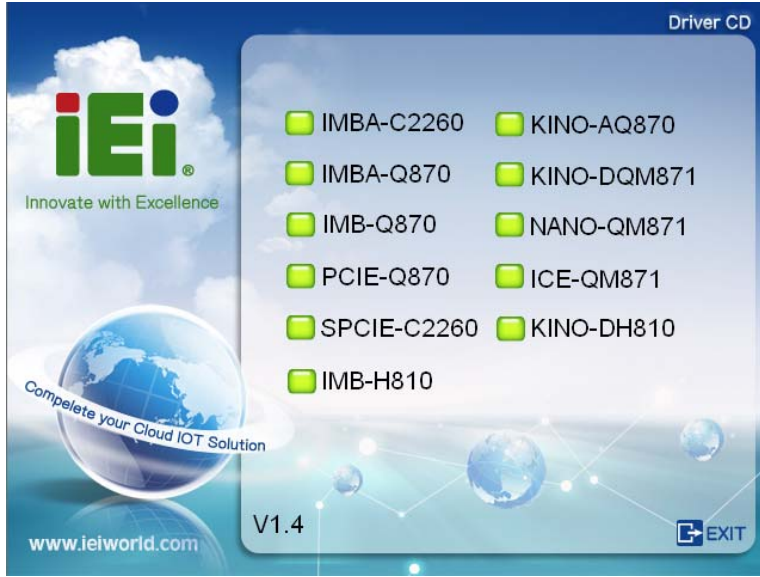

**Figure 6-1: Start Up Screen**

**Step 3:** Click KINO-DQM871.

**Step 4:** The list of drivers in **Figure 6-2** appears.



**Figure 6-2: Drivers**

### 6.3 Chipset Driver Installation

To install the chipset driver, please do the following.

**Step 1:** Access the driver list. (See **Section 6.2**)

## KINO-DQM871 Mini-ITX SBC

**Step 2:** Click “1-Chipset”.

**Step 3:** Locate the setup file and double click on it.

**Step 4:** The **Welcome Screen** in **Figure 6-3** appears. Click **Next** to continue.



**Figure 6-3: Chipset Driver Welcome Screen**

**Step 5:** The license agreement in **Figure 6-4** appears.

**Step 6:** Read the **License Agreement**.

**Step 7:** Click **Yes** to continue.



**Figure 6-4: Chipset Driver License Agreement**

**Step 8:** The Read Me file in Figure 6-5 appears.

**Step 9:** Click **Next** to continue.

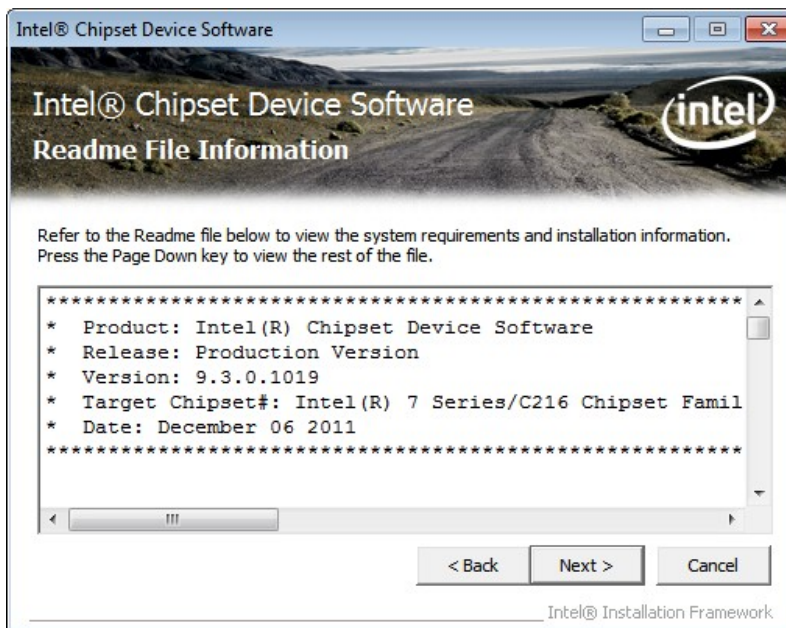
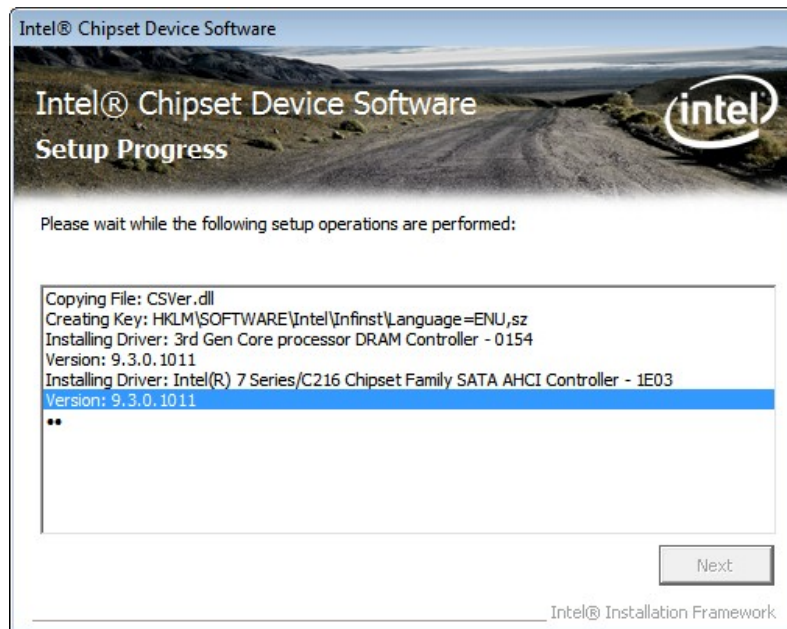

**Figure 6-5: Chipset Driver Read Me File**



## KINO-DQM871 Mini-ITX SBC

**Step 10:** Setup Operations are performed as shown in Figure 6-6.



**Figure 6-6: Chipset Driver Setup Operations**

**Step 11:** Once the Setup Operations are complete, click **Next** to continue.

**Step 12:** The **Finish** screen in Figure 6-7 appears.

**Step 13:** Select “**Yes, I want to restart the computer now**” and click the **Finish** icon.

See Figure 6-7.



Figure 6-7: Chipset Driver Installation Finish Screen

## 6.4 Graphics Driver Installation

To install the graphics driver, please do the following.

- Step 1:** Access the driver list. (See **Section 6.2**)
- Step 2:** Click "**2-Graphics**" and select the folder which corresponds to the operating system.
- Step 3:** Double click the setup file.
- Step 4:** The **Welcome Screen** in **Figure 6-8** appears. Click **Next** to continue.

## KINO-DQM871 Mini-ITX SBC

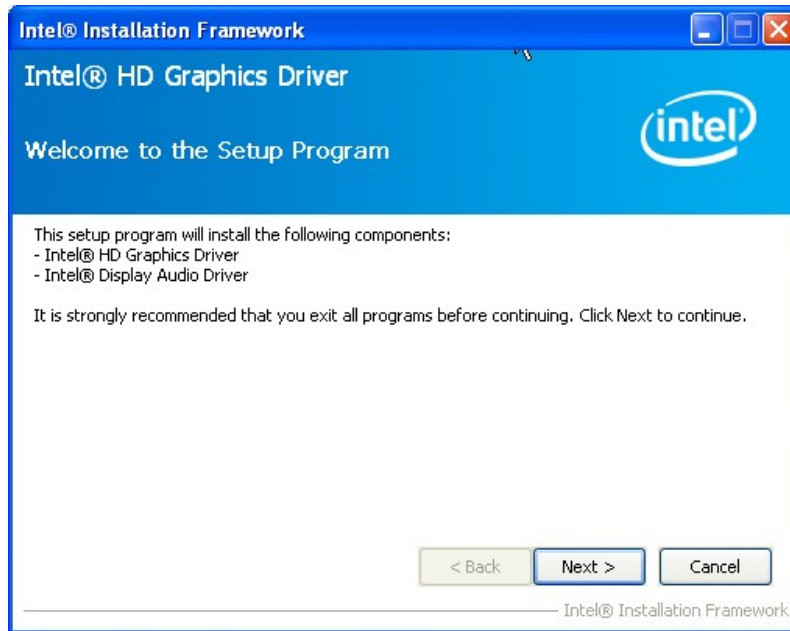

Figure 6-8: Graphics Driver Welcome Screen

**Step 5:** The license agreement in **Figure 6-9** appears. Read the **License Agreement**.

**Step 6:** Click **Yes** to continue.



Figure 6-9: Graphics Driver License Agreement

**Step 7:** The Read Me file in **Figure 6-10** appears.

**Step 8:** Click **Next** to continue.

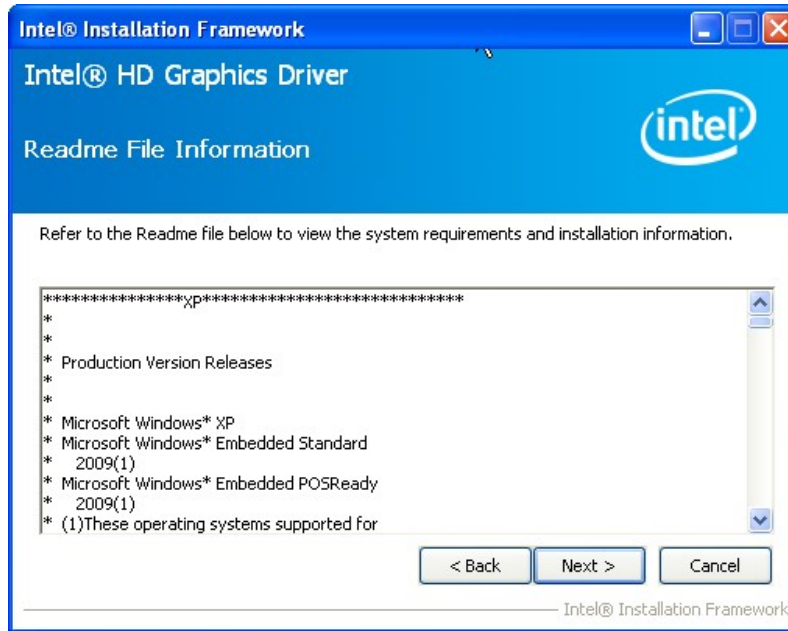

**Figure 6-10: Graphics Driver Read Me File**

**Step 9:** **Setup Operations** are performed as shown in **Figure 6-11**.

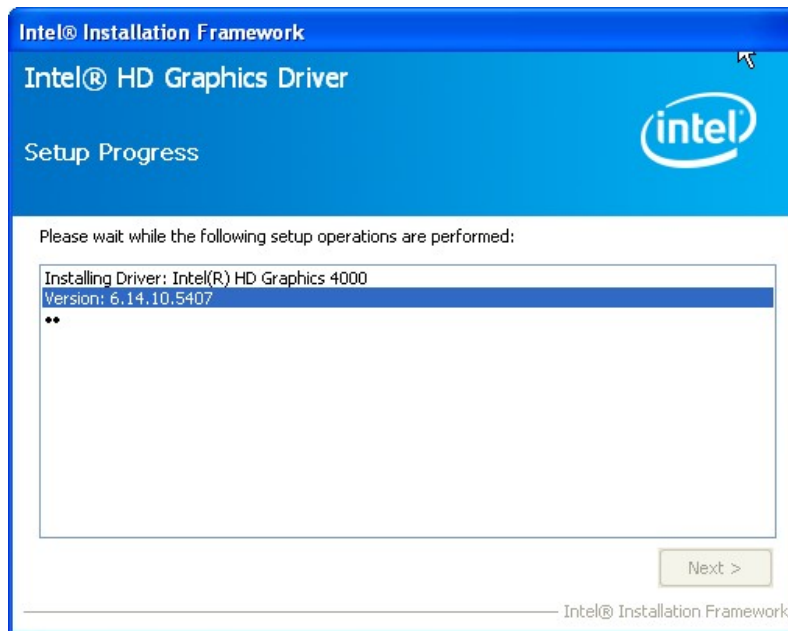

**Figure 6-11: Graphics Driver Setup Operations**

## KINO-DQM871 Mini-ITX SBC

**Step 10:** Once the **Setup Operations** are complete, click the **Next** icon to continue.

**Step 11:** The **Finish** screen appears.

**Step 12:** Select “**Yes, I want to restart the computer now**” and click the **Finish** icon.

See **Figure 6-12**.

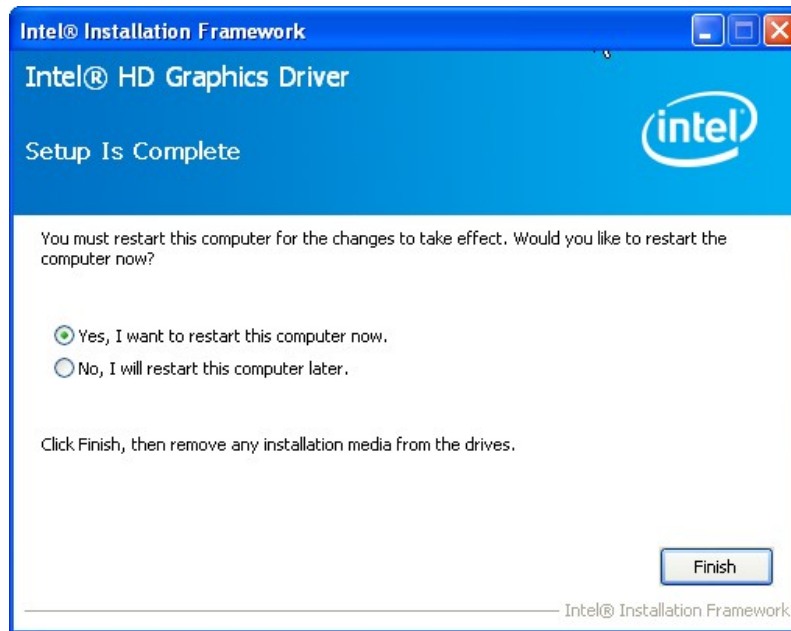

**Figure 6-12: Graphics Driver Installation Finish Screen**

## 6.5 LAN Driver Installation

To install the LAN driver, please do the following.

**Step 1:** Right-click the Computer button from the start menu and select **Properties**

(**Figure 6-13**).

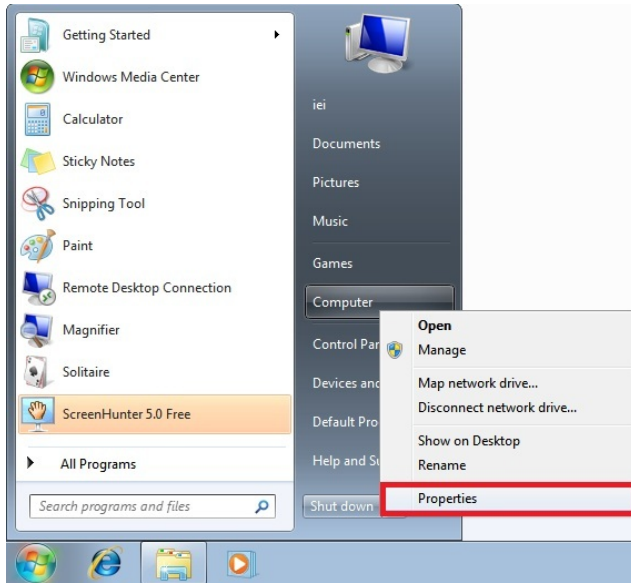

**Figure 6-13: Windows Control Panel**

**Step 2:** The system control panel window in **Figure 6-14** appears.

**Step 3:** Click the Device Manager link (**Figure 6-14**).

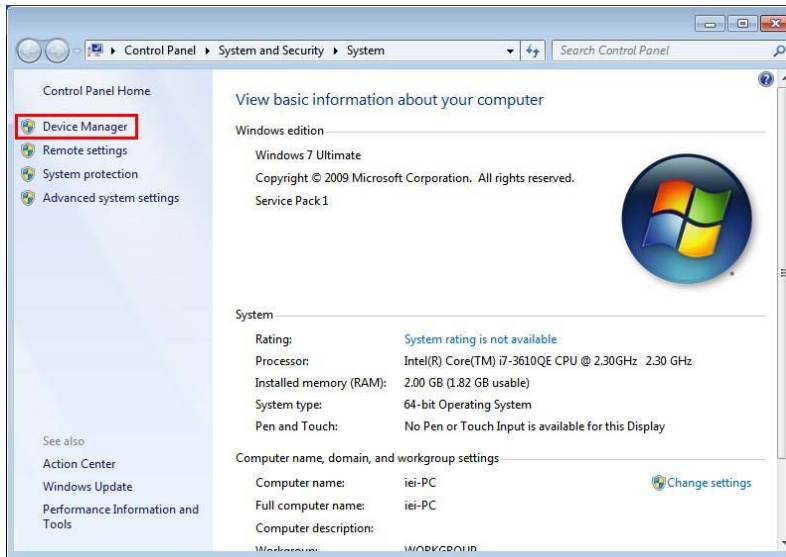

**Figure 6-14: System Control Panel**

**Step 4:** A list of system hardware devices appears (**Figure 6-15**).

**Step 5:** Right-click the Ethernet Controller that has question marks next to it (this means Windows does not recognize the device).

## KINO-DQM871 Mini-ITX SBC

**Step 6:** Select **Update Driver Software**.

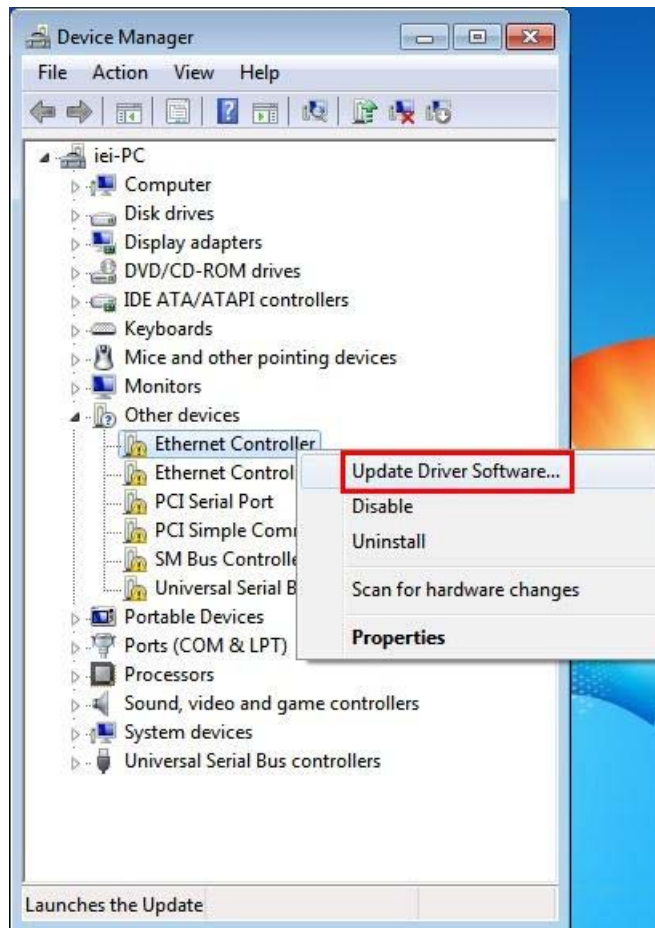

**Figure 6-15: Device Manager List**

**Step 7:** The Update Driver Software Window appears (**Figure 6-16**).

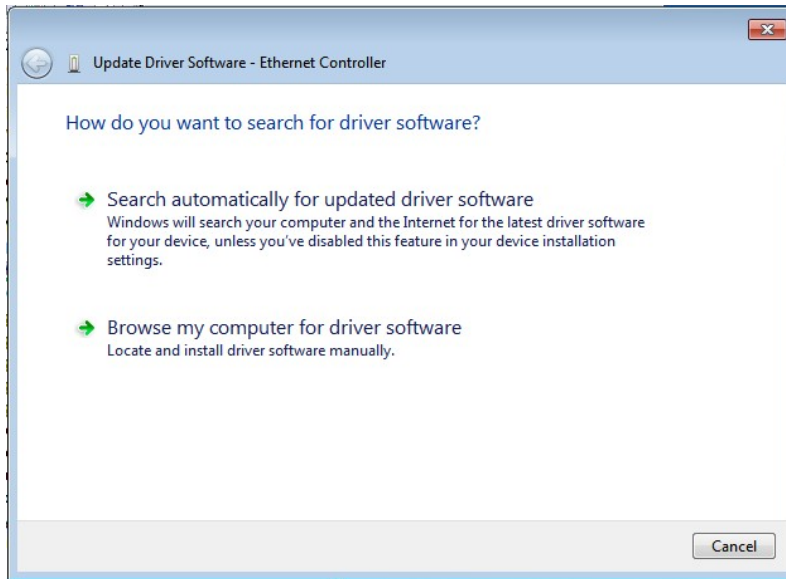

Figure 6-16: Update Driver Software Window

**Step 8:** Select “Browse my computer for driver software” and click **NEXT** to continue.

**Step 9:** Click Browse to select “X:\3-LAN” directory in the **Locate File** window, where “X:\” is the system CD drive. (Figure 6-17).

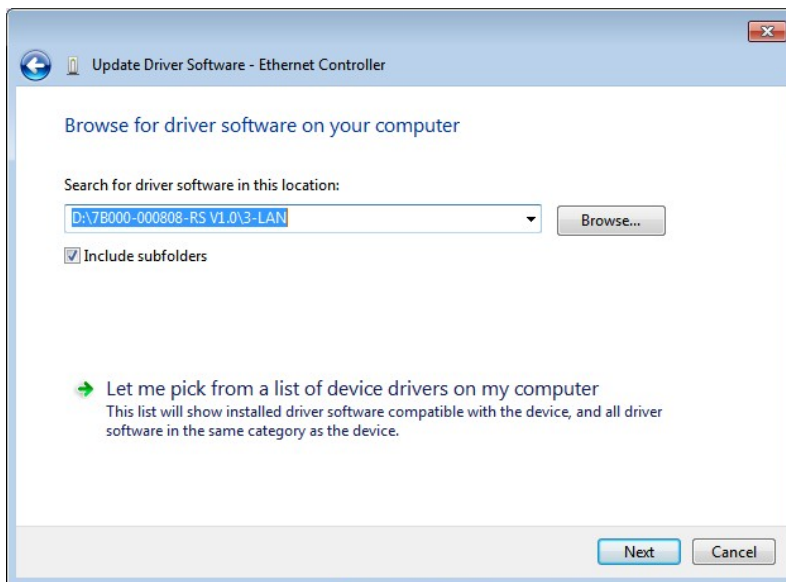

Figure 6-17: Locate Driver Files

**Step 10:** Click **NEXT** to continue.



## KINO-DQM871 Mini-ITX SBC

**Step 11:** Driver Installation is performed as shown in **Figure 6-18**.

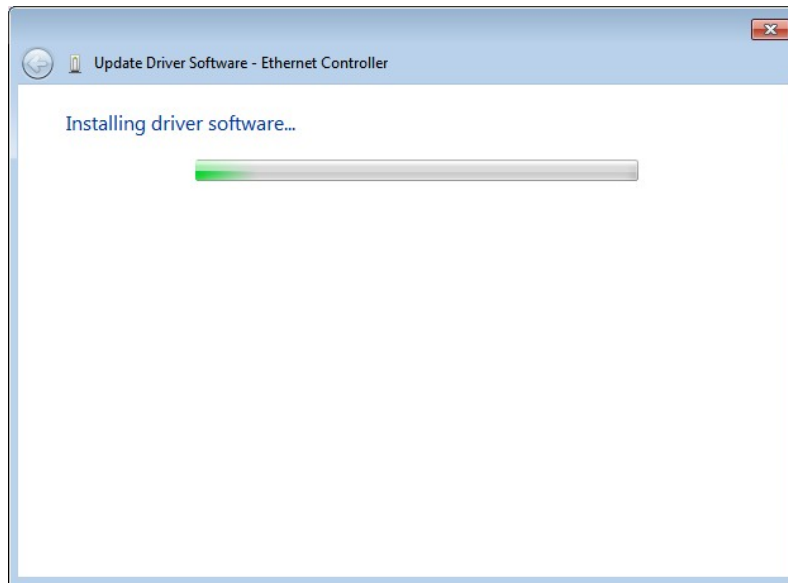

**Figure 6-18: LAN Driver Installation**

**Step 12:** The **Finish** screen in **Figure 6-19** appears. Click **Close** to exit.

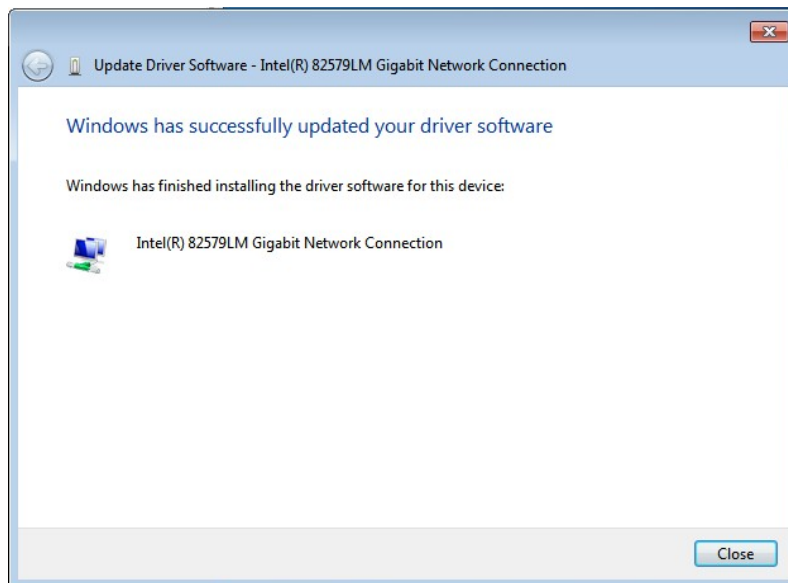

**Figure 6-19: LAN Driver Installation Complete**

## 6.6 USB 3.0 Driver Installation



### WARNING:

Do not run this driver's installer (Setup.exe) from a USB storage device (ie. external USB hard drive or USB thumb drive). For proper installation, please copy driver files to a local hard drive folder and run from there.

To install the USB 3.0 driver, please follow the steps below.

- Step 1:** Access the driver list. (See **Section 6.2**)
- Step 2:** Click “4-USB 3.0”.
- Step 3:** Locate the setup file and double click on it.
- Step 4:** The **Welcome Screen** in **Figure 6-20** appears.
- Step 5:** Click **Next** to continue.



Figure 6-20: USB 3.0 Driver Welcome Screen

**KINO-DQM871 Mini-ITX SBC**

**Step 6:** The license agreement in **Figure 6-21** appears.

**Step 7:** Read the **License Agreement**.

**Step 8:** Click **Yes** to continue.



**Figure 6-21: USB 3.0 Driver License Agreement**

**Step 9:** The **Read Me** file in **Figure 6-22** appears.

**Step 10:** Click **Next** to continue.



**Figure 6-22: USB 3.0 Driver Read Me File**

**Step 11:** Setup Operations are performed as shown in **Figure 6-23**.

**Step 12:** Once the **Setup Operations** are complete, click **Next** to continue.

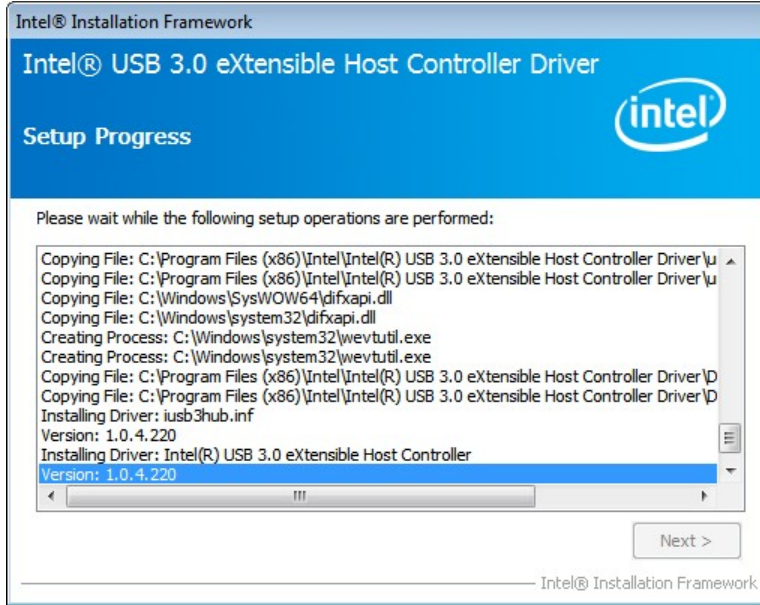

**Figure 6-23: USB 3.0 Driver Setup Operations**

**Step 13:** The **Finish** screen in **Figure 6-24** appears.

**Step 14:** Select “**Yes, I want to restart this computer now**” and click **Finish**.



**Figure 6-24: USB 3.0 Driver Installation Finish Screen**

## KINO-DQM871 Mini-ITX SBC

## 6.7 Audio Driver Installation

To install the Audio driver, please do the following.

- Step 1:** Access the driver list. (See **Section 6.2**)
- Step 2:** Click “**5-Audio**” and select the folder which corresponds to the operating system.
- Step 3:** Double click the setup file.
- Step 4:** The **InstallShield Wizard** is prepared to guide the user through the rest of the process
- Step 5:** Once initialized, the **InstallShield Wizard** welcome screen appears (**Figure 6-25**).

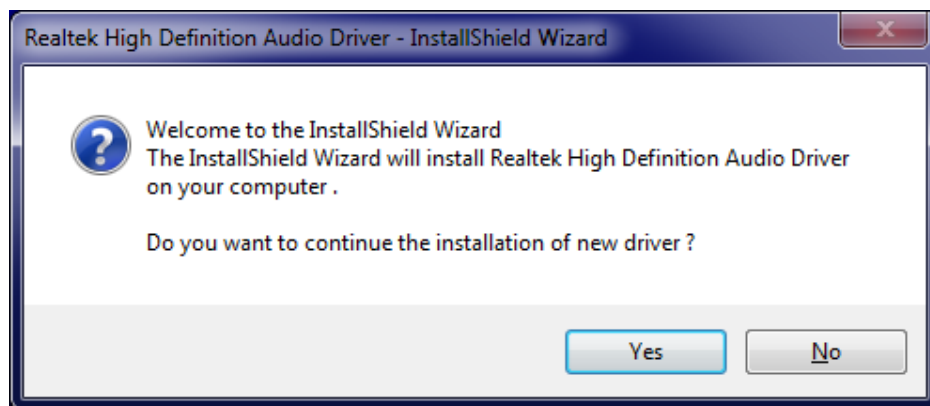

**Figure 6-25: Audio Driver Welcome Screen**

- Step 6:** Click **Yes** to continue.
- Step 7:** The program begins to install. See **Figure 6-26**.

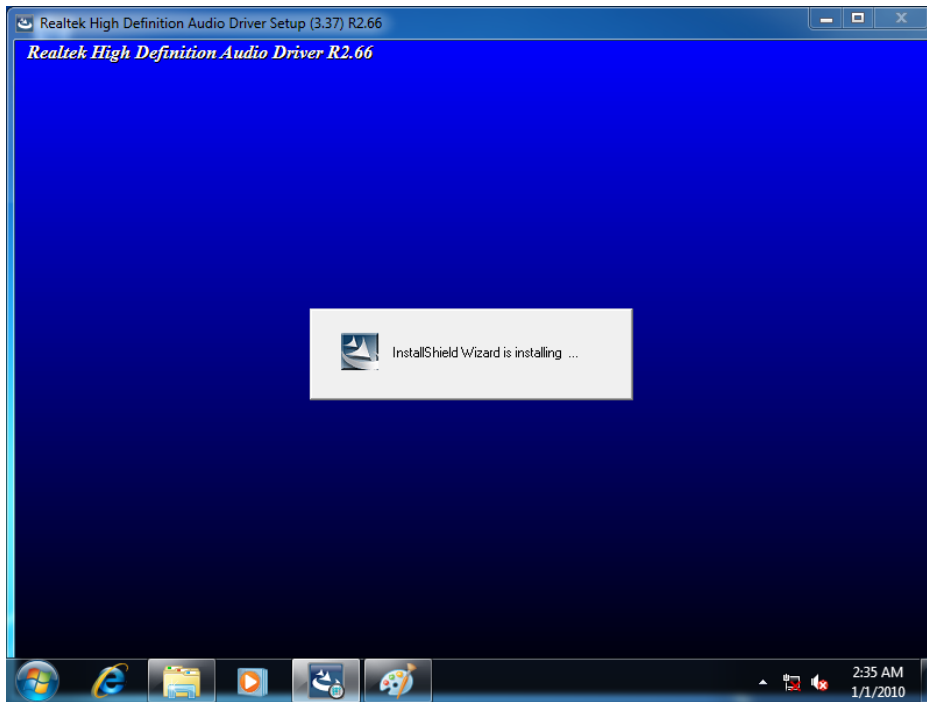

Figure 6-26: Audio Driver Installation

**Step 8:** When the driver installation is complete, the screen in **Figure 6-27** appears.

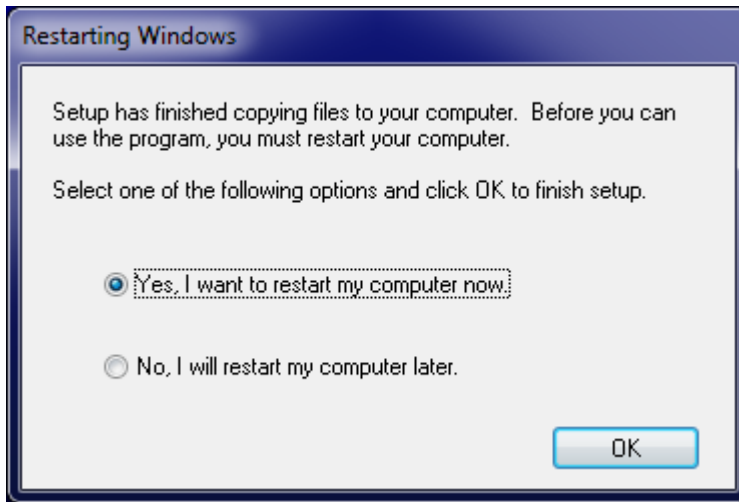

Figure 6-27: Audio Driver Installation Complete

**Step 9:** Select “Yes, I want to restart my computer now” and click **Finish**.

**Step 10:** The system reboots.

## KINO-DQM871 Mini-ITX SBC

## 6.8 Intel® AMT Driver Installation

To install these Intel® AMT components, please do the following.

**Step 1:** Access the driver list. (See **Section 6.2**)

**Step 2:** Click “7-iAMT Driver & Utility”.

**Step 3:** Locate the setup file and double click it.

**Step 4:** When the setup files are completely extracted the **Welcome Screen** in **Figure 6-28** appears.

**Step 5:** Click **Next** to continue.

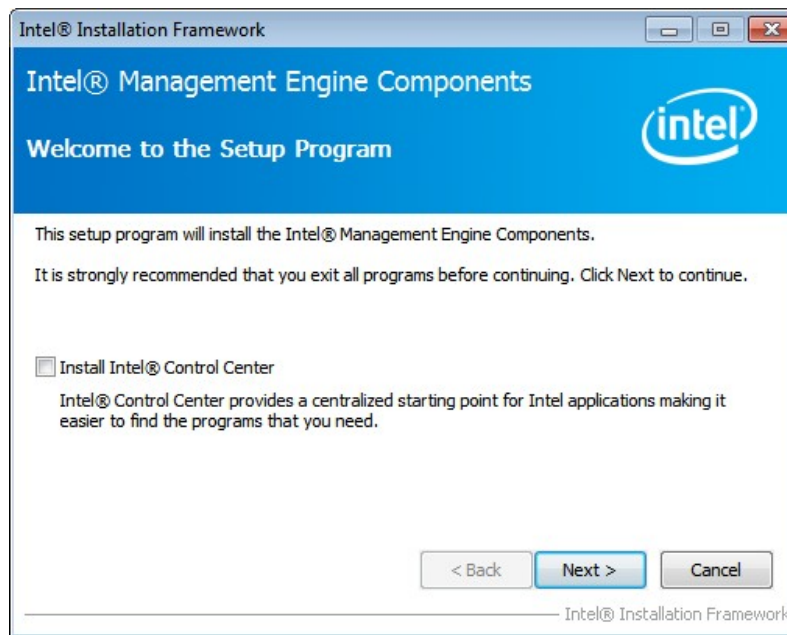
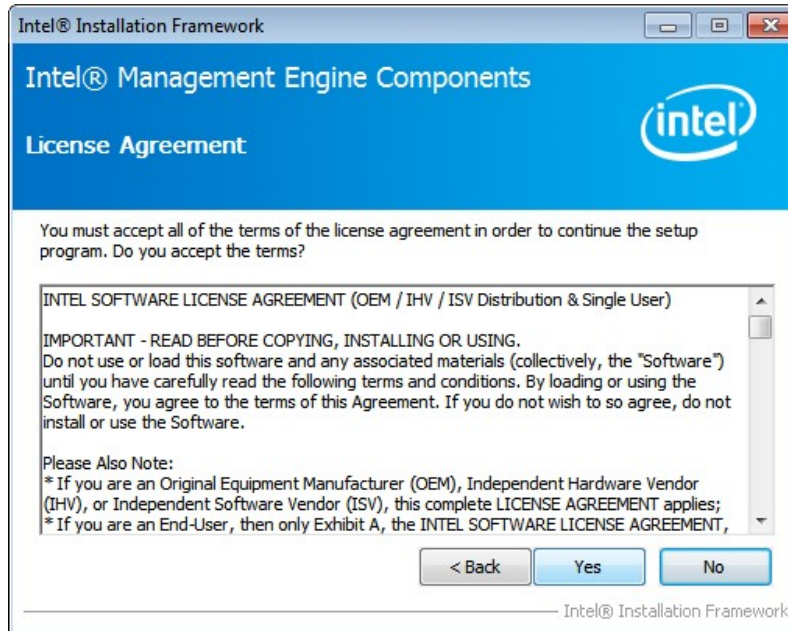

**Figure 6-28: Intel® ME Driver Welcome Screen**

**Step 6:** The license agreement in **Figure 6-29** appears.

**Step 7:** Read the **License Agreement**.

**Step 8:** Click **Yes** to continue.



**Figure 6-29: Intel® ME Driver License Agreement**

**Step 9:** Setup Operations are performed as shown in **Figure 6-30**.

**Step 10:** Once the Setup Operations are complete, click **Next** to continue.

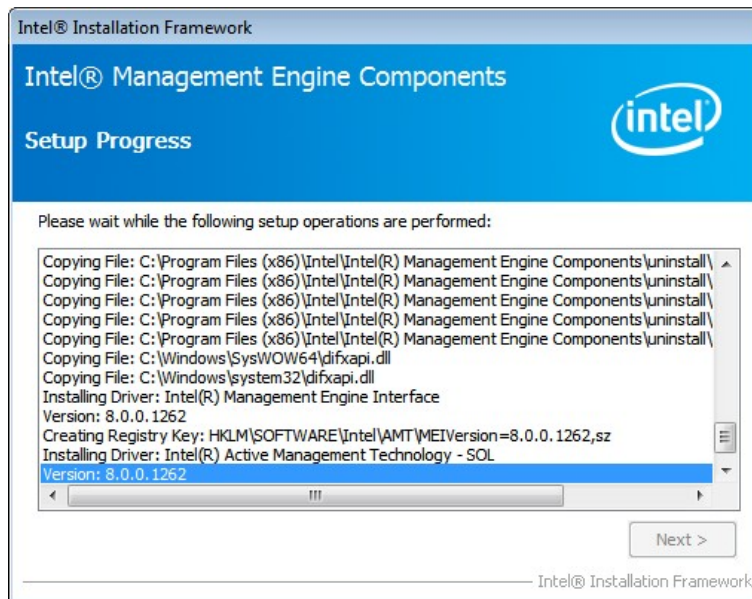

**Figure 6-30: Intel® ME Driver Setup Operations**

**Step 11:** The **Finish** screen in **Figure 6-31** appears.



## KINO-DQM871 Mini-ITX SBC

**Step 12:** Select “Yes, I want to restart this computer now” and click **Finish**.

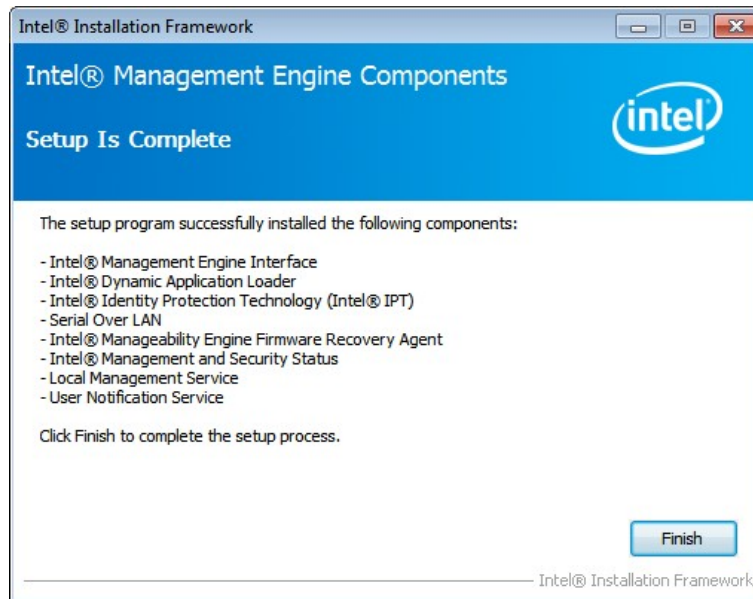

**Figure 6-31: Intel® ME Driver Installation Finish Screen**

Appendix

**A**

# BIOS Options

---

## KINO-DQM871 Mini-ITX SBC

Below is a list of BIOS configuration options in the BIOS chapter.

<b>System Overview</b> .....	<b>80</b>
<b>System Date [xx/xx/xx]</b> .....	<b>80</b>
<b>System Time [xx:xx:xx]</b> .....	<b>80</b>
<b>ACPI Sleep State [S1 only (CPU Stop Clock)]</b> .....	<b>82</b>
<b>Wake system with Fixed Time [Disabled]</b> .....	<b>83</b>
<b>SATA Mode Selection [IDE]</b> .....	<b>87</b>
<b>Intel AMT [Enabled]</b> .....	<b>89</b>
<b>Un-Configure ME [Disabled]</b> .....	<b>89</b>
<b>USB Devices</b> .....	<b>90</b>
<b>Legacy USB Support [Enabled]</b> .....	<b>90</b>
<b>PC Health Status</b> .....	<b>91</b>
<b>Fan 1 Smart Fan Control [Auto Mode]</b> .....	<b>92</b>
<b>Change Settings [Auto]</b> .....	<b>94</b>
<b>Serial Port [Enabled]</b> .....	<b>94</b>
<b>Change Settings [Auto]</b> .....	<b>95</b>
<b>Serial Port [Enabled]</b> .....	<b>95</b>
<b>Change Settings [Auto]</b> .....	<b>95</b>
<b>Serial Port [Enabled]</b> .....	<b>96</b>
<b>Change Settings [Auto]</b> .....	<b>96</b>
<b>Serial Port [Enabled]</b> .....	<b>97</b>
<b>Change Settings [Auto]</b> .....	<b>97</b>
<b>Serial Port [Enabled]</b> .....	<b>98</b>
<b>Change Settings [Auto]</b> .....	<b>98</b>
<b>Console Redirection [Disabled]</b> .....	<b>101</b>
<b>Terminal Type [ANSI]</b> .....	<b>102</b>
<b>Bits per second [115200]</b> .....	<b>102</b>
<b>Data Bits [8]</b> .....	<b>102</b>
<b>Parity [None]</b> .....	<b>103</b>
<b>Stop Bits [1]</b> .....	<b>103</b>
<b>Auto Recovery Function [Disabled]</b> .....	<b>104</b>
<b>VT-d [Disabled]</b> .....	<b>106</b>
<b>Backlight Control [Inverted]</b> .....	<b>108</b>
<b>Restore AC Power Loss [Last State]</b> .....	<b>111</b>

<b>Detect Non-Compliance Device [Disabled] .....</b>	<b>113</b>
<b>Bootup NumLock State [On].....</b>	<b>113</b>
<b>Quiet Boot [Enabled] .....</b>	<b>114</b>
<b>Option ROM Messages [Force BIOS].....</b>	<b>114</b>
<b>Launch PXE OpROM [Disabled] .....</b>	<b>114</b>
<b>UEFI Boot [Disabled] .....</b>	<b>115</b>
<b>Administrator Password .....</b>	<b>115</b>
<b>User Password .....</b>	<b>115</b>
<b>Save Changes and Reset .....</b>	<b>116</b>
<b>Discard Changes and Reset .....</b>	<b>116</b>
<b>Restore Defaults .....</b>	<b>116</b>
<b>Save as User Defaults .....</b>	<b>116</b>
<b>Restore User Defaults .....</b>	<b>117</b>

Appendix

**B**

# Terminology

---

<b>AC '97</b>	Audio Codec 97 (AC'97) refers to a codec standard developed by Intel® in 1997.
<b>ACPI</b>	Advanced Configuration and Power Interface (ACPI) is an OS-directed configuration, power management, and thermal management interface.
<b>AHCI</b>	Advanced Host Controller Interface (AHCI) is a SATA Host controller register-level interface.
<b>ATA</b>	The Advanced Technology Attachment (ATA) interface connects storage devices including hard disks and CD-ROM drives to a computer.
<b>ARMD</b>	An ATAPI Removable Media Device (ARMD) is any ATAPI device that supports removable media, besides CD and DVD drives.
<b>ASKIR</b>	Amplitude Shift Keyed Infrared (ASKIR) is a form of modulation that represents a digital signal by varying the amplitude (“volume”) of the signal. A low amplitude signal represents a binary 0, while a high amplitude signal represents a binary 1.
<b>BIOS</b>	The Basic Input/Output System (BIOS) is firmware that is first run when the computer is turned on and can be configured by the end user
<b>CODEC</b>	The Compressor-Decompressor (CODEC) encodes and decodes digital audio data on the system.
<b>CompactFlash®</b>	CompactFlash® is a solid-state storage device. CompactFlash® devices use flash memory in a standard size enclosure. Type II is thicker than Type I, but a Type II slot can support both types.
<b>CMOS</b>	Complimentary metal-oxide-conductor is an integrated circuit used in chips like static RAM and microprocessors.
<b>COM</b>	COM refers to serial ports. Serial ports offer serial communication to expansion devices. The serial port on a personal computer is usually a male D-sub 9 connector.
<b>DAC</b>	The Digital-to-Analog Converter (DAC) converts digital signals to analog signals.
<b>DDR</b>	Double Data Rate refers to a data bus transferring data on both the rising and falling edges of the clock signal.

## KINO-DQM871 Mini-ITX SBC

<b>DMA</b>	Direct Memory Access (DMA) enables some peripheral devices to bypass the system processor and communicate directly with the system memory.
<b>DIMM</b>	Dual Inline Memory Modules are a type of RAM that offer a 64-bit data bus and have separate electrical contacts on each side of the module.
<b>DIO</b>	The digital inputs and digital outputs are general control signals that control the on/off circuit of external devices or TTL devices. Data can be read or written to the selected address to enable the DIO functions.
<b>EHCI</b>	The Enhanced Host Controller Interface (EHCI) specification is a register-level interface description for USB 2.0 Host Controllers.
<b>EIDE</b>	Enhanced IDE (EIDE) is a newer IDE interface standard that has data transfer rates between 4.0 MBps and 16.6 MBps.
<b>EIST</b>	Enhanced Intel® SpeedStep Technology (EIST) allows users to modify the power consumption levels and processor performance through application software. The application software changes the bus-to-core frequency ratio and the processor core voltage.
<b>FSB</b>	The Front Side Bus (FSB) is the bi-directional communication channel between the processor and the Northbridge chipset.
<b>GbE</b>	Gigabit Ethernet (GbE) is an Ethernet version that transfers data at 1.0 Gbps and complies with the IEEE 802.3-2005 standard.
<b>GPIO</b>	General purpose input
<b>HDD</b>	Hard disk drive (HDD) is a type of magnetic, non-volatile computer storage device that stores digitally encoded data.
<b>ICH</b>	The Input/Output Control Hub (ICH) is an Intel® Southbridge chipset.
<b>IrDA</b>	Infrared Data Association (IrDA) specify infrared data transmission protocols used to enable electronic devices to wirelessly communicate with each other.
<b>L1 Cache</b>	The Level 1 Cache (L1 Cache) is a small memory cache built into the system processor.
<b>L2 Cache</b>	The Level 2 Cache (L2 Cache) is an external processor memory cache.

<b>LCD</b>	Liquid crystal display (LCD) is a flat, low-power display device that consists of two polarizing plates with a liquid crystal panel in between.
<b>LVDS</b>	Low-voltage differential signaling (LVDS) is a dual-wire, high-speed differential electrical signaling system commonly used to connect LCD displays to a computer.
<b>POST</b>	The Power-on Self Test (POST) is the pre-boot actions the system performs when the system is turned-on.
<b>RAM</b>	Random Access Memory (RAM) is volatile memory that loses data when power is lost. RAM has very fast data transfer rates compared to other storage like hard drives.
<b>SATA</b>	Serial ATA (SATA) is a serial communications bus designed for data transfers between storage devices and the computer chipsets.
<b>S.M.A.R.T</b>	Self Monitoring Analysis and Reporting Technology (S.M.A.R.T) refers to automatic status checking technology implemented on hard disk drives.
<b>UART</b>	Universal Asynchronous Receiver-transmitter (UART) is responsible for asynchronous communications on the system and manages the system's serial communication (COM) ports.
<b>UHCI</b>	The Universal Host Controller Interface (UHCI) specification is a register-level interface description for USB 1.1 Host Controllers.
<b>USB</b>	The Universal Serial Bus (USB) is an external bus standard for interfacing devices. USB 1.1 supports 12Mbps data transfer rates and USB 2.0 supports 480Mbps data transfer rates.
<b>VGA</b>	The Video Graphics Array (VGA) is a graphics display system developed by IBM.



Appendix

C

# Digital I/O Interface

---

## C.1 Introduction

The DIO connector on the KINO-DQM871 is interfaced to GPIO ports on the Super I/O chipset. The DIO has both 4-bit digital inputs and 4-bit digital outputs. The digital inputs and digital outputs are generally control signals that control the on/off circuit of external devices or TTL devices. Data can be read or written to the selected address to enable the DIO functions.



### NOTE:

For further information, please refer to the datasheet for the Super I/O chipset.

---

## C.2 DIO Connector Pinouts

PIN NO.	DESCRIPTION	PIN NO.	DESCRIPTION
1	GND	2	+V5S
3	Output 3	4	Output 2
5	Output 1	6	Output 0
7	Input 3	8	Input 2
9	Input 1	10	Input 0

**Table 6-1: Digital I/O Connector Pinouts**

## C.3 Assembly Language Samples

### C.3.1 Enable the DIO Input Function

The BIOS interrupt call INT 15H controls the digital I/O. An assembly program to enable digital I/O input functions is listed below.

<b>MOV</b>	<b>AX, 6F08H</b>	Sets the digital port as input
<b>INT</b>	<b>15H</b>	Initiates the INT 15H BIOS call

### C.3.2 Enable the DIO Output Function

The BIOS interrupt call INT 15H controls the digital I/O. An assembly program to enable digital I/O output functions is listed below.

<b>MOV</b>	<b>AX, 6F09H</b>	Sets the digital port as output
<b>MOV</b>	<b>BL, 09H</b>	
<b>INT</b>	<b>15H</b>	Initiates the INT 15H BIOS call

Appendix

**D**

# Hazardous Materials Disclosure

---

## **D.1 Hazardous Materials Disclosure Table for IPB Products Certified as RoHS Compliant Under 2002/95/EC Without Mercury**

The details provided in this appendix are to ensure that the product is compliant with the Peoples Republic of China (China) RoHS standards. The table below acknowledges the presences of small quantities of certain materials in the product, and is applicable to China RoHS only.

A label will be placed on each product to indicate the estimated “Environmentally Friendly Use Period” (EFUP). This is an estimate of the number of years that these substances would “not leak out or undergo abrupt change.” This product may contain replaceable sub-assemblies/components which have a shorter EFUP such as batteries and lamps. These components will be separately marked.

Please refer to the table on the next page.

Part Name	Toxic or Hazardous Substances and Elements					
	Lead (Pb)	Mercury (Hg)	Cadmium (Cd)	Hexavalent Chromium (CR(VI))	Polybrominated Biphenyls (PBB)	Polybrominated Diphenyl Ethers (PBDE)
<b>Housing</b>	<input type="radio"/>	<input type="radio"/>	<input type="radio"/>	<input type="radio"/>	<input type="radio"/>	<input type="radio"/>
<b>Display</b>	<input type="radio"/>	<input type="radio"/>	<input type="radio"/>	<input type="radio"/>	<input type="radio"/>	<input type="radio"/>
<b>Printed Circuit Board</b>	<input type="radio"/>	<input type="radio"/>	<input type="radio"/>	<input type="radio"/>	<input type="radio"/>	<input type="radio"/>
<b>Metal Fasteners</b>	<input type="radio"/>	<input type="radio"/>	<input type="radio"/>	<input type="radio"/>	<input type="radio"/>	<input type="radio"/>
<b>Cable Assembly</b>	<input type="radio"/>	<input type="radio"/>	<input type="radio"/>	<input type="radio"/>	<input type="radio"/>	<input type="radio"/>
<b>Fan Assembly</b>	<input type="radio"/>	<input type="radio"/>	<input type="radio"/>	<input type="radio"/>	<input type="radio"/>	<input type="radio"/>
<b>Power Supply Assemblies</b>	<input type="radio"/>	<input type="radio"/>	<input type="radio"/>	<input type="radio"/>	<input type="radio"/>	<input type="radio"/>
<b>Battery</b>	<input type="radio"/>	<input type="radio"/>	<input type="radio"/>	<input type="radio"/>	<input type="radio"/>	<input type="radio"/>

O: This toxic or hazardous substance is contained in all of the homogeneous materials for the part is below the limit requirement in SJ/T11363-2006

X: This toxic or hazardous substance is contained in at least one of the homogeneous materials for this part is above the limit requirement in SJ/T11363-2006

## KINO-DQM871 Mini-ITX SBC

此附件旨在确保本产品符合中国 RoHS 标准。以下表格标示此产品中某有毒物质的含量符合中国 RoHS 标准规定的限量要求。

本产品上会附有“环境友好使用期限”的标签，此期限是估算这些物质“不会有泄漏或突变”的年限。本产品可能包含有较短的环境友好使用期限的可替换元件，像是电池或灯管，这些元件将会单独标示出来。

部件名称	有毒有害物质或元素					
	铅 (Pb)	汞 (Hg)	镉 (Cd)	六价铬 (CR(VI))	多溴联苯 (PBB)	多溴二苯 醚 (PBDE)
壳体	○	○	○	○	○	○
显示	○	○	○	○	○	○
印刷电路板	○	○	○	○	○	○
金属螺帽	○	○	○	○	○	○
电缆组装	○	○	○	○	○	○
风扇组装	○	○	○	○	○	○
电力供应组装	○	○	○	○	○	○
电池	○	○	○	○	○	○

○: 表示该有毒有害物质在该部件所有物质材料中的含量均在 SJ/T11363-2006 标准规定的限量要求以下。  
X: 表示该有毒有害物质至少在该部件的某一均质材料中的含量超出 SJ/T11363-2006 标准规定的限量要求。