

MODEL:
NANO-BT-i1 Series

**EPIC SBC with 22nm Intel® Atom™ or Celeron® SoC,
Dual GbE, DDR3, HDMI, VGA, LVDS, USB 2.0/3.0, COM Ports
Two SATA 3Gb/s Ports, IPMI 2.0 and RoHS**

User Manual

Revision

Date	Version	Changes
October 1, 2014	1.03	Updated Section 1.6: Dimensions
June 27, 2014	1.02	Updated supported memory specifications in Chapter 1.
May 7, 2014	1.01	Updated Section 1.6: Dimensions Updated Chapter 6: Software Drivers Updated Table 3-15: LVDS Connector Pinouts
April 3, 2014	1.00	Initial release

Copyright

COPYRIGHT NOTICE

The information in this document is subject to change without prior notice in order to improve reliability, design and function and does not represent a commitment on the part of the manufacturer.

In no event will the manufacturer be liable for direct, indirect, special, incidental, or consequential damages arising out of the use or inability to use the product or documentation, even if advised of the possibility of such damages.

This document contains proprietary information protected by copyright. All rights are reserved. No part of this manual may be reproduced by any mechanical, electronic, or other means in any form without prior written permission of the manufacturer.

TRADEMARKS

All registered trademarks and product names mentioned herein are used for identification purposes only and may be trademarks and/or registered trademarks of their respective owners.

Table of Contents

1 INTRODUCTION.....	1
1.1 INTRODUCTION.....	2
1.2 MODEL VARIATIONS	3
1.3 BENEFITS	3
1.4 FEATURES.....	4
1.5 CONNECTORS	5
1.6 DIMENSIONS.....	7
1.7 DATA FLOW	9
1.8 TECHNICAL SPECIFICATIONS	10
2 PACKING LIST.....	12
2.1 ANTI-STATIC PRECAUTIONS	13
2.2 UNPACKING PRECAUTIONS.....	13
2.3 PACKING LIST.....	14
2.4 OPTIONAL ITEMS	15
3 CONNECTORS	16
3.1 PERIPHERAL INTERFACE CONNECTORS.....	17
3.1.1 NANO-BT-i1 Layout.....	17
3.1.2 Peripheral Interface Connectors	18
3.1.3 External Interface Panel Connectors.....	20
3.2 INTERNAL PERIPHERAL CONNECTORS	20
3.2.1 +12 V Power Connector	20
3.2.2 Audio Connector	21
3.2.3 Battery Connector.....	22
3.2.4 Backlight Inverter Connector	23
3.2.5 Buzzer Connector.....	24
3.2.6 Chassis Intrusion Connector.....	25
3.2.7 Digital I/O Connector.....	25
3.2.8 Fan Connector (CPU).....	26
3.2.9 Fan Connector (System)	27

NANO-BT-i1 EPIC SBC

3.2.10 Front Panel Connector	28
3.2.11 IPMI LED Connector	29
3.2.12 iRIS Module Slot	30
3.2.13 LAN LED Connectors	31
3.2.14 LVDS Connector	32
3.2.15 Memory Card Slot	33
3.2.16 PCI-104 Connector	34
3.2.17 PCIe Mini Card Slot	35
3.2.18 Power Button Connector	37
3.2.19 Power Button	38
3.2.20 Reset Button Connector	38
3.2.21 SATA 3Gb/s Drive Connectors	39
3.2.22 SATA Power Connectors	40
3.2.23 Serial Port Connectors, RS-232	41
3.2.24 Serial Port Connector, RS-422/485	42
3.2.25 SMBus Connector	43
3.2.26 SPI Flash Connector	44
3.2.27 SPI Flash Connector, EC	45
3.2.28 USB 2.0 Connector	46
3.3 EXTERNAL PERIPHERAL INTERFACE CONNECTOR PANEL	47
3.3.1 Ethernet Connectors	47
3.3.2 HDMI Connector	49
3.3.3 Keyboard/Mouse Connector	50
3.3.4 USB 2.0 Connector	51
3.3.5 USB 3.0 Connector	51
3.3.6 VGA Connector	52
4 INSTALLATION	53
4.1 ANTI-STATIC PRECAUTIONS	54
4.2 INSTALLATION CONSIDERATIONS	54
4.2.1 SO-DIMM Installation	56
4.2.2 iRIS-1010 Module Installation	56
4.2.3 PCIe Mini Card Installation	58
4.3 SYSTEM CONFIGURATION	58
4.3.1 AT/ATX Power Mode Setting	58

4.3.2	<i>Clear CMOS Button</i>	59
4.3.3	<i>LVDS Panel Resolution Selection</i>	60
4.3.4	<i>LCD Voltage Selection</i>	61
4.3.5	<i>mSATA/SATA Selection</i>	62
4.3.6	<i>PCI-104 Voltage Selection</i>	63
4.4	INTERNAL PERIPHERAL DEVICE CONNECTIONS	63
4.4.1	<i>AT Power Connection</i>	63
4.4.2	<i>SATA Drive Connection</i>	65
4.4.3	<i>Single RS-232 Cable Connection</i>	66
4.5	EXTERNAL PERIPHERAL INTERFACE CONNECTION	67
4.5.1	<i>LAN Connection</i>	67
4.5.2	<i>PS/2 Keyboard/Mouse Connection</i>	68
4.5.3	<i>USB Connection</i>	69
4.5.4	<i>VGA Monitor Connection</i>	70
4.6	IPMI SETUP PROCEDURE	72
4.6.1	<i>Managed System Hardware Setup</i>	72
5	BIOS	73
5.1	INTRODUCTION	74
5.1.1	<i>Starting Setup</i>	74
5.1.2	<i>Using Setup</i>	74
5.1.3	<i>Getting Help</i>	75
5.1.4	<i>Unable to Reboot after Configuration Changes</i>	75
5.1.5	<i>BIOS Menu Bar</i>	75
5.2	MAIN	76
5.3	ADVANCED	77
5.3.1	<i>ACPI Settings</i>	77
5.3.2	<i>Super IO Configuration</i>	79
5.3.2.1	<i>Serial Port n Configuration</i>	79
5.3.3	<i>Hardware Monitor</i>	84
5.3.3.1	<i>Smart Fan Mode Configuration</i>	86
5.3.4	<i>iWDD H/W Monitor</i>	87
5.3.4.1	<i>Smart Fan Mode Configuration</i>	89
5.3.5	<i>RTC Wake Settings</i>	90
5.3.6	<i>Serial Port Console Redirection</i>	91

NANO-BT-i1 EPIC SBC

5.3.7 CPU Configuration	93
5.3.8 IDE Configuration	96
5.3.9 USB Configuration.....	97
5.4 CHIPSET	98
5.4.1 North Bridge	99
5.4.1.1 Intel IGD Configuration.....	100
5.4.2 South Bridge.....	101
5.4.2.1 PCI Express Configuration	103
5.5 SECURITY	104
5.6 BOOT.....	105
5.7 EXIT	107
6 SOFTWARE DRIVERS	109
6.1 AVAILABLE SOFTWARE DRIVERS	110
6.2 SOFTWARE INSTALLATION	110
6.3 CHIPSET DRIVER INSTALLATION.....	112
6.4 GRAPHICS DRIVER INSTALLATION.....	115
6.5 LAN DRIVER INSTALLATION	118
A BIOS OPTIONS	123
B TERMINOLOGY.....	126
C WATCHDOG TIMER	130
D DIGITAL I/O INTERFACE.....	133
D.1 INTRODUCTION.....	134
D.2 ASSEMBLY LANGUAGE SAMPLE 1.....	135
D.3 ASSEMBLY LANGUAGE SAMPLE 2.....	135
E HAZARDOUS MATERIALS DISCLOSURE	136
E.1 HAZARDOUS MATERIALS DISCLOSURE TABLE FOR IPB PRODUCTS CERTIFIED AS ROHS COMPLIANT UNDER 2002/95/EC WITHOUT MERCURY	137

List of Figures

Figure 1-1: NANO-BT-i1	2
Figure 1-2: Connectors (Front Side).....	5
Figure 1-3: Connectors (Solder Side).....	6
Figure 1-4: NANO-BT-i1 Main Dimensions (mm).....	7
Figure 1-5: NANO-BT-i1 Height Dimensions 1 (mm).....	8
Figure 1-6: NANO-BT-i1 Height Dimensions 2 (mm).....	8
Figure 1-7: Data Flow Diagram.....	9
Figure 3-1: Connectors and Jumpers (Front Side)	17
Figure 3-2: Connectors and Jumpers (Solder Side)	18
Figure 3-3: CPU Power Connector Location.....	21
Figure 3-4: Audio Connector Location	22
Figure 3-5: Battery Connector Location.....	23
Figure 3-6: Backlight Inverter Connector Location.....	23
Figure 3-7: Buzzer Connector Location	24
Figure 3-8: Chassis Intrusion Connector Location.....	25
Figure 3-9: Digital I/O Connector Location	26
Figure 3-10: CPU Fan Connector Location	27
Figure 3-11: System Fan Connector Location.....	28
Figure 3-12: Front Panel Connector Location	29
Figure 3-13: IPMI LED Connector Location	30
Figure 3-14: iRIS Module Slot Location.....	31
Figure 3-15: LAN LED Connector Locations	31
Figure 3-16: LVDS Connector Location.....	32
Figure 3-17: Memory Card Slot Location	33
Figure 3-18: PCI-104 Connector Location	34
Figure 3-19: PCIe Mini Card Slot Location.....	36
Figure 3-20: Power Button Location.....	37
Figure 3-21: Power Button Location.....	38
Figure 3-22: Reset Button Connector Location.....	39
Figure 3-23: SATA 3Gb/s Drive Connector Locations	40

NANO-BT-i1 EPIC SBC

Figure 3-24: SATA Power Connector Locations	41
Figure 3-25: RS-232 Serial Port Connector Locations.....	42
Figure 3-26: RS-422/485 Connector Location.....	43
Figure 3-27: SMBus Connector Location.....	44
Figure 3-28: SPI Flash Connector Location.....	45
Figure 3-29: SPI EC Flash Connector Location.....	46
Figure 3-30: USB 2.0 Connector Location	47
Figure 3-31: External Peripheral Interface Connector	47
Figure 3-32: Ethernet Connector.....	49
Figure 3-33: HDMI Connector	50
Figure 3-34: PS/2 Pinout and Configuration	50
Figure 3-35: VGA Connector	52
Figure 4-1: SO-DIMM Installation	56
Figure 4-2: iRIS-1010 Module Installation	57
Figure 4-3: PCIe Mini Card Installation.....	58
Figure 4-4: AT/ATX Power Mode Switch Location	59
Figure 4-5: Clear CMOS Button Location.....	59
Figure 4-6: LVDS Panel Resolution Selection Switch Location	61
Figure 4-7: LCD Voltage Selection Switch Location	62
Figure 4-8: mSATA/SATA Switch Location.....	62
Figure 4-9: PCI-104 Voltage Switch Location	63
Figure 4-10: Power Cable to Motherboard Connection	64
Figure 4-11: Connect Power Cable to Power Supply.....	65
Figure 4-12: SATA Drive Cable Connection.....	66
Figure 4-13: Single RS-232 Cable Installation	67
Figure 4-14: LAN Connection	68
Figure 4-15: PS/2 Keyboard/Mouse Connector	69
Figure 4-16: USB Connector.....	70
Figure 4-17: VGA Connector	71
Figure 6-1: Driver CD Main Menu.....	111
Figure 6-2: Available Drivers.....	111
Figure 6-3: Chipset Driver Welcome Screen.....	112
Figure 6-4: Chipset Driver License Agreement	113
Figure 6-5: Chipset Driver Read Me File	113
Figure 6-6: Chipset Driver Setup Operations	114

Figure 6-7: Chipset Driver Installation Finish Screen.....	114
Figure 6-8: Graphics Driver Welcome Screen	116
Figure 6-9: Graphics Driver License Agreement.....	116
Figure 6-10: Graphics Driver Read Me File	117
Figure 6-11: Graphics Driver Setup Operations	117
Figure 6-12: Graphics Driver Installation Finish Screen	118
Figure 6-13: PC Properties	119
Figure 6-14: System Control Panel.....	119
Figure 6-15: Device Manager List	120
Figure 6-16: Update Driver Software Window	121
Figure 6-17: Locate Driver Files.....	121

List of Tables

Table 1-1: Model Variations	3
Table 1-2: NANO-BT-i1 Specifications.....	11
Table 2-1: Packing List.....	15
Table 2-2: Optional Items	15
Table 3-1: Peripheral Interface Connectors	19
Table 3-2: Rear Panel Connectors	20
Table 3-3: CPU Power Connector Pinouts	21
Table 3-4: Audio Connector Pinouts	22
Table 3-5: Battery Connector Pinouts	23
Table 3-6: Backlight Inverter Connector Pinouts	24
Table 3-7: Chassis Intrusion Connector Pinouts	25
Table 3-8: Digital I/O Connector Pinouts.....	26
Table 3-9: CPU Fan Connector Pinouts.....	27
Table 3-10: System Fan Connector Pinouts	28
Table 3-11: Front Panel Connector Pinouts.....	29
Table 3-12: IPMI LED Connector Pinouts	30
Table 3-13: LAN1 LED Connector (JP8) Pinouts	31
Table 3-14: LAN2 LED Connector (JP9) Pinouts	32
Table 3-15: LVDS Connector Pinouts.....	33
Table 3-16: PCI-104 Connector Pinouts	35
Table 3-17: PCIe Mini Card Slot Pinouts	37
Table 3-18: Power Button Pinouts	37
Table 3-19: Reset Button Connector Pinouts	39
Table 3-20: SATA 3Gb/s Drive Connector Pinouts.....	40
Table 3-21: SATA Power Connector Pinouts.....	41
Table 3-22: RS-232 Serial Port Connector Pinouts	42
Table 3-23: RS-422/485 Connector Pinouts	43
Table 3-24: RS-422/485 Pinouts of D-sub 9 Connector.....	43
Table 3-25: SMBus Connector Pinouts	44
Table 3-26: SPI Flash Connector Pinouts	45

Table 3-27: SPI EC Flash Connector Pinouts	46
Table 3-28: USB 2.0 Connector Pinouts	47
Table 3-29: LAN1 Ethernet Connector Pinouts	48
Table 3-30: LAN2 Ethernet Connector Pinouts	48
Table 3-31: Connector LEDs.....	49
Table 3-32: HDMI Connector Pinouts	50
Table 3-33: Keyboard Connector Pinouts	51
Table 3-34: USB 2.0 Port Pinouts	51
Table 3-35: USB 3.0 Port Pinouts	52
Table 3-36: VGA Connector Pinouts.....	52
Table 4-1: LVDS Panel Resolution Selection.....	60
Table 4-2: LCD Voltage Selection Switch Settings	61
Table 4-3: mSATA/SATA Switch Settings	62
Table 4-4: PCI-104 Voltage Switch Settings.....	63
Table 5-1: BIOS Navigation Keys	75

BIOS Menus

BIOS Menu 1: Main	76
BIOS Menu 2: Advanced	77
BIOS Menu 3: ACPI Configuration	78
BIOS Menu 4: Super IO Configuration.....	79
BIOS Menu 5: Serial Port n Configuration Menu.....	79
BIOS Menu 6: Hardware Monitor.....	85
BIOS Menu 7: Smart Fan Mode Configuration	86
BIOS Menu 8: iWDD H/W Monitor.....	88
BIOS Menu 9: Smart Fan Mode Configuration	89
BIOS Menu 10: RTC Wake Settings	90
BIOS Menu 11: Serial Port Console Redirection	91
BIOS Menu 12: CPU Configuration	94
BIOS Menu 13: IDE Configuration.....	96
BIOS Menu 14: USB Configuration	97
BIOS Menu 15: Chipset	98
BIOS Menu 16: North Bridge	99
BIOS Menu 17: Intel IGD Configuration.....	100
BIOS Menu 18: South Bridge.....	101
BIOS Menu 19: PCI Express Configuration	103
BIOS Menu 20: Security	104
BIOS Menu 21: Boot	105
BIOS Menu 22:Exit.....	107

Chapter

1

Introduction

1.1 Introduction

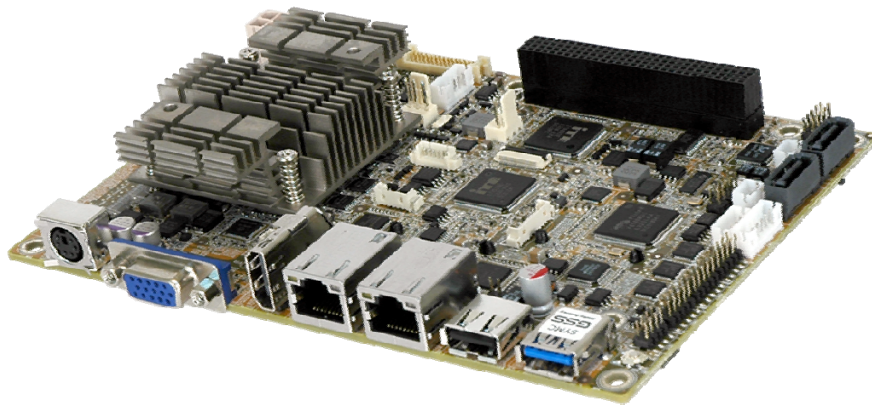

Figure 1-1: NANO-BT-i1

The NANO-BT-i1 is an EPIC form factor single board computer. It has an on-board 22nm Intel® Atom™ or Celeron® processor, and supports one 204-pin 1333/1066 MHz dual-channel unbuffered DDR3 Low Voltage (DDR3L) SDRAM SO-DIMM with up to 8.0 GB of memory.

The NANO-BT-i1 features Intelligent Platform Management Interface (IPMI) that helps lower the overall costs of server management by enabling users to maximize IT resource, save time and manage multiple systems. The NANO-BT-i1 supports IPMI 2.0 through the optional iRIS-1010 module.

The NANO-BT-i1 includes one VGA port and one HDMI port for dual independent display. It also has an internal 18-bit/24-bit dual-channel LVDS connector supporting up to 1920 x 1200 resolutions. Expansion and I/O include one PCI-104 slot, one PCIe Mini slot, one USB 3.0 port plus one USB 2.0 on the rear panel, two USB 2.0 by pin header, two SATA 3Gb/s connectors, three RS-232 serial ports, and one PS/2 keyboard/mouse connector.

NANO-BT-i1 EPIC SBC

1.2 Model Variations

There are eight models of the NANO-BT-i1 series. The model variations are listed in **Table 1-1**.

Model	On-board SoC	Max. Memory Size
NANO-BT-i1-E38151	Intel® Atom™ processor E3815 (1.46 GHz, single-core, 512 KB cache)	4 GB
NANO-BT-i1-E38251	Intel® Atom™ processor E3825 (1.33 GHz, dual-core, 1 MB cache)	4 GB
NANO-BT-i1-E38261	Intel® Atom™ processor E3826 (1.46 GHz, dual-core, 1 MB cache)	8 GB
NANO-BT-i1-E38271	Intel® Atom™ processor E3827 (1.75 GHz, dual-core, 1 MB cache)	8 GB
NANO-BT-i1-E38451	Intel® Atom™ processor E3845 (1.91 GHz, quad-core, 2 MB cache)	8 GB
NANO-BT-i1-J19001	Intel® Celeron® processor J1900 (2 GHz, quad-core, 2 MB cache)	8 GB
NANO-BT-i1-N28071	Intel® Celeron® processor N2807 (1.58 GHz, dual-core, 2 MB cache)	4 GB
NANO-BT-i1-N29301	Intel® Celeron® processor N2930 (1.83 GHz, quad-core, 2 MB cache)	8 GB

Table 1-1: Model Variations

1.3 Benefits

Some of the NANO-BT-i1 motherboard benefits include:

- Powerful graphics with multiple monitors
- Staying connected with both wired LAN connections
- Speedy running of multiple programs and applications

1.4 Features

Some of the NANO-BT-i1 motherboard features are listed below:

- EPIC form factor
- RoHS compliant
- On-board 22nm Intel® Atom™ or Celeron® processor
- One 204-pin 1333/1066 MHz dual-channel unbuffered DDR3L (1.35 V) SDRAM SO-DIMM slot supports up to 8.0 GB of memory
- LVDS, VGA and HDMI interfaces for dual independent display
- Supports IPMI 2.0 via IEI iRIS-1010 module
- Two Intel® PCIe GbE connectors
- Two SATA 3Gb/s connectors
- One PCIe Mini card expansion slot
- One PCI-104 expansion slot
- One USB 3.0 port and three USB 2.0 ports
- Three RS-232 serial ports and one RS-422/485 serial port
- High Definition Audio

NANO-BT-i1 EPIC SBC

1.5 Connectors

The connectors on the NANO-BT-i1 are shown in the figure below.

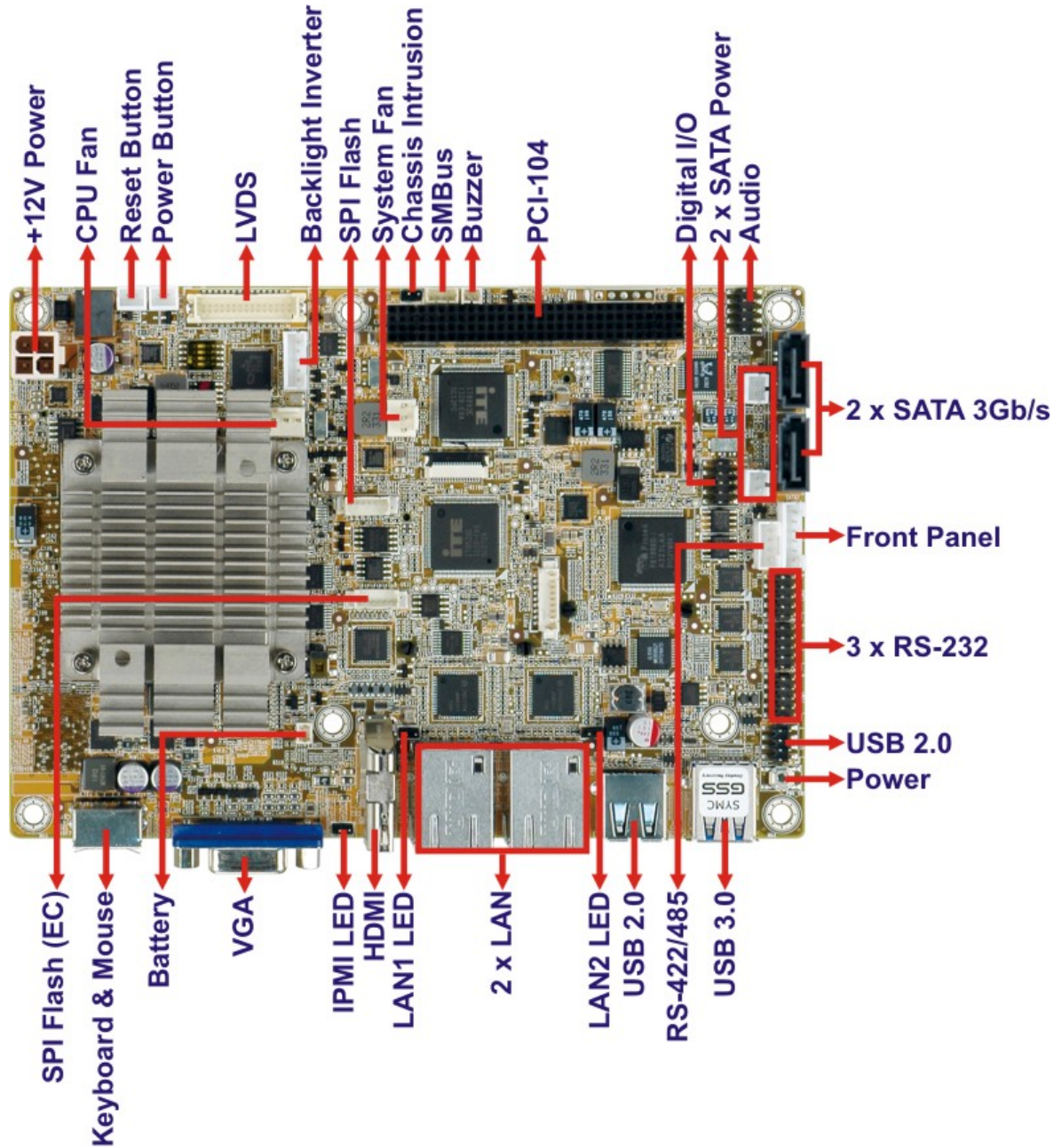

Figure 1-2: Connectors (Front Side)

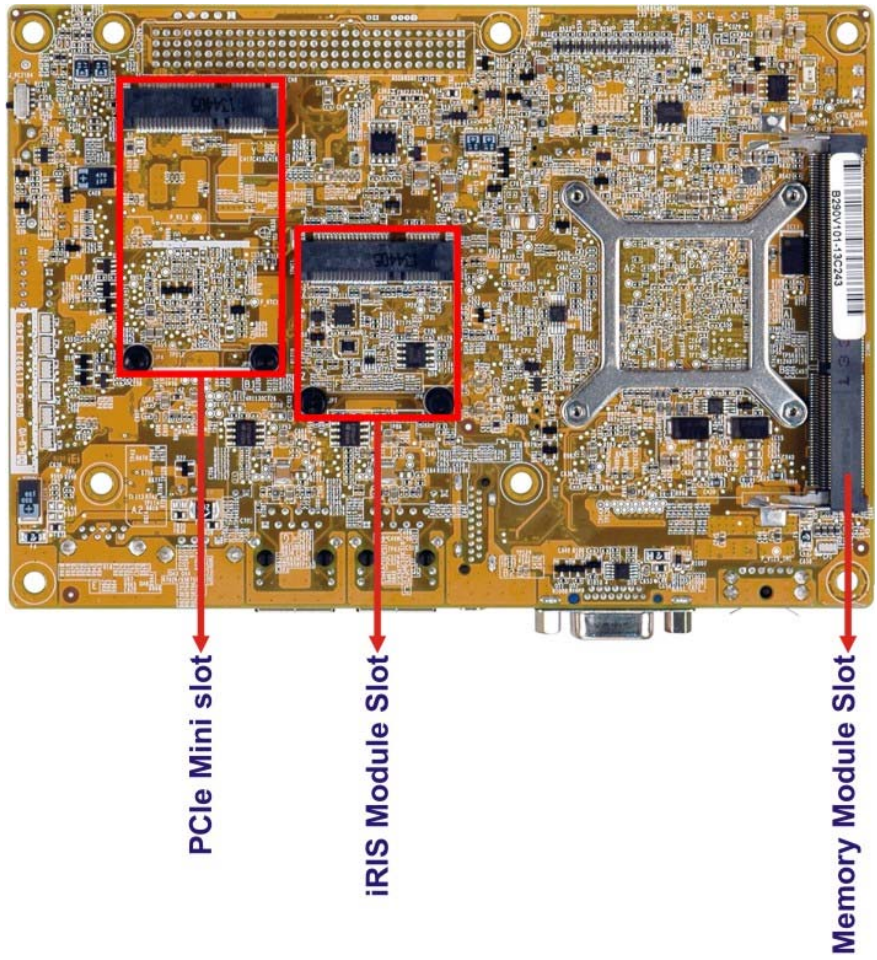

Figure 1-3: Connectors (Solder Side)

NANO-BT-i1 EPIC SBC

1.6 Dimensions

The main dimensions of the NANO-BT-i1 are shown in the diagram below.

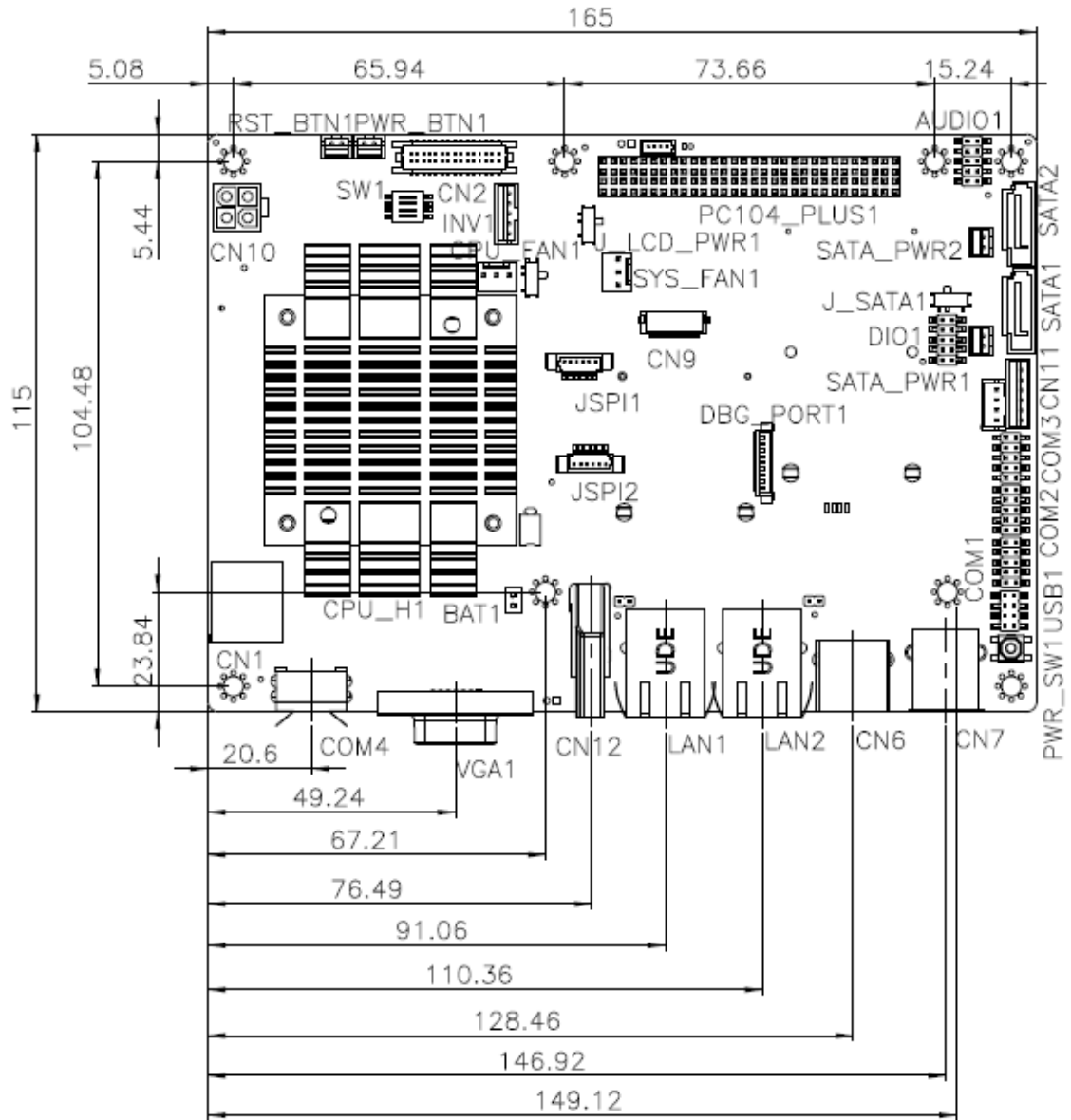

Figure 1-4: NANO-BT-i1 Main Dimensions (mm)

The height of the NANO-BT-i1 series varies depending on the heatsink installed on the board. **Figure 1-5** shows the height dimensions of the following models:

- NANO-BT-i1-E38271
- NANO-BT-i1-E38261
- NANO-BT-i1-E38251
- NANO-BT-i1-E38151
- NANO-BT-i1-N28071

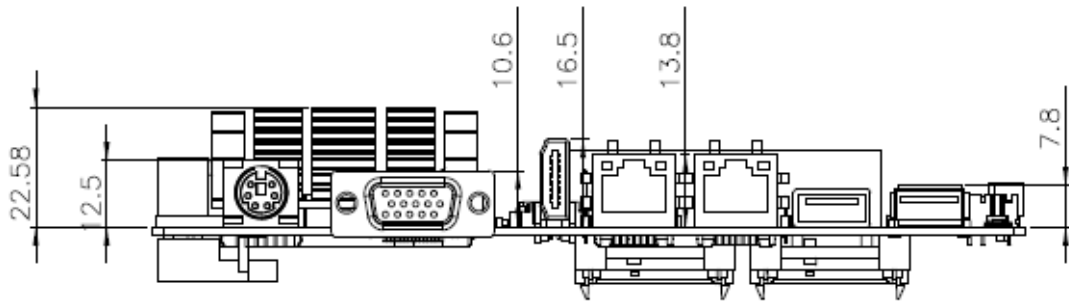

Figure 1-5: NANO-BT-i1 Height Dimensions 1 (mm)

Figure 1-6 shows the height dimensions of the following models:

- NANO-BT-i1-E38451
- NANO-BT-i1-J19001
- NANO-BT-i1-N29301

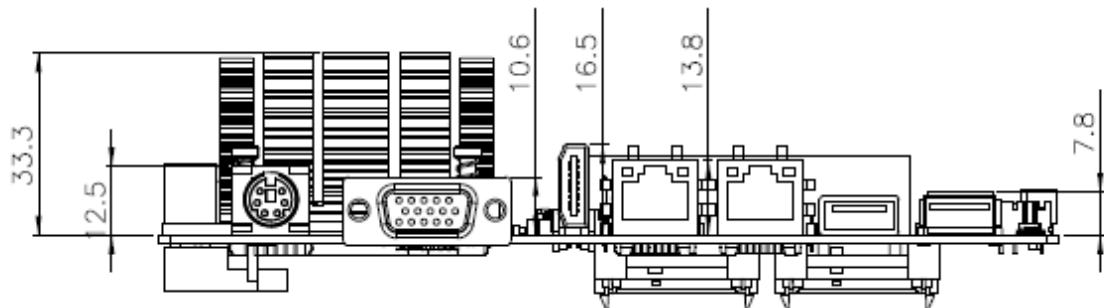

Figure 1-6: NANO-BT-i1 Height Dimensions 2 (mm)

NANO-BT-i1 EPIC SBC

1.7 Data Flow

Figure 1-7 shows the data flow between the system chipset, the CPU and other components installed on the motherboard.

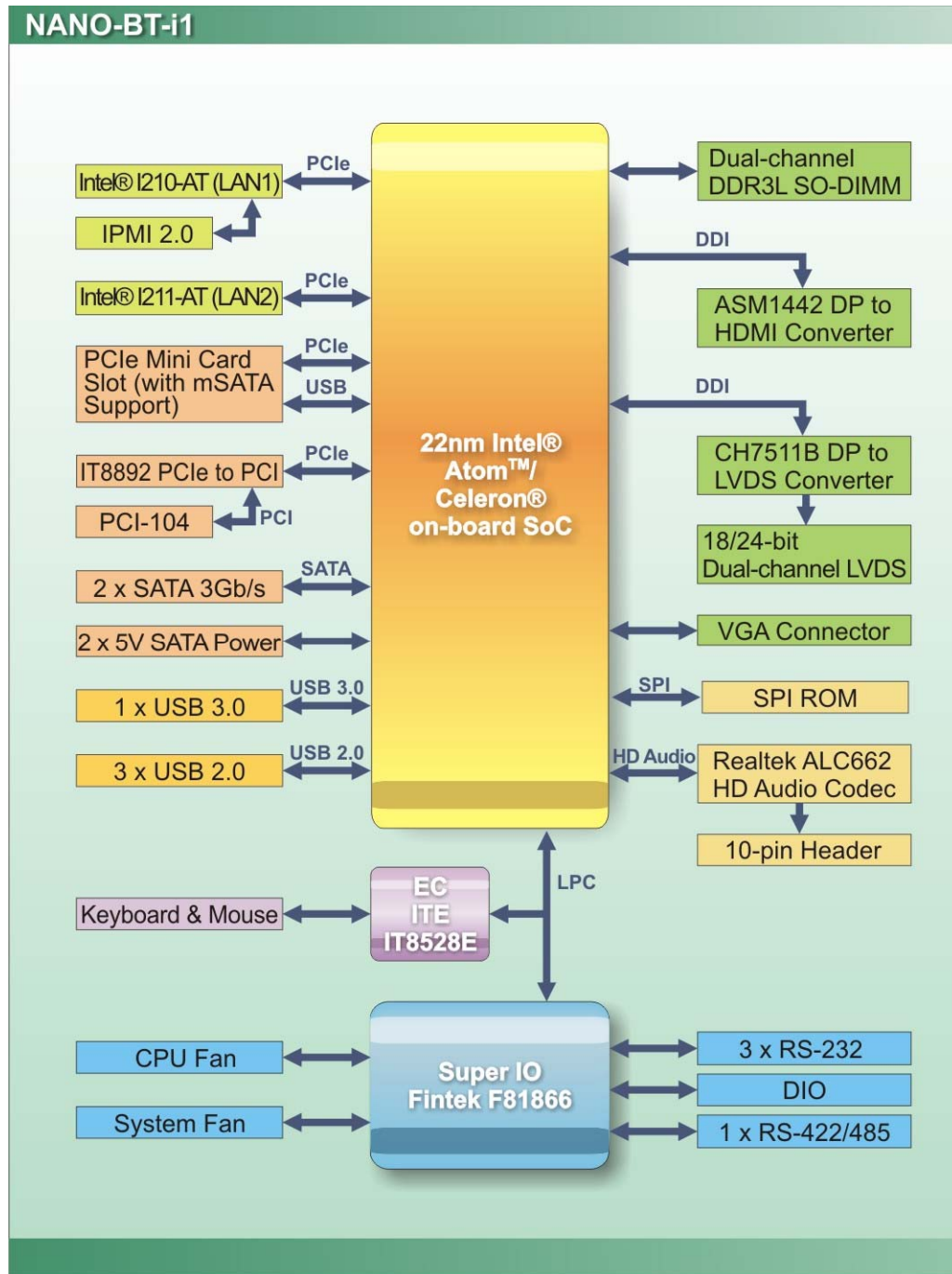

Figure 1-7: Data Flow Diagram

1.8 Technical Specifications

NANO-BT-i1 technical specifications are listed below.

Specification/Model	NANO-BT-i1
Form Factor	EPIC
On-board SoC	Intel® Atom™ processor E3845 (1.91GHz, quad-core, 2MB cache, TDP=10W) Intel® Atom™ processor E3827 (1.75GHz, dual-core, 1MB cache, TDP=8W) Intel® Atom™ processor E3826 (1.46GHz, dual-core, 1MB cache, TDP=7W) Intel® Atom™ processor E3825 (1.33GHz, dual-core, 1MB cache, TDP=6W) Intel® Atom™ processor E3815 (1.46GHz, single-core, 512KB cache, TDP=5W) Intel® Celeron® processor J1900 (2GHz, quad-core, 2MB cache, TDP=10W) Intel® Celeron® processor N2930 (1.83GHz, quad-core, 2MB cache, TDP=7.5W) Intel® Celeron® processor N2807 (1.58GHz, dual-core, 2MB cache, TDP=4.5W)
Integrated Graphics	Intel® HD Graphics Gen7 with 4 execution units, supporting DirectX 11.1, OpenCL 1.2 and OpenGL 4.2
Memory	One 204-pin 1066/1333MHz single-channel unbuffered DDR3L (1.35 V) SDRAM SO-DIMM supports up to 8 GB (J1900, N2930, E3845, E3827, E3826) or 4 GB (N2807, E3825, E3815)
Audio	Realtek ALC662 HD Audio codec
BIOS	UEFI BIOS
Ethernet Controllers	LAN1: Intel® I210-AT PCIe Ethernet controller with NCSI and IPMI 2.0 support LAN2: Intel® I211-AT PCIe Ethernet controller
Digital I/O	8-bit digital I/O (4-bit input, 4-bit output)
IPMI 2.0	Supported by the optional iRIS-1010 module
Super I/O Controller	Fintek F81866
Embedded Controller	ITE IT8528E
Watchdog Timer	Software programmable supports 1 sec – 255 sec system reset
Expansion	
PCI	One PCI-104 slot

NANO-BT-i1 EPIC SBC

Specification/Model	NANO-BT-i1
PCIe	One PCIe Mini card slot
I/O Interface Connectors	
Audio Connector	One internal audio connector (10-pin)
Display Ports	One VGA port (up to 2560 x 1600, 60Hz) One HDMI port (up to 2560 x 1600, 60Hz) 18-bit/24-bit dual-channel LVDS (up to 1920 x 1200, 60Hz)
Ethernet	Two RJ-45 GbE ports
Keyboard/Mouse	One PS/2 keyboard/mouse connector
Serial Ports	One RS-422/485 via internal wafer connector Three RS-232 via internal pin headers
USB ports	One external USB 3.0 port and one external USB 2.0 port on rear IO Two internal USB 2.0 ports by pin header
Serial ATA	Two SATA 3Gb/s connectors
LAN LED	Two 2-pin LAN active LED connectors
SMBus	Supported by one 4-pin wafer connector
Environmental and Power Specifications	
Power Supply	12 V only DC input through the internal 4-pin (2x2) power connector AT/ATX power supported
Power Consumption	12 V @ 1.52 A (1.91 GHz Intel® Atom™ processor J1900 with one 8 GB 1600 MHz DDR3 memory)
Operating Temperature	-20°C – 60°C
Storage Temperature	-30°C – 70°C
Humidity	5% – 95% (non-condensing)
Physical Specifications	
Dimensions	115 mm x 165 mm
Weight GW/NW	850 g / 350 g

Table 1-2: NANO-BT-i1 Specifications

Chapter

2

Packing List

2.1 Anti-static Precautions



WARNING!

Static electricity can destroy certain electronics. Make sure to follow the ESD precautions to prevent damage to the product, and injury to the user.

Make sure to adhere to the following guidelines:

- **Wear an anti-static wristband:** Wearing an anti-static wristband can prevent electrostatic discharge.
- **Self-grounding:** Touch a grounded conductor every few minutes to discharge any excess static buildup.
- **Use an anti-static pad:** When configuring any circuit board, place it on an anti-static mat.
- **Only handle the edges of the PCB:** Don't touch the surface of the motherboard. Hold the motherboard by the edges when handling.

2.2 Unpacking Precautions

When the NANO-BT-i1 is unpacked, please do the following:

- Follow the antistatic guidelines above.
- Make sure the packing box is facing upwards when opening.
- Make sure all the packing list items are present.





2.3 Packing List

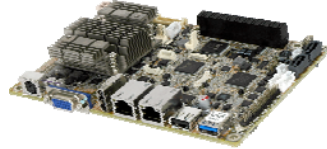

NOTE:

If any of the components listed in the checklist below are missing, do not proceed with the installation. Contact the IEI reseller or vendor the NANO-BT-i1 was purchased from or contact an IEI sales representative directly by sending an email to sales@ieiworld.com

The NANO-BT-i1 is shipped with the following components:

Quantity	Item and Part Number	Image
1	NANO-BT-i1 single board computer	
2	SATA and power cable (P/N: 32801-000201-300-RS)	
2	Single RS-232 cable (P/N: 19800-000300-200-RS)	
1	12 V AT power cable (P/N: 32100-087100-RS)	
1	Utility CD	

NANO-BT-i1 EPIC SBC



Quantity	Item and Part Number	Image
1	One Key Recovery CD	
1	Quick Installation Guide	

Table 2-1: Packing List

2.4 Optional Items

The following are optional components which may be separately purchased:





Item and Part Number	Image
IPMI 2.0 adapter card with AST1010 BMC chip (without KVM over IP function) for PCIe Mini socket interface (P/N: iRIS-1010-R10)	
Dual USB cable (P/N: 32000-070301-RS)	
RS-422/485 cable, 200mm (P/N: 32205-003800-300-RS)	
Keyboard and mouse Y cable (P/N: 32006-000300-100-RS)	

Table 2-2: Optional Items

Chapter

3

Connectors

NANO-BT-i1 EPIC SBC

3.1 Peripheral Interface Connectors

This chapter details all the jumpers and connectors.

3.1.1 NANO-BT-i1 Layout

The figures below show all the connectors and jumpers.

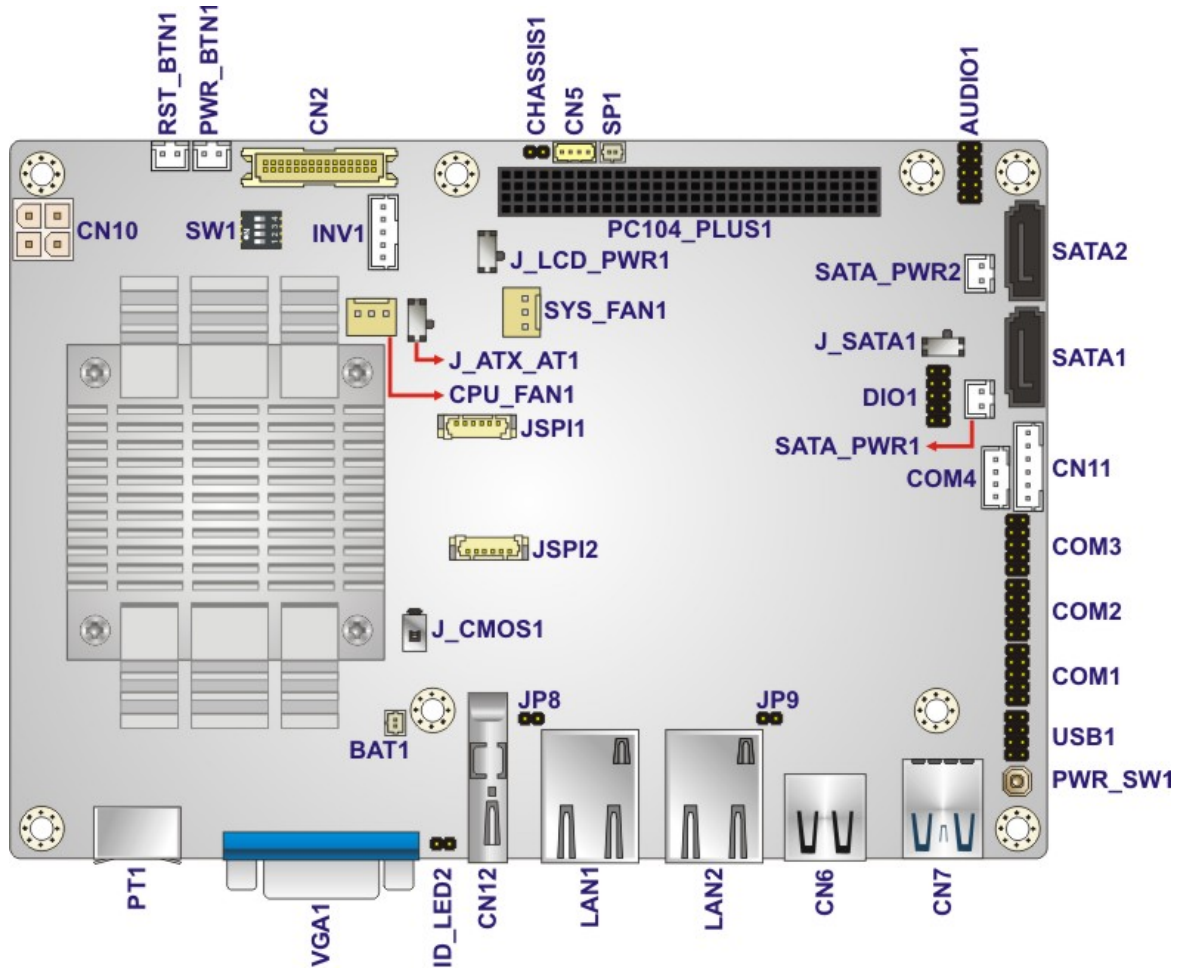

Figure 3-1: Connectors and Jumpers (Front Side)

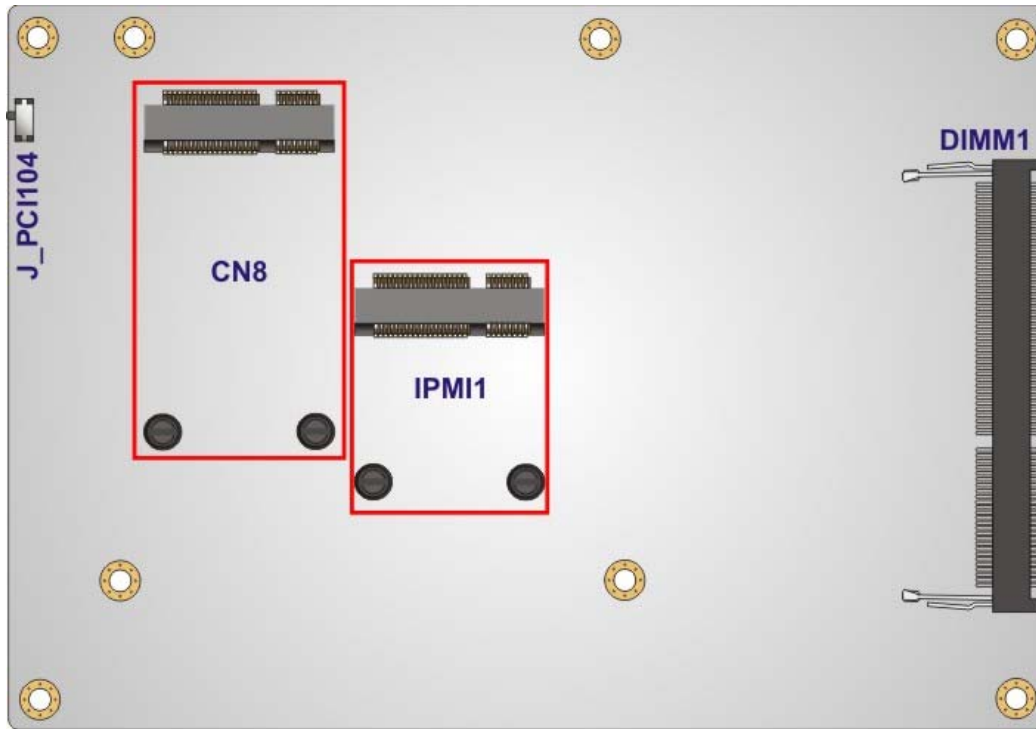

Figure 3-2: Connectors and Jumpers (Solder Side)

3.1.2 Peripheral Interface Connectors

The table below lists all the connectors on the board.

Connector	Type	Label
12 V DC input connector	4-pin connector	CN10
Audio connector	10-pin header	AUDIO1
Battery connector	2-pin wafer	BAT1
Backlight inverter connector	5-pin wafer	INV1
Buzzer connector	2-pin wafer	SP1
Chassis intrusion connector	2-pin header	CHASSIS1
Digital I/O connector	10-pin header	DIO1
Fan connector (CPU)	3-pin wafer	CPU_FAN1

NANO-BT-i1 EPIC SBC

Connector	Type	Label
Fan connector (system)	3-pin wafer	SYS_FAN1
Front panel connector	6-pin wafer	CN11
iRIS module connector	Half-size PCIe Mini slot	IPMI1
IPMI LED connector	2-pin header	ID_LED2
LAN1 LED connector	2-pin header	JP8
LAN2 LED connector	2-pin header	JP9
LVDS connector	30-pin crimp	CN2
Memory card slot	DIMM slot	DIMM1
PCI-104 slot	PCI-104 slot	PC104_PLUS1
PCIe Mini slot	Full-size PCIe Mini	CN8
Power button connector	2-pin wafer	PWR_BTN1
Power button	Push button	PWR_SW1
Reset button connector	2-pin wafer	RST_BTN1
SATA 3Gb/s drive connectors	7-pin SATA connector	SATA1, SATA2
SATA power connectors (5 V)	2-pin wafer	SATA_PWR1, SATA_PWR2
Serial ports, RS-232	10-pin header	COM1, COM2, COM3
Serial port, RS-422/485	4-pin wafer	COM4
SMBus connector	4-pin wafer	CN5
SPI flash connector	6-pin header	JSPI1
SPI flash connector (EC)	6-pin header	JSPI2
USB 2.0 connector	8-pin header	USB1

Table 3-1: Peripheral Interface Connectors

3.1.3 External Interface Panel Connectors

The table below lists the connectors on the external I/O panel.

Connector	Type	Label
Ethernet ports	RJ-45	LAN1, LAN2
HDMI connector	HDMI	CN12
Keyboard/Mouse connector	PS/2	PT1
USB 2.0 connector	USB 2.0	CN6
USB 3.0 connector	USB 3.0	CN7
VGA connector	15-pin female	VGA1

Table 3-2: Rear Panel Connectors

3.2 Internal Peripheral Connectors

The section describes all of the connectors on the NANO-BT-i1.

3.2.1 +12 V Power Connector

- CN Label:** CN10
- CN Type:** 4-pin connector
- CN Location:** See **Figure 3-3**
- CN Pinouts:** See **Table 3-3**

The +12 V power input connector provides power to the system.

NANO-BT-i1 EPIC SBC

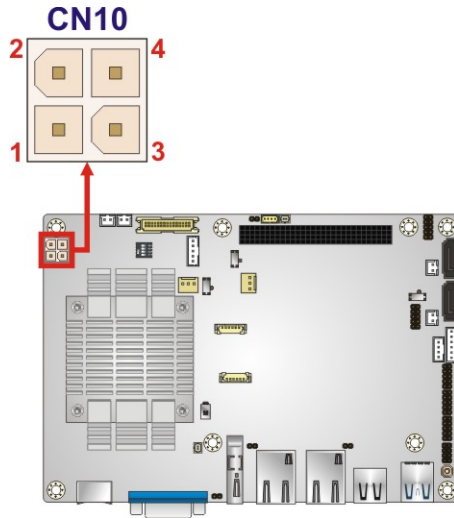

Figure 3-3: CPU Power Connector Location

PIN NO.	DESCRIPTION
1	GND
2	GND
3	+12 V
4	+12 V

Table 3-3: CPU Power Connector Pinouts

3.2.2 Audio Connector

- CN Label:** AUDIO1
- CN Type:** 10-pin header
- CN Location:** See **Figure 3-4**
- CN Pinouts:** See **Table 3-4**

This connector connects to speakers, a microphone and an audio input.

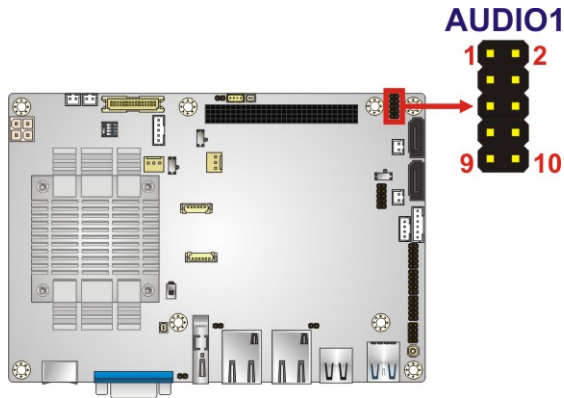

Figure 3-4: Audio Connector Location

Pin	Description	Pin	Description
1	LINE_OUTR	2	LINEIN_R
3	ANALOG_GND	4	ANALOG_GND
5	LINE_OUTL	6	LINEIN_L
7	ANALOG_GND	8	ANALOG_GND
9	MICIN1	10	MICIN2

Table 3-4: Audio Connector Pinouts

3.2.3 Battery Connector



CAUTION:

Risk of explosion if battery is replaced by an incorrect type. Only certified engineers should replace the on-board battery.

Dispose of used batteries according to instructions and local regulations.

- CN Label:** BAT1
- CN Type:** 2-pin wafer
- CN Location:** See **Figure 3-5**
- CN Pinouts:** See **Table 3-5**

NANO-BT-i1 EPIC SBC

A system battery is placed in the battery holder. The battery provides power to the system clock to retain the time when power is turned off.

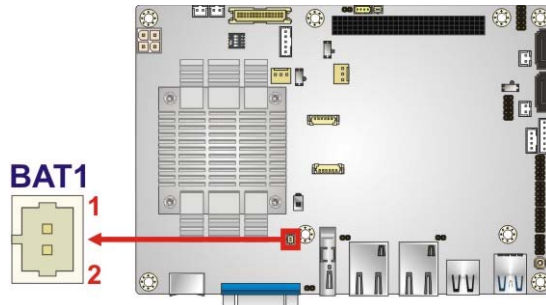

Figure 3-5: Battery Connector Location

Pin	Description
1	VBATT
2	GND

Table 3-5: Battery Connector Pinouts

3.2.4 Backlight Inverter Connector

- CN Label:** INV1
- CN Type:** 5-pin wafer
- CN Location:** See Figure 3-6
- CN Pinouts:** See Table 3-6

The backlight inverter connector provides power to an LCD panel.

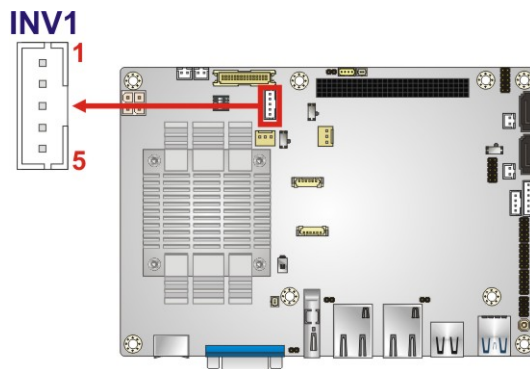

Figure 3-6: Backlight Inverter Connector Location

Pin	Description
1	BRIGHTNESS2
2	GND
3	VCC
4	GND
5	ENABKL2

Table 3-6: Backlight Inverter Connector Pinouts

3.2.5 Buzzer Connector

- CN Label:** SP1
- CN Type:** 2-pin wafer
- CN Location:** See **Figure 3-7**

The connector is connected to a buzzer.

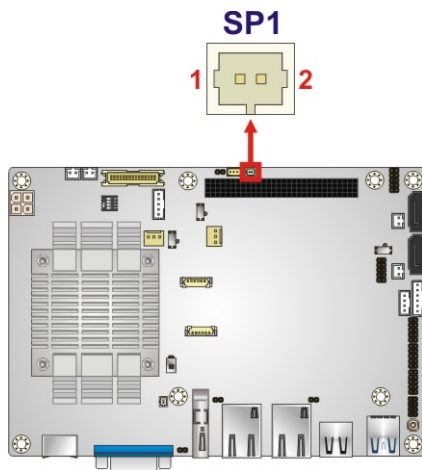

Figure 3-7: Buzzer Connector Location

NANO-BT-i1 EPIC SBC

3.2.6 Chassis Intrusion Connector

- CN Label:** CHASSIS1
- CN Type:** 2-pin header
- CN Location:** See **Figure 3-8**
- CN Pinouts:** See **Table 3-7**

The chassis intrusion connector is for a chassis intrusion detection sensor or switch that detects if a chassis component is removed or replaced.

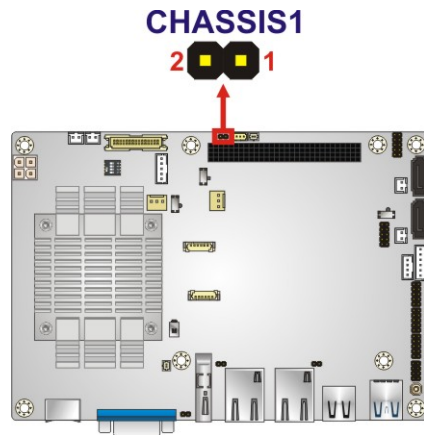

Figure 3-8: Chassis Intrusion Connector Location

Pin	Description
1	+V3.3A_EC
2	CHASSIS_EC

Table 3-7: Chassis Intrusion Connector Pinouts

3.2.7 Digital I/O Connector

- CN Label:** DIO1
- CN Type:** 10-pin header
- CN Location:** See **Figure 3-9**
- CN Pinouts:** See **Table 3-8**

The digital I/O connector provides programmable input and output for external devices. The digital I/O provides 4-bit output and 4-bit input.

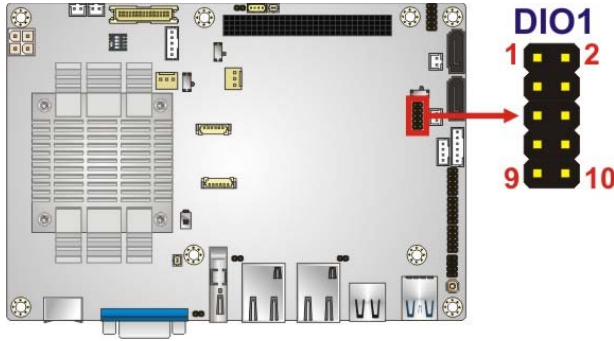

Figure 3-9: Digital I/O Connector Location

PIN NO.	DESCRIPTION	PIN NO.	DESCRIPTION
1	GND	2	+5V
3	DOUT3	4	DOUT2
5	DOUT1	6	DOUT0
7	DIN3	8	DIN2
9	DIN1	10	DIN0

Table 3-8: Digital I/O Connector Pinouts

3.2.8 Fan Connector (CPU)

- CN Label:** CPU_FAN1
- CN Type:** 3-pin wafer
- CN Location:** See **Figure 3-10**
- CN Pinouts:** See **Table 3-9**

The fan connector attaches to a CPU cooling fan.

NANO-BT-i1 EPIC SBC

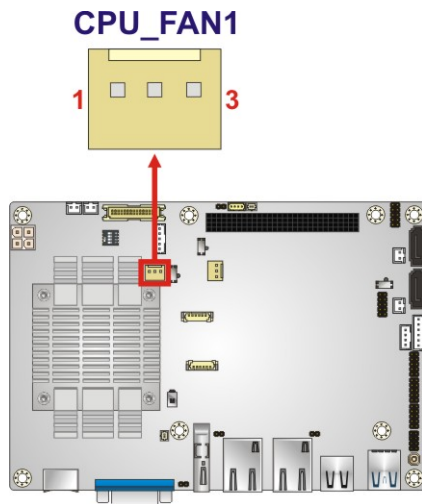

Figure 3-10: CPU Fan Connector Location

PIN NO.	DESCRIPTION
1	FAN_IN
2	VCC (+12 V)
3	GND

Table 3-9: CPU Fan Connector Pinouts

3.2.9 Fan Connector (System)

- CN Label:** **SYS_FAN1**
- CN Type:** 3-pin wafer
- CN Location:** See **Figure 3-11**
- CN Pinouts:** See **Table 3-10**

Each fan connector attaches to a system cooling fan.

SYS_FAN1

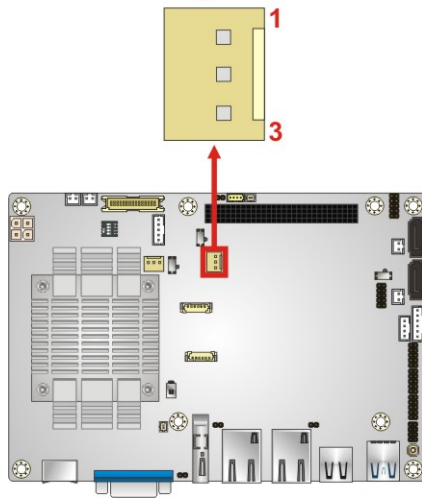

Figure 3-11: System Fan Connector Location

PIN NO.	DESCRIPTION
1	FAN_IN
2	VCC (+12 V)
3	GND

Table 3-10: System Fan Connector Pinouts

3.2.10 Front Panel Connector

- CN Label:** CN11
- CN Type:** 6-pin wafer
- CN Location:** See **Figure 3-12**
- CN Pinouts:** See **Table 3-11**

The front panel connector connects to the indicator LEDs on the computer's front panel.

NANO-BT-i1 EPIC SBC

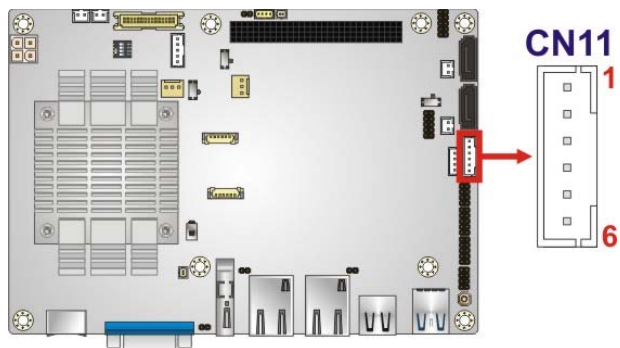

Figure 3-12: Front Panel Connector Location

PIN	DESCRIPTION	PIN	DESCRIPTION
1	VCC	4	PWR_LED-
2	GND	5	HDD_LED+
3	PWR_LED+	6	HDD_LED-

Table 3-11: Front Panel Connector Pinouts

3.2.11 IPMI LED Connector

- CN Label:** ID_LED2
- CN Type:** 2-pin header
- CN Location:** See **Figure 3-13**
- CN Pinouts:** See **Table 3-12**

The IPMI LED connector is used to connect to the IPMI LED indicator on the chassis.

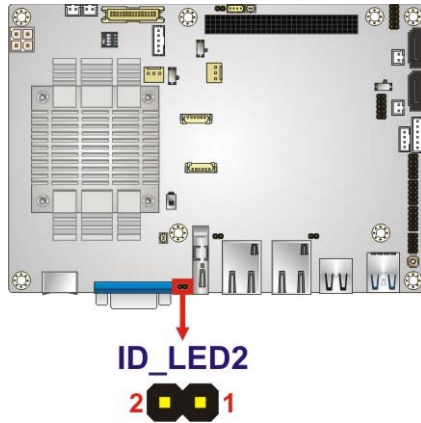

Figure 3-13: IPMI LED Connector Location

Pin	Description
1	ID_LED+
2	ID_LED-

Table 3-12: IPMI LED Connector Pinouts

3.2.12 iRIS Module Slot

- CN Label:** IPMI1
- CN Type:** Half-size PCIe Mini slot
- CN Location:** See **Figure 3-14**

The iRIS module slot is used to install the IEI iRIS-1010 IPMI 2.0 module.



WARNING:

The iRIS module slot is designed to install the IEI iRIS-1010 IPMI 2.0 module only. DO NOT install other modules into the iRIS module slot. Doing so may cause damage to the NANO-BT-i1.

NANO-BT-i1 EPIC SBC

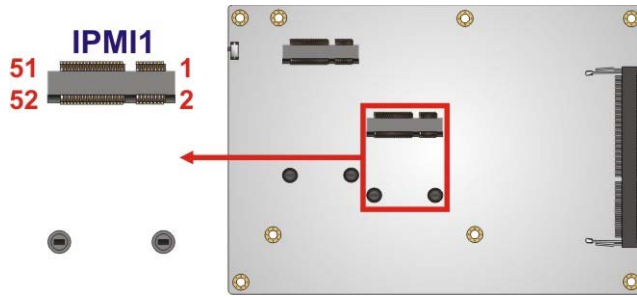

Figure 3-14: iRIS Module Slot Location

3.2.13 LAN LED Connectors

- CN Label:** JP8, JP9
- CN Type:** 2-pin header
- CN Location:** See Figure 3-15
- CN Pinouts:** See Table 3-13 and Table 3-14

The LAN LED connectors are used to connect to the LAN LED indicators on the chassis to indicate users the link activities of the two LAN ports.

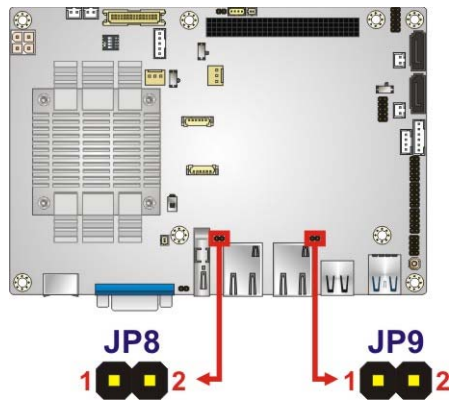

Figure 3-15: LAN LED Connector Locations

Pin	Description
1	VCC
2	L1_LINK_ACT-

Table 3-13: LAN1 LED Connector (JP8) Pinouts

Pin	Description
1	VCC
2	L2_LINK_ACT-

Table 3-14: LAN2 LED Connector (JP9) Pinouts

3.2.14 LVDS Connector

- CN Label:** CN2
- CN Type:** 30-pin crimp
- CN Location:** See **Figure 3-16**
- CN Pinouts:** See **Table 3-15**

The LVDS connector is for an LCD panel connected to the board.

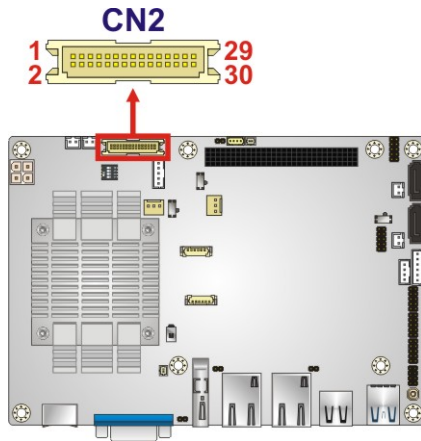

Figure 3-16: LVDS Connector Location

Pin	Description	Pin	Description
1	GND	2	GND
3	LVDS_A_TX0-P	4	LVDS_A_TX0-N
5	LVDS_A_TX1-P	6	LVDS_A_TX1-N
7	LVDS_A_TX2-P	8	LVDS_A_TX2-N
9	LVDS_A_TXCLK-P	10	LVDS_A_TXCLK-N

NANO-BT-i1 EPIC SBC

Pin	Description	Pin	Description
11	LVDS_ A_TX3-P	12	LVDS_ A_TX3-N
13	GND	14	GND
15	LVDS_ B_TX0-P	16	LVDS_ B_TX0-N
17	LVDS_ B_TX1-P	18	LVDS_ B_TX1-N
19	LVDS_ B_TX2-P	20	LVDS_ B_TX2-N
21	LVDS_ B_TXCLK-P	22	LVDS_ B_TXCLK-N
23	LVDS_ B_TX3-P	24	LVDS_ B_TX3-N
25	GND	26	GND
27	+LCD VCC	28	+LCD VCC
29	+LCD VCC	30	+LCD VCC

Table 3-15: LVDS Connector Pinouts

3.2.15 Memory Card Slot

- CN Label:** DIMM1
- CN Type:** DDR3 SO-DIMM slot
- CN Location:** See **Figure 3-17**

The SO-DIMM slot is for installing DDR3 Low Voltage SO-DIMM memory modules.

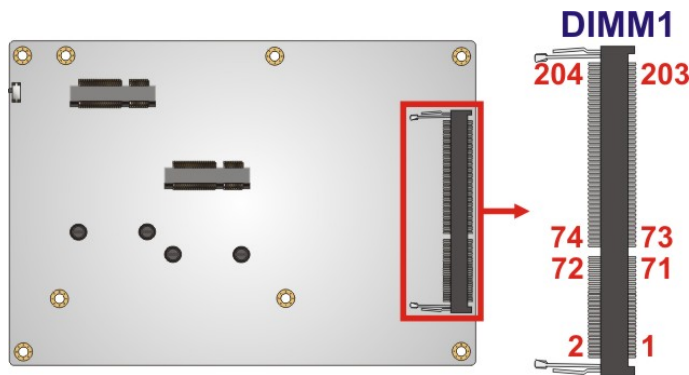

Figure 3-17: Memory Card Slot Location

3.2.16 PCI-104 Connector

- CN Label:** PC104_PLUS1
- CN Type:** PCI-104 connector
- CN Location:** See **Figure 3-18**
- CN Pinouts:** See **Table 3-16**

The PCI-104 connector is for installing a PCI-104 expansion card.

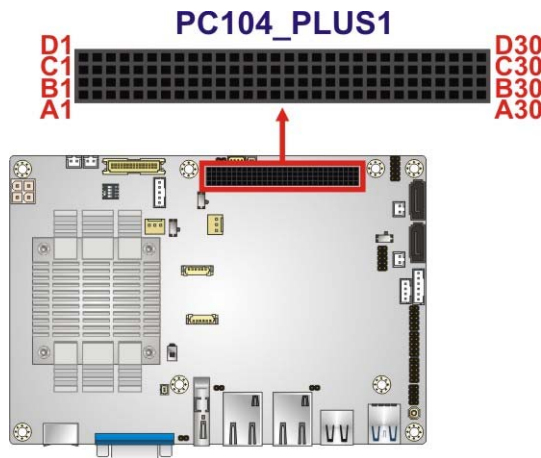

Figure 3-18: PCI-104 Connector Location

Pin	Row A	Row B	Row C	Row D
1	GND/5 V	TBD1	5 V	AD00
2	VI/O1	AD02	AD01	+5 V
3	AD05	GND	AD04	AD03
4	C/BE0#	AD07	GND	AD06
5	GND	AD09	AD08	GND
6	AD11	VI/O2	AD10	M66EN
7	AD14	AD13	GND	AD12
8	+3.3 V	C/BE1#	AD15	+3.3 V
9	SERR#	GND	SB0#	PAR
10	GND	PERR#	+3.3 V	SDONE
11	STOP#	+3.3 V	LOCK#	GND
12	+3.3 V	TRDY#	GND	DEVSEL#

NANO-BT-i1 EPIC SBC

Pin	Row A	Row B	Row C	Row D
13	FRAME#	GND	IRDY#	+3.3 V
14	GND	AD16	+3.3 V	C/BE2#
15	AD18	+3.3 V	AD17	GND
16	AD21	AD20	GND	AD19
17	+3.3 V	AD23	AD22	+3.3 V
18	IDSEL0	GND	IDSEL1	IDSEL2
19	AD24	C/BE3#	VI/O1	IDSEL3
20	GND	AD26	AD25	GND
21	AD29	+5 V	AD28	AD27
22	+5 V	AD30	GND	AD31
23	REQ0#	GND	REQ1#	VI/O2
24	GND	REQ2#	+5 V	GNT0#
25	GNT1#	VI/O3	GNT2#	GND
26	+5 V	CLK0	GND	CLK1
27	CLK2	+5 V	CLK3	GND
28	GND	INTD#	+5 V	RST#
29	+12 V	INTA#	INTB#	INTC#
30	-12 V	TBD2	TBD	GND/3.3 V

Table 3-16: PCI-104 Connector Pinouts

3.2.17 PCIe Mini Card Slot

- CN Label:** CN8
- CN Type:** PCIe Mini card slot
- CN Location:** See **Figure 3-19**
- CN Pinouts:** See **Table 3-17**

The PCIe Mini card slot is for installing PCIe Mini expansion cards, such as mSATA modules or Wi-Fi modules.

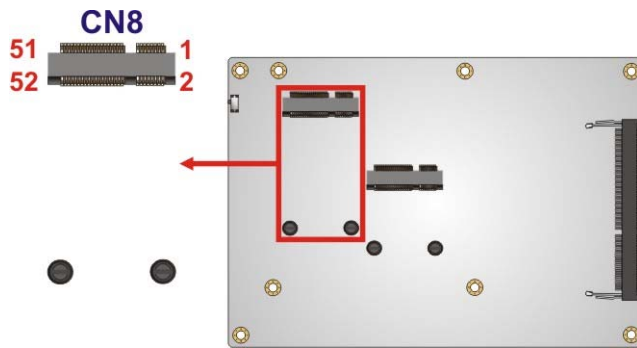

Figure 3-19: PCIe Mini Card Slot Location

Pin	Description	Pin	Description
1	PCIE_WAKE#	2	VCC3
3	N/C	4	GND
5	N/C	6	1.5 V
7	VCC3	8	N/C
9	GND	10	N/C
11	CLK-	12	N/C
13	CLK+	14	N/C
15	GND	16	N/C
17	BUF_PLT_RST#	18	GND
19	N/C	20	VCC3
21	GND	22	BUF_PLT_RST#
23	PCIE_RX4DN_M	24	VCC3
25	PCIE_RX4DP_M	26	GND
27	GND	28	1.5 V
29	GND	30	SMBCLK
31	PCIE_TX4DN_CM	32	SMBDATA
33	PCIE_TX4DP_CM	34	GND
35	GND	36	USB3-
37	GND	38	USB3+
39	VCC3	40	GND
41	VCC3	42	N/C
43	GND	44	RF_LINK#

NANO-BT-i1 EPIC SBC

Pin	Description	Pin	Description
45	N/C	46	BLUELED#
47	N/C	48	1.5 V
49	N/C	50	GND
51	M-SATADET	52	VCC3

Table 3-17: PCIe Mini Card Slot Pinouts

3.2.18 Power Button Connector

CN Label: PWR_BTN1

CN Type: 2-pin wafer

CN Location: See **Figure 3-20**

CN Pinouts: See **Table 3-18**

The power button connector is connected to a power switch on the system chassis.

PWR_BTN1

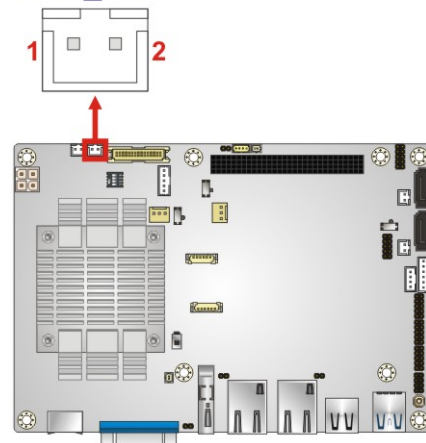

Figure 3-20: Power Button Location

Pin	Description
1	PWRBTN_SW#
2	GND

Table 3-18: Power Button Pinouts

3.2.19 Power Button

CN Label:	PWR_SW1
CN Type:	Push button
CN Location:	See Figure 3-21

The on-board power button controls system power.

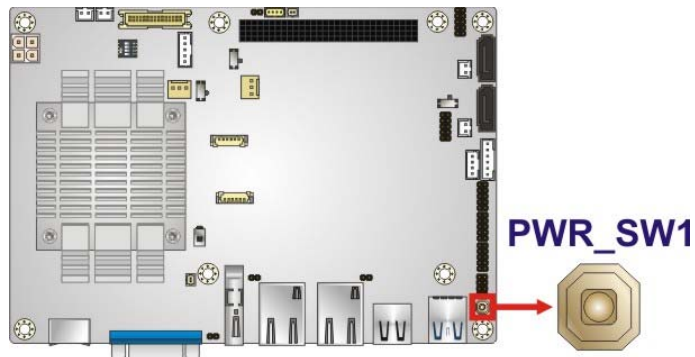

Figure 3-21: Power Button Location

3.2.20 Reset Button Connector

CN Label:	RST_BTN1
CN Type:	2-pin wafer
CN Location:	See Figure 3-22
CN Pinouts:	See Table 3-19

The reset button connector is connected to a reset switch on the system chassis.

NANO-BT-i1 EPIC SBC

RST_BTN1

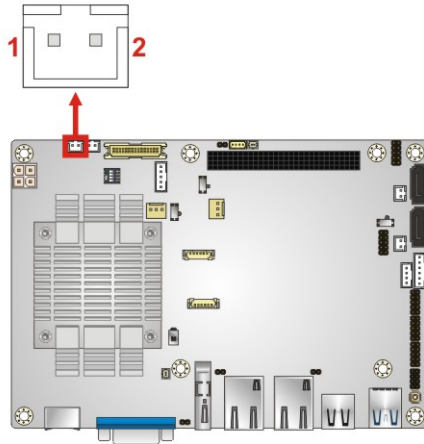

Figure 3-22: Reset Button Connector Location

Pin	Description
1	PM_SYSRST_R#
2	GND

Table 3-19: Reset Button Connector Pinouts

3.2.21 SATA 3Gb/s Drive Connectors

- CN Label:** SATA1, SATA2
- CN Type:** 7-pin SATA drive connectors
- CN Location:** See **Figure 3-23**
- CN Pinouts:** See **Table 3-20**

The SATA drive connectors can be connected to SATA drives.

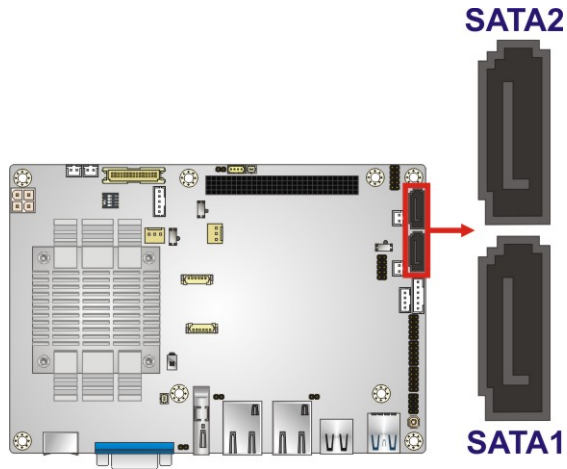

Figure 3-23: SATA 3Gb/s Drive Connector Locations

Pin	Description
1	GND
2	SATA_TX+
3	SATA_TX-
4	GND
5	SATA_RX-
6	SATA_RX+
7	GND

Table 3-20: SATA 3Gb/s Drive Connector Pinouts

3.2.22 SATA Power Connectors

CN Label: SATA_PWR1, SATA_PWR2

CN Type: 2-pin wafer

CN Location: See **Figure 3-24**

CN Pinouts: See **Table 3-21**

Use the SATA Power Connector to connect to SATA device power connections.

NANO-BT-i1 EPIC SBC

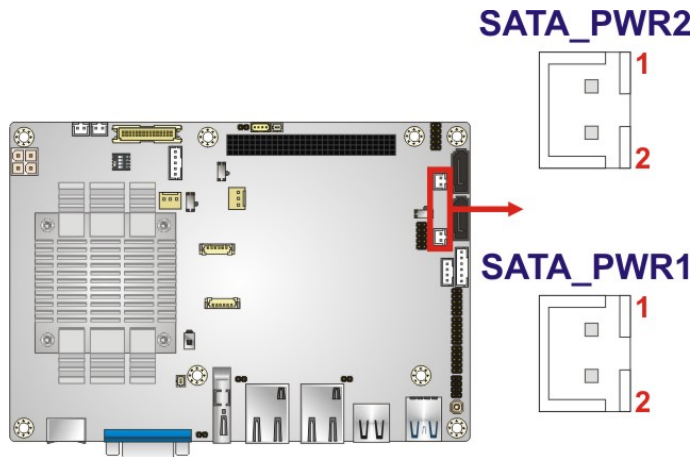

Figure 3-24: SATA Power Connector Locations

Pin	Description
1	+5VS
2	GND

Table 3-21: SATA Power Connector Pinouts

3.2.23 Serial Port Connectors, RS-232

CN Label: COM1, COM2, COM3

CN Type: 10-pin header

CN Location: See Figure 3-25

CN Pinouts: See Table 3-22

The connector provides RS-232 port connection.

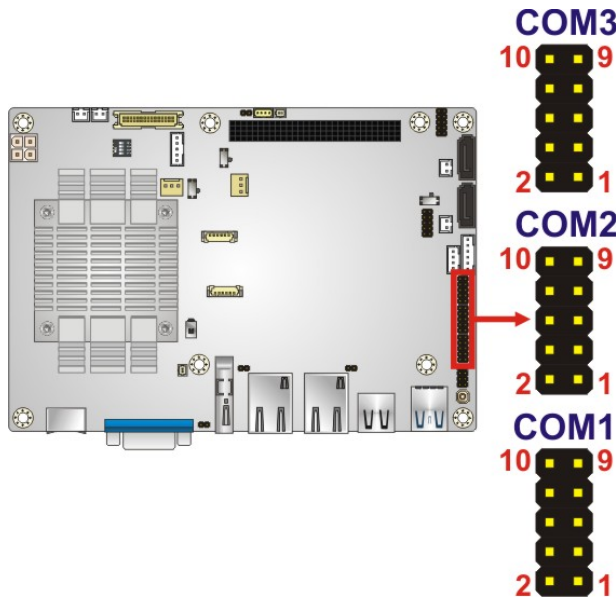

Figure 3-25: RS-232 Serial Port Connector Locations

PIN NO.	DESCRIPTION	PIN NO.	DESCRIPTION
1	DCD	2	DSR
3	SIN	4	RTS
5	SOUT	6	CTS
7	DTR	8	RI
9	GND	10	GND

Table 3-22: RS-232 Serial Port Connector Pinouts

3.2.24 Serial Port Connector, RS-422/485

- CN Label:** COM4
- CN Type:** 4-pin wafer
- CN Location:** See **Figure 3-26**
- CN Pinouts:** See **Table 3-23**

Used for RS-422/485 communications.

NANO-BT-i1 EPIC SBC

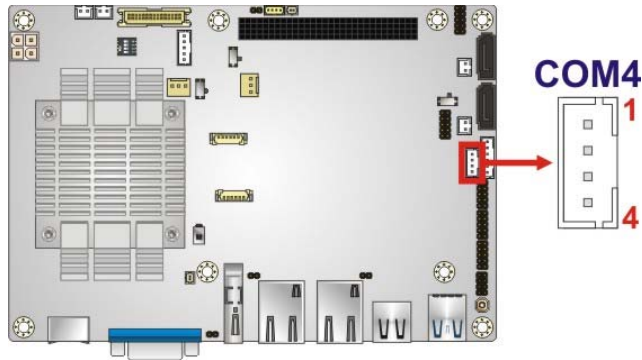

Figure 3-26: RS-422/485 Connector Location

PIN NO.	DESCRIPTION
1	RXD422-
2	RXD422+
3	TXD422+/TXD485+
4	TXD422-/TXD485-

Table 3-23: RS-422/485 Connector Pinouts

Use the optional RS-422/485 cable to connect to a serial device. The pinouts of the D-sub 9 connector are listed below.

RS-422 Pinouts	RS-485 Pinouts

Table 3-24: RS-422/485 Pinouts of D-sub 9 Connector

3.2.25 SMBus Connector

- CN Label:** CN5
- CN Type:** 4-pin wafer
- CN Location:** See Figure 3-27
- CN Pinouts:** See Table 3-25

The SMBus (System Management Bus) connector provides low-speed system management communications.

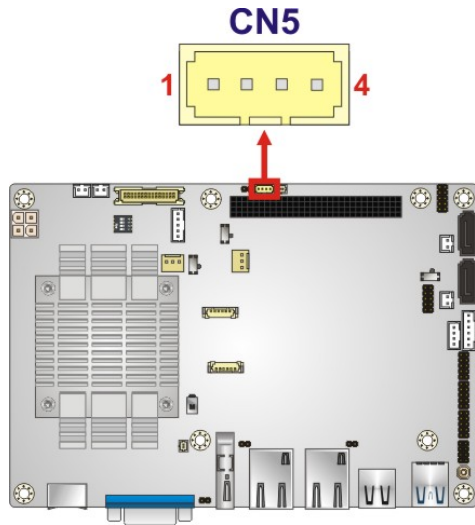

Figure 3-27: SMBus Connector Location

PIN	DESCRIPTION
1	GND
2	SMB_DATA
3	SMB_CLK
4	+5 V

Table 3-25: SMBus Connector Pinouts

3.2.26 SPI Flash Connector

- CN Label:** JSPI1
- CN Type:** 6-pin wafer
- CN Location:** See **Figure 3-28**
- CN Pinouts:** See **Table 3-26**

The SPI flash connector is used to flash the SPI ROM.

NANO-BT-i1 EPIC SBC

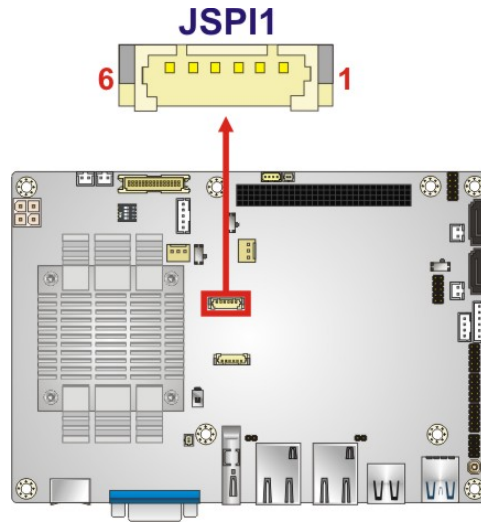

Figure 3-28: SPI Flash Connector Location

PIN NO.	DESCRIPTION	PIN NO.	DESCRIPTION
1	+1.8 VA	4	SPI_CLK_SW
2	SPI_CS	5	SPI_SI_SW
3	SPI_SO_SW	6	GND

Table 3-26: SPI Flash Connector Pinouts

3.2.27 SPI Flash Connector, EC

- CN Label:** JSPI2
- CN Type:** 6-pin wafer
- CN Location:** See **Figure 3-29**
- CN Pinouts:** See **Table 3-27**

The SPI flash connector is used to flash the EC ROM.

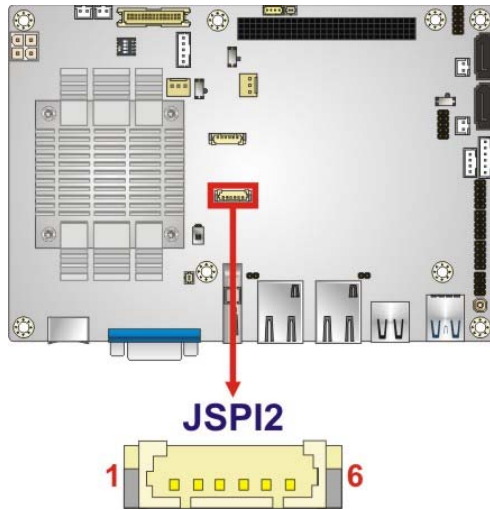

Figure 3-29: SPI EC Flash Connector Location

PIN NO.	DESCRIPTION	PIN NO.	DESCRIPTION
1	+3.3 A	4	SPI_CLK_SW_EC
2	SPI_CS#0_CN_EC	5	SPI_SI_SW_EC
3	SPI_SO_SW_EC	6	GND

Table 3-27: SPI EC Flash Connector Pinouts

3.2.28 USB 2.0 Connector

- CN Label:** USB1
- CN Type:** 8-pin header
- CN Location:** See **Figure 3-30**
- CN Pinouts:** See **Table 3-28**

The USB 2.0 connector connects to USB 2.0 devices. Each pin header provides two USB 2.0 ports.

NANO-BT-i1 EPIC SBC

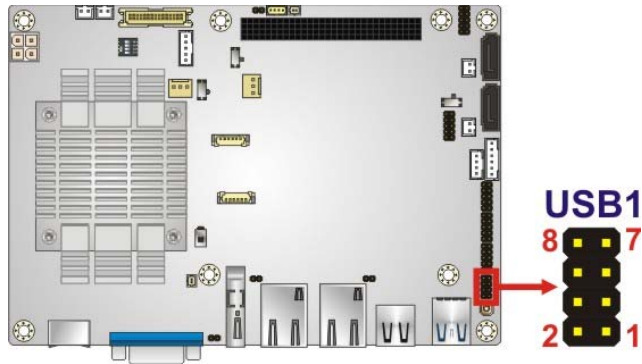

Figure 3-30: USB 2.0 Connector Location

PIN NO.	DESCRIPTION	PIN NO.	DESCRIPTION
1	+VCC_USB45	2	GND
3	DATA4-	4	DATA5+
5	DATA4+	6	DATA5-
7	GND	8	+VCC_USB45

Table 3-28: USB 2.0 Connector Pinouts

3.3 External Peripheral Interface Connector Panel

The figure below shows the external peripheral interface connector (EPIC) panel. The EPIC panel consists of the following:

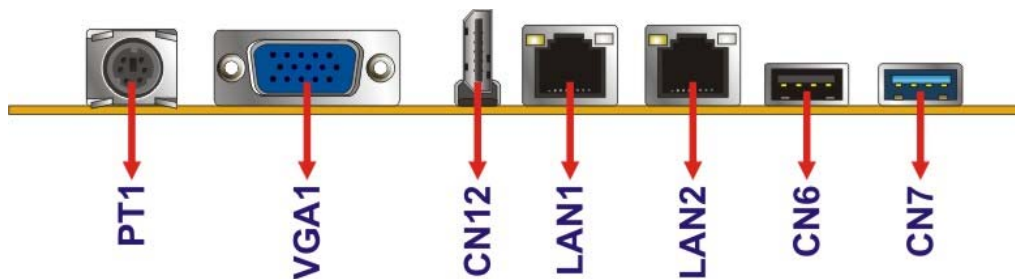

Figure 3-31: External Peripheral Interface Connector

3.3.1 Ethernet Connectors

CN Label: LAN1, LAN2

CN Type: RJ-45

CN Location: See **Figure 3-31**

CN Pinouts: See **Table 3-29** and **Table 3-30**

A 10/100/1000 Mb/s connection can be made to a Local Area Network. The LAN1 Ethernet connector supports IPMI 2.0.

Pin	Description	Pin	Description
G1	IO_GND	R2	TRD1N0
G2	IO_GND	R3	TRD1P1
L1	L1_100-	R4	TRD1N1
L2	L1_1000-	R5	N95788738
L3	L1_LINK_ACT-	R6	N95788617
L4	N100494685	R7	TRD1P2
N1	NC	R8	TRD1N2
N2	NC	R9	TRD1P3
R1	TRD1P0	R10	TRD1N3

Table 3-29: LAN1 Ethernet Connector Pinouts

Pin	Description	Pin	Description
G1	IO_GND_1	R2	TRD2N0
G2	IO_GND_1	R3	TRD2P1
L1	L2_100-	R4	TRD2N1
L2	L2_1000-	R5	N95934519
L3	L2_LINK_ACT-	R6	N95934513
L4	N100495197	R7	TRD2P2
N1	NC	R8	TRD2N2
N2	NC	R9	TRD2P3
R1	TRD2P0	R10	TRD2N3

Table 3-30: LAN2 Ethernet Connector Pinouts

NANO-BT-i1 EPIC SBC

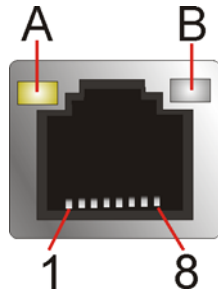

Figure 3-32: Ethernet Connector

LED	Description	LED	Description
A	on: linked blinking: data is being sent/received	B	off: 10 Mb/s green: 100 Mb/s orange: 1000 Mb/s

Table 3-31: Connector LEDs

3.3.2 HDMI Connector

- CN Label:** CN12
- CN Type:** 23-pin HDMI port
- CN Location:** See Figure 3-31
- CN Pinouts:** See Table 3-32

The HDMI connector can connect to an HDMI device.

Pin	Description	Pin	Description
1	HDMI_DATA2	2	GND
3	HDMI_DATA2#	4	HDMI_DATA1
5	GND	6	HDMI_DATA1#
7	HDMI_DATA0	8	GND
9	HDMI_DATA0#	10	HDMI_CLK
11	GND	12	HDMI_CLK#
13	N/C	14	N/C
15	HDMI_SCL	16	HDMI_SDA
17	GND	18	+5V
19	HDMI_HPD	20	HDMI_GND

Pin	Description	Pin	Description
21	HDMI_GND	22	HDMI_GND
23	HDMI_GND		

Table 3-32: HDMI Connector Pinouts

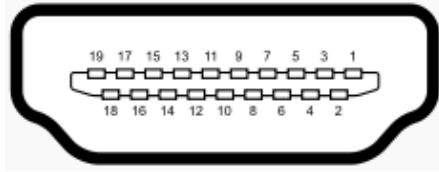

Figure 3-33: HDMI Connector

3.3.3 Keyboard/Mouse Connector

- CN Label:** PT1
- CN Type:** PS/2
- CN Location:** See **Figure 3-31**
- CN Pinouts:** See **Table 3-33**

The keyboard and mouse connector is a standard PS/2 connector.

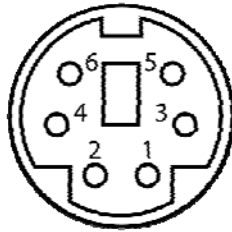

Figure 3-34: PS/2 Pinout and Configuration

Pin	Description
1	KB DATA
2	MS DATA
3	GND
4	VCC
5	KB CLOCK

NANO-BT-i1 EPIC SBC

Pin	Description
6	MS CLOCK

Table 3-33: Keyboard Connector Pinouts

3.3.4 USB 2.0 Connector

- CN Label:** CN6
- CN Type:** USB 2.0 port
- CN Location:** See **Figure 3-31**
- CN Pinouts:** See **Table 3-34**

The USB connector can be connected to a USB device.

Pin	Description	Pin	Description
1	USB3_PWR1	4	GND
2	DATA1_N	5	USB_GND
3	DATA1_P	6	USB_GND

Table 3-34: USB 2.0 Port Pinouts

3.3.5 USB 3.0 Connector

- CN Label:** CN7
- CN Type:** USB 3.0 port
- CN Location:** See **Figure 3-31**
- CN Pinouts:** See **Table 3-35**

The USB connector can be connected to a USB device.

Pin	Description	Pin	Description
1	USB3_PWR1	6	USB3P0_RXDP1
2	USB2P0_DM1_L	7	USB_GND
3	USB2P0_DP1_L	8	USB3P0_TXDN1_C
4	GND	9	USB3P0_TXDP1_C

Pin	Description	Pin	Description
5	USB3P0_RXDN1		

Table 3-35: USB 3.0 Port Pinouts

3.3.6 VGA Connector

- CN Label:** VGA1
- CN Type:** 15-pin Female
- CN Location:** See **Figure 3-31**
- CN Pinouts:** See **Table 3-36** and **Figure 3-35**

Both VGA connectors can be connected to monitors that accept standard VGA input for easy dual display setup. The VGA connectors support up to 1920 x 1200 resolutions.

PIN	DESCRIPTION	PIN	DESCRIPTION
V1	RED	V2	GREEN
V3	BLUE	V4	NC
V5	GND	V6	GND
V7	GND	V8	GND
V9	VCC	V10	GND
V11	NC	V12	DDCDA
V13	HSYNC	V14	VSYNC
V15	DDCCLK		

Table 3-36: VGA Connector Pinouts

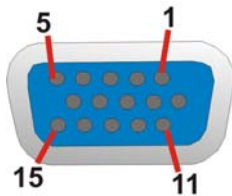

Figure 3-35: VGA Connector

Chapter

4

Installation

4.1 Anti-static Precautions



WARNING:

Failure to take ESD precautions during the installation of the NANO-BT-i1 may result in permanent damage to the NANO-BT-i1 and severe injury to the user.

Electrostatic discharge (ESD) can cause serious damage to electronic components, including the NANO-BT-i1. Dry climates are especially susceptible to ESD. It is therefore critical that whenever the NANO-BT-i1 or any other electrical component is handled, the following anti-static precautions are strictly adhered to.

- **Wear an anti-static wristband:** - Wearing a simple anti-static wristband can help to prevent ESD from damaging the board.
- **Self-grounding:** - Before handling the board touch any grounded conducting material. During the time the board is handled, frequently touch any conducting materials that are connected to the ground.
- **Use an anti-static pad:** When configuring the NANO-BT-i1, place it on an anti-static pad. This reduces the possibility of ESD damaging the NANO-BT-i1.
- **Only handle the edges of the PCB:-:** When handling the PCB, hold the PCB by the edges.

4.2 Installation Considerations



NOTE:

The following installation notices and installation considerations should be read and understood before installation. All installation notices must be strictly adhered to. Failing to adhere to these precautions may lead to severe damage and injury to the person performing the installation.

NANO-BT-i1 EPIC SBC



WARNING:

The installation instructions described in this manual should be carefully followed in order to prevent damage to the components and injury to the user.

Before and during the installation please **DO** the following:

- Read the user manual:
 - The user manual provides a complete description of the NANO-BT-i1 installation instructions and configuration options.
- Wear an electrostatic discharge cuff (ESD):
 - Electronic components are easily damaged by ESD. Wearing an ESD cuff removes ESD from the body and helps prevent ESD damage.
- Place the NANO-BT-i1 on an antistatic pad:
 - When installing or configuring the motherboard, place it on an antistatic pad. This helps to prevent potential ESD damage.
- Turn all power to the NANO-BT-i1 off:
 - When working with the NANO-BT-i1, make sure that it is disconnected from all power supplies and that no electricity is being fed into the system.

Before and during the installation of the NANO-BT-i1 **DO NOT**:

- Remove any of the stickers on the PCB board. These stickers are required for warranty validation.
- Use the product before verifying all the cables and power connectors are properly connected.
- Allow screws to come in contact with the PCB circuit, connector pins, or its components.

4.2.1 SO-DIMM Installation

To install an SO-DIMM, please follow the steps below and refer to Figure 4-1.

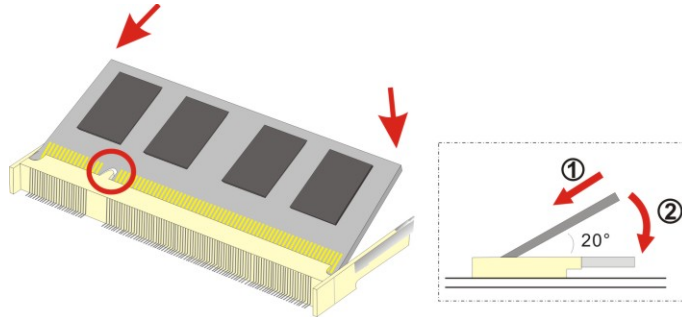

Figure 4-1: SO-DIMM Installation

- Step 1:** Locate the **SO-DIMM socket** on the solder side of the NANO-BT-i1. Place the board on an anti-static mat.
- Step 2:** **Align the SO-DIMM with the socket.** Align the notch on the memory with the notch on the memory socket.
- Step 3:** **Insert the SO-DIMM.** Push the memory in at a 20° angle. (See **Figure 4-1**)
- Step 4:** **Seat the SO-DIMM.** Gently push downwards and the arms clip into place. (See **Figure 4-1**)

4.2.2 iRIS-1010 Module Installation



WARNING:

The iRIS module slot is designed to install the IEI iRIS-1010 IPMI 2.0 module only. DO NOT install other modules into the iRIS module slot. Doing so may cause damage to the NANO-BT-i1.

To install the iRIS-1010 module, please follow the steps below and refer to **Figure 4-2**.

NANO-BT-i1 EPIC SBC

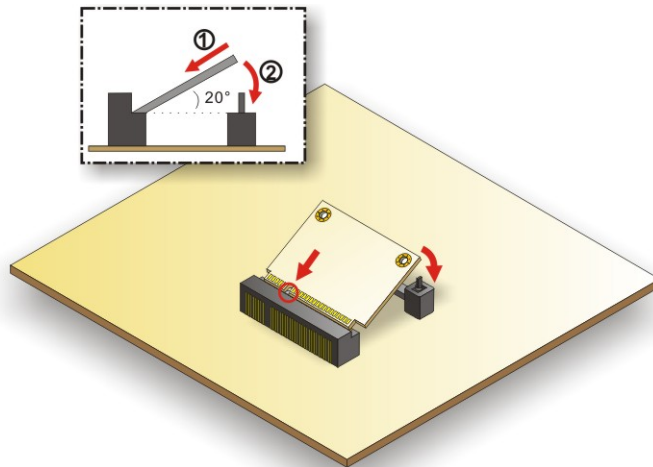

Figure 4-2: iRIS-1010 Module Installation

- Step 1:** Locate the iRIS module slot on the solder side. See Figure 3-14.
- Step 2:** Insert into the socket at an angle. Line up the notch on the RIS-1010 module with the notch on the connector. Slide the RIS-1010 module into the socket at an angle of about 20°.
- Step 3:** Push down until the RIS-1010 module clips into place. Push the other end of the RIS-1010 module down until it clips into place on the plastic connector.



NOTE:

After installing the iRIS-1010 module, use **LAN1** port to establish a network connection. Please refer to **Section 4.6** for IPMI setup procedures.

4.2.3 PCIe Mini Card Installation

To install the PCIe Mini card, please refer to the diagram and instructions below.

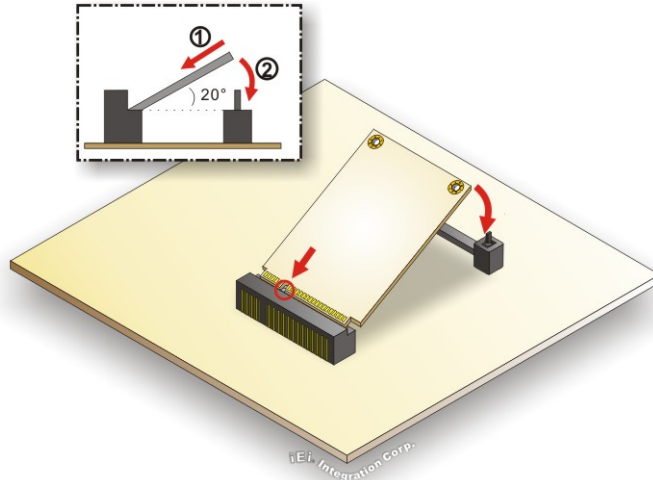

Figure 4-3: PCIe Mini Card Installation

- Step 1:** Insert into the socket at an angle. Line up the notch on the card with the notch on the connector. Slide the PCIe Mini card into the socket at an angle of about 20°.
- Step 2:** Push down until the card clips into place. Push the other end of the card down until it clips into place on the plastic connector.

4.3 System Configuration

The NANO-BT-i1 is a jumperless single board computer. The system configuration is controlled by buttons and switches. The system configuration must be performed before installation.

4.3.1 AT/ATX Power Mode Setting

The AT and ATX power mode selection is made through the AT/ATX power mode switch which is shown in **Figure 4-4**.

NANO-BT-i1 EPIC SBC

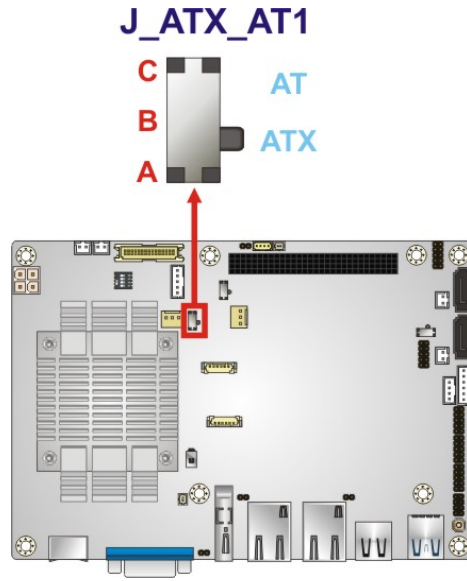

Figure 4-4: AT/ATX Power Mode Switch Location

4.3.2 Clear CMOS Button

To reset the BIOS, remove the on-board battery and press the clear CMOS button for three seconds or more. The clear CMOS button location is shown in **Figure 4-5**.

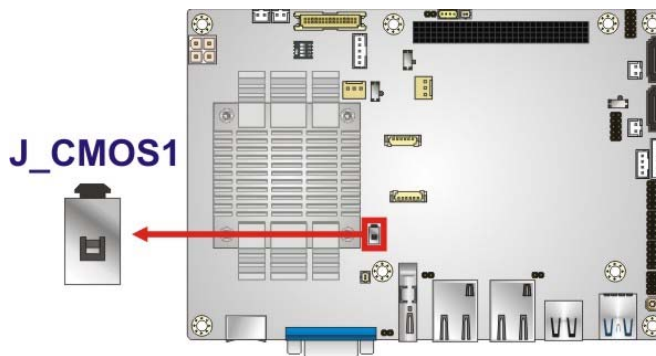

Figure 4-5: Clear CMOS Button Location

4.3.3 LVDS Panel Resolution Selection

Use the SW1 DIP switch to select the resolution of the LCD panel connected to the LVDS connector.

SW1 (4-3-2-1)	Description
0000	800x600 18-bit (Default)
0001	1024x768 18-bit
0010	1024x768 24-bit
0011	1280x768 18-bit
0100	1280x800 18-bit
0101	1280x960 18-bit
0110	1280x1024 48-bit
0111	1366x768 18-bit
1000	1366x768 24-bit
1001	1440x900 48-bit
1010	1400x1050 48-bit
1011	1600x900 48-bit
1100	1680x1050 48-bit
1101	1600x1200 48-bit
1110	1920x1080 48-bit
1111	1920x1200 48-bit

*ON=0, OFF=1

Table 4-1: LVDS Panel Resolution Selection

NANO-BT-i1 EPIC SBC

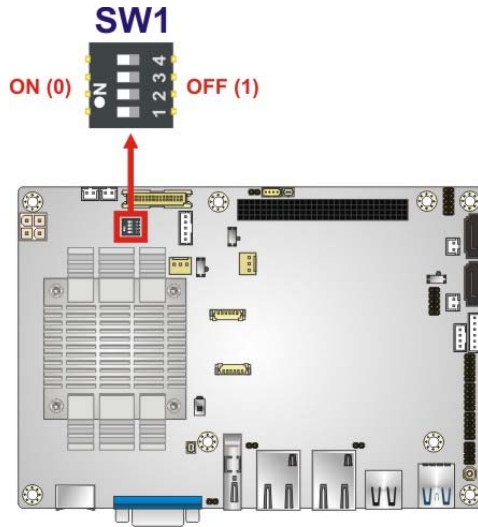

Figure 4-6: LVDS Panel Resolution Selection Switch Location

4.3.4 LCD Voltage Selection

The LCD voltage selection switch sets the voltage of the power supplied to the LCD panel. The LCD Voltage Selection settings are shown in **Table 4-2**.

Setting	Description
A-B	+3.3 V (Default)
B-C	+5.0 V

Table 4-2: LCD Voltage Selection Switch Settings

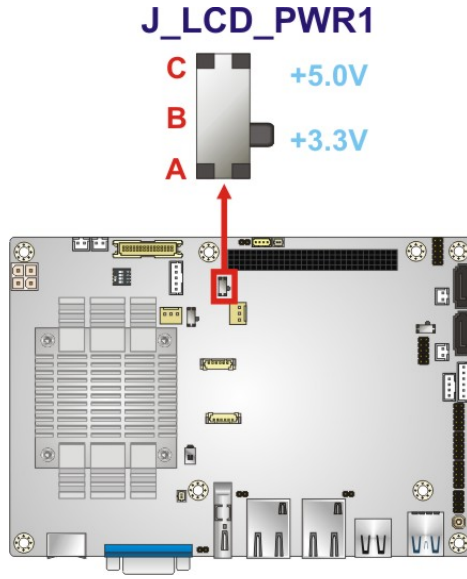

Figure 4-7: LCD Voltage Selection Switch Location

4.3.5 mSATA/SATA Selection

Use the J_SATA1 switch to select whether to automatically detect mSATA devices.

Setting	Description
A-B	Automatically detect mSATA device (Default)
B-C	Enable mSATA device

Table 4-3: mSATA/SATA Switch Settings

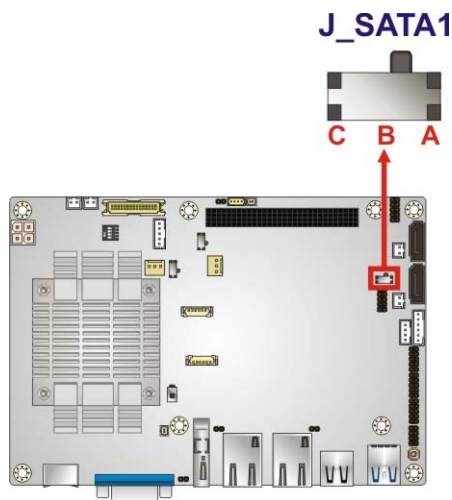

Figure 4-8: mSATA/SATA Switch Location

NANO-BT-i1 EPIC SBC

4.3.6 PCI-104 Voltage Selection

Use the J_PCI104 switch to select the voltage supplied to the PCI-104 expansion module.

Setting	Description
A-B	+3.3 V (Default)
B-C	+5.0 V

Table 4-4: PCI-104 Voltage Switch Settings

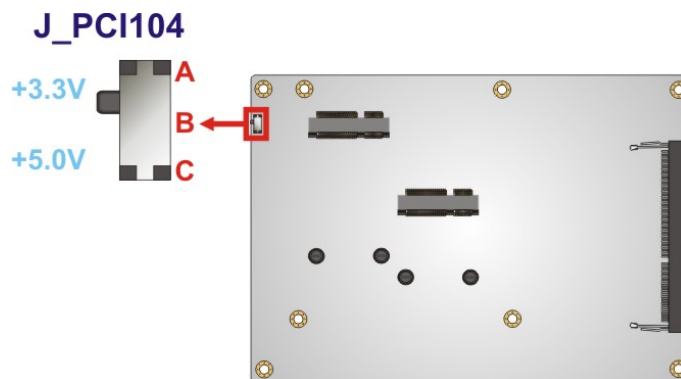

Figure 4-9: PCI-104 Voltage Switch Location

4.4 Internal Peripheral Device Connections

This section outlines the installation of peripheral devices to the on-board connectors.

4.4.1 AT Power Connection

Follow the instructions below to connect the NANO-BT-i1 to an AT power supply.



WARNING:

Disconnect the power supply power cord from its AC power source to prevent a sudden power surge to the NANO-BT-i1.

Step 1: **Locate the power cable.** The power cable is shown in the packing list in Chapter 2.

Step 2: **Connect the Power Cable to the Motherboard.** Connect the 4-pin (2x2) Molex type power cable connector to the +12V power connector on the motherboard.

See **Figure 4-10**.

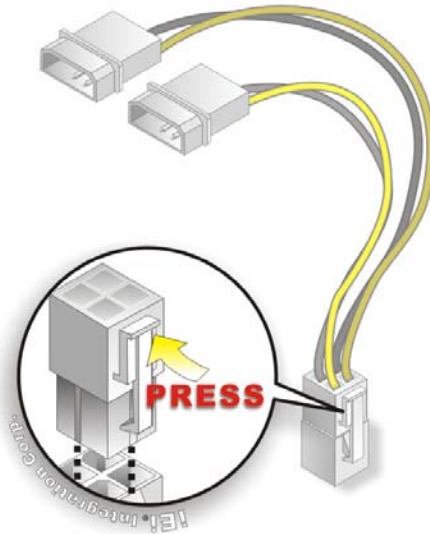

Figure 4-10: Power Cable to Motherboard Connection

Step 3: **Connect Power Cable to Power Supply.** Connect one of the 4-pin (1x4) Molex type power cable connectors to an AT power supply. See **Figure 4-11**.

NANO-BT-i1 EPIC SBC

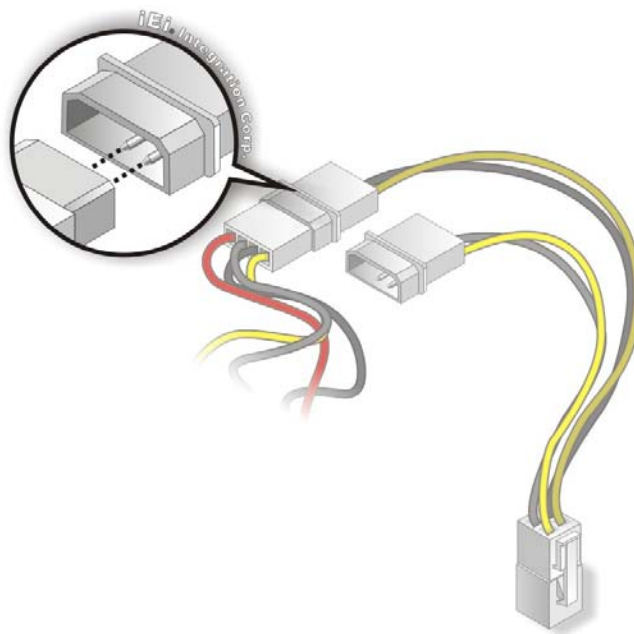

Figure 4-11: Connect Power Cable to Power Supply

4.4.2 SATA Drive Connection

The NANO-BT-i1 is shipped with two SATA drive cables. To connect the SATA drive to the connector, please follow the steps below.

- Step 1:** Locate the **SATA connector** and the **SATA power connector**. The locations of the connectors are shown in **Chapter 3**.
- Step 2:** **Insert the cable connector**. Insert the cable connector into the on-board SATA drive connector and the SATA power connector. See **Figure 4-12**.

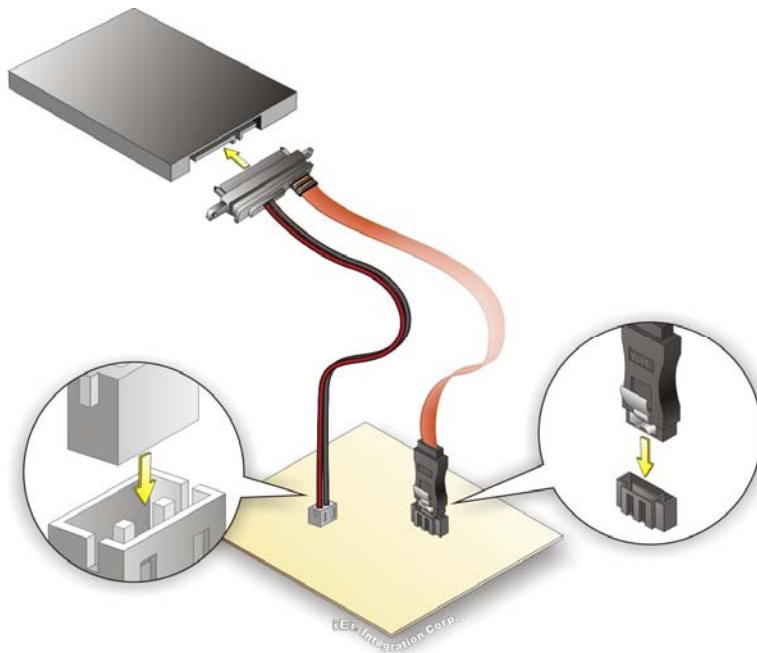

Figure 4-12: SATA Drive Cable Connection

Step 3: Connect the cable to the SATA disk. Connect the connector on the other end of the cable to the connector at the back of the SATA drive. See **Figure 4-12**.

Step 4: To remove the SATA cable from the SATA connector, press the clip on the connector at the end of the cable.

4.4.3 Single RS-232 Cable Connection

The single RS-232 cable consists of one serial port connector attached to a serial communications cable that is then attached to a D-sub 9 male connector that is mounted onto a bracket. To install the single RS-232 cable, please follow the steps below.

Step 1: Locate the RS-232 connector. The location of the RS-232 connector is shown in **Chapter 3**.

Step 2: Insert the cable connector. Align pin 1 on the on-board serial port pin header with pin 1 on the serial port connector. Pin 1 on the serial port connector is indicated with a white dot. Insert the connector into the serial port pin header. See **Figure 4-13**.

NANO-BT-i1 EPIC SBC

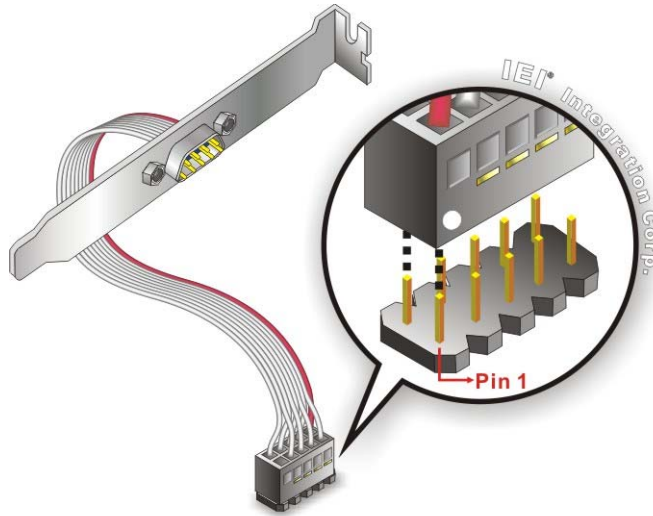

Figure 4-13: Single RS-232 Cable Installation

Step 3: Secure the bracket. The single RS-232 connector has one D-sub 9 male connector secured to a bracket. To secure the bracket to the chassis please refer to the reference material that came with the chassis.

4.5 External Peripheral Interface Connection

This section describes connecting devices to the external connectors on the NANO-BT-i1.

4.5.1 LAN Connection

There are two external RJ-45 LAN connectors. The RJ-45 connectors enable connection to an external network. To connect a LAN cable with an RJ-45 connector, please follow the instructions below.

Step 1: Locate the RJ-45 connectors. The locations of the LAN connectors are shown in **Chapter 3**.

Step 2: Align the connectors. Align the RJ-45 connector on the LAN cable with one of the RJ-45 connectors on the NANO-BT-i1. See **Figure 4-14**.

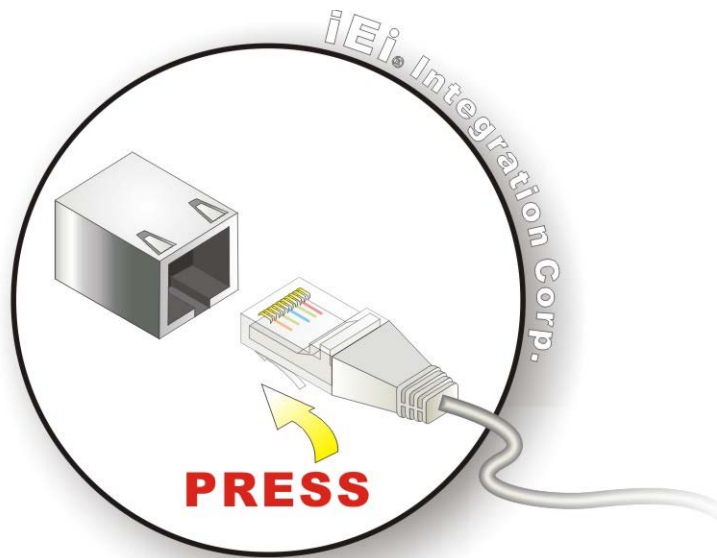

Figure 4-14: LAN Connection

Step 3: Insert the LAN cable RJ-45 connector. Once aligned, gently insert the LAN cable RJ-45 connector into the on-board RJ-45 connector.

4.5.2 PS/2 Keyboard/Mouse Connection

The NANO-BT-i1 has a single PS/2 connector on the external peripheral interface panel. The PS/2 connector is connected to the optional PS/2 Y-cable which can be purchased separately. One of the PS/2 cables is connected to a keyboard and the other to a mouse to the system. Follow the steps below to connect a keyboard and mouse to the NANO-BT-i1.

Step 1: Locate the dual PS/2 connector. The location of the PS/2 connector is shown in **Chapter 3**.

Step 2: Insert the keyboard/mouse connector. Insert the PS/2 connector on the end of the PS/2 Y-cable into the external PS/2 connector. See Figure 4-15.

NANO-BT-i1 EPIC SBC

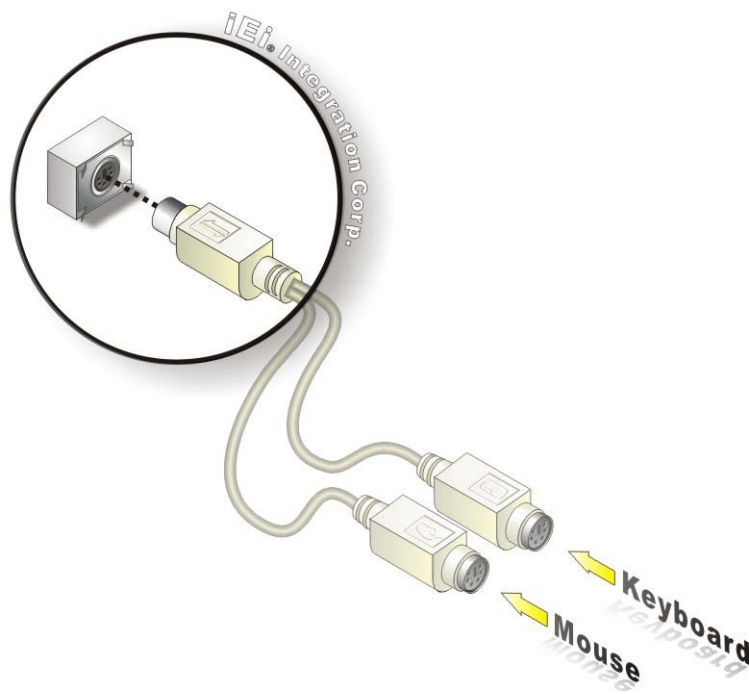

Figure 4-15: PS/2 Keyboard/Mouse Connector

Step 3: **Connect the keyboard and mouse.** Connect the keyboard and mouse to the appropriate connector. The keyboard and mouse connectors can be distinguished from each other by looking at the small graphic at the top of the connector.

4.5.3 USB Connection

The external USB Series "A" receptacle connectors provide easier and quicker access to external USB devices. Follow the steps below to connect USB devices to the NANO-BT-i1.

Step 1: **Locate the USB Series "A" receptacle connectors.** The location of the USB Series "A" receptacle connectors are shown in **Chapter 3**.

Step 2: Insert a **USB Series "A" plug**. Insert the USB Series "A" plug of a device into the USB Series "A" receptacle on the external peripheral interface. See

Figure 4-16.

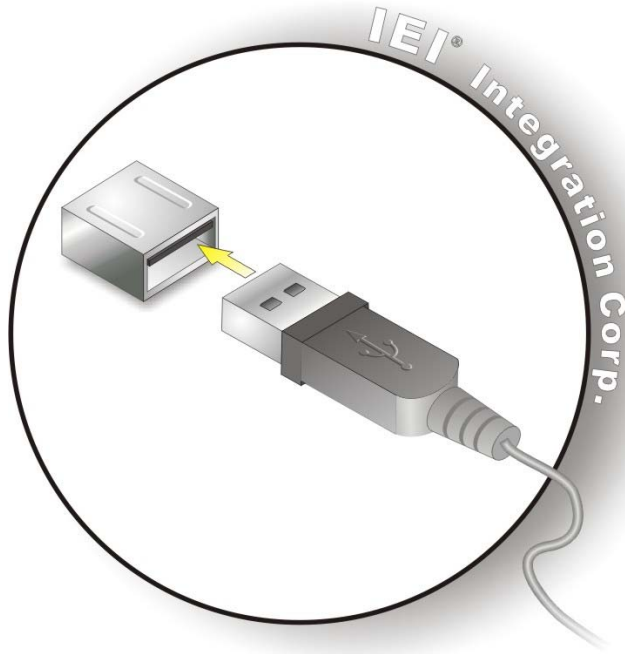

Figure 4-16: USB Connector

4.5.4 VGA Monitor Connection

The NANO-BT-i1 has one single female D-sub 15 connector on the external peripheral interface panel. The D-sub 15 connector is connected to a CRT or VGA monitor. To connect a monitor to the NANO-BT-i1, please follow the instructions below.

Step 1: **Locate the female D-sub 15 connector.** The location of the female D-sub 15 connector is shown in **Chapter 3**.

Step 2: **Align the VGA connector.** Align the male D-sub 15 connector on the VGA screen cable with the female D-sub 15 connector on the external peripheral interface.

NANO-BT-i1 EPIC SBC

Step 3: Insert the VGA connector Once the connectors are properly aligned, insert the male connector from the VGA screen into the female connector on the NANO-BT-i1. See **Figure 4-17**.

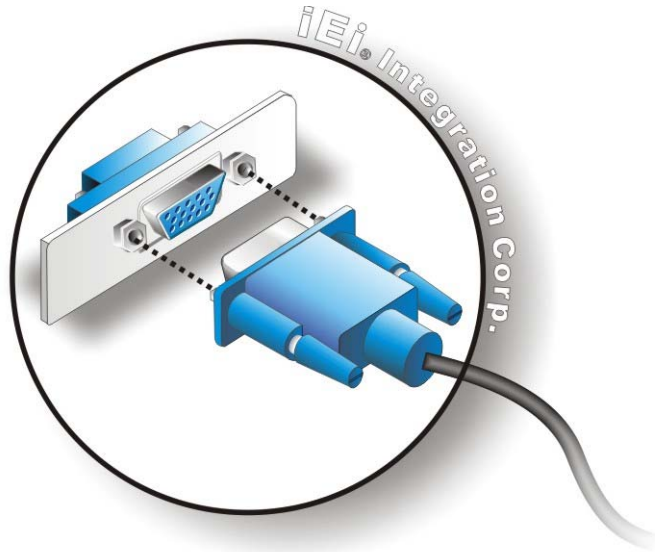

Figure 4-17: VGA Connector

Step 4: Secure the connector. Secure the D-sub 15 VGA connector from the VGA monitor to the external interface by tightening the two retention screws on either side of the connector.

4.6 IPMI Setup Procedure

The NANO-BT-i1 features Intelligent Platform Management Interface (IPMI) that helps lower the overall costs of server management by enabling users to maximize IT resources, save time and manage multiple systems. The NANO-BT-i1 supports IPMI 2.0 through the optional iRIS-1010 module. Follow the steps below to setup IPMI.

4.6.1 Managed System Hardware Setup

The hardware configuration of the managed system (NANO-BT-i1) is described below.

- Step 1:** Install an iRIS-1010 module to the IPMI module socket (refer to **Section 4.2.2**).
- Step 2:** Make sure a DDR3L SO-DIMM is installed in the SO-DIMM socket.
- Step 3:** Connect an Ethernet cable to the RJ-45 connector labeled **LAN1** (**Figure 3-31**).

Chapter

5

BIOS

5.1 Introduction

The BIOS is programmed onto the BIOS chip. The BIOS setup program allows changes to certain system settings. This chapter outlines the options that can be changed.



NOTE:

Some of the BIOS options may vary throughout the life cycle of the product and are subject to change without prior notice.

5.1.1 Starting Setup

The UEFI BIOS is activated when the computer is turned on. The setup program can be activated in one of two ways.

1. Press the **DEL** or **F2** key as soon as the system is turned on or
2. Press the **DEL** or **F2** key when the “**Press DEL or F2 to enter SETUP**” message appears on the screen.

If the message disappears before the **DEL** or **F2** key is pressed, restart the computer and try again.

5.1.2 Using Setup

Use the arrow keys to highlight items, press **ENTER** to select, use the PageUp and PageDown keys to change entries, press **F1** for help and press **ESC** to quit. Navigation keys are shown in **Table 5-1**.

Key	Function
Up arrow	Move to previous item
Down arrow	Move to next item
Left arrow	Move to the item on the left hand side
Right arrow	Move to the item on the right hand side
+	Increase the numeric value or make changes

NANO-BT-i1 EPIC SBC

Key	Function
-	Decrease the numeric value or make changes
Esc key	Main Menu – Quit and not save changes into CMOS Status Page Setup Menu and Option Page Setup Menu -- Exit current page and return to Main Menu
F1 key	General help, only for Status Page Setup Menu and Option Page Setup Menu
F2 key	Load previous values
F3 key	Load optimized defaults
F4 key	Save changes and Exit BIOS

Table 5-1: BIOS Navigation Keys

5.1.3 Getting Help

When **F1** is pressed a small help window describing the appropriate keys to use and the possible selections for the highlighted item appears. To exit the Help Window press **Esc** or the **F1** key again.

5.1.4 Unable to Reboot after Configuration Changes

If the computer cannot boot after changes to the system configuration is made, CMOS defaults. Use the clear CMOS button described in **Chapter 4**.

5.1.5 BIOS Menu Bar

The **menu bar** on top of the BIOS screen has the following main items:

- Main – Changes the basic system configuration.
- Advanced – Changes the advanced system settings.
- Chipset – Changes the chipset settings.
- Boot – Changes the system boot configuration.
- Security – Sets User and Supervisor Passwords.
- Save & Exit – Selects exit options and loads default settings

The following sections completely describe the configuration options found in the menu items at the top of the BIOS screen and listed above.

5.2 Main

The **Main** BIOS menu (**BIOS Menu 1**) appears when the **BIOS Setup** program is entered. The **Main** menu gives an overview of the basic system information.

Aptio Setup Utility - Copyright (C) 2013 American Megatrends, Inc.					
Main	Advanced	Chipset	Security	Boot	Save & Exit
BIOS Information					Set the Date. Use Tab to switch between Data elements. ----- ←→: Select Screen ↑ ↓: Select Item Enter>Select + -: Change Opt. F1: General Help F2: Previous Values F3: Optimized Defaults F4: Save & Exit ESC: Exit
BIOS Vendor		American Megatrends			
Core Version		5.009			
Compliancy		UEFI 2.3;PI1.2			
Project Version		B290AR0E.ROM			
Build Date		02/10/2014 10:03:10			
iWDD Vendor		iEi			
iWDD Version		B290ER00.bin			
CPU Configuration					
Microcode Patch		31e			
BayTrail SoC		B2 Stepping			
Memory Information					
Total Memory		4096 MB (LPDDR3)			
Memory Frequency		1333 Mhz			
GOP Information					
Intel(R) GOP Driver		[N/A]			
TXE Information					
Sec RC Version		00.05.00.00			
TXE FW Version		01.00.02.1060			
System Date		[Tue 03/05/2014]			
System Time		[15:10:27]			
Version 2.16.1242. Copyright (C) 2013 American Megatrends, Inc.					

BIOS Menu 1: Main

The System Overview field has two user configurable fields:

➔ **System Date [xx/xx/xx]**

Use the **System Date** option to set the system date. Manually enter the day, month and year.

NANO-BT-i1 EPIC SBC

→ System Time [xx:xx:xx]

Use the **System Time** option to set the system time. Manually enter the hours, minutes and seconds.

5.3 Advanced

Use the **Advanced** menu (**BIOS Menu 2**) to configure the CPU and peripheral devices through the following sub-menus:



WARNING!

Setting the wrong values in the sections below may cause the system to malfunction. Make sure that the settings made are compatible with the hardware.

```

Aptio Setup Utility - Copyright (C) 2013 American Megatrends, Inc.
Main  Advanced  Chipset  Security  Boot  Save & Exit

> ACPI Settings
> Super IO Configuration
> Hardware Monitor
> iWDD H/W Monitor
> RTC Wake Settings
> Serial Port Console Redirection
> CPU Configuration
> IDE Configuration
> USB Configuration
> ICP Board

System ACPI Parameters
-----
<=>: Select Screen
↑ ↓: Select Item
Enter>Select
+ - Change Opt.
F1 General Help
F2 Previous Values
F3 Optimized Defaults
F4 Save & Exit
ESC Exit

Version 2.16.1242. Copyright (C) 2013 American Megatrends, Inc.
    
```

BIOS Menu 2: Advanced

5.3.1 ACPI Settings

The **ACPI Settings** menu (**BIOS Menu 3**) configures the Advanced Configuration and Power Interface (ACPI) options.

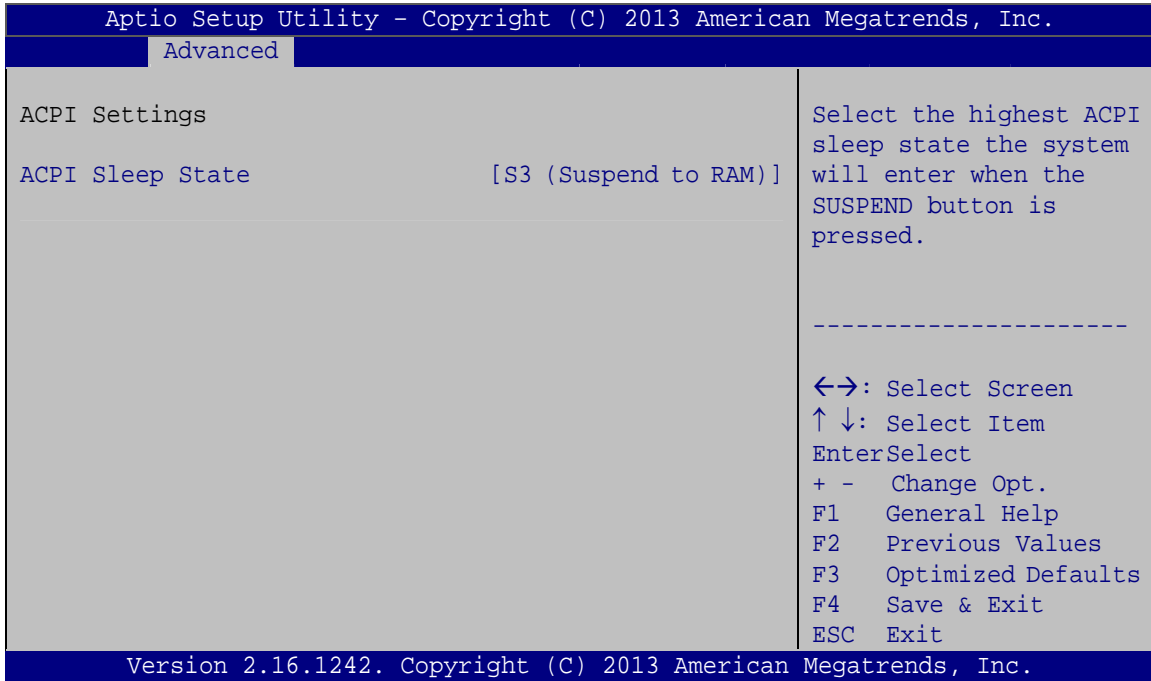

BIOS Menu 3: ACPI Configuration

→ **ACPI Sleep State [S3 (Suspend to RAM)]**

Use the **ACPI Sleep State** option to specify the sleep state the system enters when it is not being used.

- **S3 (Suspend to DEFAULT RAM)** The caches are flushed and the CPU is powered off. Power to the RAM is maintained. The computer returns slower to a working state, but more power is saved.

NANO-BT-i1 EPIC SBC

5.3.2 Super IO Configuration

Use the **Super IO Configuration** menu (**BIOS Menu 4**) to set or change the configurations for the serial ports.

```

Aptio Setup Utility - Copyright (C) 2013 American Megatrends, Inc.
  Advanced
F81866 Super IO Configuration                               Set Parameters of Serial
                                                           Port 1 (COMA)
F81866 Super IO Chip                                     F81866
> Serial Port 1 Configuration
> Serial Port 2 Configuration
> Serial Port 3 Configuration
> Serial Port 4 Configuration
-----
<-->: Select Screen
↑ ↓: Select Item
EnterSelect
+ - Change Opt.
F1 General Help
F2 Previous Values
F3 Optimized Defaults
F4 Save & Exit
ESC Exit
Version 2.16.1242. Copyright (C) 2013 American Megatrends, Inc.
    
```

BIOS Menu 4: Super IO Configuration

5.3.2.1 Serial Port n Configuration

Use the **Serial Port n Configuration** menu (**BIOS Menu 5**) to configure the serial port n.

```

Aptio Setup Utility - Copyright (C) 2013 American Megatrends, Inc.
  Advanced
Serial Port n Configuration                               Enable or Disable Serial
                                                           Port (COM)
Serial Port                                             [Enabled]
Device Settings                                         IO=3F8h;IRQ=4
Change Settings                                         [Auto]
-----
<-->: Select Screen
↑ ↓: Select Item
EnterSelect
= - Change Opt.
F1 General Help
F2 Previous Values
F3 Optimized Defaults
F4 Save & Exit
ESC Exit
Version 2.16.1242. Copyright (C) 2013 American Megatrends, Inc.
    
```

BIOS Menu 5: Serial Port n Configuration Menu

5.3.2.1.1 Serial Port 1 Configuration

→ **Serial Port [Enabled]**

Use the **Serial Port** option to enable or disable the serial port.

- **Disabled** Disable the serial port
- **Enabled DEFAULT** Enable the serial port

→ **Change Settings [Auto]**

Use the **Change Settings** option to change the serial port IO port address and interrupt address.

- **Auto DEFAULT** The serial port IO port address and interrupt address are automatically detected.
- **IO=3F8h;
IRQ=4** Serial Port I/O port address is 3F8h and the interrupt address is IRQ4
- **IO=3F8h;
IRQ=3, 4,
5, 6, 7, 9,
10, 11, 12** Serial Port I/O port address is 3F8h and the interrupt address is IRQ3, 4, 5, 6, 7, 9, 10, 11, 12
- **IO=2F8h;
IRQ=3, 4,
5, 6, 7, 9,
10, 11, 12** Serial Port I/O port address is 2F8h and the interrupt address is IRQ3, 4, 5, 6, 7, 9, 10, 11, 12
- **IO=3E8h;
IRQ=3, 4,
5, 6, 7, 9,
10, 11, 12** Serial Port I/O port address is 3E8h and the interrupt address is IRQ3, 4, 5, 6, 7, 9, 10, 11, 12
- **IO=2E8h;
IRQ=3, 4,
5, 6, 7, 9,
10, 11, 12** Serial Port I/O port address is 2E8h and the interrupt address is IRQ3, 4, 5, 6, 7, 9, 10, 11, 12

5.3.2.1.2 Serial Port 2 Configuration

→ Serial Port [Enabled]

Use the **Serial Port** option to enable or disable the serial port.

- **Disabled** Disable the serial port
- **Enabled** **DEFAULT** Enable the serial port

→ Change Settings [Auto]

Use the **Change Settings** option to change the serial port IO port address and interrupt address.

- **Auto** **DEFAULT** The serial port IO port address and interrupt address are automatically detected.
- **IO=2F8h;**
IRQ=3 Serial Port I/O port address is 2F8h and the interrupt address is IRQ3
- **IO=3F8h;**
IRQ=3, 4,
5, 6, 7, 9,
10, 11, 12 Serial Port I/O port address is 3F8h and the interrupt address is IRQ3, 4, 5, 6, 7, 9, 10, 11, 12
- **IO=2F8h;**
IRQ=3, 4,
5, 6, 7, 9,
10, 11, 12 Serial Port I/O port address is 2F8h and the interrupt address is IRQ3, 4, 5, 6, 7, 9, 10, 11, 12
- **IO=3E8h;**
IRQ=3, 4,
5, 6, 7, 9,
10, 11, 12 Serial Port I/O port address is 3E8h and the interrupt address is IRQ3, 4, 5, 6, 7, 9, 10, 11, 12

- **IO=2E8h;** Serial Port I/O port address is 2E8h and the interrupt
IRQ=3, 4, address is IRQ3, 4, 5, 6, 7, 9, 10, 11, 12
5, 6, 7, 9,
10, 11, 12

5.3.2.1.3 Serial Port 3 Configuration

→ Serial Port [Enabled]

Use the **Serial Port** option to enable or disable the serial port.

- **Disabled** Disable the serial port
- **Enabled** **DEFAULT** Enable the serial port

→ Change Settings [Auto]

Use the **Change Settings** option to change the serial port IO port address and interrupt address.

- **Auto** **DEFAULT** The serial port IO port address and interrupt address are automatically detected.
- **IO=3E8h;** Serial Port I/O port address is 3E8h and the interrupt
IRQ=7 address is IRQ7
- **IO=3F8h;** Serial Port I/O port address is 3F8h and the interrupt
IRQ=3, 4, address is IRQ3, 4, 5, 6, 7, 9, 10, 11, 12
5, 6, 7, 9,
10, 11, 12
- **IO=2F8h;** Serial Port I/O port address is 2F8h and the interrupt
IRQ=3, 4, address is IRQ3, 4, 5, 6, 7, 9, 10, 11, 12
5, 6, 7, 9,
10, 11, 12

NANO-BT-i1 EPIC SBC

- ➔ **IO=3E8h;**
IRQ=3, 4,
5, 6, 7, 9,
10, 11, 12

Serial Port I/O port address is 3E8h and the interrupt address is IRQ3, 4, 5, 6, 7, 9, 10, 11, 12
- ➔ **IO=2E8h;**
IRQ=3, 4,
5, 6, 7, 9,
10, 11, 12

Serial Port I/O port address is 2E8h and the interrupt address is IRQ3, 4, 5, 6, 7, 9, 10, 11, 12
- ➔ **IO=2F0h;**
IRQ=3, 4,
5, 6, 7, 9,
10, 11, 12

Serial Port I/O port address is 2F0h and the interrupt address is IRQ3, 4, 5, 6, 7, 9, 10, 11, 12
- ➔ **IO=2E0h;**
IRQ=3, 4,
5, 6, 7, 9,
10, 11, 12

Serial Port I/O port address is 2E0h and the interrupt address is IRQ3, 4, 5, 6, 7, 9, 10, 11, 12

5.3.2.1.4 Serial Port 4 Configuration

➔ Serial Port [Enabled]

Use the **Serial Port** option to enable or disable the serial port.

- ➔ **Disabled** Disable the serial port
- ➔ **Enabled** **DEFAULT** Enable the serial port

➔ Change Settings [Auto]

Use the **Change Settings** option to change the serial port IO port address and interrupt address.

- ➔ **Auto** **DEFAULT** The serial port IO port address and interrupt address are automatically detected.

- IO=2E8h;
IRQ=7
Serial Port I/O port address is 2E8h and the interrupt address is IRQ7
- IO=3F8h;
IRQ=3, 4,
5, 6, 7, 9,
10, 11, 12
Serial Port I/O port address is 3F8h and the interrupt address is IRQ3, 4, 5, 6, 7, 9, 10, 11, 12
- IO=2F8h;
IRQ=3, 4,
5, 6, 7, 9,
10, 11, 12
Serial Port I/O port address is 2F8h and the interrupt address is IRQ3, 4, 5, 6, 7, 9, 10, 11, 12
- IO=3E8h;
IRQ=3, 4,
5, 6, 7, 9,
10, 11, 12
Serial Port I/O port address is 3E8h and the interrupt address is IRQ3, 4, 5, 6, 7, 9, 10, 11, 12
- IO=2E8h;
IRQ=3, 4,
5, 6, 7, 9,
10, 11, 12
Serial Port I/O port address is 2E8h and the interrupt address is IRQ3, 4, 5, 6, 7, 9, 10, 11, 12
- IO=2F0h;
IRQ=3, 4,
5, 6, 7, 9,
10, 11, 12
Serial Port I/O port address is 2F0h and the interrupt address is IRQ3, 4, 5, 6, 7, 9, 10, 11, 12
- IO=2E0h;
IRQ=3, 4,
5, 6, 7, 9,
10, 11, 12
Serial Port I/O port address is 2E0h and the interrupt address is IRQ3, 4, 5, 6, 7, 9, 10, 11, 12

5.3.3 Hardware Monitor

The **Hardware Monitor** menu (**BIOS Menu 6**) contains the fan configuration submenus and displays operating temperature and system voltages.

NANO-BT-i1 EPIC SBC

```

Aptio Setup Utility - Copyright (C) 2013 American Megatrends, Inc.
Advanced
PC Health Status
Smart Fan Function [Enabled]
> Smart Fan Mode Configuration
SYS Temperature      :+42 C
CPU_FAN1             :N/A
SYS_FAN1             :N/A
VIN1                  :+0.864 V
VIN2                  :+1.096 V
VIN3                  :+3.060 V
VIN4                  :+1.513 V
VCC3V                 :+3.312 V
VSB3V                 :+3.328 V
VSB5V                 :+5.112 V
-----
<->: Select Screen
↑↓: Select Item
Enter>Select
+ - Change Opt.
F1  General Help
F2  Previous Values
F3  Optimized Defaults
F4  Save & Exit
ESC Exit
Version 2.16.1242. Copyright (C) 2013 American Megatrends, Inc.
  
```

BIOS Menu 6: Hardware Monitor

→ Smart Fan Function

Use the **Smart Fan Function** BIOS option to enable or disable the smart fan connected to the system.

- **Disabled** Disables the smart fan.
- **Enabled** **DEFAULT** Enables the smart fan.

→ PC Health Status

The following system parameters and values are shown. The system parameters that are monitored are:

- System Temperatures:
 - System Temperature
- Fan Speeds:
 - CPU Fan
 - System Fan
- Voltages:
 - VIN1
 - VIN2

- VIN3
- VIN4
- VCC3V
- VSB3V
- VSB5V

5.3.3.1 Smart Fan Mode Configuration

Use the **Smart Fan Mode Configuration** submenu (**BIOS Menu 7**) to configure smart fan temperature and speed settings.

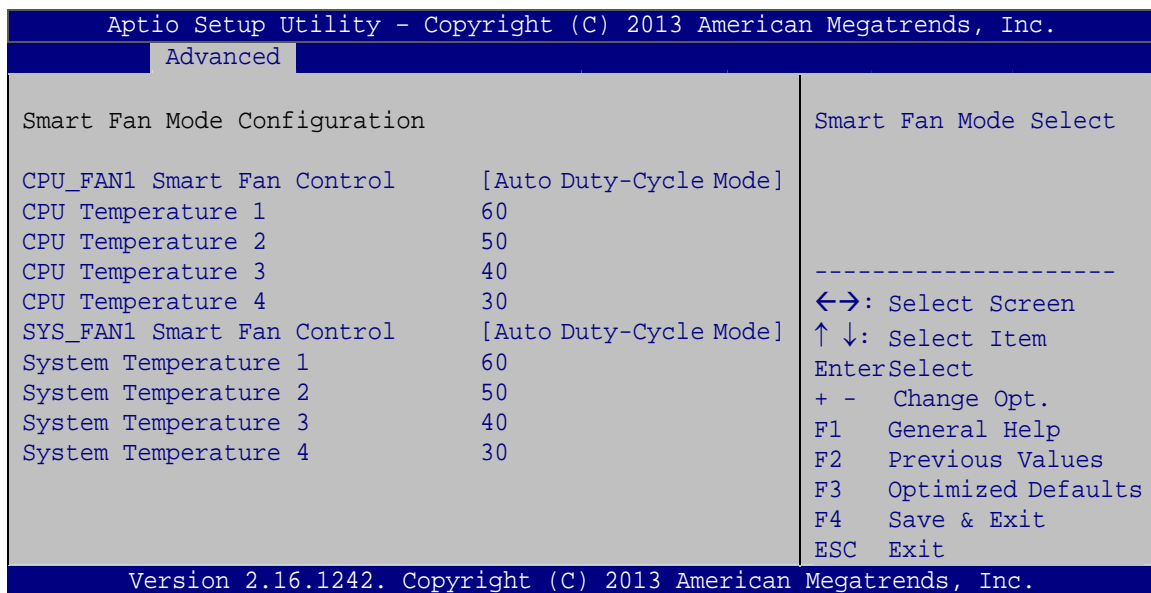

BIOS Menu 7: Smart Fan Mode Configuration

→ CPU_FAN1 Smart Fan Control/SYS_FAN1 Smart Fan Control [Auto Duty-Cycle Mode]

Use the **CPU_FAN1 Smart Fan Control/SYS_FAN1 Smart Fan Control** option to configure the CPU/System Smart Fan.

- **Manual Duty Mode** The fan spins at the speed set in Manual Mode settings.
- **Auto Duty-Cycle Mode** **DEFAULT** The fan adjusts its speed using Auto Mode settings.

NANO-BT-i1 EPIC SBC

→ CPU/System Temperature 1

Use the + or – key to change the **CPU/System Temperature 1** value. Enter a decimal number between 1 and 100. If CPU/System temperature is higher than this setting, the fan duty cycle is 100.

→ CPU/System Temperature 2

Use the + or – key to change the **CPU/System Temperature 2** value. Enter a decimal number between 1 and 100. If CPU/System temperature is higher than this setting, the fan duty cycle is 85.

→ CPU/System Temperature 3

Use the + or – key to change the **CPU/System Temperature 3** value. Enter a decimal number between 1 and 100. If CPU/System temperature is higher than this setting, the fan duty cycle is 70.

→ CPU/System Temperature 4

Use the + or – key to change the **CPU/System Temperature 4** value. Enter a decimal number between 1 and 100. If CPU/System temperature is higher than this setting, the fan duty cycle is 60. If CPU/System temperature is lower than this setting, the fan duty cycle is 50.

5.3.4 iWDD H/W Monitor

The **iWDD H/W Monitor** menu (**BIOS Menu 8**) contains the fan configuration submenus and displays operating temperature, fan speeds and system voltages.

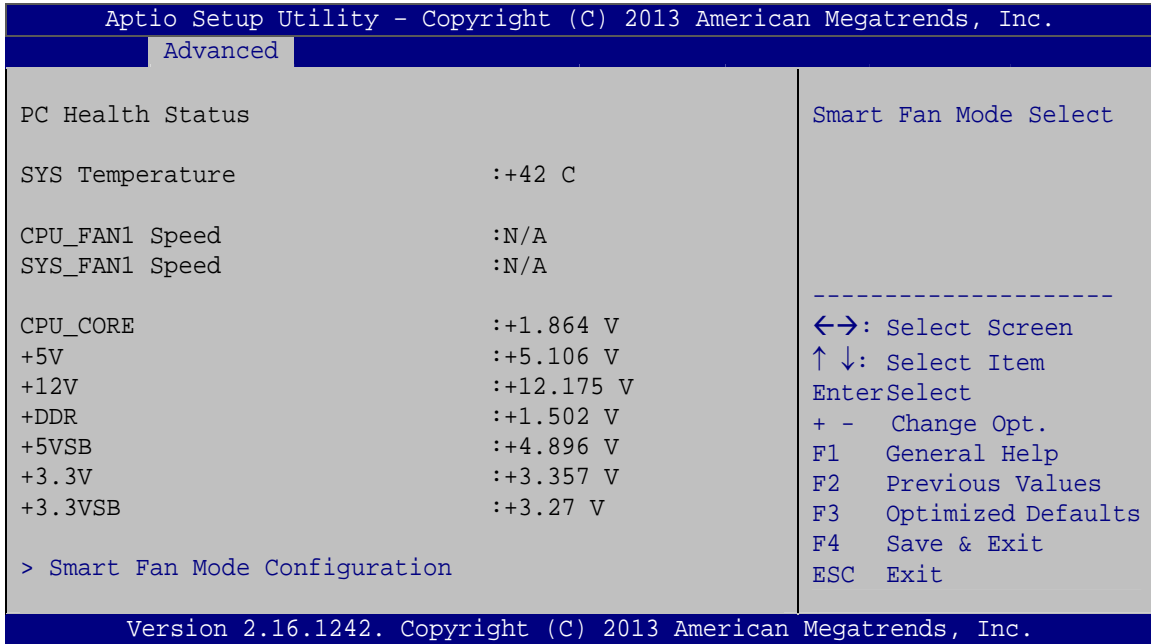

BIOS Menu 8: iWDD H/W Monitor

➔ **PC Health Status**

The following system parameters and values are shown. The system parameters that are monitored are:

- System Temperatures:
 - System Temperature
- Fan Speeds:
 - CPU Fan Speed
 - System Fan Speed
- Voltages:
 - CPU_CORE
 - +5V
 - +12V
 - +DDR
 - +5VSB
 - +3.3V
 - +3.3VSB

NANO-BT-i1 EPIC SBC

5.3.4.1 Smart Fan Mode Configuration

Use the **Smart Fan Mode Configuration** submenu (**BIOS Menu 9**) to configure smart fan temperature and speed settings.

```

Aptio Setup Utility - Copyright (C) 2013 American Megatrends, Inc.
Advanced
Smart Fan Mode Configuration
CPU_FAN1 Smart Fan Control      [Auto Mode]
Auto mode fan start temperature 50
Auto mode fan off temperature  40
Auto mode fan start PWM        30
Auto mode fan slope PWM        1
SYS_FAN1 Smart Fan Control      [Auto Mode]
Auto mode fan start temperature 50
Auto mode fan off temperature  40
Auto mode fan start PWM        30
Auto mode fan slope PWM        1
Smart Fan Mode Select
-----
<->: Select Screen
↑ ↓: Select Item
EnterSelect
+ - Change Opt.
F1  General Help
F2  Previous Values
F3  Optimized Defaults
F4  Save & Exit
ESC Exit
Version 2.16.1242. Copyright (C) 2013 American Megatrends, Inc.

```

BIOS Menu 9: Smart Fan Mode Configuration

→ CPU_FAN1 Smart Fan Control/SYS_FAN1 Smart Fan Control [Auto Mode]

Use the **CPU_FAN1 Smart Fan Control/SYS_FAN1 Smart Fan Control** option to configure the CPU/System Smart Fan.

→ **Manual Mode** The fan spins at the speed set in Manual Mode settings.

→ **Auto Mode** **DEFAULT** The fan adjusts its speed using Auto Mode settings.

→ Auto mode fan start/off temperature

Use the + or – key to change the **Auto mode fan start/off temperature** value. Enter a decimal number between 1 and 100.

➔ **Auto mode fan start PWM**

Use the + or – key to change the **Auto mode fan start PWM** value. Enter a decimal number between 1 and 100.

➔ **Auto mode fan slope PWM**

Use the + or – key to change the **Auto mode fan slope PWM** value. Enter a decimal number between 1 and 64.

5.3.5 RTC Wake Settings

The **RTC Wake Settings** menu (**BIOS Menu 10**) configures RTC wake event. The RTC wake function is supported in ACPI (S3/S4/S5) and APM soft off modes.

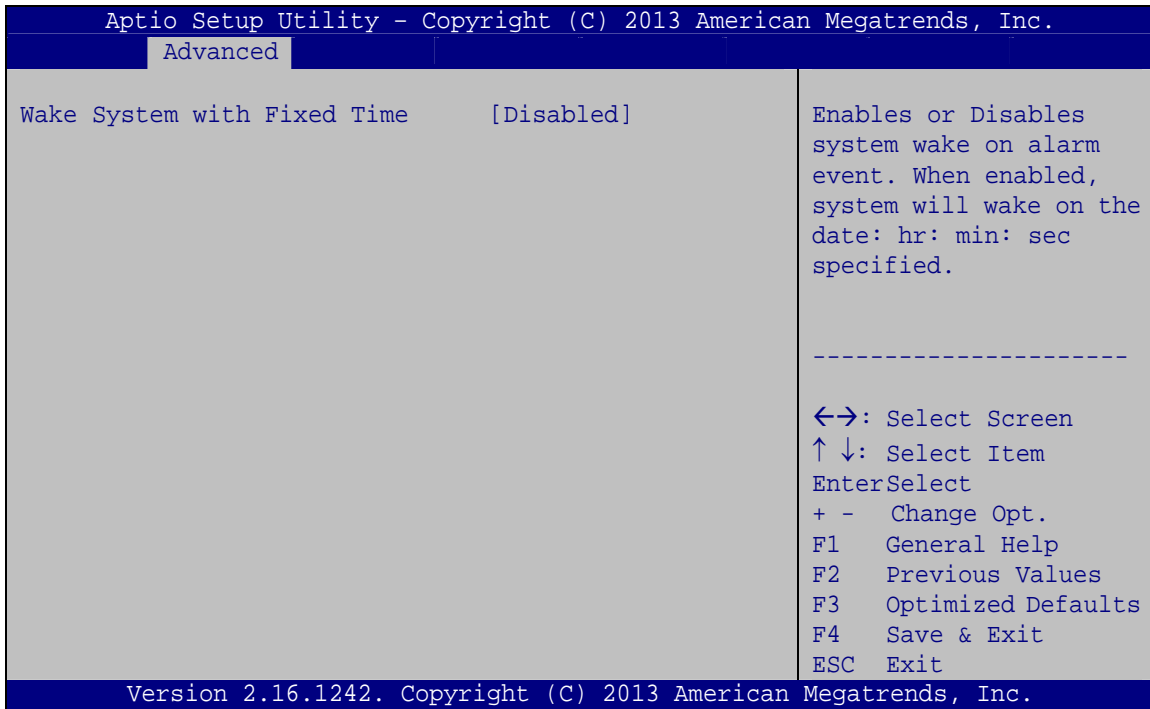

BIOS Menu 10: RTC Wake Settings

➔ **Wake System with Fixed Time [Disabled]**

Use the **Wake System with Fixed Time** option to specify the time the system should be roused from a suspended state.

NANO-BT-i1 EPIC SBC

- ➔ **Disabled** **DEFAULT** The real time clock (RTC) cannot generate a wake event

- ➔ **Enabled** If selected, the following appears with values that can be selected:
 - *Wake up every day
 - *Wake up date
 - *Wake up hour
 - *Wake up minute
 - *Wake up second

After setting the alarm, the computer turns itself on from a suspend state when the alarm goes off.

5.3.6 Serial Port Console Redirection

The **Serial Port Console Redirection** menu (**BIOS Menu 11**) allows the console redirection options to be configured. Console redirection allows users to maintain a system remotely by re-directing keyboard input and text output through the serial port.

```

Aptio Setup Utility - Copyright (C) 2013 American Megatrends, Inc.
  Advanced
-----
COM1
  Console Redirection          [Disabled]
> Console Redirection Settings  Console Redirection
                                   Enable or Disable

COM2
  Console Redirection          [Disabled]
> Console Redirection Settings

COM3
  Console Redirection          [Disabled]
> Console Redirection Settings

COM4
  Console Redirection          [Disabled]
> Console Redirection Settings

-----
<->: Select Screen
↑ ↓: Select Item
Enter>Select
+/-: Change Opt.
F1  General Help
F2  Previous Values
F3  Optimized Defaults
F4  Save & Exit
ESC Exit

Version 2.16.1242. Copyright (C) 2013 American Megatrends, Inc.
  
```

BIOS Menu 11: Serial Port Console Redirection

→ Console Redirection [Disabled]

Use **Console Redirection** option to enable or disable the console redirection function.

- **Disabled** **DEFAULT** Disabled the console redirection function
- **Enabled** Enabled the console redirection function

The following options are available in the **Console Redirection Settings** submenu when the Console Redirection option is enabled.

→ Terminal Type [ANSI]

Use the **Terminal Type** option to specify the remote terminal type.

- **VT100** The target terminal type is VT100
- **VT100+** The target terminal type is VT100+
- **VT-UTF8** The target terminal type is VT-UTF8
- **ANSI** **DEFAULT** The target terminal type is ANSI

→ Bits per second [115200]

Use the **Bits per second** option to specify the serial port transmission speed. The speed must match the other side. Long or noisy lines may require lower speeds.

- **9600** Sets the serial port transmission speed at 9600.
- **19200** Sets the serial port transmission speed at 19200.
- **38400** Sets the serial port transmission speed at 38400.
- **57600** Sets the serial port transmission speed at 57600.
- **115200** **DEFAULT** Sets the serial port transmission speed at 115200.

→ Data Bits [8]

Use the **Data Bits** option to specify the number of data bits.

- **7** Sets the data bits at 7.

NANO-BT-i1 EPIC SBC

→ **8** **DEFAULT** Sets the data bits at 8.

→ **Parity [None]**

Use the **Parity** option to specify the parity bit that can be sent with the data bits for detecting the transmission errors.

→ **None** **DEFAULT** No parity bit is sent with the data bits.

→ **Even** The parity bit is 0 if the number of ones in the data bits is even.

→ **Odd** The parity bit is 0 if the number of ones in the data bits is odd.

→ **Mark** The parity bit is always 1. This option does not provide error detection.

→ **Space** The parity bit is always 0. This option does not provide error detection.

→ **Stop Bits [1]**

Use the **Stop Bits** option to specify the number of stop bits used to indicate the end of a serial data packet. Communication with slow devices may require more than 1 stop bit.

→ **1** **DEFAULT** Sets the number of stop bits at 1.

→ **2** Sets the number of stop bits at 2.

5.3.7 CPU Configuration

Use the **CPU Configuration** BIOS menu (**BIOS Menu 12**) to view detailed CPU specifications and configure the CPU.

Aptio Setup Utility - Copyright (C) 2013 American Megatrends, Inc.		
Advanced		
CPU Configuration		Number of cores to enable in each processor package.
CPU Signature	30673	
Microcode Patch	31e	
Max CPU Speed	1910 MHz	
Min CPU Speed	500 MHz	
Processor Cores	4	
Intel HT Technology	Not Supported	
Intel VT-x Technology	Supported	

L1 Data Cache	24 kB x 4	←→: Select Screen
L1 Code Cache	32 kB x 4	↑ ↓: Select Item
L2 Cache	1024 kB x 2	EnterSelect
L3 Cache	Not Present	+ - Change Opt.
64-bit	Supported	F1 General Help
Active Processor Cores	[All]	F2 Previous Values
Intel Virtualization Technology	[Enabled]	F3 Optimized Defaults
EIST	[Enabled]	F4 Save & Exit
		ESC Exit
Version 2.16.1242. Copyright (C) 2013 American Megatrends, Inc.		

BIOS Menu 12: CPU Configuration

The CPU Configuration menu (**BIOS Menu 12**) lists the following CPU details:

- CPU Signature: Lists the CPU signature value.
- Microcode Patch: Lists the microcode patch being used.
- Max CPU Speed: Lists the maximum CPU processing speed.
- Min CPU Speed: Lists the minimum CPU processing speed.
- Processor Cores: Lists the number of the processor core
- Intel HT Technology: Indicates if Intel HT Technology is supported by the CPU.
- Intel VT-x Technology: Indicates if Intel VT-x Technology is supported by the CPU.
- L1 Data Cache: Lists the amount of data storage space on the L1 cache.
- L1 Code Cache: Lists the amount of code storage space on the L1 cache.
- L2 Cache: Lists the amount of storage space on the L2 cache.
- L3 Cache: Lists the amount of storage space on the L3 cache.

NANO-BT-i1 EPIC SBC

→ Active Processor Cores [All]

Use the **Active Processor Cores** BIOS option to enable numbers of cores in the processor package.

- **All** **DEFAULT** Enable all cores in the processor package.
- **1** Enable one core in the processor package.

→ Intel Virtualization Technology [Enabled]

Use the **Intel Virtualization Technology** option to enable or disable virtualization on the system. When combined with third party software, Intel® Virtualization technology allows several OSs to run on the same system at the same time.

- **Disabled** Disables Intel Virtualization Technology.
- **Enabled** **DEFAULT** Enables Intel Virtualization Technology.

→ EIST [Enabled]

Use the **EIST** option to enable or disable Enhanced Intel SpeedStep® Technology (EIST).

- **Disabled** Disables Enhanced Intel SpeedStep®
Technology.
- **Enabled** **DEFAULT** Enables Enhanced Intel SpeedStep®
Technology.

5.3.8 IDE Configuration

Use the **IDE Configuration** menu (**BIOS Menu 13**) to change and/or set the configuration of the SATA devices installed in the system.

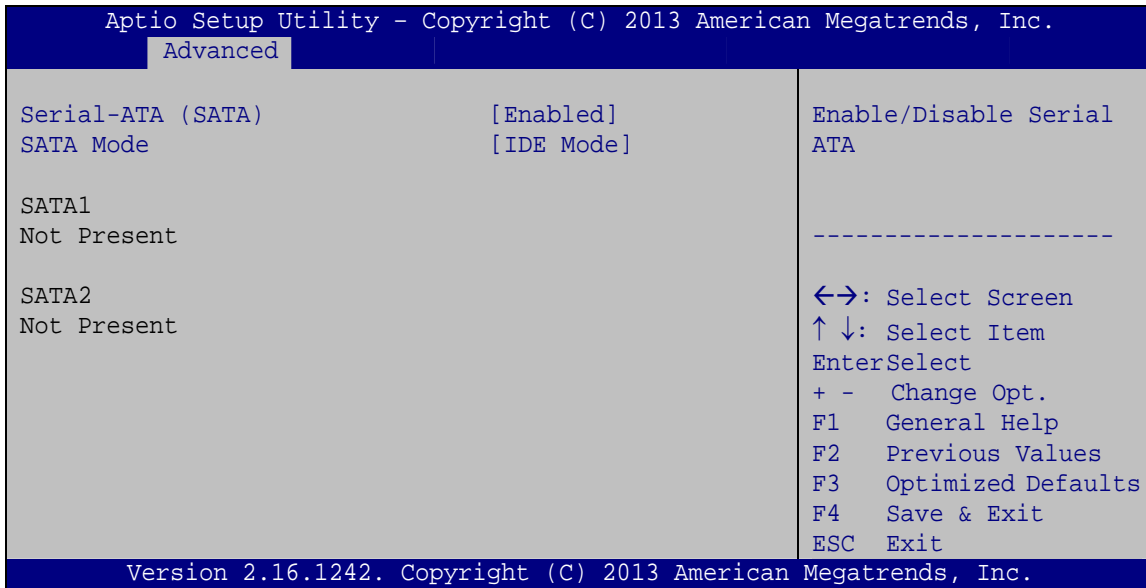

BIOS Menu 13: IDE Configuration

→ Serial-ATA (SATA) [Enabled]

Use the **Serial-ATA (SATA)** option to enable or disable the serial ATA controller.

- **Enabled** **DEFAULT** Enables the on-board SATA controller.
- **Disabled** Disables the on-board SATA controller.

→ SATA Mode Selection [IDE Mode]

Use the **SATA Mode Selection** option to configure SATA devices as normal IDE devices.

- **IDE Mode** **DEFAULT** Configures SATA devices as normal IDE device.
- **AHCI Mode** Configures SATA devices as AHCI device.

NANO-BT-i1 EPIC SBC

5.3.9 USB Configuration

Use the **USB Configuration** menu (**BIOS Menu 14**) to read USB configuration information and configure the USB settings.

```

Aptio Setup Utility - Copyright (C) 2013 American Megatrends, Inc.
  Advanced
-----
USB Configuration
USB Devices:
  1 Keyboard, 3 Hubs
Legacy USB Support          [Enabled]
-----
                                  Enables Legacy USB
                                  support. AUTO option
                                  disables legacy support
                                  if no USB devices are
                                  connected. DISABLE
                                  option will keep USB
                                  devices available only
                                  for EFI applications.
-----
                                  <->: Select Screen
                                  ↑ ↓: Select Item
                                  EnterSelect
                                  + - Change Opt.
                                  F1  General Help
                                  F2  Previous Values
                                  F3  Optimized Defaults
                                  F4  Save & Exit
                                  ESC  Exit
-----
Version 2.16.1242. Copyright (C) 2013 American Megatrends, Inc.

```

BIOS Menu 14: USB Configuration

➔ USB Devices

The **USB Devices Enabled** field lists the USB devices that are enabled on the system

➔ Legacy USB Support [Enabled]

Use the **Legacy USB Support** BIOS option to enable USB mouse and USB keyboard support. Normally if this option is not enabled, any attached USB mouse or USB keyboard does not become available until a USB compatible operating system is fully booted with all USB drivers loaded. When this option is enabled, any attached USB mouse or USB keyboard can control the system even when there is no USB driver loaded onto the system.

➔ **Enabled** **DEFAULT** Legacy USB support enabled

- ➔ **Disabled** Legacy USB support disabled
- ➔ **Auto** Legacy USB support disabled if no USB devices are connected

5.4 Chipset

Use the **Chipset** menu (**BIOS Menu 15**) to access the North Bridge and South Bridge subsystem configuration menus.



WARNING!

Setting the wrong values for the Chipset BIOS selections in the Chipset BIOS menu may cause the system to malfunction.

```

Aptio Setup Utility - Copyright (C) 2013 American Megatrends, Inc.
Main   Advanced  Chipset  Security  Boot   Save & Exit
-----
> North Bridge
> South Bridge

North Bridge Parameters.
-----
<=>: Select Screen
↑ ↓: Select Item
Enter Select
+ - Change Opt.
F1  General Help
F2  Previous Values
F3  Optimized Defaults
F4  Save & Exit
ESC Exit

Version 2.16.1242. Copyright (C) 2013 American Megatrends, Inc.
    
```

BIOS Menu 15: Chipset

NANO-BT-i1 EPIC SBC

5.4.1 North Bridge

Use the **North Bridge** menu (**BIOS Menu 16**) to configure the north bridge parameters.

```

Aptio Setup Utility - Copyright (C) 2013 American Megatrends, Inc.
  Chipset
-----
> Intel IGD Configuration          Configure Intel IGD
Memory Information                Settings.
Total Memory                      4096 MB (LPDDR3)
DIMM1                             4096 MB (LPDDR3)
-----
<=>: Select Screen
↑↓: Select Item
EnterSelect
+ - Change Opt.
F1  General Help
F2  Previous Values
F3  Optimized Defaults
F4  Save & Exit
ESC Exit
Version 2.16.1242. Copyright (C) 2013 American Megatrends, Inc.

```

BIOS Menu 16: North Bridge

5.4.1.1 Intel IGD Configuration

Use the **Intel IGD Configuration** submenu (**BIOS Menu 17**) to configure the graphics settings.

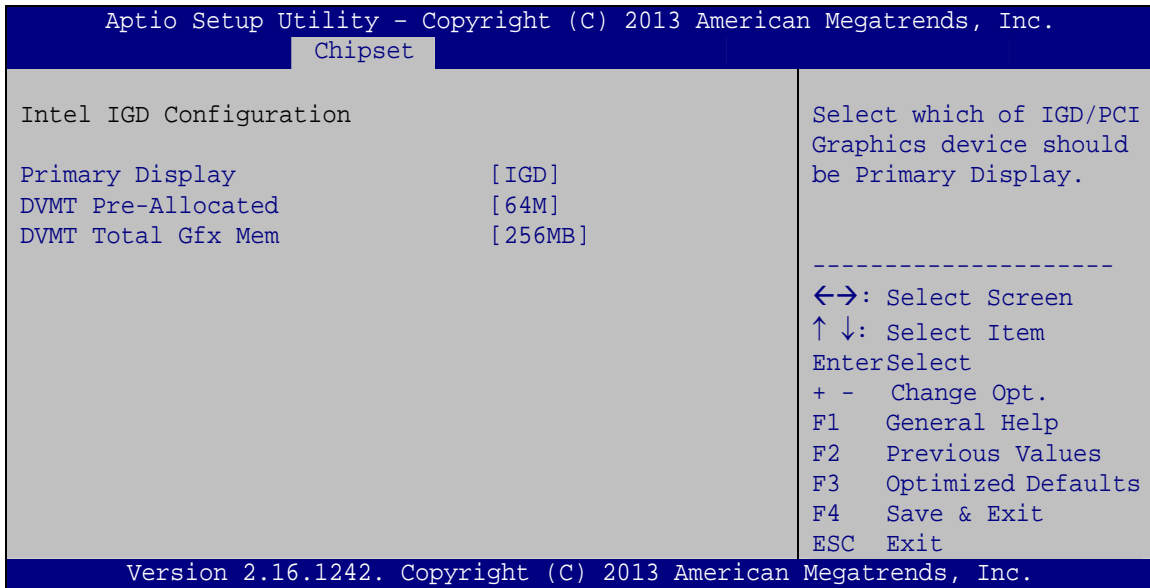

BIOS Menu 17: Intel IGD Configuration

→ Primary Display [IGD]

Use the **Primary Display** option to select the display device used by the system when it boots. Configuration options are listed below.

- Auto
- IGD **DEFAULT**
- PCI
- SG

→ DVMT Pre-Allocated [64M]

Use the **DVMT Pre-Allocated** option to specify the amount of system memory that can be used by the internal graphics device.

- 64M **DEFAULT** 64 MB of memory used by internal graphics device

NANO-BT-i1 EPIC SBC

- ➔ **128M** 128 MB of memory used by internal graphics device
- ➔ **256M** 256 MB of memory used by internal graphics device
- ➔ **512M** 512 MB of memory used by internal graphics device

➔ **DVMT Total Gfx Mem [256MB]**

Use the **DVMT Total Gfx Mem** option to specify the maximum amount of memory that can be allocated as graphics memory. Configuration options are listed below.

- 128MB
- 256MB **Default**
- Max

5.4.2 South Bridge

Use the **South Bridge** menu (**BIOS Menu 18**) to configure the south bridge parameters.

```

Aptio Setup Utility - Copyright (C) 2013 American Megatrends, Inc.
Chipset
Auto Power Button Status      [Disabled (ATX)]      Select AC power state
                             when power is re-applied
Restore AC Power Loss         [Last State]          after a power failure.

> PCI Express Configuration

Audio Configuration
Audio Controller              [Enabled]
-----
<->: Select Screen
↑ ↓: Select Item
Enter>Select
+ - Change Opt.
F1 General Help
F2 Previous Values
F3 Optimized Defaults
F4 Save & Exit
ESC Exit

USB Configuration
USB 2.0(EHCI) Support        [Enabled]
XHCI Mode                    [Disabled]

Version 2.16.1242. Copyright (C) 2013 American Megatrends, Inc.

```

BIOS Menu 18: South Bridge

→ **Restore on AC Power Loss [Last State]**

Use the **Restore on AC Power Loss** BIOS option to specify what state the system returns to if there is a sudden loss of power to the system.

- **Power Off** The system remains turned off
- **Power On** The system turns on
- **Last State** **DEFAULT** The system returns to its previous state. If it was on, it turns itself on. If it was off, it remains off.

→ **Audio Controller [Enabled]**

Use the **Audio Controller** BIOS option to enable or disable the High Definition Audio controller.

- **Disabled** The High Definition Audio controller is disabled.
- **Enabled** **DEFAULT** The High Definition Audio controller is enabled.

→ **USB 2.0(EHCI) Support [Enabled]**

Use the **USB 2.0(EHCI) Support** BIOS option to enable or disable the USB EHCI (USB 2.0). One EHCI controller must always be enabled.

- **Enabled** **DEFAULT** The USB EHCI is enabled.
- **Disabled** The USB EHCI is disabled.

NANO-BT-i1 EPIC SBC

5.4.2.1 PCI Express Configuration

Use the **PCI Express Configuration** submenu (**BIOS Menu 19**) to configure the PCI Express slots.

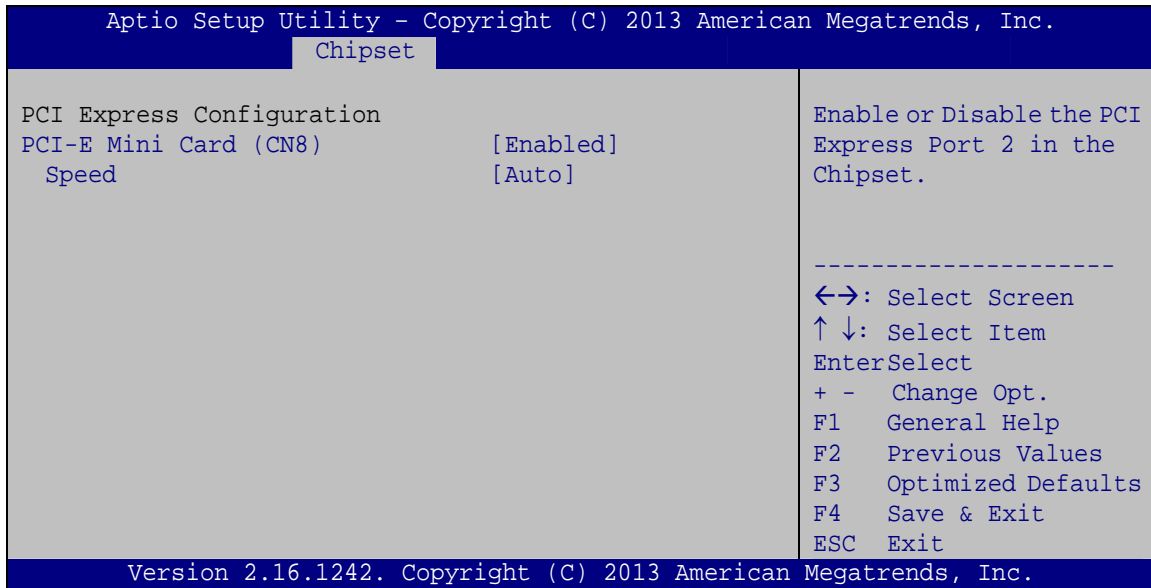

BIOS Menu 19: PCI Express Configuration

→ PCI-E Mini Card (CN8) [Enabled]

Use the **PCI-E Mini Card (CN8)** option to enable or disable the PCIe Mini card slot (CN8).

→ **Enabled** **DEFAULT** The PCIe Mini card slot (CN8) is enabled.

→ **Disabled** The PCIe Mini card slot (CN8) is disabled.

→ Speed [Auto]

Use the **Speed** option to configure the PCIe Mini card slot (CN8) speed.

- Auto **DEFAULT**
- Gen 2
- Gen 1

5.5 Security

Use the **Security** menu (**BIOS Menu 20**) to set system and user passwords.

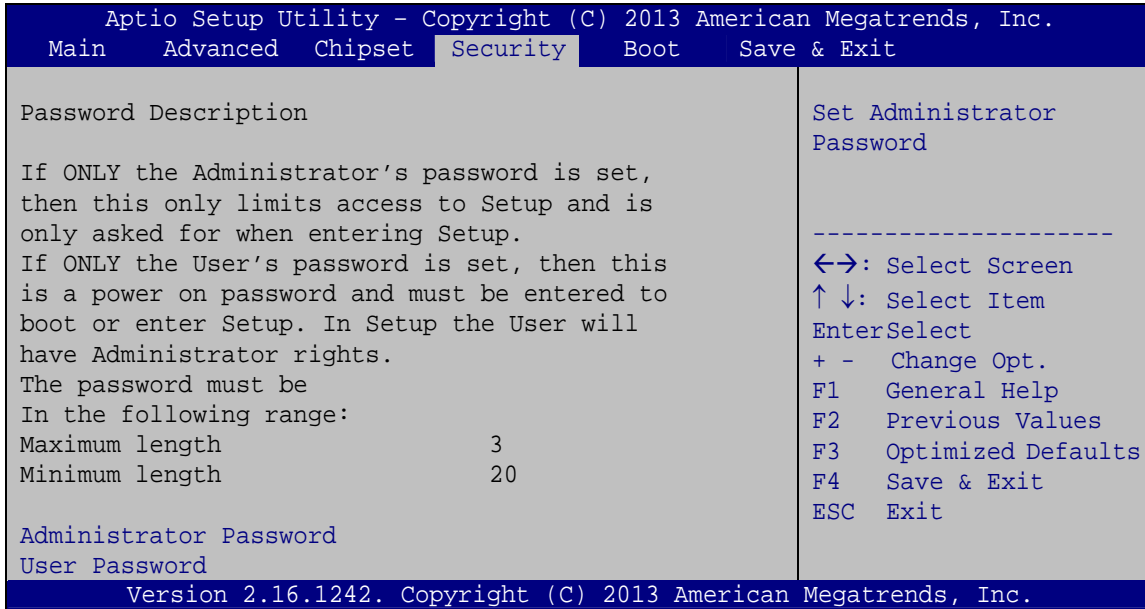

BIOS Menu 20: Security

➔ Administrator Password

Use the **Administrator Password** to set or change a administrator password.

➔ User Password

Use the **User Password** to set or change a user password.

NANO-BT-i1 EPIC SBC

5.6 Boot

Use the **Boot** menu (**BIOS Menu 21**) to configure system boot options.

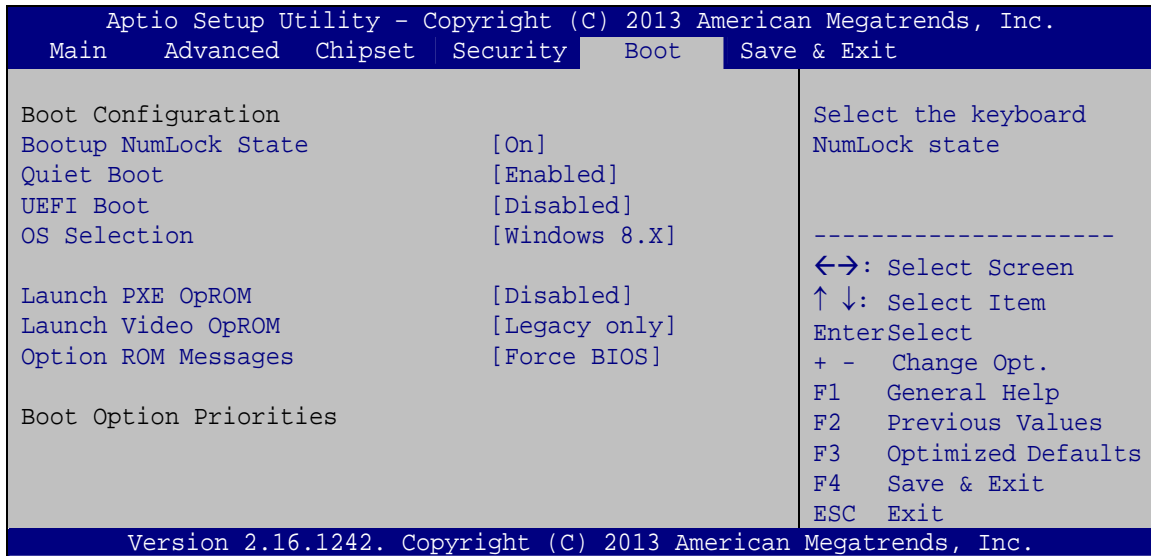

BIOS Menu 21: Boot

→ Bootup NumLock State [On]

Use the **Bootup NumLock State** BIOS option to specify if the number lock setting must be modified during boot up.

- **On** **DEFAULT** Allows the Number Lock on the keyboard to be enabled automatically when the computer system boots up. This allows the immediate use of the 10-key numeric keypad located on the right side of the keyboard. To confirm this, the Number Lock LED light on the keyboard is lit.
- **Off** Does not enable the keyboard Number Lock automatically. To use the 10-keys on the keyboard, press the Number Lock key located on the upper left-hand corner of the 10-key pad. The Number Lock LED on the keyboard lights up when the Number Lock is engaged.

→ Quiet Boot [Enabled]

Use the **Quiet Boot** BIOS option to select the screen display when the system boots.

- **Disabled** Normal POST messages displayed
- **Enabled** **DEFAULT** OEM Logo displayed instead of POST messages

→ UEFI Boot [Disabled]

Use the **UEFI Boot** option to enable or disable to boot from a UEFI device.

- **Enabled** Enable to boot from a UEFI device.
- **Disabled** **DEFAULT** Disable to boot from a UEFI device.

→ OS Selection [Windows 8.X]

Use the **OS Selection** option to select an operating system for the system.

- **Windows 8.X** **DEFAULT**
- **Android**
- **Windows 7**

→ Launch PXE OpROM [Disabled]

Use the **Launch PXE OpROM** option to enable or disable boot option for legacy network devices.

- **Disabled** **DEFAULT** Ignore all PXE Option ROMs
- **Enabled** Load PXE Option ROMs

→ Launch Video OpROM [Legacy only]

Use the **Launch Video OpROM** option to launch UEFI or legacy video OpROM.

- **Do not launch** Do not launch video OpROM.
- **UEFI only** Launch UEFI video OpROM.

NANO-BT-i1 EPIC SBC

→ **Legacy only** **DEFAULT** Launch legacy video OpROM.

→ **Option ROM Messages [Force BIOS]**

Use the **Option ROM Messages** option to set the Option ROM display mode.

→ **Force BIOS** **DEFAULT** Sets display mode to force BIOS.

→ **Keep Current** Sets display mode to current.

5.7 Exit

Use the **Exit** menu (**BIOS Menu 22**) to load default BIOS values, optimal failsafe values and to save configuration changes.

```

Aptio Setup Utility - Copyright (C) 2013 American Megatrends, Inc.
Main   Advanced   Chipset   Security   Boot   Save & Exit
-----
Save Changes and Reset
Discard Changes and Reset

Restore Defaults
Save as User Defaults
Restore User Defaults

-----
←→: Select Screen
↑ ↓: Select Item
Enter>Select
+ - Change Opt.
F1  General Help
F2  Previous Values
F3  Optimized Defaults
F4  Save & Exit
ESC Exit

Version 2.16.1242. Copyright (C) 2013 American Megatrends, Inc.
  
```

BIOS Menu 22:Exit

→ **Save Changes and Reset**

Use the **Save Changes and Reset** option to save the changes made to the BIOS options and reset the system.

→ **Discard Changes and Reset**

Use the **Discard Changes and Reset** option to exit the system without saving the changes made to the BIOS configuration setup program.

→ **Restore Defaults**

Use the **Restore Defaults** option to load the optimal default values for each of the parameters on the Setup menus. **F3 key can be used for this operation.**

→ **Save as User Defaults**

Use the **Save as User Defaults** option to save the changes done so far as user defaults.

→ **Restore User Defaults**

Use the **Restore User Defaults** option to restore the user defaults to all the setup options.

Chapter

6

Software Drivers

6.1 Available Software Drivers



NOTE:

The content of the CD may vary throughout the life cycle of the product and is subject to change without prior notice. Visit the IEI website or contact technical support for the latest updates.

The following drivers can be installed on the system:

- Chipset
- Graphics
- LAN

Installation instructions are given below.

6.2 Software Installation

All the drivers for the NANO-BT-i1 are on the CD that came with the system. To install the drivers, please follow the steps below.

Step 1: Insert the CD into a CD drive connected to the system.



NOTE:

If the installation program doesn't start automatically:
Click "Start->My Computer->CD Drive->autorun.exe"

Step 2: The driver main menu appears (**Figure 6-1**).

Step 3: Click **NANO-BT-i1**.

NANO-BT-i1 EPIC SBC



Figure 6-1: Driver CD Main Menu

Step 4: A new screen with a list of available drivers appears (Figure 6-2).



Figure 6-2: Available Drivers

Step 5: Install all of the necessary drivers in the menu.

6.3 Chipset Driver Installation

To install the chipset driver, please do the following.

Step 1: Access the driver list. (See **Section 6.2**)

Step 2: Click “1-Bay Trail SOC” and select the folder which corresponds to the operating system.



NOTE:

The remainder of this installation assumes Windows 8 as the operating system.

Step 3: Locate the setup file (infirst_autol_9.4.4.1006.exe) and double click on it.

Step 4: When the setup files are completely extracted, the **Welcome Screen** in **Figure 6-3** appears. Click **Next** to continue.

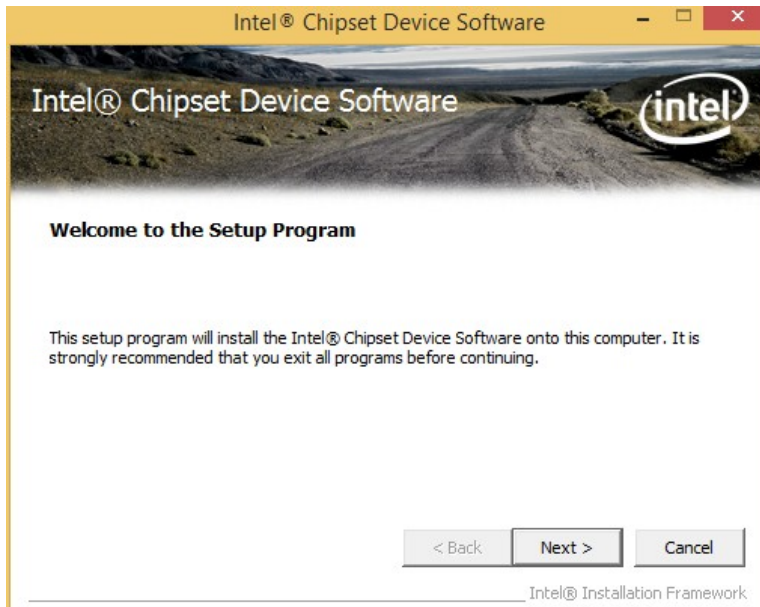

Figure 6-3: Chipset Driver Welcome Screen

NANO-BT-i1 EPIC SBC

Step 5: The **License Agreement** in **Figure 6-4** appears.

Step 6: Click **Yes** to accept the agreement and continue.



Figure 6-4: Chipset Driver License Agreement

Step 7: The **Read Me** file in **Figure 6-5** appears.

Step 8: Click **Next** to continue.

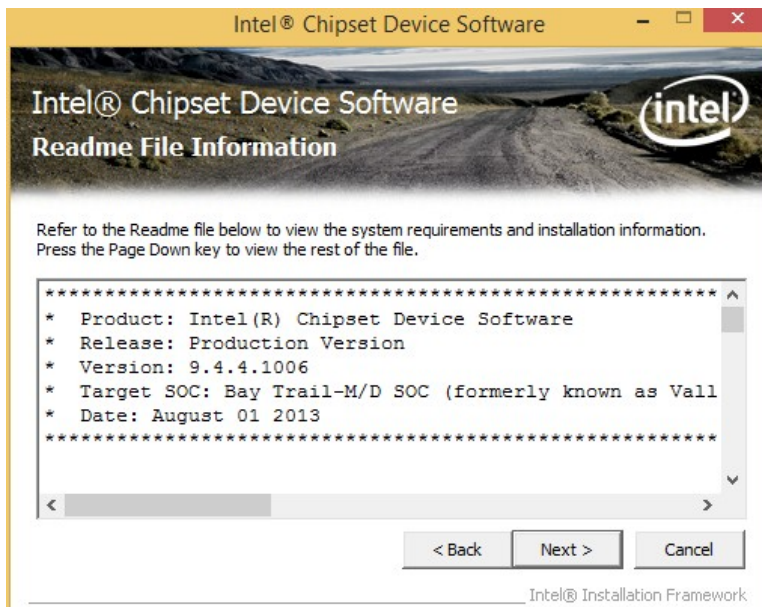

Figure 6-5: Chipset Driver Read Me File

Step 9: Setup Operations are performed as shown in **Figure 6-6**.

Step 10: Once the **Setup Operations** are complete, click **Next** to continue.

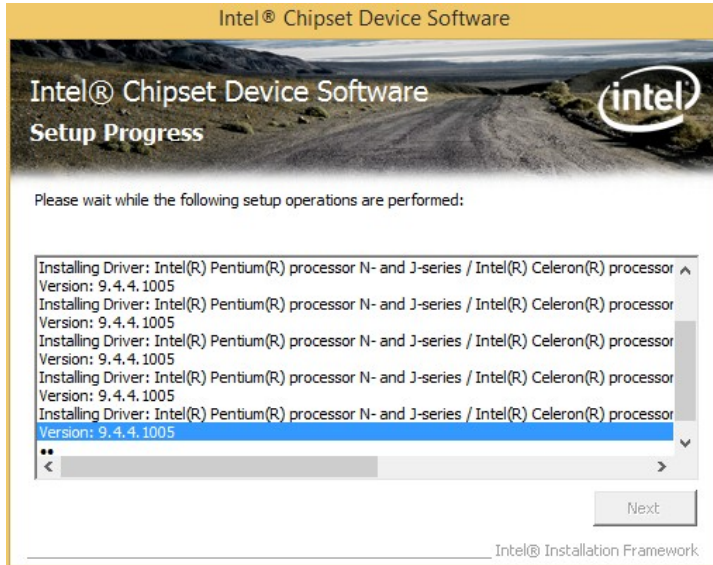

Figure 6-6: Chipset Driver Setup Operations

Step 11: The **Finish** screen in **Figure 6-7** appears.

Step 12: Select “**Yes, I want to restart this computer now**” and click **Finish**.



Figure 6-7: Chipset Driver Installation Finish Screen

6.4 Graphics Driver Installation

To install the Graphics driver, please do the following.

Step 1: Access the driver list. (See **Section 6.2**)

Step 2: Click “**1-Bay Trail SOC**” and select the folder which corresponds to the operating system.



NOTE:

The remainder of this installation assumes Windows 8 as the operating system.

Step 3: Unzip the file called **15.33.7.3366.zip**, and then locate the setup file and double click on it to start the installation. If a 64-bit operating system is installed, please unzip the 15.33.7.64.336.zip file to install the graphics driver.



NOTE:

To install graphics driver on a **32-bit** Windows 7 system, unzip INTEL_EMGD.WIN7_PC_VERSION_36_15_0_1064.7Z.

To install graphics driver on a **64-bit** Windows 7 system, unzip INTEL_EMGD.WIN7_BETA_VERSION_37_15_0_1055.7Z.

Step 4: The **Welcome Screen** in **Figure 6-8** appears.

Step 5: Click **Next** to continue.

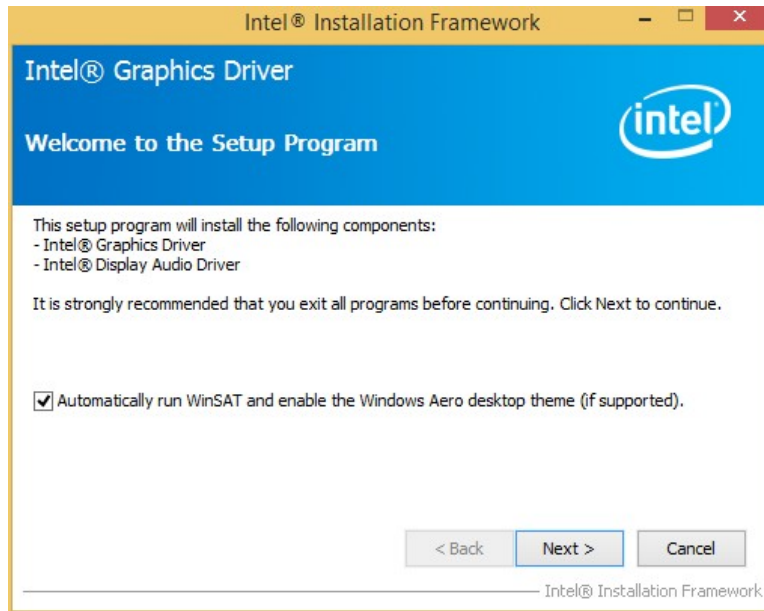

Figure 6-8: Graphics Driver Welcome Screen

Step 6: The License Agreement in Figure 6-9 appears.

Step 7: Click **Yes** to accept the agreement and continue.

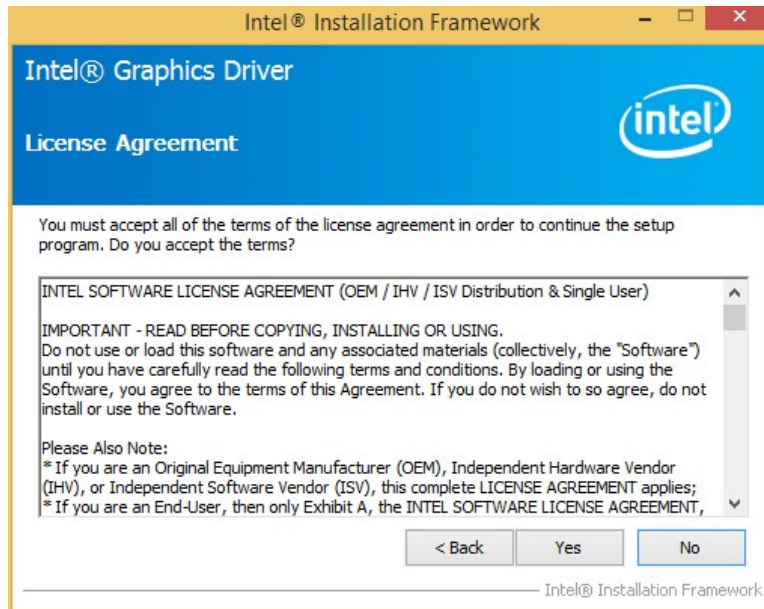

Figure 6-9: Graphics Driver License Agreement

Step 8: The Read Me file in Figure 6-10 appears. Click **Next** to continue.

NANO-BT-i1 EPIC SBC

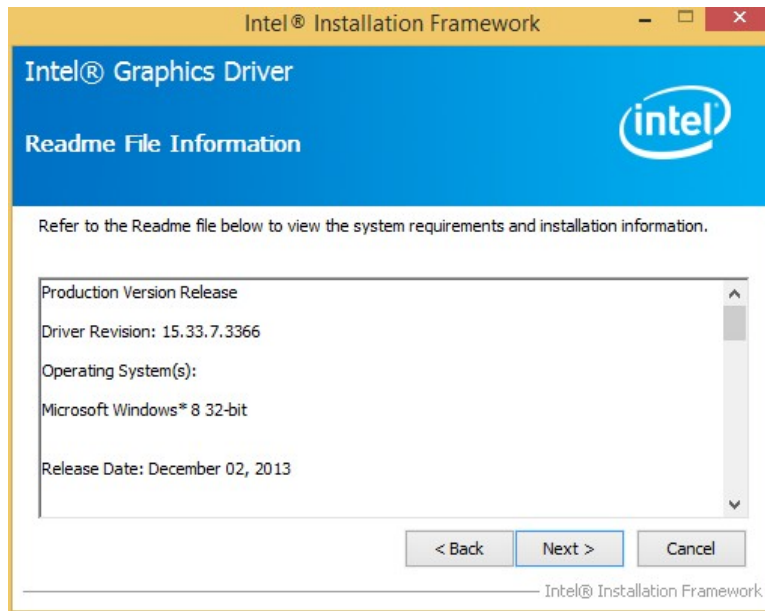

Figure 6-10: Graphics Driver Read Me File

Step 9: **Setup Operations** are performed as shown in **Figure 6-11**.

Step 10: Once the **Setup Operations** are complete, click **Next** to continue.

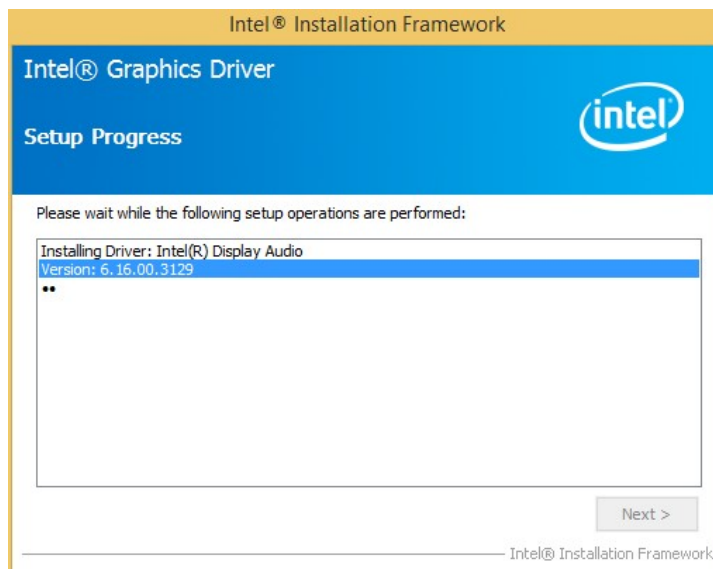

Figure 6-11: Graphics Driver Setup Operations

Step 11: The system starts installing the Graphics Driver.

Step 12: The **Finish** screen in **Figure 6-12** appears.

Step 13: Select “**Yes, I want to restart this computer now**” and click **Finish**.

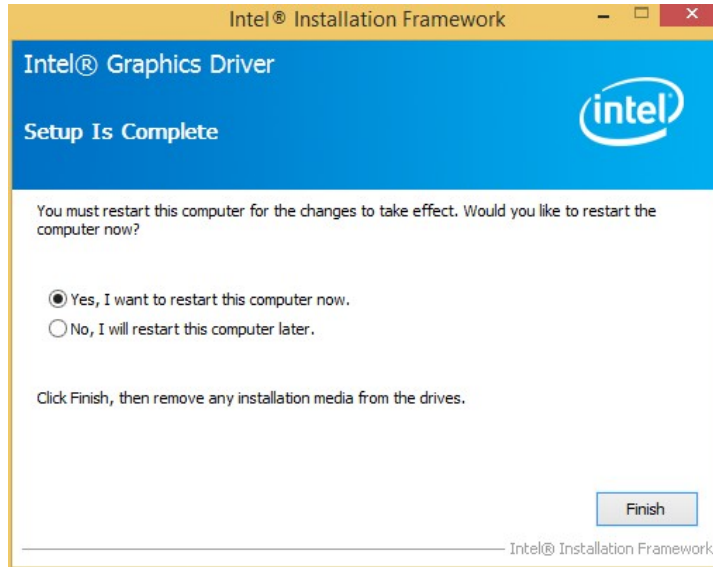

Figure 6-12: Graphics Driver Installation Finish Screen

6.5 LAN Driver Installation

To install the LAN driver, please do the following.

Step 1: Right-click This PC icon on the desktop and select **Properties**. (Figure 6-13).

NANO-BT-i1 EPIC SBC

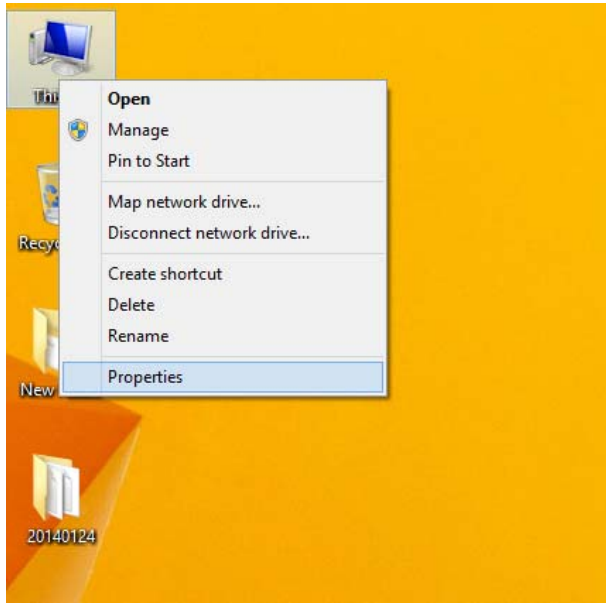

Figure 6-13: PC Properties

Step 2: The system control panel window in **Figure 6-14** appears.

Step 3: Click the Device Manager link (**Figure 6-14**).

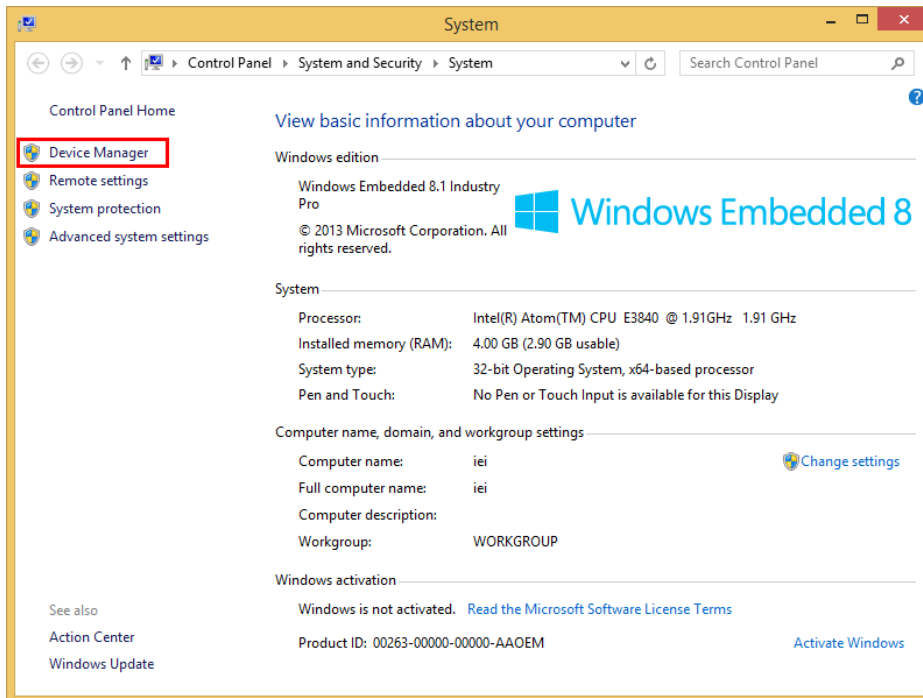

Figure 6-14: System Control Panel

- Step 4:** A list of system hardware devices appears (**Figure 6-15**).
- Step 5:** Right-click one of the Ethernet controllers that has question marks next to it (this means Windows does not recognize the device).
- Step 6:** Select **Update Driver Software**. See **Figure 6-15**.

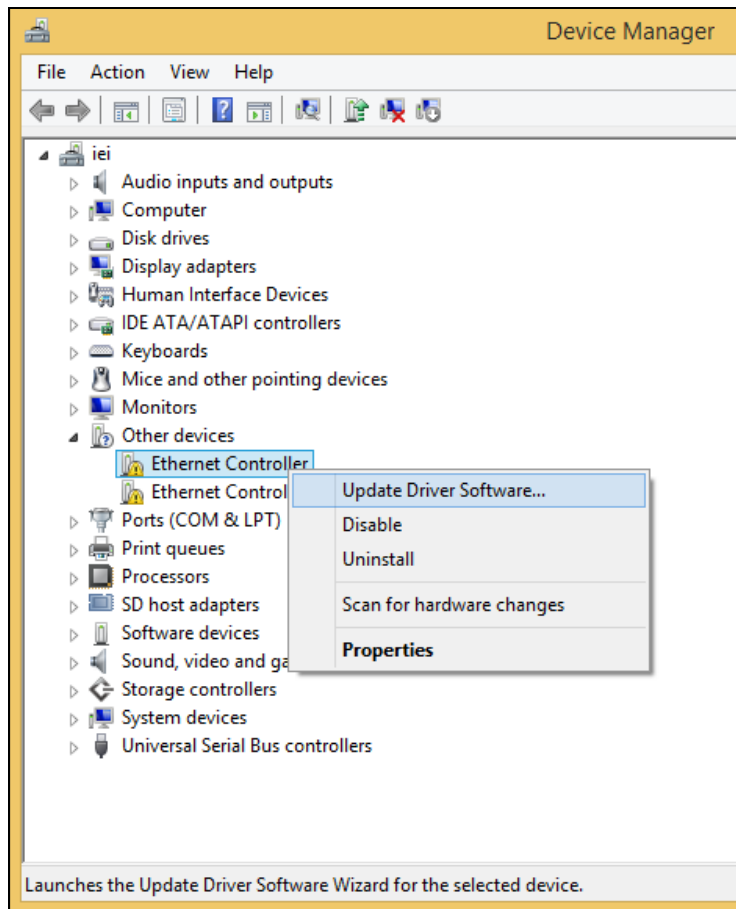

Figure 6-15: Device Manager List

- Step 7:** The Update Driver Software Window appears (**Figure 6-16**).

NANO-BT-i1 EPIC SBC

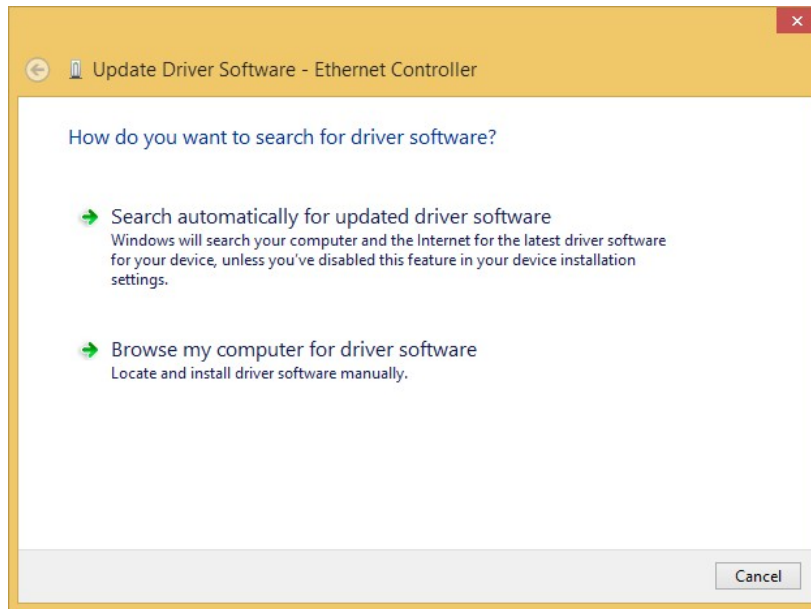

Figure 6-16: Update Driver Software Window

Step 8: Select “Browse my computer for driver software” and click **NEXT** to continue.

Step 9: Click Browse to select “X:\2-LAN\Intel” directory in the **Locate File** window, where “X:\” is the system CD drive. (Figure 6-17).

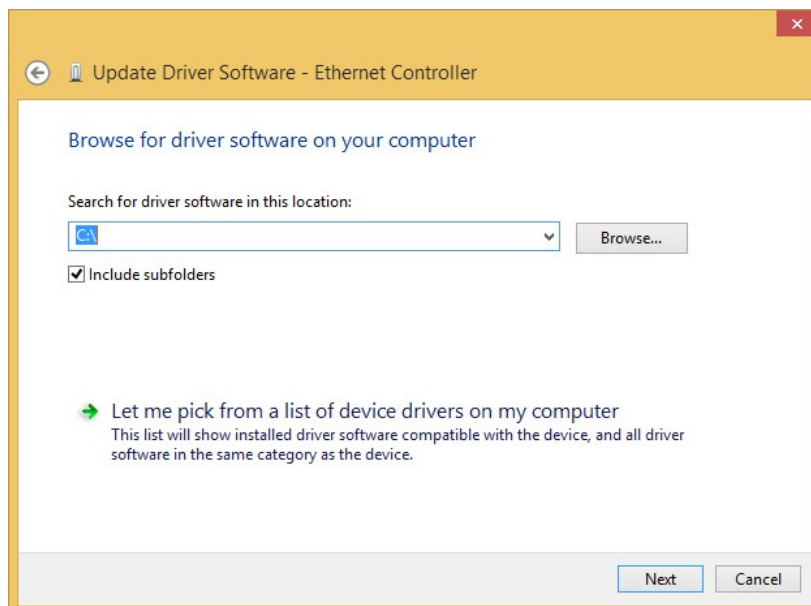

Figure 6-17: Locate Driver Files

Step 10: Click **NEXT** to continue.

Step 11: Driver Installation is performed. When the **Finish** screen appears, click **Close** to exit.

Step 12: Right-click the other Ethernet controller that has question marks next to it as shown in **Figure 6-15**. Repeat **Step 6** – **Step 11** to install the second Ethernet controller driver.

Appendix

A

BIOS Options

Below is a list of BIOS configuration options in the BIOS chapter.

System Date [xx/xx/xx]	76
System Time [xx:xx:xx]	77
ACPI Sleep State [S3 (Suspend to RAM)]	78
Serial Port [Enabled]	80
Change Settings [Auto]	80
Serial Port [Enabled]	81
Change Settings [Auto]	81
Serial Port [Enabled]	82
Change Settings [Auto]	82
Serial Port [Enabled]	83
Change Settings [Auto]	83
Smart Fan Function	85
PC Health Status	85
CPU_FAN1 Smart Fan Control/SYS_FAN1 Smart Fan Control [Auto Duty-Cycle Mode]	86
CPU/System Temperature 1	87
CPU/System Temperature 2	87
CPU/System Temperature 3	87
CPU/System Temperature 4	87
PC Health Status	88
CPU_FAN1 Smart Fan Control/SYS_FAN1 Smart Fan Control [Auto Mode]	89
Auto mode fan start/off temperature	89
Auto mode fan start PWM	90
Auto mode fan slope PWM	90
Wake System with Fixed Time [Disabled]	90
Console Redirection [Disabled]	92
Terminal Type [ANSI]	92
Bits per second [115200]	92
Data Bits [8]	92
Parity [None]	93
Stop Bits [1]	93
Active Processor Cores [All]	95
Intel Virtualization Technology [Enabled]	95

NANO-BT-i1 EPIC SBC

EIST [Enabled].....	95
Serial-ATA (SATA) [Enabled].....	96
SATA Mode Selection [IDE Mode].....	96
USB Devices.....	97
Legacy USB Support [Enabled].....	97
Primary Display [IGD].....	100
DVMT Pre-Allocated [64M].....	100
DVMT Total Gfx Mem [256MB].....	101
Restore on AC Power Loss [Last State].....	102
Audio Controller [Enabled].....	102
USB 2.0(EHCI) Support [Enabled].....	102
PCI-E Mini Card (CN8) [Enabled].....	103
Speed [Auto].....	103
Administrator Password.....	104
User Password.....	104
Bootup NumLock State [On].....	105
Quiet Boot [Enabled].....	106
UEFI Boot [Disabled].....	106
OS Selection [Windows 8.X].....	106
Launch PXE OpROM [Disabled].....	106
Launch Video OpROM [Legacy only].....	106
Option ROM Messages [Force BIOS].....	107
Save Changes and Reset.....	108
Discard Changes and Reset.....	108
Restore Defaults.....	108
Save as User Defaults.....	108
Restore User Defaults.....	108

Appendix

B

Terminology

NANO-BT-i1 EPIC SBC

AC '97	Audio Codec 97 (AC'97) refers to a codec standard developed by Intel® in 1997.
ACPI	Advanced Configuration and Power Interface (ACPI) is an OS-directed configuration, power management, and thermal management interface.
AHCI	Advanced Host Controller Interface (AHCI) is a SATA Host controller register-level interface.
ATA	The Advanced Technology Attachment (ATA) interface connects storage devices including hard disks and CD-ROM drives to a computer.
ARMD	An ATAPI Removable Media Device (ARMD) is any ATAPI device that supports removable media, besides CD and DVD drives.
ASKIR	Amplitude Shift Keyed Infrared (ASKIR) is a form of modulation that represents a digital signal by varying the amplitude (“volume”) of the signal. A low amplitude signal represents a binary 0, while a high amplitude signal represents a binary 1.
BIOS	The Basic Input/Output System (BIOS) is firmware that is first run when the computer is turned on and can be configured by the end user
CODEC	The Compressor-Decompressor (CODEC) encodes and decodes digital audio data on the system.
CMOS	Complimentary metal-oxide-conductor is an integrated circuit used in chips like static RAM and microprocessors.
COM	COM refers to serial ports. Serial ports offer serial communication to expansion devices. The serial port on a personal computer is usually a male D-sub 9 connector.
DAC	The Digital-to-Analog Converter (DAC) converts digital signals to analog signals.
DDR	Double Data Rate refers to a data bus transferring data on both the rising and falling edges of the clock signal.
DMA	Direct Memory Access (DMA) enables some peripheral devices to bypass the system processor and communicate directly with the system memory.

DIMM	Dual Inline Memory Modules are a type of RAM that offer a 64-bit data bus and have separate electrical contacts on each side of the module.
DIO	The digital inputs and digital outputs are general control signals that control the on/off circuit of external devices or TTL devices. Data can be read or written to the selected address to enable the DIO functions.
EHCI	The Enhanced Host Controller Interface (EHCI) specification is a register-level interface description for USB 2.0 Host Controllers.
EIDE	Enhanced IDE (EIDE) is a newer IDE interface standard that has data transfer rates between 4.0 MBps and 16.6 MBps.
EIST	Enhanced Intel® SpeedStep Technology (EIST) allows users to modify the power consumption levels and processor performance through application software. The application software changes the bus-to-core frequency ratio and the processor core voltage.
FSB	The Front Side Bus (FSB) is the bi-directional communication channel between the processor and the Northbridge chipset.
GbE	Gigabit Ethernet (GbE) is an Ethernet version that transfers data at 1.0 Gbps and complies with the IEEE 802.3-2005 standard.
GPIO	General purpose input
HDD	Hard disk drive (HDD) is a type of magnetic, non-volatile computer storage device that stores digitally encoded data.
ICH	The Input/Output Control Hub (ICH) is an Intel® Southbridge chipset.
IrDA	Infrared Data Association (IrDA) specify infrared data transmission protocols used to enable electronic devices to wirelessly communicate with each other.
L1 Cache	The Level 1 Cache (L1 Cache) is a small memory cache built into the system processor.
L2 Cache	The Level 2 Cache (L2 Cache) is an external processor memory cache.
LCD	Liquid crystal display (LCD) is a flat, low-power display device that consists of two polarizing plates with a liquid crystal panel in between.

NANO-BT-i1 EPIC SBC

LVDS	Low-voltage differential signaling (LVDS) is a dual-wire, high-speed differential electrical signaling system commonly used to connect LCD displays to a computer.
POST	The Power-on Self Test (POST) is the pre-boot actions the system performs when the system is turned-on.
RAM	Random Access Memory (RAM) is volatile memory that loses data when power is lost. RAM has very fast data transfer rates compared to other storage like hard drives.
SATA	Serial ATA (SATA) is a serial communications bus designed for data transfers between storage devices and the computer chipsets. The SATA bus has transfer speeds up to 1.5 Gbps and the SATA II bus has data transfer speeds of up to 3.0 Gbps.
S.M.A.R.T	Self Monitoring Analysis and Reporting Technology (S.M.A.R.T) refers to automatic status checking technology implemented on hard disk drives.
UART	Universal Asynchronous Receiver-transmitter (UART) is responsible for asynchronous communications on the system and manages the system's serial communication (COM) ports.
UHCI	The Universal Host Controller Interface (UHCI) specification is a register-level interface description for USB 1.1 Host Controllers.
USB	The Universal Serial Bus (USB) is an external bus standard for interfacing devices. USB 1.1 supports 12Mbps data transfer rates and USB 2.0 supports 480Mbps data transfer rates.
VGA	The Video Graphics Array (VGA) is a graphics display system developed by IBM.

Appendix

C

Watchdog Timer

**NOTE:**

The following discussion applies to DOS environment. Contact IEI support or visit the IEI website for specific drivers for other operating systems.

The Watchdog Timer is provided to ensure that standalone systems can always recover from catastrophic conditions that cause the CPU to crash. This condition may have occurred by external EMIs or a software bug. When the CPU stops working correctly, Watchdog Timer either performs a hardware reset (cold boot) or a Non-Maskable Interrupt (NMI) to bring the system back to a known state.

A BIOS function call (INT 15H) is used to control the Watchdog Timer.

INT 15H:

AH – 6FH Sub-function:	
AL – 2:	Sets the Watchdog Timer's period.
BL:	Time-out value (Its unit-second is dependent on the item "Watchdog Timer unit select" in CMOS setup).

Table C-1: AH-6FH Sub-function

Call sub-function 2 to set the time-out period of Watchdog Timer first. If the time-out value is not zero, the Watchdog Timer starts counting down. When the timer value reaches zero, the system resets. To ensure that this reset condition does not occur, calling sub-function 2 must periodically refresh the Watchdog Timer. However, the watchdog timer is disabled if the time-out value is set to zero.

A tolerance of at least 10% must be maintained to avoid unknown routines within the operating system (DOS), such as disk I/O that can be very time-consuming.

**NOTE:**

When exiting a program it is necessary to disable the Watchdog Timer, otherwise the system resets.

EXAMPLE PROGRAM:

```
; INITIAL TIMER PERIOD COUNTER
```

```
;
```

```
W_LOOP:
```

```
;
```

```
    MOV     AX, 6F02H      ;setting the time-out value  
    MOV     BL, 30        ;time-out value is 48 seconds  
    INT     15H
```

```
;
```

```
; ADD THE APPLICATION PROGRAM HERE
```

```
;
```

```
    CMP     EXIT_AP, 1    ;is the application over?  
    JNE     W_LOOP       ;No, restart the application
```

```
    MOV     AX, 6F02H    ;disable Watchdog Timer  
    MOV     BL, 0        ;  
    INT     15H
```

```
;
```

```
; EXIT ;
```

Appendix

D

Digital I/O Interface

D.1 Introduction

The DIO connector on the NANO-BT-i1 is interfaced to GPIO ports on the Super I/O chipset. The DIO has both 4-bit digital inputs and 4-bit digital outputs. The digital inputs and digital outputs are generally control signals that control the on/off circuit of external devices or TTL devices. Data can be read or written to the selected address to enable the DIO functions.



NOTE:

For further information, please refer to the datasheet for the Super I/O chipset.

The BIOS interrupt call **INT 15H** controls the digital I/O.

INT 15H:

AH – 6FH
<u>Sub-function:</u>
AL – 8 : Set the digital port as INPUT
AL : Digital I/O input value

NANO-BT-i1 EPIC SBC

D.2 Assembly Language Sample 1

```

MOV     AX, 6F08H      ;setting the digital port as input
INT     15H           ;
    
```

AL low byte = value

AH – 6FH
<u>Sub-function:</u>
AL – 9 : Set the digital port as OUTPUT
BL : Digital I/O input value

D.3 Assembly Language Sample 2

```

MOV     AX, 6F09H      ;setting the digital port as output
MOV     BL, 09H        ;digital value is 09H
INT     15H           ;
    
```

Digital Output is 1001b

Appendix

E

Hazardous Materials Disclosure

E.1 Hazardous Materials Disclosure Table for IPB Products Certified as RoHS Compliant Under 2002/95/EC Without Mercury

The details provided in this appendix are to ensure that the product is compliant with the Peoples Republic of China (China) RoHS standards. The table below acknowledges the presences of small quantities of certain materials in the product, and is applicable to China RoHS only.

A label will be placed on each product to indicate the estimated “Environmentally Friendly Use Period” (EFUP). This is an estimate of the number of years that these substances would “not leak out or undergo abrupt change.” This product may contain replaceable sub-assemblies/components which have a shorter EFUP such as batteries and lamps. These components will be separately marked.

Please refer to the table on the next page.

Part Name	Toxic or Hazardous Substances and Elements					
	Lead (Pb)	Mercury (Hg)	Cadmium (Cd)	Hexavalent Chromium (CR(VI))	Polybrominated Biphenyls (PBB)	Polybrominated Diphenyl Ethers (PBDE)
Housing	<input type="radio"/>	<input type="radio"/>	<input type="radio"/>	<input type="radio"/>	<input type="radio"/>	<input type="radio"/>
Display	<input type="radio"/>	<input type="radio"/>	<input type="radio"/>	<input type="radio"/>	<input type="radio"/>	<input type="radio"/>
Printed Circuit Board	<input type="radio"/>	<input type="radio"/>	<input type="radio"/>	<input type="radio"/>	<input type="radio"/>	<input type="radio"/>
Metal Fasteners	<input type="radio"/>	<input type="radio"/>	<input type="radio"/>	<input type="radio"/>	<input type="radio"/>	<input type="radio"/>
Cable Assembly	<input type="radio"/>	<input type="radio"/>	<input type="radio"/>	<input type="radio"/>	<input type="radio"/>	<input type="radio"/>
Fan Assembly	<input type="radio"/>	<input type="radio"/>	<input type="radio"/>	<input type="radio"/>	<input type="radio"/>	<input type="radio"/>
Power Supply Assemblies	<input type="radio"/>	<input type="radio"/>	<input type="radio"/>	<input type="radio"/>	<input type="radio"/>	<input type="radio"/>
Battery	<input type="radio"/>	<input type="radio"/>	<input type="radio"/>	<input type="radio"/>	<input type="radio"/>	<input type="radio"/>

O: This toxic or hazardous substance is contained in all of the homogeneous materials for the part is below the limit requirement in SJ/T11363-2006

X: This toxic or hazardous substance is contained in at least one of the homogeneous materials for this part is above the limit requirement in SJ/T11363-2006

NANO-BT-i1 EPIC SBC

此附件旨在确保本产品符合中国 RoHS 标准。以下表格标示此产品中某有毒物质的含量符合中国 RoHS 标准规定的限量要求。

本产品上会附有“环境友好使用期限”的标签，此期限是估算这些物质“不会有泄漏或突变”的年限。本产品可能包含有较短的环境友好使用期限的可替换元件，像是电池或灯管，这些元件将会单独标示出来。

部件名称	有毒有害物质或元素					
	铅 (Pb)	汞 (Hg)	镉 (Cd)	六价铬 (CR(VI))	多溴联苯 (PBB)	多溴二苯 醚 (PBDE)
壳体	○	○	○	○	○	○
显示	○	○	○	○	○	○
印刷电路板	○	○	○	○	○	○
金属螺帽	○	○	○	○	○	○
电缆组装	○	○	○	○	○	○
风扇组装	○	○	○	○	○	○
电力供应组装	○	○	○	○	○	○
电池	○	○	○	○	○	○

○: 表示该有毒有害物质在该部件所有物质材料中的含量均在 SJ/T11363-2006 标准规定的限量要求以下。
 X: 表示该有毒有害物质至少在该部件的某一均质材料中的含量超出 SJ/T11363-2006 标准规定的限量要求。