



IEI Technology Corp.



MODEL:

# AFL2-08A-N26 Series

**Flat Bezel Panel PC with 1.6 GHz Intel® Atom™ N2600 processor,  
Touch Screen, Wi-Fi, USB, GbE LAN , RS-232/422/485,  
HD Audio and RoHS**

## User Manual

Rev. 1.00 - 19 February, 2013





# Revision

---

Date	Version	Changes
19 February, 2013	1.00	Initial release

# Copyright

---

## COPYRIGHT NOTICE

The information in this document is subject to change without prior notice in order to improve reliability, design and function and does not represent a commitment on the part of the manufacturer.

In no event will the manufacturer be liable for direct, indirect, special, incidental, or consequential damages arising out of the use or inability to use the product or documentation, even if advised of the possibility of such damages.

This document contains proprietary information protected by copyright. All rights are reserved. No part of this manual may be reproduced by any mechanical, electronic, or other means in any form without prior written permission of the manufacturer.

## TRADEMARKS

All registered trademarks and product names mentioned herein are used for identification purposes only and may be trademarks and/or registered trademarks of their respective owners.

# Table of Contents

---

<b>1 INTRODUCTION.....</b>	<b>1</b>
1.1 AFL2-08A-N26 FLAT BEZEL PANEL PC OVERVIEW .....	2
1.1.1 Model Variations .....	3
1.1.2 Features .....	3
1.2 EXTERNAL OVERVIEW .....	3
1.2.1 Front Panel .....	3
1.2.1.1 LED Indicators .....	4
1.2.2 Rear Panel .....	6
1.2.3 Bottom Panel.....	7
1.3 INTERNAL OVERVIEW.....	8
1.4 SYSTEM SPECIFICATIONS.....	8
<b>2 DETAILED SPECIFICATIONS .....</b>	<b>11</b>
2.1 DIMENSIONS.....	12
2.2 INTEL® ATOM™ PROCESSOR.....	13
2.3 MOTHERBOARD COMPONENTS.....	13
2.3.1 Memory Capacity.....	13
2.3.2 Storage Capacity.....	13
2.4 EXTERNAL PERIPHERAL INTERFACE CONNECTORS.....	13
2.4.1 Serial Port Connectors .....	13
2.4.2 LAN Connectivity.....	14
2.4.3 External USB Connectors .....	14
2.5 AUDIO .....	15
2.5.1 Audio Codec Controller .....	15
2.5.2 Stereo Speakers .....	16
<b>3 UNPACKING .....</b>	<b>17</b>
3.1 UNPACKING.....	18
3.1.1 Packing List .....	18
<b>4 INSTALLATION .....</b>	<b>21</b>

4.1 ANTI-STATIC PRECAUTIONS .....	22
4.2 INSTALLATION PRECAUTIONS .....	22
4.3 INSTALLATION AND CONFIGURATION STEPS .....	23
4.4 mSATA CARD INSTALLATION .....	23
4.5 RFID READER (OPTIONAL).....	25
4.6 AT/ATX MODE SELECTION.....	27
4.6.1 AT Power Mode.....	27
4.6.2 ATX Power Mode.....	28
4.7 CLEAR CMOS.....	28
4.8 RESET THE SYSTEM.....	28
4.9 POWERING ON THE SYSTEM.....	29
4.10 POWERING OFF THE SYSTEM.....	29
4.11 MOUNTING THE SYSTEM .....	30
4.11.1 Wall Mounting .....	30
4.11.2 Panel Mounting.....	33
4.11.3 Stand Mounting .....	35
4.12 EXTERNAL PERIPHERAL DEVICE CONNECTION .....	35
4.12.1 Audio Connection.....	36
4.12.2 Display Device Connection.....	37
4.12.3 LAN Connection.....	37
4.12.4 Serial Device Connection .....	38
4.12.4.1 DB-9 Serial Port Connection .....	38
4.12.4.2 RJ-11 Serial Port Connection.....	39
4.12.5 USB Device Connection.....	41
<b>5 SYSTEM MOTHERBOARD .....</b>	<b>43</b>
5.1 OVERVIEW.....	44
5.1.1 Layout .....	44
5.2 INTERNAL PERIPHERAL CONNECTORS .....	45
5.2.1 Audio Connector (AUDIO1).....	46
5.2.2 Auto-dimming Connector (IR1) .....	47
5.2.3 Battery Connector (BAT1).....	47
5.2.4 BIOS Programming Connector (SPI1).....	47
5.2.5 Bluetooth Connector (BLUETOOTH1) .....	47
5.2.6 Debug Port Connector (LPC_DEBUG1).....	48

5.2.7 EC Firmware Connector (JSP11) .....	48
5.2.8 Hot Key Connector (HOT_KEY1) .....	48
5.2.9 K Type Connector (K_TYPE1, K_TYPE2).....	48
5.2.10 LCD Inverter Connector (INVERTER1).....	49
5.2.11 LCD LVDS connector (JR1).....	49
5.2.12 LED Connector (LEDCN1).....	49
5.2.13 LPT Connector (LPT_DB1).....	50
5.2.14 Micro SD Connector (MICRO_SD1).....	50
5.2.15 Mini USB Connector (MINI_USB1).....	50
5.2.16 Microphone Connector (WEBCAM_DMIC1).....	51
5.2.17 Power Button Connector (PW_BT1) .....	51
5.2.18 RFID USB Connector (RFID1) .....	51
5.2.19 Speaker Connector (AMP_SPKR1) .....	51
5.2.20 Touch Panel Connector (TS1).....	51
5.2.21 Touch Panel Connector (CAP_TS1) .....	52
5.2.22 VGA Connector (VGA1) .....	52
5.2.23 Webcam Connector (CAMERA1).....	52
<b>5.3 EXTERNAL INTERFACE PANEL CONNECTORS .....</b>	<b>53</b>
5.3.1 Display Port Connector (DISPLAY_PORT1).....	54
5.3.2 Ethernet Connector (LAN1).....	54
5.3.3 Power Connector (DC_IN1).....	55
5.3.4 RS-232 Serial Ports (COM1).....	55
5.3.5 RS-422/485 Serial Port (COM2) .....	55
5.3.6 USB 2.0 Connectors (USB1).....	55
5.3.7 USB 3.0 Connectors (USB3_1).....	56
<b>6 SYSTEM MAINTENANCE .....</b>	<b>57</b>
6.1 SYSTEM MAINTENANCE INTRODUCTION .....	58
6.2 ANTI-STATIC PRECAUTIONS .....	58
6.3 TURN OFF THE POWER .....	59
6.4 OPENING THE SYSTEM.....	59
6.4.1 Removing the Back Cover.....	59
6.4.2 Removing the Internal Aluminum Cover.....	60
6.5 REPLACING COMPONENTS.....	62
6.5.1 Memory Module Replacement .....	62

6.5.2 WLAN Card Replacement .....	63
6.6 REINSTALLING THE COVERS .....	66
<b>7 BIOS SETUP .....</b>	<b>67</b>
7.1 INTRODUCTION.....	68
7.1.1 Starting Setup.....	68
7.1.2 Using Setup .....	68
7.1.3 Getting Help.....	69
7.1.4 Unable to Reboot after Configuration Changes .....	69
7.1.5 BIOS Menu Bar.....	69
7.2 MAIN.....	70
7.3 ADVANCED.....	71
7.3.1 ACPI Settings .....	72
7.3.2 RTC Wake Settings .....	73
7.3.3 CPU Configuration.....	75
7.3.4 SATA Configuration .....	76
7.3.5 USB Configuration.....	77
7.3.6 F81866 Super IO Configuration .....	78
7.3.6.1 Serial Port n Configuration .....	79
7.3.7 H/W Monitor .....	81
7.3.8 Serial Port Console Redirection .....	81
7.4 iEi FEATURE .....	84
7.5 CHIPSET .....	85
7.5.1 Host Bridge Configuration .....	86
7.5.1.1 Intel IGD Configuration.....	86
7.5.2 South Bridge Configuration.....	88
7.6 BOOT.....	90
7.7 SECURITY.....	92
7.8 SAVE & EXIT .....	93
<b>8 SOFTWARE DRIVERS .....</b>	<b>95</b>
8.1 AVAILABLE SOFTWARE DRIVERS .....	96
8.2 STARTING THE DRIVER PROGRAM .....	96
8.3 CHIPSET DRIVER INSTALLATION.....	97
8.4 GRAPHICS DRIVER INSTALLATION.....	100

8.5 TOUCH SCREEN DRIVER.....	103
8.5.1 <i>Calibrating the Touch Screen</i> .....	107
8.6 AUDIO DRIVER INSTALLATION .....	109
8.7 LAN DRIVER INSTALLATION.....	111
8.8 USB 3.0 DRIVER INSTALLATION.....	114
8.9 WI-FI DRIVER INSTALLATION.....	116
8.10 BLUETOOTH DRIVER .....	120
8.11 AMCAP DRIVER INSTALLATION .....	124
<b>A SAFETY PRECAUTIONS .....</b>	<b>127</b>
A.1 SAFETY PRECAUTIONS .....	128
A.1.1 <i>General Safety Precautions</i> .....	128
A.1.2 <i>CPU Temperature Warning</i> .....	129
A.1.3 <i>Anti-static Precautions</i> .....	129
A.1.4 <i>Product Disposal</i> .....	130
A.2 MAINTENANCE AND CLEANING PRECAUTIONS .....	130
A.2.1 <i>Maintenance and Cleaning</i> .....	130
A.2.2 <i>Cleaning Tools</i> .....	131
<b>B BIOS MENU OPTIONS .....</b>	<b>132</b>
<b>C ONE KEY RECOVERY.....</b>	<b>135</b>
C.1 ONE KEY RECOVERY INTRODUCTION .....	136
C.1.1 <i>System Requirement</i> .....	137
C.1.2 <i>Supported Operating System</i> .....	138
C.2 SETUP PROCEDURE FOR WINDOWS .....	139
C.2.1 <i>Hardware and BIOS Setup</i> .....	140
C.2.2 <i>Create Partitions</i> .....	140
C.2.3 <i>Install Operating System, Drivers and Applications</i> .....	144
C.2.4 <i>Building the Recovery Partition</i> .....	145
C.2.5 <i>Create Factory Default Image</i> .....	147
C.3 AUTO RECOVERY SETUP PROCEDURE.....	152
C.4 SETUP PROCEDURE FOR LINUX .....	156
C.5 RECOVERY TOOL FUNCTIONS .....	160
C.5.1 <i>Factory Restore</i> .....	161
C.5.2 <i>Backup System</i> .....	162



C.5.3 <i>Restore Your Last Backup</i> .....	163
C.5.4 <i>Manual</i> .....	164
C.6 RESTORE SYSTEMS FROM A LINUX SERVER THROUGH LAN .....	165
C.6.1 <i>Configure DHCP Server Settings</i> .....	166
C.6.2 <i>Configure TFTP Settings</i> .....	167
C.6.3 <i>Configure One Key Recovery Server Settings</i> .....	168
C.6.4 <i>Start the DHCP, TFTP and HTTP</i> .....	169
C.6.5 <i>Create Shared Directory</i> .....	169
C.6.6 <i>Setup a Client System for Auto Recovery</i> .....	170
C.7 OTHER INFORMATION .....	173
C.7.1 <i>Using AHCI Mode or ALi M5283 / VIA VT6421A Controller</i> .....	173
C.7.2 <i>System Memory Requirement</i> .....	175
<b>D HAZARDOUS MATERIALS DISCLOSURE .....</b>	<b>176</b>
D.1 HAZARDOUS MATERIAL DISCLOSURE TABLE FOR IPB PRODUCTS CERTIFIED AS ROHS COMPLIANT UNDER 2002/95/EC WITHOUT MERCURY .....	177

# List of Figures

---

Figure 1-1: AFL2-08A-N26 Flat Bezel Panel PC .....	2
Figure 1-2: AFL2-08A-N26 Front View .....	4
Figure 1-3: LED Indicators .....	4
Figure 1-4: Function Keys .....	6
Figure 1-5: AFL2-08A-N26 Rear View .....	7
Figure 1-6: AFL2-08A-N26 Bottom Panel .....	8
Figure 2-1: AFL2-08A-N26 Dimensions (mm) .....	12
Figure 2-2: Serial Ports .....	14
Figure 2-3: RJ-45 Ethernet Connector (Bottom Panel) .....	14
Figure 2-4: External USB Ports (Bottom Panel) .....	15
Figure 2-5: Audio Jack .....	16
Figure 4-1: mSATA Cover Retention Screw .....	24
Figure 4-2: PCIe Mini Card Slot .....	24
Figure 4-3: PCIe Mini Card Installation .....	25
Figure 4-4: Connect the RFID USB cable .....	26
Figure 4-5: Install the RFID module .....	26
Figure 4-6: AT/ATX Switch Location .....	27
Figure 4-7: Clear CMOS Switch Location .....	28
Figure 4-8: Reset Button Location .....	29
Figure 4-9: Wall-mounting Bracket .....	31
Figure 4-10: Chassis Support Screws .....	32
Figure 4-11: Secure the Panel PC .....	33
Figure 4-12: Cutout Dimensions .....	33
Figure 4-13: Tighten the Panel Mounting Clamp Screws .....	34
Figure 4-14: Mounting screw location .....	35
Figure 4-15: Audio Connector .....	36
Figure 4-16: DisplayPort Connection .....	37
Figure 4-17: LAN Connection .....	38
Figure 4-18: DB-9 Serial Port Connector .....	39
Figure 4-19: RJ-11 Serial Port Connector .....	40
Figure 4-20: DB-9 Connector Pinout Locations .....	40

**Figure 4-21: USB Device Connection .....41**

**Figure 5-1: System Motherboard (front).....44**

**Figure 5-2: System Motherboard (rear) .....45**

**Figure 5-3: External Interface Panel Connectors .....53**

**Figure 6-1: Back Cover Retention Screws .....60**

**Figure 6-2: Internal Cover Retention Screws.....61**

**Figure 6-3: Internal Components .....61**

**Figure 6-4: DDR SO-DIMM Module Installation.....63**

**Figure 6-5: Releasing the WLAN Card.....64**

**Figure 6-6: Removing the WLAN card .....64**

**Figure 6-7: Attaching the Antennas.....65**

**Figure 8-1: Drivers .....97**

**Figure 8-2: Chipset Driver Screen.....98**

**Figure 8-3: Chipset Driver Welcome Screen.....98**

**Figure 8-4: Chipset Driver License Agreement .....99**

**Figure 8-5: Chipset Driver Read Me File .....99**

**Figure 8-6: Chipset Driver Setup Operations .....100**

**Figure 8-7: Graphics Driver Welcome Screen .....101**

**Figure 8-8: Graphics Driver License Agreement.....101**

**Figure 8-9: Graphics Driver Read Me File .....102**

**Figure 8-10: Graphics Driver Setup Operations .....102**

**Figure 8-11: Graphics Driver Installation Finish Screen .....103**

**Figure 8-12: Touch Screen Driver Welcome Screen .....104**

**Figure 8-13: Touch Screen Driver License Agreement.....104**

**Figure 8-14: Touch Screen Driver Choose Install Location .....105**

**Figure 8-15: Touch Screen Driver Installation Screen.....106**

**Figure 8-16: Touch Screen Driver Update Complete .....106**

**Figure 8-17: PenMount Monitor Icon .....107**

**Figure 8-18: PenMount Monitor Popup Menu.....107**

**Figure 8-19: Configuration Screen.....108**

**Figure 8-20: Calibration Initiation Screen .....108**

**Figure 8-21: Calibration Screen .....109**

**Figure 8-22: Audio Driver – Extracting Files.....110**

**Figure 8-23: Audio Driver Welcome Screen.....110**

**Figure 8-24: Audio Driver Installation.....111**

Figure 8-25: Audio Driver Installation Complete .....	111
Figure 8-26: LAN Driver Welcome Screen .....	112
Figure 8-27: LAN Driver Ready to Install Screen.....	112
Figure 8-28: LAN Driver Setup Status Screen .....	113
Figure 8-29: LAN Driver Installation Complete.....	113
Figure 8-30: USB 3.0 Driver Welcome Screen .....	114
Figure 8-31: USB 3.0 Driver License Agreement.....	115
Figure 8-32: USB 3.0 Driver Installation .....	115
Figure 8-33: USB 3.0 Driver Update Complete .....	116
Figure 8-34: License Agreement .....	117
Figure 8-35: Setup Type.....	117
Figure 8-36: Configuration Tool.....	118
Figure 8-37: Ready to Install the Program .....	118
Figure 8-38: Setup Status .....	119
Figure 8-39: Installation Complete.....	120
Figure 8-40: Welcome Screen .....	121
Figure 8-41: License Agreement .....	121
Figure 8-42: Bluetooth Driver Destination Folder .....	122
Figure 8-43: Ready to Install the Program .....	122
Figure 8-44: Installing BlueSoleil .....	123
Figure 8-45: Bluetooth Driver Complete Installation Screen .....	123
Figure 8-46: Reboot the Computer .....	124
Figure 8-47: AMCap Driver Welcome Screen .....	125
Figure 8-48: AMCap Driver Choose Install Location.....	125
Figure 8-49: AMCap Driver Installation Complete .....	126
Figure C-1: IEI One Key Recovery Tool Menu .....	136
Figure C-2: Launching the Recovery Tool .....	141
Figure C-3: Recovery Tool Setup Menu .....	141
Figure C-4: Command Prompt .....	142
Figure C-5: Partition Creation Commands.....	143
Figure C-6: Launching the Recovery Tool .....	145
Figure C-7: Manual Recovery Environment for Windows .....	145
Figure C-8: Building the Recovery Partition.....	146
Figure C-9: Press Any Key to Continue .....	146
Figure C-10: Press F3 to Boot into Recovery Mode.....	147

**Figure C-11: Recovery Tool Menu .....147**

**Figure C-12: About Symantec Ghost Window.....148**

**Figure C-13: Symantec Ghost Path .....148**

**Figure C-14: Select a Local Source Drive .....149**

**Figure C-15: Select a Source Partition from Basic Drive .....149**

**Figure C-16: File Name to Copy Image to .....150**

**Figure C-17: Compress Image.....150**

**Figure C-18: Image Creation Confirmation .....151**

**Figure C-19: Image Creation Complete .....151**

**Figure C-20: Image Creation Complete .....151**

**Figure C-21: Press Any Key to Continue .....152**

**Figure C-22: Auto Recovery Utility .....153**

**Figure C-23: Launching the Recovery Tool .....153**

**Figure C-24: Auto Recovery Environment for Windows .....153**

**Figure C-25: Building the Auto Recovery Partition.....154**

**Figure C-26: Factory Default Image Confirmation .....154**

**Figure C-27: Image Creation Complete .....155**

**Figure C-28: Press any key to continue .....155**

**Figure C-29: Partitions for Linux.....157**

**Figure C-30: Manual Recovery Environment for Linux .....158**

**Figure C-31: Access menu.lst in Linux (Text Mode).....159**

**Figure C-32: Recovery Tool Menu .....159**

**Figure C-33: Recovery Tool Main Menu .....160**

**Figure C-34: Restore Factory Default .....161**

**Figure C-35: Recovery Complete Window .....162**

**Figure C-36: Backup System.....162**

**Figure C-37: System Backup Complete Window .....163**

**Figure C-38: Restore Backup .....163**

**Figure C-39: Restore System Backup Complete Window .....164**

**Figure C-40: Symantec Ghost Window .....164**

# List of Tables

<b>Table 1-1: AFL2-08A-N26 Model Variations .....</b>	<b>3</b>
<b>Table 1-2: LED Indicators .....</b>	<b>5</b>
<b>Table 1-3: Function Key Descriptions .....</b>	<b>6</b>
<b>Table 1-4: System Specifications.....</b>	<b>10</b>
<b>Table 4-1: DB-9 Connector Pinout .....</b>	<b>40</b>
<b>Table 5-1: Peripheral Interface Connectors .....</b>	<b>46</b>
<b>Table 5-2: Audio Connector Pinouts (AUDIO1) .....</b>	<b>47</b>
<b>Table 5-3: Auto-dimming Connector Pinouts (IR1).....</b>	<b>47</b>
<b>Table 5-4: Battery Connector Pinouts (BAT1) .....</b>	<b>47</b>
<b>Table 5-5: BIOS Programming Connector Pinouts (SPI1).....</b>	<b>47</b>
<b>Table 5-6: Bluetooth Connector Pinouts (BLUETOOTH1).....</b>	<b>47</b>
<b>Table 5-7: Debug Port Connector Pinouts (LPC_DEBUG1) .....</b>	<b>48</b>
<b>Table 5-8: EC Firmware Connector Pinouts (JSPI1) .....</b>	<b>48</b>
<b>Table 5-9: Hot Key Connector Pinouts (HOT_KEY1) .....</b>	<b>48</b>
<b>Table 5-10: K Type Connector Pinouts (K_TYPE1, K_TYPE2).....</b>	<b>48</b>
<b>Table 5-11: LCD Inverter Connector Pinouts (INVERTER1).....</b>	<b>49</b>
<b>Table 5-12: LCD LVDS connector Pinouts (JR1) .....</b>	<b>49</b>
<b>Table 5-13: LED Connector Pinouts (LEDCN1) .....</b>	<b>50</b>
<b>Table 5-14: LPT Connector Pinouts ( LPT_DB1) .....</b>	<b>50</b>
<b>Table 5-15: Micro SD Connector Pinouts (MICRO_SD1) .....</b>	<b>50</b>
<b>Table 5-16: Mini USB Connector Pinouts (MINI_USB1).....</b>	<b>50</b>
<b>Table 5-17: Microphone Connector Pinouts (WEBCAM_DMIC1).....</b>	<b>51</b>
<b>Table 5-18: Power Button Connector Pinouts (PW_BT1).....</b>	<b>51</b>
<b>Table 5-19: RFID USB Connector Pinouts (RFID1).....</b>	<b>51</b>
<b>Table 5-20: Speaker Connector Pinouts (AMP_SPKR1).....</b>	<b>51</b>
<b>Table 5-21: Touch Panel Connector Pinouts (TS1).....</b>	<b>52</b>
<b>Table 5-22: Touch Panel Connector Pinouts (CAP_TS1) .....</b>	<b>52</b>
<b>Table 5-23: VGA Connector Pinouts (VGA1) .....</b>	<b>52</b>
<b>Table 5-24: Webcam Connector Pinouts (CAMERA1) .....</b>	<b>52</b>
<b>Table 5-25: Rear Panel Connectors .....</b>	<b>53</b>
<b>Table 5-26: Display Port Connector Pinouts (DISPLAY_PORT1) .....</b>	<b>54</b>

## AFL2-08A-N26

Table 5-27: Ethernet Connector Pinouts (LAN1) .....	54
Table 5-28: Power Connector Pinouts (DC_IN1) .....	55
Table 5-29: RS-232 Serial Ports Pinouts (COM1) .....	55
Table 5-30: RS-422/485 Serial Port Pinouts (COM2) .....	55
Table 5-31: USB 2.0 Connectors Pinouts (USB1).....	55
Table 5-32: USB 3.0 Connector Pinouts (USB3_1).....	56
Table 7-1: BIOS Navigation Keys .....	69

# List of BIOS Menus

---

BIOS Menu 1: Main .....	70
BIOS Menu 2: Advanced .....	72
BIOS Menu 3: ACPI Configuration .....	72
BIOS Menu 4: RTC Wake Settings .....	73
BIOS Menu 5: CPU Configuration .....	75
BIOS Menu 6: IDE Configuration .....	76
BIOS Menu 7: USB Configuration .....	77
BIOS Menu 8: Super IO Configuration.....	78
BIOS Menu 9: Serial Port n Configuration Menu .....	79
BIOS Menu 10: Hardware Health Configuration .....	81
BIOS Menu 11: Serial Port Console Redirection .....	82
BIOS Menu 12: iEi Feature .....	84
BIOS Menu 13: Chipset .....	85
BIOS Menu 14: Host Bridge Configuration .....	86
BIOS Menu 15: Intel IGD Configuration.....	87
BIOS Menu 16: Southbridge Chipset Configuration .....	88
BIOS Menu 17: Boot .....	90
BIOS Menu 18: Security .....	92
BIOS Menu 19: Exit.....	93
BIOS Menu 20: iEi Feature.....	156



Chapter

1

# Introduction

---

## 1.1 AFL2-08A-N26 Flat Bezel Panel PC Overview



**Figure 1-1: AFL2-08A-N26 Flat Bezel Panel PC**

The AFL2-08A-N26 is an Intel® Atom™ N2600 processor powered flat bezel panel PC with a rich variety of functions and peripherals. The AFL2-08A-N26 is designed for easy and simplified integration into kiosk and point-of-sales (POS) applications.

An Intel® NM10 chipset ensures optimal memory, graphics, and peripheral I/O support. The system comes with one 2.0 GB of DDR3 SO-DIMM ensuring smooth data throughputs with reduced bottlenecks and fast system access.

Two serial ports, two external USB 2.0 ports and two external USB 3.0 ports ensure simplified connectivity to a variety of external peripheral devices. Wi-Fi capabilities and one RJ-45 Ethernet connector provide the system with smooth connection to an external LAN.

## AFL2-08A-N26

### 1.1.1 Model Variations

The model variations of the AFL2-08A-N26 Series are listed below.

Model No.	Touch Screen Type	Optional Features
AFL2-08A-N26/R/2G-R10	5-Wire Resistive	N/A

**Table 1-1: AFL2-08A-N26 Model Variations**

### 1.1.2 Features

The AFL2-08A-N26 features are listed below:

- Flat-bezel LCD with LED backlight
- Intel® Atom™ N2600 dual core 1.6 GHz processor
- One 800 MHz 204-pin DDR3 SO-DIMM slot (system max. 2GB) pre-installed with 2GB
- 5-wire resistive type touch screen supported
- Wi-Fi 802.11b/g/n 2T2R high speed wireless
- EM or Mifare RFID reader
- Built-in two 0.8W speakers and microphone
- IP64 compliant front panel
- Auto dimming control

## 1.2 External Overview

### 1.2.1 Front Panel

The front side of the AFL2-08A-N26 is a flat bezel panel TFT LCD screen surrounded by a PC/ABS plastic frame.

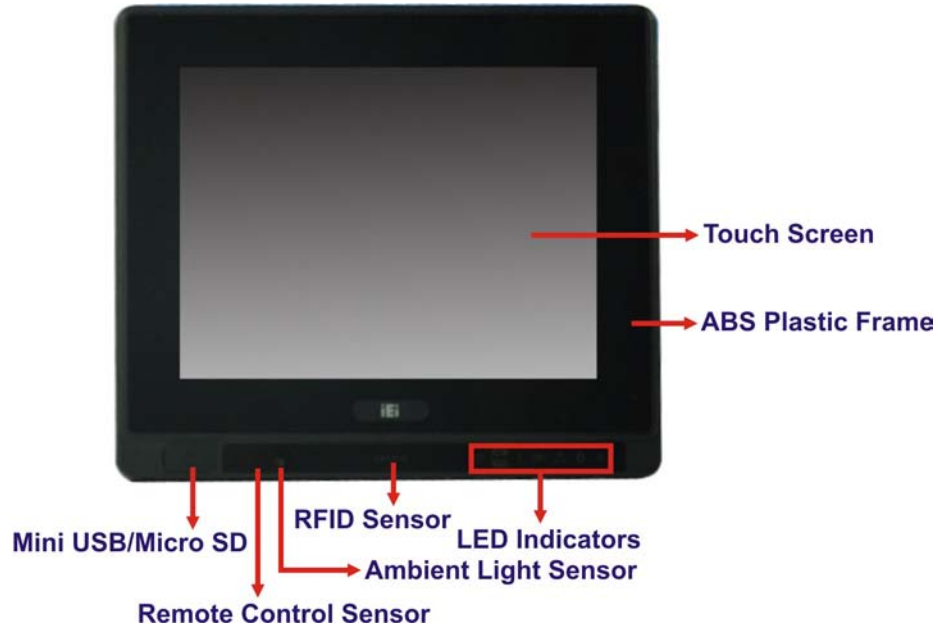

Figure 1-2: AFL2-08A-N26 Front View

### 1.2.1.1 LED Indicators

There are seven LED indicator lights located along the front of the LCD screen (Figure 1-3).

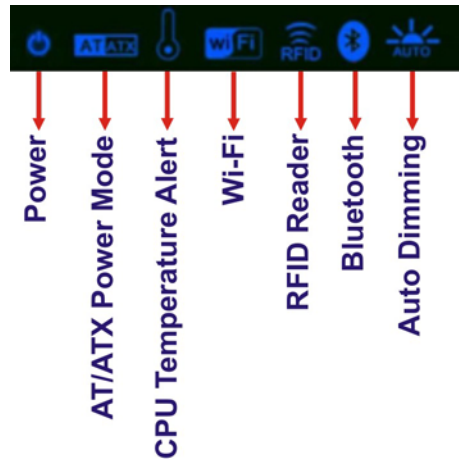

Figure 1-3: LED Indicators

The descriptions of each LED indicator are listed below.

LED Indicator	Description
Power	Shows power status. Orange: Standby mode. Blue: Power-on mode.
AT/ATX Mode	Shows the power mode status. Controlled by the AT/ATX power mode switch.
CPU Temperature Alert	BLUE: CPU temperature is normal. RED: CPU temperature is too high.
Wi-Fi	The Wi-Fi module is enabled or disabled. Controlled by the BIOS. See <b>Section 7.5.2</b>
RFID	The optional RFID reader is enabled or disabled. Controlled by the hot keys. See <b>Table 1-3</b>
Bluetooth	The Bluetooth module is enabled or disabled. Controlled by the BIOS. See <b>Section 7.5.2</b>
Auto Dimming	The auto-dimming function is enabled or disabled. Controlled by the BIOS. See <b>Section 7.5.2</b>

**Table 1-2: LED Indicators**



**NOTE:**

If the CPU temperature alert LED shows in red, the user must lower the environments temperature or close some running applications to cool down the CPU.

The corresponding Function Keys are located under the bottom right hand corner of the LCD screen (Figure 1-4).

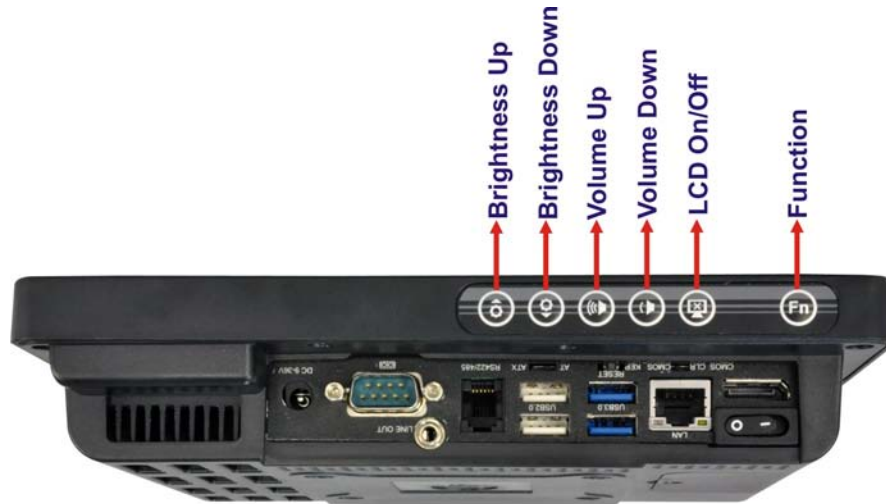

Figure 1-4: Function Keys

The Function Keys are described in Table 1-3:

Key Combination	Function Key Description
Fn + LCD On/Off	RFID Enable/Disable
Fn + Audio Volume Down	Audio Mute
Fn + Brightness Down	Mini USB / Micro SD Enable/Disable
Fn + Brightness Up	Power On/Off Note: To power on the system, hold down the Fn + Brightness Up buttons for 3 seconds. To power down the system, hold down the FN + Brightness Up buttons for six seconds.
Fn: The function key can maintain for 2sec.	

Table 1-3: Function Key Descriptions

### 1.2.2 Rear Panel

The rear panel provides access to retention screw holes that support the wall mounting. Refer to Figure 1-5.

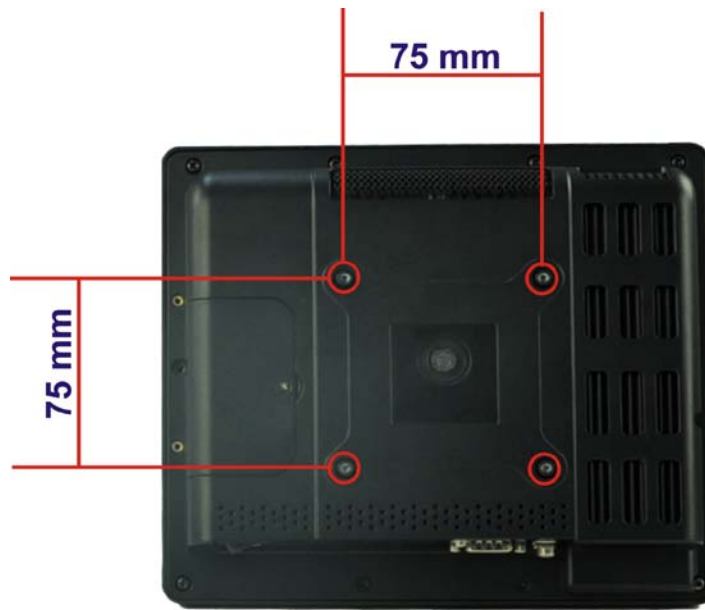
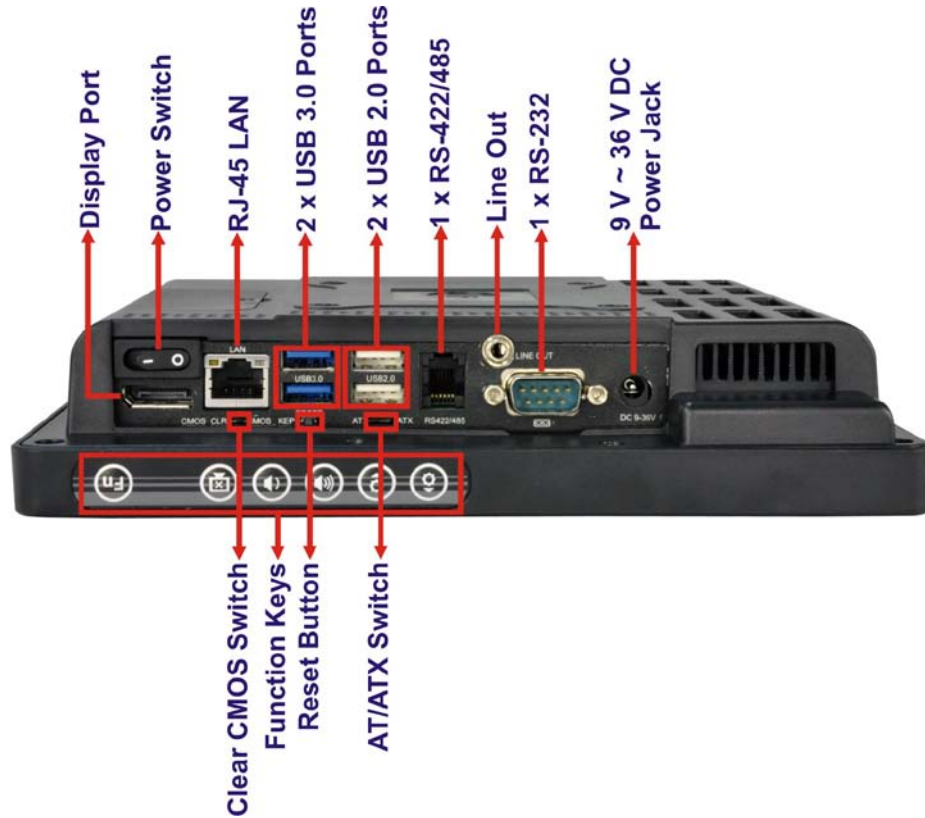

**Figure 1-5: AFL2-08A-N26 Rear View**

### 1.2.3 Bottom Panel

The bottom panel of the AFL2-08A-N26 has the following features (**Figure 1-6**):

- 1 x AT/ATX Switch
- 1 x Audio jack (Line out)
- 1 x Clear CMOS switch
- 1 x 9V ~ 36V DC power jack
- 1 x Display port
- 6 x Function keys
- 1 x Power switch
- 1 x Reset button
- 1 x RJ-45 LAN connector
- 1 x RS-232 connector (DB-9)
- 1 x RS-422/485 connector (RJ-11)
- 2 x USB 2.0 connectors
- 2 x USB 3.0 connectors



**Figure 1-6: AFL2-08A-N26 Bottom Panel**

### 1.3 Internal Overview

The AFL2-08A-N26 has the following components installed internally:

- 1 x Motherboard
- 1 x 2.0 GB 800 MHz DDR3 SO-DIMM

### 1.4 System Specifications

The technical specifications for the AFL2-08A-N26 systems are listed in **Table 1-4**.

Specification	AFL2-08A-N26
LCD Size	8" (4:3)
Max. Resolution	800 (W) x 600 (H)
Brightness (cd/m <sup>2</sup> )	250 cd/m <sup>2</sup>



## AFL2-08A-N26

<b>Contrast Ratio</b>	500:1
<b>LCD Color</b>	16.2 M
<b>Pixel Pitch (H x V) (mm)</b>	0.2025(H) x 0.2025(V)
<b>Viewing Angle (H-V)</b>	140° (H) / 130° (V)
<b>Backlight MTBF (hr)</b>	30000 hrs
<b>Touch Screen</b>	5-wire resistive type touch screen
<b>CPU</b>	Intel® Atom™ N2600 dual core 1.6 GHz CPU
<b>Chipset</b>	Intel® NM10
<b>Ethernet</b>	Realtek RTL8111E PCIe GbE controller support ASF2.0
<b>Memory</b>	Support one 800 MHz 204-pin DDR3 SO-DIMM slot (max. 2G) pre-installed with 2GB
<b>Expansion</b>	1 x PCIe x1 for Wi-Fi
<b>SSD</b>	PCIe mSATA
<b>Audio</b>	AMP 0.8 W + 0.8 W (built-in stereo speakers)
<b>Microphone</b>	Digital Microphone
<b>RFID Reader</b>	EM 125 KHz or MIFARE 13.56 MHz card reader (optional)
<b>MSR card reader</b>	MSR card reader (optional)
<b>Wireless</b>	1 x Wireless LAN 802.11 b/g/n 2T2R module (internal PCIe Mini card interface) (Optional, internal USB interface, Bluetooth V2.0+EDR)
<b>OSD Function</b>	LCD on / off, brightness up / down, volume up / down, Hot Key
<b>Construction Material</b>	PC+ ABS plastic front frame
<b>Mounting</b>	Wall, Panel, Stand and VESA 75 mm x 75mm
<b>Front Panel Color</b>	Black
<b>Net Weight</b>	1.43 kg / 2.2 kg
<b>Dimensions (W x H x D) (mm)</b>	215 (W) x 188 (H) x 46 (D)
<b>Operation Temperature</b>	-20°C ~ 40°C
<b>Storage Temperature</b>	-20°C ~ 60°C
<b>Humidity</b>	10% to 95% (non-condensing)
<b>IP level</b>	Front panel IP 64
<b>Safety&amp;EMC</b>	CE / FCC
<b>Power Supply</b>	36W power adapter Input: 90VAC~264VAC, 50/60 Hz, Output: 12VDC
<b>Power Requirement</b>	9V ~ 36V DC

<b>Power Consumption</b>	19V@1.1A (Intel® Atom™ N2600 CPU with 2GB DDR3 memory )
<b>I/O Ports and Switches</b>	1 x RS-232 connector (DB-9)
	1 x RS-422/485 connector (DJ-11)
	1 x GbE LAN (RJ-45)
	2 x USB 3.0 connectors
	2 x USB 2.0 connectors
	1 x Mini USB 2.0 port (on front panel)
	1 x Micro SD card slot (on front panel)
	1 x Audio jack (line-out)
	1 x Display port
	1 x Power switch
	1 x AT/ATX switch
	1 x Reset button
	1 x Clear CMOS button
1 x 9 V ~ 36V DC input jack	

**Table 1-4: System Specifications**

Chapter

2

# Detailed Specifications

---

## 2.1 Dimensions

The AFL2-08A-N26 dimensions are shown below.

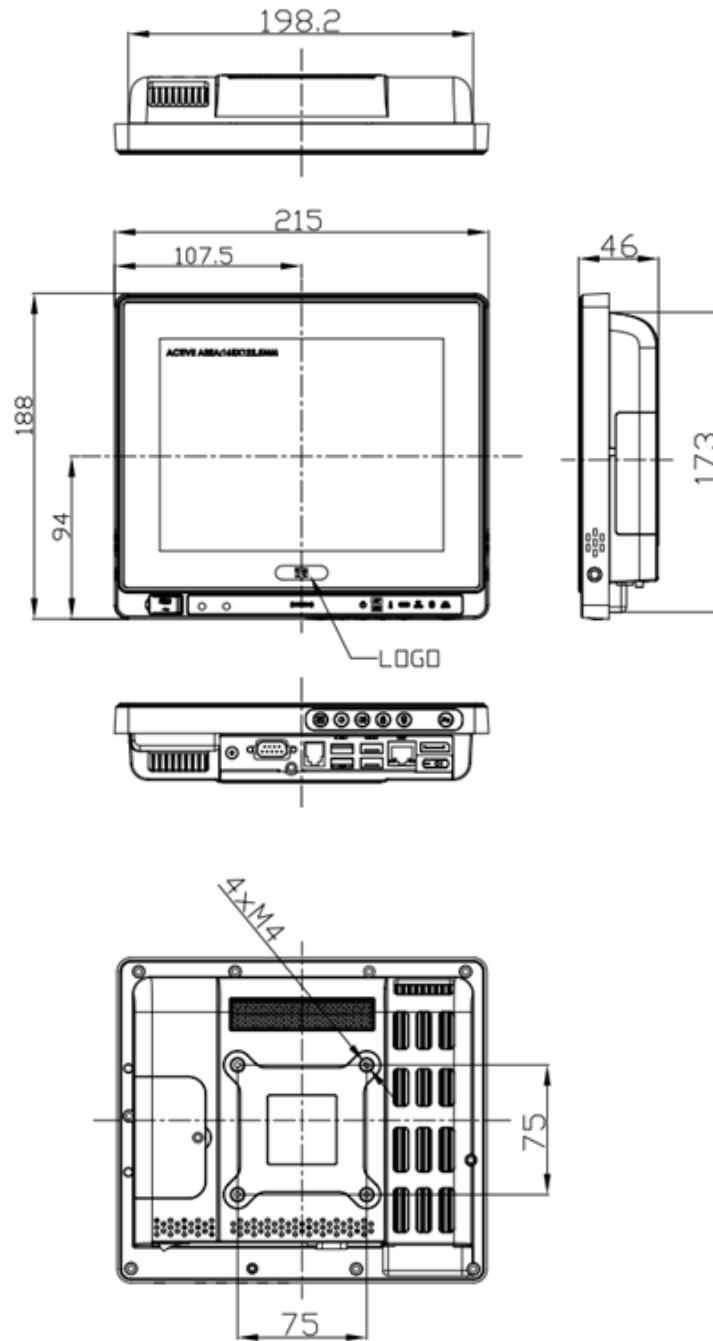

**Figure 2-1: AFL2-08A-N26 Dimensions (mm)**

## 2.2 Intel® Atom™ Processor

An Intel® Atom™ N2600 processor is installed in the system. The N2600 CPU is a 1.6 GHz dual core processor with Direct Media Interface (DMI) speed of 2.5 GT/s. The CPU also features a 1.0 MB L2 cache.

## 2.3 Motherboard Components

The following sections describe some of the features on the motherboard.

### 2.3.1 Memory Capacity

One 204-pin 2.0 GB 800 MHz DDR3 SO-DIMM is installed in the AFL2-08A-N26 and controlled by the Intel® Atom™ N2600 CPU installed on the internal motherboard.

### 2.3.2 Storage Capacity

The AFL2-08A-N26 also supports a PCIe mSATA card which can be easily accessed by removing one screw on the mSATA cover.

## 2.4 External Peripheral Interface Connectors

The following section describes the external peripheral interface connectors on the bottom panel of the system.

### 2.4.1 Serial Port Connectors

The AFL2-08A-N26 has one RS-232 serial port (DB-9) and one RS-422/485 serial port (RJ-11). Enabling COM devices to be powered through the COM port eliminates unnecessary and messy cabling.



**Figure 2-2: Serial Ports**

### 2.4.2 LAN Connectivity

The AFL2-08A-N26 has one RJ-45 LAN connector on the bottom panel.



**Figure 2-3: RJ-45 Ethernet Connector (Bottom Panel)**

The PCIe LAN from the Intel® NM10 chipset of the AFL2-08A-N26 is interfaced to the Realtek RTL8111E PCIe gigabit Ethernet (GbE) controller. The RTL8111E controller is connected directly to the RJ-45 connector and provides external GbE connectivity.

### 2.4.3 External USB Connectors

There are two USB 2.0 connectors and two USB 3.0 connectors on the bottom panel of the AFL2-08A-N26. All USB connectors are fully compliant with USB specification

## AFL2-08A-N26

Revision 2.0 and USB specification Revision 1.1 and can be interfaced to both USB 1.1 and USB 2.0 compliant devices. Only USB 3.0 connectors are compatible with USB 3.0 devices.

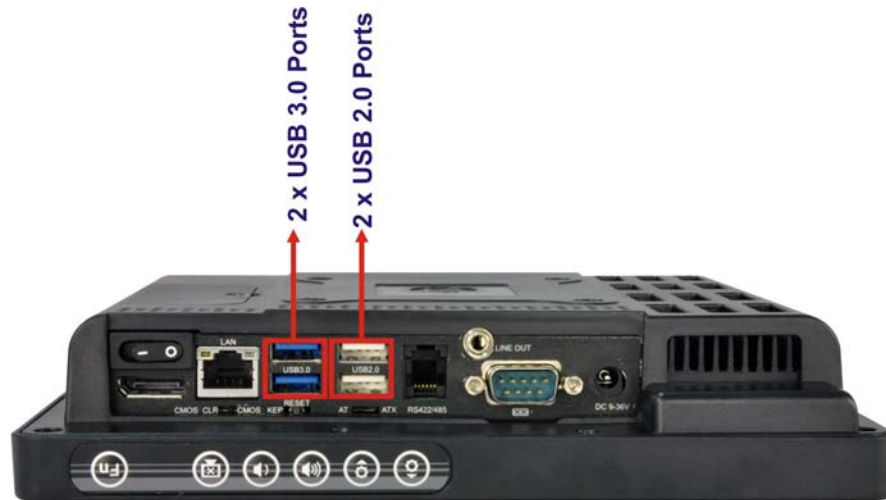

**Figure 2-4: External USB Ports (Bottom Panel)**

## 2.5 Audio

### 2.5.1 Audio Codec Controller

The integrated HD Audio compliant audio controller on the Intel® NM10 chipset is integrated to a Realtek ALC892 audio codec. The Realtek ALC892 is connected to one external audio jack (Line out), which is then connected to compliant audio device. The Realtek ALC892 is a 7.1+2 channel high definition audio codec with ten DAC channels. It supports 7.1 sound playback and 2 channels of independent stereo sound output. The audio jack is shown in **Figure 2-5**.



**Figure 2-5: Audio Jack**

### 2.5.2 Stereo Speakers

Two internal 0.8 W stereo speakers on the sides of the AFL2-08A-N26 are interfaced to the system.



Chapter

3

# Unpacking

---

### 3.1 Unpacking

To unpack the flat bezel panel PC, follow the steps below:



#### **WARNING!**

The front side LCD screen has a protective plastic cover stuck to the screen. Only remove the plastic cover after the flat bezel panel PC has been properly installed. This ensures the screen is protected during the installation process.

**Step 1:** Use box cutters, a knife or a sharp pair of scissors that seals the top side of the external (second) box.

**Step 2:** Open the external (second) box.

**Step 3:** Use box cutters, a knife or a sharp pair of scissors that seals the top side of the internal (first) box.

**Step 4:** Lift the monitor out of the boxes.

**Step 5:** Remove both polystyrene ends, one from each side.

**Step 6:** Pull the plastic cover off the flat bezel panel PC.

**Step 7:** Make sure all the components listed in the packing list are present.

#### 3.1.1 Packing List

The AFL2-08A-N26 flat bezel panel PC is shipped with the following components:

Quantity	Item	Image
Standard		
1	AFL2-08A-N26 panel PC	

## AFL2-08A-N26

1	Power adapter	
1	Power cord (P/N: 32702-000200-100-RS)	
1	Power transfer cord (P/N: 32702-000300-100-RS)	
1	RJ-11 to DB-9 COM port cable	
1	Infrared Remote Controller (P/N: 7Z000-SLPCB001-RS)	
1	Pen (P/N: 43125-0002C0-00-RS)	
1	Utility CD	
1	One Key Recovery CD	
<b>Optional</b>		
Panel Mounting Kit (P/N: AFL2PK-W07A)		
Wall mounting kit (P/N: AFLWK-12)		
Rack Mounting Kit (P/N: AFL2RK-08A)		

Stand (P/N: STAND-A08/STAND-B08/STAND-C12)	
V-stand (P/N: VSTAND-A07)	
Hybrid Card Reader (P/N: AFL2P-07AMSI-U-R10)	
Magnetic Stripe Reader (P/N: AFL2P-07AMSR-U-R10)	
Bluetooth Module Kit (P/N: AFL2-BT-KIT01-R11)	
OS: Win CE 6.0 (CD-ROM) (P/N: AFL2-W07A-CV-CE060-R10)	
OS: Win XPE (CD-ROM) (P/N: AFL2-W07A-CV-XPE-R10)	
OS: Linux (CD-ROM) (P/N: AFL2-W07A-CV-LNX-R10)	
OS: Win 7 Embedded (CD-ROM) (P/N: AFL2-W07A-CV-WES7E-R10 for Resistive Touch)	

If any of these items are missing or damaged, contact the distributor or sales representative immediately.

Chapter

4

# Installation

---

## 4.1 Anti-static Precautions

---



### WARNING:

Failure to take ESD precautions during the maintenance of the AFL2-08A-N26 may result in permanent damage to the AFL2-08A-N26 and severe injury to the user.

---

Electrostatic discharge (ESD) can cause serious damage to electronic components, including the AFL2-08A-N26. Dry climates are especially susceptible to ESD. It is therefore critical that whenever the AFL2-08A-N26 is accessed internally, or any other electrical component is handled, the following anti-static precautions are strictly adhered to.

- **Wear an anti-static wristband:** - Wearing a simple anti-static wristband can help to prevent ESD from damaging the board.
- **Self-grounding:** - Before handling the board touch any grounded conducting material. During the time the board is handled, frequently touch any conducting materials that are connected to the ground.
- **Use an anti-static pad:** - When configuring the AFL2-08A-N26, place it on an anti-static pad. This reduces the possibility of ESD damaging the AFL2-08A-N26.
- **Only handle the edges of the PCB:** - When handling the PCB, hold the PCB by the edges.

## 4.2 Installation Precautions

When installing the flat bezel panel PC, please follow the precautions listed below:

- **Power turned off:** When installing the flat bezel panel PC, make sure the power is off. Failing to turn off the power may cause severe injury to the body and/or damage to the system.
- **Certified Engineers:** Only certified engineers should install and modify onboard functionalities.

## AFL2-08A-N26

- **Anti-static Discharge:** If a user open the rear panel of the flat bezel panel PC, to configure the jumpers or plug in added peripheral devices, ground themselves first and wear an anti-static wristband.

### 4.3 Installation and Configuration Steps

The following installation steps must be followed.

- Step 1:** Unpack the flat bezel panel PC.
- Step 2:** Install the mSATA card.
- Step 3:** Configure the system.
- Step 4:** Connect peripheral devices to the flat bezel panel PC.
- Step 5:** Mount the flat bezel panel PC.

### 4.4 mSATA card Installation



#### **WARNING:**

Over-tightening back cover screws will crack the plastic frame.  
Maximum torque for cover screws is 5 kg-cm (0.36 lb-ft/0.49 Nm).

---

To install the mSATA card into the AFL2-08A-N26, please follow the steps below:

- Step 1:** Remove one (1) retention screw from the mSATA cover (**Figure 4-1**).



**Figure 4-1: mSATA Cover Retention Screw**

**Step 2:** Remove the mSATA cover from the device.

**Step 3:** Locate the PCIe mini card slot on the motherboard. **(Figure 4-2).**

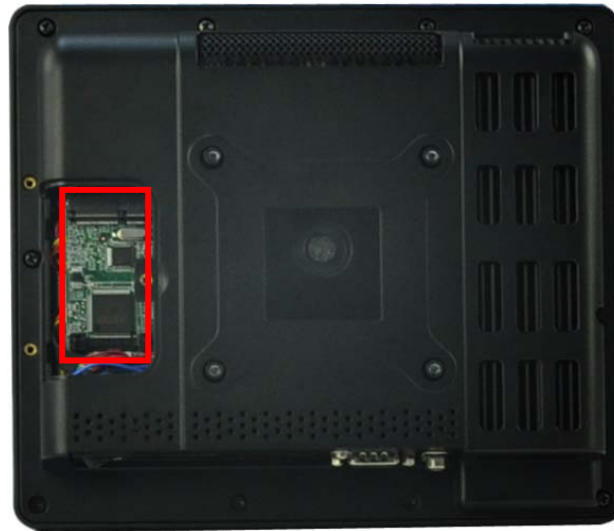

**Figure 4-2: PCIe Mini Card Slot**

**Step 4:** Insert into the slot at an angle. Line up the notch on the card with the notch on the connector. Slide the mSATA card into the slot at an angle of about 20°.



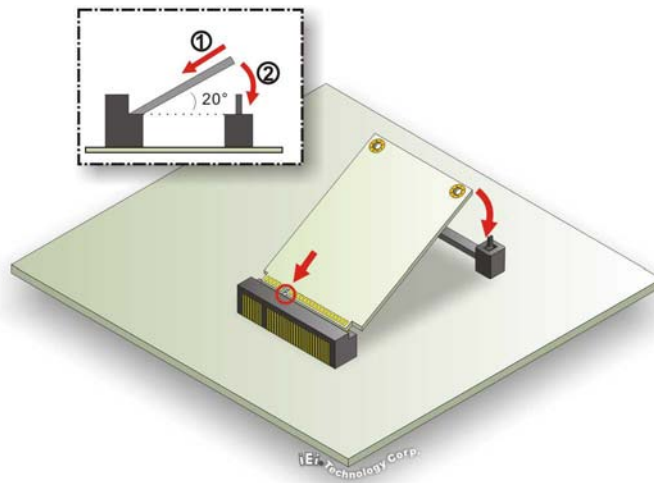

**Figure 4-3: PCIe Mini Card Installation**

**Step 5:** Push down until the card clips into place. Push the other end of the card down until it clips into place on the plastic connector.

**Step 6:** Replace the mSATA cover and secure it using one (1) retention screw.

## 4.5 RFID Reader (Optional)

The AFL2-08A-N26 series (selected models only) supports RFID reader function. The RFID reader is located at the bottom of the screen. An optional Mifare 13.56 MHz or EM 125 KHz RFID reader can be integrated in the system. All the data on the RFID tag can be easily retrieved or updated through the reader to secure the data transmission process and increase efficiency for certain identity group.

To install the RFID reader, follow the steps below.

**Step 1:** Connect the RFID USB cable to the USB connector on the RFID reader module.

(Figure 4-4)



**Figure 4-4: Connect the RFID USB cable**

**Step 2:** Connect the RFID connector of the RFID USB cable to the RFID connector on the motherboard (RFID1).

**Step 3:** Attach the sticker of the RFID module to the bottom of the panel.

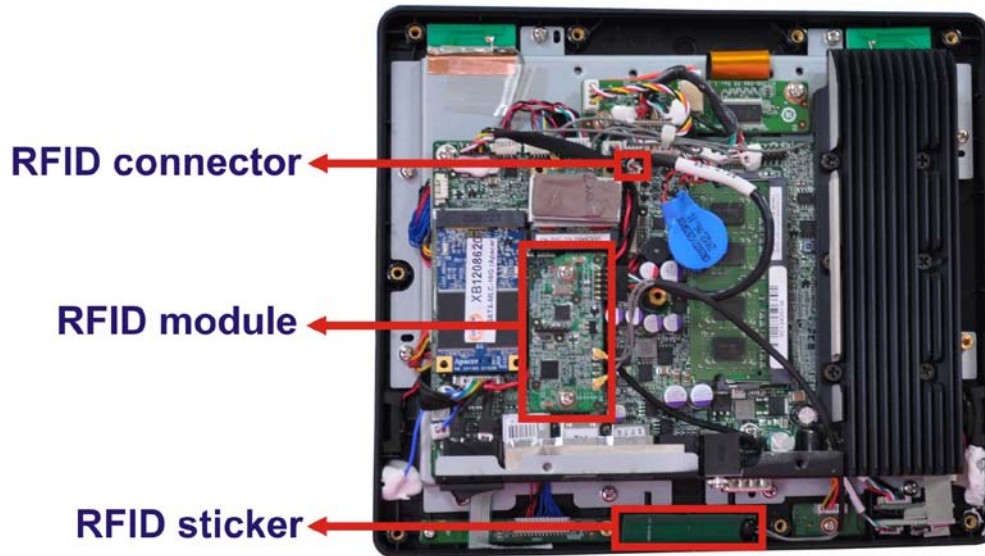

**Figure 4-5: Install the RFID module**

**Step 4:** Secure the RFID module to the motherboard using two retention screws on either side.

## AFL2-08A-N26

**Step 5:** Use the RFID reader to read a RFID card.

### 4.6 AT/ATX Mode Selection

AT or ATX power mode can be used on the AFL2-08A-N26. The selection is made through an AT/ATX switch located on the bottom panel (Figure 4-6). To select AT mode or ATX mode, follow the steps below.

**Step 1:** Locate the AT/ATX switch on the bottom panel (**Figure 4-6**).



**Figure 4-6: AT/ATX Switch Location**

**Step 2:** Adjust the AT/ATX switch.

#### 4.6.1 AT Power Mode

With the AT mode selected, the power is controlled by a central power unit rather than a power switch. The AFL2-08A-N26 panel PC turns on automatically when the power is connected. The AT mode benefits a production line to control multiple panel PCs from a central management center and other applications including:

- ATM
- Self-service kiosk
- Plant environment monitoring system
- Factory automation platform
- Manufacturing shop flow

#### 4.6.2 ATX Power Mode

With the ATX mode selected, the AFL2-08A-N26 panel PC goes in a standby mode when it is turned off. The panel PC can be easily turned on via network or a power switch in standby mode. Remote power control is perfect for advertising applications since the broadcasting time for each panel PC can be set individually and controlled remotely. Other possible application includes

- Security surveillance
- Point-of-Sale (POS)
- Advertising terminal

#### 4.7 Clear CMOS

If the AFL2-08A-N26 fails to boot due to improper BIOS settings, the clear CMOS switch clears the CMOS data and resets the system BIOS information. To do this, adjust the clear CMOS switch to clear CMOS mode for a few seconds then reinstall the clear CMOS switch back to keep CMOS mode.

**Step 1:** Locate the clear CMOS switch on the bottom panel (**Figure 4-7**).



**Figure 4-7: Clear CMOS Switch Location**

**Step 2:** Adjust the clear CMOS switch.

#### 4.8 Reset the System

The reset button enables user to reboot the system when the system is turned on. To reboot the system, follow the steps below.

**Step 1:** Locate the reset button on the bottom panel (**Figure 4-8**).



**Figure 4-8: Reset Button Location**

**Step 2:** Press the reset button.

## 4.9 Powering On the System

To power on the system, follow the steps below:

**Step 1:** Locate the **Function** and **Brightness Up** function keys. See **Section 1.2.1.1**.

**Step 2:** Hold down the Function and Brightness Up buttons for **three** seconds to power on the system.

## 4.10 Powering Off the System

To power off the system, follow the steps below:

**Step 1:** Locate the **Function** and **Brightness Up** function keys. See **Section 1.2.1.1**.

**Step 2:** Hold down the Function and Brightness Up buttons for **six** seconds to power off the system.

## 4.11 Mounting the System

---



### **WARNING!**

When mounting the flat bezel panel PC onto an arm, onto the wall or onto a panel, it is better to have more than one person to help with the installation to make sure the panel PC does not fall down and get damaged.

---

The three methods of mounting the AFL2-08A-N26 are listed below.

- Wall mounting
- Panel mounting
- Stand mounting

The three mounting methods are described below.

### 4.11.1 Wall Mounting

To mount the flat bezel panel PC onto the wall, please follow the steps below.

- Step 1:** Select the location on the wall for the wall-mounting bracket.
- Step 2:** Carefully mark the locations of the four screw holes in the bracket on the wall.
- Step 3:** Drill four pilot holes at the marked locations on the wall for the bracket retention screws.
- Step 4:** Align the wall-mounting bracket screw holes with the pilot holes.
- Step 5:** Secure the mounting-bracket to the wall by inserting the retention screws into the four pilot holes and tightening them (**Figure 4-9**).

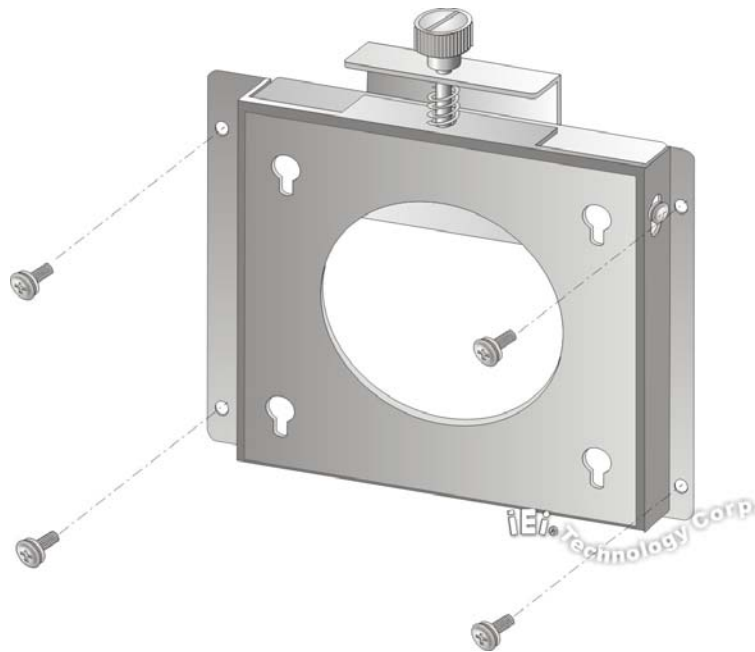

**Figure 4-9: Wall-mounting Bracket**

**Step 6:** Insert the four monitor mounting screws provided in the wall mount kit into the four screw holes on the rear panel of the flat bezel panel PC and tighten until the screw shank is secured against the rear panel (**Figure 4-10**).



**WARNING:**

Please use the M4 screws provided in the wall mount kit for the rear panel. If the screw is missing, the thread depth of the replacement screw should be not more than 4 mm.

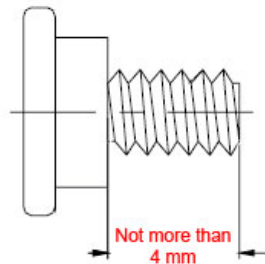

**Step 7:** Align the mounting screws on the monitor rear panel with the mounting holes on the bracket.

**Step 8:** Carefully insert the screws through the holes and gently pull the monitor downwards until the monitor rests securely in the slotted holes (**Figure 4-10**). Ensure that all four of the mounting screws fit snugly into their respective slotted holes.

**NOTE:**

In the diagram below the bracket is already installed on the wall.

---

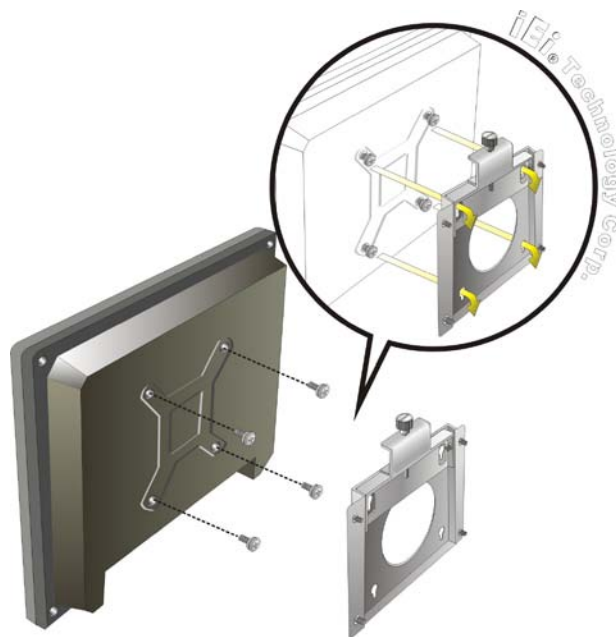

**Figure 4-10: Chassis Support Screws**

**Step 9:** Secure the panel PC by fastening the retention screw of the wall-mounting bracket. (**Figure 4-11**).



AFL2-08A-N26

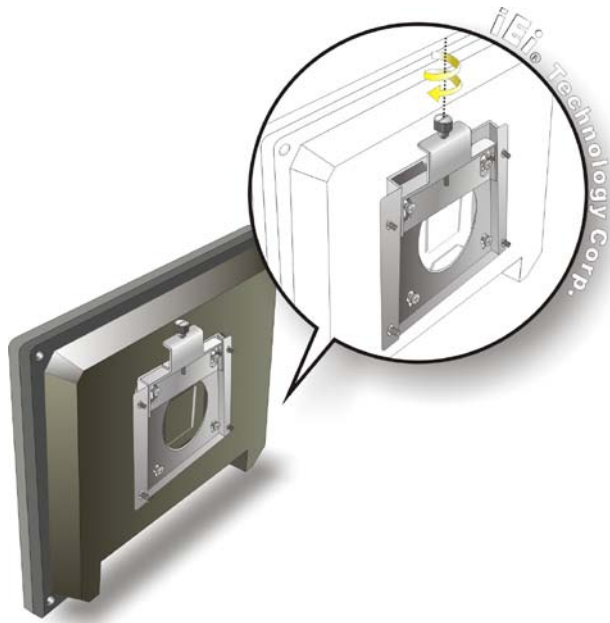

Figure 4-11: Secure the Panel PC

4.11.2 Panel Mounting

To mount the AFL2-08A-N26 flat bezel panel PC into a panel, please follow the steps below.

- Step 1: Select the position on the panel to mount the flat bezel panel PC.
- Step 2: Cut out a section corresponding to the size shown below. The size must be smaller than the outer edge.

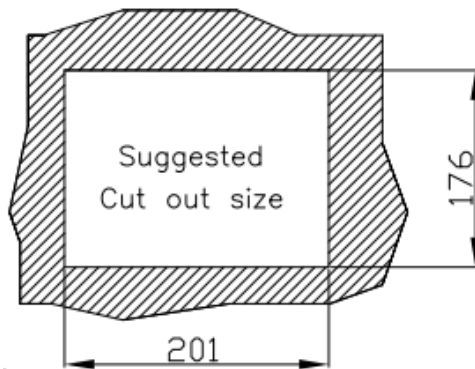
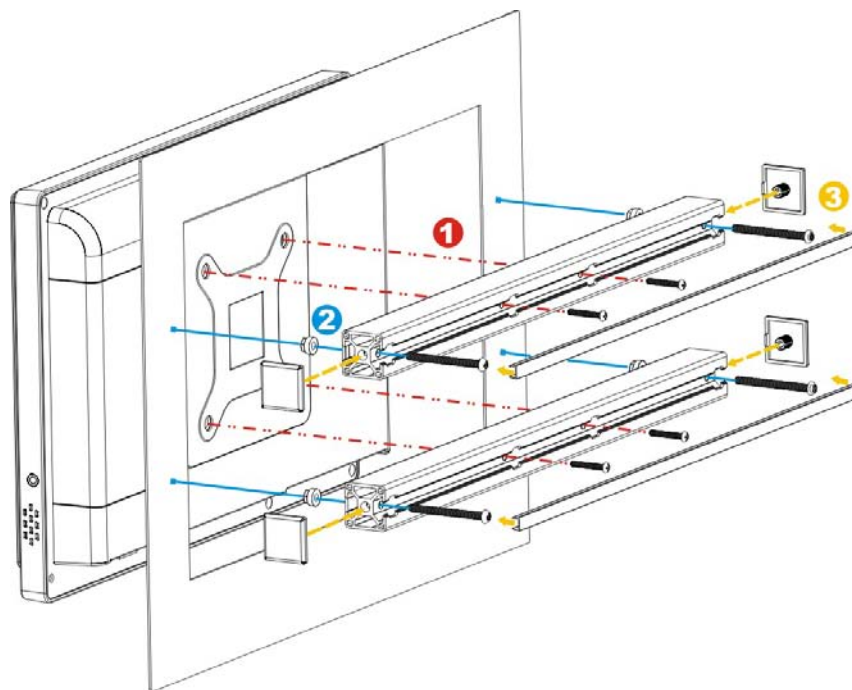

Figure 4-12: Cutout Dimensions

- Step 3:** Slide the flat bezel panel PC through the hole until the frame is flush against the panel.
- Step 4:** Align the panel mounting bracket screw holes with the VESA mounting holes on the rear of the panel PC.
- Step 5:** Secure the two panel mounting brackets to the rear of the panel PC by inserting the four retention screws into the VESA mounting holes (**Figure 4-13 ①**).
- Step 6:** Insert the panel mounting clamps into the holes of the panel mounting brackets (**Figure 4-13 ②**). There are a total of 4 panel mounting clamps for AFL2-08A-N26.
- Step 7:** Tighten the screws that pass through the panel mounting clamps until the plastic caps at the front of all the screws are firmly secured to the panel.
- Step 8:** Install the covers into the panel mounting bracket. Each mounting bracket includes two side covers and one top cover (**Figure 4-13 ③**).



**Figure 4-13: Tighten the Panel Mounting Clamp Screws**

## AFL2-08A-N26

### 4.11.3 Stand Mounting

To mount the AFL2-08A-N26 using the stand mounting kit, please follow the steps below.

**Step 1:** Locate the screw holes on the rear of the AFL2-08A-N26. This is where the bracket will be attached. (Figure 4-14)



**Figure 4-14: Mounting screw location**

**Step 2:** Align the bracket with the screw holes.

**Step 3:** To secure the bracket to the AFL2-08A-N26, insert the retention screws into the screw holes and tighten them.

## 4.12 External Peripheral Device Connection

The following external peripheral devices can be connected to the external peripheral interface connectors.

- Audio devices
- Display devices
- RJ-45 Ethernet cable connector
- Serial port devices
- USB devices

To install these devices, connect the corresponding cable connector from the actual device to the corresponding AFL2-08A-N26 external peripheral interface connector making sure the pins are properly aligned.

#### 4.12.1 Audio Connection

The audio jack on the external audio connector enables the AFL2-08A-N26 to be connected to a stereo sound setup. To install the audio devices, follow the steps below.

- Step 1: Identify the audio plugs.** The plugs on your home theater system or speakers may not match the colors on the rear panel. If audio plugs are plugged into the wrong jacks, sound quality will be very bad.
- Step 2: Plug the audio plug into the audio jack.** Plug the audio plug into the audio jack. If the plug on your speakers is different, an adapter will need to be used to plug them into the audio jack. The audio jack on the AFL2-08A-N26 is a line-out port which connects to a headphone or a speaker.

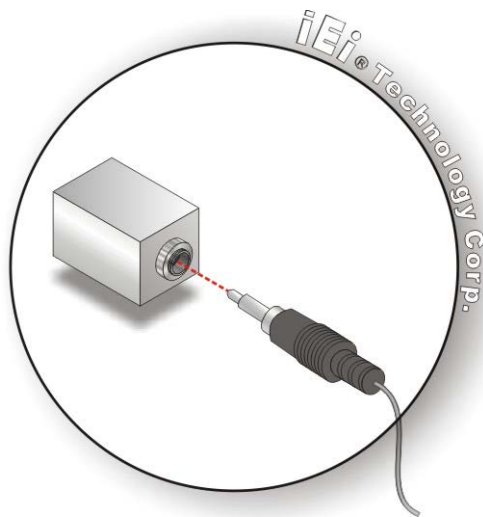

**Figure 4-15: Audio Connector**

- Step 3: Check audio clarity.** Check that the sound is coming through the right speakers by adjusting the balance front to rear and left to right.

## AFL2-08A-N26

### 4.12.2 Display Device Connection

The DisplayPort connector transmits a digital signal to compatible DisplayPort display devices such as a TV or computer screen. To connect the DisplayPort cable to the AFL2-08A-N26, follow the steps below.

**Step 1:** **Locate the DisplayPort connector.** The location is shown in **Chapter 1**.

**Step 2:** **Align the connector.** Align the DisplayPort connector with the DisplayPort port. Make sure the orientation of the connector is correct.

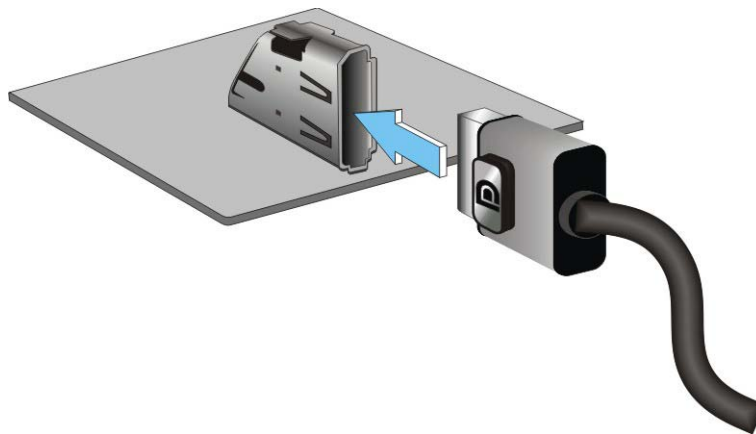

**Figure 4-16: DisplayPort Connection**

**Step 3:** **Insert the DisplayPort connector.** Gently insert the DisplayPort connector. The connector should engage with a gentle push. If the connector does not insert easily, check again that the connector is aligned correctly, and that the connector is being inserted with the right way up.

### 4.12.3 LAN Connection

There is one external RJ-45 LAN connector. The RJ-45 connector enables connection to an external network. To connect a LAN cable with an RJ-45 connector, please follow the instructions below.

**Step 1:** **Locate the RJ-45 connector.** The location of the LAN connector is shown in **Chapter 1**.

**Step 2:** **Align the connector.** Align the RJ-45 connector on the LAN cable with the RJ-45 connector on the AFL2-08A-N26. See **Figure 4-17**.

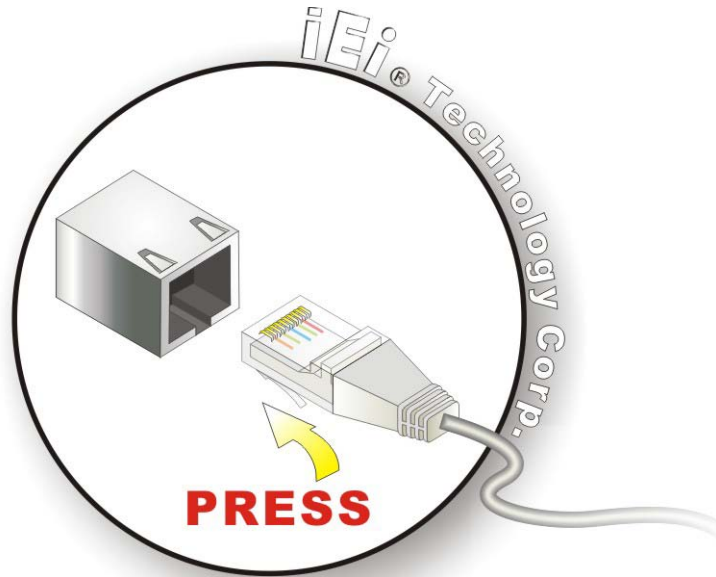

**Figure 4-17: LAN Connection**

**Step 3:** **Insert the LAN cable RJ-45 connector.** Once aligned, gently insert the LAN cable RJ-45 connector into the external interface.

#### 4.12.4 Serial Device Connection

There is one external RS-232 DB-9 connector and one RS-422/485 RJ-11 connector for serial device connection. Follow the steps below to connect a serial device to the AFL2-08A-N26.

##### 4.12.4.1 DB-9 Serial Port Connection

Follow the steps below to connect a serial device to the DB-9 connector of the AFL2-08A-N26 panel PC.

**Step 1:** **Locate the DB-9 connector.** The location of the DB-9 connector is shown in **Chapter 1**.

## AFL2-08A-N26

**Step 2:** **Insert the serial connector.** Insert the DB-9 connector of a serial device into the DB-9 connector on the bottom panel. See **Figure 4-18**.

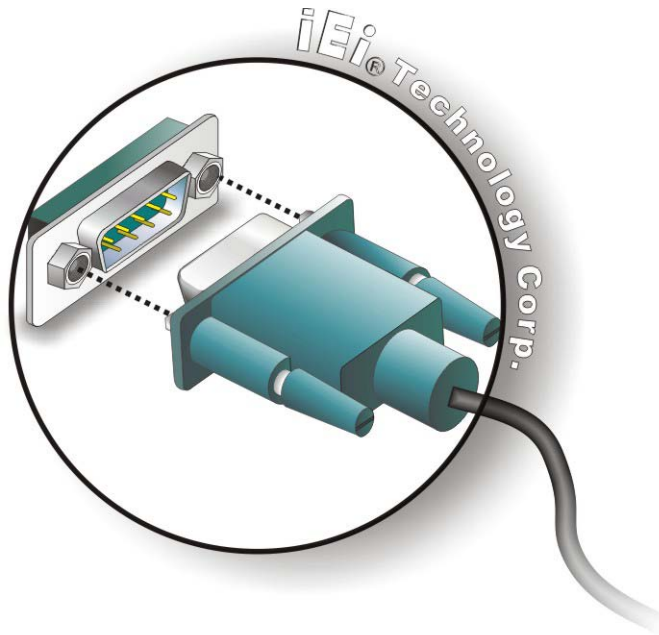

**Figure 4-18: DB-9 Serial Port Connector**

**Step 3:** **Secure the connector.** Secure the serial device connector to the external interface by tightening the two retention screws on either side of the connector.

#### 4.12.4.2 RJ-11 Serial Port Connection

Follow the steps below to connect a serial device to the RJ-11 serial port connector of the AFL2-08A-N26 panel PC.

**Step 1:** **Locate the RJ-11 serial port.** The location of the RJ-11 serial port is shown in **Chapter 1**.

**Step 2:** **Connect the RJ-11 to DB-9 COM port cable to the panel PC.** Insert the RJ-11 connector end of cable into the RJ-11 serial port. See **Figure 4-19**.

**Step 3:** **Connect the serial device.** Connect a serial device to the DB-9 connector end of the cable. See **Figure 4-19**.

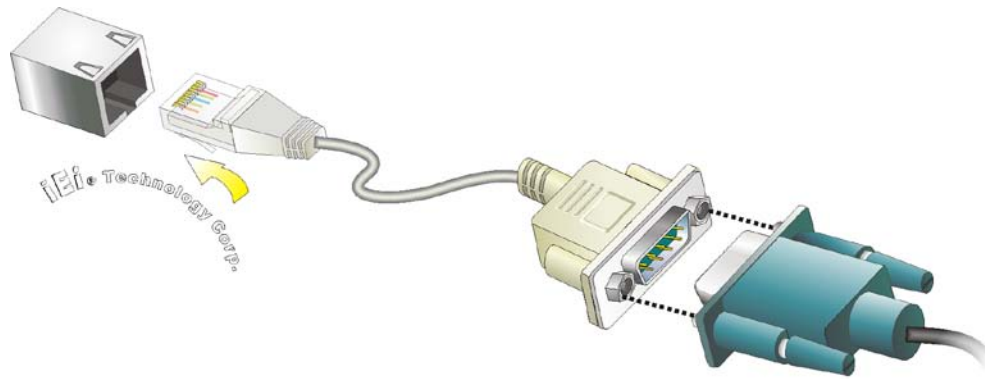

**Figure 4-19: RJ-11 Serial Port Connector**

**Step 4: Secure the connector.** Secure the serial device connector to the external interface by tightening the two retention screws on either side of the connector.

The DB-9 connector pinouts are listed below.

PIN NO.	RS-422	RS-485
1	RX+	-
2	RX-	-
3	TX+	D+
4	TX-	D-
5	-	-
6	-	-
7	-	-
8	-	-
9	-	-

#### 4.12.5 USB Device Connection



**NOTE:**

User must install the USB 3.0 driver before connecting a USB device to the system or else the system may not recognize the connected device.



#### 4.12.5 USB Device Connection

**NOTE:**

User must install the USB 3.0 driver before connecting a USB device to the system or else the system may not recognize the connected device.

There are two USB 2.0 connectors and two USB 3.0 connectors on the AFL2-08A-N26. To connect a USB device, please follow the instructions below.

**Step 1:** **Locate the USB connectors.** The locations of the USB connectors are shown in **Chapter 1**.

**Step 2:** **Align the connectors.** Align the USB device connector with one of the connectors on the bottom panel. See **Figure 4-21**.

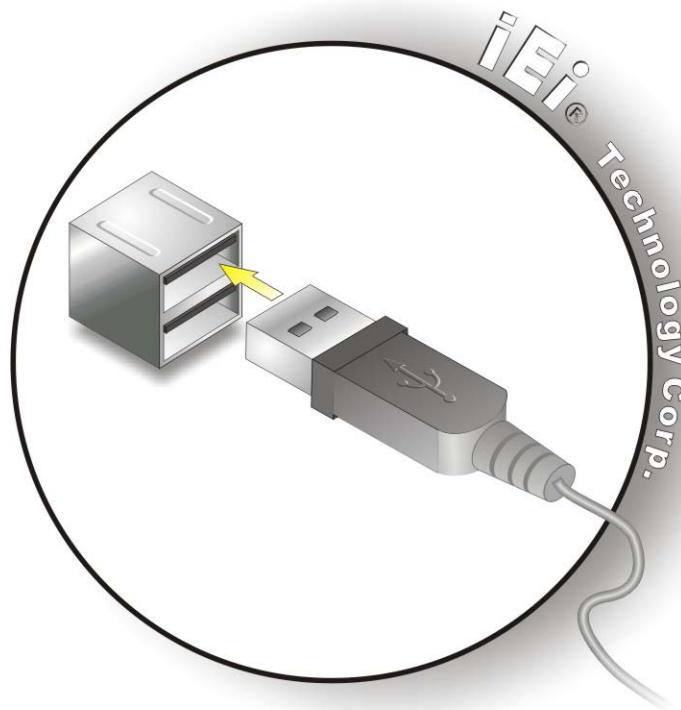

**Figure 4-21: USB Device Connection**



**Step 3: Insert the device connector.** Once aligned, gently insert the USB device connector into the onboard connector.

Chapter

5

# System Motherboard

---

## 5.1 Overview

This chapter details all the jumpers and connectors of the system motherboard.

### 5.1.1 Layout

The figures below show all the connectors and jumpers of the system motherboard. The Pin 1 locations of the on-board connectors are also indicated in the diagram below.

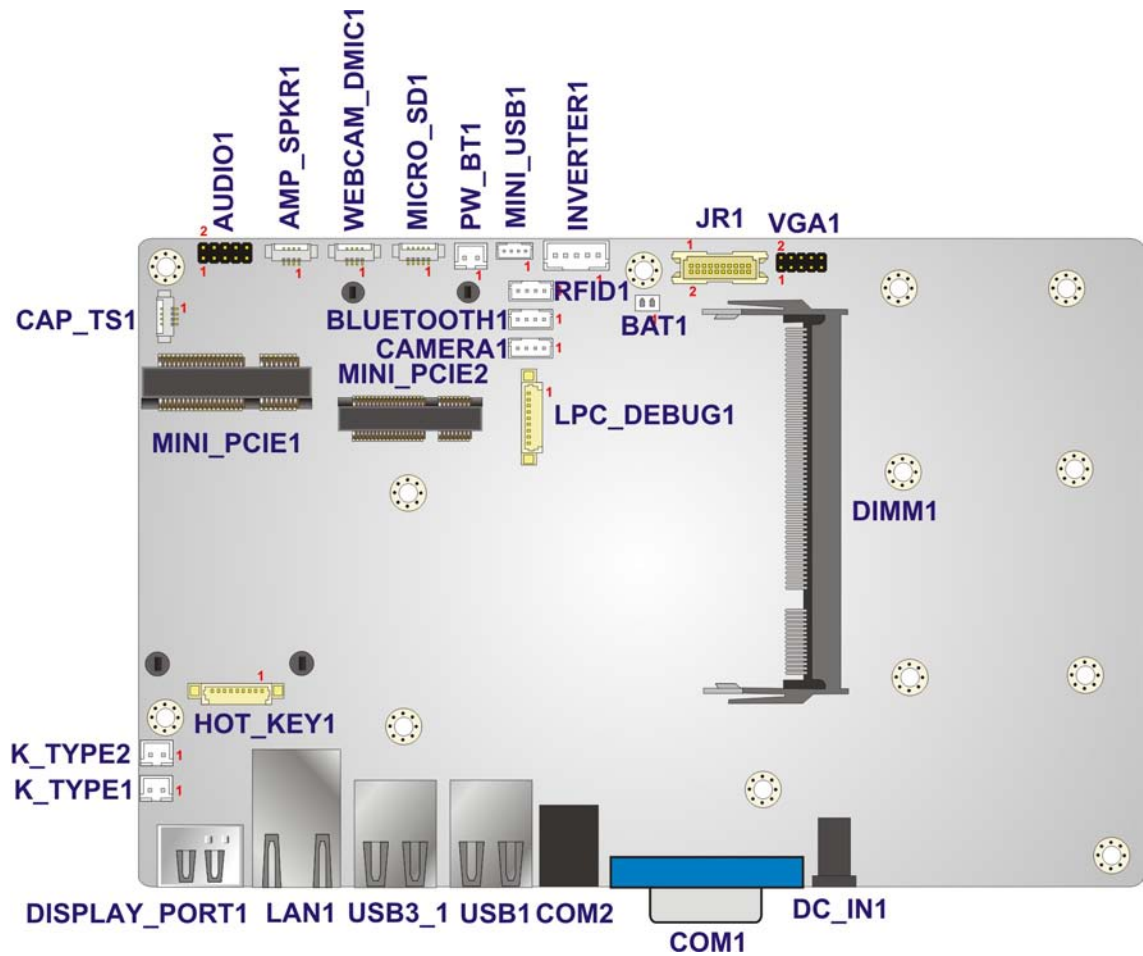
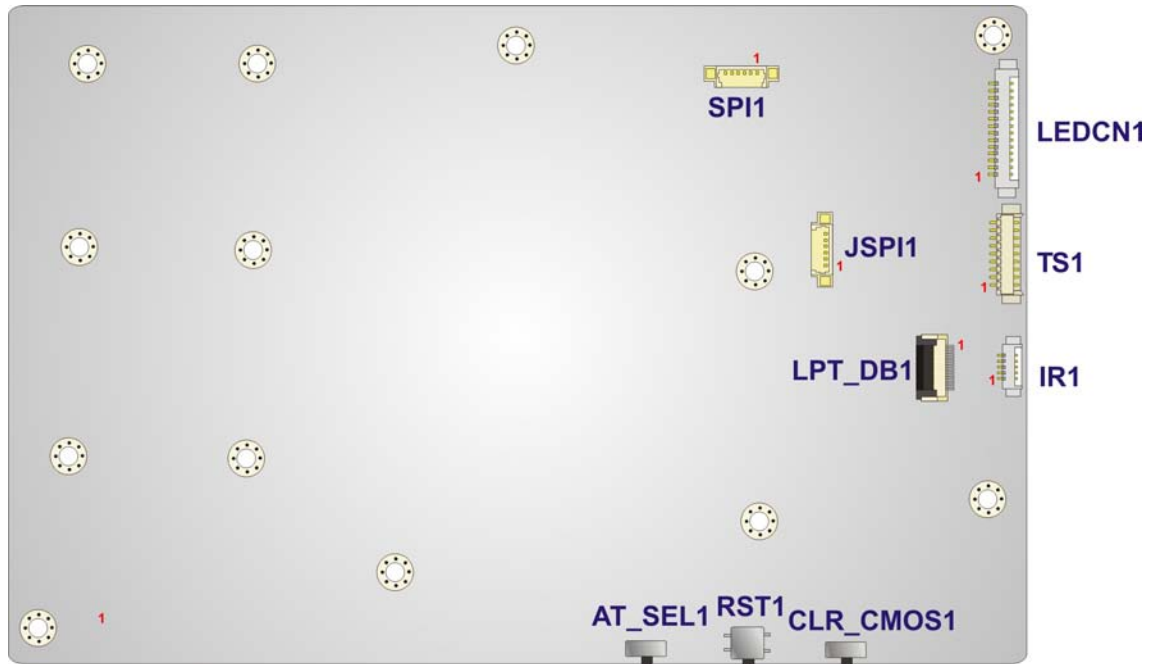

Figure 5-1: System Motherboard (front)



**Figure 5-2: System Motherboard (rear)**

## 5.2 Internal Peripheral Connectors

The table below shows a list of the internal peripheral interface connectors on the system motherboard. Pinouts of these connectors can be found in the following sections.

Connector	Type	Label
Audio connector	10-pin header	AUDIO1
Auto-dimming connector	5-pin wafer	IR1
Battery connector	2-pin wafer	BAT1
BIOS programming connector	6-pin wafer	SPI1
Bluetooth connector	4-pin wafer	BLUETOOTH1
DDR3 SO-DIMM slot	DDR3 SO-DIMM slot	DIMM1
Debug port connector	9-pin wafer	LPC_DEBUG1
EC firmware connector	6-pin wafer	JSPI1
Hot key connector	9-pin wafer	HOT_KEY1

Connector	Type	Label
K type connector	2-pin wafer	K_TYPE1, K_TYPE2
LCD inverter connector	5-pin wafer	INVERTER1
LCD LVDS connector	20-pin wafer	JR1
LED connector	14-pin wafer	LEDCN1
LPT connector	20-pin wafer	LPT_DB1
Micro SD connector	5-pin wafer	MICRO_SD1
Mini USB connector	4-pin wafer	MINI_USB1
Microphone connector	4-pin wafer	WEBCAM_DMIC1
PCIe mini card slot	PCIe mini card slot	MINI_PCIE1, MINI_PCIE2
Power button connector	2-pin wafer	PW_BT1
RFID USB connector	4-pin wafer	RFID1
Speaker connector	4-pin wafer	AMP_SPKR1
Touch panel connector	9-pin wafer	TS1
Touch panel connector	4-pin wafer	CAP_TS1
VGA connector	10-pin header	VGA1
Webcam connector	4-pin wafer	CAMERA1
AT/ATX mode select	switch	AT_SEL1
Clear CMOS	switch	CLR_COMS1
Reset button	button	RST1

**Table 5-1: Peripheral Interface Connectors**

### 5.2.1 Audio Connector (AUDIO1)

PIN NO.	DESCRIPTION	PIN NO.	DESCRIPTION
1	LINE_OUTR	2	LMIC1-L
3	AMP_INR	4	LMIC1-R
5	LINE_OUTL	6	FRONT_JD
7	FRONT_JD	8	MIC1_JD

9	GND_AUDIO	10	GND_AUDIO
---	-----------	----	-----------

**Table 5-2: Audio Connector Pinouts (AUDIO1)**

5.2.2 Auto-dimming Connector (IR1)

PIN NO.	DESCRIPTION	PIN NO.	DESCRIPTION
1	VCC	2	IRRX
3	SMB_CLK_AD	4	SMB_DAT_AD
5	GND		

**Table 5-3: Auto-dimming Connector Pinouts (IR1)**

5.2.3 Battery Connector (BAT1)

PIN NO.	DESCRIPTION
1	VCC
2	GND

**Table 5-4: Battery Connector Pinouts (BAT1)**

5.2.4 BIOS Programming Connector (SPI1)

PIN NO.	DESCRIPTION	PIN NO.	DESCRIPTION
1	SPI_VCC	2	SPI_2N_CS#
3	SPI_2N_MISO	4	SPI_2N_CLK
5	SPI_2N_MOSI	6	GND

**Table 5-5: BIOS Programming Connector Pinouts (SPI1)**

5.2.5 Bluetooth Connector (BLUETOOTH1)

PIN NO.	DESCRIPTION	PIN NO.	DESCRIPTION
1	VCC	2	DATA7_N
3	DATA7_P	4	GND

**Table 5-6: Bluetooth Connector Pinouts (BLUETOOTH1)**

### 5.2.6 Debug Port Connector (LPC\_DEBUG1)

PIN NO.	DESCRIPTION	PIN NO.	DESCRIPTION
1	PLT_RST#	2	LPC_DEBUG_CLK
3	GND	4	LPC_AD3
5	LPC_AD2	6	LPC_AD1
7	LPC_ADO	8	LPC_FRAME#
9	VCC3		

**Table 5-7: Debug Port Connector Pinouts (LPC\_DEBUG1)**

### 5.2.7 EC Firmware Connector (JSPI1)

PIN NO.	DESCRIPTION	PIN NO.	DESCRIPTION
1	SPI_VCC	2	FSCE#_S
3	FMISO_S	4	FSCK_S
5	FMOSI_S	6	GND

**Table 5-8: EC Firmware Connector Pinouts (JSPI1)**

### 5.2.8 Hot Key Connector (HOT\_KEY1)

PIN NO.	DESCRIPTION	PIN NO.	DESCRIPTION
1	EC_KS11	2	EC_KS05
3	EC_KS04	4	EC_KS03
5	EC_KS02	6	EC_KS01
7	EC_KS00	8	GND
9	GND		

**Table 5-9: Hot Key Connector Pinouts (HOT\_KEY1)**

### 5.2.9 K Type Connector (K\_TYPE1, K\_TYPE2)

PIN NO.	DESCRIPTION	PIN NO.	DESCRIPTION
1	D1+/D2+	2	D1-/D2-

**Table 5-10: K Type Connector Pinouts (K\_TYPE1, K\_TYPE2)**



**5.2.10 LCD Inverter Connector (INVERTER1)**

PIN NO.	DESCRIPTION	PIN NO.	DESCRIPTION
1	BRIGHTNESS	2	DATA7_N
3	BKL_POWER	4	GND
5	ENABKL		

**Table 5-11: LCD Inverter Connector Pinouts (INVERTER1)**

**5.2.11 LCD LVDS connector (JR1)**

PIN NO.	DESCRIPTION	PIN NO.	DESCRIPTION
1	GND	2	GND
3	LVDSA_DATA0_R	4	LVDSA_DATA#0_R
5	LVDSA_DATA1_R	6	LVDSA_DATA#1_R
7	LVDSA_DATA2_R	8	LVDSA_DATA#2_R
9	LVDSA_CLK_R	10	LVDSA_CLK#_R
11	LVDSA_DATA3_R	12	LVDSA_DATA#3_R
13	GND	14	GND
15	NC	16	NC
17	VCC3	18	VCC_LCD
19	VCC_LCD	20	VCC_LCD

**Table 5-12: LCD LVDS connector Pinouts (JR1)**

**5.2.12 LED Connector (LEDCN1)**

PIN NO.	DESCRIPTION	PIN NO.	DESCRIPTION
1	CPU_LEDR#	2	CPU_LEDB#
3	AT_LED#	4	ATX_LED#
5	PWR_LED#	6	PWR_YLED#
7	AD_LED#	8	WIFI_LED#
9	RF_LED#	10	BT_LED#
11	VCC3A_EC	12	VCC3
13	GND	14	GND

**Table 5-13: LED Connector Pinouts (LEDCN1)**
**5.2.13 LPT Connector (LPT\_DB1)**

PIN NO.	DESCRIPTION	PIN NO.	DESCRIPTION
1	EC_KS10	2	EC_KSO0
3	EC_KSO1	4	EC_KSO2
5	EC_KSO3	6	EC_KSO4
7	EC_KSO5	8	EC_KSO6
9	EC_KSO7	10	EC_KSO8
11	EC_KSO9	12	EC_KSO10
13	EC_KSO12	14	EC_KS11
15	EC_KSO11	16	EC_KS12
17	EC_KS13	18	GND
19	GND	20	GND

**Table 5-14: LPT Connector Pinouts ( LPT\_DB1)**
**5.2.14 Micro SD Connector (MICRO\_SD1)**

PIN NO.	DESCRIPTION	PIN NO.	DESCRIPTION
1	VCC_MSD	2	DATA3_N
3	DATA3_P	4	GND
5	VCC3		

**Table 5-15: Micro SD Connector Pinouts (MICRO\_SD1)**
**5.2.15 Mini USB Connector (MINI\_USB1)**

PIN NO.	DESCRIPTION	PIN NO.	DESCRIPTION
1	VCC_NIMIUSB	2	DATA2_N
3	DATA2_P	4	GND

**Table 5-16: Mini USB Connector Pinouts (MINI\_USB1)**

5.2.16 Microphone Connector (WEBCAM\_DMIC1)

PIN NO.	DESCRIPTION	PIN NO.	DESCRIPTION
1	DMIC_CLK_R	2	DMIC_DATA_R
3	VCC	4	GND

**Table 5-17: Microphone Connector Pinouts (WEBCAM\_DMIC1)**

5.2.17 Power Button Connector (PW\_BT1)

PIN NO.	DESCRIPTION	PIN NO.	DESCRIPTION
1	PWRBTN_SW#	2	GND

**Table 5-18: Power Button Connector Pinouts (PW\_BT1)**

5.2.18 RFID USB Connector (RFID1)

PIN NO.	DESCRIPTION	PIN NO.	DESCRIPTION
1	VCC	2	DATA5_N
3	DATA5_P	4	GND

**Table 5-19: RFID USB Connector Pinouts (RFID1)**

5.2.19 Speaker Connector (AMP\_SPKR1)

PIN NO.	DESCRIPTION	PIN NO.	DESCRIPTION
1	SPK_OUT_P_L	2	SPK_OUT_N_L
3	SPK_OUT_N_R	4	SPK_OUT_P_R

**Table 5-20: Speaker Connector Pinouts (AMP\_SPKR1)**

5.2.20 Touch Panel Connector (TS1)

PIN NO.	DESCRIPTION	PIN NO.	DESCRIPTION
1	X+	2	X-
3	Y+	4	SENSE
5	X+	6	X-
7	Y+	8	Y-

9	GND		
---	-----	--	--

**Table 5-21: Touch Panel Connector Pinouts (TS1)**

### 5.2.21 Touch Panel Connector (CAP\_TS1)

PIN NO.	DESCRIPTION	PIN NO.	DESCRIPTION
1	VCC	2	-DATA4
3	+DATA4	4	GND

**Table 5-22: Touch Panel Connector Pinouts (CAP\_TS1)**

### 5.2.22 VGA Connector (VGA1)

PIN NO.	DESCRIPTION	PIN NO.	DESCRIPTION
1	L_RED	2	DDC_DATA
3	L_GREEN	4	DDC_CLK
5	L_BLUE	6	D_GND
7	HSYNC	8	GND
9	VSYNC	10	GND

**Table 5-23: VGA Connector Pinouts (VGA1)**

### 5.2.23 Webcam Connector (CAMERA1)

PIN NO.	DESCRIPTION	PIN NO.	DESCRIPTION
1	VCC	2	DATA6_N
3	DATA6_P	4	GND

**Table 5-24: Webcam Connector Pinouts (CAMERA1)**

### 5.3 External Interface Panel Connectors

The figures below show all the external interface panel connectors on the system motherboard.

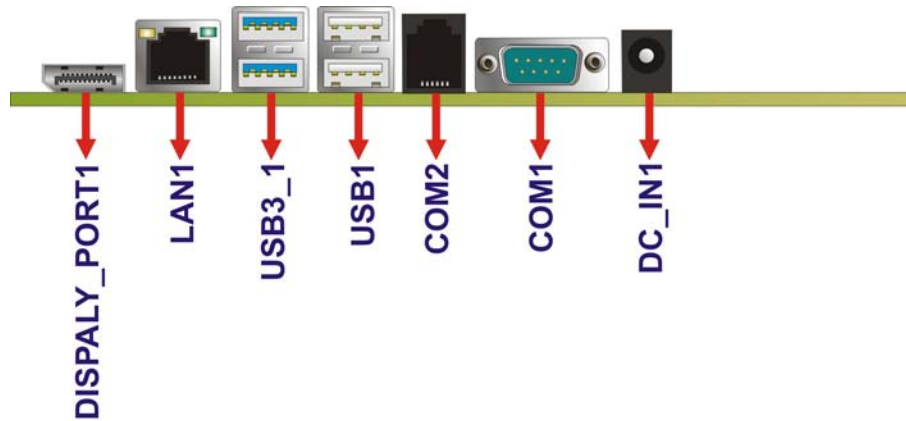

**Figure 5-3: External Interface Panel Connectors**

The table below shows a list of the external interface panel connectors on the system motherboard. Pinouts of these connectors can be found in the following sections.

Connector	Type	Label
Display port connector	Display port	DISPLAY_PORT1
Ethernet connector	RJ-45	LAN1
Power connector	Power jack	DC_IN1
RS-232 serial port connector	DB-9	COM1
RS-232 serial port connector	RJ11	COM2
USB 2.0 connectors	USB 2.0 port	USB1
USB 3.0 connectors	USB 3.0 port	USB3_1

**Table 5-25: Rear Panel Connectors**

### 5.3.1 Display Port Connector (DISPLAY\_PORT1)

PIN NO.	DESCRIPTION	PIN NO.	DESCRIPTION
1	C_DDIO_DP_DATA0	2	GND
3	C_DDIO_DP_DATA0#	4	C_DDIO_DP_DATA1
5	GND	6	C_DDIO_DP_DATA1#
7	C_DDIO_DP_DATA2	8	GND
9	C_DDIO_DP_DATA2#	10	C_DDIO_DP_DATA3
11	GND	12	C_DDIO_DP_DATA3#
13	GND	14	GND
15	C_DDIO_DP_AUXP	16	GND
17	C_DDIO_DP_AUXN	18	C_DDIO_DP_HPD
19	GND	20	VCC
21	GND	22	GND
23	GND	24	GND

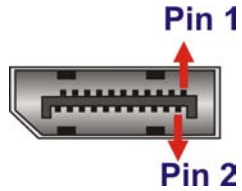

**Table 5-26: Display Port Connector Pinouts (DISPLAY\_PORT1)**

### 5.3.2 Ethernet Connector (LAN1)

PIN NO.	DESCRIPTION	PIN NO.	DESCRIPTION
R1	LAN2_MDI0+	R2	LAN2_MDI0-
R3	LAN2_MDI1+	R4	LAN2_MDI1-
R5	NC	R6	NV
R7	LAN2_MDI2+	R8	LAN2_MDI2-
R9	LAN2_MDI3+	R10	LAN2_MDI3-
11	LAN2_GND	11	LAN2_GND
L1	LAN2_LINK100	L2	LAN2_LINK1000
L3	LAN2_ACT-1	L4	VCC PU

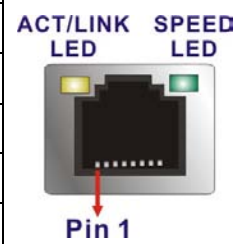

**Table 5-27: Ethernet Connector Pinouts (LAN1)**

**5.3.3 Power Connector (DC\_IN1)**

PIN NO.	DESCRIPTION	PIN NO.	DESCRIPTION
1	VCC	2	GND
3	GND		



**Table 5-28: Power Connector Pinouts (DC\_IN1)**

**5.3.4 RS-232 Serial Ports (COM1)**

PIN NO.	DESCRIPTION	PIN NO.	DESCRIPTION
1	NDCD1	2	NRX1
3	NTX1	4	NDTR1
5	GND	6	NDSR1
7	NRTS1	8	NCTS1
9	NRI1		

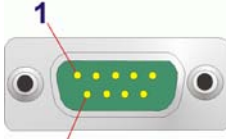

**Table 5-29: RS-232 Serial Ports Pinouts (COM1)**

**5.3.5 RS-422/485 Serial Port (COM2)**

PIN NO.	DESCRIPTION	PIN NO.	DESCRIPTION
1	RXD485+	2	RXD485#
3	TXD485+	4	TXD485#
5	GND		



**Table 5-30: RS-422/485 Serial Port Pinouts (COM2)**

**5.3.6 USB 2.0 Connectors (USB1)**

PIN NO.	DESCRIPTION	PIN NO.	DESCRIPTION
1	VCC	2	DATA0_N
3	DATA0_P	4	GND
5	VCC	6	DATA1_N
7	DATA1_P	8	GND



**Table 5-31: USB 2.0 Connectors Pinouts (USB1)**

### 5.3.7 USB 3.0 Connectors (USB3\_1)

PIN NO.	DESCRIPTION	PIN NO.	DESCRIPTION
1	VCC	2	USB2P0_DM2_L
3	USB2P0_DP2_L	4	GND
5	USB3P0_RXDN2	6	USB3P0_RXDP2
7	GND	8	USB3P0_TXDN2_C
9	USB3P0_TXDP2_C	10	VCC
11	USB2P0_DM1_L	12	USB2P0_DP1_L
13	GND	14	USB3P0_RXDN1
15	USB3P0_RXDP1	16	GND
17	USB3P0_TXDN1_C	18	USB3P0_TXDP1_C

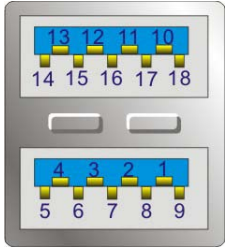

**Table 5-32: USB 3.0 Connector Pinouts (USB3\_1)**



Chapter

6

# System Maintenance

---

## 6.1 System Maintenance Introduction

If the components of the AFL2-08A-N26 fail they must be replaced. Components that can be replaced include:

- SO-DIMM module
- WLAN module

Please contact the system reseller or vendor to purchase the replacement parts. Back cover removal instructions for the AFL2-08A-N26 are described below.

## 6.2 Anti-static Precautions



### WARNING:

Failure to take ESD precautions during the maintenance of the AFL2-08A-N26 may result in permanent damage to the AFL2-08A-N26 and severe injury to the user.

---

Electrostatic discharge (ESD) can cause serious damage to electronic components, including the AFL2-08A-N26. Dry climates are especially susceptible to ESD. It is therefore critical that whenever the AFL2-08A-N26 is accessed internally, or any other electrical component is handled, the following anti-static precautions are strictly adhered to.

- **Wear an anti-static wristband:** - Wearing a simple anti-static wristband can help to prevent ESD from damaging the board.
- **Self-grounding:** - Before handling the board touch any grounded conducting material. During the time the board is handled, frequently touch any conducting materials that are connected to the ground.
- **Use an anti-static pad:** - When configuring the AFL2-08A-N26, place it on an anti-static pad. This reduces the possibility of ESD damaging the AFL2-08A-N26.
- **Only handle the edges of the PCB:** - When handling the PCB, hold the PCB by the edges.

## AFL2-08A-N26

### 6.3 Turn off the Power

---



#### **WARNING:**

Failing to turn off the system before opening it can cause permanent damage to the system and serious or fatal injury to the user.

---

Before any maintenance procedures are carried out on the system, make sure the system is turned off.

To power off the system, follow the steps below:

**Step 1:** Locate the **Function** and **Brightness Up** function keys. See **Section 1.2.1.1**.

**Step 2:** Hold down the Function and Brightness Up buttons for **six** seconds to power off the system.

### 6.4 Opening the System

#### 6.4.1 Removing the Back Cover

---



#### **WARNING:**

Over-tightening back cover screws will crack the plastic frame.  
Maximum torque for cover screws is 5 kg-cm (0.36 lb-ft/0.49 Nm).

---

To access the AFL2-08A-N26 internally the back cover must be removed. To remove the back cover, please follow the steps below.

**Step 1:** Follow all anti-static procedures. See **Section 6.2**.

**Step 2:** Turn off the power. See **Section 6.3**.

**Step 3:** Remove a total of ten (10) retention screws from the back cover (**Figure 6-1**).



**Figure 6-1: Back Cover Retention Screws**

**Step 4:** Carefully separate the back cover from the chassis and lift the cover clear of the device

#### 6.4.2 Removing the Internal Aluminum Cover

To remove the internal aluminum cover, follow the steps below.

**Step 1:** Remove the five (5) retention screws securing the internal aluminum cover to the chassis (**Figure 5-2**).

## AFL2-08A-N26

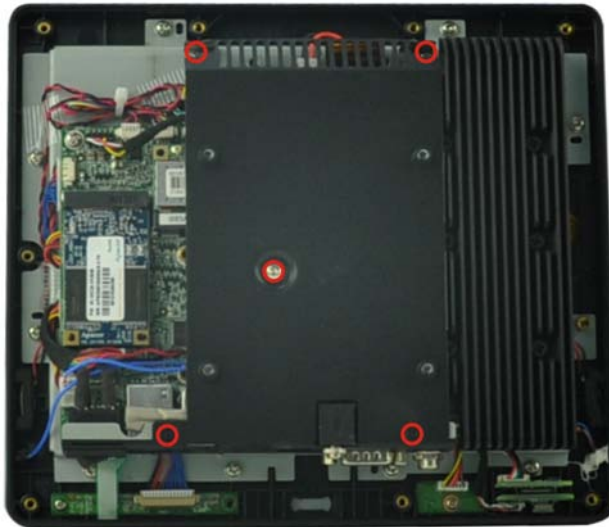

**Figure 6-2: Internal Cover Retention Screws**

**Step 2:** Lift the aluminum cover off the AFL2-08A-N26.

**Step 3:** The internal parts will all be viewable.

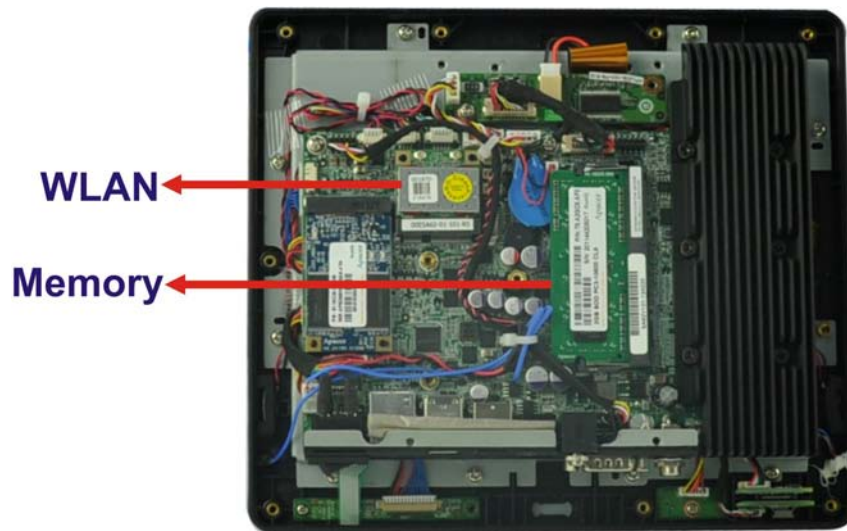

**Figure 6-3: Internal Components**

## 6.5 Replacing Components

### 6.5.1 Memory Module Replacement

The flat bezel panel PC is preinstalled with two 2.0 GB DDR3 memory module. If the memory module fails, follow the instructions below to replace the memory module.

- Step 1:** Follow all anti-static procedures. See **Section 6.2**.
- Step 2:** Turn off the power. See **Section 6.3**.
- Step 3:** Remove the back cover. See **Section 6.4.1** above.
- Step 4:** Remove the internal aluminum back cover. See **Section 6.4.2** above.
- Step 5:** Locate the DDR3 SO-DIMM on the motherboard.
- Step 6:** Remove the DDR3 memory module by pulling both the spring retainer clips outward from the socket.
- Step 7:** Grasp the DDR3 memory module by the edges and carefully pull it out of the socket.
- Step 8:** Install the new DDR3 memory module by pushing it into the socket at an angle (**Figure 6-4**).
- Step 9:** Gently pull the spring retainer clips of the SO-DIMM socket out and push the rear of the DDR memory module down (**Figure 6-4**).
- Step 10:** Release the spring retainer clips on the SO-DIMM socket. They clip into place and secure the DDR memory module in the socket.

## AFL2-08A-N26

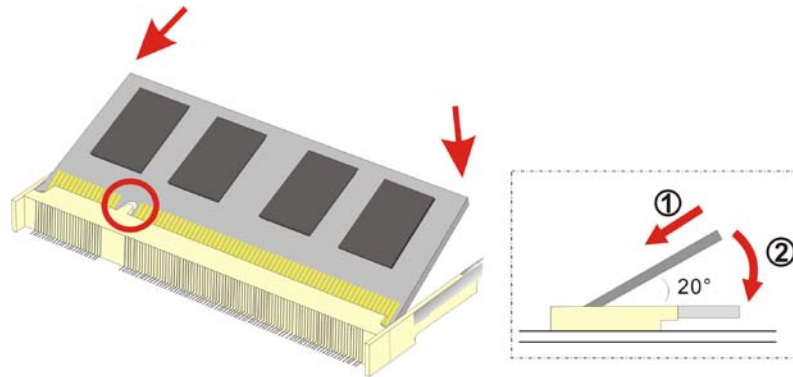

**Figure 6-4: DDR SO-DIMM Module Installation**

**Step 11:** Replace the internal aluminum cover and secure it to the chassis using five (5) retention screws.

**Step 12:** Replace the back cover and secure it using ten (10) previously removed retention screws.

### 6.5.2 WLAN Card Replacement

The AFL2-08A-N26 has one WLAN card slot. To replace the WLAN card, follow the instructions below.

**Step 1:** Follow all anti-static procedures. See **Section 6.2**.

**Step 2:** Turn off the power. See **Section 6.3**.

**Step 3:** Remove the back cover. See **Section 6.4.1** above.

**Step 4:** Remove the internal back cover. See **Section 6.4.2** above.

**Step 5:** Locate the WLAN card.

**Step 6:** Disconnect the main and auxiliary antennas on the WLAN module and push the two spring clips in to release the WLAN card (**Figure 6-5**).

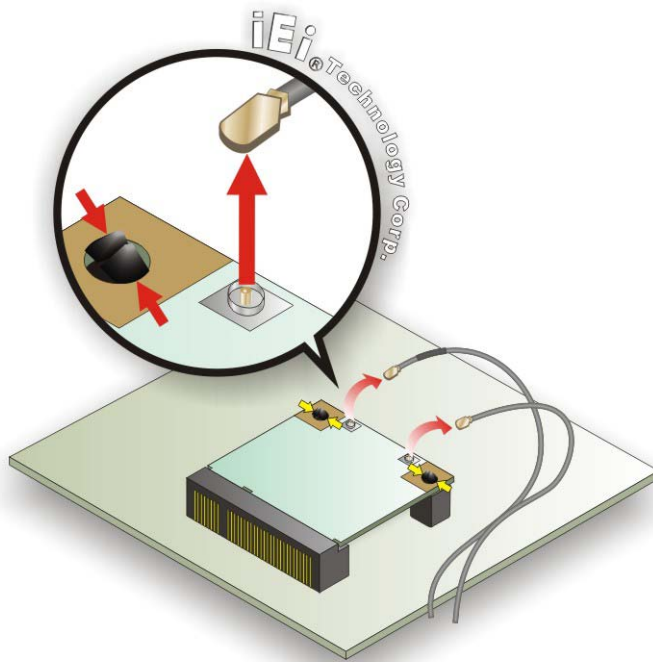

Figure 6-5: Releasing the WLAN Card

Step 7: Grasp the WLAN card by the edges and carefully pull it out of the socket (Figure 6-6).

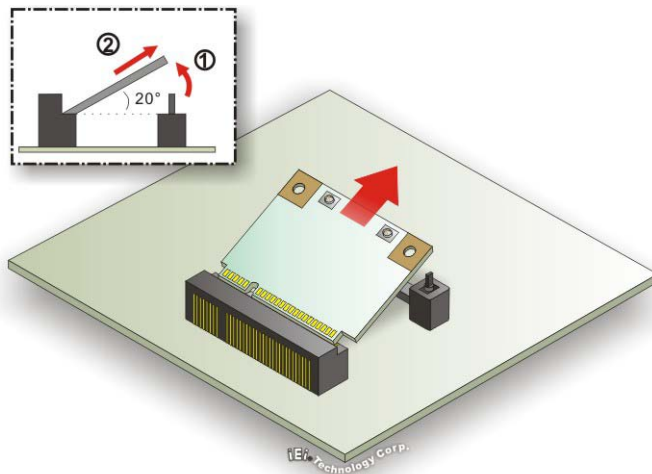

Figure 6-6: Removing the WLAN card

Step 8: Install a new WLAN card by inserting the card into the slot at an angle



## AFL2-08A-N26

**Step 9:** Push the WLAN card down until the spring retainer clips lock into place.

**Step 10:** Connect the main (1) and auxiliary (2) antennas. The main antenna is indicated with a strip of black electrical tape. See **Figure 6-7**.

**NOTE:**

To ensure the WLAN module functions correctly, please make sure the WLAN antennas are attached in the proper configuration.

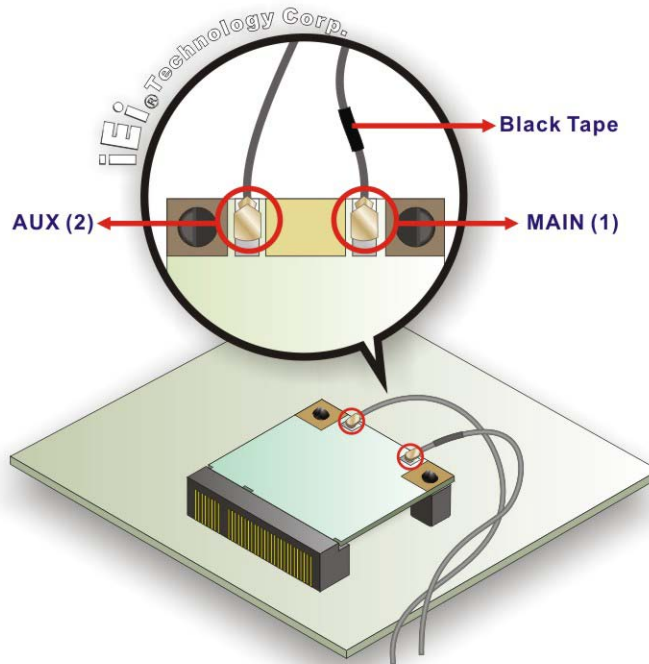

**Figure 6-7: Attaching the Antennas**

**Step 11:** Replace the internal cover and secure it to the chassis using the previously removed retention screws.

**Step 12:** Replace the back cover and secure it using the previously removed retention screws.

## 6.6 Reinstalling the Covers

---



### **WARNING:**

Failing to reinstall the covers may result in permanent damage to the system. Please make sure all coverings are properly installed.

---

When maintenance procedures are complete, please make sure all the covers are replaced, including the following:

- Aluminum internal cover
- Plastic back cover

Chapter

7

# BIOS Setup

---

## 7.1 Introduction

A licensed copy of the BIOS is preprogrammed into the ROM BIOS. The BIOS setup program allows users to modify the basic system configuration. This chapter describes how to access the BIOS setup program and the configuration options that may be changed.

### 7.1.1 Starting Setup

The UEFI BIOS is activated when the computer is turned on. The setup program can be activated in one of two ways.

1. Press the **DEL** or **F2** key as soon as the system is turned on or
2. Press the **DEL** or **F2** key when the “**Press DEL or F2 to enter SETUP**” message appears on the screen.

If the message disappears before the **DEL** or **F2** key is pressed, restart the computer and try again.

### 7.1.2 Using Setup

Use the arrow keys to highlight items, press **ENTER** to select, use the PageUp and PageDown keys to change entries, press **F1** for help and press **ESC** to quit. Navigation keys are shown in the following table.

Key	Function
Up arrow	Move to the item above
Down arrow	Move to the item below
Left arrow	Move to the item on the left hand side
Right arrow	Move to the item on the right hand side
+	Increase the numeric value or make changes
-	Decrease the numeric value or make changes
F1 key	General help, only for Status Page Setup Menu and Option Page Setup Menu

F2 key	Load previous values.
F3 key	Load optimized defaults
F4 key	Save changes and Exit BIOS
Esc key	Main Menu – Quit and do not save changes into CMOS Status Page Setup Menu and Option Page Setup Menu -- Exit current page and return to Main Menu

**Table 7-1: BIOS Navigation Keys**

### 7.1.3 Getting Help

When **F1** is pressed a small help window describing the appropriate keys to use and the possible selections for the highlighted item appears. To exit the Help Window press **Esc** or the **F1** key again.

### 7.1.4 Unable to Reboot after Configuration Changes

If the computer cannot boot after changes to the system configuration are made, CMOS defaults.

### 7.1.5 BIOS Menu Bar

The **menu bar** on top of the BIOS screen has the following main items:

- Main – Changes the basic system configuration.
- Advanced – Changes the advanced system settings.
- Chipset – Changes the chipset settings.
- Boot – Changes the system boot configuration.
- Security – Sets User and Supervisor Passwords.
- Save & Exit – Selects exit options and loads default settings

The following sections completely describe the configuration options found in the menu items at the top of the BIOS screen and listed above.

## 7.2 Main

The **Main** BIOS menu (**BIOS Menu 1**) appears when the **BIOS Setup** program is entered. The **Main** menu gives an overview of the basic system information.

```

Aptio Setup Utility - Copyright (C) 2011 American Megatrends, Inc.
Main  Advanced  Chipset  Boot  Security  Save & Exit

BIOS Information
BIOS Vendor                American Megatrends
Core Version                4.6.5.3 0.16
Compliancy                 UEFI 2.3; PI 1.2
Project Version            SE20AR11.ROM
Build Date and Time        10/09/2012 19:22:31

iWDD Vendor                ICP
iWDD Version               SE20ER11.bin

System Date                 [Fri 10/19/2012]
System Time                 [14:21:27]

Access Level                Administrator

Set the Date. Use Tab to
switch between Data
elements.

-----
<->: Select Screen
↑ ↓: Select Item
EnterSelect
+/-: Change Opt.
F1:  General Help
F2:  Previous Values
F3:  Optimized Defaults
F4:  Save & Exit
ESC: Exit

Version 2.14.1219. Copyright (C) 2011 American Megatrends, Inc.

```

### BIOS Menu 1: Main

#### → BIOS Information

The **BIOS Information** lists a brief summary of the BIOS. The fields in **BIOS Information** cannot be changed. The items shown in the system overview include:

- **BIOS Vendor:** Installed BIOS vendor
- **Core Version:** Current BIOS version
- **Compliancy:** Current compliant version
- **Project Version:** the board version
- **Build Date and Time:** Date the current BIOS version was made

#### → iWDD Vendor

- The **iWDD Vendor** displays the installed iWDD vendor. The fields in **iWDD Vendor** cannot be changed.

## AFL2-08A-N26

### → iWDD Version

- The **iWDD Version** displays the current iWDD version. The fields in **iWDD Version** cannot be changed.

The System Overview field also has two user configurable fields:

### → System Date [xx/xx/xx]

Use the **System Date** option to set the system date. Manually enter the day, month and year.

### → System Time [xx:xx:xx]

Use the **System Time** option to set the system time. Manually enter the hours, minutes and seconds.

## 7.3 Advanced

Use the **Advanced** menu (**BIOS Menu 2**) to configure the CPU and peripheral devices through the following sub-menus:



### **WARNING:**

Setting the wrong values in the sections below may cause the system to malfunction. Make sure that the settings made are compatible with the hardware.

---

```

Aptio Setup Utility - Copyright (C) 2011 American Megatrends, Inc.
Main  Advanced  Chipset  Boot  Security  Save & Exit

> ACPI Settings
> RTC Wake Settings
> CPU Configuration
> SATA Configuration
> USB Configuration
> F81866 Super IO Configuration
> H/M Monitor
> Serial Port Console Redirection
> iEi Feature

System ACPI Parameters.

-----

<->: Select Screen
↑ ↓: Select Item
EnterSelect
+/-: Change Opt.
F1: General Help
F2: Previous Values
F3: Optimized Defaults
F4: Save & Exit
ESC: Exit

Version 2.14.1219. Copyright (C) 2011 American Megatrends, Inc.

```

**BIOS Menu 2: Advanced**
**7.3.1 ACPI Settings**

The **ACPI Settings** menu (**BIOS Menu 3**) configures the Advanced Configuration and Power Interface (ACPI) options.

```

Aptio Setup Utility - Copyright (C) 2011 American Megatrends, Inc.
Advanced

ACPI Settings
ACPI Sleep State          [S1 (CPU Stop Clock)]

Select the highest ACPI
sleep state the system
will enter, when the
SUSPEND button is
pressed.

-----

<->: Select Screen
↑ ↓: Select Item
EnterSelect
+/-: Change Opt.
F1: General Help
F2: Previous Values
F3: Optimized Defaults
F4: Save & Exit
ESC: Exit

Version 2.14.1219. Copyright (C) 2011 American Megatrends, Inc.

```

**BIOS Menu 3: ACPI Configuration**



## AFL2-08A-N26

### → ACPI Sleep State [S1 (CPU Stop Clock)]

Use the **ACPI Sleep State** option to specify the sleep state the system enters when it is not being used.

- **S1 (CPU Stop Clock)** **DEFAULT** The system enters S1 (POS) sleep state. The system appears off. The CPU is stopped; RAM is refreshed; the system is running in a low power mode.
- **S3 (Suspend to RAM)** The caches are flushed and the CPU is powered off. Power to the RAM is maintained. The computer returns slower to a working state, but more power is saved.

### 7.3.2 RTC Wake Settings

The **RTC Wake Settings** menu (**BIOS Menu 4**) configures RTC wake event.

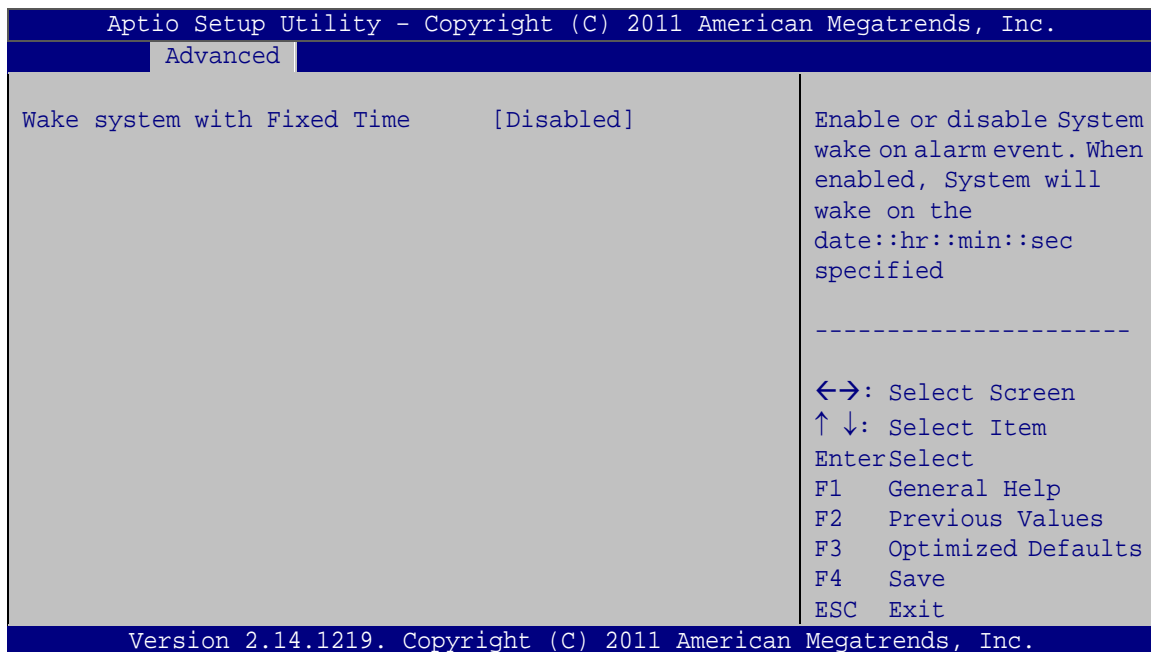

#### BIOS Menu 4: RTC Wake Settings

### → Wake system with Fixed Time [Disabled]

Use the **Wake system with Fixed Time** option to enable or disable the system wake on alarm event.

→ **Disabled**      **DEFAULT**      The real time clock (RTC) cannot generate a wake event

→ **Enabled**      If selected, the **Wake up every day** option appears allowing you to enable to disable the system to wake every day at the specified time. Besides, the following options appear with values that can be selected:

Wake up date

Wake up hour

Wake up minute

Wake up second

After setting the alarm, the computer turns itself on from a suspend state when the alarm goes off.

## AFL2-08A-N26

### 7.3.3 CPU Configuration

Use the **CPU Configuration** menu (**BIOS Menu 5**) to view detailed CPU specifications and configure the CPU.

```

Aptio Setup Utility - Copyright (C) 2011 American Megatrends, Inc.
  Advanced
CPU Configuration
Processor Type           Intel(R) Atom(TM) CPU
                        N2600 @ 1.60GHz
EMT64                   Supported
Processor Speed         1600 MHz
System Bus Speed        400 MHz
Ratio Status            16
Actual Ratio            16
Processor Stepping      30661
Processor Revision      268
L1 Cache RAM            2x56 k
L2 Cache RAM            2x512 k
Processor Core          Dual
Hyper-threading        Supported

Hyper-threading        [Enabled]

-----
<->: Select Screen
↑ ↓: Select Item
Enter>Select
F1  General Help
F2  Previous Values
F3  Optimized
Defaults
F4  Save
ESC Exit

Version 2.14.1219. Copyright (C) 2011 American Megatrends, Inc.
  
```

#### BIOS Menu 5: CPU Configuration

The CPU Configuration menu (**BIOS Menu 5**) lists the following CPU details:

- Processor Type: Lists the brand name of the CPU being used
- EMT64: Indicates if the EMT64 is supported by the CPU.
- Processor Speed: Lists the CPU processing speed
- System Bus Speed: Lists the system bus speed
- Ratio Status: Lists the ratio status
- Actual Ratio: Lists the actual ratio
- Processor Stepping: Lists the CPU processing stepping
- Microcode Revision: Lists the microcode revision
- Cache L1 RAM: Lists the CPU L1 cache size
- Cache L2 RAM: Lists the CPU L2 cache size
- Processor Core: Lists the number of the processor core
- Hyper-threading: Indicates if the Hyper-threading is supported by the CPU.

➔ Hyper-Threading [Enabled]

Use the Hyper-Threading option to enable or disable the CPU hyper threading function.

- ➔ **Disabled** Disables the use of hyper threading technology
- ➔ **Enabled** **DEFAULT** Enables the use of hyper threading technology

### 7.3.4 SATA Configuration

Use the **SATA Configuration** menu (**BIOS Menu 6**) to change and/or set the configuration of the SATA devices installed in the system.

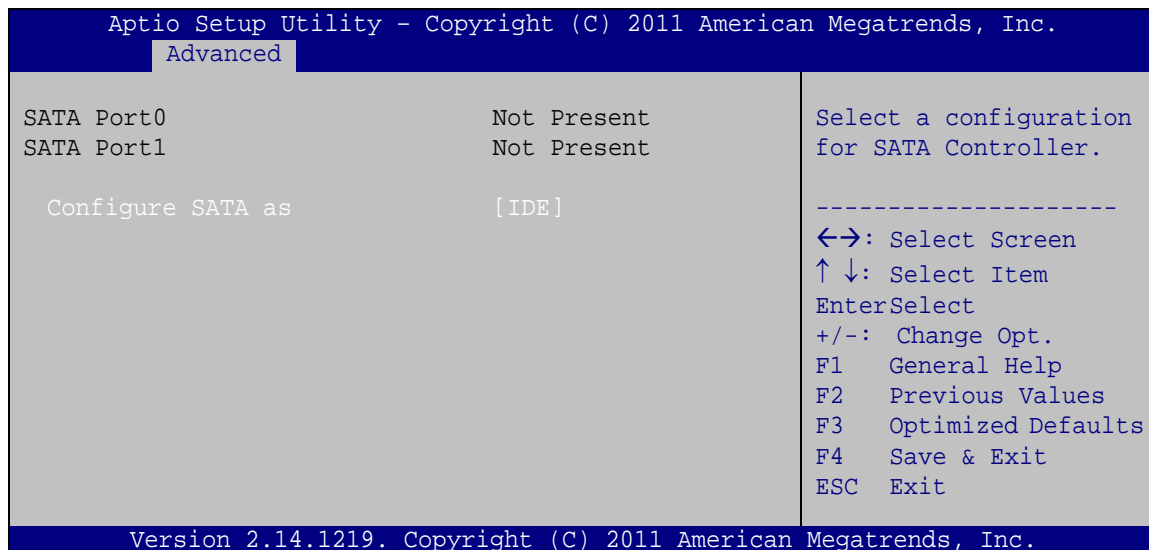

#### BIOS Menu 6: IDE Configuration

➔ Configure SATA as [IDE]

Use the **Configure SATA as** option to configure SATA devices as AHCI devices.

- ➔ **IDE** **DEFAULT** Configures SATA devices as normal IDE device.
- ➔ **AHCI** Configures SATA devices as AHCI device.

### 7.3.5 USB Configuration

Use the **USB Configuration** menu (**BIOS Menu 7**) to read USB configuration information and configure the USB settings.

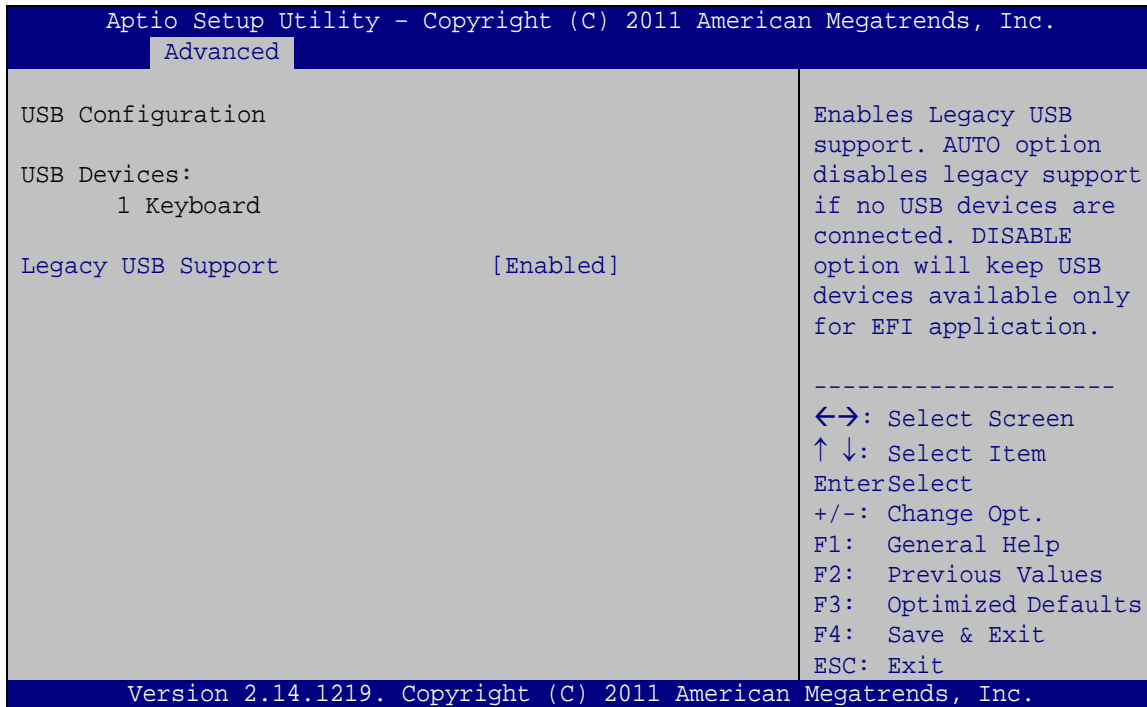

#### **BIOS Menu 7: USB Configuration**

➔ **USB Devices**

The **USB Devices Enabled** field lists the USB devices that are enabled on the system

➔ **Legacy USB Support [Enabled]**

Use the **Legacy USB Support** BIOS option to enable USB mouse and USB keyboard support. Normally if this option is not enabled, any attached USB mouse or USB keyboard does not become available until a USB compatible operating system is fully booted with all USB drivers loaded. When this option is enabled, any attached USB mouse or USB keyboard can control the system even when there is no USB driver loaded onto the system.

➔ **Enabled**      **DEFAULT**      Legacy USB support enabled

- ➔ **Disabled**                      Legacy USB support disabled
- ➔ **Auto**                            Legacy USB support disabled if no USB devices are connected

### 7.3.6 F81866 Super IO Configuration

Use the **F81866 Super IO Configuration** menu (**BIOS Menu 8**) to set or change the configurations for the serial ports.

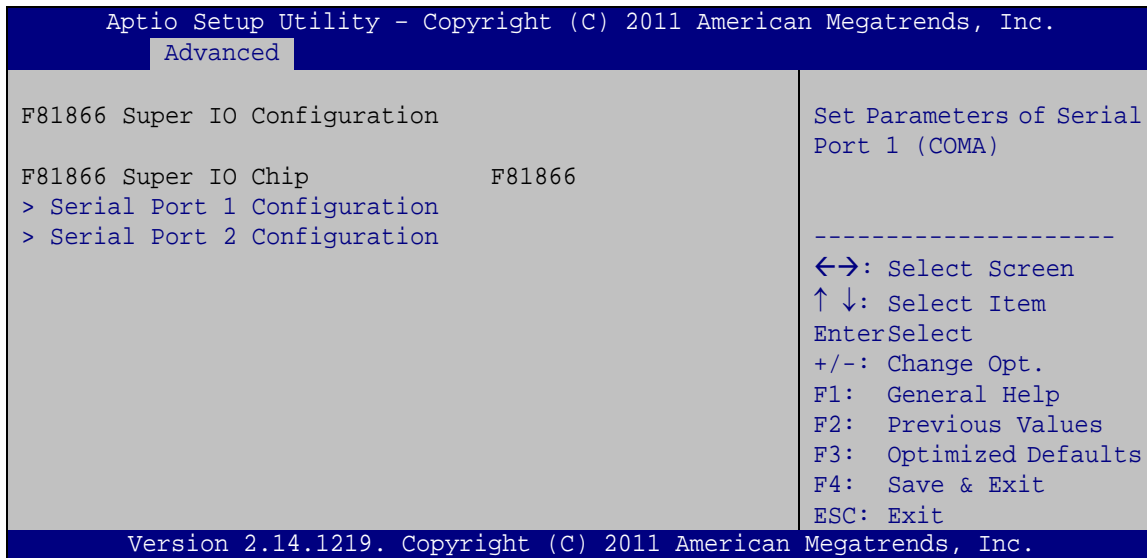

#### **BIOS Menu 8: Super IO Configuration**

### 7.3.6.1 Serial Port n Configuration

Use the **Serial Port n Configuration** menu (**BIOS Menu 9**) to configure the serial port n.

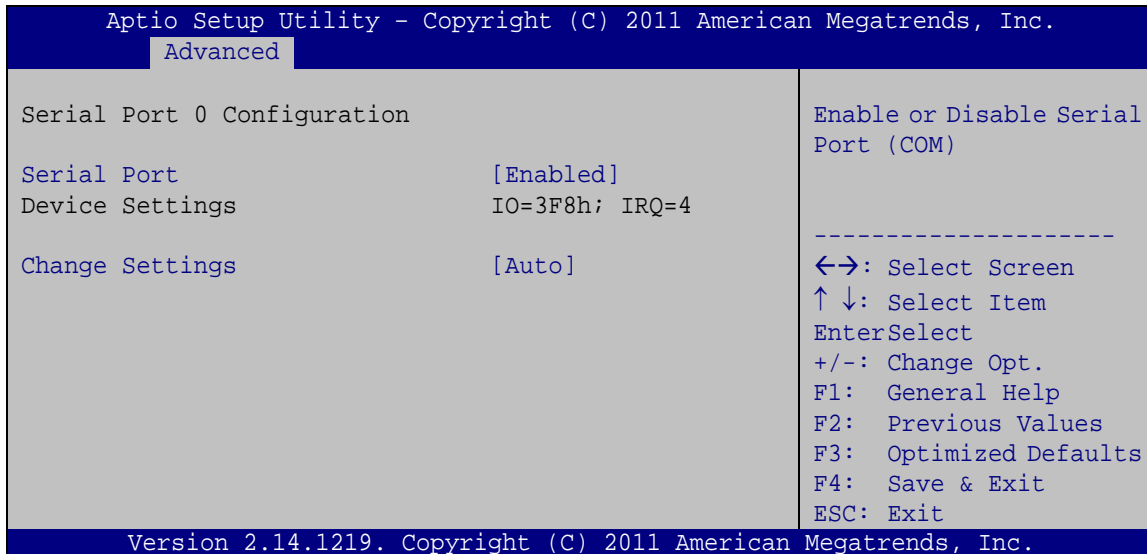

#### **BIOS Menu 9: Serial Port n Configuration Menu**

##### 7.3.6.1.1 Serial Port 1 Configuration

###### ➔ Serial Port [Enabled]

Use the **Serial Port** option to enable or disable the serial port.

- ➔ **Disabled**                      Disable the serial port
- ➔ **Enabled**            **DEFAULT**      Enable the serial port

###### ➔ Change Settings [Auto]

Use the **Change Settings** option to change the serial port IO port address and interrupt address.

- ➔ **Auto**                      **DEFAULT**      The serial port IO port address and interrupt address are automatically detected.
- ➔ **IO=3F8h; IRQ=4**                      Serial Port I/O port address is 3F8h and the interrupt address is IRQ4

- ➔ **IO=2F8h; IRQ=3**                      Serial Port I/O port address is 2F8h and the interrupt address is IRQ3

### 7.3.6.1.2 Serial Port 2 Configuration

- ➔ Serial Port [Enabled]

Use the **Serial Port** option to enable or disable the serial port.

- ➔ **Disabled**                      Disable the serial port
- ➔ **Enabled**                      **DEFAULT**                      Enable the serial port

- ➔ Change Settings [Auto]

Use the **Change Settings** option to change the serial port IO port address and interrupt address.

- ➔ **Auto**                      **DEFAULT**                      The serial port IO port address and interrupt address are automatically detected.
- ➔ **IO=2F8h; IRQ=3**                      Serial Port I/O port address is 2F8h and the interrupt address is IRQ3
- ➔ **IO=3F8h; IRQ=4**                      Serial Port I/O port address is 3F8h and the interrupt address is IRQ4

- ➔ Device Mode [RS422/485]

The **Device Mode** shows Serial Port 2 provides RS-422/485 communications.



### 7.3.7 H/W Monitor

The H/W Monitor menu (**BIOS Menu 10**) shows the hardware health status.

```

Aptio Setup Utility - Copyright (C) 2011 American Megatrends, Inc.
-----
Advanced
-----
CPU temperature           :+56 C
System temperature       :+55 C
Environment temperature   :+25 C

-----
<->: Select Screen
↑ ↓: Select Item
EnterSelect
+/-: Change Opt.
F1:  General Help
F2:  Previous Values
F3:  Optimized Defaults
F4:  Save & Exit
ESC: Exit

Version 2.14.1219. Copyright (C) 2011 American Megatrends, Inc.

```

#### **BIOS Menu 10: Hardware Health Configuration**

##### ➔ PC Health Status

The following system parameters and values are shown. The system parameters that are monitored are:

- System Temperatures:
  - CPU Temperature
  - System Temperature
  - Environment Temperature

### 7.3.8 Serial Port Console Redirection

The **Serial Port Console Redirection** menu (**BIOS Menu 11**) allows the console redirection options to be configured. Console redirection allows users to maintain a system remotely by re-directing keyboard input and text output through the serial port.

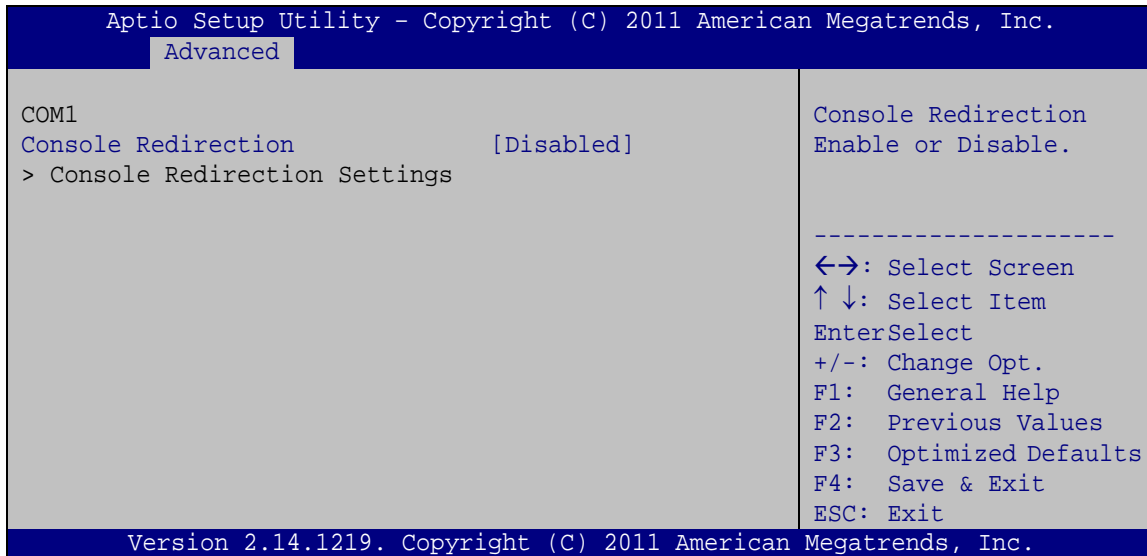

### BIOS Menu 11: Serial Port Console Redirection

→ Console Redirection [Disabled]

Use **Console Redirection** option to enable or disable the console redirection function.

- **Disabled**      **DEFAULT**      Disabled the console redirection function
- **Enabled**                      Enabled the console redirection function

→ Terminal Type [ANSI]

Use the **Terminal Type** option to specify the remote terminal type.

- **VT100**                      The target terminal type is VT100
- **VT100+**                      The target terminal type is VT100+
- **VT-UTF8**                      The target terminal type is VT-UTF8
- **ANSI**                      **DEFAULT**      The target terminal type is ANSI

→ Bits per second [115200]

Use the **Bits per second** option to specify the serial port transmission speed. The speed must match the other side. Long or noisy lines may require lower speeds.

## AFL2-08A-N26

- **9600** Sets the serial port transmission speed at 9600.
- **19200** Sets the serial port transmission speed at 19200.
- **38400** Sets the serial port transmission speed at 38400.
- **57600** Sets the serial port transmission speed at 57600.
- **115200**      **DEFAULT** Sets the serial port transmission speed at 115200.

### → Data Bits [8]

Use the **Data Bits** option to specify the number of data bits.

- **7** Sets the data bits at 7.
- **8**      **DEFAULT** Sets the data bits at 8.

### → Parity [None]

Use the **Parity** option to specify the parity bit that can be sent with the data bits for detecting the transmission errors.

- **None**      **DEFAULT** No parity bit is sent with the data bits.
- **Even** The parity bit is 0 if the number of ones in the data bits is even.
- **Odd** The parity bit is 0 if the number of ones in the data bits is odd.
- **Mark** The parity bit is always 1. This option does not provide error detection.
- **Space** The parity bit is always 0. This option does not provide error detection.

### → Stop Bits [1]

Use the **Stop Bits** option to specify the number of stop bits used to indicate the end of a serial data packet. Communication with slow devices may require more than 1 stop bit.

- ➔ 1            **DEFAULT**      Sets the number of stop bits at 1.
- ➔ 2                              Sets the number of stop bits at 2.

## 7.4 iEi Feature

Use the **iEi Feature** menu (**BIOS Menu 12**) to configure the auto recovery function.

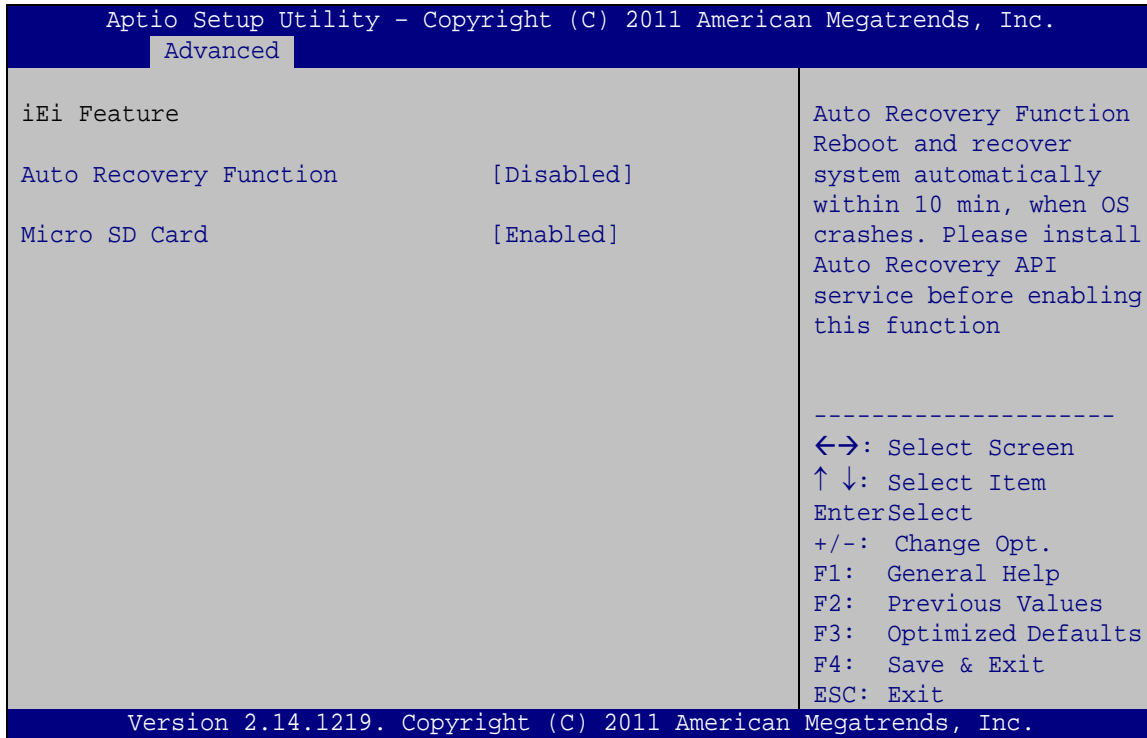

### BIOS Menu 12: iEi Feature

- ➔ Auto Recovery Function [Disabled]

Use the **Auto Recovery Function** option to enable or disable auto recovery on the system.

- ➔ **Disabled**      **DEFAULT**      Auto Recovery Function support disabled
- ➔ **Enabled**                      Auto Recovery Function support enabled

## AFL2-08A-N26

➔ Micro SD Card [Enabled]

Use the **Micro SD Card** BIOS option to enable or disable the micro SD card. Once to run One Key Recovery function, disable the micro SD card firstly.

- ➔ **Disabled**                      micro SD card disabled
- ➔ **Enabled**        **DEFAULT**      micro SD card enabled

## 7.5 Chipset

Use the **Chipset** menu (**BIOS Menu 13**) to access the Host Bridge and South Bridge configuration menus.



### WARNING!

Setting the wrong values for the Chipset BIOS selections in the Chipset BIOS menu may cause the system to malfunction.

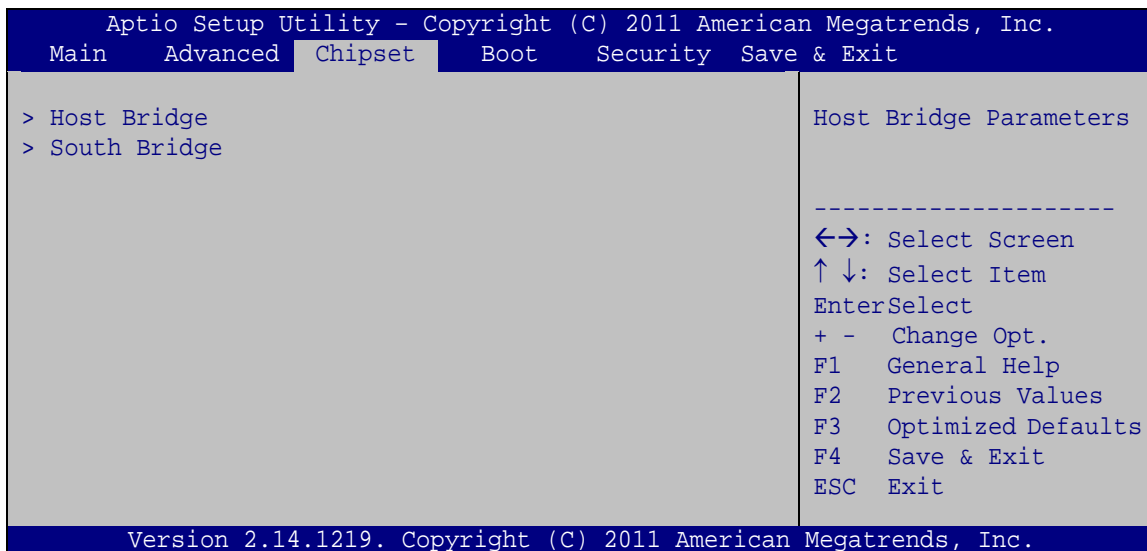

**BIOS Menu 13: Chipset**

### 7.5.1 Host Bridge Configuration

Use the **Host Bridge Configuration** menu (**BIOS Menu 14**) to configure the Intel IGD Configuration and display the memory information.

```

Aptio Setup Utility - Copyright (C) 2011 American Megatrends, Inc.
  Chipset
> Intel IGD Configuration
***** Memory Information *****
Memory Frequency           800 MHz(DDR3)
Total Memory                2048 MB
DIMM#1                     2048 MB

Config Intel IGD Settings
-----
-><: Select Screen
↑↓: Select Item
Enter: Select
+/-: Change Opt.
F1: General Help
F2: Previous Values
F3: Optimized Defaults
F4: Save & Exit
ESC: Exit

Version 2.14.1219. Copyright (C) 2011 American Megatrends, Inc.
  
```

#### **BIOS Menu 14: Host Bridge Configuration**

##### 7.5.1.1 Intel IGD Configuration

Use the **Intel IGD Configuration** submenu (**BIOS Menu 15**) to configure the video device connected to the system.

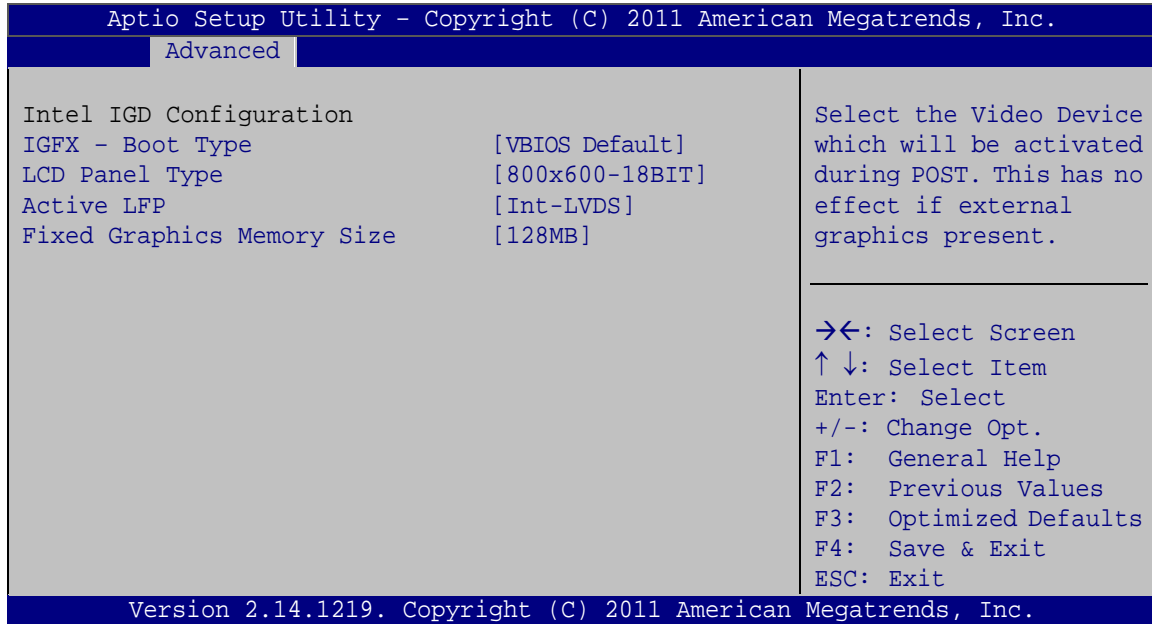

**BIOS Menu 15: Intel IGD Configuration**

➔ IGFX - Boot Type [VBIOS Default]

Use the **IGFX - Boot Type** option to select the display device used by the system when it boots. Configuration options are listed below.

- VBIOS Default    **DEFAULT**

➔ LCD Panel Type [800x600-18BIT]

Use the **LCD Panel Type** option to select the type of flat panel connected to the system. Configuration options are listed below.

- 800x600-18BIT    **DEFAULT**

➔ Active LFP [Int-LVDS]

Use the **Active LFP** option to select the Active LFP configuration.

- Int-LVDS    **DEFAULT**

➔ Fixed Graphics Memory Size [128MB]

Use the **Fixed Graphics Memory Size** option to specify the maximum amount of memory that can be allocated as graphics memory. Configuration options are listed below.

- 128MB      **DEFAULT**
- 256MB

### 7.5.2 South Bridge Configuration

Use the **South Bridge** menu (**BIOS Menu 16**) to configure the Southbridge chipset.

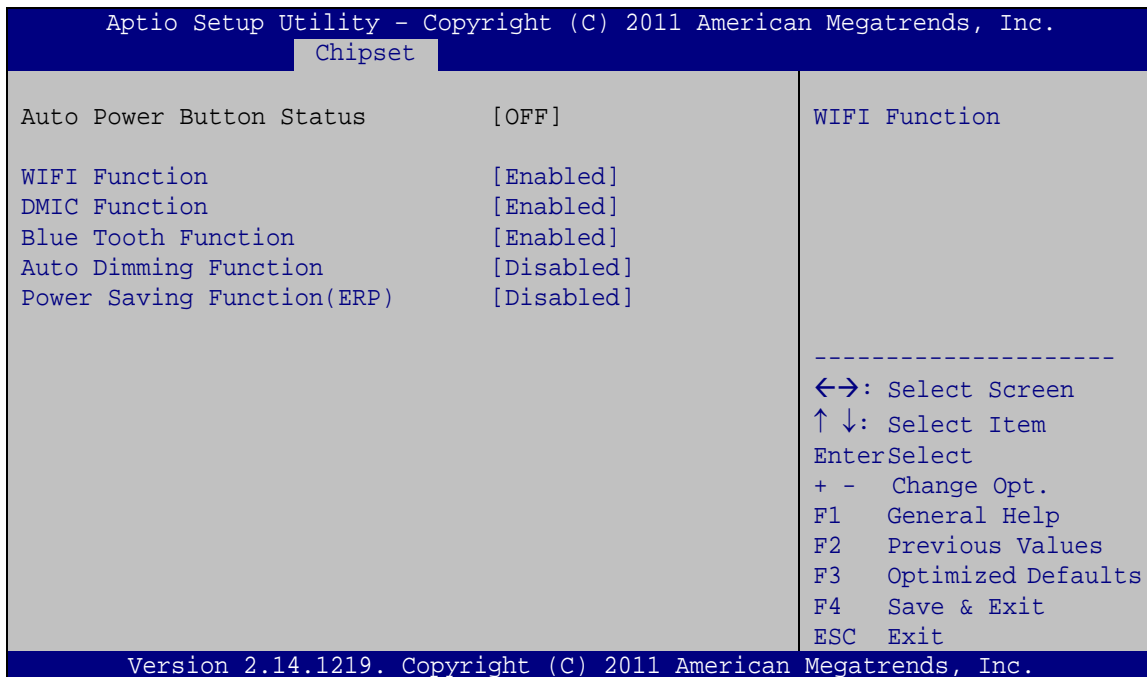

#### BIOS Menu 16: Southbridge Chipset Configuration

➔ WIFI Function [Enabled]

Use the **WIFI Function** option to enable or disable the Wi-Fi function.

- ➔ **Disabled**      Wi-Fi function disabled
- ➔ **Enabled**      **DEFAULT**      Wi-Fi function enabled



## AFL2-08A-N26

### → DMIC Function [Enabled]

Use the **DMIC Function** option to enable or disable the Microphone function.

- **Disabled**                      Microphone function disabled
- **Enabled**    **DEFAULT**      Microphone function enabled

### → Blue Tooth Function [Enabled]

Use the **Blue Tooth Function** option to enable or disable the blue tooth function.

- **Disabled**                      Blue tooth function disabled
- **Enabled**    **DEFAULT**      Blue tooth function enabled

### → Auto Dimming Support [Disabled]

Use the **Auto Dimming Support** option to enable or disable the auto dimming function.

- **Disabled**    **DEFAULT**      Auto dimming function disabled
- **Enabled**                      Auto dimming function enabled

### → Power Saving Function (ERP) [Disabled]

Use the **Power Saving Function (ERP)** option to enable or disable the power saving function.

- **Disabled**    **DEFAULT**      Disables the power saving function.
- **Enabled**                      Enables the power saving function.

## 7.6 Boot

Use the **Boot** menu (**BIOS Menu 17**) to configure system boot options.

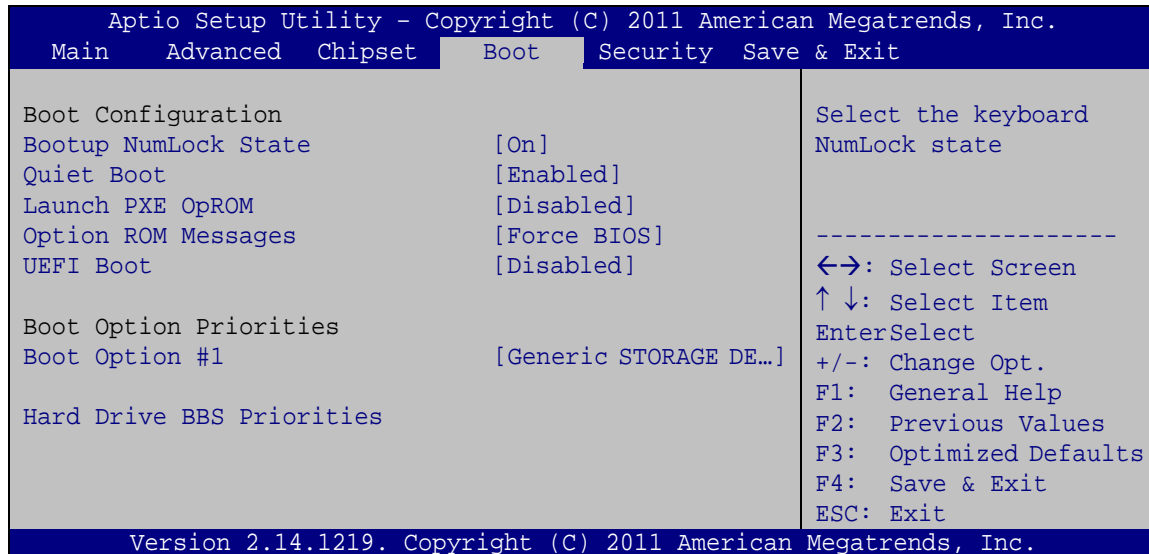

### BIOS Menu 17: Boot

#### → Bootup NumLock State [On]

Use the **Bootup NumLock State** BIOS option to specify if the number lock setting must be modified during boot up.

→ **On**                      **DEFAULT**                      Allows the Number Lock on the keyboard to be enabled automatically when the computer system boots up. This allows the immediate use of the 10-key numeric keypad located on the right side of the keyboard. To confirm this, the Number Lock LED light on the keyboard is lit.

→ **Off**    Does not enable the keyboard Number Lock automatically. To use the 10-keys on the keyboard, press the Number Lock key located on the upper left-hand corner of the 10-key pad. The Number Lock LED on the keyboard lights up when the Number Lock is engaged.

## AFL2-08A-N26

### → Quiet Boot [Enabled]

Use the **Quiet Boot** BIOS option to select the screen display when the system boots.

- **Disabled** Normal POST messages displayed
- **Enabled** **DEFAULT** OEM Logo displayed instead of POST messages

### → Launch PXE OpROM [Disabled]

Use the **Launch PXE OpROM** option to enable or disable boot option for legacy network devices.

- **Disabled** **DEFAULT** Ignore all PXE Option ROMs
- **Enabled** Load PXE Option ROMs.

### → Option ROM Messages [Force BIOS]

Use the **Option ROM Messages** option to set the Option ROM display mode.

- **Force BIOS** **DEFAULT** Sets display mode to force BIOS.
- **Keep Current** Sets display mode to current.

### → UEFI Boot [Disabled]

Use the **UEFI Boot** option to enable or disable to boot from the UEFI devices.

- **Enabled** Boot from UEFI devices is enabled.
- **Disabled** **DEFAULT** Boot from UEFI devices is disabled.

### → Boot Option Priority

Use the **Boot Option Priority** function to set the system boot sequence from the available devices. The drive sequence also depends on the boot sequence in the individual device section.

➔ **Hard Drive BBS Priorities**

Use the **Hard Drive BBS Priorities** option to set the order of the legacy devices in this group.

## 7.7 Security

Use the **Security** menu (**BIOS Menu 18**) to set system and user passwords.

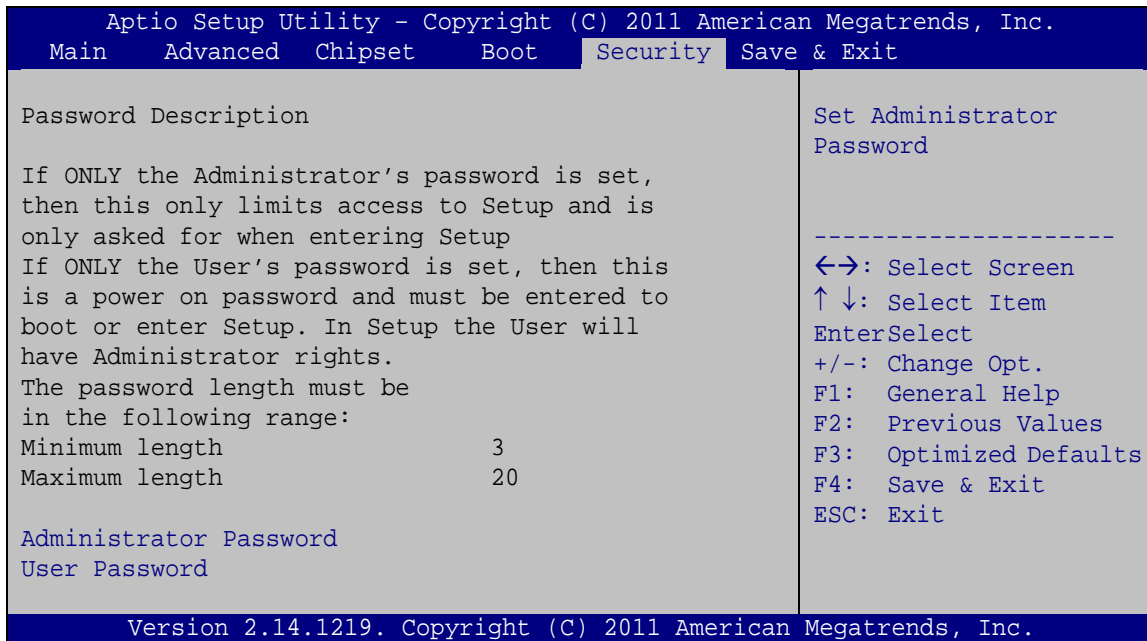

### **BIOS Menu 18: Security**

➔ **Administrator Password**

Use the **Administrator Password** field to set or change an administrator password.

➔ **User Password**

Use the **User Password** field to set or change a user password.

## 7.8 Save & Exit

Use the **Save & Exit** menu (**BIOS Menu 19**) to load default BIOS values, optimal failsafe values and to save configuration changes.

```

Aptio Setup Utility - Copyright (C) 2011 American Megatrends, Inc.
Main   Advanced  Chipset   Boot     Security  Save & Exit
-----
Save Changes and Reset
Discard Changes and Reset

Restore Defaults
Save as User Defaults
Restore User Defaults

Reset the system after
saving the changes.

-----
<->: Select Screen
↑ ↓: Select Item
Enter>Select
+/-: Change Opt.
F1:  General Help
F2:  Previous Values
F3:  Optimized Defaults
F4:  Save & Exit
ESC: Exit

Version 2.14.1219. Copyright (C) 2011 American Megatrends, Inc.
  
```

### BIOS Menu 19: Exit

#### ➔ Save Changes and Reset

Use the **Save Changes and Reset** option to save the changes made to the BIOS options and reset the system.

#### ➔ Discard Changes and Reset

Use the **Discard Changes and Reset** option to exit the system without saving the changes made to the BIOS configuration setup program.

#### ➔ Restore Defaults

Use the **Restore Defaults** option to load the optimal default values for each of the parameters on the Setup menus. **F3 key can be used for this operation.**

➔ Save as User Defaults

Use the **Save as User Defaults** option to save the changes done so far as user defaults.

➔ Restore User Defaults

Use the **Restore User Defaults** option to restore the user defaults to all the setup options.

Chapter

8

# Software Drivers

---

## 8.1 Available Software Drivers

---



### **NOTE:**

The content of the CD may vary throughout the life cycle of the product and is subject to change without prior notice. Visit the IEI website or contact technical support for the latest updates.

---

The following drivers can be installed on the system:

- Chipset
- Graphic
- Touch
- Audio
- LAN
- USB 3.0
- Wi-Fi
- Bluetooth
- Camera

Installation instructions are given below.

## 8.2 Starting the Driver Program

To access the driver installation programs, please do the following.

**Step 1:** Insert the CD-ROM that came with the system into a CD-ROM drive attached to the system.

**Step 2:** Click **AFL2-08A-N26 Driver**.

**Step 3:** A list of available drivers appears.



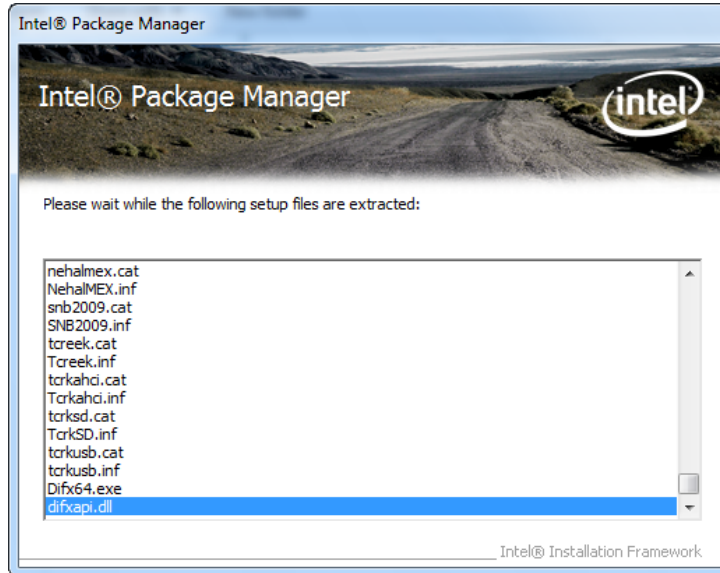

Figure 8-1: Drivers

### 8.3 Chipset Driver Installation

To install the chipset driver, please do the following.

- Step 1: Access the driver list. (See **Section 8.2**)
- Step 2: Click **“Chipset.”**
- Step 3: Locate the setup file and double click on it.
- Step 4: The setup files are extracted as shown in **Figure 8-2**.



**Figure 8-2: Chipset Driver Screen**

**Step 5:** When the setup files are completely extracted the **Welcome Screen** in **Figure 8-3** appears.

**Step 6:** Click **Next** to continue.

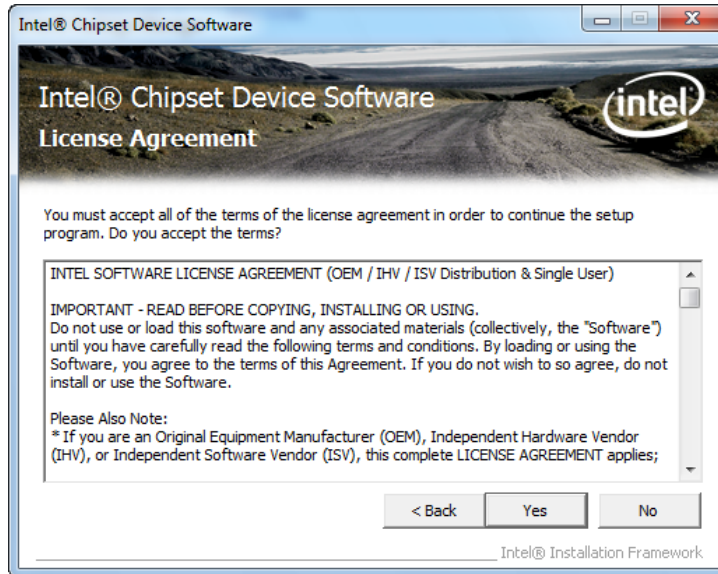

**Figure 8-3: Chipset Driver Welcome Screen**

**Step 7:** The license agreement in **Figure 8-4** appears.

**Step 8:** Read the **License Agreement**.

**Step 9:** Click **Yes** to continue.



**Figure 8-4: Chipset Driver License Agreement**

**Step 10:** The **Read Me** file in **Figure 8-5** appears.

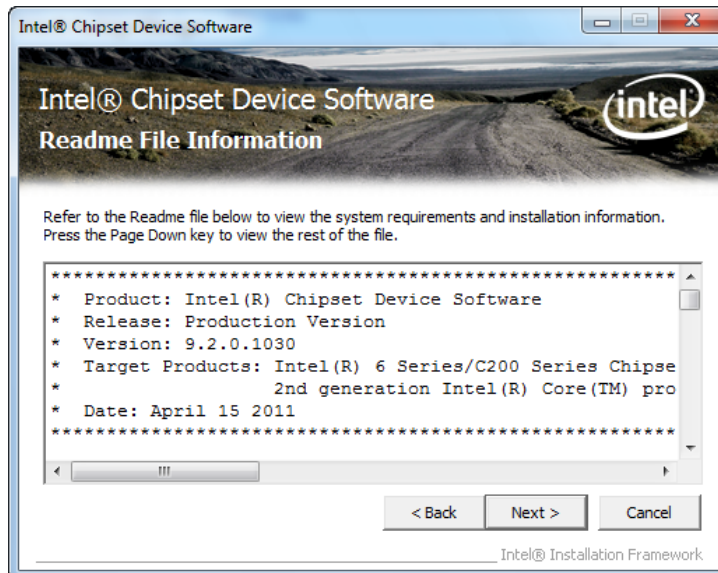

**Figure 8-5: Chipset Driver Read Me File**

**Step 11:** Click **Next** to continue

**Step 12:** Once the setup process is complete, click **Finish**.



**Figure 8-6: Chipset Driver Setup Operations**

## 8.4 Graphics Driver Installation

To install the Graphics driver, please do the following.

- Step 1:** Access the driver list. (See **Section 8.2**)
- Step 2:** Click **“Graphic”** and select the folder which corresponds to your operating system.
- Step 3:** Double click the setup file.
- Step 4:** The **Welcome Screen** in **Figure 8-7** appears.
- Step 5:** Click **Next** to continue.



**Figure 8-7: Graphics Driver Welcome Screen**

**Step 6:** The **License Agreement** in **Figure 8-8** appears.

**Step 7:** Click **Yes** to accept the agreement and continue.



**Figure 8-8: Graphics Driver License Agreement**

**Step 8:** The **Read Me** file in **Figure 8-9** appears.

**Step 9:** Click **Next** to continue.

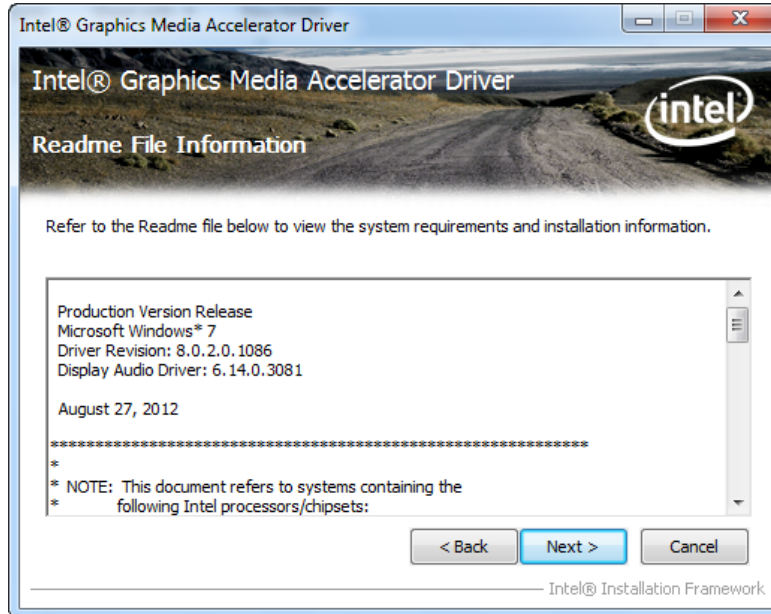

**Figure 8-9: Graphics Driver Read Me File**

**Step 10:** **Setup Operations** are performed as shown in **Figure 8-10**.

**Step 11:** Once the **Setup Operations** are complete, click **Next** to continue.

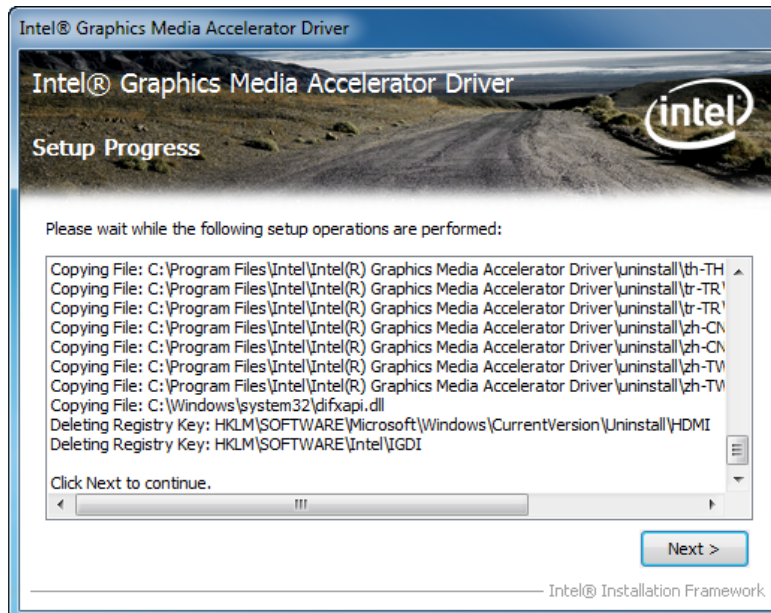
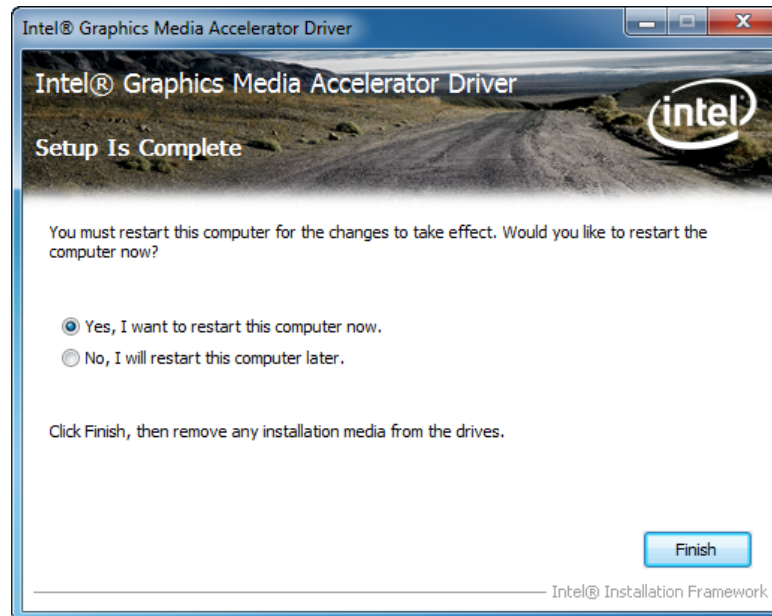

**Figure 8-10: Graphics Driver Setup Operations**

## AFL2-08A-N26

**Step 12:** The **Finish Screen** in **Figure 8-11** appears.

**Step 13:** Select **“Yes, I want to restart this computer now”** and click **Finish**.



**Figure 8-11: Graphics Driver Installation Finish Screen**

## 8.5 Touch Screen Driver

To install the touch panel software driver, please follow the steps below.

**Step 1:** Access the driver list. (See **Section 8.2**)

**Step 2:** Click **“Touch”**.

**Step 3:** Locate the setup file and double click on it.

**Step 4:** A **Welcome Screen** appears (**Figure 8-12**).

**Step 5:** Click **NEXT** to continue.

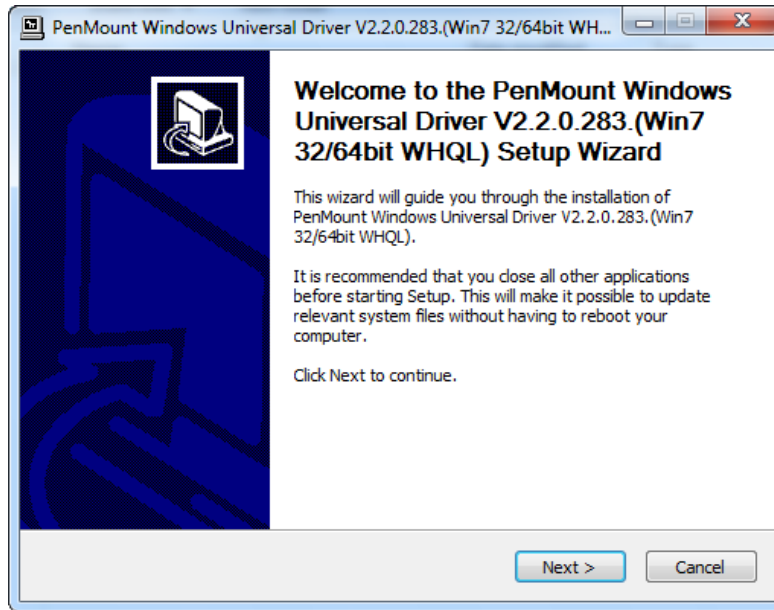

**Figure 8-12: Touch Screen Driver Welcome Screen**

**Step 6:** The **License Agreement** shown in **Figure 8-13** appears.

**Step 7:** Click **I AGREE** to accept and continue.

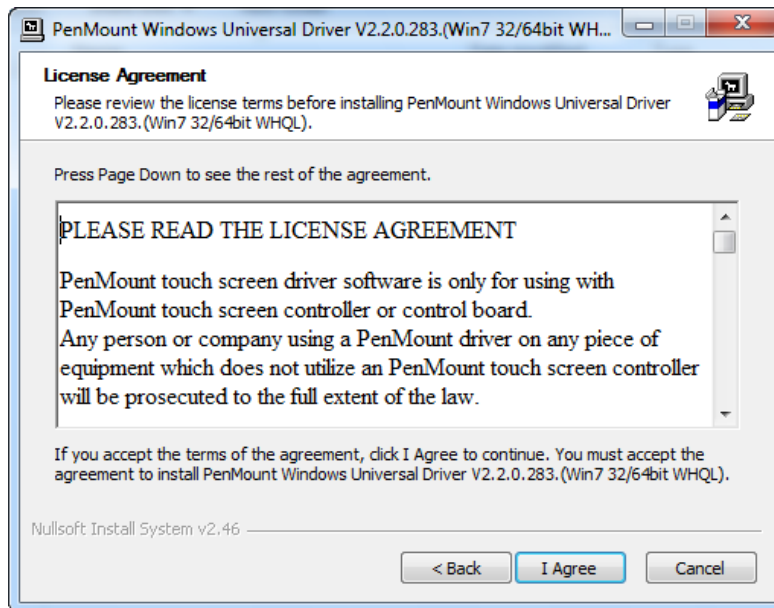

**Figure 8-13: Touch Screen Driver License Agreement**

**Step 8:** Browse for an install location or use the one suggested (**Figure 8-14**).



## AFL2-08A-N26

Step 9: Click **INSTALL** to continue.

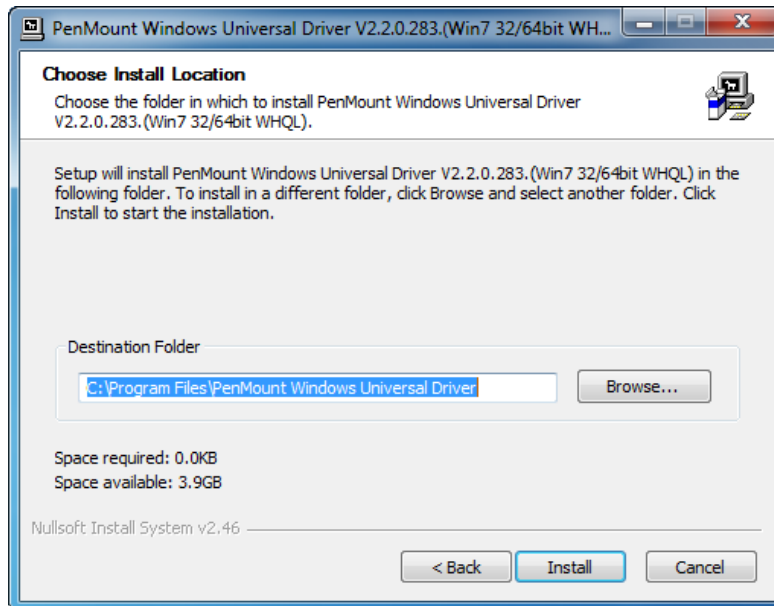

**Figure 8-14: Touch Screen Driver Choose Install Location**

Step 10: The **Install** screen appears and displays the progress of the installation (**Figure 8-15**).

Step 11: Click **NEXT** to continue.

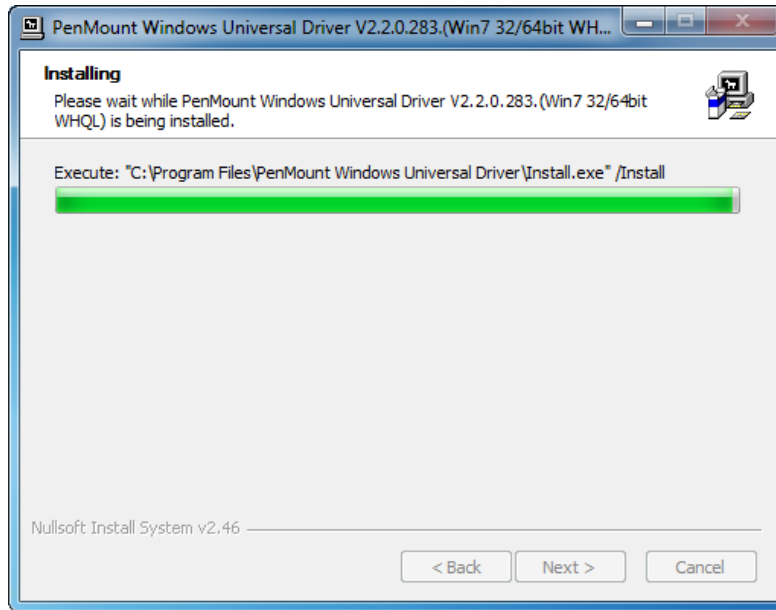

Figure 8-15: Touch Screen Driver Installation Screen

Step 12: When the installation is complete, click FINISH to exit setup. (Figure 8-16).

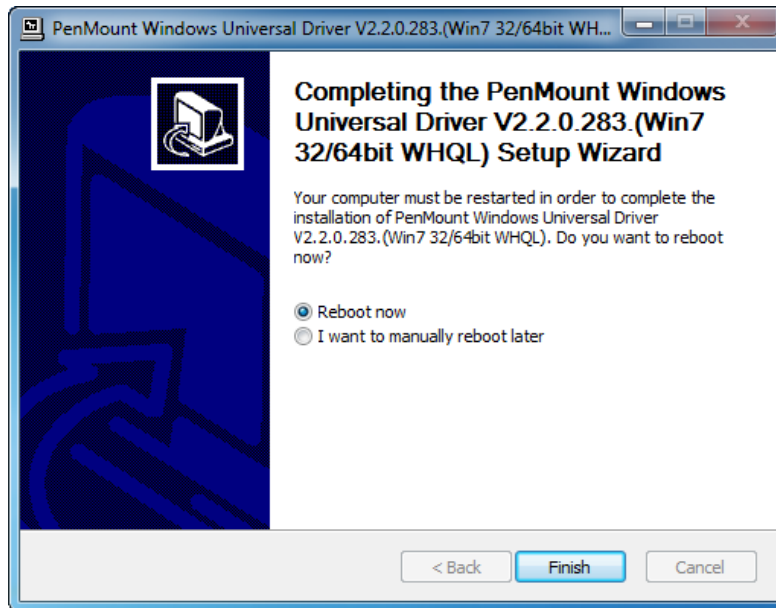

Figure 8-16: Touch Screen Driver Update Complete

### 8.5.1 Calibrating the Touch Screen

To calibrate the touch screen cursor with the motion of the touch screen pen (or finger), please follow the steps below:

**Step 1:** Make sure the touch screen driver is properly installed.

**Step 2:** Locate the PenMount Monitor icon in the bottom right corner of the screen.



**Figure 8-17: PenMount Monitor Icon**

**Step 3:** Click the icon. A pop up menu appears. See **Figure 8-18**.

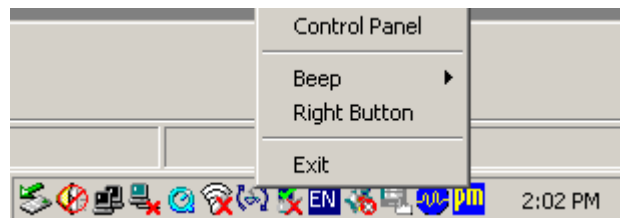

**Figure 8-18: PenMount Monitor Popup Menu**

**Step 4:** Click Control Panel in the pop up menu shown in **Figure 8-18**.

**Step 5:** The configuration screen in **Figure 8-19** appears.

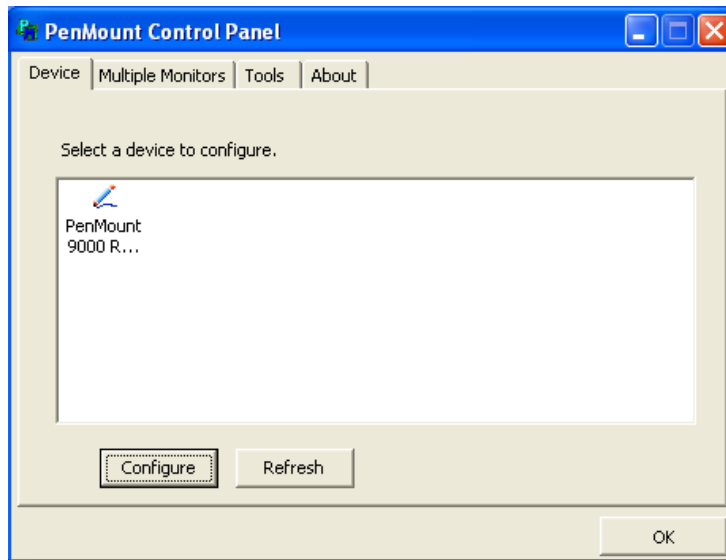

Figure 8-19: Configuration Screen

Step 6: Double click the PenMount 9000 icon as shown in **Figure 8-19**.

Step 7: The calibration initiation screen in **Figure 8-20** appears.

Step 8: Select the **Standard Calibration** button as shown in **Figure 8-20**.

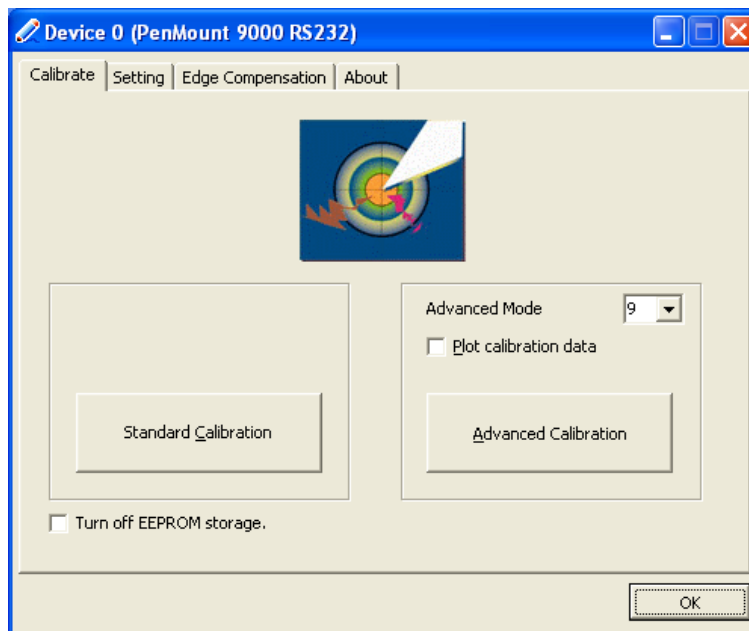
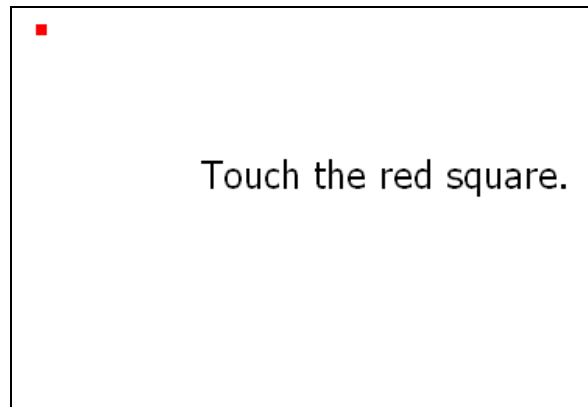

Figure 8-20: Calibration Initiation Screen

## AFL2-08A-N26

**Step 9:** The calibration screen in is shown. See **Figure 8-21**.



**Figure 8-21: Calibration Screen**

**Step 10:** Follow the instructions. The user is asked touch the screen at five specified points after which the screen is calibrated.

## 8.6 Audio Driver Installation

To install the audio driver, please do the following.

**Step 1:** Access the driver list. (See **Section 8.2**)

**Step 2:** Click "**Audio**" and select the folder which corresponds to the operating system.

**Step 3:** Double click the setup file.

**Step 4:** The InstallShield Wizard starts to extracting files (**Figure 8-22**).

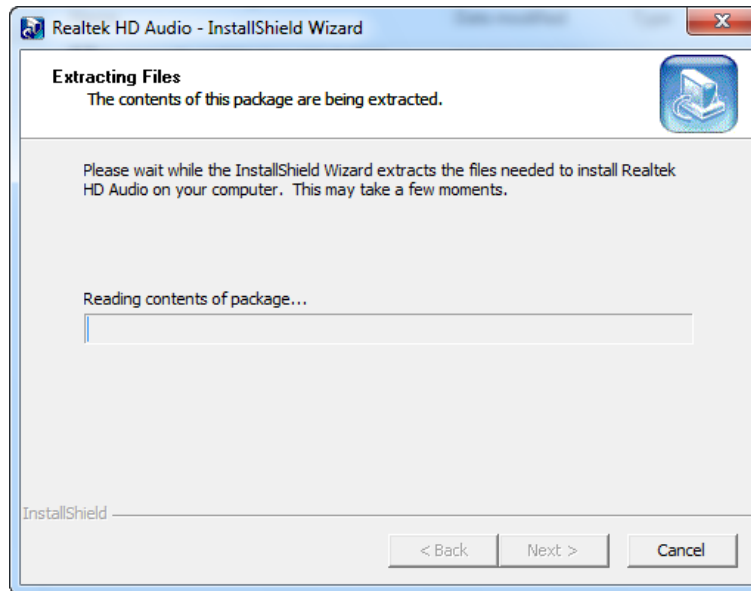

Figure 8-22: Audio Driver – Extracting Files

Step 5: The **Audio Driver Welcome** message in **Figure 8-23** appears.

Step 6: Click **Yes** to install the audio driver.

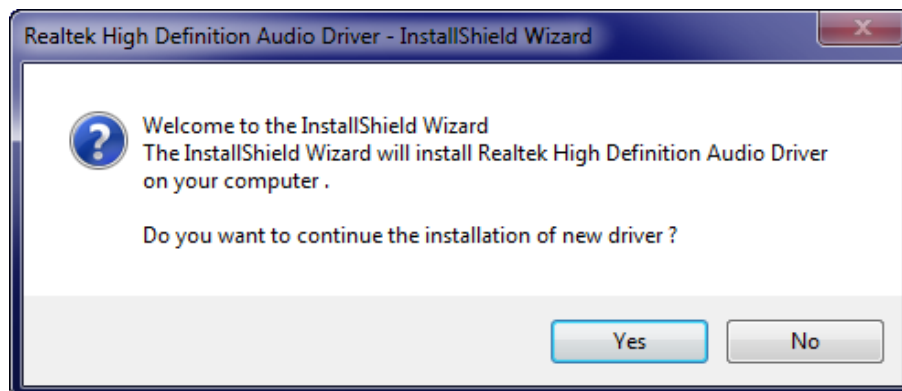

Figure 8-23: Audio Driver Welcome Screen

Step 7: The audio driver installation begins. See **Figure 8-24**.



**Figure 8-24: Audio Driver Installation**

**Step 8:** When the installation is complete, the screen in **Figure 8-25** appears.

**Step 9:** Select “**Yes, I want to restart my computer now**” and click **Finish**.



**Figure 8-25: Audio Driver Installation Complete**

## 8.7 LAN Driver Installation

To install the LAN driver, please do the following.

**Step 1:** Access the driver list. (See **Section 8.2**)

**Step 2:** Click “**LAN**” and select the folder which corresponds to the operating system.

**Step 3:** Double click the setup file.

**Step 4:** The **Welcome** screen in **Figure 8-26** appears.

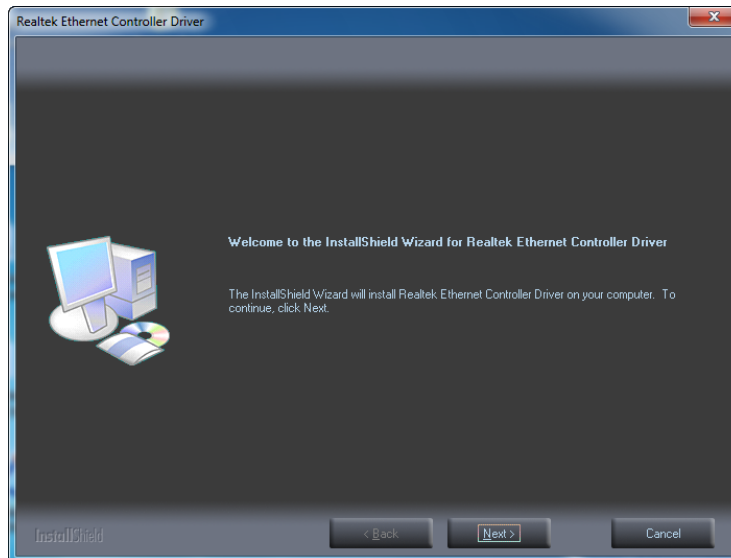
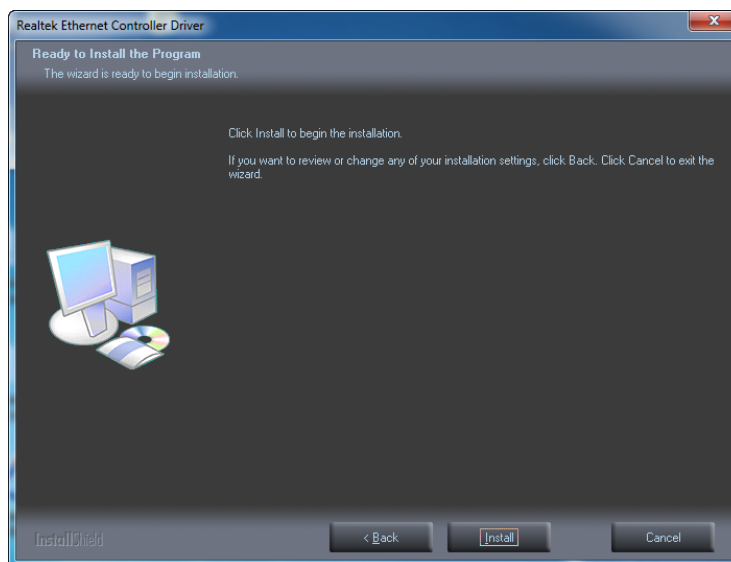

**Figure 8-26: LAN Driver Welcome Screen**

**Step 5:** Click **Next** to continue.

**Step 6:** The **Ready to Install the Program** Screen in **Figure 8-27** appears.

**Step 7:** Click **Install** to proceed with the installation.

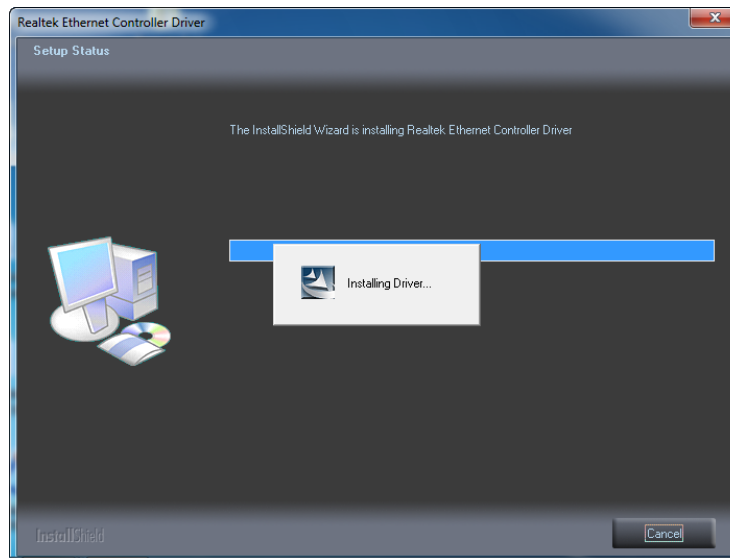

**Figure 8-27: LAN Driver Ready to Install Screen**

**Step 8:** The program begins to install.



**Step 9:** The **Setup Status** screen in **Figure 8-28** appears.



**Figure 8-28: LAN Driver Setup Status Screen**

**Step 10:** When the driver installation is complete, the screen in **Figure 8-29** appears.

**Step 11:** Click **Finish** to exit.

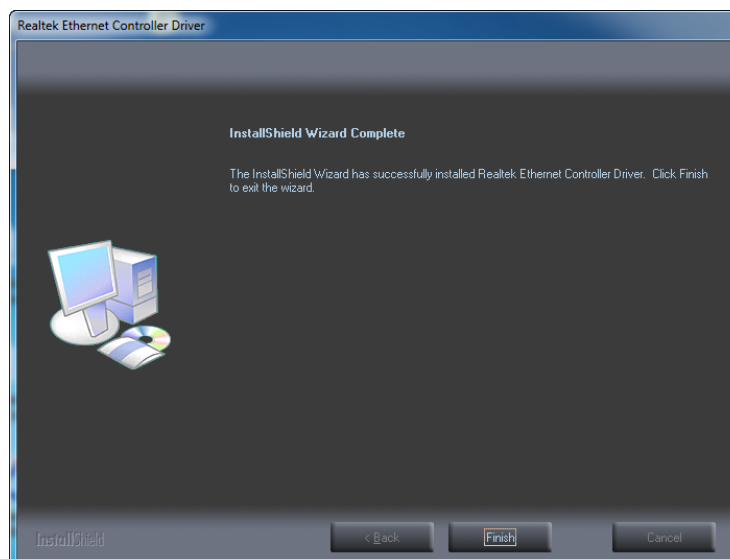

**Figure 8-29: LAN Driver Installation Complete**

## 8.8 USB 3.0 Driver Installation

To install the touch panel software driver, please follow the steps below.

**Step 1:** Access the driver list. (See **Section 8.2**)

**Step 2:** Click “**USB 3.0**”.

**Step 3:** Locate the setup file and double click on it.

**Step 4:** A **Welcome Screen** appears (**Figure 8-30**).

**Step 5:** Click **Next** to continue.

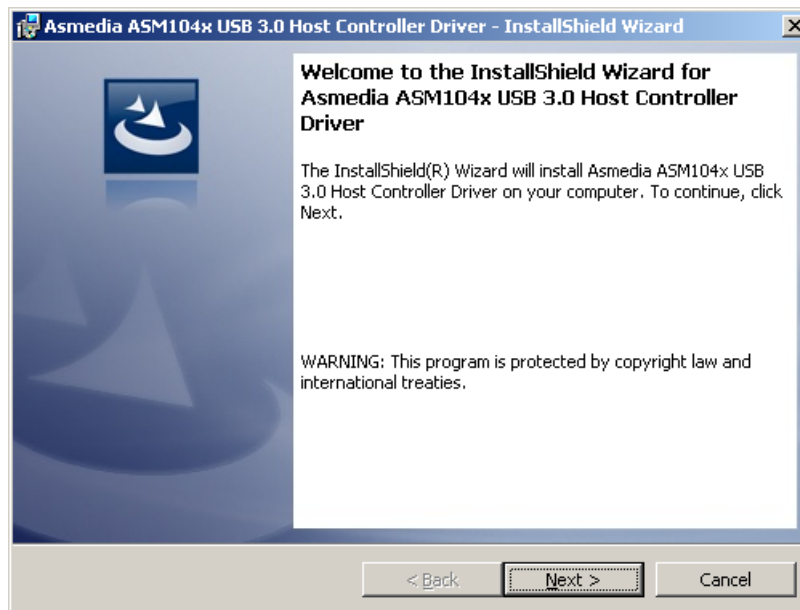

**Figure 8-30: USB 3.0 Driver Welcome Screen**

**Step 6:** The **License Agreement** shown in **Figure 8-31** appears.

**Step 7:** Accept the agreement by selecting “I accept the terms in the license agreement”.

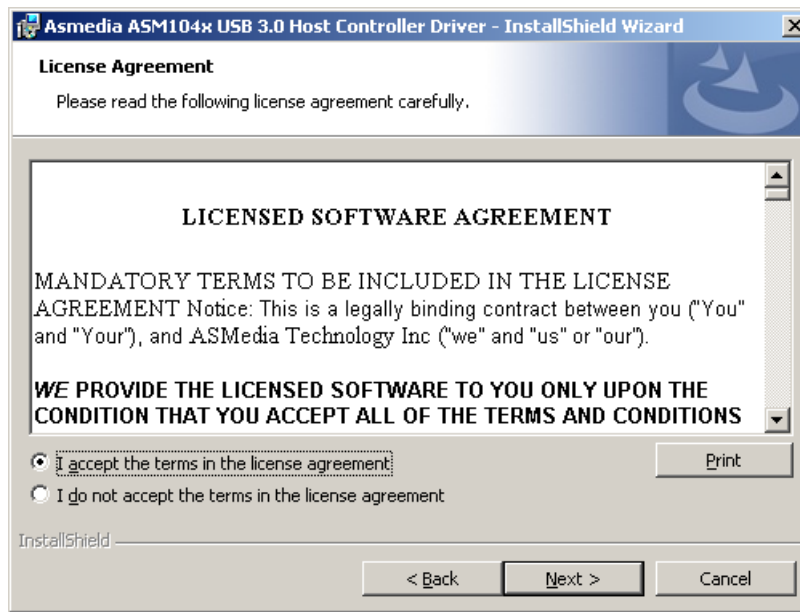

**Figure 8-31: USB 3.0 Driver License Agreement**

**Step 8:** Click NEXT to continue.

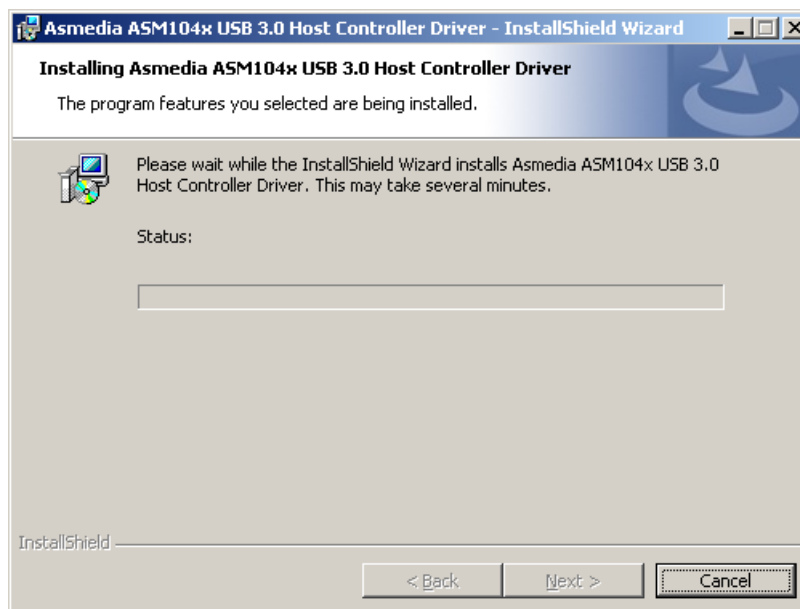

**Figure 8-32: USB 3.0 Driver Installation**

**Step 9:** The **Install** screen appears and displays the progress of the installation.

**Step 10:** When the installation is complete, click **Finish** to exit setup. (Figure 8-33).

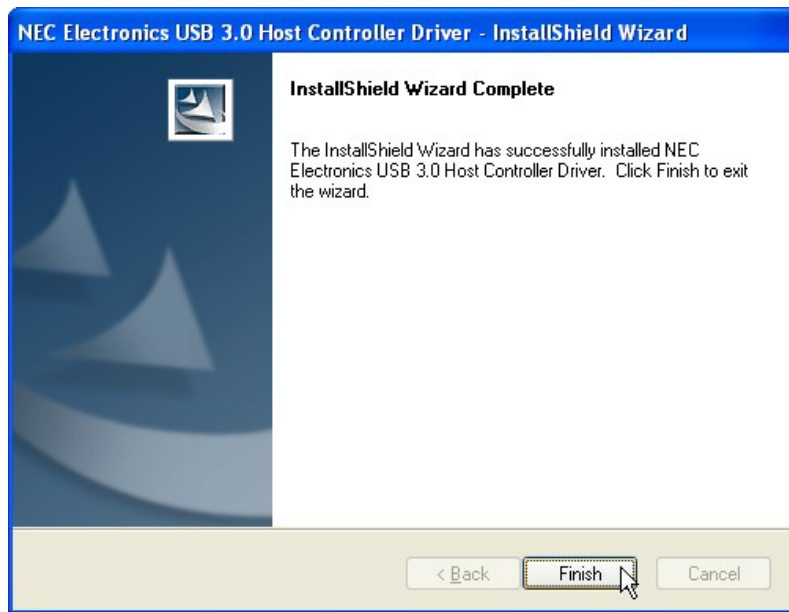
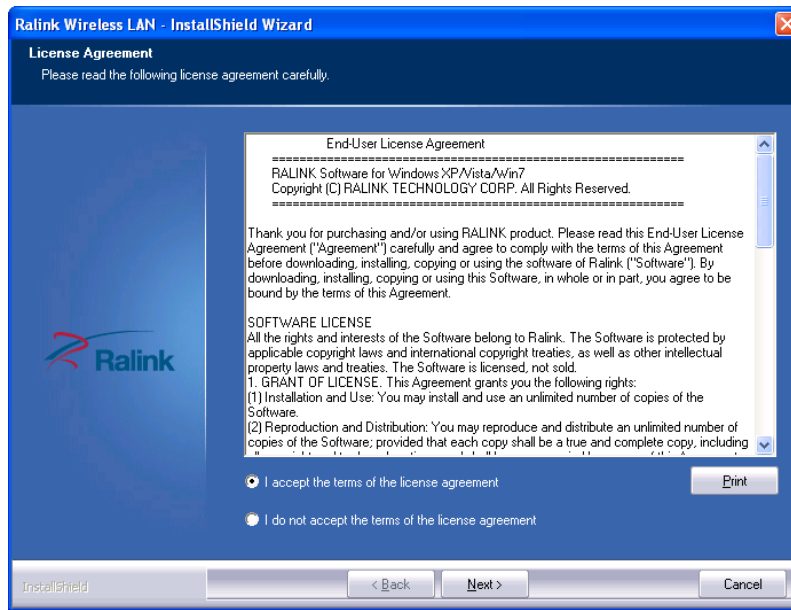

**Figure 8-33: USB 3.0 Driver Update Complete**

## 8.9 Wi-Fi Driver Installation

To install the wireless LAN driver, please follow the steps below.

- Step 1:** Access the driver list. (See **Section 8.2**)
- Step 2:** Click "**WiFi**" and select the folder which corresponds to your operating system.
- Step 3:** Double click the setup file.
- Step 4:** The **License Agreement** screen in **Figure 8-34** appears.



**Figure 8-34: License Agreement**

**Step 5:** Accept the conditions of the license agreement and click **NEXT** to continue.

**Step 6:** The **Setup Type** screen in **Figure 8-35** appears.

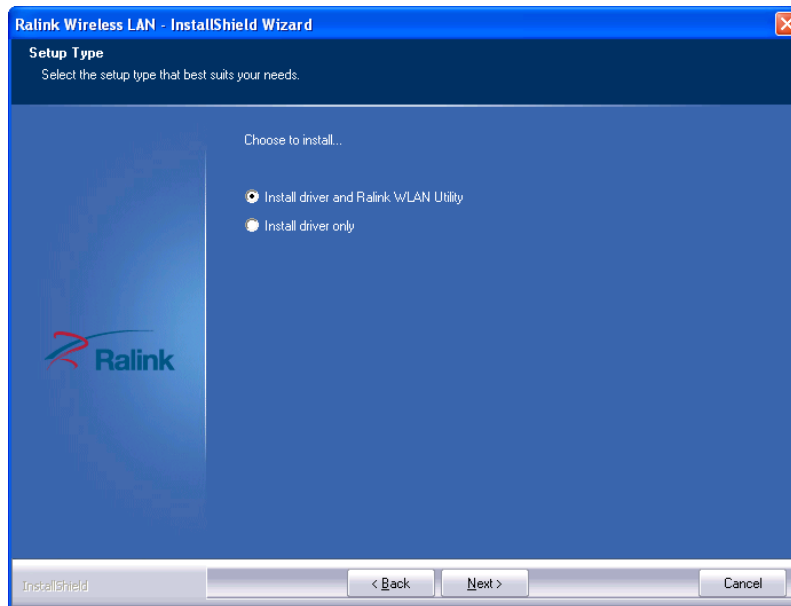

**Figure 8-35: Setup Type**

**Step 7:** Select “Install driver and Ralink WLAN Utility” and click **NEXT** to continue.

**Step 8:** The **Configuration Tool** screen in **Figure 8-36** appears.

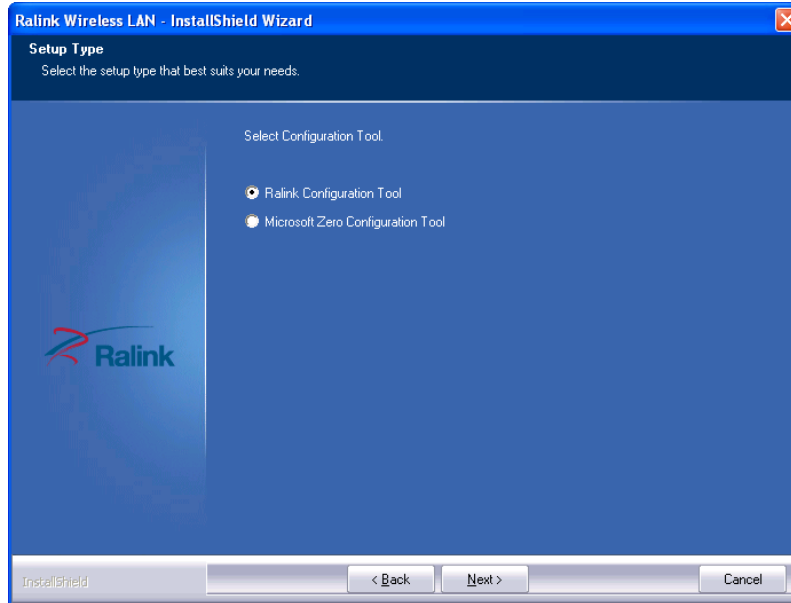

**Figure 8-36: Configuration Tool**

**Step 9:** Select “**Ralink Configuration Tool**” and click **NEXT** to continue.

**Step 10:** The **Ready to Install the Program** screen in **Figure 8-37** appears.

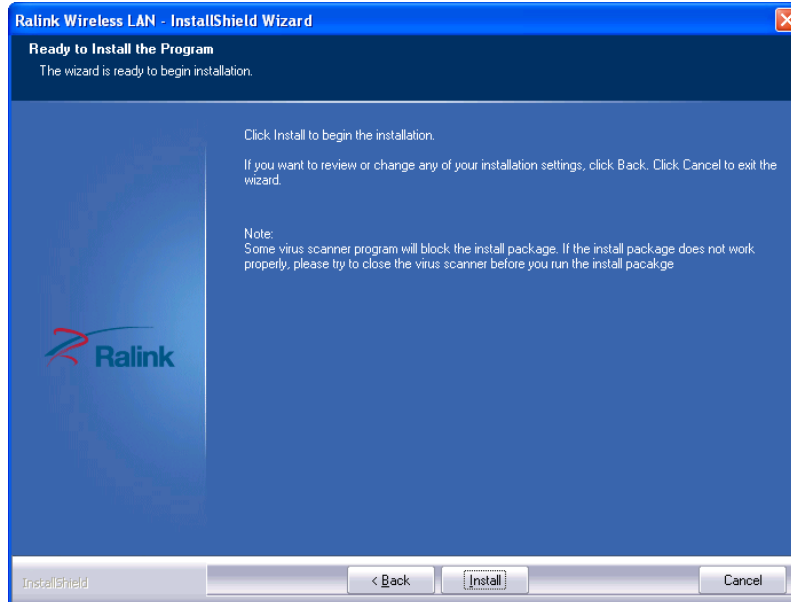
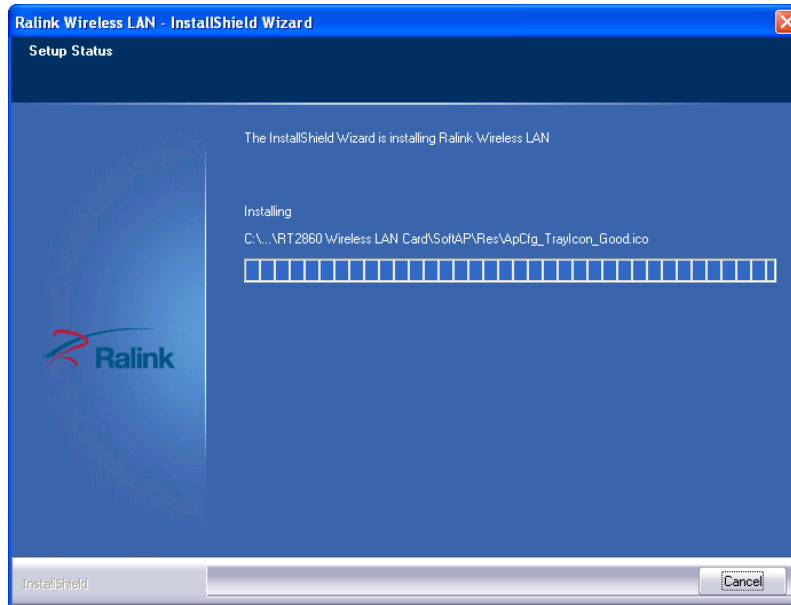

**Figure 8-37: Ready to Install the Program**

**AFL2-08A-N26**

**Step 11:** Click **Install** to proceed with the installation.

**Step 12:** The **Setup Status** screen in **Figure 8-38** appears and displays the progress of the installation.



**Figure 8-38: Setup Status**

**Step 13:** When the driver installation is complete, the screen in **Figure 8-39** appears.

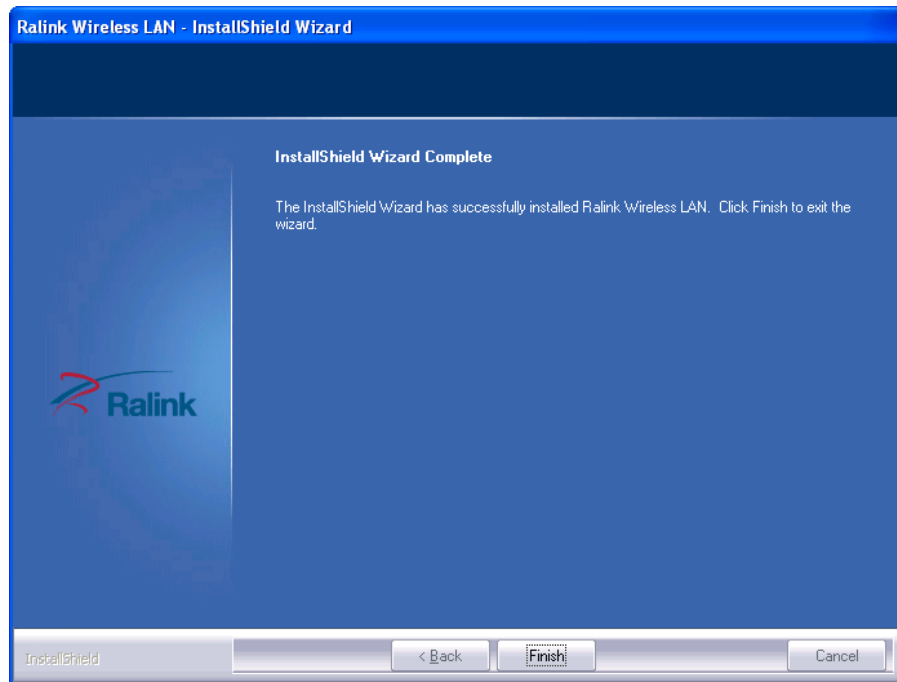

**Figure 8-39: Installation Complete**

**Step 14:** Click **FINISH** to complete installation.

## 8.10 Bluetooth Driver

To install the Bluetooth software driver, please follow the steps below.

**Step 1:** Access the driver list. (See **Section 8.2**)

**Step 2:** Click **“Bluetooth”** and select the folder which corresponds to your operating system.

**Step 3:** Double click the setup file.

**Step 4:** The **Welcome Screen** appears (**Figure 8-40**).

**Step 5:** Click **NEXT** to continue the installation process.



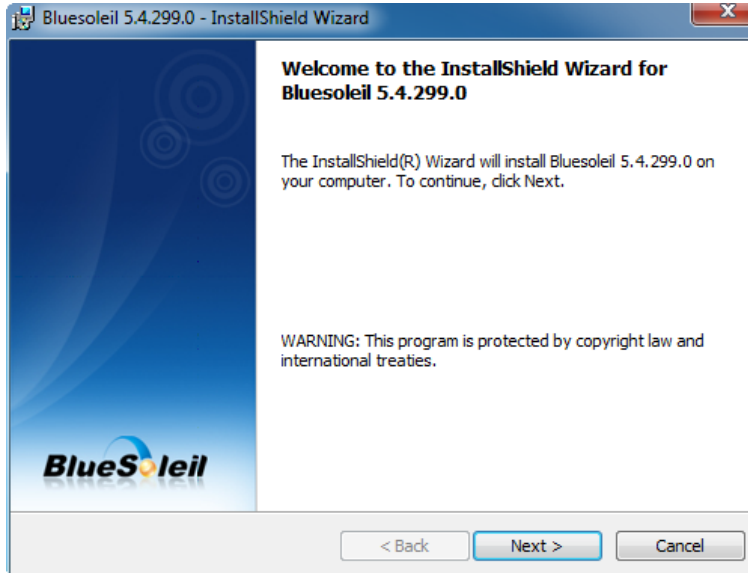

**Figure 8-40: Welcome Screen**

**Step 6:** The **License Agreement** appears as shown in **Figure 8-41**.

**Step 7:** Agree to the license by selecting “I accept the terms in the license agreement” and click **NEXT**.



**Figure 8-41: License Agreement**

**Step 8:** Browse for an install location or use the one suggested (**Figure 8-42**) and click **NEXT**.

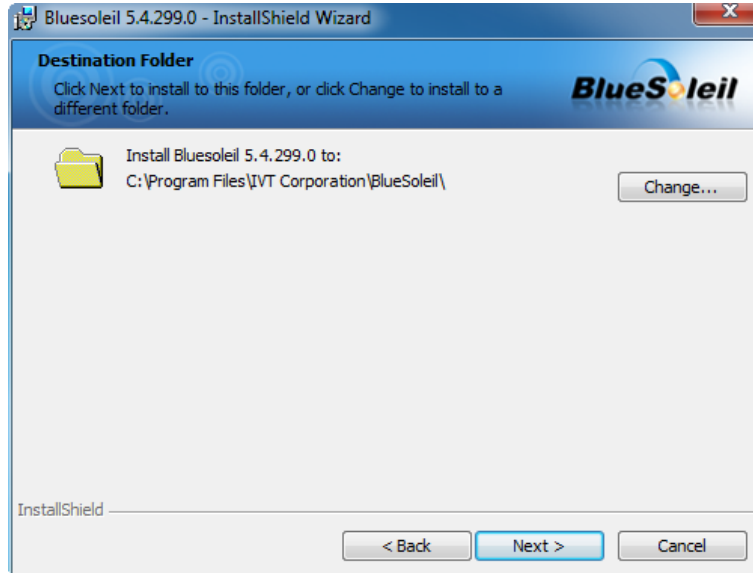

**Figure 8-42: Bluetooth Driver Destination Folder**

**Step 9:** The Installshield Wizard is ready to install the program.

**Step 10:** Click **INSTALL** to continue (**Figure 8-43**).

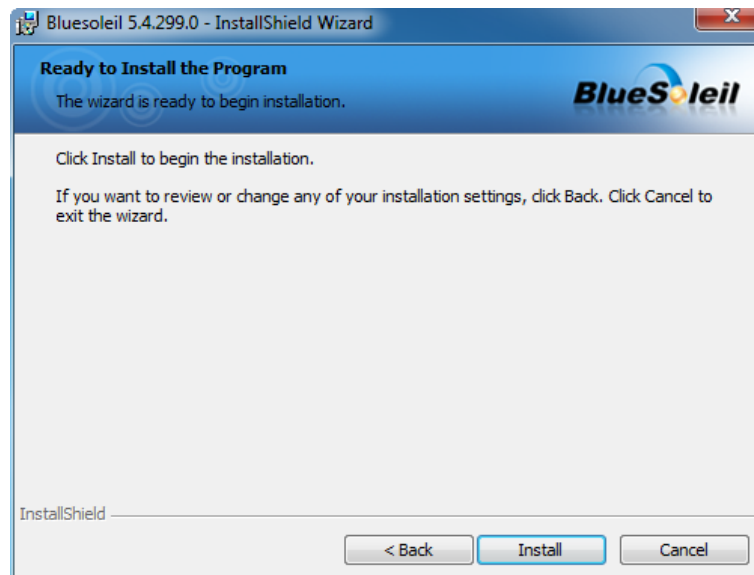

**Figure 8-43: Ready to Install the Program**

**Step 11:** The installation screen appears and displays the progress of the installation (**Figure 8-44**).

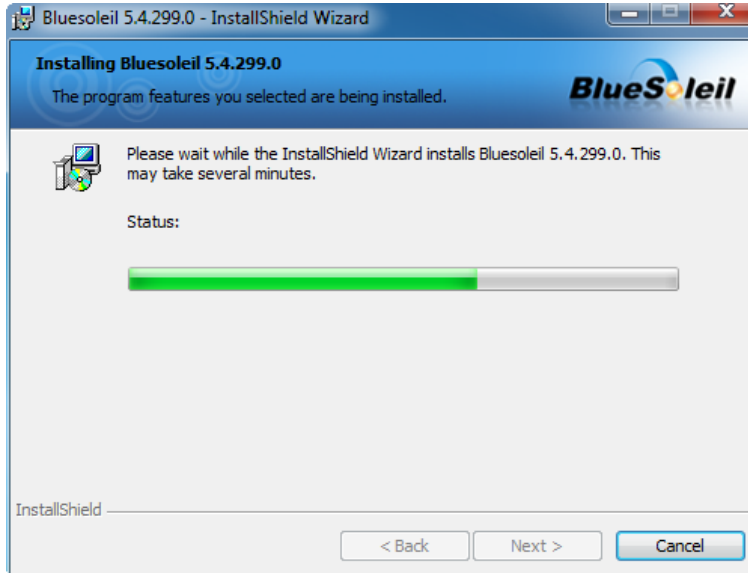

**Figure 8-44: Installing BlueSoleil**

**Step 12:** When the installation process is complete, click **FINISH**. See **Figure 8-45**.

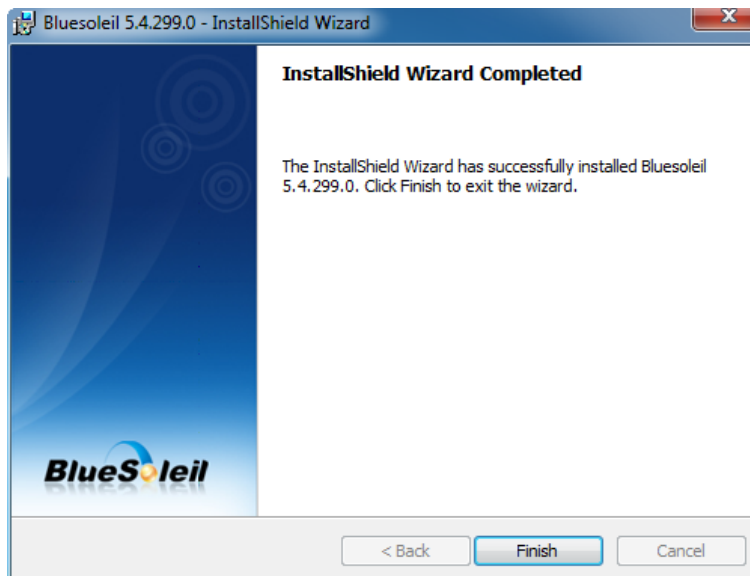

**Figure 8-45: Bluetooth Driver Complete Installation Screen**

**Step 13:** The user is then prompted to select to restart the computer now or later (**Figure 8-46**). For the settings to take effect, the computer must be restarted.

**Step 14:** Click **YES** to restart the computer.

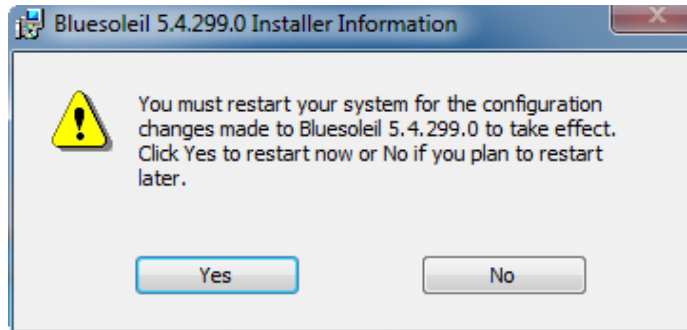

**Figure 8-46: Reboot the Computer**

## 8.11 AMCap Driver Installation

To install the AMCap driver, please do the following.

- Step 1:** Access the driver list. (See **Section 8.2**)
- Step 2:** Click "**AMCap**" and select the folder which corresponds to your operating system.
- Step 3:** Double click the setup file.
- Step 4:** The **Welcome Screen** in **Figure 8-47** appears.
- Step 5:** Click **Next** to continue.

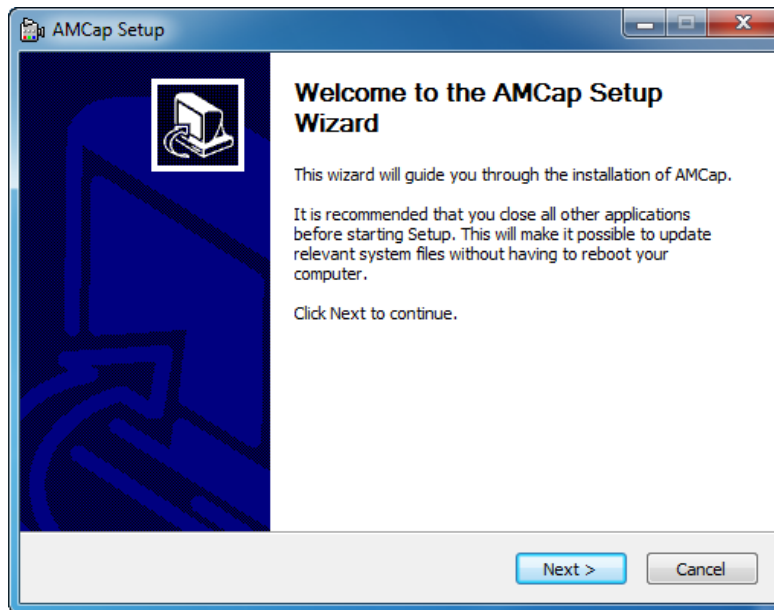

Figure 8-47: AMCap Driver Welcome Screen

Step 6: Browse for an install location or use the one suggested (Figure 8-48).

Step 7: Click INSTALL to continue.

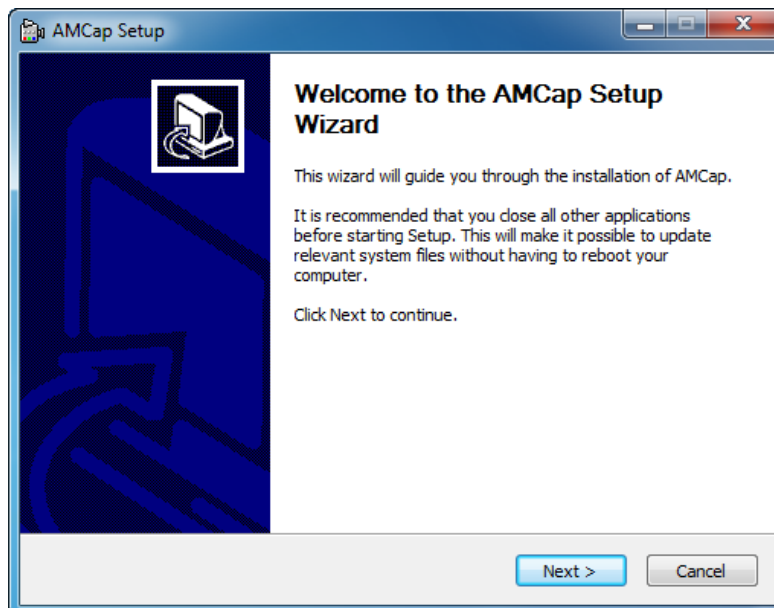
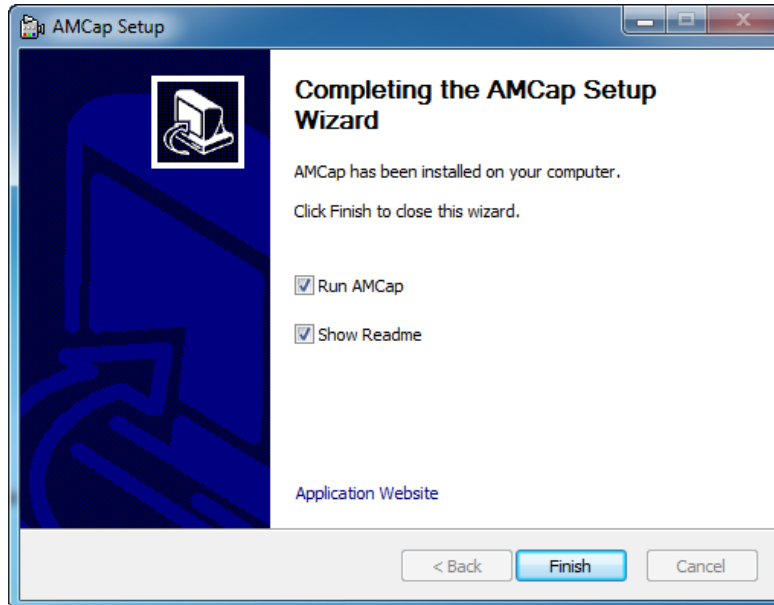

Figure 8-48: AMCap Driver Choose Install Location

Step 8: The program begins to install.

Step 9: When the driver installation is complete, the screen in **Figure 8-49** appears.

Step 10: Click **Finish** to save and exit.



**Figure 8-49: AMCap Driver Installation Complete**

Appendix

A

# Safety Precautions

---

**WARNING:**

The precautions outlined in this chapter should be strictly followed. Failure to follow these precautions may result in permanent damage to the AFL2-08A-N26.

## A.1 Safety Precautions

Please follow the safety precautions outlined in the sections that follow:

### A.1.1 General Safety Precautions

Please ensure the following safety precautions are adhered to at all times.

- **Follow the electrostatic precautions** outlined below whenever the AFL2-08A-N26 is opened.
- **Make sure the power is turned off and the power cord is disconnected** whenever the AFL2-08A-N26 is being installed, moved or modified.
- **Do not apply voltage levels that exceed the specified voltage range.** Doing so may cause fire and/or an electrical shock.
- **Electric shocks can occur** if the AFL2-08A-N26 chassis is opened when the AFL2-08A-N26 is running.
- **Do not drop or insert any objects** into the ventilation openings of the AFL2-08A-N26.
- **If considerable amounts of dust, water, or fluids enter the AFL2-08A-N26,** turn off the power supply immediately, unplug the power cord, and contact the AFL2-08A-N26 vendor.
- **DO NOT:**
  - Drop the AFL2-08A-N26 against a hard surface.
  - Strike or exert excessive force onto the LCD panel.
  - Touch any of the LCD panels with a sharp object
  - In a site where the ambient temperature exceeds the rated temperature



## AFL2-08A-N26

### A.1.2 CPU Temperature Warning

---



#### **WARNING:**

If the CPU Temperature Alert LED shows **RED**, the CPU core temperature is too high. To lower the CPU temperature, lower the environment temperature or decrease the amount of running programs.

---

### A.1.3 Anti-static Precautions

---



#### **WARNING:**

Failure to take ESD precautions during the installation of the AFL2-08A-N26 may result in permanent damage to the AFL2-08A-N26 and severe injury to the user.

---

Electrostatic discharge (ESD) can cause serious damage to electronic components, including the AFL2-08A-N26. Dry climates are especially susceptible to ESD. It is therefore critical that whenever the AFL2-08A-N26 is opened and any of the electrical components are handled, the following anti-static precautions are strictly adhered to.

- ***Wear an anti-static wristband:*** Wearing a simple anti-static wristband can help to prevent ESD from damaging any electrical component.
- ***Self-grounding:*** Before handling any electrical component, touch any grounded conducting material. During the time the electrical component is handled, frequently touch any conducting materials that are connected to the ground.
- ***Use an anti-static pad:*** When configuring or working with an electrical component, place it on an anti-static pad. This reduces the possibility of ESD damage.
- ***Only handle the edges of the electrical component:*** When handling the electrical component, hold the electrical component by its edges.

### A.1.4 Product Disposal

---

**CAUTION:**

Risk of explosion if battery is replaced by and incorrect type. Only certified engineers should replace the on-board battery.

Dispose of used batteries according to instructions and local regulations.

---

- Outside the European Union - If you wish to dispose of used electrical and electronic products outside the European Union, please contact your local authority so as to comply with the correct disposal method.
- Within the European Union:

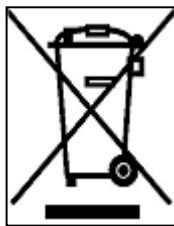

EU-wide legislation, as implemented in each Member State, requires that waste electrical and electronic products carrying the mark (left) must be disposed of separately from normal household waste. This includes monitors and electrical accessories, such as signal cables or power cords.

When you need to dispose of your display products, please follow the guidance of your local authority, or ask the shop where you purchased the product. The mark on electrical and electronic products only applies to the current European Union Member States.

Please follow the national guidelines for electrical and electronic product disposal.

## A.2 Maintenance and Cleaning Precautions

When maintaining or cleaning the AFL2-08A-N26, please follow the guidelines below.

### A.2.1 Maintenance and Cleaning

Prior to cleaning any part or component of the AFL2-08A-N26, please read the details below.

## AFL2-08A-N26

- Except for the LCD panel, never spray or squirt liquids directly onto any other components. To clean the LCD panel, gently wipe it with a piece of soft dry cloth or a slightly moistened cloth.
- The interior of the AFL2-08A-N26X does not require cleaning. Keep fluids away from the AFL2-08A-N26 interior.
- Be cautious of all small removable components when vacuuming the AFL2-08A-N26.
- Turn the AFL2-08A-N26 off before cleaning the AFL2-08A-N26.
- Never drop any objects or liquids through the openings of the AFL2-08A-N26.
- Be cautious of any possible allergic reactions to solvents or chemicals used when cleaning the AFL2-08A-N26.
- Avoid eating, drinking and smoking within vicinity of the AFL2-08A-N26.

### A.2.2 Cleaning Tools

Some components in the AFL2-08A-N26 may only be cleaned using a product specifically designed for the purpose. In such case, the product will be explicitly mentioned in the cleaning tips. Below is a list of items to use when cleaning the AFL2-08A-N26.

- **Cloth** – Although paper towels or tissues can be used, a soft, clean piece of cloth is recommended when cleaning the AFL2-08A-N26.
- **Water or rubbing alcohol** – A cloth moistened with water or rubbing alcohol can be used to clean the AFL2-08A-N26.
- **Using solvents** – The use of solvents is not recommended when cleaning the AFL2-08A-N26 as they may damage the plastic parts.
- **Vacuum cleaner** – Using a vacuum specifically designed for computers is one of the best methods of cleaning the AFL2-08A-N26. Dust and dirt can restrict the airflow in the AFL2-08A-N26 and cause its circuitry to corrode.
- **Cotton swabs** - Cotton swabs moistened with rubbing alcohol or water are excellent tools for wiping hard to reach areas.
- **Foam swabs** - Whenever possible, it is best to use lint free swabs such as foam swabs for cleaning.



Appendix

**B**

# BIOS Menu Options

---

- ➔ BIOS Information .....70
- ➔ iWDD Vendor .....70
- ➔ iWDD Version .....71
- ➔ System Date [xx/xx/xx] .....71
- ➔ System Time [xx:xx:xx] .....71
- ➔ ACPI Sleep State [S1 (CPU Stop Clock)] .....73
- ➔ Wake system with Fixed Time [Disabled].....73
- ➔ Hyper-Threading [Enabled].....76
- ➔ Configure SATA as [IDE].....76
- ➔ USB Devices .....77
- ➔ Legacy USB Support [Enabled].....77
- ➔ Serial Port [Enabled].....79
- ➔ Change Settings [Auto] .....79
- ➔ Serial Port [Enabled].....80
- ➔ Change Settings [Auto] .....80
- ➔ Device Mode [RS422/485].....80
- ➔ PC Health Status .....81
- ➔ Console Redirection [Disabled].....82
- ➔ Terminal Type [ANSI].....82
- ➔ Bits per second [115200].....82
- ➔ Data Bits [8] .....83
- ➔ Parity [None].....83
- ➔ Stop Bits [1].....83
- ➔ Auto Recovery Function [Disabled] .....84
- ➔ Micro SD Card [Enabled].....85
- ➔ IGFX - Boot Type [VBIOS Default] .....87
- ➔ LCD Panel Type [800x600-18BIT] .....87
- ➔ Active LFP [Int-LVDS] .....87
- ➔ Fixed Graphics Memory Size [128MB].....88
- ➔ WIFI Function [Enabled].....88
- ➔ DMIC Function [Enabled] .....89
- ➔ Blue Tooth Function [Enabled].....89
- ➔ Auto Dimming Support [Disabled] .....89
- ➔ Power Saving Function (ERP) [Disabled].....89

→	Bootup NumLock State [On].....	90
→	Quiet Boot [Enabled] .....	91
→	Launch PXE OpROM [Disabled] .....	91
→	Option ROM Messages [Force BIOS].....	91
→	UEFI Boot [Disabled] .....	91
→	Boot Option Priority.....	91
→	Hard Drive BBS Priorities.....	92
→	Administrator Password .....	92
→	User Password .....	92
→	Save Changes and Reset .....	93
→	Discard Changes and Reset .....	93
→	Restore Defaults .....	93
→	Save as User Defaults .....	94
→	Restore User Defaults .....	94

Appendix

C

# One Key Recovery

---

## C.1 One Key Recovery Introduction

The IEI one key recovery is an easy-to-use front end for the Norton Ghost system backup and recovery tool. This tool provides quick and easy shortcuts for creating a backup and reverting to that backup or reverting to the factory default settings.



### NOTE:

Once to run One Key Recovery function, disable the micro SD card in BIOS firstly. See Section 7.4

The latest One Key Recovery software provides an auto recovery function that allows a system running Microsoft Windows OS to automatically restore from the factory default image after encountering a Blue Screen of Death (BSoD) or a hang for around 10 minutes. Please refer to Section C.3 for the detailed setup procedure.

The IEI One Key Recovery tool menu is shown below.

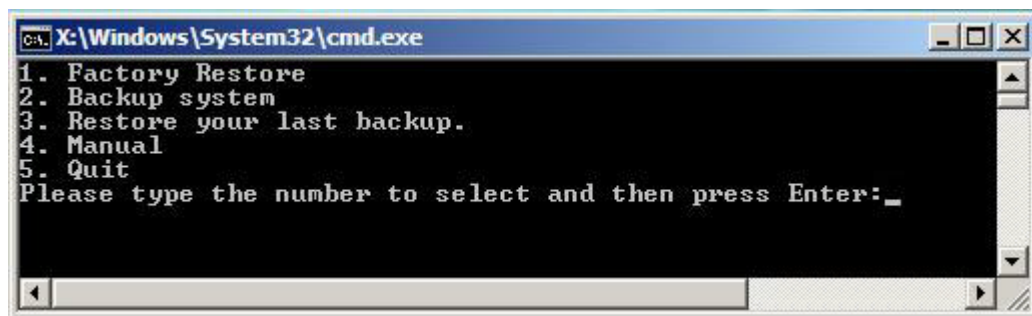

**Figure C-1: IEI One Key Recovery Tool Menu**

Prior to using the IEI One Key Recovery tool (as shown in **Figure C-1**) to backup or restore Windows system, five setup procedures are required.

1. Hardware and BIOS setup (see **Section C.2.1**)
2. Create partitions (see **Section C.2.2**)
3. Install operating system, drivers and system applications (see **Section C.2.3**)
4. Build the recovery partition (see **Section C.2.4**)



## AFL2-08A-N26

5. Create factory default image (see **Section C.2.5**)

After completing the five initial setup procedures as described above, users can access the recovery tool by pressing <F3> while booting up the system. The detailed information of each function is described in **Section C.5**.



### NOTE:

The initial setup procedures for Linux system are described in **Section C.3**.

---

### C.1.1 System Requirement



### NOTE:

The recovery CD can only be used with IEI products. The software will fail to run and a warning message will appear when used on non-IEI hardware.



---

To create the system backup, the main storage device must be split into two partitions (three partitions for Linux). The first partition will be for the operating system, while the second partition will be invisible to the operating system and contain the backup made by the one key recovery software.

The partition created for recovery images must be big enough to contain both the factory default image and the user backup image. The size must be calculated before creating the partitions. Please take the following table as a reference when calculating the size of the partition.

	<b>OS</b>	<b>OS Image after Ghost</b>	<b>Compression Ratio</b>
<b>Windows® 7</b>	7 GB	5 GB	70%
<b>Windows® XPE</b>	776 MB	560 MB	70%
<b>Windows® CE 6.0</b>	36 MB	28 MB	77%

**NOTE:**

Specialized tools are required to change the partition size if the operating system is already installed.

### C.1.2 Supported Operating System

The recovery CD is compatible with both Microsoft Windows and Linux operating systems (OS). The supported OS versions are listed below.

- Microsoft Windows
  - Windows XP (Service Pack 2 or 3 required)
  - Windows Vista
  - Windows 7
  - Windows CE 5.0
  - Windows CE 6.0
  - Windows XP Embedded
- Linux
  - Fedora Core 12 (Constantine)
  - Fedora Core 11 (Leonidas)
  - Fedora Core 10 (Cambridge)
  - Fedora Core 8 (Werewolf)
  - Fedora Core 7 (Moonshine)

## AFL2-08A-N26

- RedHat RHEL-5.4
- RedHat 9 (Ghirke)
- Ubuntu 8.10 (Intrepid)
- Ubuntu 7.10 (Gutsy)
- Ubuntu 6.10 (Edgy)
- Debian 5.0 (Lenny)
- Debian 4.0 (Etch)
- SuSe 11.2
- SuSe 10.3

**NOTE:**

Installing unsupported OS versions may cause the recovery tool to fail.

---

## C.2 Setup Procedure for Windows

Prior to using the recovery tool to backup or restore, a few setup procedures are required.

**Step 11:** Hardware and BIOS setup (see Section C.2.1)

**Step 1:** Create partitions (see **Section C.2.2**)

**Step 2:** Install operating system, drivers and system applications (see **Section C.2.3**)

**Step 3:** Build the recovery partition (see **Section C.2.4**) or build the auto recovery partition (see **Section C.3**)

**Step 4:** Create factory default image (see **Section C.2.5**)

The detailed descriptions are described in the following sections.

**NOTE:**

The setup procedures described below are for Microsoft Windows operating system users. For Linux, most of the setup procedures are the same except for several steps described in **Section C.3**.

### C.2.1 Hardware and BIOS Setup

- Step 1:** Make sure the system is powered off and unplugged.
- Step 2:** Install a hard drive or SSD in the system. An unformatted and unpartitioned disk is recommended.
- Step 3:** Connect an optical disk drive to the system and insert the recovery CD.
- Step 4:** Turn on the system.
- Step 5:** Press the <DELETE> key as soon as the system is turned on to enter the BIOS.
- Step 6:** Select the connected optical disk drive as the 1<sup>st</sup> boot device. (**Boot → Boot Device Priority → 1<sup>st</sup> Boot Device**).
- Step 7:** Save changes and restart the computer. Continue to the next section for instructions on partitioning the internal storage.

### C.2.2 Create Partitions

To create the system backup, the main storage device must be split into two partitions (three partitions for Linux). The first partition will be for the operating system, while the second partition will be invisible to the operating system and contain the backup made by the one key recovery software.

- Step 1:** Put the recovery CD in the optical drive of the system.
- Step 2:** **Boot the system from recovery CD.** When prompted, press any key to boot from the recovery CD. It will take a while to launch the recovery tool. Please be patient!

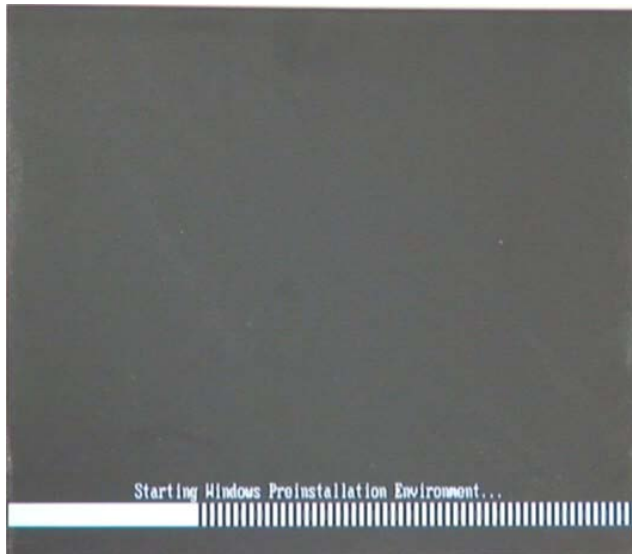

**Figure C-2: Launching the Recovery Tool**

**Step 3:** The recovery tool setup menu is shown as below.

```
c:\ C:\WINDOWS\system32\cmd.exe
1.Execute Ghost
2.Manual Recovery environment For Windows
3.Manual Recovery environment For Linux
4.Auto Recovery environment For Windows
5.Exit
6.Command Prompt
Type the number to print text.
```

**Figure C-3: Recovery Tool Setup Menu**

**Step 4:** Press <6> then <Enter>.

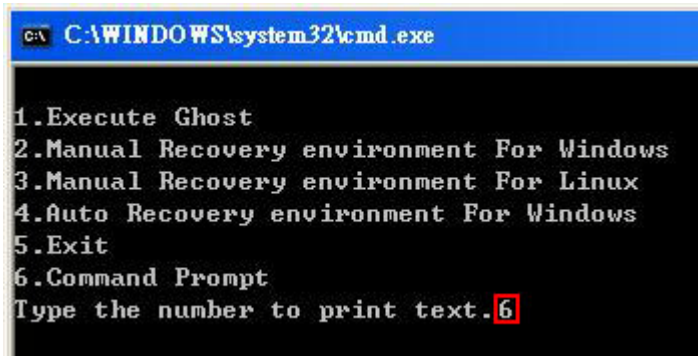

```
C:\WINDOWS\system32\cmd.exe

1.Execute Ghost
2.Manual Recovery environment For Windows
3.Manual Recovery environment For Linux
4.Auto Recovery environment For Windows
5.Exit
6.Command Prompt
Type the number to print text. 6
```

Figure C-4: Command Prompt

**Step 5:** The command prompt window appears. Type the following commands (marked in red) to create two partitions. One is for the OS installation; the other is for saving recovery files and images which will be an invisible partition.

(Press <Enter> after entering each line below)

```
system32>diskpart
DISKPART>list vol
DISKPART>sel disk 0
DISKPART>create part pri size= ____
DISKPART>assign letter=N
DISKPART>create part pri size= ____
DISKPART>assign letter=F
DISKPART>exit
system32>format N: /fs:ntfs /q /y
system32>format F: /fs:ntfs /q /v:Recovery /y
system32>exit
```

```

X:\I386\SYSTEM32\CMD.EXE
X:\I386\SYSTEM32>diskpart → Starts the Microsoft disk partitioning tool.

Microsoft DiskPart version 5.2.3790.1830
Copyright (C) 1999-2001 Microsoft Corporation.
On computer: MININT-JUC

DISKPART>list vol → Show partition information

Volume ### Ltr Label Fs Type Size Status Info
-----
Volume 0 X CD_ROM CDFS DUD-ROM 405 MB Healthy Boot
Volume 1 D FAT32 Removeable 3854 MB Healthy

DISKPART>sel disk 0 → Select a disk
Disk 0 is now the selected disk.

DISKPART>create part pri size=2000 → Create partition 1 and assign a size.
This partition is for OS installation.
DiskPart succeeded in creating the specified partition.

DISKPART>assign letter=N → Assign partition 1 a code name (N).
DiskPart successfully assigned the drive letter or mount point.

DISKPART>create part pri size=1800 → Create partition 2 and assign a size.
This partition is for recovery images.
DiskPart succeeded in creating the specified partition.

DISKPART>assign letter=F → Assign partition 2 a code name (F).
DiskPart successfully assigned the drive letter or mount point.

DISKPART>exit → Exit diskpart

X:\I386\SYSTEM32>format n: /fs:ntfs /q /y → Format partition 1 (N) as NTFS format.
The type of the file system is RAW.
The new file system is NTFS.
QuickFormatting 2000M
Creating file system structures.
Format complete.
2048254 KB total disk space.
2035620 KB are available.

X:\I386\SYSTEM32>format f: /fs:ntfs /q /v:Recovery /y → Formate partition 2 (F) as NTFS formate and
name it as "Recovery".
The type of the file system is RAW.
The new file system is NTFS.
QuickFormatting 1804M
Creating file system structures.
Format complete.
1847474 KB total disk space.
1835860 KB are available.

X:\I386\SYSTEM32>exit → Exit Windows PE
  
```

Figure C-5: Partition Creation Commands

**NOTE:**

Use the following commands to check if the partitions were created successfully.

```

X:\I386\SYSTEM32>diskpart
Microsoft DiskPart version 5.2.3790.1830
Copyright (C) 1999-2001 Microsoft Corporation.
On computer: MININT-JUC

DISKPART> sel disk 0
Disk 0 is now the selected disk.

DISKPART> list part

   Partition ###   Type              Size              Offset
-----
   Partition 1     Primary            2000 MB            32 KB
   Partition 2     Primary            1804 MB           2000 MB

DISKPART> exit
    
```

**Step 6:** Press any key to exit the recovery tool and automatically reboot the system.

Please continue to the following procedure: Build the Recovery Partition.

### C.2.3 Install Operating System, Drivers and Applications

Install the operating system onto the unlabelled partition. The partition labeled "Recovery" is for use by the system recovery tool and should not be used for installing the operating system or any applications.

**NOTE:**

The operating system installation program may offer to reformat the chosen partition. DO NOT format the partition again. The partition has already been formatted and is ready for installing the new operating system.

To install the operating system, insert the operating system installation CD into the optical drive. Restart the computer and follow the installation instructions.



## AFL2-08A-N26

## C.2.4 Building the Recovery Partition

- Step 1:** Put the recover CD in the optical drive.
- Step 2:** Start the system.
- Step 3:** **Boot the system from the recovery CD.** When prompted, press any key to boot from the recovery CD. It will take a while to launch the recovery tool. Please be patient!

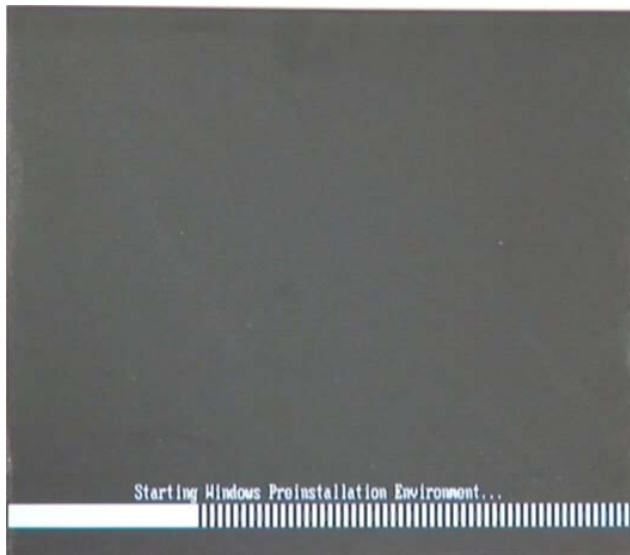

Figure C-6: Launching the Recovery Tool

- Step 4:** When the recovery tool setup menu appears, press <2> then <Enter>.

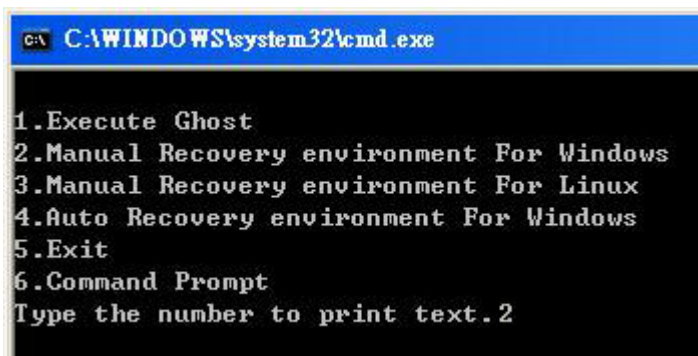
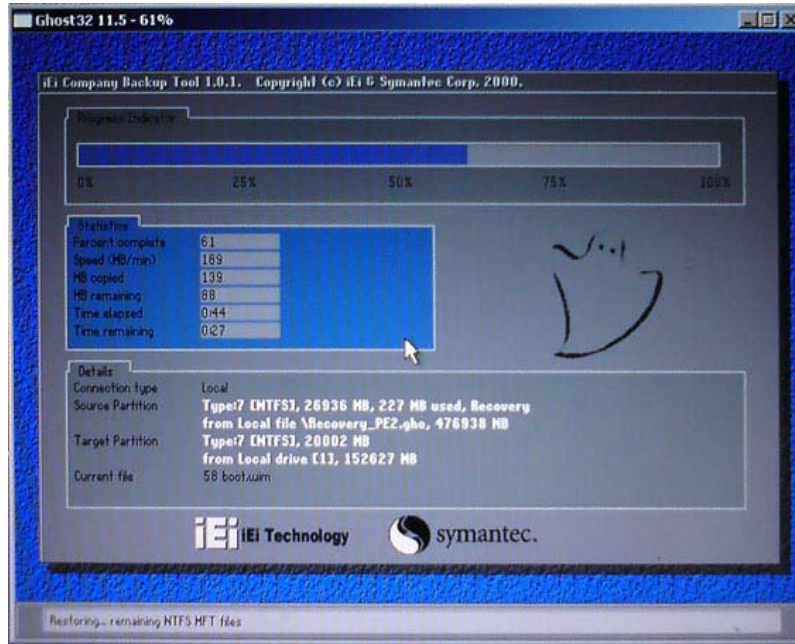

Figure C-7: Manual Recovery Environment for Windows

**Step 5:** The Symantec Ghost window appears and starts configuring the system to build a recovery partition. In this process the partition created for recovery files in **Section C.2.2** is hidden and the recovery tool is saved in this partition.



**Figure C-8: Building the Recovery Partition**

**Step 6:** After completing the system configuration, press any key in the following window to reboot the system.

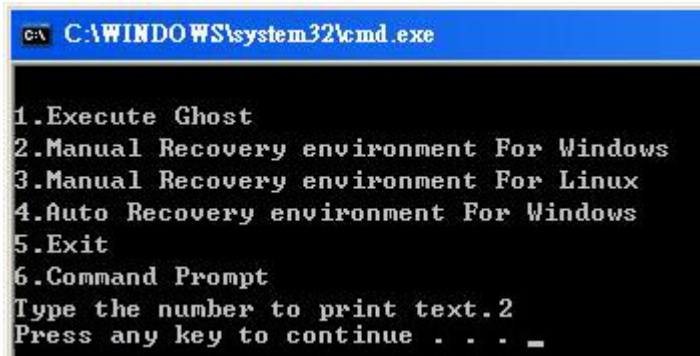

**Figure C-9: Press Any Key to Continue**

**Step 7:** Eject the recovery CD.

## AFL2-08A-N26

## C.2.5 Create Factory Default Image



## NOTE:

Before creating the factory default image, please configure the system to a factory default environment, including driver and application installations.

To create a factory default image, please follow the steps below.

**Step 1:** Turn on the system. When the following screen displays (**Figure C-10**), press the <F3> key to access the recovery tool. The message will display for 10 seconds, please press F3 before the system boots into the operating system.

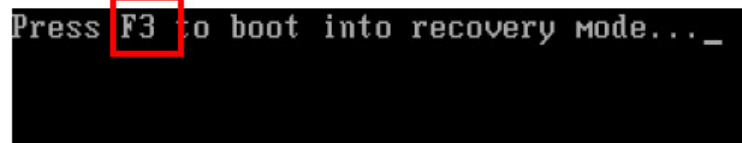

**Figure C-10: Press F3 to Boot into Recovery Mode**

**Step 2:** The recovery tool menu appears. Type <4> and press <Enter>. (**Figure C-11**)

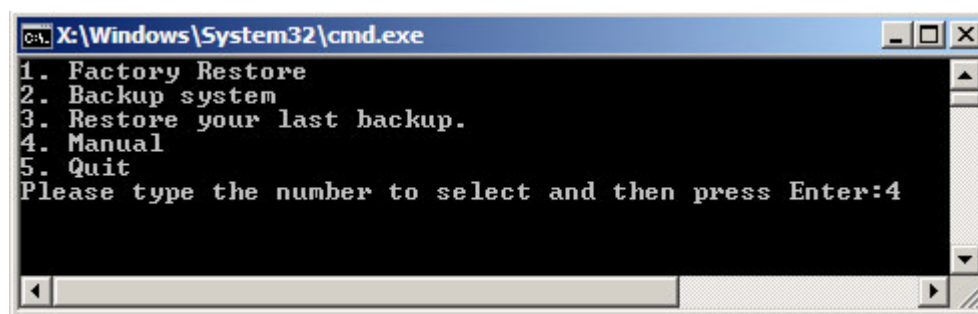

**Figure C-11: Recovery Tool Menu**

**Step 3:** The About Symantec Ghost window appears. Click **OK** button to continue.

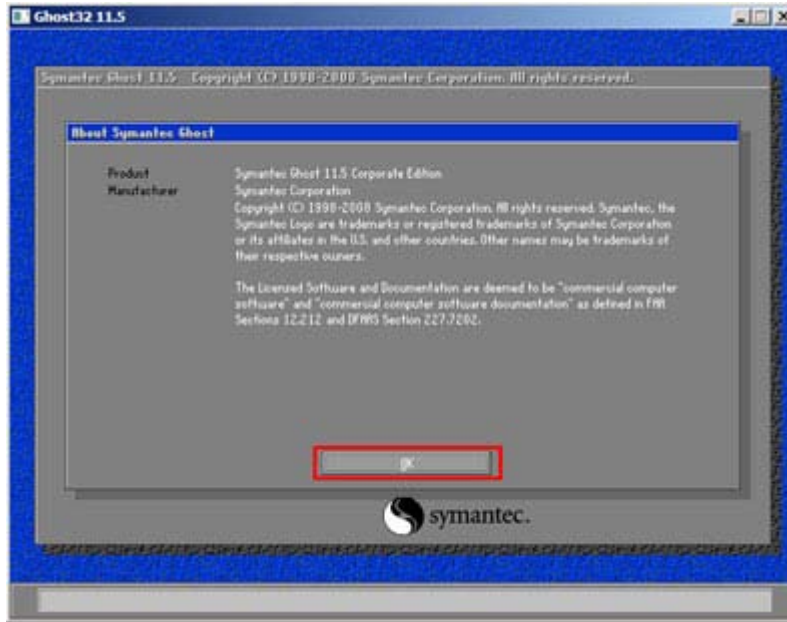

Figure C-12: About Symantec Ghost Window

Step 4: Use mouse to navigate to the option shown below (Figure C-13).

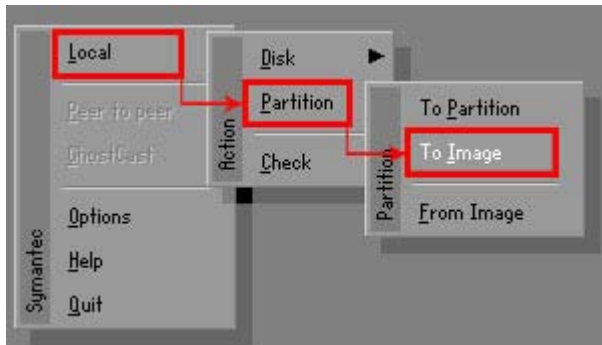
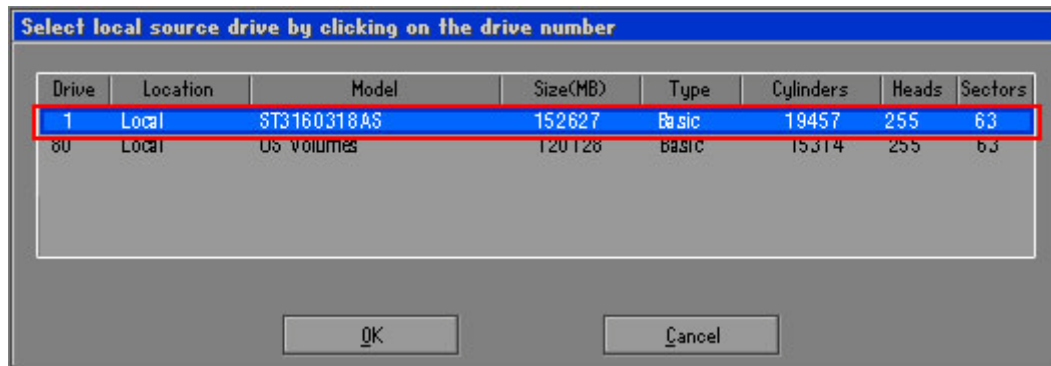

Figure C-13: Symantec Ghost Path

Step 5: Select the local source drive (Drive 1) as shown in Figure C-14. Then click OK.



**Figure C-14: Select a Local Source Drive**

**Step 6:** Select a source partition (Part 1) from basic drive as shown in **Figure C-15**. Then click OK.

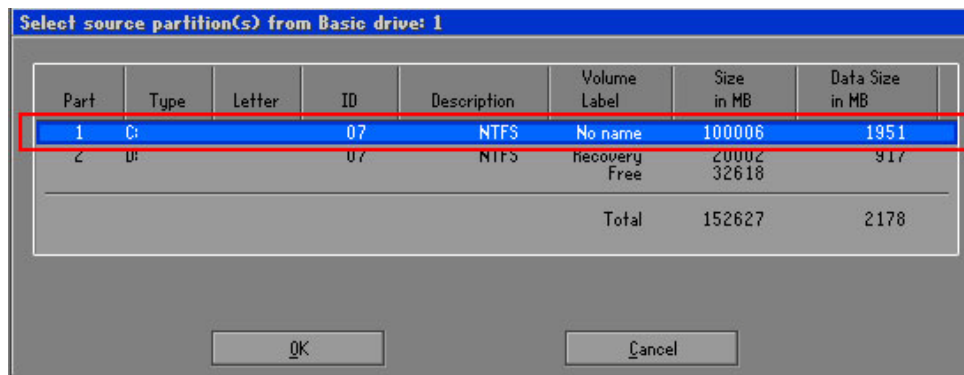

**Figure C-15: Select a Source Partition from Basic Drive**

**Step 7:** Select **1.2: [Recovery] NTFS drive** and enter a file name called **iei** (**Figure C-16**). Click **Save**. The factory default image will then be saved in the selected recovery drive and named **IEI.GHO**.



**WARNING:**

The file name of the factory default image must be **iei.GHO**.

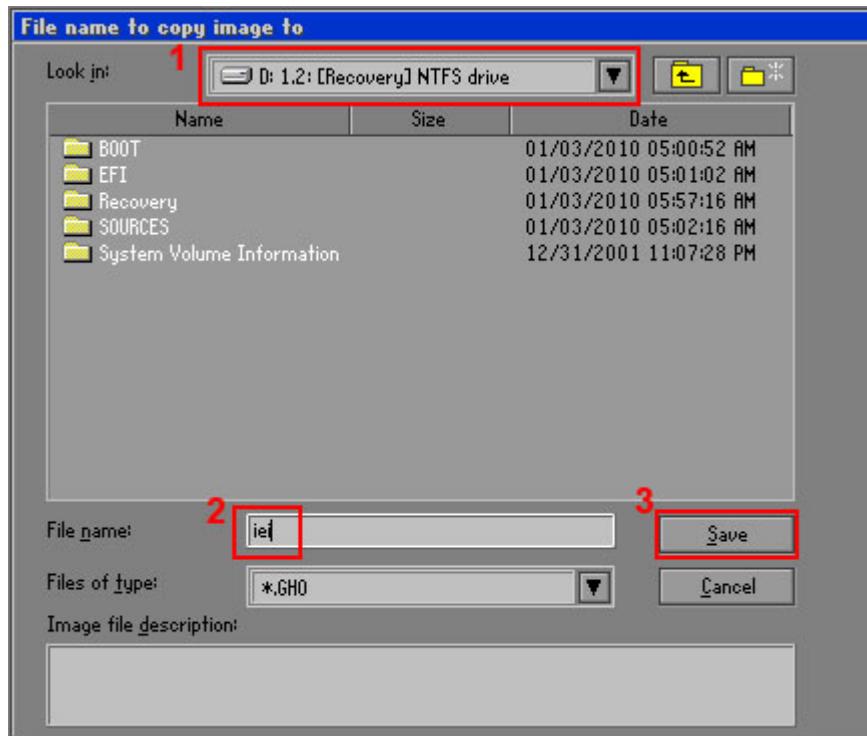

Figure C-16: File Name to Copy Image to

Step 8: When the Compress Image screen in Figure C-17 prompts, click **High** to make the image file smaller.

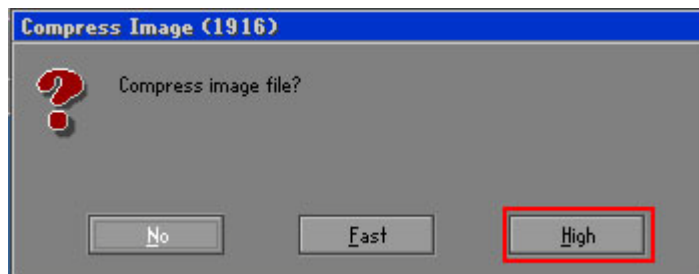
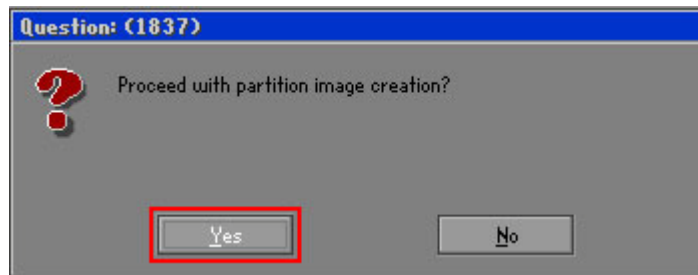

Figure C-17: Compress Image

**Step 9:** The Proceed with partition image creation window appears, click **Yes** to continue.



**Figure C-18: Image Creation Confirmation**

**Step 10:** The Symantec Ghost starts to create the factory default image (**Figure C-19**).

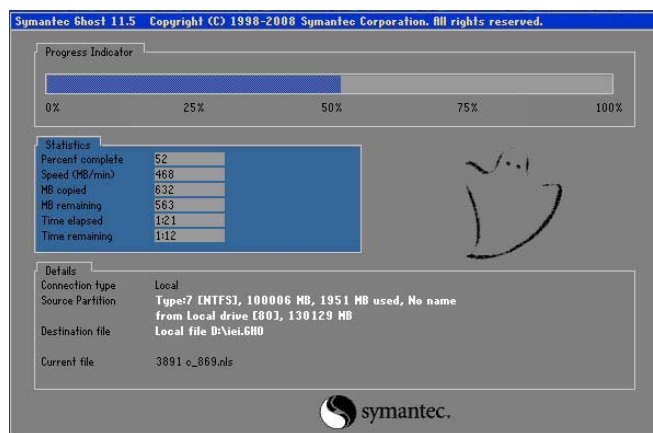

**Figure C-19: Image Creation Complete**

**Step 11:** When the image creation completes, a screen prompts as shown in **Figure C-20**.

Click **Continue** and close the Ghost window to exit the program.

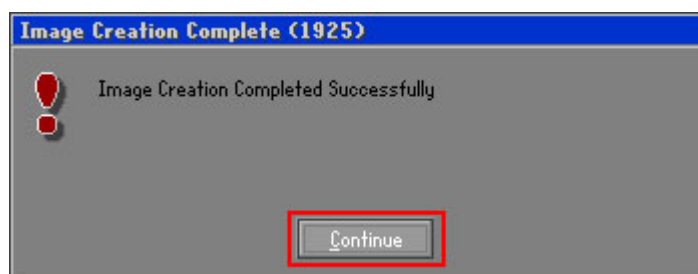

**Figure C-20: Image Creation Complete**

**Step 12:** The recovery tool main menu window is shown as below. Press any key to reboot the system.

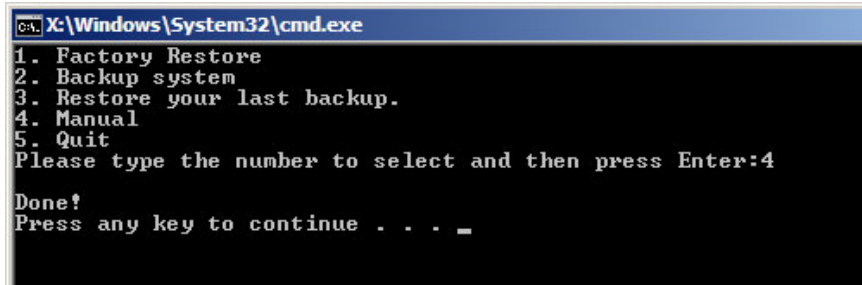

```

C:\Windows\System32\cmd.exe
1. Factory Restore
2. Backup system
3. Restore your last backup.
4. Manual
5. Quit
Please type the number to select and then press Enter:4
Done!
Press any key to continue . . . _
  
```

**Figure C-21: Press Any Key to Continue**

### C.3 Auto Recovery Setup Procedure

The auto recovery function allows a system to automatically restore from the factory default image after encountering a Blue Screen of Death (BSoD) or a hang for around 10 minutes. To use the auto recovery function, follow the steps described in the following sections.



#### **CAUTION:**

The setup procedure may include a step to create a factory default image. It is suggested to configure the system to a factory default environment before the configuration, including driver and application installations.

**Step 1:** Follow the steps described in **Section C.2.1 ~ Section C.2.3** to setup BIOS, create partitions and install operating system.

**Step 2:** Install the auto recovery utility into the system by double clicking the **Utility/AUTORECOVERY-SETUP.exe** in the One Key Recovery CD. This utility **MUST** be installed in the system, otherwise, the system will automatically restore from the factory default image every ten (10) minutes.





Figure C-22: Auto Recovery Utility

**Step 3:** Reboot the system from the recovery CD. When prompted, press any key to boot from the recovery CD. It will take a while to launch the recovery tool. Please be patient!



Figure C-23: Launching the Recovery Tool

**Step 4:** When the recovery tool setup menu appears, press <4> then <Enter>.

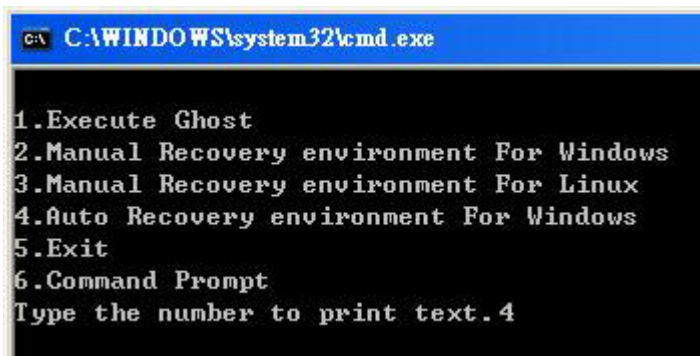
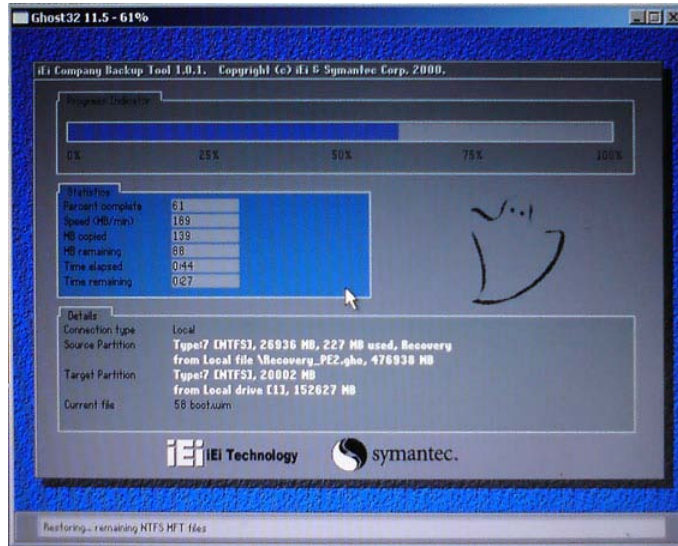

Figure C-24: Auto Recovery Environment for Windows

**Step 5:** The Symantec Ghost window appears and starts configuring the system to build an auto recovery partition. In this process the partition created for recovery files in **Section C.2.2** is hidden and the auto recovery tool is saved in this partition.



**Figure C-25: Building the Auto Recovery Partition**

**Step 6:** After completing the system configuration, the following message prompts to confirm whether to create a factory default image. Type **Y** to have the system create a factory default image automatically. Type **N** within 6 seconds to skip this process (The default option is YES). It is suggested to choose YES for this option.



**Figure C-26: Factory Default Image Confirmation**

**Step 7:** The Symantec Ghost starts to create the factory default image (**Figure C-27**).

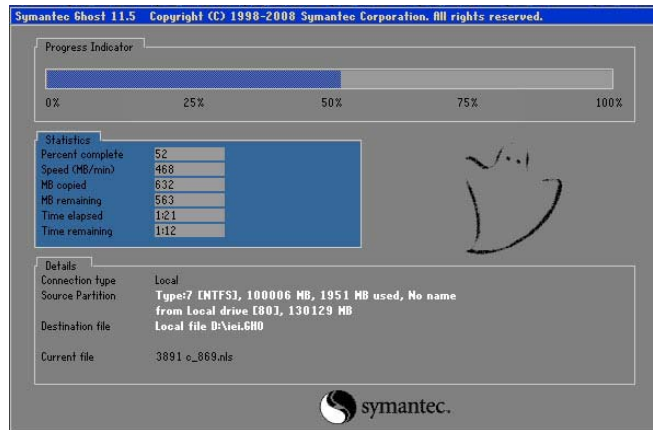

**Figure C-27: Image Creation Complete**

**Step 8:** After completing the system configuration, press any key in the following window to restart the system.

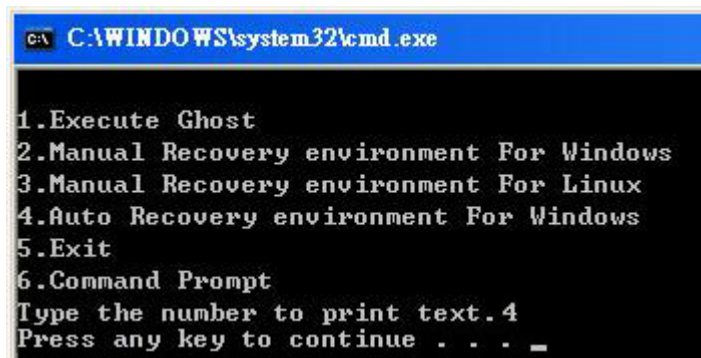
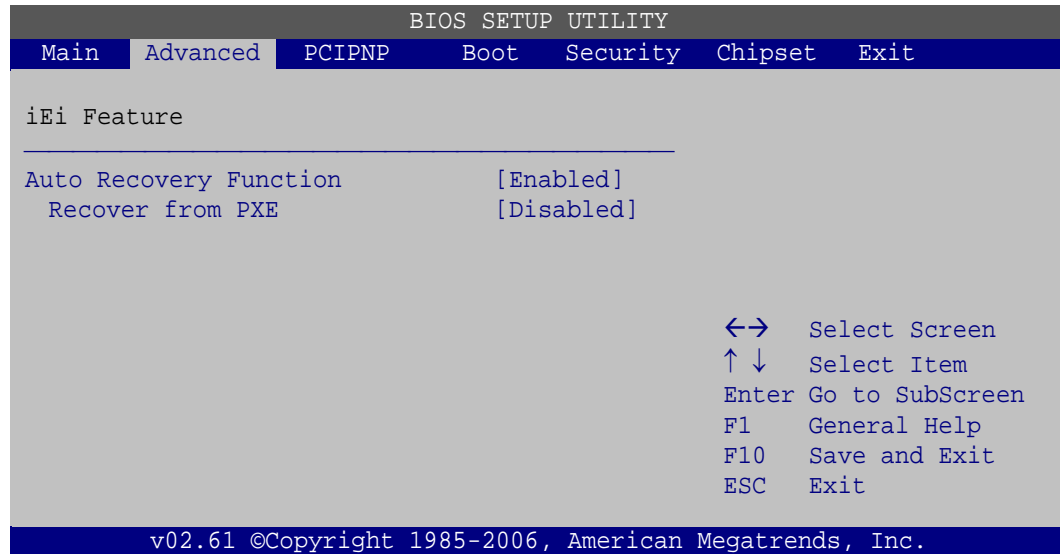

**Figure C-28: Press any key to continue**

**Step 9:** Eject the One Key Recovery CD and restart the system.

**Step 10:** Press the <DELETE> key as soon as the system is turned on to enter the BIOS.

**Step 11:** Enable the Auto Recovery Function option (**Advanced** → **iEi Feature** → **Auto Recovery Function**).

**BIOS Menu 20: iEi Feature**

**Step 12:** Save changes and restart the system. If the system encounters a Blue Screen of Death (BSoD) or a hang for around 10 minutes, it will automatically restore from the factory default image.

**CAUTION:**

The auto recovery function can only apply on a Microsoft Windows system running the following OS versions:

- Windows XP
- Windows Vista
- Windows 7

## C.4 Setup Procedure for Linux

The initial setup procedure for Linux system is mostly the same with the procedure for Microsoft Windows. Please follow the steps below to setup recovery tool for Linux OS.

**Step 1:** **Hardware and BIOS setup.** Refer to **Section C.2.1.**

## AFL2-08A-N26

**Step 2: Install Linux operating system.** Make sure to install GRUB (v0.97 or earlier) MBR type and Ext3 partition type. Leave enough space on the hard drive to create the recover partition later.

**NOTE:**

If the Linux OS is not installed with GRUB (v0.97 or earlier) and Ext3, the Symantec Ghost may not function properly.

While installing Linux OS, please create two partitions:

- Partition 1: /
- Partition 2: **SWAP**

**NOTE:**

Please reserve enough space for partition 3 for saving recovery images.

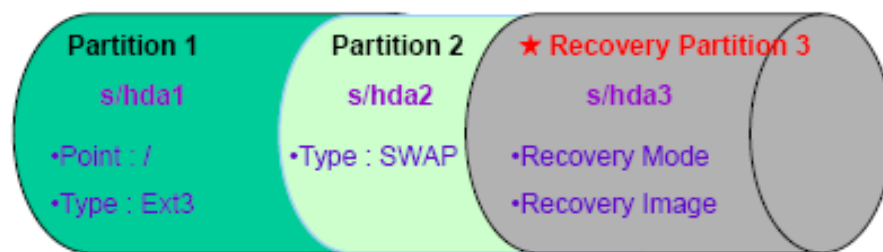

**Figure C-29: Partitions for Linux**

**Step 3: Create a recovery partition.** Insert the recovery CD into the optical disk drive. Follow **Step 1 ~ Step 3** described in **Section C.2.2**. Then type the following commands (marked in red) to create a partition for recovery images.

```
system32>diskpart
```

```
DISKPART>list vol
```

```
DISKPART>sel disk 0
```

```

DISKPART>create part pri size= ____
DISKPART>assign letter=N
DISKPART>exit
system32>format N: /fs:ntfs /q /v:Recovery /y
system32>exit
  
```

**Step 4:** **Build the recovery partition.** Press any key to boot from the recovery CD. It will take a while to launch the recovery tool. Please be patient. When the recovery tool setup menu appears, type <3> and press <Enter> (**Figure C-30**). The Symantec Ghost window appears and starts configuring the system to build a recovery partition. After completing the system configuration, press any key to reboot the system. Eject the recovery CD.

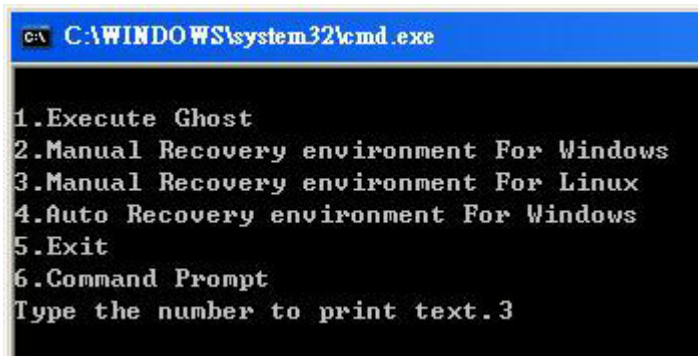

```

c:\ C:\WINDOWS\system32\cmd.exe

1.Execute Ghost
2.Manual Recovery environment For Windows
3.Manual Recovery environment For Linux
4.Auto Recovery environment For Windows
5.Exit
6.Command Prompt
Type the number to print text.3
  
```

**Figure C-30: Manual Recovery Environment for Linux**

**Step 5:** **Access the recovery tool main menu by modifying the “menu.lst”.** To first access the recovery tool main menu, the menu.lst must be modified. In Linux, enter Administrator (root). When prompt appears, type:

```

cd /boot/grub
vi menu.lst
  
```

```
Fedora release 9 (Sulphur)
Kernel 2.6.25-14.fc9.i686 on an i686 (tty2)

localhost login: root
Password:
[root@localhost ~]# cd /boot/grub/
[root@localhost grub]# vi menu.lst _
```

Figure C-31: Access menu.lst in Linux (Text Mode)

Step 6: Modify the menu.lst as shown below.

```
#boot=/dev/sda
default=0
timeout=10 ← Modify timeout=10
splashimage=(hd0,0)/grub/splash.xpm.gz
hiddenmenu
title Fedora (2.6.25-14.fc9.i686)
    root (hd0,0)
    kernel /vmlinuz-2.6.25-14.fc9.i686 ro root=UUID=10f1acd
    ac38b5c78910 rhgb quiet
    initrd /initrd-2.6.25-14.fc9.i686.img

title Recovery Partition
root (hd0,2)
makeactive ← Type command
chainloader +1
```

- Type command:  
**title Recovery Partition**  
**root (hd0,2)**  
**makeactive**  
**chainloader +1**

Step 7: The recovery tool menu appears. (Figure C-32)

```
1. Factory Restore
2. Backup system
3. Restore your last backup.
4. Manual
5. Quit
Please type the number to select and then press Enter:
```

Figure C-32: Recovery Tool Menu

Step 8: Create a factory default image. Follow Step 2 ~ Step 12 described in Section C.2.5 to create a factory default image.

## C.5 Recovery Tool Functions

After completing the initial setup procedures as described above, users can access the recovery tool by pressing <F3> while booting up the system. However, if the setup procedure in Section C.3 has been completed and the auto recovery function is enabled, the system will automatically restore from the factory default image without pressing the F3 key. The recovery tool main menu is shown below.

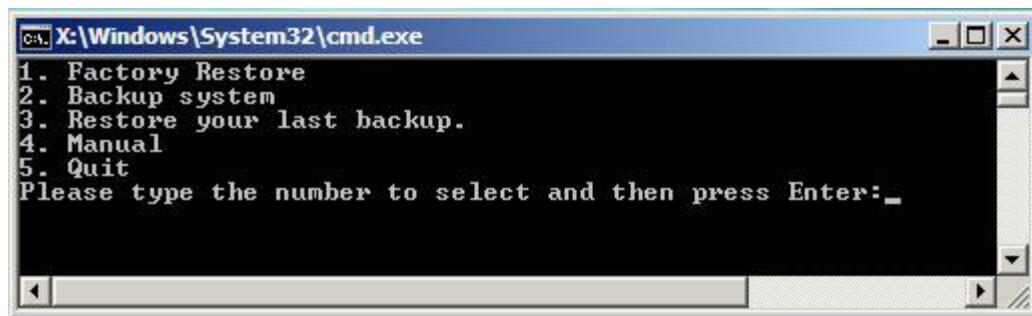

**Figure C-33: Recovery Tool Main Menu**

The recovery tool has several functions including:

1. **Factory Restore:** Restore the factory default image (iei.GHO) created in Section C.2.5.
2. **Backup system:** Create a system backup image (iei\_user.GHO) which will be saved in the hidden partition.
3. **Restore your last backup:** Restore the last system backup image
4. **Manual:** Enter the Symantec Ghost window to configure manually.
5. **Quit:** Exit the recovery tool and restart the system.



### **WARNING:**

Please do not turn off the system power during the process of system recovery or backup.





**WARNING:**

All data in the system will be deleted during the system recovery. Please backup the system files before restoring the system (either Factory Restore or Restore Backup).

### C.5.1 Factory Restore

To restore the factory default image, please follow the steps below.

**Step 1:** Type <1> and press <Enter> in the main menu.

**Step 2:** The Symantec Ghost window appears and starts to restore the factory default. A factory default image called **iei.GHO** is created in the hidden Recovery partition.

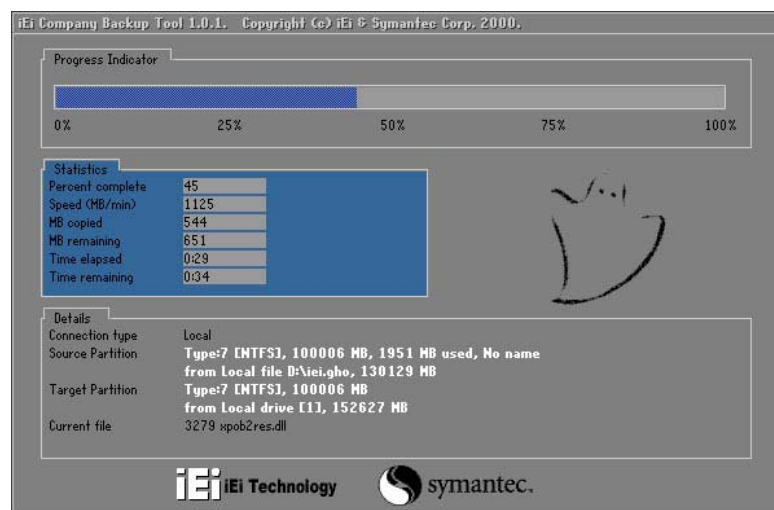

**Figure C-34: Restore Factory Default**

**Step 3:** The screen shown in **Figure C-35** appears when completed. Press any key to reboot the system.

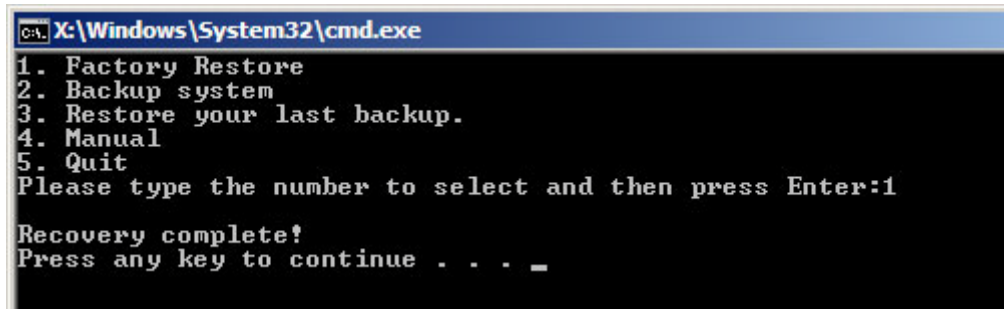

Figure C-35: Recovery Complete Window

### C.5.2 Backup System

To backup the system, please follow the steps below.

**Step 1:** Type <2> and press <Enter> in the main menu.

**Step 4:** The Symantec Ghost window appears and starts to backup the system. A backup image called `iei_user.GHO` is created in the hidden Recovery partition.

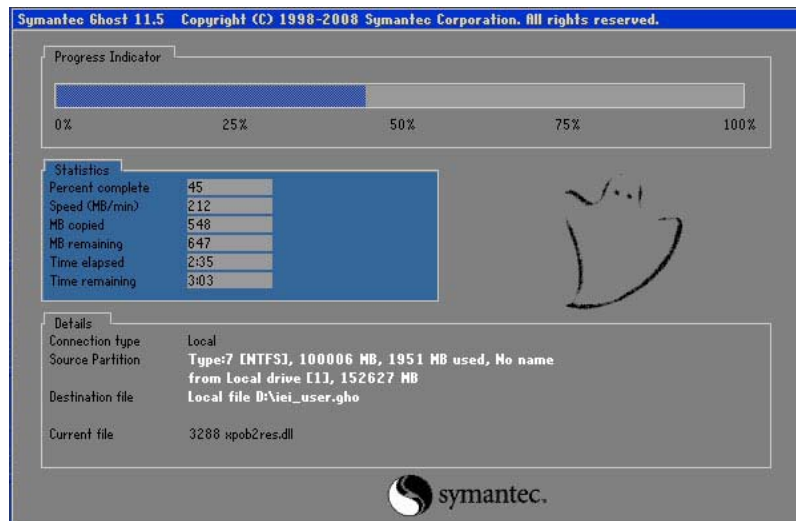

Figure C-36: Backup System

**Step 5:** The screen shown in **Figure C-37** appears when system backup is complete. Press any key to reboot the system.

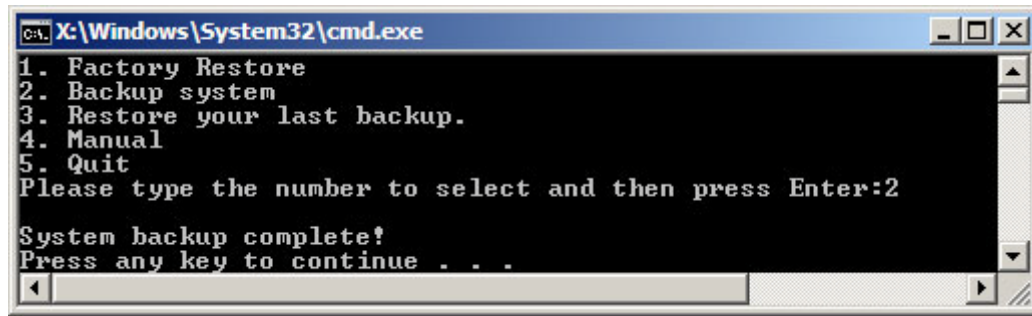

Figure C-37: System Backup Complete Window

### C.5.3 Restore Your Last Backup

To restore the last system backup, please follow the steps below.

**Step 1:** Type <3> and press <Enter> in the main menu.

**Step 2:** The Symantec Ghost window appears and starts to restore the last backup image (iei\_user.GHO).

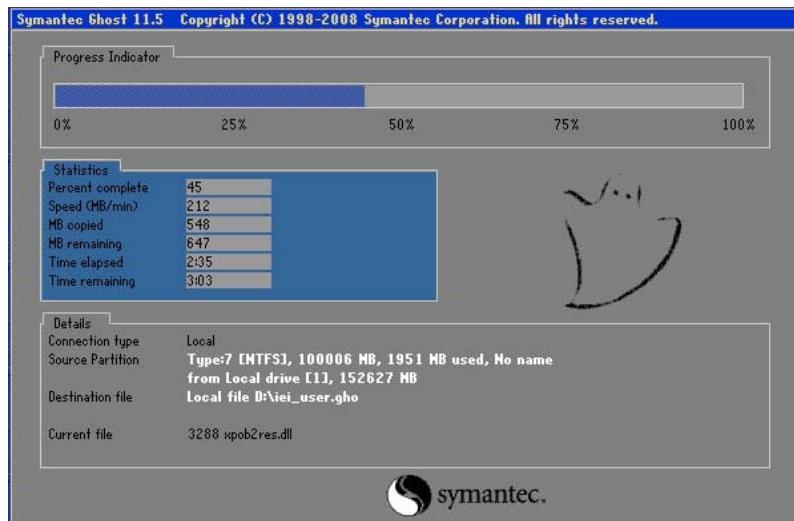

Figure C-38: Restore Backup

**Step 3:** The screen shown in **Figure C-39** appears when backup recovery is complete. Press any key to reboot the system.

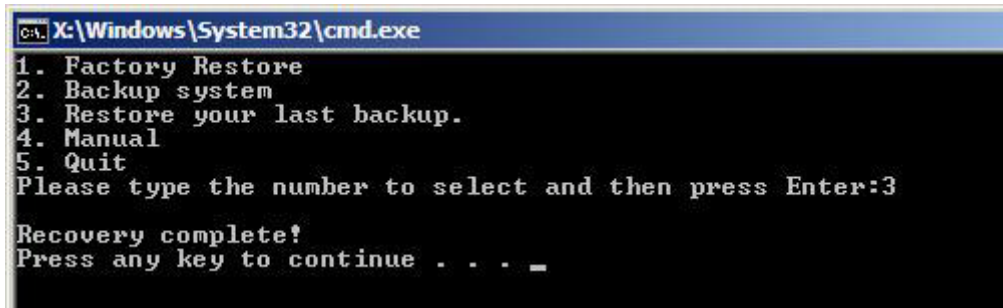

Figure C-39: Restore System Backup Complete Window

#### C.5.4 Manual

To restore the last system backup, please follow the steps below.

**Step 1:** Type <4> and press <Enter> in the main menu.

**Step 2:** The Symantec Ghost window appears. Use the Ghost program to backup or recover the system manually.

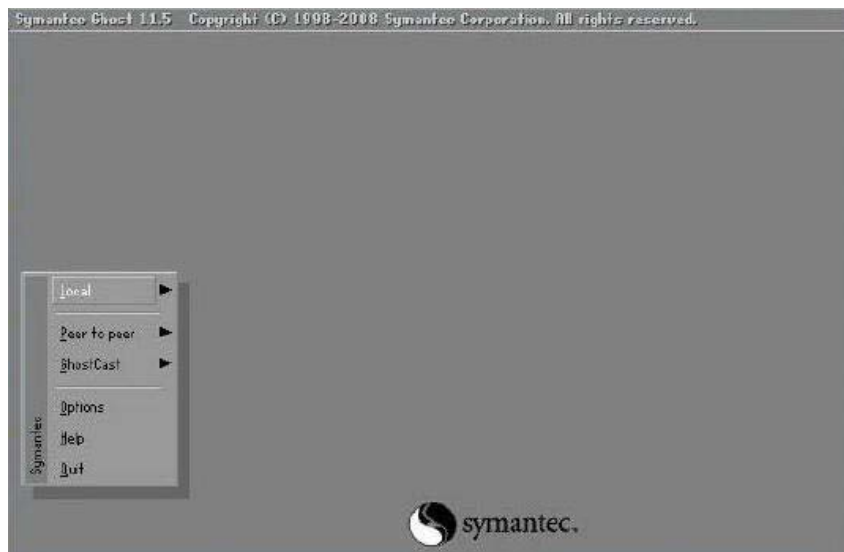
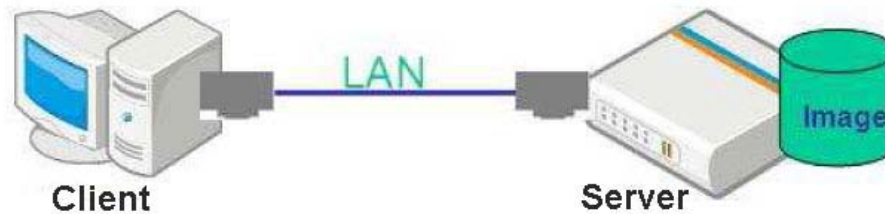

Figure C-40: Symantec Ghost Window

**Step 3:** When backup or recovery is completed, press any key to reboot the system.

## C.6 Restore Systems from a Linux Server through LAN

The One Key Recovery allows a client system to automatically restore to a factory default image saved in a Linux system (the server) through LAN connectivity after encountering a Blue Screen of Death (BSoD) or a hang for around 10 minutes. To be able to use this function, the client system and the Linux system MUST reside in the same domain.



### NOTE:

The supported client OS includes:

- Windows 2000
- Windows XP
- Windows Vista
- Windows 7
- Windows CE
- Windows XP Embedded

Prior to restoring client systems from a Linux server, a few setup procedures are required.

**Step 1:** Configure DHCP server settings

**Step 2:** Configure TFTP settings

**Step 3:** Configure One Key Recovery server settings

**Step 4:** Start DHCP, TFTP and HTTP

**Step 5:** Create a shared directory

**Step 6:** Setup a client system for auto recovery

The detailed descriptions are described in the following sections. In this document, two types of Linux OS are used as examples to explain the configuration process – CentOS 5.5 (Kernel 2.6.18) and Debian 5.0.7 (Kernel 2.6.26).

## C.6.1 Configure DHCP Server Settings

**Step 1:** Install the DHCP

`#yum install dhcp` (CentOS, commands marked in red)

`#apt-get install dhcp3-server` (Debian, commands marked in blue)

**Step 2:** Confirm the operating system default settings: dhcpd.conf.

### CentOS

Use the following command to show the DHCP server sample location:

`#vi /etc/dhcpd.conf`

The DHCP server sample location is shown as below:

```
# DHCP Server Configuration file.
# see /usr/share/doc/dhcp*/dhcpd.conf.sample
#
```

Use the following command to copy the DHCP server sample to etc/dhcpd.conf:

`#cp /usr/share/doc/dhcp-3.0.5/dhcpd.conf.sample /etc/dhcpd.conf`

`#vi /etc/dhcpd.conf`

```
ddns-update-style interim;
ignore client-updates;

subnet 192.168.0.0 netmask 255.255.255.0 {
# --- default gateway
    option routers                192.168.0.2;
    option subnet-mask            255.255.255.0;

    option nis-domain             "domain.org";
    option domain-name            "domain.org";
    option domain-name-servers   192.168.0.1;
    next-server 192.168.0.6;
    filename "pxelinux.0";
    option time-offset            -18000; # Eastern Standard Time
    option ntp-servers            192.168.1.1;
}
```

### Debian

`#vi /etc/dhcpd.conf`

Edit “/etc/dhcpd.conf” for your environment. For example, add

`next-server PXE server IP address;`

filename "pxelinux.0";

```
ddns-update-style interim;
ignore client-updates;

subnet 192.168.0.0 netmask 255.255.255.0 {
# --- default gateway
option routers                192.168.0.2;
option subnet-mask            255.255.255.0;

option nis-domain              "domain.org";
option domain-name             "domain.org";
option domain-name-servers    192.168.0.1;
next-server 192.168.0.6;
filename "pxelinux.0";
option time-offset             -18000; # Eastern Standard Time
option ntp-servers             192.168.1.1;
}
```

### C.6.2 Configure TFTP Settings

**Step 1:** Install the tftp, httpd and syslinux.

`#yum install tftp-server httpd syslinux` (CentOS)

`#apt-get install tftpd-hpa xinetd syslinux` (Debian)

**Step 2:** Enable the TFTP server by editing the "/etc/xinetd.d/tftp" file and make it use the remap file. The "-vvv" is optional but it could definitely help on getting more information while running the remap file. For example:

#### CentOS

`#vi /etc/xinetd.d/tftp`

Modify:

`disable = no`

`server_args = -s /tftpboot -m /tftpboot/tftpd.remap -vvv_`

```
socket_type      = dgram
protocol         = udp
wait            = yes
user            = root
server          = /usr/sbin/in.tftpd
server_args     = -s /tftpboot -m /tftpboot/tftpd.remap -vvv
disable         = no
per_source      = 11
cps             = 100 2
flags           = IPv4
```

### Debian

Replace the TFTP settings from “inetd” to “xinetd” and annotate the “inetd” by adding “#”.

`#vi /etc/inetd.conf`

Modify: `#tftp dgram udp wait root /usr/sbin.....` (as shown below)

```
#:BOOT: TFTP service is provided primarily for booting. Most sites
# run this only on machines acting as "boot servers."
#tftp dgram udp wait root /usr/sbin/in.tftpd /usr/sbin/in.tftpd -s
/var/lib/tftpboot
```

`#vi /etc/xinetd.d/tftp`

```
socket_type      = dgram
protocol        = udp
wait            = yes
user            = root
server          = /usr/sbin/in.tftpd
server_args     = -s /tftpboot -m /tftpboot/tftpd.remap -vvv
disable         = no
per_source      = 11
cps             = 100 2
flags           = IPv4
```

## C.6.3 Configure One Key Recovery Server Settings

**Step 1:** Copy the **Utility/RECOVERYR10.TAR.BZ2** package from the One Key Recovery CD to the system (server side).



**Step 2:** Extract the recovery package to /.

```
#cp RecoveryR10.tar.bz2 /
#cd /
#tar -xvzf RecoveryR10.tar.bz2
```

**Step 3:** Copy “pxelinux.0” from “syslinux” and install to “tftpboot”.

```
#cp /usr/lib/syslinux/pxelinux.0 /tftpboot/
```



## AFL2-08A-N26

### C.6.4 Start the DHCP, TFTP and HTTP

Start the DHCP, TFTP and HTTP. For example:

#### CentOS

```
#service xinetd restart
```

```
#service httpd restart
```

```
#service dhcpd restart
```

#### Debian

```
#/etc/init.d/xinetd reload
```

```
#/etc/init.d/xinetd restart
```

```
#/etc/init.d/dhcp3-server restart
```

### C.6.5 Create Shared Directory

**Step 1:** Install the samba.

```
#yum install samba
```

**Step 2:** Create a shared directory for the factory default image.

```
#mkdir /share
```

```
#cd /share
```

```
#mkdir /image
```

```
#cp iei.gho /image
```



#### **WARNING:**

The file name of the factory default image must be **iei.gho**.

---

**Step 3:** Confirm the operating system default settings: smb.conf.

```
#vi /etc/samba/smb.conf
```

Modify:

[image]

```
comment = One Key Recovery
```

```
path = /share/image
```

```
browseable = yes
```

```
writable = yes
```

```
public = yes
```

```
create mask = 0644
```

```
directory mask = 0755
```

**Step 4:** Edit "/etc/samba/smb.conf" for your environment. For example:

```
# "security = user" is always a good idea. This will require a Unix account
# in this server for every user accessing the server. See
# /usr/share/doc/samba-doc/htmldocs/Samba3-HOWTO/ServerType.html
# in the samba-doc package for details.
security = share
```

```
[image]
comment = One Key Recovery
path = /share/image
browseable = yes
writable = yes
public = yes
create mask = 0644
directory mask = 0755
```

**Step 5:** Modify the hostname

```
#vi /etc/hostname
```

Modify: RecoveryServer

```
RecoveryServer
```

## C.6.6 Setup a Client System for Auto Recovery

**Step 1:** Configure the following BIOS options of the client system.

Advanced → iEi Feature → Auto Recovery Function → **Enabled**

Advanced → iEi Feature → Recover from PXE → **Enabled**

Boot → Launch PXE OpROM → **Enabled**

## AFL2-08A-N26

**Step 2:** Continue to configure the **Boot Option Priorities** BIOS option of the client system:

Boot Option #1 → remain the default setting to boot from the original OS.

Boot Option #2 → select the boot from LAN option.

**Step 3:** Save changes and exit BIOS menu.

Exit → **Save Changes and Exit**

**Step 4:** Install the auto recovery utility into the system by double clicking the **Utility/AUTORECOVERY-SETUP.exe** in the One Key Recovery CD. This utility **MUST** be installed in the system, otherwise, the system will automatically restore from the factory default image every ten (10) minutes.



**Step 5:** Restart the client system from LAN. If the system encounters a Blue Screen of Death (BSoD) or a hang for around 10 minutes, it will automatically restore from the factory default image. The following screens will show when the system starts auto recovering.

```
Realtek PCIe GBE Family Controller Series v2.35 (06/14/10)
CLIENT MAC ADDR: 00 18 7D 13 E6 89  GUID: 00020003-0004-0005-0006-0007000000
DHCP . ./
```

```
My IP address seems to be C0A80009 192.168.0.9
ip=192.168.0.9:192.168.0.8:192.168.0.2:255.255.255.0
TFTP prefix:
Trying to load: pxelinux.cfg/00020003-0004-0005-0006-000700080009
Trying to load: pxelinux.cfg/01-00-18-7d-13-e6-89
Trying to load: pxelinux.cfg/C0A80009
Trying to load: pxelinux.cfg/C0A8000
Trying to load: pxelinux.cfg/C0A800
Trying to load: pxelinux.cfg/C0A80
Trying to load: pxelinux.cfg/C0A8
Trying to load: pxelinux.cfg/C0A
Trying to load: pxelinux.cfg/C0
Trying to load: pxelinux.cfg/C
Trying to load: pxelinux.cfg/default
boot:
```

Windows is loading files...

IP: 192.168.0.8, File: \Boot\WinPE.wim

Symantec Ghost 11.5 Copyright (C) 1998-2008 Symantec Corporation. All rights reserved.

Progress Indicator



0% 25% 50% 75% 100%

Statistics

Percent complete	52
Speed (MB/min)	468
MB copied	632
MB remaining	563
Time elapsed	1:21
Time remaining	1:12

Details

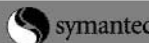
Connection type	Local
Source Partition	Type:7 [NTFS], 100006 MB, 1951 MB used, No name from Local drive [80], 130129 MB
Destination file	Local file D:\iei.GHO
Current file	3891_e_869.nls



#### NOTE:

A firewall or a SELinux is not in use in the whole setup process. If there is a firewall or a SELinux protecting the system, modify the configuration information to accommodate them.

## C.7 Other Information

### C.7.1 Using AHCI Mode or ALi M5283 / VIA VT6421A Controller

When the system uses AHCI mode or some specific SATA controllers such as ALi M5283 or VIA VT6421A, the SATA RAID/AHCI driver must be installed before using one key recovery. Please follow the steps below to install the SATA RAID/AHCI driver.

- Step 1:** Copy the SATA RAID/AHCI driver to a floppy disk and insert the floppy disk into a USB floppy disk drive. The SATA RAID/AHCI driver must be especially designed for the on-board SATA controller.
- Step 2:** Connect the USB floppy disk drive to the system.
- Step 3:** Insert the One Key Recovery CD into the system and boot the system from the CD.
- Step 4:** When launching the recovery tool, press <F6>.

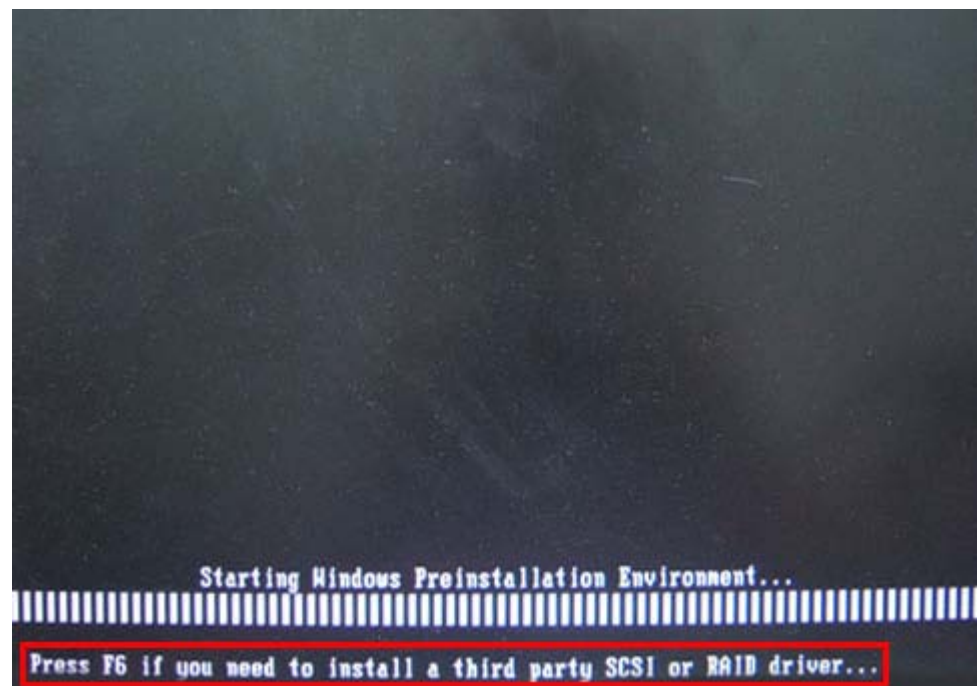

Step 5: When the following window appears, press <S> to select “Specify Additional Device”.

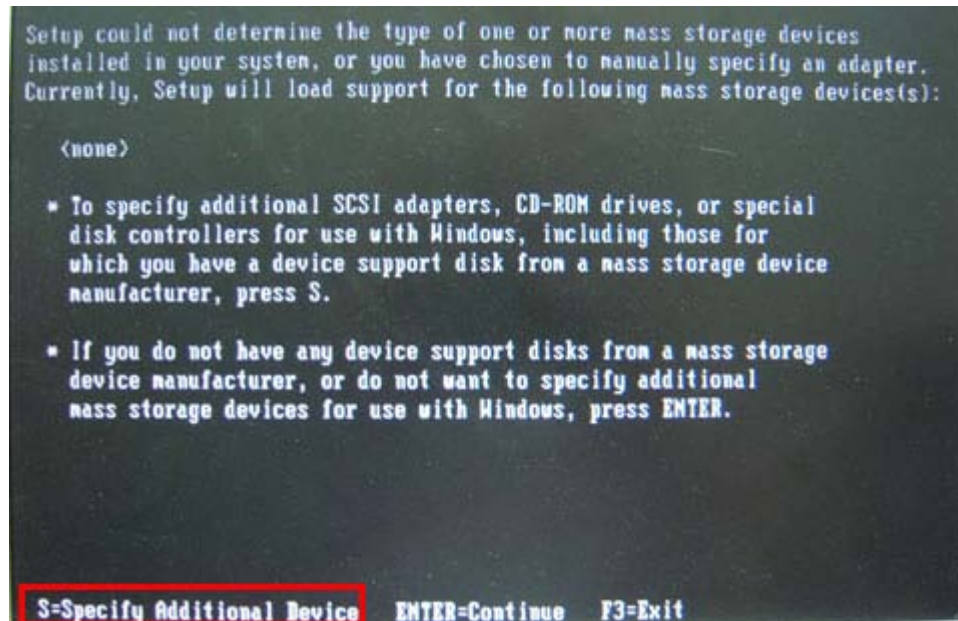

Step 6: In the following window, select a SATA controller mode used in the system. Then press <Enter>. The user can now start using the SATA HDD.

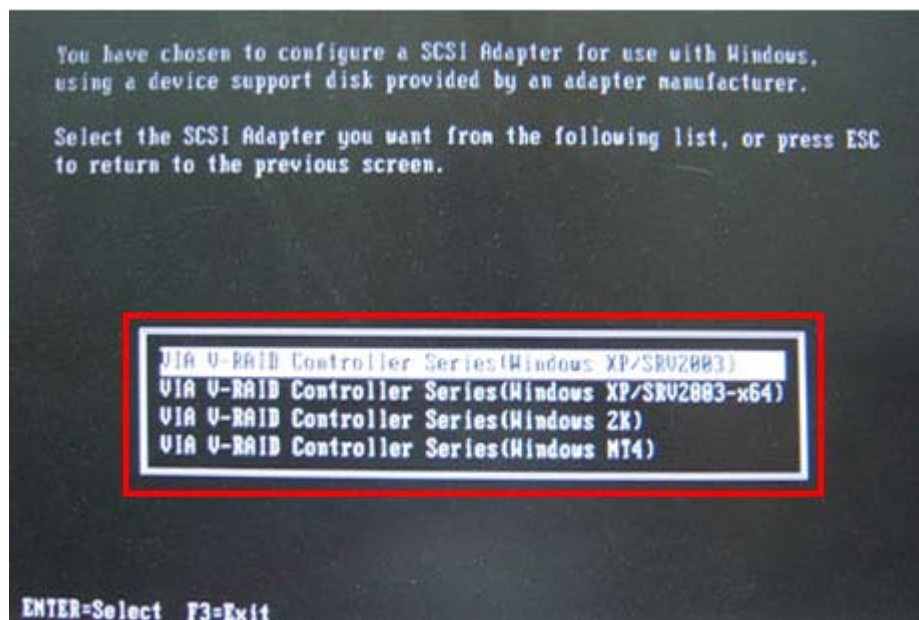

## AFL2-08A-N26

**Step 7:** After pressing <Enter>, the system will get into the recovery tool setup menu. Continue to follow the setup procedure from **Step 4** in **Section C.2.2 Create Partitions** to finish the whole setup process.

### C.7.2 System Memory Requirement

To be able to access the recovery tool by pressing <F3> while booting up the system, please make sure to have enough system memory. The minimum memory requirement is listed below.

- **Using Award BIOS:** 128 MB system memory
- **Using AMI BIOS:** 512 MB system memory.

Appendix

D

# Hazardous Materials Disclosure

---



## **D.1 Hazardous Material Disclosure Table for IPB Products Certified as RoHS Compliant Under 2002/95/EC Without Mercury**

The details provided in this appendix are to ensure that the product is compliant with the Peoples Republic of China (China) RoHS standards. The table below acknowledges the presences of small quantities of certain materials in the product, and is applicable to China RoHS only.

A label will be placed on each product to indicate the estimated “Environmentally Friendly Use Period” (EFUP). This is an estimate of the number of years that these substances would “not leak out or undergo abrupt change.” This product may contain replaceable sub-assemblies/components which have a shorter EFUP such as batteries and lamps. These components will be separately marked.

Please refer to the table on the next page.

Part Name	Toxic or Hazardous Substances and Elements					
	Lead (Pb)	Mercury (Hg)	Cadmium (Cd)	Hexavalent Chromium (CR(VI))	Polybrominated Biphenyls (PBB)	Polybrominated Diphenyl Ethers (PBDE)
Housing	X	O	O	O	O	X
Display	X	O	O	O	O	X
Printed Circuit Board	X	O	O	O	O	X
Metal Fasteners	X	O	O	O	O	O
Cable Assembly	X	O	O	O	O	X
Fan Assembly	X	O	O	O	O	X
Power Supply Assemblies	X	O	O	O	O	X
Battery	O	O	O	O	O	O
<p>O: This toxic or hazardous substance is contained in all of the homogeneous materials for the part is below the limit requirement in SJ/T11363-2006</p> <p>X: This toxic or hazardous substance is contained in at least one of the homogeneous materials for this part is above the limit requirement in SJ/T11363-2006</p>						

## AFL2-08A-N26

此附件旨在确保本产品符合中国 RoHS 标准。以下表格标示此产品中某有毒物质的含量符合中国 RoHS 标准规定的限量要求。

本产品上会附有“环境友好使用期限”的标签，此期限是估算这些物质“不会有泄漏或突变”的年限。本产品可能包含有较短的环境友好使用期限的可替换元件，像是电池或灯管，这些元件将会单独标示出来。

部件名称	有毒有害物质或元素					
	铅 (Pb)	汞 (Hg)	镉 (Cd)	六价铬 (CR(VI))	多溴联苯 (PBB)	多溴二苯醚 (PBDE)
壳体	X	O	O	O	O	X
显示	X	O	O	O	O	X
印刷电路板	X	O	O	O	O	X
金属螺帽	X	O	O	O	O	O
电缆组装	X	O	O	O	O	X
风扇组装	X	O	O	O	O	X
电力供应组装	X	O	O	O	O	X
电池	O	O	O	O	O	O

O: 表示该有毒有害物质在该部件所有物质材料中的含量均在 SJ/T11363-2006 标准规定的限量要求以下。

X: 表示该有毒有害物质至少在该部件的某一均质材料中的含量超出 SJ/T11363-2006 标准规定的限量要求。