

**MODEL:
WAFER-ULT-i1**

3.5" SBC with Intel® 4th Generation Mobile Core™ i7/i5/i3 or Celeron® ULT SoC, Dual PCIe GbE, VGA, LVDS, iDP, USB 3.0, SATA 6Gb/s, PCIe Mini, iRIS-1010, HD Audio and RoHS

User Manual

Revision

Date	Version	Changes
23 April, 2014	1.00	Initial release

Copyright

COPYRIGHT NOTICE

The information in this document is subject to change without prior notice in order to improve reliability, design and function and does not represent a commitment on the part of the manufacturer.

In no event will the manufacturer be liable for direct, indirect, special, incidental, or consequential damages arising out of the use or inability to use the product or documentation, even if advised of the possibility of such damages.

This document contains proprietary information protected by copyright. All rights are reserved. No part of this manual may be reproduced by any mechanical, electronic, or other means in any form without prior written permission of the manufacturer.

TRADEMARKS

All registered trademarks and product names mentioned herein are used for identification purposes only and may be trademarks and/or registered trademarks of their respective owners.

Table of Contents

1 INTRODUCTION.....	1
1.1 INTRODUCTION.....	2
1.2 BENEFITS	2
1.3 MODEL VARIATIONS	3
1.4 FEATURES.....	3
1.5 CONNECTORS	4
1.6 DIMENSIONS.....	5
1.7 DATA FLOW	6
1.8 TECHNICAL SPECIFICATIONS	7
2 PACKING LIST.....	10
2.1 ANTI-STATIC PRECAUTIONS	11
2.2 UNPACKING PRECAUTIONS.....	11
2.3 PACKING LIST.....	12
2.4 OPTIONAL ITEMS	13
3 CONNECTORS	15
3.1 PERIPHERAL INTERFACE CONNECTORS.....	16
3.1.1 <i>Layout</i>	16
3.1.2 <i>Peripheral Interface Connectors</i>	17
3.1.3 <i>External Interface Panel Connectors</i>	18
3.2 INTERNAL PERIPHERAL CONNECTORS	18
3.2.1 <i>+12V Power Connector</i>	19
3.2.2 <i>5 V SATA Power Connectors</i>	19
3.2.3 <i>Audio Connector</i>	20
3.2.4 <i>Battery Connector</i>	21
3.2.5 <i>Buzzer Connector</i>	22
3.2.6 <i>Chassis Intrusion Connector</i>	23
3.2.7 <i>Digital I/O Connector</i>	24
3.2.8 <i>EC Debug Connector</i>	25
3.2.9 <i>Internal DisplayPort Connector</i>	25

WAFER-ULT-i1 3.5" SBC

3.2.10 IPMI LED Connector.....	26
3.2.11 iRIS Module Slot.....	27
3.2.12 Keyboard and Mouse Connector	28
3.2.13 LAN LED Connectors	29
3.2.14 LVDS Backlight Control Connector.....	30
3.2.15 LVDS Connector	31
3.2.16 PCIe Mini Card Slot	32
3.2.17 Power and HDD LED Connector.....	34
3.2.18 Power Button Connector.....	35
3.2.19 Reset Button Connector	36
3.2.20 SATA 6Gb/s Connectors.....	37
3.2.21 Serial Port Connector, RS-232.....	38
3.2.22 Serial Port Connector, RS-422/485.....	39
3.2.23 SMBus Connector	40
3.2.24 SO-DIMM Connectors.....	41
3.2.25 SPI Flash Connector.....	41
3.2.26 System Fan Connector	42
3.2.27 USB 2.0 Connector	43
3.3 EXTERNAL INTERFACE CONNECTORS	44
3.3.1 Ethernet Connectors	45
3.3.2 USB 3.0 Ports.....	45
3.3.3 Serial Port Connector (COM1)	46
3.3.4 VGA Connector.....	47
4 INSTALLATION	48
4.1 ANTI-STATIC PRECAUTIONS	49
4.2 INSTALLATION CONSIDERATIONS.....	49
4.3 SO-DIMM INSTALLATION	51
4.4 iRIS-1010 MODULE INSTALLATION.....	51
4.5 FULL-SIZE PCIe MINI CARD INSTALLATION	53
4.6 HALF-SIZE PCIe MINI CARD INSTALLATION.....	55
4.7 SYSTEM CONFIGURATION.....	58
4.7.1 AT/ATX Power Mode Selection.....	58
4.7.2 Clear CMOS Button.....	59
4.7.3 LVDS Panel Type Selection.....	59

4.7.4 LVDS Voltage Selection.....	60
4.8 CHASSIS INSTALLATION.....	61
4.8.1 Airflow.....	61
4.8.2 Motherboard Installation.....	62
4.9 INTERNAL PERIPHERAL DEVICE CONNECTIONS.....	62
4.9.1 AT/ATX Power Connection.....	62
4.9.2 Audio Kit Installation.....	64
4.9.3 LVDS LCD Installation.....	65
4.9.4 SATA Drive Connection.....	67
4.9.5 USB Cable Installation.....	68
4.10 EXTERNAL PERIPHERAL INTERFACE CONNECTION.....	69
4.10.1 LAN Connection.....	69
4.10.2 Serial Device Connection.....	70
4.10.3 USB Connection.....	71
4.11 HEAT SINK ENCLOSURE.....	72
4.12 INTEL [®] AMT SETUP PROCEDURE.....	73
4.13 IPMI SETUP PROCEDURE.....	74
4.13.1 Managed System Hardware Setup.....	74
5 BIOS.....	75
5.1 INTRODUCTION.....	76
5.1.1 Starting Setup.....	76
5.1.2 Using Setup.....	76
5.1.3 Getting Help.....	77
5.1.4 Unable to Reboot after Configuration Changes.....	77
5.1.5 BIOS Menu Bar.....	77
5.2 MAIN.....	79
5.3 ADVANCED.....	80
5.3.1 ACPI Settings.....	81
5.3.2 RTC Wake Settings.....	82
5.3.3 CPU Configuration.....	83
5.3.4 SATA Configuration.....	84
5.3.5 Intel(R) Rapid Start Technology.....	85
5.3.6 AMT Configuration.....	86
5.3.7 USB Configuration.....	87

WAFER-ULT-i1 3.5" SBC

5.3.8 F81866 Super IO Configuration	88
5.3.8.1 Serial Port n Configuration	89
5.3.9 F81866 H/W Monitor	94
5.3.9.1 SYS_FAN1 Smart Fan Mode Configuration	94
5.3.10 Serial Port Console Redirection	96
5.3.11 iEi Feature	100
5.4 CHIPSET	101
5.4.1 PCH-IO Configuration	101
5.4.2 System Agent (SA) Configuration	102
5.4.2.1 Graphics Configuration	103
5.4.2.2 Memory Configuration	105
5.5 BOOT	105
5.6 SECURITY	107
5.7 SAVE & EXIT	108
6 SOFTWARE DRIVERS	110
6.1 AVAILABLE SOFTWARE DRIVERS	111
6.2 SOFTWARE INSTALLATION	111
6.3 CHIPSET DRIVER INSTALLATION	112
6.4 GRAPHICS DRIVER INSTALLATION	115
6.5 LAN DRIVER INSTALLATION	118
6.6 AUDIO DRIVER INSTALLATION	122
6.7 USB 3.0 DRIVER INSTALLATION	124
6.8 INTEL® AMT DRIVER INSTALLATION	127
A BIOS OPTIONS	130
B ONE KEY RECOVERY	133
B.1 ONE KEY RECOVERY INTRODUCTION	134
B.1.1 System Requirement	135
B.1.2 Supported Operating System	136
B.2 SETUP PROCEDURE FOR WINDOWS	137
B.2.1 Hardware and BIOS Setup	138
B.2.2 Create Partitions	138
B.2.3 Install Operating System, Drivers and Applications	142
B.2.4 Building the Recovery Partition	143

<i>B.2.5 Create Factory Default Image</i>	145
B.3 AUTO RECOVERY SETUP PROCEDURE	150
B.4 SETUP PROCEDURE FOR LINUX	155
B.5 RECOVERY TOOL FUNCTIONS	158
<i>B.5.1 Factory Restore</i>	160
<i>B.5.2 Backup System</i>	161
<i>B.5.3 Restore Your Last Backup</i>	162
<i>B.5.4 Manual</i>	163
B.6 RESTORE SYSTEMS FROM A LINUX SERVER THROUGH LAN	164
<i>B.6.1 Configure DHCP Server Settings</i>	165
<i>B.6.2 Configure TFTP Settings</i>	166
<i>B.6.3 Configure One Key Recovery Server Settings</i>	167
<i>B.6.4 Start the DHCP, TFTP and HTTP</i>	168
<i>B.6.5 Create Shared Directory</i>	168
<i>B.6.6 Setup a Client System for Auto Recovery</i>	169
B.7 OTHER INFORMATION	172
<i>B.7.1 Using AHCI Mode or ALi M5283 / VIA VT6421A Controller</i>	172
<i>B.7.2 System Memory Requirement</i>	174
C TERMINOLOGY	175
D DIGITAL I/O INTERFACE	179
D.1 INTRODUCTION.....	180
D.2 DIO CONNECTOR PINOUTS	180
D.3 ASSEMBLY LANGUAGE SAMPLES.....	180
<i>D.3.1 Enable the DIO Input Function</i>	180
<i>D.3.2 Enable the DIO Output Function</i>	181
E HAZARDOUS MATERIALS DISCLOSURE	182
E.1 HAZARDOUS MATERIALS DISCLOSURE TABLE FOR IPB PRODUCTS CERTIFIED AS ROHS COMPLIANT UNDER 2002/95/EC WITHOUT MERCURY	183

List of Figures

Figure 1-1: WAFER-ULT-i1	2
Figure 1-2: Connectors	4
Figure 1-3: WAFER-ULT-i1 Dimensions (mm)	5
Figure 1-4: Data Flow Diagram.....	6
Figure 3-1: Peripheral Interface Connectors	16
Figure 3-2: Power Connector Location	19
Figure 3-3: 5 V SATA Power Connector Locations	20
Figure 3-4: Audio Connector Location	21
Figure 3-5: Battery Connector Location.....	22
Figure 3-6: Buzzer Connector Location	23
Figure 3-7: Chassis Intrusion Connector Location.....	23
Figure 3-8: Digital I/O Connector Location	24
Figure 3-9: EC Debug Connector Location	25
Figure 3-10: Internal DisplayPort Connector Location	26
Figure 3-11: IPMI LED Connector Location	27
Figure 3-12: iRIS Module Slot Location.....	28
Figure 3-13: Keyboard and Mouse Connector Location.....	29
Figure 3-14: LAN LED Connector Locations	30
Figure 3-15: LVDS Backlight Control Connector Location	31
Figure 3-16: LVDS Connector Location.....	32
Figure 3-17: PCIe Mini Card Slot Location.....	33
Figure 3-18: Power and HDD LED Connector Location.....	35
Figure 3-19: Power Button Connector Location.....	36
Figure 3-20: Reset Button Connector Location.....	36
Figure 3-21: SATA 6Gb/s Connector Locations	37
Figure 3-22: RS-232 Serial Port Connector Locations.....	38
Figure 3-23: RS-422/485 Serial Port Connector Location.....	39
Figure 3-24: SMBus Connector Location	40
Figure 3-25: SO-DIMM Connector Locations	41
Figure 3-26: SPI Flash Connector Location.....	42

Figure 3-27: System Fan Connector Location.....	43
Figure 3-28: USB 2.0 Connector Location	44
Figure 3-29: External Interface Connectors.....	44
Figure 3-30: Serial Port	46
Figure 3-31: VGA Connector	47
Figure 4-1: SO-DIMM Installation	51
Figure 4-2: Removing the Retention Screw for the iRIS-1010 Module.....	52
Figure 4-3: Inserting the iRIS-1010 Module into the Slot at an Angle	52
Figure 4-4: Securing the iRIS-1010 Module	53
Figure 4-5: Removing the Retention Screw	54
Figure 4-6: Inserting the Full-size PCIe Mini Card into the Slot at an Angle	54
Figure 4-7: Securing the Full-size PCIe Mini Card	55
Figure 4-8: Removing the Standoff.....	56
Figure 4-9: Installing the Standoff	56
Figure 4-10: Inserting the Half-size PCIe Mini Card into the Slot at an Angle.....	57
Figure 4-11: Securing the Half-size PCIe Mini Card	57
Figure 4-12: AT/ATX Power Mode Switch Location	58
Figure 4-13: Clear CMOS Button Location.....	59
Figure 4-14: LVDS Panel Type Selection Switch Location.....	60
Figure 4-15: LVDS Voltage Selection Jumper Location	61
Figure 4-16: Power Cable to Motherboard Connection	63
Figure 4-17: Connect Power Cable to Power Supply.....	64
Figure 4-18: Audio Kit Cable Connection	65
Figure 4-19: LVDS Connector.....	66
Figure 4-20: Backlight Inverter Connection.....	67
Figure 4-21: SATA Drive Cable Connection.....	68
Figure 4-22: Dual-port USB Cable Connection.....	69
Figure 4-23: LAN Connection	70
Figure 4-24: Serial Device Connector.....	71
Figure 4-25: USB 3.0 Connectors.....	72
Figure 4-26: Heat Sink Retention Screws	73
Figure 6-1: Chipset Driver Welcome Screen.....	112
Figure 6-2: Chipset Driver License Agreement	113
Figure 6-3: Chipset Driver Read Me File	113
Figure 6-4: Chipset Driver Setup Operations	114

WAFER-ULT-i1 3.5" SBC

Figure 6-5: Chipset Driver Installation Finish Screen.....	114
Figure 6-6: Graphics Driver Welcome Screen	115
Figure 6-7: Graphics Driver License Agreement.....	116
Figure 6-8: Graphics Driver Read Me File	116
Figure 6-9: Graphics Driver Setup Operations	117
Figure 6-10: Graphics Driver Installation Finish Screen	117
Figure 6-11: Intel® Network Connection Menu.....	118
Figure 6-12: LAN Driver Welcome Screen	119
Figure 6-13: LAN Driver License Agreement.....	119
Figure 6-14: LAN Driver Setup Options.....	120
Figure 6-15: LAN Driver Installation	121
Figure 6-16: LAN Driver Installation Complete.....	121
Figure 6-17: InstallShield Wizard Welcome Screen	122
Figure 6-18: Audio Driver Software Configuration.....	123
Figure 6-19: Restart the Computer	123
Figure 6-20: USB 3.0 Driver Welcome Screen	124
Figure 6-21: USB 3.0 Driver License Agreement.....	125
Figure 6-22: USB 3.0 Driver Read Me File	125
Figure 6-23: USB 3.0 Driver Setup Operations	126
Figure 6-24: USB 3.0 Driver Installation Finish Screen	126
Figure 6-25: Intel® ME Driver Welcome Screen	127
Figure 6-26: Intel® ME Driver License Agreement.....	128
Figure 6-27: Intel® ME Driver Setup Operations	129
Figure 6-28: Intel® ME Driver Installation Finish Screen	129
Figure B-1: IEI One Key Recovery Tool Menu	134
Figure B-2: Launching the Recovery Tool	139
Figure B-3: Recovery Tool Setup Menu	139
Figure B-4: Command Prompt	140
Figure B-5: Partition Creation Commands.....	141
Figure B-6: Launching the Recovery Tool	143
Figure B-7: Manual Recovery Environment for Windows	143
Figure B-8: Building the Recovery Partition.....	144
Figure B-9: Press Any Key to Continue	144
Figure B-10: Press F3 to Boot into Recovery Mode.....	145
Figure B-11: Recovery Tool Menu	145

Figure B-12: About Symantec Ghost Window	146
Figure B-13: Symantec Ghost Path	146
Figure B-14: Select a Local Source Drive	147
Figure B-15: Select a Source Partition from Basic Drive	147
Figure B-16: File Name to Copy Image to	148
Figure B-17: Compress Image.....	148
Figure B-18: Image Creation Confirmation	149
Figure B-19: Creating Image.....	149
Figure B-20: Image Creation Complete	149
Figure B-21: Press Any Key to Continue	150
Figure B-22: Auto Recovery Utility	151
Figure B-23: Disable Automatically Restart.....	151
Figure B-24: Launching the Recovery Tool	152
Figure B-25: Auto Recovery Environment for Windows	152
Figure B-26: Building the Auto Recovery Partition.....	153
Figure B-27: Factory Default Image Confirmation	153
Figure B-28: Creating Image.....	154
Figure B-29: Press Any Key to Continue	154
Figure B-30: IEI Feature BIOS Menu	155
Figure B-31: Partitions for Linux.....	156
Figure B-32: Manual Recovery Environment for Linux	157
Figure B-33: Access menu.lst in Linux (Text Mode).....	157
Figure B-34: Recovery Tool Menu	158
Figure B-35: Recovery Tool Main Menu	159
Figure B-36: Restore Factory Default.....	160
Figure B-37: Recovery Complete Window	160
Figure B-38: Backup System.....	161
Figure B-39: System Backup Complete Window	161
Figure B-40: Restore Backup	162
Figure B-41: Restore System Backup Complete Window	162
Figure B-42: Symantec Ghost Window	163
Figure B-43: Disable Automatically Restart.....	170

List of Tables

Table 1-1: WAFER-ULT-i1 Model Variations	3
Table 1-2: Technical Specifications.....	9
Table 2-1: Packing List.....	13
Table 2-2: Optional Items	14
Table 3-1: Peripheral Interface Connectors	18
Table 3-2: Rear Panel Connectors	18
Table 3-3: Power Connector Pinouts.....	19
Table 3-4: 5 V SATA Power Connector Pinouts	20
Table 3-5: Audio Connector Pinouts	21
Table 3-6: Battery Connector Pinouts	22
Table 3-7: Buzzer Connector Pinouts.....	23
Table 3-8: Chassis Intrusion Connector Pinouts	24
Table 3-9: Digital I/O Connector Pinouts.....	25
Table 3-10: EC Debug Connector Pinouts	25
Table 3-11: Internal DisplayPort Connector Pinouts	26
Table 3-12: IPMI LED Connector Pinouts.....	27
Table 3-13: Keyboard and Mouse Connector Pinouts.....	29
Table 3-14: LAN LED Connector Pinouts.....	30
Table 3-15: LVDS Backlight Control Connector Pinouts.....	31
Table 3-16: LVDS Connector Pinouts.....	32
Table 3-17: PCIe Mini Card Slot Pinouts	34
Table 3-18: Power and HDD LED Connector Pinouts	35
Table 3-19: Power Button Connector Pinouts	36
Table 3-20: Reset Button Connector Pinouts	37
Table 3-21: SATA 6Gb/s Drive Connector Pinouts.....	38
Table 3-22: RS-232 Serial Port Connector Pinouts	39
Table 3-23: RS-422/485 Serial Port Connector Pinouts	39
Table 3-24: DB-9 RS-422/485 Pinouts.....	40
Table 3-25: SMBus Connector Pinouts	41
Table 3-26: SPI Flash Connector Pinouts	42

Table 3-27: System Fan Connector Pinouts	43
Table 3-28: USB 2.0 Connector Pinouts.....	44
Table 3-29: LAN Pinouts	45
Table 3-30: USB 3.0 Port Pinouts.....	46
Table 3-31: Serial Port Pinouts.....	46
Table 3-32: VGA Connector Pinouts.....	47
Table 4-1: AT/ATX Power Mode Switch Settings.....	58
Table 4-2: LVDS Panel Type Selection	60
Table 4-3: LVDS Voltage Selection Jumper Settings.....	61
Table 5-1: BIOS Navigation Keys	77
Table 6-1: Digital I/O Connector Pinouts.....	180

BIOS Menus

BIOS Menu 1: Main	79
BIOS Menu 2: Advanced	80
BIOS Menu 3: ACPI Settings	81
BIOS Menu 4: RTC Wake Settings	82
BIOS Menu 5: CPU Configuration	83
BIOS Menu 6: SATA Configuration	84
BIOS Menu 7: Intel(R) Rapid Start Technology	85
BIOS Menu 8: AMT Configuration	86
BIOS Menu 9: USB Configuration	87
BIOS Menu 10: F81866 Super IO Configuration	88
BIOS Menu 11: Serial Port n Configuration Menu	89
BIOS Menu 12: F81866 H/W Monitor	94
BIOS Menu 13: SYS_FAN1 Smart Fan Mode Configuration	95
BIOS Menu 14: Serial Port Console Redirection	96
BIOS Menu 15: iEi Feature	100
BIOS Menu 16: Chipset	101
BIOS Menu 17: PCH-IO Configuration	101
BIOS Menu 18: System Agent (SA) Configuration	102
BIOS Menu 19: Graphics Configuration	103
BIOS Menu 20: Memory Configuration	105
BIOS Menu 21: Boot	105
BIOS Menu 22: Security	107
BIOS Menu 23: Save & Exit	108

Chapter

1

Introduction

1.1 Introduction

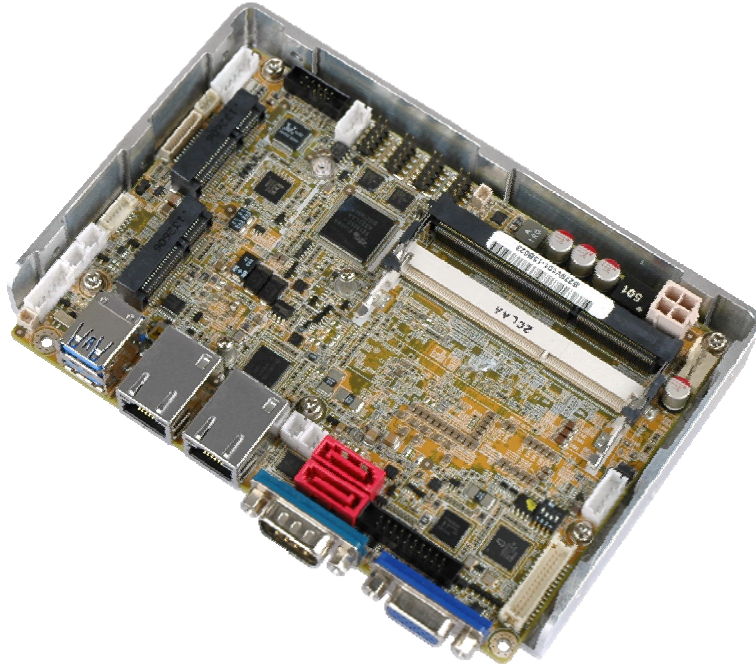

Figure 1-1: WAFER-ULT-i1

The WAFER-ULT-i1 3.5" SBC is an Intel® 4th generation mobile ULT SoC platform that supports two 1600/1333 MHz dual-channel DDR3L SO-DIMMs up to 16 GB. The WAFER-ULT-i1 provides two GbE interfaces through the Intel® I218 (with Intel® AMT 9.0 support) and the Intel® I210 GbE controllers. In addition, the WAFER-ULT-i1 includes VGA, LVDS and iDP interfaces for triple independent display. Two USB 3.0 on the rear panel, two USB 2.0 by pin header, two SATA 6Gb/s, three RS-232, one RS-422/485, one PCIe Mini card slot and one audio connector provide flexible expansion options.

1.2 Benefits

Some of the WAFER-ULT-i1 motherboard benefits include:

- Wide range temperature support
- Triple independent display support
- Heat sink enclosure design

WAFER-ULT-i1 3.5" SBC

1.3 Model Variations

The model variations of the WAFER-ULT-i1 are listed below.

Model No.	SoC
WAFER-ULT-i1-i7-R10	Intel® Core™ i7-4650U on-board SoC (1.7 GHz, dual-core, 4 MB cache, TDP=15W)
WAFER-ULT-i1-i5-R10	Intel® Core™ i5-4300U on-board SoC (1.9 GHz, dual-core, 3 MB cache, TDP=15W)
WAFER-ULT-i1-i3-R10	Intel® Core™ i3-4010U on-board SoC (1.7 GHz, dual-core, 3 MB cache, TDP=15W)
WAFER-ULT-i1-C-R10	Intel® Celeron® 2980U on-board SoC (1.6 GHz, dual-core, 2 MB cache, TDP=15W)

Table 1-1: WAFER-ULT-i1 Model Variations

1.4 Features

Some of the WAFER-ULT-i1 motherboard features are listed below:

- 3.5" form factor
- Intel® 4th generation mobile ULT SoC
- Two 204-pin 1600/1333 MHz dual-channel DDR3L SO-DIMMs support up to 16 GB
- Triple independent display by VGA, LVDS and iDP interfaces
- 18/24-bit dual-channel LVDS for high resolution panel
- Supports IPMI 2.0 via the optional iRIS-1010 module
- Two Intel® PCIe GbE connectors (LAN1 with Intel® AMT 9.0 support)
- One PCIe Mini card slot with mSATA support
- High Definition Audio
- RoHS compliant

1.5 Connectors

The connectors on the WAFER-ULT-i1 are shown in the figures below.

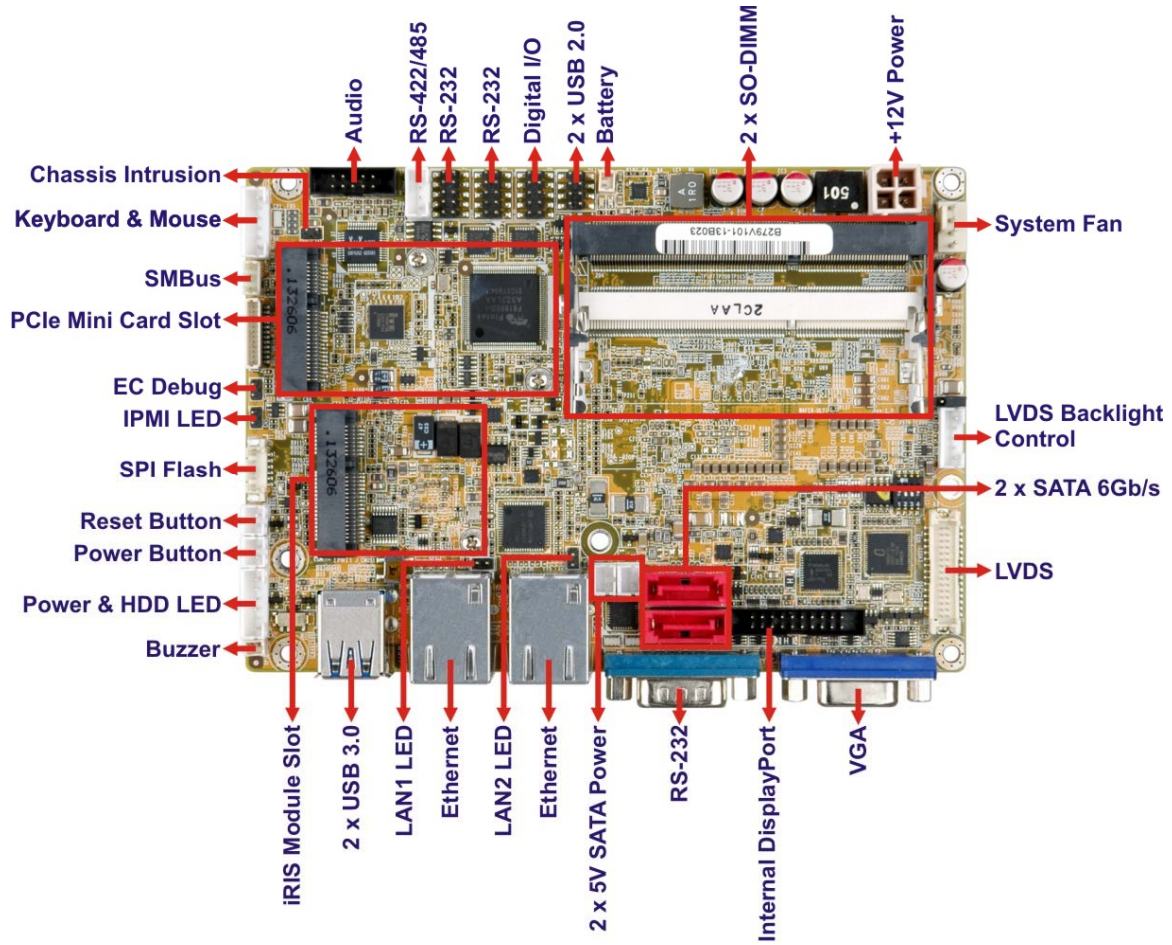

Figure 1-2: Connectors

WAFER-ULT-i1 3.5" SBC

1.6 Dimensions

The main dimensions of the WAFER-ULT-i1 are shown in the diagram below.

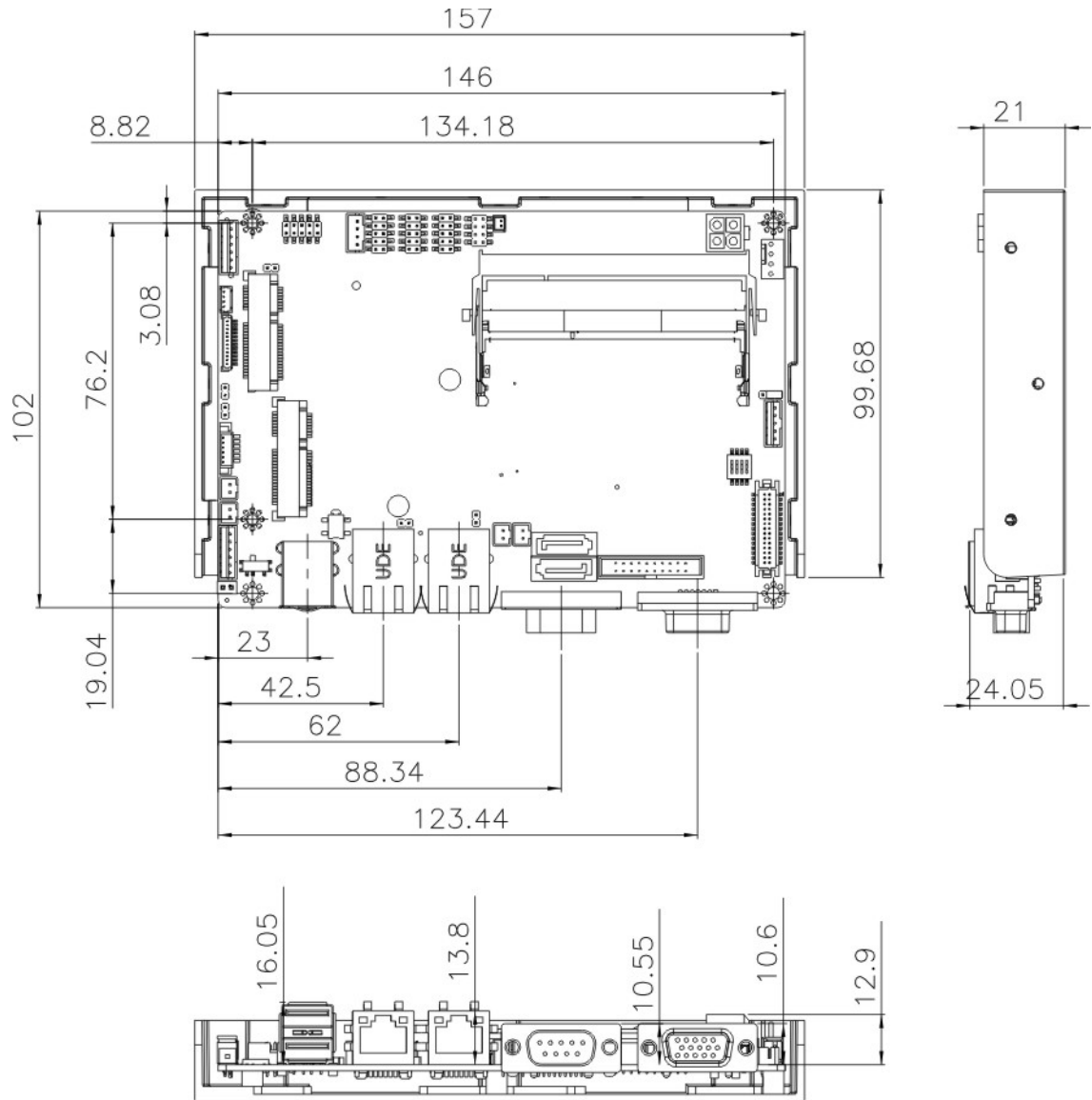

Figure 1-3: WAFER-ULT-i1 Dimensions (mm)

1.7 Data Flow

Figure 1-4 shows the data flow between the system chipset, the CPU and other components installed on the motherboard.

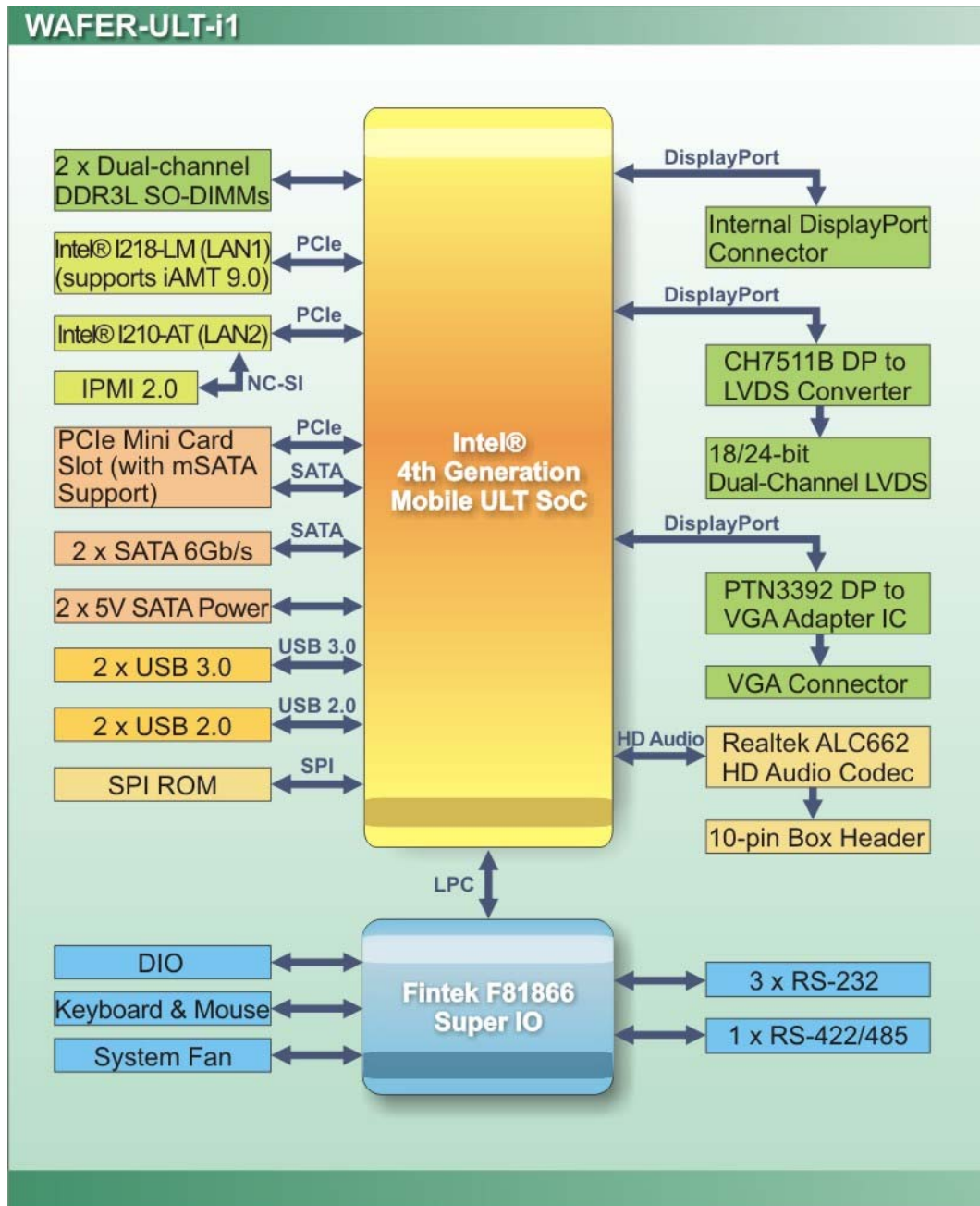

Figure 1-4: Data Flow Diagram

WAFER-ULT-i1 3.5" SBC

1.8 Technical Specifications

The WAFER-ULT-i1 technical specifications are listed in **Table 1-2**.

Specifications/Model	WAFER-ULT-i1
Form Factor	3.5"
SoC	<p>Intel® Core™ i7-4650U on-board SoC (1.7 GHz, dual-core, 4 MB cache, TDP=15W)</p> <p>Intel® Core™ i5-4300U on-board SoC (1.9 GHz, dual-core, 3 MB cache, TDP=15W)</p> <p>Intel® Core™ i3-4010U on-board SoC (1.7 GHz, dual-core, 3 MB cache, TDP=15W)</p> <p>Intel® Celeron® 2980U on-board SoC (1.6 GHz, dual-core, 2 MB cache, TDP=15W)</p>
Memory	Two 204-pin 1600/1333 MHz dual-channel unbuffered DDR3L SDRAM SO-DIMMs supported (up to 16 GB)
Graphics Engine	<p>Intel® HD Graphics Gen 7.5 supports DirectX 11.1, OpenCL 1.2 and OpenGL 4.2</p> <p>Full MPEG2, VC1, AVC decode</p>
Display Output	<p>Triple independent display support</p> <p>One VGA (up to 1920 x 1200, 60 Hz)</p> <p>One 18/24-bit dual-channel LVDS by CH7511B DP to LVDS converter (up to 1920 x 1200, 60 Hz)</p> <p>One iDP interface for HDMI, LVDS, VGA, DVI and DisplayPort (up to 3840 x 2160, 60 Hz)</p>
BIOS	UEFI BIOS
Ethernet Controllers	<p>LAN1: Intel® I218-LM PCIe GbE controller with Intel® AMT 9.0 support</p> <p>LAN2: Intel® I210-AT PCIe GbE controller with NC-SI support</p>
Audio	<p>Realtek ALC662 HD Audio codec</p> <p>One audio connector (10-pin box header)</p>
Super I/O Controller	Fintek F81866

Specifications/Model	WAFER-ULT-i1
Watchdog Timer	Software programmable, supports 1~255 sec. system reset
Expansion	One full-size/half-size PCIe Mini card slot with mSATA support
IPMI 2.0	One iRIS module slot
IPMI LED	One 2-pin header for IPMI LED
Chassis Intrusion	One 2-pin header
Digital I/O	8-bit, 4-bit input/4-bit output
Fan Connector	One system fan connector (4-pin wafer)
Front Panel	One power & HDD LED connector (6-pin wafer) One power button connector (2-pin wafer) One reset button connector (2-pin wafer)
Keyboard and Mouse	One 6-pin wafer connector for PS/2 keyboard and mouse
LAN LEDs	Two 2-pin headers for LAN1 LED and LAN2 LED (link signal)
Serial ATA	Two SATA 6Gb/s connectors with RAID support Two 5V SATA power connectors
Serial Ports	One external RS-232 serial port Two RS-232 serial ports via internal pin headers One RS-422/485 via internal 4-pin wafer connector
SMBus	One 4-pin wafer connector
USB	Two USB 3.0 ports on rear panel Two USB 2.0 ports by pin header
Power Supply	12V only DC input AT/ATX power mode support One Internal 4-pin (2x2) power connector
Power Consumption	+12V@2.72A (Intel® Core™ i5-4300U on-board SoC with two 8 GB 1600 MHz DDR3L SO-DIMMs)
Operating Temperature	-10°C ~ 60°C
Storage Temperature	-20°C ~ 85°C

WAFER-ULT-i1 3.5" SBC

Specifications/Model	WAFER-ULT-i1
Operating Humidity	5% ~ 95% (non-condensing)
Dimensions	146 mm x 102 mm
Weight (GW/NW)	600 g/250 g

Table 1-2: Technical Specifications

Chapter

2

Packing List

WAFER-ULT-i1 3.5" SBC

2.1 Anti-static Precautions



WARNING!

Static electricity can destroy certain electronics. Make sure to follow the ESD precautions to prevent damage to the product, and injury to the user.

Make sure to adhere to the following guidelines:

- **Wear an anti-static wristband:** Wearing an anti-static wristband can prevent electrostatic discharge.
- **Self-grounding:** Touch a grounded conductor every few minutes to discharge any excess static buildup.
- **Use an anti-static pad:** When configuring any circuit board, place it on an anti-static mat.
- **Only handle the edges of the PCB:** Don't touch the surface of the motherboard. Hold the motherboard by the edges when handling.

2.2 Unpacking Precautions

When the WAFER-ULT-i1 is unpacked, please do the following:

- Follow the antistatic guidelines above.
- Make sure the packing box is facing upwards when opening.
- Make sure all the packing list items are present.







2.3 Packing List



NOTE:

If any of the components listed in the checklist below are missing, do not proceed with the installation. Contact the IEI reseller or vendor the WAFER-ULT-i1 was purchased from or contact an IEI sales representative directly by sending an email to sales@ieiworld.com.

The WAFER-ULT-i1 is shipped with the following components:

Quantity	Item and Part Number	Image
1	WAFER-ULT-i1 SBC with heat sink enclosure	
2	SATA signal and power cable (P/N: 32801-000201-100-RS)	
1	Audio cable (P/N: 32000-072100-RS)	
1	Dual-port USB 2.0 cable (P/N: 32000-070301-RS)	
1	Power cable (P/N: 32100-087100-RS)	
1	Utility CD	

WAFER-ULT-i1 3.5" SBC







Quantity	Item and Part Number	Image
1	One Key Recovery CD	
1	Quick installation guide	

Table 2-1: Packing List

2.4 Optional Items

These optional items are available.

Item and Part Number	Image
iRIS-1010 module, IPMI 2.0 adapter card with AST1010 BMC chip for PCIe Mini socket interface (P/N: iRIS-1010-R10)	
RS-232 cable (P/N: 19800-000300-200-RS)	
RS-422/485 cable (200 mm) (P/N: 32205-003800-300-RS)	
PS/2 keyboard and mouse Y cable (P/N: 32000-023800-RS)	
DisplayPort to 24-bit dual-channel LVDS converter board for IEI iDP connector (P/N: DP-LVDS-R10)	





Item and Part Number	Image
DisplayPort to HDMI converter board for IEI iDP connector (P/N: DP-HDMI-R10)	
DisplayPort to VGA converter board for IEI iDP connector (P/N: DP-VGA-R10)	
DisplayPort to DVI-D converter board for IEI iDP connector (P/N: DP-DVI-R10)	
DisplayPort to DisplayPort converter board for IEI iDP connector (P/N: DP-DP-R10)	

Table 2-2: Optional Items

Chapter

3

Connectors

3.1 Peripheral Interface Connectors

This chapter details all the peripheral interface connectors.

3.1.1 Layout

The figures below show all the peripheral interface connectors.

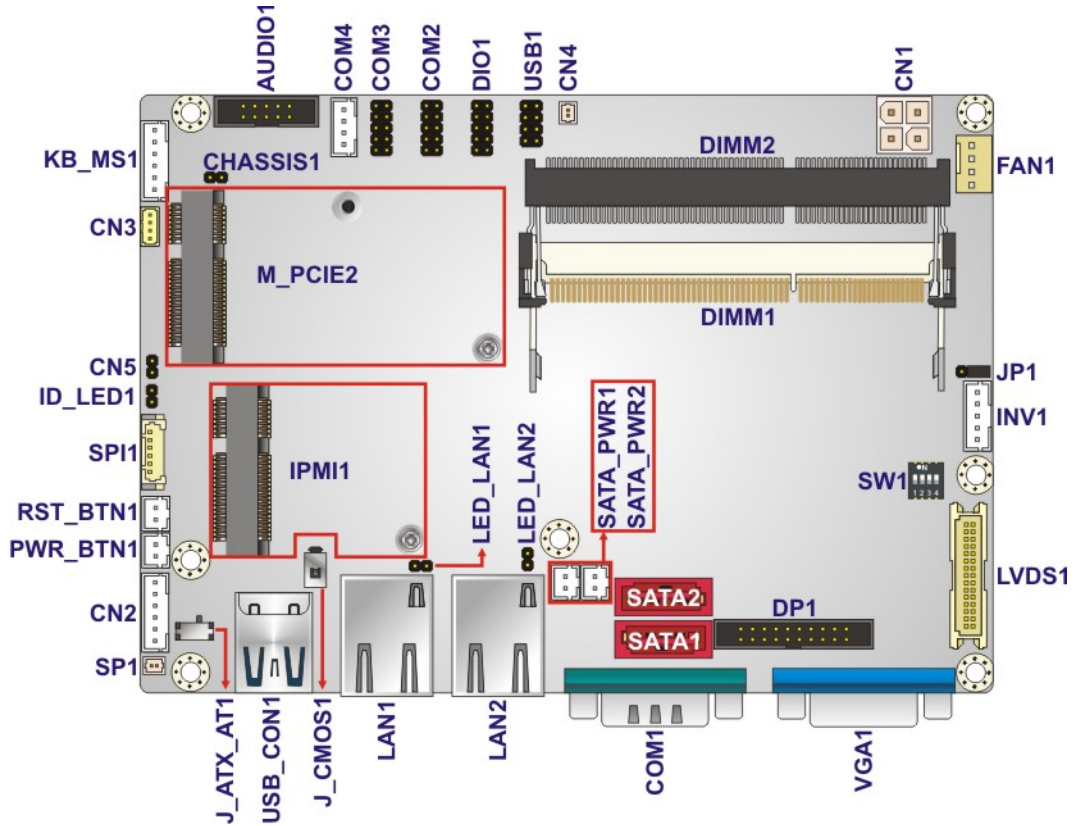

Figure 3-1: Peripheral Interface Connectors

WAFER-ULT-i1 3.5" SBC

3.1.2 Peripheral Interface Connectors

The table below shows a list of the peripheral interface connectors on the WAFER-ULT-i1. Detailed descriptions of these connectors can be found below.

Connector	Type	Label
+12V power connector	4-pin Molex power connector	CN1
5 V SATA power connectors	2-pin wafer	SATA_PWR1, SATA_PWR2
Audio connector	10-pin box header	AUDIO1
Battery connector	2-pin wafer	CN4
Buzzer connector	2-pin wafer	SP1
Chassis intrusion connector	2-pin header	CHASSIS1
Digital I/O connector	10-pin header	DIO1
EC debug connector	2-pin header	CN5
Internal DisplayPort connector	20-pin box header	DP1
IPMI LED connector	2-pin header	ID_LED1
iRIS module slot	iRIS module slot	IPMI1
Keyboard and mouse connector	6-pin wafer	KB_MS1
LAN1 LED connector	2-pin header	LED_LAN1
LAN2 LED connector	2-pin header	LED_LAN2
LVDS backlight control connector	5-pin wafer	INV1
LVDS connector	30-pin crimp	LVDS1
PCIe Mini card slot	PCIe Mini card slot	M_PCIE2
Power and HDD LED connector	6-pin wafer	CN2
Power button connector	2-pin wafer	PWR_BTN1
Reset button connector	2-pin wafer	RST_BTN1
SATA 6Gb/s connectors	7-pin SATA connector	SATA1, SATA2

Connector	Type	Label
Serial port, RS-232	10-pin header	COM2, COM3
Serial port, RS-422/485	4-pin wafer	COM4
SMBus connector	4-pin wafer	CN3
SO-DIMM connectors	204-pin DDR3L SO-DIMM connector	DIMM1, DIMM2
SPI flash connector	6-pin wafer	SPI1
System fan connector	4-pin wafer	FAN1
USB 2.0 connector	8-pin header	USB1

Table 3-1: Peripheral Interface Connectors

3.1.3 External Interface Panel Connectors

The table below lists the rear panel connectors on the WAFER-ULT-i1. Detailed descriptions of these connectors can be found in a later section.

Connector	Type	Label
Ethernet connectors	RJ-45	LAN1, LAN2
USB 3.0 ports	Dual USB 3.0 port	USB_CON1
RS-232 serial port	Male DB-9	COM1
VGA connector	15-pin female	VGA1

Table 3-2: Rear Panel Connectors

3.2 Internal Peripheral Connectors

Internal peripheral connectors are found on the motherboard and are only accessible when the motherboard is outside of the chassis. This section has complete descriptions of all the internal peripheral connectors on the WAFER-ULT-i1.

WAFER-ULT-i1 3.5" SBC

3.2.1 +12V Power Connector

- CN Label:** CN1
- CN Type:** 4-pin Molex power connector
- CN Location:** See **Figure 3-2**
- CN Pinouts:** See **Table 3-3**

The power connector is connected to an external power supply and supports +12V power input. Power is provided to the system, from the power supply through this connector.

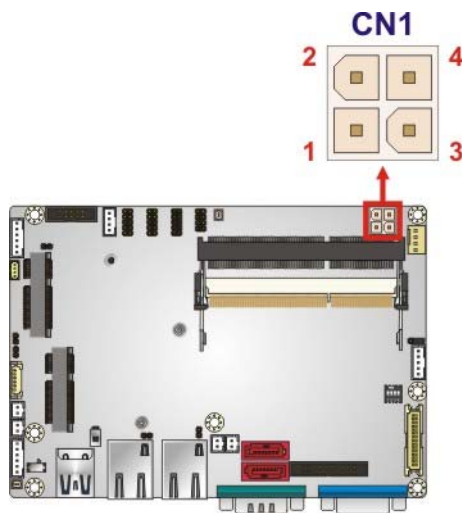

Figure 3-2: Power Connector Location

Pin	Description	Pin	Description
1	GND	2	GND
3	+12V	4	+12V

Table 3-3: Power Connector Pinouts

3.2.2 5 V SATA Power Connectors

- CN Label:** SATA_PWR1, SATA_PWR2
- CN Type:** 2-pin wafer
- CN Location:** See **Figure 3-3**
- CN Pinouts:** See **Table 3-4**

Use the 5 V SATA power connectors to connect to SATA device power connections.

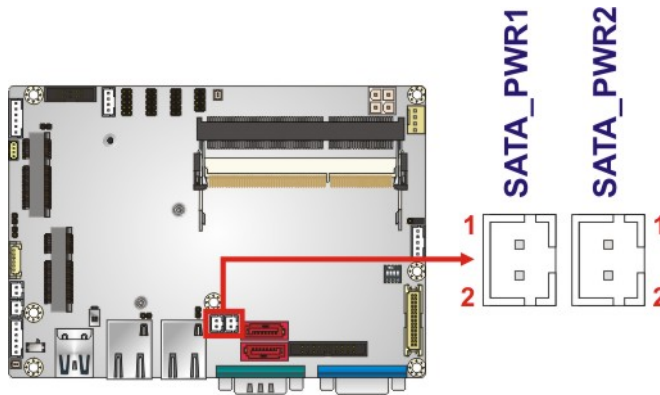

Figure 3-3: 5 V SATA Power Connector Locations

Pin	Description
1	+5V
2	GND

Table 3-4: 5 V SATA Power Connector Pinouts

3.2.3 Audio Connector

- CN Label:** AUDIO1
- CN Type:** 10-pin box header
- CN Location:** See **Figure 3-4**
- CN Pinouts:** See **Table 3-5**

This connector connects to speakers, a microphone and an audio input.

WAFER-ULT-i1 3.5" SBC

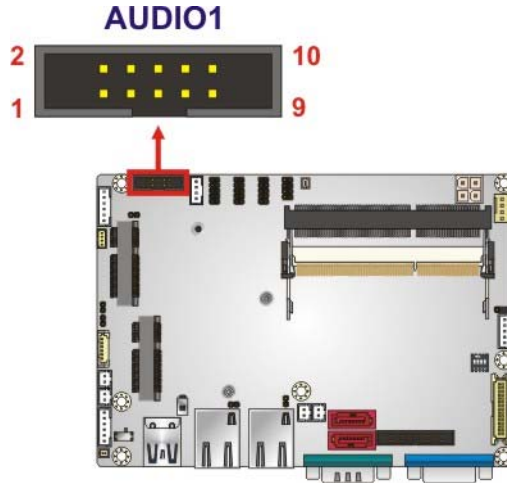

Figure 3-4: Audio Connector Location

Pin	Description	Pin	Description
1	LINEOUT1R	2	LINE1_R
3	AUD_GND	4	AUD_GND
5	LINEOUT1L	6	LINE1_L
7	AUD_GND	8	AUD_GND
9	FMIC1_R	10	FMIC1_L

Table 3-5: Audio Connector Pinouts

3.2.4 Battery Connector



CAUTION:

Risk of explosion if battery is replaced by an incorrect type. Only certified engineers should replace the on-board battery.

Dispose of used batteries according to instructions and local regulations.

- CN Label:** CN4
- CN Type:** 2-pin wafer
- CN Location:** See Figure 3-5
- CN Pinouts:** See Table 3-6

This is connected to the system battery. The battery provides power to the system clock to retain the time when power is turned off.

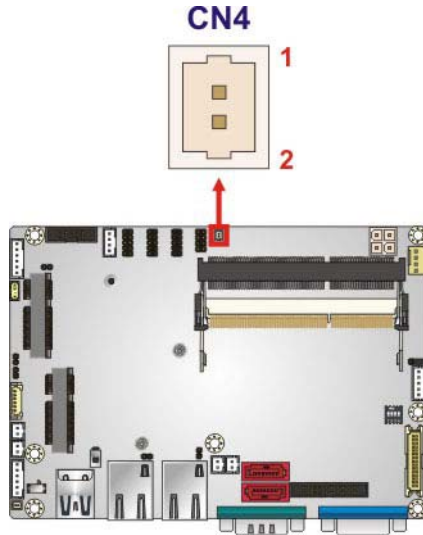

Figure 3-5: Battery Connector Location

Pin	Description
1	VBATT
2	GND

Table 3-6: Battery Connector Pinouts

3.2.5 Buzzer Connector

- CN Label:** SP1
- CN Type:** 2-pin wafer
- CN Location:** See **Figure 3-6**
- CN Pinouts:** See **Table 3-7**

This is connected to the buzzer cable.

WAFER-ULT-i1 3.5" SBC

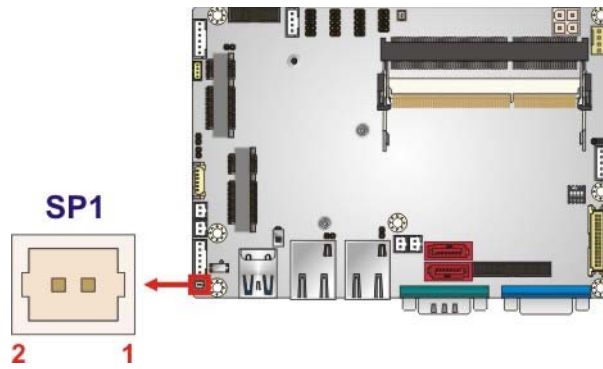

Figure 3-6: Buzzer Connector Location

Pin	Description
1	+V5S
2	GND

Table 3-7: Buzzer Connector Pinouts

3.2.6 Chassis Intrusion Connector

- CN Label:** CHASSIS1
- CN Type:** 2-pin header
- CN Location:** See **Figure 3-7**
- CN Pinouts:** See **Table 3-8**

The chassis intrusion connector is for a chassis intrusion detection sensor or switch that detects if a chassis component is removed or replaced.

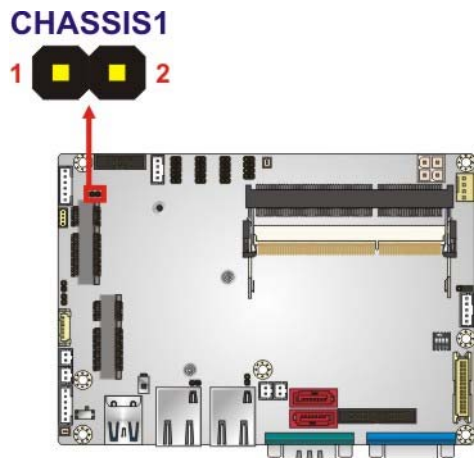

Figure 3-7: Chassis Intrusion Connector Location

Pin	Description
1	+3.3VSB
2	CHASSIS OPEN

Table 3-8: Chassis Intrusion Connector Pinouts

3.2.7 Digital I/O Connector

- CN Label:** DIO1
- CN Type:** 10-pin header
- CN Location:** See **Figure 3-8**
- CN Pinouts:** See **Table 3-9**

The digital I/O connector provides programmable input and output for external devices. The digital I/O provides 4-bit output and 4-bit input.

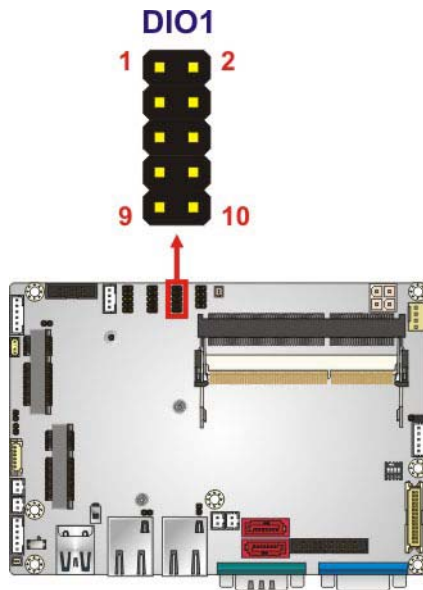

Figure 3-8: Digital I/O Connector Location

Pin	Description	Pin	Description
1	GND	2	VCC
3	Output 3	4	Output 2
5	Output 1	6	Output 0

WAFER-ULT-i1 3.5" SBC

Pin	Description	Pin	Description
7	Input 3	8	Input 2
9	Input 1	10	Input 0

Table 3-9: Digital I/O Connector Pinouts

3.2.8 EC Debug Connector

- CN Label:** CN5
- CN Type:** 2-pin header
- CN Location:** See **Figure 3-9**
- CN Pinouts:** See **Table 3-10**

The chassis intrusion connector is for a chassis intrusion detection sensor or switch that detects if a chassis component is removed or replaced.

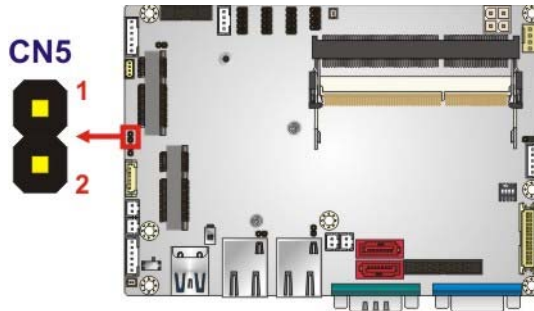

Figure 3-9: EC Debug Connector Location

Pin	Description
1	EC_SMBCLK
2	EC_SMBDAT

Table 3-10: EC Debug Connector Pinouts

3.2.9 Internal DisplayPort Connector

- CN Label:** DP1
- CN Type:** 20-pin box header
- CN Location:** See **Figure 3-10**
- CN Pinouts:** See **Table 3-11**

The DisplayPort connector supports HDMI, LVDS, VGA, DVI and DisplayPort graphics interfaces with up to 3840x2160 resolution.

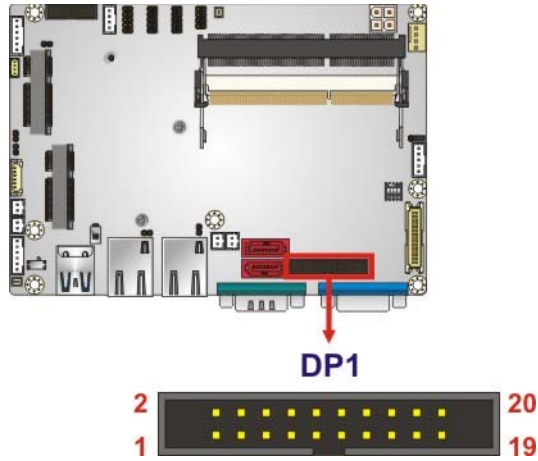

Figure 3-10: Internal DisplayPort Connector Location

Pin	Description	Pin	Description
1	+5V	11	AUXP
2	LANE1N	12	AUXN
3	LANE1P	13	GND
4	GND	14	LANE2P
5	LANE3N	15	LANE2N
6	LANE3P	16	GND
7	GND	17	LANEOP
8	AUX_CTRL_DET_D	18	LANEON
9	GND	19	+3.3V
10	HPD	20	N/C

Table 3-11: Internal DisplayPort Connector Pinouts

3.2.10 IPMI LED Connector

- CN Label:** ID_LED1
- CN Type:** 2-pin wafer
- CN Location:** See **Figure 3-11**
- CN Pinouts:** See **Table 3-12**

WAFER-ULT-i1 3.5" SBC

The IPMI LED connector is used to connect to the IPMI LED indicator on the chassis.

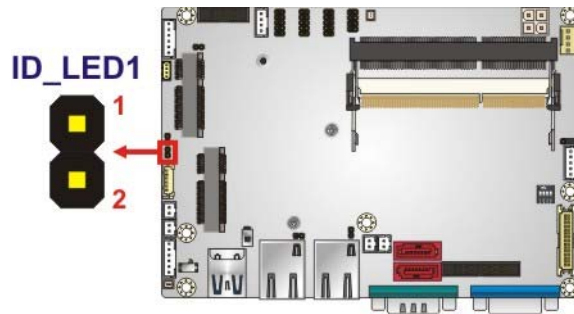

Figure 3-11: IPMI LED Connector Location

Pin	Description
1	ID_LED+
2	ID_LED-

Table 3-12: IPMI LED Connector Pinouts

3.2.11 iRIS Module Slot

- CN Label:** IPMI1
- CN Type:** iRIS module slot
- CN Location:** See **Figure 3-12**

The iRIS module slot allows installation of the iRIS-1010 module.

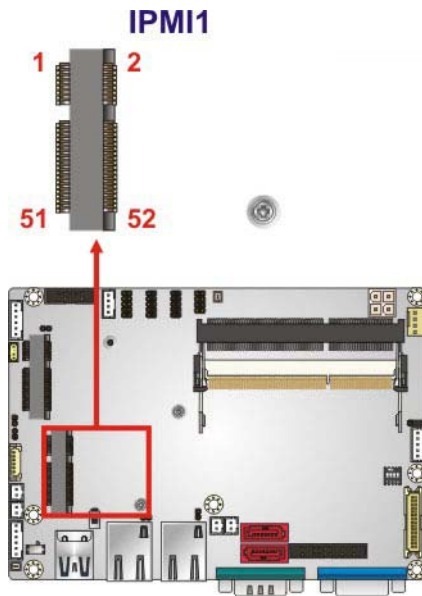

Figure 3-12: iRIS Module Slot Location



WARNING:

The iRIS module slot is designed to install the iRIS-1010 module only. DO NOT install other modules into the iRIS module slot. Doing so may cause damage to the WAFER-ULT-i1.

3.2.12 Keyboard and Mouse Connector

- CN Label:** KB_MS1
- CN Type:** 6-pin wafer
- CN Location:** See **Figure 3-13**
- CN Pinouts:** See **Table 3-13**

The keyboard and mouse connector connects to a PS/2 Y-cable that can be connected to a PS/2 keyboard and mouse.

WAFER-ULT-i1 3.5" SBC

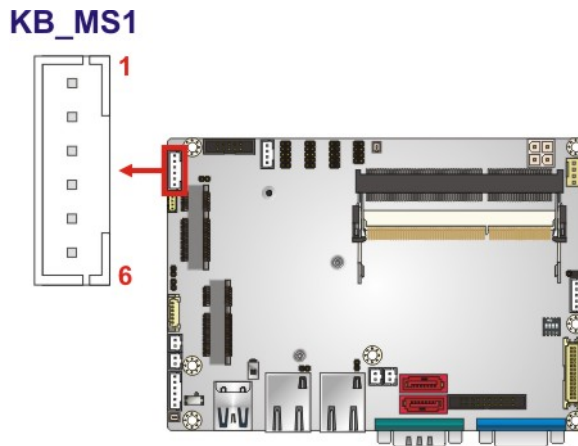

Figure 3-13: Keyboard and Mouse Connector Location

Pin	Description
1	VCC
2	Mouse Data
3	Mouse Clock
4	Keyboard Data
5	Keyboard Clock
6	GND

Table 3-13: Keyboard and Mouse Connector Pinouts

3.2.13 LAN LED Connectors

CN Label: LED_LAN1, LED_LAN2

CN Type: 2-pin header

CN Location: See **Figure 3-14**

CN Pinouts: See **Table 3-14**

The LAN LED connectors are used to connect to the LAN LED indicators on the chassis to indicate users the link activities of the two LAN ports.

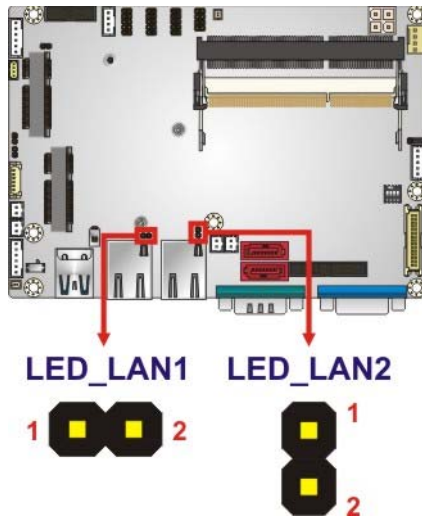

Figure 3-14: LAN LED Connector Locations

Pin	Description
1	+3.3V
2	LAN_LED_LINK#_ACT

Table 3-14: LAN LED Connector Pinouts

3.2.14 LVDS Backlight Control Connector

- CN Label:** INV1
- CN Type:** 5-pin wafer
- CN Location:** See **Figure 3-15**
- CN Pinouts:** See **Table 3-15**

The backlight control connector provides the backlight on the LCD display connected to the WAFER-ULT-i1 with +12V of power.

WAFER-ULT-i1 3.5" SBC

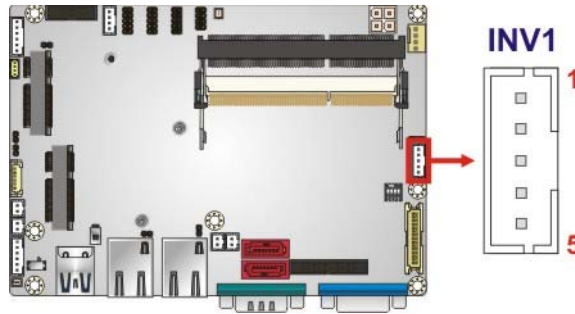

Figure 3-15: LVDS Backlight Control Connector Location

Pin	Description
1	LCD_BKLTCTL
2	GROUND
3	+12V
4	GROUND
5	BACKLIGHT ENABLE

Table 3-15: LVDS Backlight Control Connector Pinouts

3.2.15 LVDS Connector

- CN Label:** LVDS1
- CN Type:** 30-pin crimp
- CN Location:** See **Figure 3-16**
- CN Pinouts:** See **Table 3-16**

The 30-pin LVDS LCD connector can be connected to an 18/24-bit dual-channel LVDS panel.

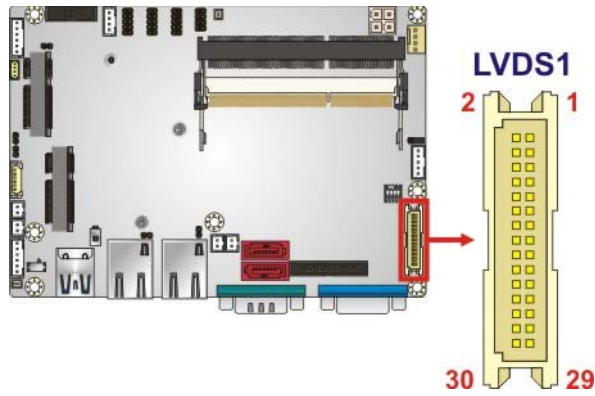

Figure 3-16: LVDS Connector Location

Pin	Description	Pin	Description
1	GND	2	GND
3	LVDS_DATA0	4	LVDS_DATA0#
5	LVDS_DATA1	6	LVDS_DATA1#
7	LVDS_DATA2	8	LVDS_DATA2#
9	LVDS_CLK1	10	LVDS_CLK1#
11	LVDS_DATA3	12	LVDS_DATA3#
13	GND	14	GND
15	LVDS_DATA4	16	LVDS_DATA4#
17	LVDS_DATA5	18	LVDS_DATA5#
19	LVDS_DATA6	20	LVDS_DATA6#
21	LVDS_CLK2	22	LVDS_CLK2#
23	LVDS_DATA7	24	LVDS_DATA7#
25	GND	26	GND
27	VCC_LCD	28	VCC_LCD
29	VCC_LCD	30	VCC_LCD

Table 3-16: LVDS Connector Pinouts

3.2.16 PCIe Mini Card Slot

CN Label: M_PCIE2
CN Type: PCIe Mini card slot

WAFER-ULT-i1 3.5" SBC

CN Location: See **Figure 3-17**

CN Pinouts: See **Table 3-17**

The PCIe Mini card slot enables a full-size/half-size PCIe Mini card expansion module to be connected to the board.

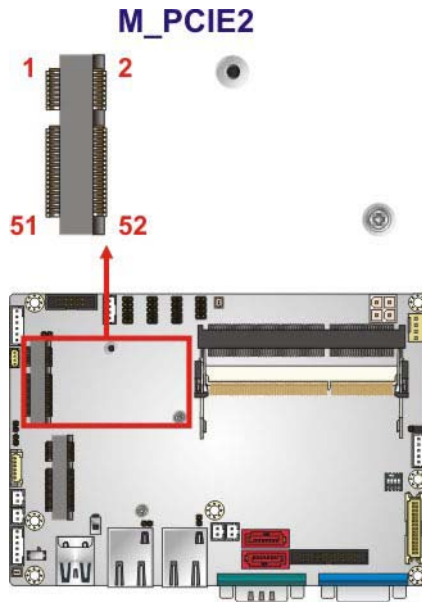

Figure 3-17: PCIe Mini Card Slot Location

Pin	Description	Pin	Description
1	PCIE_WAKE#	2	VCC3
3	N/C	4	GND
5	N/C	6	1.5V
7	N/C	8	N/C
9	GND	10	N/C
11	PCIE_CLK#	12	N/C
13	PCIE_CLK	14	N/C
15	GND	16	N/C
17	N/C	18	GND
19	N/C	20	N/C
21	GND	22	PCIRST#
23	PCIE_RXN	24	VCC3

Pin	Description	Pin	Description
25	PCIE_RXP	26	GND
27	GND	28	1.5V
29	GND	30	SMBCLK
31	PCIE_TXN	32	SMBDATA
33	PCIE_TXP	34	GND
35	GND	36	USBD-
37	GND	38	USBD+
39	VCC3	40	GND
41	VCC3	42	N/C
43	GND	44	N/C
45	N/C	46	N/C
47	N/C	48	1.5V
49	N/C	50	GND
51	M-SATA Detect	52	VCC3

Table 3-17: PCIe Mini Card Slot Pinouts

3.2.17 Power and HDD LED Connector

- CN Label:** CN2
- CN Type:** 6-pin wafer
- CN Location:** See **Figure 3-18**
- CN Pinouts:** See **Table 3-18**

The LED connector connects to an HDD indicator LED and a power LED on the system chassis to inform the user about HDD activity and the power on/off status of the system.

WAFER-ULT-i1 3.5" SBC

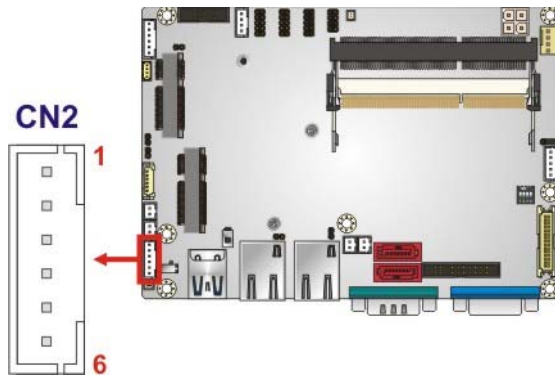

Figure 3-18: Power and HDD LED Connector Location

Function	Pin	Description
+5V	1	VCC
	2	GND
Power LED	3	PWRLED
	4	GND
HDD LED	5	VCC
	6	-HDLED

Table 3-18: Power and HDD LED Connector Pinouts

3.2.18 Power Button Connector

- CN Label:** PWR_BTN1
- CN Type:** 2-pin wafer
- CN Location:** See **Figure 3-19**
- CN Pinouts:** See **Table 3-19**

The power button connector is connected to a power switch on the system chassis to enable users to turn the system on and off.

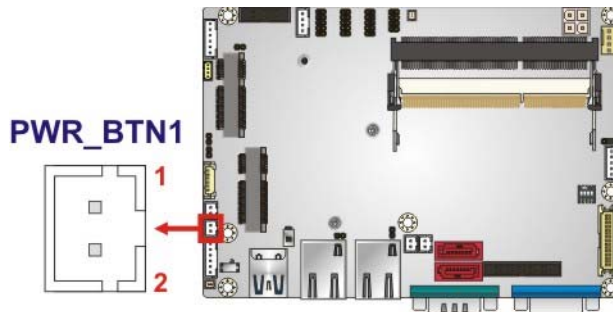

Figure 3-19: Power Button Connector Location

Pin	Description
1	PWRBTSW#
2	GND

Table 3-19: Power Button Connector Pinouts

3.2.19 Reset Button Connector

- CN Label:** RST_BTN1
- CN Type:** 2-pin wafer
- CN Location:** See **Figure 3-20**
- CN Pinouts:** See **Table 3-20**

The reset button connector is connected to a reset switch on the system chassis to enable users to reboot the system when the system is turned on.

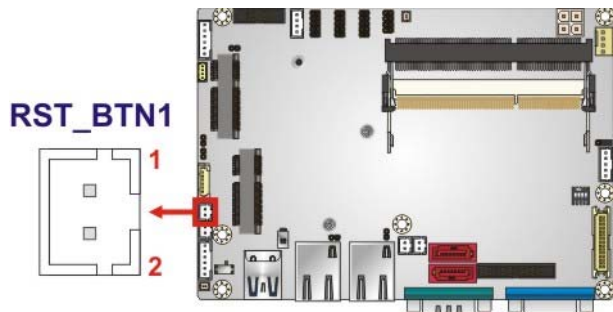

Figure 3-20: Reset Button Connector Location

WAFER-ULT-i1 3.5" SBC

Pin	Description
1	SYSRST
2	GND

Table 3-20: Reset Button Connector Pinouts

3.2.20 SATA 6Gb/s Connectors

- CN Label:** SATA1, SATA2
- CN Type:** 7-pin SATA drive connector
- CN Location:** See Figure 3-21
- CN Pinouts:** See Table 3-21

The SATA drive connectors can be connected to SATA drives and support up to 6Gb/s data transfer rate.

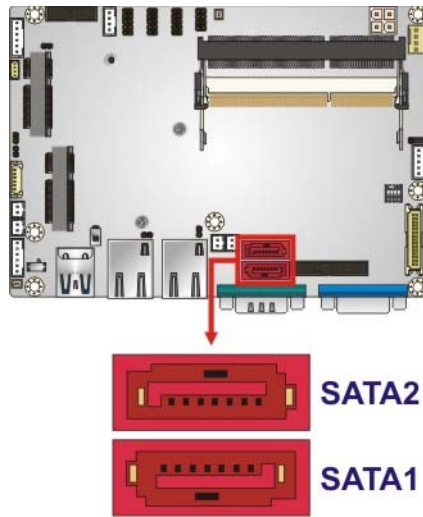

Figure 3-21: SATA 6Gb/s Connector Locations

Pin	Description
1	GND
2	TX+
3	TX-
4	GND
5	RX-

Pin	Description
6	RX+
7	GND

Table 3-21: SATA 6Gb/s Drive Connector Pinouts

3.2.21 Serial Port Connector, RS-232

- CN Label:** COM2, COM3
- CN Type:** 10-pin header
- CN Location:** See **Figure 3-22**
- CN Pinouts:** See **Table 3-22**

The 10-pin serial port connector provides one RS-232 serial communications channel. The COM serial port connector can be connected to an external RS-232 serial port device.

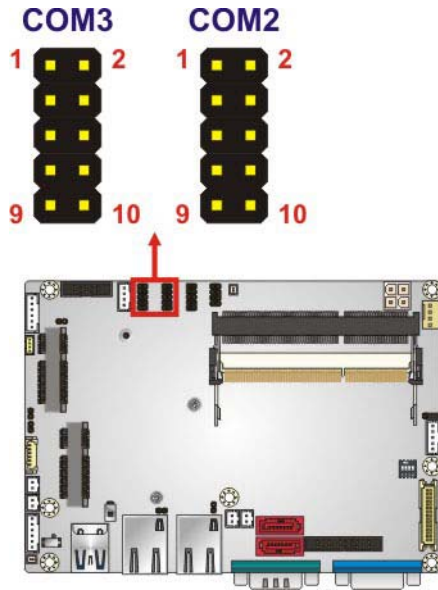

Figure 3-22: RS-232 Serial Port Connector Locations

Pin	Description	Pin	Description
1	DATA CARRIER DETECT (DCD)	2	DATA SET READY (DSR)
3	RECEIVE DATA (RXD)	4	REQUEST TO SEND (RTS)
5	TRANSMIT DATA (TXD)	6	CLEAR TO SEND (CTS)

WAFER-ULT-i1 3.5" SBC

Pin	Description	Pin	Description
7	DATA TERMINAL READY (DTR)	8	RING INDICATOR (RI)
9	GND	10	GND

Table 3-22: RS-232 Serial Port Connector Pinouts

3.2.22 Serial Port Connector, RS-422/485

- CN Label:** COM4
- CN Type:** 4-pin wafer
- CN Location:** See **Figure 3-23**
- CN Pinouts:** See **Table 3-23**

This connector provides RS-422 or RS-485 communications.

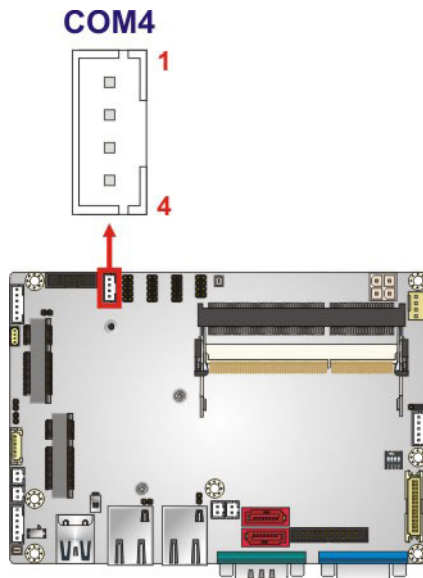

Figure 3-23: RS-422/485 Serial Port Connector Location

Pin	Description
1	RXD422-
2	RXD422+
3	TXD422+/TXD485+
4	TXD422-/TXD485-

Table 3-23: RS-422/485 Serial Port Connector Pinouts

Use the optional RS-422/485 cable to connect to a serial device. The pinouts of the DB-9 connector are listed below.

RS-422 Pinouts	RS-485 Pinouts

Table 3-24: DB-9 RS-422/485 Pinouts

3.2.23 SMBus Connector

- CN Label:** CN3
- CN Type:** 4-pin wafer
- CN Location:** See **Figure 3-24**
- CN Pinouts:** See **Table 3-25**

The SMBus (System Management Bus) connector provides low-speed system management communications.

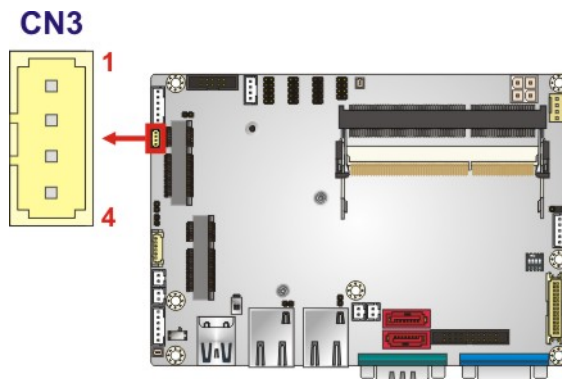

Figure 3-24: SMBus Connector Location

Pin	Description
1	GND
2	SMB_DATA

WAFER-ULT-i1 3.5" SBC

Pin	Description
3	SMB_CLK
4	+5V

Table 3-25: SMBus Connector Pinouts

3.2.24 SO-DIMM Connectors

- CN Label:** DIMM1, DIMM2
- CN Type:** 204-pin DDR3L SO-DIMM connector
- CN Location:** See **Figure 3-25**

The SO-DIMM connectors are for installing the SO-DIMMs on the system.

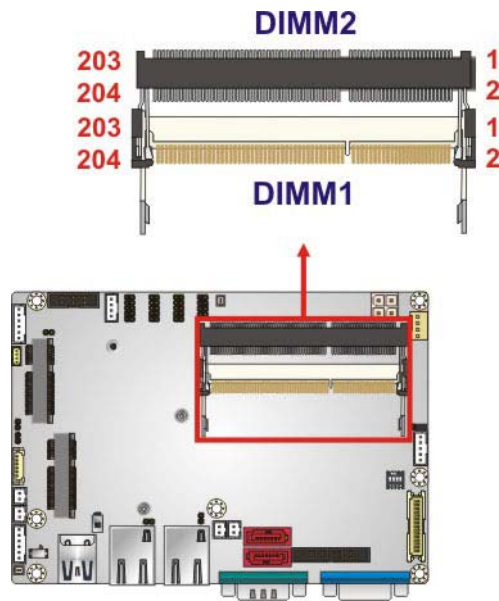

Figure 3-25: SO-DIMM Connector Locations

3.2.25 SPI Flash Connector

- CN Label:** SPI1
- CN Type:** 6-pin wafer
- CN Location:** See **Figure 3-26**
- CN Pinouts:** See **Table 3-26**

The SPI flash connector is used to flash the SPI ROM.

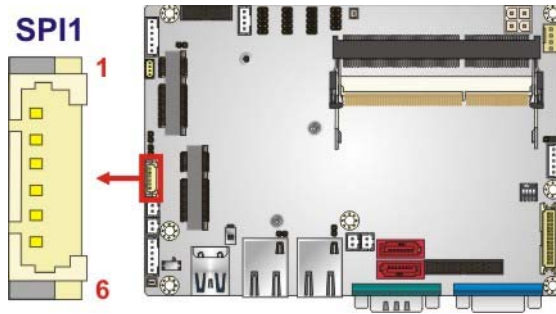

Figure 3-26: SPI Flash Connector Location

Pin	Description
1	SPI_VCC
2	SPI_2N_CS#
3	SPI_2N_MISO
4	SPI_2N_CLK
5	SPI_2N_MOSI
6	GND

Table 3-26: SPI Flash Connector Pinouts

3.2.26 System Fan Connector

- CN Label:** FAN1
- CN Type:** 4-pin wafer
- CN Location:** See **Figure 3-27**
- CN Pinouts:** See **Table 3-27**

The fan connector attaches to a system cooling fan.

WAFER-ULT-i1 3.5" SBC

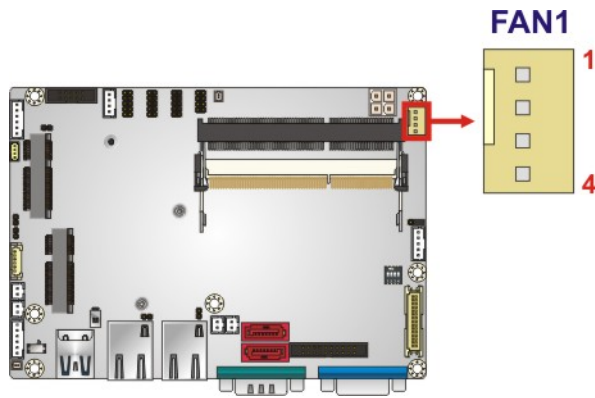

Figure 3-27: System Fan Connector Location

Pin	Description
1	GND
2	+12V
3	FANIO
4	PWM

Table 3-27: System Fan Connector Pinouts

3.2.27 USB 2.0 Connector

- CN Label:** USB1
- CN Type:** 8-pin header
- CN Location:** See **Figure 3-28**
- CN Pinouts:** See **Table 3-28**

The USB header can connect to two USB 2.0/1.1 devices.

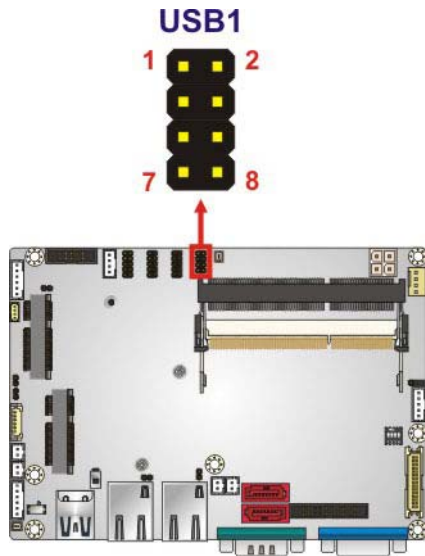

Figure 3-28: USB 2.0 Connector Location

Pin	Description	Pin	Description
1	USB_VCC	2	GND
3	DATA-	4	DATA+
5	DATA+	6	DATA-
7	GND	8	USB_VCC

Table 3-28: USB 2.0 Connector Pinouts

3.3 External Interface Connectors

The figure below shows the external peripheral interface connector (EPIC) panel. The EPIC panel consists of the following:

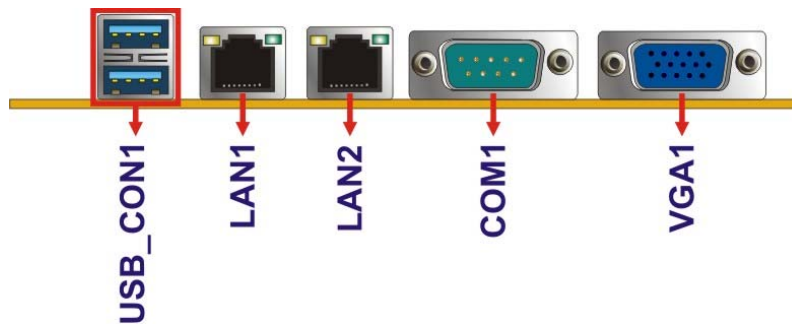

Figure 3-29: External Interface Connectors

WAFER-ULT-i1 3.5" SBC

3.3.1 Ethernet Connectors

- CN Label:** LAN1, LAN2
- CN Type:** RJ-45
- CN Location:** See **Figure 3-29**
- CN Pinouts:** See **Table 3-29**

Each LAN connector connects to a local network.

Pin	Description	Pin	Description
1	LAN_MDIO+	7	LAN_MDI2+
2	LAN_MDIO-	8	LAN_MDI2-
3	LAN_MDI1+	9	LAN_MDI3+
4	LAN_MDI1-	10	LAN_MDI3-

Table 3-29: LAN Pinouts

3.3.2 USB 3.0 Ports

- CN Label:** USB_CON1
- CN Type:** Dual USB 3.0 port
- CN Location:** See **Figure 3-29**
- CN Pinouts:** See **Table 3-30**

The WAFER-ULT-i1 has two external USB 3.0 ports.

Pin	Description	Pin	Description
1	VCC	10	VCC
2	D-	11	D-
3	D+	12	D+
4	GND	13	GND
5	RX-	14	RX-
6	RX+	15	RX+
7	GND	16	GND

Pin	Description	Pin	Description
8	TX-	17	TX-
9	TX+	18	TX+

Table 3-30: USB 3.0 Port Pinouts

3.3.3 Serial Port Connector (COM1)

- CN Label:** COM1
- CN Type:** DB-9
- CN Location:** See **Figure 3-29**
- CN Pinouts:** See **Table 3-31**

The serial port connects to an RS-232 serial communications device.

Pin	Description	Pin	Description
1	DATA CARRIER DETECT (DCD)	6	DATA SET READY (DSR)
2	RECEIVE DATA (RXD)	7	REQUEST TO SEND (RTS)
3	TRANSMIT DATA (TXD)	8	CLEAR TO SEND (CTS)
4	DATA TERMINAL READY (DTR)	9	RING INDICATOR (RI)
5	GND		

Table 3-31: Serial Port Pinouts

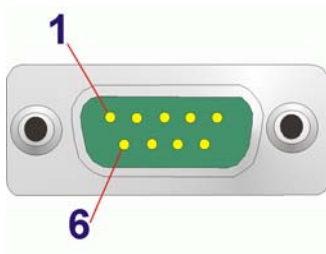

Figure 3-30: Serial Port

WAFER-ULT-i1 3.5" SBC

3.3.4 VGA Connector

- CN Label:** VGA1
- CN Type:** 15-pin female
- CN Location:** See **Figure 3-29**
- CN Pinouts:** See **Figure 3-31** and **Table 3-32**

The VGA connector connects to a monitor that accepts a standard VGA input.

Pin	Description	Pin	Description
1	RED	2	GREEN
3	BLUE	4	NC
5	GND	6	GND
7	GND	8	GND
9	VCC	10	GND
11	NC	12	DDCDAT
13	HSYNC	14	VSYNC
15	DDCCLK		

Table 3-32: VGA Connector Pinouts

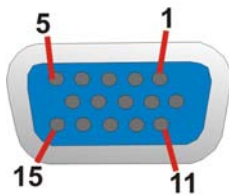

Figure 3-31: VGA Connector

Chapter

4

Installation

WAFER-ULT-i1 3.5" SBC

4.1 Anti-static Precautions



WARNING:

Failure to take ESD precautions during installation may result in permanent damage to the product and severe injury to the user.

Electrostatic discharge (ESD) can cause serious damage to electronic components, including the WAFER-ULT-i1. Dry climates are especially susceptible to ESD. It is therefore critical to strictly adhere to the following anti-static precautions whenever the WAFER-ULT-i1, or any other electrical component, is handled.

- **Wear an anti-static wristband:** - Wearing a simple anti-static wristband can help to prevent ESD from damaging the board.
- **Self-grounding:** - Before handling the board touch any grounded conducting material. During the time the board is handled, frequently touch any conducting materials that are connected to the ground.
- **Use an anti-static pad:** When configuring the WAFER-ULT-i1, place it on an anti-static pad. This reduces the possibility of ESD damaging the WAFER-ULT-i1.
- **Only handle the edges of the PCB:-** When handling the PCB, hold it by the edges.

4.2 Installation Considerations



NOTE:

The following installation notices and installation considerations should be read and understood before the WAFER-ULT-i1 is installed. All installation notices pertaining to the installation of WAFER-ULT-i1 should be strictly adhered to. Failing to adhere to these precautions may lead to severe damage of the WAFER-ULT-i1 and injury to the person installing the motherboard.

**WARNING:**

The installation instructions described in this manual should be carefully followed in order to prevent damage to the WAFER-ULT-i1, WAFER-ULT-i1 components and injury to the user.

Before and during the installation please **DO** the following:

- **Read the user manual:**
 - The user manual provides a complete description of the installation instructions and configuration options.
- **Wear an electrostatic discharge cuff (ESD):**
 - Electronic components are easily damaged by ESD. Wearing an ESD cuff removes ESD from the body and helps prevent ESD damage.
- **Place on an antistatic pad:**
 - When installing or configuring the motherboard, place it on an antistatic pad. This helps to prevent potential ESD damage.
- **Turn all power off:**
 - Make sure the product is disconnected from all power supplies and that no electricity is being fed into the system.

Before and during the installation of the WAFER-ULT-i1, **DO NOT:**

- Remove any of the stickers on the PCB board. These stickers are required for warranty validation.
- Use the product before verifying all the cables and power connectors are properly connected.
- Allow screws to come in contact with the PCB circuit, connector pins, or its components.

WAFER-ULT-i1 3.5" SBC

4.3 SO-DIMM Installation

To install a SO-DIMM, please follow the steps below and refer to **Figure 4-1**.

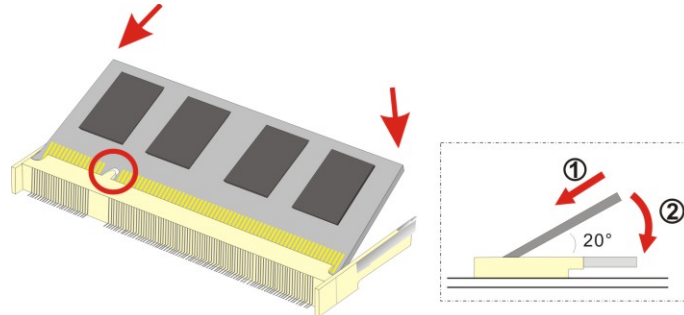

Figure 4-1: SO-DIMM Installation

- Step 1:** Locate the **SO-DIMM socket**. Place the board on an anti-static mat.
- Step 2:** Align the **SO-DIMM with the socket**. Align the notch on the memory with the notch on the memory socket.
- Step 3:** Insert the **SO-DIMM**. Push the memory in at a 20° angle. (See **Figure 4-1**)
- Step 4:** Seat the **SO-DIMM**. Gently push downwards and the arms clip into place. (See **Figure 4-1**).

4.4 iRIS-1010 Module Installation



WARNING:

The iRIS module slot is designed to install the iRIS-1010 module only. DO NOT install other modules into the iRIS module slot. Doing so may cause damage to the WAFER-ULT-i1.

To install the iRIS-1010 module, please follow the steps below.

- Step 1:** Locate the **iRIS module slot**. See **Figure 3-12**.
- Step 2:** Remove the **retention screw**. Remove the retention screw as shown in **Figure 4-2**.

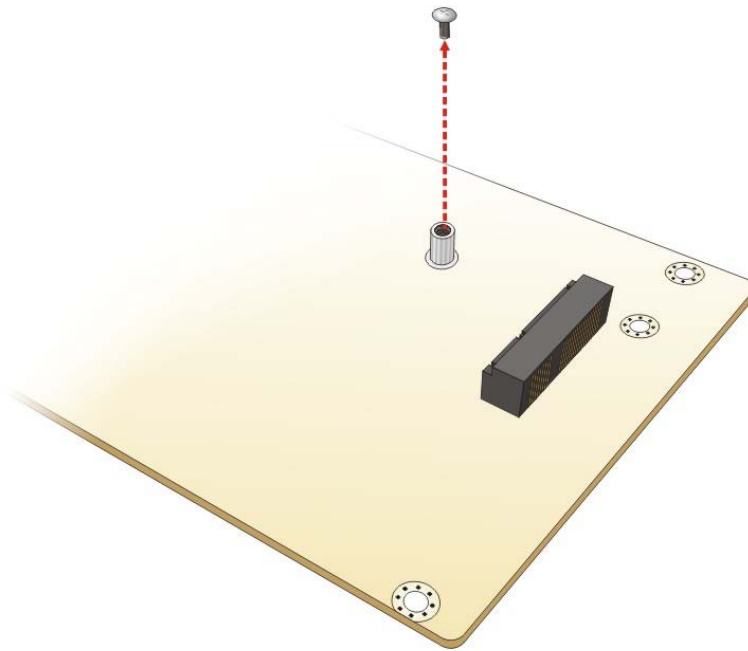

Figure 4-2: Removing the Retention Screw for the iRIS-1010 Module

Step 3: Insert into the slot at an angle. Line up the notch on the module with the notch on the slot. Slide the iRIS-1010 module into the slot at an angle of about 20° (Figure 4-3).

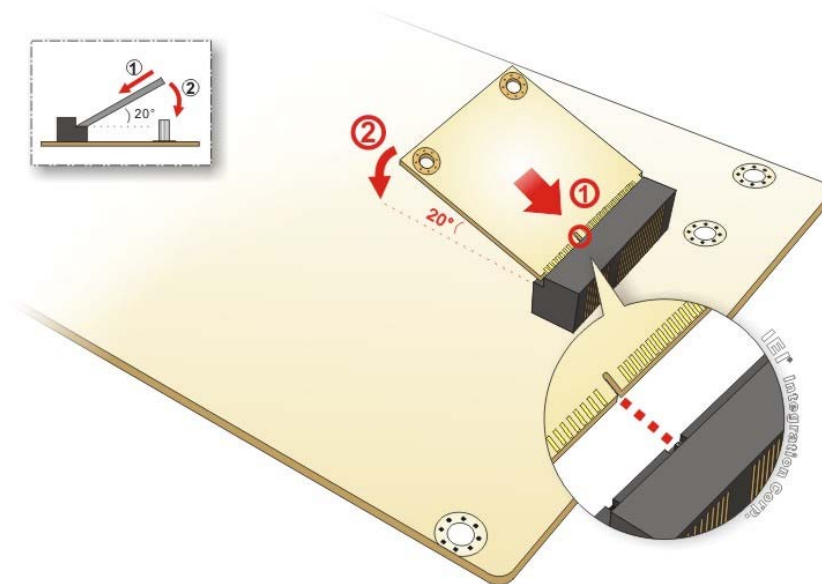

Figure 4-3: Inserting the iRIS-1010 Module into the Slot at an Angle

WAFER-ULT-i1 3.5" SBC

Step 4: **Secure the iRIS-1010 module.** Secure the iRIS-1010 module with the retention screw previously removed (**Figure 4-4**).

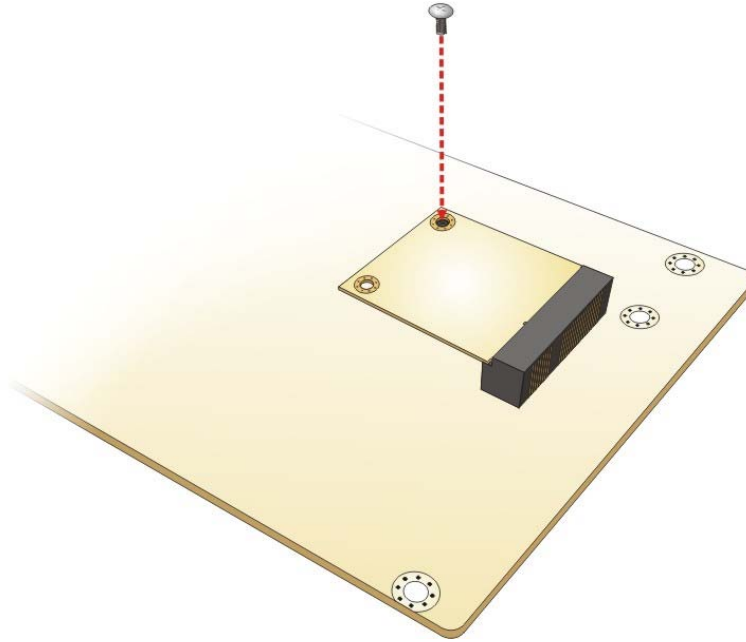

Figure 4-4: Securing the iRIS-1010 Module



NOTE:

After installing the iRIS-1010 module, use **LAN2** port to establish a network connection. Please refer to **Section 4.11** for IPMI setup procedures.

4.5 Full-size PCIe Mini Card Installation

The PCIe Mini card slot allows installation of either a full-size or half-size PCIe Mini card. To install a full-size PCIe Mini card, please follow the steps below.

Step 1: **Locate the PCIe Mini card slot.** See **Figure 3-17**.

Step 2: **Remove the retention screw.** Remove the retention screw as shown in **Figure 4-5**.

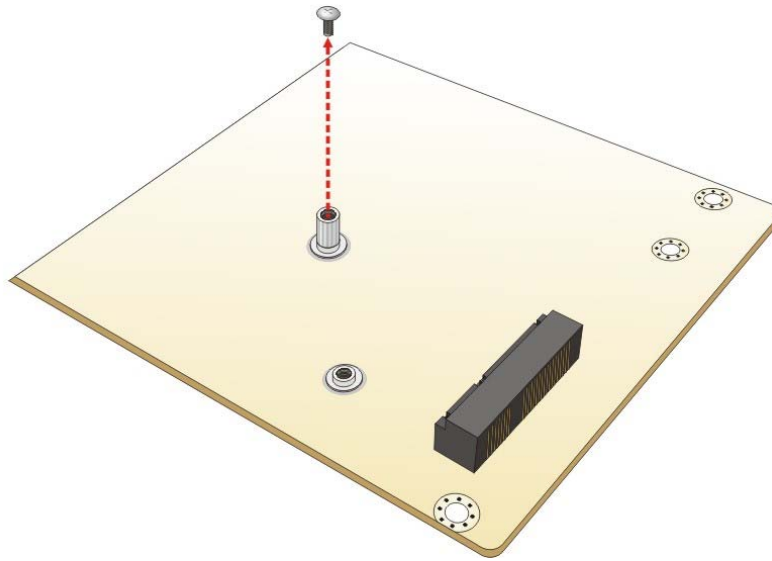

Figure 4-5: Removing the Retention Screw

Step 3: Insert into the socket at an angle. Line up the notch on the card with the notch on the slot. Slide the PCIe Mini card into the socket at an angle of about 20° (Figure 4-6).

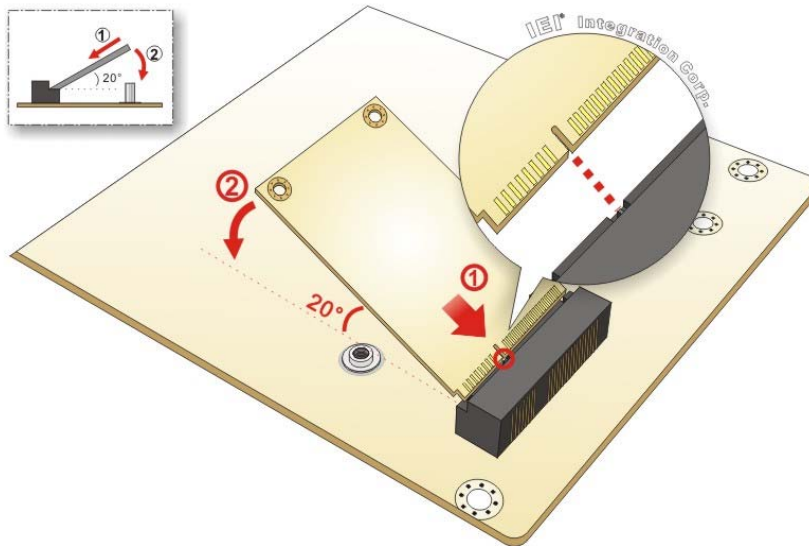

Figure 4-6: Inserting the Full-size PCIe Mini Card into the Slot at an Angle

Step 4: Secure the full-size PCIe Mini card. Secure the full-size PCIe Mini card with the retention screw previously removed (Figure 4-7).

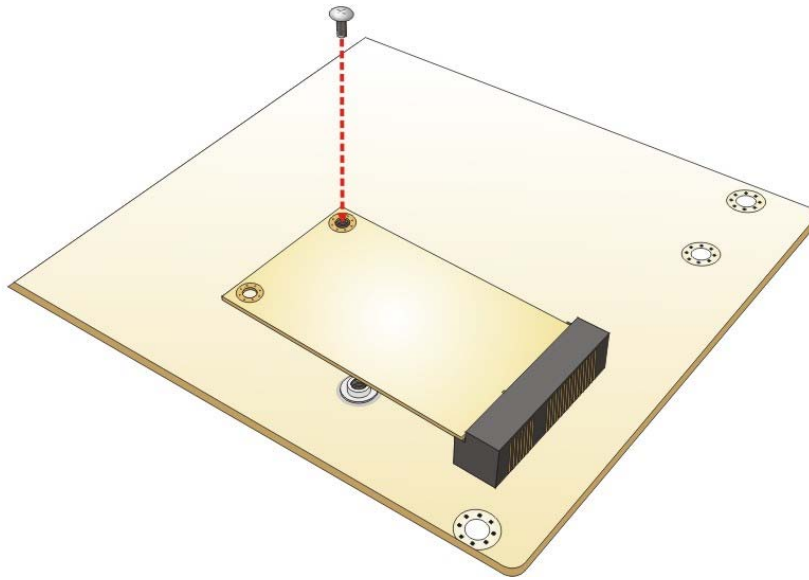

Figure 4-7: Securing the Full-size PCIe Mini Card

4.6 Half-size PCIe Mini Card Installation

The PCIe Mini card slot allows installation of either a full-size or half-size PCIe Mini card. To install a half-size PCIe Mini card, please follow the steps below.

- Step 1:** Locate the PCIe Mini card slot. See Figure 3-17.
- Step 2:** Remove the retention screw. Remove the retention screw as shown in Figure 4-5.
- Step 3:** Remove the standoff. Unscrew and remove the standoff secured on the motherboard as shown in Figure 4-8.

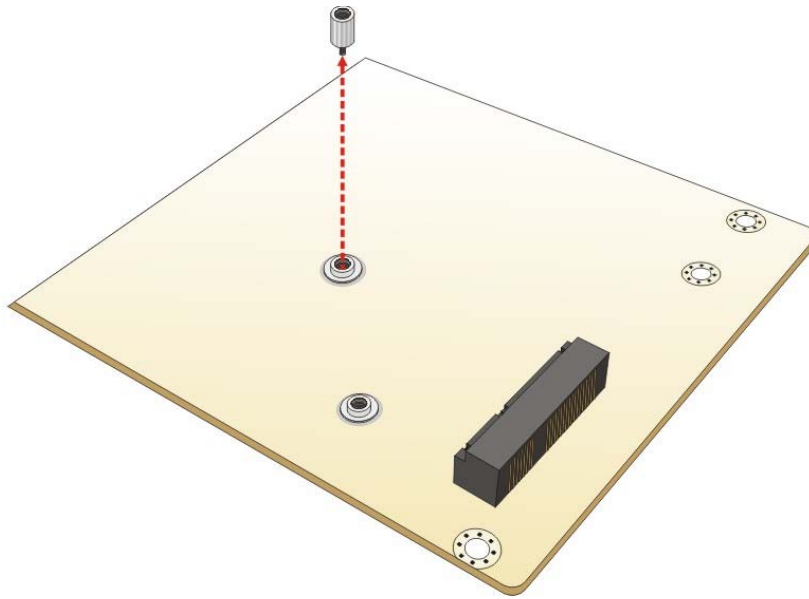

Figure 4-8: Removing the Standoff

Step 4: Install the standoff to the screw hole for the half-size PCIe Mini card. Install the previously removed standoff to the screw hole for the half-size PCIe Mini card (Figure 4-9).

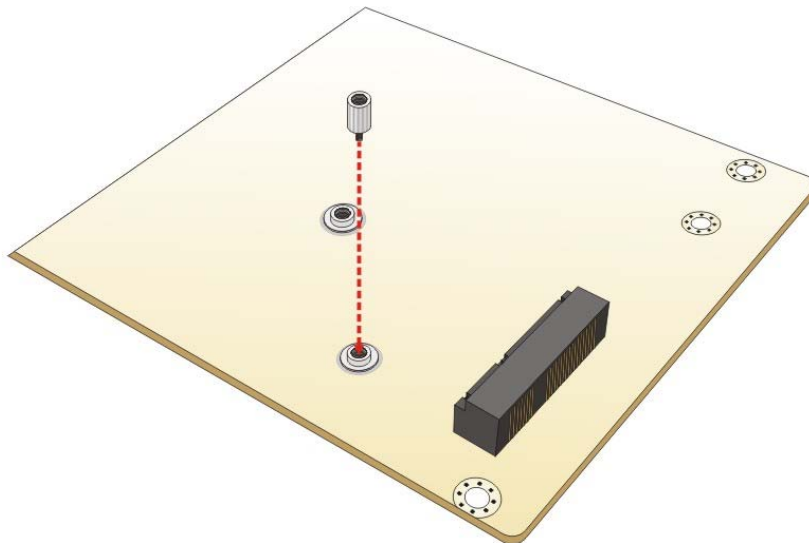

Figure 4-9: Installing the Standoff

WAFER-ULT-i1 3.5" SBC

Step 5: Insert into the socket at an angle. Line up the notch on the card with the notch on the slot. Slide the PCIe Mini card into the slot at an angle of about 20° (Figure 4-10).

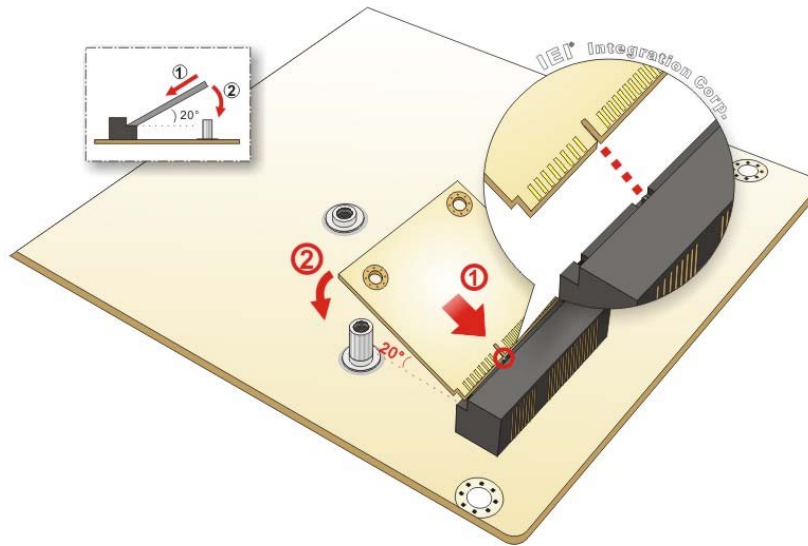

Figure 4-10: Inserting the Half-size PCIe Mini Card into the Slot at an Angle

Step 6: Secure the half-size PCIe Mini card. Secure the half-size PCIe Mini card with the retention screw previously removed (Figure 4-11).

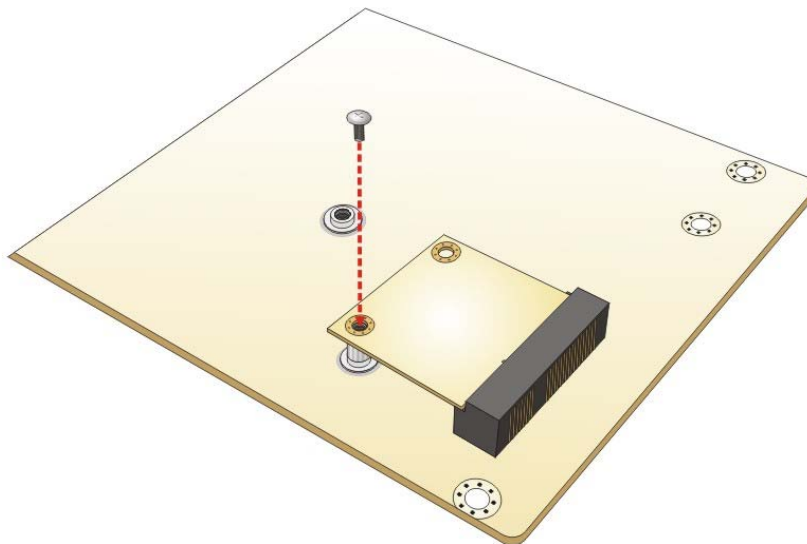

Figure 4-11: Securing the Half-size PCIe Mini Card

4.7 System Configuration

The system configuration is controlled by buttons, jumpers and switches. The system configuration should be performed before installation.

4.7.1 AT/ATX Power Mode Selection

The AT and ATX power mode selection is made through the AT/ATX power mode switch which is shown in **Figure 4-12**.

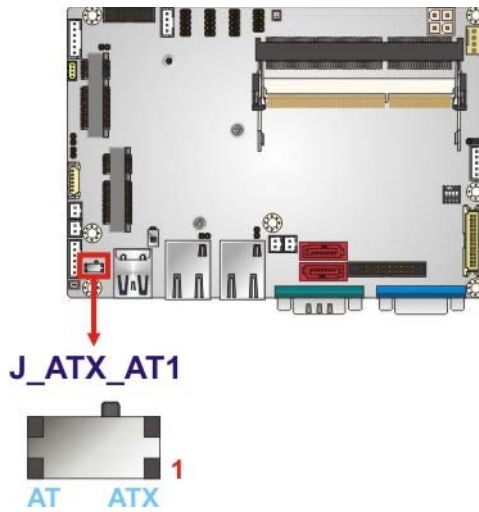

Figure 4-12: AT/ATX Power Mode Switch Location

Setting	Description
1-2	ATX power mode (default)
2-3	AT power mode

Table 4-1: AT/ATX Power Mode Switch Settings

WAFER-ULT-i1 3.5" SBC

4.7.2 Clear CMOS Button

To reset the BIOS, remove the on-board battery and press the clear CMOS button for three seconds or more. The clear CMOS button location is shown in **Figure 4-13**.

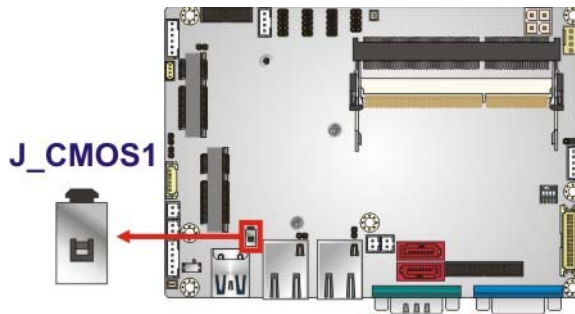

Figure 4-13: Clear CMOS Button Location

4.7.3 LVDS Panel Type Selection

- Jumper Label:** SW1
- Jumper Type:** DIP switch
- Jumper Settings:** See Table 4-2
- Jumper Location:** See Figure 4-14

Selects the resolution of the LCD panel connected to the LVDS connector.

* ON=0, OFF=1

SW1 (4-3-2-1)	EDID Resolution	Color Depth	Channel
0000 (default)	800 x 600 @ 60 Hz	18-bit	Single
0001	1024 x 768 @ 60 Hz	18-bit	Single
0010	1024 x 768 @ 60 Hz	24-bit	Single
0011	1280 x 768 @ 60 Hz	18-bit	Single
0100	1280 x 800 @ 60 Hz	18-bit	Single
0101	1280 x 960 @ 60 Hz	18-bit	Single
0110	1280 x 1024 @ 60 Hz	24-bit	Dual
0111	1366 x 768 @ 60 Hz	18-bit	Single
1000	1366 x 768 @ 60 Hz	24-bit	Single

SW1 (4-3-2-1)	EDID Resolution	Color Depth	Channel
1001	1440 x 900 @ 60 Hz	24-bit	Dual
1010	1440 x 1050 @ 60 Hz	24-bit	Dual
1011	1600 x 900 @ 60 Hz	24-bit	Dual
1100	1680 x 1050 @ 60 Hz	24-bit	Dual
1101	1600 x 1200 @ 60 Hz	24-bit	Dual
1110	1920 x 1080 @ 60 Hz	24-bit	Dual
1111	1920 x 1200 @ 60 Hz	24-bit	Dual

Table 4-2: LVDS Panel Type Selection

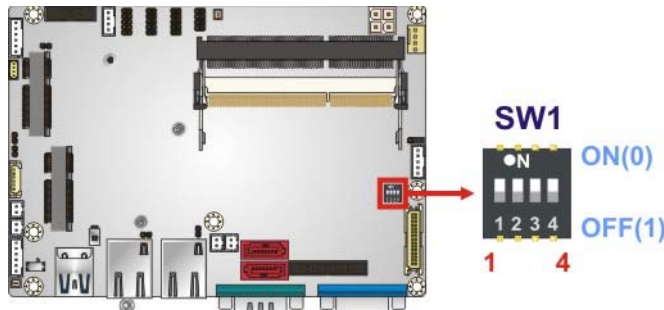

Figure 4-14: LVDS Panel Type Selection Switch Location

4.7.4 LVDS Voltage Selection



WARNING:

Permanent damage to the screen and WAFER-ULT-i1 may occur if the wrong voltage is selected with this jumper. Please refer to the user guide that came with the monitor to select the correct voltage.

- Jumper Label:** JP1
- Jumper Type:** 3-pin header
- Jumper Settings:** See Table 4-3
- Jumper Location:** See Figure 4-15

WAFER-ULT-i1 3.5" SBC

The LVDS voltage selection jumper allows setting the voltage provided to the monitor connected to the LVDS connector.

Setting	Description
Short 1-2	+3.3V LVDS (Default)
Short 2-3	+5V LVDS

Table 4-3: LVDS Voltage Selection Jumper Settings

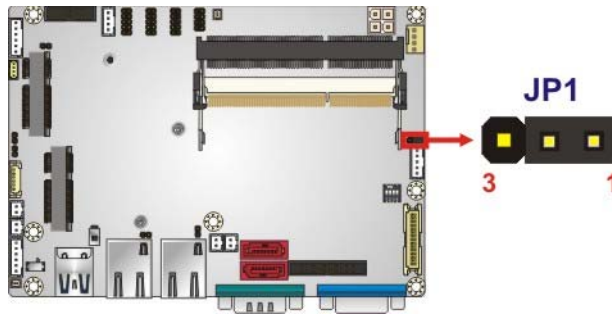

Figure 4-15: LVDS Voltage Selection Jumper Location

4.8 Chassis Installation

4.8.1 Airflow



WARNING:

Airflow is critical for keeping components within recommended operating temperatures. The chassis should have fans and vents as necessary to keep things cool.

The WAFER-ULT-i1 must be installed in a chassis with ventilation holes on the sides allowing airflow to travel through the heat sink surface. In a system with an individual power supply unit, the cooling fan of a power supply can also help generate airflow through the board surface.

4.8.2 Motherboard Installation

To install the WAFER-ULT-i1 motherboard into the chassis, please refer to the reference material that came with the chassis.

4.9 Internal Peripheral Device Connections

This section outlines the installation of peripheral devices to the on-board connectors.

4.9.1 AT/ATX Power Connection

Follow the instructions below to connect the WAFER-ULT-i1 to an AT or ATX power supply.



WARNING:

Disconnect the power supply power cord from its AC power source to prevent a sudden power surge to the WAFER-ULT-i1.

Step 1: **Locate the power cable.** The power cable is shown in the packing list in **Chapter 2.**

Step 2: **Connect the Power Cable to the Motherboard.** Connect the 4-pin (2x2) Molex type power cable connector to the power connector on the motherboard. See **Figure 4-16.**

WAFER-ULT-i1 3.5" SBC

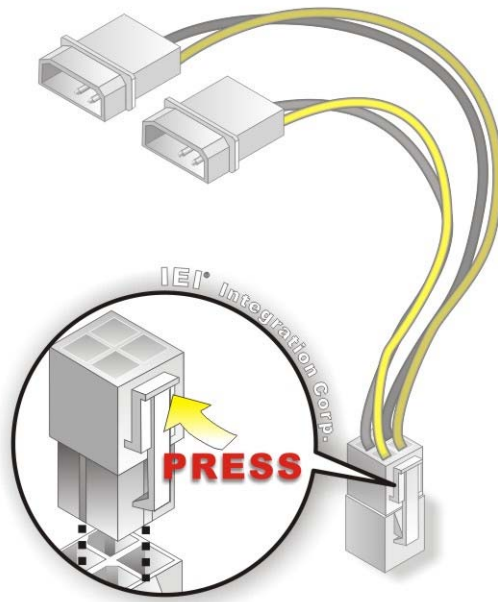

Figure 4-16: Power Cable to Motherboard Connection

Step 3: **Connect Power Cable to Power Supply.** Connect one of the 4-pin (1x4) Molex type power cable connectors to an AT/ATX power supply. See **Figure 4-17**.

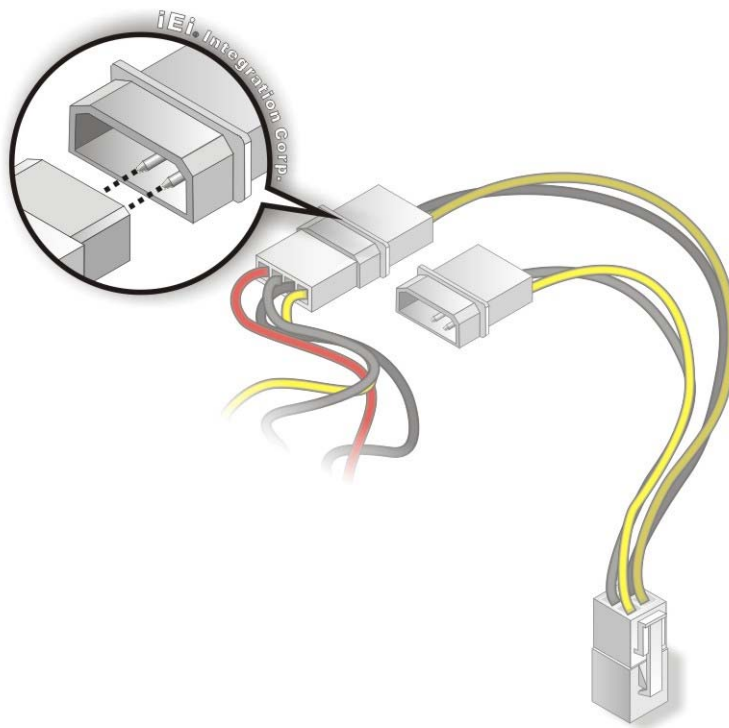

Figure 4-17: Connect Power Cable to Power Supply

4.9.2 Audio Kit Installation

The Audio Kit that came with the WAFER-ULT-i1 connects to the 10-pin audio connector on the WAFER-ULT-i1. The audio kit consists of three audio jacks. One audio jack, Mic In, connects to a microphone. The remaining two audio jacks, Line-In and Line-Out, connect to two speakers. To install the audio kit, please refer to the steps below:

- Step 1:** **Locate the audio connector.** The location of the 10-pin audio connector is shown in **Chapter 3**.
- Step 2:** **Align pin 1.** Align pin 1 on the on-board connector with pin 1 on the audio kit connector. Pin 1 on the audio kit connector is indicated with a white dot. See **Figure 4-18**.

WAFER-ULT-i1 3.5" SBC

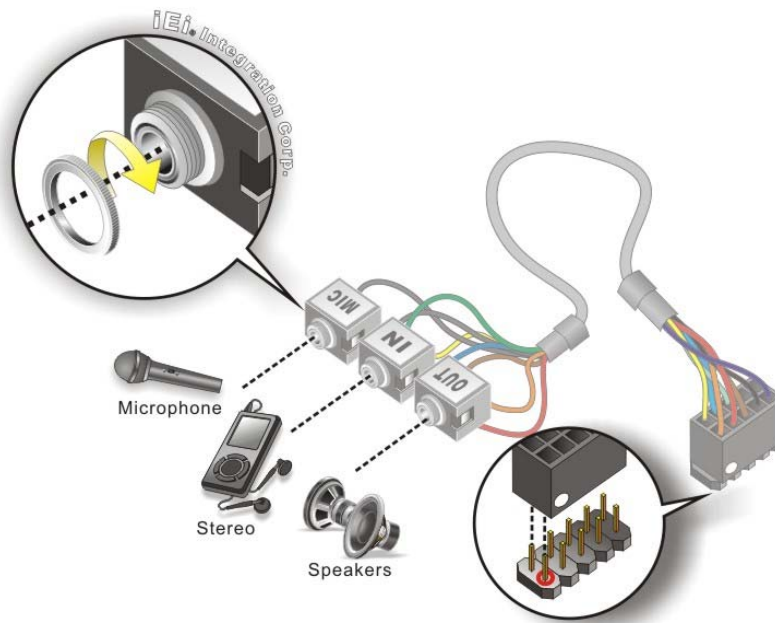

Figure 4-18: Audio Kit Cable Connection

Step 3: **Connect the audio devices.** Connect speakers to the line-out audio jack. Connect the output of an audio device to the line-in audio jack. Connect a microphone to the mic-in audio jack.

4.9.3 LVDS LCD Installation

The WAFER-ULT-i1 can be connected to a TFT LCD screen through the LVDS crimp connectors on the board. To connect a TFT LCD to the WAFER-ULT-i1, please follow the steps below.

Step 1: **Locate the connector.** The location of the LVDS connector is shown in **Chapter 3**.

Step 2: **Insert the cable connector.** Insert the connector from the LVDS PCB driving board to the LVDS connector as shown in **Figure 4-19**. When connecting the connectors, make sure the pins are properly aligned.

**WARNING:**

The diagram below is merely for illustration. The configuration and connection of the cables from the TFT LCD screen being installed may be different. Please refer to the installation manual that came with the TFT LCD screen.

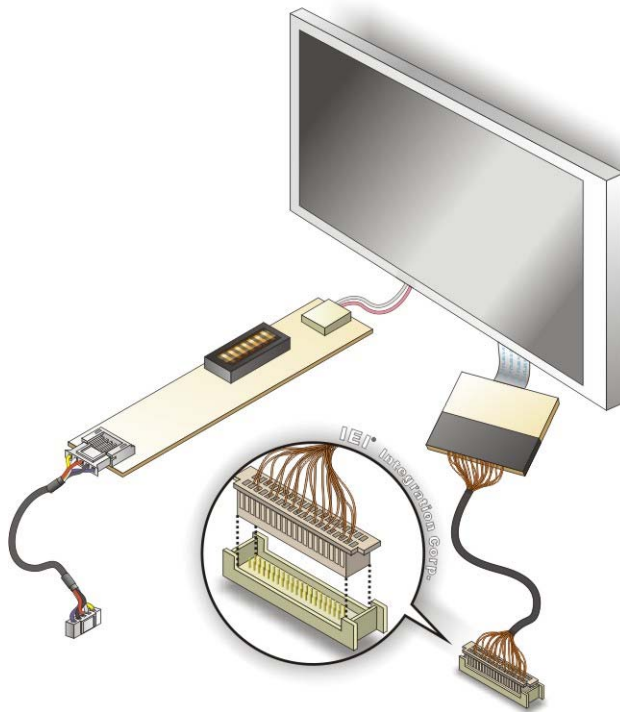

Figure 4-19: LVDS Connector

- Step 3:** **Locate the backlight inverter connector.** The location of the backlight inverter connector is shown in **Chapter 3**.
- Step 4:** **Connect backlight connector.** Connect the backlight connector to the driver TFT LCD PCB as shown in **Figure 4-20**. When inserting the cable connector, make sure the pins are properly aligned.

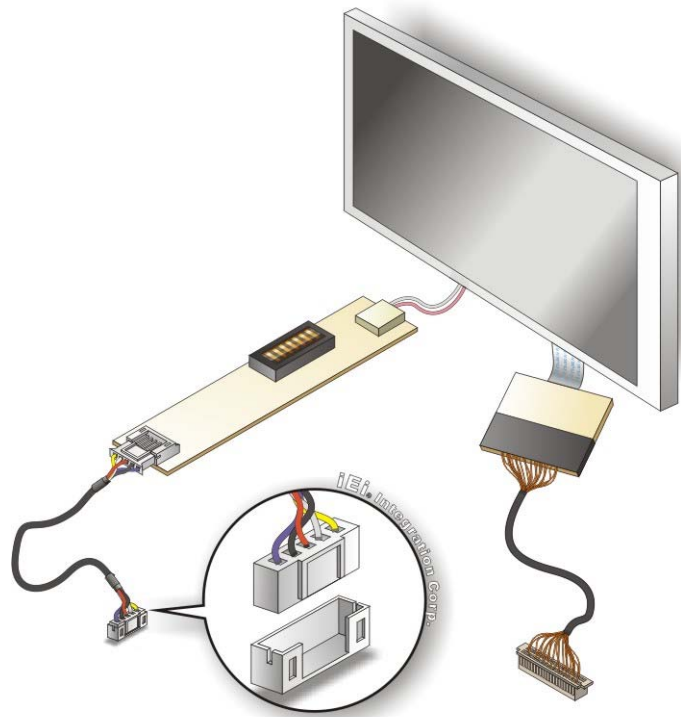

Figure 4-20: Backlight Inverter Connection

4.9.4 SATA Drive Connection

The WAFER-ULT-i1 is shipped with two SATA signal and power cables. To connect the SATA drive to the connectors, please follow the steps below.

- Step 1:** Locate the **SATA connector** and the **SATA power connector**. The locations of the connectors are shown in **Chapter 3**.
- Step 2:** **Insert the cable connectors**. Insert the cable connectors into the on-board SATA drive connector and the SATA power connector. See **Figure 4-21**.

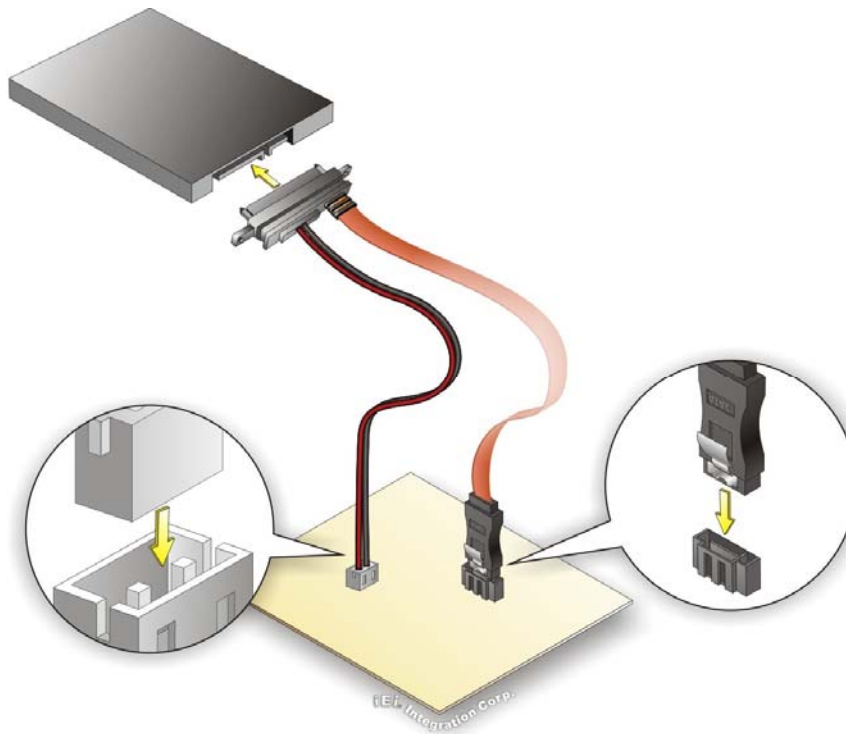

Figure 4-21: SATA Drive Cable Connection

Step 3: **Connect the cable to the SATA disk.** Connect the connector on the other end of the cable to the connector at the back of the SATA drive. See **Figure 4-21**.

Step 4: To remove the SATA cable from the SATA connector, press the clip on the connector at the end of the cable.

4.9.5 USB Cable Installation

The WAFER-ULT-i1 is shipped with a dual-port USB 2.0 cable. To connect the USB cable connector, please follow the steps below.

Step 1: **Locate the connector.** The location of the USB connector is shown in **Chapter 3**.



WARNING:

If the USB pins are not properly aligned, the USB device can burn out.

WAFER-ULT-i1 3.5" SBC

Step 2: Align the connectors. Correctly align pin 1 on the cable connector with pin 1 on the WAFER-ULT-i1 USB connector.

Step 3: Insert the cable connectors. Once the cable connector is properly aligned with the USB connector on the WAFER-ULT-i1, connect the cable connector to the on-board connector. See **Figure 4-22**.

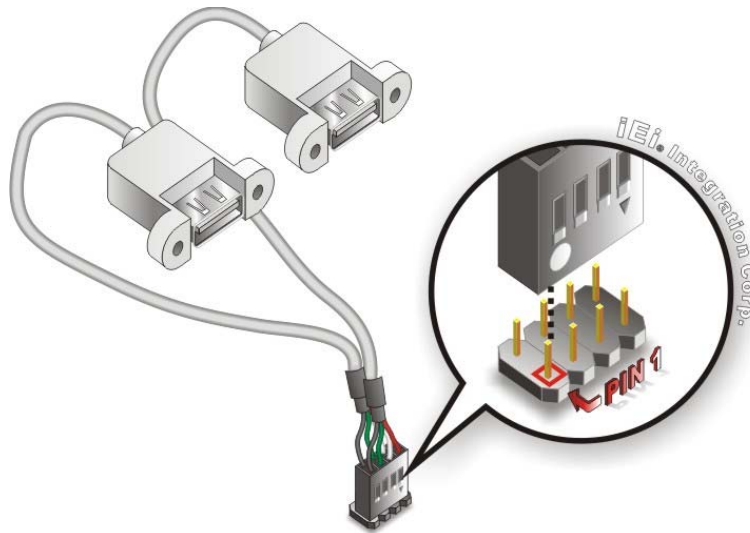

Figure 4-22: Dual-port USB Cable Connection

Step 4: Attach the USB connectors to the chassis. Each of the USB 2.0 connectors has two retention screw holes. To secure the connectors to the chassis, please refer to the installation instructions that came with the chassis.

4.10 External Peripheral Interface Connection

Devices can be connected to the external connectors. To install external devices, follow the directions in the subsections below.

4.10.1 LAN Connection

There are two external RJ-45 LAN connectors. The RJ-45 connectors enable connection to an external network. To connect a LAN cable with an RJ-45 connector, please follow the instructions below.

Step 1: Locate the RJ-45 connectors. The locations of the RJ-45 connectors are shown in **Chapter 3**.

Step 2: Align the connectors. Align the RJ-45 connector on the LAN cable with one of the RJ-45 connectors on the WAFER-ULT-i1. See **Figure 4-23**.

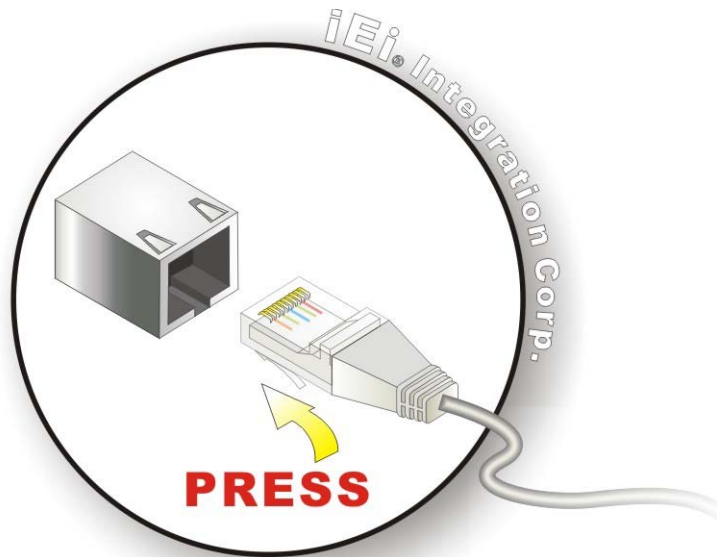

Figure 4-23: LAN Connection

Step 3: Insert the LAN cable RJ-45 connector. Once aligned, gently insert the LAN cable RJ-45 connector into the on-board RJ-45 connector.

4.10.2 Serial Device Connection

The WAFER-ULT-i1 has a single male DB-9 connector on the external peripheral interface panel for a serial device. Follow the steps below to connect a serial device to the WAFER-ULT-i1.

Step 1: Locate the DB-9 connector. The location of the DB-9 connector is shown in **Chapter 3**.

Step 2: Insert the serial connector. Insert the DB-9 connector of a serial device into the DB-9 connector on the external peripheral interface. See **Figure 4-24**.

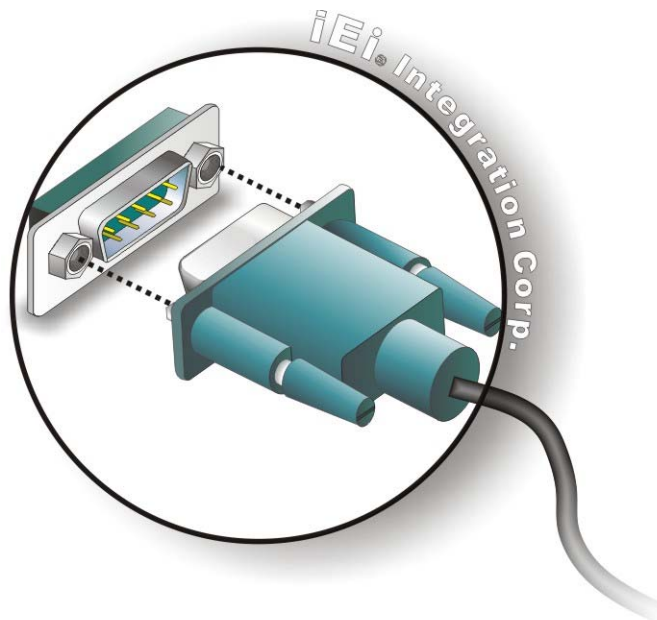

Figure 4-24: Serial Device Connector

Step 3: Secure the connector. Secure the serial device connector to the external interface by tightening the two retention screws on either side of the connector.

4.10.3 USB Connection

The external USB 3.0 connectors provide easier and quicker access to external USB devices. Follow the steps below to connect USB devices to the WAFER-ULT-i1.

Step 1: Locate the USB 3.0 connectors. The locations of the USB 3.0 connectors are shown in **Chapter 3**.

Step 2: Insert a USB plug. Insert the USB plug of a device into the USB 3.0 connector on the external peripheral interface. See **Figure 4-25**.

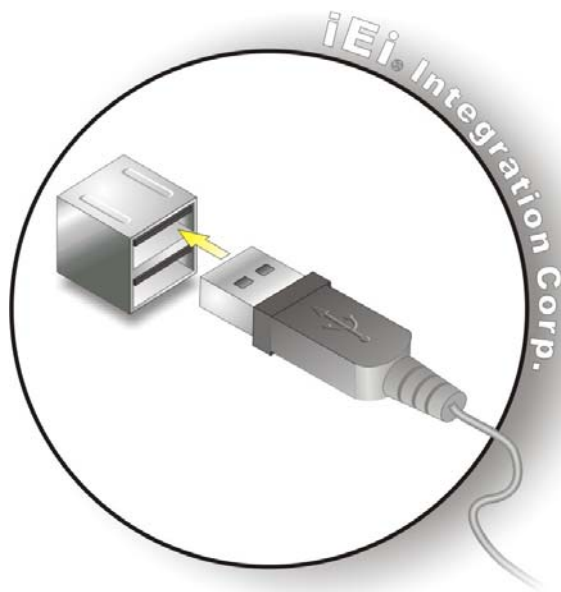

Figure 4-25: USB 3.0 Connectors

4.11 Heat Sink Enclosure



WARNING:

Never run the WAFER-ULT-i1 without the heat sink secured to the board. The heat sink ensures the system remains cool and does not need addition heat sinks to cool the system.



WARNING:

When running the WAFER-ULT-i1, do not put the WAFER-ULT-i1 directly on a surface that can not dissipate system heat, especially the wooden or plastic desk. It is highly recommended to run the WAFER-ULT-i1

→ on a heat dissipation surface or

→ using copper pillars to hold the board up from the desk below

WAFER-ULT-i1 3.5" SBC

When the WAFER-ULT-i1 is shipped, it is secured to a heat sink with five retention screws. If the WAFER-ULT-i1 must be removed from the heat sink, the five retention screws must be removed.

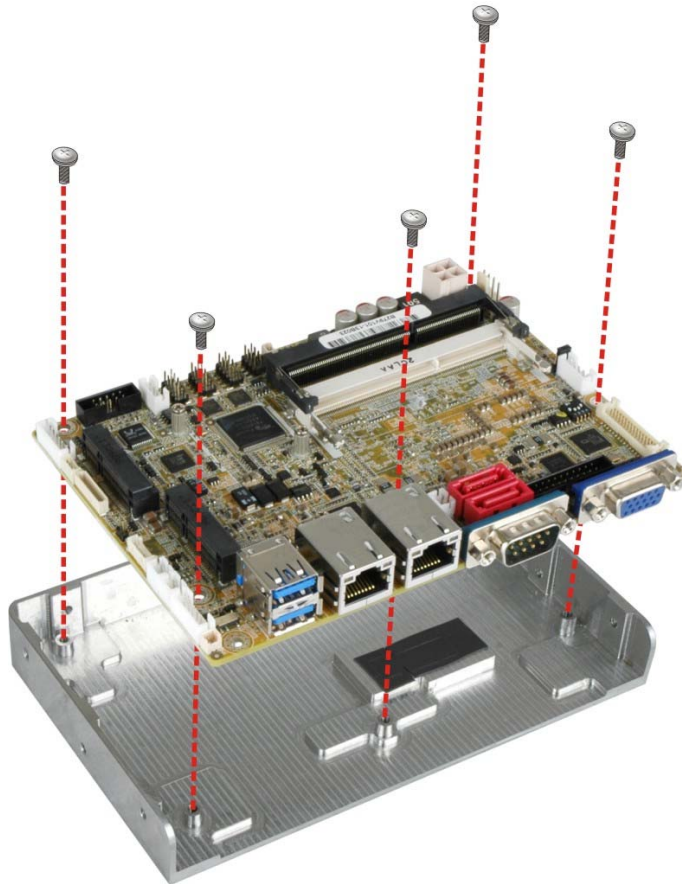

Figure 4-26: Heat Sink Retention Screws

4.12 Intel® AMT Setup Procedure

The WAFER-ULT-i1 is featured with the Intel® Active Management Technology (AMT). To enable the Intel® AMT function, follow the steps below.

- Step 1:** Make sure at least one of the memory sockets is installed with a DDR3L SO-DIMM.
- Step 2:** Connect an Ethernet cable to the RJ-45 connector labeled **LAN1**.
- Step 3:** The AMI BIOS options regarding the Intel® ME or Intel® AMT must be enabled,

- Step 4:** Properly install the Intel® Management Engine Components drivers from the iAMT Driver & Utility directory in the driver CD. See **Section 6.8**.
- Step 5:** Configure the Intel® Management Engine BIOS extension (MEBx). To get into the Intel® MEBx settings, press <Ctrl+P> after a single beep during boot-up process. Enter the Intel® current ME password as it requires (the Intel® default password is **admin**).

**NOTE:**

To change the password, enter a new password following the strong password rule (containing at least one upper case letter, one lower case letter, one digit and one special character, and be at least eight characters).

4.13 IPMI Setup Procedure

The WAFER-ULT-i1 features Intelligent Platform Management Interface (IPMI) that helps lower the overall costs of server management by enabling users to maximize IT resources, save time and manage multiple systems. The WAFER-ULT-i1 supports IPMI 2.0 through the optional iRIS-1010 module. Follow the steps below to setup IPMI.

4.13.1 Managed System Hardware Setup

The hardware configuration of the managed system (WAFER-ULT-i1) is described below.

- Step 1:** Install an iRIS-1010 module to the iRIS module slot (refer to **Section 4.4**).
- Step 2:** Make sure a DDR3L SO-DIMM is installed in the SO-DIMM socket.
- Step 3:** Connect an Ethernet cable to the RJ-45 connector labeled **LAN2** (**Figure 3-29**).

Chapter

5

BIOS

5.1 Introduction

The BIOS is programmed onto the BIOS chip. The BIOS setup program allows changes to certain system settings. This chapter outlines the options that can be changed.



NOTE:

Some of the BIOS options may vary throughout the life cycle of the product and are subject to change without prior notice.

5.1.1 Starting Setup

The UEFI BIOS is activated when the computer is turned on. The setup program can be activated in one of two ways.

1. Press the **DEL** or **F2** key as soon as the system is turned on or
2. Press the **DEL** or **F2** key when the "**Press DEL or F2 to enter SETUP**" message appears on the screen.

If the message disappears before the **DEL** or **F2** key is pressed, restart the computer and try again.

5.1.2 Using Setup

Use the arrow keys to highlight items, press **ENTER** to select, use the PageUp and PageDown keys to change entries, press **F1** for help and press **ESC** to quit. Navigation keys are shown in the following table.

Key	Function
Up arrow	Move to previous item
Down arrow	Move to next item
Left arrow	Move to the item on the left hand side
Right arrow	Move to the item on the right hand side
+	Increase the numeric value or make changes
-	Decrease the numeric value or make changes

WAFER-ULT-i1 3.5" SBC

Key	Function
Page Up key	Move to the next page
Page Dn key	Move to the previous page
Esc key	Main Menu – Quit and not save changes into CMOS Status Page Setup Menu and Option Page Setup Menu -- Exit current page and return to Main Menu
F1	General help, only for Status Page Setup Menu and Option Page Setup Menu
F2	Load previous values
F3	Load optimized defaults
F4	Save changes and Exit BIOS

Table 5-1: BIOS Navigation Keys

5.1.3 Getting Help

When **F1** is pressed a small help window describing the appropriate keys to use and the possible selections for the highlighted item appears. To exit the Help Window press **Esc** or the **F1** key again.

5.1.4 Unable to Reboot after Configuration Changes

If the computer cannot boot after changes to the system configuration are made, CMOS defaults. Use the clear CMOS button described in **Chapter 4**.

5.1.5 BIOS Menu Bar

The **menu bar** on top of the BIOS screen has the following main items:

- Main – Changes the basic system configuration.
- Advanced – Changes the advanced system settings.
- Chipset – Changes the chipset settings.
- Boot – Changes the system boot configuration.
- Security – Sets User and Supervisor Passwords.
- Save & Exit – Selects exit options and loads default settings.

The following sections completely describe the configuration options found in the menu items at the top of the BIOS screen and listed above.

WAFER-ULT-i1 3.5" SBC

5.2 Main

The **Main** BIOS menu (**BIOS Menu 1**) appears when the **BIOS Setup** program is entered.

The **Main** menu gives an overview of the basic system information.

Aptio Setup Utility - Copyright (C) 2012 American Megatrends, Inc.					
Main	Advanced	Chipset	Boot	Security	Save & Exit
BIOS Information			Set the Date. Use Tab to switch between Date elements.		
BIOS Vendor	American Megatrends				
Core Version	4.6.5.4				
Compliance	UEFI 2.3.1; PI 1.2				
Project Version	B279AR10.ROM				
Build Date and Time	02/27/2014 11:09:58				
iWDD Vendor			iEi		
iWDD Version			B279ER10.bin		
Processor Information					
Name	Haswell ULT				
Brand String	Intel(R) Core(TM) i5-4300U CPU @ 1.90GHz				
Frequency	2600 MHz				
Processor ID	40651				
Stepping	Unknown				
Number of Processors	2Core(s) / 4Thread(s)		-----		
Microcode Revision	15		→←: Select Screen		
GT Info	GT2 (400 MHz)		↑ ↓: Select Item		
IGFX VBIOS Version			Enter: Select		
Memory RC Version			+/-: Change Opt.		
Total Memory	4096 MB (DDR3)		F1: General Help		
Memory Frequency	1600 MHz		F2: Previous Values		
PCH Information			F3: Optimized Defaults		
Name	LynxPoint-LP		F4: Save & Exit		
PCH SKU	Premium SKU		ESC: Exit		
Stepping	04/B2				
LAN PHY Revision	N/A				
ME FW Version			9.5.10.1628		
ME Firmware SKU			5MB		
SPI Clock Frequency					
DOFR Support	Supported				
Read Status Clock Frequency	33 MHz				
Write Status Clock Frequency	33 MHz				
Fast Read Status Clock Frequency	33 MHz				
System Date	[Tue 03/18/2014]				
System Time	[15:10:27]				
Access Level	Administrator				
Version 2.15.1231. Copyright (C) 2012 American Megatrends, Inc.					

BIOS Menu 1: Main

The Main menu has two user configurable fields:

➔ **System Date [xx/xx/xx]**

Use the **System Date** option to set the system date. Manually enter the day, month and year.

➔ **System Time [xx:xx:xx]**

Use the **System Time** option to set the system time. Manually enter the hours, minutes and seconds.

5.3 Advanced

Use the **Advanced** menu (**BIOS Menu 2**) to configure the CPU and peripheral devices through the following sub-menus:



WARNING:

Setting the wrong values in the sections below may cause the system to malfunction. Make sure that the settings made are compatible with the hardware.

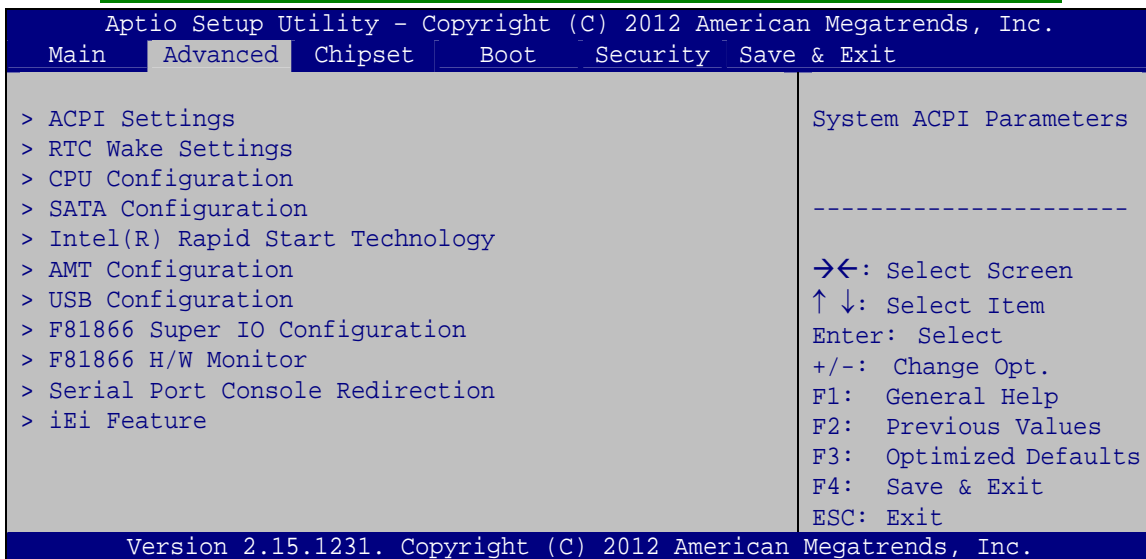

BIOS Menu 2: Advanced

WAFER-ULT-i1 3.5" SBC

5.3.1 ACPI Settings

The **ACPI Settings** menu (**BIOS Menu 3**) configures the Advanced Configuration and Power Interface (ACPI) options.

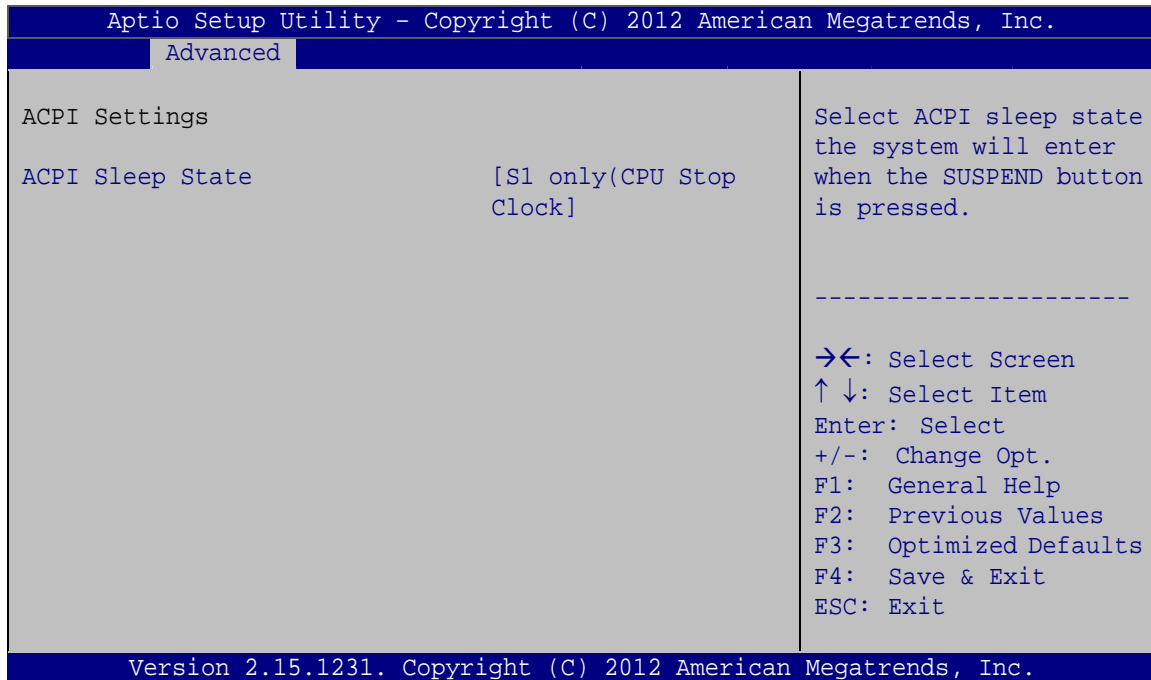

BIOS Menu 3: ACPI Settings

→ **ACPI Sleep State [S1 only (CPU Stop Clock)]**

Use the **ACPI Sleep State** option to specify the sleep state the system enters when it is not being used.

- **S1 only (CPU Stop Clock) DEFAULT** The system enters S1 (POS) sleep state. The system appears off. The CPU is stopped; RAM is refreshed; the system is running in a low power mode.
- **S3 only (Suspend to RAM)** The caches are flushed and the CPU is powered off. Power to the RAM is maintained. The computer returns slower to a working state, but more power is saved.

5.3.2 RTC Wake Settings

The **RTC Wake Settings** menu (**BIOS Menu 4**) enables the system to wake at the specified time.

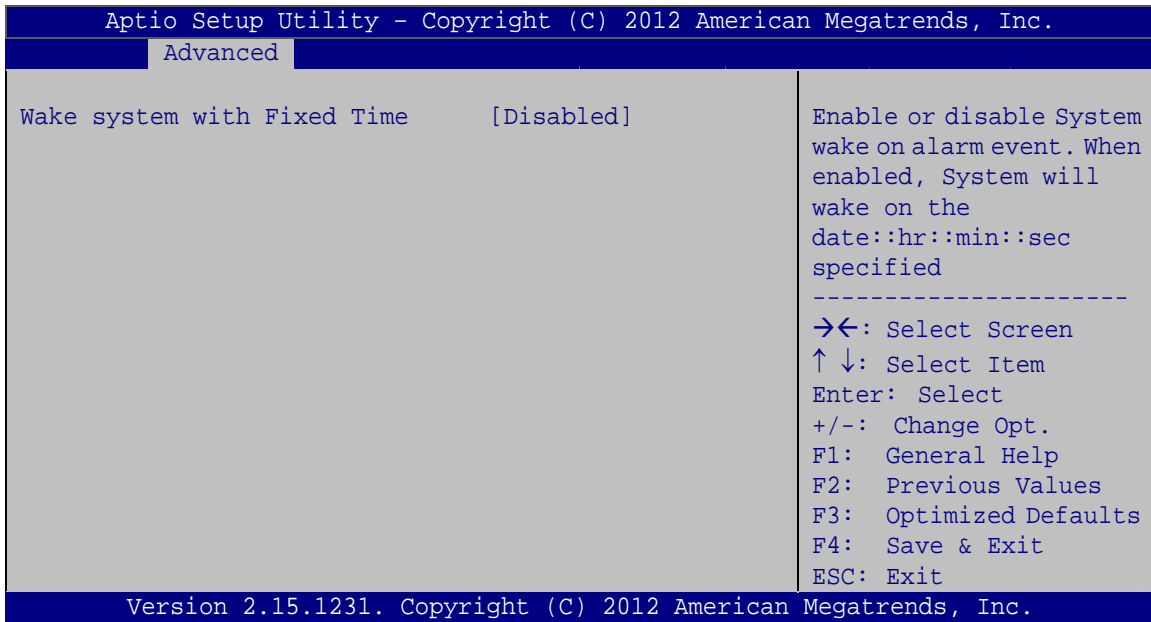

BIOS Menu 4: RTC Wake Settings

→ Wake system with Fixed Time [Disabled]

Use the **Wake system with Fixed Time** option to enable or disable the system wake on alarm event.

- **Disabled** **DEFAULT** The real time clock (RTC) cannot generate a wake event

- **Enabled** If selected, the **Wake up every day** option appears allowing you to enable to disable the system to wake every day at the specified time. Besides, the following options appear with values that can be selected:

- Wake up every day
- Wake up date
- Wake up hour

WAFER-ULT-i1 3.5" SBC

Wake up minute

Wake up second

After setting the alarm, the computer turns itself on from a suspend state when the alarm goes off.

5.3.3 CPU Configuration

Use the **CPU Configuration** menu (**BIOS Menu 5**) to view detailed CPU specifications.

Aptio Setup Utility - Copyright (C) 2012 American Megatrends, Inc.		
Advanced		
CPU Configuration		Enable for Windows XP and Linux (OS optimized for Hyper-Threading Technology and Disabled for other OS (OS not optimized for Hyper-Threading Technology). When Disabled only one thread per enabled core is enabled.
Intel(R) Core(TM) i5-4300U CPU @ 1.90GHz		
CPU Signature	40651	
Processor Family	6	
Microcode Patch	15	
FSB Speed	100 MHz	
Max CPU Speed	1900 MHz	
Min CPU Speed	800 MHz	
CPU Speed	2600 MHz	
Processor Cores	2	
Intel HT Technology	Supported	
Intel VT-x Technology	Supported	
Intel SMX Technology	Supported	
64-bit	Supported	
EIST Technology	Supported	
L1 Data Cache	32 kB x 2	
L1 Code Cache	32 kB x 2	
L2 Cache	256 kB x 2	
L3 Cache	3072 kB	
Hyper-threading	[Enabled]	
Intel Virtualization Technology	[Disabled]	

		→←: Select Screen
		↑ ↓: Select Item
		Enter: Select
		+/-: Change Opt.
		F1: General Help
		F2: Previous Values
		F3: Optimized Defaults
		F4: Save & Exit
		ESC: Exit
Version 2.15.1231. Copyright (C) 2012 American Megatrends, Inc.		

BIOS Menu 5: CPU Configuration

→ Hyper-threading [Enabled]

Use the **Hyper-threading** BIOS option to enable or disable the Intel Hyper-Threading Technology.

- **Disabled** Disables the Intel Hyper-Threading Technology.
- **Enabled** **DEFAULT** Enables the Intel Hyper-Threading Technology.

➔ **Intel Virtualization Technology [Disabled]**

Use the **Intel Virtualization Technology** option to enable or disable virtualization on the system. When combined with third party software, Intel® Virtualization technology allows several OSs to run on the same system at the same time.

- ➔ **Disabled** **DEFAULT** Disables Intel Virtualization Technology.
- ➔ **Enabled** Enables Intel Virtualization Technology.

5.3.4 SATA Configuration

Use the **SATA Configuration** menu (**BIOS Menu 6**) to change and/or set the configuration of the SATA devices installed in the system.

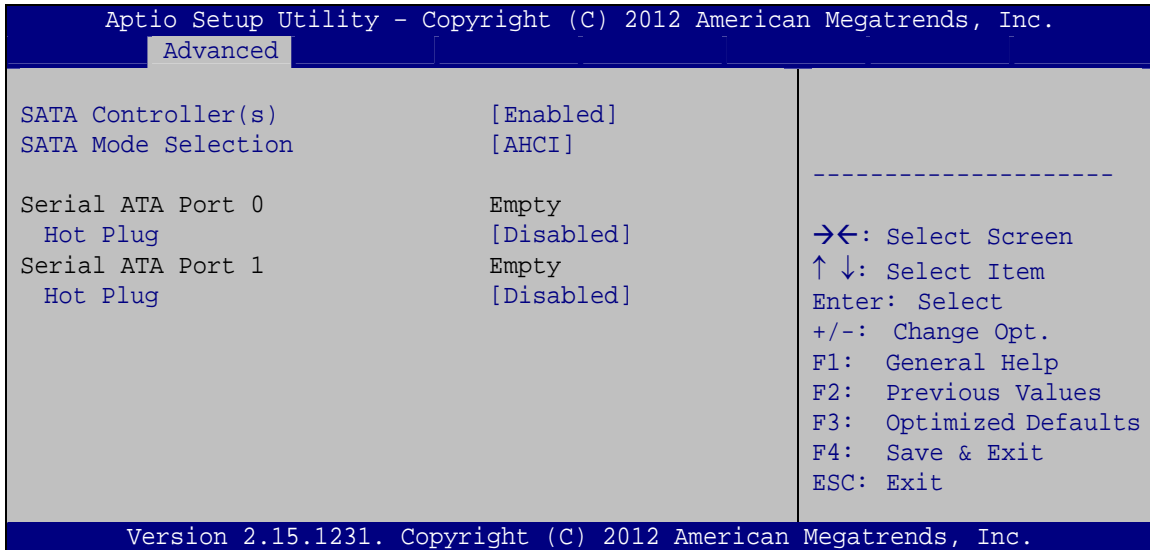

BIOS Menu 6: SATA Configuration

➔ **SATA Controller(s) [Enabled]**

Use the **SATA Controller(s)** option to configure the SATA controller.

- ➔ **Enabled** **DEFAULT** Enable SATA controller.
- ➔ **Disabled** Disable SATA controller.

➔ **SATA Mode Selection [AHCI]**

Use the **SATA Mode Selection** option to configure SATA devices.

WAFAER-ULT-i1 3.5" SBC

- ➔ **AHCI** **DEFAULT** Configures SATA devices as AHCI device.
- ➔ **RAID** Configures SATA devices as RAID device.

➔ **Hot Plug [Disabled]**

Use the **Hot Plug** option to designate the SATA port as hot pluggable.

- ➔ **Disabled** **DEFAULT** Disables the hot-pluggable function.
- ➔ **Enabled** Enables the hot-pluggable function.

5.3.5 Intel(R) Rapid Start Technology

Use the **Intel(R) Rapid Start Technology (BIOS Menu 7)** menu to configure Intel® Rapid Start Technology support.

```

Aptio Setup Utility - Copyright (C) 2012 American Megatrends, Inc.
Advanced
-----
Intel(R) Rapid Start Technology      [Disabled]
Enable or disable
Intel(R) Rapid Start
Technology

-----
->←: Select Screen
↑↓: Select Item
Enter: Select
+/-: Change Opt.
F1: General Help
F2: Previous Values
F3: Optimized Defaults
F4: Save & Exit
ESC: Exit

Version 2.15.1231. Copyright (C) 2012 American Megatrends, Inc.

```

BIOS Menu 7: Intel(R) Rapid Start Technology

➔ **Intel(R) Rapid Start Technology [Disabled]**

Use **Intel(R) Rapid Start Technology** option to enable or disable the Intel® Rapid Start Technology function.

- ➔ **Disabled** **DEFAULT** Intel® Rapid Start Technology is disabled
- ➔ **Enabled** Intel® Rapid Start Technology is enabled

5.3.6 AMT Configuration

The **AMT Configuration** menu (**BIOS Menu 8**) allows the Intel® AMT options to be configured.

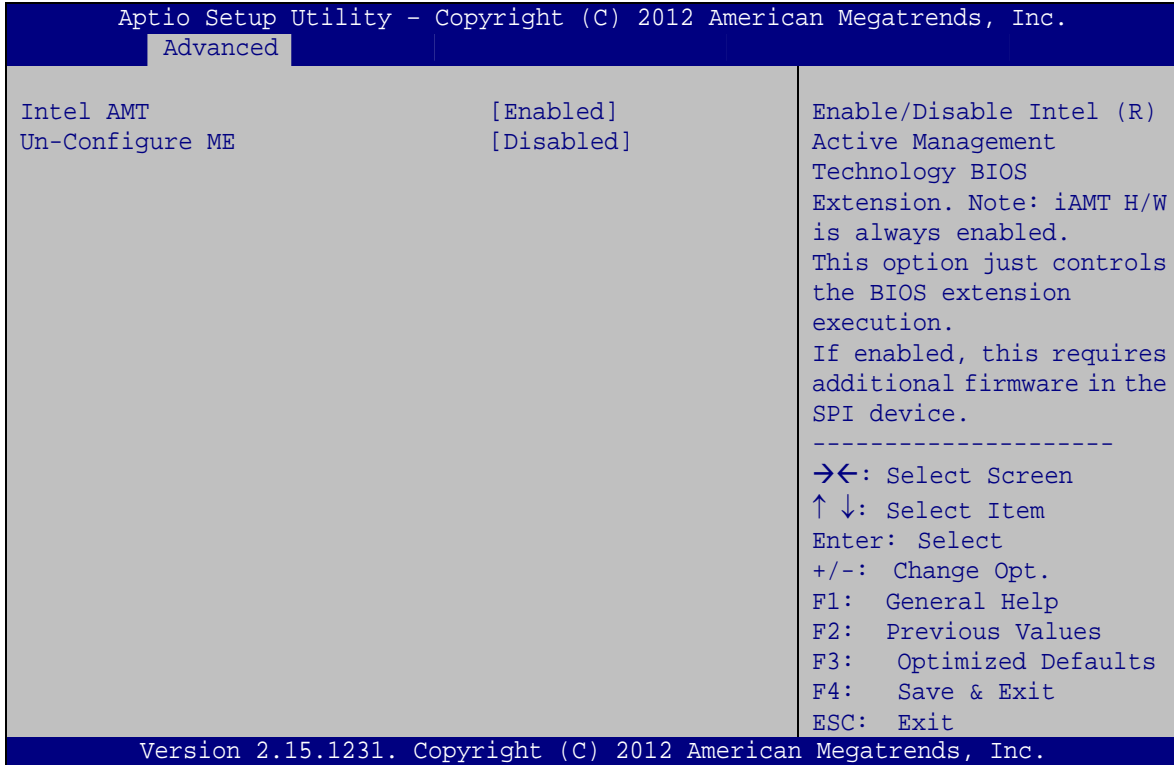

BIOS Menu 8: AMT Configuration

➔ Intel AMT [Enabled]

Use **Intel AMT** option to enable or disable the Intel® AMT function.

- ➔ **Disabled** Intel® AMT is disabled
- ➔ **Enabled** **DEFAULT** Intel® AMT is enabled

➔ Un-Configure ME [Disabled]

Use the **Un-Configure ME** option to perform ME unconfigure without password operation.

- ➔ **Disabled** **DEFAULT** Not perform ME unconfigure
- ➔ **Enabled** To perform ME unconfigure

WAFER-ULT-i1 3.5" SBC

5.3.7 USB Configuration

Use the **USB Configuration** menu (**BIOS Menu 9**) to read USB configuration information and configure the USB settings.

```

Aptio Setup Utility - Copyright (C) 2012 American Megatrends, Inc.
  Advanced
-----
USB Configuration                               Enables Legacy USB
USB Module Version                             8.10.27          support. AUTO option
USB Devices:                                    disables legacy support
  1 Keyboard, 1 Hub                             if no USB devices are
Legacy USB Support                             [Enabled]         connected. DISABLE
                                                    option will keep USB
                                                    devices available only
                                                    for EFI applications.
                                                    -----
                                                    →←: Select Screen
                                                    ↑↓: Select Item
                                                    Enter: Select
                                                    +/-: Change Opt.
                                                    F1:  General Help
                                                    F2:  Previous Values
                                                    F3:  Optimized Defaults
                                                    F4:  Save & Exit
                                                    ESC: Exit
Version 2.15.1231. Copyright (C) 2012 American Megatrends, Inc.

```

BIOS Menu 9: USB Configuration

➔ USB Devices

The **USB Devices** field lists the USB devices that are enabled on the system

➔ Legacy USB Support [Enabled]

Use the **Legacy USB Support** BIOS option to enable USB mouse and USB keyboard support.

Normally if this option is not enabled, any attached USB mouse or USB keyboard does not become available until a USB compatible operating system is fully booted with all USB drivers loaded. When this option is enabled, any attached USB mouse or USB keyboard can control the system even when there is no USB driver loaded onto the system.

- ➔ **Enabled** **DEFAULT** Legacy USB support enabled
- ➔ **Disabled** Legacy USB support disabled
- ➔ **Auto** Legacy USB support disabled if no USB devices are connected

5.3.8 F81866 Super IO Configuration

Use the **F81866 Super IO Configuration** menu (**BIOS Menu 10**) to set or change the configurations for the serial ports.

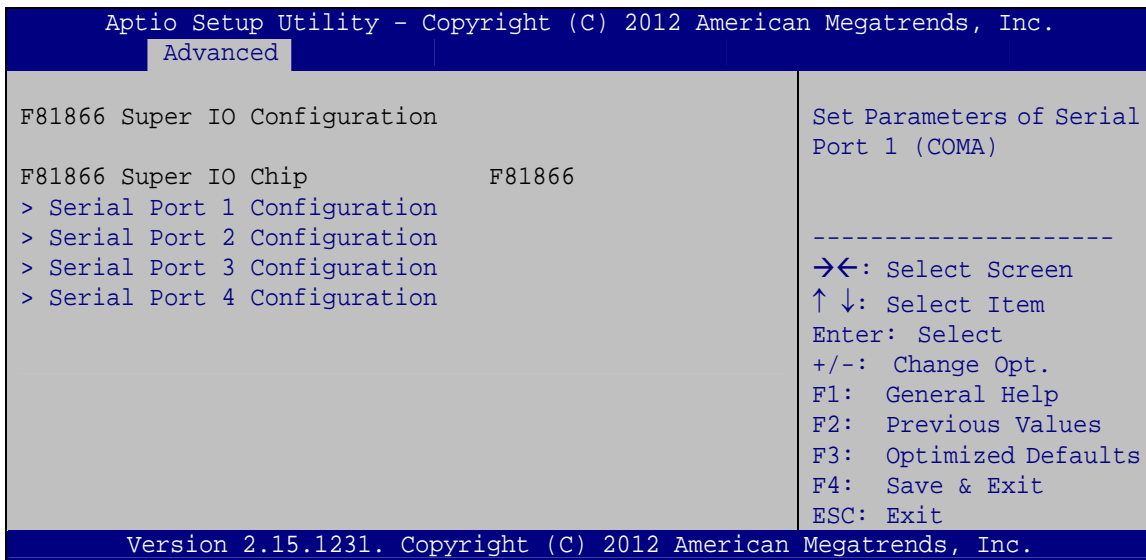

BIOS Menu 10: F81866 Super IO Configuration

WAFER-ULT-i1 3.5" SBC

5.3.8.1 Serial Port n Configuration

Use the **Serial Port n Configuration** menu (**BIOS Menu 11**) to configure the serial port n.

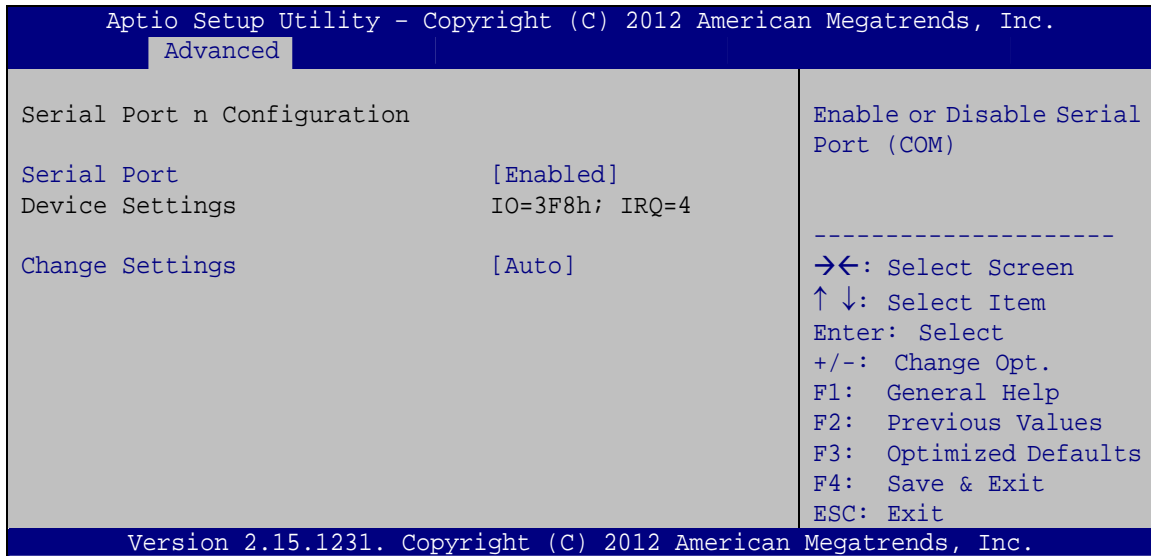

BIOS Menu 11: Serial Port n Configuration Menu

5.3.8.1.1 Serial Port 1 Configuration

➔ Serial Port [Enabled]

Use the **Serial Port** option to enable or disable the serial port.

- ➔ **Disabled** Disable the serial port
- ➔ **Enabled** **DEFAULT** Enable the serial port

➔ Change Settings [Auto]

Use the **Change Settings** option to change the serial port IO port address and interrupt address.

- ➔ **Auto** **DEFAULT** The serial port IO port address and interrupt address are automatically detected.
- ➔ **IO=3F8h;**
IRQ=4 Serial Port I/O port address is 3F8h and the interrupt address is IRQ4

- ➔ **IO=3F8h;**
IRQ=3, 4,
5, 6, 7, 10,
11, 12 Serial Port I/O port address is 3F8h and the interrupt address is IRQ3, 4, 5, 6, 7, 10, 11, 12

- ➔ **IO=2F8h;**
IRQ=3, 4,
5, 6, 7, 10,
11, 12 Serial Port I/O port address is 2F8h and the interrupt address is IRQ3, 4, 5, 6, 7, 10, 11, 12

- ➔ **IO=3E8h;**
IRQ=3, 4,
5, 6, 7, 10,
11, 12 Serial Port I/O port address is 3E8h and the interrupt address is IRQ3, 4, 5, 6, 7, 10, 11, 12

- ➔ **IO=2E8h;**
IRQ=3, 4,
5, 6, 7, 10,
11, 12 Serial Port I/O port address is 2E8h and the interrupt address is IRQ3, 4, 5, 6, 7, 10, 11, 12

5.3.8.1.2 Serial Port 2 Configuration

➔ **Serial Port [Enabled]**

Use the **Serial Port** option to enable or disable the serial port.

- ➔ **Disabled** Disable the serial port
- ➔ **Enabled** **DEFAULT** Enable the serial port

➔ **Change Settings [Auto]**

Use the **Change Settings** option to change the serial port IO port address and interrupt address.

- ➔ **Auto** **DEFAULT** The serial port IO port address and interrupt address are automatically detected.

WAFER-ULT-i1 3.5" SBC

- ➔ **IO=2F8h;**
IRQ=3 Serial Port I/O port address is 2F8h and the interrupt address is IRQ3
- ➔ **IO=3F8h;**
IRQ=3, 4,
5, 6, 7, 10,
11, 12 Serial Port I/O port address is 3F8h and the interrupt address is IRQ3, 4, 5, 6, 7, 10, 11, 12
- ➔ **IO=2F8h;**
IRQ=3, 4,
5, 6, 7, 10,
11, 12 Serial Port I/O port address is 2F8h and the interrupt address is IRQ3, 4, 5, 6, 7, 10, 11, 12
- ➔ **IO=3E8h;**
IRQ=3, 4,
5, 6, 7, 10,
11, 12 Serial Port I/O port address is 3E8h and the interrupt address is IRQ3, 4, 5, 6, 7, 10, 11, 12
- ➔ **IO=2E8h;**
IRQ=3, 4,
5, 6, 7, 10,
11, 12 Serial Port I/O port address is 2E8h and the interrupt address is IRQ3, 4, 5, 6, 7, 10, 11, 12

5.3.8.1.3 Serial Port 3 Configuration

➔ Serial Port [Enabled]

Use the **Serial Port** option to enable or disable the serial port.

- ➔ **Disabled** Disable the serial port
- ➔ **Enabled** **DEFAULT** Enable the serial port

➔ Change Settings [Auto]

Use the **Change Settings** option to change the serial port IO port address and interrupt address.

- ➔ **Auto** **DEFAULT** The serial port IO port address and interrupt address are automatically detected.
- ➔ **IO=3E8h;**
IRQ=10 Serial Port I/O port address is 3E8h and the interrupt address is IRQ10
- ➔ **IO=3E8h;**
IRQ=3, 4,
5, 6, 7, 10,
11, 12 Serial Port I/O port address is 3E8h and the interrupt address is IRQ3, 4, 5, 6, 7, 10, 11, 12
- ➔ **IO=2E8h;**
IRQ=3, 4,
5, 6, 7, 10,
11, 12 Serial Port I/O port address is 2E8h and the interrupt address is IRQ3, 4, 5, 6, 7, 10, 11, 12
- ➔ **IO=2F0h;**
IRQ=3, 4,
5, 6, 7, 10,
11, 12 Serial Port I/O port address is 2F0h and the interrupt address is IRQ3, 4, 5, 6, 7, 10, 11, 12
- ➔ **IO=2E0h;**
IRQ=3, 4,
5, 6, 7, 10,
11, 12 Serial Port I/O port address is 2E0h and the interrupt address is IRQ3, 4, 5, 6, 7, 10, 11, 12

5.3.8.1.4 Serial Port 4 Configuration

➔ **Serial Port [Enabled]**

Use the **Serial Port** option to enable or disable the serial port.

- ➔ **Disabled** Disable the serial port
- ➔ **Enabled** **DEFAULT** Enable the serial port

➔ **Change Settings [Auto]**

Use the **Change Settings** option to change the serial port IO port address and interrupt address.

WAFER-ULT-i1 3.5" SBC

- | | | | |
|---|---|----------------|--|
| → | Auto | DEFAULT | The serial port IO port address and interrupt address are automatically detected. |
| → | IO=2E8h;
IRQ=10 | | Serial Port I/O port address is 2E8h and the interrupt address is IRQ10 |
| → | IO=3E8h;
IRQ=3, 4,
5, 6, 7, 10,
11, 12 | | Serial Port I/O port address is 3E8h and the interrupt address is IRQ3, 4, 5, 6, 7, 10, 11, 12 |
| → | IO=2E8h;
IRQ=3, 4,
5, 6, 7, 10,
11, 12 | | Serial Port I/O port address is 2E8h and the interrupt address is IRQ3, 4, 5, 6, 7, 10, 11, 12 |
| → | IO=2F0h;
IRQ=3, 4,
5, 6, 7, 10,
11, 12 | | Serial Port I/O port address is 2F0h and the interrupt address is IRQ3, 4, 5, 6, 7, 10, 11, 12 |
| → | IO=2E0h;
IRQ=3, 4,
5, 6, 7, 10,
11, 12 | | Serial Port I/O port address is 2E0h and the interrupt address is IRQ3, 4, 5, 6, 7, 10, 11, 12 |

5.3.9 F81866 H/W Monitor

The **F81866 H/W Monitor** menu (**BIOS Menu 12**) contains the fan configuration submenu and displays the system temperatures and voltages.

```

Aptio Setup Utility - Copyright (C) 2012 American Megatrends, Inc.
-----
Advanced
-----
PC Health Status
-----
> SYS_FAN1 Smart Fan Mode Configuration
CPU temperature           : +45C
System temperature       : +40 C
CPU Fan Speed            : N/A
-----
Smart Fan Mode Select
-----
-><: Select Screen
↑↓: Select Item
Enter: Select
+/-: Change Opt.
F1: General Help
F2: Previous Values
F3: Optimized Defaults
F4: Save & Exit
ESC: Exit
-----
Version 2.15.1231. Copyright (C) 2012 American Megatrends, Inc.

```

BIOS Menu 12: F81866 H/W Monitor

5.3.9.1 SYS_FAN1 Smart Fan Mode Configuration

Use the **SYS_FAN1 Smart Fan Mode Configuration** submenu (**BIOS Menu 13**) to configure the smart fan temperature and speed settings.

WAFER-ULT-i1 3.5" SBC

```

Aptio Setup Utility - Copyright (C) 2012 American Megatrends, Inc.
  Advanced
SYS_FAN1 Smart Fan Mode Configuration
SYS Smart Fan Control          [Auto PWM Mode]
Temperature of Off             75
Temperature Of Start          80
Start PWM                     30
Slope (Duty Cycle)           [4]
SYS Smart Fan control
settings
-----
-><: Select Screen
↑↓: Select Item
Enter: Select
+/-: Change Opt.
F1: General Help
F2: Previous Values
F3: Optimized Defaults
F4: Save & Exit
ESC: Exit
Version 2.15.1231. Copyright (C) 2012 American Megatrends, Inc.

```

BIOS Menu 13: SYS_FAN1 Smart Fan Mode Configuration

➔ SYS Smart Fan Control [Auto PWM Mode]

Use the **SYS Smart Fan Control** option to configure the system fan.

- ➔ **Full Mode** The fan spins at full speed.
- ➔ **Manual PWM Mode** The fan spins at the speed set in Manual PWM Setting settings.
- ➔ **Auto PWM Mode** **DEFAULT** The fan adjusts its speed using Auto PWM Mode settings.

➔ Temperature of Off

Use the + or – key to change the **Temperature of Off** value. Enter a decimal number between 1 and 127. If the CPU temperature is lower than this setting, the fan spins at the lowest speed.

➔ Temperature Of Start

Use the + or – key to change the **Temperature Of Start** value. Enter a decimal number between 1 and 127. If the CPU temperature is between the settings of **Temperature of Off** and **Temperature Of Start**, the fan spins as the **Start PWM** settings.

➔ **Start PWM**

Use the + or – key to change the **Start PWM** value. Enter a decimal number between 1 and 100.

➔ **Slope (Duty Cycle)**

If the CPU temperature is higher than the **Temperature Of Start** setting, the **Slope (Duty Cycle)** setting is increased with one degree.

5.3.10 Serial Port Console Redirection

The **Serial Port Console Redirection** menu (**BIOS Menu 14**) allows the console redirection options to be configured. Console redirection allows users to maintain a system remotely by re-directing keyboard input and text output through the serial port.

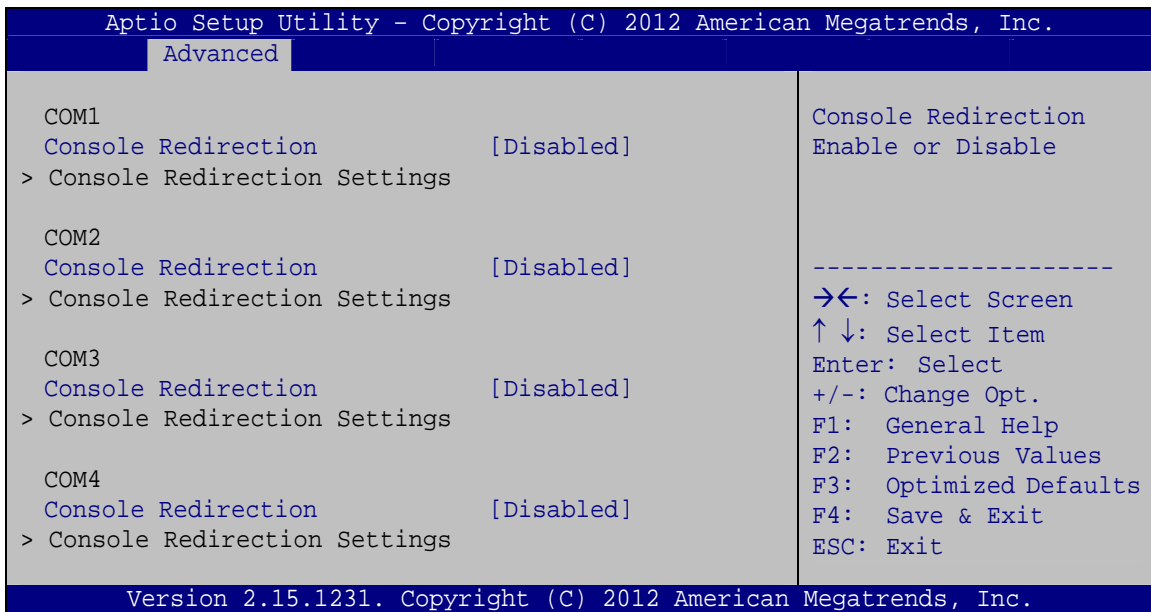

BIOS Menu 14: Serial Port Console Redirection

➔ **Console Redirection [Disabled]**

Use **Console Redirection** option to enable or disable the console redirection function.

- ➔ **Disabled** **DEFAULT** Disabled the console redirection function
- ➔ **Enabled** Enabled the console redirection function

WAFER-ULT-i1 3.5" SBC

**NOTE:**

The following options are available in the **Console Redirection Settings** submenu when the **Console Redirection** option is enabled.

→ Terminal Type [ANSI]

Use the **Terminal Type** option to specify the remote terminal type.

- | | | |
|------------------|----------------|-------------------------------------|
| → VT100 | | The target terminal type is VT100 |
| → VT100+ | | The target terminal type is VT100+ |
| → VT-UTF8 | | The target terminal type is VT-UTF8 |
| → ANSI | DEFAULT | The target terminal type is ANSI |

→ Bits per second [115200]

Use the **Bits per second** option to specify the serial port transmission speed. The speed must match the other side. Long or noisy lines may require lower speeds.

- | | | |
|-----------------|----------------|--|
| → 9600 | | Sets the serial port transmission speed at 9600. |
| → 19200 | | Sets the serial port transmission speed at 19200. |
| → 38400 | | Sets the serial port transmission speed at 38400. |
| → 57600 | | Sets the serial port transmission speed at 57600. |
| → 115200 | DEFAULT | Sets the serial port transmission speed at 115200. |

→ Data Bits [8]

Use the **Data Bits** option to specify the number of data bits.

- | | | |
|------------|----------------|--------------------------|
| → 7 | | Sets the data bits at 7. |
| → 8 | DEFAULT | Sets the data bits at 8. |

→ Parity [None]

Use the **Parity** option to specify the parity bit that can be sent with the data bits for detecting the transmission errors.

- None** **DEFAULT** No parity bit is sent with the data bits.
- Even** The parity bit is 0 if the number of ones in the data bits is even.
- Odd** The parity bit is 0 if the number of ones in the data bits is odd.
- Mark** The parity bit is always 1. This option does not provide error detection.
- Space** The parity bit is always 0. This option does not provide error detection.

→ Stop Bits [1]

Use the **Stop Bits** option to specify the number of stop bits used to indicate the end of a serial data packet. Communication with slow devices may require more than 1 stop bit.

- 1** **DEFAULT** Sets the number of stop bits at 1.
- 2** Sets the number of stop bits at 2.

→ Flow Control [None]

Use the **Flow Control** option to report the flow control method for the console redirection application.

- None** **DEFAULT** No control flow.
- Hardware** Hardware is set as the console redirection.
RTS/CTS

→ VT-UTF8 Combo Key Support [Enabled]

Use the **VT-UFT8 Combo Key Support** option to enable additional keys that are not provided by VT100 for the PC 101 keyboard.

WAFER-ULT-i1 3.5" SBC

The VT100 Terminal Definition is the standard convention used to configure and conduct emergency management tasks with UNIX-based servers. VT100 does not support all keys on the standard PC 101-key layout, however. The VT-UTF8 convention makes available additional keys that are not provided by VT100 for the PC 101 keyboard.

- ➔ **Disabled** Disables the VT-UTF8 terminal keys.
- ➔ **Enabled** **DEFAULT** Enables the VT-UTF8 combination key. Support for ANSI/VT100 terminals.

➔ **Recorder Mode [Disabled]**

Use the **Recorder Mode** option to enable or disable the recorder mode.

- ➔ **Disabled** **DEFAULT** Disables the recorder mode.
- ➔ **Enabled** Enables the recorder mode.

➔ **Resolution 100x31 [Disabled]**

Use the **Resolution 100x31** option to enable or disable 100x31 resolution of the extended terminal.

- ➔ **Disabled** **DEFAULT** Disables 100x31 resolution of the extended terminal.
- ➔ **Enabled** Enables 100x31 resolution of the extended terminal.

➔ **Legacy OS Redirection Resolution [80x24]**

Use the **Legacy OS Redirection Resolution** option to specify the resolution of the remote terminal.

- ➔ **80x24** **DEFAULT** Sets the resolution of the remote terminal at 80x24.
- ➔ **80x25** Sets the resolution of the remote terminal at 80x25.

➔ **Putty KeyPad [VT100]**

Use the **Putty KeyPad** option to select the function keys and keypad in Putty. Configuration options are listed below.

- VT100 **Default**
- LINUX
- XTERMR6
- SC0
- ESCN
- VT400

5.3.11 iEi Feature

Use the **iEi Feature** menu (**BIOS Menu 15**) to configure One Key Recovery function.

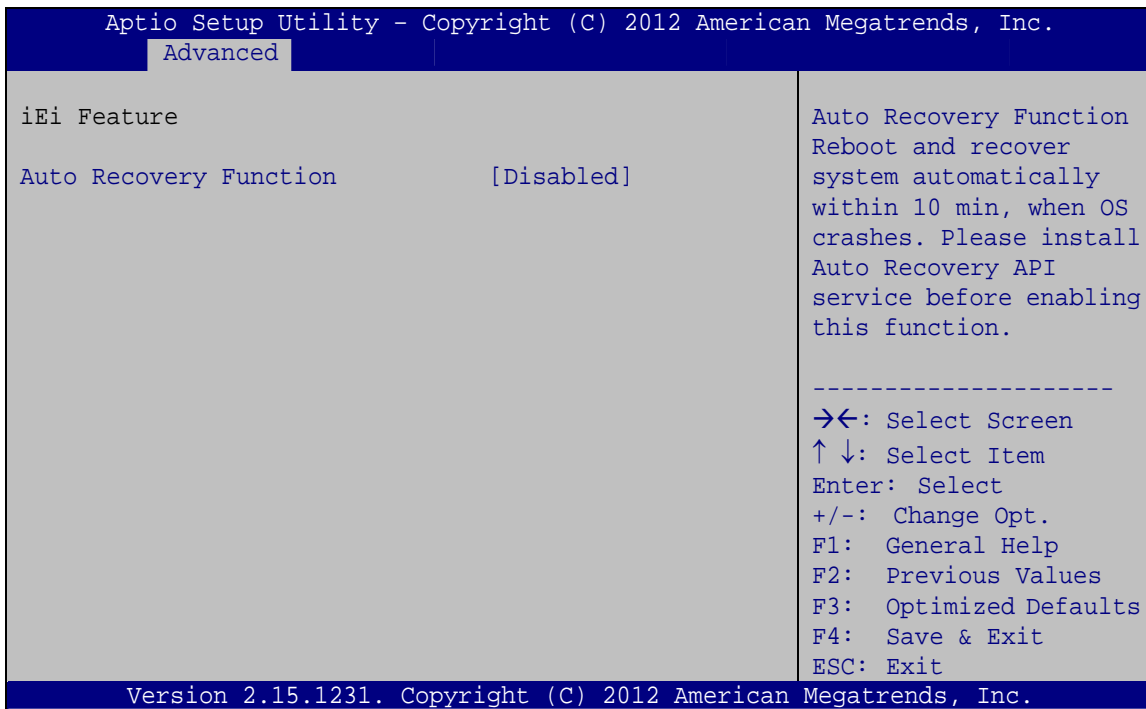

BIOS Menu 15: iEi Feature

➔ Auto Recovery Function [Disabled]

Use the **Auto Recovery Function** BIOS option to enable or disable the auto recovery function of the IEI One Key Recovery.

- ➔ **Disabled** **DEFAULT** Auto recovery function disabled
- ➔ **Enabled** Auto recovery function enabled

WAFER-ULT-i1 3.5" SBC

5.4 Chipset

Use the **Chipset** menu (**BIOS Menu 16**) to access the Northbridge and Southbridge configuration menus.

```

Aptio Setup Utility - Copyright (C) 2012 American Megatrends, Inc.
Main   Advanced  Chipset   Boot   Security  Save & Exit
-----
> PCH-IO Configuration
> System Agent (SA) Configuration

PCH Parameters
-----
-><: Select Screen
↑↓: Select Item
Enter: Select
+/-: Change Opt.
F1: General Help
F2: Previous Values
F3: Optimized Defaults
F4: Save & Exit
ESC: Exit

Version 2.15.1231. Copyright (C) 2012 American Megatrends, Inc.
  
```

BIOS Menu 16: Chipset

5.4.1 PCH-IO Configuration

Use the **PCH-IO Configuration** menu (**BIOS Menu 17**) to configure the PCH parameters.

```

Aptio Setup Utility - Copyright (C) 2012 American Megatrends, Inc.
-----
Chipset
-----
Intel PCH RC Version          1.6.1.0
Intel PCH SKU Name           Premium SKU
Intel PCH Rev ID             04/B2

Auto Power Button Function    [Disabled(ATX)]
Restore AC Power Loss         [Last State]
Power Saving Function(EUP)    [Disabled]

Select AC power state
when power is re-applied
after a power failure.
-----
-><: Select Screen
↑↓: Select Item
Enter: Select
+/-: Change Opt.
F1: General Help
F2: Previous Values
F3: Optimized Defaults
F4: Save & Exit
ESC: Exit

Version 2.15.1231. Copyright (C) 2012 American Megatrends, Inc.
  
```

BIOS Menu 17: PCH-IO Configuration

➔ **Restore AC Power Loss [Last State]**

Use the **Restore AC Power Loss** BIOS option to specify what state the system returns to if there is a sudden loss of power to the system.

- ➔ **Power Off** The system remains turned off
- ➔ **Power On** The system turns on
- ➔ **Last State DEFAULT** The system returns to its previous state. If it was on, it turns itself on. If it was off, it remains off.

➔ **Power Saving Function(EUP) [Disabled]**

Use the **Power Saving Function(EYP)** BIOS option to enable or disable the power saving function.

- ➔ **Disabled DEFAULT** Power saving function is disabled.
- ➔ **Enabled** Power saving function is enabled. It will reduce power consumption when the system is off.

5.4.2 System Agent (SA) Configuration

Use the **System Agent (SA) Configuration** menu (**BIOS Menu 18**) to display the memory information.

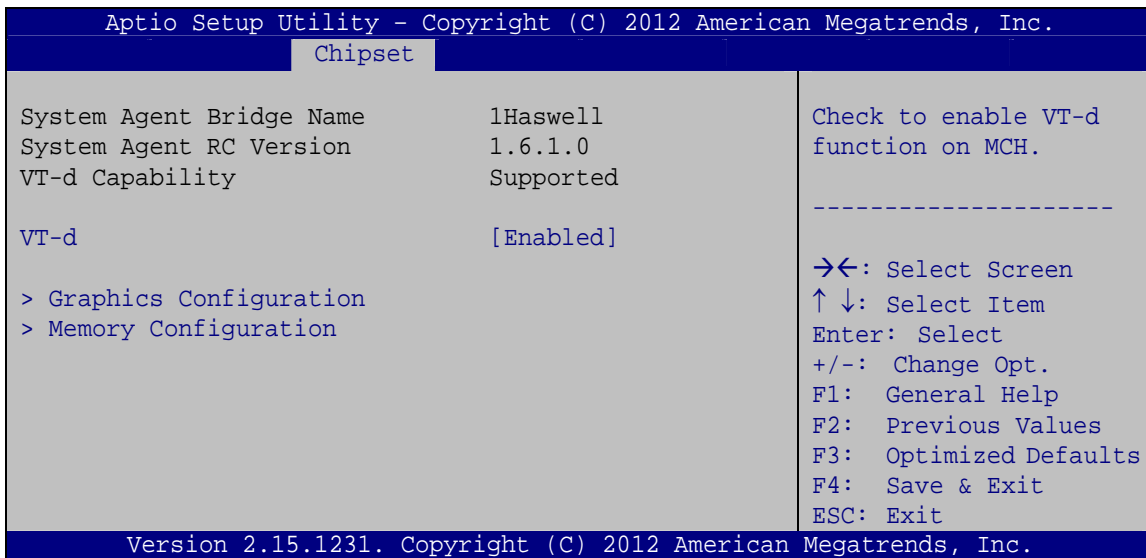

BIOS Menu 18: System Agent (SA) Configuration

WAFER-ULT-i1 3.5" SBC

→ VT-d [Enabled]

Use the **VT-d** option to enable or disable VT-d support.

- **Disabled** Disables VT-d support.
- **Enabled** **DEFAULT** Enables VT-d support.

5.4.2.1 Graphics Configuration

Use the **Graphics Configuration (BIOS Menu 19)** menu to configure the video device connected to the system.

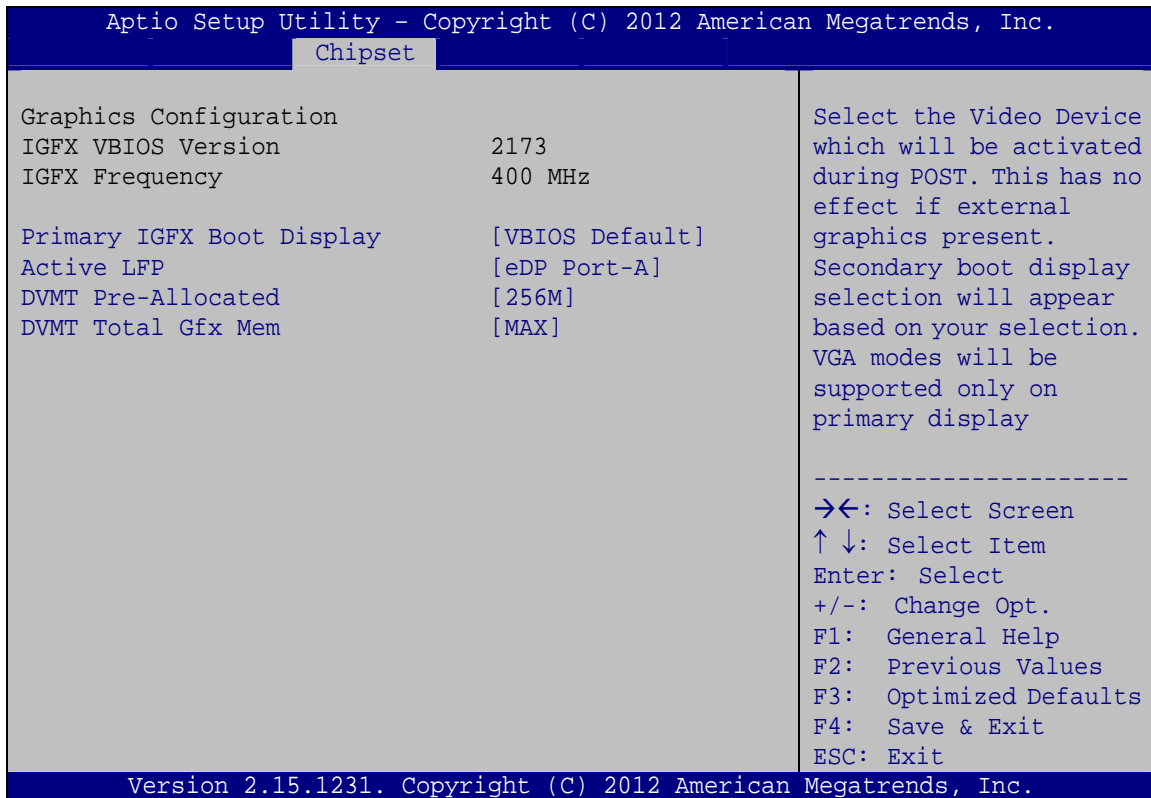

BIOS Menu 19: Graphics Configuration

→ Primary IGFX Boot Display [VBIOS Default]

Use the **Primary IGFX Boot Display** option to select the display device used by the system when it boots. Configuration options are listed below.

- VBIOS Default **DEFAULT**
- CRT
- DP port

➔ **Active LFP [eDP Port-A]**

Use the **Active LFP** option to select the active LFP configuration.

- ➔ **No LVDS** VBIOS does not enable LVDS.
- ➔ **eDP Port-A** **DEFAULT** LFP is driven by the Int-DisplayPort encoder from Port-A.

➔ **DVMT Pre-Allocated [256M]**

Use the **DVMT Pre-Allocated** option to set the amount of system memory allocated to the integrated graphics processor when the system boots. The system memory allocated can then only be used as graphics memory, and is no longer available to applications or the operating system. Configuration options are listed below:

- 32M
- 64M
- 128M
- 256M **Default**
- 512M

➔ **DVMT Total Gfx Mem [MAX]**

Use the **DVMT Total Gfx Mem** option to select DVMT5.0 total graphic memory size used by the internal graphic device. The following options are available:

- 128M
- 256M
- MAX **Default**

WAFER-ULT-i1 3.5" SBC

5.4.2.2 Memory Configuration

Use the **Memory Configuration** submenu (**BIOS Menu 20**) to view memory information.

```

Aptio Setup Utility - Copyright (C) 2012 American Megatrends, Inc.
Chipset
Memory Information
Memory RC Version          1.6.1.2
Memory Frequency          1600 MHz
Total Memory              4096 MB (DDR3)
Memory Voltage            1.35v
DIMM#0                   4096 MB (DDR3)
DIMM#1                   Not Present
-----
-><: Select Screen
↑↓: Select Item
Enter: Select
+/-: Change Opt.
F1:  General Help
F2:  Previous Values
F3:  Optimized Defaults
F4:  Save & Exit
ESC: Exit
Version 2.15.1231. Copyright (C) 2012 American Megatrends, Inc.
  
```

BIOS Menu 20: Memory Configuration

5.5 Boot

Use the **Boot** menu (**BIOS Menu 21**) to configure system boot options.

```

Aptio Setup Utility - Copyright (C) 2012 American Megatrends, Inc.
Main  Advanced  Chipset  Boot  Security  Save & Exit
Boot Configuration
Bootup NumLock State      [On]
Quiet Boot                [Enabled]
Option ROM Messages       [Force BIOS]
Boot option filter        [Legacy only]
Launch PXE OpROM          [Disabled]
Boot Option Priorities
-----
Select the keyboard
NumLock state
-----
-><: Select Screen
↑↓: Select Item
Enter: Select
+/-: Change Opt.
F1:  General Help
F2:  Previous Values
F3:  Optimized Defaults
F4:  Save & Exit
ESC: Exit
Version 2.15.1231. Copyright (C) 2012 American Megatrends, Inc.
  
```

BIOS Menu 21: Boot

➔ **Bootup NumLock State [On]**

Use the **Bootup NumLock State** BIOS option to specify if the number lock setting must be modified during boot up.

➔ **On** **DEFAULT** Allows the Number Lock on the keyboard to be enabled automatically when the computer system boots up. This allows the immediate use of the 10-key numeric keypad located on the right side of the keyboard. To confirm this, the Number Lock LED light on the keyboard is lit.

➔ **Off** Does not enable the keyboard Number Lock automatically. To use the 10-keys on the keyboard, press the Number Lock key located on the upper left-hand corner of the 10-key pad. The Number Lock LED on the keyboard lights up when the Number Lock is engaged.

➔ **Quiet Boot [Enabled]**

Use the **Quiet Boot** BIOS option to select the screen display when the system boots.

➔ **Disabled** Normal POST messages displayed

➔ **Enabled** **DEFAULT** OEM Logo displayed instead of POST messages

➔ **Option ROM Messages [Force BIOS]**

Use the **Option ROM Messages** option to set the Option ROM display mode.

➔ **Force BIOS** **DEFAULT** Sets display mode to force BIOS.

➔ **Keep Current** Sets display mode to current.

WAFER-ULT-i1 3.5" SBC

→ Boot option filter [Legacy only]

Use the **Boot option filter** option to control what devices the system can boot to.

- UEFI and Legacy
- Legacy only **DEFAULT**
- UEFI only

→ Launch PXE OpROM [Disabled]

Use the **Launch PXE OpROM** option to enable or disable boot option for legacy network devices.

- **Disabled** **DEFAULT** Ignore all PXE Option ROMs
- **Enabled** Load PXE Option ROMs.

5.6 Security

Use the **Security** menu (**BIOS Menu 22**) to set system and user passwords.

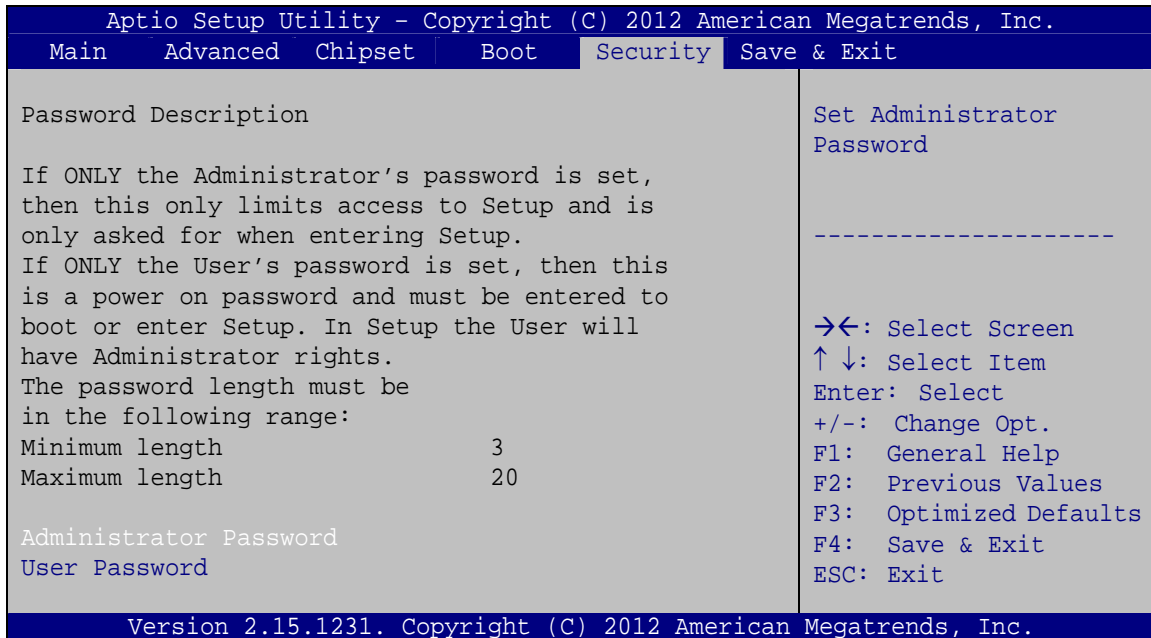

BIOS Menu 22: Security

➔ **Administrator Password**

Use the **Administrator Password** to set or change an administrator password.

➔ **User Password**

Use the **User Password** to set or change a user password.

5.7 Save & Exit

Use the **Save & Exit** menu (**BIOS Menu 23**) to load default BIOS values, optimal failsafe values and to save configuration changes.

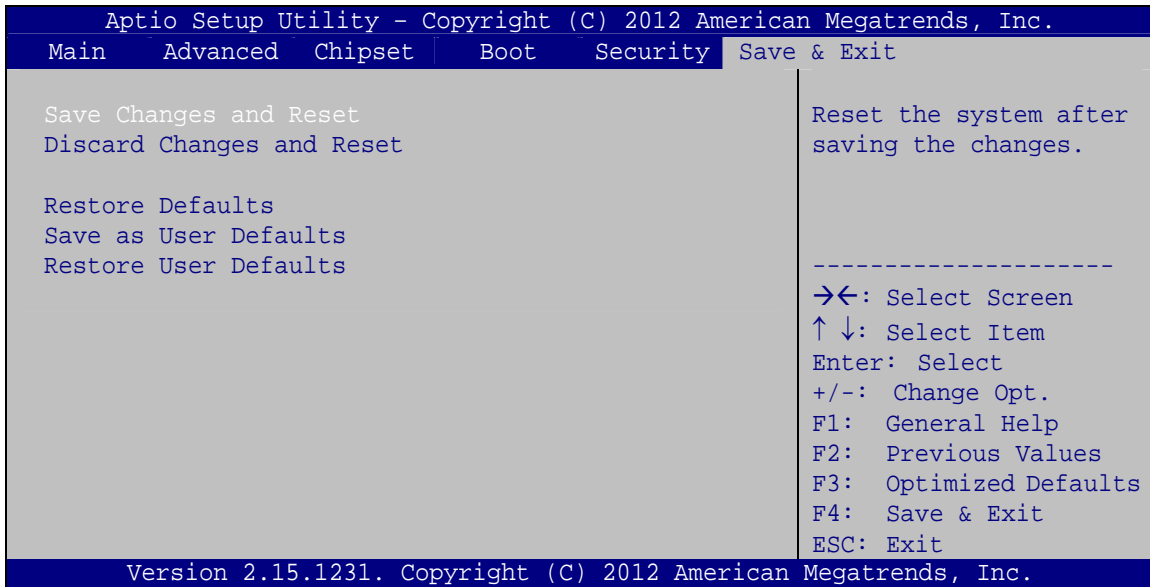

BIOS Menu 23: Save & Exit

➔ **Save Changes and Reset**

Use the **Save Changes and Reset** option to save the changes made to the BIOS options and reset the system.

➔ **Discard Changes and Reset**

Use the **Discard Changes and Reset** option to exit the system without saving the changes made to the BIOS configuration setup program.

WAFER-ULT-i1 3.5" SBC

➔ Restore Defaults

Use the **Restore Defaults** option to load the optimal default values for each of the parameters on the Setup menus. **F3 key can be used for this operation.**

➔ Save as User Defaults

Use the **Save as User Defaults** option to save the changes done so far as user defaults.

➔ Restore User Defaults

Use the **Restore User Defaults** option to restore the user defaults to all the setup options.

Chapter

6

Software Drivers

WAFER-ULT-i1 3.5" SBC

6.1 Available Software Drivers

**NOTE:**

The content of the CD may vary throughout the life cycle of the product and is subject to change without prior notice. Visit the IEI website or contact technical support for the latest updates.

The following drivers can be installed on the system:

- Chipset
- Graphics
- LAN
- Audio
- USB 3.0
- Intel® AMT

Installation instructions are given below.

6.2 Software Installation

All the drivers for the WAFER-ULT-i1 are on the CD that came with the system. To install the drivers, please follow the steps below.

Step 1: Insert the CD into a CD drive connected to the system.

**NOTE:**

If the installation program doesn't start automatically:
Click "Start->My Computer->CD Drive->autorun.exe"

Step 2: The driver main menu appears.

Step 3: Click WAFER-ULT.

Step 4: A new screen with a list of available drivers appears.

Step 5: Install all of the necessary drivers in this menu.

6.3 Chipset Driver Installation

To install the chipset driver, please do the following.

Step 1: Access the driver list. (See **Section 6.2**)

Step 2: Click **Chipset**.

Step 3: Locate the setup file and double click on it.

Step 4: When the setup files are completely extracted, the **Welcome Screen** in **Figure 6-1** appears.

Step 5: Click **Next** to continue.



Figure 6-1: Chipset Driver Welcome Screen

Step 6: The license agreement in **Figure 6-2** appears.

Step 7: Read the **License Agreement**.

Step 8: Click **Yes** to continue.

WAFER-ULT-i1 3.5" SBC



Figure 6-2: Chipset Driver License Agreement

Step 9: The Read Me file in Figure 6-3 appears.

Step 10: Click **Next** to continue.



Figure 6-3: Chipset Driver Read Me File

Step 11: Setup Operations are performed as shown in Figure 6-4.

Step 12: Once the Setup Operations are complete, click **Next** to continue.

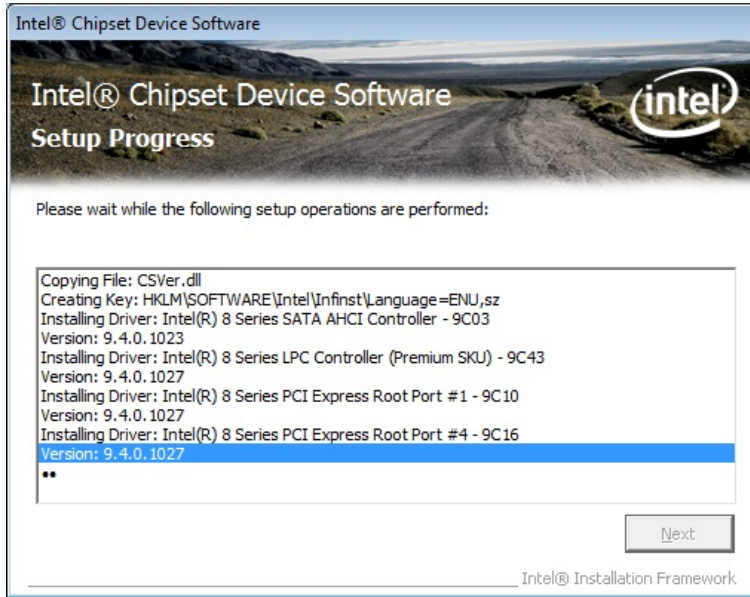

Figure 6-4: Chipset Driver Setup Operations

Step 13: The **Finish** screen in **Figure 6-5** appears.

Step 14: Select **“Yes, I want to restart this computer now”** and click **Finish**.



Figure 6-5: Chipset Driver Installation Finish Screen

WAFER-ULT-i1 3.5" SBC

6.4 Graphics Driver Installation

To install the Graphics driver, please do the following.

Step 1: Access the driver list. (See **Section 6.2**)

Step 2: Click **Graphics** and select the folder which corresponds to the operating system.

Step 3: Locate the setup file and double click on it.

Step 4: The **Welcome Screen** in **Figure 6-6** appears.

Step 5: Click **Next** to continue.



Figure 6-6: Graphics Driver Welcome Screen

Step 6: The **License Agreement** in **Figure 6-7** appears.

Step 7: Click **Yes** to accept the agreement and continue.

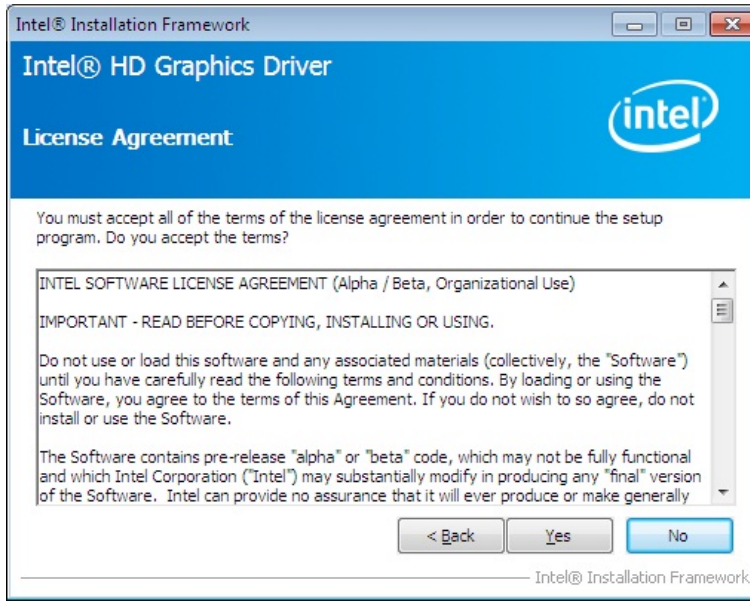

Figure 6-7: Graphics Driver License Agreement

Step 8: The Read Me file in **Figure 6-8** appears. Click **Next** to continue.

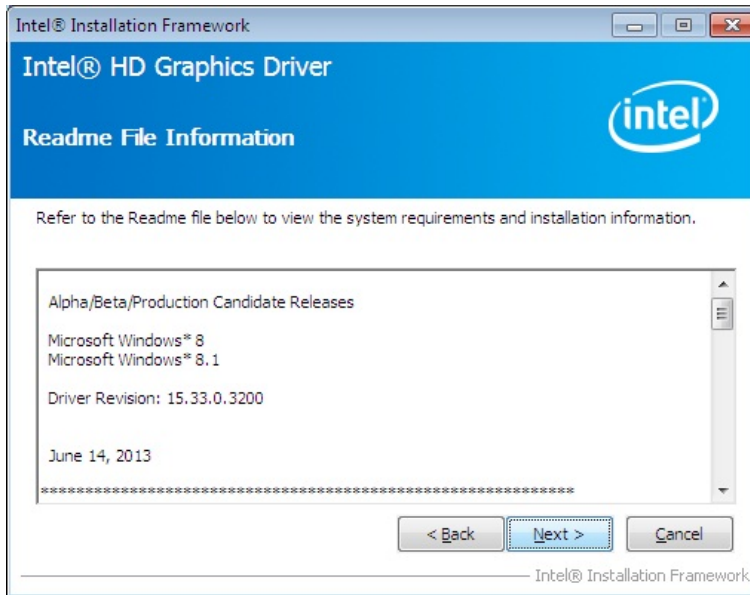

Figure 6-8: Graphics Driver Read Me File

Step 9: **Setup Operations** are performed as shown in **Figure 6-9**.

Step 10: Once the **Setup Operations** are complete, click **Next** to continue.

WAFER-ULT-i1 3.5" SBC

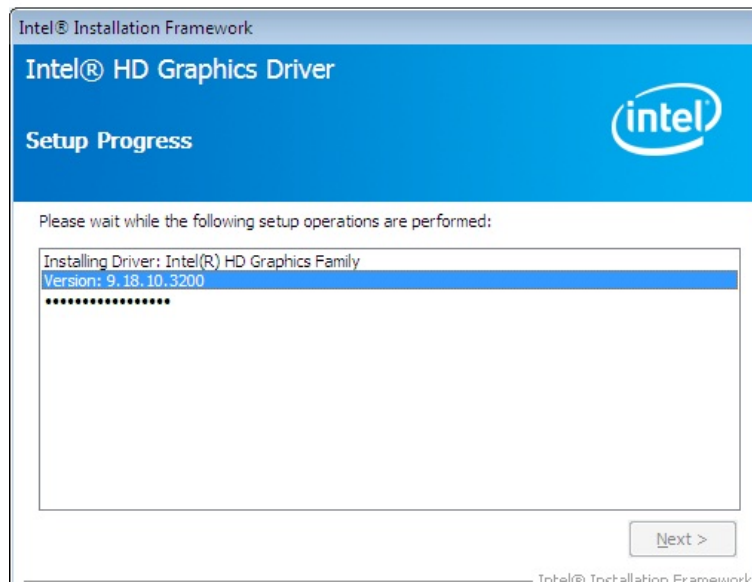

Figure 6-9: Graphics Driver Setup Operations

Step 11: The **Finish** screen in Figure 6-10 appears.

Step 12: Select “**Yes, I want to restart this computer now**” and click **Finish**.

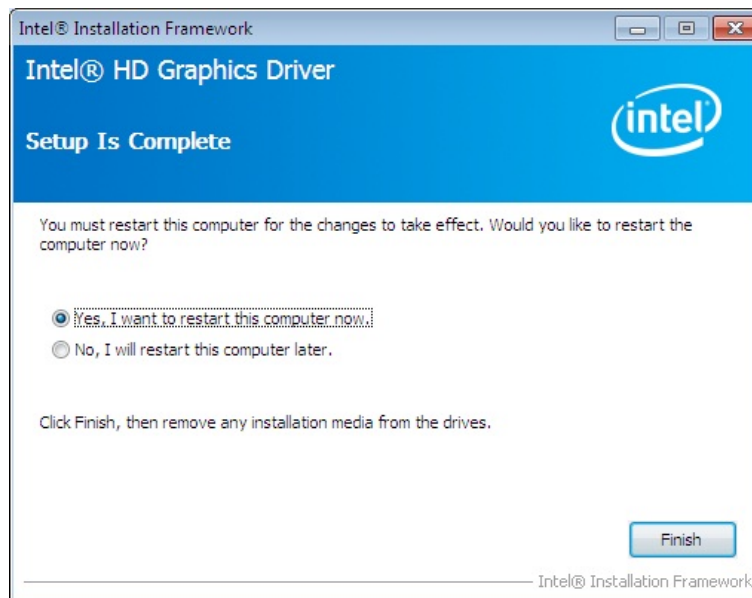

Figure 6-10: Graphics Driver Installation Finish Screen

6.5 LAN Driver Installation

To install the LAN driver, please do the following.

Step 1: Access the driver list. (See **Section 6.2**)

Step 2: Click **LAN**.

Step 3: Select the folder with the driver of correspondent LAN controller.

Step 4: Locate the Autorun file and double click on it.

Step 5: The Intel® Network Connection menu in **Figure 6-11** appears.

Step 6: Click **Install Drivers and Software**.

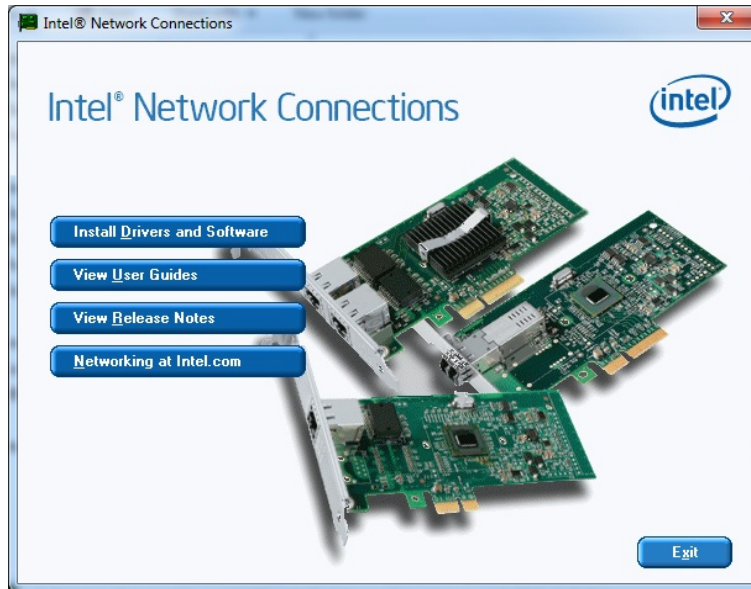

Figure 6-11: Intel® Network Connection Menu

Step 7: The **Welcome** screen in **Figure 6-12** appears.

WAFER-ULT-i1 3.5" SBC

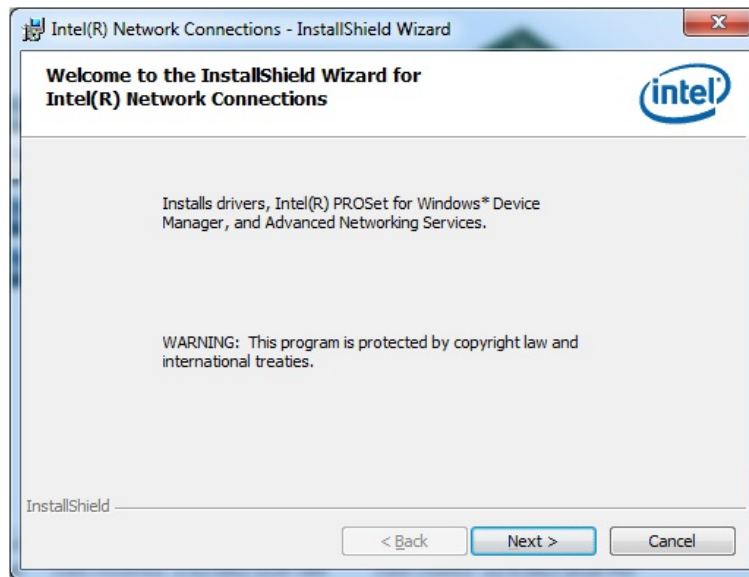

Figure 6-12: LAN Driver Welcome Screen

Step 8: Click **Next** to continue.

Step 9: The **License Agreement** in Figure 6-13 appears.

Step 10: Accept the agreement by selecting "I accept the terms in the license agreement".

Step 11: Click **Next** to continue.

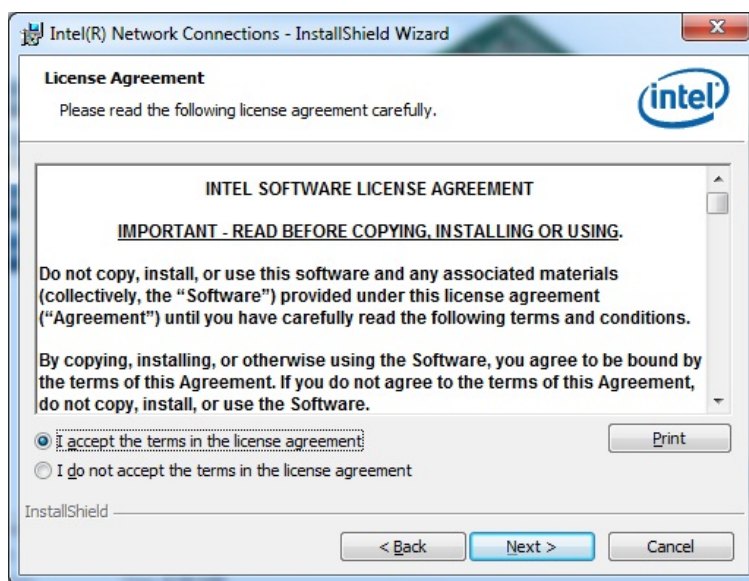

Figure 6-13: LAN Driver License Agreement

Step 12: The **Setup Options** screen in **Figure 6-14** appears.

Step 13: Select program features to install.

Step 14: Click **Next** to continue.

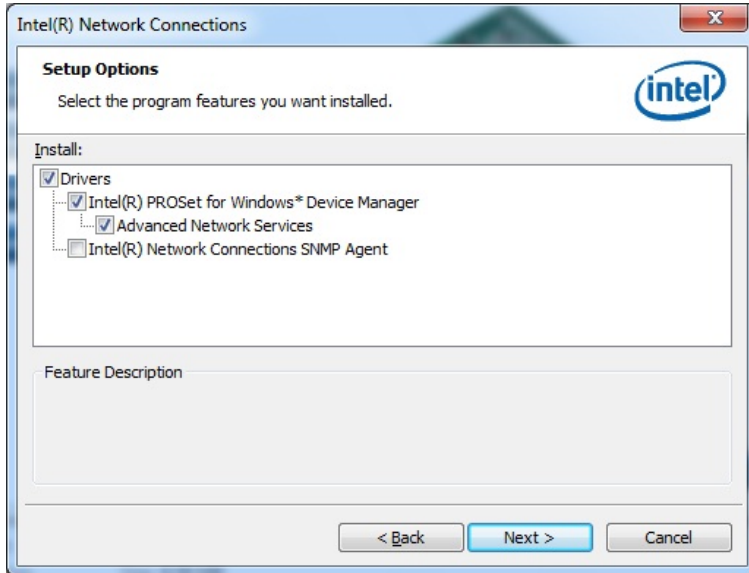

Figure 6-14: LAN Driver Setup Options

Step 15: The **Ready to Install the Program** screen in **Figure 6-15** appears.

Step 16: Click **Install** to proceed with the installation.

WAFER-ULT-i1 3.5" SBC

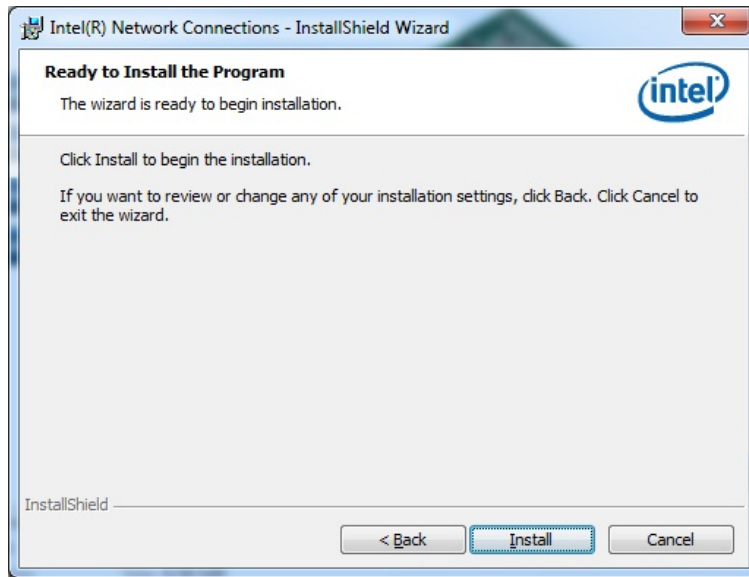

Figure 6-15: LAN Driver Installation

Step 17: The program begins to install.

Step 18: When the driver installation is complete, the screen in **Figure 6-16** appears.

Step 19: Click **Finish** to exit.

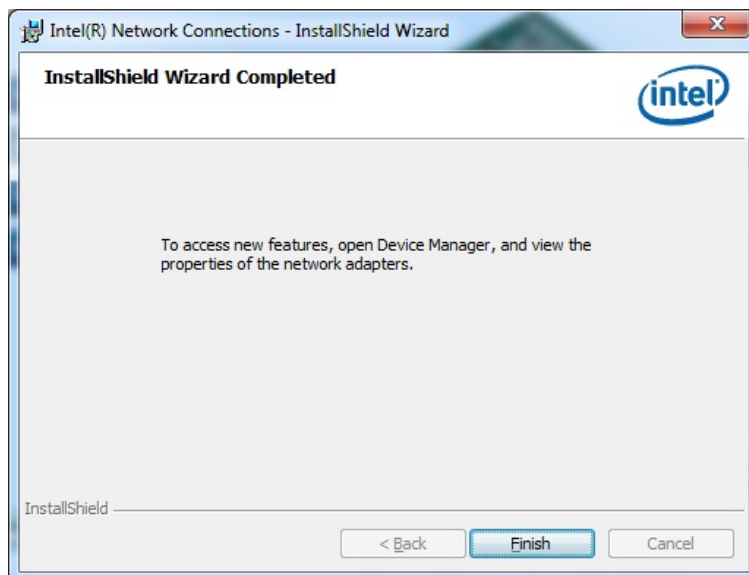

Figure 6-16: LAN Driver Installation Complete

6.6 Audio Driver Installation

To install the audio driver, please do the following.

Step 1: Access the driver list. (See **Section 6.2**)

Step 2: Click **Audio** and select the folder which corresponds to the operating system.

Step 3: Double click the setup file.

Step 4: The **InstallShield Wizard** is prepared to guide the user through the rest of the process.

Step 5: Once initialized, the **InstallShield Wizard** welcome screen appears (**Figure 6-17**).

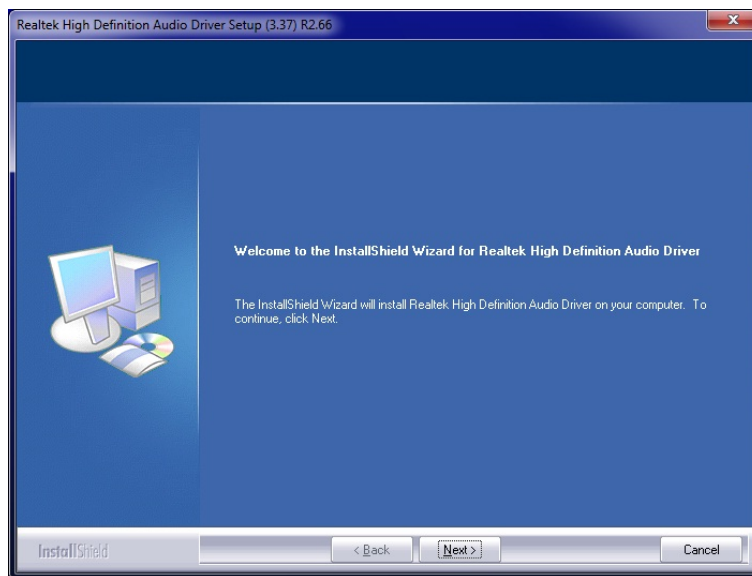

Figure 6-17: InstallShield Wizard Welcome Screen

Step 6: Click **Next** to continue the installation.

Step 7: InstallShield starts to install the new software as shown in **Figure 6-18**.

WAFER-ULT-i1 3.5" SBC

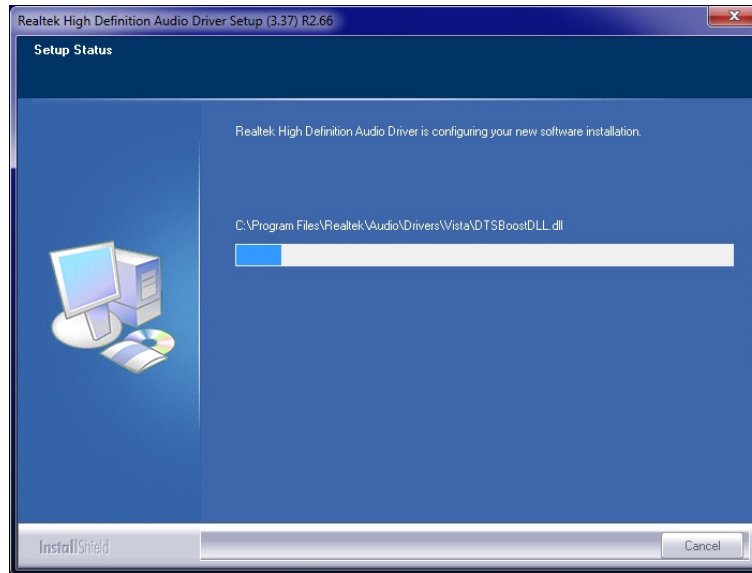

Figure 6-18: Audio Driver Software Configuration

Step 8: After the driver installation process is complete, a confirmation screen appears (Figure 6-19).

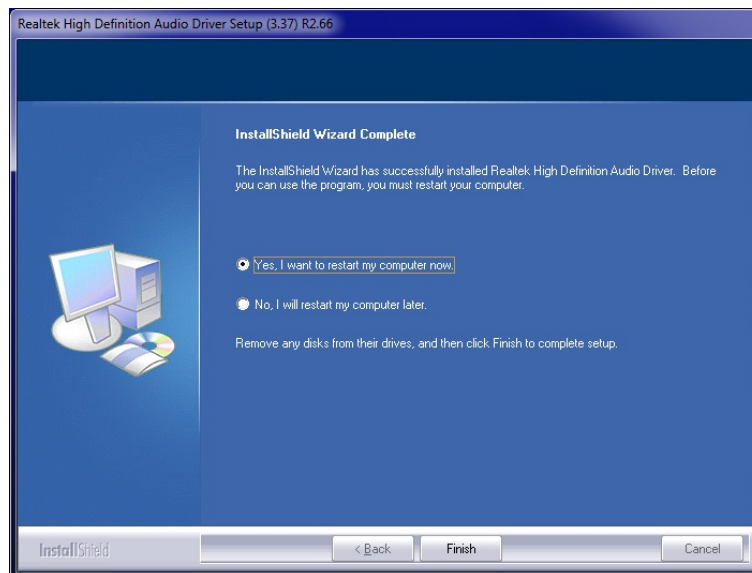

Figure 6-19: Restart the Computer

Step 9: The confirmation screen offers the option of restarting the computer now or later. For the settings to take effect, the computer must be restarted. Click **Finish** to restart the computer.

6.7 USB 3.0 Driver Installation



WARNING:

Do not run this driver's installer (Setup.exe) from a USB storage device (ie. external USB hard drive or USB thumb drive). For proper installation, please copy driver files to a local hard drive folder and run from there.

To install the USB 3.0 driver, please follow the steps below.

- Step 1:** Access the driver list. (See **Section 6.2**)
- Step 2:** Click **USB3.0**.
- Step 3:** Locate the setup file and double click on it.
- Step 4:** A **Welcome Screen** appears (**Figure 6-20**).
- Step 5:** Click **Next** to continue.



Figure 6-20: USB 3.0 Driver Welcome Screen

- Step 6:** The license agreement in **Figure 6-21** appears.

WAFER-ULT-i1 3.5" SBC

Step 7: Read the License Agreement.

Step 8: Click **Yes** to continue.



Figure 6-21: USB 3.0 Driver License Agreement

Step 9: The Read Me file in Figure 6-22 appears.

Step 10: Click **Next** to continue.



Figure 6-22: USB 3.0 Driver Read Me File

Step 11: Setup Operations are performed as shown in **Figure 6-23**.

Step 12: Once the **Setup Operations** are complete, click **Next** to continue.

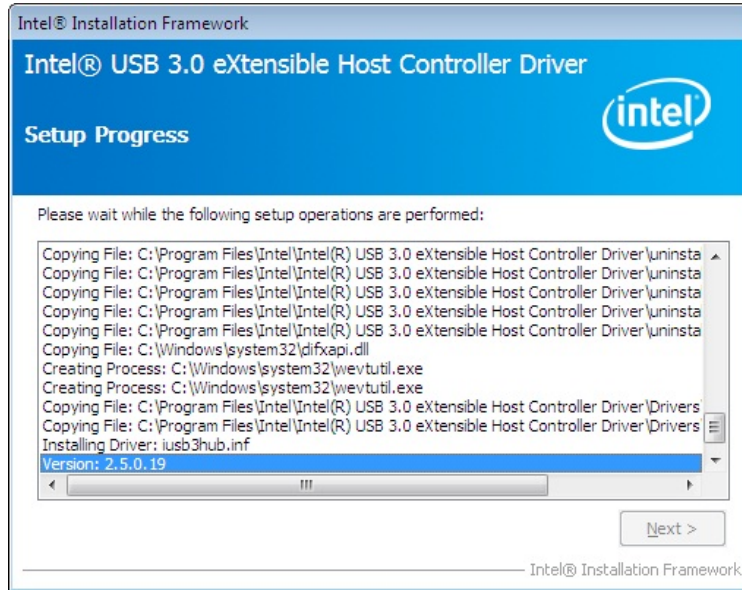

Figure 6-23: USB 3.0 Driver Setup Operations

Step 13: The **Finish** screen in **Figure 6-24** appears.

Step 14: Select “**Yes, I want to restart this computer now**” and click **Finish**.



Figure 6-24: USB 3.0 Driver Installation Finish Screen

6.8 Intel® AMT Driver Installation

The package of the Intel® ME components includes

- Intel® Management Engine Interface (Intel® ME Interface)
- Intel® Dynamic Application Loader
- Intel® Identity Protection Technology (Intel® IPT)
- Serial Over LAN (SOL) driver
- Intel® Management and Security Status Application
- Local Manageability Service (LMS)

To install these Intel® ME components, please do the following.

Step 1: Access the driver list. (See **Section 6.2**)

Step 2: Click **iAMT Driver & Utility**.

Step 3: Double click the setup file in the **ME_SW** folder.

Step 4: When the setup files are completely extracted the **Welcome Screen** in **Figure 6-25** appears.

Step 5: Click **Next** to continue.

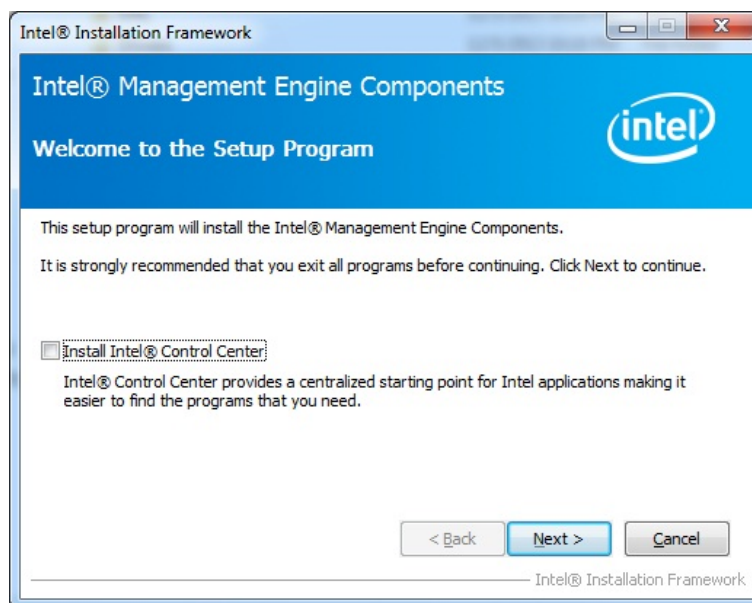

Figure 6-25: Intel® ME Driver Welcome Screen

Step 6: The license agreement in **Figure 6-26** appears.

Step 7: Read the **License Agreement**.

Step 8: Click **Yes** to continue.

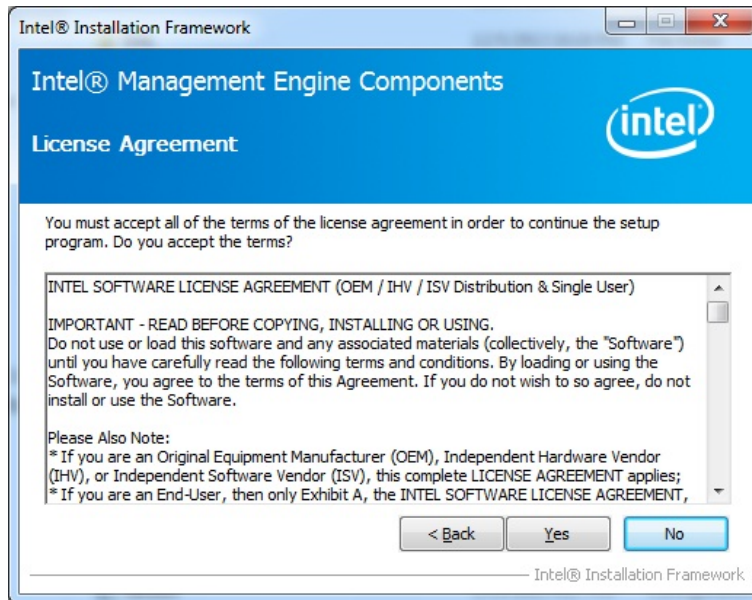

Figure 6-26: Intel® ME Driver License Agreement

Step 9: **Setup Operations** are performed as shown in **Figure 6-27**.

Step 10: Once the **Setup Operations** are complete, click **Next** to continue.

WAFER-ULT-i1 3.5" SBC

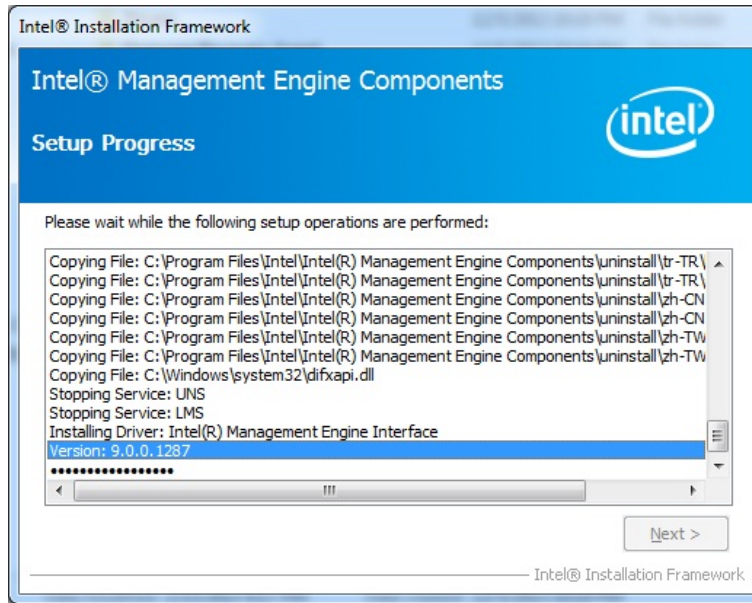

Figure 6-27: Intel® ME Driver Setup Operations

Step 11: The **Finish** screen in **Figure 6-28** appears.

Step 12: Select **“Yes, I want to restart this computer now”** and click **Finish**.



Figure 6-28: Intel® ME Driver Installation Finish Screen

Appendix

A

BIOS Options

WAFER-ULT-i1 3.5" SBC

Below is a list of BIOS configuration options in the BIOS chapter.

System Date [xx/xx/xx]	80
System Time [xx:xx:xx]	80
ACPI Sleep State [S1 only (CPU Stop Clock)]	81
Wake system with Fixed Time [Disabled]	82
Hyper-threading [Enabled]	83
Intel Virtualization Technology [Disabled]	84
SATA Controller(s) [Enabled]	84
SATA Mode Selection [AHCI]	84
Hot Plug [Disabled]	85
Intel(R) Rapid Start Technology [Disabled]	85
Intel AMT [Enabled]	86
Un-Configure ME [Disabled]	86
USB Devices	87
Legacy USB Support [Enabled]	87
Serial Port [Enabled]	89
Change Settings [Auto]	89
Serial Port [Enabled]	90
Change Settings [Auto]	90
Serial Port [Enabled]	91
Change Settings [Auto]	91
Serial Port [Enabled]	92
Change Settings [Auto]	92
SYS Smart Fan Control [Auto PWM Mode]	95
Temperature of Off	95
Temperature Of Start	95
Start PWM	96
Slope (Duty Cycle)	96
Console Redirection [Disabled]	96
Terminal Type [ANSI]	97
Bits per second [115200]	97
Data Bits [8]	97
Parity [None]	98
Stop Bits [1]	98

Flow Control [None].....	98
VT-UTF8 Combo Key Support [Enabled].....	98
Recorder Mode [Disabled]	99
Resolution 100x31 [Disabled].....	99
Legacy OS Redirection Resolution [80x24]	99
Putty KeyPad [VT100].....	99
Auto Recovery Function [Disabled].....	100
Restore AC Power Loss [Last State]	102
Power Saving Function(EUP) [Disabled].....	102
VT-d [Enabled].....	103
Primary IGFX Boot Display [VBIOS Default]	103
Active LFP [eDP Port-A].....	104
DVMT Pre-Allocated [256M]	104
DVMT Total Gfx Mem [MAX].....	104
Bootup NumLock State [On].....	106
Quiet Boot [Enabled]	106
Option ROM Messages [Force BIOS].....	106
Boot option filter [Legacy only].....	107
Launch PXE OpROM [Disabled].....	107
Administrator Password	108
User Password	108
Save Changes and Reset	108
Discard Changes and Reset	108
Restore Defaults	109
Save as User Defaults	109
Restore User Defaults	109

Appendix

B

One Key Recovery

B.1 One Key Recovery Introduction

The IEI one key recovery is an easy-to-use front end for the Norton Ghost system backup and recovery tool. This tool provides quick and easy shortcuts for creating a backup and reverting to that backup or reverting to the factory default settings.



NOTE:

The latest One Key Recovery software provides an auto recovery function that allows a system running Microsoft Windows OS to automatically restore from the factory default image after encountering a Blue Screen of Death (BSOD) or a hang for around 10 minutes. Please refer to Section B.3 for the detailed setup procedure.

The IEI One Key Recovery tool menu is shown below.

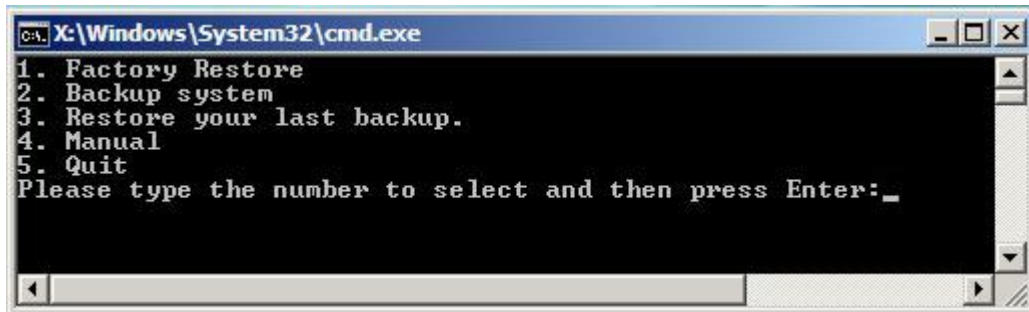

Figure B-1: IEI One Key Recovery Tool Menu

Prior to using the IEI One Key Recovery tool (as shown in **Figure B-1**) to backup or restore Windows system, five setup procedures are required.

1. Hardware and BIOS setup (see **Section B.2.1**)
2. Create partitions (see **Section B.2.2**)
3. Install operating system, drivers and system applications (see **Section B.2.3**)
4. Build the recovery partition (see **Section B.2.4**)
5. Create factory default image (see **Section B.2.5**)

WAFER-ULT-i1 3.5" SBC

After completing the five initial setup procedures as described above, users can access the recovery tool by pressing <F3> while booting up the system. The detailed information of each function is described in **Section B.5**.



NOTE:

The initial setup procedures for Linux system are described in **Section B.3**.

B.1.1 System Requirement



NOTE:

The recovery CD can only be used with IEI products. The software will fail to run and a warning message will appear when used on non-IEI hardware.

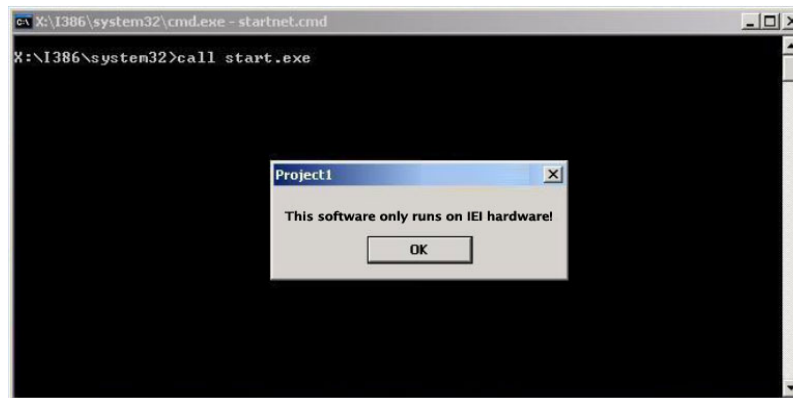

To create the system backup, the main storage device must be split into two partitions (three partitions for Linux). The first partition will be for the operating system, while the second partition will be invisible to the operating system and contain the backup made by the one key recovery software.

The partition created for recovery images must be big enough to contain both the factory default image and the user backup image. The size must be calculated before creating the

partitions. Please take the following table as a reference when calculating the size of the partition.

	OS	OS Image after Ghost	Compression Ratio
Windows® 7	7 GB	5 GB	70%
Windows® XPE	776 MB	560 MB	70%
Windows® CE 6.0	36 MB	28 MB	77%



NOTE:

Specialized tools are required to change the partition size if the operating system is already installed.

B.1.2 Supported Operating System

The recovery CD is compatible with both Microsoft Windows and Linux operating systems (OS). The supported OS versions are listed below.

- Microsoft Windows
 - Windows 2000
 - Windows XP (Service Pack 2 or 3 required)
 - Windows Vista
 - Windows 7
 - Windows CE 5.0
 - Windows CE 6.0
 - Windows XP Embedded
 - Windows Embedded Standard 7



NOTE:

The auto recovery function (described in Section B.3) and the restore through LAN function (described in Section B.6) are not supported in the Windows CE 5.0/6.0 operating system environment.

WAFER-ULT-i1 3.5" SBC

- Linux
 - Fedora Core 12 (Constantine)
 - Fedora Core 11 (Leonidas)
 - Fedora Core 10 (Cambridge)
 - Fedora Core 8 (Werewolf)
 - Fedora Core 7 (Moonshine)
 - RedHat RHEL-5.4
 - RedHat 9 (Ghirke)
 - Ubuntu 8.10 (Intrepid)
 - Ubuntu 7.10 (Gutsy)
 - Ubuntu 6.10 (Edgy)
 - Debian 5.0 (Lenny)
 - Debian 4.0 (Etch)
 - SuSe 11.2
 - SuSe 10.3



NOTE:

Installing unsupported OS versions may cause the recovery tool to fail.

B.2 Setup Procedure for Windows

Prior to using the recovery tool to backup or restore, a few setup procedures are required.

Step 1: Hardware and BIOS setup (see **Section B.2.1**)

Step 2: Create partitions (see **Section B.2.2**)

Step 3: Install operating system, drivers and system applications (see **Section B.2.3**)

Step 4: Build the recovery partition (see **Section B.2.4**) or build the auto recovery partition (see **Section B.3**)

Step 5: Create factory default image (see **Section B.2.5**)

The detailed descriptions are described in the following sections.

**NOTE:**

The setup procedures described below are for Microsoft Windows operating system users. For Linux, most of the setup procedures are the same except for several steps described in **Section B.3**.

B.2.1 Hardware and BIOS Setup

- Step 1:** Make sure the system is powered off and unplugged.
- Step 2:** Install a hard drive or SSD in the system. An unformatted and unpartitioned disk is recommended.
- Step 3:** Connect an optical disk drive to the system and insert the recovery CD.
- Step 4:** Turn on the system.
- Step 5:** Press the <DELETE> key as soon as the system is turned on to enter the BIOS.
- Step 6:** Select the connected optical disk drive as the 1st boot device. (**Boot → Boot Device Priority → 1st Boot Device**).
- Step 7:** Save changes and restart the computer. Continue to the next section for instructions on partitioning the internal storage.

B.2.2 Create Partitions

To create the system backup, the main storage device must be split into two partitions (three partitions for Linux). The first partition will be for the operating system, while the second partition will be invisible to the operating system and contain the backup made by the one key recovery software.

- Step 1:** Put the recovery CD in the optical drive of the system.

WAFER-ULT-i1 3.5" SBC

Step 2: Boot the system from recovery CD. When prompted, press any key to boot from the recovery CD. It will take a while to launch the recovery tool. Please be patient!

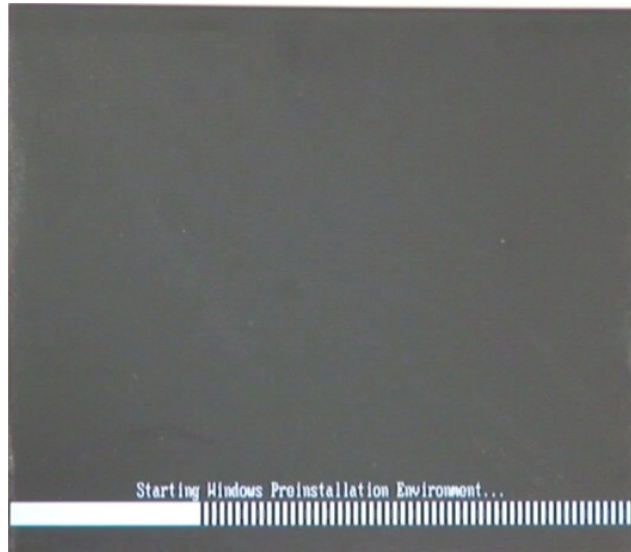

Figure B-2: Launching the Recovery Tool

Step 3: The recovery tool setup menu is shown as below.

```
C:\WINDOWS\system32\cmd.exe

1.Execute Ghost
2.Manual Recovery environment For Windows
3.Manual Recovery environment For Linux
4.Auto Recovery environment For Windows
5.Exit
6.Command Prompt
Type the number to print text.
```

Figure B-3: Recovery Tool Setup Menu

Step 4: Press <6> then <Enter>.

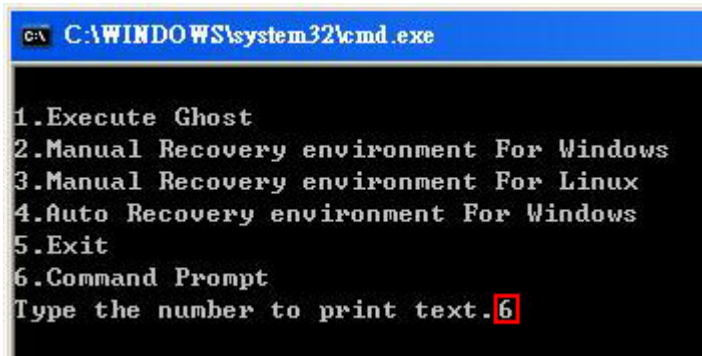

```
C:\WINDOWS\system32\cmd.exe

1.Execute Ghost
2.Manual Recovery environment For Windows
3.Manual Recovery environment For Linux
4.Auto Recovery environment For Windows
5.Exit
6.Command Prompt
Type the number to print text. 6
```

Figure B-4: Command Prompt

Step 5: The command prompt window appears. Type the following commands (marked in red) to create two partitions. One is for the OS installation; the other is for saving recovery files and images which will be an invisible partition. (Press <Enter> after entering each line below)

```
system32>diskpart
DISKPART>list vol
DISKPART>sel disk 0
DISKPART>create part pri size= ____
DISKPART>assign letter=N
DISKPART>create part pri size= ____
DISKPART>assign letter=F
DISKPART>exit
system32>format N: /fs:ntfs /q /y
system32>format F: /fs:ntfs /q /v:Recovery /y
system32>exit
```

WAFER-ULT-i1 3.5" SBC

```

X:\I386\SYSTEM32\CMD.EXE
X:\I386\SYSTEM32>diskpart → Starts the Microsoft disk partitioning tool.

Microsoft DiskPart version 5.2.3790.1830
Copyright (C) 1999-2001 Microsoft Corporation.
On computer: MININT-JUC

DISKPART> list vol → Show partition information

   Volume ###  Ltr  Label          Fs          Type          Size         Status       Info
   -----  -  -  -  -  -  -  -  -  -
   Volume 0             X   CD_ROM        CDFS        DUD-ROM        405 MB    Healthy     Boot
   Volume 1             D                   FAT32    Removeable    3854 MB    Healthy

DISKPART> sel disk 0 → Select a disk
Disk 0 is now the selected disk.

DISKPART> create part pri size=2000 → Create partition 1 and assign a size.
This partition is for OS installation.
DiskPart succeeded in creating the specified partition.

DISKPART> assign letter=N → Assign partition 1 a code name (N).
DiskPart successfully assigned the drive letter or mount point.

DISKPART> create part pri size=1800 → Create partition 2 and assign a size.
This partition is for recovery images.
DiskPart succeeded in creating the specified partition.

DISKPART> assign letter=F → Assign partition 2 a code name (F).
DiskPart successfully assigned the drive letter or mount point.

DISKPART> exit → Exit diskpart

X:\I386\SYSTEM32>format n: /fs:ntfs /q /y → Format partition 1 (N) as NTFS format.
The type of the file system is RAW.
The new file system is NTFS.
QuickFormatting 2000M
Creating file system structures.
Format complete.
 2048254 KB total disk space.
 2035620 KB are available.

X:\I386\SYSTEM32>format f: /fs:ntfs /q /v:Recovery /y
The type of the file system is RAW.
The new file system is NTFS.
QuickFormatting 1804M
Creating file system structures.
Format complete.
 1847474 KB total disk space.
 1835860 KB are available.

X:\I386\SYSTEM32>exit → Exit Windows PE

```

Figure B-5: Partition Creation Commands

**NOTE:**

Use the following commands to check if the partitions were created successfully.

```
X:\I386\SYSTEM32>diskpart
Microsoft DiskPart version 5.2.3790.1830
Copyright (C) 1999-2001 Microsoft Corporation.
On computer: MININT-JUC

DISKPART> sel disk 0
Disk 0 is now the selected disk.

DISKPART> list part

   Partition ###   Type              Size              Offset
-----
   Partition 1     Primary           2000 MB           32 KB
   Partition 2     Primary           1804 MB           2000 MB

DISKPART> exit
```

Step 6: Press any key to exit the recovery tool and automatically reboot the system.

Please continue to the following procedure: Build the Recovery Partition.

B.2.3 Install Operating System, Drivers and Applications

Install the operating system onto the unlabelled partition. The partition labeled "Recovery" is for use by the system recovery tool and should not be used for installing the operating system or any applications.

**NOTE:**

The operating system installation program may offer to reformat the chosen partition. DO NOT format the partition again. The partition has already been formatted and is ready for installing the new operating system.

To install the operating system, insert the operating system installation CD into the optical drive. Restart the computer and follow the installation instructions.

WAFER-ULT-i1 3.5" SBC

B.2.4 Building the Recovery Partition

- Step 1:** Put the recover CD in the optical drive.
- Step 2:** Start the system.
- Step 3:** **Boot the system from the recovery CD.** When prompted, press any key to boot from the recovery CD. It will take a while to launch the recovery tool. Please be patient!

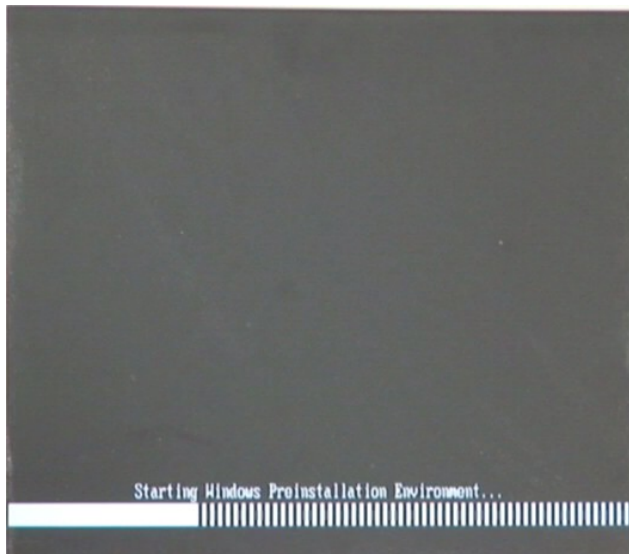

Figure B-6: Launching the Recovery Tool

- Step 4:** When the recovery tool setup menu appears, press <2> then <Enter>.

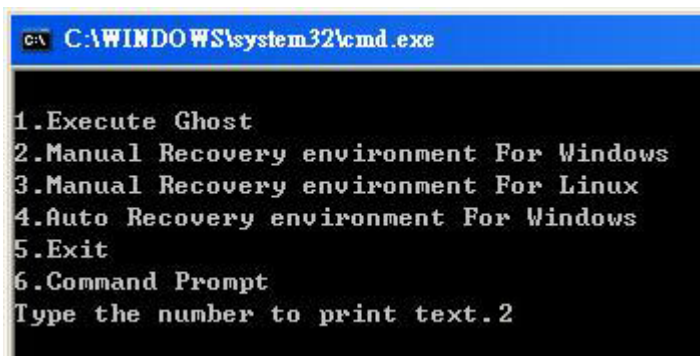

Figure B-7: Manual Recovery Environment for Windows

Step 5: The Symantec Ghost window appears and starts configuring the system to build a recovery partition. In this process the partition created for recovery files in **Section B.2.2** is hidden and the recovery tool is saved in this partition.

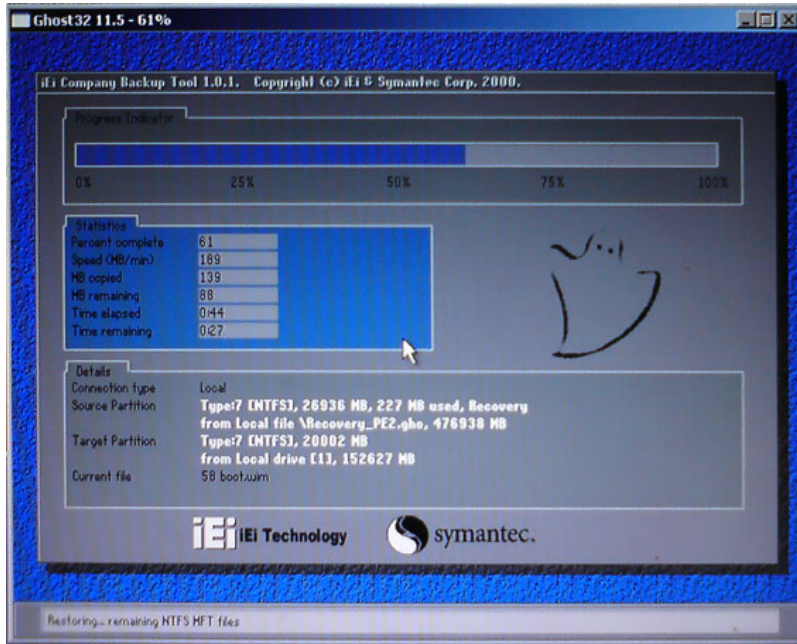

Figure B-8: Building the Recovery Partition

Step 6: After completing the system configuration, press any key in the following window to reboot the system.

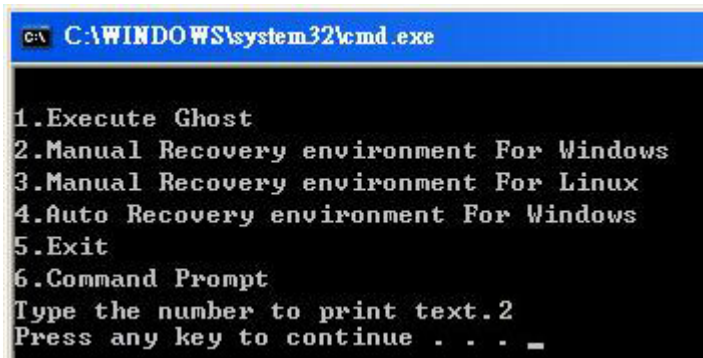

Figure B-9: Press Any Key to Continue

Step 7: Eject the recovery CD.

WAFER-ULT-i1 3.5" SBC

B.2.5 Create Factory Default Image

**NOTE:**

Before creating the factory default image, please configure the system to a factory default environment, including driver and application installations.

To create a factory default image, please follow the steps below.

Step 1: Turn on the system. When the following screen displays (**Figure B-10**), press the <F3> key to access the recovery tool. The message will display for 10 seconds, please press F3 before the system boots into the operating system.

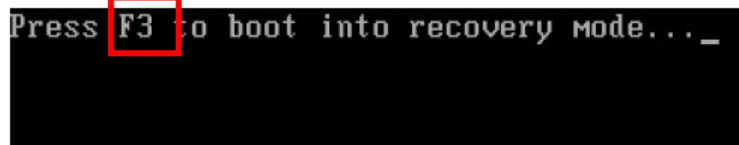

Figure B-10: Press F3 to Boot into Recovery Mode

Step 2: The recovery tool menu appears. Type <4> and press <Enter>. (**Figure B-11**)

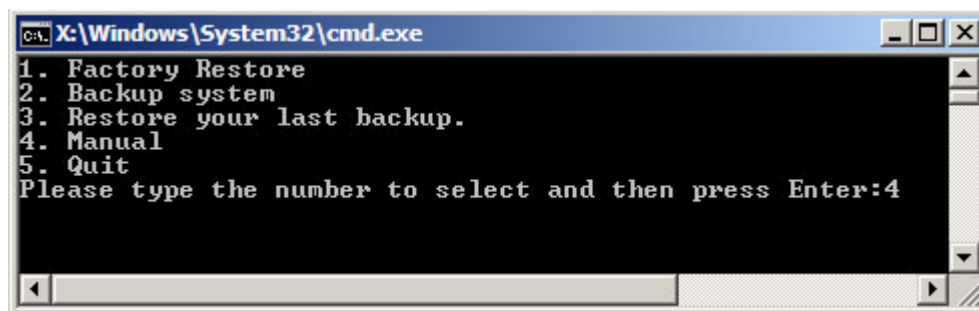

Figure B-11: Recovery Tool Menu

Step 3: The About Symantec Ghost window appears. Click **OK** button to continue.

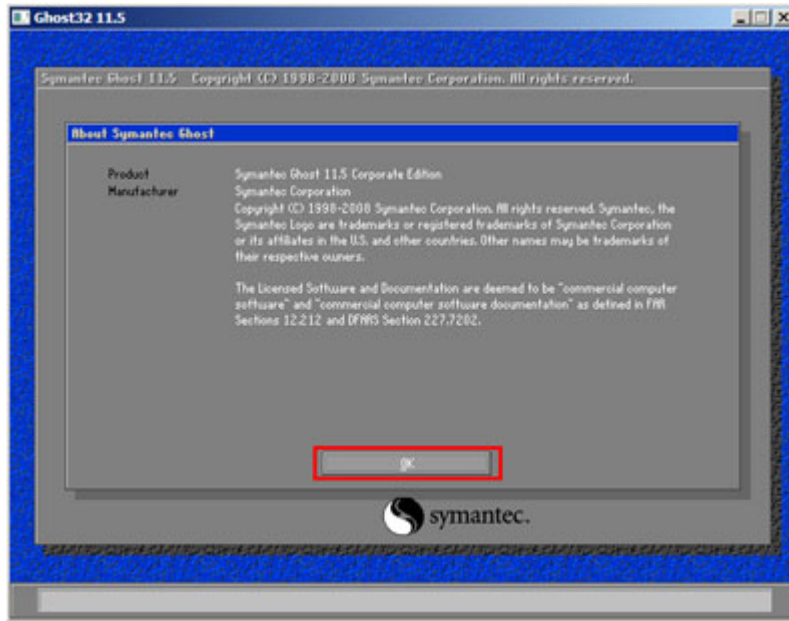

Figure B-12: About Symantec Ghost Window

Step 4: Use mouse to navigate to the option shown below (Figure B-13).

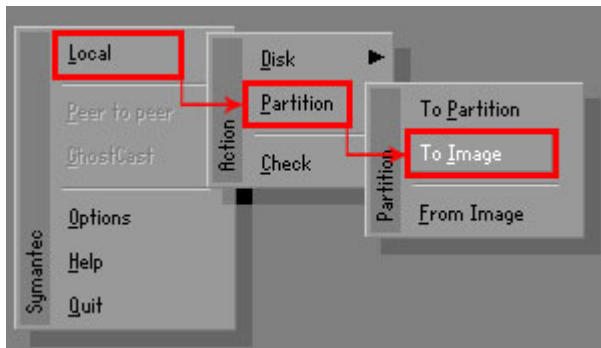

Figure B-13: Symantec Ghost Path

Step 5: Select the local source drive (Drive 1) as shown in Figure B-14. Then click OK.

WAFER-ULT-i1 3.5" SBC

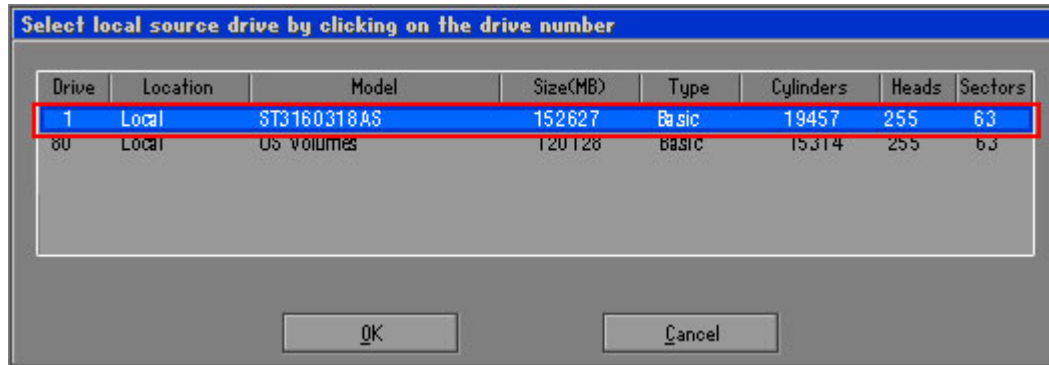

Figure B-14: Select a Local Source Drive

Step 6: Select a source partition (Part 1) from basic drive as shown in **Figure B-15**. Then click OK.

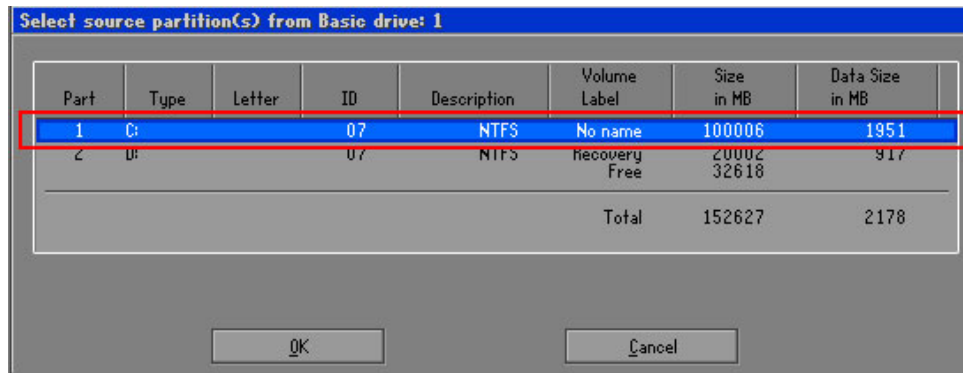

Figure B-15: Select a Source Partition from Basic Drive

Step 7: Select **1.2: [Recovery] NTFS drive** and enter a file name called **iei** (**Figure B-16**). Click **Save**. The factory default image will then be saved in the selected recovery drive and named **IEI.GHO**.



WARNING:

The file name of the factory default image must be **iei.GHO**.

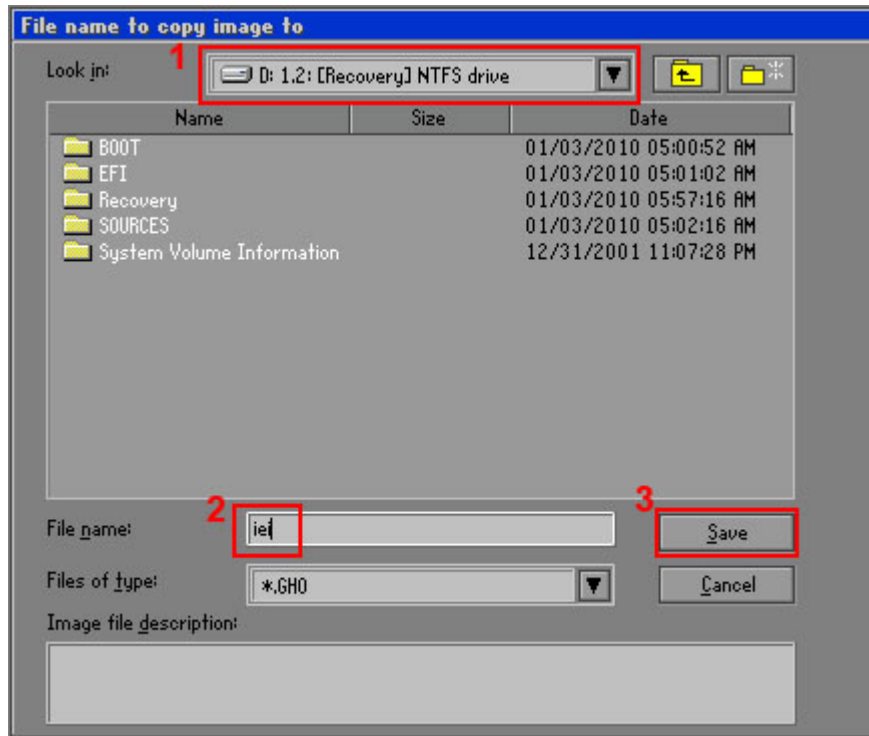

Figure B-16: File Name to Copy Image to

Step 8: When the Compress Image screen in **Figure B-17** prompts, click **High** to make the image file smaller.

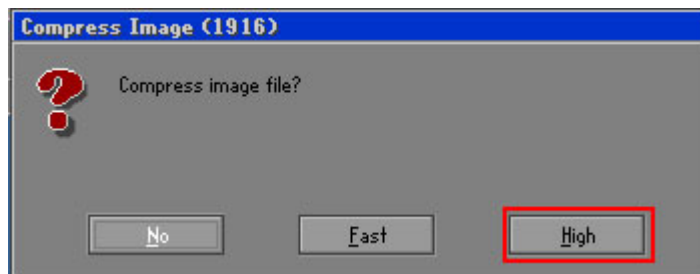

Figure B-17: Compress Image

WAFER-ULT-i1 3.5" SBC

Step 9: The Proceed with partition image creation window appears, click **Yes** to continue.

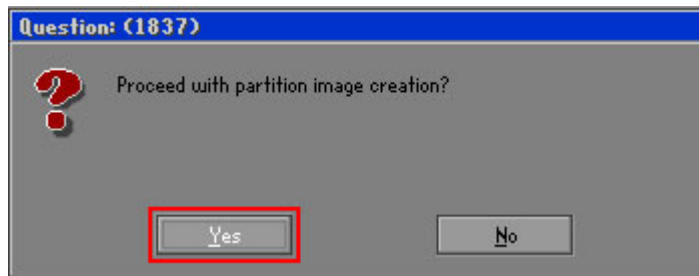

Figure B-18: Image Creation Confirmation

Step 10: The Symantec Ghost starts to create the factory default image (**Figure B-19**).

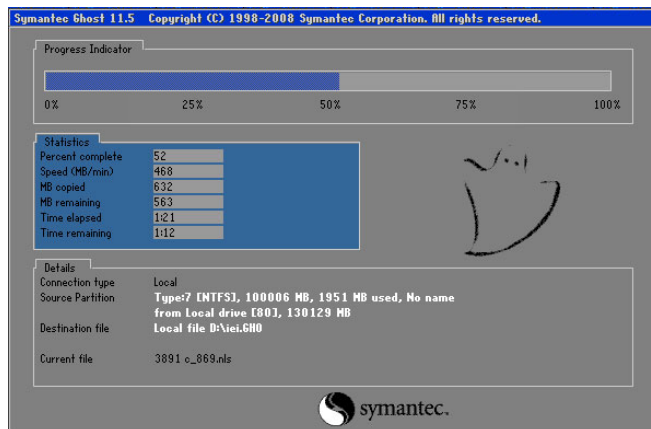

Figure B-19: Creating Image

Step 11: When the image creation completes, a screen prompts as shown in **Figure B-20**.

Click **Continue** and close the Ghost window to exit the program.

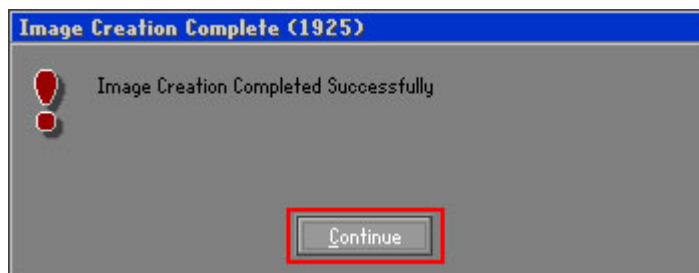
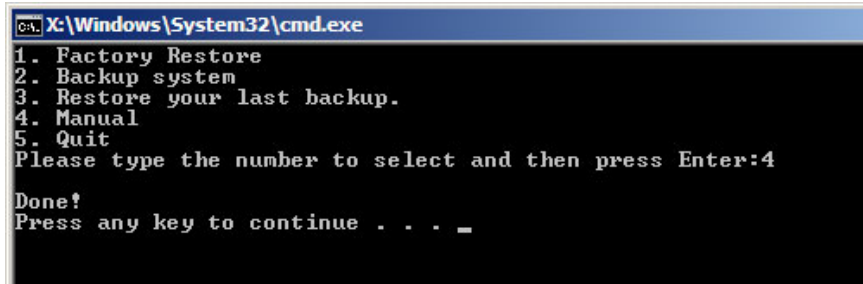

Figure B-20: Image Creation Complete

Step 12: The recovery tool main menu window is shown as below. Press any key to reboot the system.



```
C:\Windows\System32\cmd.exe
1. Factory Restore
2. Backup system
3. Restore your last backup.
4. Manual
5. Quit
Please type the number to select and then press Enter:4
Done!
Press any key to continue . . . _
```

Figure B-21: Press Any Key to Continue

B.3 Auto Recovery Setup Procedure

The auto recovery function allows a system to automatically restore from the factory default image after encountering a Blue Screen of Death (BSoD) or a hang for around 10 minutes. To use the auto recovery function, follow the steps described in the following sections.



CAUTION:

The auto recovery function can only run on a Microsoft Windows system with the following OS versions:

- Windows 2000
- Windows XP
- Windows Vista
- Windows 7
- Windows XP Embedded
- Windows Embedded Standard 7



CAUTION:

The setup procedure may include a step to create a factory default image. It is suggested to configure the system to a factory default environment before the configuration, including driver and application installations.

WAFER-ULT-i1 3.5" SBC

- Step 1:** Follow the steps described in **Section B.2.1 ~ Section B.2.3** to setup BIOS, create partitions and install operating system.
- Step 2:** Install the auto recovery utility into the system by double clicking the **Utility/AUTORECOVERY-SETUP.exe** in the One Key Recovery CD. This utility **MUST** be installed in the system, otherwise, the system will automatically restore from the factory default image every ten (10) minutes.



Figure B-22: Auto Recovery Utility

- Step 3:** **Disable the automatically restart function before creating the factory default image.** Go to: My Computer → Properties → Advanced. Click the Settings button of Startup and Recovery. Deselect “Automatically restart”. Click OK to save the settings and exit. (See Figure B-23)

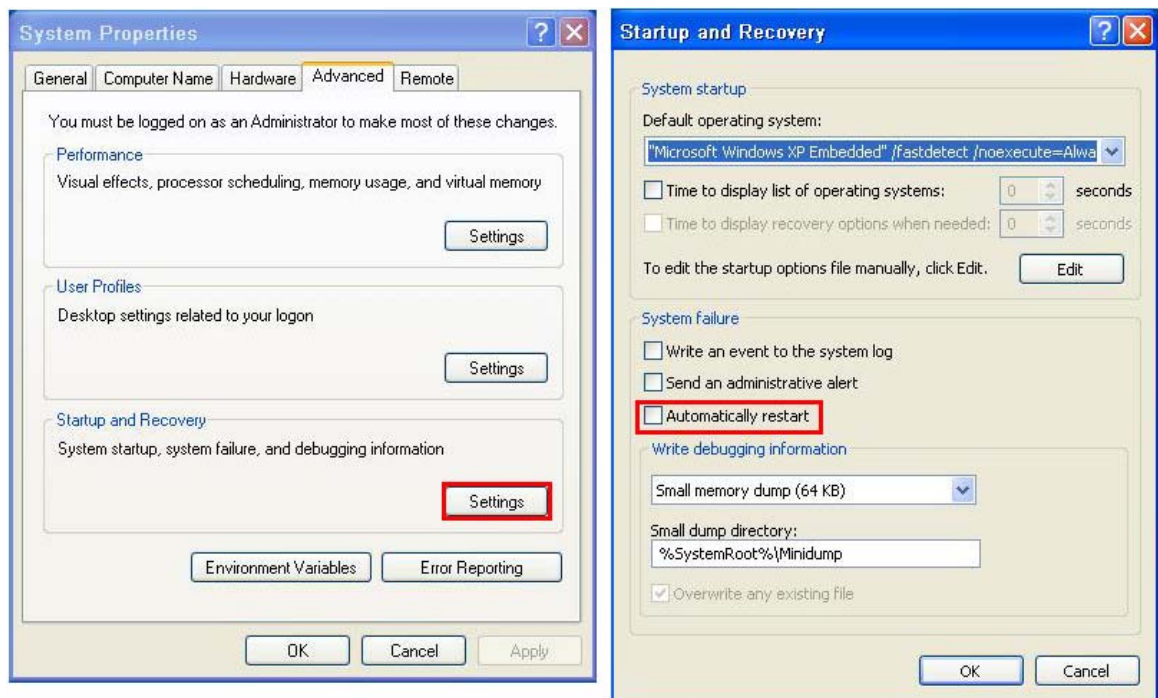

Figure B-23: Disable Automatically Restart

Step 4: Reboot the system from the recovery CD. When prompted, press any key to boot from the recovery CD. It will take a while to launch the recovery tool. Please be patient!

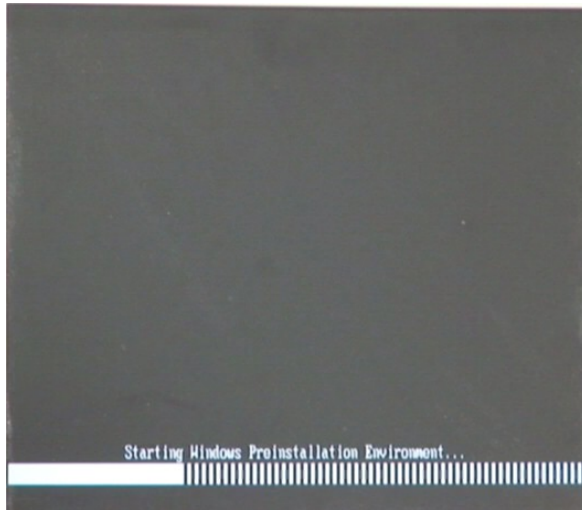

Figure B-24: Launching the Recovery Tool

Step 5: When the recovery tool setup menu appears, press <4> then <Enter>.

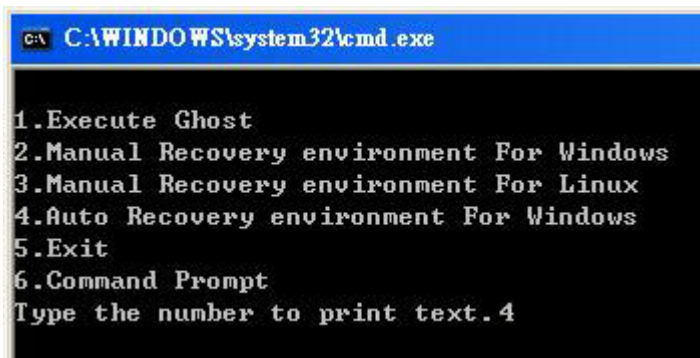

Figure B-25: Auto Recovery Environment for Windows

Step 6: The Symantec Ghost window appears and starts configuring the system to build an auto recovery partition. In this process the partition created for recovery files in **Section B.2.2** is hidden and the auto recovery tool is saved in this partition.

WAFER-ULT-i1 3.5" SBC

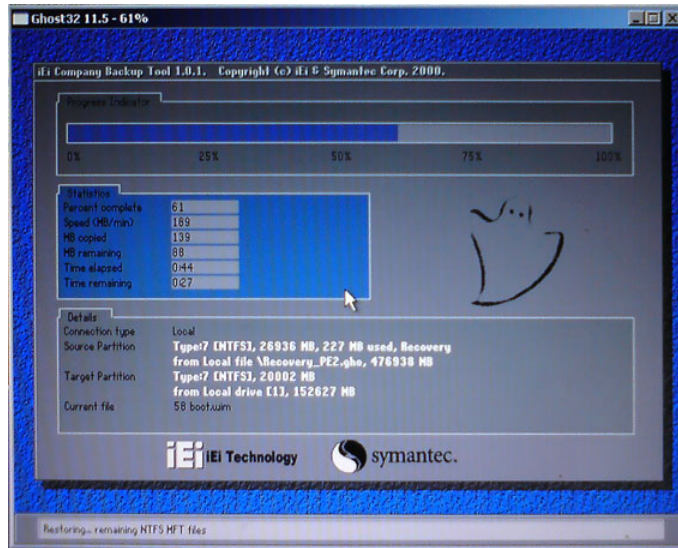

Figure B-26: Building the Auto Recovery Partition

Step 7: After completing the system configuration, the following message prompts to confirm whether to create a factory default image. Type **Y** to have the system create a factory default image automatically. Type **N** within 6 seconds to skip this process (The default option is YES). It is suggested to choose YES for this option.



Figure B-27: Factory Default Image Confirmation

Step 8: The Symantec Ghost starts to create the factory default image (**Figure B-28**).

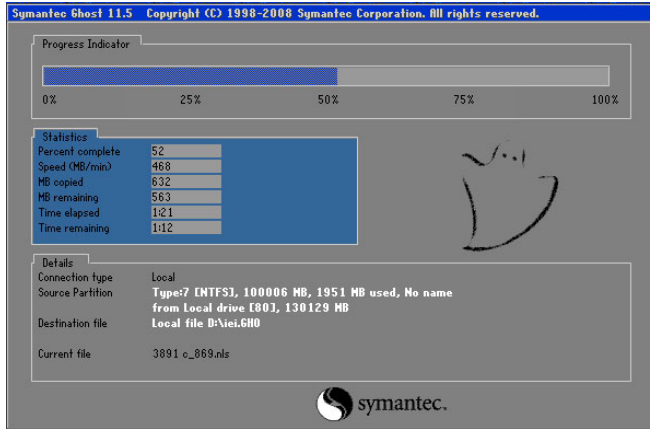

Figure B-28: Creating Image

Step 9: After completing the system configuration, press any key in the following window to restart the system.

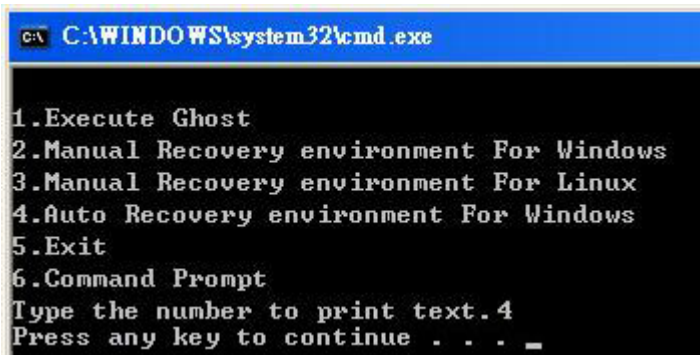

Figure B-29: Press Any Key to Continue

Step 10: Eject the One Key Recovery CD and restart the system.

Step 11: Press the <DELETE> key as soon as the system is turned on to enter the BIOS.

Step 12: Enable the Auto Recovery Function option (**Advanced** → **iEi Feature** → **Auto Recovery Function**).

WAFER-ULT-i1 3.5" SBC

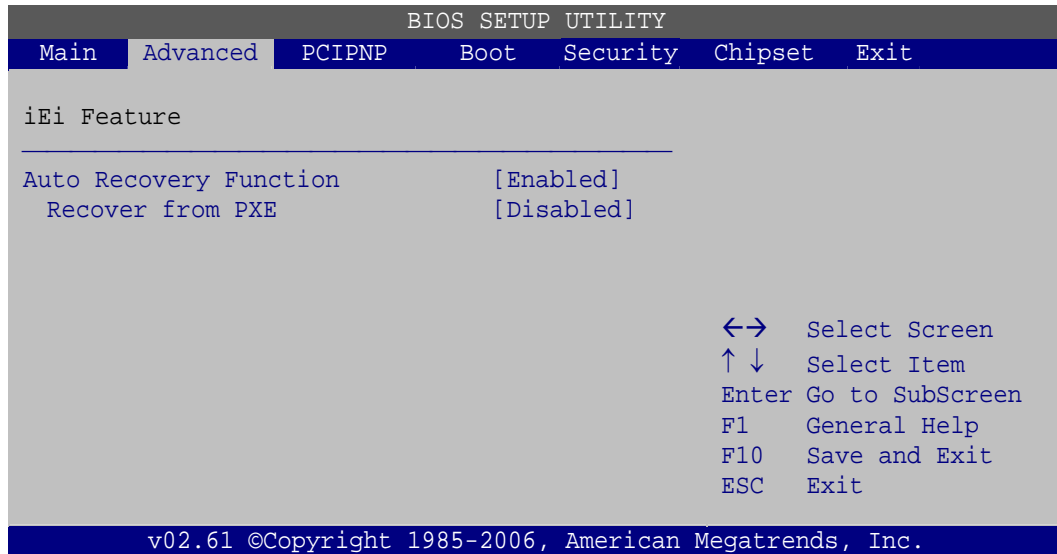

Figure B-30: IEI Feature BIOS Menu

Step 13: Save changes and restart the system. If the system encounters a Blue Screen of Death (BSoD) or a hang for around 10 minutes, it will automatically restore from the factory default image.

B.4 Setup Procedure for Linux

The initial setup procedure for Linux system is mostly the same with the procedure for Microsoft Windows. Please follow the steps below to setup recovery tool for Linux OS.

Step 1: Hardware and BIOS setup. Refer to **Section B.2.1**.

Step 2: Install Linux operating system. Make sure to install GRUB (v0.97 or earlier) MBR type and Ext3 partition type. Leave enough space on the hard drive to create the recover partition later.



NOTE:

If the Linux OS is not installed with GRUB (v0.97 or earlier) and Ext3, the Symantec Ghost may not function properly.

While installing Linux OS, please create two partitions:

- Partition 1: /
- Partition 2: SWAP

**NOTE:**

Please reserve enough space for partition 3 for saving recovery images.

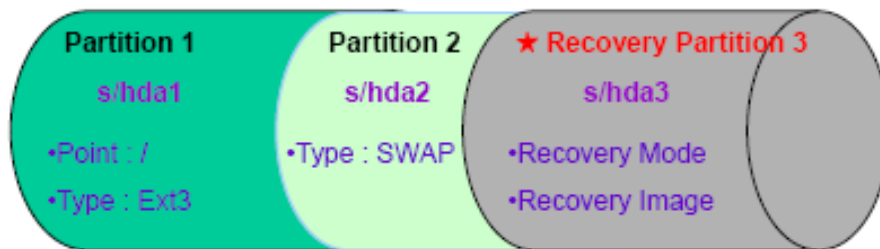

Figure B-31: Partitions for Linux

Step 3: Create a recovery partition. Insert the recovery CD into the optical disk drive.

Follow **Step 1 ~ Step 3** described in **Section B.2.2**. Then type the following commands (marked in red) to create a partition for recovery images.

```
system32>diskpart
DISKPART>list vol
DISKPART>sel disk 0
DISKPART>create part pri size= ____
DISKPART>assign letter=N
DISKPART>exit
system32>format N: /fs:ntfs /q /v:Recovery /y
system32>exit
```

Step 4: Build the recovery partition. Press any key to boot from the recovery CD. It will take a while to launch the recovery tool. Please be patient. When the recovery tool setup menu appears, type <3> and press <Enter> (**Figure B-32**). The Symantec Ghost window appears and starts configuring the system to build a

WAFER-ULT-i1 3.5" SBC

recovery partition. After completing the system configuration, press any key to reboot the system. Eject the recovery CD.

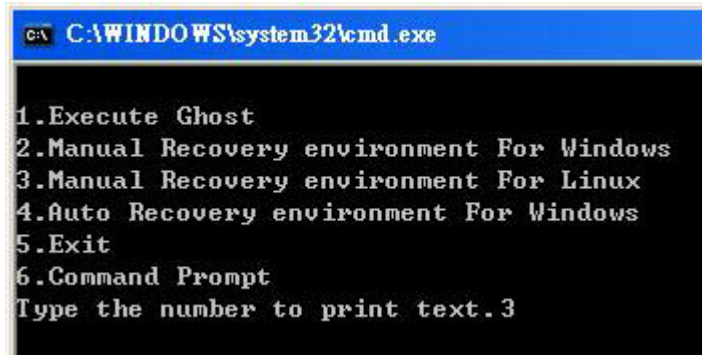

```
C:\WINDOWS\system32\cmd.exe

1.Execute Ghost
2.Manual Recovery environment For Windows
3.Manual Recovery environment For Linux
4.Auto Recovery environment For Windows
5.Exit
6.Command Prompt
Type the number to print text.3
```

Figure B-32: Manual Recovery Environment for Linux

Step 5: Access the recovery tool main menu by modifying the “menu.lst”. To first access the recovery tool main menu, the menu.lst must be modified. In Linux, enter Administrator (root). When prompt appears, type:

```
cd /boot/grub
```

```
vi menu.lst
```

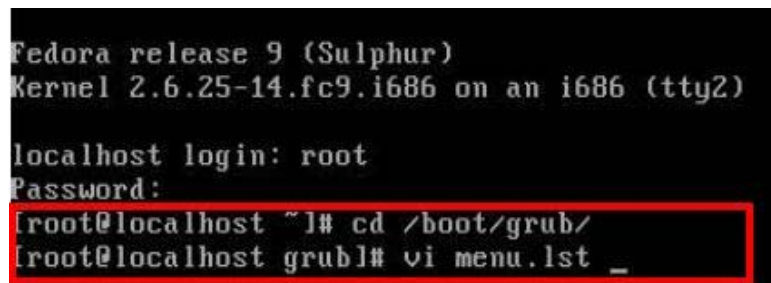

```
Fedora release 9 (Sulphur)
Kernel 2.6.25-14.fc9.i686 on an i686 (tty2)

localhost login: root
Password:
[root@localhost ~]# cd /boot/grub/
[root@localhost grub]# vi menu.lst _
```

Figure B-33: Access menu.lst in Linux (Text Mode)

Step 6: Modify the menu.lst as shown below.

```
#boot=/dev/sda
default=0
timeout=10 ← Modify timeout=10
splashimage=(hd0,0)/grub/splash.xpm.gz
hiddenmenu
title Fedora (2.6.25-14.fc9.i686)
    root (hd0,0)
    kernel /vmlinuz-2.6.25-14.fc9.i686 ro root=UUID=10f1acd
ac38b5c78910 rhgb quiet
    initrd /initrd-2.6.25-14.fc9.i686.img

title Recovery Partition
root (hd0,2)
makeactive ← Type command
chainloader +1
```

- Type command:
title Recovery Partition
root (hd0,2)
makeactive
chainloader +1

Step 7: The recovery tool menu appears. (Figure B-34)

```
1. Factory Restore
2. Backup system
3. Restore your last backup.
4. Manual
5. Quit
Please type the number to select and then press Enter:
```

Figure B-34: Recovery Tool Menu

Step 8: Create a factory default image. Follow **Step 2 ~ Step 12** described in **Section B.2.5** to create a factory default image.

B.5 Recovery Tool Functions

After completing the initial setup procedures as described above, users can access the recovery tool by pressing <F3> while booting up the system. However, if the setup procedure in Section B.3 has been completed and the auto recovery function is enabled, the system will automatically restore from the factory default image without pressing the F3 key. The recovery tool main menu is shown below.

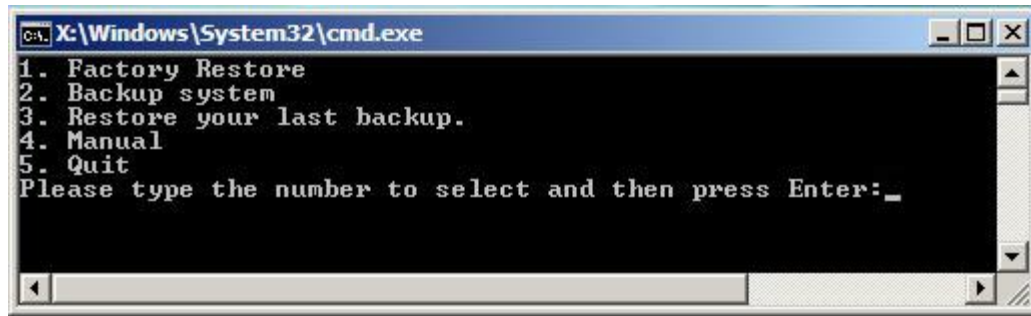

Figure B-35: Recovery Tool Main Menu

The recovery tool has several functions including:

1. **Factory Restore:** Restore the factory default image (iei.GHO) created in Section B.2.5.
2. **Backup system:** Create a system backup image (iei_user.GHO) which will be saved in the hidden partition.
3. **Restore your last backup:** Restore the last system backup image
4. **Manual:** Enter the Symantec Ghost window to configure manually.
5. **Quit:** Exit the recovery tool and restart the system.



WARNING:

Please do not turn off the system power during the process of system recovery or backup.



WARNING:

All data in the system will be deleted during the system recovery. Please backup the system files before restoring the system (either Factory Restore or Restore Backup).

B.5.1 Factory Restore

To restore the factory default image, please follow the steps below.

Step 1: Type <1> and press <Enter> in the main menu.

Step 2: The Symantec Ghost window appears and starts to restore the factory default. A factory default image called **iei.GHO** is created in the hidden Recovery partition.

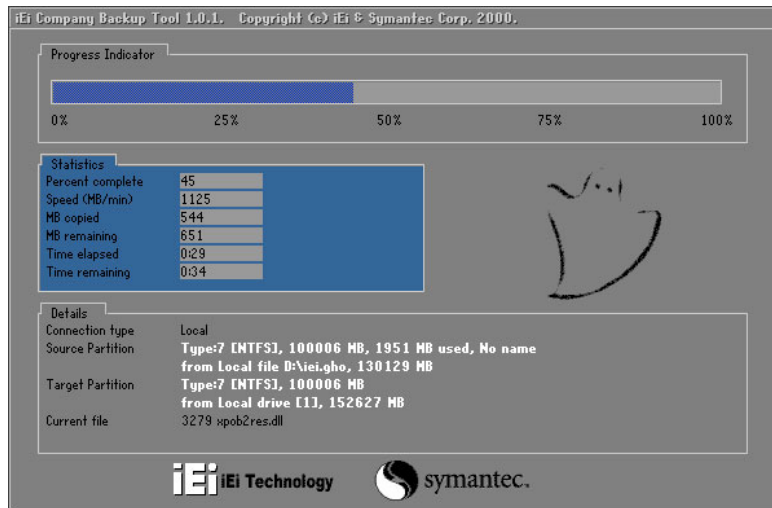

Figure B-36: Restore Factory Default

Step 3: The screen shown in **Figure B-37** appears when completed. Press any key to reboot the system.

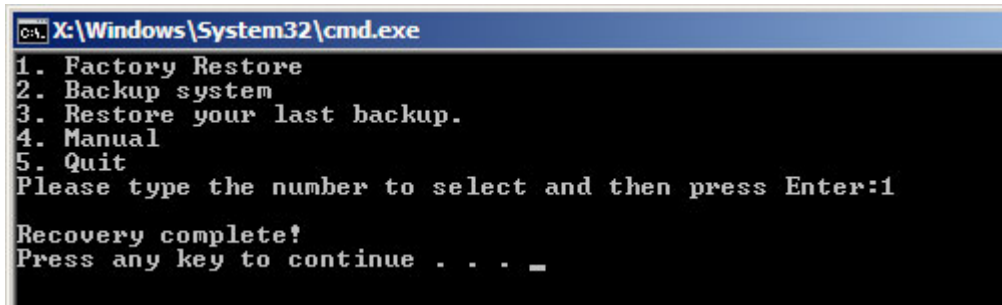

Figure B-37: Recovery Complete Window

WAFER-ULT-i1 3.5" SBC

B.5.2 Backup System

To backup the system, please follow the steps below.

Step 1: Type <2> and press <Enter> in the main menu.

Step 2: The Symantec Ghost window appears and starts to backup the system. A backup image called `iei_user.GHO` is created in the hidden Recovery partition.

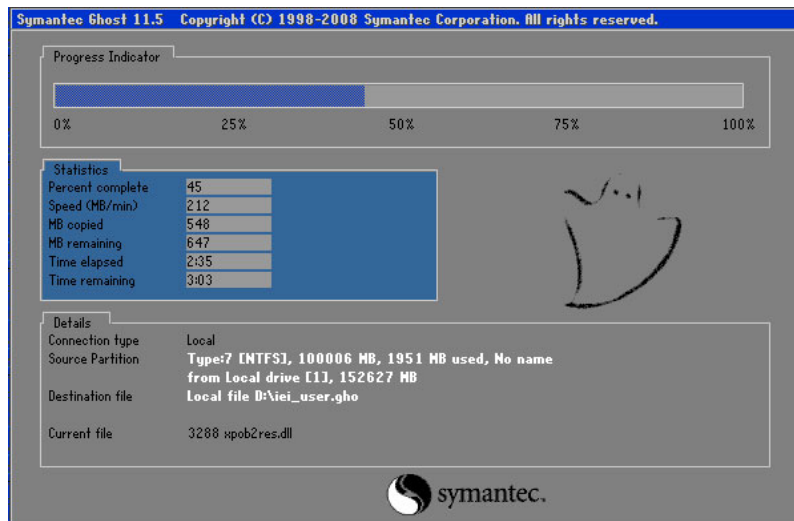

Figure B-38: Backup System

Step 3: The screen shown in **Figure B-39** appears when system backup is complete.

Press any key to reboot the system.

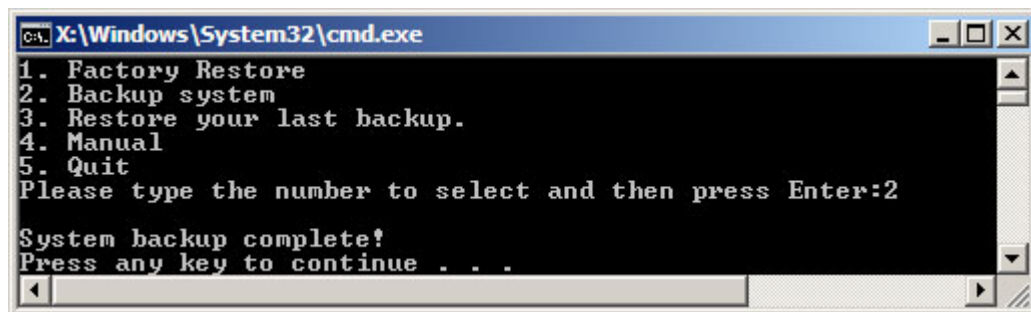

Figure B-39: System Backup Complete Window

B.5.3 Restore Your Last Backup

To restore the last system backup, please follow the steps below.

Step 1: Type <3> and press <Enter> in the main menu.

Step 2: The Symantec Ghost window appears and starts to restore the last backup image (iei_user.GHO).

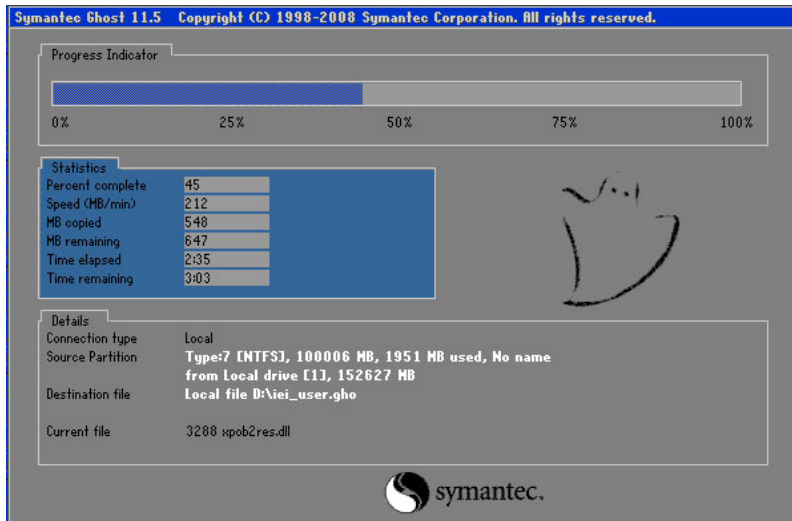

Figure B-40: Restore Backup

Step 3: The screen shown in **Figure B-41** appears when backup recovery is complete. Press any key to reboot the system.

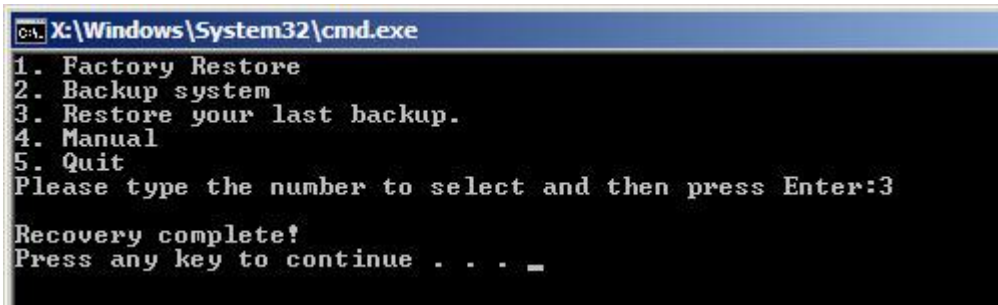

Figure B-41: Restore System Backup Complete Window

WAFER-ULT-i1 3.5" SBC

B.5.4 Manual

To restore the last system backup, please follow the steps below.

Step 1: Type <4> and press <Enter> in the main menu.

Step 2: The Symantec Ghost window appears. Use the Ghost program to backup or recover the system manually.

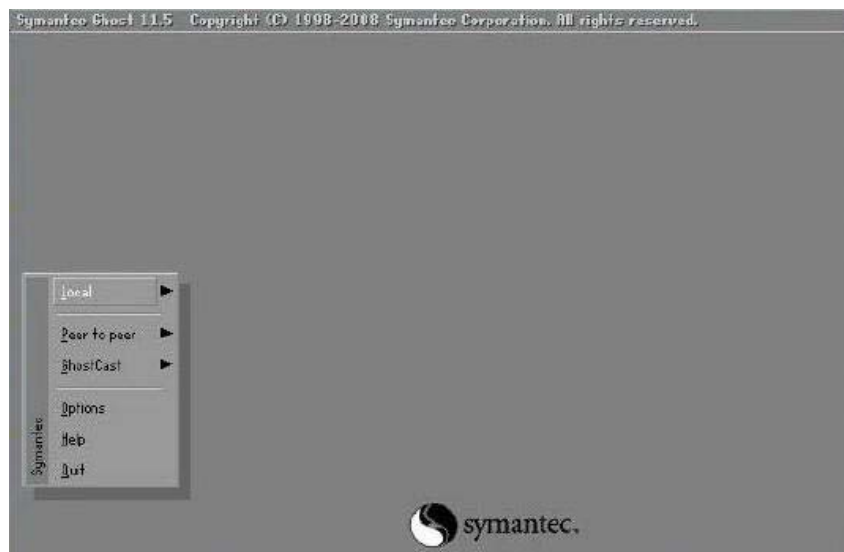
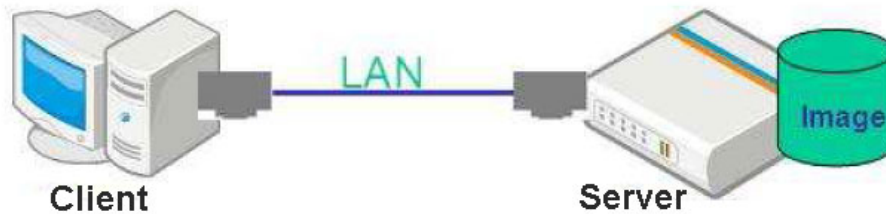

Figure B-42: Symantec Ghost Window

Step 3: When backup or recovery is completed, press any key to reboot the system.

B.6 Restore Systems from a Linux Server through LAN

The One Key Recovery allows a client system to automatically restore to a factory default image saved in a Linux system (the server) through LAN connectivity after encountering a Blue Screen of Death (BSoD) or a hang for around 10 minutes. To be able to use this function, the client system and the Linux system MUST reside in the same domain.



CAUTION:

The supported client OS includes:

- Windows 2000
- Windows XP
- Windows Vista
- Windows 7
- Windows XP Embedded
- Windows Embedded Standard 7

Prior to restoring client systems from a Linux server, a few setup procedures are required.

Step 1: Configure DHCP server settings

Step 2: Configure TFTP settings

Step 3: Configure One Key Recovery server settings

Step 4: Start DHCP, TFTP and HTTP

Step 5: Create a shared directory

Step 6: Setup a client system for auto recovery

The detailed descriptions are described in the following sections. In this document, two types of Linux OS are used as examples to explain the configuration process – CentOS 5.5 (Kernel 2.6.18) and Debian 5.0.7 (Kernel 2.6.26).

WAFER-ULT-i1 3.5" SBC

B.6.1 Configure DHCP Server Settings

Step 1: Install the DHCP

`#yum install dhcp` (CentOS, commands marked in red)

`#apt-get install dhcp3-server` (Debian, commands marked in blue)

Step 2: Confirm the operating system default settings: dhcpd.conf.

CentOS

Use the following command to show the DHCP server sample location:

`#vi /etc/dhcpd.conf`

The DHCP server sample location is shown as below:

```
# DHCP Server Configuration file.
# see /usr/share/doc/dhcp*/dhcpd.conf.sample
#
```

Use the following command to copy the DHCP server sample to etc/dhcpd.conf:

`#cp /usr/share/doc/dhcp-3.0.5/dhcpd.conf.sample /etc/dhcpd.conf`

`#vi /etc/dhcpd.conf`

```
ddns-update-style interim;
ignore client-updates;

subnet 192.168.0.0 netmask 255.255.255.0 {
# --- default gateway
    option routers                192.168.0.2;
    option subnet-mask            255.255.255.0;

    option nis-domain             "domain.org";
    option domain-name            "domain.org";
    option domain-name-servers    192.168.0.1;
    next-server 192.168.0.6;
    filename "pxelinux.0";
    option time-offset            -18000; # Eastern Standard Time
    option ntp-servers            192.168.1.1;
    option ntp-servers            192.168.1.1;
}
```

Debian

`#vi /etc/dhcpd.conf`

Edit “/etc/dhcpd.conf” for your environment. For example, add

`next-server PXE server IP address;`

```
filename "pxelinux.0";
```

```
ddns-update-style interim;
ignore client-updates;

subnet 192.168.0.0 netmask 255.255.255.0 {
# --- default gateway
    option routers                192.168.0.2;
    option subnet-mask            255.255.255.0;

    option nis-domain             "domain.org";
    option domain-name            "domain.org";
    option domain-name-servers   192.168.0.1;
    next-server 192.168.0.6;
    filename "pxelinux.0";
    option time-offset            -18000; # Eastern Standard Time
    option ntp-servers            192.168.1.1;
}
```

B.6.2 Configure TFTP Settings

Step 1: Install the tftp, httpd and syslinux.

```
#yum install tftp-server httpd syslinux (CentOS)
```

```
#apt-get install tftpd-hpa xinetd syslinux (Debian)
```

Step 2: Enable the TFTP server by editing the "/etc/xinetd.d/tftp" file and make it use the remap file. The "-vvv" is optional but it could definitely help on getting more information while running the remap file. For example:

CentOS

```
#vi /etc/xinetd.d/tftp
```

Modify:

```
disable = no
```

```
server_args = -s /tftpboot -m /tftpboot/tftpd.remap -vvv_
```

```
socket_type      = dgram
protocol         = udp
wait            = yes
user            = root
server          = /usr/sbin/in.tftpd
server_args     = -s /tftpboot -m /tftpboot/tftpd.remap -vvv
disable         = no
per_source      = 11
cps             = 100 2
flags           = IPv4
```

WAFER-ULT-i1 3.5" SBC

Debian

Replace the TFTP settings from “inetd” to “xinetd” and annotate the “inetd” by adding “#”.

`#vi /etc/inetd.conf`

Modify: `#tftp dgram udp wait root /usr/sbin.....` (as shown below)

```
#:BOOT: TFTP service is provided primarily for booting. Most sites
# run this only on machines acting as "boot servers."
#tftp dgram udp wait root /usr/sbin/in.tftpd /usr/sbin/in.tftpd -s
/var/lib/tftpboot
```

`#vi /etc/xinetd.d/tftp`

```
socket_type      = dgram
protocol         = udp
wait            = yes
user            = root
server          = /usr/sbin/in.tftpd
server_args     = -s /tftpboot -n /tftpboot/tftpd.remap -vvv
disable         = no
per_source      = 11
cps             = 100 2
flags           = IPv4
```

B.6.3 Configure One Key Recovery Server Settings

Step 1: Copy the **Utility/RECOVERYR10.TAR.BZ2** package from the One Key Recovery CD to the system (server side).



Step 2: Extract the recovery package to /.

```
#cp RecoveryR10.tar.bz2 /
#cd /
#tar -xvjf RecoveryR10.tar.bz2
```

Step 3: Copy “pxelinux.0” from “syslinux” and install to “tftpboot”.

```
#cp /usr/lib/syslinux/pxelinux.0 /tftpboot/
```

B.6.4 Start the DHCP, TFTP and HTTP

Start the DHCP, TFTP and HTTP. For example:

CentOS

```
#service xinetd restart
```

```
#service httpd restart
```

```
#service dhcpd restart
```

Debian

```
#!/etc/init.d/xinetd reload
```

```
#!/etc/init.d/xinetd restart
```

```
#!/etc/init.d/dhcp3-server restart
```

B.6.5 Create Shared Directory

Step 1: Install the samba.

```
#yum install samba
```

Step 2: Create a shared directory for the factory default image.

```
#mkdir /share
```

```
#cd /share
```

```
#mkdir /image
```

```
#cp iei.gho /image
```



WARNING:

The file name of the factory default image must be **iei.gho**.

Step 3: Confirm the operating system default settings: smb.conf.

```
#vi /etc/samba/smb.conf
```

WAFER-ULT-i1 3.5" SBC

Modify:

[image]

comment = One Key Recovery

path = /share/image

browseable = yes

writable = yes

public = yes

create mask = 0644

directory mask = 0755

Step 4: Edit "/etc/samba/smb.conf" for your environment. For example:

```
# "security = user" is always a good idea. This will require a Unix account
# in this server for every user accessing the server. See
# /usr/share/doc/samba-doc/htmldocs/Samba3-HOWTO/ServerType.html
# in the samba-doc package for details.
security = share
```

```
[image]
comment = One Key Recovery
path = /share/image
browseable = yes
writable = yes
public = yes
create mask = 0644
directory mask = 0755
```

Step 5: Modify the hostname

```
#vi /etc/hostname
```

Modify: RecoveryServer

```
RecoveryServer
```

B.6.6 Setup a Client System for Auto Recovery

Step 1: Disable the automatically restart function before creating the factory default image. Go to: My Computer → Properties → Advanced. Click the Settings button of Startup and Recovery. Deselect "Automatically restart". Click OK to save the settings and exit. (See **Figure B-23**)

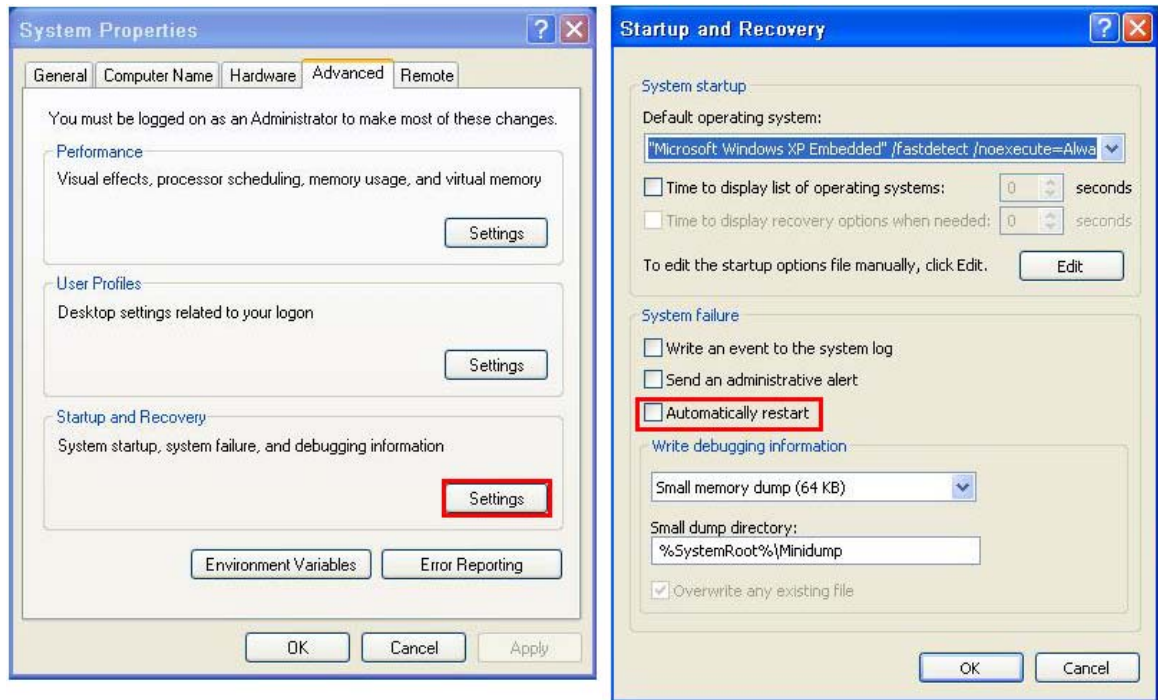

Figure B-43: Disable Automatically Restart

Step 2: Configure the following BIOS options of the client system.

Advanced → iEi Feature → Auto Recovery Function → **Enabled**

Advanced → iEi Feature → Recover from PXE → **Enabled**

Boot → Launch PXE OpROM → **Enabled**

Step 3: Continue to configure the **Boot Option Priorities** BIOS option of the client system:

Boot Option #1 → remain the default setting to boot from the original OS.

Boot Option #2 → select the boot from LAN option.

Step 4: Save changes and exit BIOS menu.

Exit → **Save Changes and Exit**

Step 5: Install the auto recovery utility into the system by double clicking the

Utility/AUTORECOVERY-SETUP.exe in the One Key Recovery CD. This utility

WAFER-ULT-i1 3.5" SBC

MUST be installed in the system, otherwise, the system will automatically restore from the factory default image every ten (10) minutes.



Step 6: Restart the client system from LAN. If the system encounters a Blue Screen of Death (BSoD) or a hang for around 10 minutes, it will automatically restore from the factory default image. The following screens will show when the system starts auto recovering.

```
Realtek PCIe GBE Family Controller Series v2.35 (06/14/10)
CLIENT MAC ADDR: 00 18 7D 13 E6 89  GUID: 00020003-0004-0005-0006-0007000000
DHCP . ./
```

```
My IP address seems to be C0A80009 192.168.0.9
ip=192.168.0.9:192.168.0.8:192.168.0.2:255.255.255.0
TFTP prefix:
Trying to load: pxelinux.cfg/00020003-0004-0005-0006-000700000009
Trying to load: pxelinux.cfg/01-00-18-7d-13-e6-89
Trying to load: pxelinux.cfg/C0A80009
Trying to load: pxelinux.cfg/C0A8000
Trying to load: pxelinux.cfg/C0A800
Trying to load: pxelinux.cfg/C0A80
Trying to load: pxelinux.cfg/C0A8
Trying to load: pxelinux.cfg/C0A
Trying to load: pxelinux.cfg/C0
Trying to load: pxelinux.cfg/C
Trying to load: pxelinux.cfg/default
boot:
```

Windows is loading files...

```
IP: 192.168.0.8, File: \Boot\WinPE.wim
```

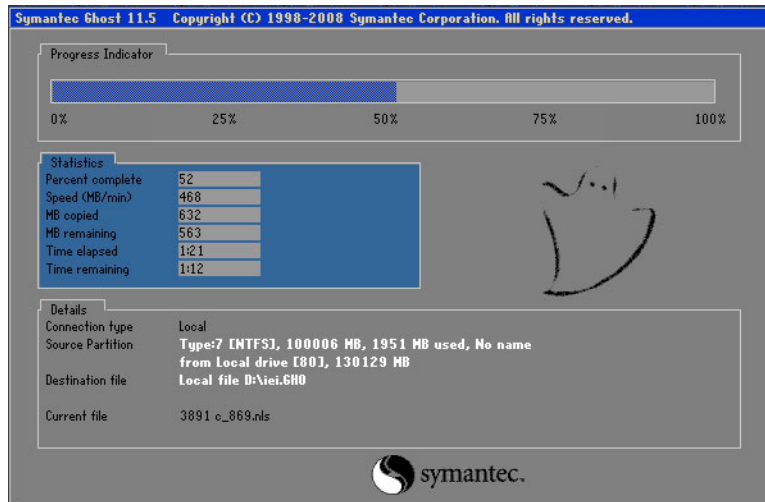
**NOTE:**

A firewall or a SELinux is not in use in the whole setup process described above. If there is a firewall or a SELinux protecting the system, modify the configuration information to accommodate them.

B.7 Other Information

B.7.1 Using AHCI Mode or ALi M5283 / VIA VT6421A Controller

When the system uses AHCI mode or some specific SATA controllers such as ALi M5283 or VIA VT6421A, the SATA RAID/AHCI driver must be installed before using one key recovery. Please follow the steps below to install the SATA RAID/AHCI driver.

- Step 1:** Copy the SATA RAID/AHCI driver to a floppy disk and insert the floppy disk into a USB floppy disk drive. The SATA RAID/AHCI driver must be especially designed for the on-board SATA controller.
- Step 2:** Connect the USB floppy disk drive to the system.
- Step 3:** Insert the One Key Recovery CD into the system and boot the system from the CD.
- Step 4:** When launching the recovery tool, press <F6>.

WAFER-ULT-i1 3.5" SBC

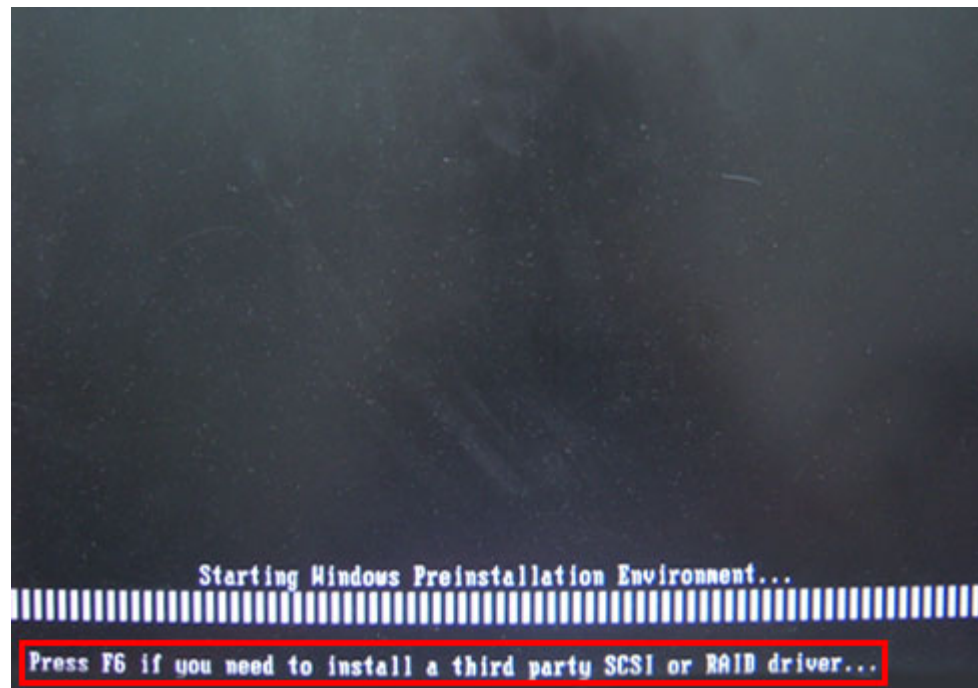

Step 5: When the following window appears, press <S> to select "Specify Additional Device".

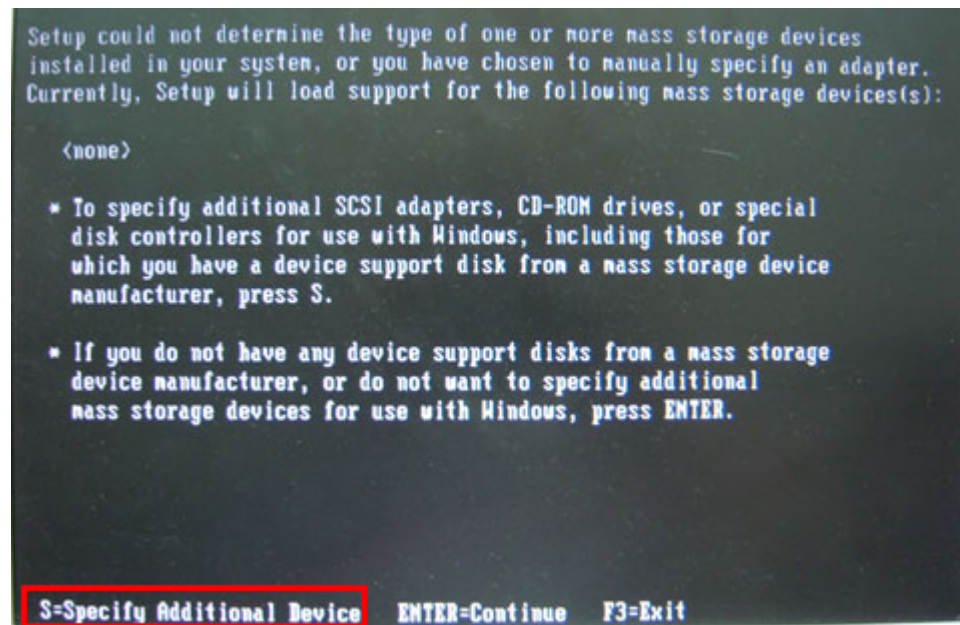

Step 6: In the following window, select a SATA controller mode used in the system. Then press <Enter>. The user can now start using the SATA HDD.

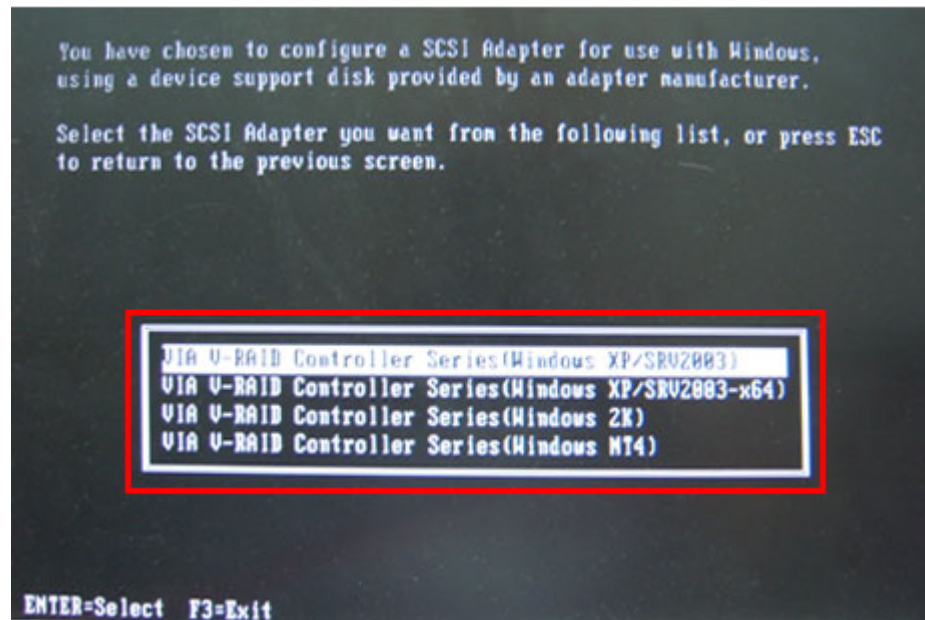

Step 7: After pressing <Enter>, the system will get into the recovery tool setup menu. Continue to follow the setup procedure from **Step 4** in **Section B.2.2 Create Partitions** to finish the whole setup process.

B.7.2 System Memory Requirement

To be able to access the recovery tool by pressing <F3> while booting up the system, please make sure to have enough system memory. The minimum memory requirement is listed below.

- **Using Award BIOS:** 128 MB system memory
- **Using AMI BIOS:** 512 MB system memory.

Appendix

C

Terminology

AC '97	Audio Codec 97 (AC'97) refers to a codec standard developed by Intel® in 1997.
ACPI	Advanced Configuration and Power Interface (ACPI) is an OS-directed configuration, power management, and thermal management interface.
AHCI	Advanced Host Controller Interface (AHCI) is a SATA Host controller register-level interface.
ATA	The Advanced Technology Attachment (ATA) interface connects storage devices including hard disks and CD-ROM drives to a computer.
ARMD	An ATAPI Removable Media Device (ARMD) is any ATAPI device that supports removable media, besides CD and DVD drives.
ASKIR	Amplitude Shift Keyed Infrared (ASKIR) is a form of modulation that represents a digital signal by varying the amplitude ("volume") of the signal. A low amplitude signal represents a binary 0, while a high amplitude signal represents a binary 1.
BIOS	The Basic Input/Output System (BIOS) is firmware that is first run when the computer is turned on and can be configured by the end user
CODEC	The Compressor-Decompressor (CODEC) encodes and decodes digital audio data on the system.
CompactFlash®	CompactFlash® is a solid-state storage device. CompactFlash® devices use flash memory in a standard size enclosure. Type II is thicker than Type I, but a Type II slot can support both types.
CMOS	Complimentary metal-oxide-conductor is an integrated circuit used in chips like static RAM and microprocessors.
COM	COM refers to serial ports. Serial ports offer serial communication to expansion devices. The serial port on a personal computer is usually a male DB-9 connector.
DAC	The Digital-to-Analog Converter (DAC) converts digital signals to analog signals.
DDR	Double Data Rate refers to a data bus transferring data on both the rising and falling edges of the clock signal.

WAFER-ULT-i1 3.5" SBC

DMA	Direct Memory Access (DMA) enables some peripheral devices to bypass the system processor and communicate directly with the system memory.
DIMM	Dual Inline Memory Modules are a type of RAM that offer a 64-bit data bus and have separate electrical contacts on each side of the module.
DIO	The digital inputs and digital outputs are general control signals that control the on/off circuit of external devices or TTL devices. Data can be read or written to the selected address to enable the DIO functions.
EHCI	The Enhanced Host Controller Interface (EHCI) specification is a register-level interface description for USB 2.0 Host Controllers.
EIDE	Enhanced IDE (EIDE) is a newer IDE interface standard that has data transfer rates between 4.0 MBps and 16.6 MBps.
EIST	Enhanced Intel® SpeedStep Technology (EIST) allows users to modify the power consumption levels and processor performance through application software. The application software changes the bus-to-core frequency ratio and the processor core voltage.
FSB	The Front Side Bus (FSB) is the bi-directional communication channel between the processor and the Northbridge chipset.
GbE	Gigabit Ethernet (GbE) is an Ethernet version that transfers data at 1.0 Gbps and complies with the IEEE 802.3-2005 standard.
GPIO	General purpose input
HDD	Hard disk drive (HDD) is a type of magnetic, non-volatile computer storage device that stores digitally encoded data.
ICH	The Input/Output Control Hub (ICH) is an Intel® Southbridge chipset.
IrDA	Infrared Data Association (IrDA) specify infrared data transmission protocols used to enable electronic devices to wirelessly communicate with each other.
L1 Cache	The Level 1 Cache (L1 Cache) is a small memory cache built into the system processor.
L2 Cache	The Level 2 Cache (L2 Cache) is an external processor memory cache.

LCD	Liquid crystal display (LCD) is a flat, low-power display device that consists of two polarizing plates with a liquid crystal panel in between.
LVDS	Low-voltage differential signaling (LVDS) is a dual-wire, high-speed differential electrical signaling system commonly used to connect LCD displays to a computer.
POST	The Power-on Self Test (POST) is the pre-boot actions the system performs when the system is turned-on.
RAM	Random Access Memory (RAM) is volatile memory that loses data when power is lost. RAM has very fast data transfer rates compared to other storage like hard drives.
SATA	Serial ATA (SATA) is a serial communications bus designed for data transfers between storage devices and the computer chipsets.
S.M.A.R.T	Self Monitoring Analysis and Reporting Technology (S.M.A.R.T) refers to automatic status checking technology implemented on hard disk drives.
UART	Universal Asynchronous Receiver-transmitter (UART) is responsible for asynchronous communications on the system and manages the system's serial communication (COM) ports.
UHCI	The Universal Host Controller Interface (UHCI) specification is a register-level interface description for USB 1.1 Host Controllers.
USB	The Universal Serial Bus (USB) is an external bus standard for interfacing devices. USB 1.1 supports 12Mbps data transfer rates and USB 2.0 supports 480Mbps data transfer rates.
VGA	The Video Graphics Array (VGA) is a graphics display system developed by IBM.

Appendix

D

Digital I/O Interface

D.1 Introduction

The DIO connector on the WAFER-ULT-i1 is interfaced to GPIO ports on the Super I/O chipset. The DIO has both 4-bit digital inputs and 4-bit digital outputs. The digital inputs and digital outputs are generally control signals that control the on/off circuit of external devices or TTL devices. Data can be read or written to the selected address to enable the DIO functions.



NOTE:

For further information, please refer to the datasheet for the Super I/O chipset.

D.2 DIO Connector Pinouts

PIN NO.	DESCRIPTION	PIN NO.	DESCRIPTION
1	GND	2	VCC
3	Output 3	4	Output 2
5	Output 1	6	Output 0
7	Input 3	8	Input 2
9	Input 1	10	Input 0

Table 6-1: Digital I/O Connector Pinouts

D.3 Assembly Language Samples

D.3.1 Enable the DIO Input Function

The BIOS interrupt call INT 15H controls the digital I/O. An assembly program to enable digital I/O input functions is listed below.

MOV	AX, 6F08H	Sets the digital port as input
INT	15H	Initiates the INT 15H BIOS call

D.3.2 Enable the DIO Output Function

The BIOS interrupt call INT 15H controls the digital I/O. An assembly program to enable digital I/O output functions is listed below.

MOV	AX, 6F09H	Sets the digital port as output
MOV	BL, 09H	
INT	15H	Initiates the INT 15H BIOS call

Appendix

E

Hazardous Materials Disclosure

E.1 Hazardous Materials Disclosure Table for IPB Products Certified as RoHS Compliant Under 2002/95/EC Without Mercury

The details provided in this appendix are to ensure that the product is compliant with the Peoples Republic of China (China) RoHS standards. The table below acknowledges the presences of small quantities of certain materials in the product, and is applicable to China RoHS only.

A label will be placed on each product to indicate the estimated “Environmentally Friendly Use Period” (EFUP). This is an estimate of the number of years that these substances would “not leak out or undergo abrupt change.” This product may contain replaceable sub-assemblies/components which have a shorter EFUP such as batteries and lamps. These components will be separately marked.

Please refer to the table on the next page.

Part Name	Toxic or Hazardous Substances and Elements					
	Lead (Pb)	Mercury (Hg)	Cadmium (Cd)	Hexavalent Chromium (CR(VI))	Polybrominated Biphenyls (PBB)	Polybrominated Diphenyl Ethers (PBDE)
Housing	<input type="radio"/>	<input type="radio"/>	<input type="radio"/>	<input type="radio"/>	<input type="radio"/>	<input type="radio"/>
Display	<input type="radio"/>	<input type="radio"/>	<input type="radio"/>	<input type="radio"/>	<input type="radio"/>	<input type="radio"/>
Printed Circuit Board	<input type="radio"/>	<input type="radio"/>	<input type="radio"/>	<input type="radio"/>	<input type="radio"/>	<input type="radio"/>
Metal Fasteners	<input type="radio"/>	<input type="radio"/>	<input type="radio"/>	<input type="radio"/>	<input type="radio"/>	<input type="radio"/>
Cable Assembly	<input type="radio"/>	<input type="radio"/>	<input type="radio"/>	<input type="radio"/>	<input type="radio"/>	<input type="radio"/>
Fan Assembly	<input type="radio"/>	<input type="radio"/>	<input type="radio"/>	<input type="radio"/>	<input type="radio"/>	<input type="radio"/>
Power Supply Assemblies	<input type="radio"/>	<input type="radio"/>	<input type="radio"/>	<input type="radio"/>	<input type="radio"/>	<input type="radio"/>
Battery	<input type="radio"/>	<input type="radio"/>	<input type="radio"/>	<input type="radio"/>	<input type="radio"/>	<input type="radio"/>

O: This toxic or hazardous substance is contained in all of the homogeneous materials for the part is below the limit requirement in SJ/T11363-2006

X: This toxic or hazardous substance is contained in at least one of the homogeneous materials for this part is above the limit requirement in SJ/T11363-2006

WAFER-ULT-i1 3.5" SBC

此附件旨在确保本产品符合中国 RoHS 标准。以下表格标示此产品中某有毒物质的含量符合中国 RoHS 标准规定的限量要求。

本产品上会附有“环境友好使用期限”的标签，此期限是估算这些物质“不会有泄漏或突变”的年限。本产品可能包含有较短的环境友好使用期限的可替换元件，像是电池或灯管，这些元件将会单独标示出来。

部件名称	有毒有害物质或元素					
	铅 (Pb)	汞 (Hg)	镉 (Cd)	六价铬 (CR(VI))	多溴联苯 (PBB)	多溴二苯 醚 (PBDE)
壳体	○	○	○	○	○	○
显示	○	○	○	○	○	○
印刷电路板	○	○	○	○	○	○
金属螺帽	○	○	○	○	○	○
电缆组装	○	○	○	○	○	○
风扇组装	○	○	○	○	○	○
电力供应组装	○	○	○	○	○	○
电池	○	○	○	○	○	○

○: 表示该有毒有害物质在该部件所有物质材料中的含量均在 SJ/T11363-2006 标准规定的限量要求以下。
 X: 表示该有毒有害物质至少在该部件的某一均质材料中的含量超出 SJ/T11363-2006 标准规定的限量要求。