

**MODEL:
KINO-QM670**

**Mini-ITX Motherboard Supports Socket G2 for
Intel® Mobile Core™ i7/i5 CPU, VGA/LVDS/HDMI
Dual GbE, USB 3.0, PCIe Mini, SATA 6Gb/s and Audio**

User Manual

Revision

Date	Version	Changes
24 April, 2014	2.01	Modified LAN pinouts Updated Chapter 2: Unpacking
24 December, 2013	2.00	Updated for R20 version
7 February, 2013	1.04	Updated LAN port pinouts
3 May, 2012	1.03	Updated Section 3.2.20 SPI Flash Connector Updated Appendix C One Key Recovery
15 December, 2011	1.02	Minor update to Section 3.2.13 12V Power Connector and Section 3.2.14 SATA Drive Connectors
10 August, 2011	1.01	Minor update to COM3 pin definition
7 July, 2011	1.00	Initial release

Copyright

COPYRIGHT NOTICE

The information in this document is subject to change without prior notice in order to improve reliability, design and function and does not represent a commitment on the part of the manufacturer.

In no event will the manufacturer be liable for direct, indirect, special, incidental, or consequential damages arising out of the use or inability to use the product or documentation, even if advised of the possibility of such damages.

This document contains proprietary information protected by copyright. All rights are reserved. No part of this manual may be reproduced by any mechanical, electronic, or other means in any form without prior written permission of the manufacturer.

TRADEMARKS

All registered trademarks and product names mentioned herein are used for identification purposes only and may be trademarks and/or registered trademarks of their respective owners.

Table of Contents

1 INTRODUCTION.....	1
1.1 INTRODUCTION.....	2
1.2 CONNECTORS	3
1.3 DIMENSIONS.....	4
1.3.1 Board Dimensions.....	4
1.3.2 External Interface Panel Dimensions	5
1.4 DATA FLOW	6
1.5 TECHNICAL SPECIFICATIONS	7
2 UNPACKING	9
2.1 ANTI-STATIC PRECAUTIONS	10
2.2 UNPACKING PRECAUTIONS.....	10
2.3 PACKING LIST.....	11
2.3.1 Optional Items.....	12
3 CONNECTORS	13
3.1 PERIPHERAL INTERFACE CONNECTORS.....	14
3.1.1 KINO-QM670 Layout	14
3.1.2 Peripheral Interface Connectors	15
3.1.3 External Interface Panel Connectors.....	16
3.2 INTERNAL PERIPHERAL CONNECTORS	17
3.2.1 Audio Connector	17
3.2.2 Battery Connector.....	18
3.2.3 Backlight Inverter Connector	19
3.2.4 Digital I/O Connector.....	20
3.2.5 EC Debug Port.....	21
3.2.6 Fan Connector (CPU).....	22
3.2.7 Fan Connector (System)	22
3.2.8 Front Panel Connector	23
3.2.9 Infrared Interface Connector.....	24
3.2.10 Keyboard/Mouse Connector	25

KINO-QM670 Mini-ITX SBC

3.2.11 LVDS Connector.....	26
3.2.12 PCIe Mini Card Slot	28
3.2.13 12V Power Connector.....	29
3.2.14 SATA Drive Connectors	30
3.2.15 SATA Power Connector.....	31
3.2.16 Serial Port Connector (RS-232).....	32
3.2.17 Serial Port Connectors (RS-422/485).....	33
3.2.18 SMBus Connector	34
3.2.19 SPDIF Connector.....	35
3.2.20 SPI Flash Connector.....	36
3.2.21 TPM Connector.....	37
3.2.22 USB Connectors.....	38
3.3 EXTERNAL PERIPHERAL INTERFACE CONNECTOR PANEL	39
3.3.1 Audio Connector	40
3.3.2 Ethernet and USB 2.0 Connector.....	41
3.3.3 Ethernet and USB 3.0 Connector.....	42
3.3.4 HDMI Connectors.....	43
3.3.5 Power Connector (12 V, Power Adapter)	43
3.3.6 Serial Port Connector (COM1)	44
3.3.7 VGA Connector	45
4 INSTALLATION	46
4.1 ANTI-STATIC PRECAUTIONS	47
4.2 INSTALLATION CONSIDERATIONS.....	48
4.2.1 Installation Notices	48
4.3 UNPACKING.....	49
4.4 CPU, CPU COOLING KIT AND SO-DIMM INSTALLATION.....	49
4.4.1 Socket G2 CPU Installation.....	50
4.4.2 Socket G2 Cooling Kit Installation	52
4.4.3 SO-DIMM Installation	54
4.5 JUMPER SETTINGS	54
4.5.1 AT/ATX Power Mode Jumper Settings.....	55
4.5.2 Clear CMOS Jumper.....	56
4.5.3 LVDS Panel Resolution Jumper.....	57
4.5.4 LVDS Voltage Selection.....	59

4.5.5	<i>ME RTC Register Jumper</i>	60
4.5.6	<i>Flash Security Override Jumper</i>	61
4.5.7	<i>MPC Switch Control (Reserved)</i>	62
4.6	CHASSIS INSTALLATION	63
4.6.1	<i>Airflow</i>	63
4.6.2	<i>Motherboard Installation</i>	63
4.7	INTERNAL PERIPHERAL DEVICE CONNECTIONS	63
4.7.1	<i>SATA Drive Connection</i>	64
4.7.2	<i>Dual RS-232 Cable with Slot Bracket</i>	65
4.8	EXTERNAL PERIPHERAL INTERFACE CONNECTION	66
4.8.1	<i>Audio Connector</i>	67
4.8.2	<i>LAN and USB Connection</i>	67
4.8.3	<i>Serial Device Connection</i>	69
4.8.4	<i>VGA Monitor Connection</i>	70
4.9	SOFTWARE INSTALLATION	71
5	BIOS SCREENS	73
5.1	INTRODUCTION	74
5.1.1	<i>Starting Setup</i>	74
5.1.2	<i>Using Setup</i>	74
5.1.3	<i>Getting Help</i>	75
5.1.4	<i>Unable to Reboot After Configuration Changes</i>	75
5.1.5	<i>BIOS Menu Bar</i>	75
5.2	MAIN	76
5.3	ADVANCED	77
5.3.1	<i>ACPI Settings</i>	78
5.3.2	<i>Trusted Computing</i>	79
5.3.3	<i>CPU Configuration</i>	80
5.3.4	<i>SATA Configuration</i>	81
5.3.5	<i>USB Configuration</i>	82
5.3.6	<i>Super IO Configuration</i>	84
5.3.6.1	<i>Serial Port n Configuration</i>	84
5.3.7	<i>H/W Monitor</i>	89
5.3.7.1	<i>FAN 1 Configuration</i>	90
5.3.7.2	<i>FAN 2 Configuration</i>	91

KINO-QM670 Mini-ITX SBC

5.3.8 Serial Port Console Redirection	92
5.3.9 iEi Feature.....	95
5.4 CHIPSET	95
5.4.1 Northbridge Configuration	97
5.4.1.1 Graphics Configuration.....	98
5.4.2 Southbridge Configuration	101
5.4.3 ME Configuration	103
5.5 BOOT.....	104
5.6 SECURITY.....	105
5.7 SAVE & EXIT	106
A INTEL® AMT CONFIGURATION.....	108
A.1 INTEL® AMT SETUP PROCEDURE	109
A.2 INTEL® MANAGEMENT ENGINE BIOS EXTENSION	109
A.3 IEI EASY MANAGER APPLICATION	114
B BIOS MENU OPTIONS	115
C ONE KEY RECOVERY.....	118
C.1 ONE KEY RECOVERY INTRODUCTION	119
C.1.1 System Requirement	120
C.1.2 Supported Operating System.....	121
C.2 SETUP PROCEDURE FOR WINDOWS	122
C.2.1 Hardware and BIOS Setup	123
C.2.2 Create Partitions	123
C.2.3 Install Operating System, Drivers and Applications.....	127
C.2.4 Build-up Recovery Partition.....	128
C.2.5 Create Factory Default Image	130
C.3 AUTO RECOVERY SETUP PROCEDURE	135
C.4 SETUP PROCEDURE FOR LINUX	140
C.5 RECOVERY TOOL FUNCTIONS	143
C.5.1 Factory Restore	145
C.5.2 Backup System.....	146
C.5.3 Restore Your Last Backup.....	147
C.5.4 Manual	148
C.6 RESTORE SYSTEMS FROM A LINUX SERVER THROUGH LAN	149

<i>C.6.1 Configure DHCP Server Settings</i>	150
<i>C.6.2 Configure TFTP Settings</i>	151
<i>C.6.3 Configure One Key Recovery Server Settings</i>	152
<i>C.6.4 Start the DHCP, TFTP and HTTP</i>	153
<i>C.6.5 Create Shared Directory</i>	153
<i>C.6.6 Setup a Client System for Auto Recovery</i>	154
C.7 OTHER INFORMATION	157
<i>C.7.1 Using AHCI Mode or ALi M5283 / VIA VT6421A Controller</i>	157
<i>C.7.2 System Memory Requirement</i>	159
D TERMINOLOGY	160
E WATCHDOG TIMER	165
F HAZARDOUS MATERIALS DISCLOSURE	168
F.1 HAZARDOUS MATERIALS DISCLOSURE TABLE FOR IPB PRODUCTS CERTIFIED AS ROHS COMPLIANT UNDER 2002/95/EC WITHOUT MERCURY	169

List of Figures

Figure 1-1: KINO-QM670	2
Figure 1-2: Connectors	3
Figure 1-3: KINO-QM670 Dimensions (mm).....	4
Figure 1-4: External Interface Panel Dimensions (mm).....	5
Figure 1-5: Data Flow Block Diagram.....	6
Figure 3-1: Connector and Jumper Locations.....	14
Figure 3-2: Audio Connector Location.....	17
Figure 3-3: Battery Connector Location.....	18
Figure 3-4: Panel Backlight Connector Pinout Location.....	19
Figure 3-5: Digital I/O Connector Location	20
Figure 3-6: BIOS Debug Port Location.....	21
Figure 3-7: CPU Fan Connector Location	22
Figure 3-8: +12V Fan Connector Location	23
Figure 3-9: Front Panel Connector Location	24
Figure 3-10: Infrared Connector Location.....	25
Figure 3-11: Keyboard/Mouse Connector Location.....	26
Figure 3-12: LVDS LCD Connector Pinout Location.....	27
Figure 3-13: PCIe Mini Card Slot Location.....	28
Figure 3-14: CPU 12V Power Connector Location	30
Figure 3-15: SATA Drive Connector Location	31
Figure 3-16: SATA Power Connector Location	32
Figure 3-17: Serial Port Connector Location	33
Figure 3-18: Serial Port Connector (RS-422/485) Location	34
Figure 3-19: SMBus Connector Location.....	35
Figure 3-20: SPDIF Connector Location	36
Figure 3-21: SPI Flash Connector Location.....	37
Figure 3-22: TPM Connector Pinout Location	38
Figure 3-23: USB Connector Pinout Location	39
Figure 3-24: KINO-QM670 External Peripheral Interface Connector.....	40
Figure 3-25: Audio Jacks	40
Figure 3-26: Ethernet Connector.....	41

Figure 3-27: 4-pin Power Mini-DIN Connection44

Figure 3-28: Serial Port Pinouts44

Figure 3-29: VGA Connector45

Figure 4-1: Unlock CPU socket retention screw51

Figure 4-2: Lock the CPU Socket Retention Screw.....52

Figure 4-3: Cooling Kit Support Bracket.....53

Figure 4-4: SO-DIMM Installation54

Figure 4-5: Jumper Locations54

Figure 4-6: AT/ATX Power Mode Jumper Location.....56

Figure 4-7: Clear CMOS Jumper57

Figure 4-8: LVDS Panel Resolution Jumper Pinout Locations.....58

Figure 4-9: LVDS Voltage Selection Jumper Pinout Locations60

Figure 4-10: ME RTC Register Jumper Location.....61

Figure 4-11: Flash Security Override Jumper Location.....62

Figure 4-12: MPC Switch Control Jumper Location.....63

Figure 4-13: SATA Drive Cable Connection.....64

Figure 4-14: SATA Power Drive Connection.....65

Figure 4-15: Dual RS-232 Cable Installation66

Figure 4-16: Audio Connector67

Figure 4-17: LAN Connection68

Figure 4-18: Serial Device Connector.....69

Figure 4-19: VGA Connector70

Figure 4-20: Introduction Screen71

Figure 4-21: Available Drivers72

Figure A-1: Intel® Active Management Technology Status Dialog 109

Figure A-2: Intel® Current ME Password 110

Figure A-3: Intel® ME New Password..... 110

Figure A-4: Intel® AMT Configuration 111

Figure A-5: Select KVM Configuration 111

Figure A-6: KVM Configuration 112

Figure A-7: KVM User Opt-in 112

Figure A-8: Exit 113

Figure C-1: IEI One Key Recovery Tool Menu 119

Figure C-2: Launching the Recovery Tool 124

Figure C-3: Recovery Tool Setup Menu 124

KINO-QM670 Mini-ITX SBC

Figure C-4: Command Mode.....	125
Figure C-5: Partition Creation Commands.....	126
Figure C-6: Launching the Recovery Tool	128
Figure C-7: Manual Recovery Environment for Windows	128
Figure C-8: Building the Recovery Partition.....	129
Figure C-9: Press Any Key to Continue	129
Figure C-10: Press F3 to Boot into Recovery Mode.....	130
Figure C-11: Recovery Tool Menu	130
Figure C-12: About Symantec Ghost Window.....	131
Figure C-13: Symantec Ghost Path	131
Figure C-14: Select a Local Source Drive	132
Figure C-15: Select a Source Partition from Basic Drive	132
Figure C-16: File Name to Copy Image to	133
Figure C-17: Compress Image.....	133
Figure C-18: Image Creation Confirmation	134
Figure C-19: Image Creation Complete	134
Figure C-20: Image Creation Complete	134
Figure C-21: Press Any Key to Continue	135
Figure C-22: Auto Recovery Utility	136
Figure C-23: Disable Automatically Restart.....	136
Figure C-24: Launching the Recovery Tool	137
Figure C-25: Auto Recovery Environment for Windows	137
Figure C-26: Building the Auto Recovery Partition.....	138
Figure C-27: Factory Default Image Confirmation	138
Figure C-28: Image Creation Complete	139
Figure C-29: Press any key to continue	139
Figure C-30: Partitions for Linux.....	141
Figure C-31: System Configuration for Linux.....	142
Figure C-32: Access menu.lst in Linux (Text Mode).....	142
Figure C-33: Recovery Tool Menu	143
Figure C-34: Recovery Tool Main Menu	144
Figure C-35: Restore Factory Default.....	145
Figure C-36: Recovery Complete Window	145
Figure C-37: Backup System.....	146
Figure C-38: System Backup Complete Window	146

Figure C-39: Restore Backup	147
Figure C-40: Restore System Backup Complete Window	147
Figure C-41: Symantec Ghost Window	148
Figure C-42: Disable Automatically Restart.....	155

List of Tables

Table 1-1: Technical Specifications.....	8
Table 3-1: Peripheral Interface Connectors.....	16
Table 3-2: Rear Panel Connectors.....	16
Table 3-3: Audio Connector Pinouts.....	17
Table 3-4: Battery Connector Pinouts.....	18
Table 3-5: Panel Backlight Connector Pinouts.....	19
Table 3-6: Digital I/O Connector Pinouts.....	20
Table 3-7: EC Debug Port Pinouts.....	21
Table 3-8: CPU Fan Connector Pinouts.....	22
Table 3-9: +12V Fan Connector Pinouts.....	23
Table 3-10: Front Panel Connector Pinouts.....	24
Table 3-11: Infrared Connector Pinouts.....	25
Table 3-12: Keyboard/Mouse Connector Pinouts.....	26
Table 3-13: LVDS LCD Port Connector Pinouts.....	27
Table 3-14: PCIe Mini Card Slot Pinouts.....	29
Table 3-15: CPU 12V Power Connector Pinouts.....	30
Table 3-16: SATA Drive Connector Pinouts.....	31
Table 3-17: SATA Power Connector Pinouts.....	32
Table 3-18: Serial Port Connector Pinouts.....	33
Table 3-19: Serial Port Connector (RS-422/485) Pinouts.....	34
Table 3-20: DB-9 RS-422/485 Pinouts.....	34
Table 3-21: SMBus Connector Pinouts.....	35
Table 3-22: SPDIF Connector Pinouts.....	36
Table 3-23: JSPI1 Flash Connector Pinouts.....	37
Table 3-24: JSPI2 Flash Connector Pinouts.....	37
Table 3-25: TPM Connector Pinouts.....	38
Table 3-26: USB Port Connector Pinouts.....	39
Table 3-27: LAN Pinouts.....	41
Table 3-28: Ethernet Connector LEDs.....	41
Table 3-29: USB 2.0 Port Pinouts.....	42
Table 3-30: USB 3.0 Port Pinouts.....	42

Table 3-31: HDMI Connector Pinouts	43
Table 3-32: Serial Port Pinouts.....	44
Table 3-33: VGA Connector Pinouts.....	45
Table 4-1: Jumpers	55
Table 4-2: AT/ATX Power Mode Jumper Settings	55
Table 4-3: Clear CMOS Jumper Settings.....	57
Table 4-4: LVDS Panel Resolution Jumper Settings.....	58
Table 4-5: LVDS Voltage Selection Jumper Settings.....	59
Table 4-6: ME RTC Register Jumper Settings	60
Table 4-7: Flash Security Override Jumper Settings	61
Table 4-8: MPC Switch Control Jumper Settings (Reserved)	62
Table 5-1: BIOS Navigation Keys	75

List of BIOS Menus

BIOS Menu 1: Main	76
BIOS Menu 2: Advanced	78
BIOS Menu 3: ACPI Configuration	78
BIOS Menu 4: TPM Configuration	79
BIOS Menu 5: CPU Configuration	80
BIOS Menu 6: SATA Configuration	81
BIOS Menu 7: USB Configuration	82
BIOS Menu 8: Super IO Configuration.....	84
BIOS Menu 9: Serial Port n Configuration Menu.....	84
BIOS Menu 10: H/W Monitor	89
BIOS Menu 11: FAN 1 Configuration	90
BIOS Menu 12: FAN 2 Configuration	91
BIOS Menu 13: Serial Port Console Redirection	93
BIOS Menu 14: iEi Feature	95
BIOS Menu 15: Chipset	96
BIOS Menu 16: Northbridge Chipset Configuration.....	97
BIOS Menu 17: Northbridge Chipset Configuration.....	98
BIOS Menu 18: Southbridge Chipset Configuration	101
BIOS Menu 19: ME Subsystem.....	103
BIOS Menu 20: Boot	104
BIOS Menu 21: Security	106
BIOS Menu 22: Exit.....	107
BIOS Menu 23: IEI Feature	140

Chapter

1

Introduction

1.1 Introduction

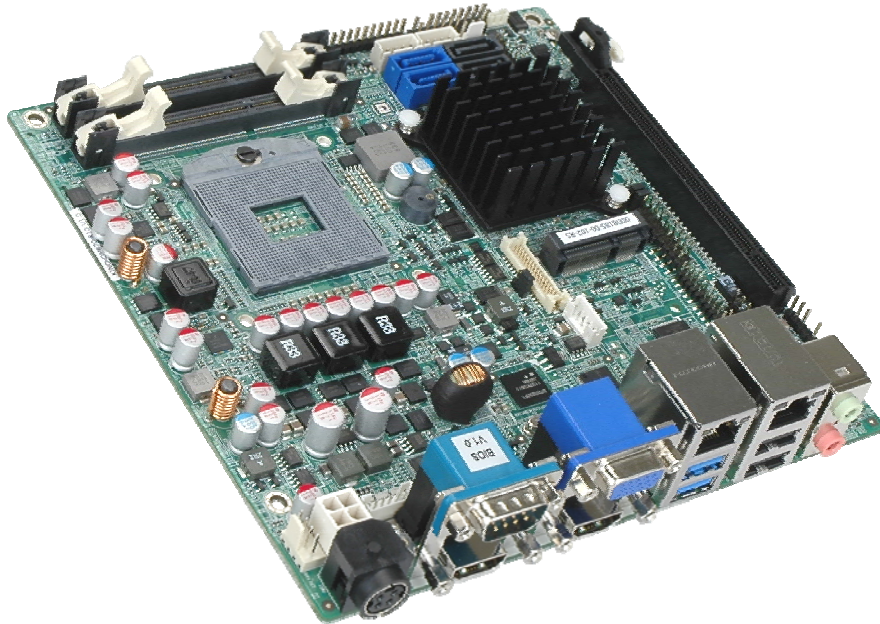

Figure 1-1: KINO-QM670

The KINO-QM670 Mini-ITX motherboard is a Socket G 32nm Intel® Core™ i5 and Core™ i7 processor (Arrandale) platform. Up to two 4.0 GB 1066 MHz or 1333 MHz DDR3 SDRAM SO-DIMM are supported by the Intel® Arrandale processor. The processor also supports a PCIe x16 slot.

The integrated Intel® QM67 Express Chipset supports two GbE LAN: one through the Intel® 82579 Ethernet controller (with iAMT 7.0 support) and another through the Intel® 82583V Ethernet controller. The Intel® QM67 also supports two SATA 3Gb/s drives, two SATA 6Gb/s drives, and provides 12 V or 5 V SATA power.

The KINO-QM670 supports multiple display devices, including 18-bit or 24-bit dual-channel LVDS, analog CRT, and dual HDMI. Six USB 2.0 channels, two USB 3.0 channels and one expansion PCIe Mini socket provide flexible expansion options. High Definition Audio (HDA) support ensures HDA devices can be easily implemented on the KINO-QM670.

KINO-QM670 Mini-ITX SBC

1.2 Connectors

The connectors on the KINO-QM670 are shown in the figure below.

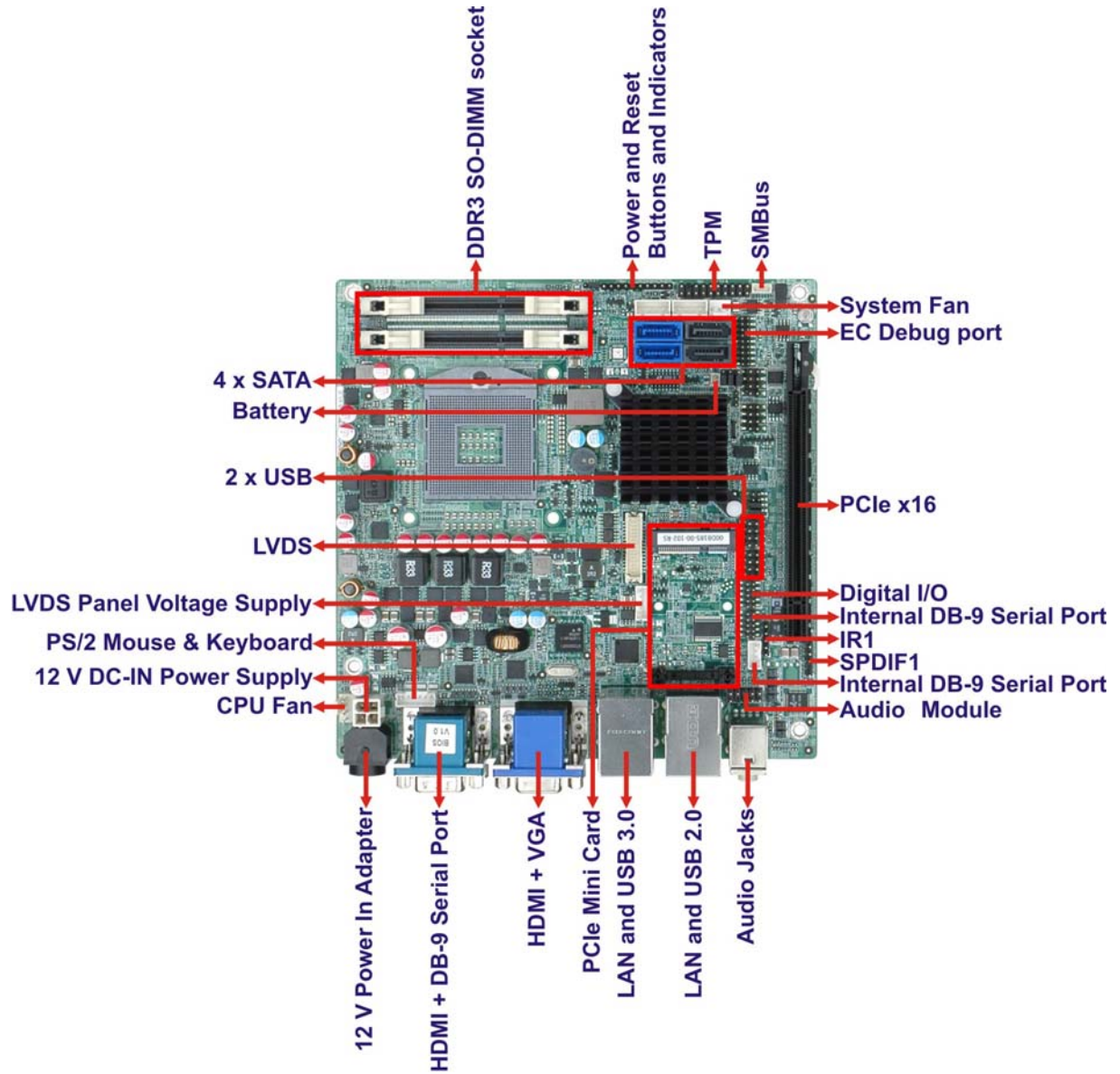

Figure 1-2: Connectors

1.3 Dimensions

1.3.1 Board Dimensions

The dimensions of the board are listed below:

- **Length:** 170 mm
- **Width:** 170 mm

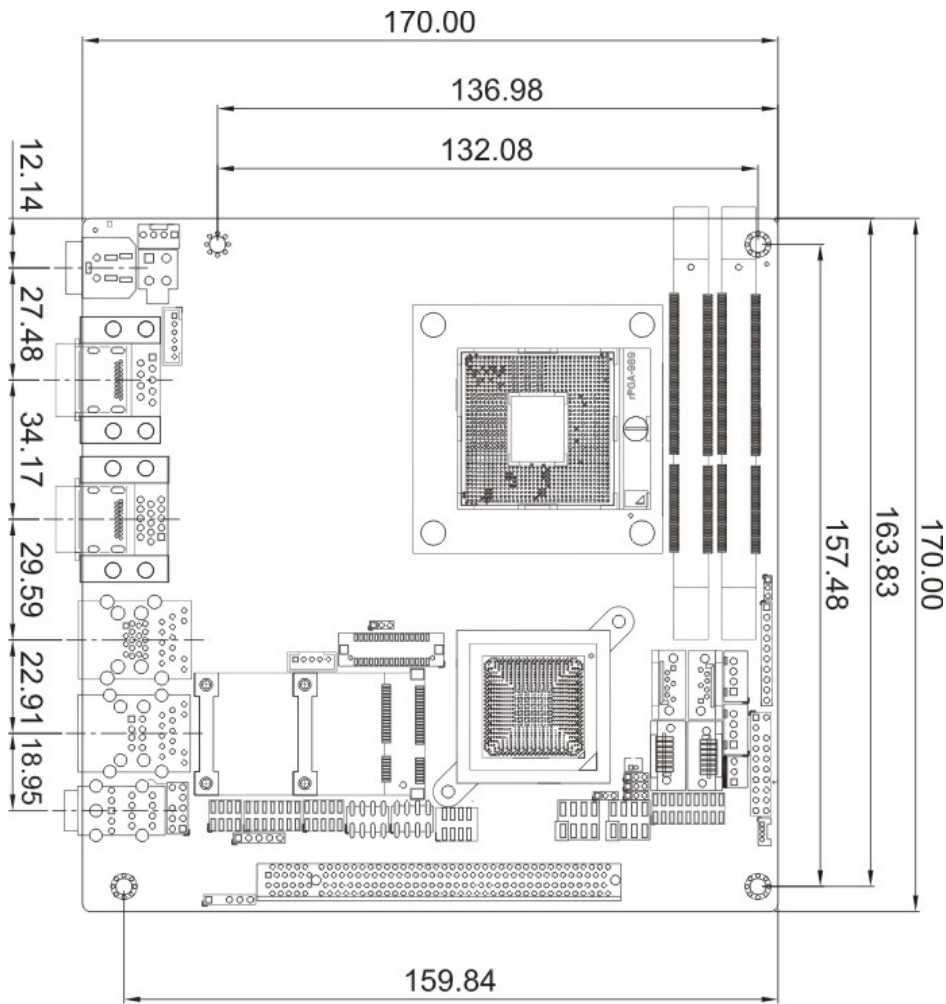

Figure 1-3: KINO-QM670 Dimensions (mm)

KINO-QM670 Mini-ITX SBC

1.3.2 External Interface Panel Dimensions

External peripheral interface connector panel dimensions are shown in **Figure 1-4**.

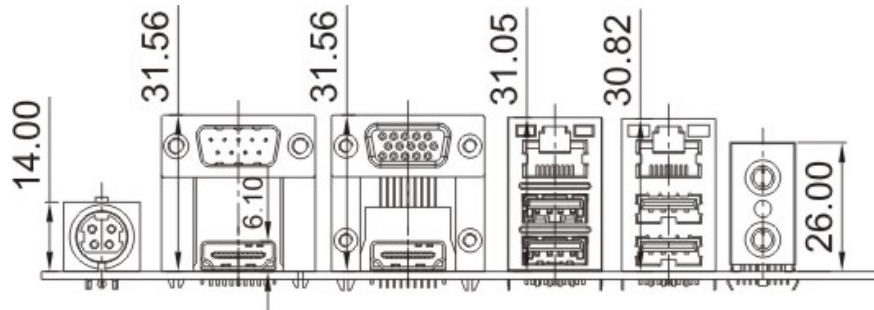

Figure 1-4: External Interface Panel Dimensions (mm)

1.4 Data Flow

Figure 1-5 shows the data flow between the two on-board chipsets and other components installed on the motherboard and described in the following sections of this chapter.

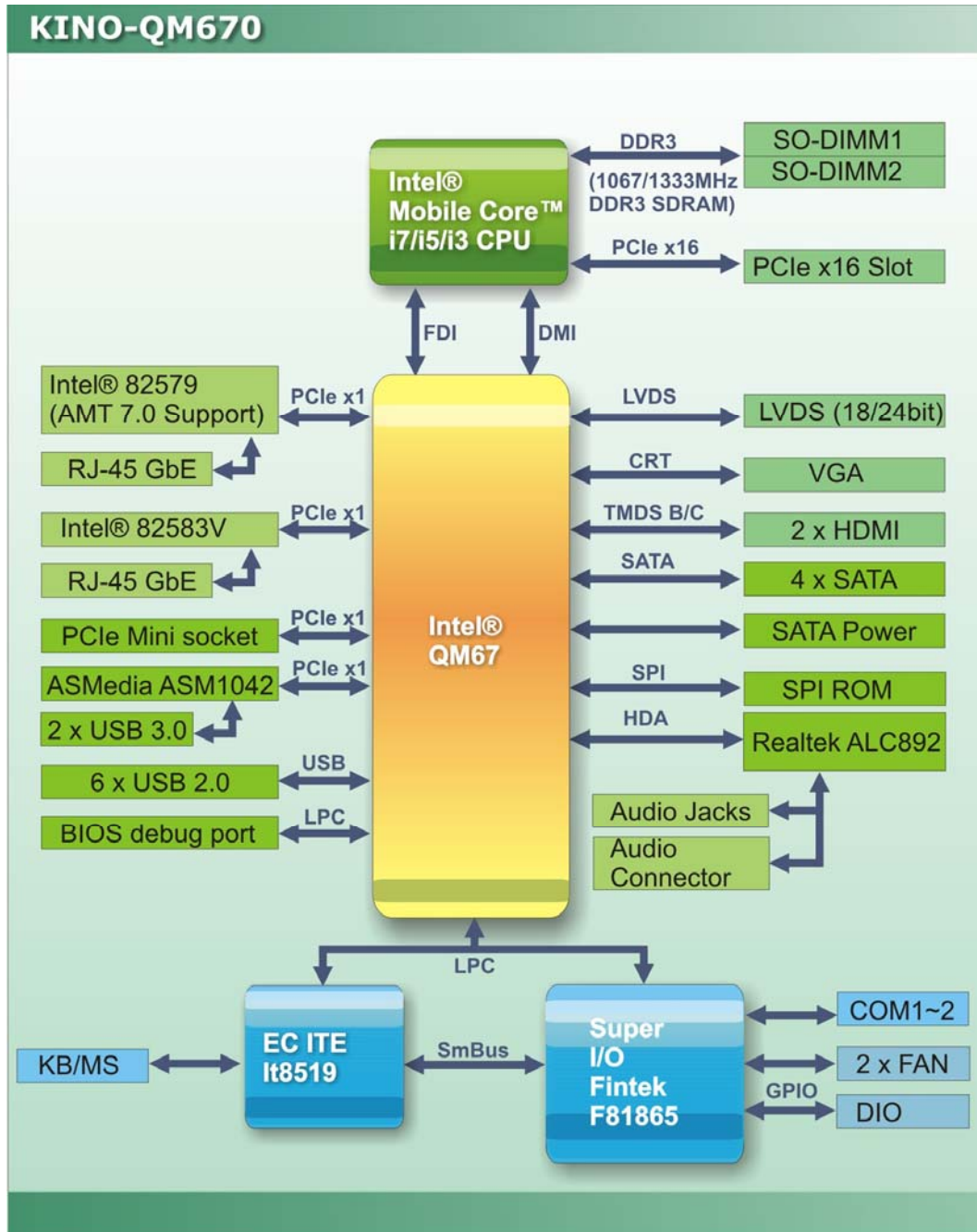

Figure 1-5: Data Flow Block Diagram

KINO-QM670 Mini-ITX SBC

1.5 Technical Specifications

KINO-QM670 technical specifications are listed in table below.

Specification	KINO-QM670
Form Factor	Mini-ITX
Socket	Socket G2
CPU Supported	Intel® Core™ i3 processor Intel® Core™ i5 processor Intel® Core™ i7 processor
Express Chipset	Intel® QM67
Memory	Two 204-pin SO-DIMM sockets support two 1066/1333 MHz 4 GB (max.) DDR3 SDRAM SO-DIMMs (system max. 8 GB)
Audio	Realtek ALC892 7.1-channel HD audio codec
LAN	One Intel® 82579 PHY with Intel® AMT 7.0 support One Intel® 82583V PCIe GbE controller
Super I/O	Fintek F81865
BIOS	UEFI BIOS label
Watchdog Timer	Software programmable supports 1~255 sec. system reset
Expansion	
PCIe	One PCIe x16 slot One PCIe mini slot
I/O Interface Connectors	
Audio Connector	One internal audio connector (10-pin header) One internal SPDIF connector (5-pin header) One external audio line-out connector One external mic-in connector
Display Ports	One VGA port One 18-bit or 24-bit dual-channel LVDS port Two external HDMI ports support resolution up to 1080p

Specification	KINO-QM670
Ethernet	Two RJ-45 GbE port
Serial Ports	One RS-232 via DB-9 connector One RS-232 via 10-pin header connectors One RS-422/485 via 4-pin header connector
USB Ports	Two external USB 2.0 ports Two external USB 3.0 ports Four internal USB ports via 8-pin header connector
Storage	
Serial ATA	Two SATA 3Gb/s connectors Two SATA 6Gb/s connectors with RAID 0/1/5/10 support Two 12V/5V SATA power connectors
Environmental and Power Specifications	
Power Supply	12 V only ATX and AT power supported
Power Connector	One internal 4-pin Molex power connector for power supply One external 4-pin Mini-DIN for power adapter
Power Consumption	12V@6.5A 2.1 GHz Intel® Core™ i7-2710QE CPU with DDR3 1333MHz 2GB*2 DIMM
Operating Temperature	-10°C ~ 60°C (requires cooler and silicone heat sink paste)
Humidity	5% ~ 95% (non-condensing)
Physical Specifications	
Dimensions	170 mm x 170 mm
Weight GW/NW	900g/450g

Table 1-1: Technical Specifications

Chapter

2

Unpacking

2.1 Anti-static Precautions



WARNING!

Static electricity can destroy certain electronics. Make sure to follow the ESD precautions to prevent damage to the product, and injury to the user.

Make sure to adhere to the following guidelines:

- **Wear an anti-static wristband:** Wearing an anti-static wristband can prevent electrostatic discharge.
- **Self-grounding:** Touch a grounded conductor every few minutes to discharge any excess static buildup.
- **Use an anti-static pad:** When configuring any circuit board, place it on an anti-static mat.
- **Only handle the edges of the PCB:** Don't touch the surface of the motherboard. Hold the motherboard by the edges when handling.

2.2 Unpacking Precautions

When the KINO-QM670 is unpacked, please do the following:

- Follow the antistatic guidelines above.
- Make sure the packing box is facing upwards when opening.
- Make sure all the packing list items are present.

KINO-QM670 Mini-ITX SBC







2.3 Packing List



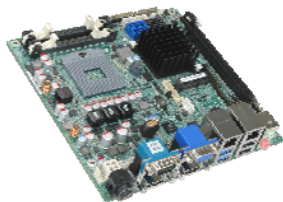

NOTE:

If any of the components listed in the checklist below are missing, do not proceed with the installation. Contact the IEI reseller or vendor the KINO-QM670 was purchased from or contact an IEI sales representative directly by sending an email to sales@ieiworld.com.







The KINO-QM670 is shipped with the following components:

Quantity	Item and Part Number	Image
1	KINO-QM670 motherboard	
2	SATA with power output cable (P/N: 32801-000100-300-RS)	
1	Dual RS-232 cable (P/N: 19800-000300-100-RS)	
1	I/O shielding (P/N: 45014-0029C0-00-RS)	
1	Mini jumper pack	
1	One Key Recovery CD	

1	Utility CD	
1	Quick Installation Guide	

2.3.1 Optional Items

The following are optional components which may be separately purchased:

Item and Part Number	Image
Dual-port USB cable with bracket (P/N: 19800-003100-300-RS)	
KB/MS Y cable (P/N: 32000-023800-RS)	
RS-422/485 cable (P/N: 32205-003800-300-RS)	
SATA to CF converter board (P/N: SACF-KIT01-R10)	
CPU cooler (P/N: CF-989A-RS-R12)	
20-Pin Infineon TPM module, software management tool, firmware V3.17 (P/N: TPM-IN01-R11)	

Chapter

3

Connectors

3.1 Peripheral Interface Connectors

This chapter details all the jumpers and connectors.

3.1.1 KINO-QM670 Layout

The figures below show all the connectors and jumpers.

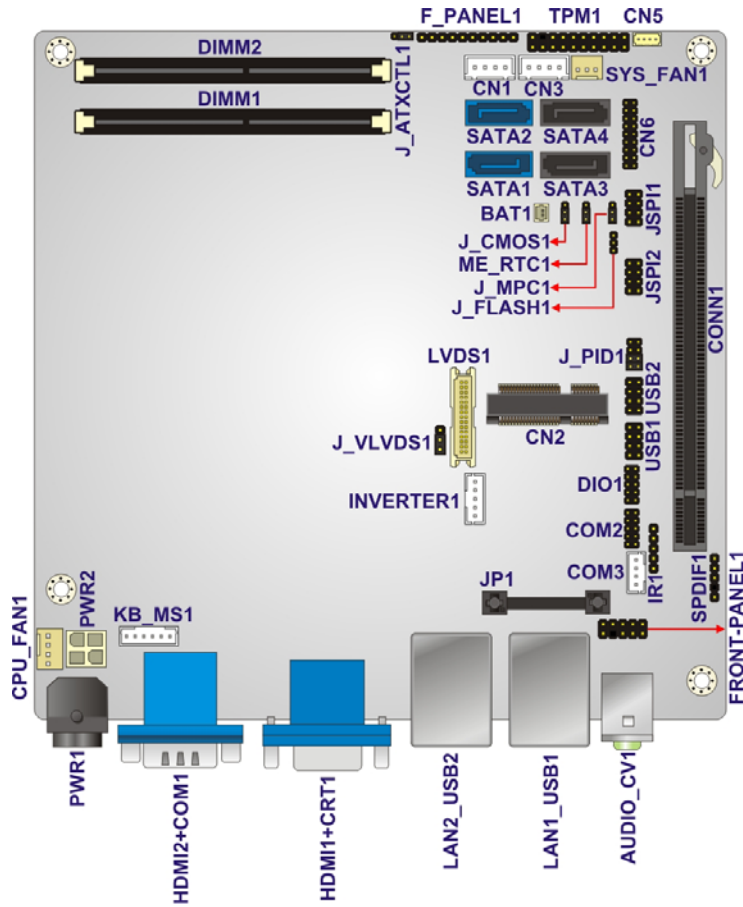

Figure 3-1: Connector and Jumper Locations

KINO-QM670 Mini-ITX SBC

3.1.2 Peripheral Interface Connectors

The table below lists all the connectors on the board.

Connector	Type	Label
Audio connector	10-pin header	FRONT-PANEL1
Battery connector	2-pin wafer	BAT1
Backlight inverter 12 V power connector	5-pin wafer	INVERTER1
DDR3 SO-DIMM socket	204-pin socket	DIMM1
DDR3 SO-DIMM socket	204-pin socket	DIMM2
Digital I/O connector	10-pin header	DIO1
EC Debug port	18-pin header	CN6
Fan connector (CPU)	4-pin wafer	CPU_FAN1
Fan connector (system)	3-pin wafer	SYS_FAN1
Front panel connector	10-pin header	F_PANEL1
Infrared connector	5-pin header	IR1
Keyboard and mouse connector	6-pin wafer	KB_MS1
LVDS connector	30-pin crimp	LVDS1
PCIe mini card socket	52-pin socket	CN2
Power supply	4-pin connector	PWR2
Serial ATA (SATA) drive connector	7-pin SATA	S_ATA1, S_ATA2, S_ATA3, S_ATA4
SATA power connector	4-pin wafer	CN1, CN3
Serial port connector (RS-232)	10-pin header	COM2

Serial port connector (RS-422/485)	4-pin header	COM3
SMBus connector	4-pin wafer	CN5
SPDIF connector	5-pin header	SPDIF1
SPI Flash connector	8-pin header	JSPI1, JSPI2
TPM connector	20-pin header	TPM1
USB connectors	8-pin header	USB1, USB2

Table 3-1: Peripheral Interface Connectors

3.1.3 External Interface Panel Connectors

The table below lists the connectors on the external I/O panel.

Connector	Type	Label
Audio jacks	Audio jack	AUDIO_CV1
Ethernet and USB 3.0 connector	RJ-45/USB	LAN1_USB1
Ethernet and USB 2.0 connector	RJ-45/USB	LAN2_USB2
HDMI port	HDMI Type A port	HDMI1, HDMI2
Power connector (12V, power adapter)	4-pin power jack	PWR1
RS-232 serial port	DB-9	COM1
VGA connector	15-pin female	CRT1

Table 3-2: Rear Panel Connectors

KINO-QM670 Mini-ITX SBC

3.2 Internal Peripheral Connectors

The section describes all of the connectors on the KINO-QM670.

3.2.1 Audio Connector

- CN Label:** FRONT-PANEL1
- CN Type:** 10-pin header (2x5)
- CN Location:** See **Figure 3-2**
- CN Pinouts:** See **Table 3-3**

The audio connector is connected to external audio devices including speakers and microphones for the input and output of audio signals to and from the system.

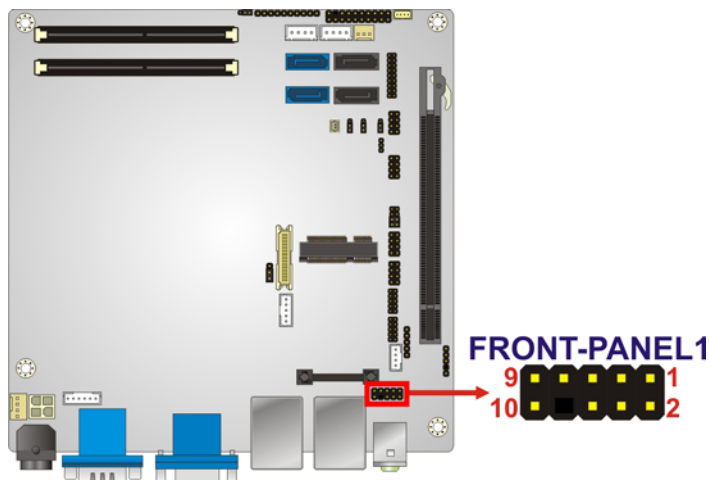

Figure 3-2: Audio Connector Location

PIN NO.	DESCRIPTION	PIN NO.	DESCRIPTION
1	LMIC2-L	2	ANALOG GND
3	LMIC2-R	4	PRESENCE#
5	LLINE2-R	6	MIC2-JD
7	FRONT-IO	8	NC
9	LLINE2-L	10	LINE2-JD

Table 3-3: Audio Connector Pinouts

3.2.2 Battery Connector



CAUTION:

Risk of explosion if battery is replaced by an incorrect type. Only certified engineers should replace the on-board battery.

Dispose of used batteries according to instructions and local regulations.

- CN Label:** **BAT1**
- CN Type:** 2-pin wafer (1x2)
- CN Location:** See **Figure 3-3**
- CN Pinouts:** See **Table 3-4**

This is connected to the system battery. The battery provides power to the system clock to retain the time when power is turned off.

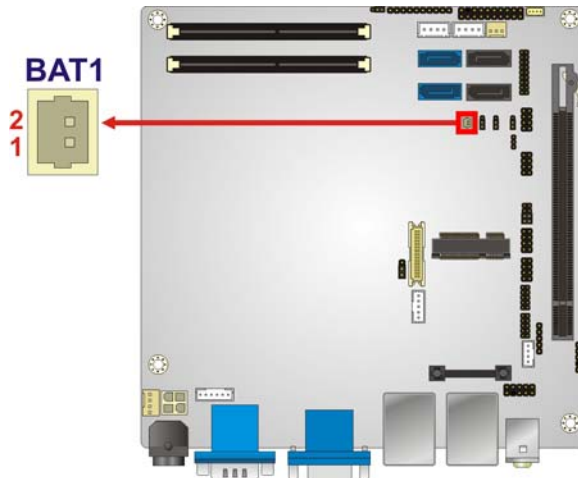

Figure 3-3: Battery Connector Location

Pin	Description
1	BAT (+3.3V)
2	GND

Table 3-4: Battery Connector Pinouts

KINO-QM670 Mini-ITX SBC

3.2.3 Backlight Inverter Connector

- CN Label:** **INVERTER1**
- CN Type:** 5-pin wafer (1x5)
- CN Location:** See **Figure 3-4**
- CN Pinouts:** See **Table 3-5**

The backlight inverter connector provides the backlight on the LCD display connected to the KINO-QM670 with +12V of power.

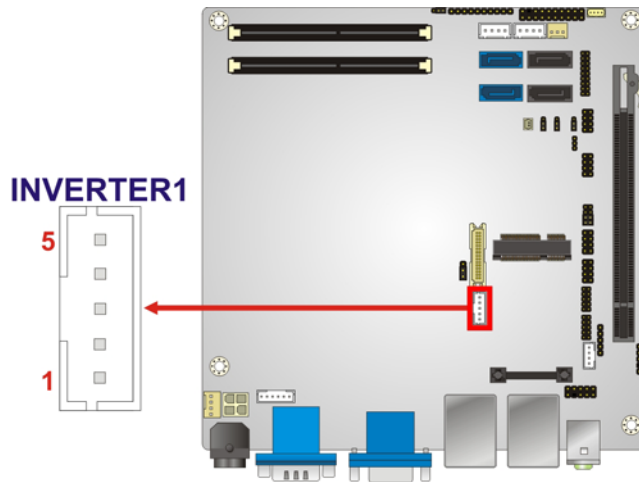

Figure 3-4: Panel Backlight Connector Pinout Location

PIN NO.	DESCRIPTION
1	LCD BKLTCTL
2	GND
3	+12V
4	GND
5	BACKLIGHT ENABLE

Table 3-5: Panel Backlight Connector Pinouts

3.2.4 Digital I/O Connector

- CN Label:** DIO1
- CN Type:** 10-pin header (2x5)
- CN Location:** See **Figure 3-5**
- CN Pinouts:** See **Table 3-6**

The digital I/O connector provides programmable input and output for external devices. The digital I/O provides 4-bit output and 4-bit input.

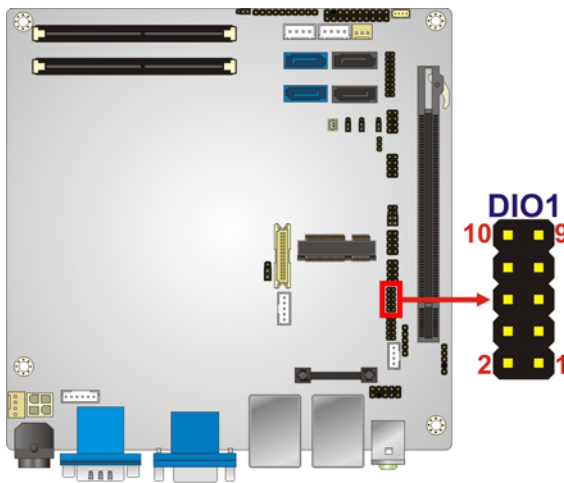

Figure 3-5: Digital I/O Connector Location

Pin	Description	Pin	Description
1	GND	2	VCC (+5V)
3	Output 3	4	Output 2
5	Output 1	6	Output 0
7	Input 3	8	Input 2
9	Input 1	10	Input 0

Table 3-6: Digital I/O Connector Pinouts

KINO-QM670 Mini-ITX SBC

3.2.5 EC Debug Port

- CN Label:** CN6
- CN Type:** 18-pin header
- CN Location:** See **Figure 3-6**
- CN Pinouts:** See **Table 3-7**

The connector is for EC debug only.

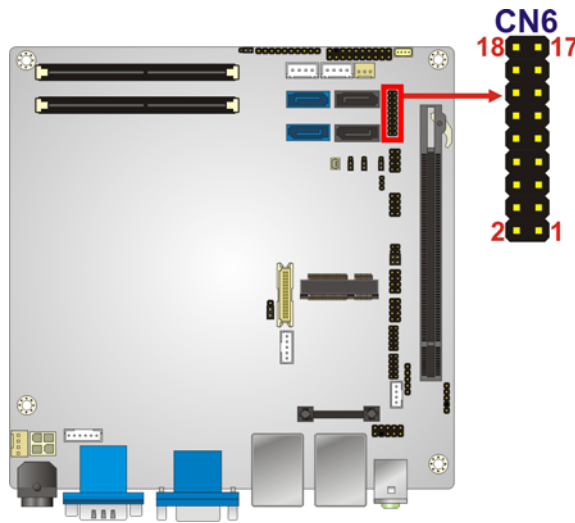

Figure 3-6: BIOS Debug Port Location

Pin	Description	Pin	Description
1	EC_EPP_STB#	2	EC_EPP_AFD#
3	EC_EPP_PDO	4	NC
5	EC_EPP_PD1	6	EC_EPP_INIT#
7	EC_EPP_PD2	8	EC_EPP_SLIN#
9	EC_EPP_PD3	10	GND
11	EC_EPP_PD4	12	NC
13	EC_EPP_PD5	14	EC_EPP_BUSY
15	EC_EPP_PD6	16	EC_EPP_KS15
17	EC_EPP_PD7	18	EC_EPP_KS14

Table 3-7: EC Debug Port Pinouts

3.2.6 Fan Connector (CPU)

- CN Label:** CPU_FAN1
- CN Type:** 4-pin wafer (1x4)
- CN Location:** See **Figure 3-7**
- CN Pinouts:** See **Table 3-8**

The fan connector attaches to a CPU cooling fan.

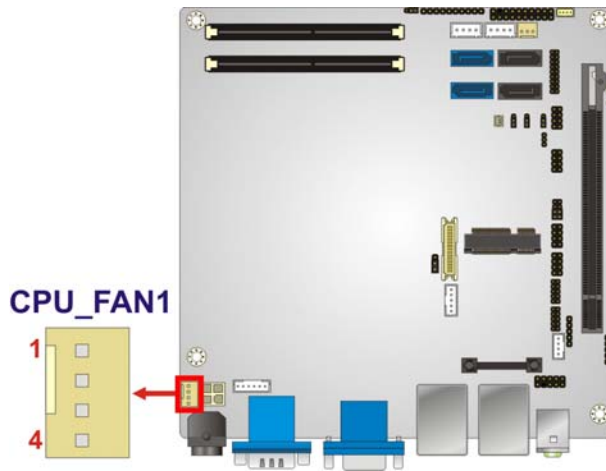

Figure 3-7: CPU Fan Connector Location

Pin	Description
1	GROUND
2	+12V
3	Rotation Signal
4	PWM Control Signal

Table 3-8: CPU Fan Connector Pinouts

3.2.7 Fan Connector (System)

- CN Label:** SYS_FAN1
- CN Type:** 3-pin wafer (1x3)
- CN Location:** See **Figure 3-8**
- CN Pinouts:** See **Table 3-9**

KINO-QM670 Mini-ITX SBC

The cooling fan connector provides a 12V, 500mA current to the cooling fan. The connector has a "rotation" pin to get rotation signals from fans and notify the system so the system BIOS can recognize the fan speed. Please note that only specified fans can issue the rotation signals.

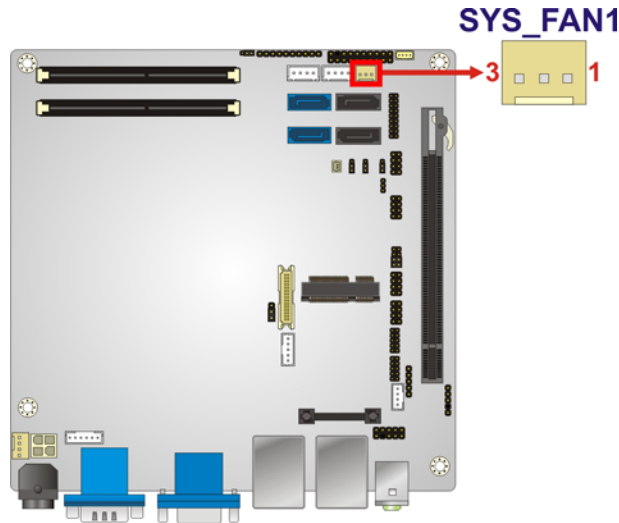

Figure 3-8: +12V Fan Connector Location

PIN NO.	DESCRIPTION
1	Rotation Signal
2	+12V
3	GND

Table 3-9: +12V Fan Connector Pinouts

3.2.8 Front Panel Connector

CN Label:	F_PANEL1
CN Type:	10-pin header (1x10)
CN Location:	See Figure 3-9
CN Pinouts:	See Table 3-10

The front panel connector connects to external switches and indicators to monitor and controls the motherboard. These indicators and switches include:

- Power button
- Reset
- Power LED
- HDD LED

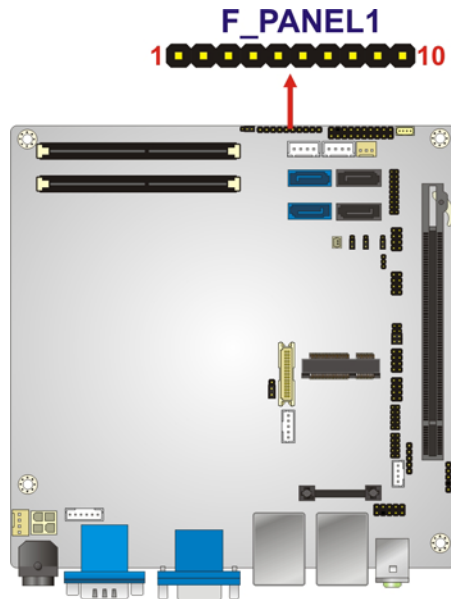

Figure 3-9: Front Panel Connector Location

FUNCTION	PIN	DESCRIPTION	FUNCTION	PIN	DESCRIPTION
	1	NC	Power LED	6	PWR_LED+
Power Button	2	PWR_BTN+		7	PWR_LED+
	3	PWR_BTN-		8	GND
HDD LED	4	HDD_LED+	Reset	9	RESET+
	5	HDD_LED-		10	GND

Table 3-10: Front Panel Connector Pinouts

3.2.9 Infrared Interface Connector

- CN Label:** IR1
- CN Type:** 5-pin header (1x5)
- CN Location:** See **Figure 3-10**
- CN Pinouts:** See **Table 3-11**

KINO-QM670 Mini-ITX SBC

The infrared connector attaches to an infrared receiver for use with remote controls.

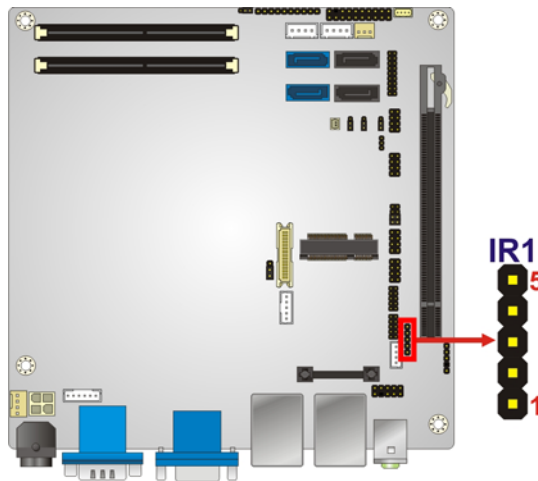

Figure 3-10: Infrared Connector Location

Pin	Description
1	VCC (+5V)
2	NC
3	IR-RX
4	GND
5	IR-TX

Table 3-11: Infrared Connector Pinouts

3.2.10 Keyboard/Mouse Connector

- CN Label:** KB_MS1
- CN Type:** 6-pin wafer (1x6)
- CN Location:** See **Figure 3-11**
- CN Pinouts:** See **Table 3-12**

The keyboard/mouse connector connects to a PS/2 Y-cable that can be connected to a PS/2 keyboard and mouse.

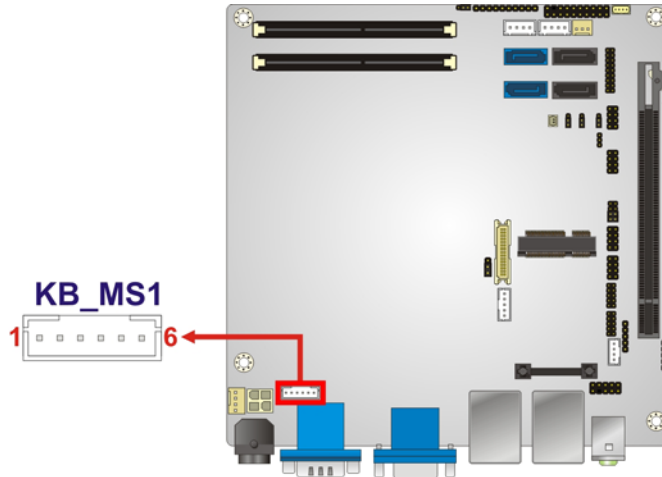

Figure 3-11: Keyboard/Mouse Connector Location

Pin	Description
1	VCC (+5V)
2	Mouse Data
3	Mouse Clock
4	Keyboard Data
5	Keyboard Clock
6	GND

Table 3-12: Keyboard/Mouse Connector Pinouts

3.2.11 LVDS Connector

- CN Label:** LVDS1
- CN Type:** 30-pin crimp (2x15)
- CN Location:** See **Figure 3-12**
- CN Pinouts:** See **Table 3-13**

The 30-pin LVDS LCD connectors can be connected to single channel or dual channel, 18-bit LVDS panel.

KINO-QM670 Mini-ITX SBC

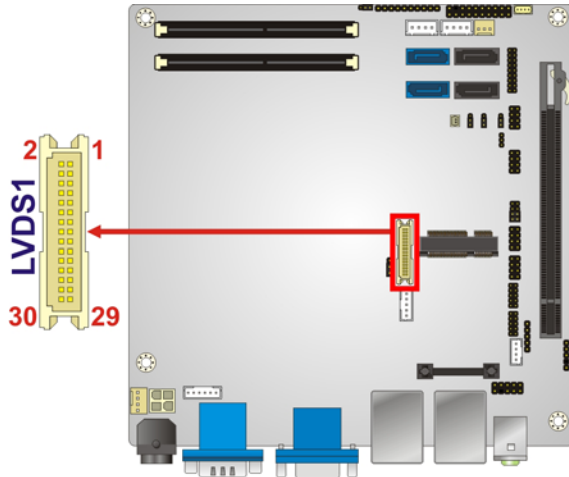

Figure 3-12: LVDS LCD Connector Pinout Location

PIN NO.	DESCRIPTION	PIN NO.	DESCRIPTION
1	GND	2	GND
3	A_Y0	4	A_Y0#
5	A_Y1	6	A_Y1#
7	A_Y2	8	A_Y2#
9	A_CK	10	A_CK#
11	A_Y3	12	A_Y3#
13	GND	14	GND
15	B_Y0	16	B_Y0#
17	B_Y1	18	B_Y1#
19	B_Y2	20	B_Y2#
21	B_CK	22	B_CK#
23	B_Y3	24	B_Y3#
25	GND	26	GND
27	VCC/VCC3	28	VCC/VCC3
29	VCC/VCC3	30	VCC/VCC3

Table 3-13: LVDS LCD Port Connector Pinouts

3.2.12 PCIe Mini Card Slot

- CN Label:** CN2
- CN Type:** 52-pin PCIe Mini Card Slot
- CN Location:** See **Figure 3-13**
- CN Pinouts:** See **Table 3-14**

The PCIe mini card slot enables a PCIe mini card expansion module to be connected to the board. Cards supported include among others wireless LAN (WLAN) cards.

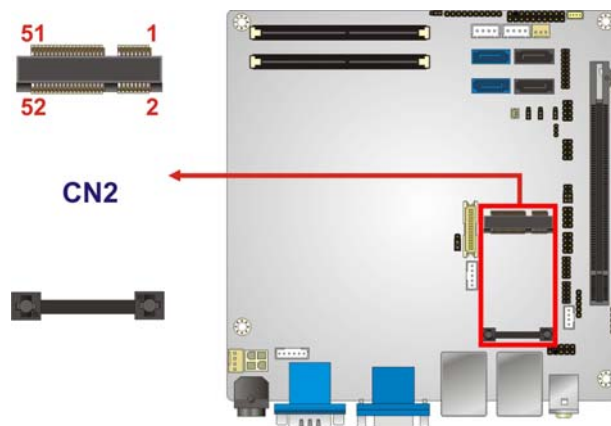

Figure 3-13: PCIe Mini Card Slot Location

PIN NO.	DESCRIPTION	PIN NO.	DESCRIPTION
1	PCIE_WAKE#	2	VCC3
3	N/C	4	GND
5	N/C	6	1.5V
7	N/C	8	N/C
9	GND	10	N/C
11	CLK-	12	N/C
13	CLK+	14	N/C
15	GND	16	N/C
17	PCIRST#	18	GND
19	N/C	20	VCC3
21	GND	22	PCIRST#
23	PERN2	24	3VDual

KINO-QM670 Mini-ITX SBC

25	PERP2	26	GND
27	GND	28	1.5V
29	GND	30	SMBCLK
31	PETN2	32	SMBDATA
33	PETP2	34	GND
35	GND	36	USBD-
37	N/C	38	USBD+
39	N/C	40	GND
41	N/C	42	N/C
43	N/C	44	N/C
45	N/C	46	N/C
47	N/C	48	1.5V
49	N/C	50	GND
51	N/C	52	VCC3

Table 3-14: PCIe Mini Card Slot Pinouts

3.2.13 12V Power Connector

- CN Label:** PWR2
- CN Type:** 4-pin Molex power connector (1x4)
- CN Location:** See **Figure 3-14**
- CN Pinouts:** See **Table 3-15**

The connector supports the 12V power supply.

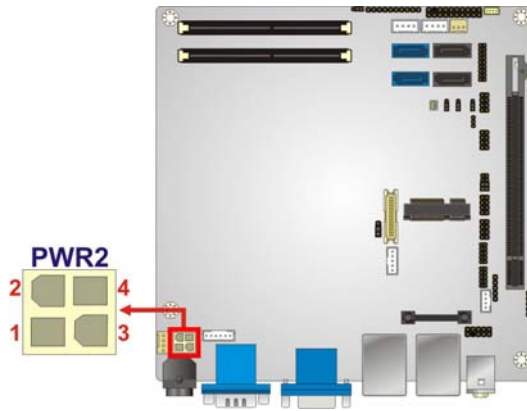

Figure 3-14: CPU 12V Power Connector Location

PIN NO.	DESCRIPTION	PIN NO.	DESCRIPTION
1	GND	2	GND
3	+12V	4	+12V

Table 3-15: CPU 12V Power Connector Pinouts

3.2.14 SATA Drive Connectors

CN Label: S_ATA1, S_ATA2, S_ATA3, S_ATA4

CN Type: 7-pin SATA drive connectors

CN Location: See **Figure 3-15**

CN Pinouts: See **Table 3-16**

There are two SATA 6Gb/s drive connectors (SATA1, SATA2) and two SATA 3Gb/s drive connectors (SATA3, SATA 4).

KINO-QM670 Mini-ITX SBC

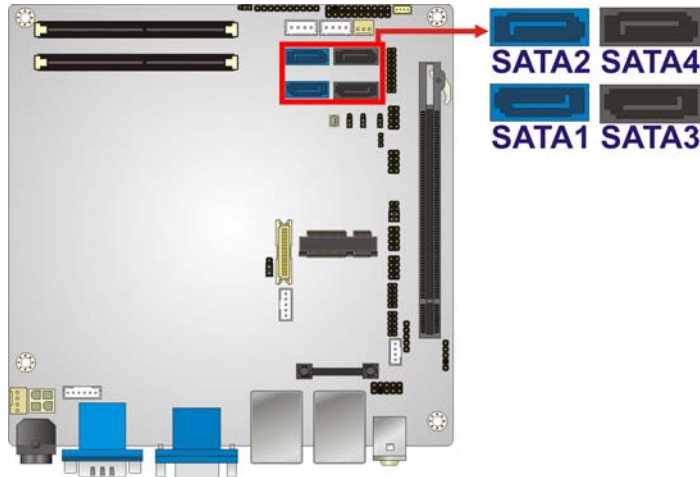

Figure 3-15: SATA Drive Connector Location

PIN NO.	DESCRIPTION
1	GND
2	TX+
3	TX-
4	GND
5	RX-
6	RX+
7	GND

Table 3-16: SATA Drive Connector Pinouts

3.2.15 SATA Power Connector

- CN Label:** CN1, CN3
- CN Type:** 4-pin wafer (1x4)
- CN Location:** See **Figure 3-16**
- CN Pinouts:** See **Table 3-17**

The SATA Power Connector provides +5V and +12V power output to the SATA connector.

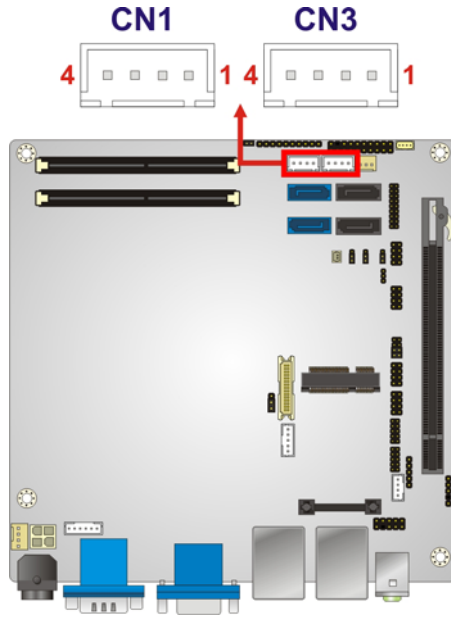

Figure 3-16: SATA Power Connector Location

PIN NO.	DESCRIPTION
1	+12V
2	GND
3	GND
4	+5V

Table 3-17: SATA Power Connector Pinouts

3.2.16 Serial Port Connector (RS-232)

- CN Label:** COM2
- CN Type:** 10-pin header
- CN Location:** See **Figure 3-17**
- CN Pinouts:** See **Table 3-18**

Used for RS-232 communications.

KINO-QM670 Mini-ITX SBC

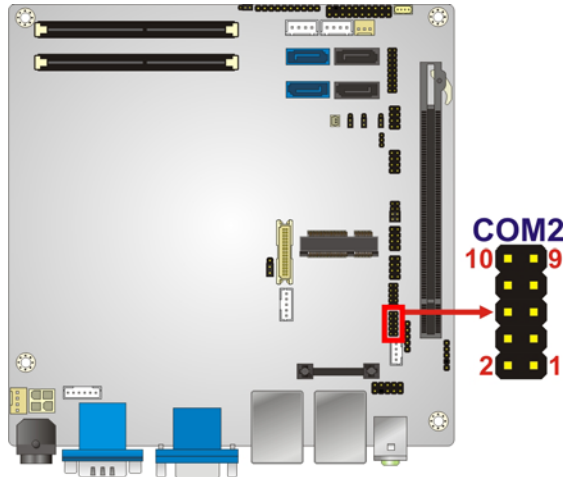

Figure 3-17: Serial Port Connector Location

PIN NO.	DESCRIPTION	PIN NO.	DESCRIPTION
1	-NDCD2	2	-NDSR2
3	NSIN2	4	-NRTS2
5	NSOUT2	6	-NCTS2
7	-NDTR2	8	-XR12
9	GND	10	GND

Table 3-18: Serial Port Connector Pinouts

3.2.17 Serial Port Connectors (RS-422/485)

- CN Label:** COM3
- CN Type:** 4-pin wafer
- CN Location:** See **Figure 3-18**
- CN Pinouts:** See **Table 3-19**

This connector provides RS-422/485 communications.

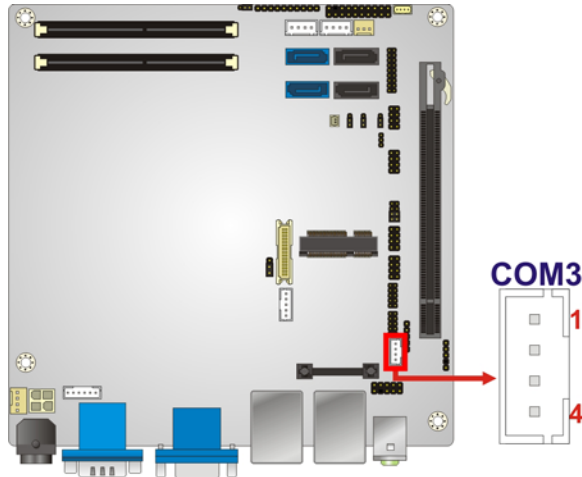

Figure 3-18: Serial Port Connector (RS-422/485) Location

Pin	Description
1	RXD422-
2	RXD422+
3	TXD422+/TXD485+
4	TXD422-/TXD485-

Table 3-19: Serial Port Connector (RS-422/485) Pinouts

Use the optional RS-422/485 cable to connect to a serial device. The pinouts of the DB-9 connector are listed below.

RS-422 Pinouts	RS-485 Pinouts

Table 3-20: DB-9 RS-422/485 Pinouts

3.2.18 SMBus Connector

CN Label: CN5
CN Type: 4-pin wafer

KINO-QM670 Mini-ITX SBC

CN Location: See **Figure 3-19**

CN Pinouts: See **Table 3-21**

The SMBus (System Management Bus) connector provides low-speed system management communications.

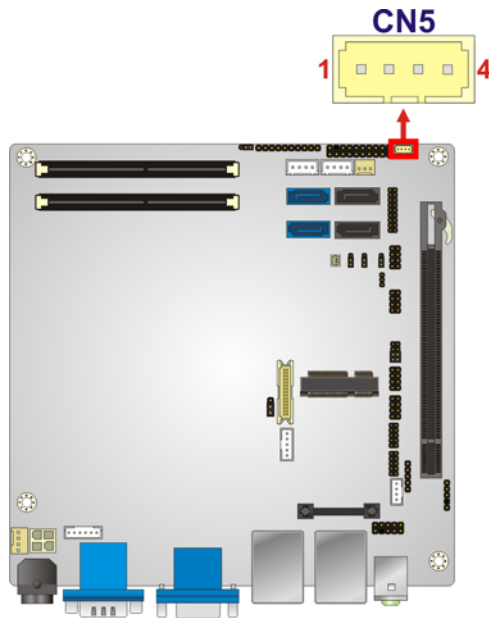

Figure 3-19: SMBus Connector Location

Pin	Description
1	GND
2	SMB_DATA
3	SMB_CLK
4	+V5S

Table 3-21: SMBus Connector Pinouts

3.2.19 SPDIF Connector

CN Label: SPDIF1

CN Type: 5-pin header (1x5)

CN Location: See **Figure 3-20**

CN Pinouts: See **Table 3-22**

Use the SPDIF connector to connect digital audio devices to the system.

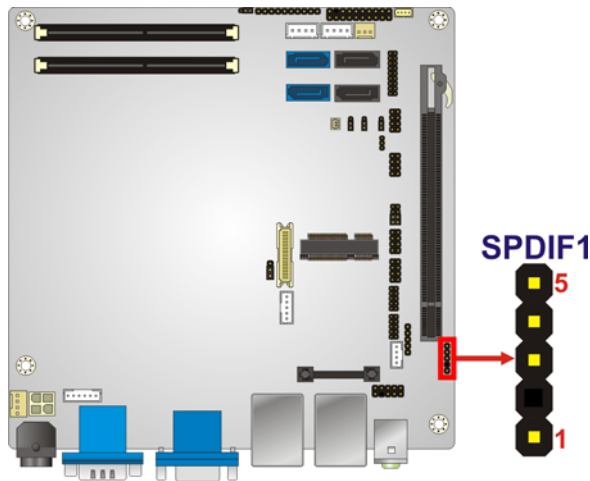

Figure 3-20: SPDIF Connector Location

PIN	DESCRIPTION
1	+V5S
2	NC
3	SPDIFOUT
4	GND
5	SPDIFIN

Table 3-22: SPDIF Connector Pinouts

3.2.20 SPI Flash Connector

- CN Label:** JSPI1, JSPI2
- CN Type:** 8-pin header (2x4)
- CN Location:** See **Figure 3-21**
- CN Pinouts:** See **Table 3-23** and **Table 3-24**

The 8-pin SPI Flash connector is used to flash the BIOS.

KINO-QM670 Mini-ITX SBC

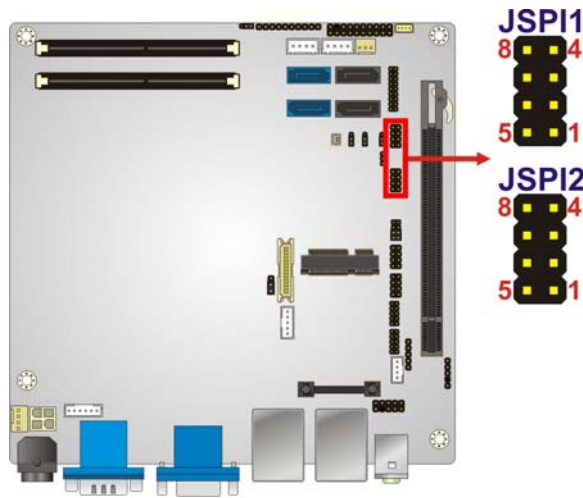

Figure 3-21: SPI Flash Connector Location

PIN	DESCRIPTION	PIN	DESCRIPTION
1	+V3.3M_SPI_CON	5	GND
2	SPI_CS	6	SPI_CLK_SW
3	SPI_SO_SW	7	SPI_SI_SW
4	N/C	8	N/C

Table 3-23: JSPI1 Flash Connector Pinouts

PIN	DESCRIPTION	PIN	DESCRIPTION
1	+V3.3M_SPI_CON_EC	5	GND
2	SPI_CS#0_CN_EC	6	SPI_CLK_SW_EC
3	SPI_SO_SW_EC	7	SPI_SI_SW_EC
4	N/C	8	NC

Table 3-24: JSPI2 Flash Connector Pinouts

3.2.21 TPM Connector

- CN Label:** TPM1
- CN Type:** 20-pin header (2x10)
- CN Location:** See Figure 3-22
- CN Pinouts:** See Table 3-25

The Trusted Platform Module (TPM) connector secures the system on bootup.

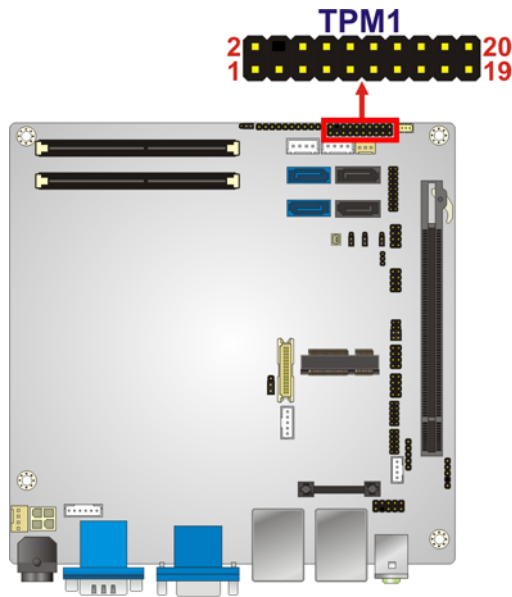

Figure 3-22: TPM Connector Pinout Location

Pin	Description	Pin	Description
1	LCLK	2	GND
3	LFRAME#	4	KEY
5	LRERST#	6	+5V
7	LAD3	8	LAD2
9	+3 V	10	LAD1
11	LAD0	12	GND
13	SCL	14	SDA
15	SB3V	16	SERIRQ
17	GND	18	GLKRUN#
19	LPCPD#	20	LDRO#

Table 3-25: TPM Connector Pinouts

3.2.22 USB Connectors

CN Label: USB1, USB2

CN Type: 8-pin header (2x4)

KINO-QM670 Mini-ITX SBC

CN Location: See Figure 3-23

CN Pinouts: See Table 3-26

The USB connectors connect to USB devices. Each pin header provides two USB ports.

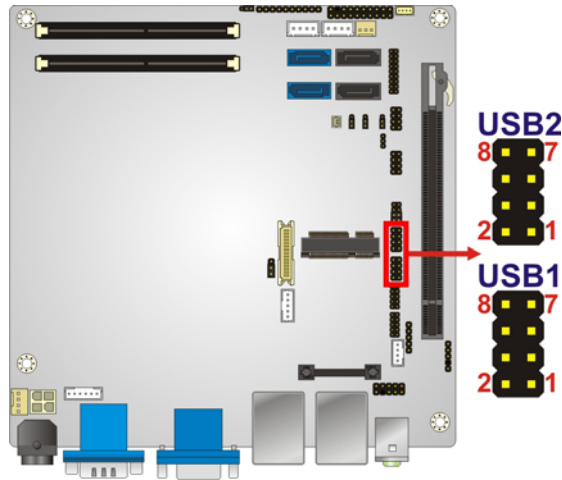

Figure 3-23: USB Connector Pinout Location

PIN NO.	DESCRIPTION	PIN NO.	DESCRIPTION
1	VCC (+5V)	2	GND
3	DATA-	4	DATA+
5	DATA+	6	DATA-
7	GND	8	VCC (+5V)

Table 3-26: USB Port Connector Pinouts

3.3 External Peripheral Interface Connector Panel

Figure 3-24 shows the KINO-QM670 external peripheral interface connector (EPIC) panel.

The KINO-QM670 EPIC panel consists of the following:

- 2 x Audio jacks
- 2 x Ethernet connectors
- 2 x HDMI connectors
- 1 x Power connector
- 1 x RS-232 serial port connector
- 2 x USB 3.0 connectors

- 2 x USB 2.0 connectors
- 1 x VGA connector

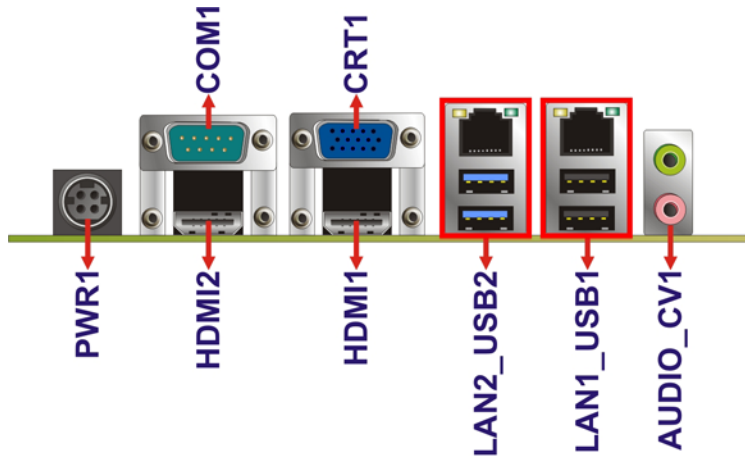

Figure 3-24: KINO-QM670 External Peripheral Interface Connector

3.3.1 Audio Connector

- CN Label:** AUDIO_CV1
- CN Type:** Audio jack
- CN Location:** See **Figure 3-24**

The audio jacks connect to external audio devices.

- **Line Out port (Lime):** Connects to a headphone or a speaker. With multi-channel configurations, this port can also connect to front speakers.
- **Microphone (Pink):** Connects a microphone.



Figure 3-25: Audio Jacks

KINO-QM670 Mini-ITX SBC

3.3.2 Ethernet and USB 2.0 Connector

- CN Label:** LAN1_USB1
- CN Type:** RJ-45 and USB 2.0
- CN Location:** See **Figure 3-24**
- CN Pinouts:** See **Table 3-27** and **Table 3-29**

The LAN connector connects to a local network.

Pin	Description	Pin	Description
1	MDIA3-	5	MDIA2+
2	MDIA3+	6	MDIA1+
3	MDIA1-	7	MDIA0-
4	MDIA2-	8	MDIA0+

Table 3-27: LAN Pinouts

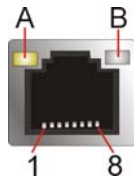

Figure 3-26: Ethernet Connector

LED	Description	LED	Description
A	on: linked blinking: data is being sent/received	B	off: 10 Mb/s green: 100 Mb/s orange: 1000 Mb/s

Table 3-28: Ethernet Connector LEDs

The KINO-QM670 has two external USB 2.0 ports. Each USB 2.0 port can be connected to a USB 2.0/1.1 device.

PIN	DESCRIPTION
1	VCC
2	DATA-
3	DATA+
4	GND

Table 3-29: USB 2.0 Port Pinouts

3.3.3 Ethernet and USB 3.0 Connector

- CN Label:** LAN2_USB2
- CN Type:** RJ-45 and USB 3.0
- CN Location:** See **Figure 3-24**
- CN Pinouts:** See **Table 3-27** and **Table 3-30**

The LAN connector connects to a local network. Refer to **Table 3-27**, **Table 3-28** and **Figure 3-26** for the LAN connector pinouts and LED indications.

The KINO-QM670 has two external USB 3.0 ports. Each USB 3.0 port can be connected to a USB device.

PIN	DESCRIPTION	PIN	DESCRIPTION
1	VBUS	6	STDA_SSRX1_P
2	D1-	7	GND_DRAIN
3	D1+	8	STDA_STX1_N
4	GND1	9	STDA_STX1_P
5	STDA_SSRX1_N		

Table 3-30: USB 3.0 Port Pinouts

KINO-QM670 Mini-ITX SBC

3.3.4 HDMI Connectors

CN Label:	HDMI1 and HDMI2
CN Type:	HDMI type A connector
CN Location:	See Figure 3-24
CN Pinouts:	See Table 3-31

The HDMI (High-Definition Multimedia Interface) connectors connect to digital audio or video sources.

Pin	Description	Pin	Description
1	HDMI_DATA2	2	GND
3	HDMI_DATA2#	4	HDMI_DATA1
5	GND	6	HDMI_DATA1#
7	HDMI_DATA0	8	GND
9	HDMI_DATA0#	10	HDMI_CLK
11	GND	12	HDMI_CLK#
13	N/C	14	N/C
15	HDMI_SCL	16	HDMI_SDA
17	GND	18	+5V
19	HDMI_HPD	20	HDMI_GND
21	HDMI_GND	22	HDMI_GND
23	HDMI_GND		

Table 3-31: HDMI Connector Pinouts

3.3.5 Power Connector (12 V, Power Adapter)

CN Label:	PWR1
CN Type:	4-pin Mini-DIN
CN Location:	See Figure 3-24
CN Pinouts:	See Figure 3-27

The connector supports the 12V power adapter.

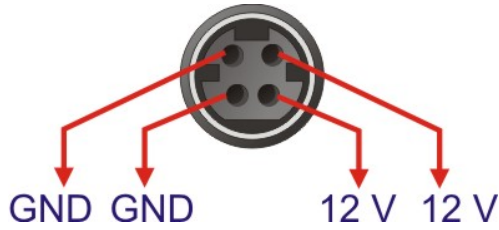

Figure 3-27: 4-pin Power Mini-DIN Connection

3.3.6 Serial Port Connector (COM1)

- CN Label:** COM1
- CN Type:** DB-9
- CN Location:** See **Figure 3-24**
- CN Pinouts:** See **Table 3-32**

The serial port connects to a RS-232 serial communications device.

PIN NO.	DESCRIPTION	PIN NO.	DESCRIPTION
1	DATA CARRIER DETECT (DCD#)	6	DATA SET READY (DSR#)
2	RECEIVE DATA (RXD)	7	REQUEST TO SEND (RTS#)
3	TRANSMIT DATA (TXD)	8	CLEAR TO SEND (CTS#)
4	DATA TERMINAL READY (DTR#)	9	RING INDICATOR (RI#)
5	GND		

Table 3-32: Serial Port Pinouts

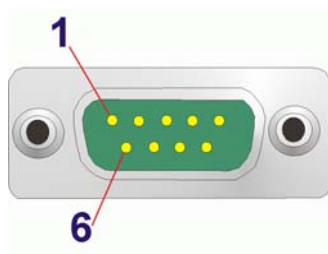

Figure 3-28: Serial Port Pinouts

KINO-QM670 Mini-ITX SBC

3.3.7 VGA Connector

- CN Label:** CRT1
- CN Type:** 15-pin Female
- CN Location:** See **Figure 3-24**
- CN Pinouts:** See **Figure 3-29** and **Table 3-33**

The KINO-QM670 has a single 15-pin female connector for connectivity to standard display devices.

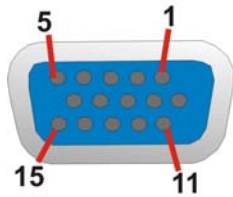

Figure 3-29: VGA Connector

PIN	DESCRIPTION	PIN	DESCRIPTION
1	RED	9	CRT_VCC
2	GREEN	10	GROUND
3	BLUE	11	NC
4	NC	12	5VDDCDA
5	GROUND	13	5HSYNC
6	CRT_PLUG#	14	5VSYNC
7	GROUND	15	5DDCCLK
8	GROUND		

Table 3-33: VGA Connector Pinouts

Chapter

4

Installation

KINO-QM670 Mini-ITX SBC

4.1 Anti-static Precautions

**WARNING:**

Failure to take ESD precautions during the installation of the KINO-QM670 may result in permanent damage to the KINO-QM670 and severe injury to the user.

Electrostatic discharge (ESD) can cause serious damage to electronic components, including the KINO-QM670. Dry climates are especially susceptible to ESD. It is therefore critical that whenever the KINO-QM670, or any other electrical component is handled, the following anti-static precautions are strictly adhered to.

- **Wear an anti-static wristband:** - Wearing a simple anti-static wristband can help to prevent ESD from damaging the board.
- **Self-grounding:** - Before handling the board touch any grounded conducting material. During the time the board is handled, frequently touch any conducting materials that are connected to the ground.
- **Use an anti-static pad:** When configuring the KINO-QM670, place it on an anti-static pad. This reduces the possibility of ESD damaging the KINO-QM670.
- **Only handle the edges of the PCB:-:** When handling the PCB, hold the PCB by the edges.

4.2 Installation Considerations



NOTE:

The following installation notices and installation considerations should be read and understood before the KINO-QM670 is installed. All installation notices pertaining to the installation of the KINO-QM670 should be strictly adhered to. Failing to adhere to these precautions may lead to severe damage of the KINO-QM670 and injury to the person installing the motherboard.

4.2.1 Installation Notices



WARNING:

The installation instructions described in this manual should be carefully followed in order to prevent damage to the KINO-QM670, KINO-QM670 components and injury to the user.

Before and during the installation please **DO** the following:

- Read the user manual:
 - The user manual provides a complete description of the KINO-QM670 installation instructions and configuration options.
- Wear an electrostatic discharge cuff (ESD):
 - Electronic components are easily damaged by ESD. Wearing an ESD cuff removes ESD from the body and helps prevent ESD damage.
- Place the KINO-QM670 on an antistatic pad:
 - When installing or configuring the motherboard, place it on an antistatic pad. This helps to prevent potential ESD damage.
- Turn all power to the KINO-QM670 off:

KINO-QM670 Mini-ITX SBC

- When working with the KINO-QM670, make sure that it is disconnected from all power supplies and that no electricity is being fed into the system.

Before and during the installation of the KINO-QM670 **DO NOT**:

- Remove any of the stickers on the PCB board. These stickers are required for warranty validation.
- Use the product before verifying all the cables and power connectors are properly connected.
- Allow screws to come in contact with the PCB circuit, connector pins, or its components.

4.3 Unpacking

When the KINO-QM670 is unpacked, please check all the unpacking list items listed in Chapter 3 are indeed present. If any of the unpacking list items are not available please contact the KINO-QM670 vendor reseller/vendor where the KINO-QM670 was purchased or contact an IEI sales representative.

4.4 CPU, CPU Cooling Kit and SO-DIMM Installation



WARNING:

A CPU should never be turned on without the specified cooling kit being installed. If the cooling kit (heat sink and fan) is not properly installed and the system turned on, permanent damage to the CPU, KINO-QM670 and other electronic components attached to the system may be incurred. Running a CPU without a cooling kit may also result in injury to the user.

The CPU, CPU cooling kit and DIMM are the most critical components of the KINO-QM670. If one of these component is not installed the KINO-QM670 cannot run.

4.4.1 Socket G2 CPU Installation

**WARNING:**

CPUs are expensive and sensitive components. When installing the CPU please be careful not to damage it in anyway. Make sure the CPU is installed properly and ensure the correct cooling kit is properly installed.

To install a socket G2 CPU onto the KINO-QM670, follow the steps below:

**WARNING:**

When handling the CPU, only hold it on the sides. DO NOT touch the pins at the bottom of the CPU.

Step 1: Unlock the CPU retention screw. When shipped, the retention screw of the CPU socket should be in the unlocked position. If it is not in the unlocked position, use a screwdriver to unlock the screw. See **Figure 4-1**.

KINO-QM670 Mini-ITX SBC

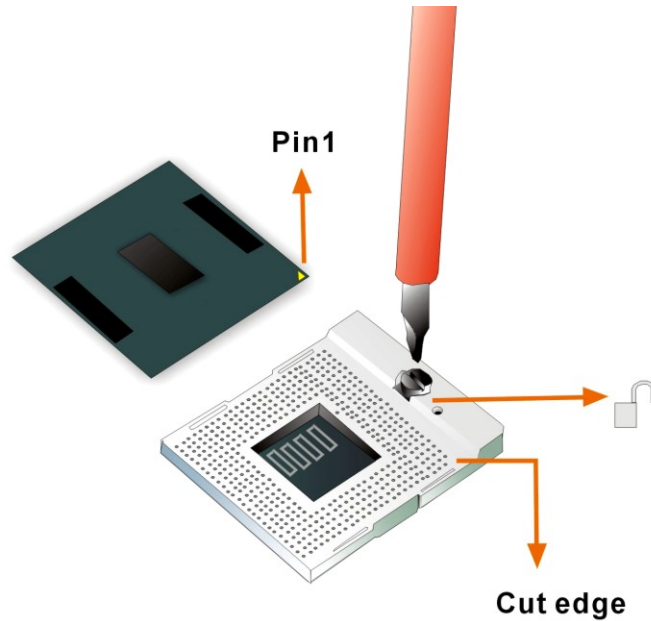

Figure 4-1: Unlock CPU socket retention screw

- Step 2: Inspect the CPU socket.** Make sure there are no bent pins and make sure the socket contacts are free of foreign material. If any debris is found, remove it with compressed air.
- Step 3: Correctly Orientate the CPU.** Make sure the IHS (integrated heat sink) side is facing upwards.
- Step 4: Correctly position the CPU.** Match the Pin 1 mark with the cut edge on the CPU socket. See **Figure 4-1**.
- Step 5: Align the CPU pins.** Carefully align the CPU pins with the holes in the CPU socket.
- Step 6: Insert the CPU.** Gently insert the CPU into the socket. If the CPU pins are properly aligned, the CPU should slide into the CPU socket smoothly.
- Step 7: Lock the retention screw.** Rotate the retention screw into the locked position. See **Figure 4-2**.

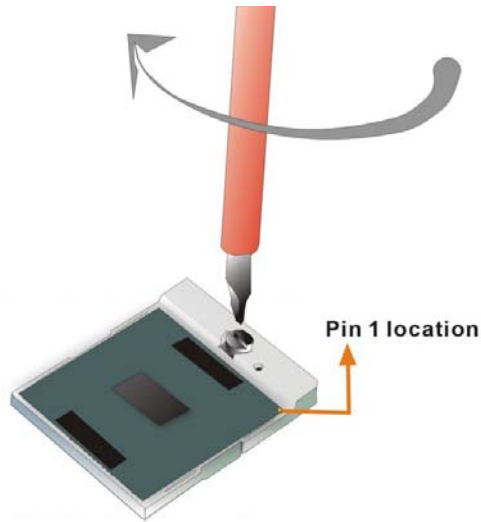

Figure 4-2: Lock the CPU Socket Retention Screw

4.4.2 Socket G2 Cooling Kit Installation

An IEI Socket G2 CPU cooling kit can be purchased separately (See **Chapter 2**). The cooling kit is comprised of a CPU heat sink and a cooling fan.



WARNING:

Do not wipe off (accidentally or otherwise) the pre-sprayed layer of thermal paste on the bottom of the heat sink. The thermal paste between the CPU and the heat sink is important for optimum heat dissipation.

To install the cooling kit, please follow the steps below.

Step 1: Install the cooling kit bracket. A cooling kit bracket is installed on the rear of the motherboard. Align the bracket with the four retention holes at the back of the motherboard. Once properly aligned, insert four retention screws from the front of the motherboard.

KINO-QM670 Mini-ITX SBC

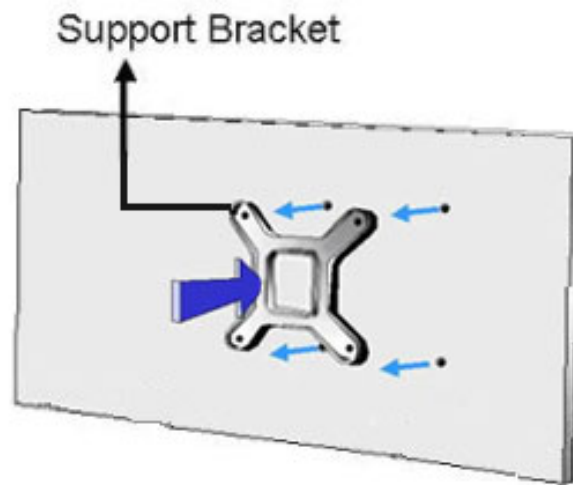

Figure 4-3: Cooling Kit Support Bracket

- Step 2:** **Open the lever at the top of the heat sink.** Lift the lever at the top of the cooling kit to loosen the cooling kit clamps.
- Step 3:** **Secure the cooling kit.** Gently place the heat sink and cooling kit onto the CPU. Make sure the hooks are properly secured to the bracket. To secure the cooling kit, close the top lever.
- Step 4:** **Connect the fan cable.** Connect the cooling kit fan cable to the fan connector on the KINO-QM670. Carefully route the cable and avoid heat generating chips and fan blades.

4.4.3 SO-DIMM Installation

To install a SO-DIMM, please follow the steps below and refer to **Figure 4-4**.

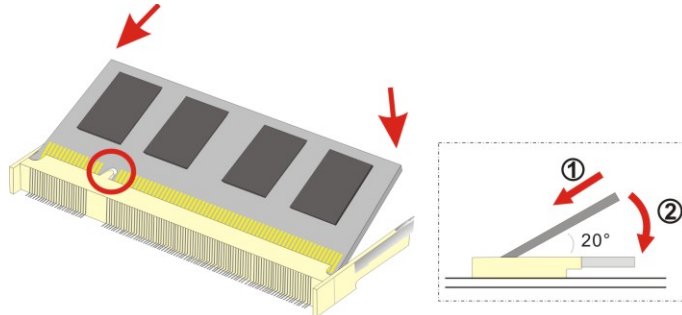

Figure 4-4: SO-DIMM Installation

- Step 1:** Locate the SO-DIMM socket. Place the board on an anti-static mat.
- Step 2:** Align the SO-DIMM with the socket. Align the notch on the memory with the notch on the memory socket.
- Step 3:** Insert the SO-DIMM. Push the memory in at a 20° angle. (See **Figure 4-4**)
- Step 4:** Seat the SO-DIMM. Gently push downwards and the arms clip into place. (See **Figure 4-4**)

4.5 Jumper Settings



NOTE:

A jumper is a metal bridge used to close an electrical circuit. It consists of two or three metal pins and a small metal clip (often protected by a plastic cover) that slides over the pins to connect them. To CLOSE/SHORT a jumper means connecting the pins of the jumper with the plastic clip and to OPEN a jumper means removing the plastic clip from a jumper.

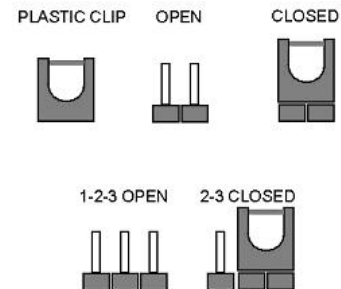

Figure 4-5: Jumper Locations

KINO-QM670 Mini-ITX SBC

Before the KINO-QM670 is installed in the system, the jumpers must be set in accordance with the desired configuration. The jumpers on the KINO-QM670 are listed in **Table 4-1**.

Description	Type	Label
AT/ATX Power Mode Setting	3-pin header	J_ATXCTL1
Clear CMOS	3-pin header	J_CMOS1
LVDS Panel Resolution	8-pin header	J_PID1
LVDS Voltage Select	3-pin header	J_VLVDS1
ME RTC Register	3-pin header	ME_RTC1
Flash Security Override	3-pin header	J_FLASH1
MPC Switch Control (Reserved)	3-pin header	J_MPC1

Table 4-1: Jumpers

4.5.1 AT/ATX Power Mode Jumper Settings

Jumper Label:	J_ATXCTL1
Jumper Type:	3-pin header (1x3)
Jumper Settings:	See Table 4-2
Jumper Location:	See Figure 4-6

The AT Power Select jumper specifies the systems power mode as AT or ATX. AT/ATX Power Mode jumper settings are shown in **Table 4-2**.

AT Power Select	Description
Short 1 - 2	Use ATX power
Short 2 – 3	Use AT power

Table 4-2: AT/ATX Power Mode Jumper Settings

The location of the AT/ATX Power Mode jumper is shown in **Figure 4-6** below.

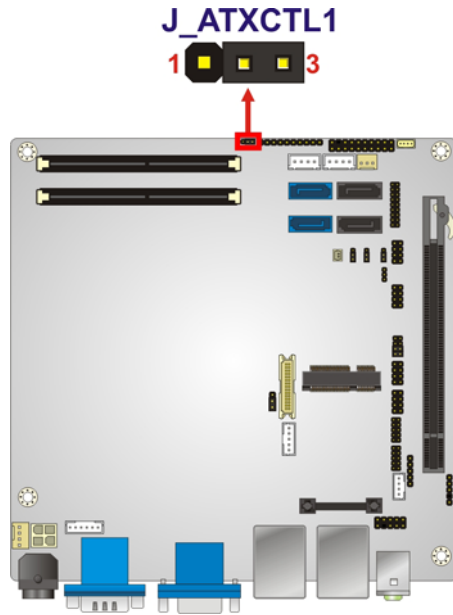

Figure 4-6: AT/ATX Power Mode Jumper Location

4.5.2 Clear CMOS Jumper

Jumper Label:	J_CMOS1
Jumper Type:	3-pin header (1x3)
Jumper Settings:	See Table 4-3
Jumper Location:	See Figure 4-7

If the KINO-QM670 fails to boot due to improper BIOS settings, the clear CMOS jumper clears the CMOS data and resets the system BIOS information. To do this, use the jumper cap to close pins 2 and 3 for a few seconds then reinstall the jumper clip back to pins 1 and 2.

If the “CMOS Settings Wrong” message is displayed during the boot up process, the fault may be corrected by pressing the F1 to enter the CMOS Setup menu. Do one of the following:

- Enter the correct CMOS setting
- Load Optimal Defaults
- Load Failsafe Defaults.

KINO-QM670 Mini-ITX SBC

After having done one of the above, save the changes and exit the CMOS Setup menu.

The clear CMOS jumper settings are shown in **Table 4-3**.

Clear CMOS	Description
Short 1 - 2	Keep CMOS Setup
Short 2 - 3	Clear CMOS Setup

Table 4-3: Clear CMOS Jumper Settings

The location of the clear CMOS jumper is shown in **Figure 4-7** below.

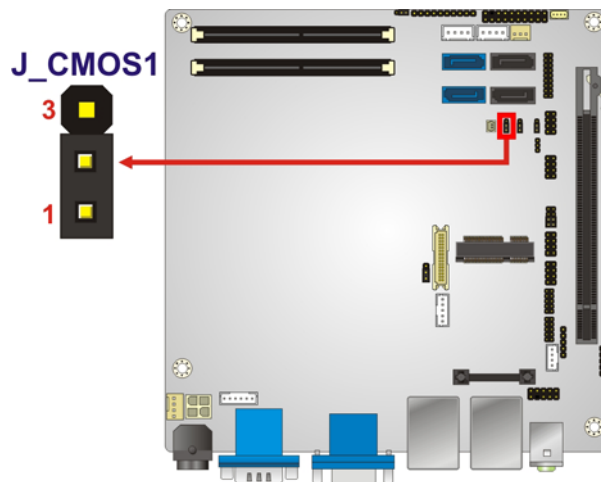

Figure 4-7: Clear CMOS Jumper

4.5.3 LVDS Panel Resolution Jumper

Jumper Label:	J_PID1
Jumper Type:	8-pin header (2x4)
Jumper Settings:	See Table 4-4
Jumper Location:	See Figure 4-8

The LVDS Panel Resolution jumper allows the resolution of the LVDS screens connected to the LVDS1 connector to be configured. The LVDS Panel Resolution jumper settings are shown in **Table 4-4**.

Setting	Description
Open	640 x 480 (18-bit)
Short 1-2	800 x 480 (18-bit)
Short 3-4	800 x 600 (18-bit)
Short 1-2, 3-4	1024 x 768 (18-bit)
Short 5-6	1024 x 768 (24-bit)
Short 1-2, 5-6	1280 x 1024 (48-bit)
Short 3-4, 5-6	1600 x 1200 (48-bit)
Short 1-2, 3-4, 5-6	1280 x 768 (18-bit)
Short 7-8	1280 x 800 (18-bit)
Short 1-2, 7-8	1366 x 768 (24-bit)
Short 3-4, 7-8	1440 x 900 (48-bit)
Short 1-2, 3-4, 7-8	1600 x 900 (48-bit)
Short 5-6, 7-8	1680 x 1050 (48-bit)
Short 1-2, 5-6, 7-8	1920 x 1080 (48-bit)
Short 3-4, 5-6, 7-8	1920 x 1200 (48-bit)
Short 1-2, 3-4, 5-6, 7-8	LVDS disabled

Table 4-4: LVDS Panel Resolution Jumper Settings

The LVDS Panel Resolution jumper location is shown in **Figure 4-8**.

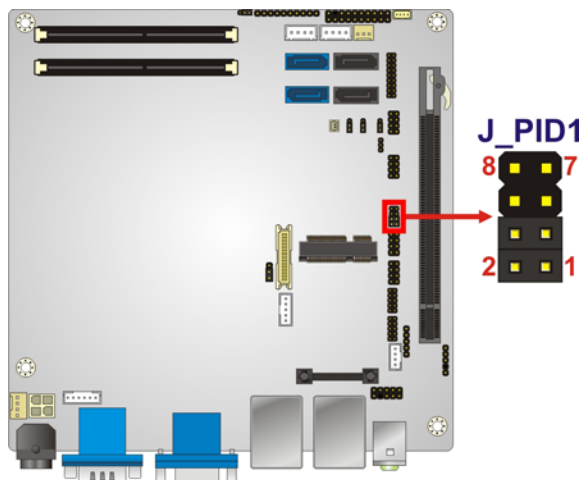

Figure 4-8: LVDS Panel Resolution Jumper Pinout Locations

KINO-QM670 Mini-ITX SBC

4.5.4 LVDS Voltage Selection

**WARNING:**

Permanent damage to the screen and KINO-QM670 may occur if the wrong voltage is selected with this jumper. Please refer to the user guide that came with the monitor to select the correct voltage.

Jumper Label:	J_VLVDS1
Jumper Type:	3-pin header (1x3)
Jumper Settings:	See Table 4-5
Jumper Location:	See Figure 4-9

The **LVDS Voltage Selection** jumpers allow the LVDS screen voltages to be set. The jumper sets the voltage connected to LVDS1. The **LVDS Voltage Selection** jumper settings are shown in **Table 4-5**.

LCD Voltage Select	Description
Short 1-2	+3.3V LVDS
Short 2-3	+5V LVDS

Table 4-5: LVDS Voltage Selection Jumper Settings

The LVDS Voltage Selection jumper location is shown in **Figure 4-9**.

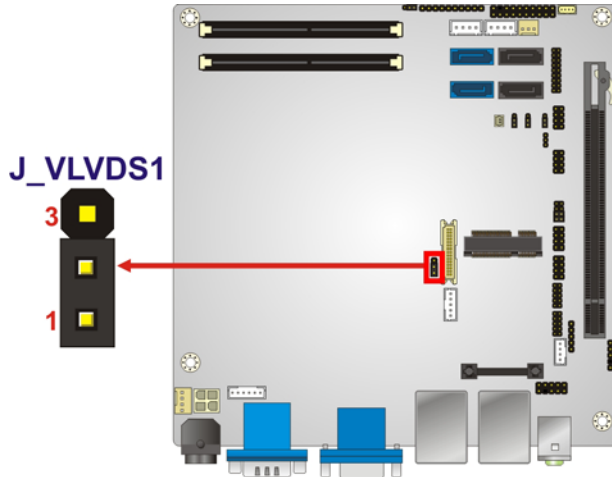

Figure 4-9: LVDS Voltage Selection Jumper Pinout Locations

4.5.5 ME RTC Register Jumper

- Jumper Label:** ME_RTC1
- Jumper Type:** 3-pin header
- Jumper Settings:** See **Table 4-6**
- Jumper Location:** See **Figure 4-10**

The ME RTC Register jumper saves or clears the ME RTC registers. The ME RTC Register jumper settings are shown in **Table 4-3**.

Setting	Description
Short 1-2	Save ME RTC registers (normal operation)
Short 2-3	Clear ME RTC registers

Table 4-6: ME RTC Register Jumper Settings

KINO-QM670 Mini-ITX SBC

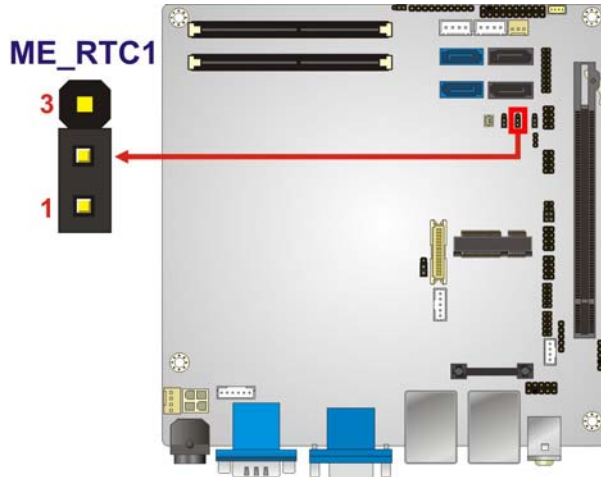

Figure 4-10: ME RTC Register Jumper Location

4.5.6 Flash Security Override Jumper

- Jumper Label: J_SPI
- Jumper Type: 3-pin header
- Jumper Settings: See Table 4-7
- Jumper Location: See Figure 4-11

The Flash Security Override jumper settings are shown in Table 4-3.

Setting	Description
Short 1-2	Disabled
Short 2-3	Enabled

Table 4-7: Flash Security Override Jumper Settings

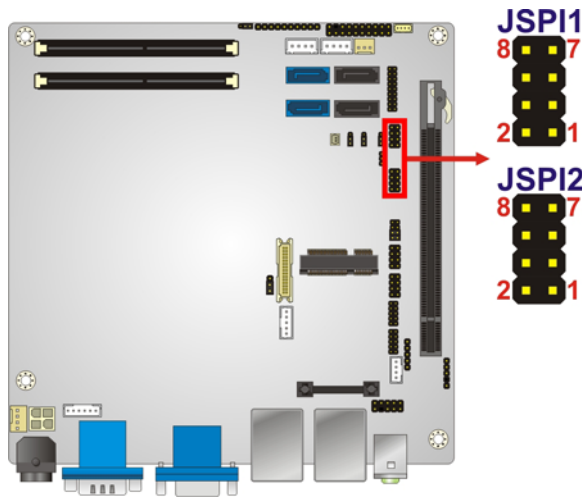

Figure 4-11: Flash Security Override Jumper Location

4.5.7 MPC Switch Control (Reserved)

- Jumper Label:** J_MPC1
- Jumper Type:** 3-pin header
- Jumper Settings:** See **Table 4-8**
- Jumper Location:** See **Figure 4-12**

The MPC Switch Control jumper enables or disables the MPC function. The MPC Switch Control jumper settings are shown in **Table 4-3**.

Setting	Description
Short 1-2	MPC OFF
Short 2-3	MPC ON

Table 4-8: MPC Switch Control Jumper Settings (Reserved)

KINO-QM670 Mini-ITX SBC

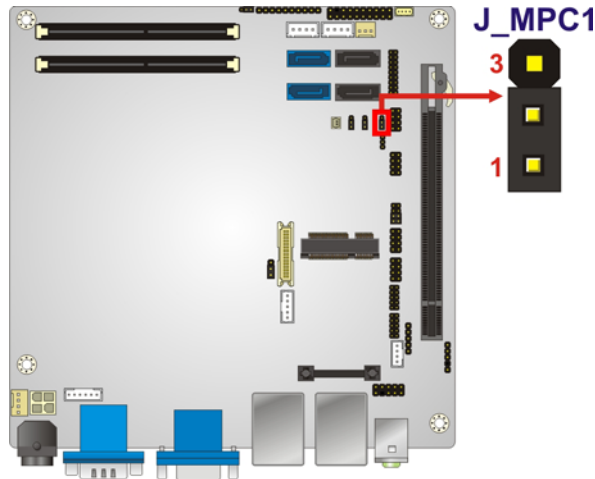

Figure 4-12: MPC Switch Control Jumper Location

4.6 Chassis Installation

4.6.1 Airflow



WARNING:

Airflow is critical to the cooling of the CPU and other onboard components. The chassis in which the KINO-QM670 must have air vents to allow cool air to move into the system and hot air to move out.

The KINO-QM670 must be installed in a chassis with ventilation holes on the sides allowing airflow to travel through the heat sink surface. In a system with an individual power supply unit, the cooling fan of a power supply can also help generate airflow through the board surface.

4.6.2 Motherboard Installation

To install the KINO-QM670 motherboard into the chassis please refer to the reference material that came with the chassis.

4.7 Internal Peripheral Device Connections

This section outlines the installation of peripheral devices to the onboard connectors

4.7.1 SATA Drive Connection

The KINO-QM670 is shipped with two SATA drive cables and one SATA drive power cable. To connect the SATA drives to the connectors, please follow the steps below.

Step 1: Locate the connectors. The locations of the SATA drive connectors are shown in **Chapter 3**.

Step 2: Insert the cable connector. Press the clip on the connector at the end of the SATA cable and insert the cable connector into the on-board SATA drive connector. See Figure 4-13.

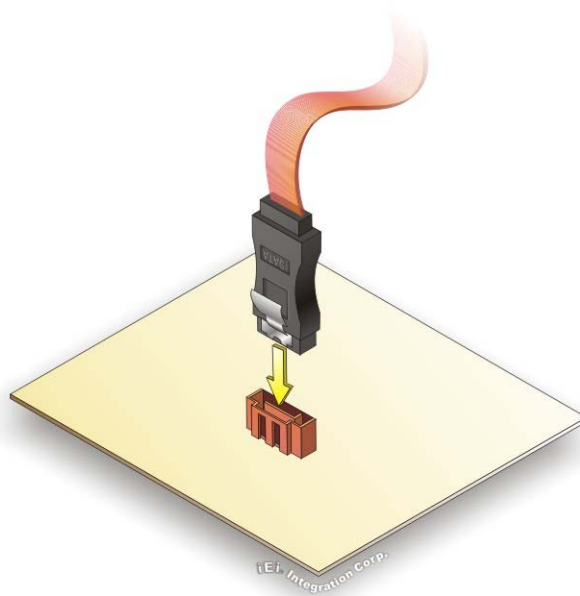

Figure 4-13: SATA Drive Cable Connection

Step 3: Connect the cable to the SATA disk. Connect the connector on the other end of the cable to the connector at the back of the SATA drive. See Figure 4-14.

Step 4: Connect the SATA power cable. Connect the SATA power connector to the back of the SATA drive. See Figure 4-14.

KINO-QM670 Mini-ITX SBC

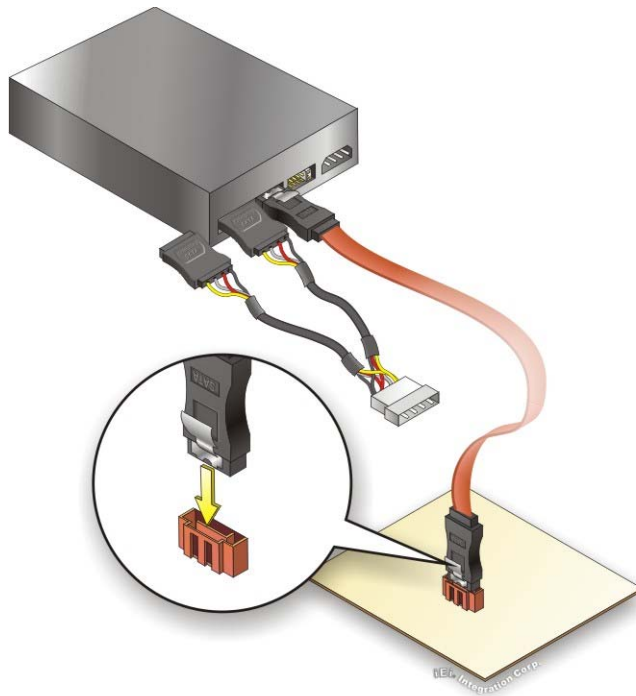

Figure 4-14: SATA Power Drive Connection

4.7.2 Dual RS-232 Cable with Slot Bracket

The dual RS-232 cable slot connector consists of two connectors attached to two independent cables. Each cable is then attached to a D-sub 9 male connector that is mounted onto a slot. To install the dual RS-232 cable, please follow the steps below.

Step 1: Locate the connectors. The locations of the RS-232 connectors are shown in Chapter 3.

Step 2: Insert the cable connectors. Insert one connector into each serial port box headers. See Figure 4-15. A key on the front of the cable connectors ensures the connector can only be installed in one direction.

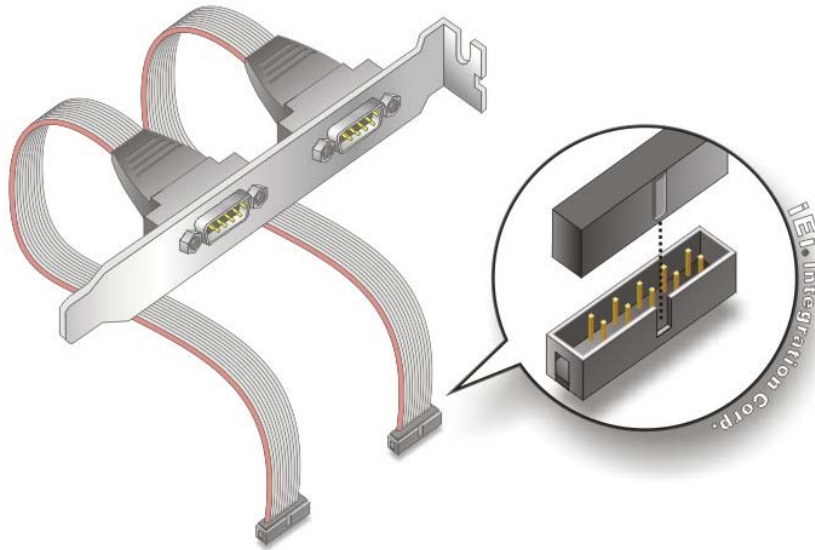

Figure 4-15: Dual RS-232 Cable Installation

Step 3: **Secure the bracket.** The dual RS-232 connector has two D-sub 9 male connectors secured on a bracket. To secure the bracket to the chassis please refer to the reference material that came with the chassis.

4.8 External Peripheral Interface Connection

The following external peripheral devices can be connected to the external peripheral interface connectors.

- Audio devices
- HDMI devices
- RJ-45 Ethernet cable connectors
- RS-232 serial port
- USB devices
- VGA monitors

To install these devices, connect the corresponding cable connector from the actual device to the corresponding KINO-QM670 external peripheral interface connector making sure the pins are properly aligned.

KINO-QM670 Mini-ITX SBC

4.8.1 Audio Connector

The audio jacks on the external audio connector enable the KINO-QM670 to be connected to a stereo sound setup. To install the audio devices, follow the steps below.

- Step 1: Identify the audio plugs.** The plugs on your home theater system or speakers may not match the colors on the rear panel. If audio plugs are plugged into the wrong jacks, sound quality will be very bad.
- Step 2: Plug the audio plugs into the audio jacks.** Plug the audio plugs into the audio jacks. If the plugs on your speakers are different, an adapter will need to be used to plug them into the audio jacks.
- **Line Out port (Lime):** Connects to a headphone or a speaker.
 - **Microphone (Pink):** Connects to a microphone.

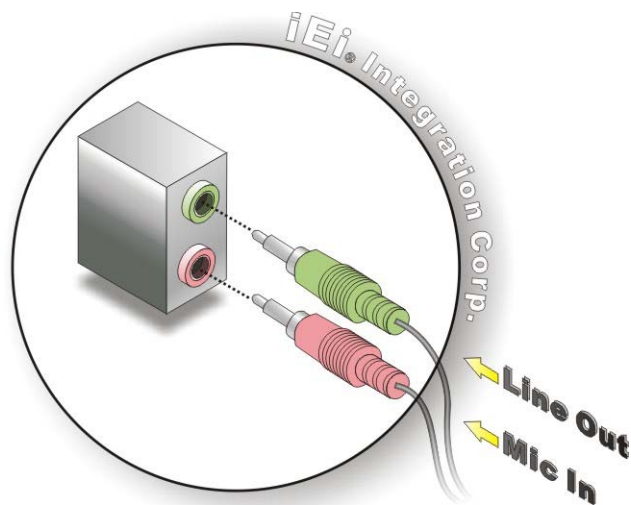

Figure 4-16: Audio Connector

- Step 3: Check audio clarity.** Check that the sound is coming through the right speakers by adjusting the balance front to rear and left to right.

4.8.2 LAN and USB Connection

There are two external RJ-45 LAN connectors and four USB connectors on the KINO-QM670. The RJ-45 connectors enable connection to an external network. The external USB Series "A" receptacle connectors provide easier and quicker access to

external USB devices. Follow the steps below to connect USB devices and LAN cable to the KINO-QM670.

Step 1: Locate the RJ-45 and USB connectors. The locations of the RJ-45 and USB connectors are shown in **Chapter 4**.

Step 2: Align the connectors. Align the RJ-45 connector on the LAN cable with one of the RJ-45 connectors on the KINO-QM670.

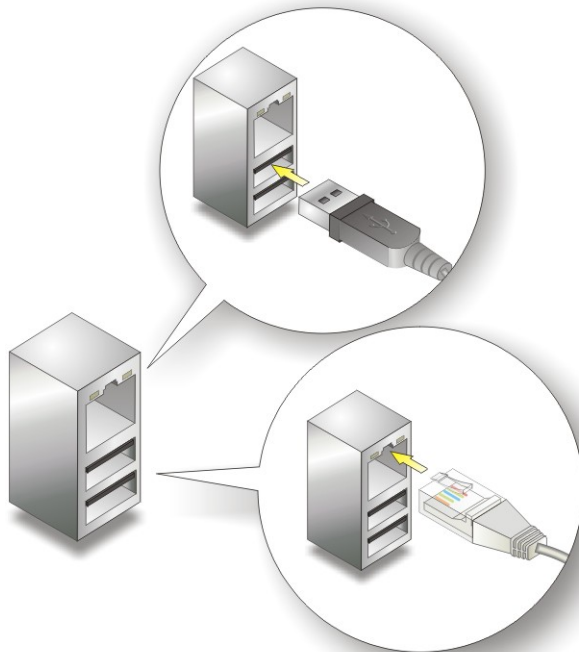

Figure 4-17: LAN Connection

Step 3: Insert the LAN cable RJ-45 connector. Once aligned, gently insert the LAN cable RJ-45 connector into the onboard RJ-45 connector. See **Figure 4-17**.

Step 4: Insert a USB Series "A" plug. Insert the USB Series "A" plug of a device into the USB Series "A" receptacle on the external peripheral interface. See **Figure 4-17**.

KINO-QM670 Mini-ITX SBC

4.8.3 Serial Device Connection

The KINO-QM670 has a single female DB-9 connector on the external peripheral interface panel for a serial device. Follow the steps below to connect a serial device to the KINO-QM670.

Step 1: Locate the DB-9 connector. The location of the DB-9 connector is shown in **Chapter 3**.

Step 2: Insert the serial connector. Insert the DB-9 connector of a serial device into the DB-9 connector on the external peripheral interface. See **Figure 4-18**.

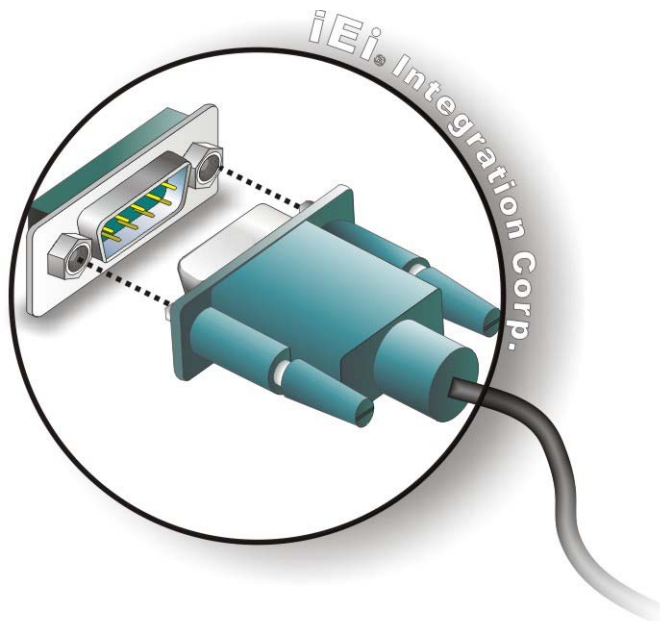

Figure 4-18: Serial Device Connector

Step 3: Secure the connector. Secure the serial device connector to the external interface by tightening the two retention screws on either side of the connector.

4.8.4 VGA Monitor Connection

The KINO-QM670 has a single female DB-15 connector on the external peripheral interface panel. The DB-15 connector is connected to a CRT or VGA monitor. To connect a monitor to the KINO-QM670, please follow the instructions below.

- Step 1:** **Locate the female DB-15 connector.** The location of the female DB-15 connector is shown in **Chapter 3**.
- Step 2:** **Align the VGA connector.** Align the male DB-15 connector on the VGA screen cable with the female DB-15 connector on the external peripheral interface.
- Step 3:** **Insert the VGA connector.** Once the connectors are properly aligned with the insert the male connector from the VGA screen into the female connector on the KINO-QM670. See **Figure 4-19**.

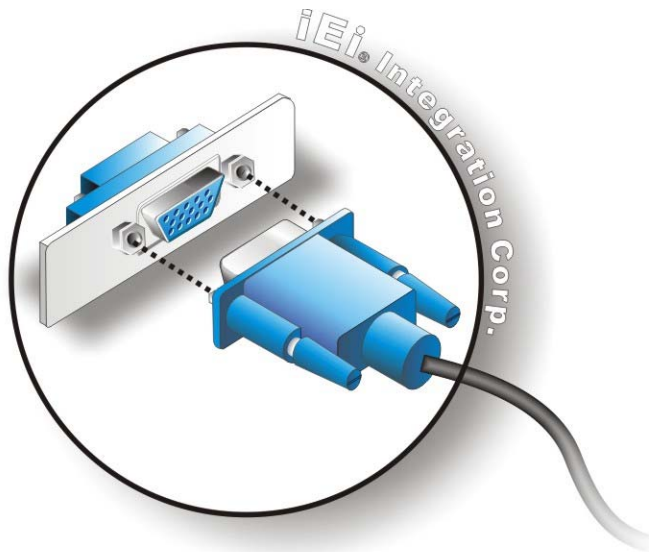

Figure 4-19: VGA Connector

- Step 4:** **Secure the connector.** Secure the DB-15 VGA connector from the VGA monitor to the external interface by tightening the two retention screws on either side of the connector.

KINO-QM670 Mini-ITX SBC

4.9 Software Installation

All the drivers for the KINO-QM670 are on the CD that came with the system. To install the drivers, please follow the steps below.

Step 1: Insert the CD into a CD drive connected to the system.



NOTE:

If the installation program doesn't start automatically:
Click "Start->My Computer->CD Drive->autorun.exe"

Step 2: The driver main menu appears (**Figure 4-20**).

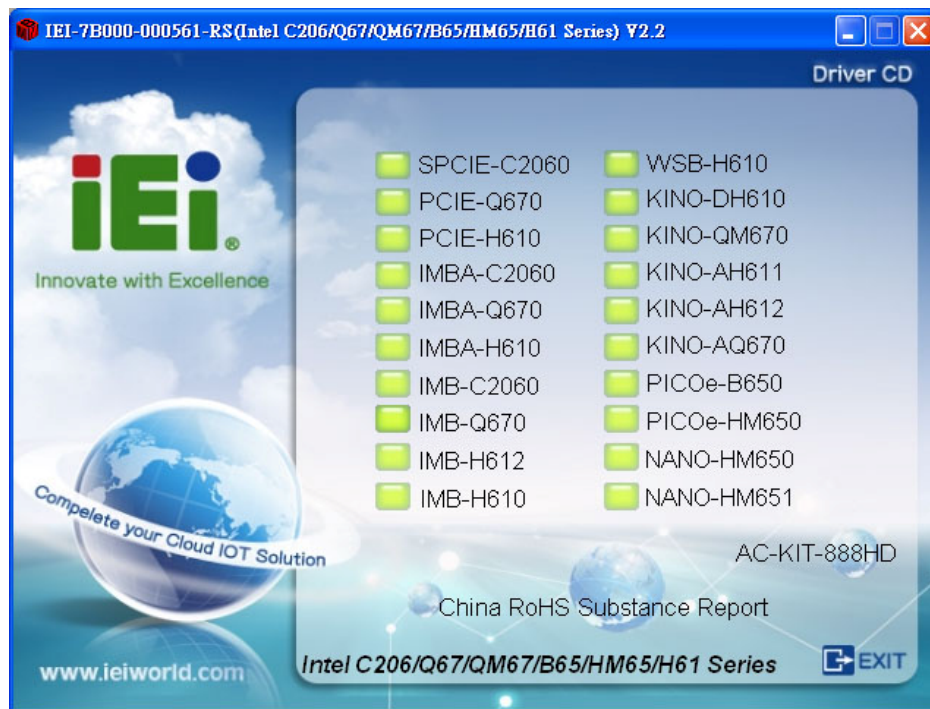

Figure 4-20: Introduction Screen

Step 3: Click **KINO-QM670**.

Step 4: A new screen with a list of available drivers appears (**Figure 4-21**).

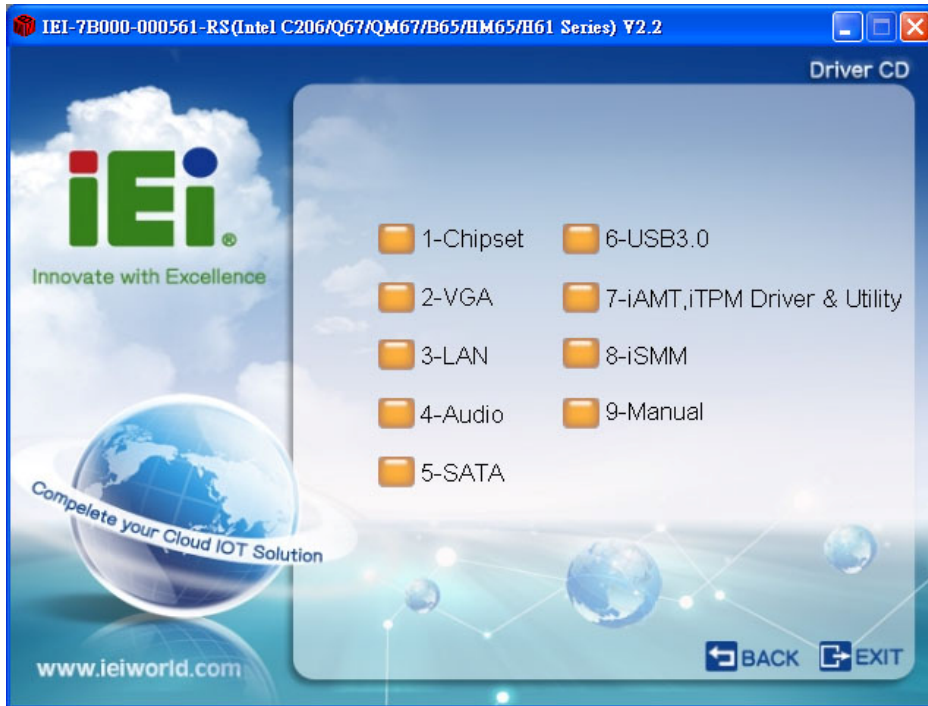

Figure 4-21: Available Drivers

Step 5: Install all of the necessary drivers in this menu.

Chapter

5

BIOS Screens

5.1 Introduction

The BIOS is programmed onto the BIOS chip. The BIOS setup program allows changes to certain system settings. This chapter outlines the options that can be changed.



NOTE:

Some of the BIOS options may vary throughout the life cycle of the product and are subject to change without prior notice.

5.1.1 Starting Setup

The UEFI BIOS is activated when the computer is turned on. The setup program can be activated in one of two ways.

1. Press the **F2** key as soon as the system is turned on or
2. Press the **F2** key when the “**Press F2 to enter SETUP**” message appears on the screen.

If the message disappears before the **F2** key is pressed, restart the computer and try again.

5.1.2 Using Setup

Use the arrow keys to highlight items, press **ENTER** to select, use the PageUp and PageDown keys to change entries, press **F1** for help and press **ESC** to quit. Navigation keys are shown in the following table.

Key	Function
Up arrow	Move to the item above
Down arrow	Move to item below
Left arrow	Move to the item on the left hand side
Right arrow	Move to the item on the right hand side
+	Increase the numeric value or make changes

KINO-QM670 Mini-ITX SBC

Key	Function
-	Decrease the numeric value or make changes
Page up	Move to the next page
Page down	Move to the previous page
Esc	Main Menu – Quit and not save changes into CMOS Status Page Setup Menu and Option Page Setup Menu -- Exit current page and return to Main Menu
F1	General help, only for Status Page Setup Menu and Option Page Setup Menu
F2	Load previous values
F3	Load optimized defaults
F4	Save changes and Exit BIOS

Table 5-1: BIOS Navigation Keys

5.1.3 Getting Help

When **F1** is pressed a small help window describing the appropriate keys to use and the possible selections for the highlighted item appears. To exit the Help Window press **Esc** or the **F1** key again.

5.1.4 Unable to Reboot After Configuration Changes

If the computer cannot boot after changes to the system configuration is made, CMOS defaults. Use the jumper described in Chapter 4.

5.1.5 BIOS Menu Bar

The **menu bar** on top of the BIOS screen has the following main items:

- Main – Changes the basic system configuration.
- Advanced – Changes the advanced system settings.
- Chipset – Changes the chipset settings.
- Boot – Changes the system boot configuration.

- Security – Sets User and Supervisor Passwords.
- Save & Exit – Selects exit options and loads default settings

The following sections completely describe the configuration options found in the menu items at the top of the BIOS screen and listed above.

5.2 Main

The **Main** BIOS menu (**BIOS Menu 1**) appears when the **BIOS Setup** program is entered.

The **Main** menu gives an overview of the basic system information.

Aptio Setup Utility - Copyright (C) 2010 American Megatrends, Inc.					
Main	Advanced	Chipset	Boot	Security	Save & Exit
BIOS Information					Set the Date. Use Tab to switch between Data elements.
BIOS Vendor			American Megatrends		
Core Version			4.6.4.0 0.01		
Compliancy			UEFI 2.1		
Project Version			B185AR13.ROM		
Build Date			07/01/2011 09:43:18		-----
iWDD Vendor			ICP		←→: Select Screen
iWDD Verstion			B185ER12.bin		↑ ↓: Select Item
System Date			[Tue 07/06/2011]		EnterSelect
System Time			[14:20:27]		+/-: Change Opt.
Access Level			Administrator		F1: General Help
					F2: Previous Values
					F3: Optimized Defaults
					F4: Save & Exit
					ESC: Exit
Version 2.10.1208. Copyright (C) 2010 American Megatrends, Inc.					

BIOS Menu 1: Main

→ BIOS Information

The **BIOS Information** lists a brief summary of the BIOS. The fields in **BIOS Information** cannot be changed. The items shown in the system overview include:

- **BIOS Vendor:** Installed BIOS vendor
- **Core Version:** Current BIOS version
- **Compliancy:** The compliancy version
- **Project Version:** The board version
- **Build Date:** Date the current BIOS version was made

KINO-QM670 Mini-ITX SBC

The System Overview field also has two user configurable fields:

→ **System Date [xx/xx/xx]**

Use the **System Date** option to set the system date. Manually enter the day, month and year.

→ **System Time [xx:xx:xx]**

Use the **System Time** option to set the system time. Manually enter the hours, minutes and seconds.

5.3 Advanced

Use the **Advanced** menu (**BIOS Menu 2**) to configure the CPU and peripheral devices through the following sub-menus:



WARNING!

Setting the wrong values in the sections below may cause the system to malfunction. Make sure that the settings made are compatible with the hardware.

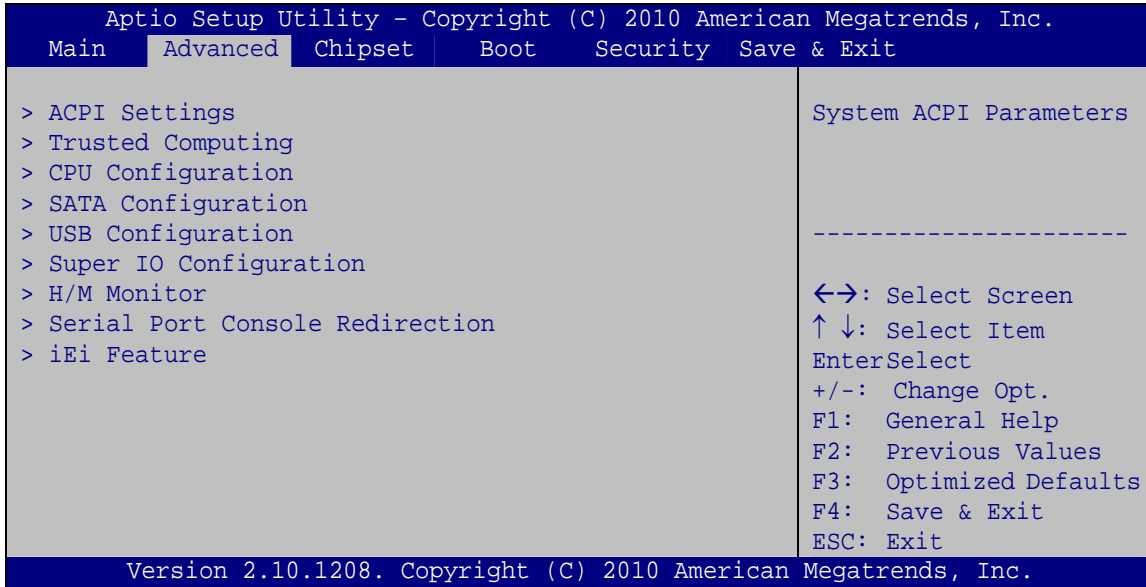

BIOS Menu 2: Advanced

5.3.1 ACPI Settings

The **ACPI Settings** menu (**BIOS Menu 3**) configures the Advanced Configuration and Power Interface (ACPI) options.

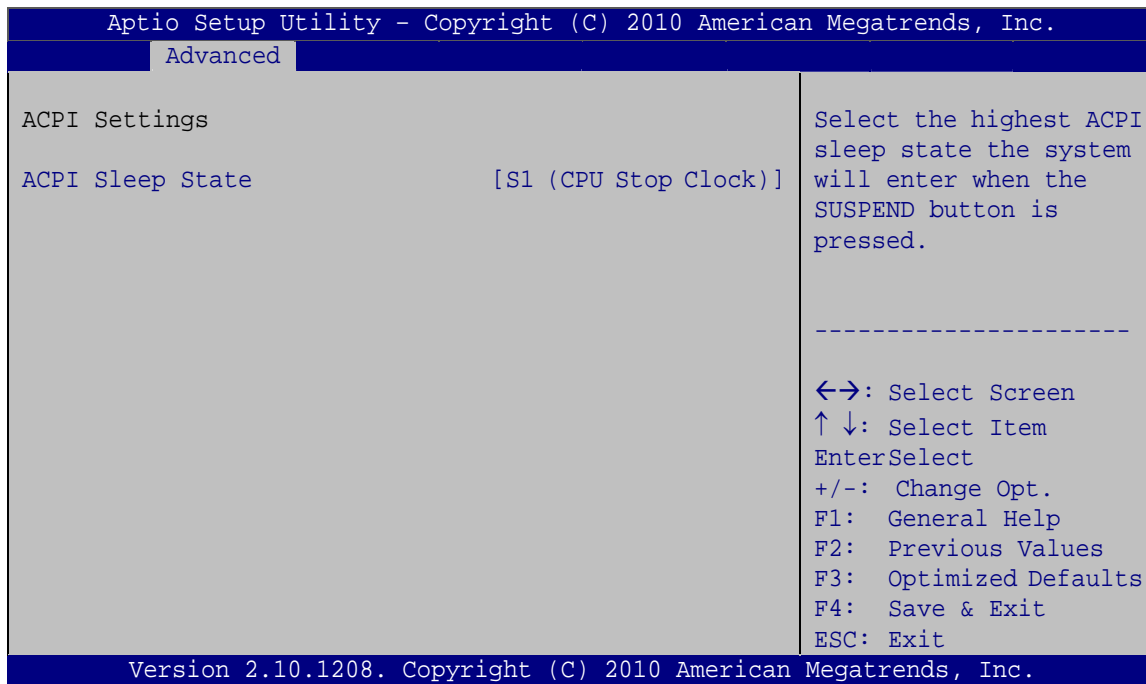

BIOS Menu 3: ACPI Configuration

KINO-QM670 Mini-ITX SBC

→ ACPI Sleep State [S1 (CPU Stop Clock)]

Use the **ACPI Sleep State** option to specify the sleep state the system enters when it is not being used.

→ Suspend Disabled

→ **S1 (CPU Stop Clock)** **DEFAULT** The system enters S1(POS) sleep state. The system appears off. The CPU is stopped; RAM is refreshed; the system is running in a low power mode.

→ S3 (Suspend to RAM)

The caches are flushed and the CPU is powered off. Power to the RAM is maintained. The computer returns slower to a working state, but more power is saved.

5.3.2 Trusted Computing

Use the **Trusted Computing** menu (**BIOS Menu 4**) to configure settings related to the Trusted Computing Group (TCG) Trusted Platform Module (TPM).

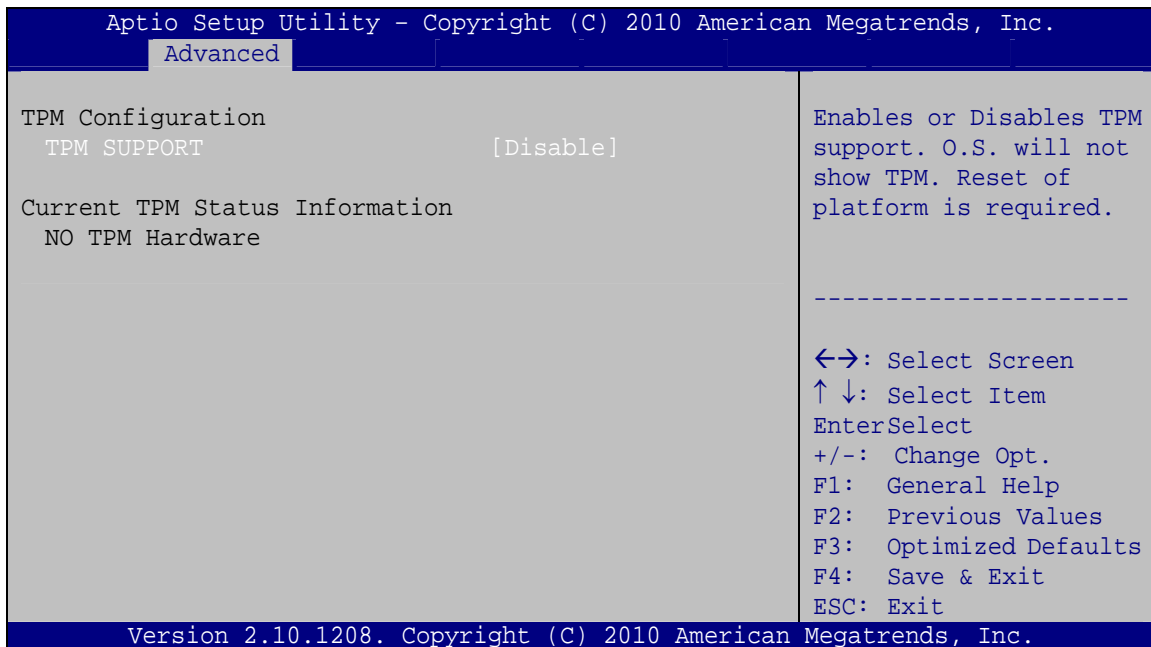

BIOS Menu 4: TPM Configuration

➔ **TPM Support [Disable]**

Use the **TPM Support** option to configure support for the TPM.

➔ **Disable** **DEFAULT** TPM support is disabled.

➔ **Enable** TPM support is enabled.

5.3.3 CPU Configuration

Use the **CPU Configuration** menu (**BIOS Menu 5**) to enter the **CPU Information** submenu or enable Intel Virtualization Technology.

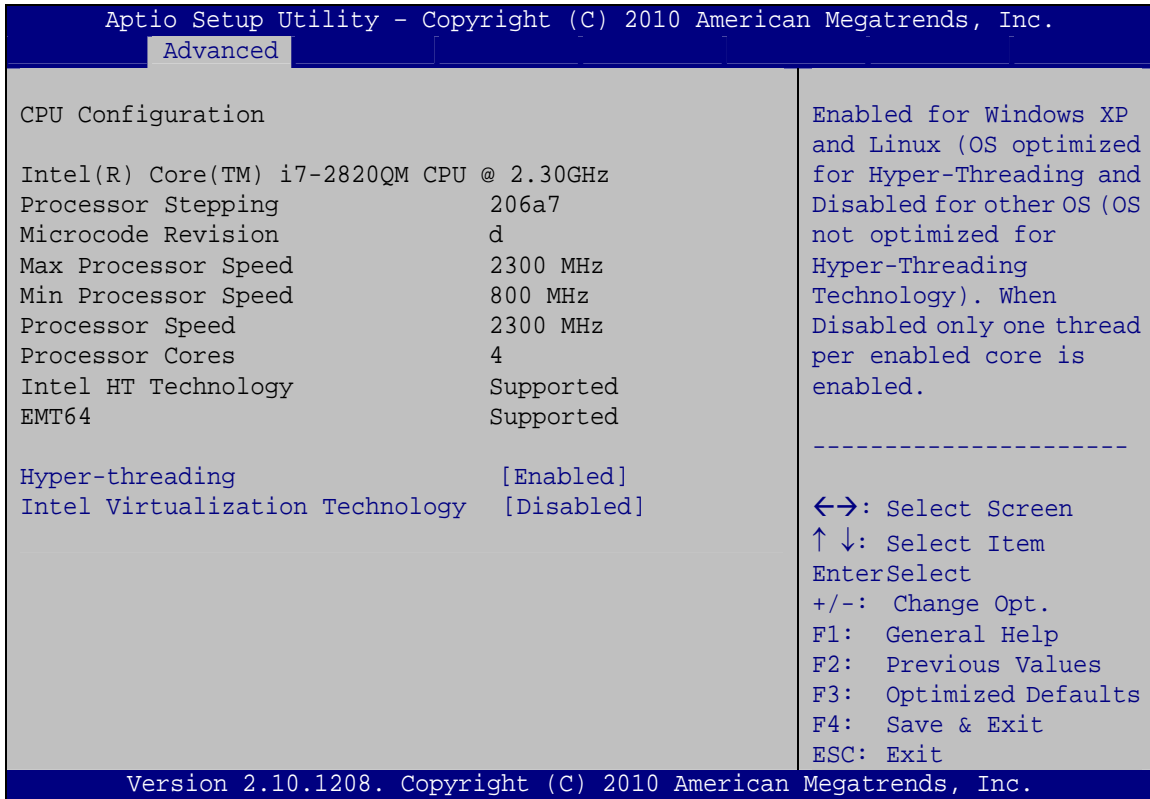

BIOS Menu 5: CPU Configuration

➔ **Hyper Threading [Enabled]**

Use the Hyper Threading option to enable or disable the CPU hyper threading function.

KINO-QM670 Mini-ITX SBC

- ➔ **Disabled** Disables the use of hyper threading technology
- ➔ **Enabled** **DEFAULT** Enables the use of hyper threading technology

➔ **Intel® Virtualization Technology [Disabled]**

Use the **Intel® Virtualization Technology** option to enable or disable virtualization on the system. When combined with third party software, Intel Virtualization technology allows several OSs to run on the same system at the same time.

- ➔ **Disabled** **DEFAULT** Disables Intel Virtualization Technology.
- ➔ **Enabled** Enables Intel Virtualization Technology.

5.3.4 SATA Configuration

Use the **SATA Configuration** menu (**BIOS Menu 6**) to change and/or set the configuration of the SATA devices installed in the system.

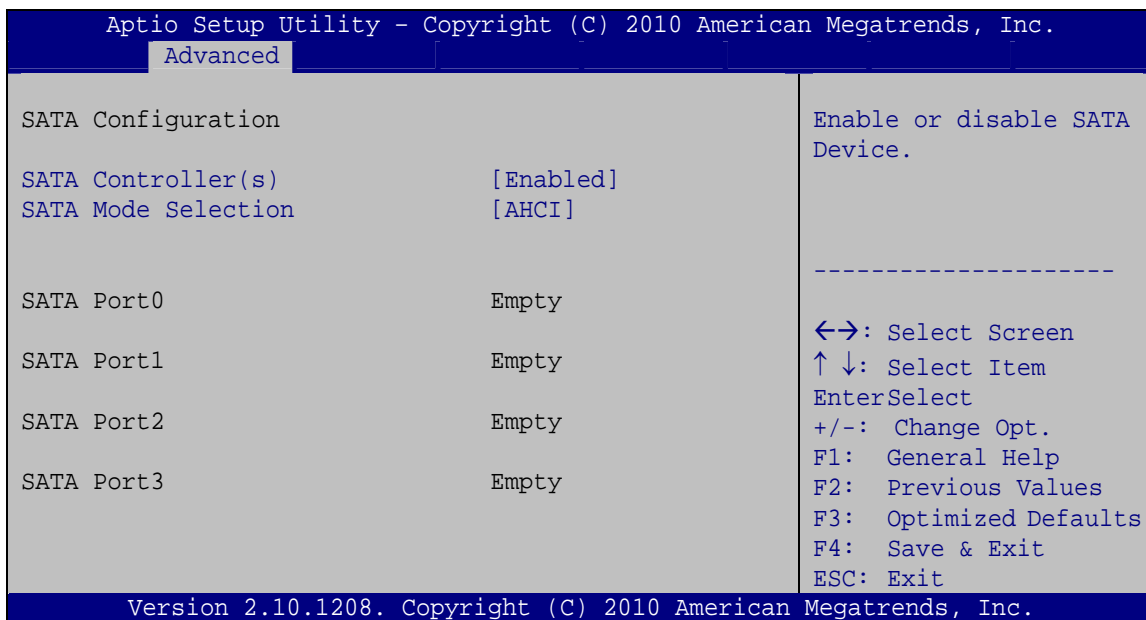

BIOS Menu 6: SATA Configuration

→ **SATA Controller(s) [Enabled]**

Use the **SATA Controller(s)** option to enable or disable the use of SATA Devices.

- **Enabled** **DEFAULT** Enables SATA devices.
- **Disabled** Disables SATA devices.

→ **SATA Mode Selection [AHCI]**

Use the **SATA Mode** option to configure SATA devices as normal IDE devices.

- **IDE** Configures SATA devices as normal IDE device.
- **AHCI** **DEFAULT** Configures SATA devices as AHCI device.
- **RAID** Configures SATA devices as RAID device.

5.3.5 USB Configuration

Use the **USB Configuration** menu (**BIOS Menu 7**) to read USB configuration information and configure the USB settings.

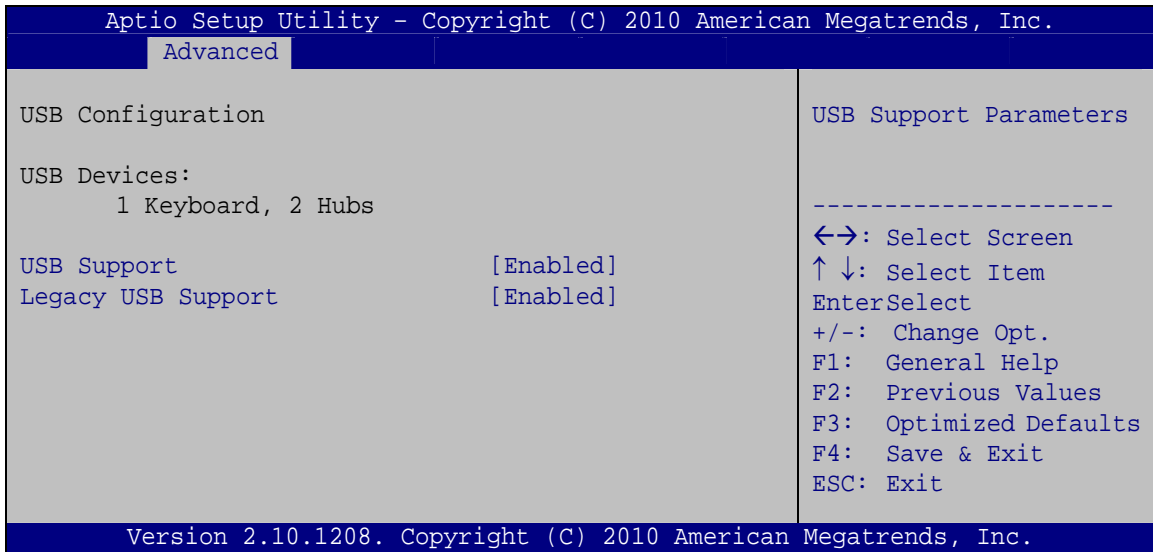

BIOS Menu 7: USB Configuration

→ **USB Devices**

The **USB Devices Enabled** field lists the USB devices that are enabled on the system

KINO-QM670 Mini-ITX SBC

→ USB Support [Enabled]

Use the **USB Support** option to enable or disable USB support on the system.

- **Disabled** USB support disabled
- **Enabled** **DEFAULT** USB support enabled

→ Legacy USB Support [Enabled]

Use the **Legacy USB Support** BIOS option to enable USB mouse and USB keyboard support. Normally if this option is not enabled, any attached USB mouse or USB keyboard does not become available until a USB compatible operating system is fully booted with all USB drivers loaded. When this option is enabled, any attached USB mouse or USB keyboard can control the system even when there is no USB driver loaded onto the system.

- **Enabled** **DEFAULT** Legacy USB support enabled
- **Disabled** Legacy USB support disabled

5.3.6 Super IO Configuration

Use the **Super IO Configuration** menu (**BIOS Menu 8**) to set or change the configurations for the FDD controllers, parallel ports and serial ports.

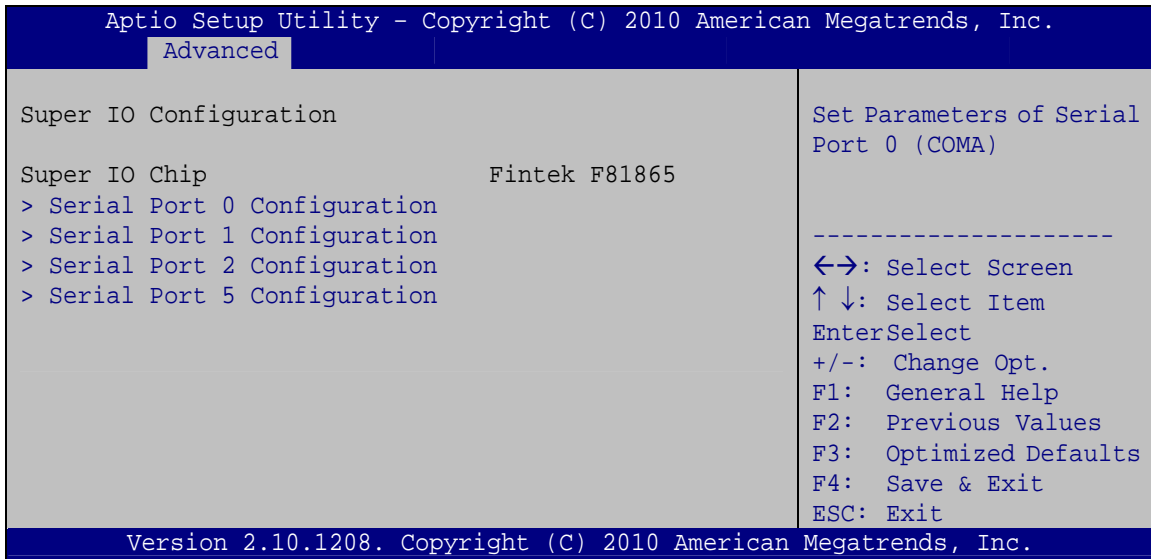

BIOS Menu 8: Super IO Configuration

5.3.6.1 Serial Port n Configuration

Use the **Serial Port n Configuration** menu (**BIOS Menu 9**) to configure the serial port n.

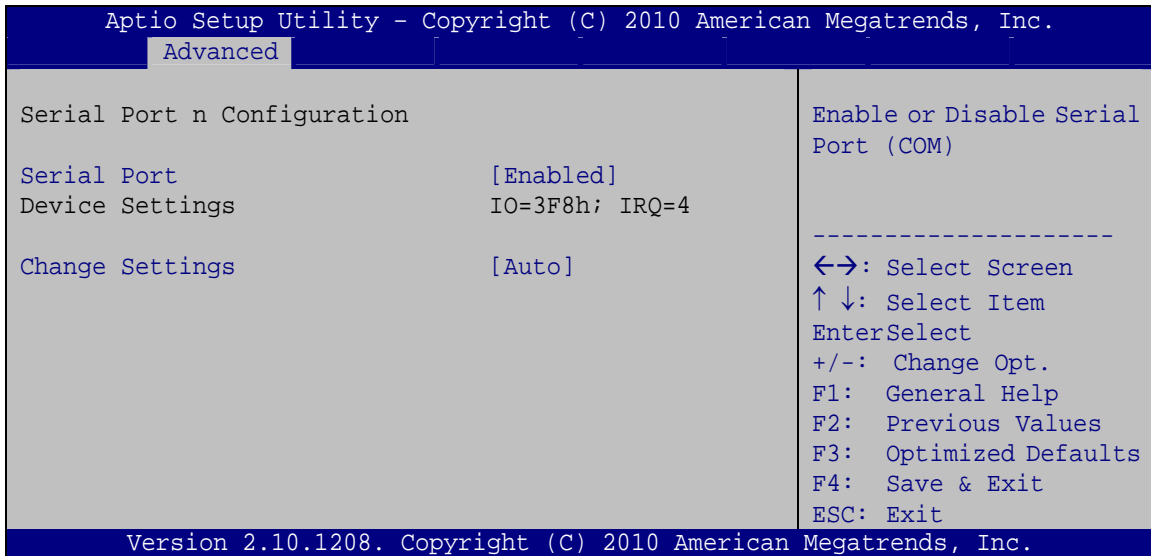

BIOS Menu 9: Serial Port n Configuration Menu

5.3.6.1.1 Serial Port 0 Configuration

→ Serial Port [Enabled]

Use the **Serial Port** option to enable or disable the serial port.

- **Disabled** Disable the serial port
- **Enabled** **DEFAULT** Enable the serial port

→ Change Settings [Auto]

Use the **Change Settings** option to change the serial port IO port address and interrupt address.

- **Auto** **DEFAULT** The serial port IO port address and interrupt address are automatically detected.
- **IO=3F8h; IRQ=4** Serial Port I/O port address is 3F8h and the interrupt address is IRQ4
- **IO=3F8h; IRQ=3, 4, 5, 6, 7, 10, 11, 12** Serial Port I/O port address is 3F8h and the interrupt address is IRQ3, 4, 5, 6, 7, 10, 11, 12
- **IO=2F8h; IRQ=3, 4, 5, 6, 7, 10, 11, 12** Serial Port I/O port address is 2F8h and the interrupt address is IRQ3, 4, 5, 6, 7, 10, 11, 12
- **IO=3E8h; IRQ=3, 4, 5, 6, 7, 10, 11, 12** Serial Port I/O port address is 3E8h and the interrupt address is IRQ3, 4, 5, 6, 7, 10, 11, 12
- **IO=2E8h; IRQ=3, 4, 5, 6, 7, 10, 11, 12** Serial Port I/O port address is 2E8h and the interrupt address is IRQ3, 4, 5, 6, 7, 10, 11, 12

5.3.6.1.2 Serial Port 1 Configuration

➔ **Serial Port [Enabled]**

Use the **Serial Port** option to enable or disable the serial port.

- ➔ **Disabled** Disable the serial port
- ➔ **Enabled DEFAULT** Enable the serial port

➔ **Change Settings [Auto]**

Use the **Change Settings** option to change the serial port IO port address and interrupt address.

- ➔ **Auto DEFAULT** The serial port IO port address and interrupt address are automatically detected.
- ➔ **IO=2F8h; IRQ=3** Serial Port I/O port address is 2F8h and the interrupt address is IRQ3
- ➔ **IO=3F8h; IRQ=3, 4, 5, 6, 7, 10, 11, 12** Serial Port I/O port address is 3F8h and the interrupt address is IRQ3, 4, 5, 6, 7, 10, 11, 12
- ➔ **IO=2F8h; IRQ=3, 4, 5, 6, 7, 10, 11, 12** Serial Port I/O port address is 2F8h and the interrupt address is IRQ3, 4, 5, 6, 7, 10, 11, 12
- ➔ **IO=3E8h; IRQ=3, 4, 5, 6, 7, 10, 11, 12** Serial Port I/O port address is 3E8h and the interrupt address is IRQ3, 4, 5, 6, 7, 10, 11, 12
- ➔ **IO=2E8h; IRQ=3, 4, 5, 6, 7, 10, 11, 12** Serial Port I/O port address is 2E8h and the interrupt address is IRQ3, 4, 5, 6, 7, 10, 11, 12

KINO-QM670 Mini-ITX SBC

5.3.6.1.3 Serial Port 2 Configuration

→ Serial Port [Enabled]

Use the **Serial Port** option to enable or disable the serial port.

- **Disabled** Disable the serial port
- **Enabled** **DEFAULT** Enable the serial port

→ Change Settings [Auto]

Use the **Change Settings** option to change the serial port IO port address and interrupt address.

- **Auto** **DEFAULT** The serial port IO port address and interrupt address are automatically detected.
- **IO=3E8h; IRQ=7** Serial Port I/O port address is 3E8h and the interrupt address is IRQ7
- **IO=3F8h; IRQ=3, 4, 5, 6, 7, 10, 11, 12** Serial Port I/O port address is 3F8h and the interrupt address is IRQ3, 4, 5, 6, 7, 10, 11, 12
- **IO=2F8h; IRQ=3, 4, 5, 6, 7, 10, 11, 12** Serial Port I/O port address is 2F8h and the interrupt address is IRQ3, 4, 5, 6, 7, 10, 11, 12
- **IO=3E8h; IRQ=3, 4, 5, 6, 7, 10, 11, 12** Serial Port I/O port address is 3E8h and the interrupt address is IRQ3, 4, 5, 6, 7, 10, 11, 12
- **IO=2E8h; IRQ=3, 4, 5, 6, 7, 10, 11, 12** Serial Port I/O port address is 2E8h and the interrupt address is IRQ3, 4, 5, 6, 7, 10, 11, 12
- **IO=2E0h; IRQ=3, 4, 5, 6, 7, 10, 11, 12** Serial Port I/O port address is 2E0h and the interrupt address is IRQ3, 4, 5, 6, 7, 10, 11, 12
- **IO=2F0h; IRQ=3, 4, 5, 6, 7, 10, 11, 12** Serial Port I/O port address is 2F0h and the interrupt address is IRQ3, 4, 5, 6, 7, 10, 11, 12

→ Device Mode [RS422/RS485]

The **Device Mode** option enables RS-422/RS-485 serial port mode.

- ➔ **RS422/RS 485** **DEFAULT** RS-422/485 support enabled.

5.3.6.1.4 Serial Port 5 Configuration

➔ Serial Port [Enabled]

Use the **Serial Port** option to enable or disable the serial port.

- ➔ **Disabled** Disable the serial port
- ➔ **Enabled** **DEFAULT** Enable the serial port

➔ Change Settings [Auto]

Use the **Change Settings** option to change the serial port IO port address and interrupt address.

- ➔ **Auto** **DEFAULT** The serial port IO port address and interrupt address are automatically detected.
- ➔ **IO=2F0h; IRQ=7** Serial Port I/O port address is 2F0h and the interrupt address is IRQ7
- ➔ **IO=3F8h; IRQ=3, 4, 5, 6, 7, 10, 11, 12** Serial Port I/O port address is 3F8h and the interrupt address is IRQ3, 4, 5, 6, 7, 10, 11, 12
- ➔ **IO=2F8h; IRQ=3, 4, 5, 6, 7, 10, 11, 12** Serial Port I/O port address is 2F8h and the interrupt address is IRQ3, 4, 5, 6, 7, 10, 11, 12
- ➔ **IO=3E8h; IRQ=3, 4, 5, 6, 7, 10, 11, 12** Serial Port I/O port address is 3E8h and the interrupt address is IRQ3, 4, 5, 6, 7, 10, 11, 12
- ➔ **IO=2E8h; IRQ=3, 4, 5, 6, 7, 10, 11, 12** Serial Port I/O port address is 2E8h and the interrupt address is IRQ3, 4, 5, 6, 7, 10, 11, 12
- ➔ **IO=2E0h; IRQ=3, 4, 5, 6, 7, 10, 11, 12** Serial Port I/O port address is 2E0h and the interrupt address is IRQ3, 4, 5, 6, 7, 10, 11, 12
- ➔ **IO=2F0h; IRQ=3, 4, 5, 6, 7, 10, 11, 12** Serial Port I/O port address is 2F0h and the interrupt address is IRQ3, 4, 5, 6, 7, 10, 11, 12

KINO-QM670 Mini-ITX SBC

5.3.7 H/W Monitor

The H/W Monitor menu (**BIOS Menu 10**) contains the fan configuration submenus and displays operating temperature, fan speeds and system voltages.

```

Aptio Setup Utility - Copyright (C) 2010 American Megatrends, Inc.
Advanced
PC Health Status
CPU Temperature           :+57 C
Accuracy: 1. -5 ~ +10 degree around 100 degree.
                2. -10 ~ +15 degree around 50 degree.

System temperature       :+39 C
System FAN1 Speed       :3875 RPM
System FAN2 Speed       :N/A
VCC3V                   :+3.344 V
Vin0                    :+1.064 V
Vin1                    :+5.045 V
Vin2                    :+12.056 V
Vin3                    :+1.600 V
VSB3V                   :+3.344 V
VBAT                    :+3.216 V

> FAN 1 Configuration
> FAN 2 Configuration

Smart FAN Configuration
-----
<->: Select Screen
↑ ↓: Select Item
EnterSelect
+/-: Change Opt.
F1:  General Help
F2:  Previous Values
F3:  Optimized Defaults
F4:  Save & Exit
ESC: Exit

Version 2.10.1208. Copyright (C) 2010 American Megatrends, Inc.

```

BIOS Menu 10: H/W Monitor

➔ PC Health Status

The following system parameters and values are shown. The system parameters that are monitored are:

- System Temperature
- Fan Speeds:
 - System Fan1 Speed
 - System Fan2 Speed
- Voltages:
 - VCC3V
 - Vin0

- Vin1
- Vin2
- Vin3
- VSB3V
- VBAT

5.3.7.1 FAN 1 Configuration

Use the **FAN 1 Configuration submenu (BIOS Menu 11)** to configure fan 1 temperature and speed settings.

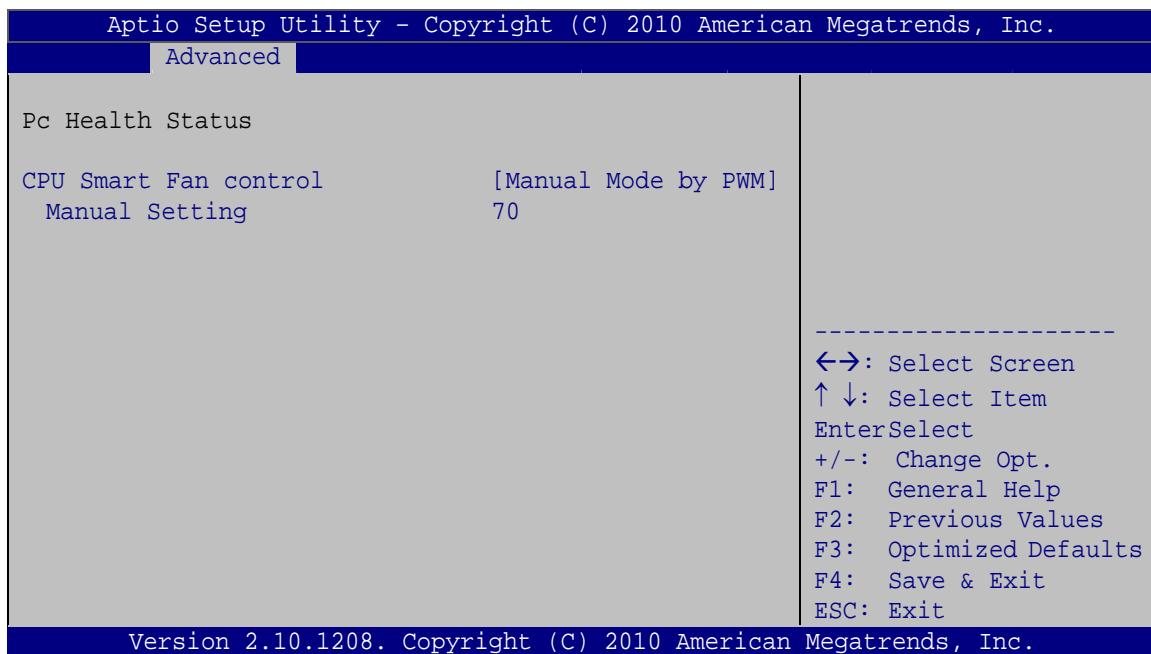

BIOS Menu 11: FAN 1 Configuration

➔ CPU Smart Fan control [Manual by RPM]

Use the **CPU Smart Fan control** option to configure the CPU Smart Fan.

- ➔ **Full Mode** The fan adjusts its speed using Full Mode settings
- ➔ **Manual Mode DEFAULT** The fan spins at the speed set in Manual by PWM settings
by PWM

KINO-QM670 Mini-ITX SBC

➔ **Auto Mode** The fan spins at the speed set in Auto Mode settings

➔ **Manual Setting**

Use the + or – key to change the fan **Manual Setting** value. Enter a decimal number between 0 and 100.

5.3.7.2 FAN 2 Configuration

Use the **FAN 2 Configuration submenu (BIOS Menu 12)** to configure fan 2 temperature and speed settings.

```

Aptio Setup Utility - Copyright (C) 2010 American Megatrends, Inc.
-----
Advanced
-----
PC Health Status
SYS Smart Fan control          [Auto Mode by PWM]
Temperature Bound 1           60
Temperature Bound 2           50
Temperature Bound 3           40
Temperature Bound 4           30
Segment 1 Speed (PWM)         100
Segment 2 Speed (PWM)         85
Segment 3 Speed (PWM)         70
Segment 4 Speed (PWM)         60
Segment 5 Speed (PWM)         50
-----
<=>: Select Screen
↑ ↓: Select Item
EnterSelect
+/-: Change Opt.
F1: General Help
F2: Previous Values
F3: Optimized Defaults
F4: Save & Exit
ESC: Exit
-----
Version 2.10.1208. Copyright (C) 2010 American Megatrends, Inc.
  
```

BIOS Menu 12: FAN 2 Configuration

➔ **CPU Smart Fan control [Auto Mode by PWM]**

Use the **SYS Smart Fan control** option to configure the system smart fan.

➔ **Auto by RPM** The fan adjusts its speed using Auto by RPM settings

- **Auto Mode by DEFAULT PWM** The fan adjusts its speed using Auto by PWM settings
- **Manual by RPM** The fan spins at the speed set in Manual Mode by RPM settings
- **Manual Mode by PWM** The fan spins at the speed set in Manual by PWM settings

→ **Temperature Bound n**

Use the + or – key to change the fan **Temperature Bound n** value. Enter a decimal number between 0 and 127.

→ **Segment n Speed (PWM)**

Use the + or – key to change the fan **Segment n Speed** value in Pulse Width Modulation (PWM). Enter a decimal number between 0 and 100.

5.3.8 Serial Port Console Redirection

The **Serial Port Console Redirection** menu (**BIOS Menu 13**) allows the console redirection options to be configured. Console redirection allows users to maintain a system remotely by re-directing keyboard input and text output through the serial port.

KINO-QM670 Mini-ITX SBC

```

Aptio Setup Utility - Copyright (C) 2010 American Megatrends, Inc.
  Advanced
COM0
  Console Redirection          [Disabled]
  > Console Redirection Settings
  Console Redirection          [Disabled]
  > Console Redirection Settings
COM1
  Console Redirection          [Disabled]
  > Console Redirection Settings
COM2 (Pci Bus0, Dev22, Func3)
  Console Redirection          [Disabled]
  > Console Redirection Settings
Serial Port for Out-of-Band Management/
Windows Emergency Management Services (EMS)
  Console Redirection          [Enabled]
  > Console Redirection Settings
-----
<->: Select Screen
↑ ↓: Select Item
Enter>Select
+/-: Change Opt.
F1   General Help
F2   Previous Values
F3   Optimized Defaults
F4   Save & Exit
ESC  Exit
Version 2.10.1208. Copyright (C) 2010 American Megatrends, Inc.
  
```

BIOS Menu 13: Serial Port Console Redirection

→ Console Redirection [Disabled]

Use **Console Redirection** option to enable or disable the console redirection function.

- **Disabled** **DEFAULT** Disabled the console redirection function
- **Enabled** Enabled the console redirection function

→ Out-of-Band Mgmt Port [COM0]

Use the **Out-of-Mgmt Port** option to enable or disable the Out-of-Mgmt port function.

- **COM0** **DEFAULT** Enabled the COM0 function.
- **COM1** Enabled the COM1 function.
- **COM2 (Pci Bus0, Dev22, Func3)** Enabled the COM2 function.

→ Terminal Type [VT-UTF8]

Use the **Terminal Type** option to specify the remote terminal type.

- **VT100** The target terminal type is VT100
- **VT100+** The target terminal type is VT100+
- **VT-UTF8** **DEFAULT** The target terminal type is VT-UTF8
- **ANSI** The target terminal type is ANSI

→ Bits per second [115200]

Use the **Bits per second** option to specify the serial port transmission speed. The speed must match the other side. Long or noisy lines may require lower speeds.

- **9600** Sets the serial port transmission speed at 9600.
- **19200** Sets the serial port transmission speed at 19200.
- **57600** Sets the serial port transmission speed at 57600.
- **115200** **DEFAULT** Sets the serial port transmission speed at 115200.

→ Flow Control [None]

Use the **Flow Control** option to configure the flow control function.

- **None** Disables flow control.
- **Hardware
RTS/CTS** Enables Hardware RTS/CTS flow control.
- **Software
Xon/Xoff** Enables Software Xon/Xoff flow control.

KINO-QM670 Mini-ITX SBC

5.3.9 iEi Feature

Use the **iEi Feature** menu (**BIOS Menu 14**) to configure the auto recovery function.

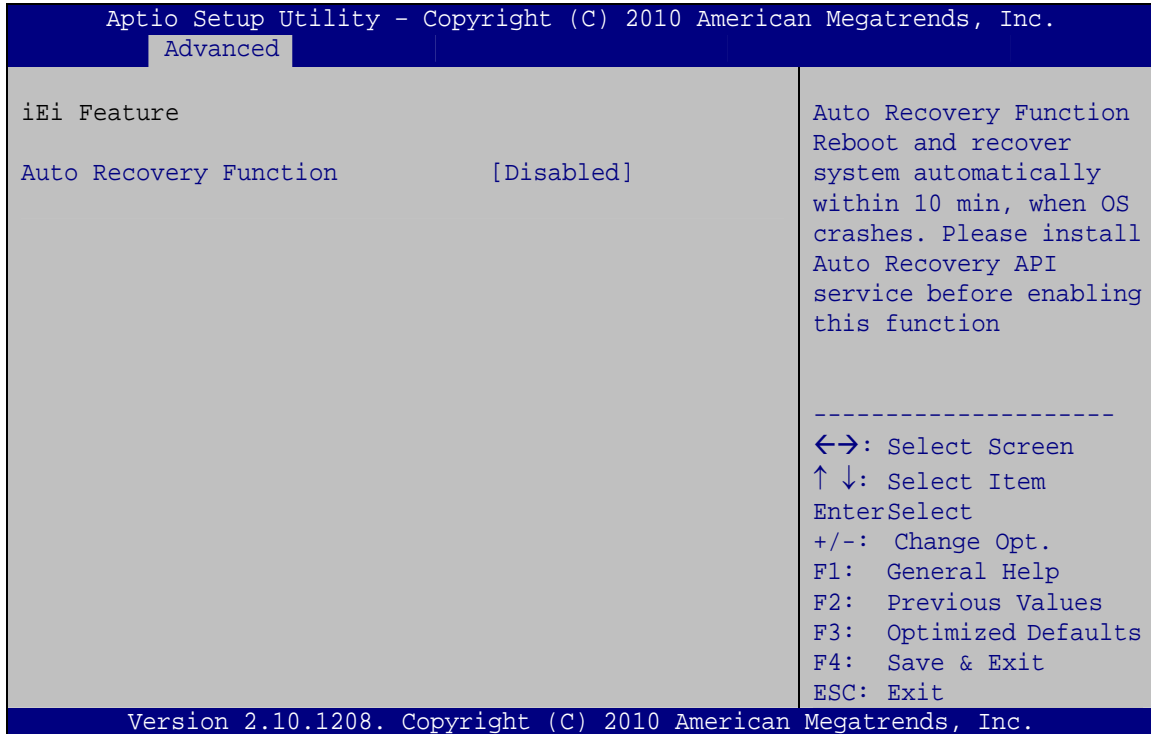

BIOS Menu 14: iEi Feature

➔ Auto Recovery Function [Disabled]

Use the **Auto Recovery Function** option to enable or disable auto recovery on the system.

- ➔ **Disabled** **DEFAULT** Auto Recovery Function support disabled
- ➔ **Enabled** Auto Recovery Function support enabled

5.4 Chipset

Use the **Chipset** menu (**BIOS Menu 15**) to access the Northbridge, Southbridge, Integrated Graphics, and ME Subsystem configuration menus.



WARNING!

Setting the wrong values for the Chipset BIOS selections in the Chipset BIOS menu may cause the system to malfunction.

```
Aptio Setup Utility - Copyright (C) 2010 American Megatrends, Inc.
Main   Advanced  Chipset  Boot   Security  Save & Exit
-----
> NorthBridge Configuration
> SouthBridge Configuration
> ME Configuration

NorthBridge Parameters
-----
<=>: Select Screen
↑↓: Select Item
EnterSelect
+/-: Change Opt.
F1:  General Help
F2:  Previous Values
F3:  Optimized Defaults
F4:  Save & Exit
ESC: Exit

Version 2.10.1208. Copyright (C) 2010 American Megatrends, Inc.
```

BIOS Menu 15: Chipset

KINO-QM670 Mini-ITX SBC

5.4.1 Northbridge Configuration

Use the **Northbridge Chipset Configuration** menu (**BIOS Menu 16**) to configure the Northbridge chipset.

```

Aptio Setup Utility - Copyright (C) 2010 American Megatrends, Inc.
Chipset
NorthBridge Configuration
Memory Information
Memory Frequency          1333 Mhz
Total Memory              4096 MB (DDR3)
DIMM#1                   2048 MB (DDR3)
DIMM#2                   2048 MB (DDR3)
VT-d                      [Disabled]
Primary Display           [Auto]
> Graphics Configuration

Check to enable VT-d
function on MCH.

-----
<=>: Select Screen
↑↓: Select Item
Enter>Select
+/-: Change Opt.
F1: General Help
F2: Previous Values
F3: Optimized Defaults
F4: Save & Exit
ESC: Exit

Version 2.10.1208. Copyright (C) 2010 American Megatrends, Inc.

```

BIOS Menu 16: Northbridge Chipset Configuration

➔ VT-d [Disabled]

Use the **VT-d** option to enable or disable VT-d support.

- ➔ **Disabled** **DEFAULT** Disables VT-d support.
- ➔ **Enabled** Enables VT-d support.

➔ Primary Display [Auto]

Use the **Primary Display** option to select the graphics controller used as the primary boot device. Select either an integrated graphics controller (IGFX) or a PCI graphics controller, a PCI express (PEG) controller. Configuration options are listed below:

- **Auto** **DEFAULT**

- IGFX
- PEG
- PCI

5.4.1.1 Graphics Configuration

Use the **Graphics Configuration** submenu (**BIOS Menu 9**) to configure graphics options.

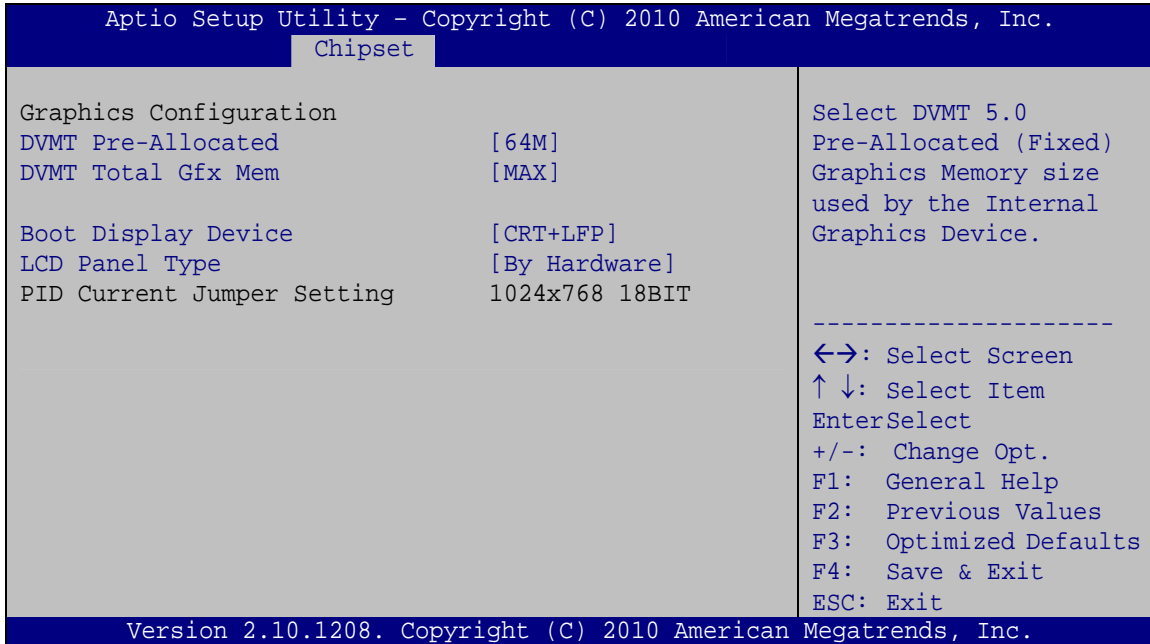

BIOS Menu 17: Northbridge Chipset Configuration

→ DVMT Pre-Allocated [64 M]

Use the **DVMT Pre-Allocated** option to specify the amount of system memory that can be used by the Internal Graphics Device.

- | | | | |
|---|--------------|----------------|---|
| → | 0M | | 0 MB of memory used by internal graphics device |
| → | 32 M | | 32 MB of memory used by internal graphics device |
| → | 64 M | DEFAULT | 64 MB of memory used by internal graphics device |
| → | 96 M | | 96 MB of memory used by internal graphics device |
| → | 128 M | | 128 MB of memory used by internal graphics device |

KINO-QM670 Mini-ITX SBC

- **160 M** 160 MB of memory used by internal graphics device
- **192 M** 192 MB of memory used by internal graphics device
- **224 M** 224 MB of memory used by internal graphics device
- **256 M** 256 MB of memory used by internal graphics device
- **288 M** 288 MB of memory used by internal graphics device
- **320 M** 320 MB of memory used by internal graphics device
- **352 M** 352 MB of memory used by internal graphics device
- **384 M** 384 MB of memory used by internal graphics device
- **416 M** 416 MB of memory used by internal graphics device
- **448 M** 448 MB of memory used by internal graphics device
- **480 M** 480 MB of memory used by internal graphics device
- **512 M** 512 MB of memory used by internal graphics device

→ DVMT Total Gfx Mem [MAX]

Use the **DVMT Total Gfx Mem** option to select the amount of DVMT5.0 total memory used by the Internal Graphics Device.

- **128M** 128 MB of memory used by internal graphics device
- **256M** 256MB of memory used by internal graphics device
- **MAX** **DEFAULT** Maximum amount of memory used by internal graphics device

→ **Boot Display Device [CRT+LFP]**

Use the **CRT+LFP** option to configure the boot display device function.

- **CRT+LFP** **DEFAULT** Enables CRT+LFP as the boot display device.
- **CRT** Enables CRT as the boot display device.
- **HDMI** Enables HDMI as the boot display device.
- **LFP** Enables LFP as the boot display device.
- **HDMI2** Enables HDMI2 as the boot display device.

→ **LCD Panel Type [By Hardware]**

Use the **LCD Panel Type** option to select the LCD panel used by the Internal Graphics Device.

- **By Hardware** **DEFAULT** Selects the panel type by hardware.
- **640x480 18bit** Sets the panel type to 640x480 18bit
- **800x480 18bit** Sets the panel type to 800x480 18bit
- **800x600 18bit** Sets the panel type to 800x600 18bit
- **1024x768 18bit** Sets the panel type to 1024x768 18bit
- **1024x768 24bit** Sets the panel type to 1024x768 24bit
- **1280x1024 48bit** Sets the panel type to 1280x1024 48bit
- **1600x1200 48bit** Sets the panel type to 1600x1200 48bit
- **1280x768 18bit** Sets the panel type to 1280x768 18bit

KINO-QM670 Mini-ITX SBC

➔	1280x800 18bit	Sets the panel type to 1280x800 18bit
➔	1366x768 24bit	Sets the panel type to 1366x768 24bit
➔	1440x900 48bit	Sets the panel type to 1440x900 48bit
➔	1600x900 48bit	Sets the panel type to 1600x900 48bit
➔	1680x1050 48bit	Sets the panel type to 1680x1050 48bit
➔	1920x1080 48bit	Sets the panel type to 1920x1080 48bit
➔	1920x1200 48bit	Sets the panel type to 1920x1200 48bit

5.4.2 Southbridge Configuration

Use the **Southbridge Configuration** menu (**BIOS Menu 18**) to configure the Southbridge chipset.

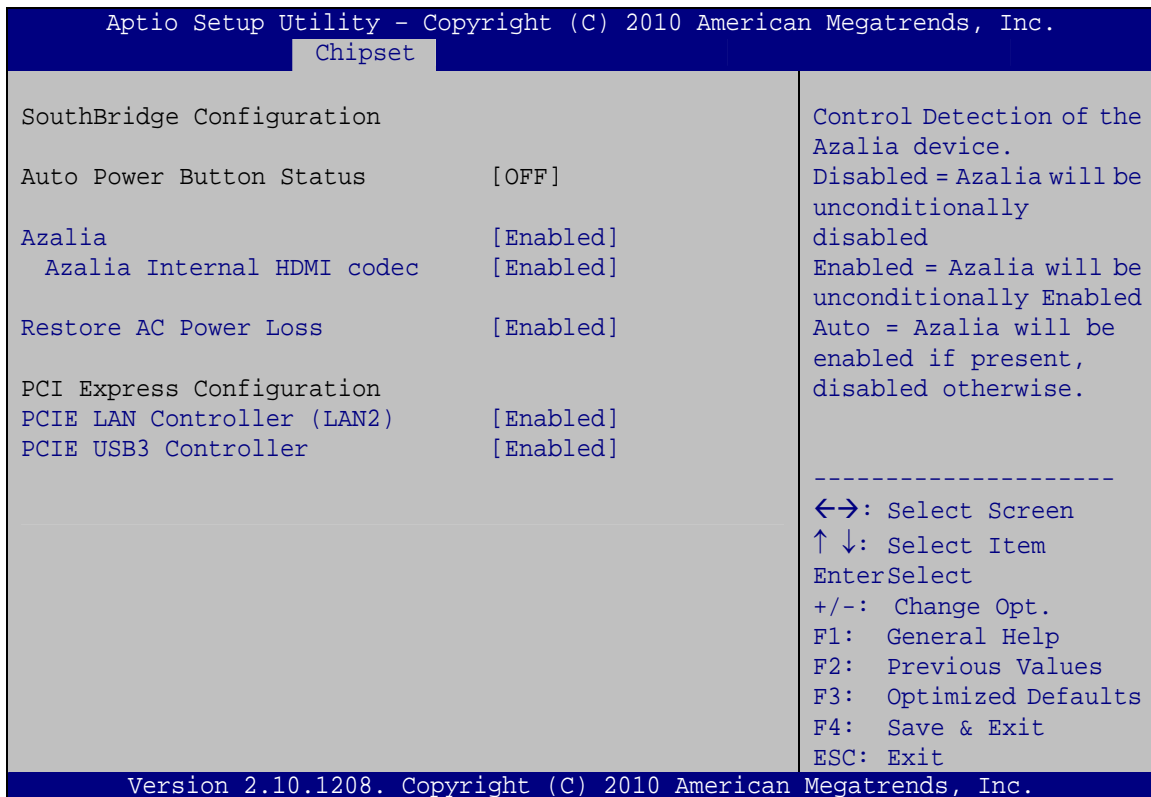

BIOS Menu 18: Southbridge Chipset Configuration

→ Azalia [Enabled]

Use the **Azalia HD Audio** option to enable or disable the High Definition Audio controller.

- **Disabled** The onboard High Definition Audio controller is disabled
- **Enabled** **DEFAULT** The onboard High Definition Audio controller is detected automatically and enabled

→ Azalia Internal HDMI codec [Disabled]

Use the **Azalia internal HDMI codec** option to enable or disable the internal HDMI codec for High Definition Audio.

- **Disabled** Disables the internal HDMI codec for High Definition Audio
- **Enabled** **DEFAULT** Enables the internal HDMI codec for High Definition Audio

→ Restore AC Power Loss [Last State]

Use the **Restore on AC Power Loss** BIOS option to specify what state the system returns to if there is a sudden loss of power to the system.

- **Power Off** The system remains turned off
- **Power On** The system turns on
- **Last State** **DEFAULT** The system returns to its previous state. If it was on, it turns itself on. If it was off, it remains off.

→ PCIe LAN Controller (LAN2) [Enabled]

Use the **PCIe LAN Controller (LAN2)** option to enable or disable the PCI Express LAN controller.

- **Disabled** The onboard PCIe LAN controller is disabled
- **Enabled** **DEFAULT** The onboard PCIe LAN controller is enabled

KINO-QM670 Mini-ITX SBC

→ PCIe USB3 Controller [Enabled]

Use the **PCIe USB3.0 Controller** option to enable or disable the PCI Express USB 3.0 controller.

- **Disabled** The onboard USB 3.0 controller is disabled
- **Enabled** **DEFAULT** The onboard USB 3.0 controller is enabled

5.4.3 ME Configuration

Use the **ME Configuration** menu (**BIOS Menu 19**) to configure the Intel® Management Engine (ME) configuration options.

```

Aptio Setup Utility - Copyright (C) 2010 American Megatrends, Inc.
Chipset
ME Configuration
ME FW Version          7.0.10.1203
ME Firmware Mode       Normal Mode
ME Firmware Type       Full Sku Firmware
ME Firmware SKU        5MB
Intel AMT               [Enabled]
Un-Configure ME        [Disabled]
Enable/Disable Intel (R) Active Management Technology BIOS Extension. Note: iAMT H/W is always enabled. This option just controls the BIOS extension execution. If enabled, this requires additional firmware in the SPI device
-----
←→: Select Screen
↑ ↓: Select Item
Enter>Select
+/-: Change Opt.
F1: General Help
F2: Previous Values
F3: Optimized Defaults
F4: Save & Exit
ESC: Exit
Version 2.10.1208. Copyright (C) 2010 American Megatrends, Inc.

```

BIOS Menu 19: ME Subsystem

→ Intel AMT [Enabled]

Use **Intel AMT** option to enable or disable the Intel® AMT function.

- ➔ **Disabled** Intel® AMT is disabled
- ➔ **Enabled** **DEFAULT** Intel® AMT is enabled

➔ **Un-configure ME [Disabled]**

Use the **Un-configure ME** option to perform ME un-configure without password operation.

- ➔ **Disabled** **DEFAULT** Disable ME un-configure
- ➔ **Enabled** Enable ME un-configure

5.5 Boot

Use the **Boot** menu (**BIOS Menu 20**) to configure system boot options.

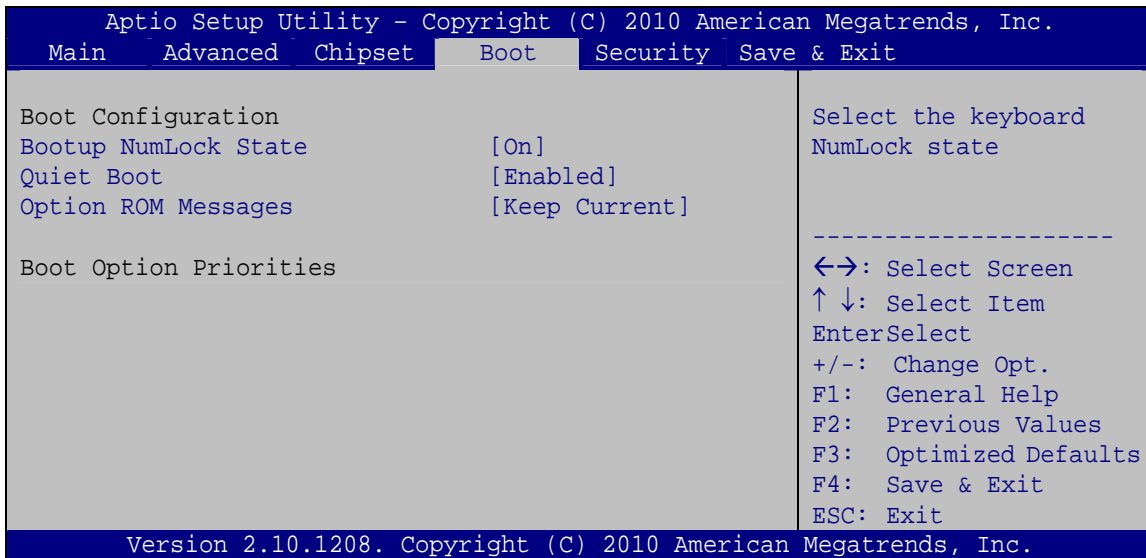

BIOS Menu 20: Boot

➔ **Bootup NumLock State [On]**

Use the **Bootup NumLock State** BIOS option to specify if the number lock setting must be modified during boot up.

KINO-QM670 Mini-ITX SBC

- **On** **DEFAULT** Allows the Number Lock on the keyboard to be enabled automatically when the computer system boots up. This allows the immediate use of the 10-key numeric keypad located on the right side of the keyboard. To confirm this, the Number Lock LED light on the keyboard is lit.
- **Off** Does not enable the keyboard Number Lock automatically. To use the 10-keys on the keyboard, press the Number Lock key located on the upper left-hand corner of the 10-key pad. The Number Lock LED on the keyboard lights up when the Number Lock is engaged.

→ **Quiet Boot [Enabled]**

Use the **Quiet Boot** BIOS option to select the screen display when the system boots.

- **Disabled** Normal POST messages displayed
- **Enabled** **DEFAULT** OEM Logo displayed instead of POST messages

→ **Option ROM Messages [Keep Current]**

Use the **Option ROM Messages** option to set the Option ROM display mode.

- **Force BIOS** Sets display mode to force BIOS.
- **Keep Current** **DEFAULT** Sets display mode to current.

5.6 Security

Use the **Security** menu (**BIOS Menu 21**) to set system and user passwords.

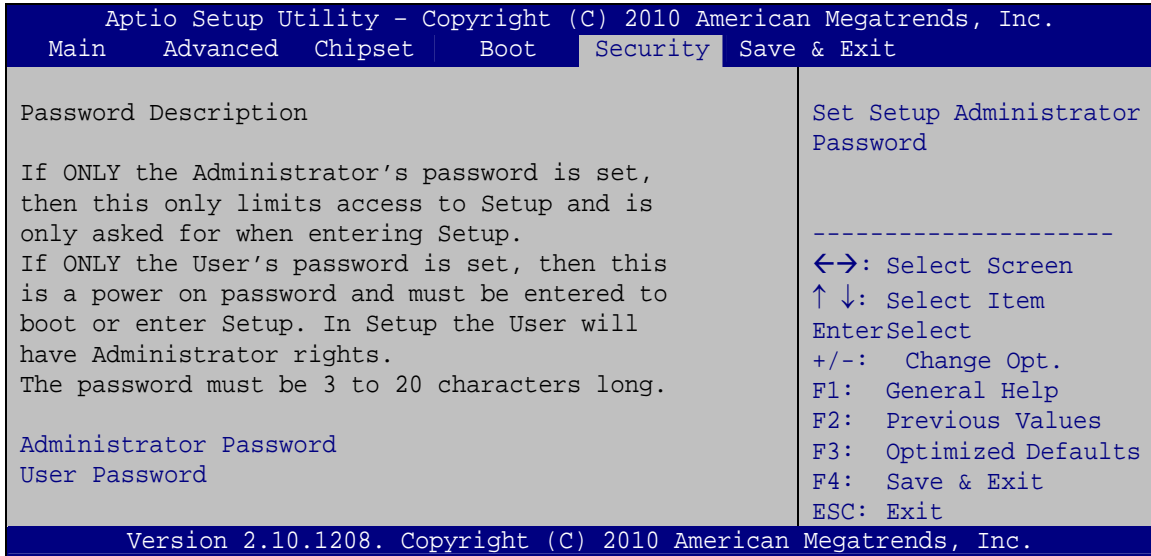

BIOS Menu 21: Security

→ **Administrator Password**

Use the **Administrator Password** to set or change an administrator password.

→ **User Password**

Use the **User Password** to set or change a user password.

5.7 Save & Exit

Use the **Save & Exit** menu (**BIOS Menu 22**) to load default BIOS values, optimal failsafe values and to save configuration changes.

KINO-QM670 Mini-ITX SBC

```

Aptio Setup Utility - Copyright (C) 2010 American Megatrends, Inc.
Main   Advanced   Chipset   Boot   Security   Save & Exit

Save Changes and Reset
Discard Changes and Reset

Restore Defaults
Save as User Defaults
Restore User Defaults

-----
<->: Select Screen
↑ ↓: Select Item
Enter>Select
+ -  Change Opt.
F1   General Help
F2   Previous Values
F3   Optimized Defaults
F4   Save & Exit
ESC  Exit

Version 2.10.1208. Copyright (C) 2010 American Megatrends, Inc.

```

BIOS Menu 22:Exit**→ Save Changes and Reset**

Use the **Save Changes and Reset** option to save the changes made to the BIOS options and reset the system.

→ Discard Changes and Reset

Use the **Discard Changes and Reset** option to exit the system without saving the changes made to the BIOS configuration setup program.

→ Restore Defaults

Use the **Restore Defaults** option to load the optimal default values for each of the parameters on the Setup menus. **F3 key can be used for this operation.**

→ Save as User Defaults

Use the **Save as User Defaults** option to save the changes done so far as user defaults.

→ Restore User Defaults

Use the **Restore User Defaults** option to restore the user defaults to all the setup options.

Appendix

A

Intel® AMT Configuration

KINO-QM670 Mini-ITX SBC

A.1 Intel® AMT Setup Procedure

The KINO-QM670 is featured with the Intel® Active Management Technology (AMT) 7.0. To enable the Intel® AMT function, follow the steps below.

- Step 1:** Make sure the DIMM1 socket is installed with one DDR3 SO-DIMM.
- Step 2:** Connect an Ethernet cable to the RJ-45 connector labeled LAN2_USB2.
- Step 3:** The UEFI BIOS options regarding the Intel® ME or Intel® AMT must be enabled using the ME Configuration [BIOS Chipset menu]
- Step 4:** Configure the Intel® Management Engine BIOS extension (MEBx) (see Section **A.2** below)
- Step 5:** The following dialog window is displayed after the OS is loaded to show the Intel® AMT status on the KINO-QM670 is enabled.



Figure A-1: Intel® Active Management Technology Status Dialog

A.2 Intel® Management Engine BIOS Extension

This section describes the essential steps for using the Intel® Management Engine BIOS extension (MEBx).

- Step 1:** A screen prompts the user to press <Ctrl+P> after a single beep during boot-up process. To get into the Intel® MEBx settings, press <Ctrl+P>.
- Step 2:** Enter the Intel® ME password as it requires (**Figure A-2**). Enter the Intel® default password: **admin**.

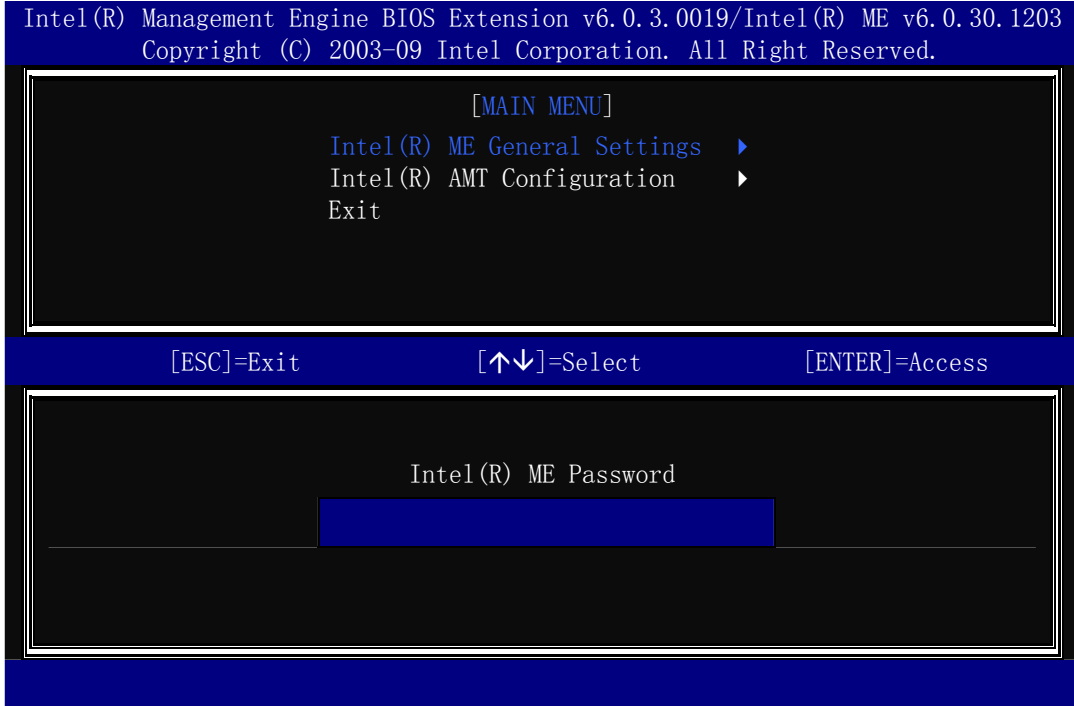

Figure A-2: Intel® Current ME Password

- Step 3:** Enter a new password following the strong password rule (containing at least one upper case letter, one lower case letter, one digit and one special character, and be at least eight characters). (Figure A-3)

- Step 4:** Verify the new password by entering again.

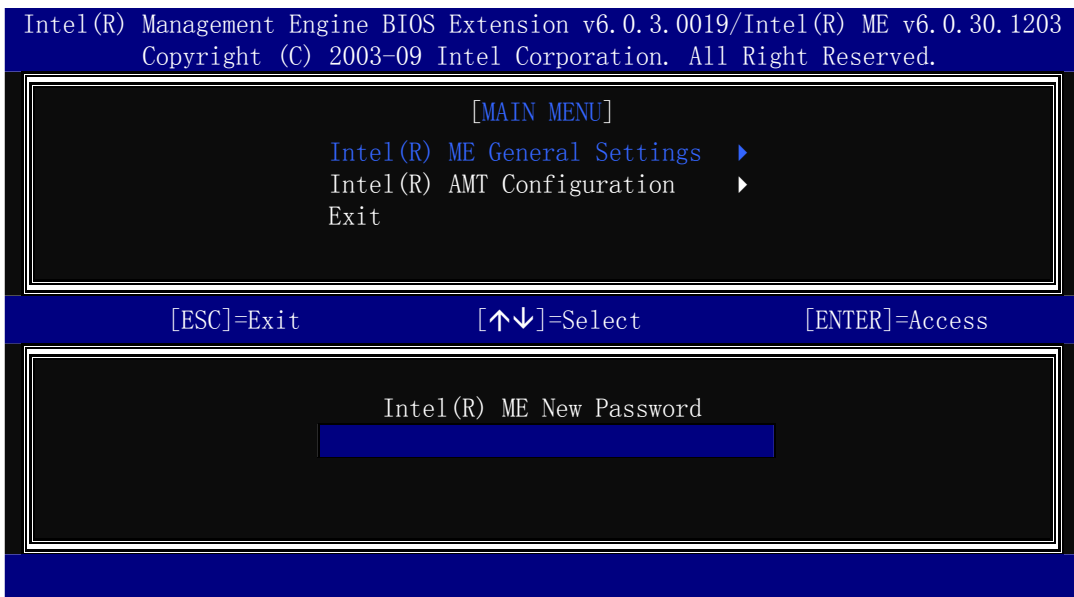

Figure A-3: Intel® ME New Password

KINO-QM670 Mini-ITX SBC

Step 5: Select **Intel® AMT Configuration** and press **Enter** (Figure A-4).

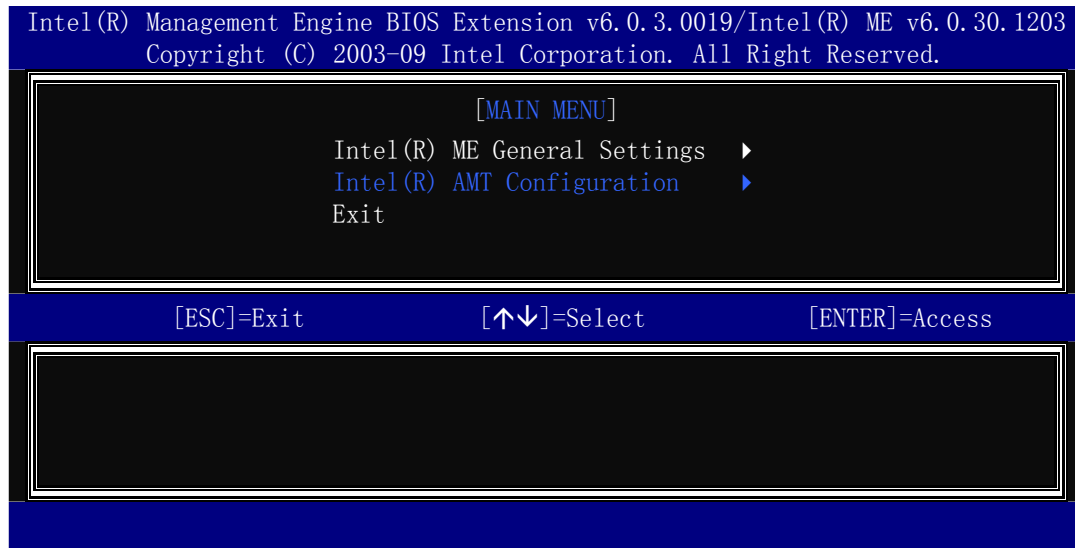

Figure A-4: Intel® AMT Configuration

Step 6: Select **KVM Configuration** and press **Enter**. (Figure A-5)

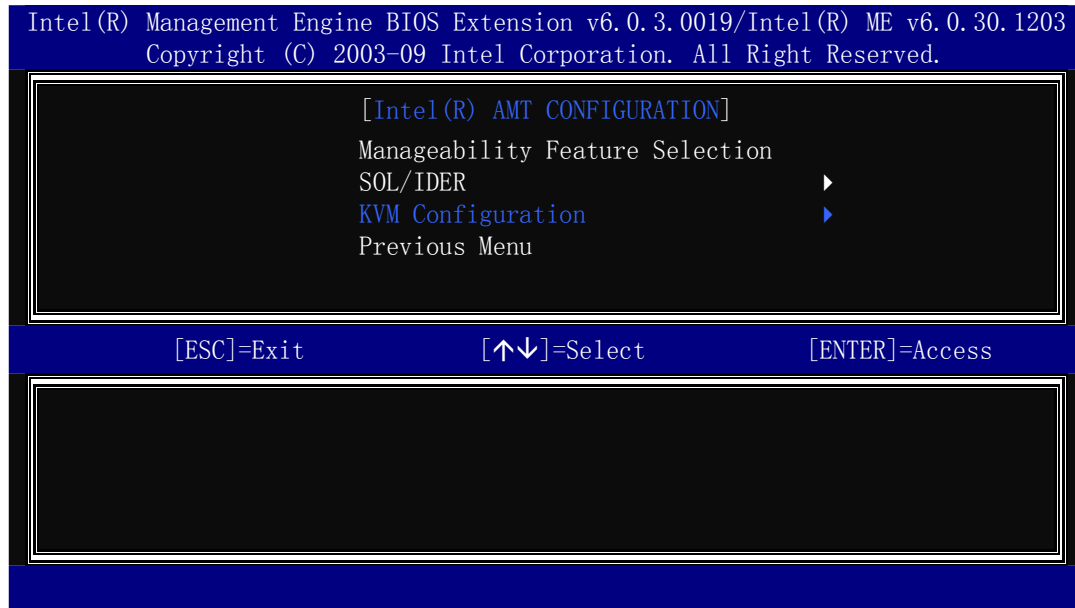

Figure A-5: Select KVM Configuration

Step 7: When the screen in **Figure A-6** prompts, select **User Opt-in** and press **Enter**.

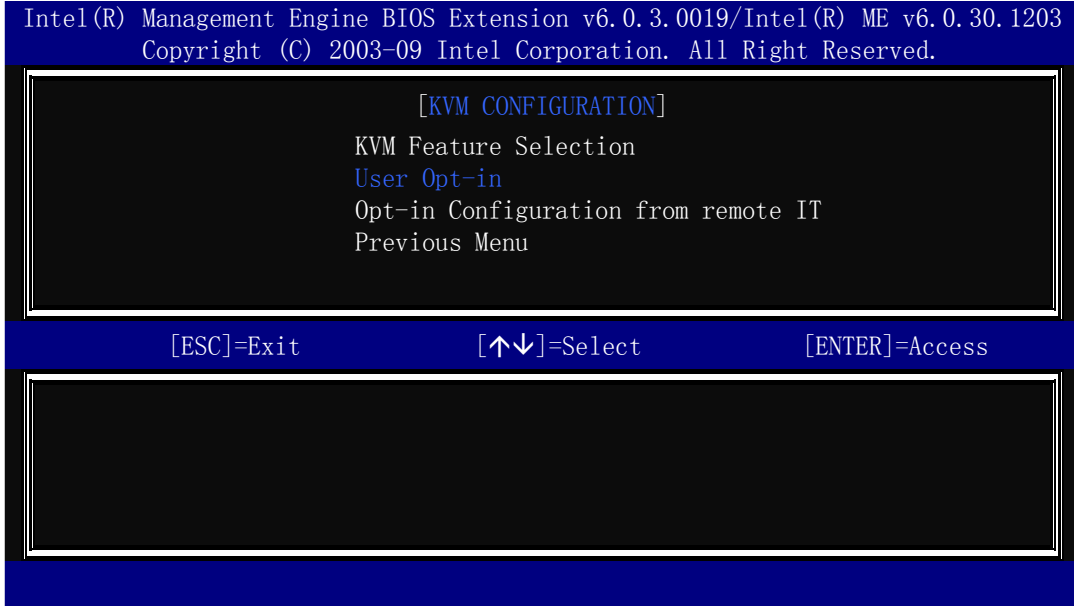

Figure A-6: KVM Configuration

Step 8: Two options are shown as in **Figure A-7**. Choose **User Consent is not required for KVM session** which means no password is required for using iAMT function. Then press **Enter**.

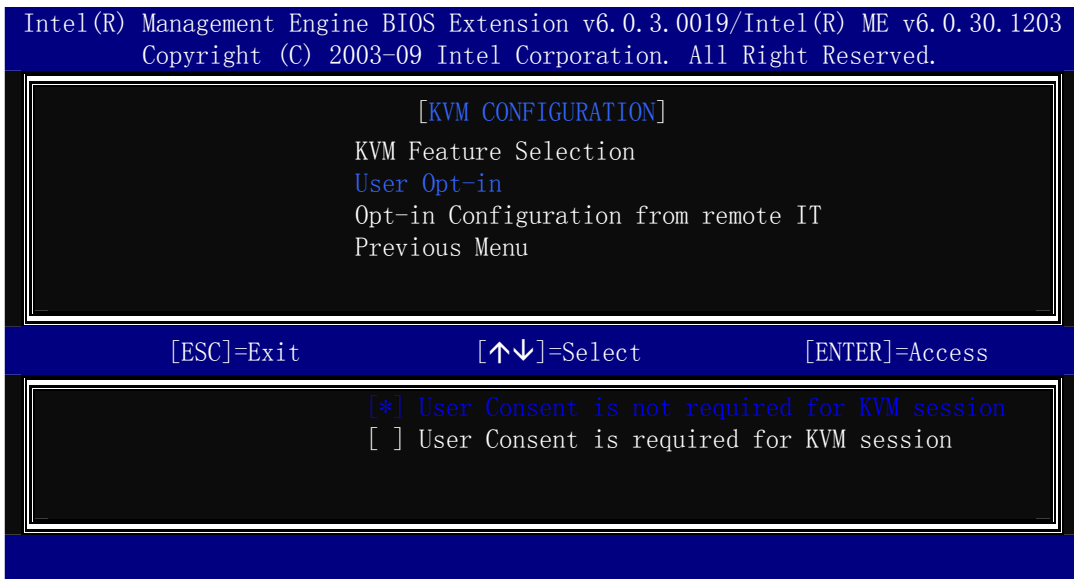

Figure A-7: KVM User Opt-in

Step 9: Make other necessary settings in the Intel® MEBx depending on users' need.

KINO-QM670 Mini-ITX SBC

Step 10: To exit the Intel® MEBx, return to the main menu and select Exit. (Figure A-8)

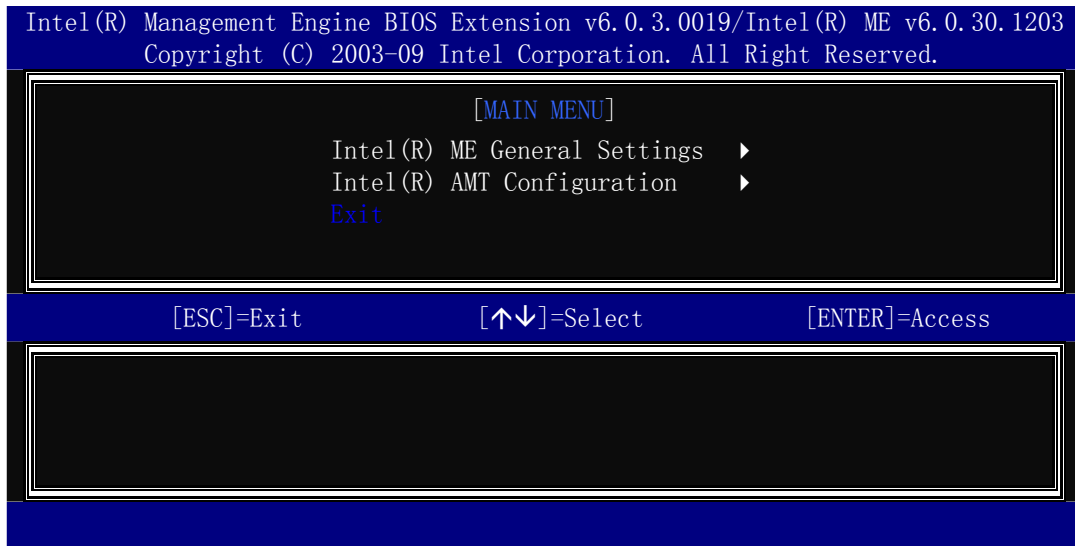

Figure A-8: Exit

A.3 Iei Easy Manager Application



IEI Easy Manager (iEZMan) application program allows a remote user, such as a support person, to remotely control and perform administrative tasks through a graphical user interface in Windows. The functions of the iEZMan application include

- Power Management
- Schedule Power Management
- Remote Access
- Group Management
- Patch Management
- Alert and Events

For more information regarding the iEZMan application, please refer to the instruction manual of the iEZMan.

Appendix

B

BIOS Menu Options

BIOS Information	76
System Date [xx/xx/xx]	77
System Time [xx:xx:xx]	77
ACPI Sleep State [S1 (CPU Stop Clock)]	79
TPM Support [Disable]	80
Hyper Threading [Enabled]	80
Intel® Virtualization Technology [Disabled]	81
SATA Controller(s) [Enabled]	82
SATA Mode Selection [AHCI]	82
USB Devices	82
USB Support [Enabled]	83
Legacy USB Support [Enabled]	83
Serial Port [Enabled]	85
Change Settings [Auto]	85
Serial Port [Enabled]	86
Change Settings [Auto]	86
Serial Port [Enabled]	87
Change Settings [Auto]	87
Device Mode [RS422/RS485]	87
Serial Port [Enabled]	88
Change Settings [Auto]	88
PC Health Status	89
CPU Smart Fan control [Manual by RPM]	90
Manual Setting	91
CPU Smart Fan control [Auto Mode by PWM]	91
Temperature Bound n	92
Segment n Speed (PWM)	92
Console Redirection [Disabled]	93
Out-of-Band Mgmt Port [COM0]	93
Terminal Type [VT-UTF8]	94
Bits per second [115200]	94
Flow Control [None]	94
Auto Recovery Function [Disabled]	95
VT-d [Disabled]	97

KINO-QM670 Mini-ITX SBC

Primary Display [Auto]	97
DVMT Pre-Allocated [64 M]	98
DVMT Total Gfx Mem [MAX].....	99
Boot Display Device [CRT+LFP].....	100
LCD Panel Type [By Hardware]	100
Azalia [Enabled]	102
Azalia Internal HDMI codec [Disabled]	102
Restore AC Power Loss [Last State]	102
PCIe LAN Controller (LAN2) [Enabled].....	102
PCIe USB3 Controller [Enabled].....	103
Intel AMT [Enabled]	103
Un-configure ME [Disabled].....	104
Bootup NumLock State [On].....	104
Quiet Boot [Enabled]	105
Option ROM Messages [Keep Current]	105
Administrator Password	106
User Password	106
Save Changes and Reset	107
Discard Changes and Reset	107
Restore Defaults	107
Save as User Defaults	107
Restore User Defaults	107

Appendix

C

One Key Recovery

C.1 One Key Recovery Introduction

The IEI one key recovery is an easy-to-use front end for the Norton Ghost system backup and recovery tool. This tool provides quick and easy shortcuts for creating a backup and reverting to that backup or reverting to the factory default settings.



NOTE:

The latest One Key Recovery software provides an auto recovery function that allows a system running Microsoft Windows OS to automatically restore from the factory default image after encountering a Blue Screen of Death (BSoD) or a hang for around 10 minutes. Please refer to Section C.2 for the detailed setup procedure.

The IEI One Key Recovery tool menu is shown below.

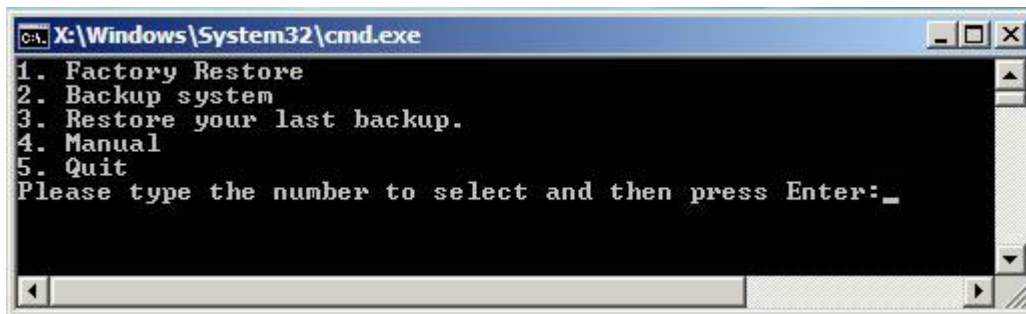

Figure C-1: IEI One Key Recovery Tool Menu

Prior to using the IEI One Key Recovery tool (as shown in **Figure C-1**) to backup or restore Windows system, five setup procedures are required.

1. Hardware and BIOS setup (see **Section C.2.1**)
2. Create partitions (see **Section C.2.2**)
3. Install operating system, drivers and system applications (see **Section C.2.3**)
4. Build-up recovery partition (see **Section C.2.4**)
5. Create factory default image (see **Section C.2.5**)

After completing the five initial setup procedures as described above, users can access the recovery tool by pressing <F3> while booting up the system. The detailed information of each function is described in **Section C.5**.

**NOTE:**

The initial setup procedures for Linux system are described in **Section C.2**.

C.1.1 System Requirement

**NOTE:**

The recovery CD can only be used with IEI products. The software will fail to run and a warning message will appear when used on non-IEI hardware.

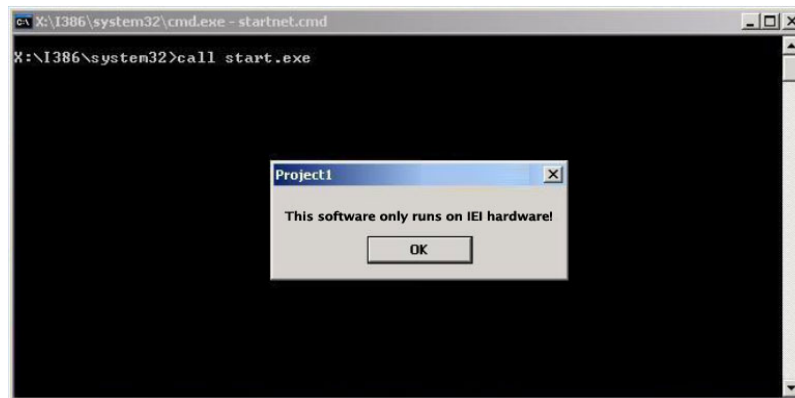

To create the system backup, the main storage device must be split into two partitions (three partitions for Linux). The first partition will be for the operating system, while the second partition will be invisible to the operating system and contain the backup made by the one key recovery software.

The partition created for recovery images must be big enough to contain both the factory default image and the user backup image. The size must be calculated before creating the

KINO-QM670 Mini-ITX SBC

partitions. Please take the following table as a reference when calculating the size of the partition.

	OS	OS Image after Ghost	Compression Ratio
Windows® 7	7 GB	5 GB	70%
Windows® XPE	776 MB	560 MB	70%
Windows® CE 6.0	36 MB	28 MB	77%



NOTE:

Specialized tools are required to change the partition size if the operating system is already installed.

C.1.2 Supported Operating System

The recovery CD is compatible with both Microsoft Windows and Linux operating system (OS). The supported OS versions are listed below.

- Microsoft Windows
 - Windows 2000
 - Windows XP (Service Pack 2 or 3 required)
 - Windows Vista
 - Windows 7
 - Windows CE 5.0
 - Windows CE 6.0
 - Windows XP Embedded
 - Windows Embedded Standard 7
-



NOTE:

The auto recovery function (described in Section C.3) and the restore through LAN function (described in Section C.6) are not supported in the Windows CE 5.0/6.0 operating system environment.

- Linux
 - Fedora Core 12 (Constantine)
 - Fedora Core 11 (Leonidas)
 - Fedora Core 10 (Cambridge)
 - Fedora Core 8 (Werewolf)
 - Fedora Core 7 (Moonshine)
 - RedHat RHEL-5.4
 - RedHat 9 (Ghirke)
 - Ubuntu 8.10 (Intrepid)
 - Ubuntu 7.10 (Gutsy)
 - Ubuntu 6.10 (Edgy)
 - Debian 5.0 (Lenny)
 - Debian 4.0 (Etch)
 - SuSe 11.2
 - SuSe 10.3

**NOTE:**

Installing unsupported OS versions may cause the recovery tool to fail.

C.2 Setup Procedure for Windows

Prior to using the recovery tool to backup or restore, a few setup procedures are required.

Step 1: Hardware and BIOS setup (see Section **C.2.1**)

Step 2: Create partitions (see **Section C.2.2**)

Step 3: Install operating system, drivers and system applications (see **Section C.2.3**)

Step 4: Build the recovery partition (see **Section C.2.4**) or build the auto recovery partition (see **Section C.3**)

Step 5: Create factory default image (see **Section C.2.5**)

KINO-QM670 Mini-ITX SBC

The detailed descriptions are described in the following sections.



NOTE:

The setup procedures described below are for Microsoft Windows operating system users. For Linux, most of the setup procedures are the same except for several steps described in **Section C.2**.

C.2.1 Hardware and BIOS Setup

- Step 1:** Make sure the system is powered off and unplugged.
- Step 2:** Install a hard drive or SSD in the system. An unformatted and unpartitioned disk is recommended.
- Step 3:** Connect an optical disk drive to the system and insert the recovery CD.
- Step 4:** Turn on the system.
- Step 5:** Press the <DELETE> key as soon as the system is turned on to enter the BIOS.
- Step 6:** Select the connected optical disk drive as the 1st boot device. (**Boot** → **Boot Device Priority** → **1st Boot Device**).
- Step 7:** Save changes and restart the computer. Continue to the next section for instructions on partitioning the internal storage.

C.2.2 Create Partitions

To create the system backup, the main storage device must be split into two partitions (three partitions for Linux). The first partition will be for the operating system, while the second partition will be invisible to the operating system and contain the backup made by the one key recovery software.

- Step 1:** Put the recovery CD in the optical drive of the system.

Step 2: Boot the system from recovery CD. When prompted, press any key to boot from the recovery CD. It will take a while to launch the recovery tool. Please be patient!

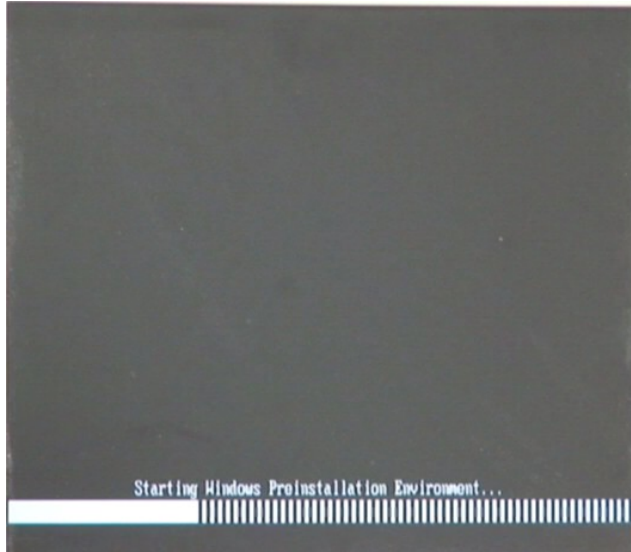

Figure C-2: Launching the Recovery Tool

Step 3: The recovery tool setup menu is shown as below.

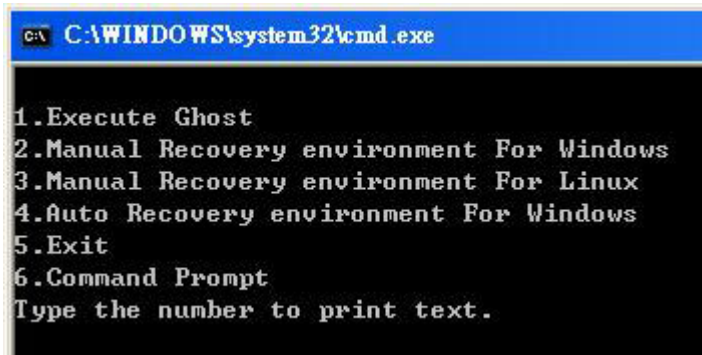
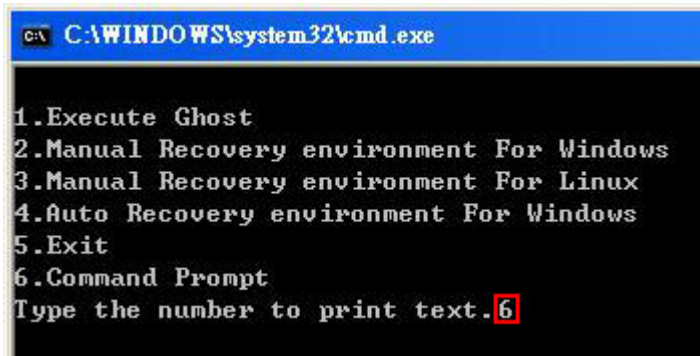

Figure C-3: Recovery Tool Setup Menu

Step 4: Press <6> then <Enter>.

KINO-QM670 Mini-ITX SBC



```
C:\WINDOWS\system32\cmd.exe

1.Execute Ghost
2.Manual Recovery environment For Windows
3.Manual Recovery environment For Linux
4.Auto Recovery environment For Windows
5.Exit
6.Command Prompt
Type the number to print text.6
```

Figure C-4: Command Mode

Step 5: The command prompt window appears. Type the following commands (marked in red) to create two partitions. One is for the OS installation; the other is for saving recovery files and images which will be an invisible partition.

(Press <Enter> after entering each line below)

```
system32>diskpart
```

```
DISKPART>list vol
```

```
DISKPART>sel disk 0
```

```
DISKPART>create part pri size= ____
```

```
DISKPART>assign letter=N
```

```
DISKPART>create part pri size= ____
```

```
DISKPART>assign letter=F
```

```
DISKPART>exit
```

```
system32>format N: /fs:ntfs /q /y
```

```
system32>format F: /fs:ntfs /q /v:Recovery /y
```

```
system32>exit
```

```

X:\I386\SYSTEM32\CMD.EXE
X:\I386\SYSTEM32>diskpart → Starts the Microsoft disk partitioning tool.
Microsoft DiskPart version 5.2.3790.1830
Copyright (C) 1999-2001 Microsoft Corporation.
On computer: MININT-JUC

DISKPART> list vol → Show partition information

Volume ### Ltr Label Fs Type Size Status Info
-----
Volume 0 X CD_ROM CDFS DUD-ROM 405 MB Healthy Boot
Volume 1 D FAT32 Removeable 3854 MB Healthy

DISKPART> sel disk 0 → Select a disk
Disk 0 is now the selected disk.

DISKPART> create part pri size=2000 → Create partition 1 and assign a size.
This partition is for OS installation.
DiskPart succeeded in creating the specified partition.

DISKPART> assign letter=N → Assign partition 1 a code name (N).
DiskPart successfully assigned the drive letter or mount point.

DISKPART> create part pri size=1800 → Create partition 2 and assign a size.
This partition is for recovery images.
DiskPart succeeded in creating the specified partition.

DISKPART> assign letter=F → Assign partition 2 a code name (F).
DiskPart successfully assigned the drive letter or mount point.

DISKPART> exit → Exit diskpart
X:\I386\SYSTEM32>format n: /fs:ntfs /q /y → Format partition 1 (N) as NTFS format.
The type of the file system is RAW.
The new file system is NTFS.
QuickFormatting 2000M
Creating file system structures.
Format complete.
2048254 KB total disk space.
2035620 KB are available.

X:\I386\SYSTEM32>format f: /fs:ntfs /q /v:Recovery /y → Formate partition 2 (F) as NTFS formate and
name it as "Recovery".
The type of the file system is RAW.
The new file system is NTFS.
QuickFormatting 1804M
Creating file system structures.
Format complete.
1847474 KB total disk space.
1835860 KB are available.

X:\I386\SYSTEM32>exit → Exit Windows PE
  
```

Figure C-5: Partition Creation Commands

KINO-QM670 Mini-ITX SBC

**NOTE:**

Use the following commands to check if the partitions were created successfully.

```
X:\I386\SYSTEM32>diskpart
Microsoft DiskPart version 5.2.3790.1830
Copyright (C) 1999-2001 Microsoft Corporation.
On computer: MININT-JUC

DISKPART> sel disk 0
Disk 0 is now the selected disk.

DISKPART> list part

   Partition ###   Type              Size              Offset
-----
   Partition 1     Primary           2000 MB           32 KB
   Partition 2     Primary           1804 MB           2000 MB

DISKPART> exit
```

Step 6: Press any key to exit the recovery tool and automatically reboot the system.

Please continue to the following procedure: Build the Recovery Partition.

C.2.3 Install Operating System, Drivers and Applications

Install the operating system onto the unlabelled partition. The partition labeled "Recovery" is for use by the system recovery tool and should not be used for installing the operating system or any applications.

**NOTE:**

The operating system installation program may offer to reformat the chosen partition. DO NOT format the partition again. The partition has already been formatted and is ready for installing the new operating system.

To install the operating system, insert the operating system installation CD into the optical drive. Restart the computer and follow the installation instructions.

C.2.4 Build-up Recovery Partition

- Step 1:** Put the recover CD in the optical drive.
- Step 2:** Start the system.
- Step 3:** **Boot the system from the recovery CD.** When prompted, press any key to boot from the recovery CD. It will take a while to launch the recovery tool. Please be patient!

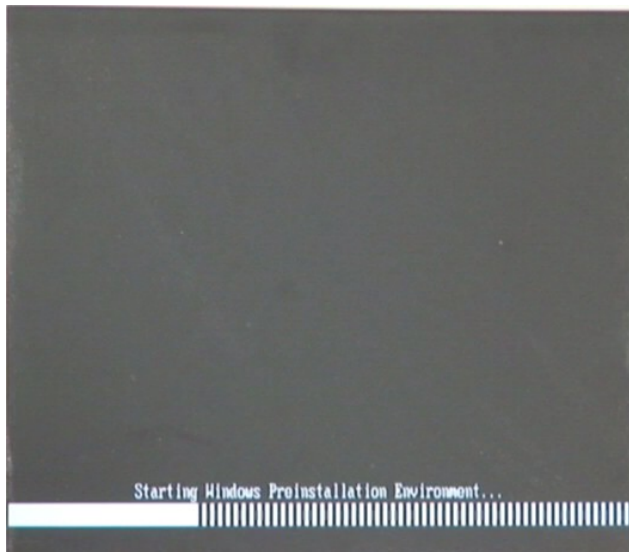

Figure C-6: Launching the Recovery Tool

- Step 4:** When the recovery tool setup menu appears, press <2> then <Enter>.

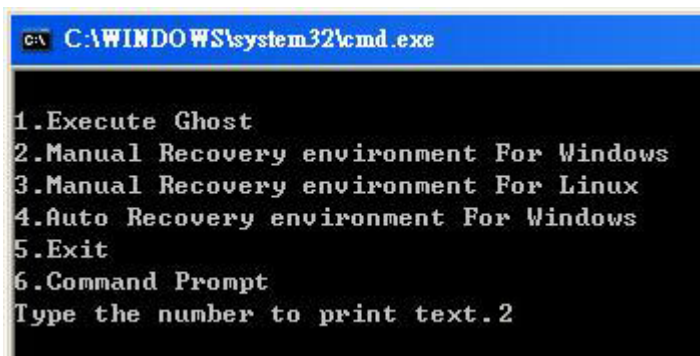

Figure C-7: Manual Recovery Environment for Windows

KINO-QM670 Mini-ITX SBC

Step 5: The Symantec Ghost window appears and starts configuring the system to build a recovery partition. In this process the partition created for recovery files in **Section C.2.2** is hidden and the recovery tool is saved in this partition.

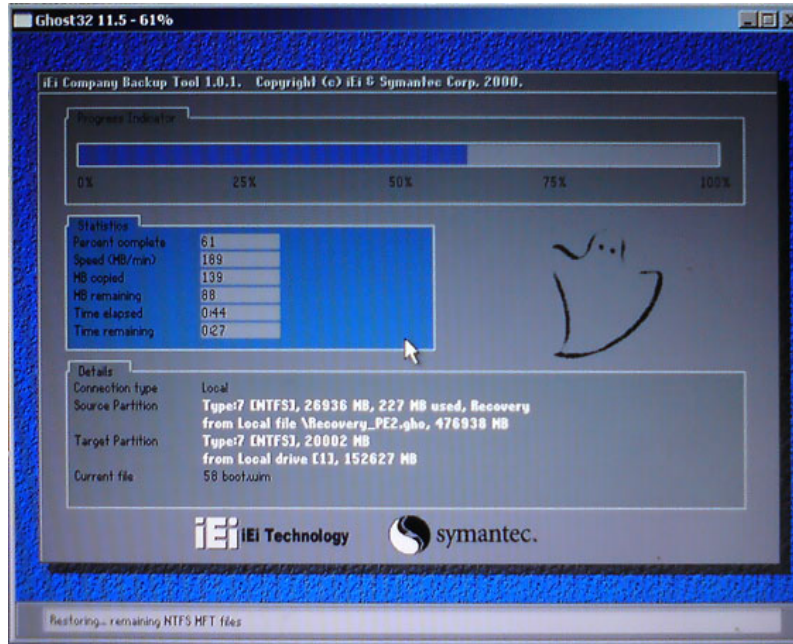

Figure C-8: Building the Recovery Partition

Step 6: After completing the system configuration, press any key in the following window to reboot the system.

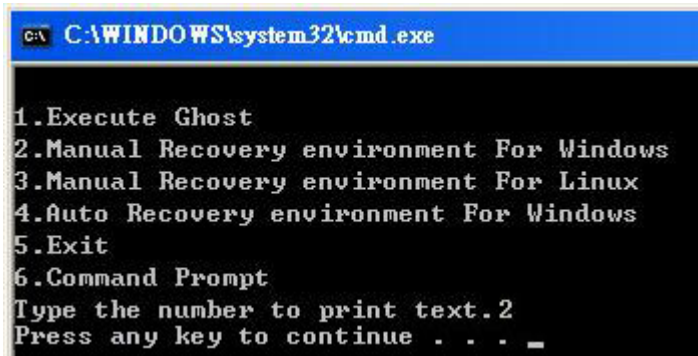

Figure C-9: Press Any Key to Continue

Step 7: Eject the recovery CD.

C.2.5 Create Factory Default Image



NOTE:

Before creating the factory default image, please configure the system to a factory default environment, including driver and application installations.

To create a factory default image, please follow the steps below.

Step 1: Turn on the system. When the following screen displays (**Figure C-10**), press the <F3> key to access the recovery tool. The message will display for 10 seconds, please press F3 before the system boots into the operating system.

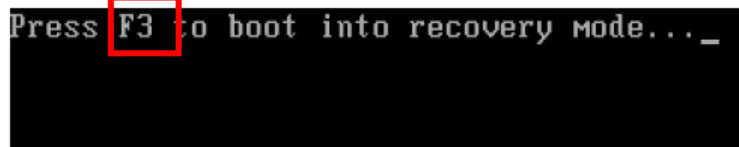

Figure C-10: Press F3 to Boot into Recovery Mode

Step 2: The recovery tool menu appears. Type <4> and press <Enter>. (**Figure C-11**)

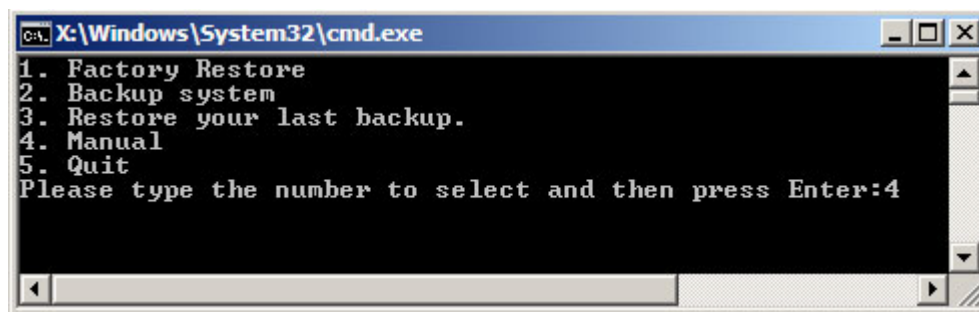

Figure C-11: Recovery Tool Menu

Step 3: The About Symantec Ghost window appears. Click **OK** button to continue.

KINO-QM670 Mini-ITX SBC

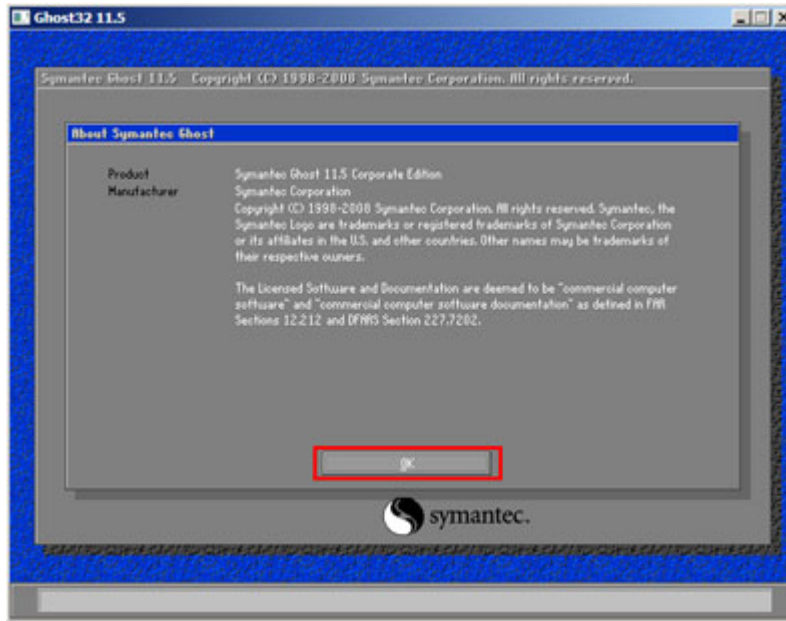

Figure C-12: About Symantec Ghost Window

Step 4: Use mouse to navigate to the option shown below (Figure C-13).

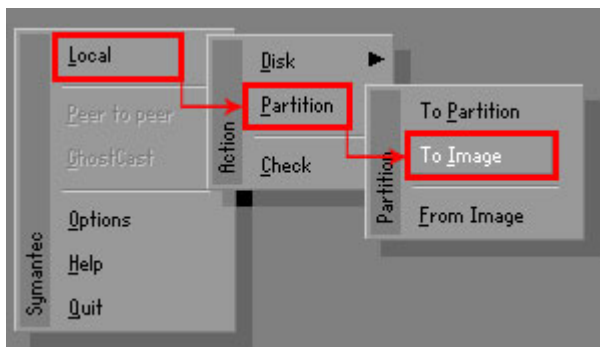

Figure C-13: Symantec Ghost Path

Step 5: Select the local source drive (Drive 1) as shown in Figure C-14. Then click OK.

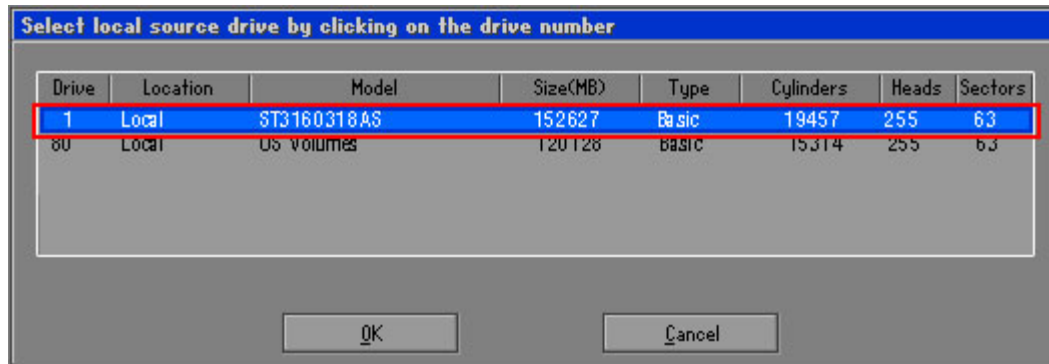

Figure C-14: Select a Local Source Drive

Step 6: Select a source partition (Part 1) from basic drive as shown in **Figure C-15**. Then click OK.

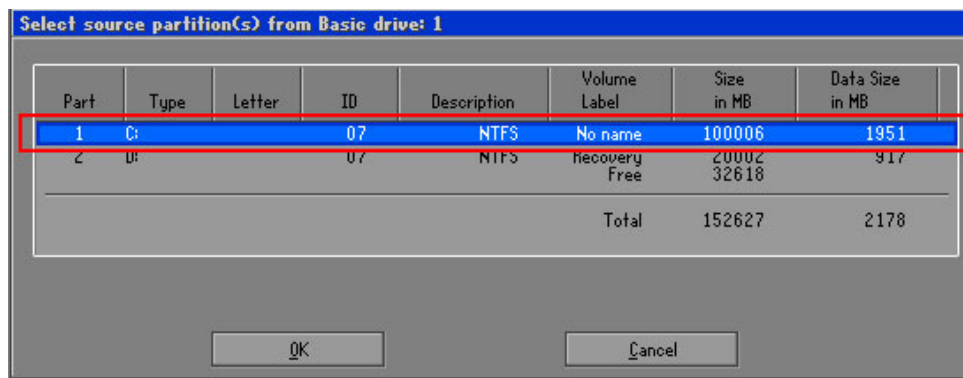

Figure C-15: Select a Source Partition from Basic Drive

Step 7: Select 1.2: **[Recovery] NTFS drive** and enter a file name called **iei** (**Figure C-16**). Click **Save**. The factory default image will then be saved in the selected recovery drive and named **IEI.GHO**.



WARNING:

The file name of the factory default image must be **iei.GHO**.

KINO-QM670 Mini-ITX SBC

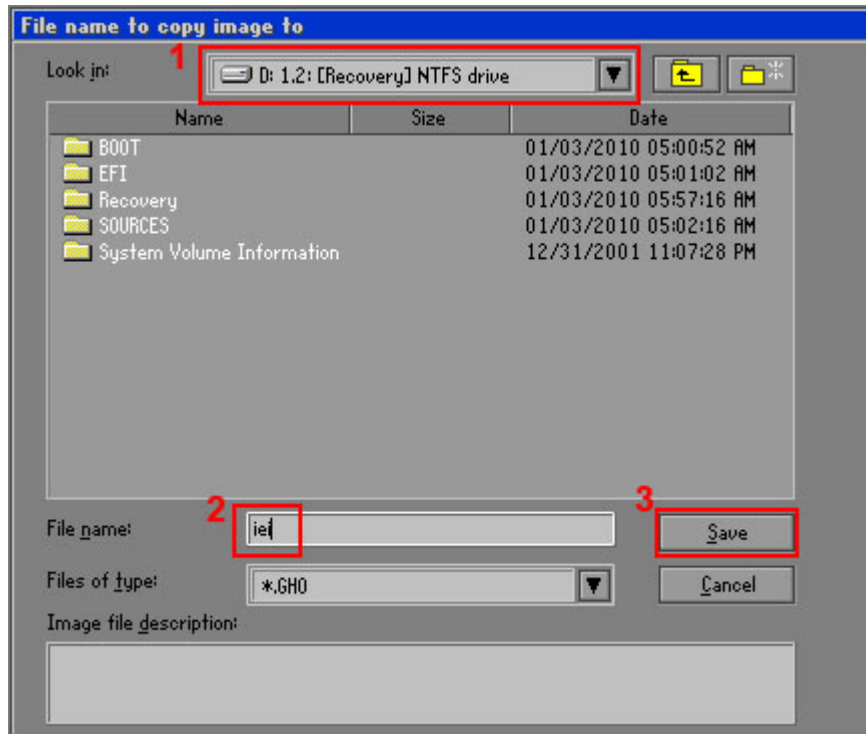

Figure C-16: File Name to Copy Image to

Step 8: When the Compress Image screen in **Figure C-17** prompts, click **High** to make the image file smaller.

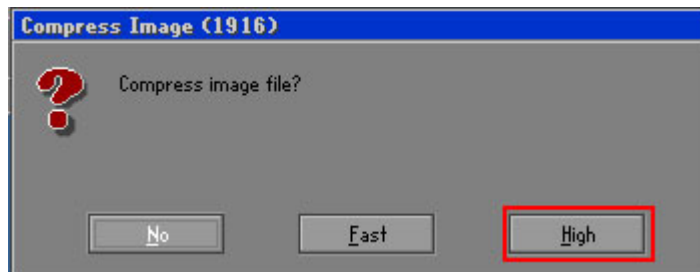

Figure C-17: Compress Image

Step 9: The Proceed with partition image creation window appears, click **Yes** to continue.

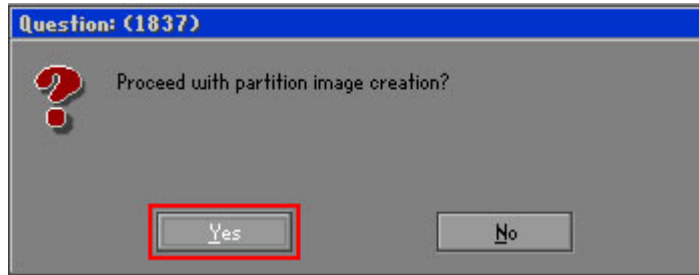

Figure C-18: Image Creation Confirmation

Step 10: The Symantec Ghost starts to create the factory default image (**Figure C-19**).

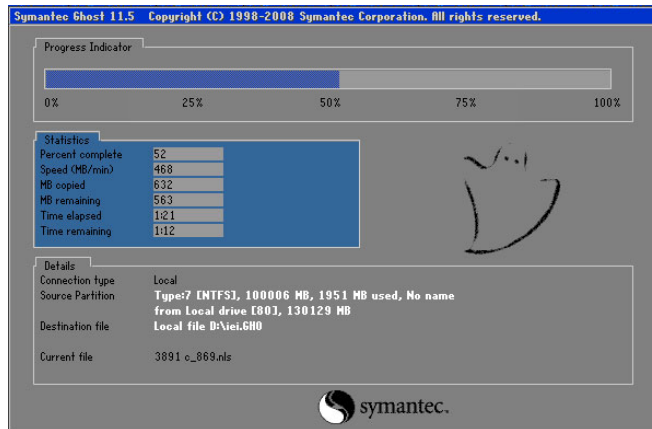

Figure C-19: Image Creation Complete

Step 11: When the image creation completes, a screen prompts as shown in **Figure C-20**.

Click **Continue** and close the Ghost window to exit the program.

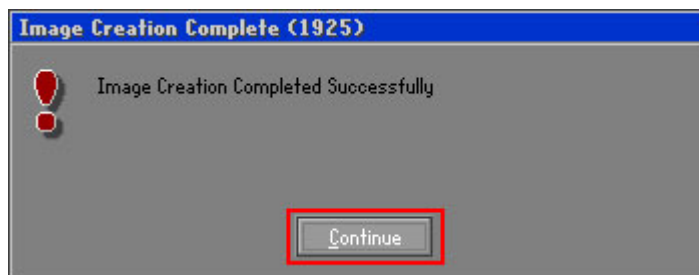
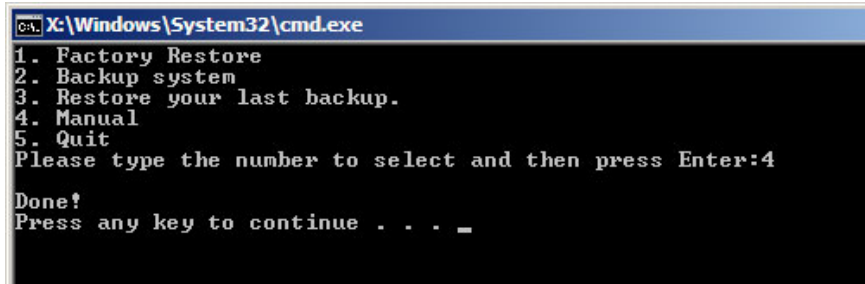

Figure C-20: Image Creation Complete

KINO-QM670 Mini-ITX SBC

Step 12: The recovery tool main menu window is shown as below. Press any key to reboot the system.



```
C:\Windows\System32\cmd.exe
1. Factory Restore
2. Backup system
3. Restore your last backup.
4. Manual
5. Quit
Please type the number to select and then press Enter:4
Done!
Press any key to continue . . . _
```

Figure C-21: Press Any Key to Continue

C.3 Auto Recovery Setup Procedure

The auto recovery function allows a system to automatically restore from the factory default image after encountering a Blue Screen of Death (BSOD) or a hang for around 10 minutes. To use the auto recovery function, follow the steps described in the following sections.



CAUTION:

The auto recovery function can only run on a Microsoft Windows system with the following OS versions:

- Windows 2000
- Windows XP
- Windows Vista
- Windows 7
- Windows XP Embedded
- Windows Embedded Standard 7



CAUTION:

The setup procedure may include a step to create a factory default image. It is suggested to configure the system to a factory default environment before the configuration, including driver and application installations.

Step 1: Follow the steps described in **Section C.2.1 ~ Section C.2.3** to setup BIOS, create partitions and install operating system.

Step 2: Install the auto recovery utility into the system by double clicking the **Utility/AUTORECOVERY-SETUP.exe** in the One Key Recovery CD. This utility **MUST** be installed in the system, otherwise, the system will automatically restore from the factory default image every ten (10) minutes.



Figure C-22: Auto Recovery Utility

Step 3: **Disable the automatically restart function before creating the factory default image.** Go to: My Computer → Properties → Advanced. Click the Settings button of Startup and Recovery. Deselect “Automatically restart”. Click OK to save the settings and exit. (See **Figure C-23**)

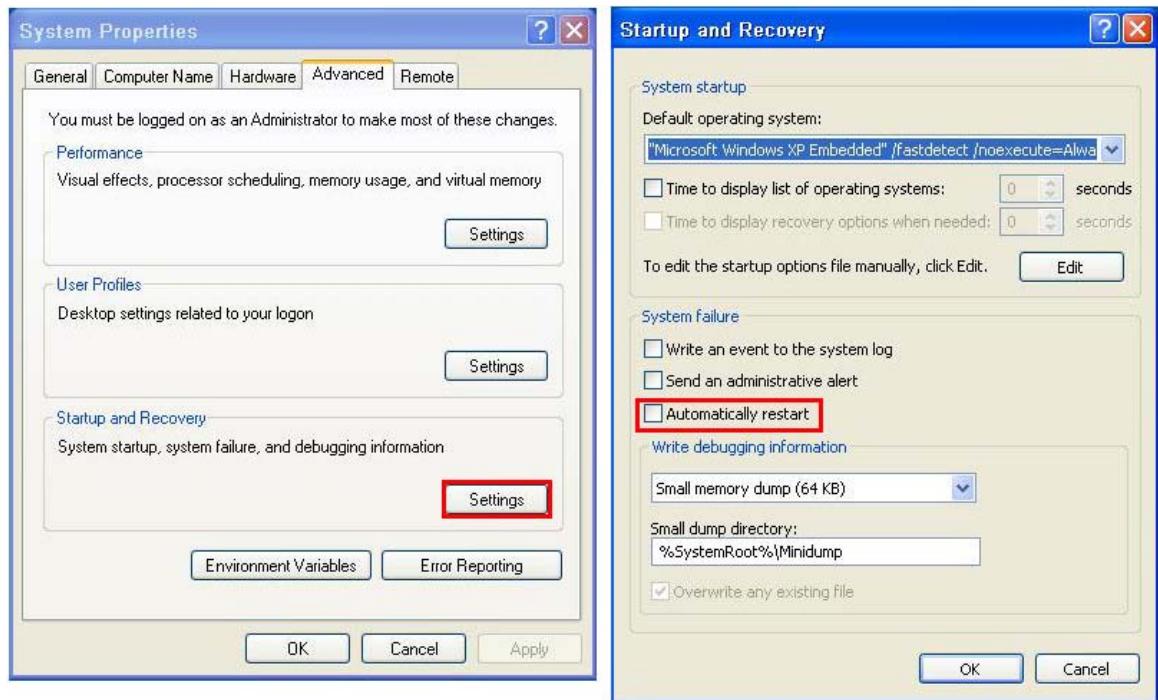

Figure C-23: Disable Automatically Restart

KINO-QM670 Mini-ITX SBC

Step 4: Reboot the system from the recovery CD. When prompted, press any key to boot from the recovery CD. It will take a while to launch the recovery tool. Please be patient!

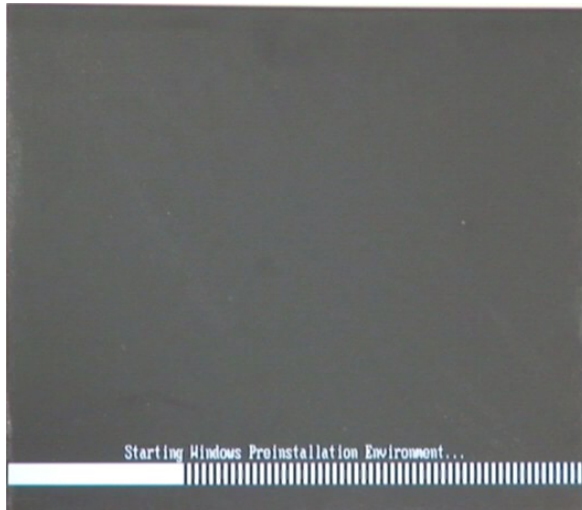

Figure C-24: Launching the Recovery Tool

Step 5: When the recovery tool setup menu appears, press <4> then <Enter>.

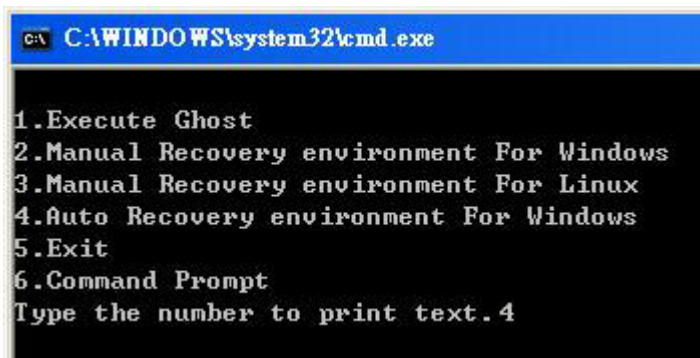

Figure C-25: Auto Recovery Environment for Windows

Step 6: The Symantec Ghost window appears and starts configuring the system to build an auto recovery partition. In this process the partition created for recovery files in **Section C.2.2** is hidden and the auto recovery tool is saved in this partition.

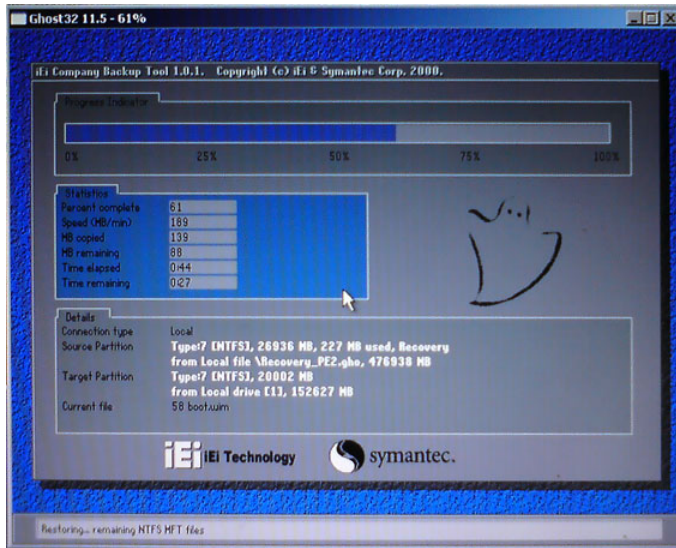

Figure C-26: Building the Auto Recovery Partition

Step 7: After completing the system configuration, the following message prompts to confirm whether to create a factory default image. Type **Y** to have the system create a factory default image automatically. Type **N** within 6 seconds to skip this process (The default option is YES). It is suggested to choose YES for this option.



Figure C-27: Factory Default Image Confirmation

KINO-QM670 Mini-ITX SBC

Step 8: The Symantec Ghost starts to create the factory default image (Figure C-28).

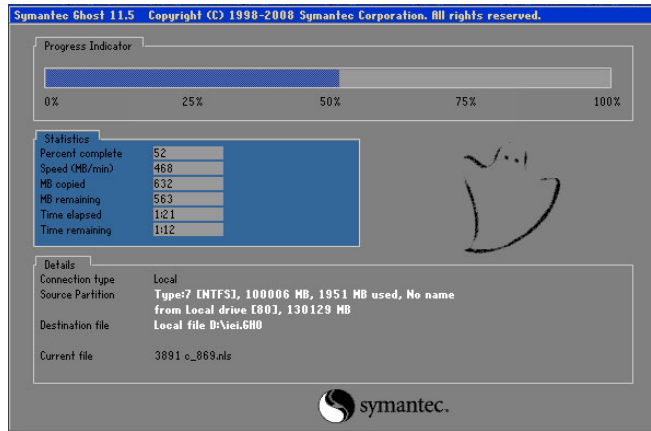

Figure C-28: Image Creation Complete

Step 9: After completing the system configuration, press any key in the following window to restart the system.

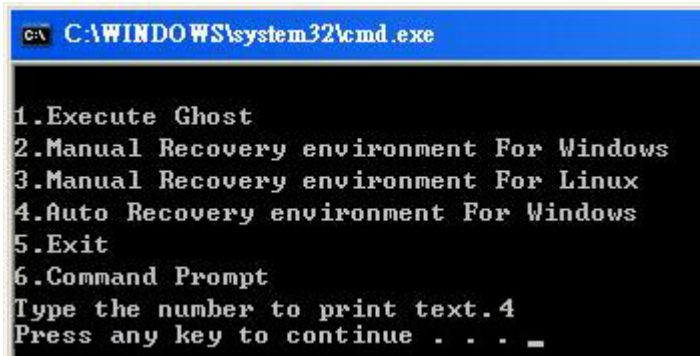
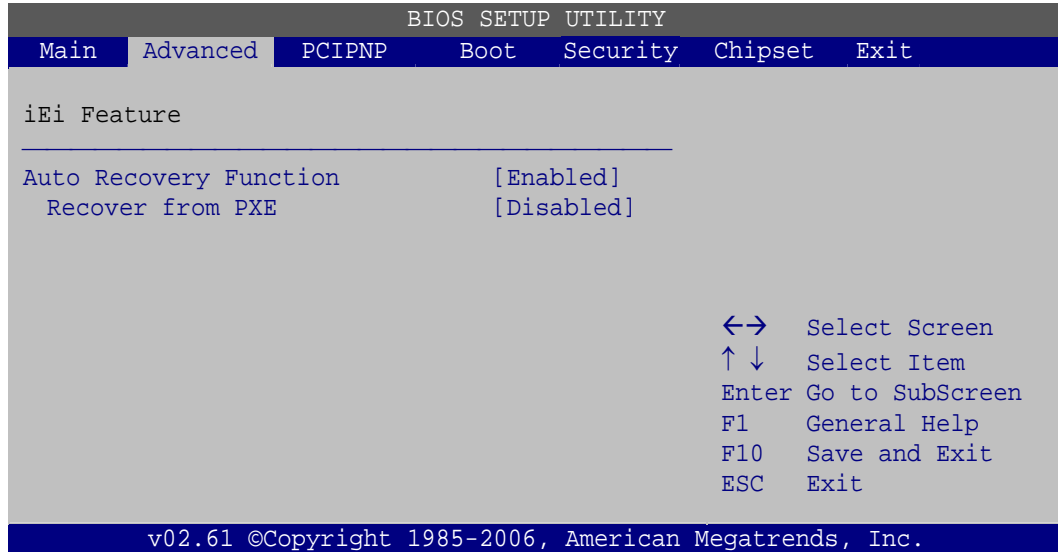

Figure C-29: Press any key to continue

Step 10: Eject the One Key Recovery CD and restart the system.

Step 11: Press the <DELETE> key as soon as the system is turned on to enter the BIOS.

Step 12: Enable the Auto Recovery Function option (**Advanced** → **iEi Feature** → **Auto Recovery Function**).



BIOS Menu 23: IEI Feature

Step 13: Save changes and restart the system. If the system encounters a Blue Screen of Death (BSoD) or a hang for around 10 minutes, it will automatically restore from the factory default image.

C.4 Setup Procedure for Linux

The initial setup procedures for a Linux system are mostly the same with the procedure for Microsoft Windows. Please follow the steps below to setup the recovery tool for Linux OS.

Step 1: Hardware and BIOS setup. Refer to Section **C.2.1**.

Step 2: Install Linux operating system. Make sure to install GRUB (v0.97 or earlier) MBR type and Ext3 partition type. Leave enough space on the hard drive to create the recover partition later.



NOTE:

If the Linux OS is not installed with GRUB (v0.97 or earlier) and Ext3, the Symantec Ghost may not function properly.

While installing Linux OS, please create two partitions:

KINO-QM670 Mini-ITX SBC

- Partition 1: /
- Partition 2: SWAP

**NOTE:**

Please reserve enough space for partition 3 for saving recovery images.

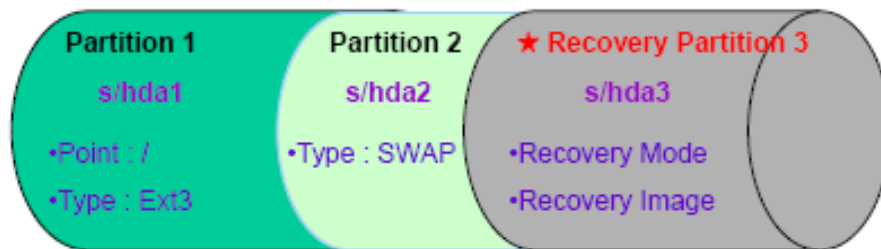

Figure C-30: Partitions for Linux

Step 3: Create a recovery partition. Insert the recovery CD into the optical disk drive.

Follow **Step 1 ~ Step 3** described in **Section C.2.2**. Then type the following commands (marked in red) to create a partition for recovery images.

```
system32>diskpart
DISKPART>list vol
DISKPART>sel disk 0
DISKPART>create part pri size= ____
DISKPART>assign letter=N
DISKPART>exit
system32>format N: /fs:ntfs /q /v:Recovery /y
system32>exit
```

Step 4: Build-up recovery partition. Press any key to boot from the recovery CD. It will take a while to launch the recovery tool. Please be patient. When the recovery tool setup menu appears, type <3> and press <Enter> (**Figure C-31**). The Symantec Ghost window appears and starts configuring the system to build-up a

recovery partition. After completing the system configuration, press any key to reboot the system. Eject the recovery CD.

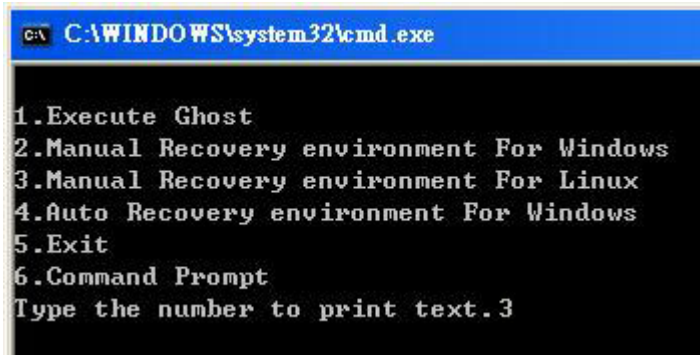

```
C:\WINDOWS\system32\cmd.exe

1.Execute Ghost
2.Manual Recovery environment For Windows
3.Manual Recovery environment For Linux
4.Auto Recovery environment For Windows
5.Exit
6.Command Prompt
Type the number to print text.3
```

Figure C-31: System Configuration for Linux

Step 5: Access the recovery tool main menu by modifying the “menu.lst”. To first access the recovery tool main menu, the menu.lst must be modified. In Linux, enter Administrator (root). When prompt appears, type:

```
cd /boot/grub
```

```
vi menu.lst
```

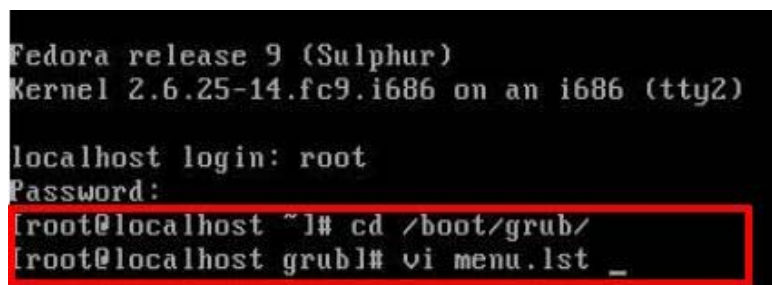

```
Fedora release 9 (Sulphur)
Kernel 2.6.25-14.fc9.i686 on an i686 (tty2)

localhost login: root
Password:
[root@localhost ~]# cd /boot/grub/
[root@localhost grub]# vi menu.lst _
```

Figure C-32: Access menu.lst in Linux (Text Mode)

Step 6: Modify the menu.lst as shown below.

KINO-QM670 Mini-ITX SBC

```
#boot=/dev/sda
default=0
timeout=10 ← Modify timeout=10
splashimage=(hd0,0)/grub/splash.xpm.gz
hiddenmenu
title Fedora (2.6.25-14.fc9.i686)
    root (hd0,0)
    kernel /vmlinuz-2.6.25-14.fc9.i686 ro root=UUID=10f1acd
ac38b5c78910 rhgb quiet
    initrd /initrd-2.6.25-14.fc9.i686.img

title Recovery Partition
root (hd0,2)
makeactive ← Type command
chainloader +1
```

- Type command:
title Recovery Partition
root (hd0,2)
makeactive
chainloader +1

Step 7: The recovery tool menu appears. (Figure C-33)

```
1. Factory Restore
2. Backup system
3. Restore your last backup.
4. Manual
5. Quit
Please type the number to select and then press Enter:
```

Figure C-33: Recovery Tool Menu

Step 8: Create a factory default image. Follow **Step 2 ~ Step 12** described in **Section C.2.5** to create a factory default image.

C.5 Recovery Tool Functions

After completing the initial setup procedures as described above, users can access the recovery tool by pressing <F3> while booting up the system. However, if the setup procedure in Section C.3 has been completed and the auto recovery function is enabled, the system will automatically restore from the factory default image without pressing the F3 key. The recovery tool main menu is shown below.

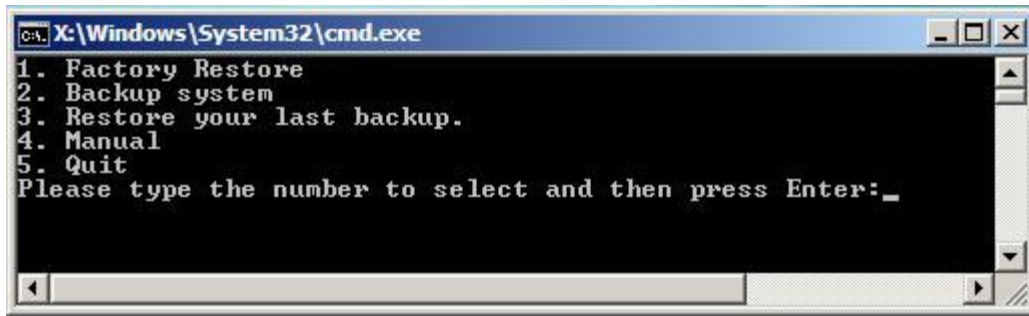

Figure C-34: Recovery Tool Main Menu

The recovery tool has several functions including:

1. **Factory Restore:** Restore the factory default image (iei.GHO) created in Section C.2.5.
2. **Backup system:** Create a system backup image (iei_user.GHO) which will be saved in the hidden partition.
3. **Restore your last backup:** Restore the last system backup image
4. **Manual:** Enter the Symantec Ghost window to configure manually.
5. **Quit:** Exit the recovery tool and restart the system.



WARNING:

Please do not turn off the system power during the process of system recovery or backup.



WARNING:

All data in the system will be deleted during the system recovery. Please backup the system files before restoring the system (either Factory Restore or Restore Backup).

KINO-QM670 Mini-ITX SBC

C.5.1 Factory Restore

To restore the factory default image, please follow the steps below.

Step 1: Type <1> and press <Enter> in the main menu.

Step 2: The Symantec Ghost window appears and starts to restore the factory default. A factory default image called **iei.GHO** is created in the hidden Recovery partition.

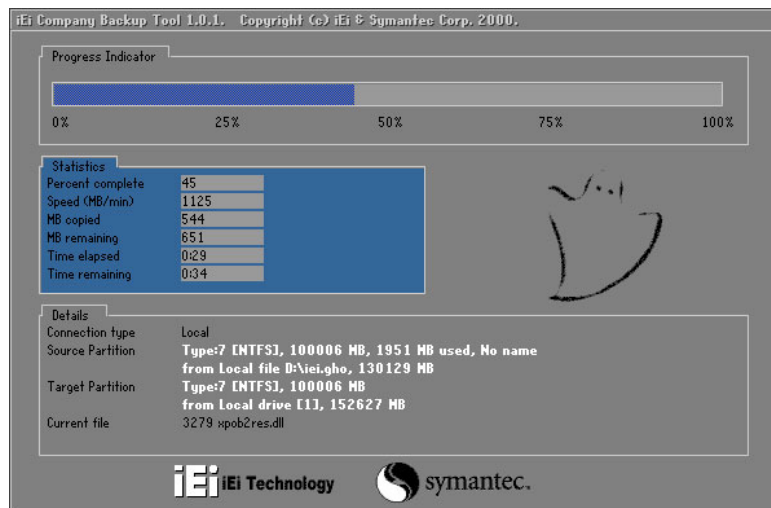

Figure C-35: Restore Factory Default

Step 3: The screen is shown in **Figure C-36** appears when completed. Press any key to reboot the system.

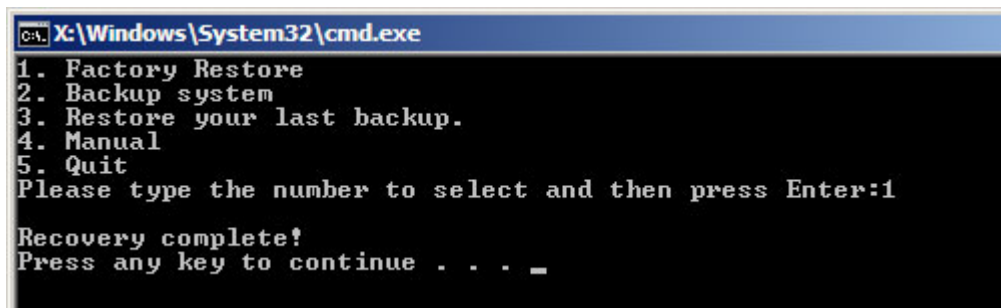

Figure C-36: Recovery Complete Window

C.5.2 Backup System

To backup the system, please follow the steps below.

Step 1: Type <2> and press <Enter> in the main menu.

Step 2: The Symantec Ghost window appears and starts to backup the system. A backup image called **iei_user.GHO** is created in the hidden Recovery partition.

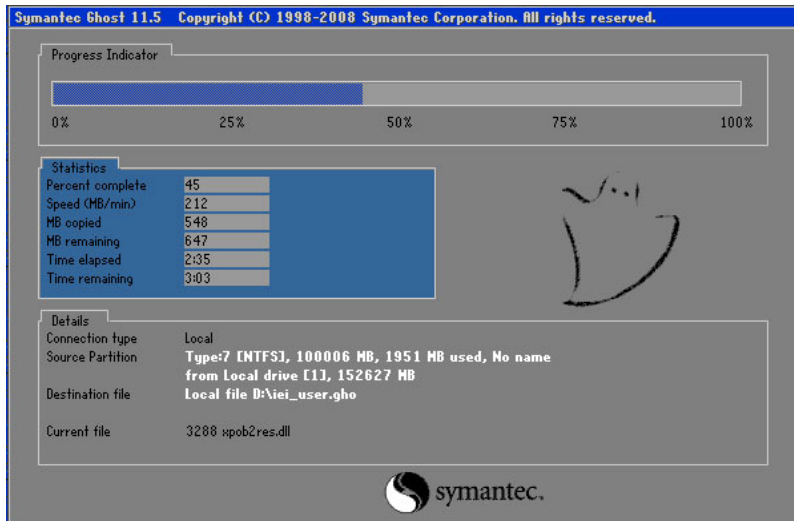

Figure C-37: Backup System

Step 3: The screen is shown in **Figure C-38** appears when system backup is complete. Press any key to reboot the system.

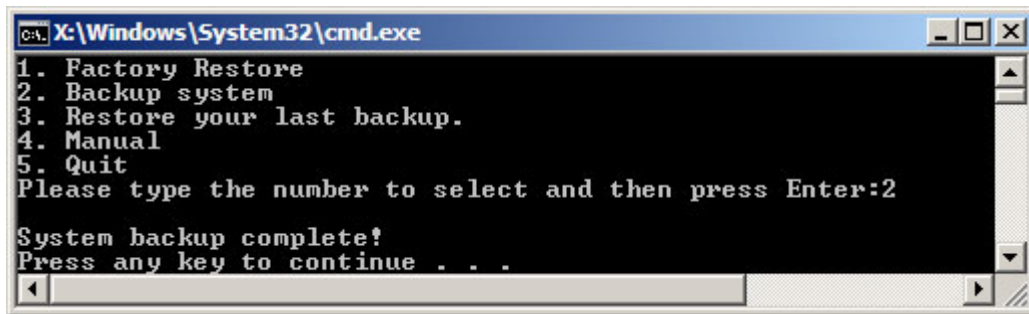

Figure C-38: System Backup Complete Window

KINO-QM670 Mini-ITX SBC

C.5.3 Restore Your Last Backup

To restore the last system backup, please follow the steps below.

Step 1: Type <3> and press <Enter> in the main menu.

Step 2: The Symantec Ghost window appears and starts to restore the last backup image (iei_user.GHO).

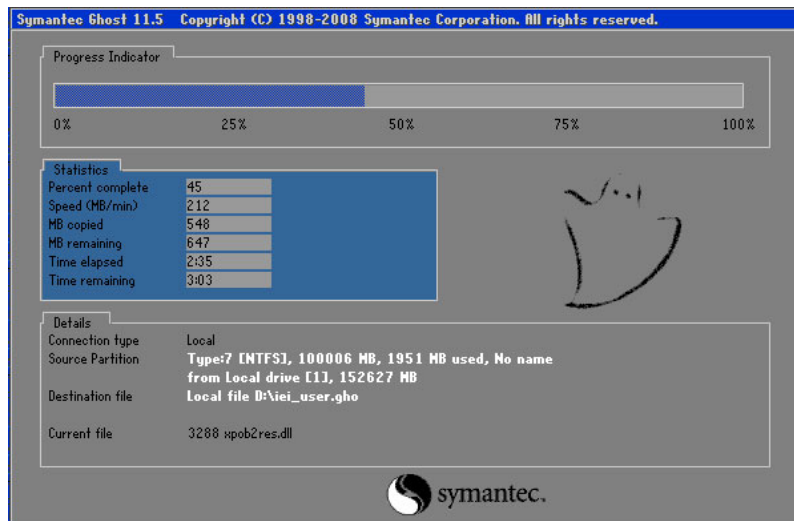

Figure C-39: Restore Backup

Step 3: The screen shown in **Figure C-40** appears when backup recovery is complete. Press any key to reboot the system.

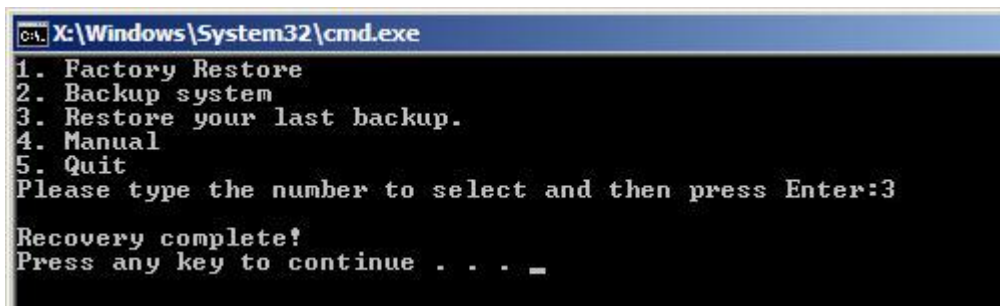

Figure C-40: Restore System Backup Complete Window

C.5.4 Manual

To restore the last system backup, please follow the steps below.

Step 1: Type <4> and press <Enter> in the main menu.

Step 2: The Symantec Ghost window appears. Use the Ghost program to backup or recover the system manually.

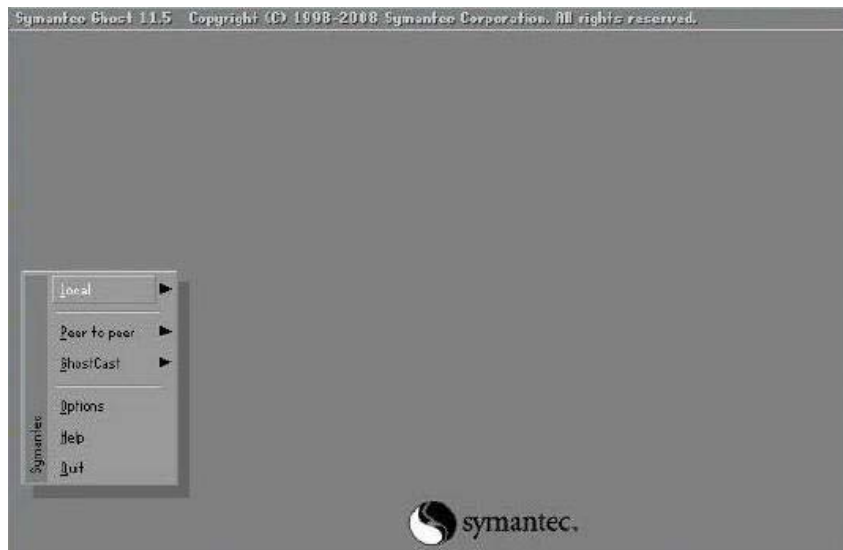
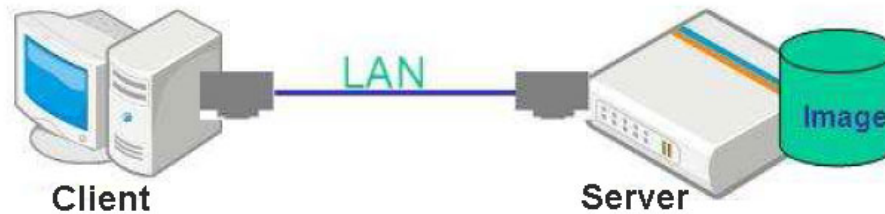

Figure C-41: Symantec Ghost Window

Step 3: When backup or recovery is completed, press any key to reboot the system.

C.6 Restore Systems from a Linux Server through LAN

The One Key Recovery allows a client system to automatically restore to a factory default image saved in a Linux system (the server) through LAN connectivity after encountering a Blue Screen of Death (BSoD) or a hang for around 10 minutes. To be able to use this function, the client system and the Linux system MUST reside in the same domain.



CAUTION:

The supported client OS includes:

- Windows 2000
- Windows XP
- Windows Vista
- Windows 7
- Windows XP Embedded
- Windows Embedded Standard 7

Prior to restoring client systems from a Linux server, a few setup procedures are required.

Step 1: Configure DHCP server settings

Step 2: Configure TFTP settings

Step 3: Configure One Key Recovery server settings

Step 4: Start DHCP, TFTP and HTTP

Step 5: Create a shared directory

Step 6: Setup a client system for auto recovery

The detailed descriptions are described in the following sections. In this document, two types of Linux OS are used as examples to explain the configuration process – CentOS 5.5 (Kernel 2.6.18) and Debian 5.0.7 (Kernel 2.6.26).

C.6.1 Configure DHCP Server Settings

Step 1: Install the DHCP

`#yum install dhcp` (CentOS, commands marked in red)

`#apt-get install dhcp3-server` (Debian, commands marked in blue)

Step 2: Confirm the operating system default settings: dhcpd.conf.

CentOS

Use the following command to show the DHCP server sample location:

`#vi /etc/dhcpd.conf`

The DHCP server sample location is shown as below:

```
# DHCP Server Configuration file.
# see /usr/share/doc/dhcp*/dhcpd.conf.sample
```

Use the following command to copy the DHCP server sample to etc/dhcpd.conf:

`#cp /usr/share/doc/dhcp-3.0.5/dhcpd.conf.sample /etc/dhcpd.conf`

`#vi /etc/dhcpd.conf`

```
ddns-update-style interim;
ignore client-updates;

subnet 192.168.0.0 netmask 255.255.255.0 {
# --- default gateway
    option routers                192.168.0.2;
    option subnet-mask            255.255.255.0;

    option nis-domain             "domain.org";
    option domain-name            "domain.org";
    option domain-name-servers   192.168.0.1;
    next-server 192.168.0.6;
    filename "pxelinux.0";
    option time-offset            -18000; # Eastern Standard Time
    option ntp-servers            192.168.1.1;
    option bootfile-name          pxelinux.0;
}
```

Debian

`#vi /etc/dhcpd.conf`

Edit “/etc/dhcpd.conf” for your environment. For example, add

`next-server PXE server IP address;`

KINO-QM670 Mini-ITX SBC

```
filename "pxelinux.0";
```

```
ddns-update-style interim;
ignore client-updates;

subnet 192.168.0.0 netmask 255.255.255.0 {
# --- default gateway
    option routers          192.168.0.2;
    option subnet-mask     255.255.255.0;

    option nis-domain      "domain.org";
    option domain-name     "domain.org";
    option domain-name-servers 192.168.0.1;
    next-server 192.168.0.6;
    filename "pxelinux.0";
    option time-offset     -18000; # Eastern Standard Time
    option ntp-servers     192.168.1.1;
}
```

C.6.2 Configure TFTP Settings

Step 1: Install the tftp, httpd and syslinux.

```
#yum install tftp-server httpd syslinux (CentOS)
```

```
#apt-get install tftpd-hpa xinetd syslinux (Debian)
```

Step 2: Enable the TFTP server by editing the "/etc/xinetd.d/tftp" file and make it use the remap file. The "-vvv" is optional but it could definitely help on getting more information while running the remap file. For example:

CentOS

```
#vi /etc/xinetd.d/tftp
```

Modify:

```
disable = no
```

```
server_args = -s /tftpboot -m /tftpboot/tftpd.remap -vvv_
```

```
socket_type      = dgram
protocol        = udp
wait            = yes
user            = root
server          = /usr/sbin/in.tftpd
server_args     = -s /tftpboot -m /tftpboot/tftpd.remap -vvv
disable         = no
per_source      = 11
cps             = 100 2
flags           = IPv4
```

Debian

Replace the TFTP settings from “inetd” to “xinetd” and annotate the “inetd” by adding “#”.

`#vi /etc/inetd.conf`

Modify: `#tftp dgram udp wait root /usr/sbin.....` (as shown below)

```
#:BOOT: TFTP service is provided primarily for booting. Most sites
#      run this only on machines acting as "boot servers."
#tftp  dgram  udp   wait  root  /usr/sbin/in.tftpd /usr/sbin/in.tftpd -s
      /var/lib/tftpboot
```

`#vi /etc/xinetd.d/tftp`

```
socket_type      = dgram
protocol        = udp
wait            = yes
user           = root
server         = /usr/sbin/in.tftpd
server_args    = -s /tftpboot -n /tftpboot/tftpd.remap -vvv
disable        = no
per_source     = 11
cps            = 100 2
flags          = IPv4
```

C.6.3 Configure One Key Recovery Server Settings

Step 1: Copy the **Utility/RECOVERYR10.TAR.BZ2** package from the One Key Recovery CD to the system (server side).



Step 2: Extract the recovery package to /.

```
#cp RecoveryR10.tar.bz2 /
#cd /
#tar -xvjf RecoveryR10.tar.bz2
```

Step 3: Copy “pxelinux.0” from “syslinux” and install to “tftpboot”.

```
#cp /usr/lib/syslinux/pxelinux.0 /tftpboot/
```

KINO-QM670 Mini-ITX SBC

C.6.4 Start the DHCP, TFTP and HTTP

Start the DHCP, TFTP and HTTP. For example:

CentOS

```
#service xinetd restart
```

```
#service httpd restart
```

```
#service dhcpd restart
```

Debian

```
#/etc/init.d/xinetd reload
```

```
#/etc/init.d/xinetd restart
```

```
#/etc/init.d/dhcp3-server restart
```

C.6.5 Create Shared Directory

Step 1: Install the samba.

```
#yum install samba
```

Step 2: Create a shared directory for the factory default image.

```
#mkdir /share
```

```
#cd /share
```

```
#mkdir /image
```

```
#cp iei.gho /image
```



WARNING:

The file name of the factory default image must be **iei.gho**.

Step 3: Confirm the operating system default settings: smb.conf.

```
#vi /etc/samba/smb.conf
```

Modify:

[image]

```
comment = One Key Recovery
```

```
path = /share/image
```

```
browseable = yes
```

```
writable = yes
```

```
public = yes
```

```
create mask = 0644
```

```
directory mask = 0755
```

Step 4: Edit “/etc/samba/smb.conf” for your environment. For example:

```
# "security = user" is always a good idea. This will require a Unix account
# in this server for every user accessing the server. See
# /usr/share/doc/samba-doc/htmldocs/Samba3-HOWTO/ServerType.html
# in the samba-doc package for details.
security = share
```

```
[image]
comment = One Key Recovery
path = /share/image
browseable = yes
writable = yes
public = yes
create mask = 0644
directory mask = 0755
```

Step 5: Modify the hostname

```
#vi /etc/hostname
```

Modify: RecoveryServer

```
RecoveryServer
```

C.6.6 Setup a Client System for Auto Recovery

Step 1: Disable the automatically restart function before creating the factory default image. Go to: My Computer → Properties → Advanced. Click the Settings button of Startup and Recovery. Deselect “Automatically restart”. Click OK to save the settings and exit. (See Figure C-23)

KINO-QM670 Mini-ITX SBC

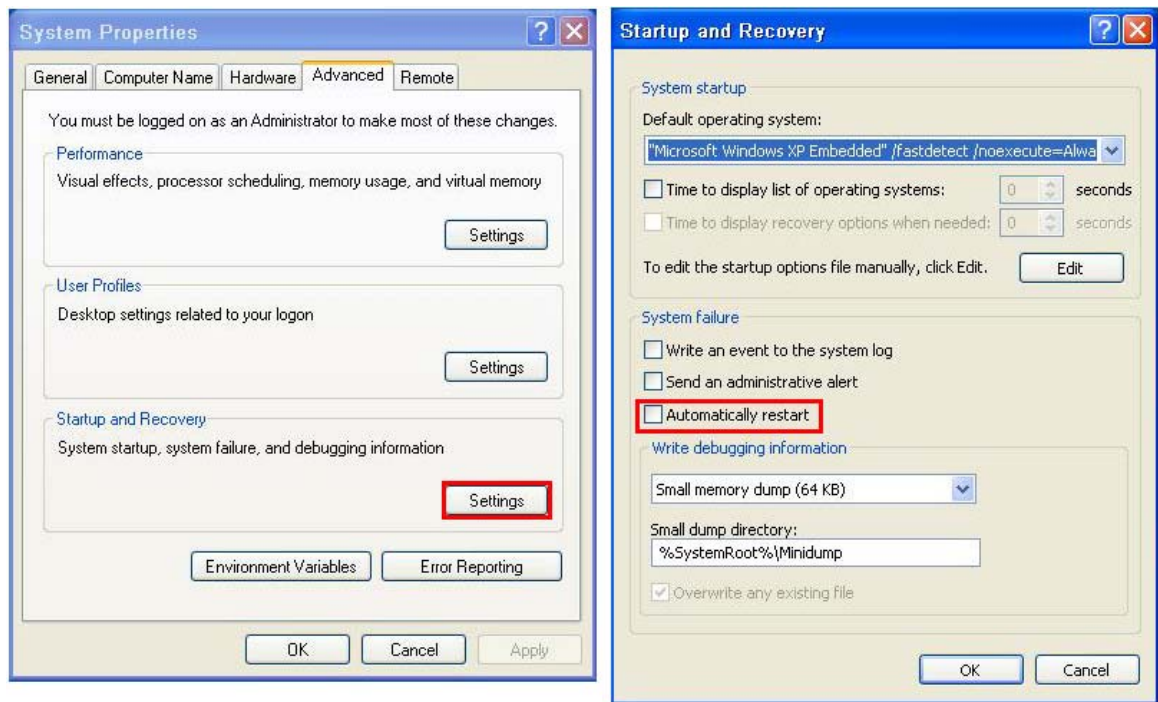

Figure C-42: Disable Automatically Restart

Step 2: Configure the following BIOS options of the client system.

Advanced → iEi Feature → Auto Recovery Function → **Enabled**

Advanced → iEi Feature → Recover from PXE → **Enabled**

Boot → Launch PXE OpROM → **Enabled**

Step 3: Continue to configure the **Boot Option Priorities** BIOS option of the client system:

Boot Option #1 → remain the default setting to boot from the original OS.

Boot Option #2 → select the boot from LAN option.

Step 4: Save changes and exit BIOS menu.

Exit → **Save Changes and Exit**

Step 5: Install the auto recovery utility into the system by double clicking the

Utility/AUTORECOVERY-SETUP.exe in the One Key Recovery CD. This utility

MUST be installed in the system, otherwise, the system will automatically restore from the factory default image every ten (10) minutes.



Step 6: Restart the client system from LAN. If the system encounters a Blue Screen of Death (BSoD) or a hang for around 10 minutes, it will automatically restore from the factory default image. The following screens will show when the system starts auto recovering.

```
Realtek PCIe GBE Family Controller Series v2.35 (06/14/10)
CLIENT MAC ADDR: 00 18 7D 13 E6 89  GUID: 00020003-0004-0005-0006-0007000000
DHCP . ./
```

```
My IP address seems to be C0A80009 192.168.0.9
ip=192.168.0.9:192.168.0.8:192.168.0.2:255.255.255.0
TFTP prefix:
Trying to load: pxelinux.cfg/00020003-0004-0005-0006-000700000009
Trying to load: pxelinux.cfg/01-00-18-7d-13-e6-89
Trying to load: pxelinux.cfg/C0A80009
Trying to load: pxelinux.cfg/C0A8000
Trying to load: pxelinux.cfg/C0A800
Trying to load: pxelinux.cfg/C0A80
Trying to load: pxelinux.cfg/C0A8
Trying to load: pxelinux.cfg/C0A
Trying to load: pxelinux.cfg/C0
Trying to load: pxelinux.cfg/C
Trying to load: pxelinux.cfg/default
boot:
```

```
Windows is loading files...
IP: 192.168.0.8, File: \Boot\WinPE.wim
```

KINO-QM670 Mini-ITX SBC

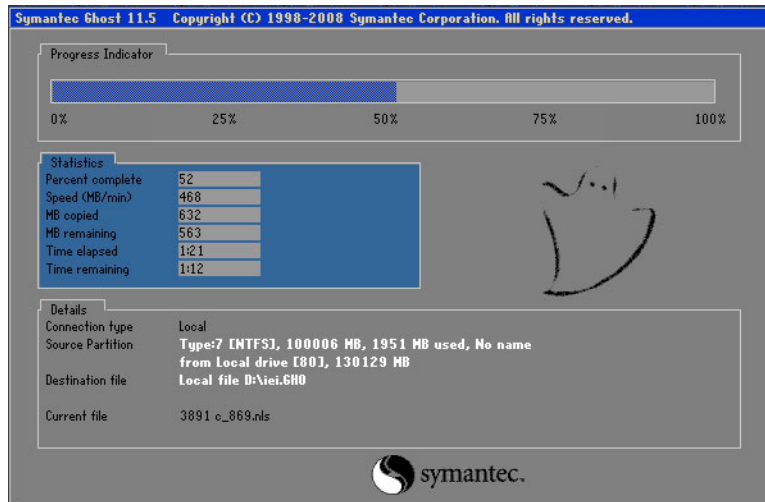
**NOTE:**

A firewall or a SELinux is not in use in the whole setup process described above. If there is a firewall or a SELinux protecting the system, modify the configuration information to accommodate them.

C.7 Other Information

C.7.1 Using AHCI Mode or ALi M5283 / VIA VT6421A Controller

When the system uses AHCI mode or some specific SATA controllers such as ALi M5283 or VIA VT6421A, the SATA RAID/AHCI driver must be installed before using one key recovery. Please follow the steps below to install the SATA RAID/AHCI driver.

- Step 1:** Copy the SATA RAID/AHCI driver to a floppy disk and insert the floppy disk into a USB floppy disk drive. The SATA RAID/AHCI driver must be especially designed for the on-board SATA controller.
- Step 2:** Connect the USB floppy disk drive to the system.
- Step 3:** Insert the One Key Recovery CD into the system and boot the system from the CD.
- Step 4:** When launching the recovery tool, press <F6>.

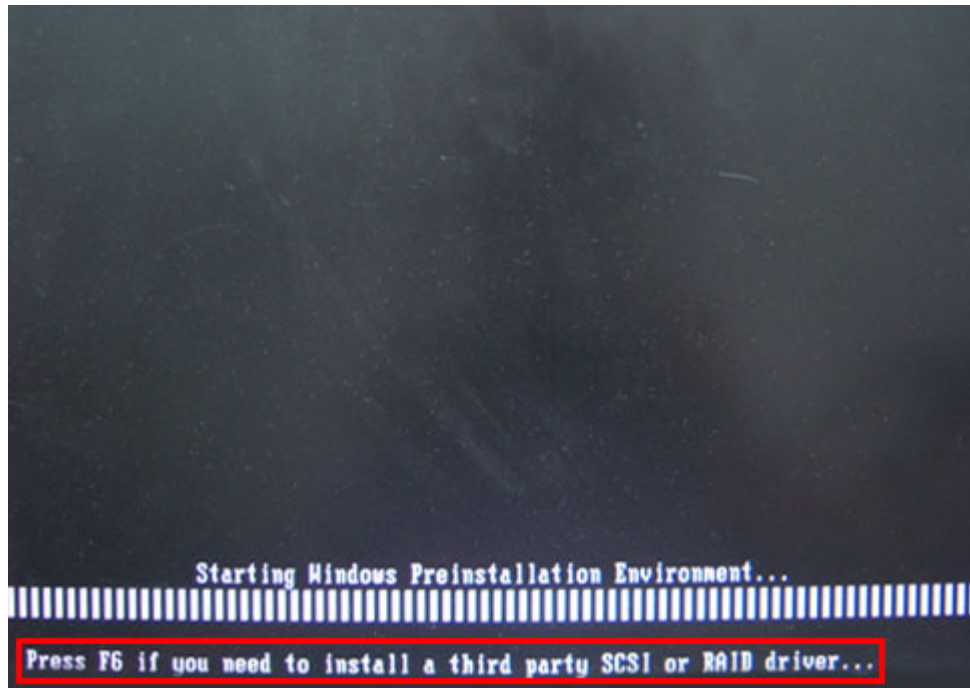

Step 5: When the following window appears, press <S> to select "Specify Additional Device".

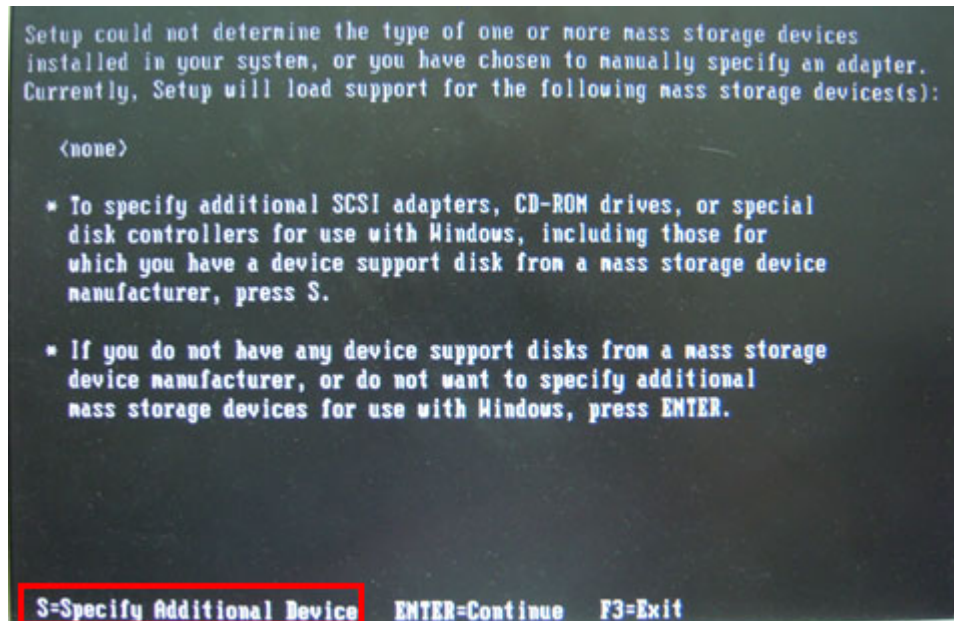

KINO-QM670 Mini-ITX SBC

Step 6: In the following window, select a SATA controller mode used in the system. Then press <Enter>. The user can now start using the SATA HDD.

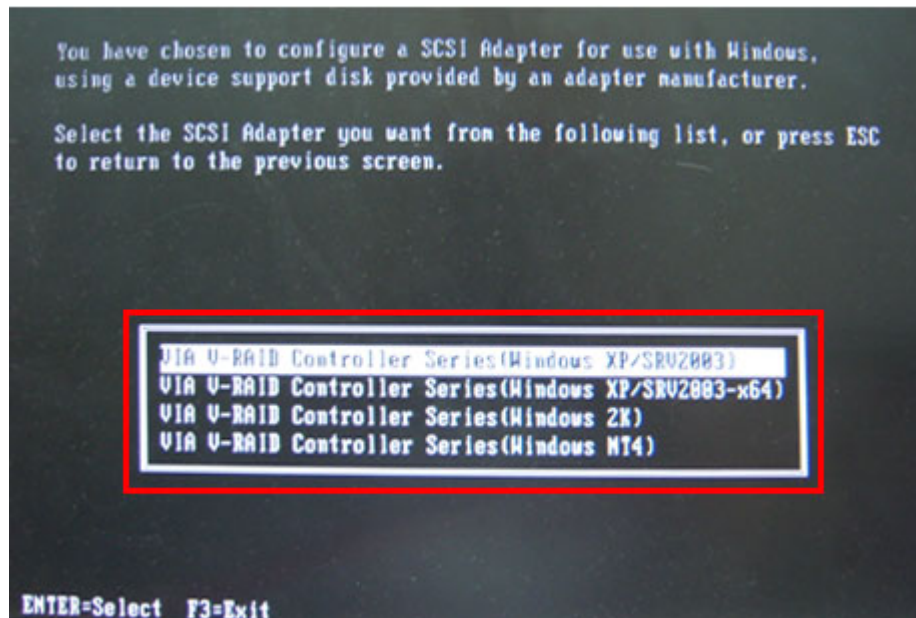

Step 7: After pressing <Enter>, the system will get into the recovery tool setup menu. Continue to follow the setup procedure from **Step 4** in **Section C.2.2 Create Partitions** to finish the whole setup process.

C.7.2 System Memory Requirement

To be able to access the recovery tool by pressing <F3> while booting up the system, please make sure to have enough system memory. The minimum memory requirement is listed below.

- **Using Award BIOS:** 128 MB system memory
- **Using AMI BIOS:** 512 MB system memory.

Appendix

D

Terminology

KINO-QM670 Mini-ITX SBC

AC '97	Audio Codec 97 (AC'97) refers to a codec standard developed by Intel® in 1997.
ACPI	Advanced Configuration and Power Interface (ACPI) is an OS-directed configuration, power management, and thermal management interface.
AHCI	Advanced Host Controller Interface (AHCI) is a SATA Host controller register-level interface.
ATA	The Advanced Technology Attachment (ATA) interface connects storage devices including hard disks and CD-ROM drives to a computer.
APM	The Advanced Power Management (APM) application program interface (API) enables the inclusion of power management in the BIOS.
ARMD	An ATAPI Removable Media Device (ARMD) is any ATAPI device that supports removable media, besides CD and DVD drives.
ASKIR	Amplitude Shift Keyed Infrared (ASKIR) is a form of modulation that represents a digital signal by varying the amplitude (“volume”) of the signal. A low amplitude signal represents a binary 0, while a high amplitude signal represents a binary 1.
BIOS	The Basic Input/Output System (BIOS) is firmware that is first run when the computer is turned on and can be configured by the end user
CODEC	The Compressor-Decompressor (CODEC) encodes and decodes digital audio data on the system.
CMOS	Complimentary metal-oxide-conductor is a type of integrated circuit used in chips like static RAM and microprocessors.
COM	COM is used to refer to serial ports. Serial ports offer serial communication to expansion devices. The serial port on a personal computer is usually a male DE-9 connector.

DAC	The Digital-to-Analog Converter (DAC) converts digital signals to analog signals.
DDR	Double Data Rate refers to a data bus transferring data on both the rising and falling edges of the clock signal.
DMA	Direct Memory Access (DMA) enables some peripheral devices to bypass the system processor and communicate directly with the system memory.
DIMM	Dual Inline Memory Modules are a type of RAM that offer a 64-bit data bus and have separate electrical contacts on each side of the module.
EHCI	The Enhanced Host Controller Interface (EHCI) specification is a register-level interface description for USB 2.0 Host Controllers.
GbE	Gigabit Ethernet (GbE) is an Ethernet version that transfers data at 1.0 Gbps and complies with the IEEE 802.3-2005 standard.
GPIO	General purpose input
IrDA	Infrared Data Association (IrDA) specify infrared data transmission protocols used to enable electronic devices to wirelessly communicate with each other.
L1 Cache	The Level 1 Cache (L1 Cache) is a small memory cache built into the system processor.
L2 Cache	The Level 2 Cache (L2 Cache) is an external processor memory cache.
LVDS	Low-voltage differential signaling (LVDS) is a dual-wire, high-speed differential electrical signaling system commonly used to connect LCD displays to a computer.
MAC	The Media Access Control (MAC) protocol enables several terminals or network nodes to communicate in a LAN, or other multipoint networks.
PCIe	PCI Express (PCIe) is a communications bus that uses dual data lines

KINO-QM670 Mini-ITX SBC

for full-duplex (two-way) serial (point-to-point) communications between the SBC components and/or expansion cards and the SBC chipsets. Each line has a 2.5 Gbps data transmission rate and a 250 MBps sustained data transfer rate.

POST	The Power-on Self Test (POST) is the pre-boot actions the system performs when the system is turned-on.
QVGA	Quarter Video Graphics Array (QVGA) refers to a display with a resolution of 320 x 240 pixels.
RAM	Random Access Memory (RAM) is a form of storage used in computer. RAM is volatile memory, so it loses its data when power is lost. RAM has very fast data transfer rates compared to other storage like hard drives.
SATA	Serial ATA (SATA) is a serial communications bus designed for data transfers between storage devices and the computer chipsets. The SATA bus has transfer speeds up to 1.5 Gbps and the SATA 3Gb/s bus has data transfer speeds of up to 3.0 Gbps.
S.M.A.R.T	Self Monitoring Analysis and Reporting Technology (S.M.A.R.T) refers to automatic status checking technology implemented on hard disk drives.
UART	Universal Asynchronous Receiver-transmitter (UART) is responsible for asynchronous communications on the system and manages the system's serial communication (COM) ports.
UHCI	The Universal Host Controller Interface (UHCI) specification is a register-level interface description for USB 1.1 Host Controllers.
USB	The Universal Serial Bus (USB) is an external bus standard for interfacing devices. USB 1.1 supports 12Mbps data transfer rates, while USB 2.0 supports 480Mbps data transfer rates.

VGA

The Video Graphics Array (VGA) is a graphics display system developed by IBM.

Appendix

E

Watchdog Timer



NOTE:

The following discussion applies to DOS environment. IEI support is contacted or the IEI website visited for specific drivers for more sophisticated operating systems, e.g., Windows and Linux.

The Watchdog Timer is provided to ensure that standalone systems can always recover from catastrophic conditions that cause the CPU to crash. This condition may have occurred by external EMI or a software bug. When the CPU stops working correctly, Watchdog Timer either performs a hardware reset (cold boot) or a Non-Maskable Interrupt (NMI) to bring the system back to a known state.

A BIOS function call (INT 15H) is used to control the Watchdog Timer:

INT 15H:

AH – 6FH Sub-function:	
AL – 2:	Sets the Watchdog Timer's period.
BL:	Time-out value (Its unit-second is dependent on the item "Watchdog Timer unit select" in CMOS setup).

Table E-1: AH-6FH Sub-function

Call sub-function 2 to set the time-out period of Watchdog Timer first. If the time-out value is not zero, the Watchdog Timer starts counting down. While the timer value reaches zero, the system resets. To ensure that this reset condition does not occur, calling sub-function 2 must periodically refresh the Watchdog Timer. However, the Watchdog timer is disabled if the time-out value is set to zero.

A tolerance of at least 10% must be maintained to avoid unknown routines within the operating system (DOS), such as disk I/O that can be very time-consuming.

**NOTE:**

When exiting a program it is necessary to disable the Watchdog Timer, otherwise the system resets.

Example program:

```
; INITIAL TIMER PERIOD COUNTER
```

```
;
```

```
W_LOOP:
```

```
    MOV    AX, 6F02H    ;setting the time-out value
```

```
    MOV    BL, 30H      ;time-out value is 48 seconds
```

```
    INT    15H
```

```
;
```

```
; ADD THE APPLICATION PROGRAM HERE
```

```
;
```

```
    CMP    EXIT_AP, 1    ;is the application over?
```

```
    JNE    W_LOOP      ;No, restart the application
```

```
    MOV    AX, 6F02H    ;disable Watchdog Timer
```

```
    MOV    BL, 0        ;
```

```
    INT    15H
```

```
;
```

```
; EXIT ;
```

Appendix

F

Hazardous Materials Disclosure

F.1 Hazardous Materials Disclosure Table for IPB Products Certified as RoHS Compliant Under 2002/95/EC Without Mercury

The details provided in this appendix are to ensure that the product is compliant with the Peoples Republic of China (China) RoHS standards. The table below acknowledges the presences of small quantities of certain materials in the product, and is applicable to China RoHS only.

A label will be placed on each product to indicate the estimated “Environmentally Friendly Use Period” (EFUP). This is an estimate of the number of years that these substances would “not leak out or undergo abrupt change.” This product may contain replaceable sub-assemblies/components which have a shorter EFUP such as batteries and lamps. These components will be separately marked.

Please refer to the table on the next page.

Part Name	Toxic or Hazardous Substances and Elements					
	Lead (Pb)	Mercury (Hg)	Cadmium (Cd)	Hexavalent Chromium (CR(VI))	Polybrominated Biphenyls (PBB)	Polybrominated Diphenyl Ethers (PBDE)
Housing	<input type="radio"/>	<input type="radio"/>	<input type="radio"/>	<input type="radio"/>	<input type="radio"/>	<input type="radio"/>
Display	<input type="radio"/>	<input type="radio"/>	<input type="radio"/>	<input type="radio"/>	<input type="radio"/>	<input type="radio"/>
Printed Circuit Board	<input type="radio"/>	<input type="radio"/>	<input type="radio"/>	<input type="radio"/>	<input type="radio"/>	<input type="radio"/>
Metal Fasteners	<input type="radio"/>	<input type="radio"/>	<input type="radio"/>	<input type="radio"/>	<input type="radio"/>	<input type="radio"/>
Cable Assembly	<input type="radio"/>	<input type="radio"/>	<input type="radio"/>	<input type="radio"/>	<input type="radio"/>	<input type="radio"/>
Fan Assembly	<input type="radio"/>	<input type="radio"/>	<input type="radio"/>	<input type="radio"/>	<input type="radio"/>	<input type="radio"/>
Power Supply Assemblies	<input type="radio"/>	<input type="radio"/>	<input type="radio"/>	<input type="radio"/>	<input type="radio"/>	<input type="radio"/>
Battery	<input type="radio"/>	<input type="radio"/>	<input type="radio"/>	<input type="radio"/>	<input type="radio"/>	<input type="radio"/>

O: This toxic or hazardous substance is contained in all of the homogeneous materials for the part is below the limit requirement in SJ/T11363-2006

X: This toxic or hazardous substance is contained in at least one of the homogeneous materials for this part is above the limit requirement in SJ/T11363-2006

KINO-QM670 Mini-ITX SBC

此附件旨在确保本产品符合中国 RoHS 标准。以下表格标示此产品中某有毒物质的含量符合中国 RoHS 标准规定的限量要求。

本产品上会附有“环境友好使用期限”的标签，此期限是估算这些物质“不会有泄漏或突变”的年限。本产品可能包含有较短的环境友好使用期限的可替换元件，像是电池或灯管，这些元件将会单独标示出来。

部件名称	有毒有害物质或元素					
	铅 (Pb)	汞 (Hg)	镉 (Cd)	六价铬 (CR(VI))	多溴联苯 (PBB)	多溴二苯 醚 (PBDE)
壳体	○	○	○	○	○	○
显示	○	○	○	○	○	○
印刷电路板	○	○	○	○	○	○
金属螺帽	○	○	○	○	○	○
电缆组装	○	○	○	○	○	○
风扇组装	○	○	○	○	○	○
电力供应组装	○	○	○	○	○	○
电池	○	○	○	○	○	○

○: 表示该有毒有害物质在该部件所有物质材料中的含量均在 SJ/T11363-2006 标准规定的限量要求以下。
 X: 表示该有毒有害物质至少在该部件的某一均质材料中的含量超出 SJ/T11363-2006 标准规定的限量要求。