



IEI Technology Corp.



MODEL:
IMB-C2160

microATX Motherboard supports 22nm LGA1155 Intel® Xeon® E3/
Intel® Core™ i3 CPU with Intel® C216, DDR3, VGA, Dual Intel® PCIe
GbE, USB 3.0, SATA 6Gb/s, Ten Serial Ports, HD Audio and RoHS

User Manual

Rev. 1.00 – August 21, 2012



Revision

Date	Version	Changes
August 21, 2012	1.00	Initial release

Copyright

COPYRIGHT NOTICE

The information in this document is subject to change without prior notice in order to improve reliability, design and function and does not represent a commitment on the part of the manufacturer.

In no event will the manufacturer be liable for direct, indirect, special, incidental, or consequential damages arising out of the use or inability to use the product or documentation, even if advised of the possibility of such damages.

This document contains proprietary information protected by copyright. All rights are reserved. No part of this manual may be reproduced by any mechanical, electronic, or other means in any form without prior written permission of the manufacturer.

TRADEMARKS

All registered trademarks and product names mentioned herein are used for identification purposes only and may be trademarks and/or registered trademarks of their respective owners.

Table of Contents

1 INTRODUCTION.....	1
1.1 INTRODUCTION.....	2
1.2 BENEFITS	3
1.3 FEATURES.....	3
1.4 CONNECTORS	4
1.5 DIMENSIONS.....	5
1.6 DATA FLOW	6
1.7 TECHNICAL SPECIFICATIONS	7
2 PACKING LIST	9
2.1 ANTI-STATIC PRECAUTIONS	10
2.2 UNPACKING PRECAUTIONS.....	10
2.3 PACKING LIST.....	11
2.4 OPTIONAL ITEMS	12
3 CONNECTORS	14
3.1 PERIPHERAL INTERFACE CONNECTORS.....	15
3.1.1 IMB-C2160 Layout	15
3.1.2 Peripheral Interface Connectors	16
3.1.3 External Interface Panel Connectors.....	17
3.2 INTERNAL PERIPHERAL CONNECTORS	17
3.2.1 ATX Power Connector	17
3.2.2 Battery Connector.....	18
3.2.3 CPU Fan Connector	19
3.2.4 CPU Power Connector	20
3.2.5 DDR3 DIMM Slots.....	21
3.2.6 Digital I/O Connector.....	22
3.2.7 Front Panel Audio Connector.....	23
3.2.8 Front Panel Connector	24
3.2.9 FW Programming Connector.....	25
3.2.10 Infrared Interface Connector.....	26

3.2.11 Keyboard/Mouse Connector.....	27
3.2.12 PCH Fan Connector	28
3.2.13 PCIe x4 Slots.....	29
3.2.14 PCIe x8 Slot	30
3.2.15 PCIe x16 Slot	31
3.2.16 SATA 3Gb/s Drive Connectors.....	31
3.2.17 SATA 6Gb/s Drive Connectors.....	32
3.2.18 Serial Port Connector, RS-422/485.....	33
3.2.19 Serial Port Connectors, RS-232.....	34
3.2.20 SMBus Connector	36
3.2.21 SPI Connector.....	37
3.2.22 System Fan Connector	38
3.2.23 TPM Connector.....	38
3.2.24 USB Connectors.....	39
3.3 EXTERNAL PERIPHERAL INTERFACE CONNECTOR PANEL	40
3.3.1 Audio Connector	41
3.3.2 Ethernet and USB Connectors.....	42
3.3.3 Keyboard/Mouse and USB Connector.....	44
3.3.4 RS-232 Serial Port Connectors.....	45
3.3.5 USB Connectors.....	46
3.3.6 VGA Connectors	46
4 INSTALLATION	48
4.1 ANTI-STATIC PRECAUTIONS	49
4.2 INSTALLATION CONSIDERATIONS.....	49
4.3 BASIC INSTALLATION	51
4.3.1 Socket LGA1155 CPU Installation	51
4.3.2 Cooling Kit Installation	54
4.3.3 DIMM Installation	56
4.4 JUMPER SETTINGS	57
4.4.1 AT/ATX Power Select Jumper.....	57
4.4.2 Clear CMOS Jumper.....	58
4.4.3 WOL Mode Select Jumper.....	59
4.5 INTERNAL PERIPHERAL DEVICE CONNECTIONS.....	60
4.5.1 SATA Drive Connection	60

4.6 EXTERNAL PERIPHERAL INTERFACE CONNECTION	62
4.6.1 Audio Connection.....	62
4.6.2 LAN Connection.....	63
4.6.3 PS/2 Y-Cable Connection.....	64
4.6.4 Serial Device Connection	65
4.6.5 USB Connection.....	66
4.6.6 VGA Monitor Connection	67
5 BIOS.....	69
5.1 INTRODUCTION.....	70
5.1.1 Starting Setup.....	70
5.1.2 Using Setup	70
5.1.3 Getting Help.....	71
5.1.4 Unable to Reboot after Configuration Changes	71
5.1.5 BIOS Menu Bar.....	71
5.2 MAIN.....	72
5.3 ADVANCED.....	73
5.3.1 RTC Wake Settings	73
5.3.2 Trusted Computing	75
5.3.3 CPU Configuration.....	76
5.3.4 SATA Configuration	78
5.3.5 Intel(R) Rapid Start Technology.....	79
5.3.6 Intel TXT(LT) Configuration.....	79
5.3.7 AMT Configuration	80
5.3.8 USB Configuration.....	81
5.3.9 F81216 Second Super IO Configuration	82
5.3.9.1 Serial Port 7 Configuration	83
5.3.9.2 Serial Port 8 Configuration	84
5.3.9.3 Serial Port 9 Configuration	84
5.3.9.4 Serial Port 10 Configuration	85
5.3.10 F81866 Super IO Configuration	86
5.3.10.1 Serial Port n Configuration	87
5.3.11 F81866 H/W Monitor	92
5.3.11.1 Smart Fan Mode Configuration	93
5.3.12 Serial Port Console Redirection	96

5.3.13 IEI Feature	98
5.4 CHIPSET	99
5.4.1 PCH-IO Configuration	100
5.4.1.1 PCH Azalia Configuration.....	101
5.4.2 System Agent (SA) Configuration	102
5.4.2.1 Graphics Configuration.....	103
5.4.2.2 Memory Configuration	105
5.5 BOOT.....	106
5.6 SECURITY.....	108
5.7 EXIT	109
6 SOFTWARE DRIVERS	111
6.1 AVAILABLE SOFTWARE DRIVERS	112
6.2 SOFTWARE INSTALLATION	112
6.3 CHIPSET DRIVER INSTALLATION.....	114
6.4 GRAPHICS DRIVER INSTALLATION.....	117
6.5 LAN DRIVER INSTALLATION.....	120
6.6 AUDIO DRIVER INSTALLATION	125
6.7 INTEL® RAPID STORAGE TECHNOLOGY DRIVER INSTALLATION	127
6.8 USB 3.0 DRIVER INSTALLATION.....	130
6.9 INTEL® AMT DRIVER INSTALLATION	133
A BIOS OPTIONS	136
B ONE KEY RECOVERY	139
B.1 ONE KEY RECOVERY INTRODUCTION	140
B.1.1 System Requirement.....	141
B.1.2 Supported Operating System.....	142
B.2 SETUP PROCEDURE FOR WINDOWS	143
B.2.1 Hardware and BIOS Setup	144
B.2.2 Create Partitions	144
B.2.3 Install Operating System, Drivers and Applications.....	148
B.2.4 Building the Recovery Partition.....	149
B.2.5 Create Factory Default Image.....	151
B.3 AUTO RECOVERY SETUP PROCEDURE.....	156
B.4 SETUP PROCEDURE FOR LINUX	160

B.5 RECOVERY TOOL FUNCTIONS	164
<i>B.5.1 Factory Restore</i>	165
<i>B.5.2 Backup System</i>	166
<i>B.5.3 Restore Your Last Backup</i>	167
<i>B.5.4 Manual</i>	168
B.6 RESTORE SYSTEMS FROM A LINUX SERVER THROUGH LAN	169
<i>B.6.1 Configure DHCP Server Settings</i>	170
<i>B.6.2 Configure TFTP Settings</i>	171
<i>B.6.3 Configure One Key Recovery Server Settings</i>	172
<i>B.6.4 Start the DHCP, TFTP and HTTP</i>	173
<i>B.6.5 Create Shared Directory</i>	173
<i>B.6.6 Setup a Client System for Auto Recovery</i>	175
B.7 OTHER INFORMATION	177
<i>B.7.1 Using AHCI Mode or ALi M5283 / VIA VT6421A Controller</i>	177
<i>B.7.2 System Memory Requirement</i>	179
C TERMINOLOGY	180
D WATCHDOG TIMER	184
E HAZARDOUS MATERIALS DISCLOSURE	187
E.1 HAZARDOUS MATERIALS DISCLOSURE TABLE FOR IPB PRODUCTS CERTIFIED AS ROHS COMPLIANT UNDER 2002/95/EC WITHOUT MERCURY	188

List of Figures

Figure 1-1: IMB-C2160	2
Figure 1-2: Connectors	4
Figure 1-3: IMB-C2160 Dimensions (mm)	5
Figure 1-4: Data Flow Diagram	6
Figure 3-1: Connectors and Jumpers	15
Figure 3-2: ATX Power Connector Location	18
Figure 3-3: Battery Connector Location	19
Figure 3-4: CPU Fan Connector Location	20
Figure 3-5: CPU Power Connector Location	21
Figure 3-6: DDR3 DIMM Slot Locations	22
Figure 3-7: Digital I/O Connector Location	23
Figure 3-8: Front Panel Audio Connector Location	24
Figure 3-9: Front Panel Connector Location	25
Figure 3-10: FW Programming Connector Location	26
Figure 3-11: Infrared Connector Location	27
Figure 3-12: Keyboard/Mouse Connector Location	28
Figure 3-13: PCH Fan Connector Location	29
Figure 3-14: PCIe x4 Slot Locations	30
Figure 3-15: PCIe x8 Slot Location	30
Figure 3-16: PCIe x16 Slot Location	31
Figure 3-17: SATA 3Gb/s Drive Connector Locations	32
Figure 3-18: SATA 3Gb/s Drive Connector Locations	33
Figure 3-19: Serial Port Connector (RS-422/485) Location	34
Figure 3-20: Serial Port Connector (RS-232) Locations	35
Figure 3-21: SMBus Connector Location	36
Figure 3-22: SPI Connector Location	37
Figure 3-23: System Fan Connector Locations	38
Figure 3-24: TPM Connector Location	39
Figure 3-25: USB Connector Pinout Locations	40
Figure 3-26: External Peripheral Interface Connector	41

Figure 3-27: Audio Connector	42
Figure 3-28: LAN Connector	42
Figure 3-29: Keyboard/Mouse Connector	44
Figure 3-30: RS-232 Serial Port Connector	45
Figure 3-31: VGA Connector	46
Figure 4-1: Disengage the CPU Socket Load Lever.....	52
Figure 4-2: Remove Protective Cover.....	52
Figure 4-3: Insert the Socket LGA1155 CPU.....	53
Figure 4-4: Close the Socket LGA1155.....	54
Figure 4-5: Cooling Kits (CF-1156A-RS, CF-1156B-RS, CF-1156C-RS, CF-1156D-RS).....	54
Figure 4-6: Cooling Kit Support Bracket	55
Figure 4-7: DIMM Installation.....	56
Figure 4-8: Jumper Locations	57
Figure 4-9: AT/ATX Power Select Jumper Location.....	58
Figure 4-10: Clear CMOS Jumper Location	59
Figure 4-11: WOL Mode Select Jumper Location.....	60
Figure 4-12: SATA Drive Cable Connection.....	61
Figure 4-13: SATA Power Drive Connection.....	62
Figure 4-14: Audio Connector	63
Figure 4-15: LAN Connection	64
Figure 4-16: PS/2 Keyboard/Mouse Connector	65
Figure 4-17: Serial Device Connector.....	66
Figure 4-18: USB Connector.....	67
Figure 4-19: VGA Connector	68
Figure 6-1: Introduction Screen	113
Figure 6-2: Available Drivers	113
Figure 6-3: Chipset Driver Welcome Screen.....	114
Figure 6-4: Chipset Driver License Agreement	115
Figure 6-5: Chipset Driver Read Me File	115
Figure 6-6: Chipset Driver Setup Operations	116
Figure 6-7: Chipset Driver Installation Finish Screen.....	117
Figure 6-8: Graphics Driver Welcome Screen	118
Figure 6-9: Graphics Driver License Agreement.....	118
Figure 6-10: Graphics Driver Setup Operations	119
Figure 6-11: Graphics Driver Installation Finish Screen	120

Figure 6-12: Windows Control Panel	121
Figure 6-13: System Control Panel	121
Figure 6-14: Device Manager List	122
Figure 6-15: Update Driver Software Window	123
Figure 6-16: Locate Driver Files	123
Figure 6-17: LAN Driver Installation	124
Figure 6-18: LAN Driver Installation Complete	124
Figure 6-19: InstallShield Wizard Welcome Screen	125
Figure 6-20: Audio Driver Software Configuration	126
Figure 6-21: Restart the Computer	126
Figure 6-22: SATA RAID Driver Welcome Screen	127
Figure 6-23: SATA RAID Driver License Agreement	128
Figure 6-24: SATA RAID Driver Read Me File	128
Figure 6-25: SATA RAID Driver Setup Operations	129
Figure 6-26: SATA RAID Driver Installation Finish Screen	129
Figure 6-27: USB 3.0 Driver Welcome Screen	130
Figure 6-28: USB 3.0 Driver License Agreement	131
Figure 6-29: USB 3.0 Driver Read Me File	131
Figure 6-30: USB 3.0 Driver Setup Operations	132
Figure 6-31: USB 3.0 Driver Installation Finish Screen	132
Figure 6-32: Intel® ME Driver Welcome Screen	134
Figure 6-33: Intel® ME Driver License Agreement	134
Figure 6-34: Intel® ME Driver Setup Operations	135
Figure 6-35: Intel® ME Driver Installation Finish Screen	135
Figure B-1: IEI One Key Recovery Tool Menu	140
Figure B-2: Launching the Recovery Tool	145
Figure B-3: Recovery Tool Setup Menu	145
Figure B-4: Command Prompt	146
Figure B-5: Partition Creation Commands	147
Figure B-6: Launching the Recovery Tool	149
Figure B-7: Manual Recovery Environment for Windows	149
Figure B-8: Building the Recovery Partition	150
Figure B-9: Press Any Key to Continue	150
Figure B-10: Press F3 to Boot into Recovery Mode	151
Figure B-11: Recovery Tool Menu	151

Figure B-12: About Symantec Ghost Window	152
Figure B-13: Symantec Ghost Path	152
Figure B-14: Select a Local Source Drive	153
Figure B-15: Select a Source Partition from Basic Drive	153
Figure B-16: File Name to Copy Image to	154
Figure B-17: Compress Image.....	154
Figure B-18: Image Creation Confirmation	155
Figure B-19: Image Creation Complete	155
Figure B-20: Image Creation Complete	155
Figure B-21: Press Any Key to Continue	156
Figure B-22: Auto Recovery Utility	157
Figure B-23: Launching the Recovery Tool	157
Figure B-24: Auto Recovery Environment for Windows	157
Figure B-25: Building the Auto Recovery Partition.....	158
Figure B-26: Factory Default Image Confirmation	158
Figure B-27: Image Creation Complete	159
Figure B-28: Press any key to continue	159
Figure B-29: Partitions for Linux.....	161
Figure B-30: Manual Recovery Environment for Linux	162
Figure B-31: Access menu.lst in Linux (Text Mode).....	163
Figure B-32: Recovery Tool Menu	163
Figure B-33: Recovery Tool Main Menu	164
Figure B-34: Restore Factory Default	165
Figure B-35: Recovery Complete Window	166
Figure B-36: Backup System.....	166
Figure B-37: System Backup Complete Window	167
Figure B-38: Restore Backup	167
Figure B-39: Restore System Backup Complete Window	168
Figure B-40: Symantec Ghost Window	168

List of Tables

Table 1-1: IMB-C2160 Specifications	8
Table 2-1: Packing List	12
Table 2-2: Optional Items	13
Table 3-1: Peripheral Interface Connectors	17
Table 3-2: Rear Panel Connectors	17
Table 3-3: ATX Power Connector Pinouts	18
Table 3-4: CPU Fan Connector Pinouts	20
Table 3-5: CPU Power Connector Pinouts	21
Table 3-6: Digital I/O Connector Pinouts	23
Table 3-7: Front Panel Audio Connector Pinouts	24
Table 3-8: Front Panel Connector Pinouts	25
Table 3-9: FW Programming Connector Pinouts	26
Table 3-10: Infrared Connector Pinouts	27
Table 3-11: Keyboard/Mouse Connector Pinouts	28
Table 3-12: PCH Fan Connector Pinouts	29
Table 3-13: SATA 3Gb/s Drive Connector Pinouts	32
Table 3-14: SATA 3Gb/s Drive Connector Pinouts	33
Table 3-15: Serial Port Connector (RS-422/485) Pinouts	34
Table 3-16: Serial Port Connector (RS-232) Pinouts	36
Table 3-17: SMBus Connector Pinouts	37
Table 3-18: SPI Connector Pinouts	37
Table 3-19: System Fan Connector Pinouts	38
Table 3-20: TPM Connector Pinouts	39
Table 3-21: USB Port Connector Pinouts	40
Table 3-22: LAN and USB 3.0 Connector Pinouts (LAN_USB1)	43
Table 3-23: LAN and USB 3.0 Connector Pinouts (LAN_USB2)	44
Table 3-24: Keyboard/Mouse and USB Connector Pinouts	45
Table 3-25: RS-232 Serial Port Connector Pinouts	45
Table 3-26: USB 2.0 Connector Pinouts	46
Table 3-27: VGA Connector Pinouts	47

Table 4-1: Jumpers	57
Table 4-2: AT/ATX Power Select Jumper Settings	58
Table 4-3: Clear CMOS Jumper Settings.....	59
Table 4-4: WOL Mode Select Jumper Settings	59
Table 5-1: BIOS Navigation Keys	71

BIOS Menus

BIOS Menu 1: Main	72
BIOS Menu 2: Advanced	73
BIOS Menu 3: RTC Wake Settings	74
BIOS Menu 4: Trusted Computing	75
BIOS Menu 5: CPU Configuration	76
BIOS Menu 6: SATA Configuration	78
BIOS Menu 7: Intel(R) Rapid Start Technology	79
BIOS Menu 8: Intel TXT(LT) Configuration	80
BIOS Menu 9: AMT Configuration	80
BIOS Menu 10: USB Configuration	81
BIOS Menu 11: Secondary Super IO Configuration	82
BIOS Menu 12: Super IO Configuration	86
BIOS Menu 13: Serial Port n Configuration Menu	87
BIOS Menu 14: Hardware Health Configuration	92
BIOS Menu 15: FAN 1 Configuration	94
BIOS Menu 16: Serial Port Console Redirection	97
BIOS Menu 17: IEI Feature	98
BIOS Menu 18: Chipset	99
BIOS Menu 19: PCH-IO Configuration	100
BIOS Menu 20: PCH-IO Configuration	101
BIOS Menu 21: System Agent (SA) Configuration	102
BIOS Menu 22: Graphics Configuration	103
BIOS Menu 23: Graphics Configuration	105
BIOS Menu 24: Memory Configuration	106
BIOS Menu 25: Boot	106
BIOS Menu 26: Security	108
BIOS Menu 27: Exit	109
BIOS Menu 28: IEI Feature	160

Chapter

1

Introduction

1.1 Introduction



Figure 1-1: IMB-C2160

The IMB-C2160 is a Micro-ATX motherboard. It accepts a LGA1155 Intel® Xeon® E3 or Intel® Core™ i3 quad/dual core processor and supports four 240-pin 1600/1333 MHz dual-channel DDR3 DIMM modules up to 32 GB.

The integrated Intel® C216 System Chipset supports two GbE LAN: one through the Intel® 82579 PHY with Intel® AMT 8.0 support and the other through the Intel® 82574L PCIe controller.

The IMB-C2160 includes one VGA port. Expansion and I/O include one PCIe x16 slot, one PCIe x16 slot with x8 signal, two PCIe x4 slots, four USB 3.0 ports on the rear panel, four USB 2.0 ports on the rear panel, six USB 2.0 ports by pin header, four SATA 3Gb/s connectors, two SATA 6Gb/s connectors. Serial device connectivity is provided by one internal RS-422/485 connector, one external RS-232 connector and eight internal RS-232 connectors.

IMB-C2160 Micro-ATX Motherboard

1.2 Benefits

Some of the IMB-C2160 motherboard benefits include:

- Powerful graphics with multiple monitors
- Staying connected with both wired LAN connections
- Speedy running of multiple programs and applications

1.3 Features

Some of the IMB-C2160 motherboard features are listed below:

- LGA1155 Intel® Xeon® E3 and Intel® Core™ i3 processor supported
- Dual-channel DDR3 1600/1333MHz supports up to 32GB
- Intel® PCIe GbE with Intel® AMT 8.0 supported
- Support PCI-Express generation 3.0 at 8GT/s I/O bandwidth
- USB 3.0 and SATA 6Gb/s supported
- Support much scalable serial ports
- IEI One Key Recovery solution allows you to create rapid OS backup and recovery

1.4 Connectors

The connectors on the IMB-C2160 are shown in the figure below.

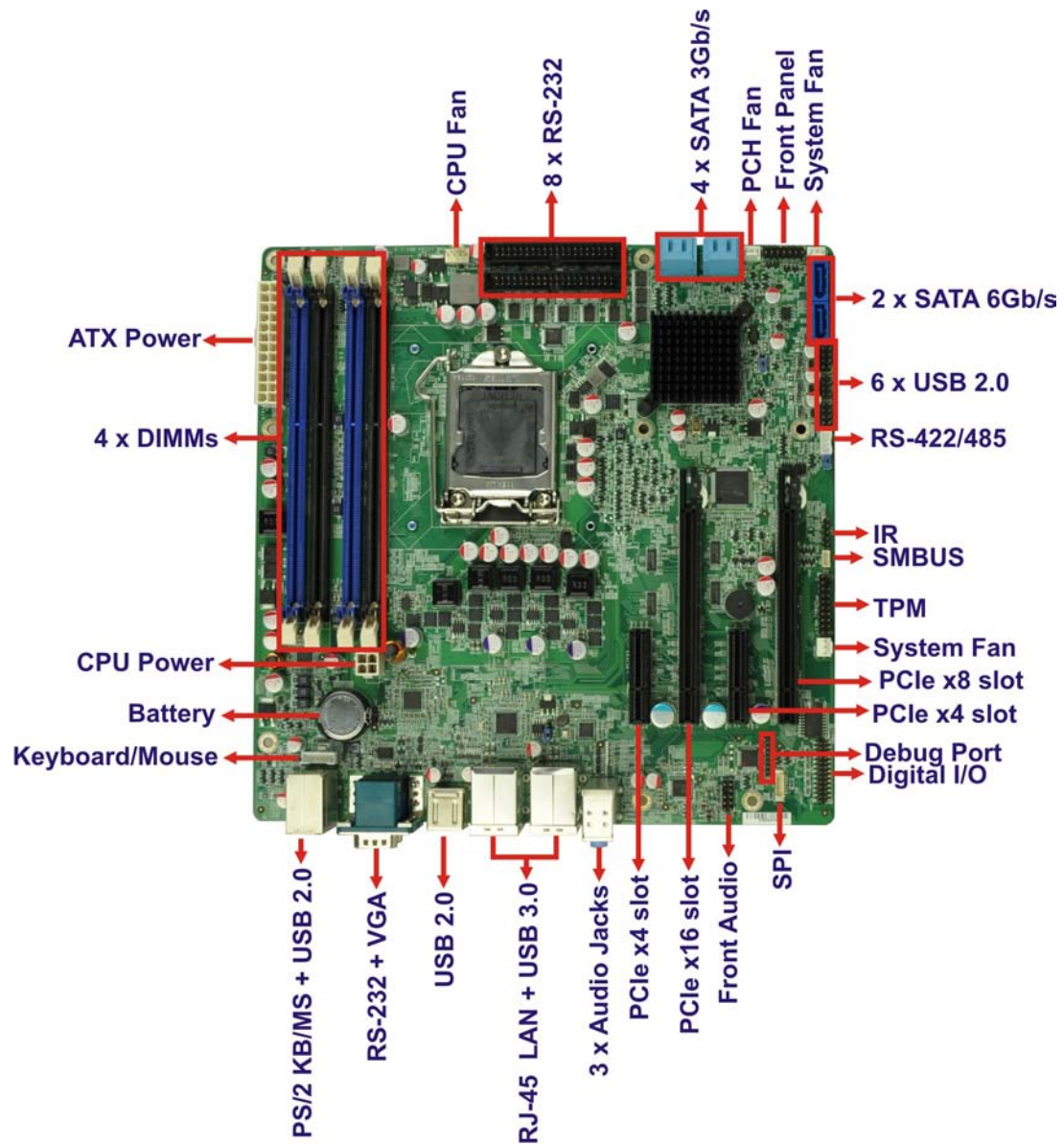

Figure 1-2: Connectors

IMB-C2160 Micro-ATX Motherboard

1.5 Dimensions

The main dimensions of the IMB-C2160 are shown in the diagram below.

- **Length:** 244 mm
- **Width:** 244 mm

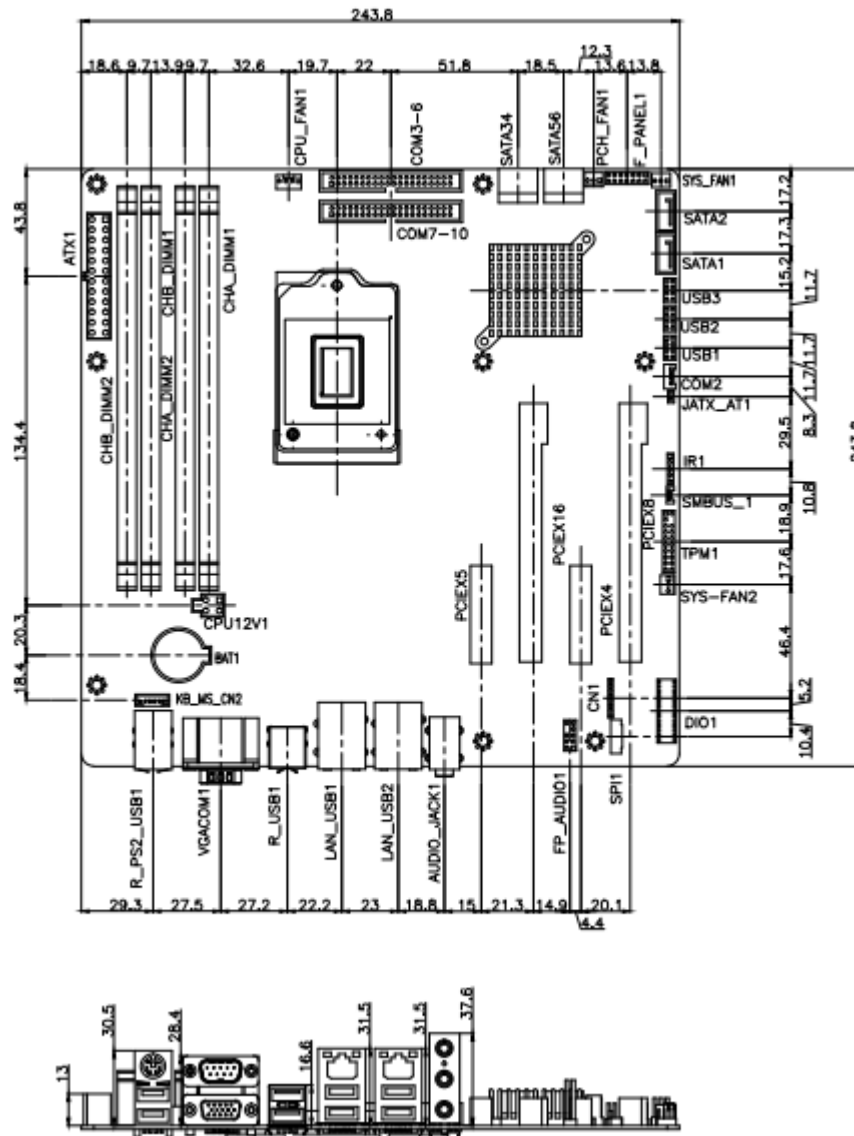

1.6 Data Flow

Figure 1-4 shows the data flow between the system chipset, the CPU and other components installed on the motherboard.

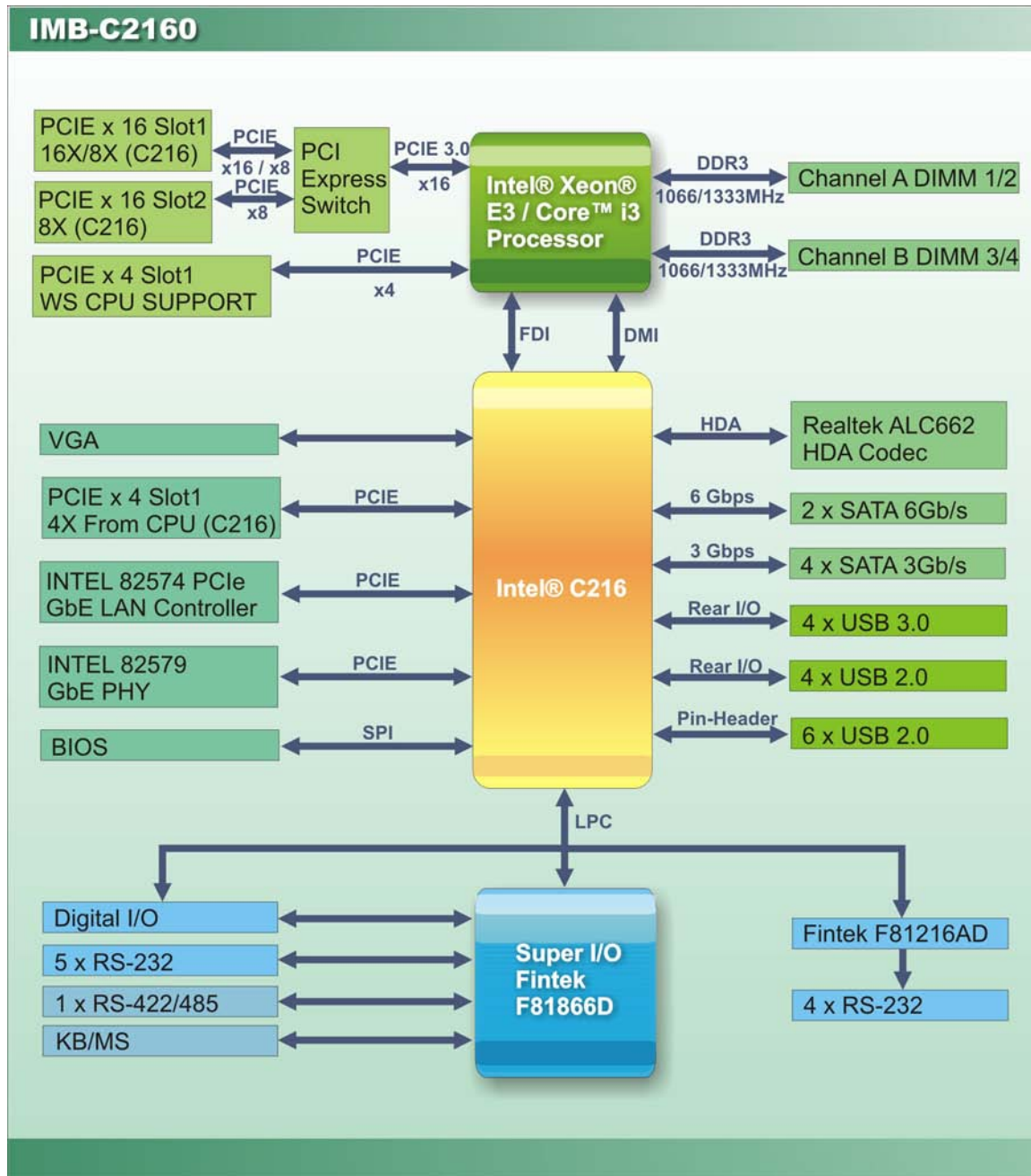

Figure 1-4: Data Flow Diagram

IMB-C2160 Micro-ATX Motherboard

1.7 Technical Specifications

IMB-C2160 technical specifications are listed below.

Specification/Model	IMB-C2160
Form Factor	Micro-ATX
CPU	LGA1155 socket supports Intel® Xeon® E3 and Intel® Core™ i3 quad/dual core processors
System Chipset	Intel® C216
Graphics Engine	Supports DX10.1 and OpenGL 3.0 Full MPEG2, VC1, AVC Decode
Display Output	VGA integrated in the Intel® C216
Memory	Four 240-pin 1600/1333MHz dual-channel DDR3 SDRAM ECC and non-ECC unbuffered DIMMs supported (system max. 32GB)
Audio	Realtek ALC662 HD audio codec (Line-in, Line-out, Mic)
BIOS	UEFI BIOS
Digital I/O	24-bit Digital I/O (24-bit GPIO is for programming I/O)
Ethernet	Intel® 82579 PHY with Intel® AMT 8.0 supported Intel® 82574L PCIe controller
Super I/O	Fintek F81866
Watchdog Timer	Software programmable supports 1~255 sec. system reset
Expansions	
PCIe	One PCIe x16 slot One PCIe x16 slot (with x8 signal) Two PCIe x4 slots
I/O Interface Connectors	
Audio Connectors	Three external audio jacks (Line-in, Line-out, Mic)
Ethernet	Two RJ-45 ports
Keyboard/Mouse	One external PS/2 keyboard/mouse port One internal 6-pin keyboard/mouse connector

Specification/Model	IMB-C2160
TPM	One 20-pin header
Front Audio	One 10-pin header
Front Panel	One 14-pin header
SMBus	One 4-pin wafer
IR	One 5 pin header
Fan	One 4-pin CPU fan connector One 3-pin PCH fan connector Two 3-pin system fan connectors
Serial Ports	One external RS-232 via DB-9 male connectors Eight RS-232 via internal 40-pin box headers One RS-422/485 via internal 4-pin header
USB ports	Four external USB 3.0 ports by rear IO Four external USB 2.0 ports by rear IO Six internal USB 2.0 ports via three 8-pin headers
Serial ATA	Two SATA 6Gb/s connectors Four SATA 3Gb/s connectors (RAID 0,1,5,10 support)
Environmental and Power Specifications	
Power Supply	ATX Power Supply
Power Consumption	3.3V@0.96A, 5V@4.33A, 12V@3.5A, 12V@2.09A, 5VSB@0.1A (3.10GHz Intel® i5-2400 CPU with two 1333MHz 4GB DDR3 DIMMs)
Operating Temperature	-10°C ~ 60°C
Operating Humidity	5% ~ 95% (non-condensing)
Physical Specifications	
Dimensions	244 mm x 244 mm
Weight GW/NW	1200 g / 700 g

Table 1-1: IMB-C2160 Specifications

Chapter

2

Packing List

2.1 Anti-static Precautions



WARNING!

Static electricity can destroy certain electronics. Make sure to follow the ESD precautions to prevent damage to the product, and injury to the user.

Make sure to adhere to the following guidelines:

- **Wear an anti-static wristband:** Wearing an anti-static wristband can prevent electrostatic discharge.
- **Self-grounding:** Touch a grounded conductor every few minutes to discharge any excess static buildup.
- **Use an anti-static pad:** When configuring any circuit board, place it on an anti-static mat.
- **Only handle the edges of the PCB:** Don't touch the surface of the motherboard. Hold the motherboard by the edges when handling.

2.2 Unpacking Precautions

When the IMB-C2160 is unpacked, please do the following:

- Follow the antistatic guidelines above.
- Make sure the packing box is facing upwards when opening.
- Make sure all the packing list items are present.







2.3 Packing List



NOTE:

If any of the components listed in the checklist below are missing, do not proceed with the installation. Contact the IEI reseller or vendor the IMB-C2160 was purchased from or contact an IEI sales representative directly by sending an email to sales@iei.com.tw.

The IMB-C2160 is shipped with the following components:

Quantity	Item and Part Number	Image
1	IMB-C2160	
4	SATA cable (P/N: 32801-000703-200-RS)	
1	I/O shielding (P/N: 45014-0034C0-00-RS)	
1	Mini jumper pack (2.54mm)	
1	Utility CD	
1	One Key Recovery CD	

Quantity	Item and Part Number	Image
1	Quick Installation Guide	

Table 2-1: Packing List

2.4 Optional Items

The following are optional components which may be separately purchased:

Item and Part Number	Image
Dual-port USB cable with bracket (P/N: 19800-003100-100-RS)	
Male PS/2 KB/MS Y-cable w/o bracket, 12cm(KB)+14cm(MS) (P/N: 32006-000300-100-RS)	
RS-422/485 cable, 200mm (P/N: 32205-003800-100-RS)	
Quad-port RS-232 cable without bracket (40/40/40/40cm) (P/N: 32205-001203-100-RS)	
SATA power cable (P/N: 32102-000100-200-RS)	
PS/2 KB/MS Y-cable with bracket, 6-pin header, 220mm (P/N: 19800-000075-RS)	
High-performance LGA1155/LGA1156 cooler kit, 1U Chassis compatible, 73W (P/N: CF-1156A-RS)	

IMB-C2160 Micro-ATX Motherboard

Item and Part Number	Image
High-performance LGA1155/LGA1156 cooler kit, 95W (P/N: CF-1156B-RS)	
LGA1155/LGA1156 cooler kit, 1U chassis compatible, 45W (P/N: CF-1156C-RS)	
LGA1155/LGA1156 cooler kit, 1U chassis compatible, 65W (P/N: CF-1156D-RS)	
20-pin Infineon TPM module, SW management tool, firmware V3.17 (P/N: TPM-IN01-R11)	

Table 2-2: Optional Items

Chapter

3

Connectors

IMB-C2160 Micro-ATX Motherboard

3.1 Peripheral Interface Connectors

This chapter details all the jumpers and connectors.

3.1.1 IMB-C2160 Layout

The figure below show all the connectors and jumpers.

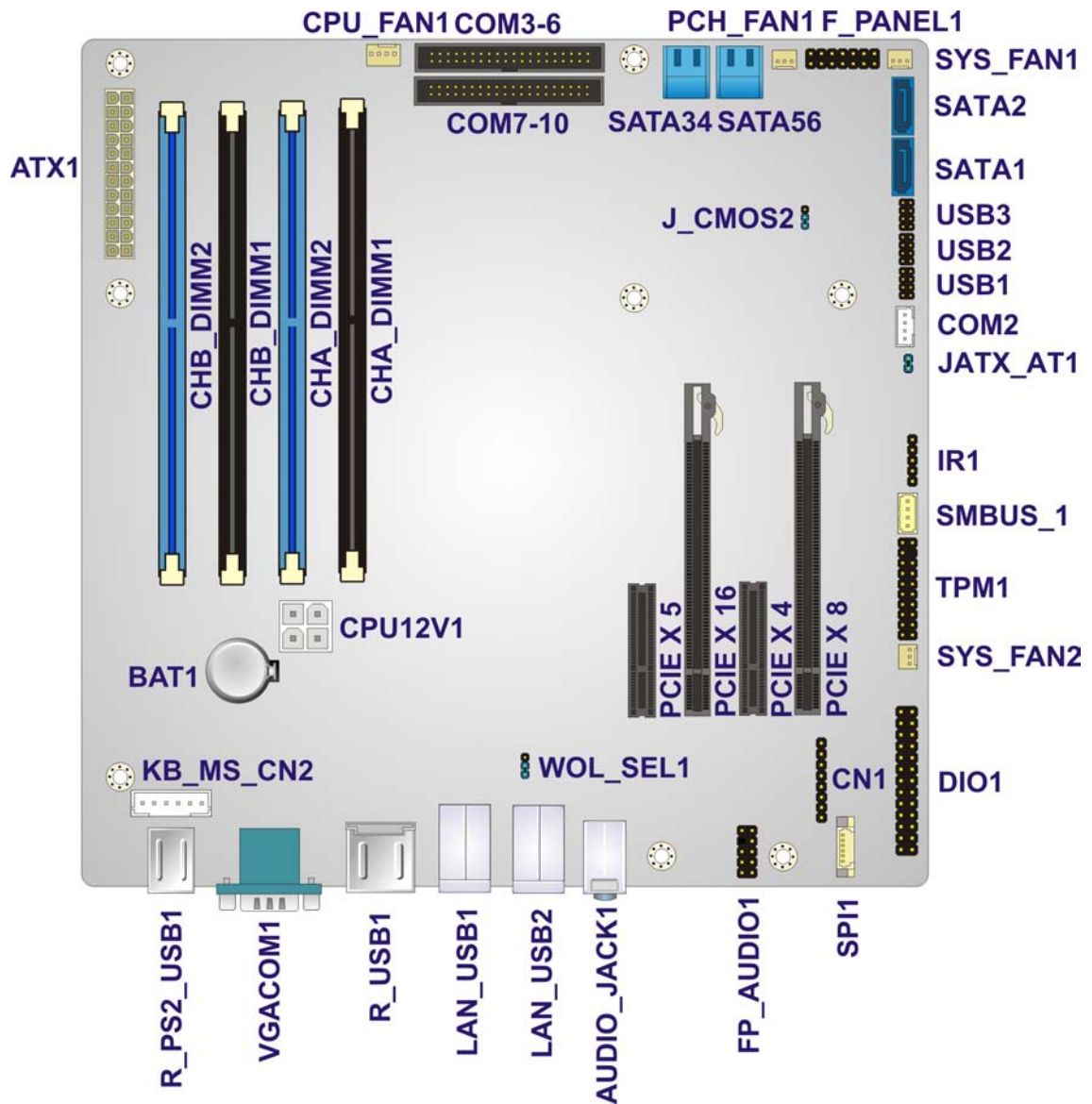

Figure 3-1: Connectors and Jumpers

3.1.2 Peripheral Interface Connectors

The table below lists all the connectors on the board.

Connector	Type	Label
ATX power connector	24-pin ATX	ATX1
Battery connector	Battery holder	BAT1
CPU fan connector	4-pin wafer	CPU_FAN1
CPU power connector	4-pin Molex	CPU12V1
DDR3 DIMM slots	DDR3 DIMM slot	CHA_DIMM1, CHA_DIMM2, CHB_DIMM1, CHB_DIMM2
Digital I/O connector	26-pin header	DIO1
Front panel audio connector	10-pin header	FP_AUDIO1
Front panel connector	14-pin header	F_PANEL1
FW programming connector	8-pin header	CN1
Infrared interface connector	5-pin header	IR1
Keyboard/mouse connector	6-pin wafer	KB_MS_CN2
PCH fan connector	3-pin wafer	PCH_FAN1
PCIe x4 slots	PCIe x4 slot	PCIe X 4, PCIe X 5
PCIe x8 slot	PCIe x16 slot	PCIe X 8
PCIe x16 slot	PCIe x16 slot	PCIe X 16
SATA 3Gb/s drive connectors	14-pin SATA connector	SATA34, SATA56
SATA 6Gb/s drive connectors	7-pin SATA connector	SATA1, SATA2
Serial port connector, RS-422/485	4-pin wafer	COM2
Serial port connectors, RS-232	40-pin box header	COM3-6, COM7-10
SMBus connector	4-pin wafer	SMBUS_1

Connector	Type	Label
SPI connector	6-pin wafer	SPI1
System fan connectors	3-pin wafer	SYS_FAN1, SYS_FAN2
TPM connector	20-pin header	TPM1
USB 2.0 connectors	8-pin header	USB1, USB2, USB3

Table 3-1: Peripheral Interface Connectors

3.1.3 External Interface Panel Connectors

The table below lists the connectors on the external I/O panel.

Connector	Type	Label
Audio connector	Audio jack	AUDIO_JACK1
Ethernet and USB connectors	RJ-45, USB 3.0	LAN_USB1, LAN_USB2
Keyboard/Mouse and USB connectors	PS/2, USB 2.0	R_PS2_USB1
RS-232 serial port and VGA connectors	DB-9 male, 15-pin female	VGACOM1
USB connectors	USB 2.0	R_USB1

Table 3-2: Rear Panel Connectors

3.2 Internal Peripheral Connectors

The section describes all of the connectors on the IMB-C2160.

3.2.1 ATX Power Connector

- CN Label: ATX1
- CN Type: 24-pin ATX
- CN Location: See **Figure 3-2**
- CN Pinouts: See **Table 3-3**

The ATX power connector connects to an ATX power supply.

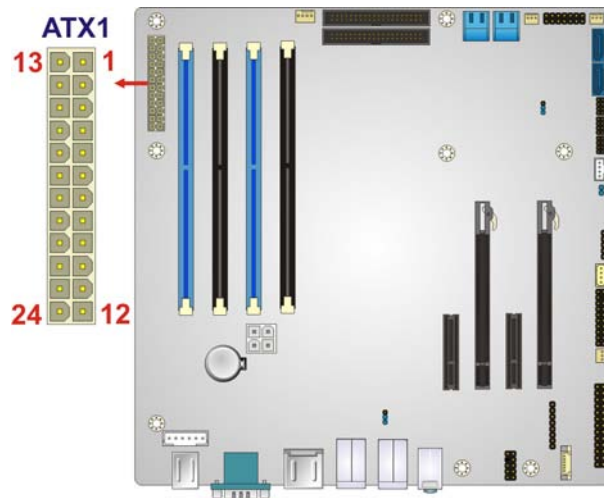

Figure 3-2: ATX Power Connector Location

Pin	Description	Pin	Description
1	+3.3 V	2	+3.3V
3	GND	4	+5 V
5	GND	6	+5 V
7	GND	8	PWROK
9	5VSB	10	+12 V
11	+12 V	12	+3.3V
13	+3.3 V	14	-12V
15	GND	16	PSON
17	GND	18	GND
19	GND	20	NC
21	+5 V	22	+5 V
23	+5 V	24	GND

Table 3-3: ATX Power Connector Pinouts

3.2.2 Battery Connector

CN Label: BAT1

CN Type: Battery holder

IMB-C2160 Micro-ATX Motherboard

CN Location: See **Figure 3-3**

The battery connector is connected to the system battery. The battery provides power to the system clock to retain the time when power is turned off.

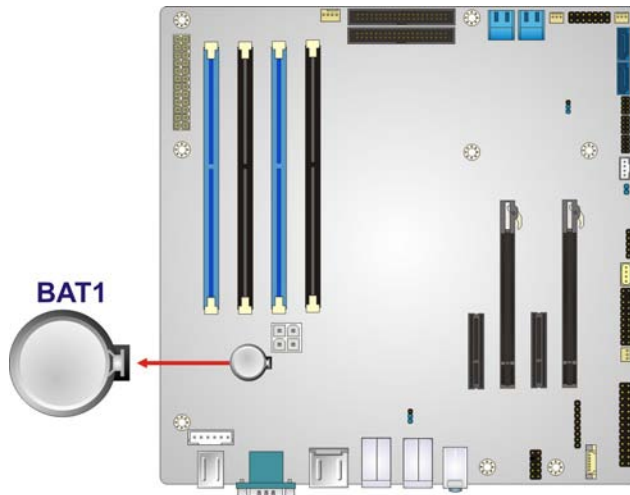

Figure 3-3: Battery Connector Location

3.2.3 CPU Fan Connector

CN Label: CPU_FAN1

CN Type: 4-pin wafer

CN Location: See **Figure 3-4**

CN Pinouts: See **Table 3-4**

The CPU fan connector attaches to a CPU cooling fan.

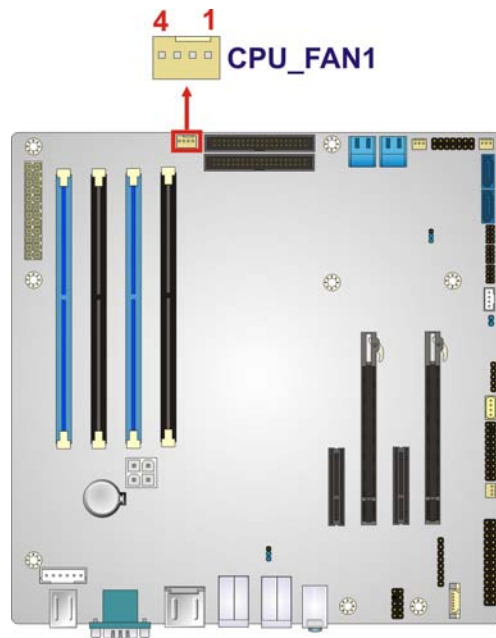
Figure 3-4: CPU Fan Connector Location

PIN NO.	DESCRIPTION
1	GND
2	VCC12
3	FANIO1
4	FANOUT1

Table 3-4: CPU Fan Connector Pinouts

3.2.4 CPU Power Connector

CN Label:	CPU12V1
CN Type:	4-pin Molex
CN Location:	See Figure 3-5
CN Pinouts:	See Table 3-5

The CPU power connector provides power to the CPU.

IMB-C2160 Micro-ATX Motherboard

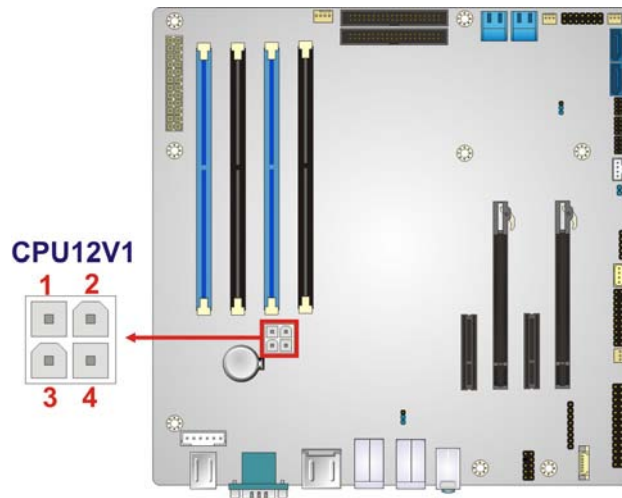

Figure 3-5: CPU Power Connector Location

PIN NO.	DESCRIPTION
1	GND
2	GND
3	+12V
4	+12V

Table 3-5: CPU Power Connector Pinouts

3.2.5 DDR3 DIMM Slots

CN Label: CHA_DIMM1, CHA_DIMM2, CHB_DIMM1, CHB_DIMM2

CN Type: DDR3 DIMM slot

CN Location: See **Figure 3-6**

The DDR3 DIMM slots are for DDR3 DIMM memory modules.

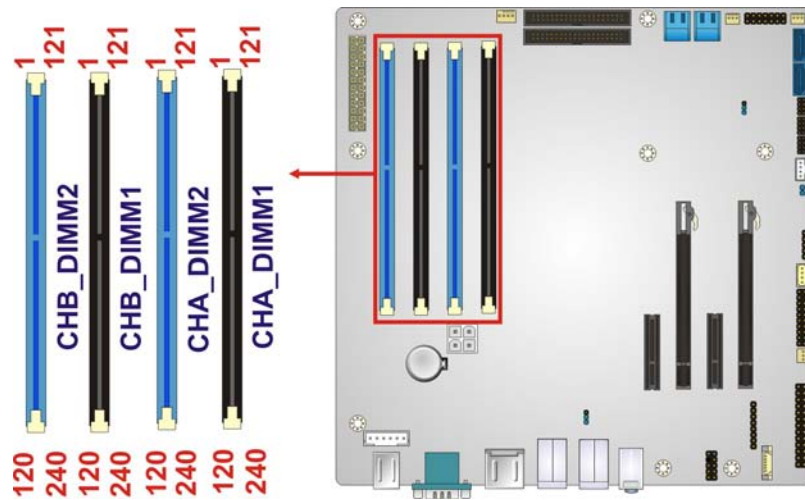

Figure 3-6: DDR3 DIMM Slot Locations

3.2.6 Digital I/O Connector

CN Label:	DIO1
CN Type:	26-pin header
CN Location:	See Figure 3-7
CN Pinouts:	See Table 3-6

The digital I/O connector provides programmable input and output for external devices. The digital I/O provides 12-bit output and 12-bit input.

IMB-C2160 Micro-ATX Motherboard

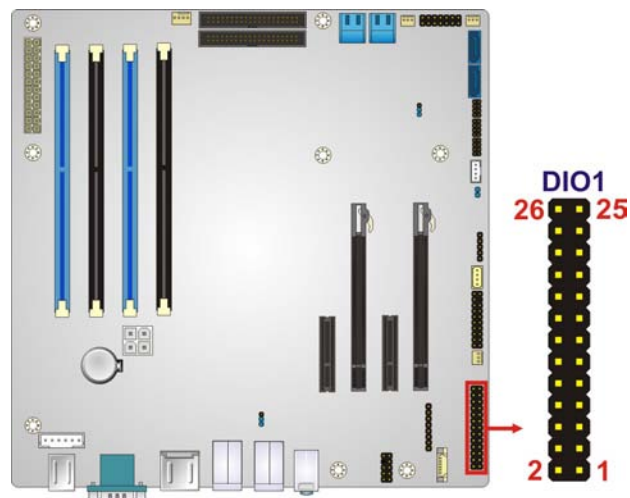

Figure 3-7: Digital I/O Connector Location

PIN NO.	DESCRIPTION	PIN NO.	DESCRIPTION
1	GND	2	+5V
3	D_IN0	4	D_OUT0
5	D_IN1	6	D_OUT1
7	D_IN2	8	D_OUT2
9	D_IN3	10	D_OUT3
11	D_8IN0	12	D_8OUT0
13	D_8IN1	14	D_8OUT1
15	D_8IN2	16	D_8OUT2
17	D_8IN3	18	D_8OUT3
19	D_8IN4	20	D_8OUT4
21	D_8IN5	22	D_8OUT5
23	D_8IN6	24	D_8OUT6
25	D_8IN7	26	D_8OUT7

Table 3-6: Digital I/O Connector Pinouts

3.2.7 Front Panel Audio Connector

CN Label: FP_AUDIO1

CN Type: 10-pin header

CN Location: See **Figure 3-8**

CN Pinouts: See **Table 3-7**

The front panel audio connector connects to speakers, a microphone and an audio input.



Figure 3-8: Front Panel Audio Connector Location

Pin	Description	Pin	Description
1	MIC_L	2	GND
3	MIC_R	4	FP_AUO_DETECT
5	LINE_R	6	GND
7	F_SENCE	8	NC
9	LINE_L	10	GND

Table 3-7: Front Panel Audio Connector Pinouts

3.2.8 Front Panel Connector

CN Label: F_PANEL1

CN Type: 14-pin header

CN Location: See **Figure 3-9**

CN Pinouts: See **Table 3-8**

IMB-C2160 Micro-ATX Motherboard

The front panel connector connects to the indicator LEDs and buttons on the computer's front panel.

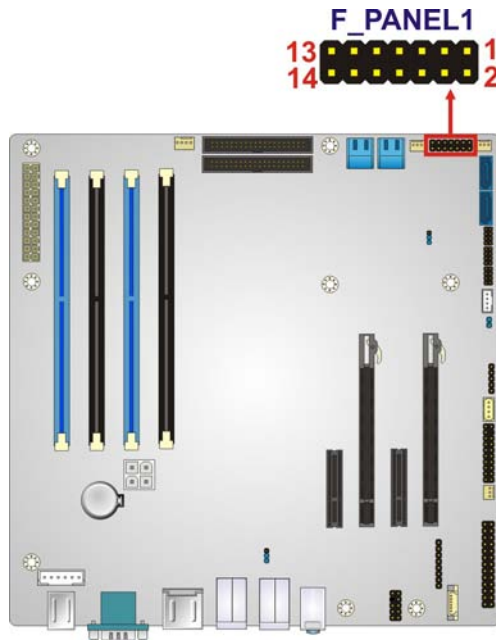

Figure 3-9: Front Panel Connector Location

FUNCTION	PIN	DESCRIPTION	FUNCTION	PIN	DESCRIPTION
PWR_LED	1	Power LED	BUZZER	2	Beep Power
	3	NC		4	NC
	5	GND		6	NC
PWR_BTN	7	PWRBTW#	8	PC Beep	
	9	GND	RESET	10	NC
HDD_LED	11	HDDLED		12	EXTRST#
	13	HDDLED#		14	GND

Table 3-8: Front Panel Connector Pinouts

3.2.9 FW Programming Connector

CN Label: CN1
 CN Type: 8-pin header
 CN Location: See **Figure 3-10**

CN Pinouts: See **Table 3-9**

The FW Programming connector is used for programming the firmware.

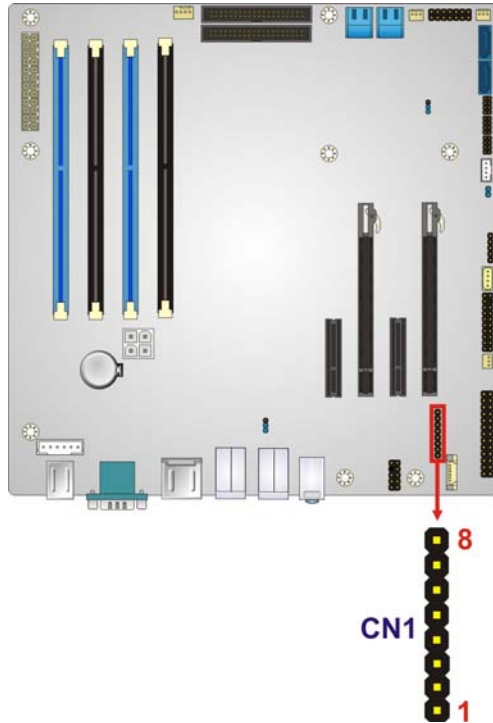

Figure 3-10: FW Programming Connector Location

Pin	Description	Pin	Description
1	+3.3V	2	TDO
3	TDI	4	NC
5	NC	6	TMS
7	GND	8	TCK

Table 3-9: FW Programming Connector Pinouts

3.2.10 Infrared Interface Connector

CN Label: IR1

CN Type: 5-pin header

CN Location: See **Figure 3-11**

CN Pinouts: See **Table 3-10**

IMB-C2160 Micro-ATX Motherboard

The infrared connector attaches to an infrared receiver for use with remote controls.

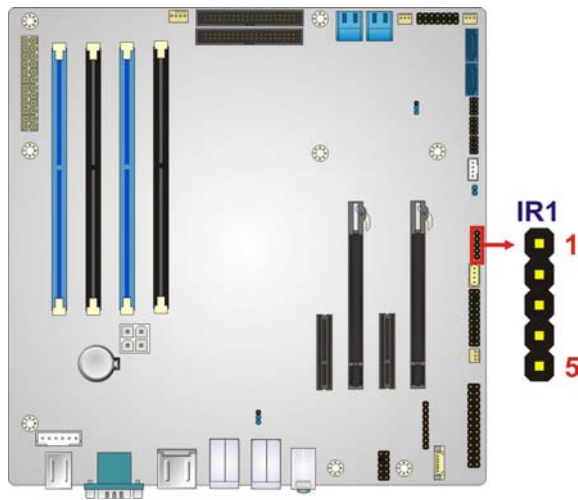

Figure 3-11: Infrared Connector Location

Pin	Description
1	+5V
2	NC
3	IR_RX
4	GND
5	IR_TX

Table 3-10: Infrared Connector Pinouts

3.2.11 Keyboard/Mouse Connector

CN Label: KB_MS_CN2

CN Type: 6-pin wafer

CN Location: See **Figure 3-12**

CN Pinouts: See **Table 3-11**

The keyboard/mouse connector connects to a PS/2 Y-cable that can be connected to a PS/2 keyboard and mouse.

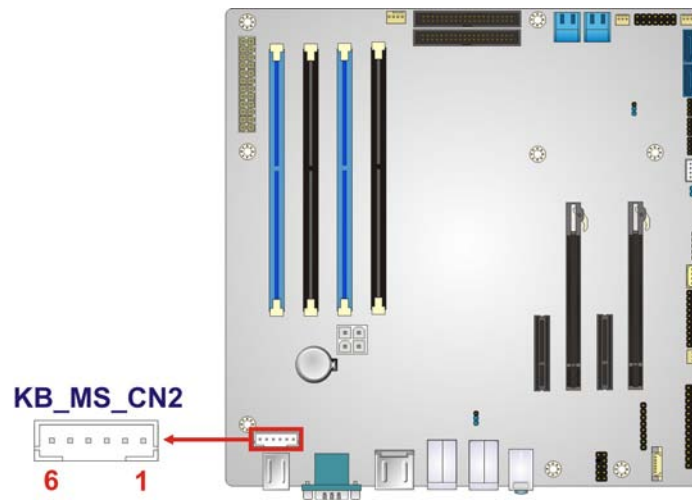
Figure 3-12: Keyboard/Mouse Connector Location

Pin	Description
1	+5V
2	MS DATA
3	MS CLK
4	KB DATA
5	KB CLK
6	GND

Table 3-11: Keyboard/Mouse Connector Pinouts

3.2.12 PCH Fan Connector

- CN Label: PCH_FAN1
- CN Type: 3-pin header
- CN Location: See **Figure 3-13**
- CN Pinouts: See **Table 3-12**

The PCH fan connector attaches to a PCH cooling fan.

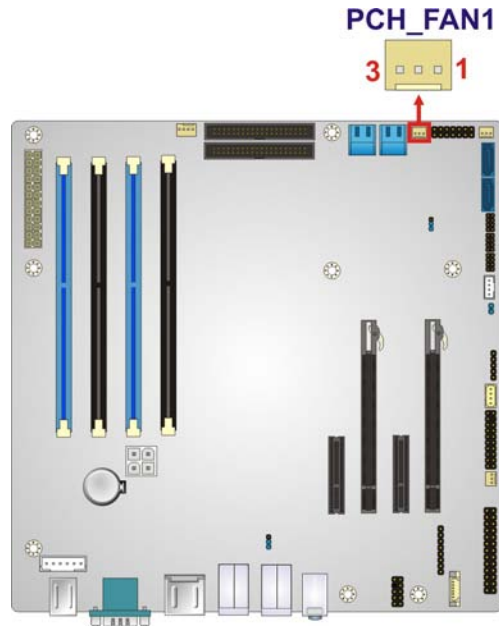

Figure 3-13: PCH Fan Connector Location

Pin	Description
1	FANIO2
2	FANOUT2
3	GND

Table 3-12: PCH Fan Connector Pinouts

3.2.13 PCIe x4 Slots

CN Label: PCIEX4, PCIEX5

CN Type: PCIe x4 slot

CN Location: See **Figure 3-14**

The PCIe x4 slots are for PCIe x4 expansion cards.

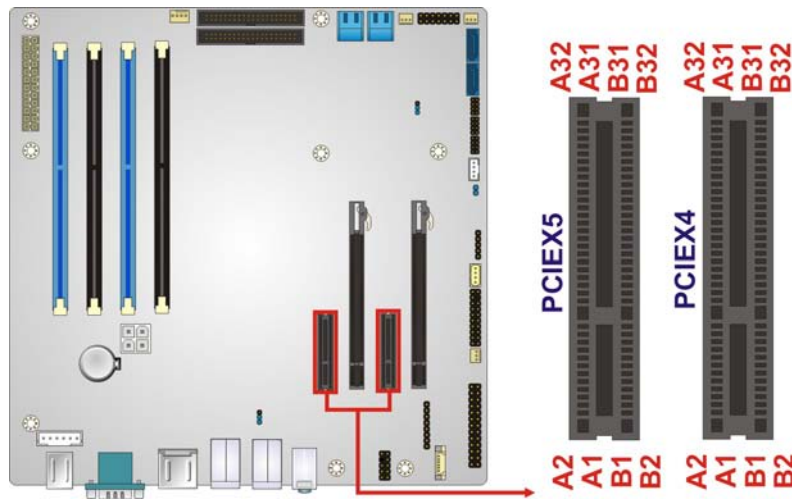

Figure 3-14: PCIe x4 Slot Locations

3.2.14 PCIe x8 Slot

- CN Label: PCIEX8
- CN Type: PCIe x16 slot
- CN Location: See **Figure 3-15**

The PCIe x16 slot with PCIe x8 signal is for PCIe x8 expansion cards.

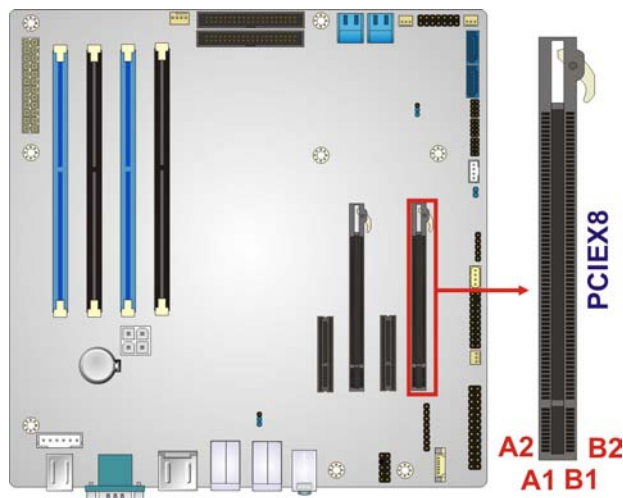

Figure 3-15: PCIe x8 Slot Location

IMB-C2160 Micro-ATX Motherboard

3.2.15 PCIe x16 Slot

CN Label:	PCIEX16
CN Type:	PCIe x16 slot
CN Location:	See Figure 3-16

The PCIe x16 slot is for PCIe x16 expansion cards.

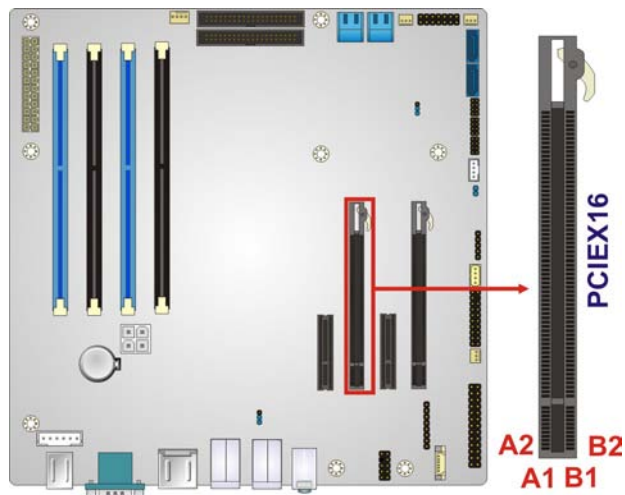
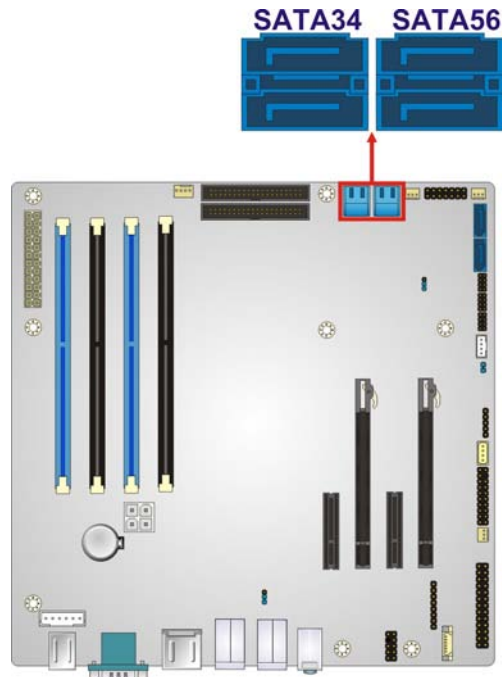

Figure 3-16: PCIe x16 Slot Location

3.2.16 SATA 3Gb/s Drive Connectors

CN Label:	SATA34, SATA56
CN Type:	14-pin SATA connector
CN Location:	See Figure 3-17
CN Pinouts:	See Table 3-13

The SATA drive connectors can be connected to SATA drives and support up to 3Gb/s data transfer rate.

Figure 3-17: SATA 3Gb/s Drive Connector Locations

Pin	Description	Pin	Description
1	GND	2	TXP_A
3	TXN_A	4	GND
5	RXN_A	6	RXP_A
7	GND	8	GND
9	TXP_B	10	TXN_B
11	GND	12	RXN_B
13	RXP_B	14	GND

Table 3-13: SATA 3Gb/s Drive Connector Pinouts

3.2.17 SATA 6Gb/s Drive Connectors

- CN Label: SATA1, SATA2
- CN Type: 7-pin SATA connector
- CN Location: See **Figure 3-18**
- CN Pinouts: See **Table 3-14**

IMB-C2160 Micro-ATX Motherboard

The SATA drive connectors can be connected to SATA drives and support up to 6Gb/s data transfer rate.

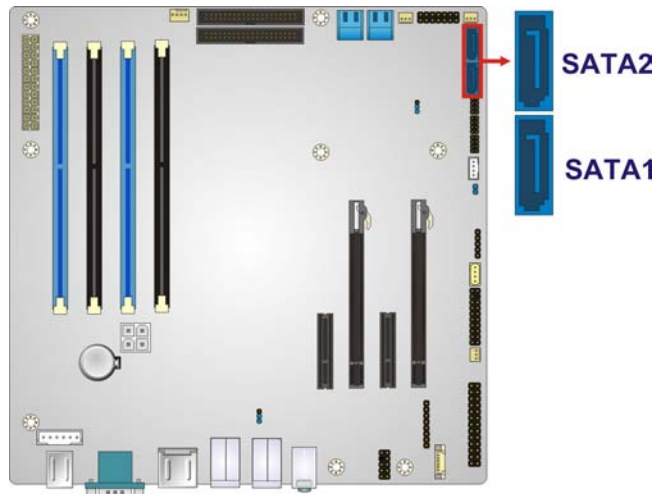

Figure 3-18: SATA 3Gb/s Drive Connector Locations

Pin	Description	Pin	Description
1	GND	2	TX
3	TX-	4	GND
5	RX-	6	RX
7	GND		

Table 3-14: SATA 3Gb/s Drive Connector Pinouts

3.2.18 Serial Port Connector, RS-422/485

- CN Label: COM2
- CN Type: 4-pin wafer
- CN Location: See **Figure 3-19**
- CN Pinouts: See **Table 3-15**

This connector provides RS-422 or RS-485 communications.

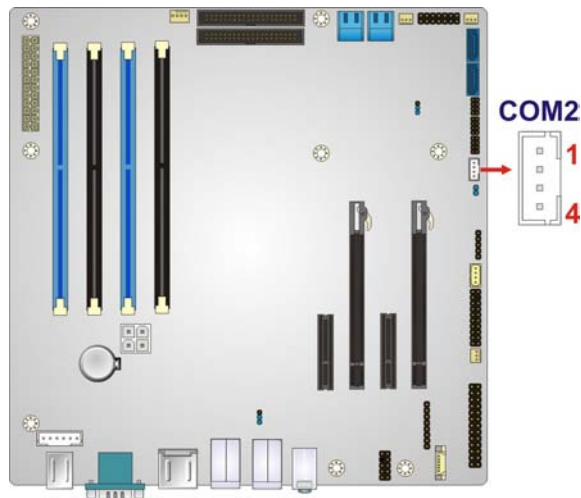

Figure 3-19: Serial Port Connector (RS-422/485) Location

PIN NO.	DESCRIPTION	PIN NO.	DESCRIPTION
1	RXD485#	2	RXD485
3	TXD485	4	TXD485#

Table 3-15: Serial Port Connector (RS-422/485) Pinouts

3.2.19 Serial Port Connectors, RS-232

CN Label: COM3-6, COM7-10

CN Type: 40-pin box header

CN Location: See **Figure 3-20**

CN Pinouts: See **Table 3-16**

Each of these connectors provides RS-232 connections.

IMB-C2160 Micro-ATX Motherboard

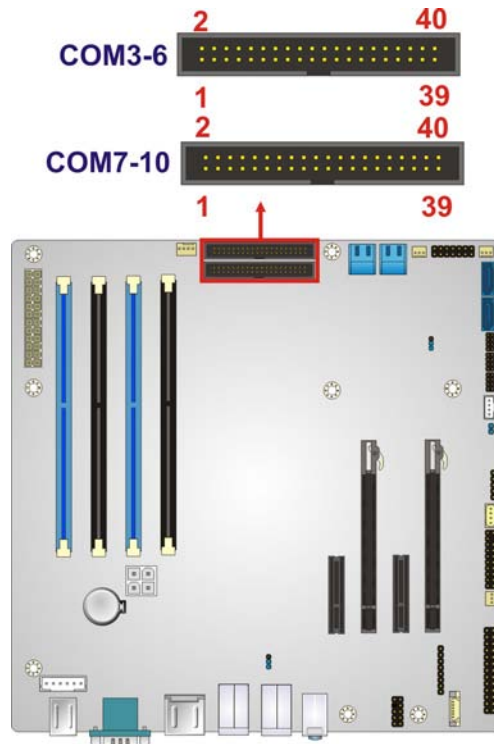

Figure 3-20: Serial Port Connector (RS-232) Locations

PIN NO.	DESCRIPTION	PIN NO.	DESCRIPTION
1	NDCD3/7#	2	NDSR3/7#
3	NRXD3/7	4	NRTS3/7#
5	NTXD3/7	6	NCTS3/7#
7	NDTR3/7#	8	NRI3/7#
9	GND	10	GND
11	NDCD4/8#	12	NDSR4/8#
13	NRXD4/8	14	NRTS4/8#
15	NTXD4/8	16	NCTS4/8#
17	NDTR4/8#	18	NRI4/8#
19	GND	20	GND
21	NDCD5/9#	22	NDSR5/9#
23	NRXD5/9	24	NRTS5/9#
25	NTXD5/9	26	NCTS5/9#
27	NDTR5/9#	28	NRI5/9#
29	GND	30	GND

PIN NO.	DESCRIPTION	PIN NO.	DESCRIPTION
31	NDCD6/10#	32	NDSR6/10#
33	NRXD6/10	34	NRTS6/10#
35	NTXD6/10	36	NCTS6/10#
37	NDTR6/10#	38	NRI6/10#
39	GND	40	GND

Table 3-16: Serial Port Connector (RS-232) Pinouts

3.2.20 SMBus Connector

- CN Label: SMBUS_1
 CN Type: 4-pin wafer
 CN Location: See **Figure 3-21**
 CN Pinouts: See **Table 3-17**

The SMBus (System Management Bus) connector provides low-speed system management communications.

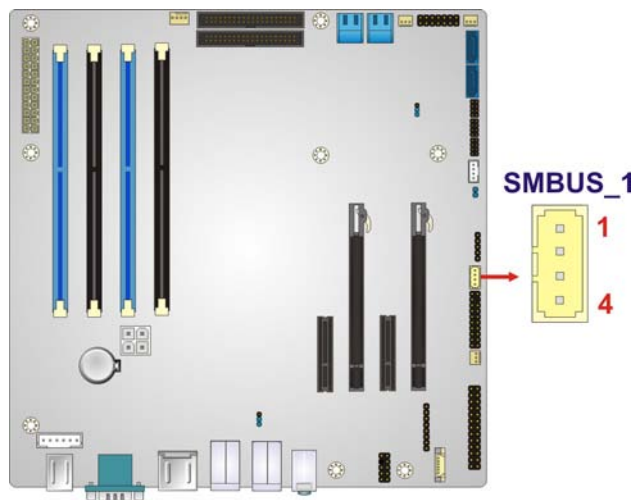
Figure 3-21: SMBus Connector Location

PIN	DESCRIPTION
1	+5V
2	SMBCLK

IMB-C2160 Micro-ATX Motherboard

PIN	DESCRIPTION
3	SMBDATA
4	GND

Table 3-17: SMBus Connector Pinouts

3.2.21 SPI Connector

CN Label:	SPI1
CN Type:	6-pin header
CN Location:	See Figure 3-22
CN Pinouts:	See Table 3-18

The SPI connector is used to flash the BIOS.

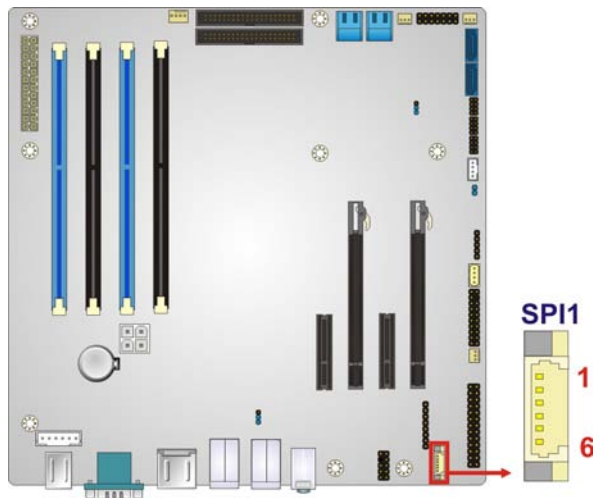

Figure 3-22: SPI Connector Location

PIN NO.	DESCRIPTION	PIN NO.	DESCRIPTION
1	+SPI_VCC	2	SPI_CS0#_CN
3	SPI_S00_CN	4	SPI_CLK0_CN
5	SPI_S10_CN	6	GND

Table 3-18: SPI Connector Pinouts

3.2.22 System Fan Connector

- CN Label: SYS_FAN1, SYS_FAN2
- CN Type: 3-pin wafer
- CN Location: See **Figure 3-23**
- CN Pinouts: See **Table 3-19**

The fan connector attaches to a cooling fan.

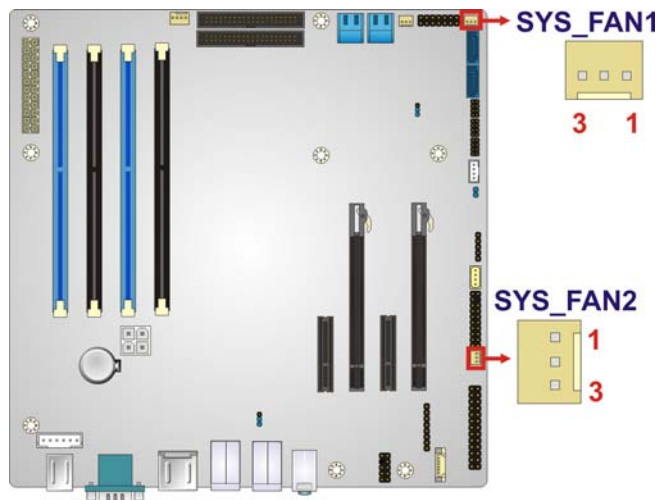

Figure 3-23: System Fan Connector Locations

PIN NO.	DESCRIPTION
1	NC
2	+12V
3	GND

Table 3-19: System Fan Connector Pinouts

3.2.23 TPM Connector

- CN Label: TPM1
- CN Type: 20-pin header
- CN Location: See **Figure 3-24**
- CN Pinouts: See **Table 3-20**

IMB-C2160 Micro-ATX Motherboard

The TPM connector connects to a TPM module.

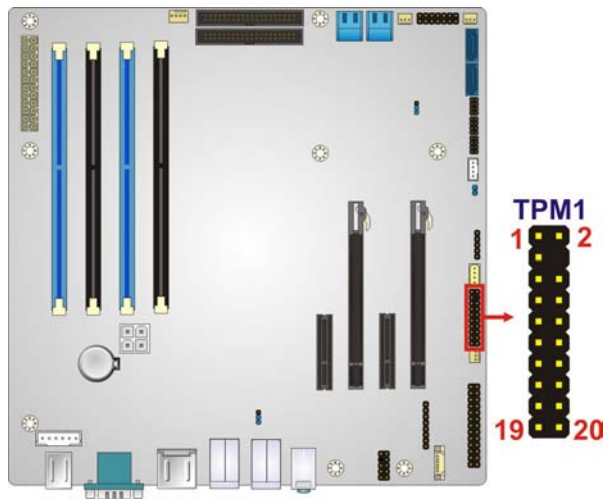

Figure 3-24: TPM Connector Location

PIN NO.	DESCRIPTION	PIN NO.	DESCRIPTION
1	TPMPCLK	2	GND
3	LPC_FRAME#	4	NC
5	BUF_PCIRST#	6	+5V
7	LPC_AD3	8	LPC_AD2
9	+3.3V	10	LPC_AD1
11	LPC_AD0	12	GND
13	SMBCLK_RESUME	14	SMBDATA_RESUME
15	+3.3V	16	SERIRQ
17	GND	18	+3.3V
19	LPCPD_N	20	LDRQ0#

Table 3-20: TPM Connector Pinouts

3.2.24 USB Connectors

CN Label: USB1, USB2, USB3

CN Type: 8-pin header

CN Location: See **Figure 3-25**

CN Pinouts: See **Table 3-21**

The USB connectors connect to USB devices. Each pin header provides two USB ports.

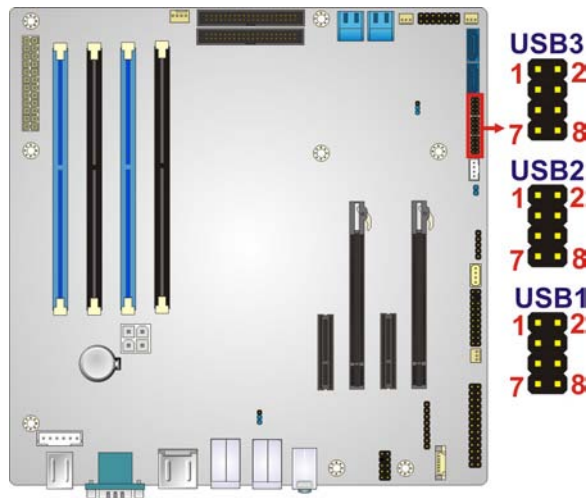

Figure 3-25: USB Connector Pinout Locations

PIN NO.	DESCRIPTION	PIN NO.	DESCRIPTION
1	+5V	2	GND
3	USB20_C_N6/10/12	4	USB20_C_P7/11/13
5	USB20_C_P6/10/12	6	USB20_C_N7/11/13
7	GND	8	+5V

Table 3-21: USB Port Connector Pinouts

3.3 External Peripheral Interface Connector Panel

The figure below shows the external peripheral interface connector (EPIC) panel. The EPIC panel consists of the following:

- 3 x Audio jacks
- 2 x Ethernet connectors
- 1 x Keyboard/Mouse connector
- 1 x RS-232 serial port connectors
- 4 x USB 3.0 connectors
- 4 x USB 2.0 connectors
- 1 x VGA connectors

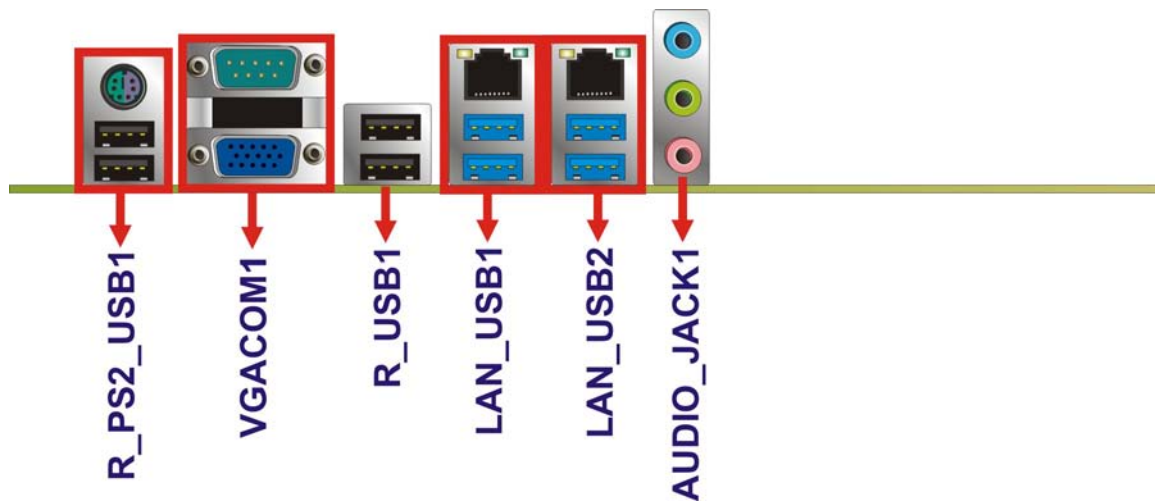

Figure 3-26: External Peripheral Interface Connector

3.3.1 Audio Connector

CN Label:	AUDIO_JACK1
CN Type:	Audio jack
CN Location:	See Figure 3-26

The audio jacks connect to external audio devices.

- **Line In port (Light Blue):** Connects a CD-ROM, DVD player, or other audio devices.
- **Line Out port (Lime):** Connects to a headphone or a speaker. With multi-channel configurations, this port can also connect to front speakers.
- **Microphone (Pink):** Connects a microphone.

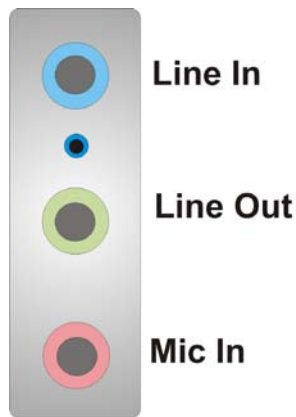

Figure 3-27: Audio Connector

3.3.2 Ethernet and USB Connectors

CN Label:	LAN_USB1, LAN_USB2
CN Type:	RJ-45, USB 3.0 port
CN Location:	See Figure 3-26
CN Pinouts:	See Table 3-22 and Table 3-23

The LAN connector connects to a local network.

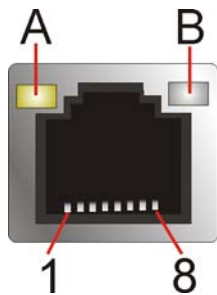

Figure 3-28: LAN Connector

The USB 3.0 ports are for attaching USB 3.0 peripheral devices to the system. To be able to use the USB 3.0 ports, please make sure the USB 3.0 driver is installed (see **Section 6.8**). The pinouts of LAN and USB 3.0 connectors are shown below.

IMB-C2160 Micro-ATX Motherboard

PIN NO.	DESCRIPTION	PIN NO.	DESCRIPTION
U1	+5V	U10	+5V
U2	USB20_C_N2	U11	USB20_C_N3
U3	USB20_C_P2	U12	USB20_C_P3
U4	GND	U13	GND
U5	USB3_RX3_DN_C	U14	USB3_RX4_DN_C
U6	USB3_RX3_DP_C	U15	USB3_RX4_DP_C
U7	GND	U16	GND
U8	USB3_TX3_DN_C	U17	USB3_TX4_DN_C
U9	USB3_TX3_DP_C	U18	USB3_TX4_DP_C
R1	+1.9V_LAN1	L1	L1_1000#
R2	TRD1P0	L2	L1_100#
R3	TRD1N0	L3	L1_LINK_ACT#
R4	TRD1P1	L4	POWER+
R5	TRD1N1	G1	GND
R6	TRD1P2	G2	GND
R7	TRD1N2	G3	GND
R8	TRD1P3	G4	GND
R9	TRD1N3	G5	GND
R10	GND	G6-G8	GND

Table 3-22: LAN and USB 3.0 Connector Pinouts (LAN_USB1)

PIN NO.	DESCRIPTION	PIN NO.	DESCRIPTION
U1	+5V	U10	+5V
U2	USB20_C_N0	U11	USB20_C_N1
U3	USB20_C_P0	U12	USB20_C_P1
U4	GND	U13	GND
U5	USB3_RX1_DN_C	U14	USB3_RX2_DN_C
U6	USB3_RX1_DP_C	U15	USB3_RX2_DP_C
U7	GND	U16	GND
U8	USB3_TX1_DN_C	U17	USB3_TX2_DN_C
U9	USB3_TX1_DP_C	U18	USB3_TX2_DP_C
R1	+1.05V_LAN2	L1	L2_1000#

R2	TRD2P0	L2	L2_100#
R3	TRD2N0	L3	L2_LINK_ACT#
R4	TRD2P1	L4	POWER+
R5	TRD2N1	G1	GND
R6	TRD2P2	G2	GND
R7	TRD2N2	G3	GND
R8	TRD2P3	G4	GND
R9	TRD2N3	G5	GND
R10	GND	G6-G8	GND

Table 3-23: LAN and USB 3.0 Connector Pinouts (LAN_USB2)

3.3.3 Keyboard/Mouse and USB Connector

- CN Label: R_PS2_USB1
 CN Type: PS/2, USB 2.0 ports
 CN Location: See **Figure 3-26**
 CN Pinouts: See **Table 3-24**

The keyboard/mouse connector is for connecting a PS/2 mouse and a PS/2 keyboard.

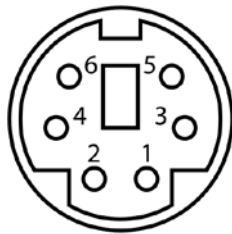
Figure 3-29: Keyboard/Mouse Connector

The USB connector can be connected to a USB device.

PIN	DESCRIPTION	PIN	DESCRIPTION
1	GND	2	USB20_C_P8
3	USB20_C_N8	4	+5V
5	GND	6	USB20_C_P9

IMB-C2160 Micro-ATX Motherboard

PIN	DESCRIPTION	PIN	DESCRIPTION
7	USB20_C_N9	8	+5V
9	GND	10	KBDATA
11	MSDATA	12	+5V
13	KBCLK	14	MSCLK

Table 3-24: Keyboard/Mouse and USB Connector Pinouts

3.3.4 RS-232 Serial Port Connectors

- CN Label: COM1
- CN Type: DB-9 Male
- CN Location: See **Figure 3-26**
- CN Pinouts: See **Table 3-25**

The serial port connects to a RS-232 serial communications device.

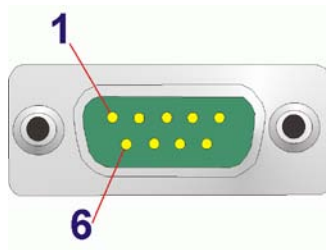

Figure 3-30: RS-232 Serial Port Connector

PIN NO.	DESCRIPTION	PIN NO.	DESCRIPTION
1	NDCD1#	2	NRXD1
3	NTXD1	4	NDTR1#
5	GND	6	NDSR1#
7	NRTS1#	8	NCTS1#
9	NRI1#		

Table 3-25: RS-232 Serial Port Connector Pinouts

3.3.5 USB Connectors

- CN Label: **R_USB1**
 CN Type: USB 2.0 port
 CN Location: See **Figure 3-26**
 CN Pinouts: See **Table 3-26**

The USB connector can be connected to a USB device.

PIN NO.	DESCRIPTION	PIN NO.	DESCRIPTION
1	+5V	2	USB20_C_N4
3	USB20_C_P4	4	GND
5	+5V	6	USB20_C_N5
7	USB20_C_P5	8	GND

Table 3-26: USB 2.0 Connector Pinouts

3.3.6 VGA Connectors

- CN Label: VGA
 CN Type: 15-pin female
 CN Location: See **Figure 3-26**
 CN Pinouts: See **Table 3-27**

The VGA connector connects to a monitor that accepts a standard VGA input.

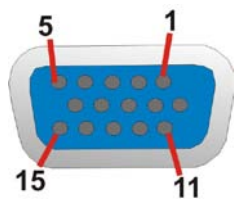

Figure 3-31: VGA Connector

PIN	DESCRIPTION	PIN	DESCRIPTION
1	CRT_RED	2	CRT_GREEN

IMB-C2160 Micro-ATX Motherboard

3	CRT_BLUE	4	NC
5	GND	6	GND
7	GND	8	GND
9	+5V	10	GND
11	NC	12	CRT_DDC_DATA
13	CRT_HSYNC	14	CRT_VSYNC
15	CRT_DDC_CLK		

Table 3-27: VGA Connector Pinouts

Chapter

4

Installation

4.1 Anti-static Precautions



WARNING:

Failure to take ESD precautions during the installation of the IMB-C2160 may result in permanent damage to the IMB-C2160 and severe injury to the user.

Electrostatic discharge (ESD) can cause serious damage to electronic components, including the IMB-C2160. Dry climates are especially susceptible to ESD. It is therefore critical that whenever the IMB-C2160 or any other electrical component is handled, the following anti-static precautions are strictly adhered to.

- **Wear an anti-static wristband:** Wearing a simple anti-static wristband can help to prevent ESD from damaging the board.
- **Self-grounding:** Before handling the board touch any grounded conducting material. During the time the board is handled, frequently touch any conducting materials that are connected to the ground.
- **Use an anti-static pad:** When configuring the IMB-C2160, place it on an anti-static pad. This reduces the possibility of ESD damaging the IMB-C2160.
- **Only handle the edges of the PCB:** When handling the PCB, hold the PCB by the edges.

4.2 Installation Considerations



NOTE:

The following installation notices and installation considerations should be read and understood before installation. All installation notices must be strictly adhered to. Failing to adhere to these precautions may lead to severe damage and injury to the person performing the installation.

**WARNING:**

The installation instructions described in this manual should be carefully followed in order to prevent damage to the IMB-C2160, IMB-C2160 components and injury to the user.

Before and during the installation please **DO** the following:

- Read the user manual:
 - The user manual provides a complete description of the IMB-C2160 installation instructions and configuration options.
- Wear an electrostatic discharge cuff (ESD):
 - Electronic components are easily damaged by ESD. Wearing an ESD cuff removes ESD from the body and helps prevent ESD damage.
- Place the IMB-C2160 on an antistatic pad:
 - When installing or configuring the motherboard, place it on an antistatic pad. This helps to prevent potential ESD damage.
- Turn all power to the IMB-C2160 off:
 - When working with the IMB-C2160, make sure that it is disconnected from all power supplies and that no electricity is being fed into the system.

Before and during the installation of the IMB-C2160 **DO NOT**:

- Remove any of the stickers on the PCB board. These stickers are required for warranty validation.
- Use the product before verifying all the cables and power connectors are properly connected.
- Allow screws to come in contact with the PCB circuit, connector pins, or its components.

4.3 Basic Installation



WARNING:

A CPU should never be turned on without the specified cooling kit being installed. If the cooling kit (heat sink and fan) is not properly installed and the system turned on, permanent damage to the CPU, IMB-C2160 and other electronic components attached to the system may be incurred. Running a CPU without a cooling kit may also result in injury to the user.

The CPU, CPU cooling kit and DIMM are the most critical components of the IMB-C2160. If one of these component is not installed the IMB-C2160 cannot run.

4.3.1 Socket LGA1155 CPU Installation



WARNING:

CPUs are expensive and sensitive components. When installing the CPU please be careful not to damage it in anyway. Make sure the CPU is installed properly and ensure the correct cooling kit is properly installed.

DO NOT touch the pins at the bottom of the CPU. When handling the CPU, only hold it on the sides.

To install the CPU, follow the steps below.

Step 1: **Disengage the load lever** by pressing the lever down and slightly outwards to clear the retention tab. Fully open the lever. See **Figure 4-1**.

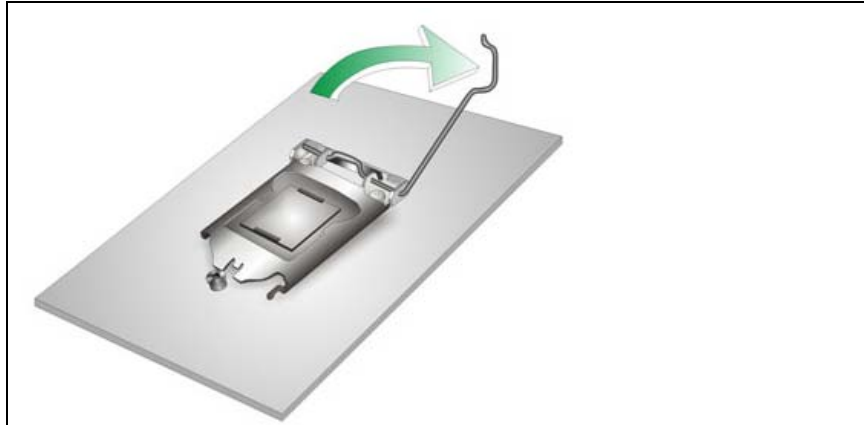

Figure 4-1: Disengage the CPU Socket Load Lever

Step 2: **Open the socket and remove the protective cover.** The black protective cover can be removed by pulling up on the tab labeled “Remove”. See

Figure 4-2.

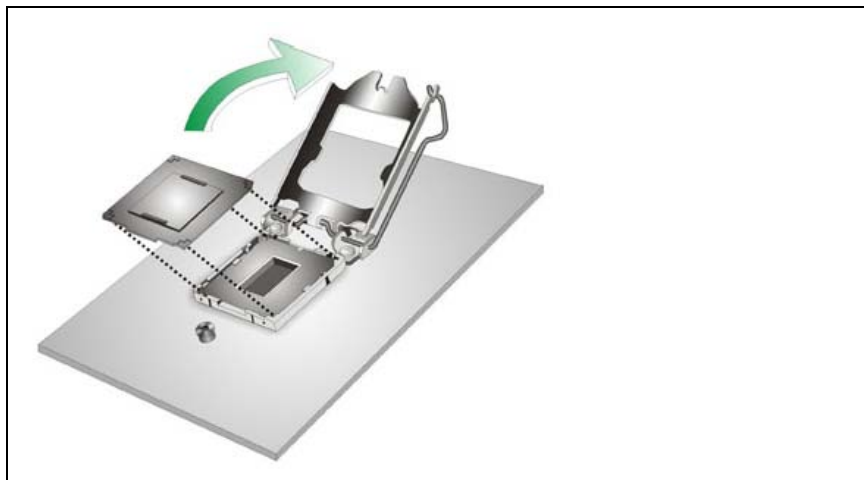

Figure 4-2: Remove Protective Cover

Step 3: **Inspect the CPU socket.** Make sure there are no bent pins and make sure the socket contacts are free of foreign material. If any debris is found, remove it with compressed air.

Step 4: **Orientate the CPU properly.** The contact array should be facing the CPU socket.

IMB-C2160 Micro-ATX Motherboard

- Step 5:** Correctly position the CPU. Match the Pin 1 mark with the CPU edge on the CPU socket.
- Step 6:** Align the CPU pins. Locate pin 1 and the two orientation notches on the CPU. Carefully match the two orientation notches on the CPU with the socket alignment keys.
- Step 7:** Insert the CPU. Gently insert the CPU into the socket. If the CPU pins are properly aligned, the CPU should slide into the CPU socket smoothly. See **Figure 4-3**.

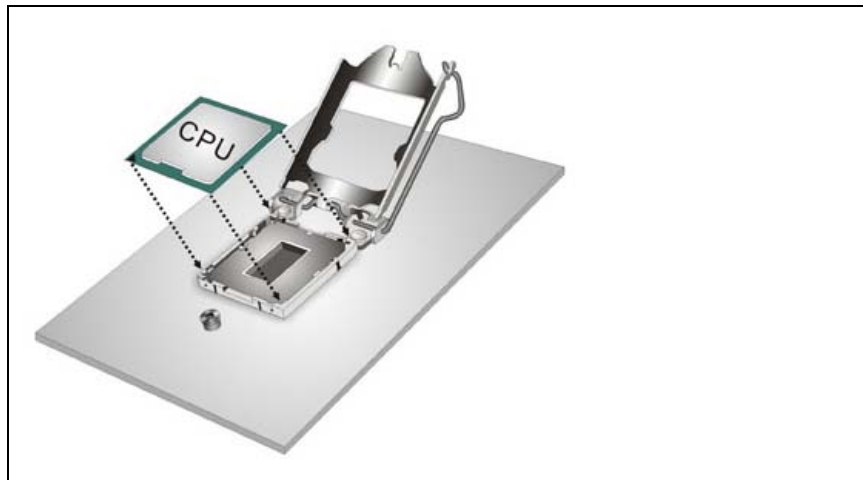

Figure 4-3: Insert the Socket LGA1155 CPU

- Step 8:** Close the CPU socket. Close the load plate and pull the load back a little to have the load plate be able to secure to the knob. Engage the load lever by pushing it back to its original position. See **Figure 4-4**. There will be some resistance, but will not require extreme pressure.



Step 9: Connect the 12 V power to the board. Connect the 12 V power from the power supply to the board.

4.3.2 Cooling Kit Installation



WARNING:

DO NOT attempt to install a push-pin cooling fan.

The pre-installed support bracket prevents the board from bending and is ONLY compatible with captive screw type cooling fans.



Figure 4-5: Cooling Kits (CF-1156A-RS, CF-1156B-RS, CF-1156C-RS, CF-1156D-RS)

The cooling kit can be bought from IEI. The cooling kit has a heat sink and fan.

**WARNING:**

Do not wipe off (accidentally or otherwise) the pre-sprayed layer of thermal paste on the bottom of the heat sink. The thermal paste between the CPU and the heat sink is important for optimum heat dissipation.

To install the cooling kit, follow the instructions below.

Step 1: A cooling kit bracket is pre-installed on the rear of the motherboard. See **Figure 4-6**.

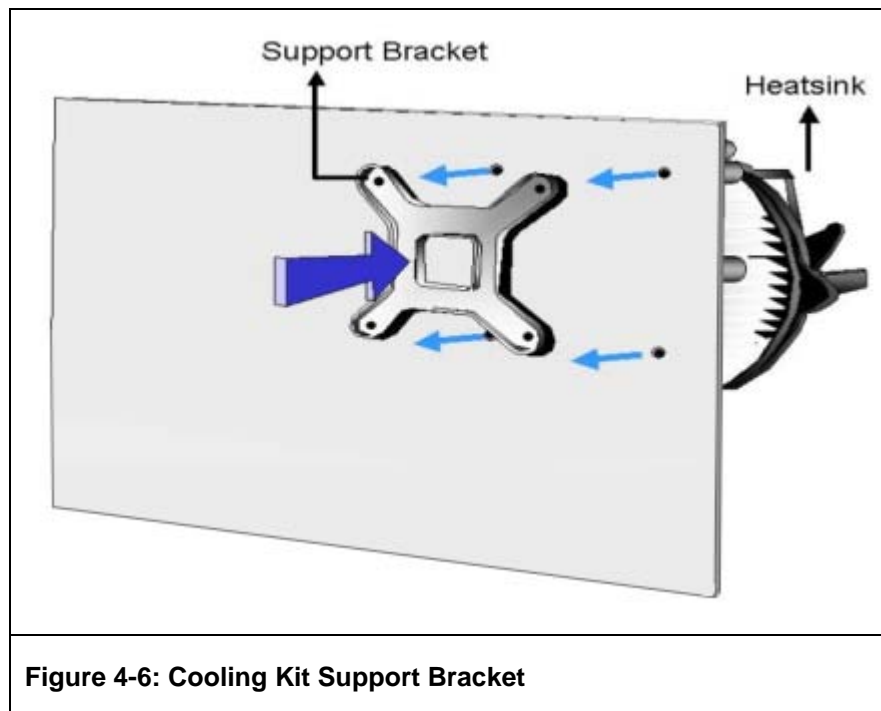

Figure 4-6: Cooling Kit Support Bracket

Step 2: Place the cooling kit onto the socket LGA1155 CPU. Make sure the CPU cable can be properly routed when the cooling kit is installed.

Step 3: Mount the cooling kit. Gently place the cooling kit on top of the CPU. Make sure the four threaded screws on the corners of the cooling kit properly pass through the holes of the cooling kit bracket.

Step 4: Secure the cooling kit by fastening the four retention screw of the cooling kit.

Step 5: Connect the fan cable. Connect the cooling kit fan cable to the fan connector on the IMB-C2160. Carefully route the cable and avoid heat generating chips and fan blades.

4.3.3 DIMM Installation

To install a DIMM, please follow the steps below and refer to **Figure 4-7**.

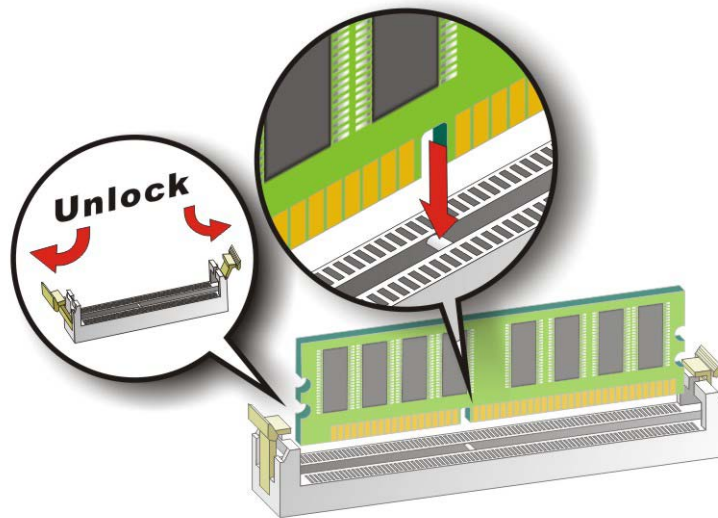

Figure 4-7: DIMM Installation

Step 1: Open the DIMM socket handles. Open the two handles outwards as far as they can. See **Figure 4-7**.

Step 2: Align the DIMM with the socket. Align the DIMM so the notch on the memory lines up with the notch on the memory socket. See **Figure 4-7**.

Step 3: Insert the DIMM. Once aligned, press down until the DIMM is properly seated. Clip the two handles into place. See **Figure 4-7**.

Step 4: Removing a DIMM. To remove a DIMM, push both handles outward. The memory module is ejected by a mechanism in the socket.

4.4 Jumper Settings



NOTE:

A jumper is a metal bridge used to close an electrical circuit. It consists of two or three metal pins and a small metal clip (often protected by a plastic cover) that slides over the pins to connect them. To CLOSE/SHORT a jumper means connecting the pins of the jumper with the plastic clip and to OPEN a jumper means removing the plastic clip from a jumper.

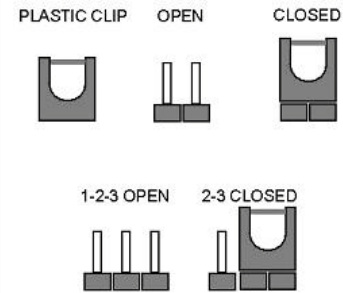

Figure 4-8: Jumper Locations

The jumpers on the IMB-C2160 must be set in accordance with the desired configuration before installation. The jumpers on the IMB-C2160 are listed in **Table 4-1**.

Description	Label	Type
AT/ATX power select	JATX_AT1	2-pin header
Clear CMOS	J_CMOS2	3-pin header
WOL Mode select	WOL_SEL1	3-pin header

Table 4-1: Jumpers

4.4.1 AT/ATX Power Select Jumper

Jumper Label:	JATX_AT1
Jumper Type:	2-pin header
Jumper Settings:	See Table 4-2
Jumper Location:	See Figure 4-9

The AT/ATX power select jumper specifies the systems power mode as AT or ATX.

Setting	Description
Closed	ATX Mode (Default)

Setting	Description
Open	AT Mode

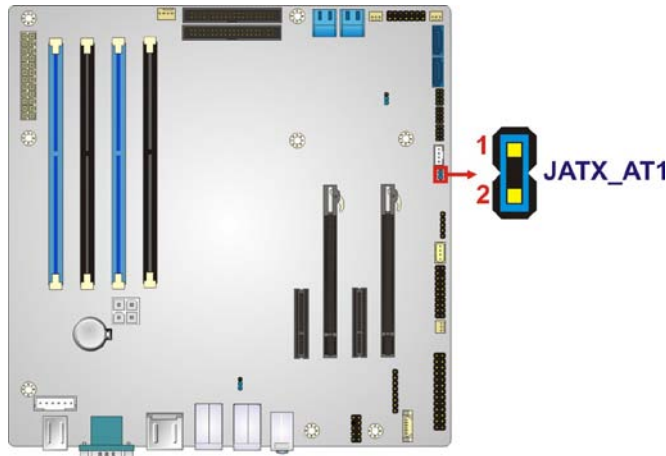
Table 4-2: AT/ATX Power Select Jumper Settings

Figure 4-9: AT/ATX Power Select Jumper Location

4.4.2 Clear CMOS Jumper

Jumper Label:	J_CMOS2
Jumper Type:	3-pin header
Jumper Settings:	See Table 4-3
Jumper Location:	See Figure 4-10

If the IMB-C2160 fails to boot due to improper BIOS settings, the clear CMOS jumper clears the CMOS data and resets the system BIOS information. To do this, use the jumper cap to close pins 2 and 3 for a few seconds then reinstall the jumper clip back to pins 1 and 2.

If the “CMOS Settings Wrong” message is displayed during the boot up process, the fault may be corrected by pressing the F1 to enter the CMOS Setup menu. Do one of the following:

- Enter the correct CMOS setting
- Load Optimal Defaults
- Load Failsafe Defaults.

IMB-C2160 Micro-ATX Motherboard

After having done one of the above, save the changes and exit the CMOS Setup menu.

Setting	Description
1-2	Keep CMOS Setup (Default)
2-3	Clear CMOS Setup

Table 4-3: Clear CMOS Jumper Settings

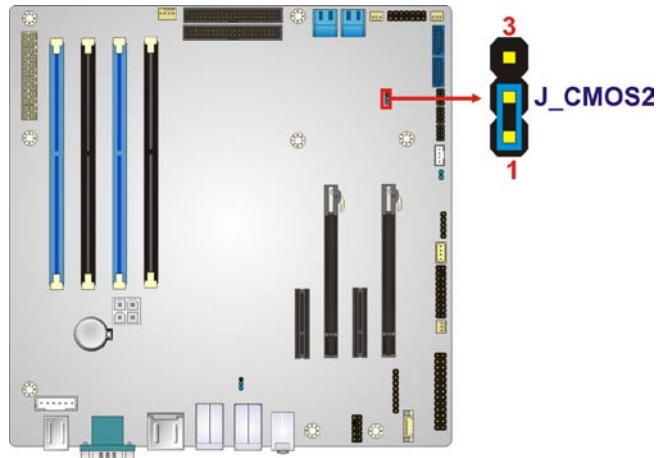

Figure 4-10: Clear CMOS Jumper Location

4.4.3 WOL Mode Select Jumper

Jumper Label:	WOL_SEL1
Jumper Type:	3-pin header
Jumper Settings:	See Table 4-4
Jumper Location:	See Figure 4-11

The Wake-on LAN (WOL) mode select jumper allows the user to enable or disable the WOL function. WOL mode select jumper settings are shown in **Table 4-3**.

Setting	Description
Short 1-2	WOL Mode Enable Default
Short 2-3	WOL Mode Disable

Table 4-4: WOL Mode Select Jumper Settings

The location of the WOL mode select jumper is shown in **Figure 4-10** below.

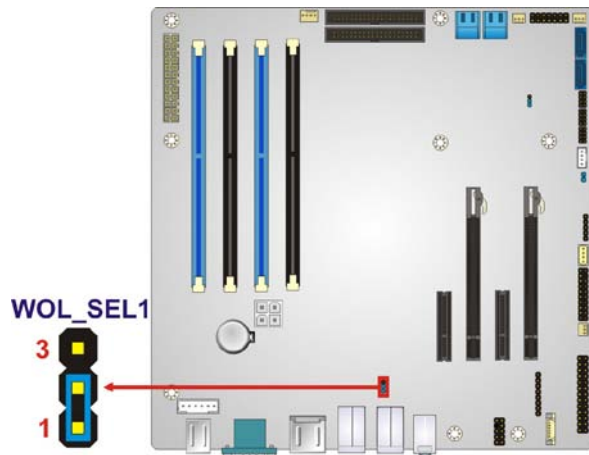

Figure 4-11: WOL Mode Select Jumper Location

4.5 Internal Peripheral Device Connections

This section outlines the installation of peripheral devices to the onboard connectors.

4.5.1 SATA Drive Connection

The IMB-C2160 is shipped with four SATA drive cables. To connect the SATA drives to the connectors, please follow the steps below.

Step 1: Locate the connectors. The locations of the SATA drive connectors are shown in **Chapter 3**.

Step 2: Insert the cable connector. Press the clip on the connector at the end of the SATA cable and insert the cable connector into the on-board SATA drive connector. See **Figure 4-12**.

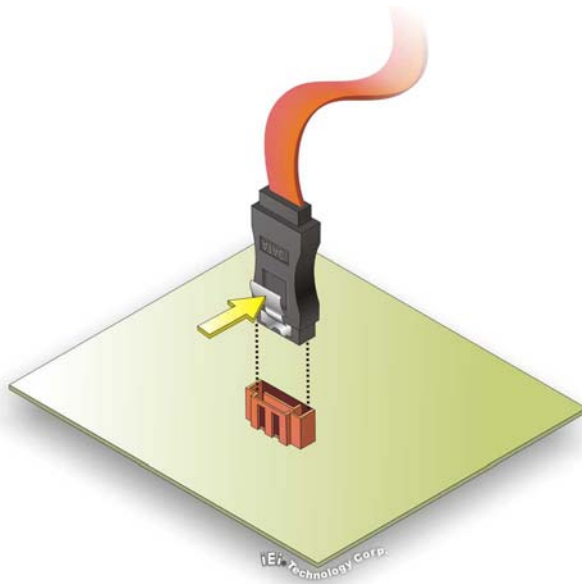

Figure 4-12: SATA Drive Cable Connection

- Step 3:** **Connect the cable to the SATA disk.** Connect the connector on the other end of the cable to the connector at the back of the SATA drive. See **Figure 4-13**.
- Step 4:** **Connect the SATA power cable (optional).** Connect the SATA power connector to the back of the SATA drive. See **Figure 4-13**.



Figure 4-13: SATA Power Drive Connection

The SATA power cable can be bought from IEI. See Optional Items in Section 2.4.

4.6 External Peripheral Interface Connection

This section describes connecting devices to the external connectors on the IMB-C2160.

4.6.1 Audio Connection

The audio jacks on the external audio connector enable the IMB-C2160 to be connected to a stereo sound setup. Each jack supports both input and output. When connecting a device, the High Definition Audio utility will automatically detect input or output. The light blue (top) audio jack does not support input from a microphone. To install the audio devices, follow the steps below.

- Step 1: Identify the audio plugs.** The plugs on your home theater system or speakers may not match the colors on the rear panel.
- Step 2: Plug the audio plugs into the audio jacks.** Plug the audio plugs into the audio jacks. If the plugs on your speakers are different, an adapter will need to be used to plug them into the audio jacks.

IMB-C2160 Micro-ATX Motherboard

- **Line In port (Light Blue):** Connects a CD-ROM, DVD player, or other audio devices.
- **Line Out port (Lime):** Connects to a headphone or a speaker.
- **Microphone (Pink):** Connects a microphone.

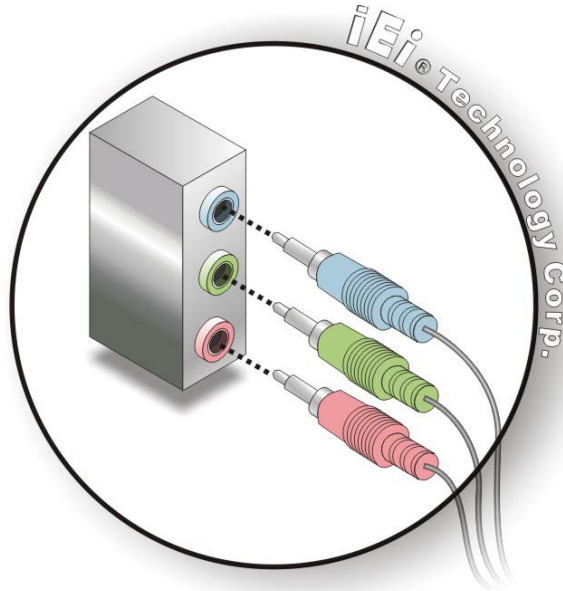

Figure 4-14: Audio Connector

Step 3: Check audio clarity. Check that the sound is coming through the right speakers by adjusting the balance front to rear and left to right.

4.6.2 LAN Connection

There are two external RJ-45 LAN connectors. The RJ-45 connectors enable connection to an external network. To connect a LAN cable with an RJ-45 connector, please follow the instructions below.

Step 1: Locate the RJ-45 connectors. The locations of the USB connectors are shown in **Chapter 3**.

Step 2: Align the connectors. Align the RJ-45 connector on the LAN cable with one of the RJ-45 connectors on the IMB-C2160. See **Figure 4-15**.

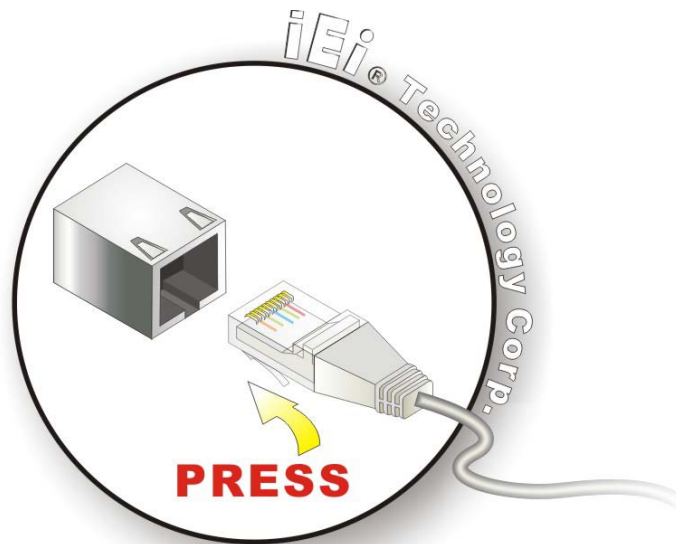

Figure 4-15: LAN Connection

Step 3: Insert the LAN cable RJ-45 connector. Once aligned, gently insert the LAN cable RJ-45 connector into the on-board RJ-45 connector.

4.6.3 PS/2 Y-Cable Connection

The IMB-C2160 has a PS/2 connector on the external peripheral interface panel. The dual PS/2 connector is connected to the PS/2 Y-cable that came with the IMB-C2160. One of the PS/2 cables is connected to a keyboard and the other to a mouse to the system. Follow the steps below to connect a keyboard and mouse to the IMB-C2160.

Step 1: Locate the dual PS/2 connector. The location of the PS/2 connector is shown in **Chapter 3**.

Step 2: Insert the keyboard/mouse connector. Insert the PS/2 connector on the end of the PS/2 y-cable into the external PS/2 connector. See **Figure 4-16**.

IMB-C2160 Micro-ATX Motherboard

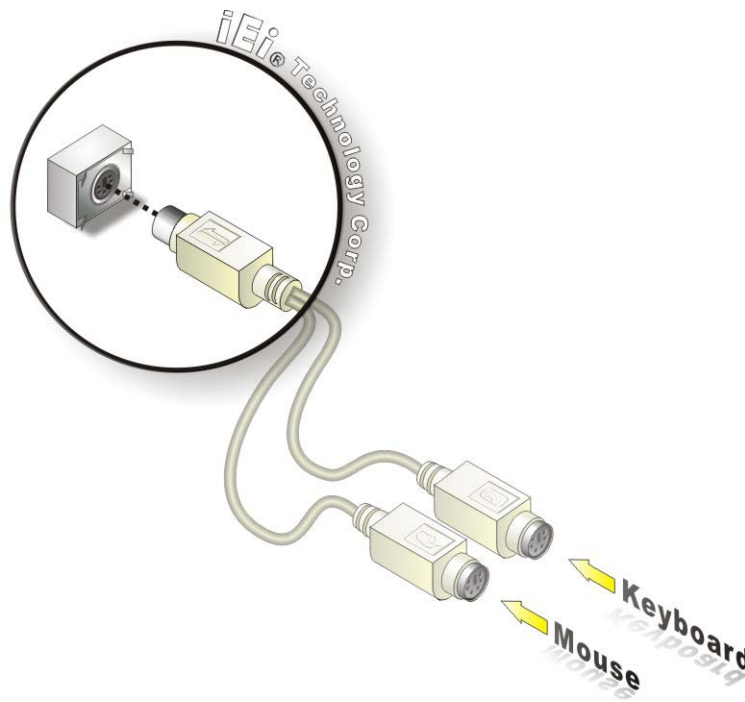

Figure 4-16: PS/2 Keyboard/Mouse Connector

Step 3: Connect the keyboard and mouse. Connect the keyboard and mouse to the appropriate connector. The keyboard and mouse connectors can be distinguished from each other by looking at the small graphic at the top of the connector.

4.6.4 Serial Device Connection

The IMB-C2160 has one DB-9 male connector on the external peripheral interface panel for serial devices. Follow the steps below to connect serial devices to the IMB-C2160.

Step 1: Locate the DB-9 connector. The location of the DB-9 connector is shown in **Chapter 3**.

Step 2: Insert the serial connector. Insert the DB-9 connector of a serial device into the DB-9 connector on the external peripheral interface. See **Figure 4-17**.

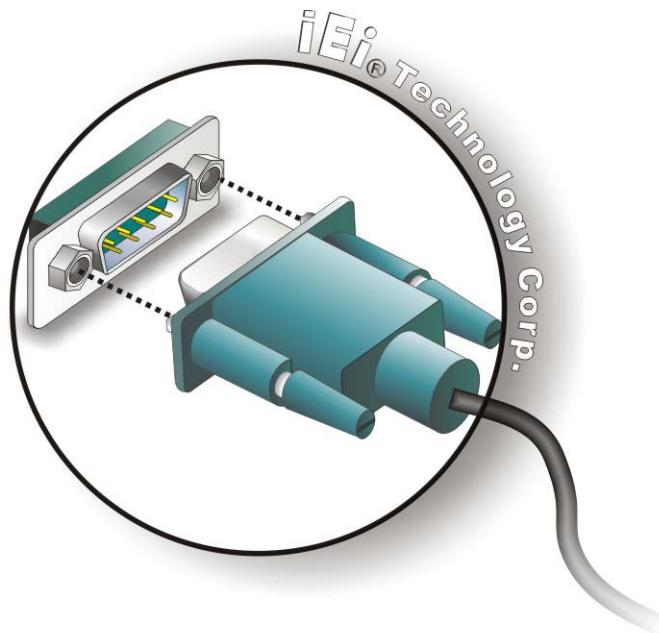

Figure 4-17: Serial Device Connector

Step 3: Secure the connector. Secure the serial device connector to the external interface by tightening the two retention screws on either side of the connector.

4.6.5 USB Connection

The external USB Series "A" receptacle connectors provide easier and quicker access to external USB devices. Follow the steps below to connect USB devices to the IMB-C2160.

Step 1: Locate the USB Series "A" receptacle connectors. The location of the USB Series "A" receptacle connectors are shown in **Chapter 3**.

Step 2: Insert a USB Series "A" plug. Insert the USB Series "A" plug of a device into the USB Series "A" receptacle on the external peripheral interface. See **Figure 4-18**.

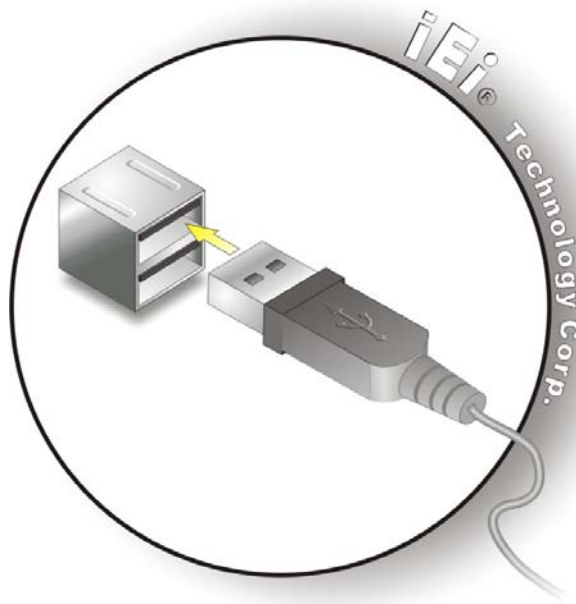

Figure 4-18: USB Connector

4.6.6 VGA Monitor Connection

The IMB-C2160 has two female DB-15 connectors on the external peripheral interface panel. The DB-15 connector is connected to a CRT or VGA monitor. To connect a monitor to the IMB-C2160, please follow the instructions below.

- Step 1: Locate the female DB-15 connector.** The location of the female DB-15 connector is shown in **Chapter 3**.
- Step 2: Align the VGA connector.** Align the male DB-15 connector on the VGA screen cable with the female DB-15 connector on the external peripheral interface.
- Step 3: Insert the VGA connector** Once the connectors are properly aligned with the insert the male connector from the VGA screen into the female connector on the IMB-C2160. See **Figure 4-19**.

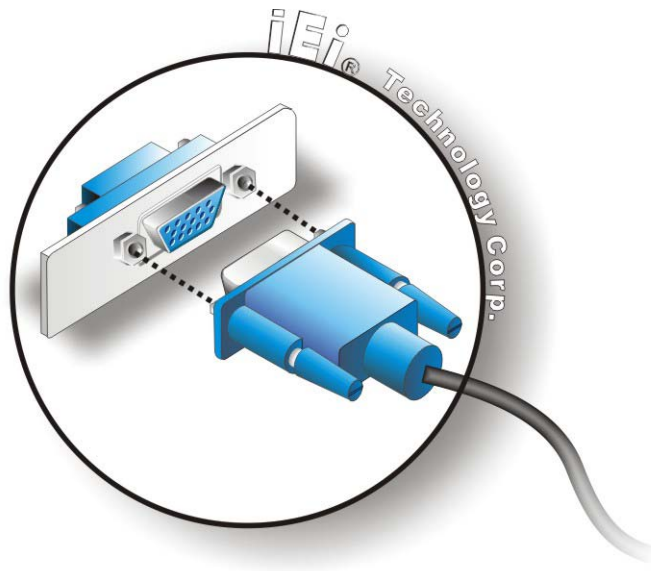

Figure 4-19: VGA Connector

- Step 4:** **Secure the connector.** Secure the DB-15 VGA connector from the VGA monitor to the external interface by tightening the two retention screws on either side of the connector.

Chapter

5

BIOS

5.1 Introduction

The BIOS is programmed onto the BIOS chip. The BIOS setup program allows changes to certain system settings. This chapter outlines the options that can be changed.

5.1.1 Starting Setup

The UEFI BIOS is activated when the computer is turned on. The setup program can be activated in one of two ways.

1. Press the **DELETE** or **F2** key as soon as the system is turned on or
2. Press the **DELETE** or **F2** key when the “**Press Del to enter SETUP**” message appears on the screen.

If the message disappears before the **DELETE** or **F2** key is pressed, restart the computer and try again.

5.1.2 Using Setup

Use the arrow keys to highlight items, press **ENTER** to select, use the PageUp and PageDown keys to change entries, press **F1** for help and press **ESC** to quit. Navigation keys are shown in.

Key	Function
Up arrow	Move to the item above
Down arrow	Move to the item below
Left arrow	Move to the item on the left hand side
Right arrow	Move to the item on the right hand side
+	Increase the numeric value or make changes
-	Decrease the numeric value or make changes
Page up	Move to the next page
Page down	Move to the previous page

Key	Function
Esc	Main Menu – Quit and do not save changes into CMOS Status Page Setup Menu and Option Page Setup Menu -- Exit current page and return to Main Menu
F1	General help, only for Status Page Setup Menu and Option Page Setup Menu
F9	Load optimized defaults
F10	Save changes and Exit BIOS

Table 5-1: BIOS Navigation Keys

5.1.3 Getting Help

When **F1** is pressed a small help window describing the appropriate keys to use and the possible selections for the highlighted item appears. To exit the Help Window press **Esc** or the **F1** key again.

5.1.4 Unable to Reboot after Configuration Changes

If the computer cannot boot after changes to the system configuration is made, CMOS defaults. Use the jumper described in Chapter 4.

5.1.5 BIOS Menu Bar

The **menu bar** on top of the BIOS screen has the following main items:

- Main – Changes the basic system configuration.
- Advanced – Changes the advanced system settings.
- Chipset – Changes the chipset settings.
- Boot – Changes the system boot configuration.
- Security – Sets User and Supervisor Passwords.
- Save & Exit – Selects exit options and loads default settings

The following sections completely describe the configuration options found in the menu items at the top of the BIOS screen and listed above.

5.2 Main

The **Main** BIOS menu (**BIOS Menu 1**) appears when the **BIOS Setup** program is entered. The **Main** menu gives an overview of the basic system information.

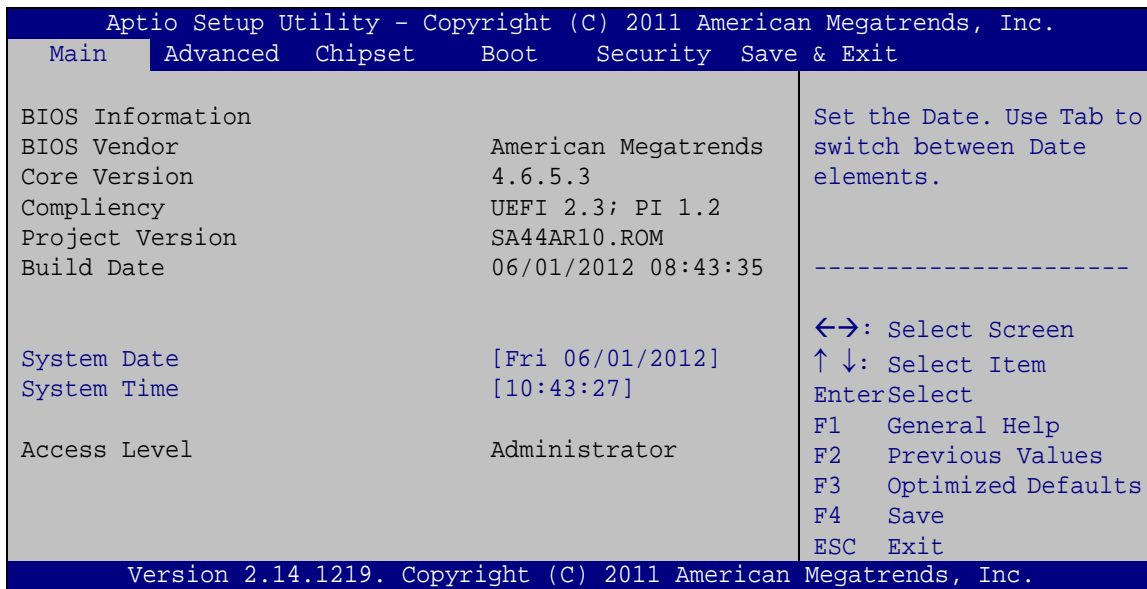

BIOS Menu 1: Main

→ BIOS Information

The **BIOS Information** lists a brief summary of the BIOS. The fields in **BIOS Information** cannot be changed. The items shown in the system overview include:

- **BIOS Vendor:** Installed BIOS vendor
- **Core Version:** Current BIOS version
- **Compliency:** Current compliant version
- **Project Version:** the board version
- **Build Date and Time:** Date and time the current BIOS version was made

The System Overview field also has two user configurable fields:

→ System Date [xx/xx/xx]

Use the **System Date** option to set the system date. Manually enter the day, month and year.

IMB-C2160 Micro-ATX Motherboard

→ System Time [xx:xx:xx]

Use the **System Time** option to set the system time. Manually enter the hours, minutes and seconds.

5.3 Advanced

Use the **Advanced** menu (**BIOS Menu 2**) to configure the CPU and peripheral devices through the following sub-menus:



WARNING!

Setting the wrong values in the sections below may cause the system to malfunction. Make sure that the settings made are compatible with the hardware.

```

Aptio Setup Utility - Copyright (C) 2011 American Megatrends, Inc.
Main  Advanced  Chipset  Boot  Security  Save & Exit
-----
> RTC Wake Settings                Enabled system to wake
> Trusted Computing                from Soft-off,S3,S4,
> CPU Configuration                S5,using RTC alarm
> SATA Configuration
> Intel(R) Rapid Start Technology
> Intel TXT(LT) Configuration
> AMT Configuration
> USB Configuration
> F81216 Second Super IO Configuration
> F81866 Super IO Configuration
> F81866 H/M Monitor
> Serial Port Console Redirection
> iEi Feature
-----
<=>: Select Screen
↑ ↓: Select Item
Enter>Select
F1  General Help
F2  Previous Values
F3  Optimized Defaults
F4  Save
ESC Exit
Version 2.14.1219. Copyright (C) 2011 American Megatrends, Inc.

```

BIOS Menu 2: Advanced

5.3.1 RTC Wake Settings

The **RTC Wake Settings** menu (**BIOS Menu 3**) configures RTC wake event.

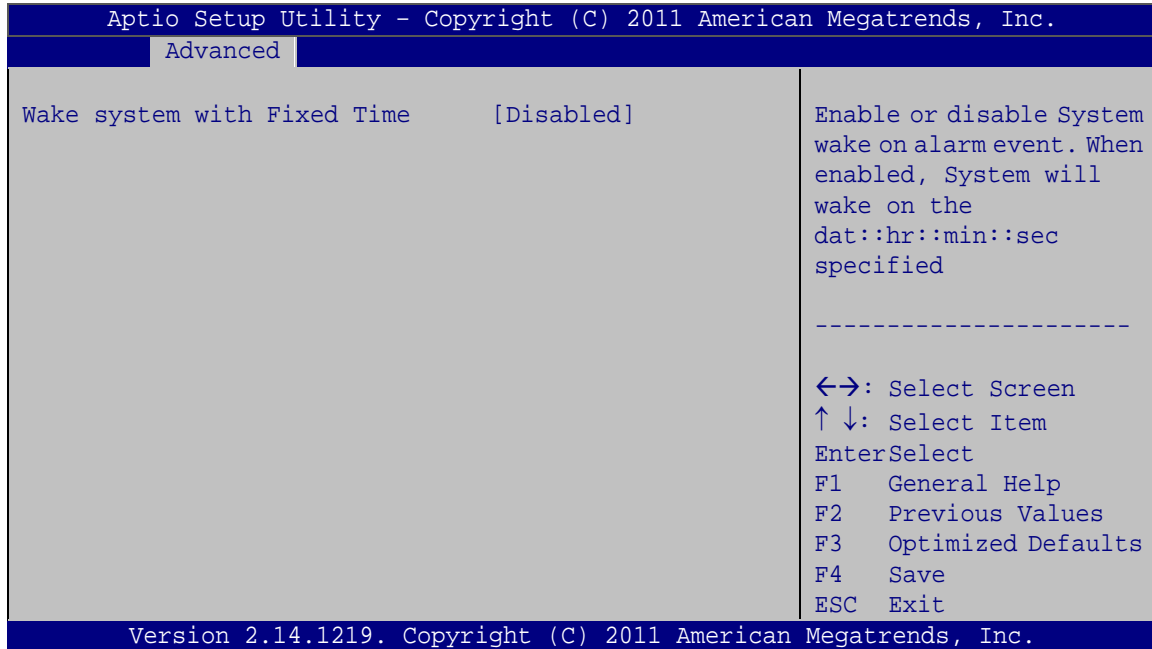
BIOS Menu 3: RTC Wake Settings

→ Wake system with Fixed Time [Disabled]

Use the **Wake system with Fixed Time** option to enable or disable the system wake on alarm event.

→ **Disabled** **DEFAULT** The real time clock (RTC) cannot generate a wake event

→ **Enabled** If selected, the **Wake up every day** option appears allowing you to enable to disable the system to wake every day at the specified time. Besides, the following options appear with values that can be selected:

Wake up date

Wake up hour

Wake up minute

Wake up second

After setting the alarm, the computer turns itself on from a suspend state when the alarm goes off.

5.3.2 Trusted Computing

Use the **Trusted Computing** menu (**BIOS Menu 4**) to configure settings related to the Trusted Computing Group (TCG) Trusted Platform Module (TPM).

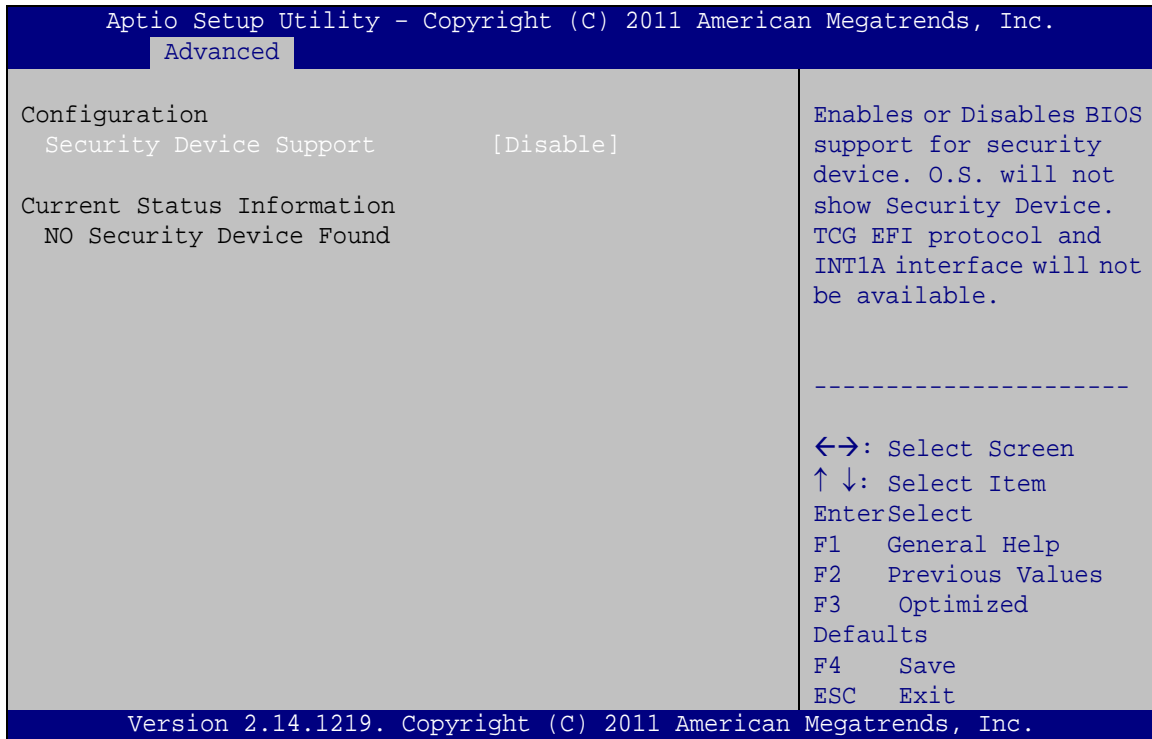

BIOS Menu 4: Trusted Computing

➔ Security Device Support [Disable]

Use the **Security Device Support** option to configure support for the TPM.

➔ **Disable** **DEFAULT** TPM support is disabled.

➔ **Enable** TPM support is enabled.

5.3.3 CPU Configuration

Use the **CPU Configuration** menu (**BIOS Menu 5**) to view detailed CPU specifications and configure the CPU.

```

Aptio Setup Utility - Copyright (C) 2011 American Megatrends, Inc.
  Advanced
CPU Configuration
Intel(R) Core(TM) i5-2500T CPU @ 2.30GHz
CPU Signature                206a7
Microcode Patch              26
Max CPU Speed                 2300 MHz
Min CPU Speed                 1600 MHz
CPU Speed                     2300 MHz
Processor Cores                4
Intel HT Technology           Not Supported
Intel VT-x Technology         Supported
Intel SMX Technology           Supported
64-bit                         Supported

L1 Data Cache                 32 KB x 4
L1 Code Cache                 32 KB x 4
L2 Cache                      256 KB x 4
L3 Cache                      6144 KB

Intel Virtualization Technology [Disabled]

When enabled, a VMM can utilize the additional hardware capabilities provided by Vanderpool Technology

-----
<->: Select Screen
↑ ↓: Select Item
Enter>Select
F1   General Help
F2   Previous Values
F3   Optimized
Defaults
F4   Save
ESC  Exit

Version 2.14.1219. Copyright (C) 2011 American Megatrends, Inc.
  
```

BIOS Menu 5: CPU Configuration

The CPU Configuration menu (**BIOS Menu 5**) lists the following CPU details:

- Processor Type: Lists the brand name of the CPU being used
- CPU Signature: Lists the CPU signature value.
- Microcode Patch: Lists the microcode patch being used.
- Max CPU Speed: Lists the maximum CPU processing speed.
- Min CPU Speed: Lists the minimum CPU processing speed.
- CPU Speed: Lists the CPU processing speed
- Processor Core: Lists the number of the processor cores
- Intel HT Technology: Indicates if Intel HT Technology is supported by the CPU.

5.3.4 SATA Configuration

Use the **SATA Configuration** menu (**BIOS Menu 6**) to change and/or set the configuration of the SATA devices installed in the system.

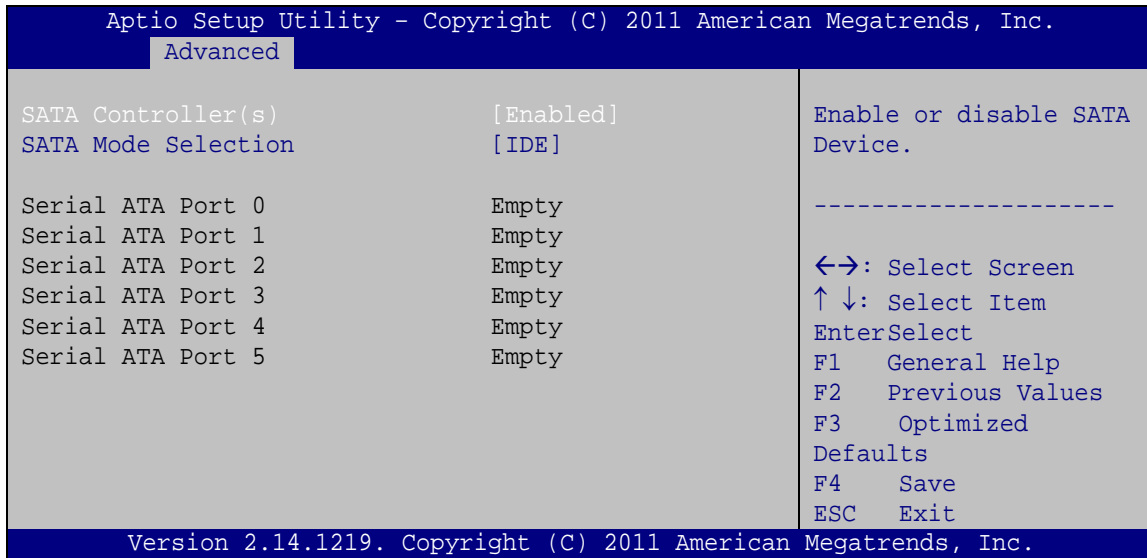

BIOS Menu 6: SATA Configuration

→ SATA Controller [Enabled]

Use the **SATA Controller** option to enable or disable the SATA device.

- **Disabled** Disables the SATA device.
- **Enabled** **DEFAULT** Enables the SATA device.

→ SATA Mode Selection [IDE]

Use the **SATA Mode Selection** option to configure SATA devices as normal IDE devices.

- **IDE** **DEFAULT** Configures SATA devices as normal IDE device.
- **AHCI** Configures SATA devices as AHCI device.
- **RAID** Configures SATA devices as RAID device.

IMB-C2160 Micro-ATX Motherboard

5.3.5 Intel(R) Rapid Start Technology

Use the **Intel(R) Rapid Start Technology** menu to configure Intel® Rapid Start Technology support.

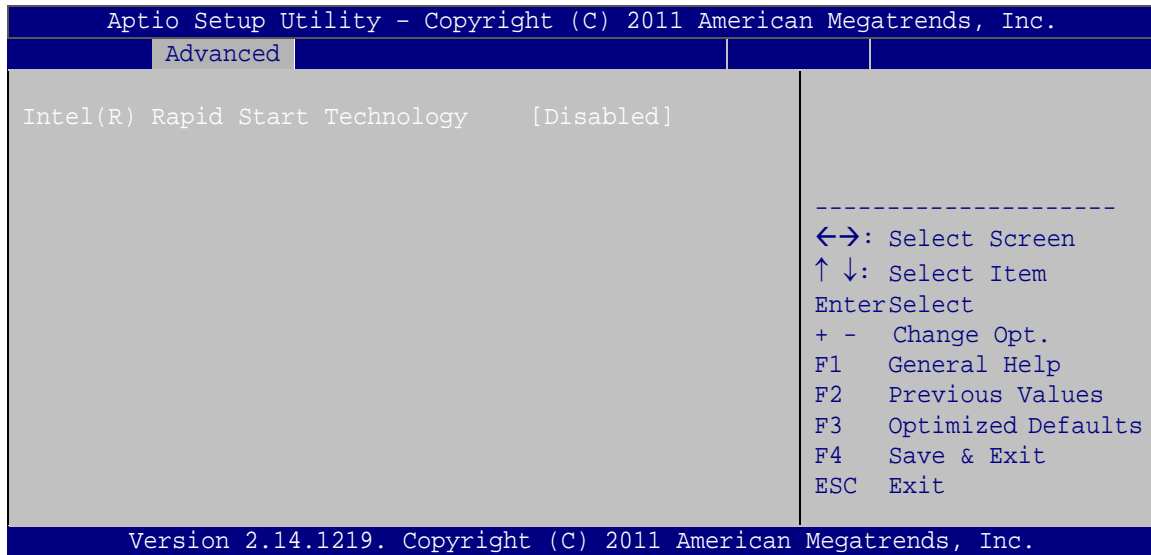

BIOS Menu 7: Intel(R) Rapid Start Technology

→ Intel(R) Rapid Start Technology [Disabled]

Use **Intel(R) Rapid Start Technology** option to enable or disable the Intel® Rapid Start Technology function.

- **Disabled** **DEFAULT** Intel® Rapid Start Technology is disabled
- **Enabled** Intel® Rapid Start Technology is enabled

5.3.6 Intel TXT(LT) Configuration

Use the **Intel TXT(LT) Configuration** menu to configure Intel® Trusted Execution Technology support.

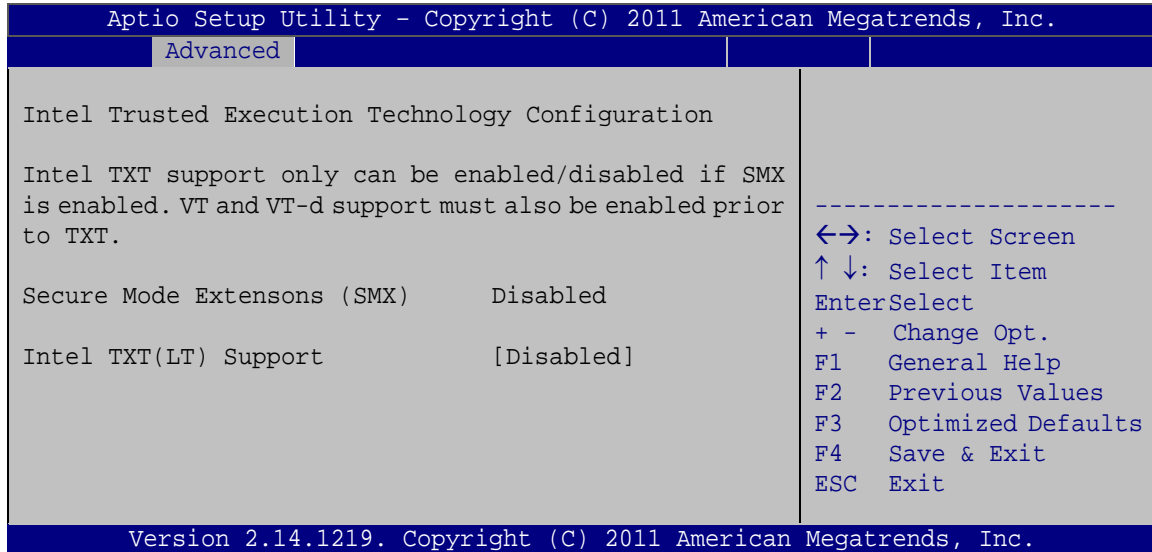
BIOS Menu 8: Intel TXT(LT) Configuration
5.3.7 AMT Configuration

The **AMT Configuration** menu (**BIOS Menu 9**) allows the advanced power management options to be configured.

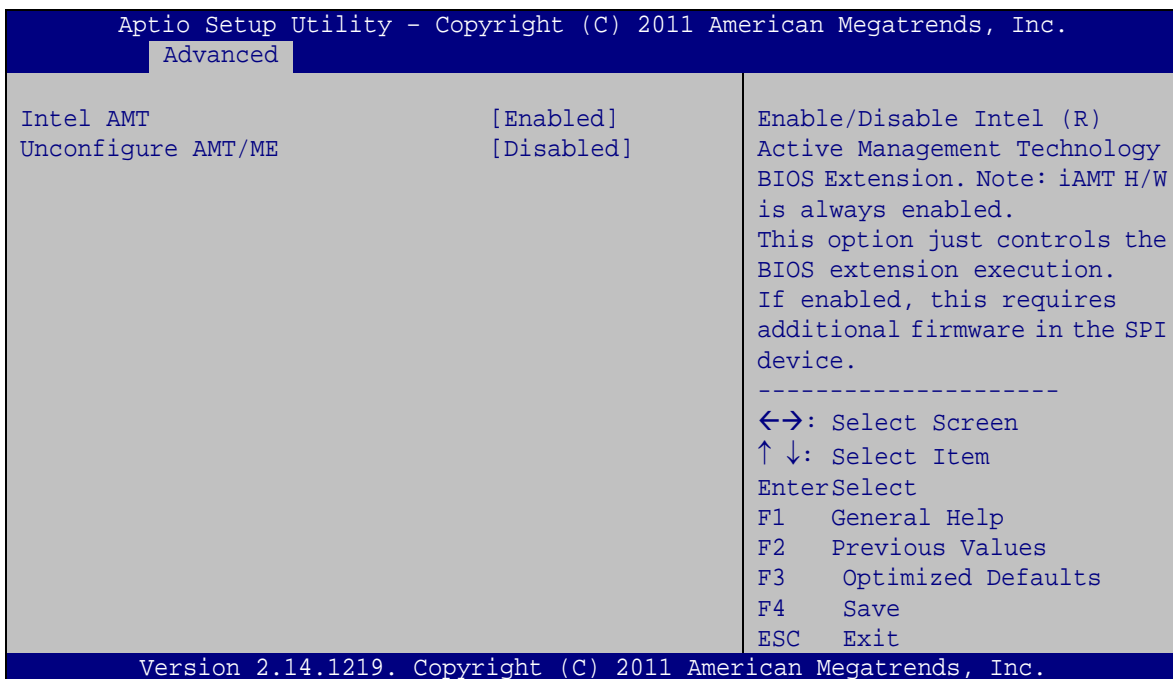
BIOS Menu 9: AMT Configuration

IMB-C2160 Micro-ATX Motherboard

→ Intel AMT [Enabled]

Use **Intel AMT** option to enable or disable the Intel® AMT function.

- **Disabled** Intel® AMT is disabled
- **Enabled** **DEFAULT** Intel® AMT is enabled

→ Unconfigure AMT/ME [Dis abled]

Use the **Unconfigure AMT/ME** option to perform AMT/ME unconfigure without password operation.

- **Disabled** **DEFAULT** Not perform AMT/ME unconfigure
- **Enabled** To perform AMT/ME unconfigure

5.3.8 USB Configuration

Use the **USB Configuration** menu (**BIOS Menu 10**) to read USB configuration information and configure the USB settings.

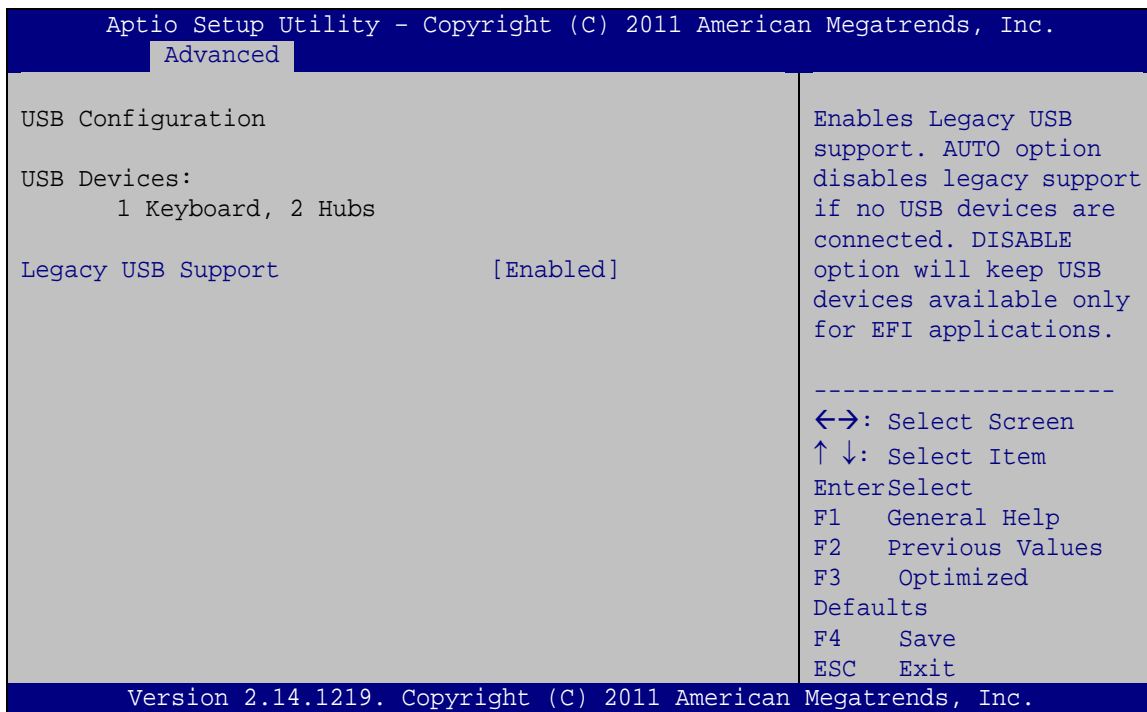

BIOS Menu 10: USB Configuration

➔ **USB Devices**

The **USB Devices Enabled** field lists the USB devices that are enabled on the system

➔ **Legacy USB Support [Enabled]**

Use the **Legacy USB Support** BIOS option to enable USB mouse and USB keyboard support. Normally if this option is not enabled, any attached USB mouse or USB keyboard does not become available until a USB compatible operating system is fully booted with all USB drivers loaded. When this option is enabled, any attached USB mouse or USB keyboard can control the system even when there is no USB driver loaded onto the system.

- ➔ **Enabled** **DEFAULT** Legacy USB support enabled
- ➔ **Disabled** Legacy USB support disabled
- ➔ **Auto** Legacy USB support disabled if no USB devices are connected

5.3.9 F81216 Second Super IO Configuration

The **F81216 Second Super IO Configuration (BIOS Menu 11)** displays IO chip type and the submenus for configuring the external SATA ports 7, 8, 9, and 10.

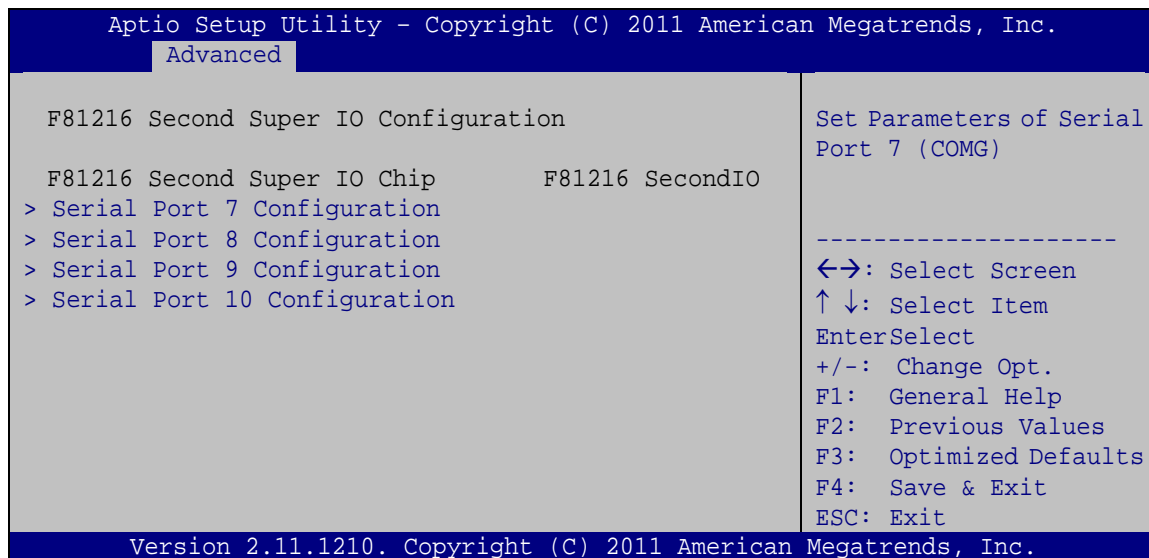

BIOS Menu 11: Secondary Super IO Configuration

IMB-C2160 Micro-ATX Motherboard

5.3.9.1 Serial Port 7 Configuration

→ Serial Port [Enabled]

Use the **Serial Port** option to enable or disable the serial port.

- **Disabled** Disable the serial port
- **Enabled DEFAULT** Enable the serial port

→ Change Settings [Auto]

Use the **Change Settings** option to change the serial port IO port address and interrupt address.

- **Auto DEFAULT** The serial port IO port address and interrupt address are automatically detected.
- **IO=260h;
IRQ=11** Serial Port I/O port address is 260h and the interrupt address is IRQ11
- **IO=260h;
IRQ=10, 11** Serial Port I/O port address is 260h and the interrupt address is IRQ10, 11
- **IO=268h;
IRQ=10, 11** Serial Port I/O port address is 268h and the interrupt address is IRQ10, 11

→ Device Mode [Normal]

Use the Device Mode option to change the serial port mode.

- **Serial Port DEFAULT** Enables the serial port to function in serial port function mode.
- **IR Mode, Pulse** Enables the serial port to function in IR mode, pulse 1.6 us at full duplex
- **IR Mode, Pulse** Enables the serial port to function in IR mode, pulse 1.6 us at half duplex

- ➔ **IR Mode, Pulse 3/16 Bit Time, Full Duplex** Enables the serial port to function in IR mode, pulse 3/16 bit time at full duplex.
- ➔ **IR Mode, Pulse 3/16 Bit Time, Half Duplex** Enables the serial port to function in IR mode, pulse 3/16 bit time at half duplex.

5.3.9.2 Serial Port 8 Configuration

➔ Serial Port [Enabled]

Use the **Serial Port** option to enable or disable the serial port.

- ➔ **Disabled** Disable the serial port
- ➔ **Enabled DEFAULT** Enable the serial port

➔ Change Settings [Auto]

Use the **Change Settings** option to change the serial port IO port address and interrupt address.

- ➔ **Auto DEFAULT** The serial port IO port address and interrupt address are automatically detected.
- ➔ **IO=268h; Serial Port I/O port address is 268h and the interrupt
IRQ=11 address is IRQ11**
- ➔ **IO=260h; Serial Port I/O port address is 260h and the interrupt
IRQ=10, 11 address is IRQ10, 11**
- ➔ **IO=268h; Serial Port I/O port address is 268h and the interrupt
IRQ=10, 11 address is IRQ10, 11**

5.3.9.3 Serial Port 9 Configuration

➔ Serial Port [Enabled]

Use the **Serial Port** option to enable or disable the serial port.

IMB-C2160 Micro-ATX Motherboard

- ➔ **Disabled** Disable the serial port
- ➔ **Enabled** **DEFAULT** Enable the serial port

➔ Change Settings [Auto]

Use the **Change Settings** option to change the serial port IO port address and interrupt address.

- ➔ **Auto** **DEFAULT** The serial port IO port address and interrupt address are automatically detected.
- ➔ **IO=270h;**
IRQ=11 Serial Port I/O port address is 270h and the interrupt address is IRQ11
- ➔ **IO=270h;**
IRQ=10, 11 Serial Port I/O port address is 270h and the interrupt address is IRQ10, 11
- ➔ **IO=2E0h;**
IRQ=10, 11 Serial Port I/O port address is 2E0h and the interrupt address is IRQ10, 11

5.3.9.4 Serial Port 10 Configuration

➔ Serial Port [Enabled]

Use the **Serial Port** option to enable or disable the serial port.

- ➔ **Disabled** Disable the serial port
- ➔ **Enabled** **DEFAULT** Enable the serial port

➔ Change Settings [Auto]

Use the **Change Settings** option to change the serial port IO port address and interrupt address.

- ➔ **Auto** **DEFAULT** The serial port IO port address and interrupt address are automatically detected.
- ➔ **IO=2E0h;**
IRQ=11 Serial Port I/O port address is 2E0h and the interrupt address is IRQ11

- ➔ **IO=270h;** Serial Port I/O port address is 270h and the interrupt address is IRQ10, 11
IRQ=10, 11
- ➔ **IO=2E0h;** Serial Port I/O port address is 2E0h and the interrupt address is IRQ10, 11
IRQ=10, 11

5.3.10 F81866 Super IO Configuration

Use the **F81866 Super IO Configuration** menu (**BIOS Menu 12**) to set or change the configurations for the serial ports.

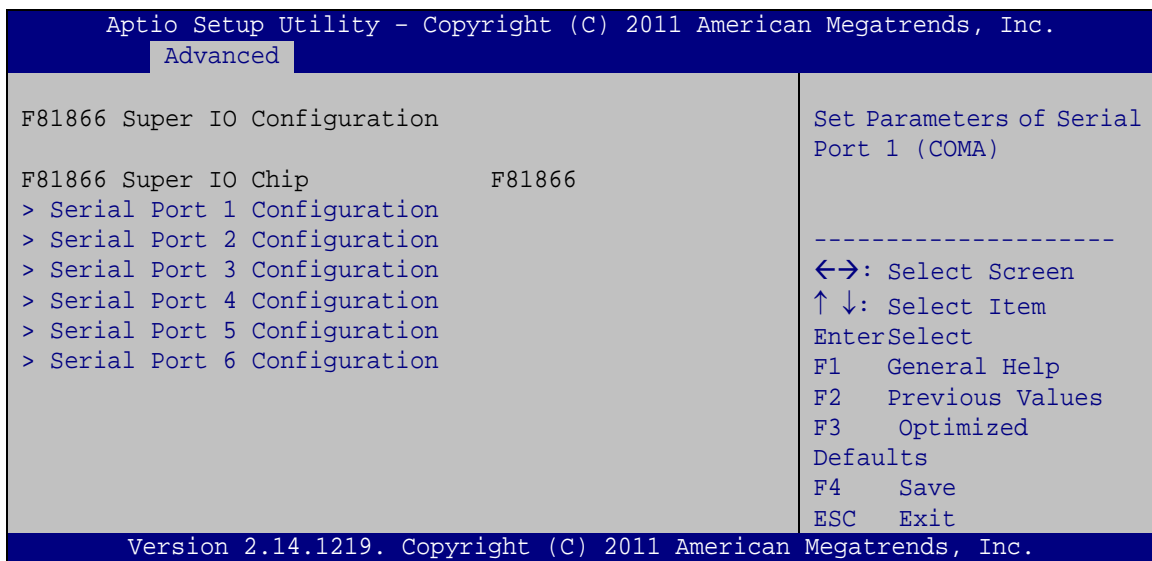

BIOS Menu 12: Super IO Configuration

IMB-C2160 Micro-ATX Motherboard

5.3.10.1 Serial Port n Configuration

Use the **Serial Port n Configuration** menu (**BIOS Menu 13**) to configure the serial port n.

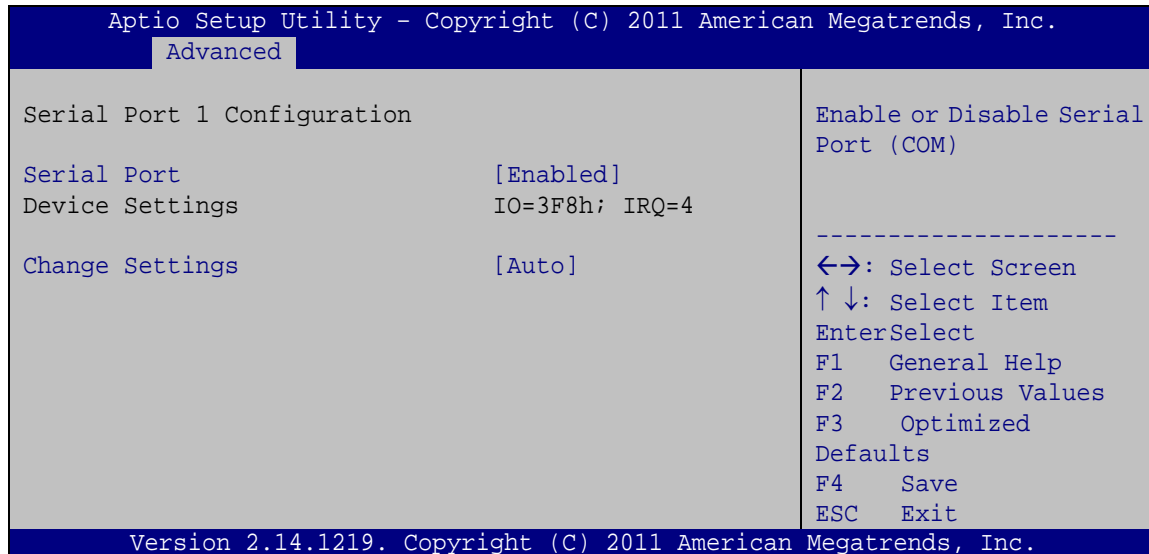

BIOS Menu 13: Serial Port n Configuration Menu

5.3.10.1.1 Serial Port 1 Configuration

→ Serial Port [Enabled]

Use the **Serial Port** option to enable or disable the serial port.

- **Disabled** Disable the serial port
- **Enabled** **DEFAULT** Enable the serial port

→ Change Settings [Auto]

Use the **Change Settings** option to change the serial port IO port address and interrupt address.

- **Auto** **DEFAULT** The serial port IO port address and interrupt address are automatically detected.
- **IO=3F8h;**
IRQ=4 Serial Port I/O port address is 3F8h and the interrupt address is IRQ4

- ➔ **IO=3F8h;**
IRQ=3, 4 Serial Port I/O port address is 3E8h and the interrupt address is IRQ3, 4
- ➔ **IO=2F8h;**
IRQ=3, 4 Serial Port I/O port address is 2F8h and the interrupt address is IRQ3, 4

5.3.10.1.2 Serial Port 2 Configuration

➔ Serial Port [Enabled]

Use the **Serial Port** option to enable or disable the serial port.

- ➔ **Disabled** Disable the serial port
- ➔ **Enabled** **DEFAULT** Enable the serial port

➔ Change Settings [Auto]

Use the **Change Settings** option to change the serial port IO port address and interrupt address.

- ➔ **Auto** **DEFAULT** The serial port IO port address and interrupt address are automatically detected.
- ➔ **IO=2F8h;**
IRQ=3 Serial Port I/O port address is 2F8h and the interrupt address is IRQ3
- ➔ **IO=3F8h;**
IRQ=3, 4 Serial Port I/O port address is 3F8h and the interrupt address is IRQ3, 4
- ➔ **IO=2F8h;**
IRQ=3, 4 Serial Port I/O port address is 2F8h and the interrupt address is IRQ3, 4

5.3.10.1.3 Serial Port 3 Configuration

➔ Serial Port [Enabled]

Use the **Serial Port** option to enable or disable the serial port.

- ➔ **Disabled** Disable the serial port

IMB-C2160 Micro-ATX Motherboard

→ **Enabled** **DEFAULT** Enable the serial port

→ Change Settings [Auto]

Use the **Change Settings** option to change the serial port IO port address and interrupt address.

→ **Auto** **DEFAULT** The serial port IO port address and interrupt address are automatically detected.

→ **IO=2A0h;**
IRQ=10 Serial Port I/O port address is 2A0h and the interrupt address is IRQ10

→ **IO=2A0h;**
IRQ=10, 11 Serial Port I/O port address is 2A0h and the interrupt address is IRQ10, 11

→ **IO=2E8h;**
IRQ=10, 11 Serial Port I/O port address is 2E8h and the interrupt address is IRQ10, 11

5.3.10.1.4 Serial Port 4 Configuration

→ Serial Port [Enabled]

Use the **Serial Port** option to enable or disable the serial port.

→ **Disabled** Disable the serial port

→ **Enabled** **DEFAULT** Enable the serial port

→ Change Settings [Auto]

Use the **Change Settings** option to change the serial port IO port address and interrupt address.

→ **Auto** **DEFAULT** The serial port IO port address and interrupt address are automatically detected.

- ➔ **IO=2E8h;**
IRQ=10 Serial Port I/O port address is 2E8h and the interrupt address is IRQ10
- ➔ **IO=2A0h;**
IRQ=10, 11 Serial Port I/O port address is 2A0h and the interrupt address is IRQ10, 11
- ➔ **IO=2E8h;**
IRQ=10, 11 Serial Port I/O port address is 2E8h and the interrupt address is IRQ10, 11

5.3.10.1.5 Serial Port 5 Configuration

➔ Serial Port [Enabled]

Use the **Serial Port** option to enable or disable the serial port.

- ➔ **Disabled** Disable the serial port
- ➔ **Enabled** **DEFAULT** Enable the serial port

➔ Change Settings [Auto]

Use the **Change Settings** option to change the serial port IO port address and interrupt address.

- ➔ **Auto** **DEFAULT** The serial port IO port address and interrupt address are automatically detected.
- ➔ **IO=2A8h;**
IRQ=10 Serial Port I/O port address is 2A8h and the interrupt address is IRQ10
- ➔ **IO=2A8h;**
IRQ=10, 11 Serial Port I/O port address is 2A8h and the interrupt address is IRQ10, 11
- ➔ **IO=288h;**
IRQ=10, 11 Serial Port I/O port address is 288h and the interrupt address is IRQ10, 11

5.3.10.1.6 Serial Port 6 Configuration

➔ Serial Port [Enabled]

Use the **Serial Port** option to enable or disable the serial port.

- ➔ **Disabled** Disable the serial port
- ➔ **Enabled DEFAULT** Enable the serial port

➔ Change Settings [Auto]

Use the **Change Settings** option to change the serial port IO port address and interrupt address.

- ➔ **Auto DEFAULT** The serial port IO port address and interrupt address are automatically detected.
- ➔ **IO=288h;
IRQ=10** Serial Port I/O port address is 288h and the interrupt address is IRQ10
- ➔ **IO=2A8h;
IRQ=10, 11** Serial Port I/O port address is 2A8h and the interrupt address is IRQ10, 11
- ➔ **IO=288h;
IRQ=10, 11** Serial Port I/O port address is 288h and the interrupt address is IRQ10, 11

5.3.11 F81866 H/W Monitor

The **F8186 H/W Monitor** menu (**BIOS Menu 14**) shows the operating temperature, fan speeds and system voltages.

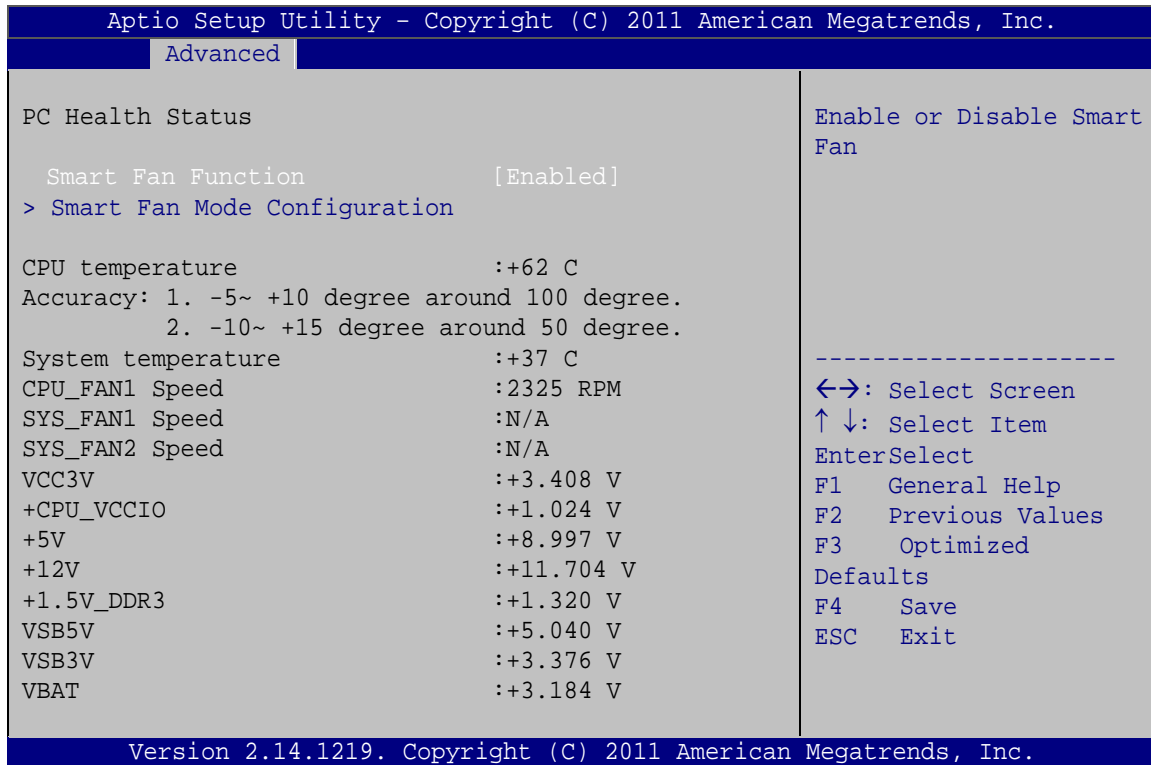

BIOS Menu 14: Hardware Health Configuration

➔ PC Health Status

The following system parameters and values are shown. The system parameters that are monitored are:

- System Temperatures:
 - CPU Temperature
 - System Temperature
- Fan Speeds:
 - CPU_FAN1 Speed
 - SYS_FAN1 Speed
 - SYS_FAN2 Speed
- Voltages:

IMB-C2160 Micro-ATX Motherboard

- VCC3V
- +CPU_VCCIO
- +5V
- +12V
- +1.5V_DDR3
- VSB5V
- VSB3V
- VBAT

➔ Smart Fan Function [Enabled]

Use the **Smart Fan Function** option to enable or disable the smart fan function.

- ➔ **Disabled** Disables the smart fan function.
- ➔ **Enabled** **DEFAULT** Enables the smart fan function.

5.3.11.1 Smart Fan Mode Configuration

Use the **Smart Fan Mode Configuration** submenu (**BIOS Menu 15**) to configure the smart fan temperature and speed settings.

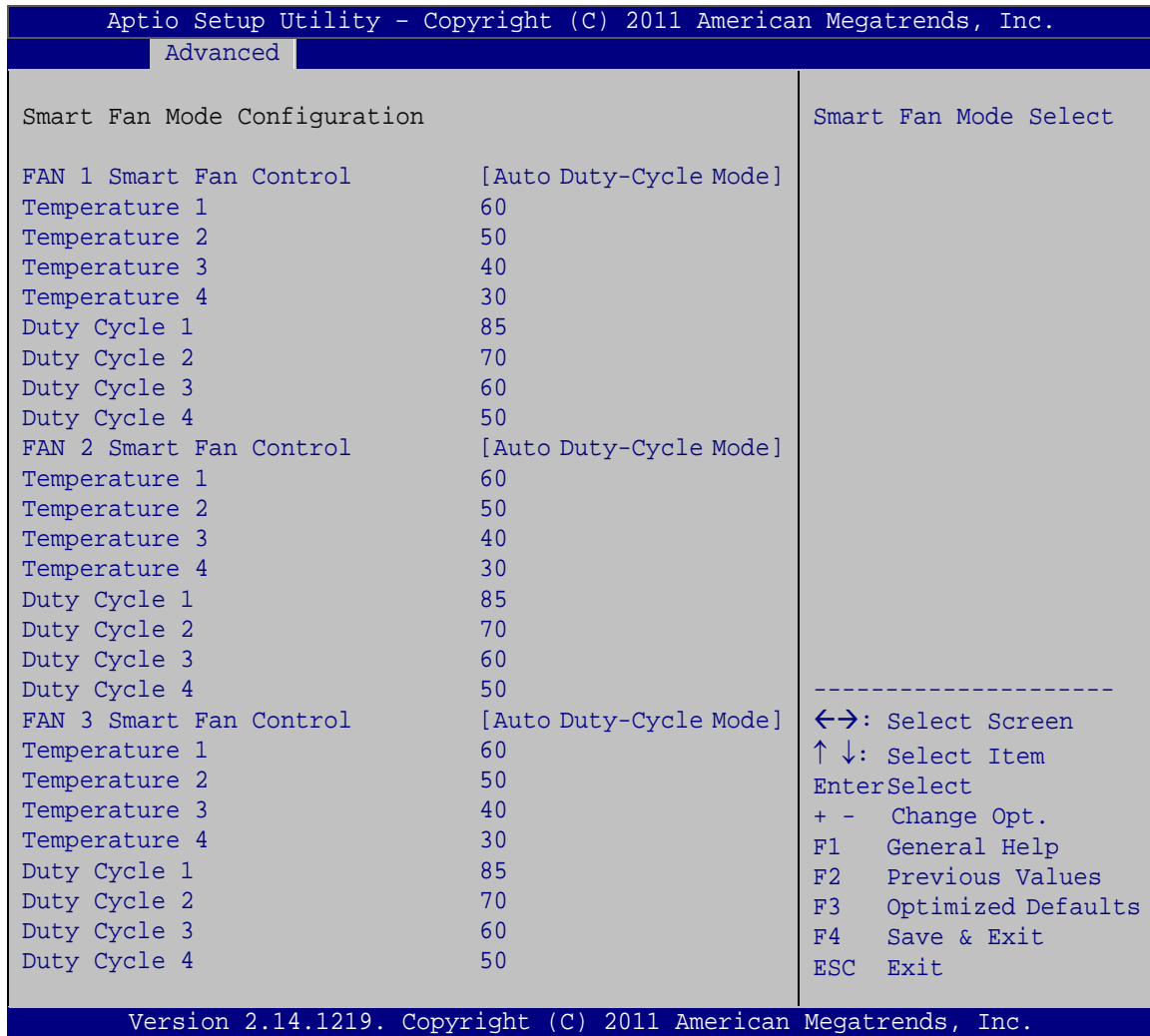

BIOS Menu 15: FAN 1 Configuration

→ FAN 1 Smart Fan Control [Auto Duty-Cycle Mode]

Use the **FAN 1 Smart Fan Control** option to configure the FAN 1 Smart Fan.

- **Manual RPM Mode** The fan spins at the speed set in Manual by RPM settings
- **Manual Duty Mode** The fan spins at the speed set in Manual by Duty Cycle settings
- **Auto RPM Mode** The fan adjusts its speed using Auto by RPM settings

IMB-C2160 Micro-ATX Motherboard

→ **Auto Duty-Cycle Mode** **DEFAULT** The fan adjusts its speed using Auto by Duty-Cycle settings

→ FAN 2 Smart Fan Control [Auto Duty-Cycle Mode]

Use the **FAN 2 Smart Fan Control** option to configure the FAN 2 Smart Fan.

→ **Manual Mode** **RPM** The fan spins at the speed set in Manual by RPM settings

→ **Manual Mode** **Duty** The fan spins at the speed set in Manual by Duty Cycle settings

→ **Auto RPM Mode** The fan adjusts its speed using Auto by RPM settings

→ **Auto Duty-Cycle Mode** **DEFAULT** The fan adjusts its speed using Auto by Duty-Cycle settings

→ FAN 3 Smart Fan Control [Auto Duty-Cycle Mode]

Use the **FAN 3 Smart Fan Control** option to configure the FAN 3 Smart Fan.

→ **Manual Mode** **RPM** The fan spins at the speed set in Manual by RPM settings

→ **Manual Mode** **Duty** The fan spins at the speed set in Manual by Duty Cycle settings

→ **Auto RPM Mode** The fan adjusts its speed using Auto by RPM settings

→ **Auto Duty-Cycle Mode** **DEFAULT** The fan adjusts its speed using Auto by Duty-Cycle settings

→ Temperature n

Use the + or – key to change the fan **Temperature n** value. Enter a decimal number between 1 and 100.

→ Duty Cycle n

Use the + or – key to change the fan **Duty Cycle n** value. Enter a decimal number between 1 and 100.

5.3.12 Serial Port Console Redirection

The **Serial Port Console Redirection** menu (**BIOS Menu 16**) allows the console redirection options to be configured. Console redirection allows users to maintain a system remotely by re-directing keyboard input and text output through the serial port.

IMB-C2160 Micro-ATX Motherboard

```

Aptio Setup Utility - Copyright (C) 2011 American Megatrends, Inc.
  Advanced
COM1
  Console Redirection      [Disabled]      Console Redirection
  > Console Redirection Settings      Enable or Disable

COM2
  Console Redirection      [Disabled]
  > Console Redirection Settings

COM3
  Console Redirection      [Disabled]
  > Console Redirection Settings

COM4
  Console Redirection      [Disabled]
  > Console Redirection Settings

COM5
  Console Redirection      [Disabled]
  > Console Redirection Settings

COM6
  Console Redirection      [Disabled]
  > Console Redirection Settings

COM7
  Console Redirection      [Disabled]
  > Console Redirection Settings

COM8
  Console Redirection      [Disabled]
  > Console Redirection Settings

COM9
  Console Redirection      [Disabled]
  > Console Redirection Settings

COM10
  Console Redirection      [Disabled]
  > Console Redirection Settings

COMA(Pci Bus0, Dev0,Func0) (Disabled)
  Console Redirection      Port is Disabled

-----
<=>: Select Screen
↑ ↓: Select Item
Enter>Select
F1   General Help
F2   Previous Values
F3   Optimized
Defaults
F4   Save
ESC  Exit

Version 2.14.1219. Copyright (C) 2011 American Megatrends, Inc.
  
```

BIOS Menu 16: Serial Port Console Redirection

➔ Console Redirection [Disabled]

Use **Console Redirection** option to enable or disable the console redirection function.

- ➔ **Disabled** **DEFAULT** Disabled the console redirection function
- ➔ **Enabled** Enabled the console redirection function

5.3.13 IEI Feature

Use the **IEI Feature** menu (**BIOS Menu 17**) to configure One Key Recovery function.

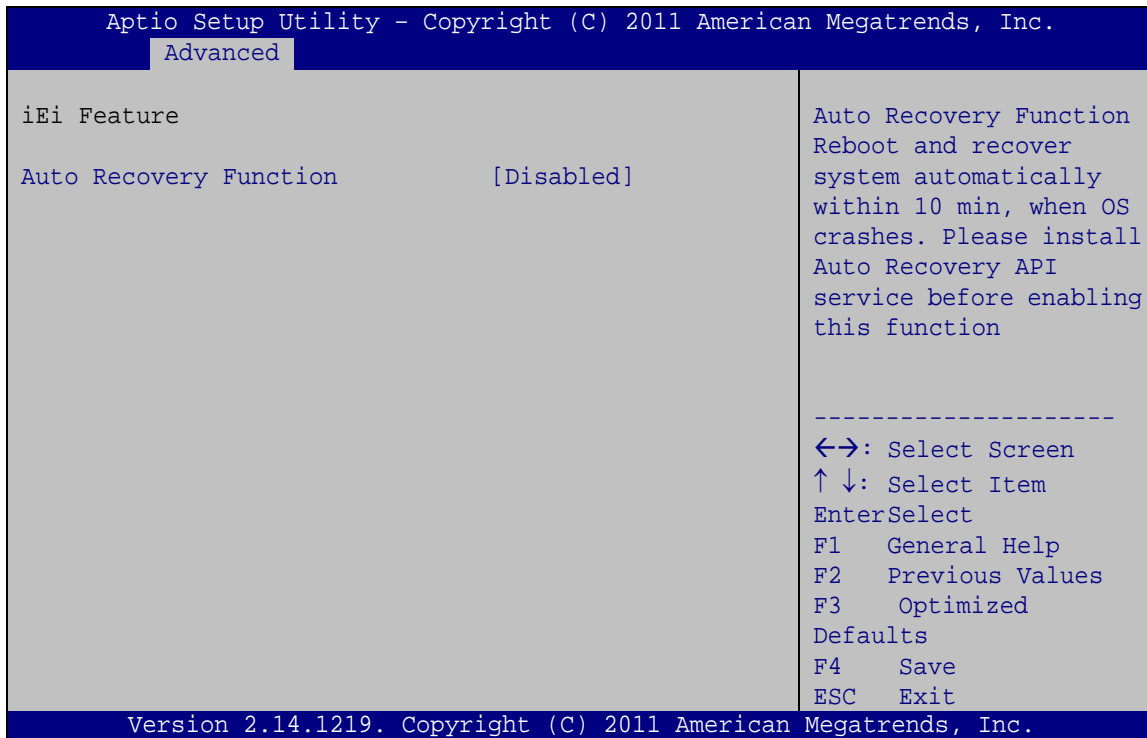

BIOS Menu 17: IEI Feature

- ➔ Auto Recovery Function [Disabled]

Use the **Auto Recovery Function** BIOS option to enable or disable the auto recovery function of the IEI One Key Recovery.

- ➔ **Disabled** **DEFAULT** Auto recovery function disabled
- ➔ **Enabled** Auto recovery function enabled

5.4 Chipset

Use the **Chipset** menu (**BIOS Menu 18**) to access the PCH-IO and System Agent (SA) configuration menus.



WARNING!

Setting the wrong values for the Chipset BIOS selections in the Chipset BIOS menu may cause the system to malfunction.

```
Aptio Setup Utility - Copyright (C) 2011 American Megatrends, Inc.
Main   Advanced  Chipset  Boot   Security  Save & Exit
-----
> PCH-IO Configuration
> System Agent (SA) Configuration

-----
<=>: Select Screen
↑ ↓: Select Item
Enter>Select
F1   General Help
F2   Previous Values
F3   Optimized
Defaults
F4   Save
ESC  Exit

Version 2.14.1219. Copyright (C) 2011 American Megatrends, Inc.
```

BIOS Menu 18: Chipset

5.4.1 PCH-IO Configuration

Use the **PCH-IO Configuration** menu (**BIOS Menu 19**) to configure the PCH chipset.

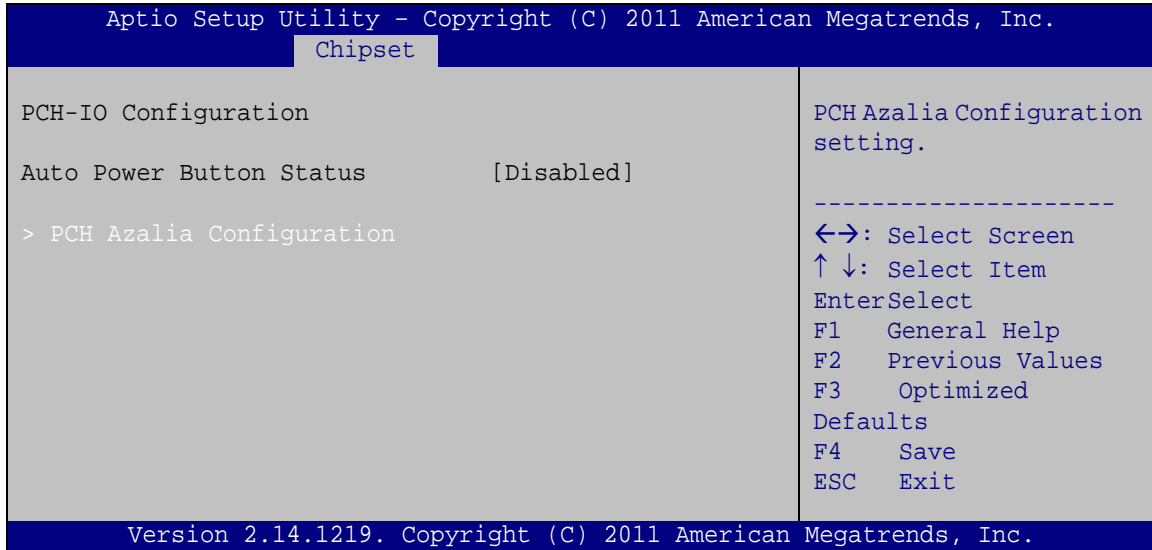

BIOS Menu 19: PCH-IO Configuration

IMB-C2160 Micro-ATX Motherboard

5.4.1.1 PCH Azalia Configuration

Use the **PCH Azalia Configuration** submenu (**BIOS Menu 20**) to configure the PCH Azalia device.

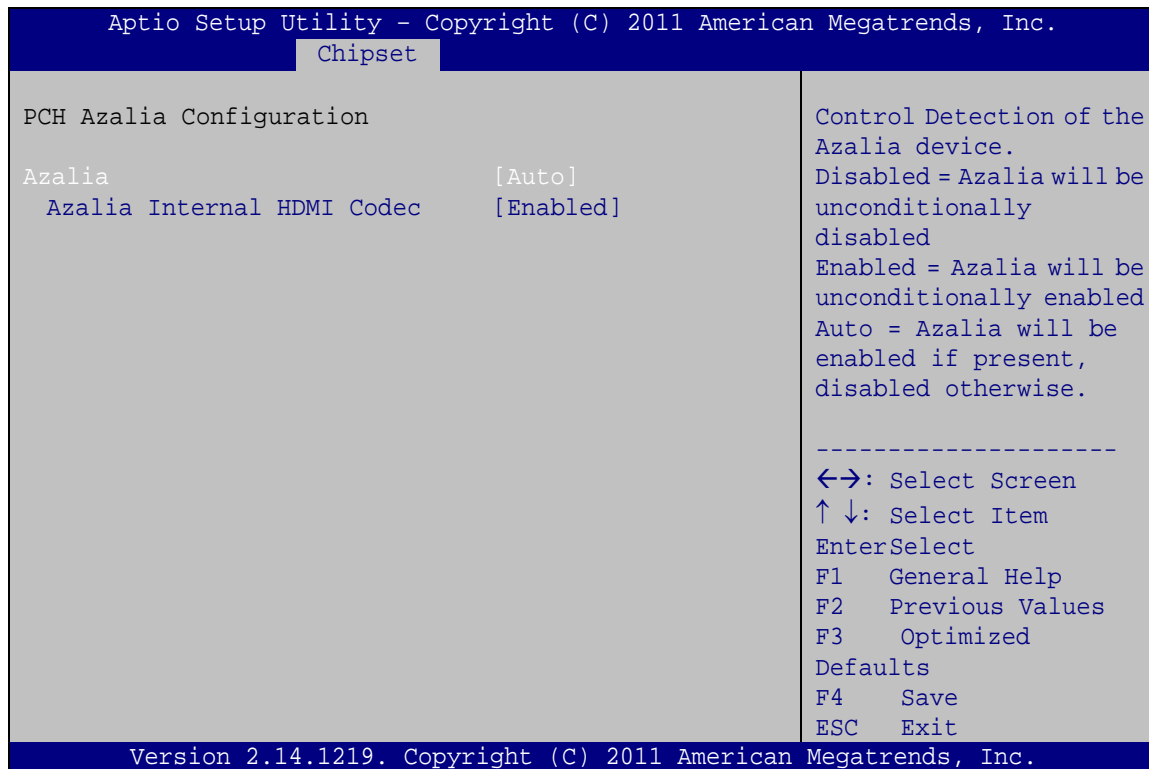

BIOS Menu 20: PCH-IO Configuration

→ Azalia [Auto]

Use the **Azalia** option to enable or disable the High Definition Audio controller.

- **Disabled** The onboard High Definition Audio controller is disabled
- **Enabled** The onboard High Definition Audio controller automatically detected and enabled
- **Auto** **DEFAULT** The onboard High Definition Audio controller automatically detected and enabled

➔ Azalia internal HDMI codec [Enabled]

Use the **Azalia internal HDMI codec** option to enable or disable the internal HDMI codec for High Definition Audio.

- ➔ **Disabled** Disable internal HDMI codec for High Definition Audio
- ➔ **Enabled** **DEFAULT** Enable internal HDMI codec for High Definition Audio

5.4.2 System Agent (SA) Configuration

Use the **System Agent (SA) Configuration** menu (**BIOS Menu 21**) to configure the Southbridge chipset.

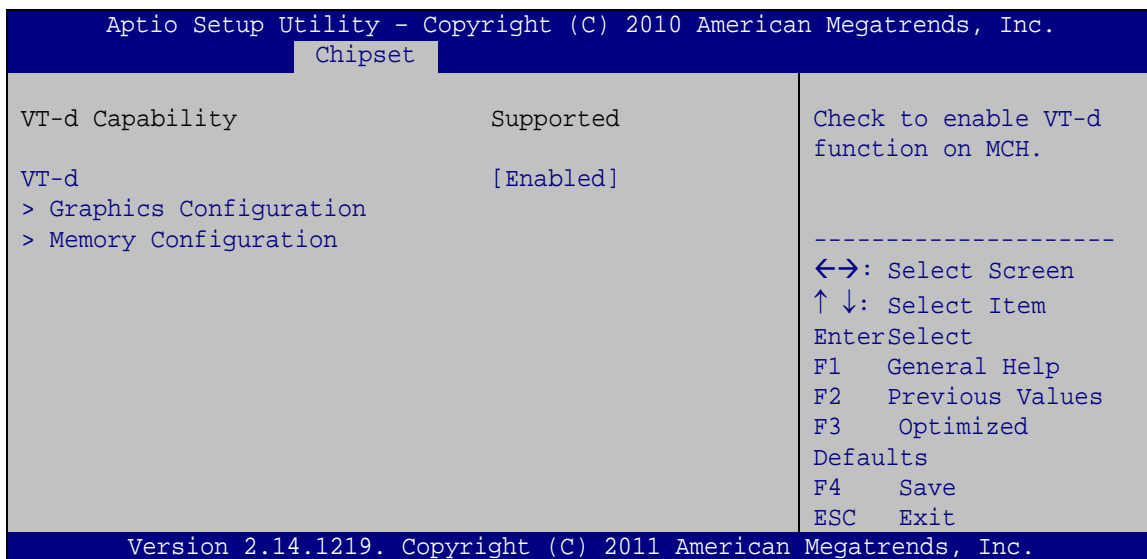

BIOS Menu 21: System Agent (SA) Configuration

➔ VT-d [Enabled]

Use the **VT-d** option to enable or disable VT-d support.

- ➔ **Disabled** Disables VT-d support.
- ➔ **Enabled** **DEFAULT** Enables VT-d support.

5.4.2.1 Graphics Configuration

Use the **Graphics Configuration** menu to configure the video device connected to the system.

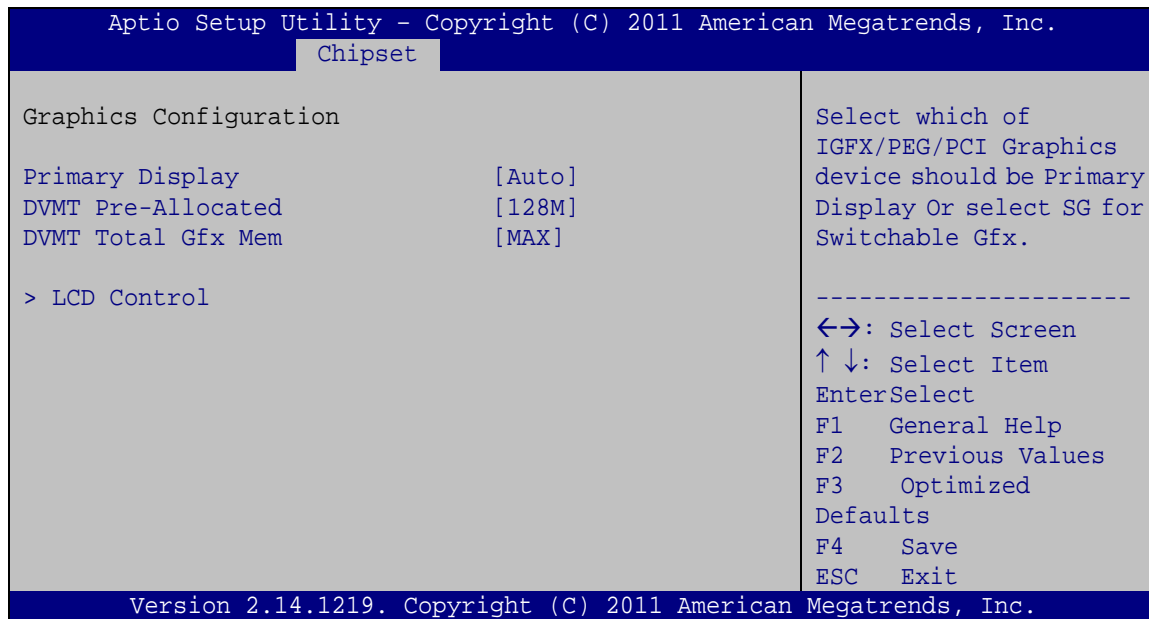

BIOS Menu 22: Graphics Configuration

→ Primary Display [Auto]

Use the **Primary Display** option to select the primary graphics controller the system uses. The following options are available:

- Auto **Default**
- IGFX
- PEG
- PCI

→ DVMT Pre-Allocated [128MB]

Use the **DVMT Pre-Allocated** option to set the amount of system memory allocated to the integrated graphics processor when the system boots. The system memory allocated can then only be used as graphics memory, and is no longer available to applications or the operating system. Configuration options are listed below:

- 32M
- 64M
- 128M **Default**
- 256M
- 512M

➔ DVMT Total Gfx Mem [MAX]

Use the **DVMT Total Gfx Mem** option to select DVMT5.0 total graphic memory size used by the internal graphic device. The following options are available:

- 128M
- 256M
- MAX **Default**

5.4.2.1.1 LCD Control

Use the **LCD Control** menu to configure the video device connected to the system.

IMB-C2160 Micro-ATX Motherboard

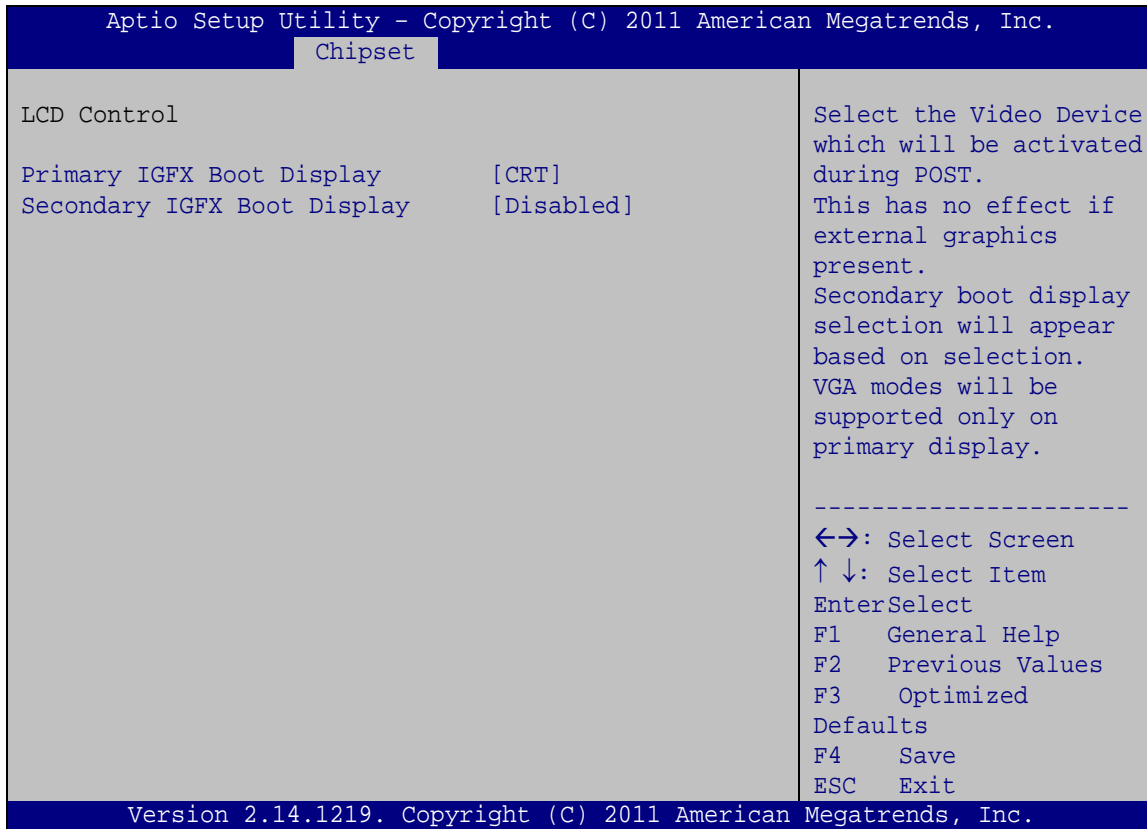

BIOS Menu 23: Graphics Configuration

→ Primary IGFX Boot Display [CRT]

Use the **Primary IGFX Boot Display** option to select the primary graphics controller the system uses. The following options are available:

- CRT **Default**

→ Secondary IGFX Boot Display [Disabled]

Use the **Secondary IGFX Boot Display** option to enable or disable the secondary graphics controller the system uses. The following options are available:

- Disabled **Default**

5.4.2.2 Memory Configuration

Use the **Memory Configuration** submenu (**BIOS Menu 24**) to view memory information.

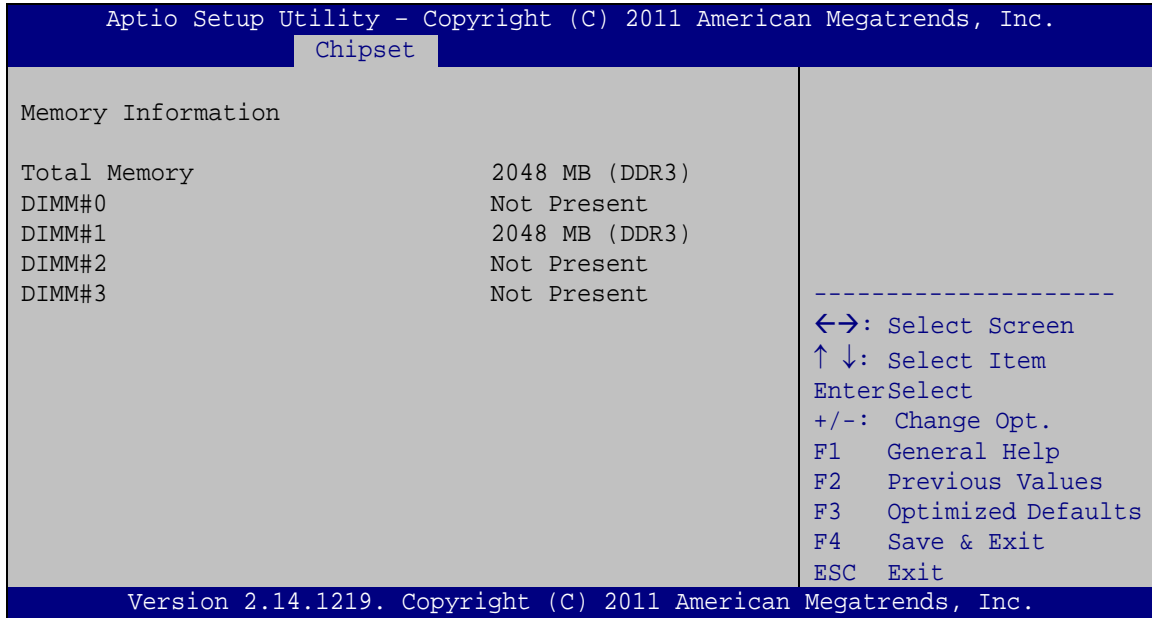
BIOS Menu 24: Memory Configuration

5.5 Boot

Use the **Boot** menu (**BIOS Menu 25**) to configure system boot options.

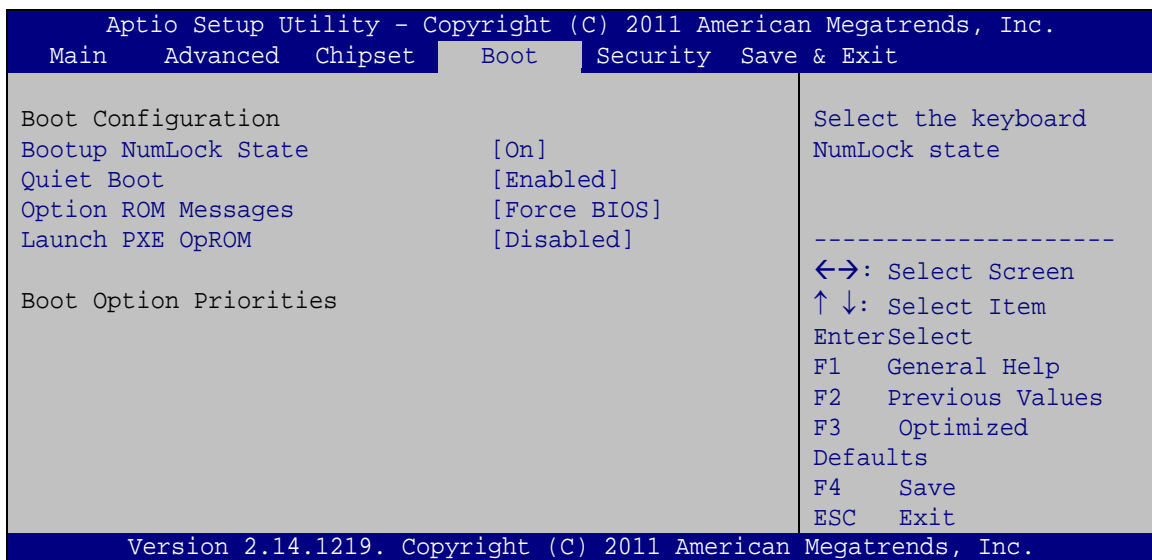
BIOS Menu 25: Boot

IMB-C2160 Micro-ATX Motherboard

→ Bootup NumLock State [On]

Use the **Bootup NumLock State** BIOS option to specify if the number lock setting must be modified during boot up.

- **On** **DEFAULT** Allows the Number Lock on the keyboard to be enabled automatically when the computer system boots up. This allows the immediate use of the 10-key numeric keypad located on the right side of the keyboard. To confirm this, the Number Lock LED light on the keyboard is lit.

- **Off** Does not enable the keyboard Number Lock automatically. To use the 10-keys on the keyboard, press the Number Lock key located on the upper left-hand corner of the 10-key pad. The Number Lock LED on the keyboard lights up when the Number Lock is engaged.

→ Quiet Boot [Enabled]

Use the **Quiet Boot** BIOS option to select the screen display when the system boots.

- **Disabled** Normal POST messages displayed

- **Enabled** **DEFAULT** OEM Logo displayed instead of POST messages

→ Option ROM Messages [Force BIOS]

Use the **Option ROM Messages** option to set the Option ROM display mode.

- **Force BIOS** **DEFAULT** Sets display mode to force BIOS.

- **Keep Current** Sets display mode to current.

➔ **Launch PXE OpROM [Disabled]**

Use the **Launch PXE OpROM** option to enable or disable boot option for legacy network devices.

- ➔ **Disabled** **DEFAULT** Ignore all PXE Option ROMs
- ➔ **Enabled** Load PXE Option ROMs.

5.6 Security

Use the **Security** menu (**BIOS Menu 26**) to set system and user passwords.

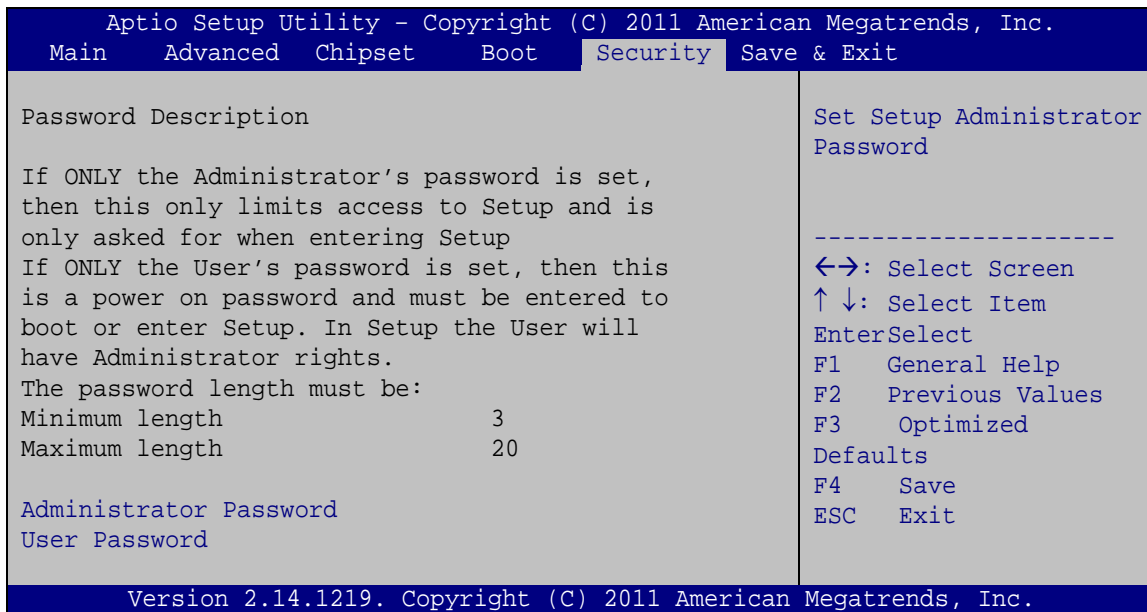

BIOS Menu 26: Security

➔ **Administrator Password**

Use the **Administrator Password** to set or change a administrator password.

➔ **User Password**

Use the **User Password** to set or change a user password.

IMB-C2160 Micro-ATX Motherboard

5.7 Exit

Use the **Exit** menu (**BIOS Menu 27**) to load default BIOS values, optimal failsafe values and to save configuration changes.

```

Aptio Setup Utility - Copyright (C) 2011 American Megatrends, Inc.
Main   Advanced  Chipset   Boot     Security  Save & Exit
-----
Save Changes and Reset
Discard Changes and Reset

Restore Defaults
Save as User Defaults
Restore User Defaults

Reset the system after
saving the changes.

-----
<->: Select Screen
↑ ↓: Select Item
Enter>Select
F1   General Help
F2   Previous Values
F3   Optimized
Defaults
F4   Save
ESC  Exit

Version 2.14.1219. Copyright (C) 2011 American Megatrends, Inc.

```

BIOS Menu 27:Exit

➔ Save Changes and Reset

Use the **Save Changes and Reset** option to save the changes made to the BIOS options and to exit the BIOS configuration setup program.

➔ Discard Changes and Reset

Use the **Discard Changes and Reset** option to exit the system without saving the changes made to the BIOS configuration setup program.

➔ Restore Defaults

Use the **Restore Defaults** option to load the optimal default values for each of the parameters on the Setup menus. **F3 key can be used for this operation.**

➔ Save as User Defaults

Use the **Save as User Defaults** option to save the changes done so far as user defaults.

➔ Restore User Defaults

Use the **Restore User Defaults** option to restore the user defaults to all the setup options.

Chapter

6

Software Drivers

6.1 Available Software Drivers

**NOTE:**

The content of the CD may vary throughout the life cycle of the product and is subject to change without prior notice. Visit the IEI website or contact technical support for the latest updates.

The following drivers can be installed on the system:

- Chipset
- Graphics
- LAN
- Audio
- SATA (Intel® Rapid Storage Technology)
- USB 3.0
- Intel® AMT

Installation instructions are given below.

6.2 Software Installation

All the drivers for the IMB-C2160 are on the CD that came with the system. To install the drivers, please follow the steps below.

Step 1: Insert the CD into a CD drive connected to the system.

**NOTE:**

If the installation program doesn't start automatically:
Click "Start->My Computer->CD Drive->autorun.exe"

Step 2: The driver main menu appears (Figure 6-1).

IMB-C2160 Micro-ATX Motherboard

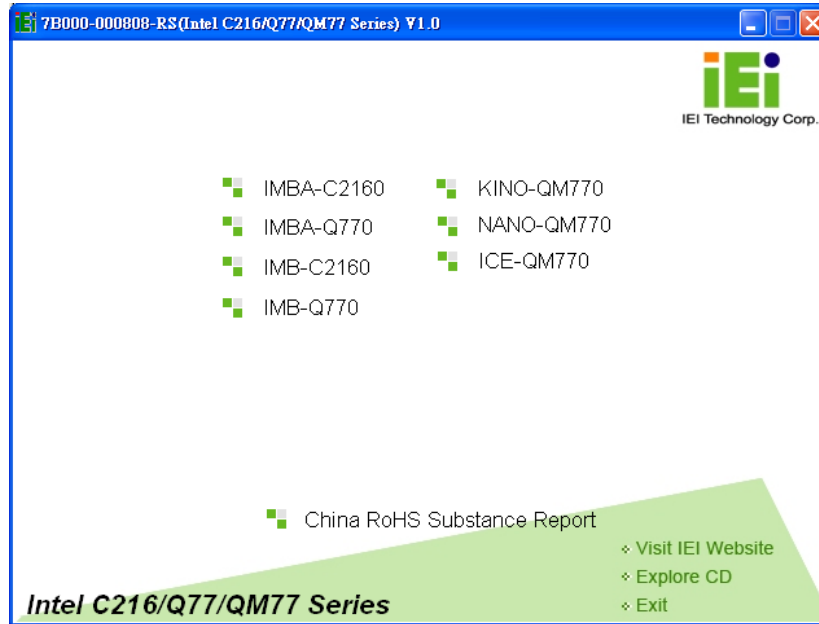

Figure 6-1: Introduction Screen

Step 3: Click IMB-C2160.

Step 4: A new screen with a list of available drivers appears (Figure 6-2).

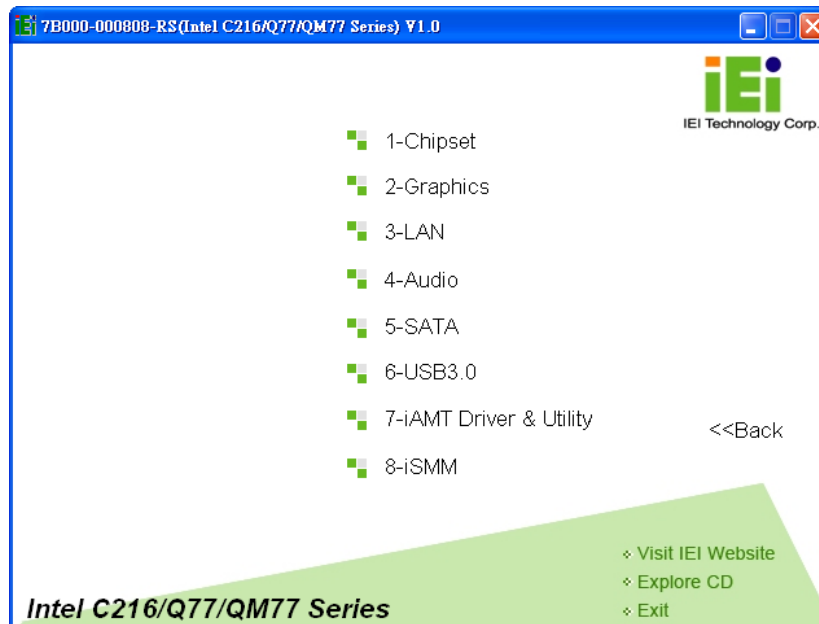

Figure 6-2: Available Drivers

Step 5: Install all of the necessary drivers in this menu.

6.3 Chipset Driver Installation

To install the chipset driver, please do the following.

Step 1: Access the driver list. (See **Section 6.2**)

Step 2: Click **“Chipset”**.

Step 3: Locate the setup file and double click on it.

Step 4: The **Welcome Screen** in Figure 6-3 appears.

Step 5: Click **Next** to continue.



Figure 6-3: Chipset Driver Welcome Screen

Step 6: The license agreement in Figure 6-4 appears.

Step 7: Read the **License Agreement**.

Step 8: Click **Yes** to continue.



Figure 6-4: Chipset Driver License Agreement

Step 9: The **Read Me** file in Figure 6-5 appears.

Step 10: Click **Next** to continue.

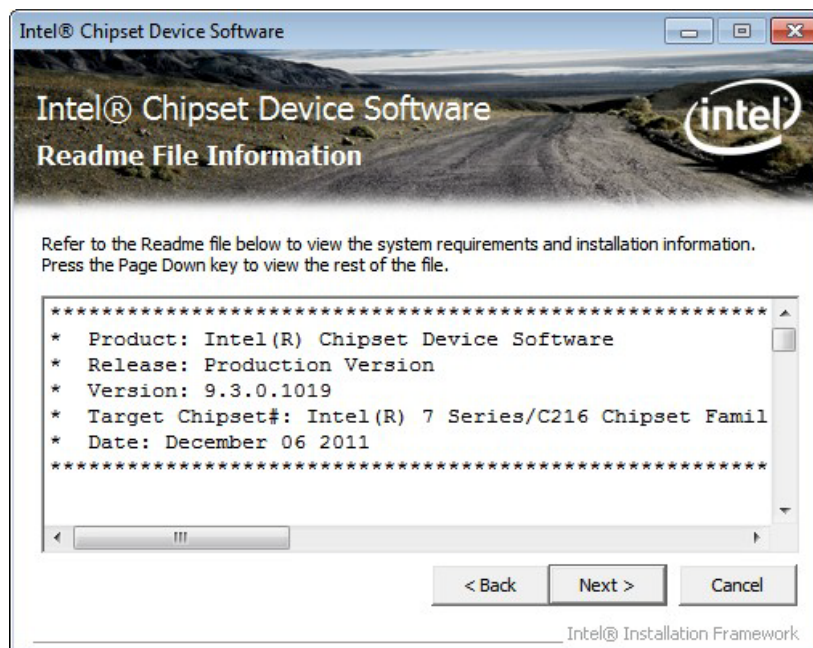

Figure 6-5: Chipset Driver Read Me File

Step 11: **Setup Operations** are performed as shown in Figure 6-6.

Step 12: Once the **Setup Operations** are complete, click **Next** to continue.

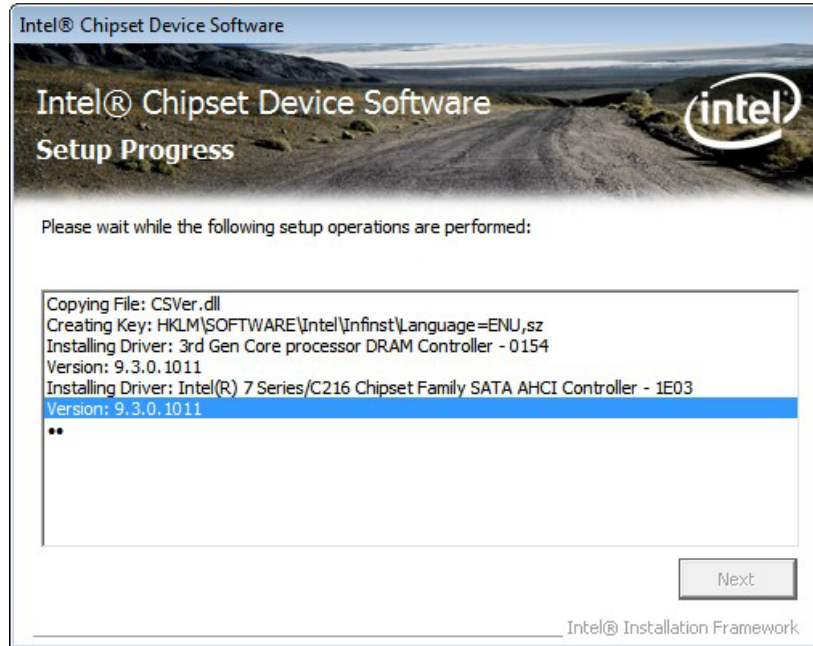

Figure 6-6: Chipset Driver Setup Operations

Step 13: The **Finish** screen in Figure 6-7 appears.

Step 14: Select **“Yes, I want to restart this computer now”** and click **Finish**.



Figure 6-7: Chipset Driver Installation Finish Screen

6.4 Graphics Driver Installation

To install the Graphics driver, please do the following.

- Step 1:** Access the driver list. (See **Section 6.2**)
- Step 2:** Click "**Graphics**" and select the folder which corresponds to the operating system.
- Step 3:** Double click the setup file.
- Step 4:** The **Welcome Screen** in Figure 6-8 appears.
- Step 5:** Click **Next** to continue.

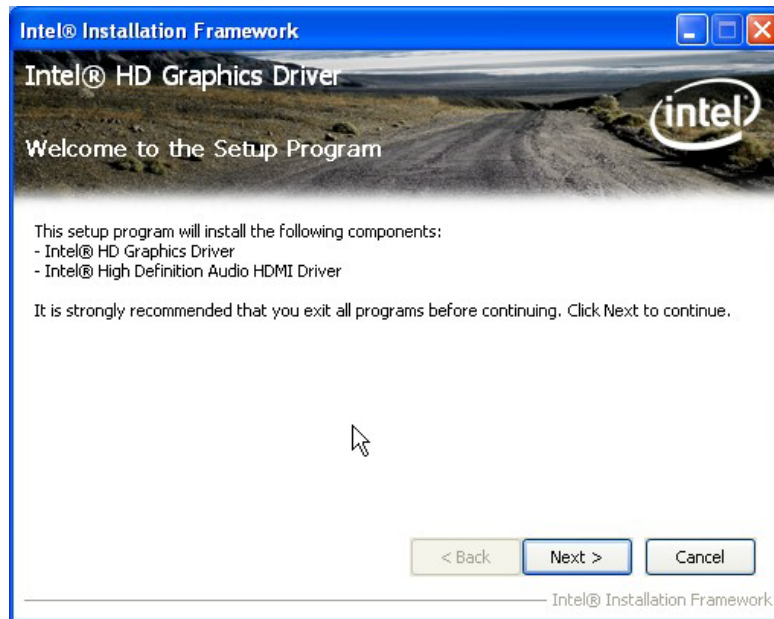

Figure 6-8: Graphics Driver Welcome Screen

Step 6: The **License Agreement** in Figure 6-9 appears.

Step 7: Click **Yes** to accept the agreement and continue.



Figure 6-9: Graphics Driver License Agreement

IMB-C2160 Micro-ATX Motherboard

Step 8: **Setup Operations** are performed as shown in Figure 6-10.

Step 9: Once the **Setup Operations** are complete, click **Next** to continue.

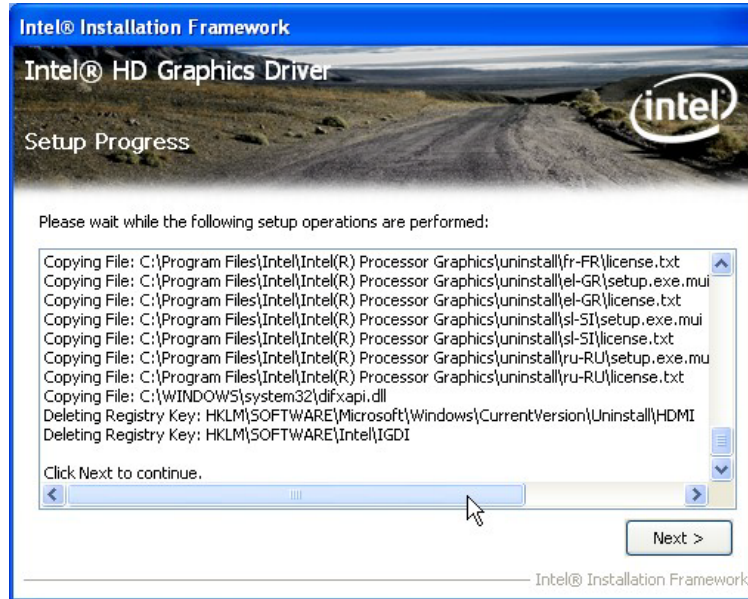

Figure 6-10: Graphics Driver Setup Operations

Step 10: The **Finish** screen in Figure 6-11 appears.

Step 11: Select **“Yes, I want to restart this computer now”** and click **Finish**.

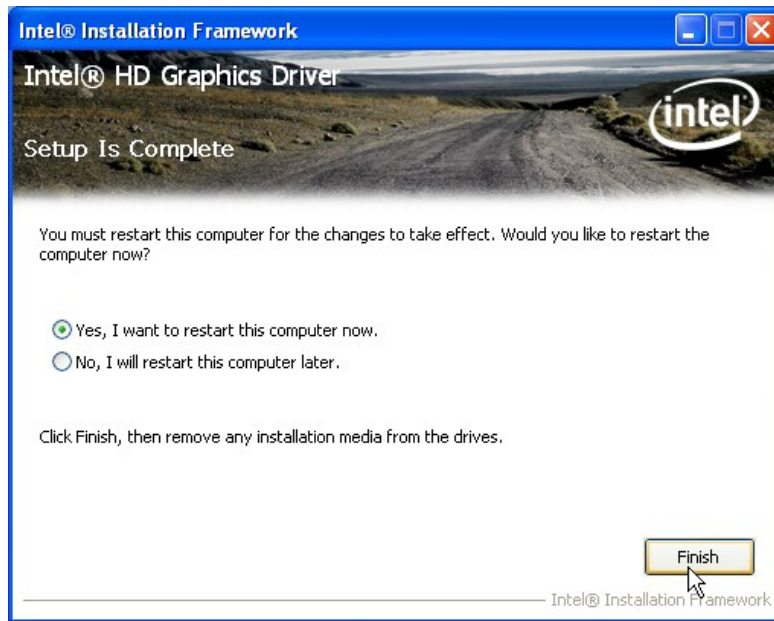

Figure 6-11: Graphics Driver Installation Finish Screen

6.5 LAN Driver Installation

- Step 1:** Right-click the Computer button from the start menu and select **Properties**.
(Figure 6-12).

IMB-C2160 Micro-ATX Motherboard

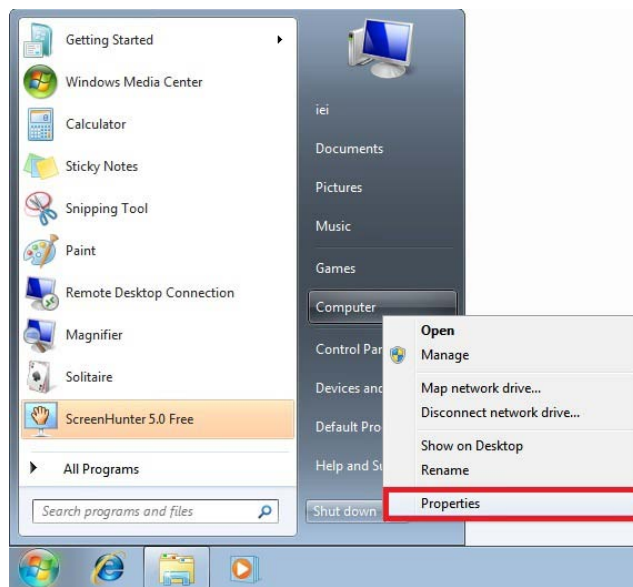

Figure 6-12: Windows Control Panel

Step 2: The system control panel window in **Figure 6-13** appears.

Step 3: Click the Device Manager link (**Figure 6-13**).

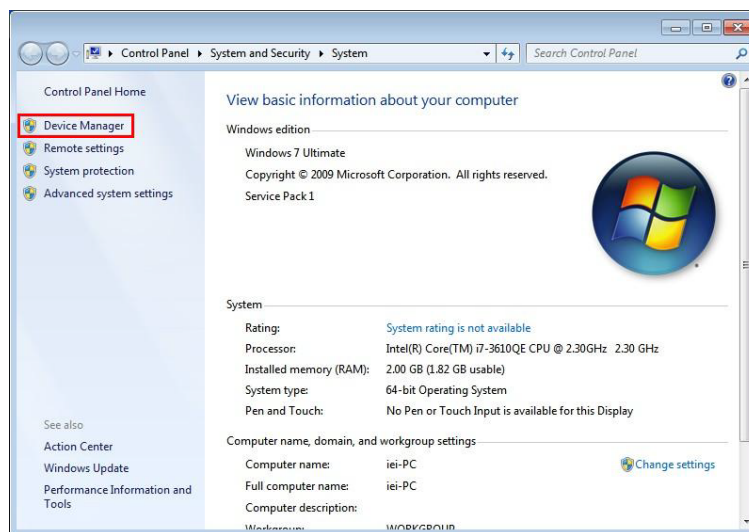

Figure 6-13: System Control Panel

Step 4: A list of system hardware devices appears (**Figure 6-14**).

Step 5: Right-click the Ethernet Controller that has question marks next to it (this means Windows does not recognize the device).

Step 6: Select **Update Driver Software**.

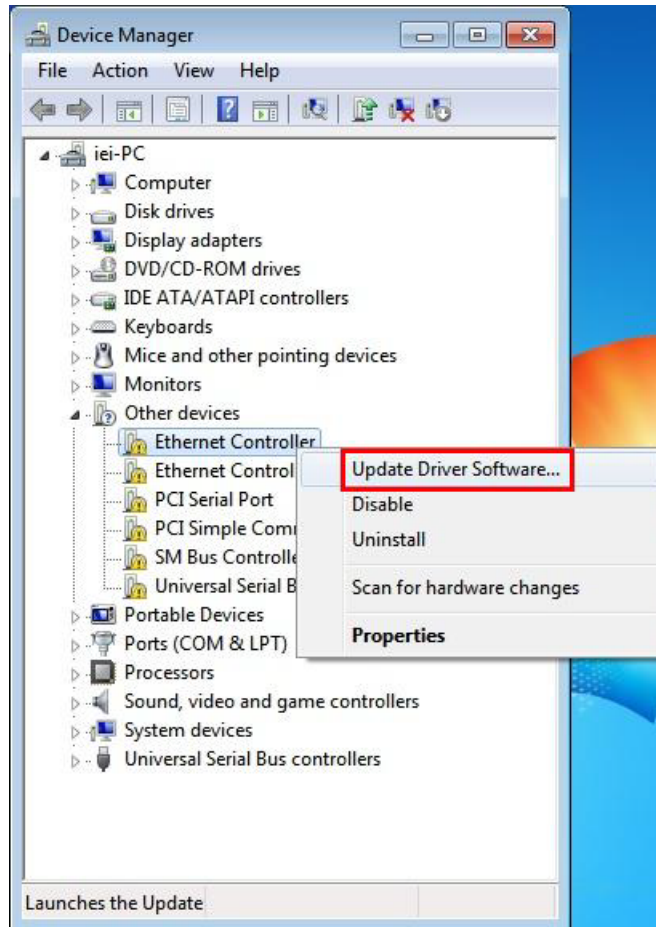

Figure 6-14: Device Manager List

Step 7: The Update Driver Software Window appears (Figure 6-15).

IMB-C2160 Micro-ATX Motherboard

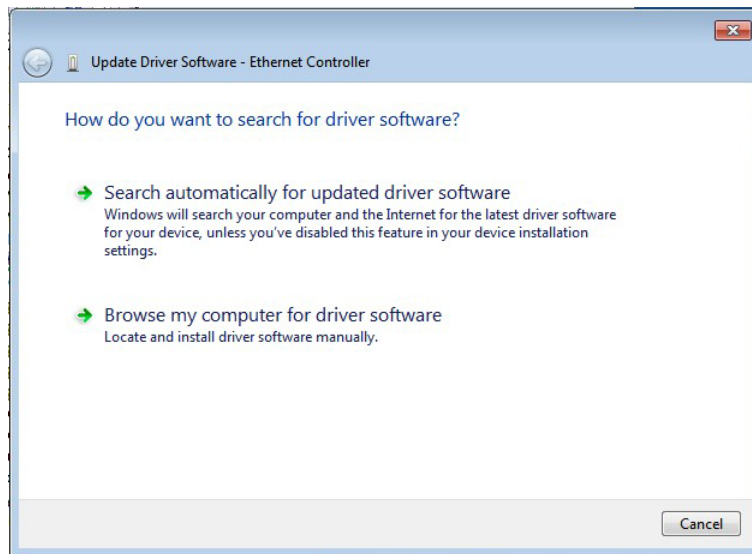

Figure 6-15: Update Driver Software Window

Step 8: Select “Browse my computer for driver software” and click **NEXT** to continue.

Step 9: Click Browse to select “X:\3-LAN” directory in the **Locate File** window, where “X:” is the system CD drive. (**Figure 6-16**).

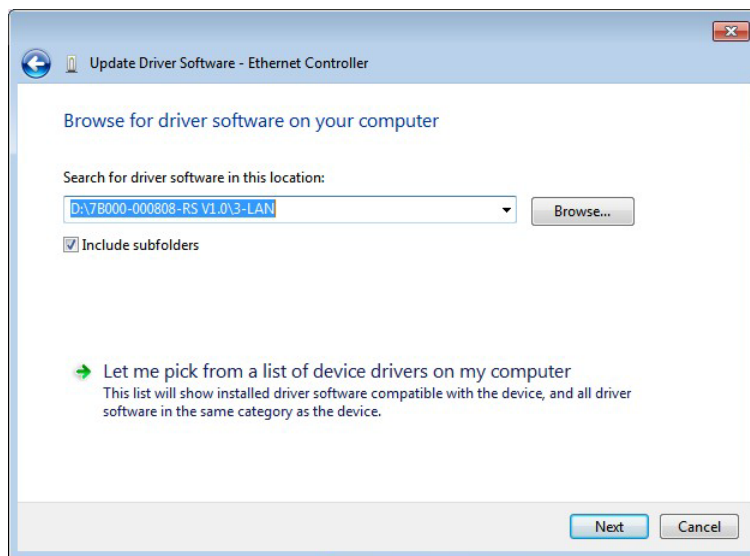

Figure 6-16: Locate Driver Files

Step 10: Click **NEXT** to continue.

Step 11: Driver Installation is performed as shown in **Figure 6-17**.

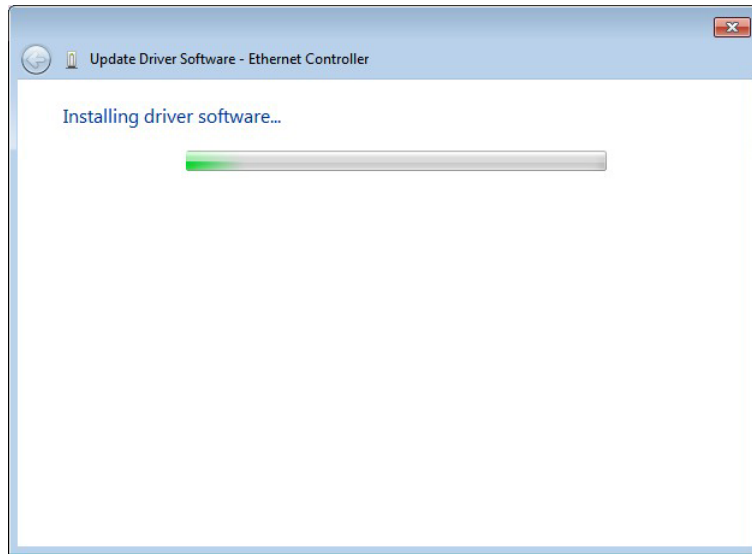

Figure 6-17: LAN Driver Installation

Step 12: The **Finish** screen in **Figure 6-18** appears. Click **Close** to exit.

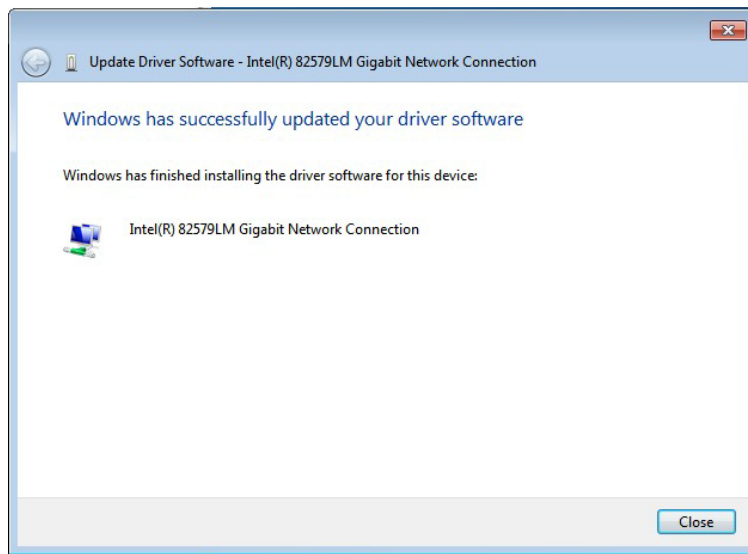

Figure 6-18: LAN Driver Installation Complete

6.6 Audio Driver Installation

To install the audio driver, please do the following.

- Step 1:** Access the driver list. (See **Section 6.2**)
- Step 2:** Click **“Audio”** and select the folder which corresponds to the operating system.
- Step 3:** Double click the setup file.
- Step 4:** The **InstallShield Wizard** is prepared to guide the user through the rest of the process.
- Step 5:** Once initialized, the **InstallShield Wizard** welcome screen appears (**Figure 6-19**).

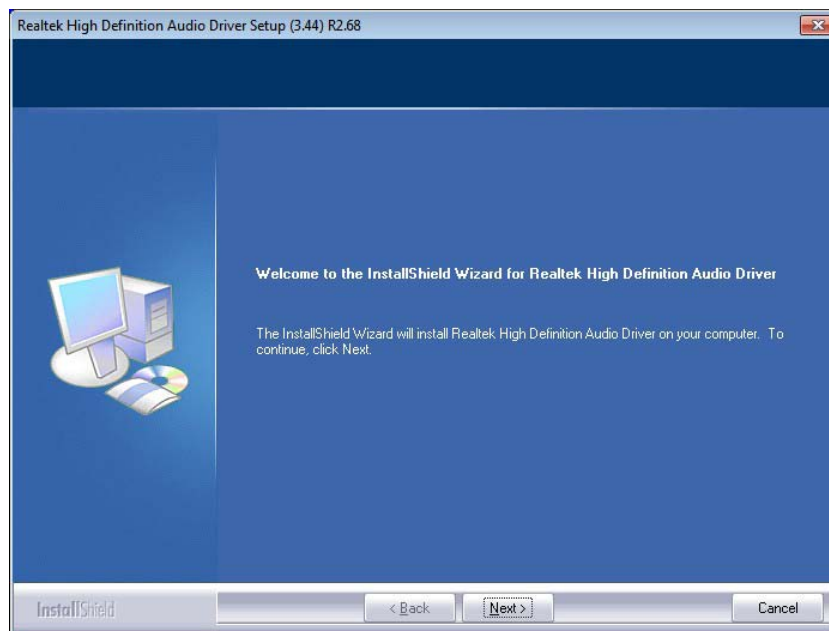

Figure 6-19: InstallShield Wizard Welcome Screen

- Step 6:** Click **NEXT** to continue the installation.
- Step 7:** InstallShield starts to install the new software as shown in **Figure 6-20**.

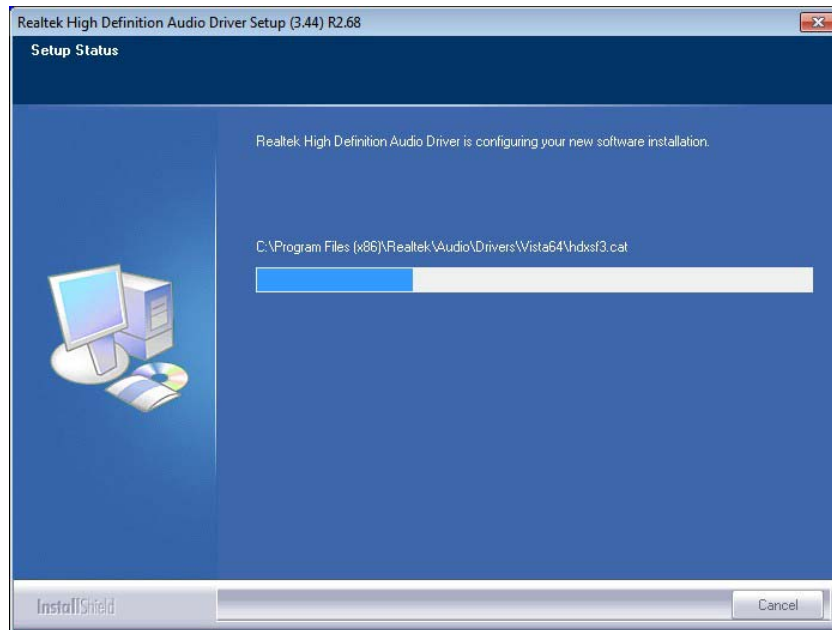

Figure 6-20: Audio Driver Software Configuration

Step 8: After the driver installation process is complete, a confirmation screen appears (Figure 6-21).

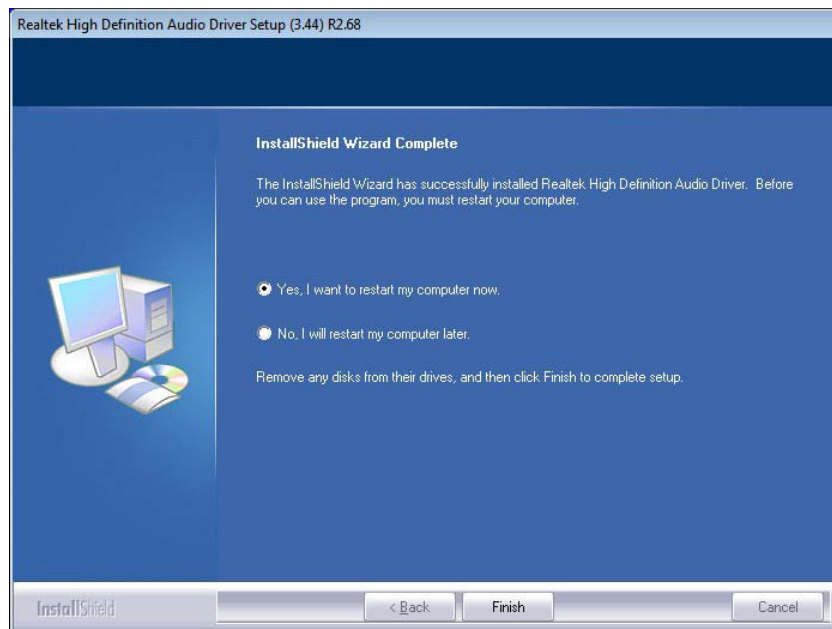

Figure 6-21: Restart the Computer

IMB-C2160 Micro-ATX Motherboard

Step 9: The confirmation screen offers the option of restarting the computer now or later. For the settings to take effect, the computer must be restarted. Click **FINISH** to restart the computer.

6.7 Intel® Rapid Storage Technology Driver Installation

To install the Intel® Rapid Storage Technology driver, please do the following.

Step 1: Access the driver list. (See **Section 6.2**)

Step 2: Click **“SATA”**.

Step 3: Locate the setup file and double click on it.

Step 4: The **Welcome Screen** in **Figure 6-22** appears.

Step 5: Click **Next** to continue.

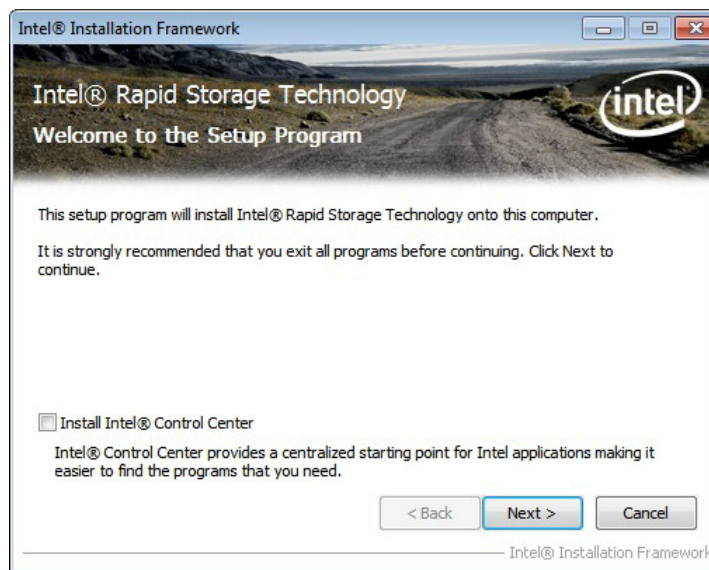

Figure 6-22: SATA RAID Driver Welcome Screen

Step 6: The license agreement in **Figure 6-23** appears.

Step 7: Read the **License Agreement**.

Step 8: Click **Yes** to continue.



Figure 6-23: SATA RAID Driver License Agreement

Step 9: The **Read Me** file in **Figure 6-24** appears.

Step 10: Click **Next** to continue.

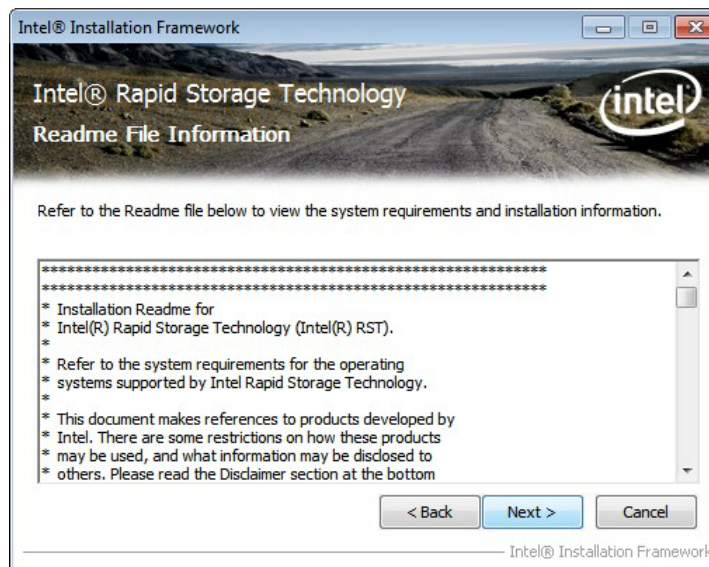

Figure 6-24: SATA RAID Driver Read Me File

Step 11: **Setup Operations** are performed as shown in **Figure 6-25**.

Step 12: Once the **Setup Operations** are complete, click **Next** to continue.

IMB-C2160 Micro-ATX Motherboard

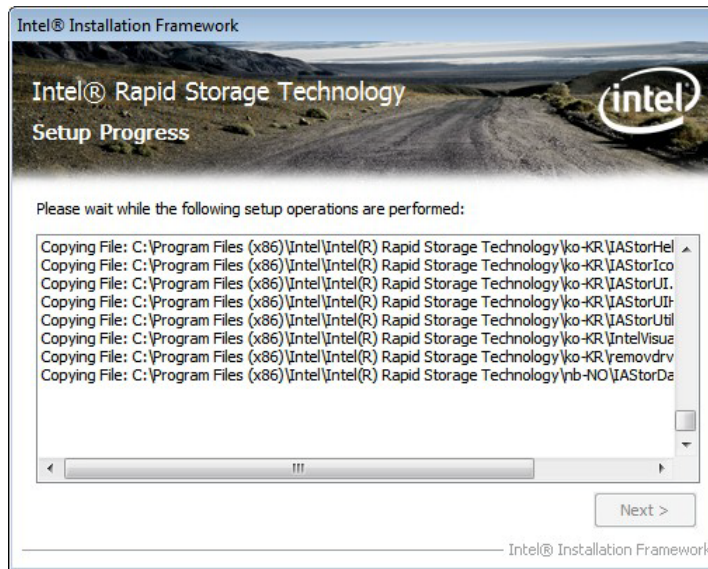

Figure 6-25: SATA RAID Driver Setup Operations

Step 13: The **Finish** screen in **Figure 6-26** appears.

Step 14: Select **“Yes, I want to restart this computer now”** and click **Finish**.



Figure 6-26: SATA RAID Driver Installation Finish Screen

6.8 USB 3.0 Driver Installation



WARNING:

Do not run this driver's installer (Setup.exe) from a USB storage device (ie. external USB hard drive or USB thumb drive). For proper installation, please copy driver files to a local hard drive folder and run from there.

To install the touch panel software driver, please follow the steps below.

- Step 1:** Access the driver list. (See **Section 6.2**)
- Step 2:** Click "**USB 3.0**".
- Step 3:** Locate the setup file and double click on it.
- Step 4:** The **Welcome Screen** in **Figure 6-27** appears.
- Step 5:** Click **Next** to continue.

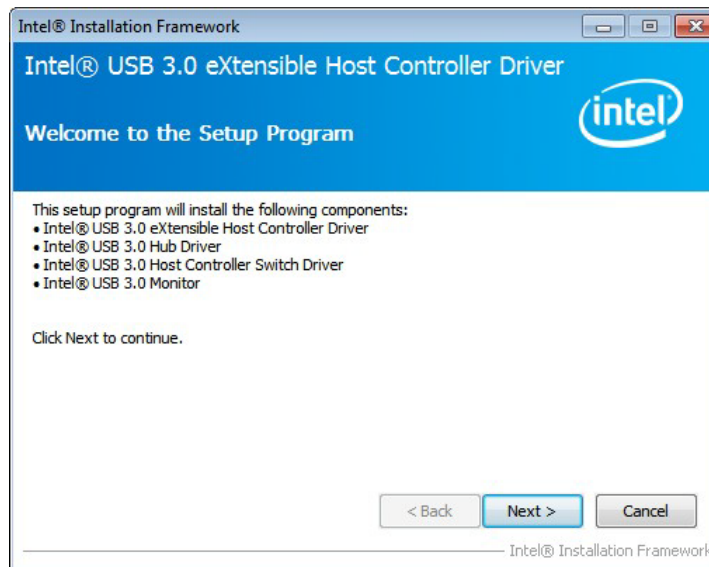

Figure 6-27: USB 3.0 Driver Welcome Screen

- Step 6:** The license agreement in **Figure 6-28** appears.

IMB-C2160 Micro-ATX Motherboard

Step 7: Read the **License Agreement**.

Step 8: Click **Yes** to continue.



Figure 6-28: USB 3.0 Driver License Agreement

Step 9: The **Read Me** file in **Figure 6-29** appears.

Step 10: Click **Next** to continue.



Figure 6-29: USB 3.0 Driver Read Me File

Step 11: **Setup Operations** are performed as shown in **Figure 6-30**.

Step 12: Once the **Setup Operations** are complete, click **Next** to continue.

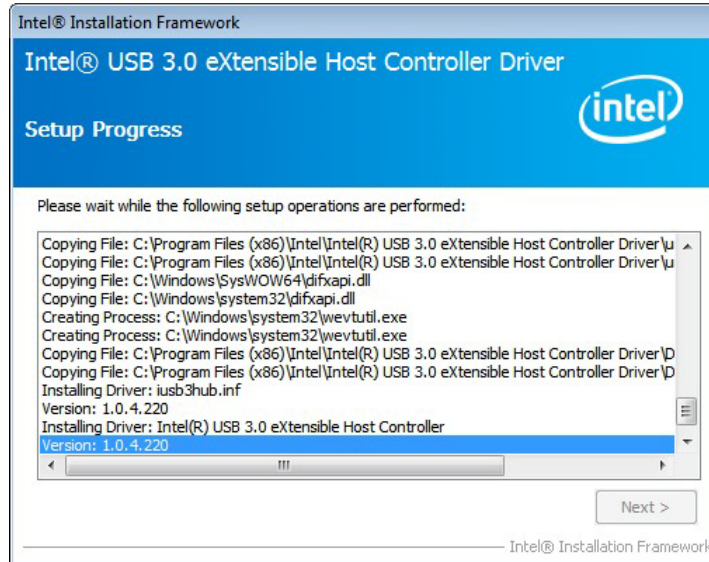

Figure 6-30: USB 3.0 Driver Setup Operations

Step 13: The **Finish** screen in **Figure 6-31** appears.

Step 14: Select “**Yes, I want to restart this computer now**” and click **Finish**.



Figure 6-31: USB 3.0 Driver Installation Finish Screen

6.9 Intel® AMT Driver Installation

The package of the Intel® AMT components includes

- Intel® Management Engine Interface (Intel® ME Interface)
- Intel® Dynamic Application Loader
- Intel® Identity Protection Technology (Intel® IPT)
- Serial Over LAN (SOL)
- Intel® Manageability Engine Firmware Recovery Agent
- Intel® Management and Security Status
- Local Management Service (LMS)
- User Notification Service (UNS)

To install these Intel® AMT components, please do the following.

Step 1: Access the driver list. (See **Section 6.2**)

Step 2: Click “**iAMT**”.

Step 3: Locate the setup file and double click it.

Step 4: When the setup files are completely extracted the **Welcome Screen** in **Figure 6-32** appears.

Step 5: Click **Next** to continue.



Figure 6-32: Intel® ME Driver Welcome Screen

Step 6: The license agreement in **Figure 6-33** appears.

Step 7: Read the **License Agreement**.

Step 8: Click **Yes** to continue.

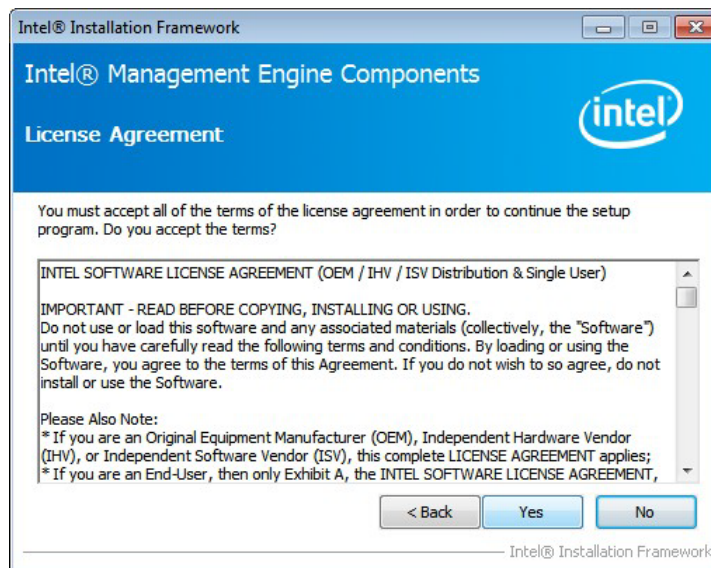

Figure 6-33: Intel® ME Driver License Agreement

Step 9: Setup Operations are performed as shown in **Figure 6-34**.

Step 10: Once the Setup Operations are complete, click **Next** to continue.

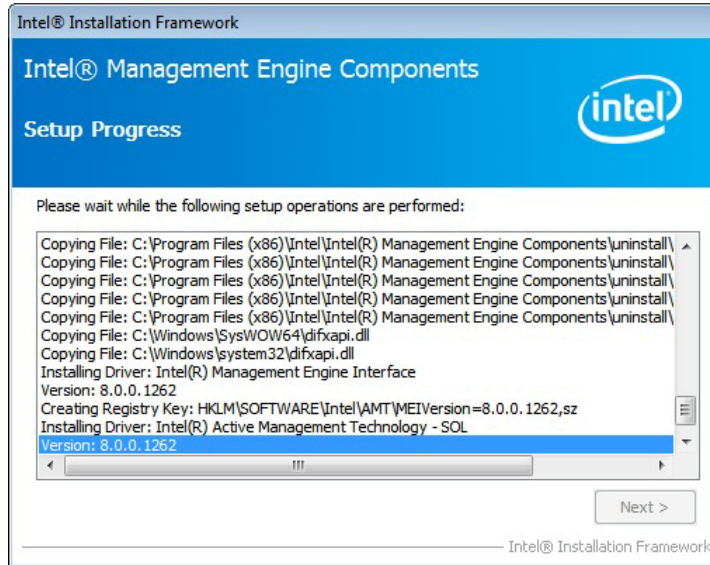

Figure 6-34: Intel® ME Driver Setup Operations

Step 11: The **Finish** screen in **Figure 6-35** appears.

Step 12: Select “**Yes, I want to restart this computer now**” and click **Finish**.

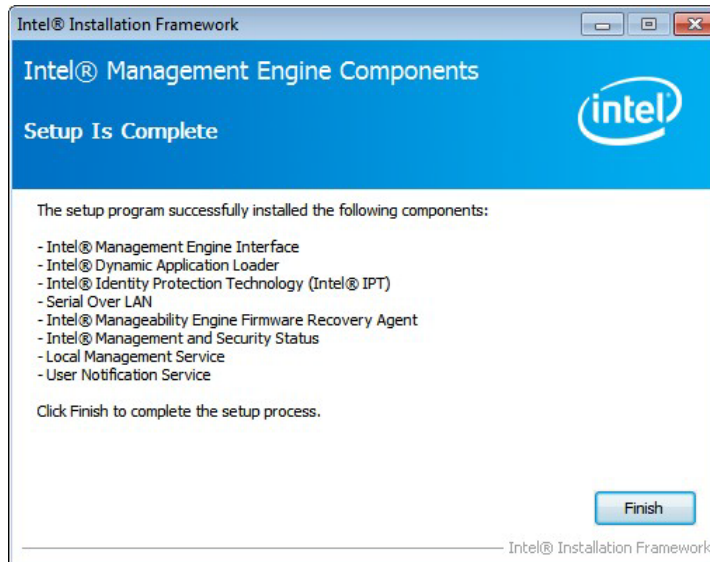

Figure 6-35: Intel® ME Driver Installation Finish Screen

Appendix

A

BIOS Options

IMB-C2160 Micro-ATX Motherboard

Below is a list of BIOS configuration options in the BIOS chapter.

➔ BIOS Information	72
➔ System Date [xx/xx/xx]	72
➔ System Time [xx:xx:xx]	73
➔ Wake system with Fixed Time [Disabled].....	74
➔ Security Device Support [Disable]	75
➔ Intel Virtualization Technology [Disabled]	77
➔ SATA Controller [Enabled].....	78
➔ SATA Mode Selection [IDE]	78
➔ Intel(R) Rapid Start Technology [Disabled].....	79
➔ Intel AMT [Enabled]	81
➔ Unconfigure AMT/ME [Disabled]	81
➔ USB Devices	82
➔ Legacy USB Support [Enabled].....	82
➔ Serial Port [Enabled].....	83
➔ Change Settings [Auto]	83
➔ Device Mode [Normal]	83
➔ Serial Port [Enabled].....	84
➔ Change Settings [Auto]	84
➔ Serial Port [Enabled].....	84
➔ Change Settings [Auto]	85
➔ Serial Port [Enabled].....	85
➔ Change Settings [Auto]	85
➔ Serial Port [Enabled].....	87
➔ Change Settings [Auto]	87
➔ Serial Port [Enabled].....	88
➔ Change Settings [Auto]	88
➔ Serial Port [Enabled].....	88
➔ Change Settings [Auto]	89
➔ Serial Port [Enabled].....	89
➔ Change Settings [Auto]	89
➔ Serial Port [Enabled].....	90
➔ Change Settings [Auto]	90
➔ Serial Port [Enabled].....	91

→ Change Settings [Auto]	91
→ PC Health Status	92
→ Smart Fan Function [Enabled].....	93
→ FAN 1 Smart Fan Control [Auto Duty-Cycle Mode]	94
→ FAN 2 Smart Fan Control [Auto Duty-Cycle Mode]	95
→ FAN 3 Smart Fan Control [Auto Duty-Cycle Mode]	95
→ Temperature n	95
→ Duty Cycle n	96
→ Console Redirection [Disabled].....	97
→ Auto Recovery Function [Disabled]	98
→ Azalia [Auto]	101
→ Azalia internal HDMI codec [Enabled]	102
→ VT-d [Enabled].....	102
→ Primary Display [Auto]	103
→ DVMT Pre-Allocated [128MB].....	103
→ DVMT Total Gfx Mem [MAX].....	104
→ Primary IGFX Boot Display [CRT]	105
→ Secondary IGFX Boot Display [Disabled].....	105
→ Bootup NumLock State [On].....	107
→ Quiet Boot [Enabled]	107
→ Option ROM Messages [Force BIOS].....	107
→ Launch PXE OpROM [Disabled]	108
→ Administrator Password	108
→ User Password	108
→ Save Changes and Reset	109
→ Discard Changes and Reset	109
→ Restore Defaults	109
→ Save as User Defaults	110
→ Restore User Defaults	110

Appendix

B

One Key Recovery

B.1 One Key Recovery Introduction

The IEI one key recovery is an easy-to-use front end for the Norton Ghost system backup and recovery tool. This tool provides quick and easy shortcuts for creating a backup and reverting to that backup or reverting to the factory default settings.



NOTE:

The latest One Key Recovery software provides an auto recovery function that allows a system running Microsoft Windows OS to automatically restore from the factory default image after encountering a Blue Screen of Death (BSoD) or a hang for around 10 minutes. Please refer to Section B.3 for the detailed setup procedure.

The IEI One Key Recovery tool menu is shown below.

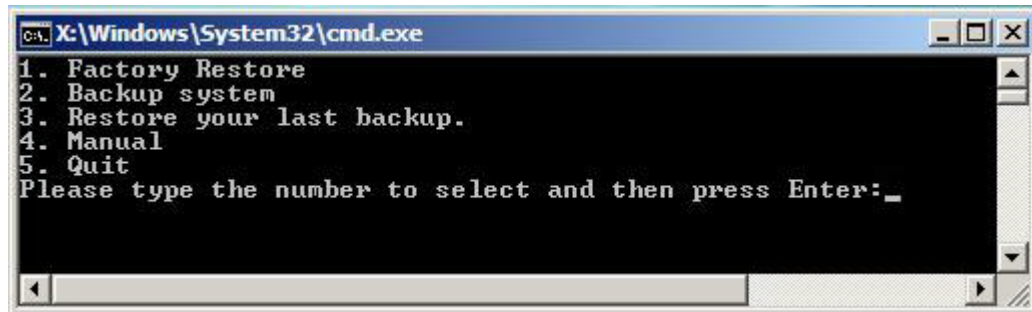

Figure B-1: IEI One Key Recovery Tool Menu

Prior to using the IEI One Key Recovery tool (as shown in **Figure B-1**) to backup or restore Windows system, five setup procedures are required.

1. Hardware and BIOS setup (see **Section B.2.1**)
2. Create partitions (see **Section B.2.2**)
3. Install operating system, drivers and system applications (see **Section B.2.3**)
4. Build the recovery partition (see **Section B.2.4**)
5. Create factory default image (see **Section B.2.5**)

IMB-C2160 Micro-ATX Motherboard

After completing the five initial setup procedures as described above, users can access the recovery tool by pressing <F3> while booting up the system. The detailed information of each function is described in **Section B.5**.



NOTE:

The initial setup procedures for Linux system are described in **Section B.3**.

B.1.1 System Requirement



NOTE:

The recovery CD can only be used with IEI products. The software will fail to run and a warning message will appear when used on non-IEI hardware.

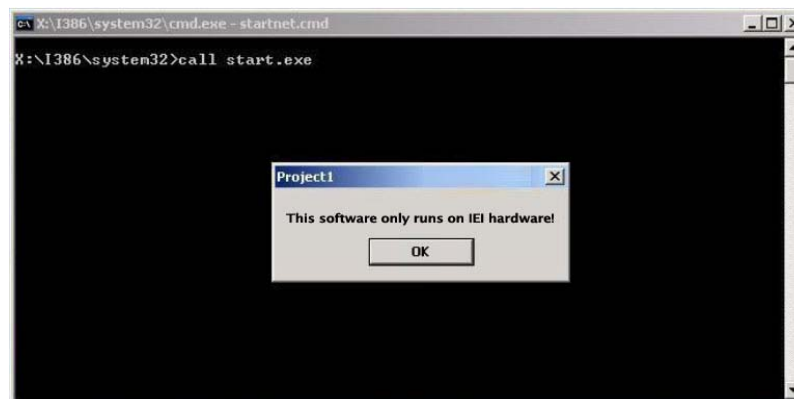

To create the system backup, the main storage device must be split into two partitions (three partitions for Linux). The first partition will be for the operating system, while the second partition will be invisible to the operating system and contain the backup made by the one key recovery software.

The partition created for recovery images must be big enough to contain both the factory default image and the user backup image. The size must be calculated before creating the

partitions. Please take the following table as a reference when calculating the size of the partition.

	OS	OS Image after Ghost	Compression Ratio
Windows® 7	7 GB	5 GB	70%
Windows® XPE	776 MB	560 MB	70%
Windows® CE 6.0	36 MB	28 MB	77%

NOTE:

Specialized tools are required to change the partition size if the operating system is already installed.

B.1.2 Supported Operating System

The recovery CD is compatible with both Microsoft Windows and Linux operating systems (OS). The supported OS versions are listed below.

- Microsoft Windows
 - Windows XP (Service Pack 2 or 3 required)
 - Windows Vista
 - Windows 7
 - Windows CE 5.0
 - Windows CE 6.0
 - Windows XP Embedded
- Linux
 - Fedora Core 12 (Constantine)
 - Fedora Core 11 (Leonidas)
 - Fedora Core 10 (Cambridge)
 - Fedora Core 8 (Werewolf)
 - Fedora Core 7 (Moonshine)
 - RedHat RHEL-5.4
 - RedHat 9 (Ghirke)

IMB-C2160 Micro-ATX Motherboard

- Ubuntu 8.10 (Intrepid)
- Ubuntu 7.10 (Gutsy)
- Ubuntu 6.10 (Edgy)
- Debian 5.0 (Lenny)
- Debian 4.0 (Etch)
- SuSe 11.2
- SuSe 10.3

**NOTE:**

Installing unsupported OS versions may cause the recovery tool to fail.

B.2 Setup Procedure for Windows

Prior to using the recovery tool to backup or restore, a few setup procedures are required.

Step 1: Hardware and BIOS setup (see **Section B.2.1**)

Step 2: Create partitions (see **Section B.2.2**)

Step 3: Install operating system, drivers and system applications (see **Section B.2.3**)

Step 4: Build the recovery partition (see **Section B.2.4**) or build the auto recovery partition (see **Section B.3**)

Step 5: Create factory default image (see **Section B.2.5**)

The detailed descriptions are described in the following sections.

**NOTE:**

The setup procedures described below are for Microsoft Windows operating system users. For Linux, most of the setup procedures are the same except for several steps described in **Section B.3**.

B.2.1 Hardware and BIOS Setup

- Step 1:** Make sure the system is powered off and unplugged.
- Step 2:** Install a hard drive or SSD in the system. An unformatted and unpartitioned disk is recommended.
- Step 3:** Connect an optical disk drive to the system and insert the recovery CD.
- Step 4:** Turn on the system.
- Step 5:** Press the <DELETE> key as soon as the system is turned on to enter the BIOS.
- Step 6:** Select the connected optical disk drive as the 1st boot device. (**Boot → Boot Device Priority → 1st Boot Device**).
- Step 7:** Save changes and restart the computer. Continue to the next section for instructions on partitioning the internal storage.

B.2.2 Create Partitions

To create the system backup, the main storage device must be split into two partitions (three partitions for Linux). The first partition will be for the operating system, while the second partition will be invisible to the operating system and contain the backup made by the one key recovery software.

- Step 1:** Put the recovery CD in the optical drive of the system.
- Step 2:** **Boot the system from recovery CD.** When prompted, press any key to boot from the recovery CD. It will take a while to launch the recovery tool. Please be patient!

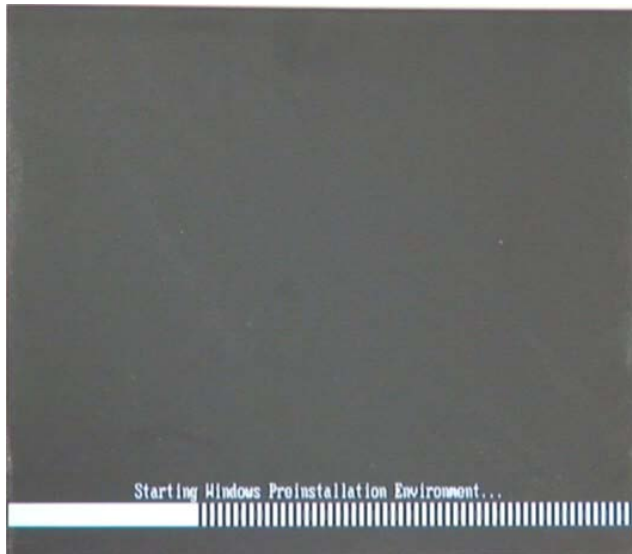

Figure B-2: Launching the Recovery Tool

Step 3: The recovery tool setup menu is shown as below.

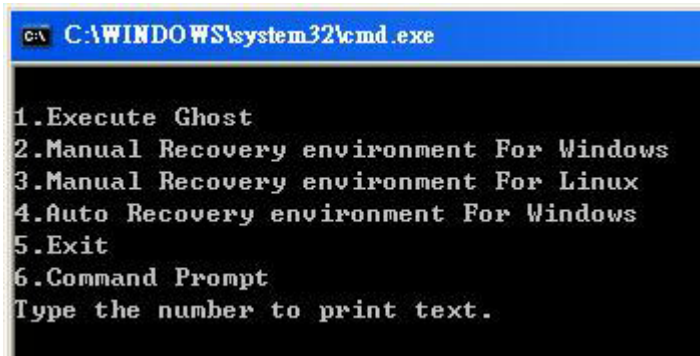
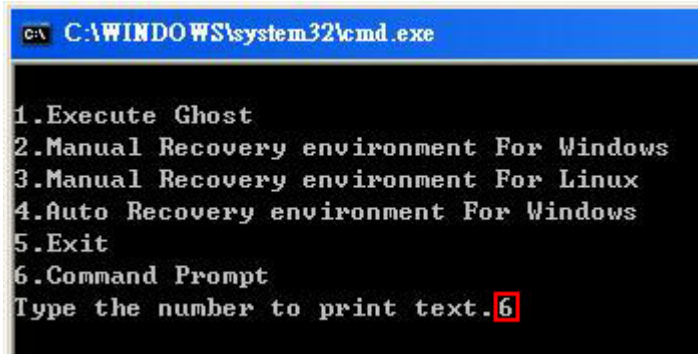

Figure B-3: Recovery Tool Setup Menu

Step 4: Press <6> then <Enter>.



```

C:\WINDOWS\system32\cmd.exe

1.Execute Ghost
2.Manual Recovery environment For Windows
3.Manual Recovery environment For Linux
4.Auto Recovery environment For Windows
5.Exit
6.Command Prompt
Type the number to print text.6
    
```

Figure B-4: Command Prompt

Step 5: The command prompt window appears. Type the following commands (marked in red) to create two partitions. One is for the OS installation; the other is for saving recovery files and images which will be an invisible partition.
(Press <Enter> after entering each line below)

```

system32>diskpart
DISKPART>list vol
DISKPART>sel disk 0
DISKPART>create part pri size= ____
DISKPART>assign letter=N
DISKPART>create part pri size= ____
DISKPART>assign letter=F
DISKPART>exit
system32>format N: /fs:ntfs /q /y
system32>format F: /fs:ntfs /q /v:Recovery /y
system32>exit
    
```

```

C:\X:\I386\system32\CMD.EXE
X:\I386\SYSTEM32>diskpart → Starts the Microsoft disk partitioning tool.
Microsoft DiskPart version 5.2.3790.1830
Copyright (C) 1999-2001 Microsoft Corporation.
On computer: MININT-JUC

DISKPART> list vol → Show partition information

   Volume ###  Ltr  Label          Fs          Type          Size         Status       Info
   -----
   Volume 0      X    CD_ROM         CDFS        DUD-ROM       405 MB       Healthy      Boot
   Volume 1      D                   FAT32       Removeable    3854 MB       Healthy

DISKPART> sel disk 0 → Select a disk
Disk 0 is now the selected disk.

DISKPART> create part pri size=2000 → Create partition 1 and assign a size.
                                     This partition is for OS installation.
DiskPart succeeded in creating the specified partition.

DISKPART> assign letter=N → Assign partition 1 a code name (N).
DiskPart successfully assigned the drive letter or mount point.

DISKPART> create part pri size=1800 → Create partition 2 and assign a size.
                                     This partition is for recovery images.
DiskPart succeeded in creating the specified partition.

DISKPART> assign letter=F → Assign partition 2 a code name (F).
DiskPart successfully assigned the drive letter or mount point.

DISKPART> exit → Exit diskpart
X:\I386\SYSTEM32>format n: /fs:ntfs /q /y → Format partition 1 (N) as NTFS format.
The type of the file system is RAW.
The new file system is NTFS.
QuickFormatting 2000M
Creating file system structures.
Format complete.
 2048254 KB total disk space.
 2035620 KB are available.

X:\I386\SYSTEM32>format f: /fs:ntfs /q /v:Recovery /y → Formate partition 2 (F) as NTFS formate and
                                                         name it as "Recovery".
The type of the file system is RAW.
The new file system is NTFS.
QuickFormatting 1804M
Creating file system structures.
Format complete.
 1847474 KB total disk space.
 1835860 KB are available.

X:\I386\SYSTEM32>exit → Exit Windows PE

```

Figure B-5: Partition Creation Commands

**NOTE:**

Use the following commands to check if the partitions were created successfully.

```
X:\I386\SYSTEM32>diskpart
Microsoft DiskPart version 5.2.3790.1830
Copyright (C) 1999-2001 Microsoft Corporation.
On computer: MININT-JUC
DISKPART> sel disk 0
Disk 0 is now the selected disk.
DISKPART> list part
  Partition ###  Type              Size      Offset
-----
  Partition 1    Primary           2000 MB   32 KB
  Partition 2    Primary           1804 MB  2000 MB
DISKPART> exit
```

Step 6: Press any key to exit the recovery tool and automatically reboot the system.

Please continue to the following procedure: Build the Recovery Partition.

B.2.3 Install Operating System, Drivers and Applications

Install the operating system onto the unlabelled partition. The partition labeled "Recovery" is for use by the system recovery tool and should not be used for installing the operating system or any applications.

**NOTE:**

The operating system installation program may offer to reformat the chosen partition. DO NOT format the partition again. The partition has already been formatted and is ready for installing the new operating system.

To install the operating system, insert the operating system installation CD into the optical drive. Restart the computer and follow the installation instructions.

B.2.4 Building the Recovery Partition

- Step 1:** Put the recovery CD in the optical drive.
- Step 2:** Start the system.
- Step 3:** **Boot the system from the recovery CD.** When prompted, press any key to boot from the recovery CD. It will take a while to launch the recovery tool. Please be patient!



Figure B-6: Launching the Recovery Tool

- Step 4:** When the recovery tool setup menu appears, press <2> then <Enter>.

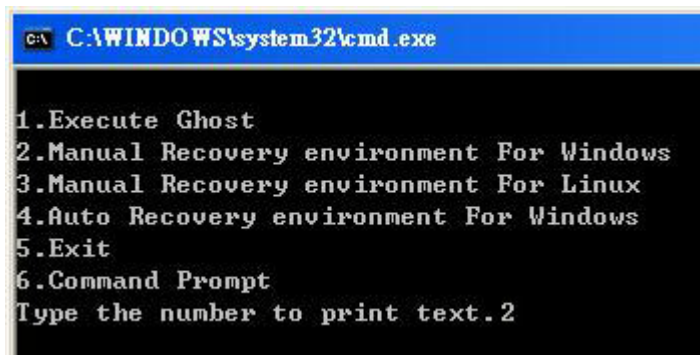

Figure B-7: Manual Recovery Environment for Windows

Step 5: The Symantec Ghost window appears and starts configuring the system to build a recovery partition. In this process the partition created for recovery files in **Section B.2.2** is hidden and the recovery tool is saved in this partition.

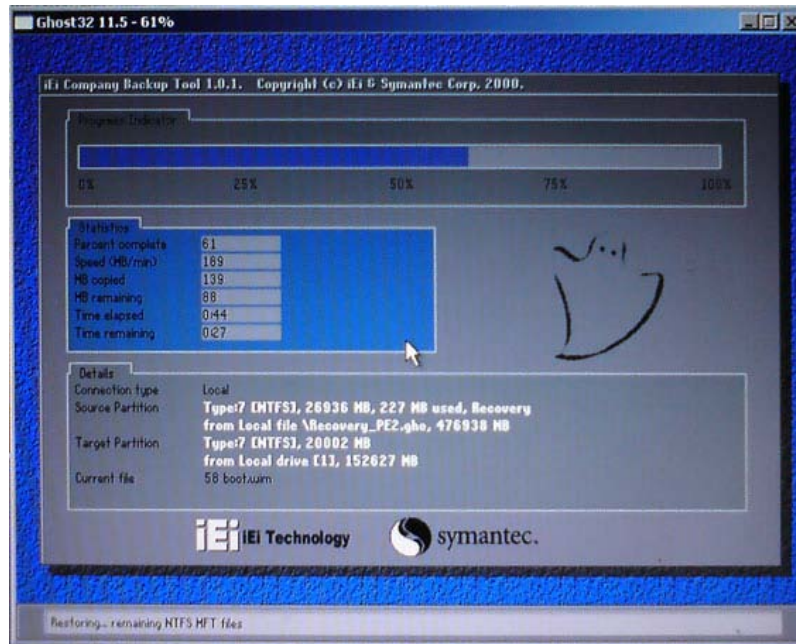

Figure B-8: Building the Recovery Partition

Step 6: After completing the system configuration, press any key in the following window to reboot the system.

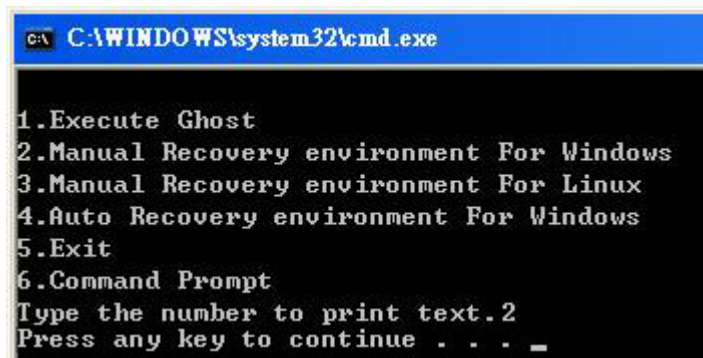

Figure B-9: Press Any Key to Continue

Step 7: Eject the recovery CD.

B.2.5 Create Factory Default Image



NOTE:

Before creating the factory default image, please configure the system to a factory default environment, including driver and application installations.

To create a factory default image, please follow the steps below.

Step 1: Turn on the system. When the following screen displays (**Figure B-10**), press the <F3> key to access the recovery tool. The message will display for 10 seconds, please press F3 before the system boots into the operating system.

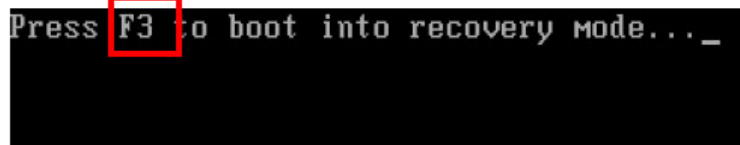

Figure B-10: Press F3 to Boot into Recovery Mode

Step 2: The recovery tool menu appears. Type <4> and press <Enter>. (**Figure B-11**)

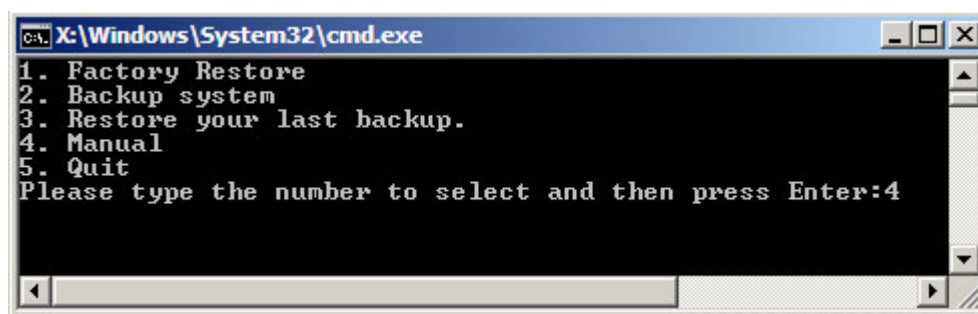

Figure B-11: Recovery Tool Menu

Step 3: The About Symantec Ghost window appears. Click **OK** button to continue.

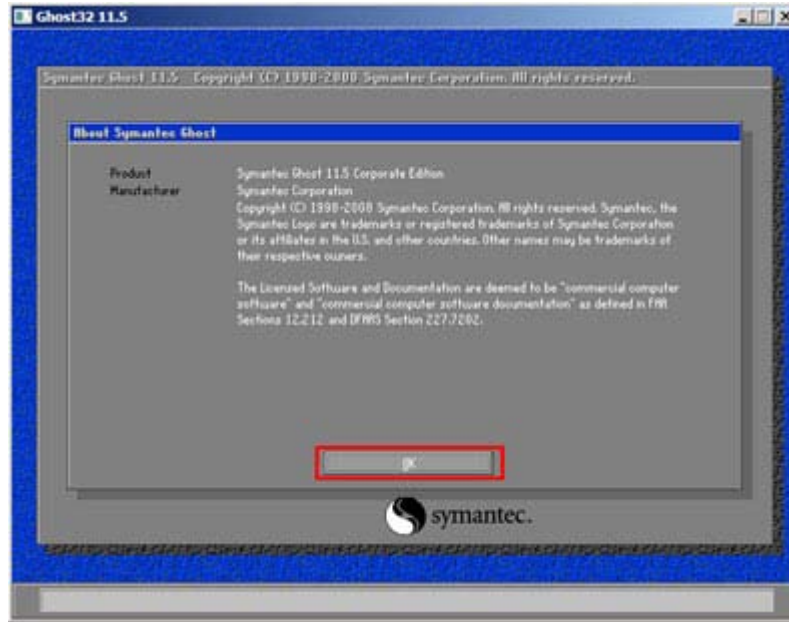

Figure B-12: About Symantec Ghost Window

Step 4: Use mouse to navigate to the option shown below (Figure B-13).

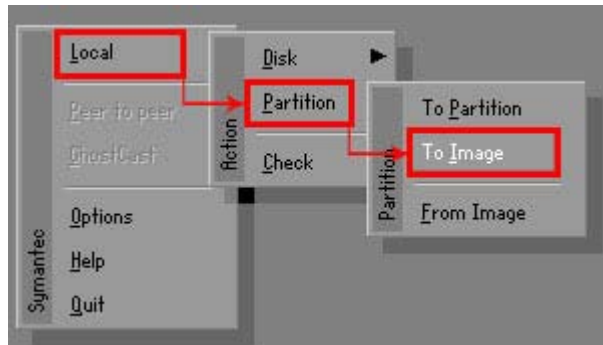

Figure B-13: Symantec Ghost Path

Step 5: Select the local source drive (Drive 1) as shown in Figure B-14. Then click OK.

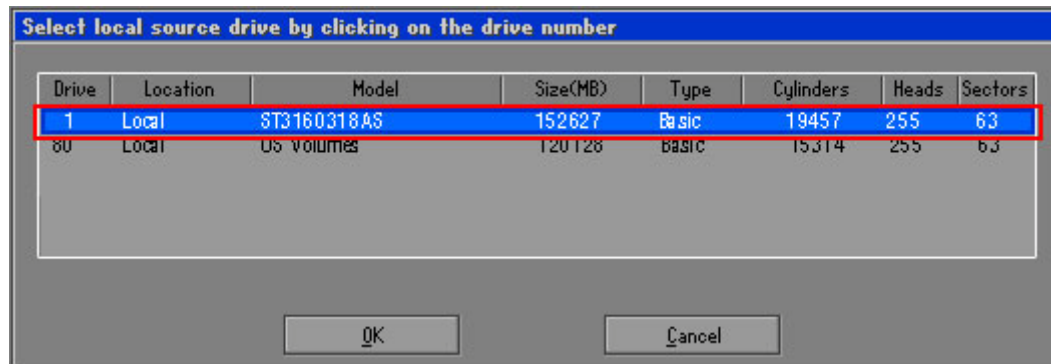

Figure B-14: Select a Local Source Drive

Step 6: Select a source partition (Part 1) from basic drive as shown in **Figure B-15**. Then click OK.

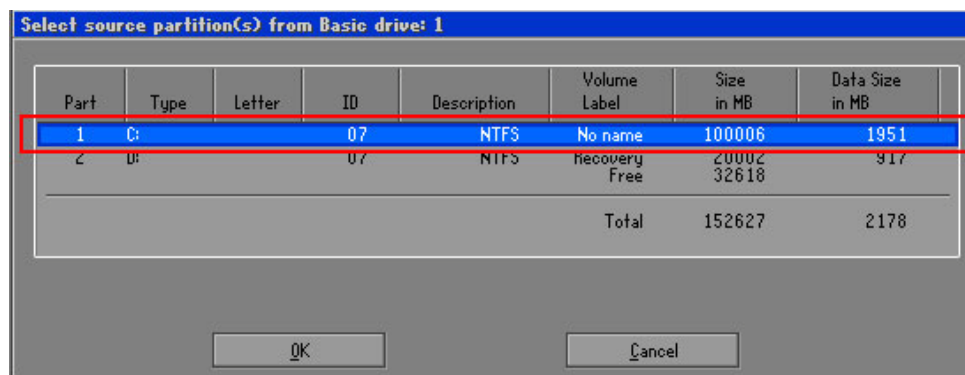

Figure B-15: Select a Source Partition from Basic Drive

Step 7: Select **1.2: [Recovery] NTFS drive** and enter a file name called **iei** (**Figure B-16**). Click **Save**. The factory default image will then be saved in the selected recovery drive and named **IEI.GHO**.



WARNING:

The file name of the factory default image must be **iei.GHO**.

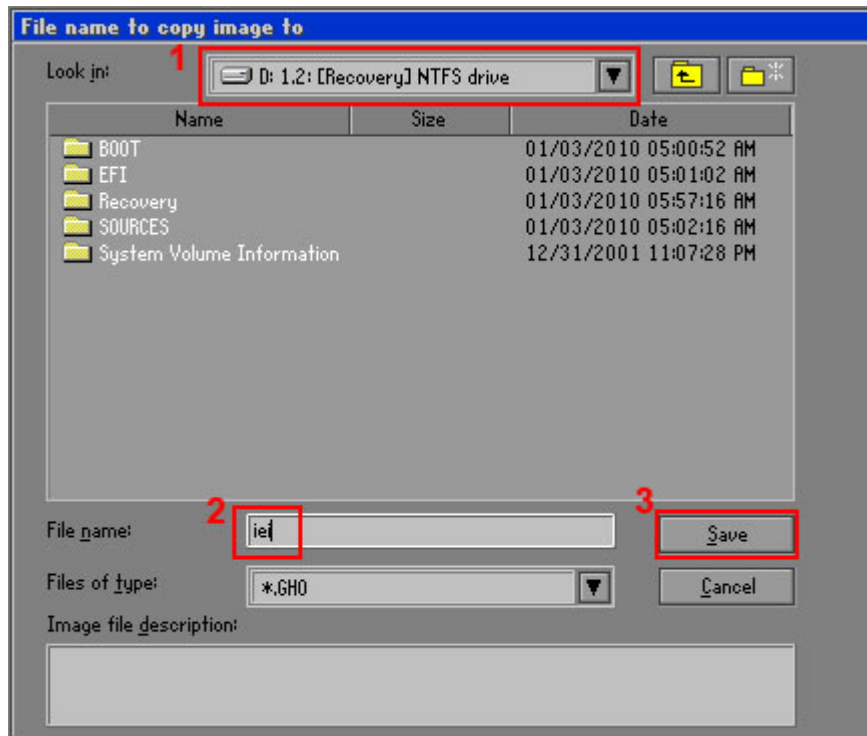

Figure B-16: File Name to Copy Image to

Step 8: When the Compress Image screen in Figure B-17 prompts, click **High** to make the image file smaller.

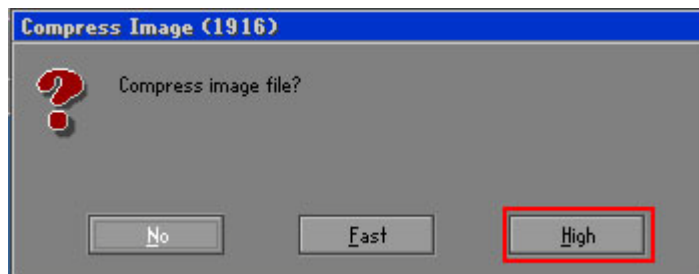

Figure B-17: Compress Image

Step 9: The Proceed with partition image creation window appears, click **Yes** to continue.

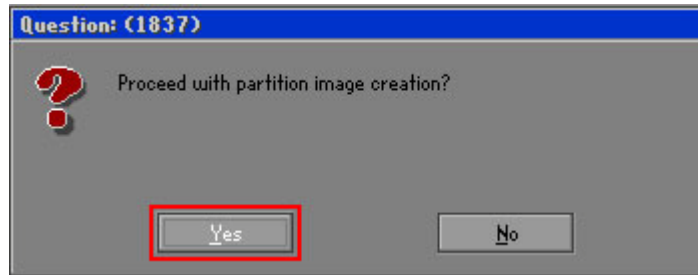

Figure B-18: Image Creation Confirmation

Step 10: The Symantec Ghost starts to create the factory default image (**Figure B-19**).

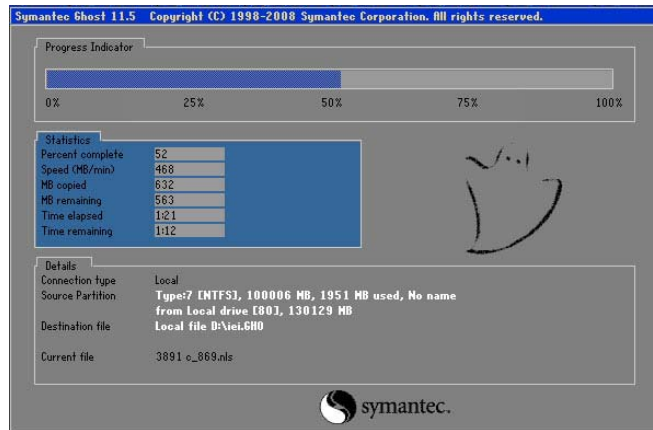

Figure B-19: Image Creation Complete

Step 11: When the image creation completes, a screen prompts as shown in **Figure B-20**.

Click **Continue** and close the Ghost window to exit the program.



Figure B-20: Image Creation Complete

Step 12: The recovery tool main menu window is shown as below. Press any key to reboot the system.

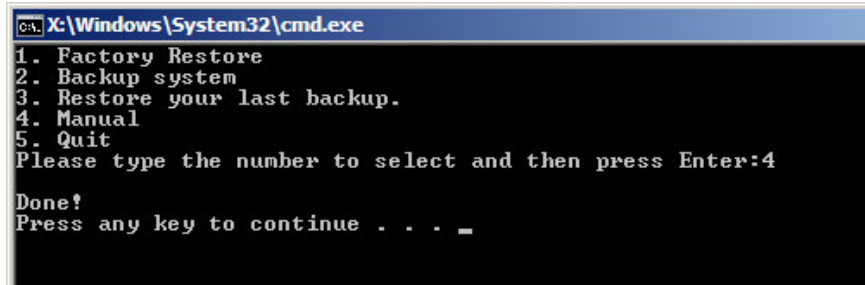

```

C:\Windows\System32\cmd.exe
1. Factory Restore
2. Backup system
3. Restore your last backup.
4. Manual
5. Quit
Please type the number to select and then press Enter:4
Done!
Press any key to continue . . . _
  
```

Figure B-21: Press Any Key to Continue

B.3 Auto Recovery Setup Procedure

The auto recovery function allows a system to automatically restore from the factory default image after encountering a Blue Screen of Death (BSoD) or a hang for around 10 minutes. To use the auto recovery function, follow the steps described in the following sections.



CAUTION:

The setup procedure may include a step to create a factory default image. It is suggested to configure the system to a factory default environment before the configuration, including driver and application installations.

Step 1: Follow the steps described in **Section B.2.1 ~ Section B.2.3** to setup BIOS, create partitions and install operating system.

Step 2: Install the auto recovery utility into the system by double clicking the **Utility/AUTORECOVERY-SETUP.exe** in the One Key Recovery CD. This utility **MUST** be installed in the system, otherwise, the system will automatically restore from the factory default image every ten (10) minutes.



Figure B-22: Auto Recovery Utility

Step 3: Reboot the system from the recovery CD. When prompted, press any key to boot from the recovery CD. It will take a while to launch the recovery tool. Please be patient!

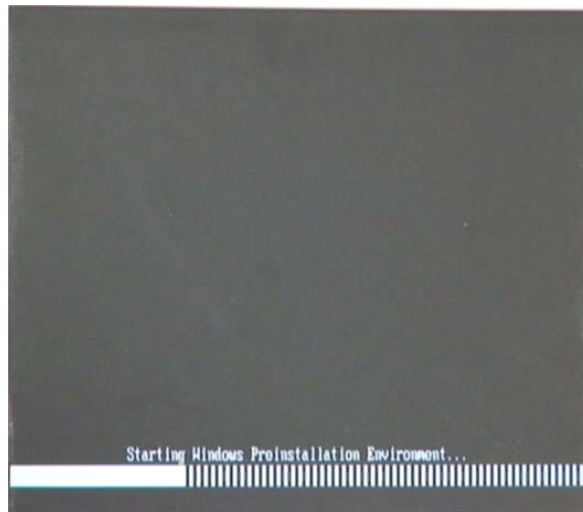

Figure B-23: Launching the Recovery Tool

Step 4: When the recovery tool setup menu appears, press <4> then <Enter>.

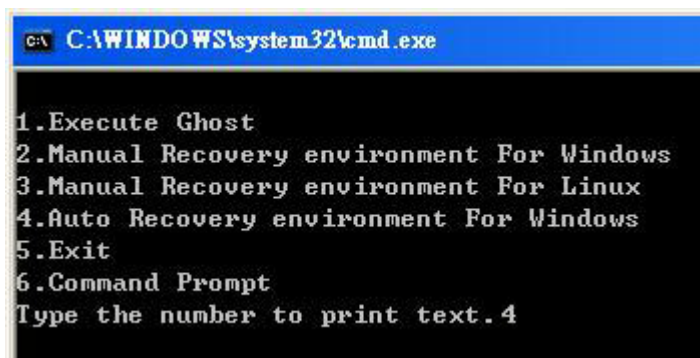

Figure B-24: Auto Recovery Environment for Windows

Step 5: The Symantec Ghost window appears and starts configuring the system to build an auto recovery partition. In this process the partition created for recovery files in **Section B.2.2** is hidden and the auto recovery tool is saved in this partition.

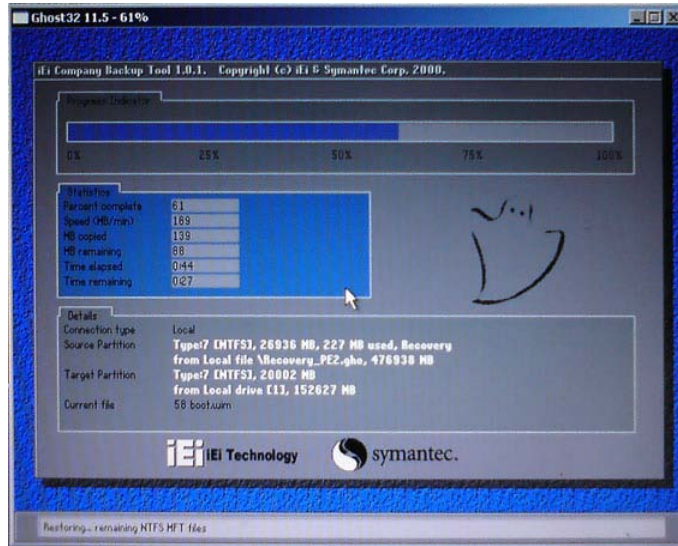

Figure B-25: Building the Auto Recovery Partition

Step 6: After completing the system configuration, the following message prompts to confirm whether to create a factory default image. Type **Y** to have the system create a factory default image automatically. Type **N** within 6 seconds to skip this process (The default option is YES). It is suggested to choose YES for this option.



Figure B-26: Factory Default Image Confirmation

Step 7: The Symantec Ghost starts to create the factory default image (**Figure B-27**).

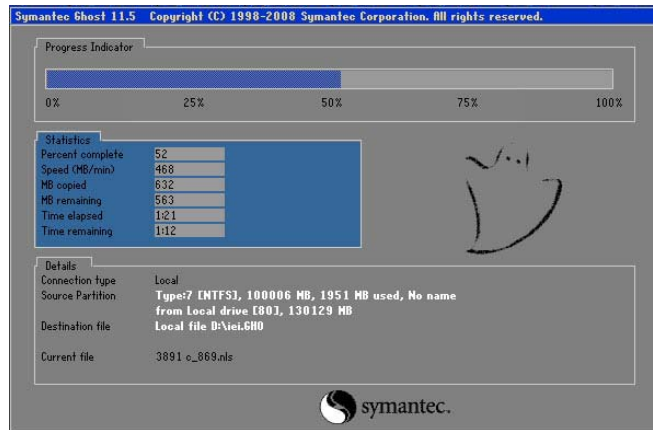

Figure B-27: Image Creation Complete

Step 8: After completing the system configuration, press any key in the following window to restart the system.

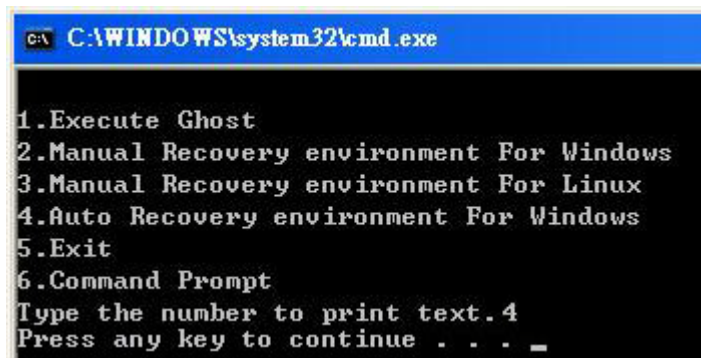
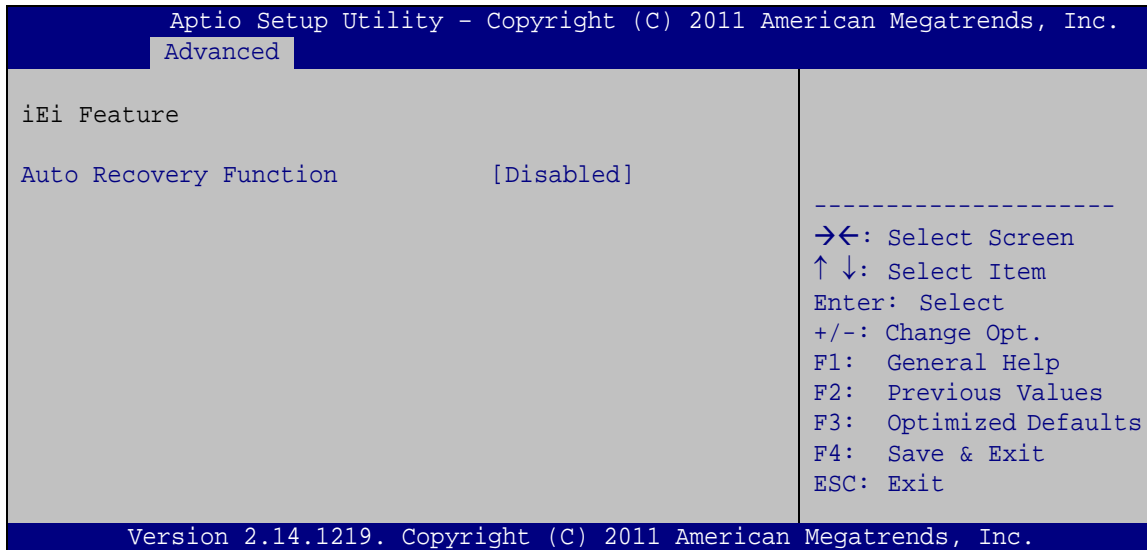

Figure B-28: Press any key to continue

Step 9: Eject the One Key Recovery CD and restart the system.

Step 10: Press the <DELETE> key as soon as the system is turned on to enter the BIOS.

Step 11: Enable the Auto Recovery Function option (**Advanced** → **iEi Feature** → **Auto Recovery Function**).



BIOS Menu 28: IEI Feature

Step 12: Save changes and restart the system. If the system encounters a Blue Screen of Death (BSoD) or a hang for around 10 minutes, it will automatically restore from the factory default image.



CAUTION:

The auto recovery function can only apply on a Microsoft Windows system running the following OS versions:

- Windows XP
- Windows Vista
- Windows 7

B.4 Setup Procedure for Linux

The initial setup procedure for Linux system is mostly the same with the procedure for Microsoft Windows. Please follow the steps below to setup recovery tool for Linux OS.

Step 1: Hardware and BIOS setup. Refer to **Section B.2.1**.

IMB-C2160 Micro-ATX Motherboard

Step 2: Install Linux operating system. Make sure to install GRUB (v0.97 or earlier) MBR type and Ext3 partition type. Leave enough space on the hard drive to create the recover partition later.

**NOTE:**

If the Linux OS is not installed with GRUB (v0.97 or earlier) and Ext3, the Symantec Ghost may not function properly.

While installing Linux OS, please create two partitions:

- Partition 1: /
- Partition 2: **SWAP**

**NOTE:**

Please reserve enough space for partition 3 for saving recovery images.

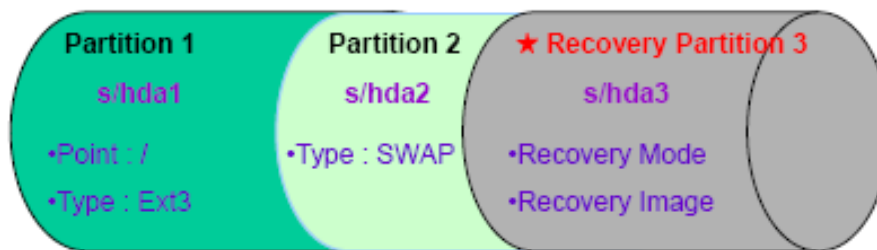

Figure B-29: Partitions for Linux

Step 3: Create a recovery partition. Insert the recovery CD into the optical disk drive. Follow **Step 1 ~ Step 3** described in **Section B.2.2**. Then type the following commands (marked in red) to create a partition for recovery images.

```
system32>diskpart
```

```
DISKPART>list vol
```



```
DISKPART>sel disk 0
DISKPART>create part pri size= ____
DISKPART>assign letter=N
DISKPART>exit
system32>format N: /fs:ntfs /q /v:Recovery /y
system32>exit
```

Step 4: Build the recovery partition. Press any key to boot from the recovery CD. It will take a while to launch the recovery tool. Please be patient. When the recovery tool setup menu appears, type <3> and press <Enter> (**Figure B-30**). The Symantec Ghost window appears and starts configuring the system to build a recovery partition. After completing the system configuration, press any key to reboot the system. Eject the recovery CD.

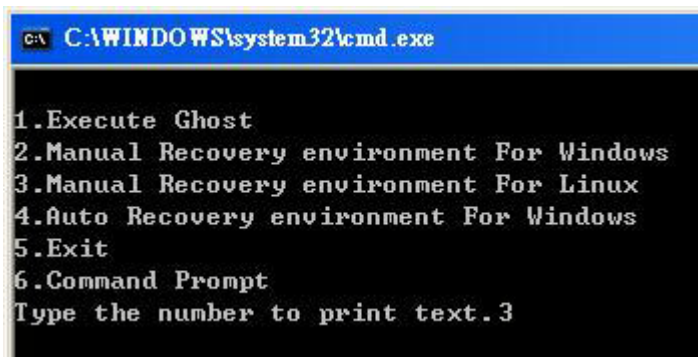
A screenshot of a Windows command prompt window. The title bar reads "C:\WINDOWS\system32\cmd.exe". The window contains a list of numbered options: 1. Execute Ghost, 2. Manual Recovery environment For Windows, 3. Manual Recovery environment For Linux, 4. Auto Recovery environment For Windows, 5. Exit, 6. Command Prompt. Below the list, it says "Type the number to print text.3".

```
C:\WINDOWS\system32\cmd.exe
1. Execute Ghost
2. Manual Recovery environment For Windows
3. Manual Recovery environment For Linux
4. Auto Recovery environment For Windows
5. Exit
6. Command Prompt
Type the number to print text.3
```

Figure B-30: Manual Recovery Environment for Linux

Step 5: Access the recovery tool main menu by modifying the “menu.lst”. To first access the recovery tool main menu, the menu.lst must be modified. In Linux, enter Administrator (root). When prompt appears, type:

```
cd /boot/grub
vi menu.lst
```

```
Fedora release 9 (Sulphur)
Kernel 2.6.25-14.fc9.i686 on an i686 (tty2)

localhost login: root
Password:
[root@localhost ~]# cd /boot/grub/
[root@localhost grub]# vi menu.lst _
```

Figure B-31: Access menu.lst in Linux (Text Mode)

Step 6: Modify the menu.lst as shown below.

```
#boot=/dev/sda
default=0
timeout=10 ← Modify timeout=10
splashimage=(hd0,0)/grub/splash.xpm.gz
hiddenmenu
title Fedora (2.6.25-14.fc9.i686)
    root (hd0,0)
    kernel /vmlinuz-2.6.25-14.fc9.i686 ro root=UUID=10f1acd
ac38b5c78910 rhgb quiet
    initrd /initrd-2.6.25-14.fc9.i686.img

title Recovery Partition
root (hd0,2)
makeactive ← Type command
chainloader +1
```

- Type command:
title Recovery Partition
root (hd0,2)
makeactive
chainloader +1

Step 7: The recovery tool menu appears. (Figure B-32)

```
1. Factory Restore
2. Backup system
3. Restore your last backup.
4. Manual
5. Quit
Please type the number to select and then press Enter:
```

Figure B-32: Recovery Tool Menu

Step 8: Create a factory default image. Follow Step 2 ~ Step 12 described in Section B.2.5 to create a factory default image.

B.5 Recovery Tool Functions

After completing the initial setup procedures as described above, users can access the recovery tool by pressing <F3> while booting up the system. However, if the setup procedure in Section B.3 has been completed and the auto recovery function is enabled, the system will automatically restore from the factory default image without pressing the F3 key. The recovery tool main menu is shown below.

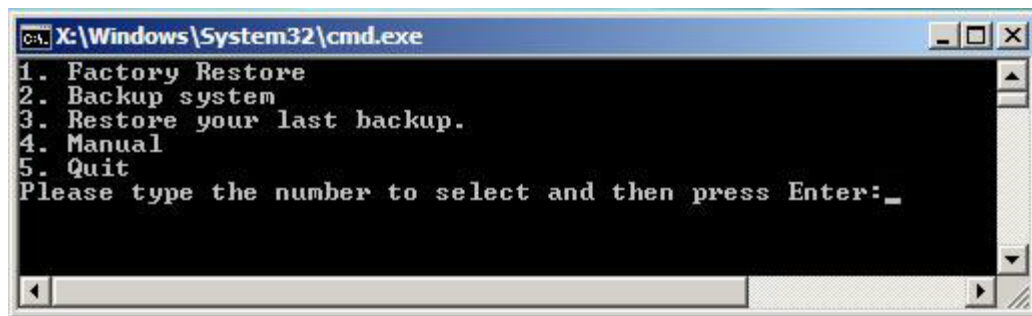

Figure B-33: Recovery Tool Main Menu

The recovery tool has several functions including:

1. **Factory Restore:** Restore the factory default image (iei.GHO) created in Section B.2.5.
2. **Backup system:** Create a system backup image (iei_user.GHO) which will be saved in the hidden partition.
3. **Restore your last backup:** Restore the last system backup image
4. **Manual:** Enter the Symantec Ghost window to configure manually.
5. **Quit:** Exit the recovery tool and restart the system.



WARNING:

Please do not turn off the system power during the process of system recovery or backup.



WARNING:

All data in the system will be deleted during the system recovery. Please backup the system files before restoring the system (either Factory Restore or Restore Backup).

B.5.1 Factory Restore

To restore the factory default image, please follow the steps below.

Step 1: Type <1> and press <Enter> in the main menu.

Step 2: The Symantec Ghost window appears and starts to restore the factory default. A factory default image called **iei.GHO** is created in the hidden Recovery partition.

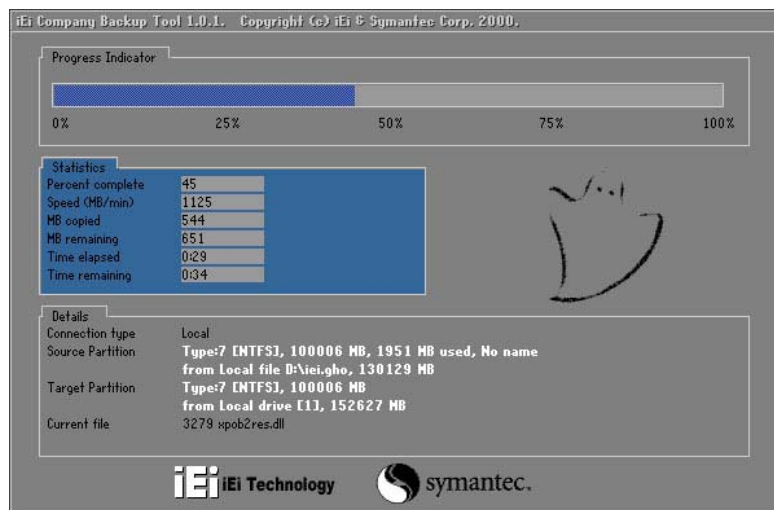

Figure B-34: Restore Factory Default

Step 3: The screen shown in **Figure B-35** appears when completed. Press any key to reboot the system.

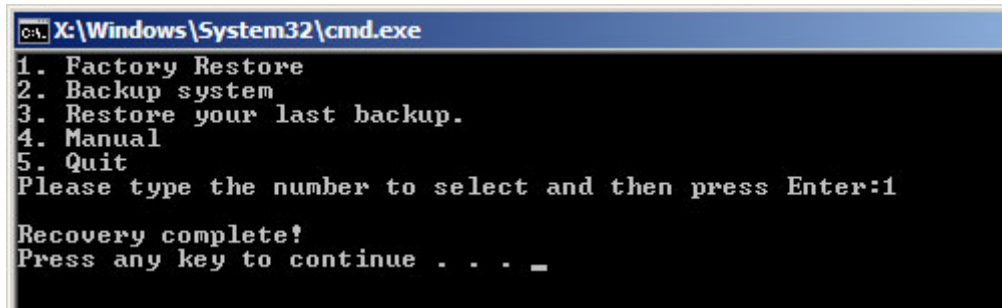

Figure B-35: Recovery Complete Window

B.5.2 Backup System

To backup the system, please follow the steps below.

Step 1: Type <2> and press <Enter> in the main menu.

Step 2: The Symantec Ghost window appears and starts to backup the system. A backup image called `iei_user.GHO` is created in the hidden Recovery partition.

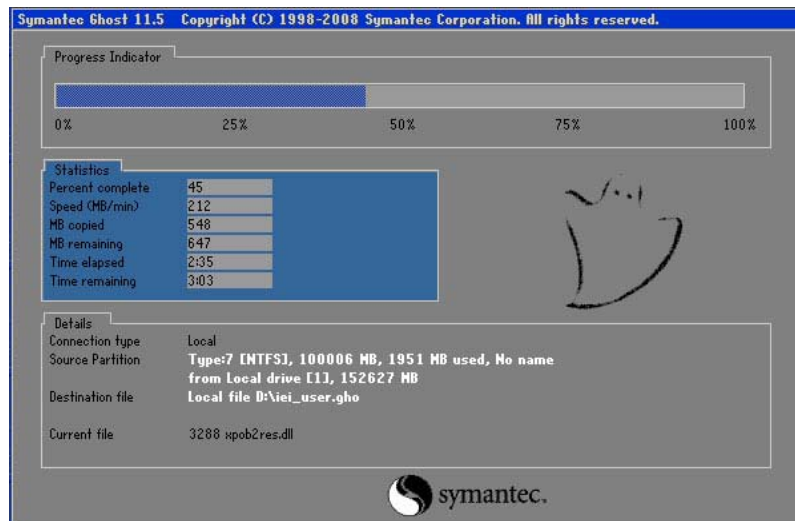

Figure B-36: Backup System

Step 3: The screen shown in **Figure B-37** appears when system backup is complete.

Press any key to reboot the system.

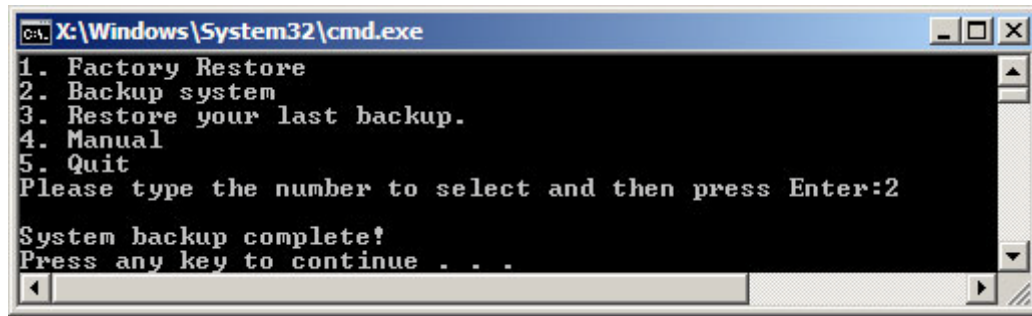

Figure B-37: System Backup Complete Window

B.5.3 Restore Your Last Backup

To restore the last system backup, please follow the steps below.

Step 1: Type <3> and press <Enter> in the main menu.

Step 2: The Symantec Ghost window appears and starts to restore the last backup image (iei_user.GHO).

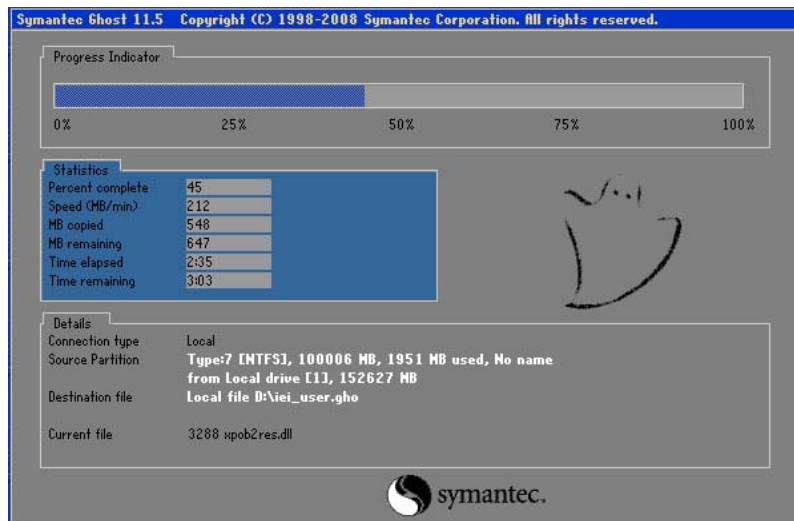

Figure B-38: Restore Backup

Step 3: The screen shown in **Figure B-39** appears when backup recovery is complete.

Press any key to reboot the system.

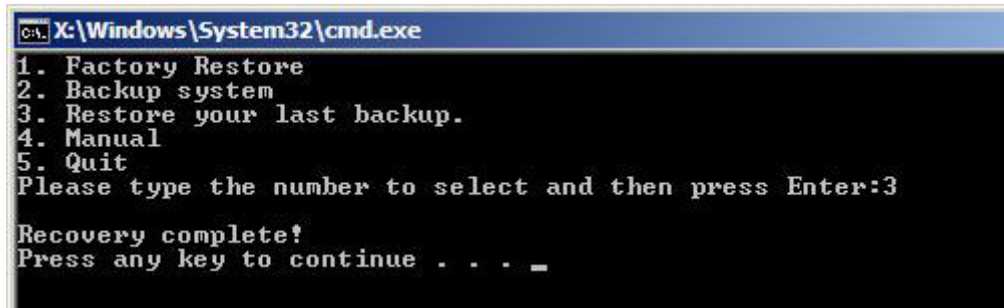

Figure B-39: Restore System Backup Complete Window

B.5.4 Manual

To restore the last system backup, please follow the steps below.

Step 1: Type <4> and press <Enter> in the main menu.

Step 2: The Symantec Ghost window appears. Use the Ghost program to backup or recover the system manually.

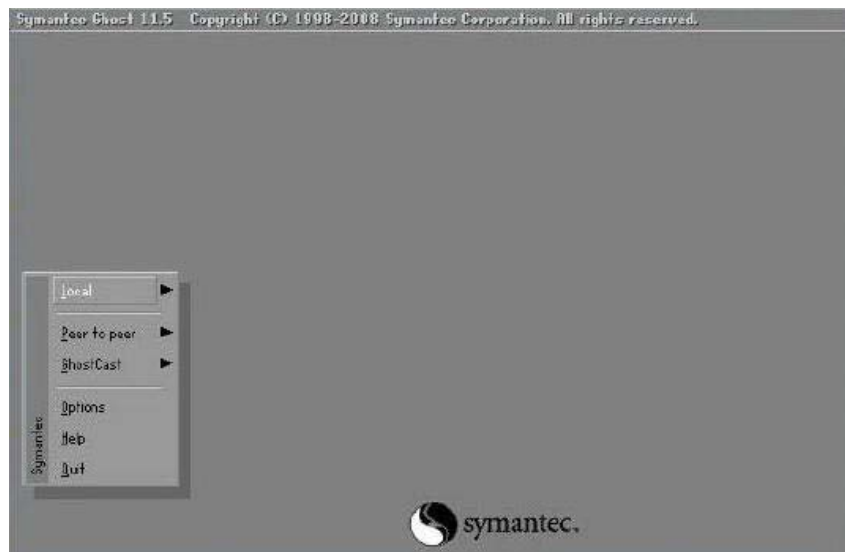
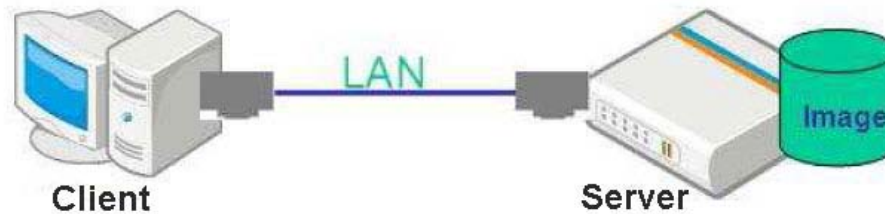

Figure B-40: Symantec Ghost Window

Step 3: When backup or recovery is completed, press any key to reboot the system.

B.6 Restore Systems from a Linux Server through LAN

The One Key Recovery allows a client system to automatically restore to a factory default image saved in a Linux system (the server) through LAN connectivity after encountering a Blue Screen of Death (BSoD) or a hang for around 10 minutes. To be able to use this function, the client system and the Linux system MUST reside in the same domain.



NOTE:

The supported client OS includes:

- Windows 2000
- Windows XP
- Windows Vista
- Windows 7
- Windows CE
- Windows XP Embedded

Prior to restoring client systems from a Linux server, a few setup procedures are required.

Step 1: Configure DHCP server settings

Step 2: Configure TFTP settings

Step 3: Configure One Key Recovery server settings

Step 4: Start DHCP, TFTP and HTTP

Step 5: Create a shared directory

Step 6: Setup a client system for auto recovery

The detailed descriptions are described in the following sections. In this document, two types of Linux OS are used as examples to explain the configuration process – CentOS 5.5 (Kernel 2.6.18) and Debian 5.0.7 (Kernel 2.6.26).

B.6.1 Configure DHCP Server Settings

Step 1: Install the DHCP

`#yum install dhcp` (CentOS, commands marked in red)

`#apt-get install dhcp3-server` (Debian, commands marked in blue)

Step 2: Confirm the operating system default settings: dhcpd.conf.

CentOS

Use the following command to show the DHCP server sample location:

`#vi /etc/dhcpd.conf`

The DHCP server sample location is shown as below:

```
# DHCP Server Configuration file.
# see /usr/share/doc/dhcp*/dhcpd.conf.sample
#
```

Use the following command to copy the DHCP server sample to etc/dhcpd.conf:

`#cp /usr/share/doc/dhcp-3.0.5/dhcpd.conf.sample /etc/dhcpd.conf`

`#vi /etc/dhcpd.conf`

```
ddns-update-style interim;
ignore client-updates;

subnet 192.168.0.0 netmask 255.255.255.0 {
# --- default gateway
    option routers                192.168.0.2;
    option subnet-mask            255.255.255.0;

    option nis-domain             "domain.org";
    option domain-name            "domain.org";
    option domain-name-servers   192.168.0.1;
    next-server 192.168.0.6;
    filename "pxelinux.0";
    option time-offset            -18000; # Eastern Standard Time
    option ntp-servers            192.168.1.1;
}
```

Debian

`#vi /etc/dhcpd.conf`

IMB-C2160 Micro-ATX Motherboard

Edit “/etc/dhcpd.conf” for your environment. For example, add

`next-server PXE server IP address;`

`filename “pxelinux.0”;`

```
ddns-update-style interim;
ignore client-updates;

subnet 192.168.0.0 netmask 255.255.255.0 {
# --- default gateway
    option routers                192.168.0.2;
    option subnet-mask            255.255.255.0;

    option nis-domain             "domain.org";
    option domain-name            "domain.org";
    option domain-name-servers   192.168.0.1;
    next-server 192.168.0.6;
    filename "pxelinux.0";
    option time-offset            -18000; # Eastern Standard Time
    option ntp-servers            192.168.1.1;
    option public-name            192.168.1.1;
}
```

B.6.2 Configure TFTP Settings

Step 1: Install the tftp, httpd and syslinux.

`#yum install tftp-server httpd syslinux` (CentOS)

`#apt-get install tftpd-hpa xinetd syslinux` (Debian)

Step 2: Enable the TFTP server by editing the “/etc/xinetd.d/tftp” file and make it use the remap file. The “-vvv” is optional but it could definitely help on getting more information while running the remap file. For example:

CentOS

`#vi /etc/xinetd.d/tftp`

Modify:

`disable = no`

`server_args = -s /tftpboot -m /tftpboot/tftpd.remap -vvv_`

```

socket_type      = dgram
protocol        = udp
wait            = yes
user            = root
server          = /usr/sbin/in.tftpd
server_args     = -s /tftpboot -m /tftpboot/tftpd.remap -vvv
disable         = no
per_source      = 11
cps             = 100 2
flags           = IPv4
    
```

Debian

Replace the TFTP settings from “inetd” to “xinetd” and annotate the “inetd” by adding “#”.

[#vi /etc/inetd.conf](#)

Modify: #tftp dgram udp wait root /usr/sbin..... (as shown below)

```

#:BOOT: TFTP service is provided primarily for booting. Most sites
#      run this only on machines acting as "boot servers."

#tftp      dgram  udp    wait   root   /usr/sbin/in.tftpd /usr/sbin/in.tftpd -s
          /var/lib/tftpboot
    
```

[#vi /etc/xinetd.d/tftp](#)

```

socket_type      = dgram
protocol        = udp
wait            = yes
user            = root
server          = /usr/sbin/in.tftpd
server_args     = -s /tftpboot -m /tftpboot/tftpd.remap -vvv
disable         = no
per_source      = 11
cps             = 100 2
flags           = IPv4
    
```

B.6.3 Configure One Key Recovery Server Settings

- Step 1:** Copy the **Utility/RECOVERYR10.TAR.BZ2** package from the One Key Recovery CD to the system (server side).



IMB-C2160 Micro-ATX Motherboard

Step 2: Extract the recovery package to /.

```
#cp RecoveryR10.tar.bz2 /  
#cd /  
#tar -xvzf RecoveryR10.tar.bz2
```

Step 3: Copy "pxelinux.0" from "syslinux" and install to "/tftpboot".

```
#cp /usr/lib/syslinux/pxelinux.0 /tftpboot/
```

B.6.4 Start the DHCP, TFTP and HTTP

Start the DHCP, TFTP and HTTP. For example:

CentOS

```
#service xinetd restart
```

```
#service httpd restart
```

```
#service dhcpd restart
```

Debian

```
#/etc/init.d/xinetd reload
```

```
#/etc/init.d/xinetd restart
```

```
#/etc/init.d/dhcp3-server restart
```

B.6.5 Create Shared Directory

Step 1: Install the samba.

```
#yum install samba
```

Step 2: Create a shared directory for the factory default image.

```
#mkdir /share  
#cd /share  
#mkdir /image  
#cp iei.gho /image
```

**WARNING:**

The file name of the factory default image must be **iei.gho**.

Step 3: Confirm the operating system default settings: smb.conf.

```
#vi /etc/samba/smb.conf
```

Modify:

```
[image]
```

```
comment = One Key Recovery
```

```
path = /share/image
```

```
browseable = yes
```

```
writable = yes
```

```
public = yes
```

```
create mask = 0644
```

```
directory mask = 0755
```

Step 4: Edit “/etc/samba/smb.conf” for your environment. For example:

```
# "security = user" is always a good idea. This will require a Unix account
# in this server for every user accessing the server. See
# /usr/share/doc/samba-doc/html/docs/Samba3-HOWTO/ServerType.html
# in the samba-doc package for details.
security = share
```

```
[image]
comment = One Key Recovery
path = /share/image
browseable = yes
writable = yes
public = yes
create mask = 0644
directory mask = 0755
```

Step 5: Modify the hostname

```
#vi /etc/hostname
```

Modify: RecoveryServer

```
RecoveryServer
```

IMB-C2160 Micro-ATX Motherboard

B.6.6 Setup a Client System for Auto Recovery

Step 1: Configure the following BIOS options of the client system.

Advanced → iEi Feature → Auto Recovery Function → **Enabled**

Advanced → iEi Feature → Recover from PXE → **Enabled**

Boot → Launch PXE OpROM → **Enabled**

Step 2: Continue to configure the **Boot Option Priorities** BIOS option of the client system:

Boot Option #1 → remain the default setting to boot from the original OS.

Boot Option #2 → select the boot from LAN option.

Step 3: Save changes and exit BIOS menu.

Exit → **Save Changes and Exit**

Step 4: Install the auto recovery utility into the system by double clicking the **Utility/AUTORECOVERY-SETUP.exe** in the One Key Recovery CD. This utility **MUST** be installed in the system, otherwise, the system will automatically restore from the factory default image every ten (10) minutes.



Step 5: Restart the client system from LAN. If the system encounters a Blue Screen of Death (BSoD) or a hang for around 10 minutes, it will automatically restore from the factory default image. The following screens will show when the system starts auto recovering.

```
Realtek PCIe GBE Family Controller Series v2.35 (06/14/10)
CLIENT MAC ADDR: 00 18 7D 13 E6 89  GUID: 00020003-0004-0005-0006-0007000000
DHCP.._
```

```
My IP address seems to be C0A80009 192.168.0.9
ip=192.168.0.9:192.168.0.8:192.168.0.2:255.255.255.0
TFTP prefix:
Trying to load: pxelinux.cfg/00020003-0004-0005-0006-000700080009
Trying to load: pxelinux.cfg/01-00-18-7d-13-e6-89
Trying to load: pxelinux.cfg/C0A80009
Trying to load: pxelinux.cfg/C0A8000
Trying to load: pxelinux.cfg/C0A800
Trying to load: pxelinux.cfg/C0A80
Trying to load: pxelinux.cfg/C0A8
Trying to load: pxelinux.cfg/C0A
Trying to load: pxelinux.cfg/C0
Trying to load: pxelinux.cfg/C
Trying to load: pxelinux.cfg/default
boot:
```

Windows is loading files...

IP: 192.168.0.8, File: \Boot\WinPE.wim

Symantec Ghost 11.5 Copyright (C) 1998-2008 Symantec Corporation. All rights reserved.

Progress Indicator



0% 25% 50% 75% 100%

Statistics

Percent complete	52
Speed (MB/min)	468
MB copied	632
MB remaining	563
Time elapsed	1:21
Time remaining	1:12

Details

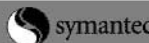
Connection type	Local
Source Partition	Type:7 [NTFS], 100006 MB, 1951 MB used, No name from Local drive [80], 130129 MB
Destination file	Local file D:\iei.GHO
Current file	3891_e_869.nls



NOTE:

A firewall or a SELinux is not in use in the whole setup process. If there is a firewall or a SELinux protecting the system, modify the configuration information to accommodate them.

B.7 Other Information

B.7.1 Using AHCI Mode or ALi M5283 / VIA VT6421A Controller

When the system uses AHCI mode or some specific SATA controllers such as ALi M5283 or VIA VT6421A, the SATA RAID/AHCI driver must be installed before using one key recovery. Please follow the steps below to install the SATA RAID/AHCI driver.

Step 1: Copy the SATA RAID/AHCI driver to a floppy disk and insert the floppy disk into a USB floppy disk drive. The SATA RAID/AHCI driver must be especially designed for the on-board SATA controller.

Step 2: Connect the USB floppy disk drive to the system.

Step 3: Insert the One Key Recovery CD into the system and boot the system from the CD.

Step 4: When launching the recovery tool, press <F6>.

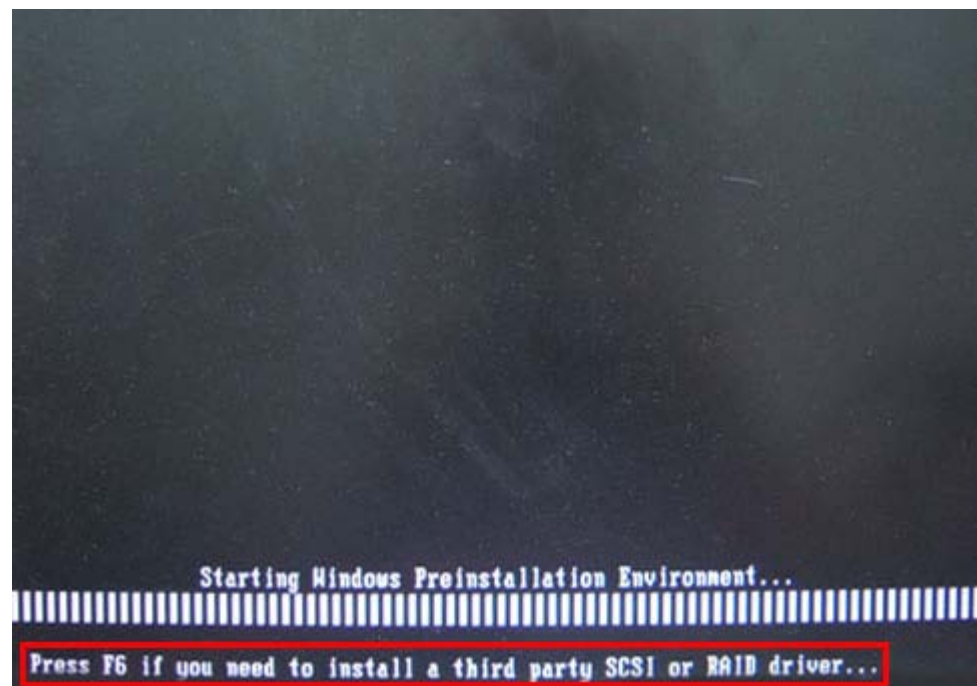

Step 5: When the following window appears, press <S> to select “Specify Additional Device”.

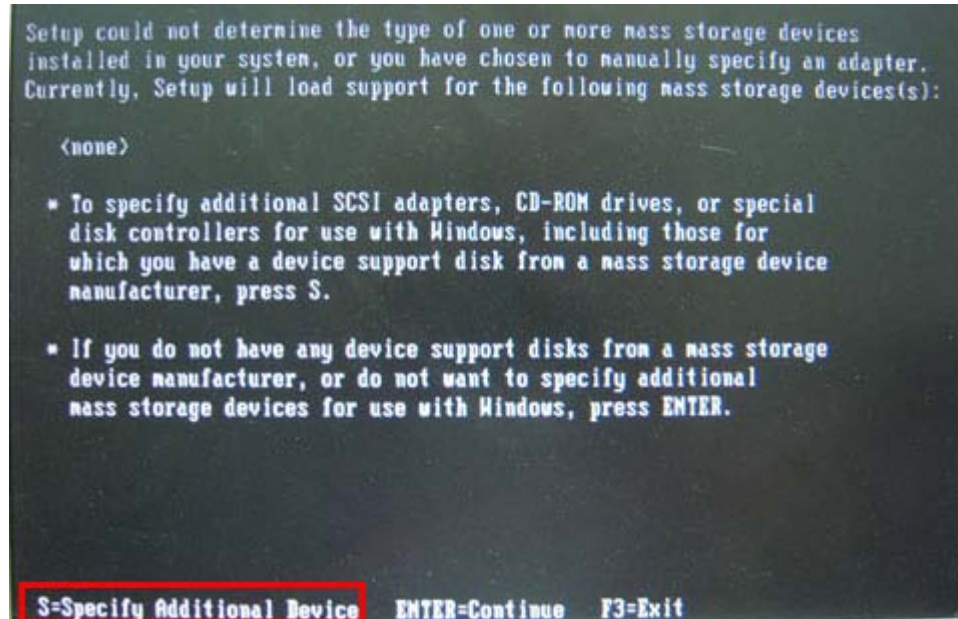

Step 6: In the following window, select a SATA controller mode used in the system. Then press <Enter>. The user can now start using the SATA HDD.

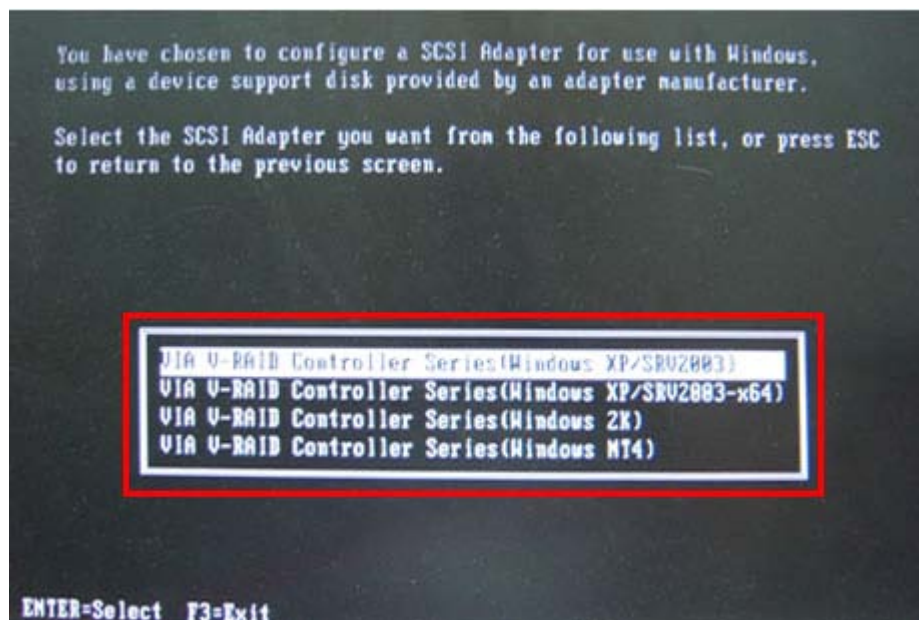

- Step 7:** After pressing <Enter>, the system will get into the recovery tool setup menu. Continue to follow the setup procedure from **Step 4** in **Section B.2.2 Create Partitions** to finish the whole setup process.

B.7.2 System Memory Requirement

To be able to access the recovery tool by pressing <F3> while booting up the system, please make sure to have enough system memory. The minimum memory requirement is listed below.

- **Using Award BIOS:** 128 MB system memory
- **Using AMI BIOS:** 512 MB system memory.



Appendix

C

Terminology

IMB-C2160 Micro-ATX Motherboard

AC '97	Audio Codec 97 (AC'97) refers to a codec standard developed by Intel® in 1997.
ACPI	Advanced Configuration and Power Interface (ACPI) is an OS-directed configuration, power management, and thermal management interface.
AHCI	Advanced Host Controller Interface (AHCI) is a SATA Host controller register-level interface.
ATA	The Advanced Technology Attachment (ATA) interface connects storage devices including hard disks and CD-ROM drives to a computer.
ARMD	An ATAPI Removable Media Device (ARMD) is any ATAPI device that supports removable media, besides CD and DVD drives.
ASKIR	Amplitude Shift Keyed Infrared (ASKIR) is a form of modulation that represents a digital signal by varying the amplitude (“volume”) of the signal. A low amplitude signal represents a binary 0, while a high amplitude signal represents a binary 1.
BIOS	The Basic Input/Output System (BIOS) is firmware that is first run when the computer is turned on and can be configured by the end user
CODEC	The Compressor-Decompressor (CODEC) encodes and decodes digital audio data on the system.
CMOS	Complimentary metal-oxide-conductor is an integrated circuit used in chips like static RAM and microprocessors.
COM	COM refers to serial ports. Serial ports offer serial communication to expansion devices. The serial port on a personal computer is usually a male DB-9 connector.
DAC	The Digital-to-Analog Converter (DAC) converts digital signals to analog signals.
DDR	Double Data Rate refers to a data bus transferring data on both the rising and falling edges of the clock signal.
DMA	Direct Memory Access (DMA) enables some peripheral devices to bypass the system processor and communicate directly with the system memory.

DIMM	Dual Inline Memory Modules are a type of RAM that offer a 64-bit data bus and have separate electrical contacts on each side of the module.
DIO	The digital inputs and digital outputs are general control signals that control the on/off circuit of external devices or TTL devices. Data can be read or written to the selected address to enable the DIO functions.
EHCI	The Enhanced Host Controller Interface (EHCI) specification is a register-level interface description for USB 2.0 Host Controllers.
EIDE	Enhanced IDE (EIDE) is a newer IDE interface standard that has data transfer rates between 4.0 MBps and 16.6 MBps.
EIST	Enhanced Intel® SpeedStep Technology (EIST) allows users to modify the power consumption levels and processor performance through application software. The application software changes the bus-to-core frequency ratio and the processor core voltage.
FSB	The Front Side Bus (FSB) is the bi-directional communication channel between the processor and the Northbridge chipset.
GbE	Gigabit Ethernet (GbE) is an Ethernet version that transfers data at 1.0 Gbps and complies with the IEEE 802.3-2005 standard.
GPIO	General purpose input
HDD	Hard disk drive (HDD) is a type of magnetic, non-volatile computer storage device that stores digitally encoded data.
ICH	The Input/Output Control Hub (ICH) is an Intel® Southbridge chipset.
IrDA	Infrared Data Association (IrDA) specify infrared data transmission protocols used to enable electronic devices to wirelessly communicate with each other.
L1 Cache	The Level 1 Cache (L1 Cache) is a small memory cache built into the system processor.
L2 Cache	The Level 2 Cache (L2 Cache) is an external processor memory cache.
LCD	Liquid crystal display (LCD) is a flat, low-power display device that consists of two polarizing plates with a liquid crystal panel in between.

IMB-C2160 Micro-ATX Motherboard

LVDS	Low-voltage differential signaling (LVDS) is a dual-wire, high-speed differential electrical signaling system commonly used to connect LCD displays to a computer.
POST	The Power-on Self Test (POST) is the pre-boot actions the system performs when the system is turned-on.
RAM	Random Access Memory (RAM) is volatile memory that loses data when power is lost. RAM has very fast data transfer rates compared to other storage like hard drives.
SATA	Serial ATA (SATA) is a serial communications bus designed for data transfers between storage devices and the computer chipsets. The SATA bus has transfer speeds up to 1.5 Gbps and the SATA II bus has data transfer speeds of up to 3.0 Gbps.
S.M.A.R.T	Self Monitoring Analysis and Reporting Technology (S.M.A.R.T) refers to automatic status checking technology implemented on hard disk drives.
UART	Universal Asynchronous Receiver-transmitter (UART) is responsible for asynchronous communications on the system and manages the system's serial communication (COM) ports.
UHCI	The Universal Host Controller Interface (UHCI) specification is a register-level interface description for USB 1.1 Host Controllers.
USB	The Universal Serial Bus (USB) is an external bus standard for interfacing devices. USB 1.1 supports 12Mbps data transfer rates and USB 2.0 supports 480Mbps data transfer rates.
VGA	The Video Graphics Array (VGA) is a graphics display system developed by IBM.

Appendix

D

Watchdog Timer

**NOTE:**

The following discussion applies to DOS environment. Contact IEI support or visit the IEI website for specific drivers for other operating systems.

The Watchdog Timer is provided to ensure that standalone systems can always recover from catastrophic conditions that cause the CPU to crash. This condition may have occurred by external EMIs or a software bug. When the CPU stops working correctly, Watchdog Timer either performs a hardware reset (cold boot) or a Non-Maskable Interrupt (NMI) to bring the system back to a known state.

A BIOS function call (INT 15H) is used to control the Watchdog Timer.

INT 15H:

AH – 6FH Sub-function:	
AL – 2:	Sets the Watchdog Timer's period.
BL:	Time-out value (Its unit-second is dependent on the item "Watchdog Timer unit select" in CMOS setup).

Table D-1: AH-6FH Sub-function

Call sub-function 2 to set the time-out period of Watchdog Timer first. If the time-out value is not zero, the Watchdog Timer starts counting down. When the timer value reaches zero, the system resets. To ensure that this reset condition does not occur, calling sub-function 2 must periodically refresh the Watchdog Timer. However, the watchdog timer is disabled if the time-out value is set to zero.

A tolerance of at least 10% must be maintained to avoid unknown routines within the operating system (DOS), such as disk I/O that can be very time-consuming.

**NOTE:**

When exiting a program it is necessary to disable the Watchdog Timer, otherwise the system resets.

EXAMPLE PROGRAM:**; INITIAL TIMER PERIOD COUNTER**

;

W_LOOP:

;

```
MOV     AX, 6F02H      ;setting the time-out value
MOV     BL, 30         ;time-out value is 48 seconds
INT     15H
```

;

; ADD THE APPLICATION PROGRAM HERE

;

```
CMP     EXIT_AP, 1     ;is the application over?
JNE     W_LOOP        ;No, restart the application
```

```
MOV     AX, 6F02H     ;disable Watchdog Timer
MOV     BL, 0         ;
INT     15H
```

;

; EXIT ;

Appendix

E

Hazardous Materials Disclosure

E.1 Hazardous Materials Disclosure Table for IPB Products Certified as RoHS Compliant Under 2002/95/EC Without Mercury

The details provided in this appendix are to ensure that the product is compliant with the Peoples Republic of China (China) RoHS standards. The table below acknowledges the presences of small quantities of certain materials in the product, and is applicable to China RoHS only.

A label will be placed on each product to indicate the estimated “Environmentally Friendly Use Period” (EFUP). This is an estimate of the number of years that these substances would “not leak out or undergo abrupt change.” This product may contain replaceable sub-assemblies/components which have a shorter EFUP such as batteries and lamps. These components will be separately marked.

Please refer to the table on the next page.

IMB-C2160 Micro-ATX Motherboard

Part Name	Toxic or Hazardous Substances and Elements					
	Lead (Pb)	Mercury (Hg)	Cadmium (Cd)	Hexavalent Chromium (CR(VI))	Polybrominated Biphenyls (PBB)	Polybrominated Diphenyl Ethers (PBDE)
Housing	X	O	O	O	O	X
Display	X	O	O	O	O	X
Printed Circuit Board	X	O	O	O	O	X
Metal Fasteners	X	O	O	O	O	O
Cable Assembly	X	O	O	O	O	X
Fan Assembly	X	O	O	O	O	X
Power Supply Assemblies	X	O	O	O	O	X
Battery	O	O	O	O	O	O

O: This toxic or hazardous substance is contained in all of the homogeneous materials for the part is below the limit requirement in SJ/T11363-2006

X: This toxic or hazardous substance is contained in at least one of the homogeneous materials for this part is above the limit requirement in SJ/T11363-2006

此附件旨在确保本产品符合中国 RoHS 标准。以下表格标示此产品中某有毒物质的含量符合中国 RoHS 标准规定的限量要求。

本产品上会附有“环境友好使用期限”的标签，此期限是估算这些物质“不会有泄漏或突变”的年限。本产品可能包含有较短的环境友好使用期限的可替换元件，像是电池或灯管，这些元件将会单独标示出来。

部件名称	有毒有害物质或元素					
	铅 (Pb)	汞 (Hg)	镉 (Cd)	六价铬 (CR(VI))	多溴联苯 (PBB)	多溴二苯 醚 (PBDE)
壳体	X	O	O	O	O	X
显示	X	O	O	O	O	X
印刷电路板	X	O	O	O	O	X
金属螺帽	X	O	O	O	O	O
电缆组装	X	O	O	O	O	X
风扇组装	X	O	O	O	O	X
电力供应组装	X	O	O	O	O	X
电池	O	O	O	O	O	O

O: 表示该有毒有害物质在该部件所有物质材料中的含量均在 SJ/T11363-2006 标准规定的限量要求以下。
X: 表示该有毒有害物质至少在该部件的某一均质材料中的含量超出 SJ/T11363-2006 标准规定的限量要求。