



IEI Technology Corp.



MODEL:
PPC-51xxA-H61

Industrial Panel PC for 2nd/3rd Generation Intel® Core™, Pentium® or Celeron® CPU, Intel® H61 Express Chipset, Touchscreen, USB 3.0, Dual Gigabit LAN supporting SFP Fiber, IP 65 Compliant Front Panel and RoHS Compliant

User Manual

Rev. 1.01 – 28 June, 2013



Revision

Date	Version	Changes
28 June, 2013	1.01	Updated Figure 3-25: PPC-5150A-H61 Panel Cutout Dimensions Added the limitation of the expansion card dimensions
26 October, 2012	1.00	Initial release

Copyright

COPYRIGHT NOTICE

The information in this document is subject to change without prior notice in order to improve reliability, design and function and does not represent a commitment on the part of the manufacturer.

In no event will the manufacturer be liable for direct, indirect, special, incidental, or consequential damages arising out of the use or inability to use the product or documentation, even if advised of the possibility of such damages.

This document contains proprietary information protected by copyright. All rights are reserved. No part of this manual may be reproduced by any mechanical, electronic, or other means in any form without prior written permission of the manufacturer.

TRADEMARKS

All registered trademarks and product names mentioned herein are used for identification purposes only and may be trademarks and/or registered trademarks of their respective owners.

Table of Contents

1 INTRODUCTION.....	1
1.1 OVERVIEW.....	2
1.2 MODEL VARIATIONS	2
1.3 FEATURES.....	3
1.4 EXTERNAL OVERVIEW.....	4
1.4.1 Front Panel	4
1.4.2 Rear Panel	5
1.4.3 Top Panel	5
1.4.4 Bottom Panel.....	6
1.4.5 Left Panel.....	9
1.4.6 Right Panel.....	9
1.5 INTERNAL OVERVIEW.....	10
1.6 DIMENSIONS.....	11
1.6.1 PPC-5150A-H61 Dimensions	11
1.6.2 PPC-5170A-H61 Dimensions	12
1.6.3 PPC-5190A-H61 Dimensions	13
1.7 SPECIFICATIONS	14
2 UNPACKING	17
2.1 UNPACKING.....	18
2.2 PACKING LIST.....	19
2.3 OPTIONAL ITEMS	20
3 INSTALLATION	22
3.1 ANTI-STATIC PRECAUTIONS	23
3.2 INSTALLATION PRECAUTIONS	23
3.3 PREINSTALLED COMPONENTS.....	24
3.4 INSTALLATION AND CONFIGURATION STEPS	24
3.5 REMOVING THE BACK COVER	25
3.6 JUMPER SETTINGS	26
3.6.1 Access the Jumpers	26

PPC-51xxA-H61 Panel PC

3.6.2	<i>Preconfigured Jumpers</i>	27
3.6.3	<i>COM1 to COM5 Pin 9 Setting Jumpers</i>	27
3.6.4	<i>COM5 RS-232/422/485 Serial Port Selection Jumper</i>	29
3.7	DRIVE INSTALLATION	30
3.7.1	<i>Hard Drive Installation</i>	30
3.7.2	<i>CompactFlash® Card Installation</i>	32
3.7.3	<i>Optical Disk Drive Installation (Optional)</i>	33
3.8	PCI EXPANSION CARD INSTALLATION (OPTIONAL)	37
3.9	PCIe EXPANSION CARD INSTALLATION (OPTIONAL)	40
3.10	AT/ATX MODE SELECTION	42
3.11	MOUNTING THE SYSTEM	43
3.11.1	<i>Wall Mounting</i>	43
3.11.2	<i>Panel Mounting</i>	46
3.11.3	<i>Rack and Cabinet Installation</i>	49
3.11.4	<i>Arm Mounting</i>	49
3.11.5	<i>Stand Mounting</i>	50
3.12	SFP FIBER MODULE INSTALLATION (OPTIONAL).....	51
3.13	BOTTOM PANEL CONNECTORS.....	52
3.13.1	<i>Audio Connectors</i>	52
3.13.2	<i>RJ-45 LAN Connectors</i>	53
3.13.3	<i>RS-232 Serial Ports (COM1, COM2, COM3, COM4)</i>	54
3.13.4	<i>RS-232/422/485 Serial Port (COM5)</i>	56
3.13.5	<i>SFP Fiber LAN Connectors</i>	57
3.13.6	<i>USB 2.0 Connectors</i>	57
3.13.7	<i>USB 3.0 Connectors</i>	58
3.13.8	<i>VGA Connector</i>	59
3.14	DRIVER INSTALLATION.....	60
4	SYSTEM MAINTENANCE	62
4.1	SYSTEM MAINTENANCE INTRODUCTION	63
4.2	MOTHERBOARD REPLACEMENT	63
4.3	BACK COVER REMOVAL.....	63
4.4	SO-DIMM REPLACEMENT.....	64
4.5	ELEVATED PLATFORM REMOVAL	65
4.6	PSU MODULE REPLACEMENT	67

4.6.1 Remove the Old PSU.....	67
4.6.2 Install the New PSU.....	68
4.7 SYSTEM COOLING FAN REPLACEMENT.....	69
4.7.1 Remove the Old System Cooling Fans.....	69
4.7.2 Install the New System Cooling Fans.....	70
5 BIOS SETUP	71
5.1 INTRODUCTION.....	72
5.1.1 Starting Setup.....	72
5.1.2 Using Setup.....	72
5.1.3 Getting Help.....	73
5.1.4 Unable to Reboot after Configuration Changes.....	73
5.1.5 BIOS Menu Bar.....	73
5.2 MAIN.....	74
5.3 ADVANCED.....	75
5.3.1 ACPI Settings.....	76
5.3.2 RTC Wake Settings.....	77
5.3.3 CPU Configuration.....	78
5.3.4 SATA Configuration.....	80
5.3.5 USB Configuration.....	81
5.3.6 F81866 Super IO Configuration.....	82
5.3.6.1 Serial Port n Configuration.....	83
5.3.7 F81866 H/W Monitor.....	88
5.3.7.1 Smart Fan Mode Configuration.....	88
5.3.8 Serial Port Console Redirection.....	90
5.3.8.1 Console Redirection Settings.....	91
5.4 CHIPSET.....	93
5.4.1 PCH-IO Configuration.....	94
5.4.1.1 PCH Azalia Configuration.....	95
5.4.2 System Agent (SA) Configuration.....	96
5.4.2.1 Graphics Configuration.....	96
5.4.2.2 Memory Configuration.....	99
5.5 BOOT.....	99
5.6 SECURITY.....	101
5.7 SAVE & EXIT.....	102

6 INTERFACE CONNECTORS	104
6.1 PERIPHERAL INTERFACE CONNECTORS.....	105
6.2 INTERNAL PERIPHERAL CONNECTORS	106
6.2.1 +12V Power Source Connector (CPU12V1).....	108
6.2.2 ATX Power Connector (ATX1).....	108
6.2.3 CompactFlash® Card Slot (CF1).....	109
6.2.4 DIO Connector (DIO1).....	110
6.2.5 Fan Connector (CPU_FAN1/SYS_FAN1/SYS_FAN2/SYS_FAN3)	110
6.2.6 I2C Connector (I2C_1).....	110
6.2.7 Internal Audio Connector (SPKL1)	111
6.2.8 Internal Audio Connector (SPKR1).....	111
6.2.9 Internal Power Button Connector (PWR_SW1)	111
6.2.10 Internal Power Button Connector (PWR_SW2)	111
6.2.11 K Type Thermocouple Connectors (K_TYPE1/K_TYPE2).....	112
6.2.12 LVDS Backlight Connector (INVERTER1).....	112
6.2.13 LVDS Connector (LVDS1)	112
6.2.14 PCIe Mini Card Slot (MINI_PCIE1)	113
6.2.15 SATA 3Gb/s Connectors (SATA1/SATA2).....	114
6.2.16 SATA Power Connectors (JSATA_PWR1/JSATA_PWR2).....	114
6.2.17 SFP Fiber LED Connector (F_LED1).....	115
6.2.18 SMBus Connector (SMBUS_1).....	115
6.2.19 SPI Flash Connector (JSP11).....	115
6.2.20 Touch Panel Connector (TOUCH1).....	116
6.2.21 USB 2.0 Connectors (USB1/USB2/USB3/USB4)	116
6.3 EXTERNAL INTERFACE PANEL CONNECTORS	116
6.3.1 RJ-45 LAN Connector (LAN1/2).....	117
6.3.2 RS-232 Serial Ports (COM1/2, COM3/4).....	117
6.3.3 RS-232/422/485 Serial Port (COM5)	118
6.3.4 USB 2.0 Connectors (USB_CON2).....	118
6.3.5 USB 3.0 Connectors (USB_CON1).....	118
6.3.6 VGA Connector (VGA1).....	119
6.4 PRECONFIGURED JUMPER SETTINGS.....	119
6.4.1 CF Card Power Selection Jumper (JP1)	120
6.4.2 CPU Fan Type Selection Jumper (JCPUFAN1).....	120

6.4.3 Inverter Brightness Voltage Selection Jumper (J_ADJ1)	120
6.4.4 LCD Power Selection Jumper (JLCD_PWR1)	121
6.4.5 Panel Type and Resolution Selection Jumper (JLCD_SET1)	121
6.4.6 Pull High/Low Selection (for RS-422/485 only) Jumper (UART_SEL1)	121
6.4.7 System Fan Type Selection Jumper (JSYSFAN1/JSYSFAN3)	122
6.4.8 Touchscreen Selection Jumper (JTOUCH1)	122
6.4.9 USB1~USB4 Power Selection Jumpers	122
A BIOS CONFIGURATION OPTIONS.....	123
A.1 BIOS CONFIGURATION OPTIONS	124
B ONE KEY RECOVERY	126
B.1 ONE KEY RECOVERY INTRODUCTION	127
B.1.1 System Requirement.....	128
B.1.2 Supported Operating System	129
B.2 SETUP PROCEDURE FOR WINDOWS	130
B.2.1 Hardware and BIOS Setup	131
B.2.2 Create Partitions	131
B.2.3 Install Operating System, Drivers and Applications	135
B.2.4 Building the Recovery Partition	136
B.2.5 Create Factory Default Image.....	138
B.3 AUTO RECOVERY SETUP PROCEDURE	143
B.4 SETUP PROCEDURE FOR LINUX	147
B.5 RECOVERY TOOL FUNCTIONS	151
B.5.1 Factory Restore	152
B.5.2 Backup System.....	153
B.5.3 Restore Your Last Backup.....	154
B.5.4 Manual.....	155
B.6 RESTORE SYSTEMS FROM A LINUX SERVER THROUGH LAN	156
B.6.1 Configure DHCP Server Settings	157
B.6.2 Configure TFTP Settings	158
B.6.3 Configure One Key Recovery Server Settings	159
B.6.4 Start the DHCP, TFTP and HTTP	160
B.6.5 Create Shared Directory.....	160
B.6.6 Setup a Client System for Auto Recovery	161

PPC-51xxA-H61 Panel PC

B.7 OTHER INFORMATION	164
<i>B.7.1 Using AHCI Mode or ALi M5283 / VIA VT6421A Controller</i>	164
<i>B.7.2 System Memory Requirement</i>	166
C SAFETY PRECAUTIONS	167
C.1 SAFETY PRECAUTIONS.....	168
<i>C.1.1 General Safety Precautions</i>	168
<i>C.1.2 Anti-static Precautions</i>	169
<i>C.1.3 Product Disposal</i>	169
C.2 MAINTENANCE AND CLEANING PRECAUTIONS	170
<i>C.2.1 Maintenance and Cleaning</i>	170
<i>C.2.2 Cleaning Tools</i>	171
D WATCHDOG TIMER	172
E HAZARDOUS MATERIALS DISCLOSURE	175
E.1 HAZARDOUS MATERIAL DISCLOSURE TABLE FOR IPB PRODUCTS CERTIFIED AS ROHS COMPLIANT UNDER 2002/95/EC WITHOUT MERCURY	176

List of Figures

Figure 1-1: PPC-51xxA-H61 Panel PC.....	2
Figure 1-2: Front View.....	4
Figure 1-3: Rear View.....	5
Figure 1-4: Top View.....	5
Figure 1-5: PPC-5150A-H61/PPC-5170A-H61 Bottom View.....	7
Figure 1-6: PPC-5190A-H61 Bottom View.....	8
Figure 1-7: Left View.....	9
Figure 1-8: Right View.....	9
Figure 1-9: Internal Components.....	10
Figure 1-10: PPC-5150A-H61 Dimensions (mm).....	11
Figure 1-11: PPC-5170A-H61 Dimensions (mm).....	12
Figure 1-12: PPC-5190A-H61 Dimensions (mm).....	13
Figure 3-1: PPC-5150A-H61 Back Cover Retention Screws.....	25
Figure 3-2: COM1 to COM5 Pin 9 Setting Jumper Locations.....	28
Figure 3-3: COM5 RS-232/422/485 Serial Port Selection Jumper Location.....	29
Figure 3-4: HDD Bracket Retention Screws.....	30
Figure 3-5: HDD Retention Screws.....	31
Figure 3-6: Replacing the HDD Bracket.....	31
Figure 3-7: CompactFlash® Cover Plate.....	32
Figure 3-8: Installing the CompactFlash® Card.....	32
Figure 3-9: Replacing the CompactFlash® Cover Plate.....	33
Figure 3-10: Optical Drive Bracket Retention Screws.....	34
Figure 3-11: Optical Drive Blank Plate Assembly.....	34
Figure 3-12: Optical Drive Screws.....	35
Figure 3-13: Optical Drive SATA Cable.....	35
Figure 3-14: Replacing the Optical Drive Bracket.....	36
Figure 3-15: Installing the PCI Riser Card.....	38
Figure 3-16: Expansion Slot Retention Screw.....	38
Figure 3-17: Installing the PCI Card.....	39
Figure 3-18: Installing the PCIe Riser Card.....	41
Figure 3-19: Expansion Slot Retention Screw.....	41

PPC-51xxA-H61 Panel PC

Figure 3-20: Installing the PCIe Card.....	42
Figure 3-21: AT/ATX Mode Selection.....	42
Figure 3-22: Wall-mounting Bracket.....	44
Figure 3-23: Mount the Chassis.....	45
Figure 3-24: Secure the Chassis.....	46
Figure 3-25: PPC-5150A-H61 Panel Cutout Dimensions.....	47
Figure 3-26: PPC-5170A-H61 Panel Cutout Dimensions.....	47
Figure 3-27: PPC-5190A-H61 Panel Cutout Dimensions.....	47
Figure 3-28: Panel Mounting Clamp Positions.....	48
Figure 3-29: Tighten the Panel Mounting Clamp Screws.....	49
Figure 3-30: Arm Mounting Retention Screw Holes.....	50
Figure 3-31: Stand Mounting Retention Screw Holes.....	51
Figure 3-32: SFP Fiber Module Installation.....	52
Figure 3-33: RJ-45 LAN Connector.....	53
Figure 3-34: LAN Connection.....	54
Figure 3-35: RS-232 Serial Port.....	54
Figure 3-36: RS-232 Serial Device Connector.....	55
Figure 3-37: RS-232/422/485 Serial Port.....	56
Figure 3-38: RS-232/422/485 Serial Device Connector.....	57
Figure 3-39: USB Device Connection.....	58
Figure 3-40: VGA Connector.....	59
Figure 3-41: VGA Connector.....	60
Figure 3-42: Driver Menu.....	61
Figure 4-1: SO-DIMM Module Locations.....	64
Figure 4-2: SO-DIMM Module Installation.....	65
Figure 4-3: PPC-5150A-H61 Top Panel Elevated Platform Screws.....	65
Figure 4-4: PPC-5150A-H61 Side Panel Elevated Platform Screws.....	66
Figure 4-5: PPC-5150A-H61 Bottom Panel Elevated Platform Screws.....	66
Figure 4-6: PPC-5150A-H61 Internal Elevated Platform Screws.....	66
Figure 4-7: PSU Power Cables.....	67
Figure 4-8: PSU Bottom Panel Retention Screws.....	68
Figure 4-9: PSU Bottom Panel Screws.....	68
Figure 4-10: System Cooling Fans Motherboard Connector.....	69
Figure 4-11: System Cooling Fans Left Panel Retention Screws.....	70
Figure 6-1: Main Board Layout Diagram (Front Side).....	105

Figure 6-2: Main Board Layout Diagram (Solder Side).....	106
Figure B-1: IEI One Key Recovery Tool Menu	127
Figure B-2: Launching the Recovery Tool	132
Figure B-3: Recovery Tool Setup Menu	132
Figure B-4: Command Prompt	133
Figure B-5: Partition Creation Commands.....	134
Figure B-6: Launching the Recovery Tool	136
Figure B-7: Manual Recovery Environment for Windows	136
Figure B-8: Building the Recovery Partition.....	137
Figure B-9: Press Any Key to Continue	137
Figure B-10: Press F3 to Boot into Recovery Mode.....	138
Figure B-11: Recovery Tool Menu	138
Figure B-12: About Symantec Ghost Window.....	139
Figure B-13: Symantec Ghost Path	139
Figure B-14: Select a Local Source Drive	140
Figure B-15: Select a Source Partition from Basic Drive	140
Figure B-16: File Name to Copy Image to	141
Figure B-17: Compress Image.....	141
Figure B-18: Image Creation Confirmation	142
Figure B-19: Image Creation Complete	142
Figure B-20: Image Creation Complete	142
Figure B-21: Press Any Key to Continue	143
Figure B-22: Auto Recovery Utility	144
Figure B-23: Launching the Recovery Tool	144
Figure B-24: Auto Recovery Environment for Windows	144
Figure B-25: Building the Auto Recovery Partition.....	145
Figure B-26: Factory Default Image Confirmation	145
Figure B-27: Image Creation Complete	146
Figure B-28: Press any key to continue	146
Figure B-29: Partitions for Linux.....	148
Figure B-30: Manual Recovery Environment for Linux	149
Figure B-31: Access menu.lst in Linux (Text Mode).....	150
Figure B-32: Recovery Tool Menu	150
Figure B-33: Recovery Tool Main Menu	151
Figure B-34: Restore Factory Default.....	152

PPC-51xxA-H61 Panel PC

Figure B-35: Recovery Complete Window	153
Figure B-36: Backup System.....	153
Figure B-37: System Backup Complete Window	154
Figure B-38: Restore Backup	154
Figure B-39: Restore System Backup Complete Window	155
Figure B-40: Symantec Ghost Window	155

List of Tables

Table 1-1: Model Variations	3
Table 1-2: System Specifications.....	16
Table 2-1: Packing List.....	19
Table 2-2: Optional Items	21
Table 3-1: Jumpers	26
Table 3-2: Preconfigured Jumpers	27
Table 3-3: COM1 to COM5 Pin 9 Setting Jumper Settings	28
Table 3-4: COM5 RS-232/422/485 Serial Port Selection Jumper Settings.....	29
Table 3-5: LAN Pinouts	53
Table 3-6: RJ-45 LAN Connector LEDs	53
Table 3-7: RS-232 Serial Port Pinouts	55
Table 3-8: RS-232/422/485 Serial Port Pinouts	56
Table 3-9: USB 2.0 Port Pinouts.....	57
Table 3-10: USB 3.0 Port Pinouts.....	59
Table 3-11: VGA Connector Pinouts.....	59
Table 5-1: BIOS Navigation Keys	73
Table 6-1: Peripheral Interface Connectors	108
Table 6-2: +12V Power Source Connector (CPU12V1) Pinouts	108
Table 6-3: ATX Power Connector (ATX1) Pinouts.....	108
Table 6-4: CompactFlash® Card Slot (CF1) Pinouts.....	109
Table 6-5: DIO Connector (DIO1) Pinouts	110
Table 6-6: Fan Connector Pinouts	110
Table 6-7: Fan Connector (I2C_1) Pinouts	110
Table 6-8: Internal Audio Connector (SPKL1) Pinouts	111
Table 6-9: Internal Audio Connector (SPKR1) Pinouts.....	111
Table 6-10: Internal Power Button Connector (PWR_SW1) Pinouts	111
Table 6-11: Internal Power Button Connector (PWR_SW2) Pinouts	111
Table 6-12: K Type Thermocouple Connectors (K_TYPE1/K_TYPE2) Pinouts.....	112
Table 6-13: LVDS Backlight Connector (INVERTER1) Pinouts.....	112
Table 6-14: LVDS Connector (LVDS1) Pinouts.....	113
Table 6-15: PCIe Mini Card Slot (MINI_PCIE1) Pinouts.....	114

PPC-51xxA-H61 Panel PC

Table 6-16: SATA 3Gb/s Connectors (SATA1/SATA2) Pinouts	114
Table 6-17: SATA Power Connectors (JSATA_PWR1/JSATA_PWR2 Pinouts.....	114
Table 6-18: SATA Power Connectors (JSATA_PWR1/JSATA_PWR2 Pinouts.....	115
Table 6-19: SMBus Connector (SMBUS_1) Pinouts.....	115
Table 6-20: SPI Flash Connector (JSPI1) Pinouts	115
Table 6-21: Touch Panel Connector (TOUCH1) Pinouts.....	116
Table 6-22: USB 2.0 Connector (USB1/USB2/USB3/USB4) Pinouts.....	116
Table 6-23: Rear Panel Connectors	117
Table 6-24: RJ-45 LAN Connector Pinouts	117
Table 6-25: RS-232 Serial Port Pinouts	117
Table 6-26: RS-232/422/485 Serial Port Pinouts	118
Table 6-27: USB 2.0 Connectors (USB_CON2) Pinouts.....	118
Table 6-28: USB 3.0 Connectors (USB_CON1) Pinouts.....	119
Table 6-29: VGA Connector (VGA1) Pinouts	119
Table 6-30: Preconfigured Jumpers	120
Table 6-31: CF Card Power Selection Jumper (JP1) Settings.....	120
Table 6-32: CPU Fan Type Selection Jumper (JCPUFAN1) Settings	120
Table 6-33: Inverter Brightness Voltage Selection Jumper (J_ADJ1) Settings	120
Table 6-34: LCD Power Selection Jumper (JLCD_PWR1) Settings.....	121
Table 6-35: Panel Type and Resolution Selection Jumper (JLCD_SET1) Settings	121
Table 6-36: Pull High/Low Selection (for RS-422/485 only) Jumper (UART_SEL1) Settings..	121
Table 6-37: System Fan Type Selection Jumper Settings.....	122
Table 6-38: Touchscreen Selection Jumper (JTOUCH1) Settings.....	122
Table 6-39: USB1~USB4 Power Selection Jumpers Settings	122

Chapter

1

Introduction

1.1 Overview



Figure 1-1: PPC-51xxA-H61 Panel PC

The PPC-51xxA-H61 panel PC is for industrial environments like production lines and machine automation. The PPC-51xxA-H61 provides all the features of a PC, combined with a touch panel screen for mouse and keyboard free data input. The PPC-51xxA-H61 provides wired networking for integration into company networks. The major external device connections include USB 2.0, USB 3.0 and serial port connectors. Storage options include a 2.5" hard drive, a CompactFlash® card slot and optional mSATA, allowing for flexibility in choosing solid state drives or traditional hard drives. A VGA output on the bottom panel allows the PPC-51xxA-H61 to connect to a second screen for duplicating the screen contents or extending the user interface.

1.2 Model Variations

The model numbers and model variations are listed below.

Model	CPU	Power	Screen
PPC-5150A-H61-P/R-R10	Intel® Pentium® G6xxT Dual Core (above 2.2 GHz)	AC input	15"
PPC-5150AD-H61-P/R-R10		18~36 V DC input	15"
PPC-5150A-H61-i3/R-R10	Intel® Core™ i3 2xxxT Dual Core (above 2.5 GHz)	AC input	15"
PPC-5150AD-H61-i3/R-R10		18~36 V DC input	15"

PPC-51xxA-H61 Panel PC

Model	CPU	Power	Screen
PPC-5150A-H61-i5/R-R10	Intel® Core™ i5 2xxxT Dual Core (above 2.7 GHz)	AC input	15"
PPC-5150AD-H61-i5/R-R10		18~36 V DC input	15"
PPC-5170A-H61-P/R-R10	Intel® Pentium® G6xxT Dual Core (above 2.2 GHz)	AC input	17"
PPC-5170AD-H61-P/R-R10		18~36 V DC input	17"
PPC-5170A-H61-i3/R-R10	Intel® Core™ i3 2xxxT Dual Core (above 2.5 GHz)	AC input	17"
PPC-5170AD-H61-i3/R-R10		18~36 V DC input	17"
PPC-5170A-H61-i5/R-R10	Intel® Core™ i5 2xxxT Dual Core (above 2.7 GHz)	AC input	17"
PPC-5170AD-H61-i5/R-R10		18~36 V DC input	17"
PPC-5190A-H61-P/R-R10	Intel® Pentium® G6xxT Dual Core (above 2.2 GHz)	AC input	19"
PPC-5190AD-H61-P/R-R10		18~36 V DC input	19"
PPC-5190A-H61-i3/R-R10	Intel® Core™ i3 2xxxT Dual Core (above 2.5 GHz)	AC input	19"
PPC-5190AD-H61-i3/R-R10		18~36 V DC input	19"
PPC-5190A-H61-i5/R-R10	Intel® Core™ i5 2xxxT Dual Core (above 2.7 GHz)	AC input	19"
PPC-5190AD-H61-i5/R-R10		18~36 V DC input	19"

Table 1-1: Model Variations

1.3 Features

Some of the features of the PPC-51xxA-H61 panel PC include:

- Mainstream panel PC design with dual display function.
- Aluminum die-casting front panel meet IP 65 water proof standard
- High brightness TFT LCD panel with LED backlight
- Supports 2nd/3rd generation Intel® Core™, Pentium® and Celeron® processors
- Intel® H61 Express Chipset
- Dual DDR3 SO-DIMM (system max. 16 GB)
- Multiple storage options: 2.5" SATA HDD, CompactFlash® card and mSATA
- Dual Gigabit LAN supporting either RJ-45 or SFP fiber
- Optional PCIe Mini 802.11b/g/n wireless module

- Optional PCI/PCIe x1 expansion slot
- Supports slim type optical disk drive
- Includes the following I/O ports:
 - Five COM ports (one RS-232/422/485)
 - One CompactFlash® slot
 - One VGA port
 - RJ-45 and SFP fiber Gigabit LAN ports
 - USB 3.0 ports
 - USB 2.0 ports
- RoHS compliant

1.4 External Overview

The PPC-51xxA-H61 panel PC is comprised of an LCD screen, aluminum front panel and heavy duty steel rear and side panels. The rear panel provides screw holes for wall and an arm mounting. The right panel provides access to a slim type optical disk drive bay. The bottom panel provides access to external interface connectors that include GbE, USB 3.0, USB 2.0, audio, serial port connectors, VGA port and a CompactFlash® card slot.

1.4.1 Front Panel

The front panel of the PPC-51xxA-H61 (**Figure 1-2**) is a flat panel TFT LCD screen surrounded by an aluminum frame.

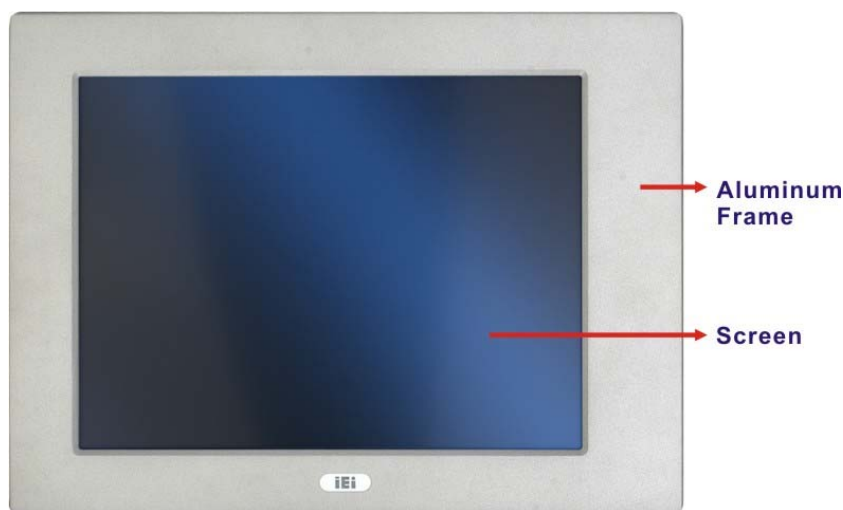

Figure 1-2: Front View

PPC-51xxA-H61 Panel PC

1.4.2 Rear Panel

The rear panel has a fan vent, four VESA standard mounting holes and several retention screw holes. The VESA mounting holes are circled in **Figure 1-3**.



Figure 1-3: Rear View

1.4.3 Top Panel

The top panel has panel mounting clamp slots, a fan vent and retention screws for securing the drive bay bracket. The numbers and locations of the panel mounting clamp slots may vary by models.

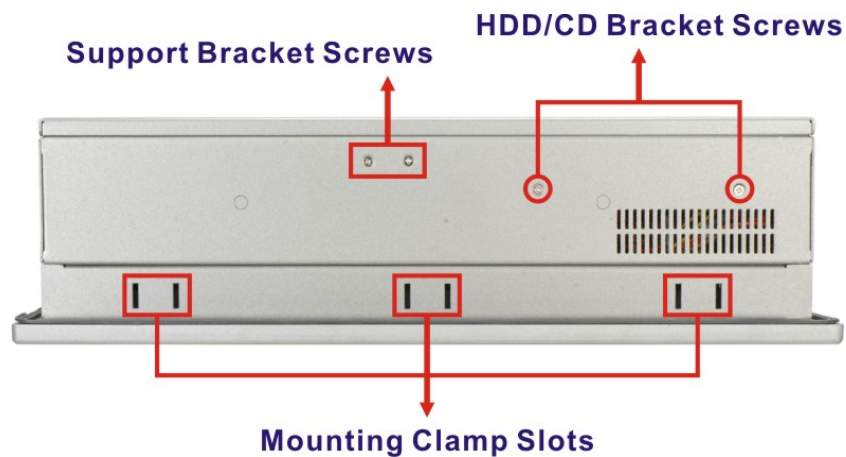

Figure 1-4: Top View

1.4.4 Bottom Panel

The bottom panel has the following interfaces:

- 1 x Power input connector
- 1 x Power switch
- 2 x USB 3.0 connectors
- 4 x USB 2.0 connectors (six USB 2.0 ports for PPC-5190A-H61)
- 1 x Reset button
- 1 x Clear CMOS button
- 2 x RJ-45 GbE connectors
- 2 x SFP fiber Gigabit LAN connectors
- 4 x RS-232 connectors (COM1, COM2, COM3 and COM4)
- 1 x RS-232/422/485 connector (COM5)
- 1 x PCI/PCIe x1 expansion card slot
- 1 x Line-out jack
- 1 x Mic-in jack
- 1 x VGA connector
- 1 x CompactFlash® card slot
- 1 x AT/ATX switch
- 2 x SFP fiber indicators

PPC-51xxA-H61 Panel PC

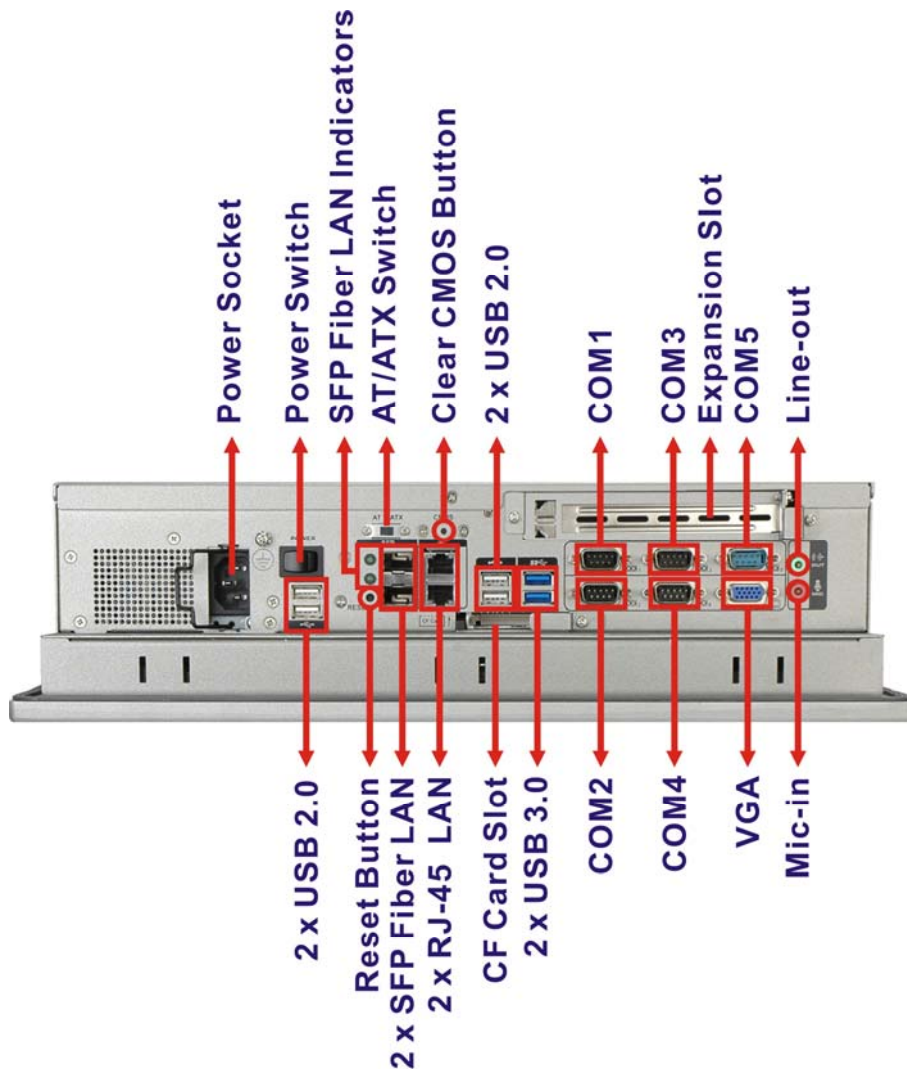

Figure 1-5: PPC-5150A-H61/PPC-5170A-H61 Bottom View

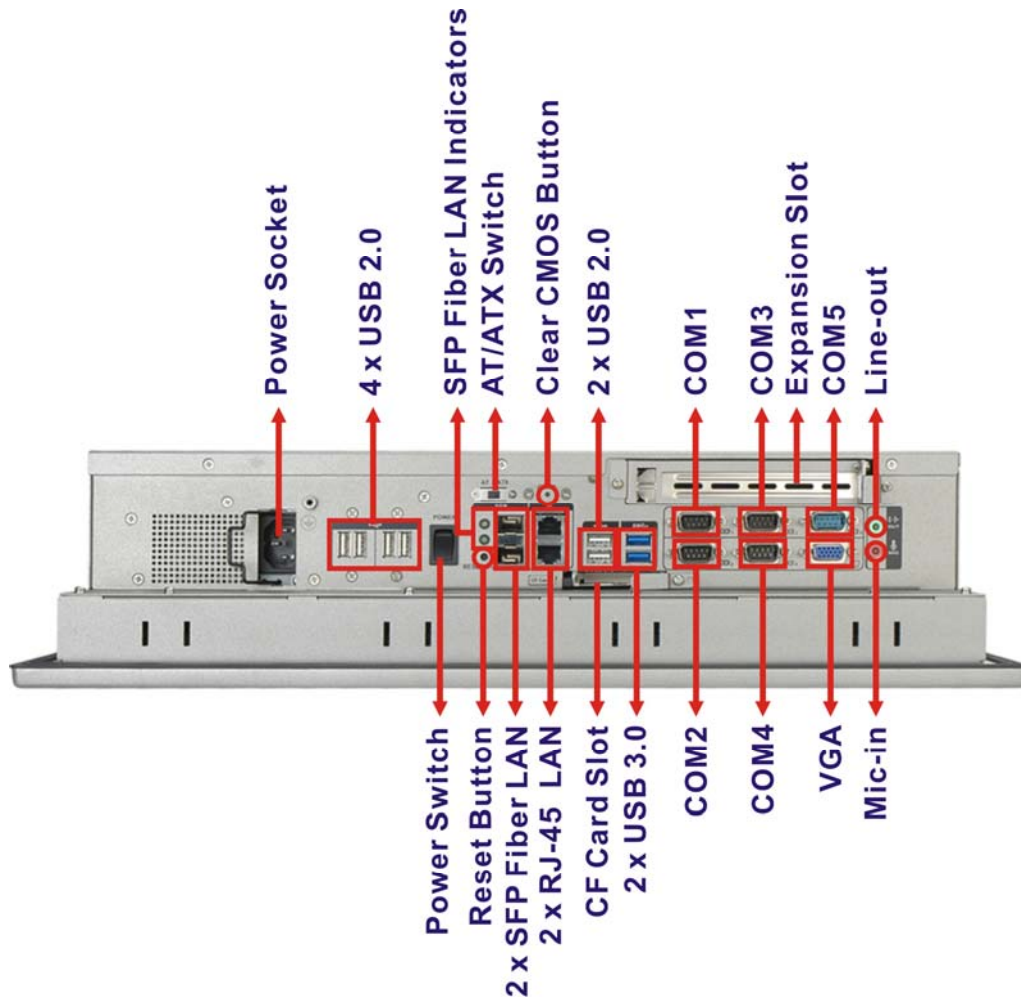

Figure 1-6: PPC-5190A-H61 Bottom View



NOTE:

The PPC-51xxA-H61 provides two types of Gigabit LAN, one is SFP fiber and the other is RJ-45. The user can use either one of it. When a SFP fiber LAN port is linked, the corresponding SFP fiber indicator lights up.

PPC-51xxA-H61 Panel PC

1.4.5 Left Panel

The left panel has two cooling fans that cool the interior of the system and slots for installing the panel mounting clamps. The numbers and locations of the panel mounting clamp slots may vary by models.

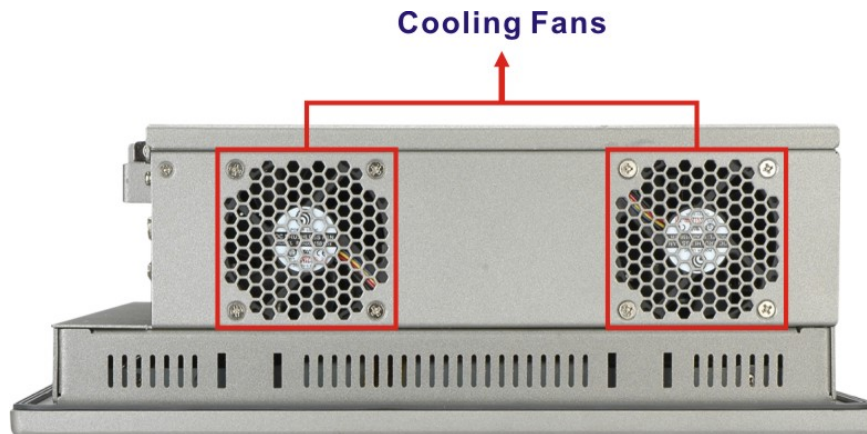

Figure 1-7: Left View

1.4.6 Right Panel

The right panel has a slim type optical disk drive bay for ODD installation and slots for installing the panel mounting clamps. The numbers and locations of the panel mounting clamp slots may vary by models.

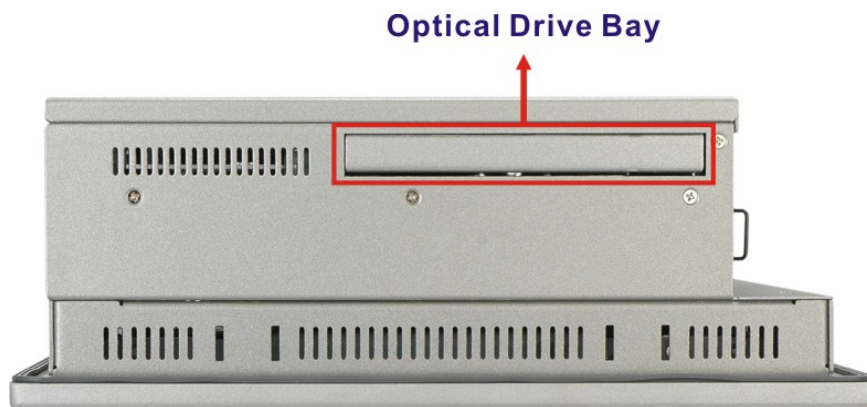

Figure 1-8: Right View

1.5 Internal Overview

The PPC-51xxA-H61 internal components are configured in three levels. The PSU cover bracket to the left (**Figure 1-9**) supports the hard drive and optical drive brackets. Below the PSU cover bracket is the power supply. On the same level as the power supply is the motherboard. Below the motherboard and PSU level is an LCD panel. An overview picture of the internal components is shown in **Figure 1-9** below.

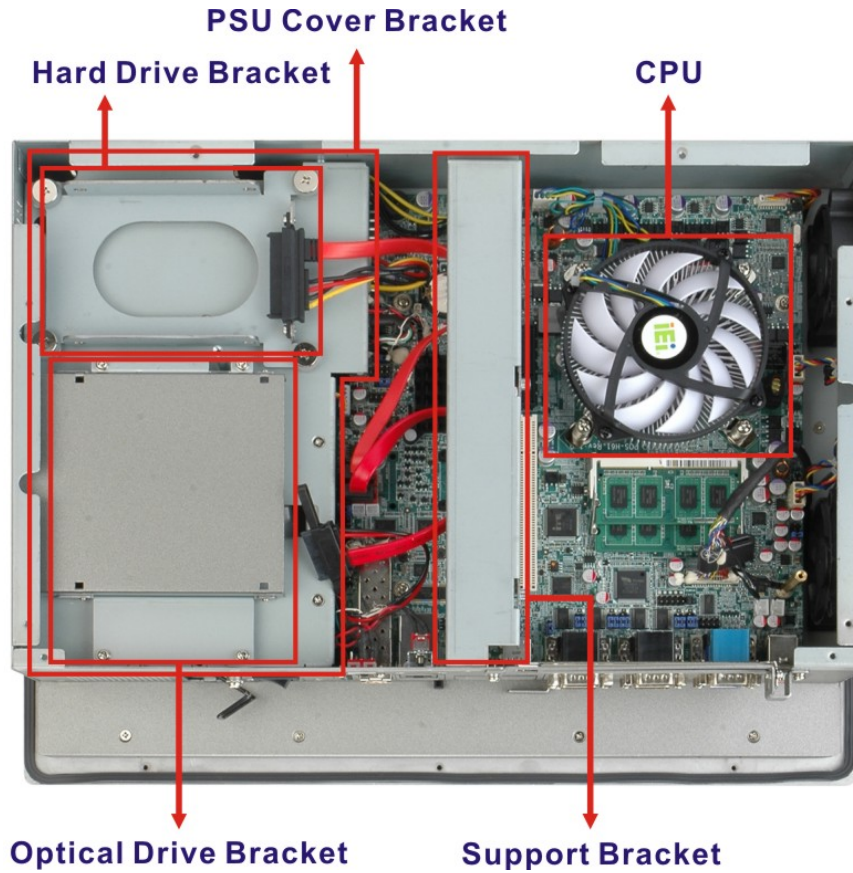

Figure 1-9: Internal Components

PPC-51xxA-H61 Panel PC

1.6 Dimensions

1.6.1 PPC-5150A-H61 Dimensions

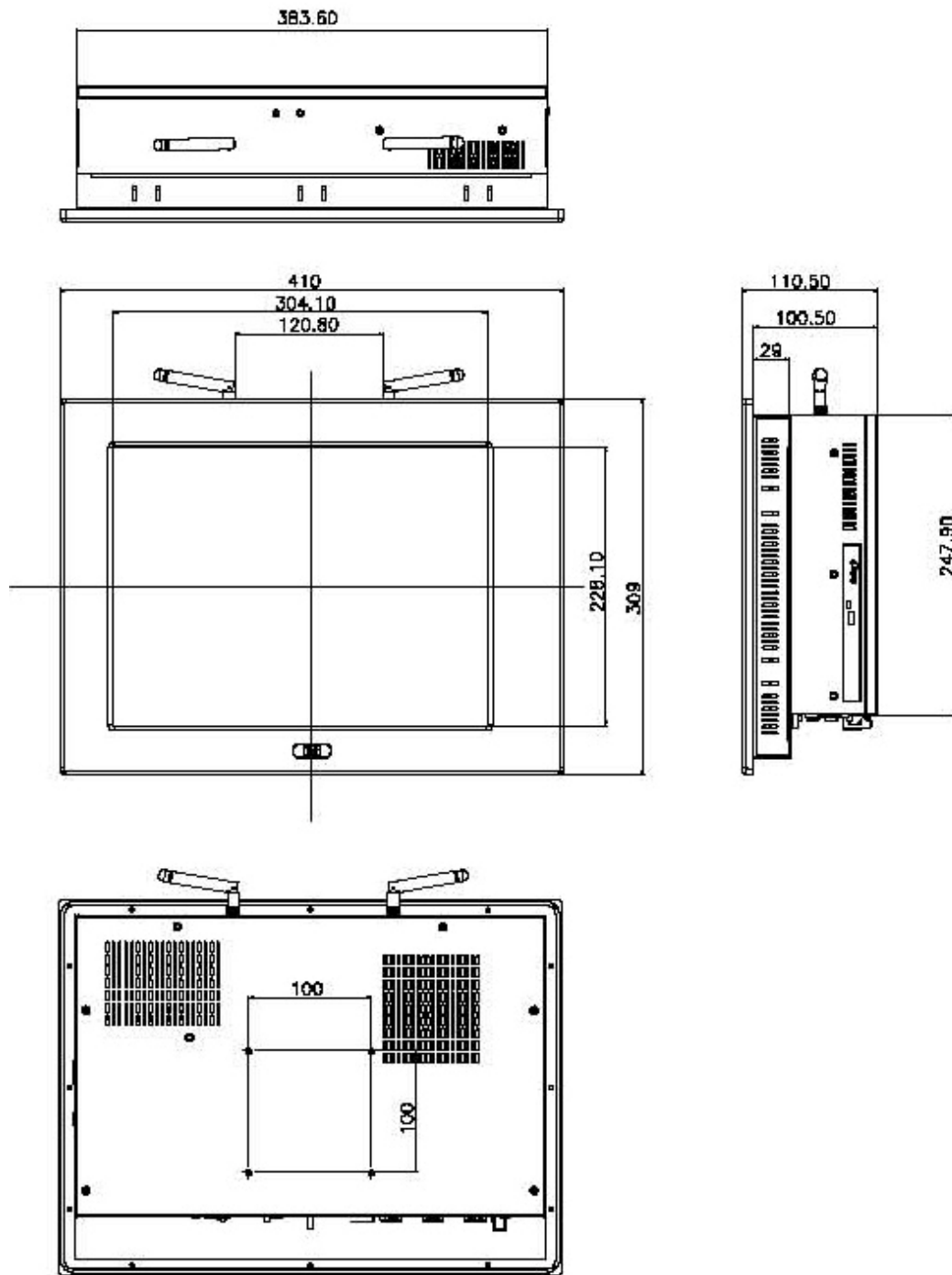

Figure 1-10: PPC-5150A-H61 Dimensions (mm)

1.6.2 PPC-5170A-H61 Dimensions

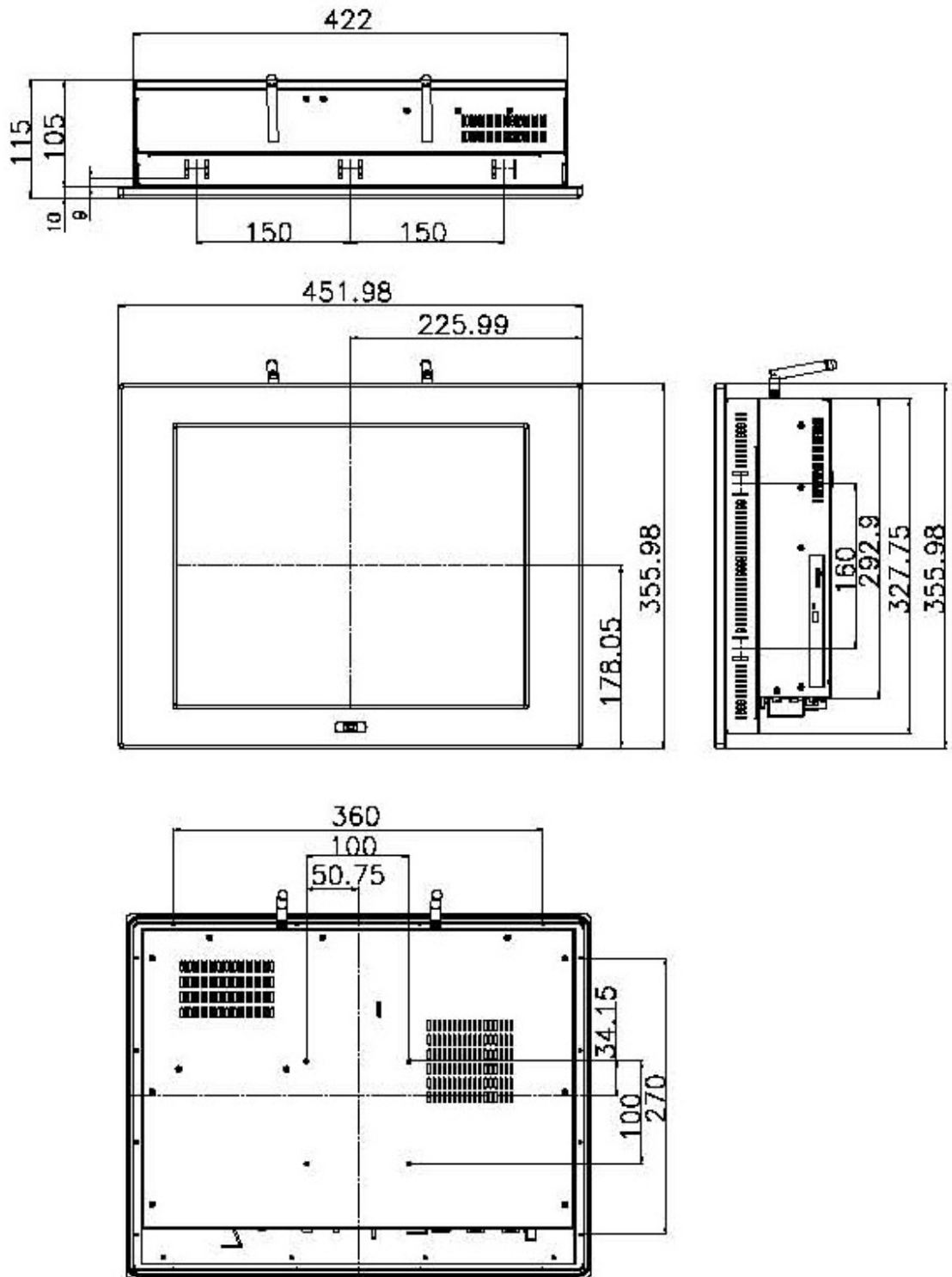

Figure 1-11: PPC-5170A-H61 Dimensions (mm)

PPC-51xxA-H61 Panel PC

1.6.3 PPC-5190A-H61 Dimensions

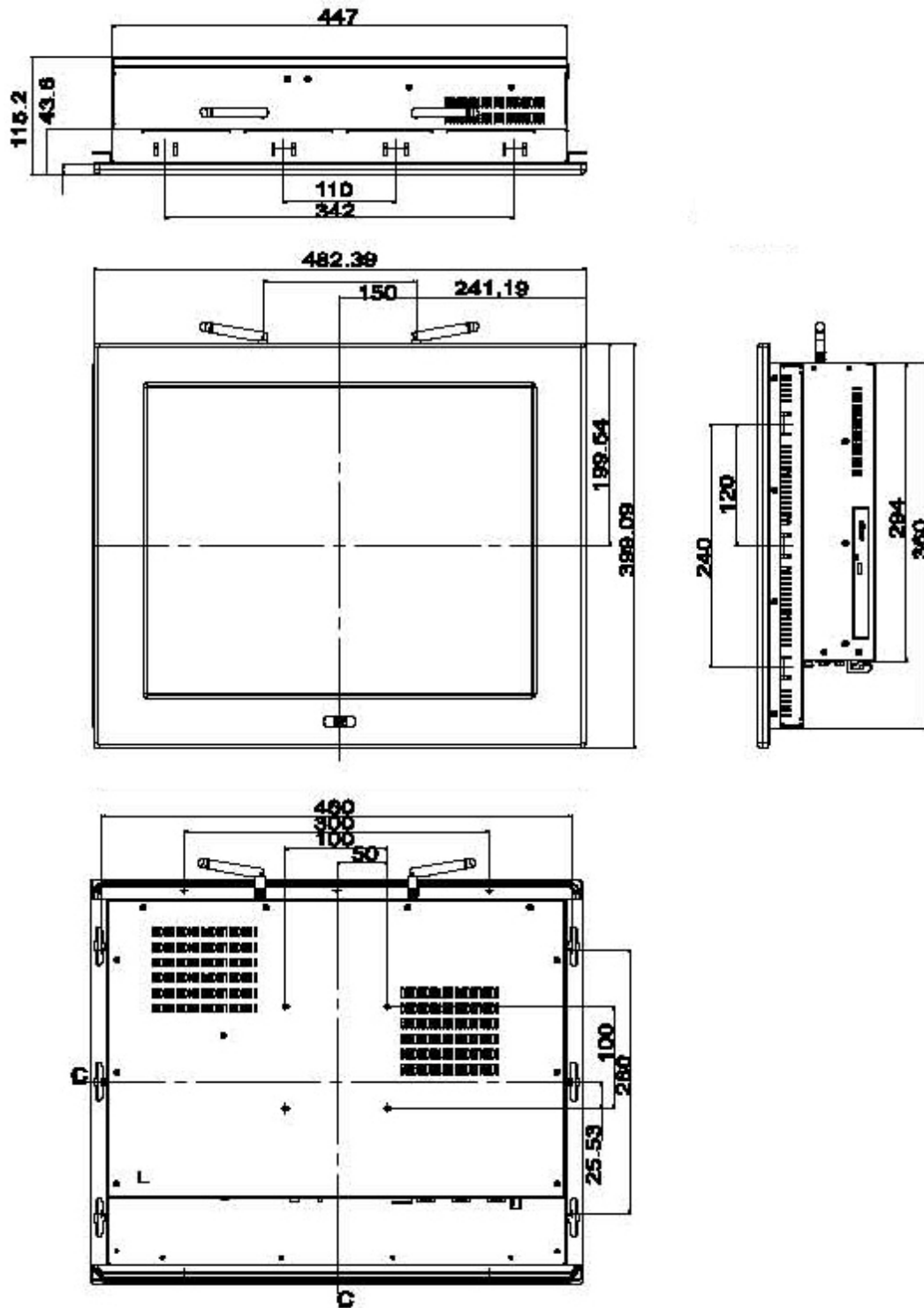

Figure 1-12: PPC-5190A-H61 Dimensions (mm)

1.7 Specifications

The technical specifications for the PPC-51xxA-H61 system are listed in **Table 1-2**.

	PPC-5150A-H61	PPC-5170A-H61	PPC-5190A-H61
LCD Size	15"	17"	19"
Max. Resolution	1024 (W) x 768 (H)	1280 (W) x 1024 (H)	1280 (W) x 1024 (H)
Brightness	400 cd/m ²	350 cd/m ²	350 cd/m ²
Contrast Ratio	700:1	800:1	1000:1
Pixel Pitch (mm)	0.297 x 0.297	0.264 x 0.264	0.294 x 0.294
Viewing Angle (V-H)	140/160	170/160	160/170
LCD Color	16.2M	16.7M	16.7M
Backlight MTBF	50,000 hours	50,000 hours	50,000 hours
SBC Model	POS-H61		
CPU	2nd/3rd generation Intel® Core™, Pentium® or Celeron® CPU		
Express Chipset	Intel® H61		
Memory	Two 204-pin DDR3 SO-DIMM slots (system max. 16 GB)		
Solid State Drive (SSD)	CompactFlash® Type II and mSATA (optional)		
Drive Bays	One 2.5" SATA HDD bay with anti-shock		
	One slim type optical disk drive bay		
Expansion Slots	One PCIe Mini		
	Optional riser card:		
	One PCI or One PCIe x4 with PCIe x1 signal		
Touchscreen	5-wire resistive type with RS-232 interface		
Wireless LAN	IEEE 802.11b/g/n 2T2R mode WLAN via internal PCIe Mini card (optional)		

PPC-51xxA-H61 Panel PC

	PPC-5150A-H61	PPC-5170A-H61	PPC-5190A-H61
I/O Ports, Switches and Indicators	2 x USB 3.0 4 x USB 2.0 (six USB 2.0 ports for PPC-5190A-H61 series) 4 x RS-232 (COM1 ~ COM4) 1 x RS-232/422/485 (COM5) 2 x PS/2 for keyboard and mouse 1 x VGA connector 2 x RJ-45 LAN connectors 2 x SFP fiber LAN connectors 2 x Audio jacks (Line-out and Mic-in) 1 x CMOS reset button 1 x AT/ATX switch 1 x Power switch 2 x SFP fiber LAN indicators		
Mounting	VESA 100 mm x 100 mm (panel, wall, rack, stand and arm)		
Chassis Construction	Heavy-duty steel		
Front Panel Construction	Aluminum		
Vibration	5 Hz ~ 17 Hz 0.1" double amplitude displacement 17 Hz ~ 640 Hz 1.5G acceleration peak to peak		
Shock	10G acceleration part to part (11 ms)		
Humidity	10% ~ 95%, non-condensing		
Operating Temperature (Ambient with air flow)	-20°C ~ 60°C	-20°C ~ 60°C	-10°C ~ 50°C
Storage Temperature	-30°C ~ 70°C	-30°C ~ 70°C	-20°C ~ 60°C
Net/Gross Weight	7 kg/11 kg	8 kg/12 kg	12.6 kg/18.2 kg
Dimensions (W x H x D) (mm)	410 x 309 x 110.5	452 x 356 x 115	482 x 399 x 115

	PPC-5150A-H61	PPC-5170A-H61	PPC-5190A-H61
AC Input ATX (A Model)	ACE-A622A-RS <ul style="list-style-type: none"> ▪ 220 W ▪ Input: 90 V AC~264 V AC, 50/60 Hz ▪ Output (max.): 3.3 A@14 A, 5 V@16 A, 12 V@10 A, -12 V@0.8 A 		
DC Input ATX (AD Model)	ACE-4520C-RS <ul style="list-style-type: none"> ▪ 200 W ▪ Input: 24 V DC (18~36 V DC), 50/60 Hz ▪ -Output (max.): 3.3 A@12 A, 5 V@12 A, 12 V@15.4 A, -12 V@0.5 A 		

Table 1-2: System Specifications

Chapter

2

Unpacking

2.1 Unpacking

To unpack the panel PC, follow the steps below:



WARNING!

The front side LCD screen has a protective plastic cover stuck to the screen. Only remove the plastic cover after the panel PC has been properly installed. This ensures the screen is protected during the installation process.

- Step 1:** Use box cutters, a knife or a sharp pair of scissors that seals the top side of the external (second) box.
- Step 2:** Open the external (second) box.
- Step 3:** Use box cutters, a knife or a sharp pair of scissors that seals the top side of the internal (first) box.
- Step 4:** Lift the monitor out of the boxes.
- Step 5:** Remove both polystyrene ends, one from each side.
- Step 6:** Pull the plastic cover off the panel PC.
- Step 7:** Make sure all the components listed in the packing list are present.

PPC-51xxA-H61 Panel PC

2.2 Packing List

The PPC-51xxA-H61 panel PC is shipped with the following components:













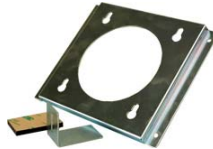

Quantity	Item	Image
1	PPC-51xxA-H61	
1	SATA CD-ROM cable (P/N: 32803-000300-100-RS)	
1	Power cord (P/N: 32000-000002-RS)	
1	Panel mounting kit (P/N: 19Z00-000024-RS)	
1	Wall mounting kit (P/N: 41020-016102-00-RS)	
1	Touch pen	
1	User manual and driver CD	
1	One Key Recovery CD (P/N: IEI-7B000-000478-RS)	

Table 2-1: Packing List

If any of the above items are missing or damaged, contact the distributor or sales representative immediately.

2.3 Optional Items

The following items are optional accessories for the PPC-51xxA-H61:

Item	Image
Slim type SATA DVD-ROM (P/N: 73400-AD7760H01-RS)	
1-slot PCI riser card (P/N: PCIR-01H-R10)	
1-slot PCIe x1 riser card (P/N: PCIER-101H-R10)	
Arm (P/N: ARM-31-RS)	
Stand (P/N: STAND-210-R11)	
Gigabit Ethernet SFP fiber module (P/N: SFP1G-SX/-I SFP1G-MLX/-I SFP1G-LX10/-I SFP1G-ZX70/-I)	

PPC-51xxA-H61 Panel PC

Item	Image
Rack mounting kit (P/N: RK-150MS-R10 RK-170MS-R10 RK-190MS-R10)	
Wi-Fi module with RF cable and antenna for PPC-5150A-H61/PPC-5170A-H61, 2T2R, 802.11b/g/n (P/N: PPC-WL-KIT02-R10)	
Wi-Fi module with RF cable and antenna for PPC-5190A-H61, 2T2R, 802.11b/g/n (P/N: PPC-WL-KIT03-R10)	

Table 2-2: Optional Items

Chapter

3

Installation

3.1 Anti-static Precautions

**WARNING:**

Failure to take ESD precautions during the maintenance of the EP series may result in permanent damage to the EP series and severe injury to the user.

Electrostatic discharge (ESD) can cause serious damage to electronic components, including the PPC-51xxA-H61. Dry climates are especially susceptible to ESD. It is therefore critical that whenever the PPC-51xxA-H61 is accessed internally, or any other electrical component is handled, the following anti-static precautions are strictly adhered to.

- ***Wear an anti-static wristband:*** - Wearing a simple anti-static wristband can help to prevent ESD from damaging the board.
- ***Self-grounding:*** - Before handling the board touch any grounded conducting material. During the time the board is handled, frequently touch any conducting materials that are connected to the ground.
- ***Use an anti-static pad:*** - When configuring the PPC-51xxA-H61, place it on an anti-static pad. This reduces the possibility of ESD damaging the PPC-51xxA-H61.
- ***Only handle the edges of the PCB:*** - When handling the PCB, hold the PCB by the edges.

3.2 Installation Precautions

When installing the panel PC, please follow the precautions listed below:

- **Power turned off:** When installing the panel PC, make sure the power is off. Failing to turn off the power may cause severe injury to the body and/or damage to the system.
- **Certified Engineers:** Only certified engineers should install and modify onboard functionalities.

- **Mounting:** The PPC-51xxA-H61 is a heavy device. When mounting the system onto a rack, panel, wall or arm, please make sure that at least two people are assisting with the procedure.
- **Anti-static Discharge:** If a user open the rear panel of the panel PC, to configure the jumpers or plug in added peripheral devices, ground themselves first and wear an anti-static wristband.

3.3 Preinstalled Components

The following components are all preinstalled.

- Motherboard
- DDR3 memory module
- TFT LCD
- Touchscreen
- Power supply
- Inverter board
- System cooling fans

Preinstalled OEM customizations may include the following.

- CPU
- HDD
- Wi-Fi module
- Optical disk drive
- PCI/PCIe x1 riser card

3.4 Installation and Configuration Steps

The following installation steps must be followed.

- Step 1:** Unpack the PPC-51xxA-H61.
- Step 2:** Set the jumper settings.
- Step 3:** Install HDD, CompactFlash® card and optical disk drive.
- Step 4:** Mount the PPC-51xxA-H61 panel PC.

PPC-51xxA-H61 Panel PC

Step 5: Connect peripheral devices to the bottom panel of the PPC-51xxA-H61.

Step 6: Configure the system.

3.5 Removing the Back Cover

Remove all the retention screws on the back cover. Lift the cover up to remove.

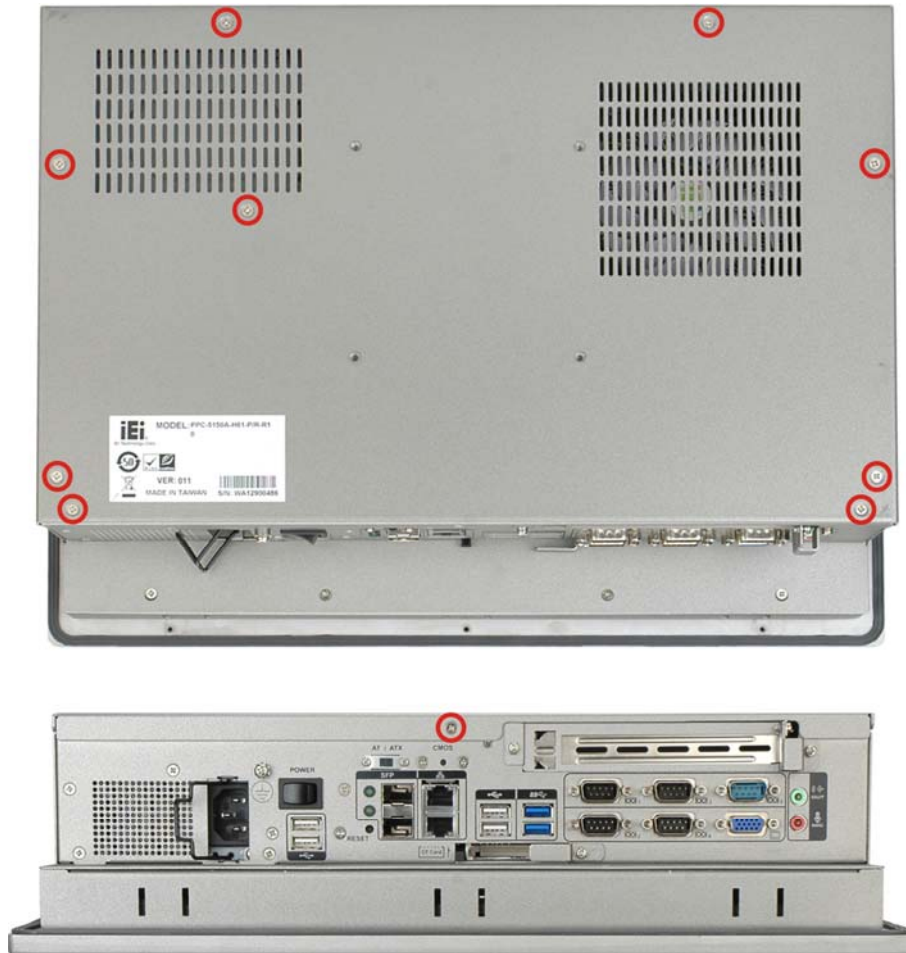
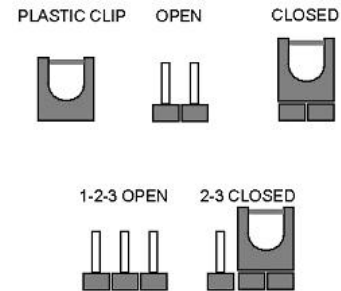

Figure 3-1: PPC-5150A-H61 Back Cover Retention Screws

3.6 Jumper Settings

NOTE:

A jumper is a metal bridge used to close an electrical circuit. It consists of two or three metal pins and a small metal clip (often protected by a plastic cover) that slides over the pins to connect them. To CLOSE/SHORT a jumper means connecting the pins of the jumper with the plastic clip and to OPEN a jumper means removing the plastic clip from a jumper.



The following jumpers can be found on the motherboard installed in the PPC-51xxA-H61. Before the PPC-51xxA-H61 is installed, the jumpers must be set in accordance with the desired configuration. The jumpers on the PPC-51xxA-H61 motherboard are listed in **Table 3-1**.

Description	Label	Type
COM1 Pin 9 setting	J_COM_V1	6-pin header
COM2 Pin 9 setting	J_COM_V2	6-pin header
COM3 Pin 9 setting	J_COM_V3	6-pin header
COM4 Pin 9 setting	J_COM_V4	6-pin header
COM5 Pin 9 setting	J_COM_V5	6-pin header
COM5 RS-232/422/485 selection	JP2	4-pin header

Table 3-1: Jumpers

3.6.1 Access the Jumpers

To access the jumpers, remove the back cover. To remove the back cover, please refer to **Section 3.5**.

PPC-51xxA-H61 Panel PC

3.6.2 Preconfigured Jumpers



WARNING:

Do not change the settings on the jumpers in described here. Doing so may disable or damage the system

The following jumpers are preconfigured for the PPC-51xxA-H61. Users should not change these jumpers.

Jumper Name	Label	Type
CF card power selection	JP1	3-pin header
Inverter brightness voltage selection	J_ADJ1	3-pin header
LCD power selection	JLCD_PWR1	6-pin header
Panel type and resolution selection	JLCD_SET1	8-pin header
Touchscreen selection	JTOUCH1	4-pin header
USB1~USB4 power selection	USBAB_PWR1, USB01_PWR1, USB23_PWR1, USB45_PWR1	3-pin header

Table 3-2: Preconfigured Jumpers

3.6.3 COM1 to COM5 Pin 9 Setting Jumpers

Jumper Label: J_COM_V1, J_COM_V2, J_COM_V3, J_COM_V4 and J_COM_V5

Jumper Type: 6-pin header

Jumper Settings: See Table 3-3

Jumper Location: See Figure 3-2

Five jumpers configure pin 9 on the COM1, COM2, COM3, COM4 and COM5 connectors. Pin 9 on these connectors can be set as either +5 V, +12 V or as the ring (RI) signal. The COM1, COM2, COM3, COM4 and COM5 Pin 9 setting jumper selection options are shown in **Table 3-3**.

	Serial Port	Short 1 – 3	Short 2 - 4	Short	Short
		Default	Default	3 – 5	4 – 6
J_COM_V1	COM1	RI signal	+5 V	Pin 9 power	+12 V
J_COM_V2	COM2	RI signal	+5 V	Pin 9 power	+12 V
J_COM_V3	COM3	RI signal	+5 V	Pin 9 power	+12 V
J_COM_V4	COM4	RI signal	+5 V	Pin 9 power	+12 V
J_COM_V5	COM5	RI signal	+5 V	Pin 9 power	+12 V

Table 3-3: COM1 to COM5 Pin 9 Setting Jumper Settings

The COM1 to COM5 Pin 9 setting jumper locations are shown in **Figure 3-2** below.

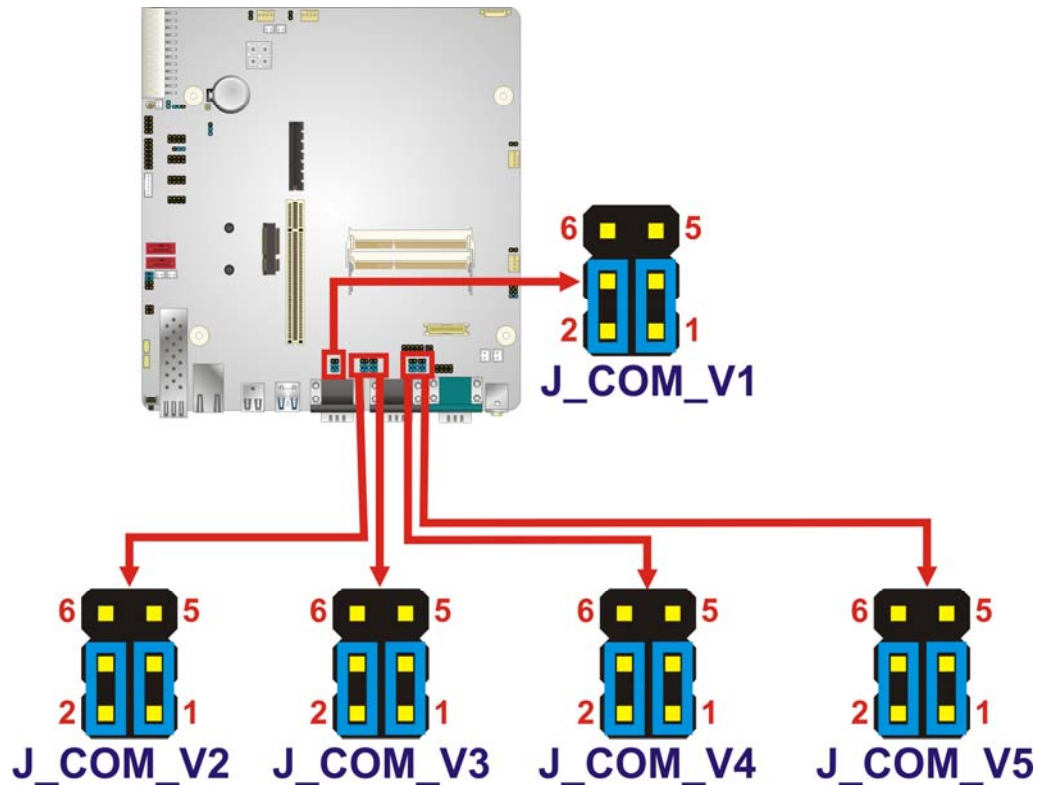

Figure 3-2: COM1 to COM5 Pin 9 Setting Jumper Locations

PPC-51xxA-H61 Panel PC

3.6.4 COM5 RS-232/422/485 Serial Port Selection Jumper

Jumper Label:	JP2
Jumper Type:	4-pin header
Jumper Settings:	See Table 3-4
Jumper Location:	See Figure 3-3

The COM5 RS-232/422/485 Serial Port Selection jumper sets the communication protocol used by the COM5 serial communications port as RS-232, RS-422 or RS-485. The COM5 RS-232/422/485 Serial Port Selection settings are shown in **Table 3-4**.

COM5 Mode	Pin 1-2	Pin 3-4
RS-232 (Default)	Short	Open
RS-422	Short	Short
RS-485 (Default: RX)	Open	Short
RS-485 (Default: TX)	Open	Open

Table 3-4: COM5 RS-232/422/485 Serial Port Selection Jumper Settings

The COM5 RS-232/422/485 Serial Port Select jumper location is shown in **Figure 3-3**.

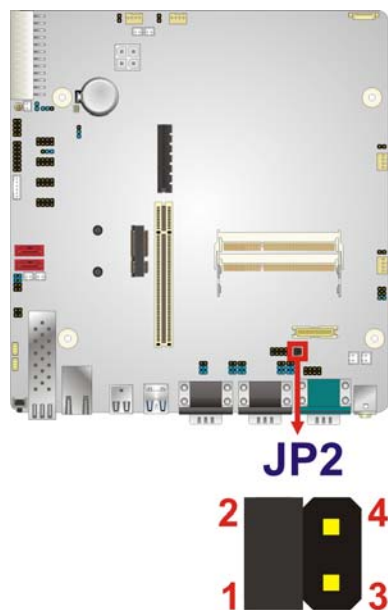

Figure 3-3: COM5 RS-232/422/485 Serial Port Selection Jumper Location

3.7 Drive Installation

The drive installation process is shown in the sections below.

3.7.1 Hard Drive Installation

To install a HDD, please follow the steps below:

Step 1: Remove the back cover (**Section 3.5**).

Step 2: The HDD bracket is attached to the elevated platform by four retention screws.
Remove the four retention screws from the elevated platform (**Figure 3-4**).

Hard Drive Bracket Screws

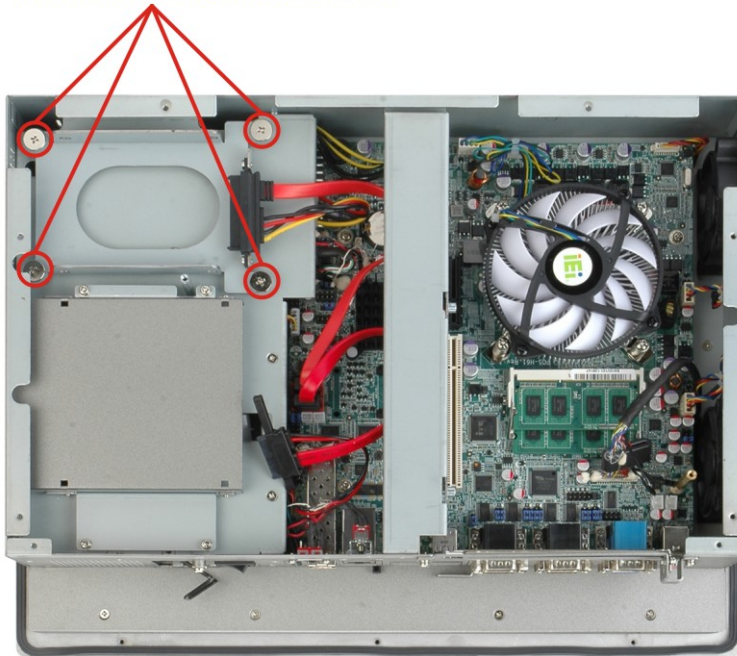

Figure 3-4: HDD Bracket Retention Screws

Step 3: Attach the hard drive in the bracket. To do this, slide the hard drive onto the bracket until it connects with the SATA connector at the back. Fasten the four retention screws on the side.

PPC-51xxA-H61 Panel PC

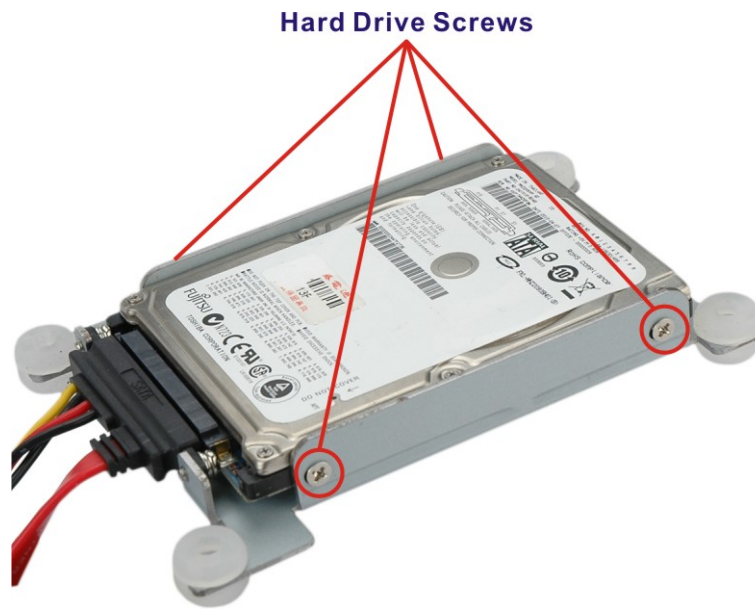

Figure 3-5: HDD Retention Screws

Step 4: Install the hard drive bracket (with hard drive and SATA cable attached) into the PPC-51xxA-H61 and fasten the four hard drive bracket screws.

Hard Drive Bracket Screws

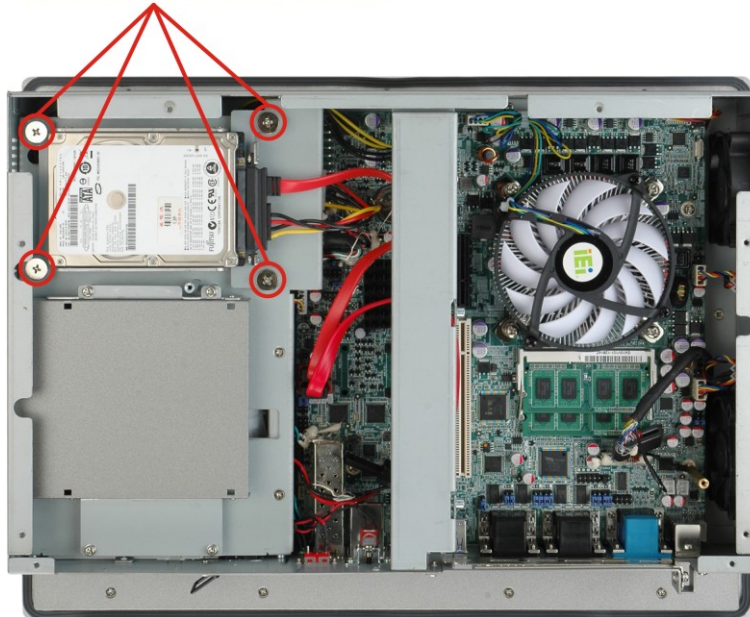

Figure 3-6: Replacing the HDD Bracket

3.7.2 CompactFlash® Card Installation

To install the CompactFlash® card, please follow the steps below:

Step 1: Undo the CompactFlash® slot cover screw and remove the CompactFlash® cover plate.



Figure 3-7: CompactFlash® Cover Plate

Step 2: Insert the CompactFlash® card into the slot.



Figure 3-8: Installing the CompactFlash® Card

PPC-51xxA-H61 Panel PC

Step 3: Replace the CompactFlash® cover plate.



Figure 3-9: Replacing the CompactFlash® Cover Plate

3.7.3 Optical Disk Drive Installation (Optional)

To install an optical disk drive, please follow the steps below.

Step 1: Remove the back cover (Section 3.5).

Step 2: Undo the optical drive bracket screws and remove the optical drive bracket.

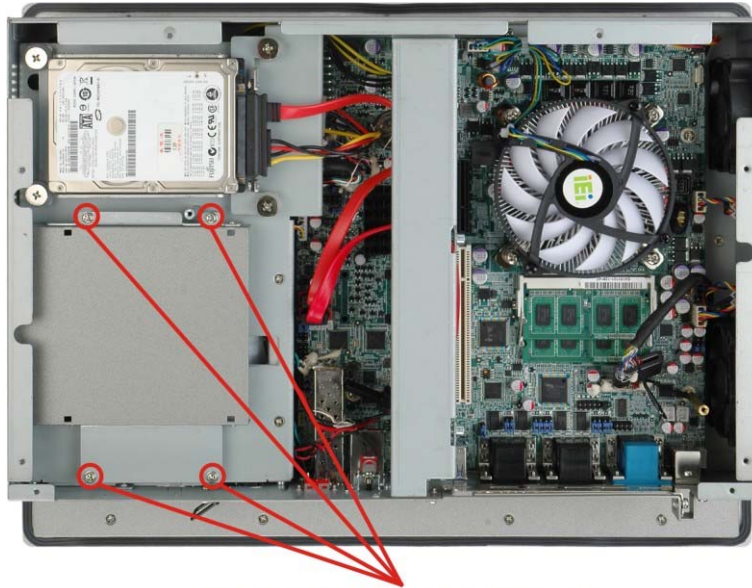

Optical Drive Bracket Screws

Figure 3-10: Optical Drive Bracket Retention Screws

Step 3: Remove the four screws from the optical drive bracket assembly (**Figure 3-11**).

Remove the blank drive plate.

Optical Drive Blank Plate Screws

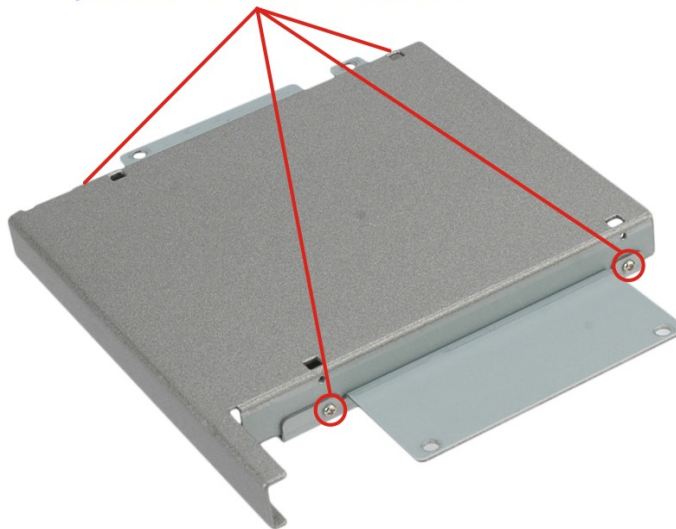

Figure 3-11: Optical Drive Blank Plate Assembly

Step 4: Install the optical drive in the same position as the previously removed blank optical drive plate. Fasten the same four screws to attach the optical drive to the bracket.

PPC-51xxA-H61 Panel PC

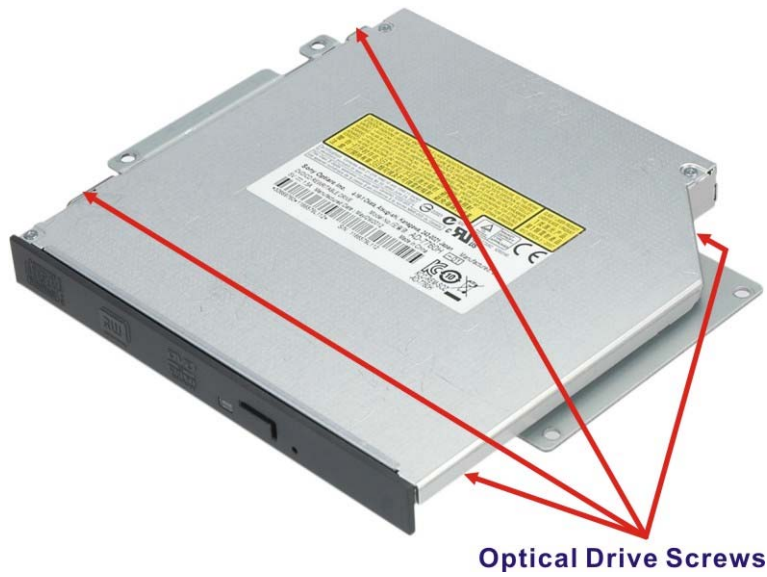

Figure 3-12: Optical Drive Screws

Step 5: Attach the SATA cable to the back of the optical drive and fasten the SATA cable screws.

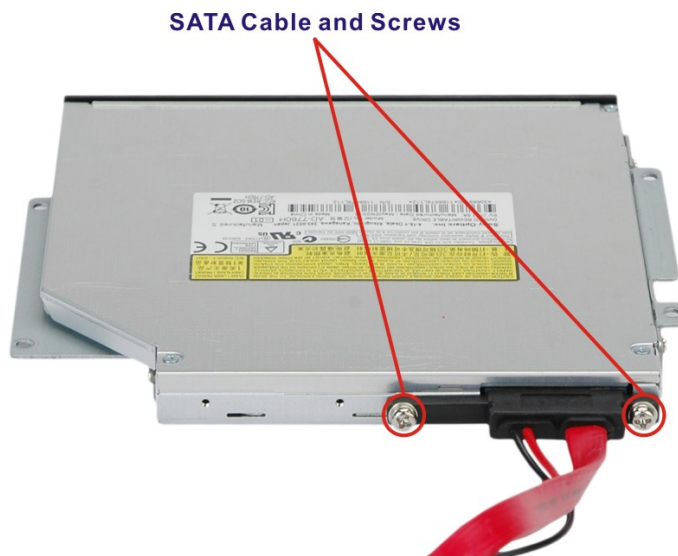
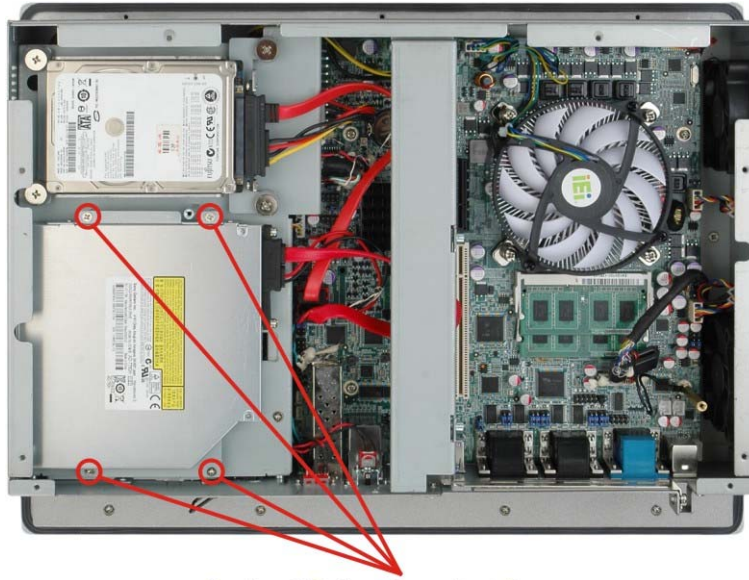

Figure 3-13: Optical Drive SATA Cable

Step 6: Reinstall the optical drive bracket into the PPC-51xxA-H61 and fasten the optical bracket screws.



Optical Drive Bracket Screws

Figure 3-14: Replacing the Optical Drive Bracket

3.8 PCI Expansion Card Installation (Optional)



NOTE:

The expansion card cannot exceed the dimensions shown below.

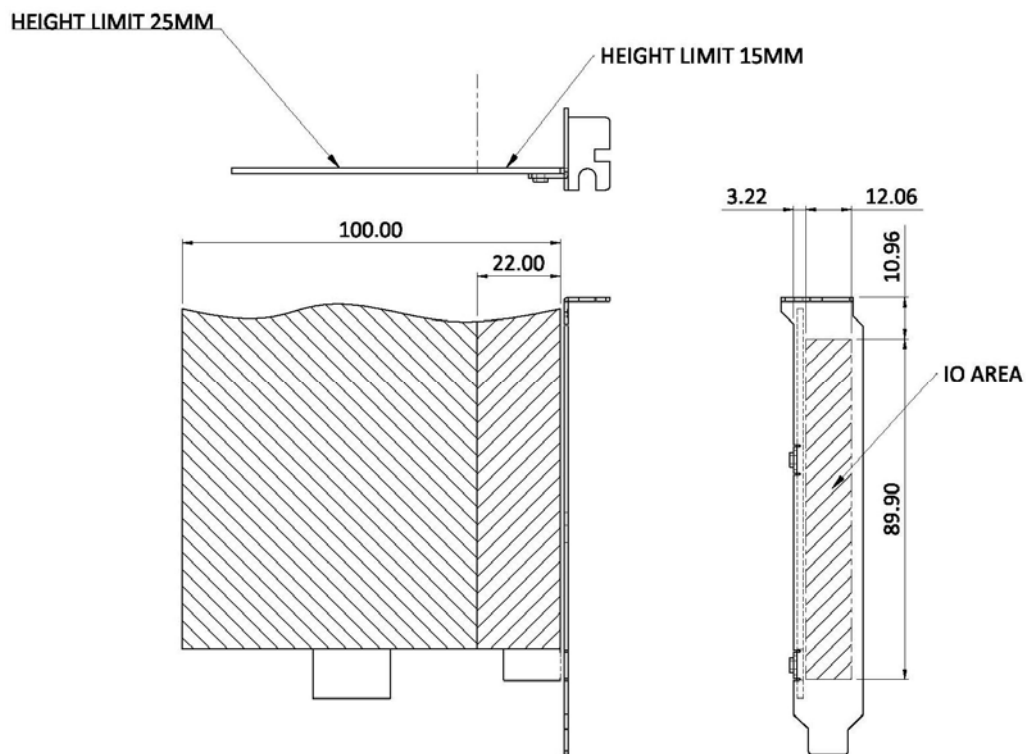

To install a PCI expansion card, please do the following.

Step 1: Remove the back cover. See **Section 3.5**.

Step 2: Install the PCI riser card. Insert the PCI riser card into the PCI slot on the motherboard of the system. Secure the PCI riser card to the system with two retention screws.

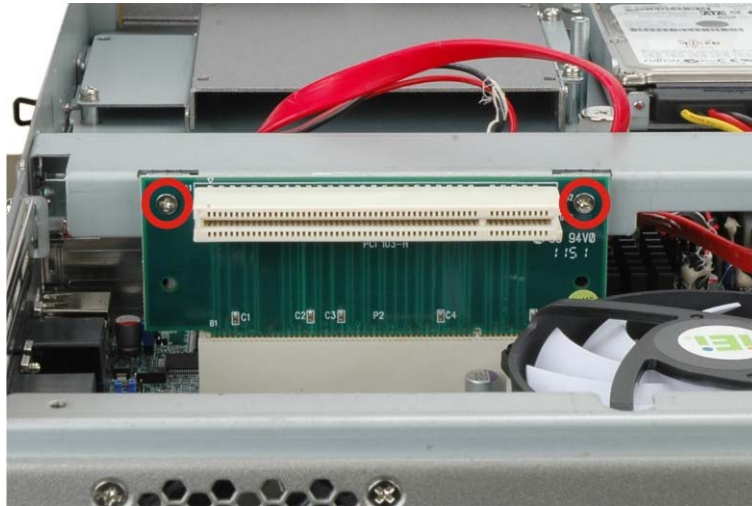

Figure 3-15: Installing the PCI Riser Card

Step 3: Remove the expansion slot cover. The expansion slot on the I/O panel interface is secured to the system with a single retention screw. Remove the screw (**Figure 3-16**).



Figure 3-16: Expansion Slot Retention Screw

Step 4: Insert the expansion card. Align the PCI expansion card edge connector with the PCI expansion slot on the PCI riser card. Gently insert the PCI card into the PCI expansion slot.

PPC-51xxA-H61 Panel PC

Step 5: Secure the expansion card. Once the PCI card is correctly installed in the system, reinsert the previously removed retention screw to secure the card to the I/O interface panel.



Figure 3-17: Installing the PCI Card

3.9 PCIe Expansion Card Installation (Optional)



NOTE:

The expansion card cannot exceed the dimensions shown below.

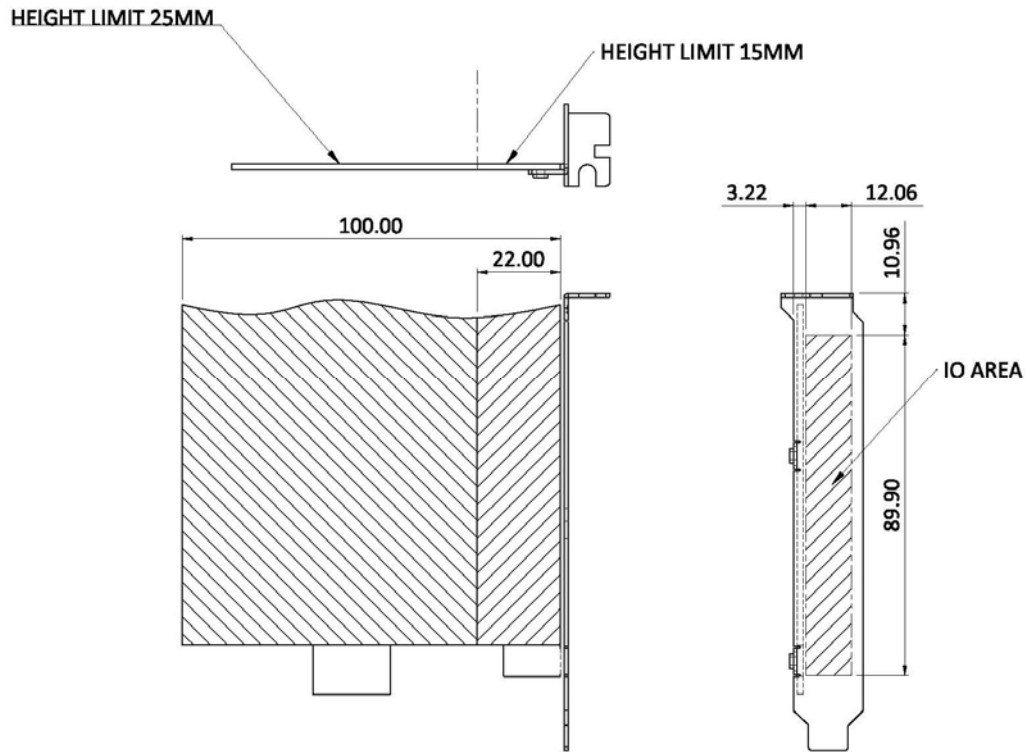

To install a PCIe expansion card, please do the following.

Step 1: Remove the back cover. See **Section 3.5**.

Step 2: Install the PCIe riser card. Insert the PCIe riser card into the PCI slot and PCIe x4 slot on the motherboard of the system. Secure the PCIe riser card to the system with two retention screws.

PPC-51xxA-H61 Panel PC



Figure 3-18: Installing the PCIe Riser Card

Step 3: Remove the expansion slot cover. The expansion slot on the I/O panel interface is secured to the system with a single retention screw. Remove the screw.

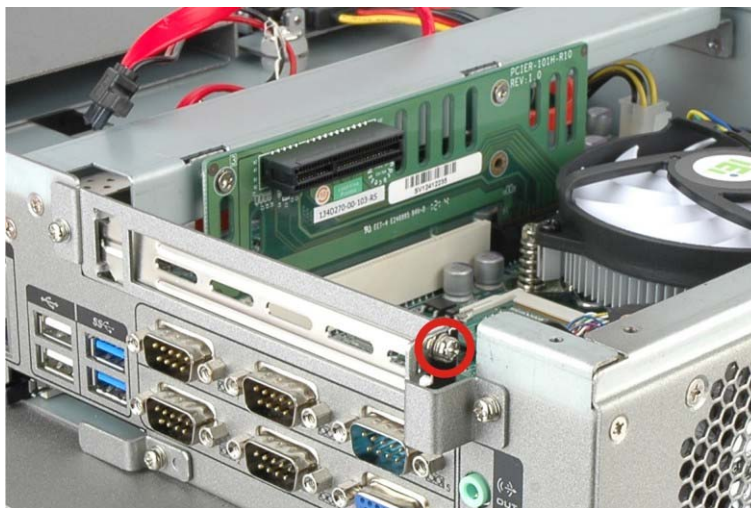

Figure 3-19: Expansion Slot Retention Screw

Step 4: Insert the expansion card. Align the PCIe expansion card edge connector with the PCIe expansion slot on the PCIe riser card. Gently insert the PCIe card into the PCIe expansion slot.

Step 5: Secure the expansion card. Once the PCIe card is correctly installed in the system, reinsert the previously removed retention screw to secure the card to the I/O interface panel.



Figure 3-20: Installing the PCIe Card

3.10 AT/ATX Mode Selection

AT and ATX power modes can both be used on the PPC-51xxA-H61 panel PC. The selection is made through an AT/ATX switch on the I/O interface panel. The switch is shown below.

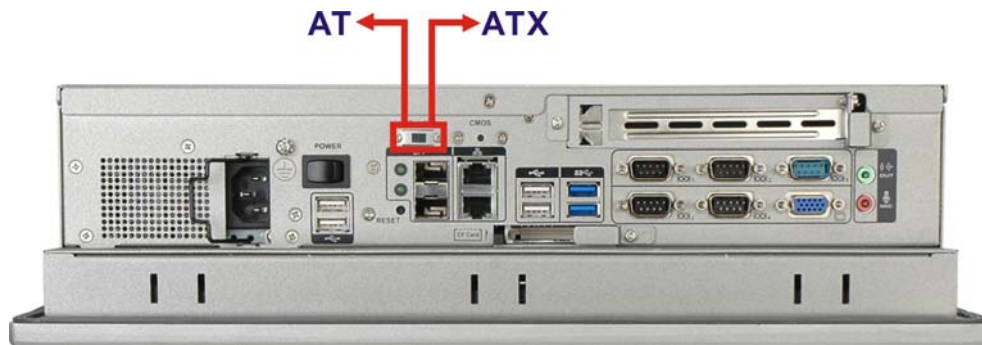

Figure 3-21: AT/ATX Mode Selection

3.11 Mounting the System



WARNING!

When mounting the PPC-51xxA-H61 panel PC, it is advisable to have more than one person help with the installation to prevent accidental damage to the panel and avoid personal injury.

The methods of mounting the PPC-51xxA-H61 are:

- Wall mounting
- Panel mounting
- Arm mounting
- Stand mounting
- Rack mounting

The mounting methods are described in the following sections.

3.11.1 Wall Mounting

To mount the PPC-51xxA-H61 panel PC onto a wall, please follow the steps below.

- Step 1:** Select the location on the wall for the wall-mounting bracket.
- Step 2:** Carefully mark the locations of the four bracket screw holes on the wall.
- Step 3:** Drill four pilot holes at the marked locations on the wall for the bracket retention screws.
- Step 4:** Align the wall-mounting bracket screw holes with the pilot holes.
- Step 5:** Secure the mounting bracket to the wall by inserting the retention screws into the four pilot holes and tightening them (**Figure 3-22**).

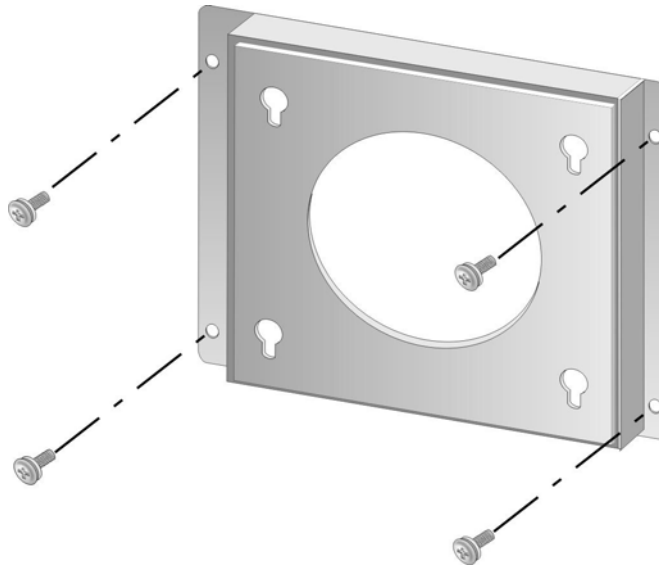

Figure 3-22: Wall-mounting Bracket

- Step 6:** Insert the four monitor mounting screws provided in the wall mounting kit into the four screw holes on the rear panel of the monitor and tighten until the screw shank is secured against the rear panel (**Figure 3-23**).
- Step 7:** Align the mounting screws on the monitor rear panel with the mounting holes on the bracket.
- Step 8:** Carefully insert the screws through the holes and gently pull the monitor downwards until the monitor rests securely in the slotted holes (**Figure 3-23**). Ensure that all four of the mounting screws fit snugly into their respective slotted holes.



NOTE:

In the diagram below the bracket is already installed on the wall.

PPC-51xxA-H61 Panel PC

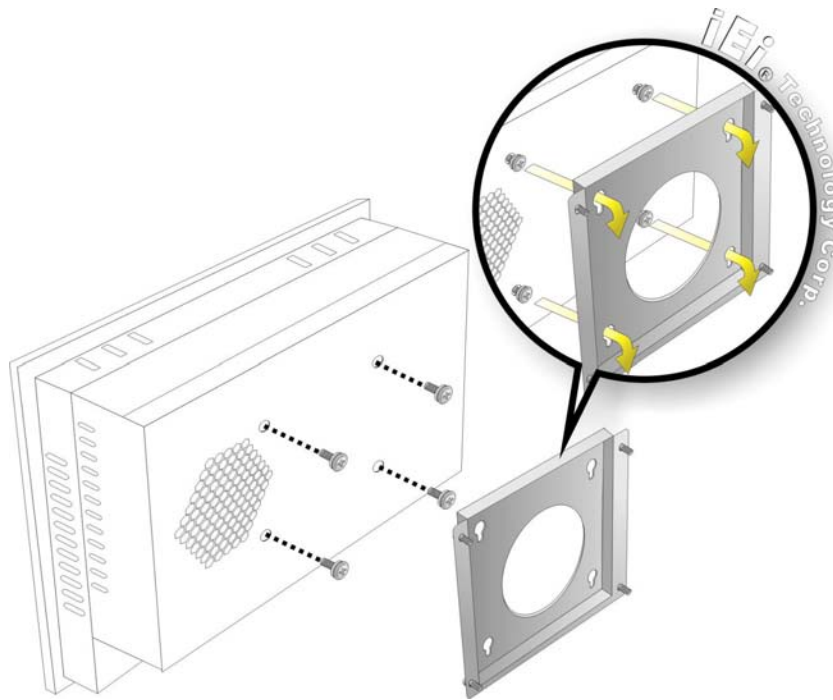

Figure 3-23: Mount the Chassis

Step 9: Secure the panel PC with the wall-mounting kit. To do this, stick the protective cushion to the wall-mounting kit first. Then, put the wall-mounting kit on the top panel of the panel PC. Carefully mark the location of the wall-mounting kit screw holes on the wall. Drill a pilot hole at the marked location on the wall. Secure the wall-mounting kit to the wall by inserting a retention screw into the pilot hole on the wall (**Figure 3-24**). This step is to avoid the panel PC being pushed apart from the wall-mounting bracket accidentally.

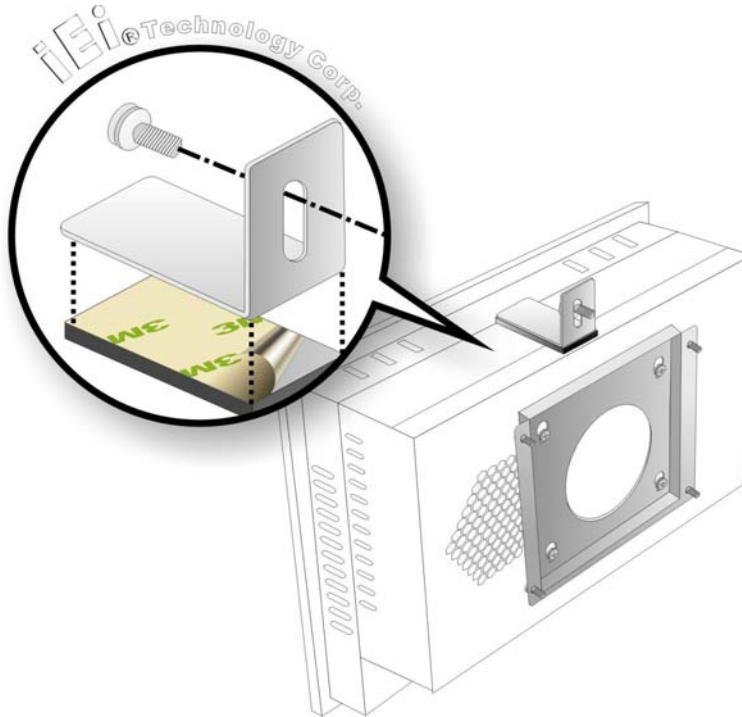

Figure 3-24: Secure the Chassis

3.11.2 Panel Mounting

To mount the PPC-51xxA-H61 panel PC into a panel, please follow the steps below.



NOTE:

The maximum panel thickness should be no more than 6 mm.

Step 1: Select the position on the panel to mount the PPC-51xxA-H61.

Step 2: Cut out a section of the panel that corresponds to the rear panel dimensions of the PPC-51xxA-H61. The recommended cutout sizes are shown below (Figure 3-25, Figure 3-26 and Figure 3-27).

PPC-51xxA-H61 Panel PC

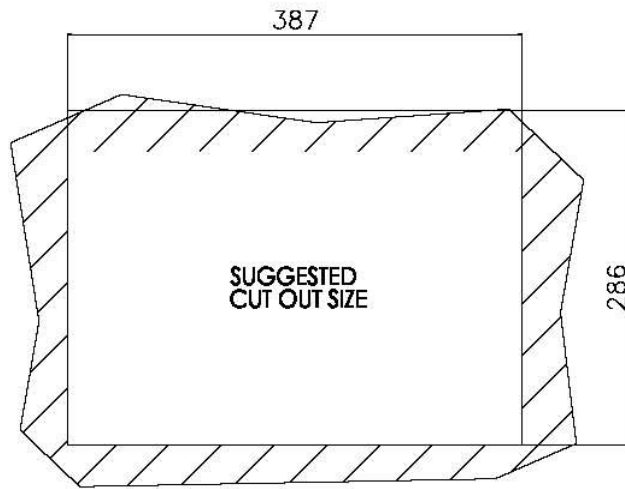

Figure 3-25: PPC-5150A-H61 Panel Cutout Dimensions

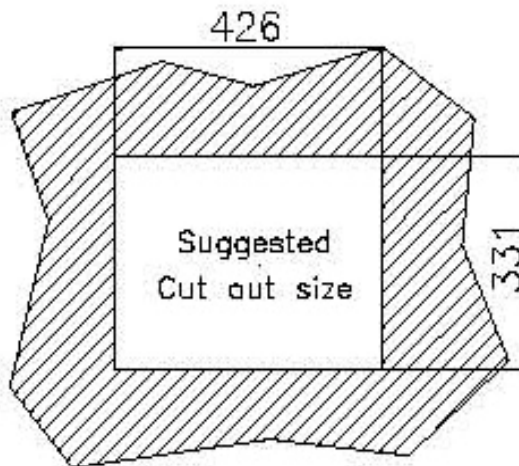

Figure 3-26: PPC-5170A-H61 Panel Cutout Dimensions

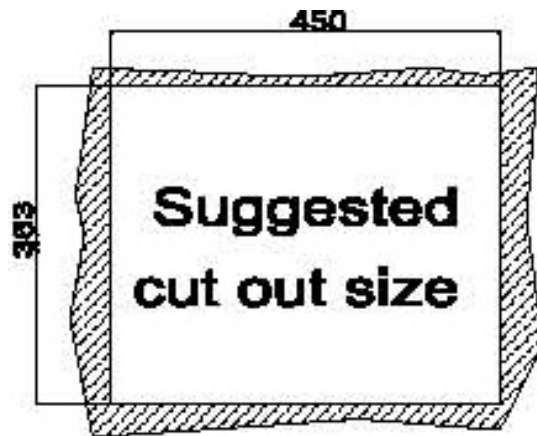

Figure 3-27: PPC-5190A-H61 Panel Cutout Dimensions

Step 3: Slide the PPC-51xxA-H61 through the hole until the metal frame is flush against the panel.

Step 4: Insert the panel mounting clamps into the pre-formed holes along the edges of the PPC-51xxA-H61, behind the aluminum frame (**Figure 3-28**). Refer to the mounting kit packing list for the required number of mounting clamps.

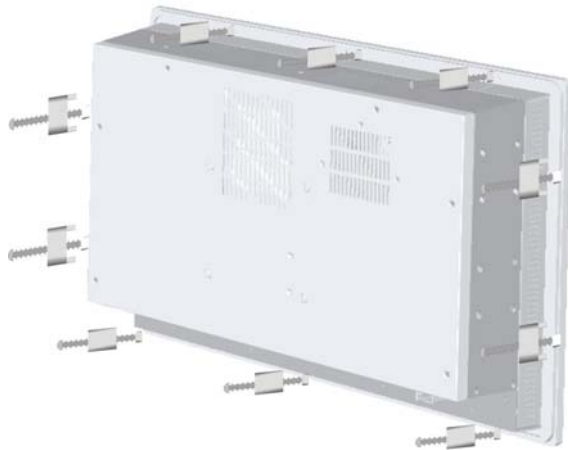

Figure 3-28: Panel Mounting Clamp Positions

Step 5: Tighten the screws that pass through the panel mounting clamps until the plastic caps at the front of all the screws are firmly secured to the panel (**Figure 3-29**).

PPC-51xxA-H61 Panel PC

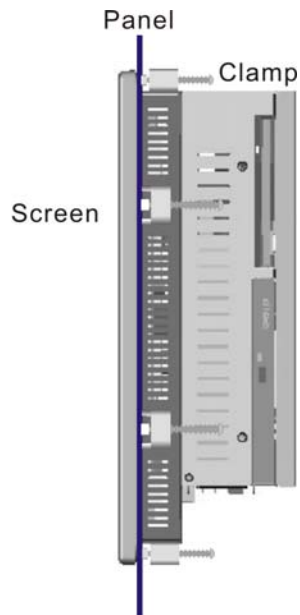

Figure 3-29: Tighten the Panel Mounting Clamp Screws

3.11.3 Rack and Cabinet Installation

To mount the PPC-51xxA-H61 into a rack/cabinet, please follow the steps below.

- Step 1:** Secure the rack mounting bracket to two sides of the monitor using the supplied retention screws. Each bracket requires four screws.
- Step 2:** Secure the rack mounting bracket to the rack by inserting and tightening the supplied mounting nuts and bolts. Each bracket requires three nuts and bolts for installation.

3.11.4 Arm Mounting

The PPC-51xxA-H61 is VESA (Video Electronics Standards Association) compliant and can be mounted on an arm with a 100 mm interface pad. To mount the PPC-51xxA-H61 on an arm, please follow the steps below.

- Step 1:** The arm is a separately purchased item. Please correctly mount the arm onto the surface it uses as a base. To do this, refer to the installation documentation that came with the mounting arm.

NOTE:

When purchasing the arm please ensure that it is VESA compliant and that the arm has a 100 mm interface pad. If the mounting arm is not VESA compliant, it cannot be used to support the PPC-51xxA-H61 panel PC.

Step 2: Once the mounting arm has been firmly attached to its surface, lift the PPC-51xxA-H61 panel PC onto the interface pad of the mounting arm.

Step 3: Align the retention screw holes on the mounting arm interface with those in the PPC-51xxA-H61 panel PC. The arm mounting retention screw holes of the PPC-51xxA-H61 panel PC are shown in **Figure 3-30**.

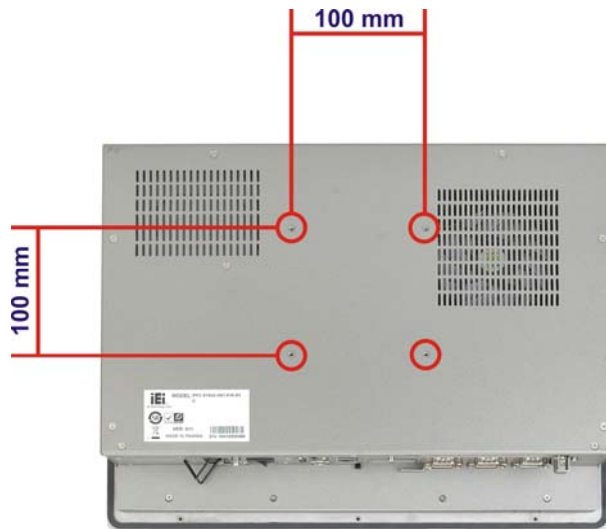

Figure 3-30: Arm Mounting Retention Screw Holes

Step 4: Secure the PPC-51xxA-H61 to the interface pad by inserting four retention screws through the mounting arm interface pad and into the PPC-51xxA-H61 panel PC.

3.11.5 Stand Mounting

To mount the PPC-51xxA-H61 using the stand mounting kit, please follow the steps below.

PPC-51xxA-H61 Panel PC

Step 1: Locate the screw holes on the rear of the PPC-51xxA-H61. This is where the bracket will be attached.

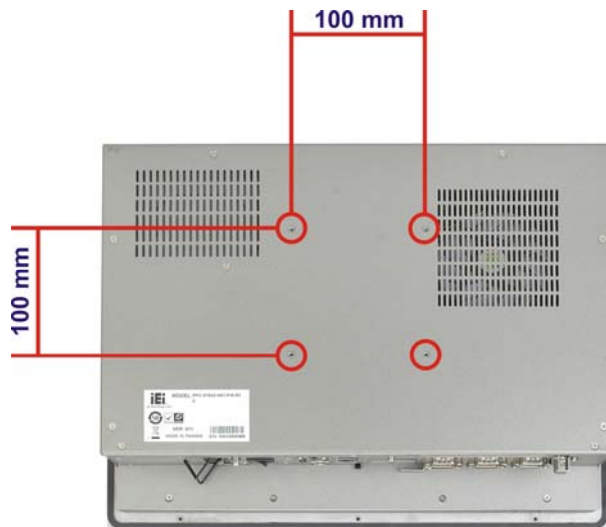

Figure 3-31: Stand Mounting Retention Screw Holes

Step 2: Align the bracket with the screw holes.

Step 3: To secure the bracket to the PPC-51xxA-H61, insert the retention screws into the screw holes and tighten them.

3.12 SFP Fiber Module Installation (Optional)

To install the SFP fiber module, please follow the steps below:

Step 1: Locate the SFP fiber connectors. The locations of the connectors are shown in **Figure 1-5** and **Figure 1-6**.

Step 2: Align the SFP fiber module with one of the SFP fiber connectors on the PPC-51xxA-H61 (**Figure 3-32**).

Step 3: Once aligned, slide the SFP module into place (**Figure 3-32**).



Figure 3-32: SFP Fiber Module Installation



NOTE:

The pin locations of the SFP connector 2 are opposite to the SFP connector 1. Please rotate the SFP module to a proper position to install the SFP module into the SFP connector 2.

3.13 Bottom Panel Connectors

The bottom panel of the PPC-51xxA-H61 contains I/O connectors, switches and a CF card slot. Detailed descriptions of the connectors can be found in the subsections below.

3.13.1 Audio Connectors

The audio jacks connect to external audio devices.

- **Mic-in (Pink):** Connects a microphone.
- **Line-out (Green):** Connects to a headphone or a speaker. With multi-channel configurations, this port can also connect to front speakers.

PPC-51xxA-H61 Panel PC

3.13.2 RJ-45 LAN Connectors

The RJ-45 LAN connectors allow connections to external networks. The pinouts of the RJ-45 LAN connector is shown below.

Pin	Description	Pin	Description
1	MDIA3-	2	MDIA3+
3	MDIA2-	4	MDIA1-
5	MDIA1+	6	MDIA2+
7	MDIA0-	8	MDIA0+

Table 3-5: LAN Pinouts

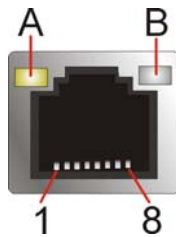

Figure 3-33: RJ-45 LAN Connector

Each RJ-45 LAN connector has two status LEDs, one green and one yellow. See **Figure 3-33**.

LED	Description	LED	Description
A	on: linked blinking: data is being sent/received	B	off: 10 Mb/s green: 100 Mb/s orange: 1000 Mb/s

Table 3-6: RJ-45 LAN Connector LEDs

To connect the PPC-51xxA-H61 to a network through the RJ-45 LAN connectors, follow the steps below.

- Step 1: Locate the RJ-45 connectors.** The locations of the RJ-45 connectors are shown in **Figure 1-5** and **Figure 1-6**.
- Step 2: Align the connectors.** Align the RJ-45 connector on the LAN cable with one of the RJ-45 connectors on the PPC-51xxA-H61. See **Figure 3-34**.

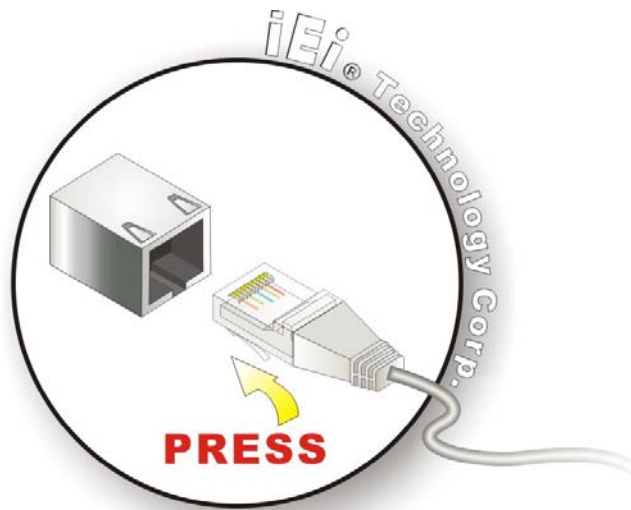

Figure 3-34: LAN Connection

Step 3: Insert the LAN cable RJ-45 connector. Once aligned, gently insert the LAN cable RJ-45 connector into the on-board RJ-45 connector.

3.13.3 RS-232 Serial Ports (COM1, COM2, COM3, COM4)

- CN Label:** COM1, COM2, COM3, COM4
- CN Type:** DB-9 connector
- CN Location:** See Figure 1-5 and Figure 1-6
- CN Pinouts:** See Table 3-7 and Figure 3-35

An RS-232 device can be connected to the RS-232 serial port on the bottom panel. The pinouts of the RS-232 serial port is shown below.

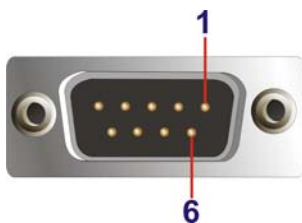

Figure 3-35: RS-232 Serial Port

PPC-51xxA-H61 Panel PC

Pin	Description
1	DCD
2	RXD
3	TXD
4	DTR
5	GND
6	DSR
7	RTS
8	CTS
9	RI

Table 3-7: RS-232 Serial Port Pinouts

To install the RS-232 devices, follow the steps below.

Step 1: Locate the DB-9 connector. The locations of the DB-9 connectors are shown in **Figure 1-5** and **Figure 1-6**.

Step 2: Insert the serial connector. Insert the DB-9 connector of a serial device into the DB-9 connector on the external peripheral interface. See **Figure 3-36**.

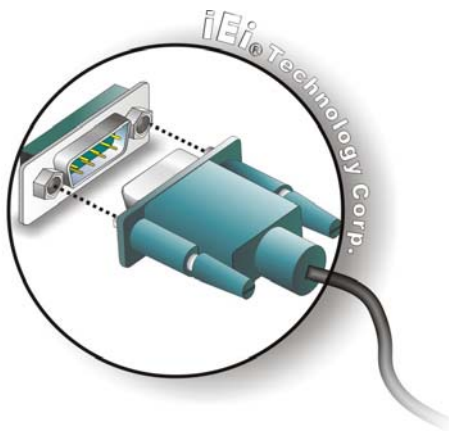

Figure 3-36: RS-232 Serial Device Connector

Step 3: Secure the connector. Secure the serial device connector to the external interface by tightening the two retention screws on either side of the connector.

3.13.4 RS-232/422/485 Serial Port (COM5)

- CN Label:** COM5
- CN Type:** DB-9 connector
- CN Location:** See **Figure 1-5**
- CN Pinouts:** See **Table 3-8** and **Figure 3-37**

An RS-232/422/485 device can be connected to the RS-232/422/485 serial port on the bottom panel. The pinouts of the RS-232/422/485 serial port is shown below.

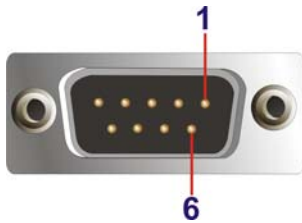

Figure 3-37: RS-232/422/485 Serial Port

Pin	RS-232	RS-422	RS-485
1	-NDCD	TXD422#	TXD485#
2	NSIN	TXD422+	TXD485+
3	NSOUT	RXD422+	
4	-NDTR	RXD422#	
5	GND		
6	-NDSR		
7	-NRTS		
8	-NCTS		
9	COMPIN9		

Table 3-8: RS-232/422/485 Serial Port Pinouts

To install the RS-232/422/485 devices, follow the steps below.

- Step 1:** **Locate the DB-9 connector.** The location of the DB-9 connector is shown in **Figure 1-5** and **Figure 1-6**.

PPC-51xxA-H61 Panel PC

Step 2: **Insert the serial connector.** Insert the DB-9 connector of a serial device into the DB-9 connector on the external peripheral interface. See **Figure 3-38**.

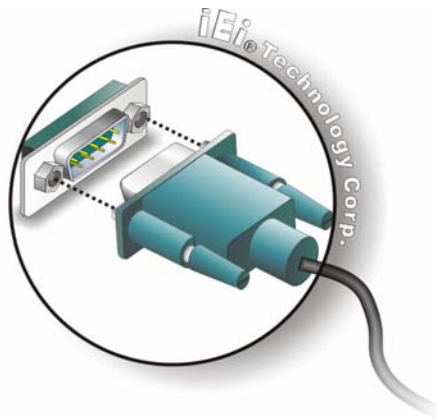

Figure 3-38: RS-232/422/485 Serial Device Connector

Step 3: **Secure the connector.** Secure the serial device connector to the external interface by tightening the two retention screws on either side of the connector.

3.13.5 SFP Fiber LAN Connectors

The PPC-51xxA-H61 has two SFP fiber LAN connectors. The locations of the connectors are shown in **Figure 1-5** and **Figure 1-6**. To install an SFP module, refer to **Section 3.12**.

3.13.6 USB 2.0 Connectors

The USB 2.0 ports are for attaching USB 2.0/1.1 peripheral devices to the system. The pinouts of the USB 2.0 port is shown below.

Pin	Description
1	VCC
2	DATA-
3	DATA+
4	GROUND

Table 3-9: USB 2.0 Port Pinouts

To connect a USB 2.0 or USB 1.1 device, please follow the instructions below.

Step 1: Located the **USB connectors**. The locations of the USB connectors are shown in **Chapter 1**.

Step 2: **Align the connectors**. Align the USB device connector with one of the connectors on the bottom panel. See **Figure 3-39**.

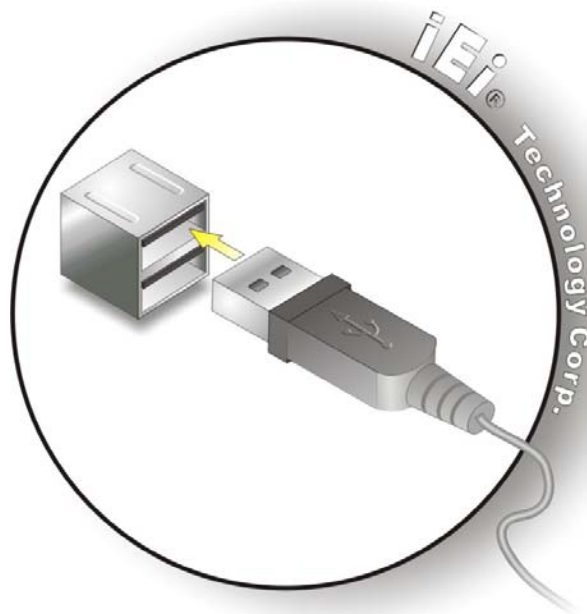

Figure 3-39: USB Device Connection

Step 3: **Insert the device connector**. Once aligned, gently insert the USB device connector into the onboard connector.

3.13.7 USB 3.0 Connectors

The USB 3.0 ports are for attaching USB 3.0 peripheral devices to the system. The pinouts of the USB 3.0 port is shown below.

Pin	Description	Pin	Description
1	USB3_PWR1	10	USB3_PWR2
2	USB2P0_DM1	11	USB2P0_DM2
3	USB2P0_DP1	12	USB2P0_DP2
4	GND	13	GND
5	USB3P0_RXDN1	14	USB3P0_RXDN2

PPC-51xxA-H61 Panel PC

Pin	Description	Pin	Description
6	USB3P0_RXDP1	15	USB3P0_RXDP2
7	GND	16	GND
8	USB3P0_TXDN1	17	USB3P0_TXDN2
9	USB3P0_TXDP1	18	USB3P0_TXDP2

Table 3-10: USB 3.0 Port Pinouts

3.13.8 VGA Connector

The VGA connector connects to a monitor that accepts VGA video input. The pinouts of the VGA connector is shown below.

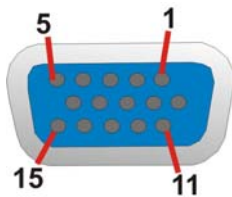

Figure 3-40: VGA Connector

Pin	Description	Pin	Description
1	RED	2	GREEN
3	BLUE	4	NC
5	GND	6	GND
7	GND	8	GND
9	5V	10	GND
11	NC	12	DCCDAT
13	HSYNC	14	VSYNC
15	DDCCLK		

Table 3-11: VGA Connector Pinouts

To connect the PPC-51xxA-H61 to a second display, follow the steps below,

Step 1: Locate the female DB-15 connector. The location of the female DB-15 connector is shown in **Figure 1-5** and **Figure 1-6**.

Step 2: **Align the VGA connector.** Align the male DB-15 connector on the VGA screen cable with the female DB-15 connector on the external peripheral interface.

Step 3: **Insert the VGA connector.** Once the connectors are properly aligned with the insert the male connector from the VGA screen into the female connector on the PPC-51xxA-H61. See **Figure 3-41**.

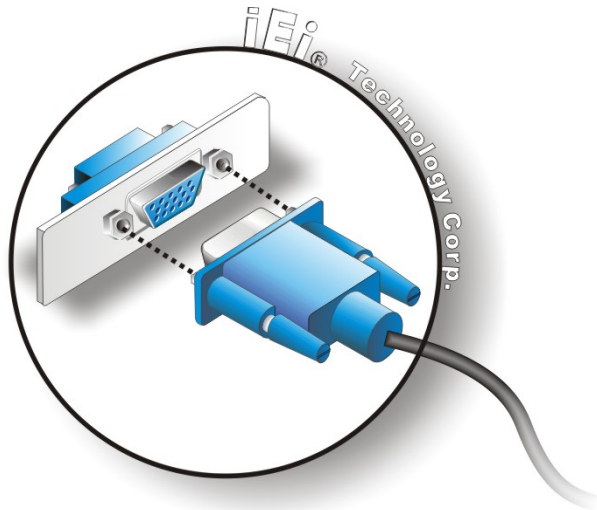

Figure 3-41: VGA Connector

3.14 Driver Installation



NOTE:

The content of the CD may vary throughout the life cycle of the product and is subject to change without prior notice. Visit the IEI website or contact technical support for the latest updates.

All the drivers for the PPC-51xxA-H61 are on the CD that came with the system. To install the drivers, please follow the steps below.

Step 1: Insert the CD into an optical disk drive connected to the system.

PPC-51xxA-H61 Panel PC



NOTE:

If the installation program doesn't start automatically:
Click "Start->My Computer->CD Drive->autorun.exe"

Step 2: The driver main menu appears (**Figure 3-42**).



Figure 3-42: Driver Menu

Step 3: Install all of the necessary drivers in this menu.

Chapter

4

System Maintenance

4.1 System Maintenance Introduction

The following system components may require maintenance.

- Motherboard
- SO-DIMM module
- PSU module
- Cooling fans

If these components fail, they must be replaced. Please contact the system reseller or vendor to purchase replacement parts. Replacement instructions for the above listed components are described below.

4.2 Motherboard Replacement

A user cannot replace a motherboard. If the motherboard fails it must be shipped back to IEI to be replaced. If the system motherboard has failed, please contact the system vendor, reseller or an IEI sales person directly.

4.3 Back Cover Removal



WARNING!

Before removing the back cover, make sure all power to the system has been disconnected. Failing to do so may cause severe damage to the PPC-51xxA-H61 and injury to the user.

**WARNING!**

Please take antistatic precautions when working with the internal components. The interior of the PPC-51xxA-H61 contains very sensitive electronic components. These components are easily damaged by electrostatic discharge (ESD). Before working with the internal components, make sure all anti-static precautions described earlier have been observed.

To access the panel PC internal components, the back cover must be removed. To remove the back cover, please refer to **Section 3.5** for back cover removal instructions.

4.4 SO-DIMM Replacement

Please read the warnings at the beginning of the previous section before attempting to access any PPC-51xxA-H61 internal components.

To install/replace the SO-DIMM modules, please follow the steps below.

Step 1: Remove the back cover (**Section 3.5**).

Step 2: Locate the SO-DIMM module on the motherboard.

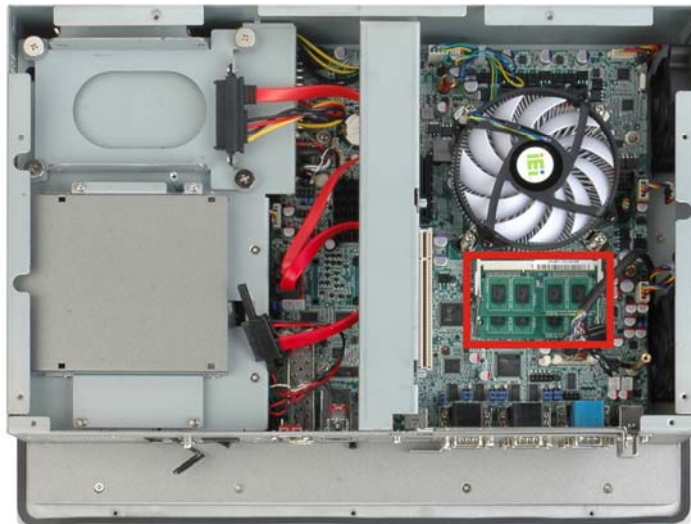

Figure 4-1: SO-DIMM Module Locations

PPC-51xxA-H61 Panel PC

- Step 3:** Release the SO-DIMM module by pulling both the spring retainer clips outward from the socket.
- Step 4:** Grasp the SO-DIMM module by the edges and carefully pull it out of the socket.
- Step 5:** Install the new SO-DIMM module by pushing it into the socket at an angle (Figure 4-2).
- Step 6:** Gently push the rear of the SO-DIMM module down (Figure 4-2). The spring retainer clips clip into place and secure the SO-DIMM module in the socket.

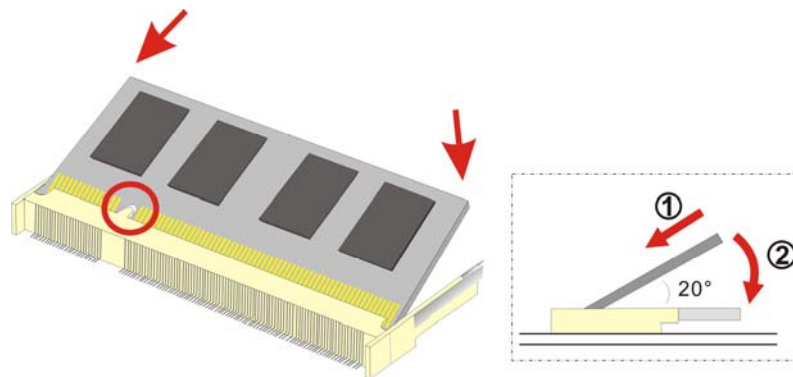

Figure 4-2: SO-DIMM Module Installation

- Step 7:** Push the new DIMM module until it engages and the white plastic end clips click into place. Make sure the end clips are fully secured after installation.

4.5 Elevated Platform Removal

The elevated platform supports the optical drive and the hard drive. It is not necessary to remove the hard drive bracket to remove the elevated platform.

- Step 1:** Unfasten the elevated platform screws on the top panel (Figure 4-3).



Figure 4-3: PPC-5150A-H61 Top Panel Elevated Platform Screws

Step 2: Unfasten the elevated platform screws on the side panel (**Figure 4-4**).



Figure 4-4: PPC-5150A-H61 Side Panel Elevated Platform Screws

Step 3: Unfasten the elevated platform screws on the bottom panel (**Figure 4-5**).



Figure 4-5: PPC-5150A-H61 Bottom Panel Elevated Platform Screws

Step 4: Unfasten the internal elevated platform screws (**Figure 4-6**).



Figure 4-6: PPC-5150A-H61 Internal Elevated Platform Screws

Step 5: Slide the elevated platform out of the chassis.

PPC-51xxA-H61 Panel PC

4.6 PSU Module Replacement

Please read the warnings at the beginning of **Section 4.3** before attempting to access any PPC-51xxA-H61 internal components.

If the PSU module has been damaged it must be replaced. To replace the PSU module, please follow the steps below.

4.6.1 Remove the Old PSU

- Step 1:** Remove the back cover (**Section 3.5**).
- Step 2:** Detach and remove the elevated platform (**Section 4.5**).
- Step 3:** Disconnect all PSU connections including those to the motherboard (**Figure 4-7**) and any disk drives.

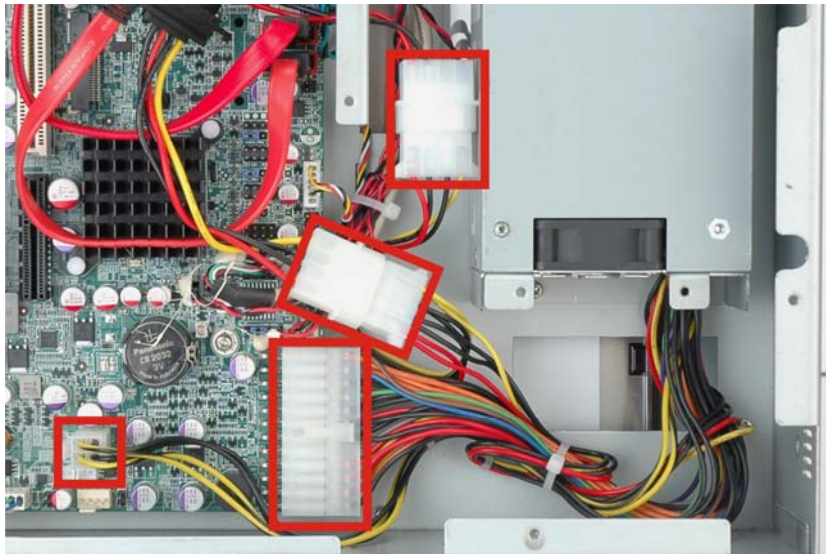

Figure 4-7: PSU Power Cables

Step 4: Unfasten the screws on the inside panel (Figure 4-8).

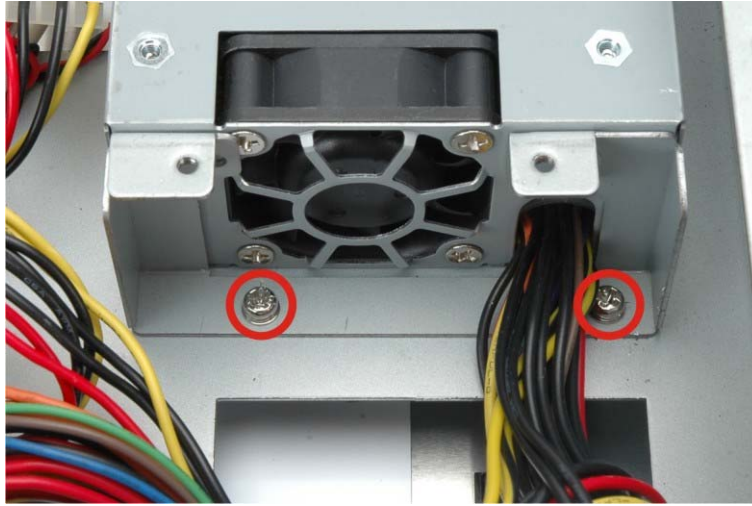

Figure 4-8: PSU Bottom Panel Retention Screws

Step 5: Remove the retention screws that connect the PSU bracket to the chassis (Figure 4-9).



Figure 4-9: PSU Bottom Panel Screws

Step 6: Remove the retention screws that connect the PSU to the PSU bracket.

4.6.2 Install the New PSU

Installation is done in the reverse order to removal. To install a new PSU module, please follow the steps below.

Step 1: Attach the PSU bracket to the PSU module with the previously removed retention screws.

Step 2: Insert the PSU module and bracket assembly into the chassis and attach the PSU bracket to the chassis with the previously removed retention screws.

PPC-51xxA-H61 Panel PC

- Step 3:** Secure the PSU module to the chassis by reinserting the previously removed retention screws through the bottom panel.
- Step 4:** Bundle the cables of the new PSU module and secure them with a plastic tie similar to the old PSU module.
- Step 5:** Reconnect all previously disconnected power connectors to the motherboard and disk drives.
- Step 6:** Reattach the elevated platform.
- Step 7:** Replace the back cover.

4.7 System Cooling Fan Replacement

If the system cooling fans have been damaged, they must be replaced. To replace the system cooling fans, please follow the steps below.

4.7.1 Remove the Old System Cooling Fans

- Step 1:** Remove the back cover (**Section 3.5**).
- Step 2:** Disconnect the system cooling fans from the motherboard (**Figure 4-10**).

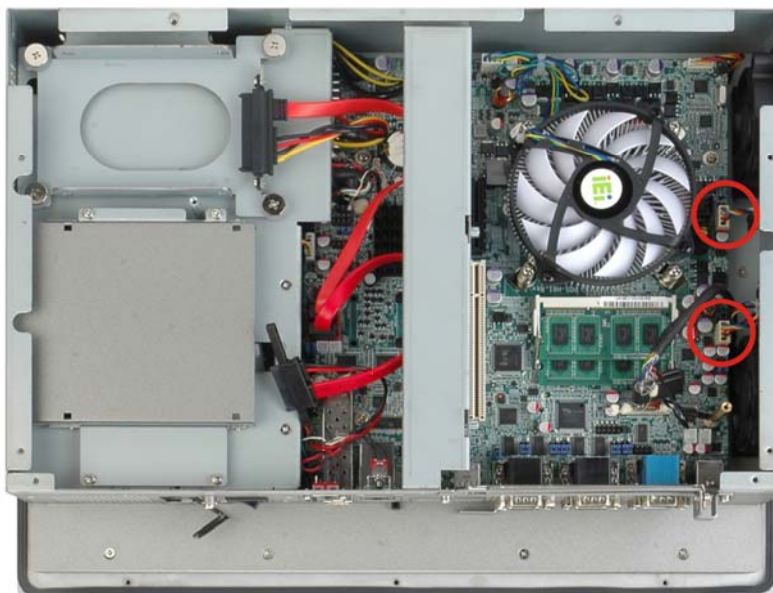

Figure 4-10: System Cooling Fans Motherboard Connector

Step 3: Remove the system cooling fans retention screws from the left panel (Figure 4-11).

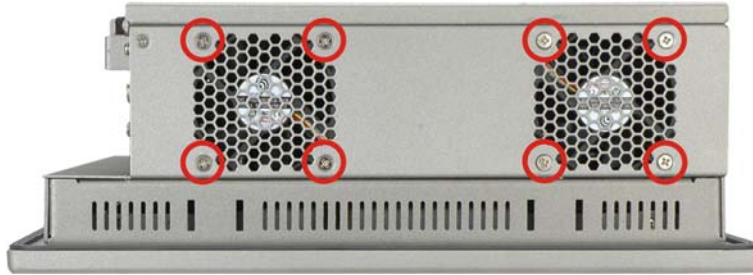

Figure 4-11: System Cooling Fans Left Panel Retention Screws

Step 4: Remove the system cooling fans from the chassis.

4.7.2 Install the New System Cooling Fans

To install the new system cooling fans, please follow the steps below.

Step 1: Insert the system cooling fans into the chassis and attach to the left panel with the previously removed retention screws.

Step 2: Rebundle the new fan wires and tie them to the chassis like the old fan wires.

Step 3: Reconnect the new fan connector to the motherboard.

Step 4: Replace the back cover.

Chapter

5

BIOS Setup

5.1 Introduction

The BIOS is programmed onto the BIOS chip. The BIOS setup program allows changes to certain system settings. This chapter outlines the options that can be changed.

5.1.1 Starting Setup

The UEFI BIOS is activated when the computer is turned on. The setup program can be activated in one of two ways.

1. Press the **DELETE** or **F2** key as soon as the system is turned on or
2. Press the **DELETE** or **F2** key when the “**Press DELETE or F2 to enter SETUP**” message appears on the screen.

If the message disappears before the **DELETE** or **F2** key is pressed, restart the computer and try again.

5.1.2 Using Setup

Use the arrow keys to highlight items, press **ENTER** to select, use the PageUp and PageDown keys to change entries, press **F1** for help and press **Esc** to quit. Navigation keys are shown in the following table.

Key	Function
Up arrow	Move to the item above
Down arrow	Move to the item below
Left arrow	Move to the item on the left hand side
Right arrow	Move to the item on the right hand side
+	Increase the numeric value or make changes
-	Decrease the numeric value or make changes
Page up	Move to the next page
Page down	Move to the previous page

Key	Function
Esc	Main Menu – Quit and do not save changes into CMOS Status Page Setup Menu and Option Page Setup Menu -- Exit current page and return to Main Menu
F1	General help, only for Status Page Setup Menu and Option Page Setup Menu
F2	Load previous values
F3	Load optimized defaults
F4	Save changes and Exit BIOS

Table 5-1: BIOS Navigation Keys

5.1.3 Getting Help

When **F1** is pressed a small help window describing the appropriate keys to use and the possible selections for the highlighted item appears. To exit the Help Window press **Esc** or the **F1** key again.

5.1.4 Unable to Reboot after Configuration Changes

If the computer cannot boot after changes to the system configuration are made, press the CMOS button on the bottom panel to clear the CMOS data and reset the system BIOS information. The location of the CMOS button is shown in **Figure 1-5** and **Figure 1-6**.

5.1.5 BIOS Menu Bar

The **menu bar** on top of the BIOS screen has the following main items:

- Main – Changes the basic system configuration.
- Advanced – Changes the advanced system settings.
- Chipset – Changes the chipset settings.
- Boot – Changes the system boot configuration.
- Security – Sets User and Supervisor Passwords.
- Save & Exit – Selects exit options and loads default settings

The following sections completely describe the configuration options found in the menu items at the top of the BIOS screen and listed above.

5.2 Main

The **Main** BIOS menu (**BIOS Menu 1**) appears when the **BIOS Setup** program is entered. The **Main** menu gives an overview of the basic system information.

Aptio Setup Utility - Copyright (C) 2011 American Megatrends, Inc.					
Main	Advanced	Chipset	Boot	Security	Save & Exit
BIOS Information					Set the Date. Use Tab to switch between Data elements.
BIOS Vendor			American Megatrends		
Core Version			4.6.5.3		
Compliancy			UEFI 2.3; PI 1.2		
Project Version			E410AT13.ROM 0.18 x64		
Build Date and Time			08/27/2012 11:46:29		-----
Total Memory			4096 MB (DDR3)		→←: Select Screen
System Date			[Tue 10/16/2012]		↑ ↓: Select Item
System Time			[14:20:27]		Enter: Select
Access Level			Administrator		+/-: Change Opt.
					F1: General Help
					F2: Previous Values
					F3: Optimized Defaults
					F4: Save & Exit
					ESC: Exit
Version 2.14.1219. Copyright (C) 2011 American Megatrends, Inc.					

BIOS Menu 1: Main

→ BIOS Information

The **BIOS Information** lists a brief summary of the BIOS. The fields in **BIOS Information** cannot be changed. The items shown in the system overview include:

- **BIOS Vendor:** Installed BIOS vendor
- **Core Version:** Current BIOS version
- **Compliancy:** compliant UEFI specification version
- **Project Version:** the board version
- **Build Date and Time:** Date and time the current BIOS version was made

PPC-51xxA-H61 Panel PC

→ System Date [xx/xx/xx]

Use the **System Date** option to set the system date. Manually enter the day, month and year.

→ System Time [xx:xx:xx]

Use the **System Time** option to set the system time. Manually enter the hours, minutes and seconds.

5.3 Advanced

Use the **Advanced** menu (**BIOS Menu 2**) to configure the CPU and peripheral devices through the following sub-menus:



WARNING!

Setting the wrong values in the sections below may cause the system to malfunction. Make sure that the settings made are compatible with the hardware.

```

Aptio Setup Utility - Copyright (C) 2011 American Megatrends, Inc.
Main  Advanced  Chipset  Boot  Security  Save & Exit
-----
AMI Debug Rx Enabled!

> ACPI Settings
> RTC Wake Settings
> CPU Configuration
> SATA Configuration
> USB Configuration
> F81866 Super IO Configuration
> F81866 H/M Monitor
> Serial Port Console Redirection

System ACPI Parameters
-----
-><: Select Screen
↑ ↓: Select Item
Enter: Select
+/-: Change Opt.
F1: General Help
F2: Previous Values
F3: Optimized Defaults
F4: Save & Exit
ESC: Exit

Version 2.14.1219. Copyright (C) 2011 American Megatrends, Inc.

```

BIOS Menu 2: Advanced

5.3.1 ACPI Settings

The **ACPI Settings** menu (**BIOS Menu 3**) configures the Advanced Configuration and Power Interface (ACPI) options.

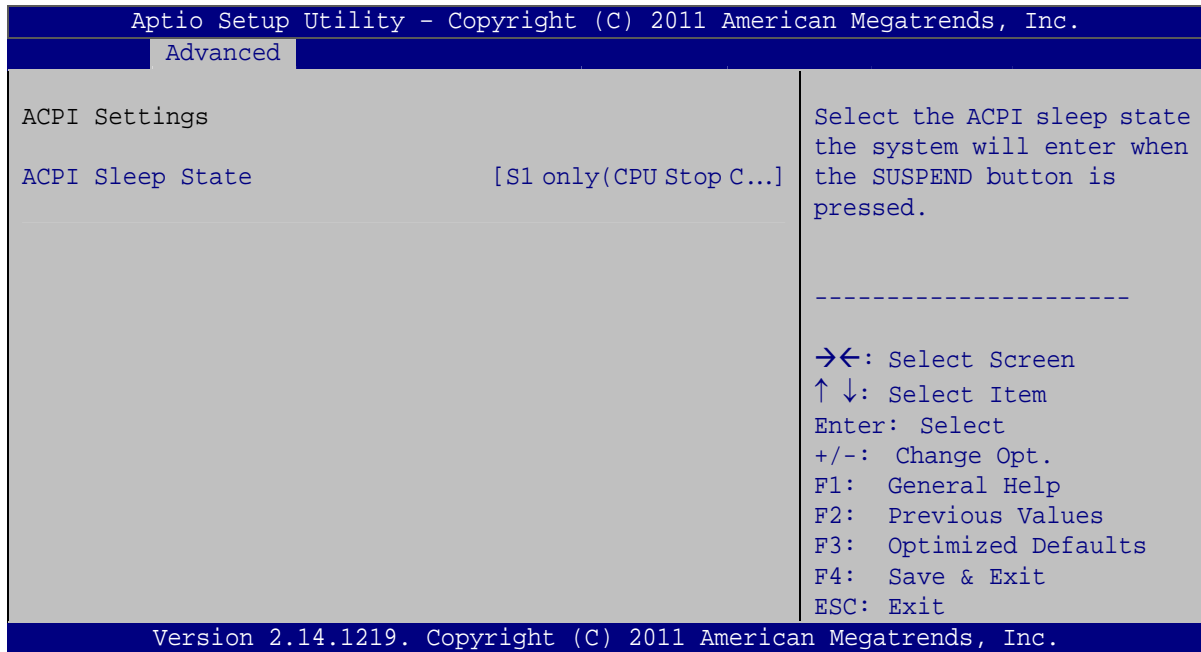

BIOS Menu 3: ACPI Settings

→ **ACPI Sleep State [S1 only (CPU Stop Clock)]**

Use the **ACPI Sleep State** option to specify the sleep state the system enters when it is not being used.

- **S1 only (CPU Stop Clock) DEFAULT** The system enters S1(POS) sleep state. The system appears off. The CPU is stopped; RAM is refreshed; the system is running in a low power mode.
- **S3 only (Suspend to RAM)** The caches are flushed and the CPU is powered off. Power to the RAM is maintained. The computer returns slower to a working state, but more power is saved.

PPC-51xxA-H61 Panel PC

5.3.2 RTC Wake Settings

The **RTC Wake Settings** menu (**BIOS Menu 4**) enables the system to wake at the specified time.

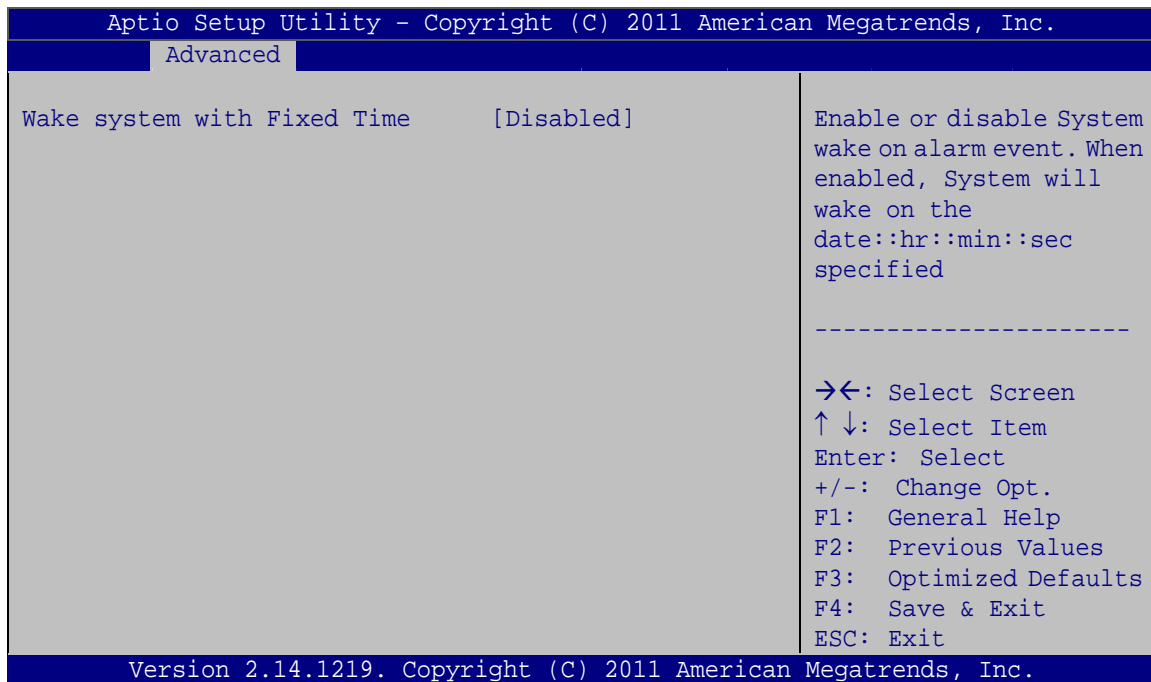

BIOS Menu 4: RTC Wake Settings

→ Wake system with Fixed Time [Disabled]

Use the **Wake system with Fixed Time** option to enable or disable the system wake on alarm event.

- **Disabled** **DEFAULT** The real time clock (RTC) cannot generate a wake event
- **Enabled** If selected, the **Wake up every day** option appears allowing you to enable to disable the system to wake every day at the specified time. Besides, the following options appear with values that can be selected:

Wake up date

Wake up hour

Wake up minute

Wake up second

After setting the alarm, the computer turns itself on from a suspend state when the alarm goes off.

5.3.3 CPU Configuration

Use the **CPU Configuration** menu (**BIOS Menu 5**) to view detailed CPU specifications and configure the CPU.

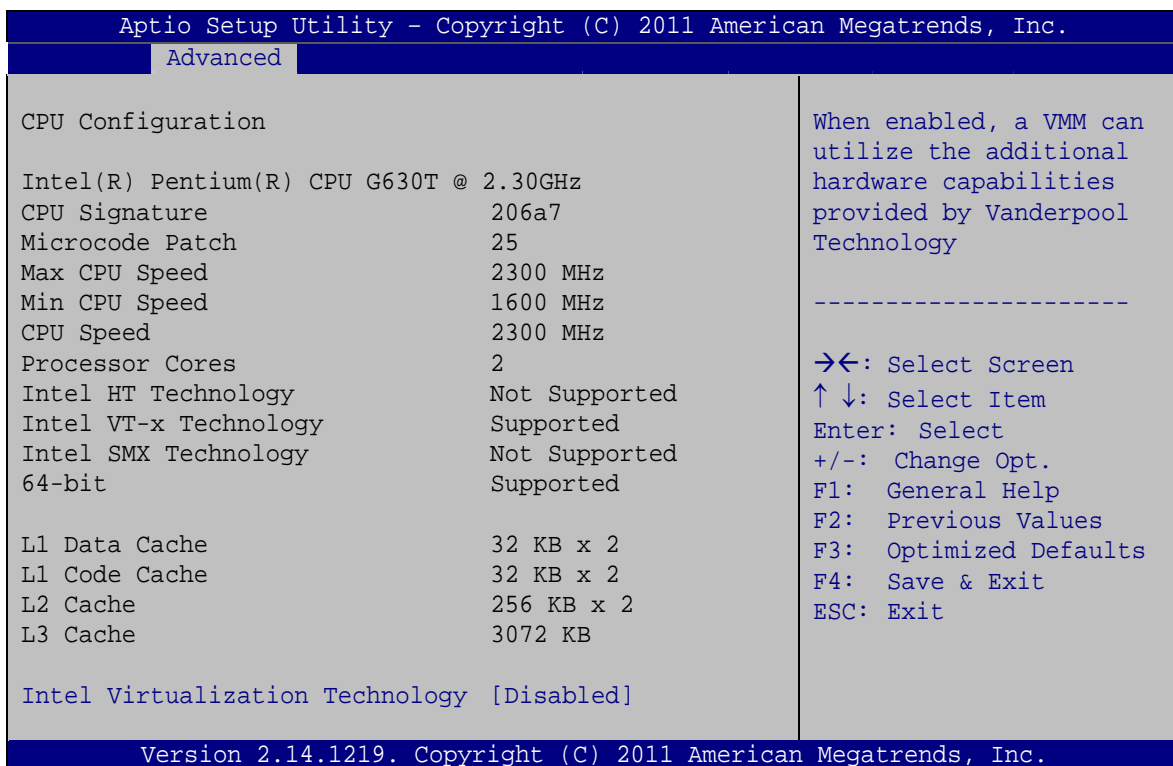

BIOS Menu 5: CPU Configuration

The CPU Configuration menu (**BIOS Menu 5**) lists the following CPU details:

- CPU Signature: Lists the CPU signature value.
- Microcode Patch: Lists the microcode patch being used.
- Max CPU Speed: Lists the maximum CPU processing speed.
- Min CPU Speed: Lists the minimum CPU processing speed.
- CPU Speed: Lists the CPU processing speed.
- Processor Cores: Lists the number of the processor core

5.3.4 SATA Configuration

Use the **SATA Configuration** menu (**BIOS Menu 6**) to change and/or set the configuration of the SATA devices installed in the system.

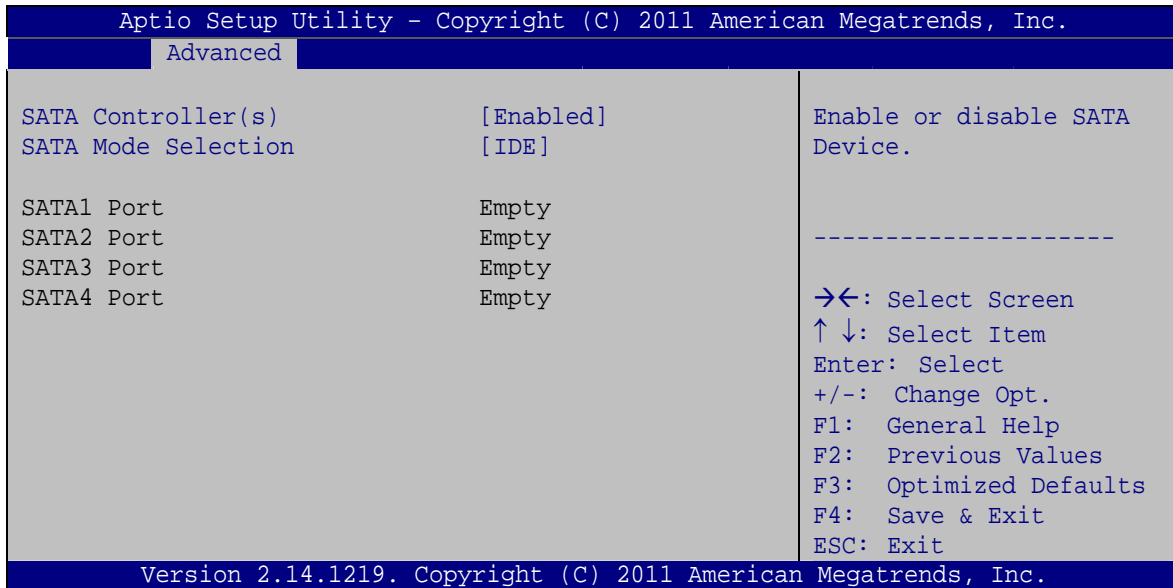

BIOS Menu 6: SATA Configuration

→ SATA Controller(s) [Enabled]

Use the **SATA Controller(s)** option to configure the SATA controller(s).

- **Enabled** **DEFAULT** Enables the on-board SATA controller(s).
- **Disabled** Disables the on-board SATA controller(s).

→ SATA Mode Selection [IDE]

Use the **SATA Mode Selection** option to configure SATA devices as normal IDE devices.

- **IDE** **DEFAULT** Configures SATA devices as normal IDE device.
- **AHCI** The SATA drive connected to the nth SATA drive port is specified as a normal SATA drive.

PPC-51xxA-H61 Panel PC

5.3.5 USB Configuration

Use the **USB Configuration** menu (**BIOS Menu 7**) to read USB configuration information and configure the USB settings.

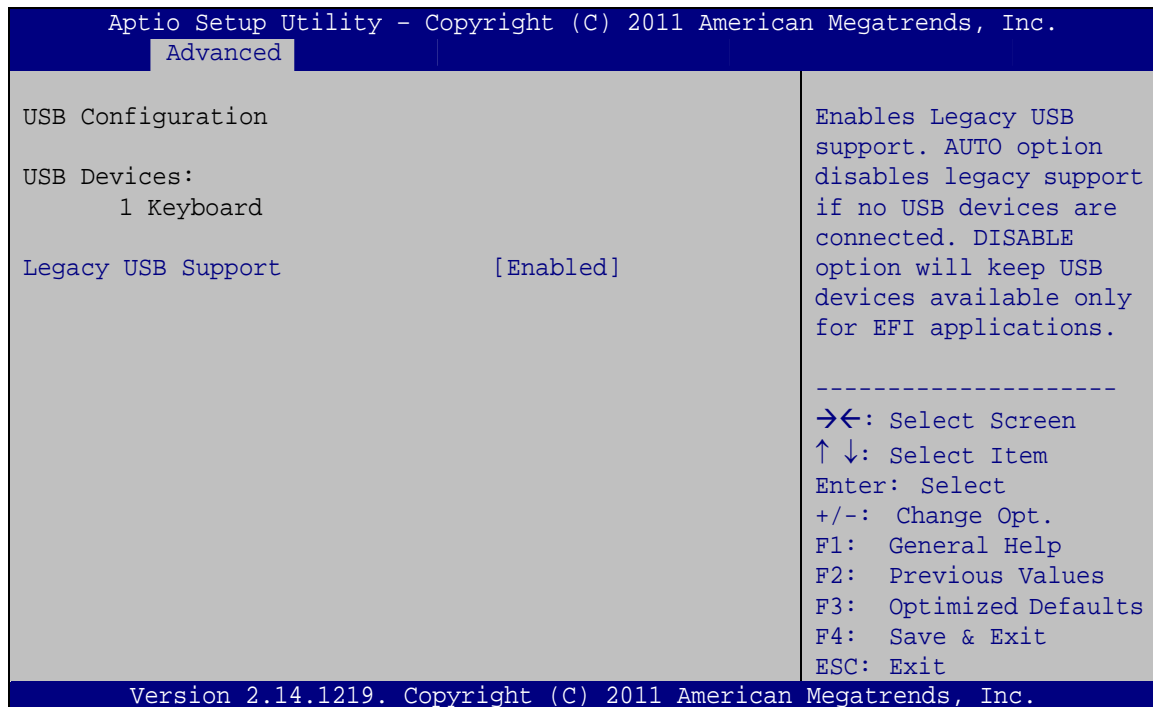

BIOS Menu 7: USB Configuration

→ USB Devices

The **USB Devices** field lists the USB devices that are enabled on the system

→ Legacy USB Support [Enabled]

Use the **Legacy USB Support** BIOS option to enable USB mouse and USB keyboard support. Normally if this option is not enabled, any attached USB mouse or USB keyboard does not become available until a USB compatible operating system is fully booted with all USB drivers loaded. When this option is enabled, any attached USB mouse or USB keyboard can control the system even when there is no USB driver loaded onto the system.

→ **Enabled** **DEFAULT** Legacy USB support enabled

- ➔ **Disabled** Legacy USB support disabled
- ➔ **Auto** Legacy USB support disabled if no USB devices are connected

5.3.6 F81866 Super IO Configuration

Use the **F81866 Super IO Configuration** menu (**BIOS Menu 8**) to set or change the configurations for the serial ports.

```

Aptio Setup Utility - Copyright (C) 2011 American Megatrends, Inc.
  Advanced
F81866 Super IO Configuration
F81866 Super IO Chip          F81866
> Serial Port 1 Configuration
> Serial Port 2 Configuration
> Serial Port 3 Configuration
> Serial Port 4 Configuration
> Serial Port 5 Configuration

Set Parameters of Serial
Port 1 (COMA)
-----
➔←: Select Screen
↑↓: Select Item
Enter: Select
+/-: Change Opt.
F1: General Help
F2: Previous Values
F3: Optimized Defaults
F4: Save & Exit
ESC: Exit

Version 2.14.1219. Copyright (C) 2011 American Megatrends, Inc.
  
```

BIOS Menu 8: F81866 Super IO Configuration

PPC-51xxA-H61 Panel PC

5.3.6.1 Serial Port n Configuration

Use the **Serial Port n Configuration** menu (**BIOS Menu 9**) to configure the serial port n.

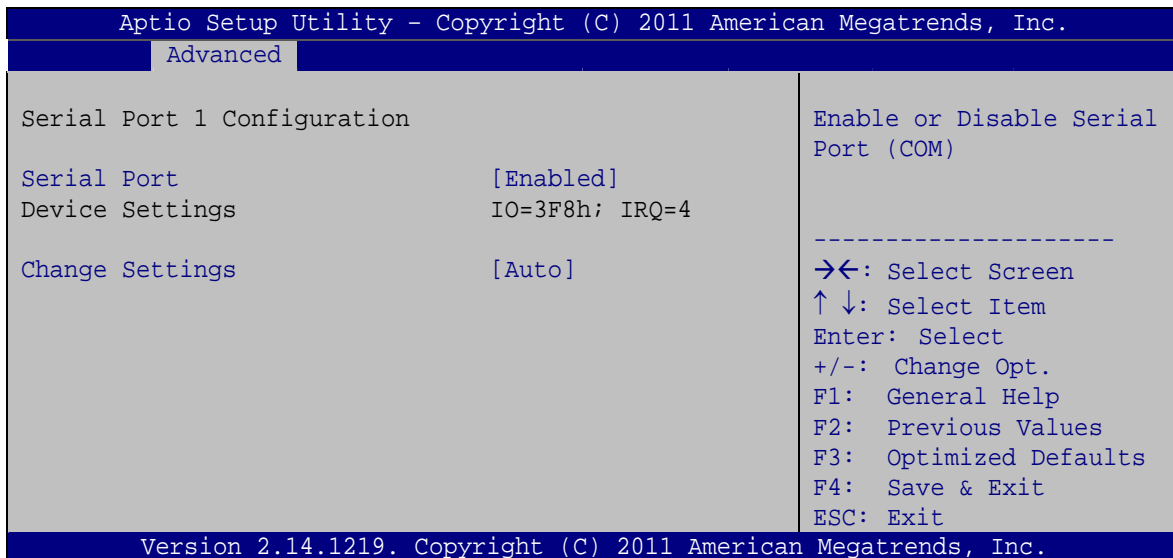

BIOS Menu 9: Serial Port n Configuration Menu

5.3.6.1.1 Serial Port 1 Configuration

→ Serial Port [Enabled]

Use the **Serial Port** option to enable or disable the serial port.

- **Disabled** Disable the serial port
- **Enabled** **DEFAULT** Enable the serial port

→ Change Settings [Auto]

Use the **Change Settings** option to change the serial port IO port address and interrupt address.

- **Auto** **DEFAULT** The serial port IO port address and interrupt address are automatically detected.
- **IO=3F8h;**
IRQ=4 Serial Port I/O port address is 3F8h and the interrupt address is IRQ4

- **IO=3F8h;**
IRQ=3, 4 Serial Port I/O port address is 3F8h and the interrupt address is IRQ3, 4
- **IO=2F8h;**
IRQ=3, 4 Serial Port I/O port address is 2F8h and the interrupt address is IRQ3, 4
- **IO=2C0h;**
IRQ=3, 4 Serial Port I/O port address is 2C0h and the interrupt address is IRQ3, 4
- **IO=2C8h;**
IRQ=3, 4 Serial Port I/O port address is 2C8h and the interrupt address is IRQ3, 4

5.3.6.1.2 Serial Port 2 Configuration

→ Serial Port [Enabled]

Use the **Serial Port** option to enable or disable the serial port.

- **Disabled** Disable the serial port
- **Enabled** **DEFAULT** Enable the serial port

→ Change Settings [Auto]

Use the **Change Settings** option to change the serial port IO port address and interrupt address.

- **Auto** **DEFAULT** The serial port IO port address and interrupt address are automatically detected.
- **IO=2F8h;**
IRQ=3 Serial Port I/O port address is 2F8h and the interrupt address is IRQ3
- **IO=3F8h;**
IRQ=3, 4 Serial Port I/O port address is 3F8h and the interrupt address is IRQ3, 4
- **IO=2F8h;**
IRQ=3, 4 Serial Port I/O port address is 2F8h and the interrupt address is IRQ3, 4
- **IO=2C0h;**
IRQ=3, 4 Serial Port I/O port address is 2C0h and the interrupt address is IRQ3, 4

PPC-51xxA-H61 Panel PC

- ➔ **IO=2C8h;** Serial Port I/O port address is 2C8h and the interrupt
IRQ=3, 4 address is IRQ3, 4

5.3.6.1.3 Serial Port 3 Configuration

➔ Serial Port [Enabled]

Use the **Serial Port** option to enable or disable the serial port.

- ➔ **Disabled** Disable the serial port
- ➔ **Enabled** **DEFAULT** Enable the serial port

➔ Change Settings [Auto]

Use the **Change Settings** option to change the serial port IO port address and interrupt address.

- ➔ **Auto** **DEFAULT** The serial port IO port address and interrupt address are automatically detected.
- ➔ **IO=3E8h;** Serial Port I/O port address is 3E8h and the interrupt
IRQ=10 address is IRQ10
- ➔ **IO=3E8h;** Serial Port I/O port address is 3E8h and the interrupt
IRQ=10, 11 address is IRQ10, 11
- ➔ **IO=2E8h;** Serial Port I/O port address is 2E8h and the interrupt
IRQ=10, 11 address is IRQ10, 11
- ➔ **IO=2D0h;** Serial Port I/O port address is 2D0h and the interrupt
IRQ=10, 11 address is IRQ10, 11
- ➔ **IO=2D8h;** Serial Port I/O port address is 2D8h and the interrupt
IRQ=10, 11 address is IRQ10, 11

5.3.6.1.4 Serial Port 4 Configuration

→ Serial Port [Enabled]

Use the **Serial Port** option to enable or disable the serial port.

- **Disabled** Disable the serial port
- **Enabled** **DEFAULT** Enable the serial port

→ Change Settings [Auto]

Use the **Change Settings** option to change the serial port IO port address and interrupt address.

- **Auto** **DEFAULT** The serial port IO port address and interrupt address are automatically detected.
- **IO=2E8h;**
IRQ=10 Serial Port I/O port address is 2E8h and the interrupt address is IRQ10
- **IO=3E8h;**
IRQ=10, 11 Serial Port I/O port address is 3E8h and the interrupt address is IRQ10, 11
- **IO=2E8h;**
IRQ=10, 11 Serial Port I/O port address is 2E8h and the interrupt address is IRQ10, 11
- **IO=2D0h;**
IRQ=10, 11 Serial Port I/O port address is 2D0h and the interrupt address is IRQ10, 11
- **IO=2D8h;**
IRQ=10, 11 Serial Port I/O port address is 2D8h and the interrupt address is IRQ10, 11

5.3.6.1.5 Serial Port 5 Configuration

→ Serial Port [Enabled]

Use the **Serial Port** option to enable or disable the serial port.

PPC-51xxA-H61 Panel PC

- ➔ **Disabled** Disable the serial port
- ➔ **Enabled** **DEFAULT** Enable the serial port

➔ **Device Mode [Normal]**

The **Device Mode** option is used to set the Serial Port 5 signaling mode.

- ➔ **Normal** **DEFAULT** Sets the serial port mode to normal.
- ➔ **RS422/
RS485** Enables serial port RS-422/485 support.

➔ **Change Settings [Auto]**

Use the **Change Settings** option to change the serial port IO port address and interrupt address.

- ➔ **Auto** **DEFAULT** The serial port IO port address and interrupt address are automatically detected.
- ➔ **IO=2D0h;
IRQ=10** Serial Port I/O port address is 2D0h and the interrupt address is IRQ10
- ➔ **IO=2C0h;
IRQ=10, 11** Serial Port I/O port address is 2C0h and the interrupt address is IRQ10, 11
- ➔ **IO=2C8h;
IRQ=10, 11** Serial Port I/O port address is 2C8h and the interrupt address is IRQ10, 11
- ➔ **IO=2D0h;
IRQ=10, 11** Serial Port I/O port address is 2D0h and the interrupt address is IRQ10, 11
- ➔ **IO=2D8h;
IRQ=10, 11** Serial Port I/O port address is 2D8h and the interrupt address is IRQ10, 11
- ➔ **IO=2E0h;
IRQ=10, 11** Serial Port I/O port address is 2E0h and the interrupt address is IRQ10, 11

5.3.7 F81866 H/W Monitor

The F81866 H/W Monitor menu (**BIOS Menu 10**) contains the fan configuration submenu and displays operating temperature and fan speeds.

```

Aptio Setup Utility - Copyright (C) 2011 American Megatrends, Inc.
  Advanced
PC Health Status
> Smart Fan Mode Configuration
CPU temperature           : +42 C
System temperature       : +45 C
CPU_FAN1 Speed           : 2183 RPM
SYS_FAN2 Speed           : 2722 RPM
SYS_FAN3 Speed           : 1323 RPM

Smart Fan Mode Select
-----
-><: Select Screen
↑↓: Select Item
Enter: Select
+/-: Change Opt.
F1: General Help
F2: Previous Values
F3: Optimized Defaults
F4: Save & Exit
ESC: Exit

Version 2.14.1219. Copyright (C) 2011 American Megatrends, Inc.
  
```

BIOS Menu 10: F81866 H/W Monitor

→ PC Health Status

The following system parameters and values are shown. The system parameters that are monitored are:

- System Temperatures:
 - CPU Temperature
 - System Temperature
- Fan Speeds:
 - CPU_Fan1 Speed
 - SYS_Fan2 Speed
 - SYS_Fan3 Speed

5.3.7.1 Smart Fan Mode Configuration

Use the **Smart Fan Mode Configuration** submenu (**BIOS Menu 11**) to configure the fan temperature and speed settings.

PPC-51xxA-H61 Panel PC

```

Aptio Setup Utility - Copyright (C) 2011 American Megatrends, Inc.
Advanced

Smart Fan Mode Configuration
CPU_FAN1 Smart Fan control      [Auto Duty-Cycle Mode]
CPU Temperature 1               60
CPU Temperature 2               50
CPU Temperature 3               40
CPU Temperature 4               30
Duty Cycle 1                    100
Duty Cycle 2                    80
Duty Cycle 3                    70
Duty Cycle 4                    50
SYS_FAN2 Smart Fan control      [Auto Duty-Cycle Mode]
System Temperature 1            60
System Temperature 2            50
System Temperature 3            40
System Temperature 4            30
Duty Cycle 1                    90
Duty Cycle 2                    60
Duty Cycle 3                    40
Duty Cycle 4                    10
SYS_FAN3 Smart Fan control      [Auto Duty-Cycle Mode]
Temperature 1                   70
Temperature 2                   60
Temperature 3                   50
Temperature 4                   30
Duty Cycle 1                    90
Duty Cycle 2                    60
Duty Cycle 3                    40
Duty Cycle 4                    10

Smart Fan Mode Select
-----
-><: Select Screen
↑↓: Select Item
Enter: Select
+/-: Change Opt.
F1: General Help
F2: Previous Values
F3: Optimized Defaults
F4: Save & Exit
ESC: Exit

Version 2.14.1219. Copyright (C) 2011 American Megatrends, Inc.

```

BIOS Menu 11: Smart Fan Mode Configuration

→ CPU_FAN1/SYS_FAN2/SYS_FAN3 Smart Fan Control [Auto by RPM]

Use the **CPU_FAN1/SYS_FAN2/SYS_FAN3 Smart Fan Control** option to configure the smart fans.

- **Manual Duty Mode** The fan spins at the speed set in Manual Duty Mode settings.
- **Auto Duty-Cycle Mode** **DEFAULT** The fan adjusts its speed using Auto Duty-Cycle Mode settings.

➔ **CPU Temperature n/System Temperature n/Temperature n**

Use the + or – key to change the temperature value. Enter a decimal number between 1 and 100.

➔ **Duty Cycle n**

Use the + or – key to change the fan value in percentage. Enter a decimal number between 1 and 100.

5.3.8 Serial Port Console Redirection

The **Serial Port Console Redirection** menu (**BIOS Menu 12**) allows the console redirection options to be configured. Console redirection allows users to maintain a system remotely by re-directing keyboard input and text output through the serial port.

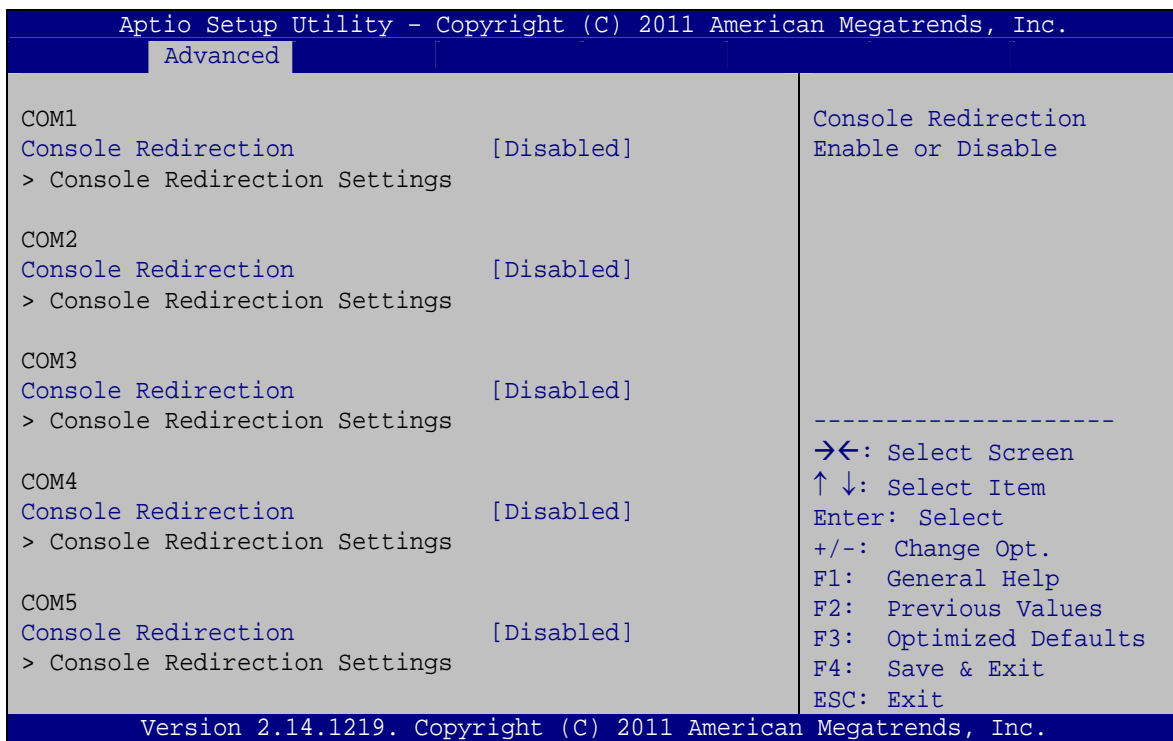

BIOS Menu 12: Serial Port Console Redirection

➔ **Console Redirection [Disabled]**

Use **Console Redirection** option to enable or disable the console redirection function.

PPC-51xxA-H61 Panel PC

- ➔ **Disabled** **DEFAULT** Disabled the console redirection function
- ➔ **Enabled** Enabled the console redirection function

5.3.8.1 Console Redirection Settings

Use the **Console Redirection Settings** menu (**BIOS Menu 13**) to configure console redirection settings of the specified serial port. This menu appears only when the Console Redirection is enabled.

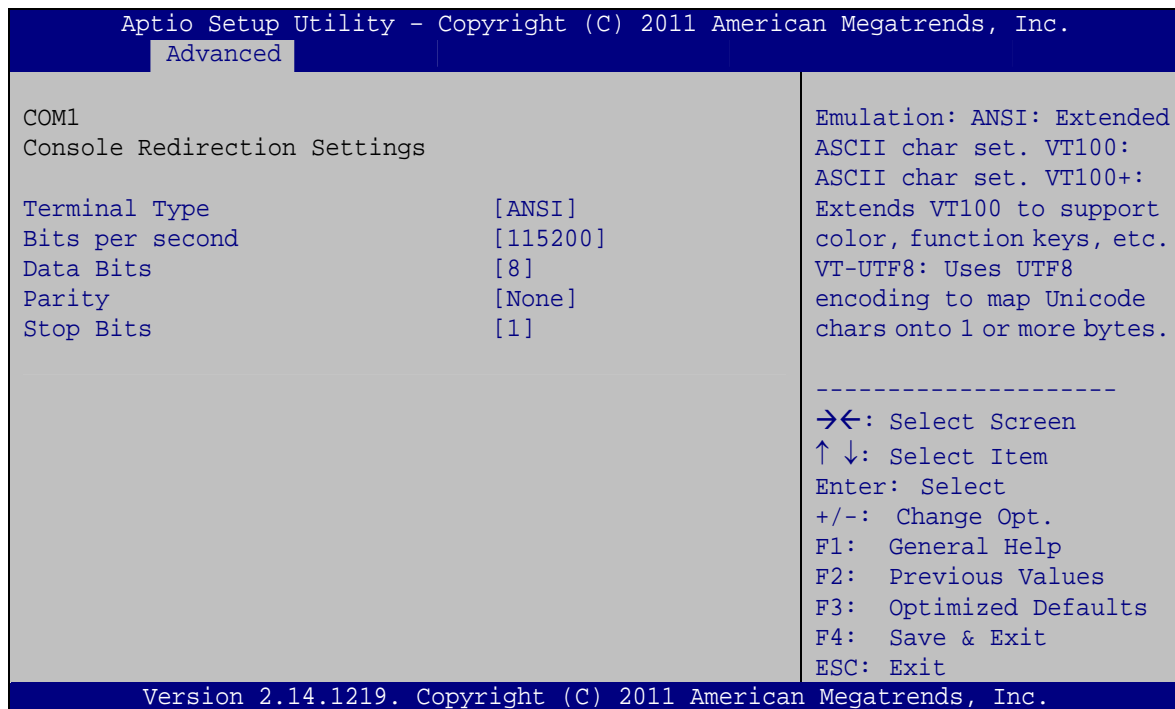

BIOS Menu 13: Console Redirection Settings

➔ Terminal Type [ANSI]

Use the **Terminal Type** option to specify the remote terminal type.

- ➔ **VT100** The target terminal type is VT100
- ➔ **VT100+** The target terminal type is VT100+
- ➔ **VT-UTF8** The target terminal type is VT-UTF8
- ➔ **ANSI** **DEFAULT** The target terminal type is ANSI

→ Bits per second [115200]

Use the **Bits per second** option to specify the serial port transmission speed. The speed must match the other side. Long or noisy lines may require lower speeds.

- | | | |
|-----------------|----------------|--|
| → 9600 | | Sets the serial port transmission speed at 9600. |
| → 19200 | | Sets the serial port transmission speed at 19200. |
| → 38400 | | Sets the serial port transmission speed at 38400. |
| → 57600 | | Sets the serial port transmission speed at 57600. |
| → 115200 | DEFAULT | Sets the serial port transmission speed at 115200. |

→ Data Bits [8]

Use the **Data Bits** option to specify the number of data bits.

- | | | |
|------------|----------------|--------------------------|
| → 7 | | Sets the data bits at 7. |
| → 8 | DEFAULT | Sets the data bits at 8. |

→ Parity [None]

Use the **Parity** option to specify the parity bit that can be sent with the data bits for detecting the transmission errors.

- | | | |
|----------------|----------------|---|
| → None | DEFAULT | No parity bit is sent with the data bits. |
| → Even | | The parity bit is 0 if the number of ones in the data bits is even. |
| → Odd | | The parity bit is 0 if the number of ones in the data bits is odd. |
| → Mark | | The parity bit is always 1. This option does not provide error detection. |
| → Space | | The parity bit is always 0. This option does not provide error detection. |

PPC-51xxA-H61 Panel PC

→ Stop Bits [1]

Use the **Stop Bits** option to specify the number of stop bits used to indicate the end of a serial data packet. Communication with slow devices may require more than 1 stop bit.

- 1 **DEFAULT** Sets the number of stop bits at 1.
- 2 Sets the number of stop bits at 2.

5.4 Chipset

Use the **Chipset** menu (**BIOS Menu 14**) to access the PCH and System Agent (SA) configuration menus.



WARNING!

Setting the wrong values for the Chipset BIOS selections in the Chipset BIOS menu may cause the system to malfunction.

```

Aptio Setup Utility - Copyright (C) 2011 American Megatrends, Inc.
Main   Advanced  Chipset   Boot   Security  Save & Exit
-----
> PCH-IO Configuration
> System Agent (SA) Configuration

PCH Parameters
-----
→←: Select Screen
↑ ↓: Select Item
Enter: Select
+/-: Change Opt.
F1: General Help
F2: Previous Values
F3: Optimized Defaults
F4: Save & Exit
ESC: Exit

Version 2.14.1219. Copyright (C) 2011 American Megatrends, Inc.

```

BIOS Menu 14: Chipset

5.4.1 PCH-IO Configuration

Use the **PCH-IO Configuration** menu (**BIOS Menu 15**) to configure the PCH IO settings.

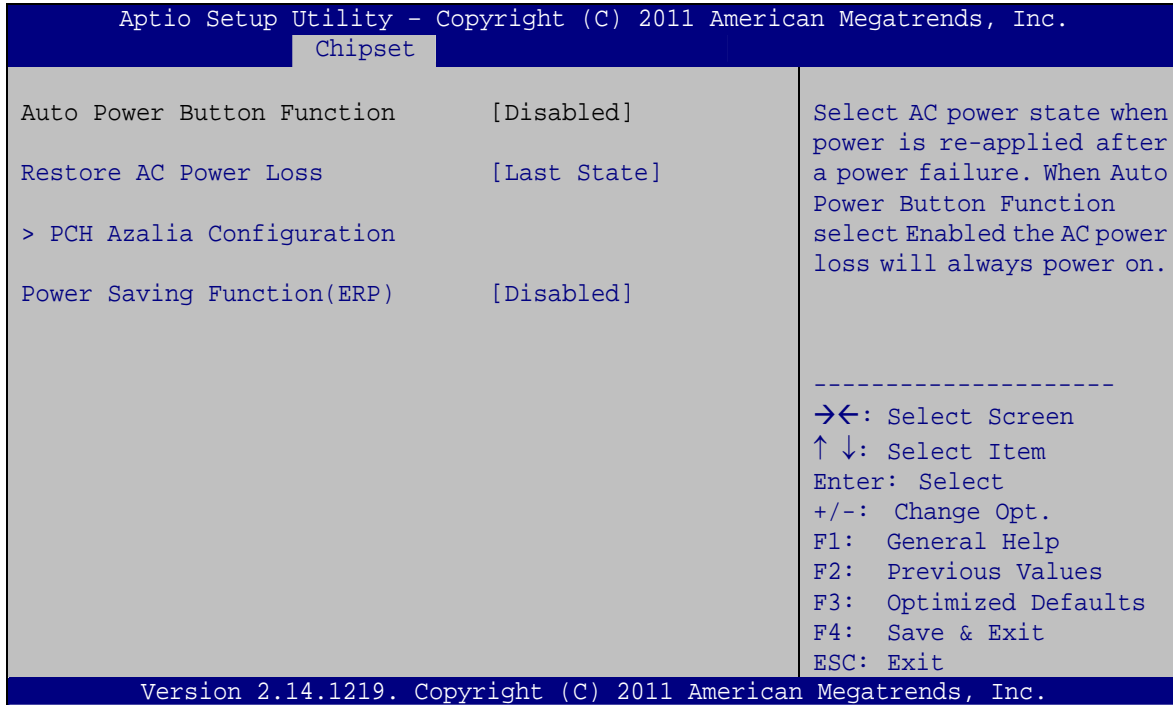

BIOS Menu 15: PCH-IO Configuration

➔ Restore AC Power Loss [Last State]

Use the **Restore AC Power Loss** BIOS option to specify what state the system returns to if there is a sudden loss of power to the system.

- ➔ **Power Off** The system remains turned off
- ➔ **Power On** The system turns on
- ➔ **Last State** **DEFAULT** The system returns to its previous state. If it was on, it turns itself on. If it was off, it remains off.

➔ Power Saving Function(ERP) [Disabled]

Use the **Power Saving Function(ERP)** option to enable or disable the power saving function.

PPC-51xxA-H61 Panel PC

- ➔ **Disabled** **DEFAULT** Disables the power saving function.
- ➔ **Enabled** Enables the power saving function.

5.4.1.1 PCH Azalia Configuration

Use the **PCH Azalia Configuration** menu (**BIOS Menu 16**) to configure the PCH Azalia controller.

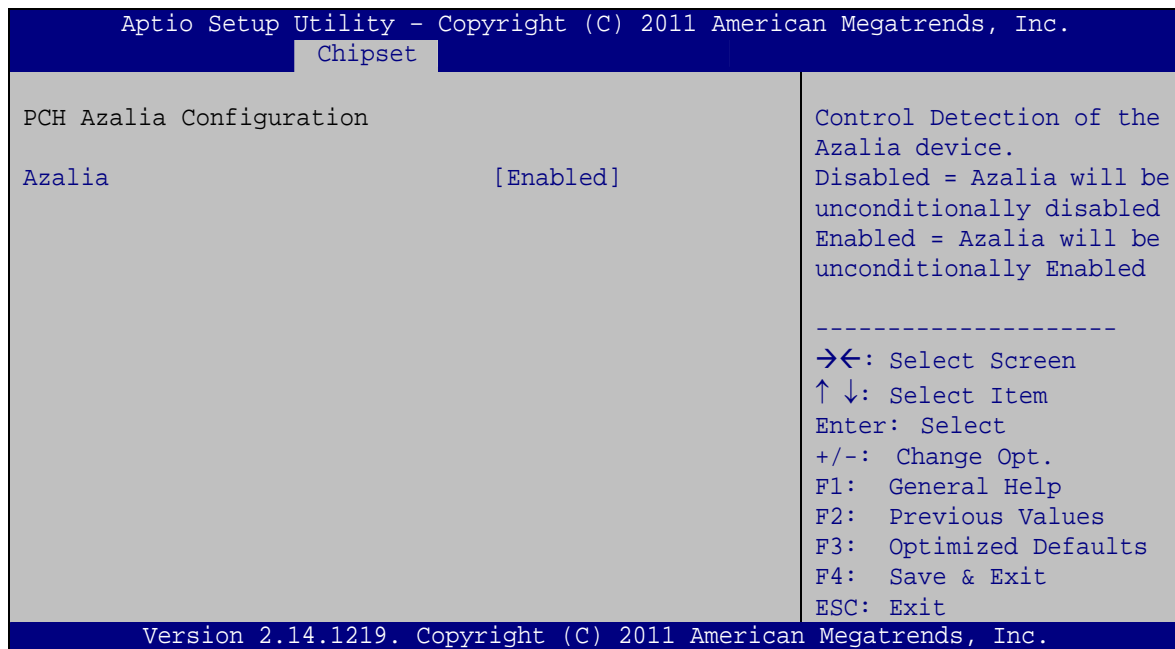

BIOS Menu 16: PCH Azalia Configuration

➔ **Azalia [Enabled]**

The **Azalia** option enables or disables the HD Audio controller.

- ➔ **Enabled** **DEFAULT** The onboard HD Audio controller is enabled.
- ➔ **Disabled** The onboard HD Audio controller is disabled.

5.4.2 System Agent (SA) Configuration

Use the **System Agent (SA) Configuration** menu (**BIOS Menu 17**) to configure the System Agent (SA) parameters.

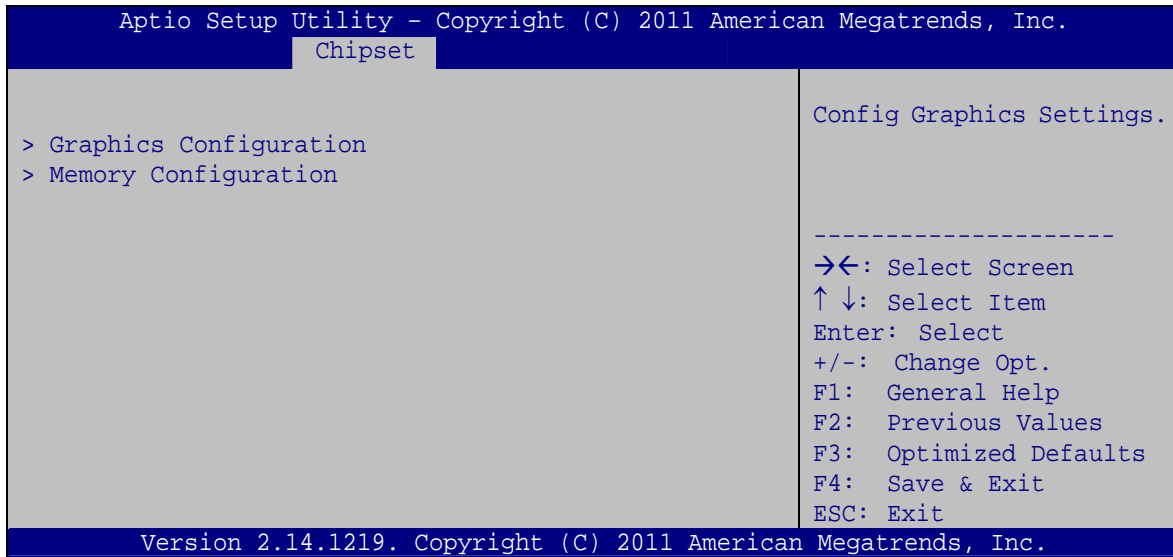

BIOS Menu 17: System Agent (SA) Configuration

5.4.2.1 Graphics Configuration

Use the **Graphics Configuration** menu (**BIOS Menu 18**) to configure the graphics settings

PPC-51xxA-H61 Panel PC

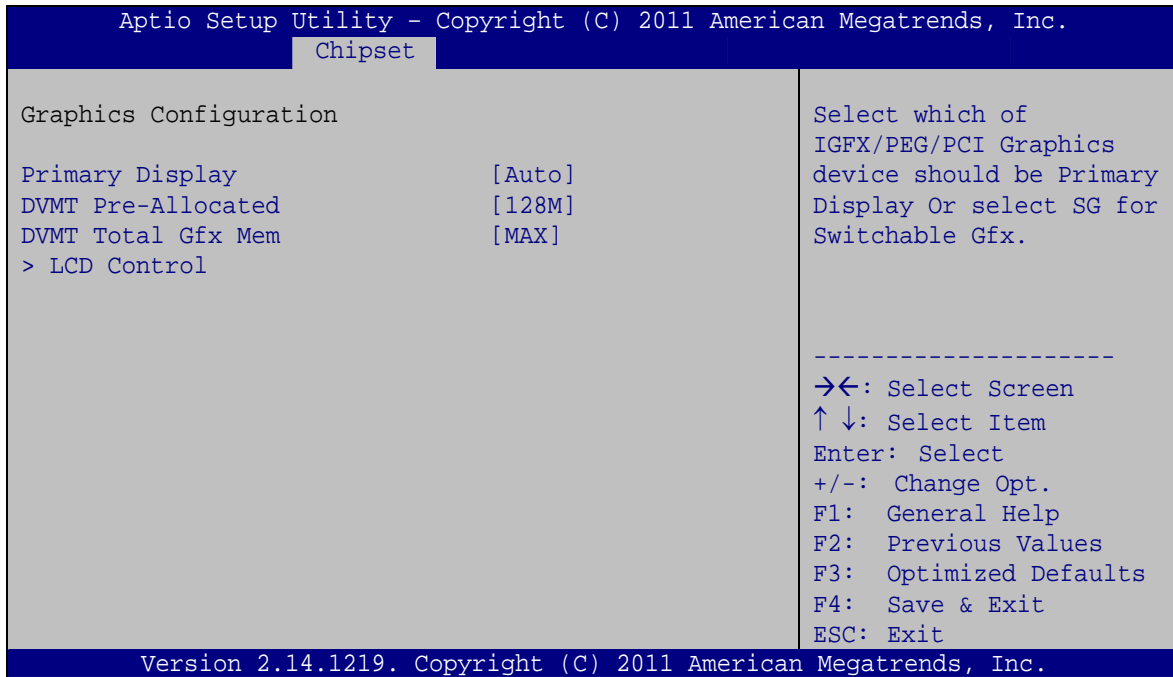

BIOS Menu 18: Graphics Configuration

→ Primary Display [Auto]

Use the **Primary Display** option to select the graphics controller used as the primary boot device.

- Auto **DEFAULT**
- IGFX
- PEG
- PCI

→ DVMT Pre-Allocated [128M]

Use the **DVMT Pre-Allocated** option to specify a fixed amount of memory that can be allocated for the internal graphics device. Configuration options are listed below.

- 128M **DEFAULT**
- 256M
- 512M

→ DVMT Total Gfx Mem [MAX]

Use the **DVMT Total Gfx Mem** option to specify the maximum amount of memory that can be allocated for the internal graphics device. Configuration options are listed below.

- 128M
- 256M
- MAX **DEFAULT**

5.4.2.1.1 LCD Control

Use the **LCD Control** menu (**BIOS Menu 19**) to display the LCD Control settings.

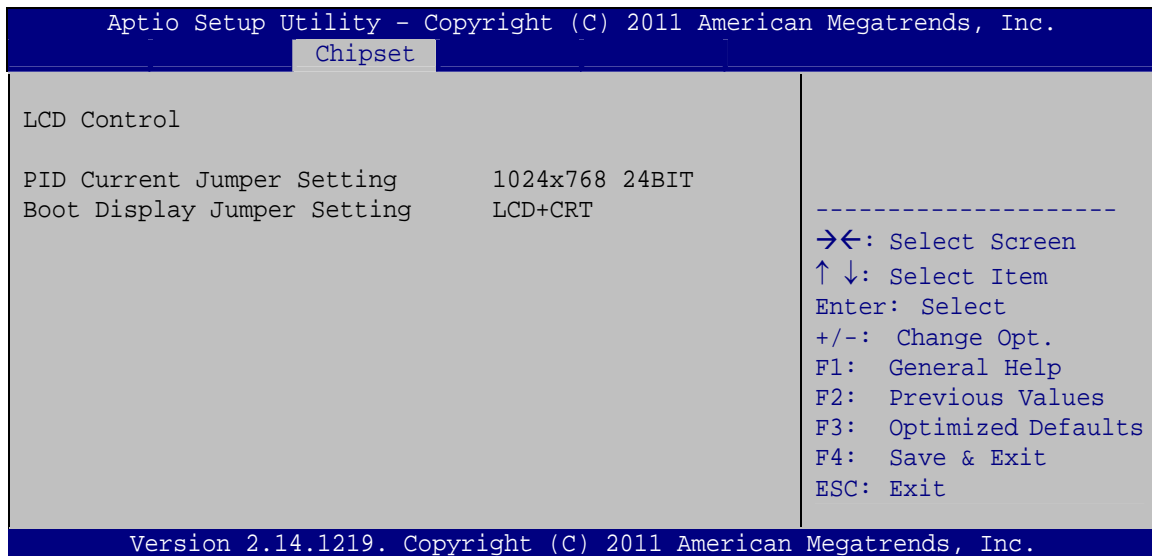
BIOS Menu 19: LCD Control

PPC-51xxA-H61 Panel PC

5.4.2.2 Memory Configuration

Use the **Memory Configuration** menu (**BIOS Menu 20**) to display the memory information.

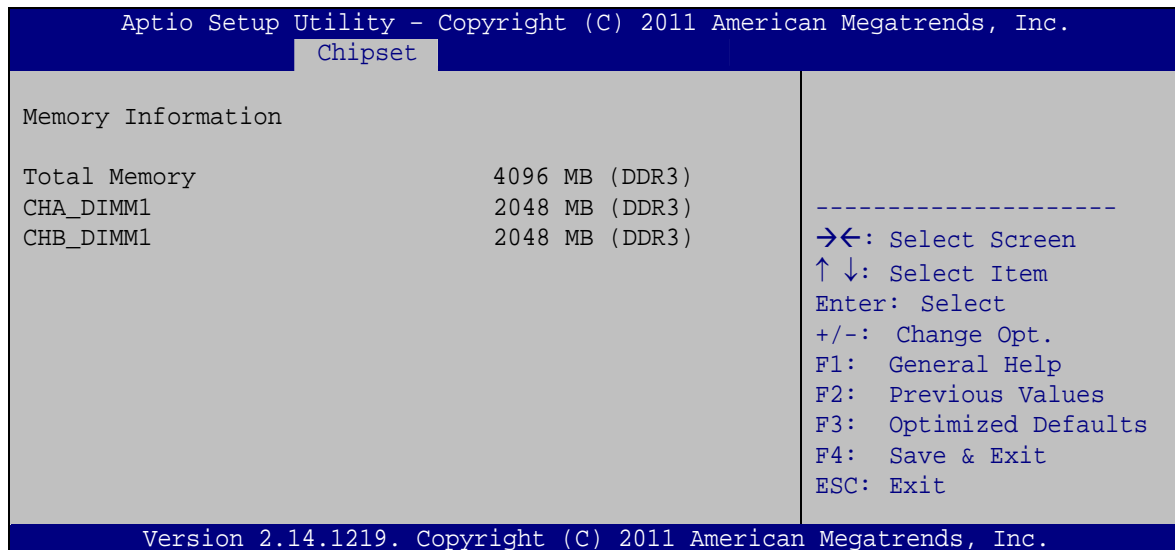

BIOS Menu 20: Memory Configuration

5.5 Boot

Use the **Boot** menu (**BIOS Menu 21**) to configure system boot options.

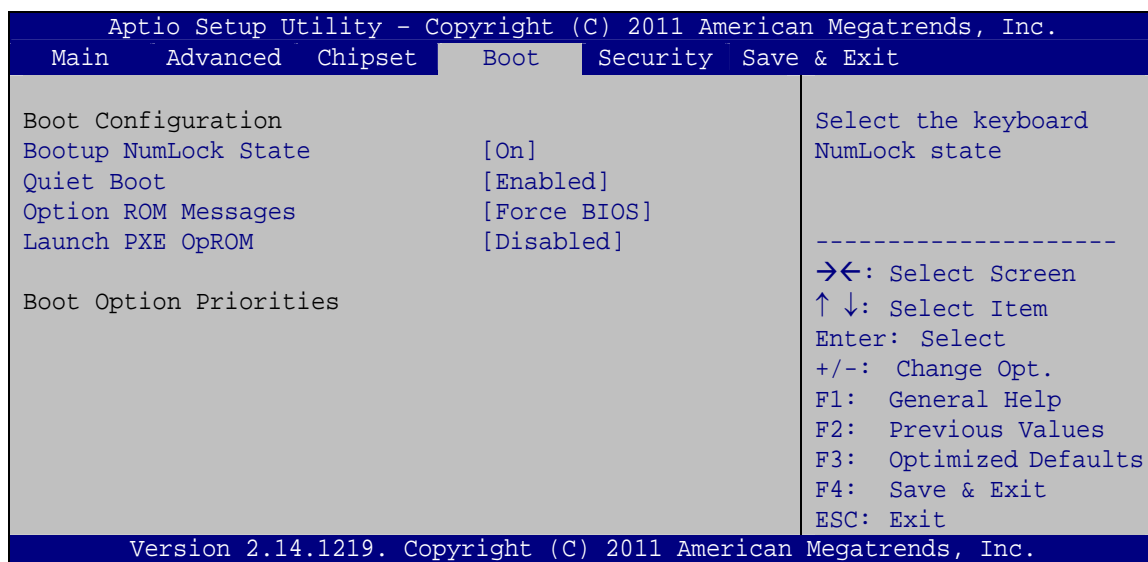

BIOS Menu 21: Boot

→ Bootup NumLock State [On]

Use the **Bootup NumLock State** BIOS option to specify if the number lock setting must be modified during boot up.

- On** **DEFAULT** Allows the Number Lock on the keyboard to be enabled automatically when the computer system boots up. This allows the immediate use of the 10-key numeric keypad located on the right side of the keyboard. To confirm this, the Number Lock LED light on the keyboard is lit.

- Off** Does not enable the keyboard Number Lock automatically. To use the 10-keys on the keyboard, press the Number Lock key located on the upper left-hand corner of the 10-key pad. The Number Lock LED on the keyboard lights up when the Number Lock is engaged.

→ Quiet Boot [Enabled]

Use the **Quiet Boot** BIOS option to select the screen display when the system boots.

- Disabled** Normal POST messages displayed

- Enabled** **DEFAULT** OEM Logo displayed instead of POST messages

→ Option ROM Messages [Force BIOS]

Use the **Option ROM Messages** option to set the Option ROM display mode.

- Force BIOS** **DEFAULT** Sets display mode to force BIOS.

- Keep Current** Sets display mode to current.

PPC-51xxA-H61 Panel PC

→ Launch PXE OpROM [Disabled]

Use the **Launch PXE OpROM** option to enable or disable boot option for legacy network devices.

- **Disabled** **DEFAULT** Ignore all PXE Option ROMs
- **Enabled** Load PXE Option ROMs

5.6 Security

Use the **Security** menu (**BIOS Menu 22**) to set system and user passwords.

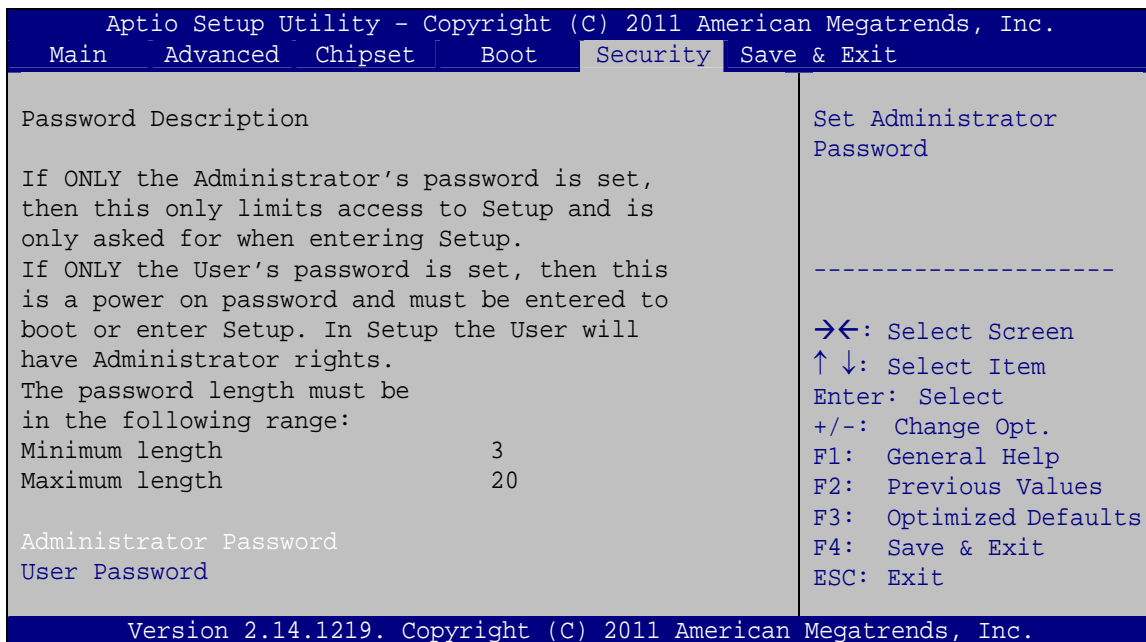

BIOS Menu 22: Security

→ Administrator Password

Use the **Administrator Password** to set or change an administrator password.

→ User Password

Use the **User Password** to set or change a user password.

5.7 Save & Exit

Use the **Save & Exit** menu (**BIOS Menu 23**) to load default BIOS values, optimal failsafe values and to save configuration changes.

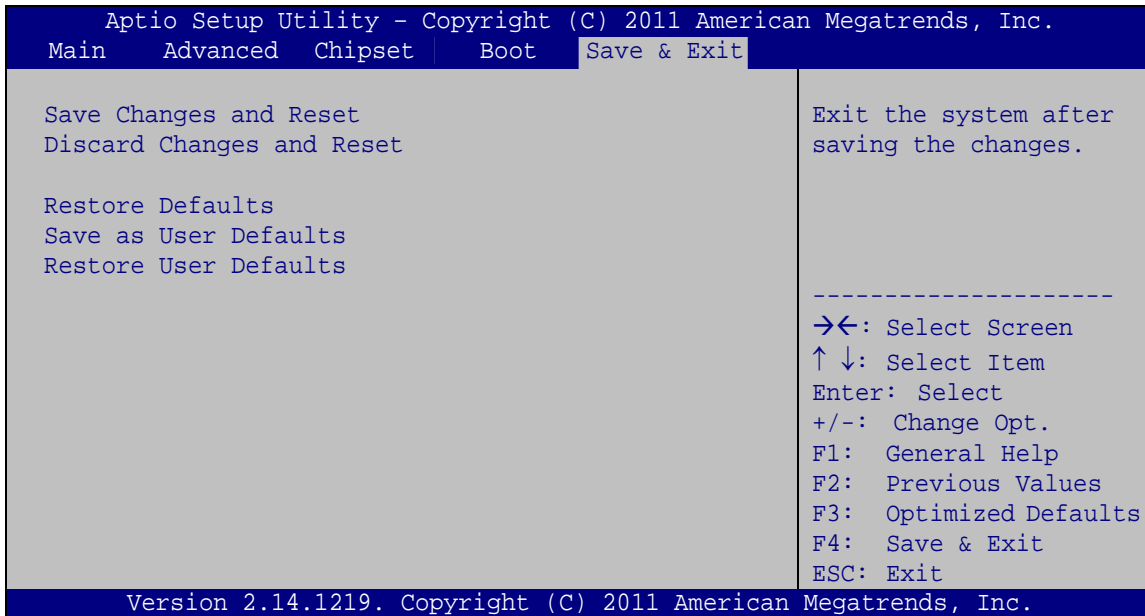

BIOS Menu 23: Save & Exit

→ Save Changes and Reset

Use the **Save Changes and Reset** option to save the changes made to the BIOS options and reset the system.

→ Discard Changes and Reset

Use the **Discard Changes and Reset** option to exit the system without saving the changes made to the BIOS configuration setup program.

→ Restore Defaults

Use the **Restore Defaults** option to load the optimal default values for each of the parameters on the Setup menus. **F3 key can be used for this operation.**

→ Save as User Defaults

Use the **Save as User Defaults** option to save the changes done so far as user defaults.

PPC-51xxA-H61 Panel PC

→ Restore User Defaults

Use the **Restore User Defaults** option to restore the user defaults to all the setup options.

Chapter

6

Interface Connectors

PPC-51xxA-H61 Panel PC

6.1 Peripheral Interface Connectors

The PPC-51xxA-H61 panel PC motherboard comes with a number of peripheral interface connectors and configuration jumpers. The connector locations are shown in **Figure 6-1** and **Figure 6-2**. The Pin 1 locations of the on-board connectors are also indicated in the diagrams. The connector pinouts for these connectors are listed in the following sections.

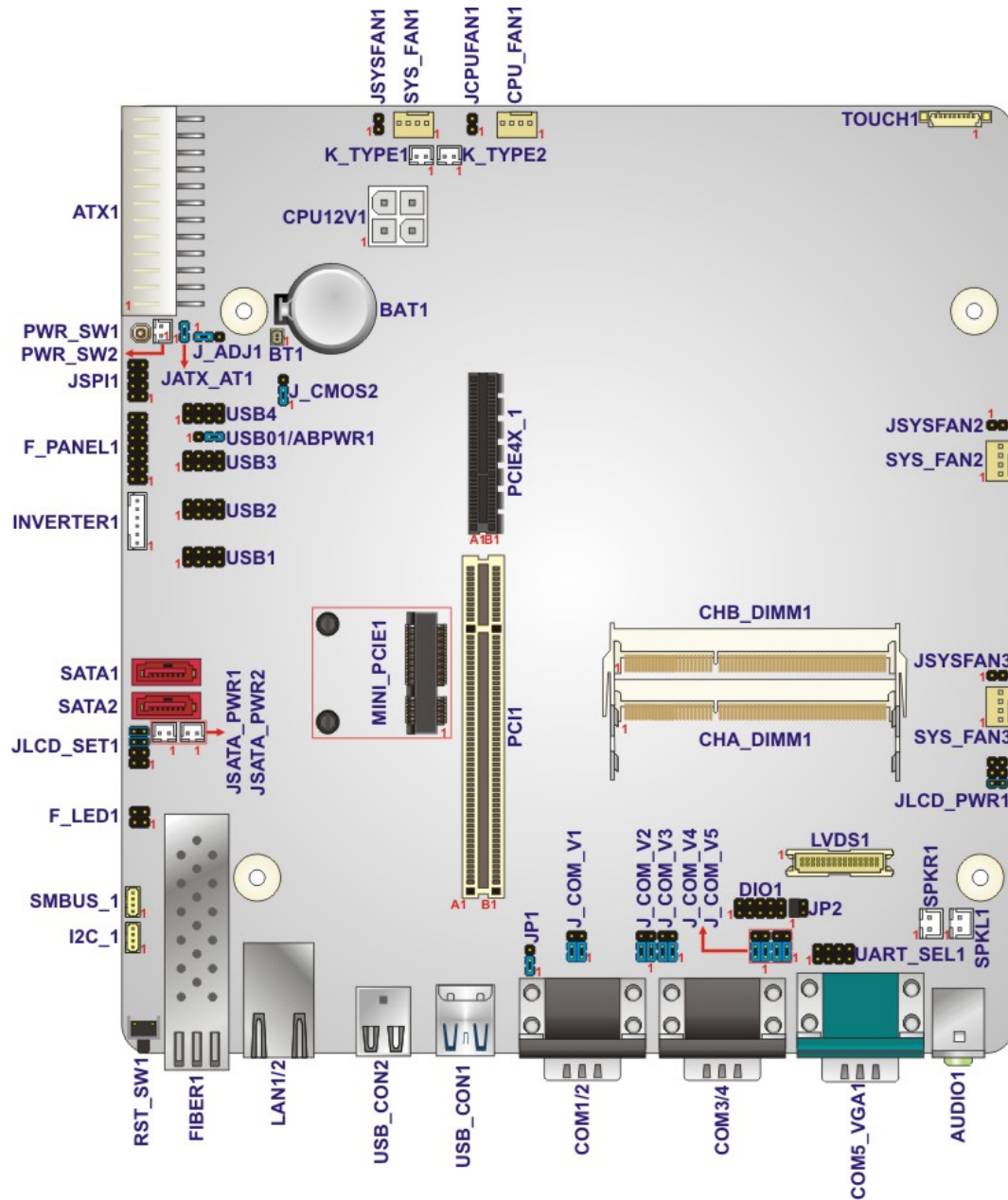

Figure 6-1: Main Board Layout Diagram (Front Side)

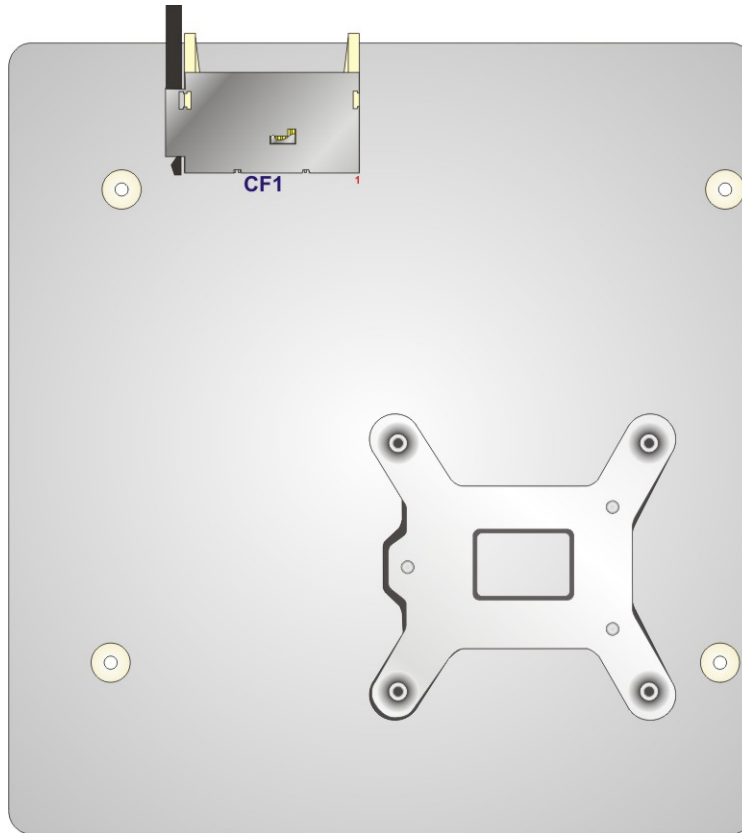

Figure 6-2: Main Board Layout Diagram (Solder Side)

6.2 Internal Peripheral Connectors

Internal peripheral connectors are found on the motherboard and are only accessible when the motherboard is outside of the chassis. The table below shows a list of the peripheral interface connectors on the PPC-51xxA-H61 motherboard. Pinouts of these connectors can be found in the following sections.

Connector	Type	Label
AT/ATX switch connector	2-pin header	JATX_AT1
+12V power source connector	4-pin Molex	CPU12V1
ATX power connector	24-pin ATX	ATX1

PPC-51xxA-H61 Panel PC

Connector	Type	Label
CompactFlash® card slot (solder side)	CF slot	CF1
CMOS state setting connector	3-pin header	J_CMOS2
DIO connector	10-pin header	DIO1
Fan connector (CPU)	4-pin wafer	CPU_FAN1
Fan connector (system 1)	4-pin wafer	SYS_FAN1
Fan connector (system 2)	4-pin wafer	SYS_FAN2
Fan connector (system 3)	4-pin wafer	SYS_FAN3
Front panel connector	14-pin header	F_PANEL1
I2C connector	4-pin wafer	I2C_1
Internal audio connectors	2-pin wafer	SPKL1, SPKR1
Internal power button connector	Push button	PWR_SW1
Internal power button connector	2-pin wafer	PWR_SW2
K type thermocouple connectors	2-pin wafer	K_TYPE1, K_TYPE2
LVDS backlight connector	6-pin wafer	INVERTER1
LVDS connector	30-pin crimp	LVDS1
PCI slot	PCI slot	PCI1
PCIe x4 slot with x1 signal	PCI x4 slot	PCIE4X_1
PCIe Mini card slot (supports mSATA)	PCIe Mini card slot	MINI_PCIE1
SATA 3Gb/s connectors	SATA connector	SATA1, SATA2
SATA power connectors	2-pin wafer	JSATA_PWR1, JSATA_PWR2
SFP fiber LED connector	4-pin header	F_LED1
SMBus connector	4-pin wafer	SMBUS_1
SO-DIMM connectors	SO-DIMM connector	CHA_DIMM1, CHB_DIMM1

Connector	Type	Label
SPI Flash connector	8-pin header	JSPI1
Touch panel connector	9-pin wafer	TOUCH1
USB 2.0 connectors	8-pin header	USB1, USB2, USB3, USB4

Table 6-1: Peripheral Interface Connectors

6.2.1 +12V Power Source Connector (CPU12V1)

PIN NO.	DESCRIPTION
1	GND
2	GND
3	+12V
4	+12V

Table 6-2: +12V Power Source Connector (CPU12V1) Pinouts

6.2.2 ATX Power Connector (ATX1)

PIN NO.	DESCRIPTION	PIN NO.	DESCRIPTION
1	+3.3V	13	+3.3V
2	+3.3V	14	-12V
3	GND	15	GND
4	+5V	16	PS_ON-
5	GND	17	GND
6	+5V	18	GND
7	GND	19	GND
8	NC	20	NC
9	+5V	21	+5V
10	+12V	22	+5V
11	+12V	23	+5V
12	+3.3V	24	GND

Table 6-3: ATX Power Connector (ATX1) Pinouts

6.2.3 CompactFlash® Card Slot (CF1)

PIN NO.	DESCRIPTION	PIN NO.	DESCRIPTION
1	GROUND	26	S_IDE_Detect
2	S_D3	27	S_D11
3	S_D4	28	S_D12
4	S_D5	29	S_D13
5	S_D6	30	S_D14
6	S_D7	31	S_D15
7	S_DCS1#	32	S_DCS3#
8	GROUND	33	GROUND
9	GROUND	34	S_IOR#
10	GROUND	35	S_IOW#
11	GROUND	36	VCC_COM
12	GROUND	37	S_INT
13	VCC_COM	38	VCC_COM
14	GROUND	39	M/S
15	GROUND	40	NC
16	GROUND	41	S_RST
17	GROUND	42	S_IORDY
18	S_DA2	43	S_DRO
19	S_DA1	44	S_DACK#
20	S_DA0	45	SIDE_LED#
21	S_D0	46	S_PCBLID
22	S_D1	47	S_D8
23	S_D2	48	S_D9
24	NC	49	S_D10
25	CFD2	50	GROUND

Table 6-4: CompactFlash® Card Slot (CF1) Pinouts

6.2.4 DIO Connector (DIO1)

PIN NO.	DESCRIPTION	PIN NO.	DESCRIPTION
1	GND	2	VCC
3	Output 3	4	Output 2
5	Output 1	6	Output 0
7	Input 3	8	Input 2
9	Input 1	10	Input 0

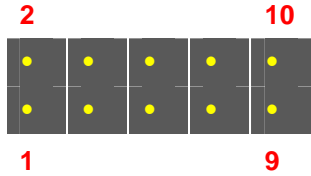

Table 6-5: DIO Connector (DIO1) Pinouts

6.2.5 Fan Connector (CPU_FAN1/SYS_FAN1/SYS_FAN2/SYS_FAN3)

PIN NO.	DESCRIPTION
1	GND
2	+12V
3	SENSE
4	CONTROL

Table 6-6: Fan Connector Pinouts

6.2.6 I2C Connector (I2C_1)

PIN NO.	DESCRIPTION
1	+5V_DUAL
2	PCH_GP38_PU
3	PCH_GP39_PU
4	GND

Table 6-7: Fan Connector (I2C_1) Pinouts

6.2.7 Internal Audio Connector (SPKL1)

PIN NO.	DESCRIPTION
1	LOUT-
2	LOUT+

Table 6-8: Internal Audio Connector (SPKL1) Pinouts

6.2.8 Internal Audio Connector (SPKR1)

PIN NO.	DESCRIPTION
1	ROUT-
2	ROUT+

Table 6-9: Internal Audio Connector (SPKR1) Pinouts

6.2.9 Internal Power Button Connector (PWR_SW1)

PIN NO.	DESCRIPTION
1	PWRBTN_SW#_C
2	PWRBTN_SW#_C
3	GND
4	GND

Table 6-10: Internal Power Button Connector (PWR_SW1) Pinouts

6.2.10 Internal Power Button Connector (PWR_SW2)

PIN NO.	DESCRIPTION
1	PWRBTN_SW#_C
2	GND

Table 6-11: Internal Power Button Connector (PWR_SW2) Pinouts

6.2.11 K Type Thermocouple Connectors (K_TYPE1/K_TYPE2)

PIN NO.	DESCRIPTION
1	D-
2	D+

Table 6-12: K Type Thermocouple Connectors (K_TYPE1/K_TYPE2) Pinouts

6.2.12 LVDS Backlight Connector (INVERTER1)

PIN NO.	DESCRIPTION
1	+12V
2	+12V
3	Backlight ON/OFF
4	Backlight Brightness Control
5	GND
6	GND

Table 6-13: LVDS Backlight Connector (INVERTER1) Pinouts

6.2.13 LVDS Connector (LVDS1)

PIN NO.	DESCRIPTION	PIN NO.	DESCRIPTION
1	GND	2	GND
3	LVDSA0+	4	LVDSA0-
5	LVDSA1+	6	LVDSA1-
7	LVDSA2+	8	LVDSA2-
9	LVDSACLK+	10	LVDSACLK-
11	LVDSA3+	12	N LVDSA3-
13	GND	14	GND
15	LVDSA4+	16	LVDSA4-
17	LVDSA5+	18	LVDSA5-
19	LVDSA6+	20	LVDSA6-
21	LVDSBCLK+	22	LVDSBCLK-

PPC-51xxA-H61 Panel PC

PIN NO.	DESCRIPTION	PIN NO.	DESCRIPTION
23	LVDSA7+	24	LVDSA7-
25	GND	26	GND
27	LCDVCC	28	LCDVCC
29	LCDVCC	30	LCDVCC

Table 6-14: LVDS Connector (LVDS1) Pinouts

6.2.14 PCIe Mini Card Slot (MINI_PCIE1)

PIN NO.	DESCRIPTION	PIN NO.	DESCRIPTION
1	WAKE#	2	3.3 V
3	RESERVED	4	GND
5	RESERVED	6	1.5 V
7	CLKREQ#	8	N/C
9	GND	10	N/C
11	REFCLK-	12	N/C
13	REFCLK+	14	N/C
15	GND	16	N/C
17	N/C	18	GND
19	N/C	20	W_DISABLE#
21	GND	22	PERST#
23	PERn0	24	3.3VAUX
25	PERp0	26	GND
27	GND	28	1.5 V
29	GND	30	SMBCLK
31	PETn0	32	SMBDATA
33	PETp0	34	GND
35	GND	36	USBD-
37	RESERVED	38	USBD+
39	RESERVED	40	GND
41	RESERVED	42	LED_WWAN#
43	RESERVED	44	LED_WLAN#
45	RESERVED	46	LED_WPAN#

PIN NO.	DESCRIPTION	PIN NO.	DESCRIPTION
47	RESERVED	48	1.5 V
49	RESERVED	50	GND
51	RESERVED	52	3.3 V

Table 6-15: PCIe Mini Card Slot (MINI_PCIE1) Pinouts

6.2.15 SATA 3Gb/s Connectors (SATA1/SATA2)

PIN NO.	DESCRIPTION
1	GND
2	SATATXP
3	SATATXN
4	GND
5	SATARXN
6	SATARXP
7	GND

Table 6-16: SATA 3Gb/s Connectors (SATA1/SATA2) Pinouts

6.2.16 SATA Power Connectors (JSATA_PWR1/JSATA_PWR2)

PIN NO.	DESCRIPTION
1	+5V
2	GND

Table 6-17: SATA Power Connectors (JSATA_PWR1/JSATA_PWR2) Pinouts

6.2.17 SFP Fiber LED Connector (F_LED1)

PIN NO.	DESCRIPTION
1	FIBER0_LED-
2	FIBER0_LED+
3	FIBER1_LED-
4	FIBER1_LED+

Table 6-18: SATA Power Connectors (JSATA_PWR1/JSATA_PWR2 Pinouts)

6.2.18 SMBus Connector (SMBUS_1)

PIN NO.	DESCRIPTION
1	+5V_DUAL
2	SMBCLK
3	SMBDATA
4	GND

Table 6-19: SMBus Connector (SMBUS_1) Pinouts

6.2.19 SPI Flash Connector (JSPI1)

PIN NO.	DESCRIPTION	PIN NO.	DESCRIPTION
1	SPI_VCC	2	GND
3	SPI_CSO	4	SPI_CLK0
5	SPI_SO0	6	SPI_SIO
7	NC	8	NC

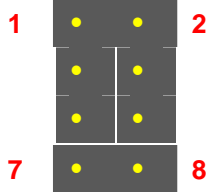

Table 6-20: SPI Flash Connector (JSPI1) Pinouts

6.2.20 Touch Panel Connector (TOUCH1)

PIN NO.	8-Wire	4-Wire	5-Wire
1	Right Sense	N/A	N/A
2	Left Sense	N/A	N/A
3	Bottom Sense	N/A	N/A
4	Top Sense	N/A	Sense (S)
5	Right Excite	Right	LR (X)
6	Left Excite	Left	LL (L)
7	Bottom Excite	Bottom	UR (Y)
8	Top Excite	Top	UL (Y)
9	GND	GND	GND

Table 6-21: Touch Panel Connector (TOUCH1) Pinouts

6.2.21 USB 2.0 Connectors (USB1/USB2/USB3/USB4)

PIN NO.	DESCRIPTION	PIN NO.	DESCRIPTION
1	VCC	2	GND
3	DATA-	4	DATA+
5	DATA+	6	DATA-
7	GND	8	VCC

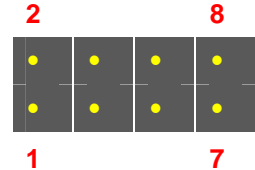

Table 6-22: USB 2.0 Connector (USB1/USB2/USB3/USB4) Pinouts

6.3 External Interface Panel Connectors

The table below lists the rear panel connectors on the PPC-51xxA-H61 motherboard. Pinouts of these connectors can be found in the following sections.

Connector	Type	Label
Audio connector (line-out and mic-in)	Audio jack	AUDIO1
RJ-45 LAN connectors	RJ-45	LAN1/2
Reset button	Push button	RST_SW1

PPC-51xxA-H61 Panel PC

Connector	Type	Label
RS-232 serial ports	DB-9	COM1/2, COM3/4
SFP fiber LAN connectors	SFP fiber	FIBER1
USB 2.0 connectors	USB 2.0 port	USB_CON2
USB 3.0 connectors	USB 3.0 port	USB_CON1
VGA and RS-232/422/485 serial port connector	15-pin female, DB-9	COM5_VGA1

Table 6-23: Rear Panel Connectors

6.3.1 RJ-45 LAN Connector (LAN1/2)

PIN NO.	DESCRIPTION	PIN NO.	DESCRIPTION
1	MDIA3-	2	MDIA3+
3	MDIA2-	4	MDIA1-
5	MDIA1+	6	MDIA2+
7	MDIA0-	8	MDIA0+

Table 6-24: RJ-45 LAN Connector Pinouts

6.3.2 RS-232 Serial Ports (COM1/2, COM3/4)

PIN NO.	DESCRIPTION	PIN NO.	DESCRIPTION
1	DCD	2	RXD
3	TXD	4	DTR
5	GND	6	DSR
7	RTS	8	CTS
9	RI		

Table 6-25: RS-232 Serial Port Pinouts

6.3.3 RS-232/422/485 Serial Port (COM5)

PIN NO.	RS-232	RS-422	RS-485
1	-NDCD	TXD422#	TXD485#
2	NSIN	TXD422+	TXD485+
3	NSOUT	RXD422+	
4	-NDTR	RXD422#	
5	GND		
6	-NDSR		
7	-NRTS		
8	-NCTS		
9	COMPIN9		

Table 6-26: RS-232/422/485 Serial Port Pinouts

6.3.4 USB 2.0 Connectors (USB_CON2)

PIN NO.	DESCRIPTION
1	VCC
2	DATA-
3	DATA+
4	GND

Table 6-27: USB 2.0 Connectors (USB_CON2) Pinouts

6.3.5 USB 3.0 Connectors (USB_CON1)

PIN NO.	DESCRIPTION	PIN NO.	DESCRIPTION
1	USB3_PWR1	10	USB3_PWR2
2	USB2P0_DM1	11	USB2P0_DM2
3	USB2P0_DP1	12	USB2P0_DP2
4	GND	13	GND
5	USB3P0_RXDN1	14	USB3P0_RXDN2
6	USB3P0_RXDP1	15	USB3P0_RXDP2
7	GND	16	GND

PPC-51xxA-H61 Panel PC

8	USB3P0_TXDN1	17	USB3P0_TXDN2
9	USB3P0_TXDP1	18	USB3P0_TXDP2

Table 6-28: USB 3.0 Connectors (USB_CON1) Pinouts

6.3.6 VGA Connector (VGA1)

PIN NO.	DESCRIPTION	PIN NO.	DESCRIPTION
1	RED	9	5V
2	GREEN	10	GROUND
3	BLUE	11	NC
4	NC	12	DDCDAT
5	GROUND	13	HSYNC
6	GROUND	14	VSYNC
7	GROUND	15	DDCCLK
8	GROUND		

Table 6-29: VGA Connector (VGA1) Pinouts

6.4 Preconfigured Jumper Settings

The following jumpers are preconfigured for the PPC-51xxA-H61. Users should not change these jumpers (**Table 6-30**). It is only for reference.

Jumper Name	Label	Type
CF card power selection	JP1	3-pin header
CPU fan type selection	JCPUFAN1	3-pin header
Inverter brightness voltage selection	J_ADJ1	3-pin header
LCD power selection	JLCD_PWR1	6-pin header
Panel type and resolution selection	JLCD_SET1	8-pin header
Pull high/low selection (for RS-422/485 only)	UART_SEL1	8-pin header

System fan type selection	JSYSFAN1, JSYSFAN3	3-pin header
Touchscreen selection	JTOUCH1	4-pin header
USB1 ~ USB4 power selection	USBAB_PWR1, USB01_PWR1, USB23_PWR1, USB45_PWR1	3-pin header

Table 6-30: Preconfigured Jumpers

6.4.1 CF Card Power Selection Jumper (JP1)

Pin	Description
Short 1-2	+5 V (Default)
Short 2-3	+3.3 V

Table 6-31: CF Card Power Selection Jumper (JP1) Settings

6.4.2 CPU Fan Type Selection Jumper (JCPUFAN1)

Pin	Description
Open	4-pin Fan (Default)
Short 2-3	3-pin Fan

Table 6-32: CPU Fan Type Selection Jumper (JCPUFAN1) Settings

6.4.3 Inverter Brightness Voltage Selection Jumper (J_ADJ1)

Pin	Description
Short 1-2	+5 V (Default)
Short 2-3	+3.3 V

Table 6-33: Inverter Brightness Voltage Selection Jumper (J_ADJ1) Settings

6.4.4 LCD Power Selection Jumper (JLCD_PWR1)

Pin	Description
Short 1-2	+3.3V (Default)
Short 3-4	+5 V
Short 5-6	+12 V

Table 6-34: LCD Power Selection Jumper (JLCD_PWR1) Settings

6.4.5 Panel Type and Resolution Selection Jumper (JLCD_SET1)

Resolution	Pin 3-4	Pin 1-2
1280x1024, 48 bits	Short	Short
1280x1024, 36 bits	Short	Open
1024x768, 18 bits	Open	Short
1024x768, 24 bits	Open	Open

Panel Type	Pin 7-8	Pin 5-6
CRT+LCD	Short	Short
LCD	Short	Open
CRT	Open	Short
AUTO	Open	Open

Table 6-35: Panel Type and Resolution Selection Jumper (JLCD_SET1) Settings

6.4.6 Pull High/Low Selection (for RS-422/485 only) Jumper (UART_SEL1)

Pin	Description
Short 1-2	2.2K Pull Low
Short 3-4	2.2K Pull High
Short 5-6	2.2K Pull High
Short 7-8	2.2K Pull Low

Table 6-36: Pull High/Low Selection (for RS-422/485 only) Jumper (UART_SEL1) Settings

6.4.7 System Fan Type Selection Jumper (JSYSFAN1/JSYSFAN3)

Pin	Description
Open	4-pin Fan (Default)
Short 2-3	3-pin Fan

Table 6-37: System Fan Type Selection Jumper Settings

6.4.8 Touchscreen Selection Jumper (JTOUCH1)

Type	Pin 1-2	Pin 3-4
5-Wire (Default)	Short	Open
4-Wire and 8-Wire	Open	Short

Table 6-38: Touchscreen Selection Jumper (JTOUCH1) Settings

6.4.9 USB1~USB4 Power Selection Jumpers

Pin	Description
Short 1-2	+5V_DUAL
Short 2-3	+5V (Default)

Table 6-39: USB1~USB4 Power Selection Jumpers Settings

Appendix

A

BIOS Configuration Options

A.1 BIOS Configuration Options

Below is a list of BIOS configuration options described in **Chapter 0**.

BIOS Information	74
System Date [xx/xx/xx]	75
System Time [xx:xx:xx]	75
ACPI Sleep State [S1 only (CPU Stop Clock)]	76
Wake system with Fixed Time [Disabled]	77
Intel Virtualization Technology [Disabled]	79
SATA Controller(s) [Enabled]	80
SATA Mode Selection [IDE]	80
USB Devices	81
Legacy USB Support [Enabled]	81
Serial Port [Enabled]	83
Change Settings [Auto]	83
Serial Port [Enabled]	84
Change Settings [Auto]	84
Serial Port [Enabled]	85
Change Settings [Auto]	85
Serial Port [Enabled]	86
Change Settings [Auto]	86
Serial Port [Enabled]	86
Device Mode [Normal]	87
Change Settings [Auto]	87
PC Health Status	88
CPU_FAN1/SYS_FAN2/SYS_FAN3 Smart Fan Control [Auto by RPM]	89
CPU Temperature n/System Temperature n/Temperature n	90
Duty Cycle n	90
Console Redirection [Disabled]	90
Terminal Type [ANSI]	91
Bits per second [115200]	92
Data Bits [8]	92
Parity [None]	92
Stop Bits [1]	93

PPC-51xxA-H61 Panel PC

Restore AC Power Loss [Last State]	94
Power Saving Function(ERP) [Disabled].....	94
Azalia [Enabled]	95
Primary Display [Auto]	97
DVMT Pre-Allocated [128M]	97
DVMT Total Gfx Mem [MAX].....	98
Bootup NumLock State [On].....	100
Quiet Boot [Enabled]	100
Option ROM Messages [Force BIOS].....	100
Launch PXE OpROM [Disabled]	101
Administrator Password	101
User Password	101
Save Changes and Reset	102
Discard Changes and Reset	102
Restore Defaults	102
Save as User Defaults	102
Restore User Defaults	103

Appendix

B

One Key Recovery

B.1 One Key Recovery Introduction

The IEI one key recovery is an easy-to-use front end for the Norton Ghost system backup and recovery tool. This tool provides quick and easy shortcuts for creating a backup and reverting to that backup or reverting to the factory default settings.



NOTE:

The latest One Key Recovery software provides an auto recovery function that allows a system running Microsoft Windows OS to automatically restore from the factory default image after encountering a Blue Screen of Death (BSoD) or a hang for around 10 minutes. Please refer to Section B.3 for the detailed setup procedure.

The IEI One Key Recovery tool menu is shown below.

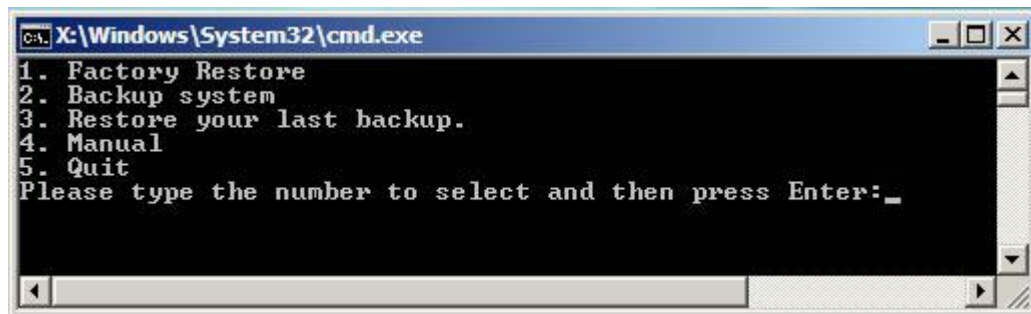

Figure B-1: IEI One Key Recovery Tool Menu

Prior to using the IEI One Key Recovery tool (as shown in **Figure B-1**) to backup or restore Windows system, five setup procedures are required.

1. Hardware and BIOS setup (see **Section B.2.1**)
2. Create partitions (see **Section B.2.2**)
3. Install operating system, drivers and system applications (see **Section B.2.3**)
4. Build the recovery partition (see **Section B.2.4**)
5. Create factory default image (see **Section B.2.5**)

After completing the five initial setup procedures as described above, users can access the recovery tool by pressing <F3> while booting up the system. The detailed information of each function is described in **Section B.5**.

**NOTE:**

The initial setup procedures for Linux system are described in **Section B.3**.

B.1.1 System Requirement

**NOTE:**

The recovery CD can only be used with IEI products. The software will fail to run and a warning message will appear when used on non-IEI hardware.

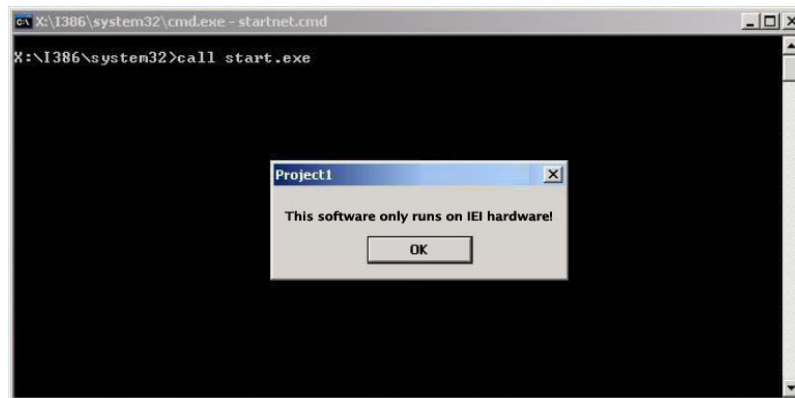

To create the system backup, the main storage device must be split into two partitions (three partitions for Linux). The first partition will be for the operating system, while the second partition will be invisible to the operating system and contain the backup made by the one key recovery software.

The partition created for recovery images must be big enough to contain both the factory default image and the user backup image. The size must be calculated before creating the

PPC-51xxA-H61 Panel PC

partitions. Please take the following table as a reference when calculating the size of the partition.

	OS	OS Image after Ghost	Compression Ratio
Windows® 7	7 GB	5 GB	70%
Windows® XPE	776 MB	560 MB	70%
Windows® CE 6.0	36 MB	28 MB	77%



NOTE:

Specialized tools are required to change the partition size if the operating system is already installed.

B.1.2 Supported Operating System

The recovery CD is compatible with both Microsoft Windows and Linux operating systems (OS). The supported OS versions are listed below.

- Microsoft Windows
 - Windows XP (Service Pack 2 or 3 required)
 - Windows Vista
 - Windows 7
 - Windows CE 5.0
 - Windows CE 6.0
 - Windows XP Embedded
- Linux
 - Fedora Core 12 (Constantine)
 - Fedora Core 11 (Leonidas)
 - Fedora Core 10 (Cambridge)
 - Fedora Core 8 (Werewolf)
 - Fedora Core 7 (Moonshine)
 - RedHat RHEL-5.4
 - RedHat 9 (Ghirke)

- Ubuntu 8.10 (Intrepid)
- Ubuntu 7.10 (Gutsy)
- Ubuntu 6.10 (Edgy)
- Debian 5.0 (Lenny)
- Debian 4.0 (Etch)
- SuSe 11.2
- SuSe 10.3

**NOTE:**

Installing unsupported OS versions may cause the recovery tool to fail.

B.2 Setup Procedure for Windows

Prior to using the recovery tool to backup or restore, a few setup procedures are required.

- Step 1:** Hardware and BIOS setup (see **Section B.2.1**)
- Step 2:** Create partitions (see **Section B.2.2**)
- Step 3:** Install operating system, drivers and system applications (see **Section B.2.3**)
- Step 4:** Build the recovery partition (see **Section B.2.4**) or build the auto recovery partition (see **Section B.3**)
- Step 5:** Create factory default image (see **Section B.2.5**)

The detailed descriptions are described in the following sections.

**NOTE:**

The setup procedures described below are for Microsoft Windows operating system users. For Linux, most of the setup procedures are the same except for several steps described in **Section B.3**.

PPC-51xxA-H61 Panel PC

B.2.1 Hardware and BIOS Setup

- Step 1:** Make sure the system is powered off and unplugged.
- Step 2:** Install a hard drive or SSD in the system. An unformatted and unpartitioned disk is recommended.
- Step 3:** Connect an optical disk drive to the system and insert the recovery CD.
- Step 4:** Turn on the system.
- Step 5:** Press the <DELETE> key as soon as the system is turned on to enter the BIOS.
- Step 6:** Select the connected optical disk drive as the 1st boot device. (**Boot → Boot Device Priority → 1st Boot Device**).
- Step 7:** Save changes and restart the computer. Continue to the next section for instructions on partitioning the internal storage.

B.2.2 Create Partitions

To create the system backup, the main storage device must be split into two partitions (three partitions for Linux). The first partition will be for the operating system, while the second partition will be invisible to the operating system and contain the backup made by the one key recovery software.

- Step 1:** Put the recovery CD in the optical drive of the system.
- Step 2:** **Boot the system from recovery CD.** When prompted, press any key to boot from the recovery CD. It will take a while to launch the recovery tool. Please be patient!

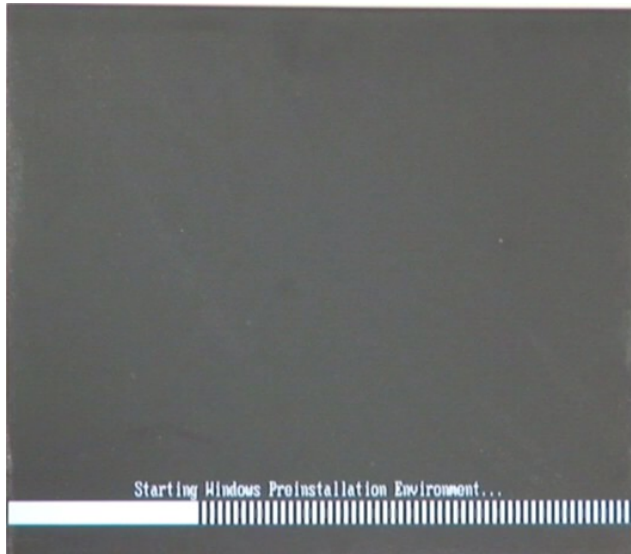

Figure B-2: Launching the Recovery Tool

Step 3: The recovery tool setup menu is shown as below.

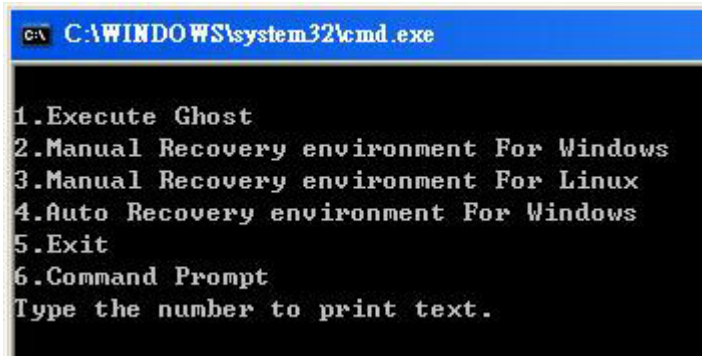
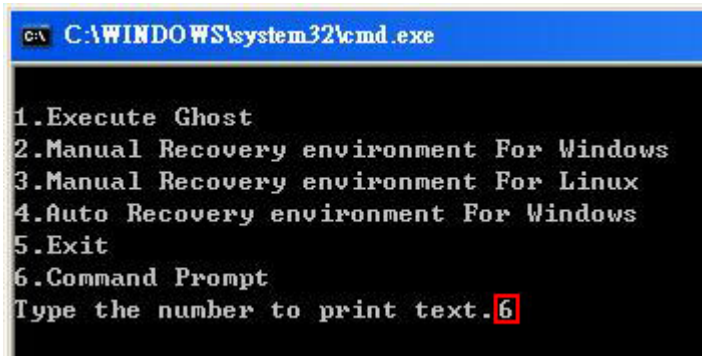

Figure B-3: Recovery Tool Setup Menu

Step 4: Press <6> then <Enter>.

PPC-51xxA-H61 Panel PC



```
C:\WINDOWS\system32\cmd.exe

1.Execute Ghost
2.Manual Recovery environment For Windows
3.Manual Recovery environment For Linux
4.Auto Recovery environment For Windows
5.Exit
6.Command Prompt
Type the number to print text.6
```

Figure B-4: Command Prompt

Step 5: The command prompt window appears. Type the following commands (marked in red) to create two partitions. One is for the OS installation; the other is for saving recovery files and images which will be an invisible partition. (Press <Enter> after entering each line below)

```
system32>diskpart
DISKPART>list vol
DISKPART>sel disk 0
DISKPART>create part pri size= ____
DISKPART>assign letter=N
DISKPART>create part pri size= ____
DISKPART>assign letter=F
DISKPART>exit
system32>format N: /fs:ntfs /q /y
system32>format F: /fs:ntfs /q /v:Recovery /y
system32>exit
```

```

X:\I386\SYSTEM32\CMD.EXE
X:\I386\SYSTEM32>diskpart → Starts the Microsoft disk partitioning tool.
Microsoft DiskPart version 5.2.3790.1830
Copyright (C) 1999-2001 Microsoft Corporation.
On computer: MININT-JUC

DISKPART> list vol → Show partition information

   Volume ###  Ltr  Label          Fs          Type          Size         Status       Info
   -----
   Volume 0          X  CD_ROM         CDFS        DUD-ROM       405 MB       Healthy      Boot
   Volume 1          D                FAT32      Removeable   3854 MB       Healthy

DISKPART> sel disk 0 → Select a disk
Disk 0 is now the selected disk.

DISKPART> create part pri size=2000 → Create partition 1 and assign a size.
                                     This partition is for OS installation.
DiskPart succeeded in creating the specified partition.

DISKPART> assign letter=N → Assign partition 1 a code name (N).
DiskPart successfully assigned the drive letter or mount point.

DISKPART> create part pri size=1800 → Create partition 2 and assign a size.
                                     This partition is for recovery images.
DiskPart succeeded in creating the specified partition.

DISKPART> assign letter=F → Assign partition 2 a code name (F).
DiskPart successfully assigned the drive letter or mount point.

DISKPART> exit → Exit diskpart

X:\I386\SYSTEM32>format n: /fs:ntfs /q /y → Format partition 1 (N) as NTFS format.
The type of the file system is RAW.
The new file system is NTFS.
QuickFormatting 2000M
Creating file system structures.
Format complete.
 2048254 KB total disk space.
 2035620 KB are available.

X:\I386\SYSTEM32>format f: /fs:ntfs /q /v:Recovery /y
The type of the file system is RAW.
The new file system is NTFS.
QuickFormatting 1804M
Creating file system structures.
Format complete.
 1847474 KB total disk space.
 1835860 KB are available.

X:\I386\SYSTEM32>exit → Exit Windows PE
  
```

Figure B-5: Partition Creation Commands



NOTE:

Use the following commands to check if the partitions were created successfully.

```
X:\I386\SYSTEM32>diskpart
Microsoft DiskPart version 5.2.3790.1830
Copyright (C) 1999-2001 Microsoft Corporation.
On computer: MININT-JUC
DISKPART> sel disk 0
Disk 0 is now the selected disk.
DISKPART> list part
  Partition ###  Type              Size              Offset
-----
  Partition 1    Primary           2000 MB           32 KB
  Partition 2    Primary           1804 MB          2000 MB
DISKPART> exit
```

Step 6: Press any key to exit the recovery tool and automatically reboot the system.

Please continue to the following procedure: Build the Recovery Partition.

B.2.3 Install Operating System, Drivers and Applications

Install the operating system onto the unlabelled partition. The partition labeled "Recovery" is for use by the system recovery tool and should not be used for installing the operating system or any applications.



NOTE:

The operating system installation program may offer to reformat the chosen partition. DO NOT format the partition again. The partition has already been formatted and is ready for installing the new operating system.

To install the operating system, insert the operating system installation CD into the optical drive. Restart the computer and follow the installation instructions.

B.2.4 Building the Recovery Partition

- Step 1:** Put the recover CD in the optical drive.
- Step 2:** Start the system.
- Step 3:** **Boot the system from the recovery CD.** When prompted, press any key to boot from the recovery CD. It will take a while to launch the recovery tool. Please be patient!

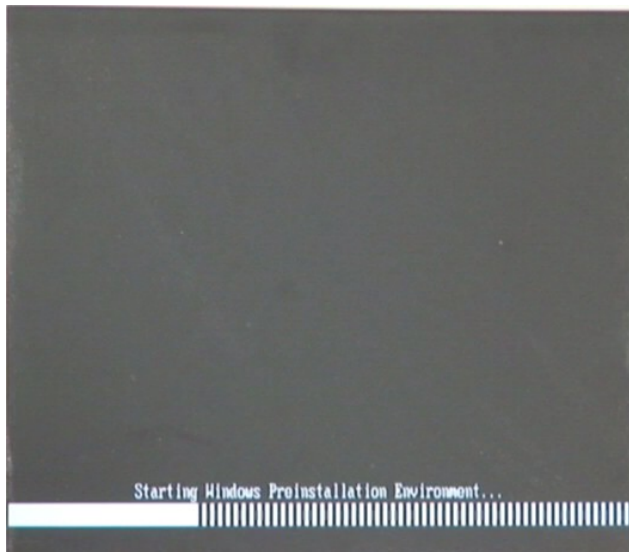

Figure B-6: Launching the Recovery Tool

- Step 4:** When the recovery tool setup menu appears, press <2> then <Enter>.

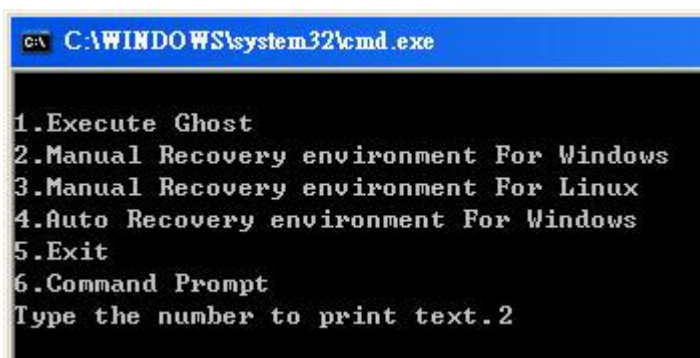

Figure B-7: Manual Recovery Environment for Windows

PPC-51xxA-H61 Panel PC

Step 5: The Symantec Ghost window appears and starts configuring the system to build a recovery partition. In this process the partition created for recovery files in **Section B.2.2** is hidden and the recovery tool is saved in this partition.

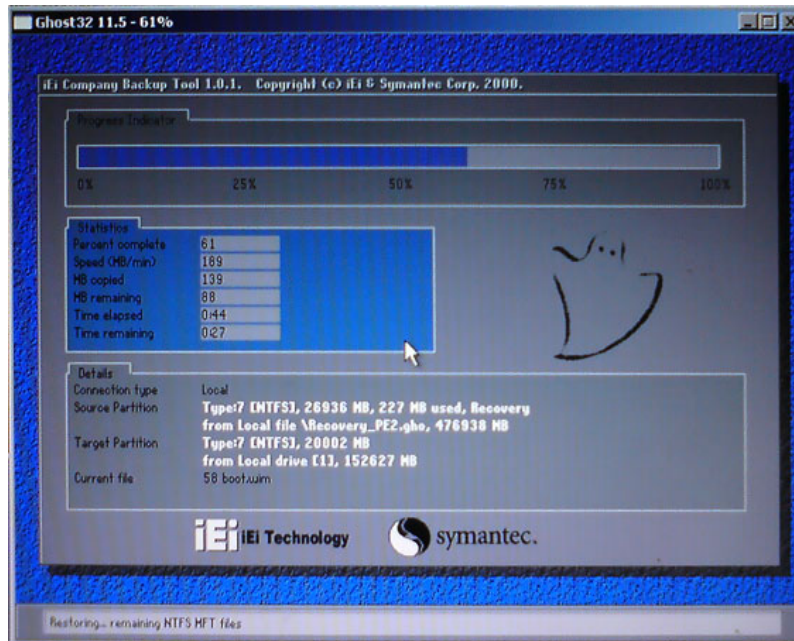

Figure B-8: Building the Recovery Partition

Step 6: After completing the system configuration, press any key in the following window to reboot the system.

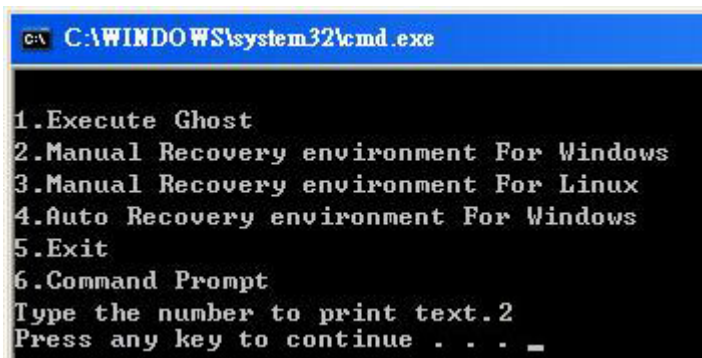

Figure B-9: Press Any Key to Continue

Step 7: Eject the recovery CD.

B.2.5 Create Factory Default Image



NOTE:

Before creating the factory default image, please configure the system to a factory default environment, including driver and application installations.

To create a factory default image, please follow the steps below.

Step 1: Turn on the system. When the following screen displays (**Figure B-10**), press the <F3> key to access the recovery tool. The message will display for 10 seconds, please press F3 before the system boots into the operating system.

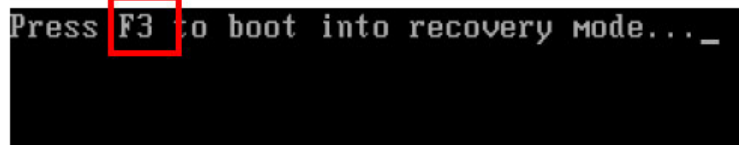

Figure B-10: Press F3 to Boot into Recovery Mode

Step 2: The recovery tool menu appears. Type <4> and press <Enter>. (**Figure B-11**)

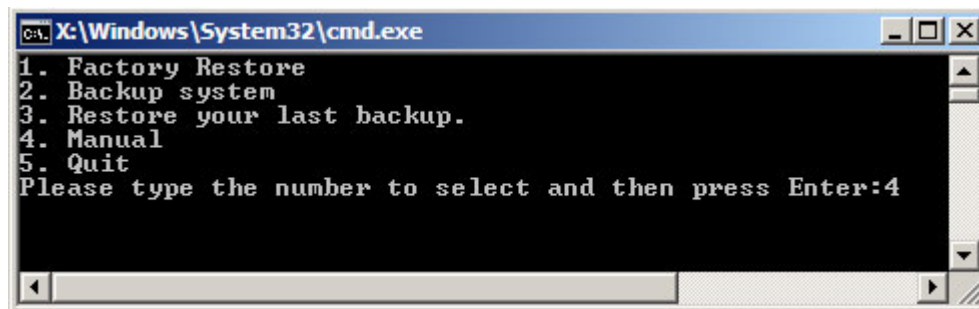

Figure B-11: Recovery Tool Menu

Step 3: The About Symantec Ghost window appears. Click **OK** button to continue.

PPC-51xxA-H61 Panel PC

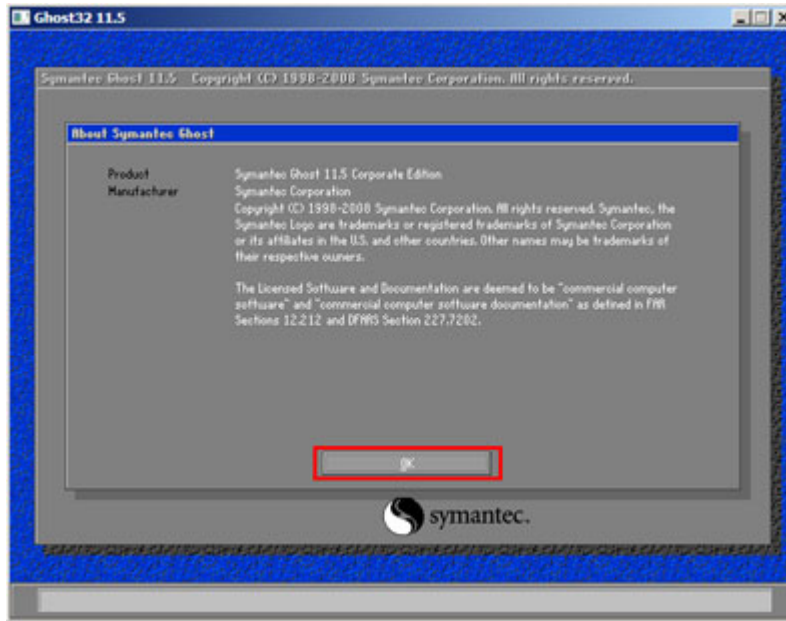

Figure B-12: About Symantec Ghost Window

Step 4: Use mouse to navigate to the option shown below (Figure B-13).

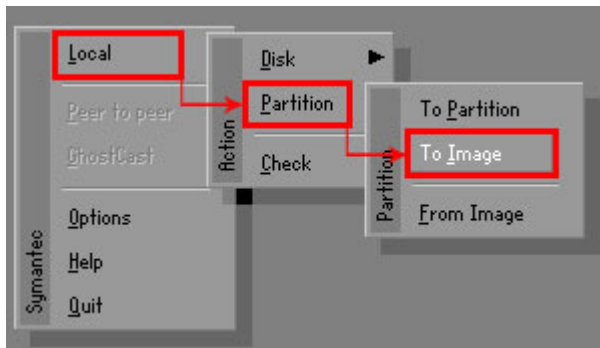

Figure B-13: Symantec Ghost Path

Step 5: Select the local source drive (Drive 1) as shown in Figure B-14. Then click OK.

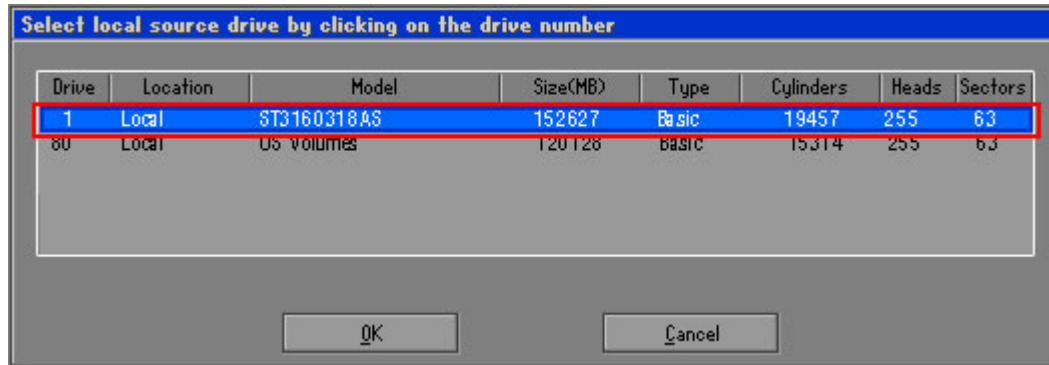

Figure B-14: Select a Local Source Drive

Step 6: Select a source partition (Part 1) from basic drive as shown in **Figure B-15**. Then click OK.

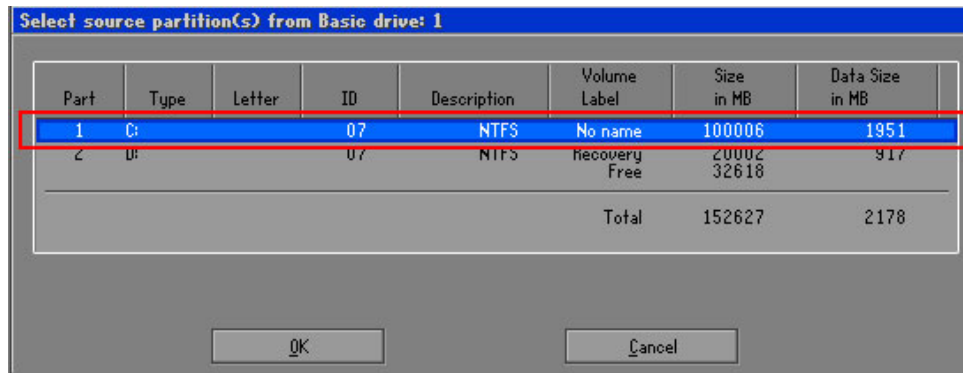

Figure B-15: Select a Source Partition from Basic Drive

Step 7: Select **1.2: [Recovery] NTFS drive** and enter a file name called **iei** (**Figure B-16**). Click **Save**. The factory default image will then be saved in the selected recovery drive and named **IEI.GHO**.



WARNING:

The file name of the factory default image must be **iei.GHO**.

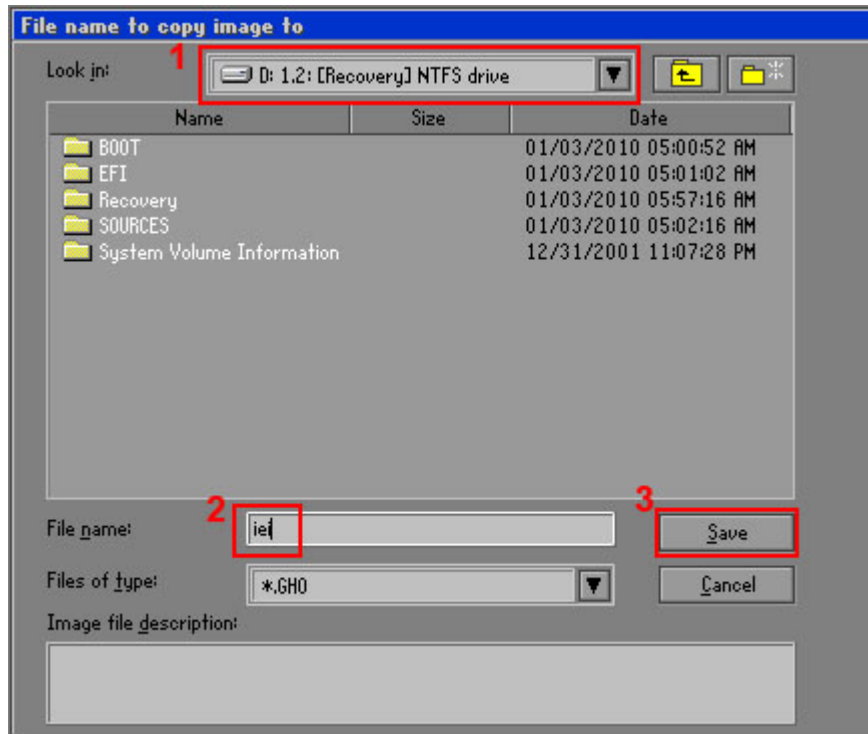

Figure B-16: File Name to Copy Image to

Step 8: When the Compress Image screen in **Figure B-17** prompts, click **High** to make the image file smaller.

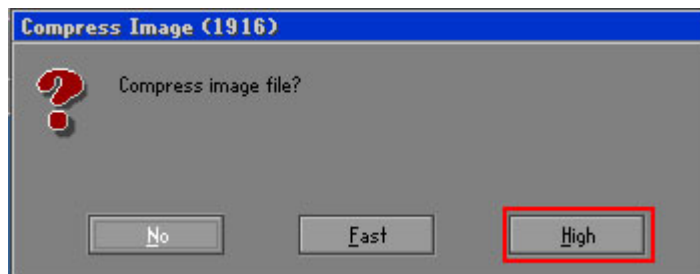

Figure B-17: Compress Image

Step 9: The Proceed with partition image creation window appears, click **Yes** to continue.

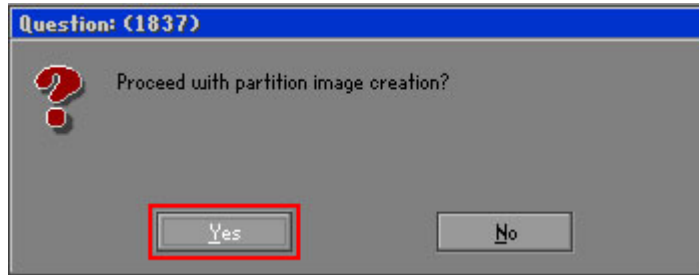

Figure B-18: Image Creation Confirmation

Step 10: The Symantec Ghost starts to create the factory default image (**Figure B-19**).

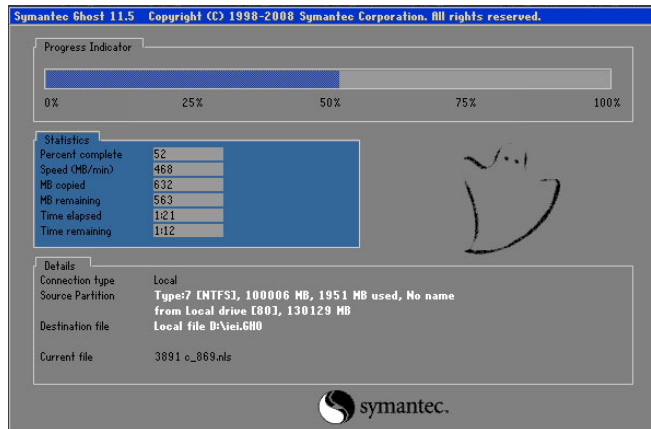

Figure B-19: Image Creation Complete

Step 11: When the image creation completes, a screen prompts as shown in **Figure B-20**.

Click **Continue** and close the Ghost window to exit the program.

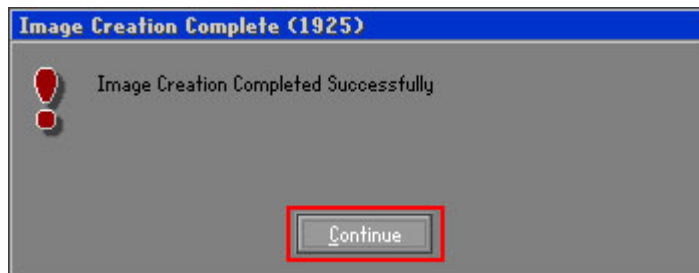
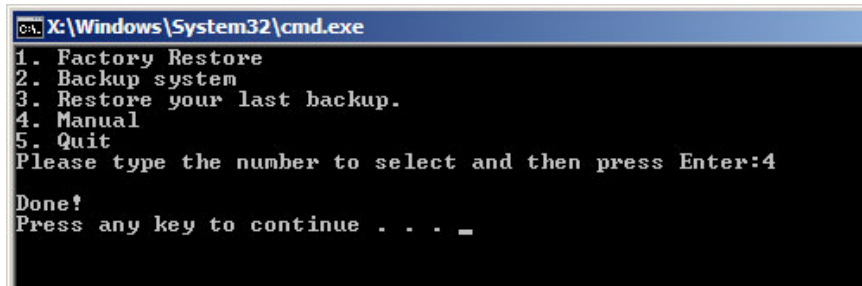

Figure B-20: Image Creation Complete

PPC-51xxA-H61 Panel PC

Step 12: The recovery tool main menu window is shown as below. Press any key to reboot the system.



```
C:\Windows\System32\cmd.exe
1. Factory Restore
2. Backup system
3. Restore your last backup.
4. Manual
5. Quit
Please type the number to select and then press Enter:4
Done!
Press any key to continue . . . _
```

Figure B-21: Press Any Key to Continue

B.3 Auto Recovery Setup Procedure

The auto recovery function allows a system to automatically restore from the factory default image after encountering a Blue Screen of Death (BSoD) or a hang for around 10 minutes. To use the auto recovery function, follow the steps described in the following sections.



CAUTION:

The setup procedure may include a step to create a factory default image. It is suggested to configure the system to a factory default environment before the configuration, including driver and application installations.

Step 1: Follow the steps described in **Section B.2.1 ~ Section B.2.3** to setup BIOS, create partitions and install operating system.

Step 2: Install the auto recovery utility into the system by double clicking the **Utility/AUTORECOVERY-SETUP.exe** in the One Key Recovery CD. This utility **MUST** be installed in the system, otherwise, the system will automatically restore from the factory default image every ten (10) minutes.



Figure B-22: Auto Recovery Utility

Step 3: Reboot the system from the recovery CD. When prompted, press any key to boot from the recovery CD. It will take a while to launch the recovery tool. Please be patient!

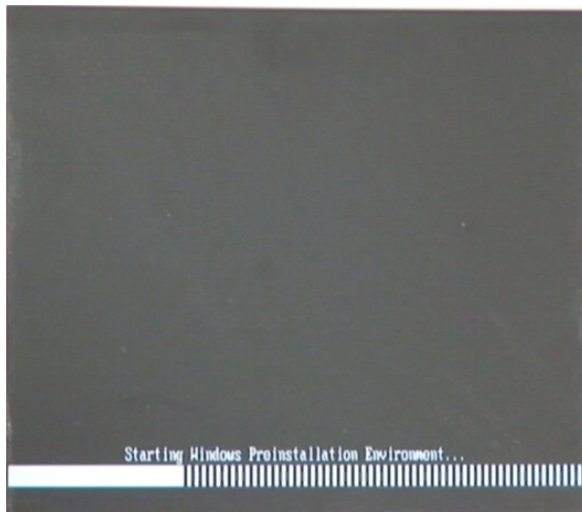

Figure B-23: Launching the Recovery Tool

Step 4: When the recovery tool setup menu appears, press <4> then <Enter>.

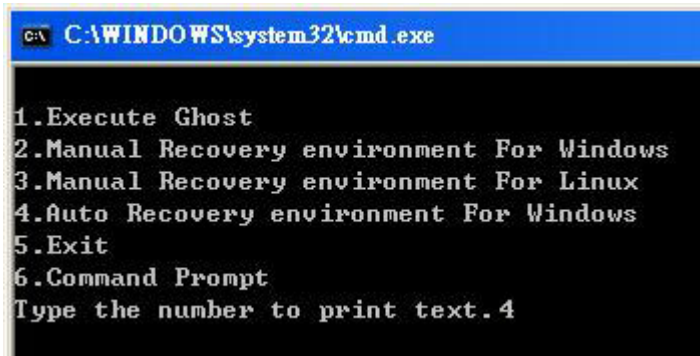

Figure B-24: Auto Recovery Environment for Windows

PPC-51xxA-H61 Panel PC

Step 5: The Symantec Ghost window appears and starts configuring the system to build an auto recovery partition. In this process the partition created for recovery files in **Section B.2.2** is hidden and the auto recovery tool is saved in this partition.

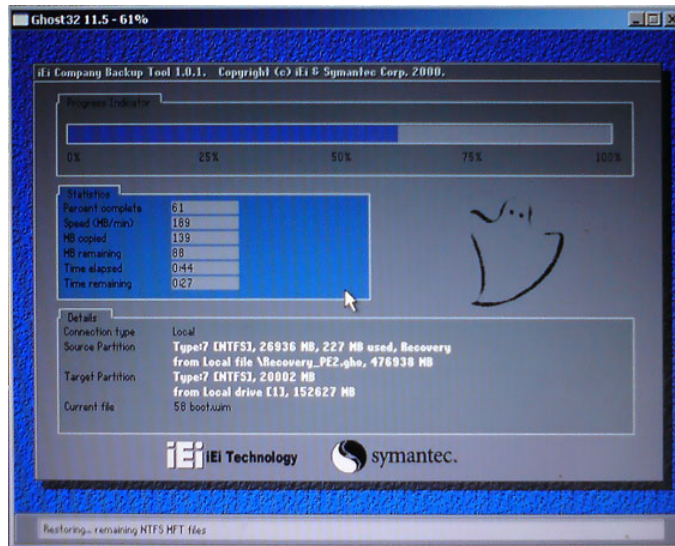

Figure B-25: Building the Auto Recovery Partition

Step 6: After completing the system configuration, the following message prompts to confirm whether to create a factory default image. Type **Y** to have the system create a factory default image automatically. Type **N** within 6 seconds to skip this process (The default option is YES). It is suggested to choose YES for this option.



Figure B-26: Factory Default Image Confirmation

Step 7: The Symantec Ghost starts to create the factory default image (Figure B-27).

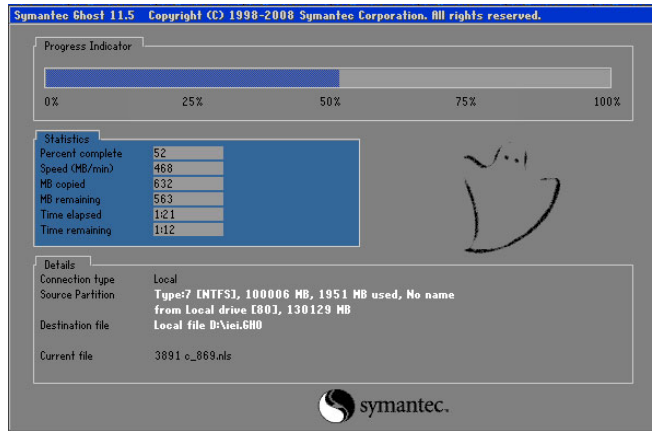

Figure B-27: Image Creation Complete

Step 8: After completing the system configuration, press any key in the following window to restart the system.

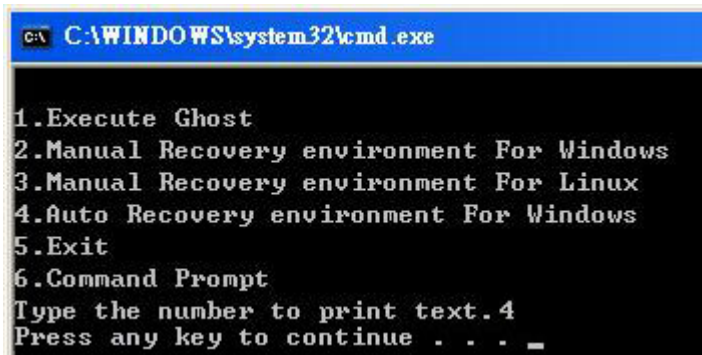

Figure B-28: Press any key to continue

Step 9: Eject the One Key Recovery CD and restart the system.

Step 10: Press the <DELETE> key as soon as the system is turned on to enter the BIOS.

Step 11: Enable the Auto Recovery Function option (**Advanced** → **iEi Feature** → **Auto Recovery Function**).

PPC-51xxA-H61 Panel PC

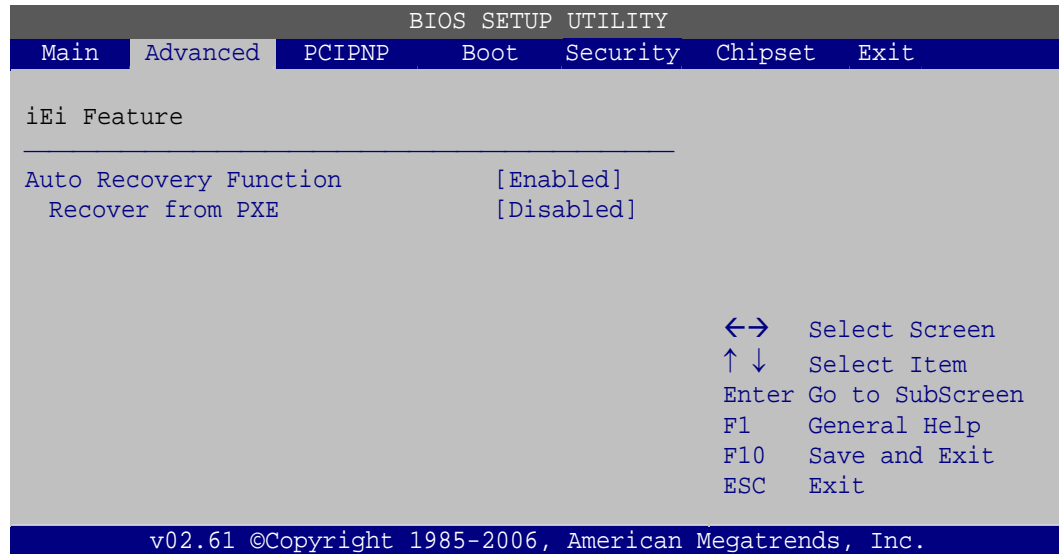

BIOS Menu 24: IEI Feature

Step 12: Save changes and restart the system. If the system encounters a Blue Screen of Death (BSoD) or a hang for around 10 minutes, it will automatically restore from the factory default image.



CAUTION:

The auto recovery function can only apply on a Microsoft Windows system running the following OS versions:

- Windows XP
- Windows Vista
- Windows 7

B.4 Setup Procedure for Linux

The initial setup procedure for Linux system is mostly the same with the procedure for Microsoft Windows. Please follow the steps below to setup recovery tool for Linux OS.

Step 1: Hardware and BIOS setup. Refer to **Section B.2.1**.

Step 2: Install Linux operating system. Make sure to install GRUB (v0.97 or earlier) MBR type and Ext3 partition type. Leave enough space on the hard drive to create the recover partition later.



NOTE:

If the Linux OS is not installed with GRUB (v0.97 or earlier) and Ext3, the Symantec Ghost may not function properly.

While installing Linux OS, please create two partitions:

- Partition 1: /
- Partition 2: **SWAP**



NOTE:

Please reserve enough space for partition 3 for saving recovery images.

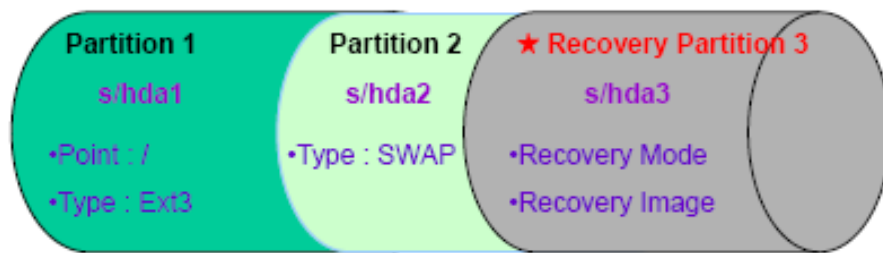

Figure B-29: Partitions for Linux

Step 3: Create a recovery partition. Insert the recovery CD into the optical disk drive. Follow **Step 1 ~ Step 3** described in **Section B.2.2**. Then type the following commands (marked in red) to create a partition for recovery images.

```
system32>diskpart
DISKPART>list vol
DISKPART>sel disk 0
```

PPC-51xxA-H61 Panel PC

```
DISKPART>create part pri size= ____
DISKPART>assign letter=N
DISKPART>exit
system32>format N: /fs:ntfs /q /v:Recovery /y
system32>exit
```

Step 4: Build the recovery partition. Press any key to boot from the recovery CD. It will take a while to launch the recovery tool. Please be patient. When the recovery tool setup menu appears, type <3> and press <Enter> (**Figure B-30**). The Symantec Ghost window appears and starts configuring the system to build a recovery partition. After completing the system configuration, press any key to reboot the system. Eject the recovery CD.

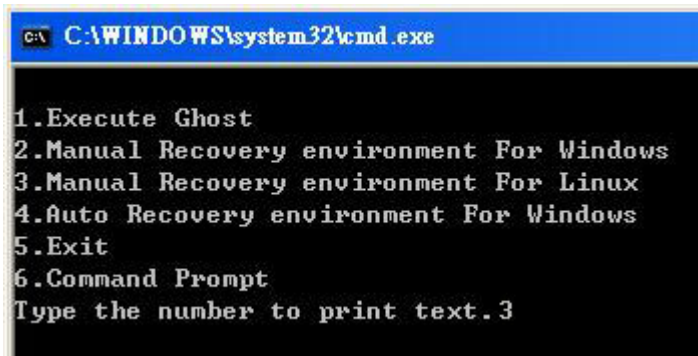

Figure B-30: Manual Recovery Environment for Linux

Step 5: Access the recovery tool main menu by modifying the “menu.lst”. To first access the recovery tool main menu, the menu.lst must be modified. In Linux, enter Administrator (root). When prompt appears, type:

```
cd /boot/grub
vi menu.lst
```

```
Fedora release 9 (Sulphur)
Kernel 2.6.25-14.fc9.i686 on an i686 (tty2)

localhost login: root
Password:
[root@localhost ~]# cd /boot/grub/
[root@localhost grub]# vi menu.lst _
```

Figure B-31: Access menu.lst in Linux (Text Mode)

Step 6: Modify the menu.lst as shown below.

```
#boot=/dev/sda
default=0
timeout=10 ← Modify timeout=10
splashimage=(hd0,0)/grub/splash.xpm.gz
hiddenmenu
title Fedora (2.6.25-14.fc9.i686)
    root (hd0,0)
    kernel /vmlinuz-2.6.25-14.fc9.i686 ro root=UUID=10f1acda
    ac38b5c78910 rhgb quiet
    initrd /initrd-2.6.25-14.fc9.i686.img

title Recovery Partition
root (hd0,2) ← Type command
makeactive
chainloader +1
```

- **Type command:**
title Recovery Partition
root (hd0,2)
makeactive
chainloader +1

Step 7: The recovery tool menu appears. (**Figure B-32**)

```
1. Factory Restore
2. Backup system
3. Restore your last backup.
4. Manual
5. Quit
Please type the number to select and then press Enter:
```

Figure B-32: Recovery Tool Menu

Step 8: Create a factory default image. Follow **Step 2 ~ Step 12** described in **Section B.2.5** to create a factory default image.

B.5 Recovery Tool Functions

After completing the initial setup procedures as described above, users can access the recovery tool by pressing <F3> while booting up the system. However, if the setup procedure in Section B.3 has been completed and the auto recovery function is enabled, the system will automatically restore from the factory default image without pressing the F3 key. The recovery tool main menu is shown below.

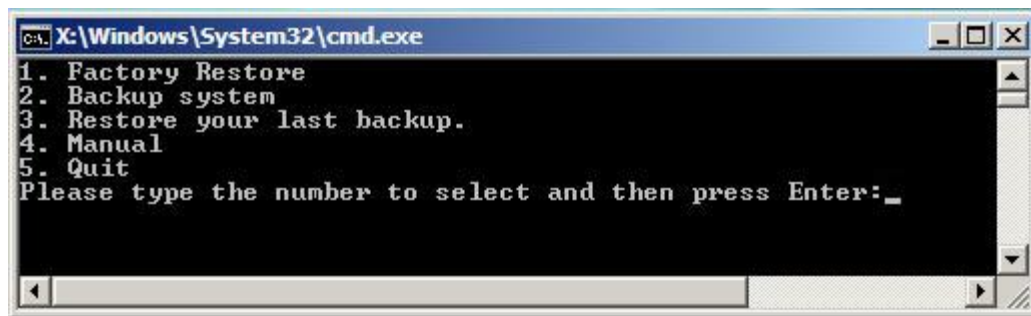

Figure B-33: Recovery Tool Main Menu

The recovery tool has several functions including:

1. **Factory Restore:** Restore the factory default image (iei.GHO) created in Section B.2.5.
2. **Backup system:** Create a system backup image (iei_user.GHO) which will be saved in the hidden partition.
3. **Restore your last backup:** Restore the last system backup image
4. **Manual:** Enter the Symantec Ghost window to configure manually.
5. **Quit:** Exit the recovery tool and restart the system.



WARNING:

Please do not turn off the system power during the process of system recovery or backup.



WARNING:

All data in the system will be deleted during the system recovery. Please backup the system files before restoring the system (either Factory Restore or Restore Backup).

B.5.1 Factory Restore

To restore the factory default image, please follow the steps below.

Step 1: Type <1> and press <Enter> in the main menu.

Step 2: The Symantec Ghost window appears and starts to restore the factory default. A factory default image called **iei.GHO** is created in the hidden Recovery partition.

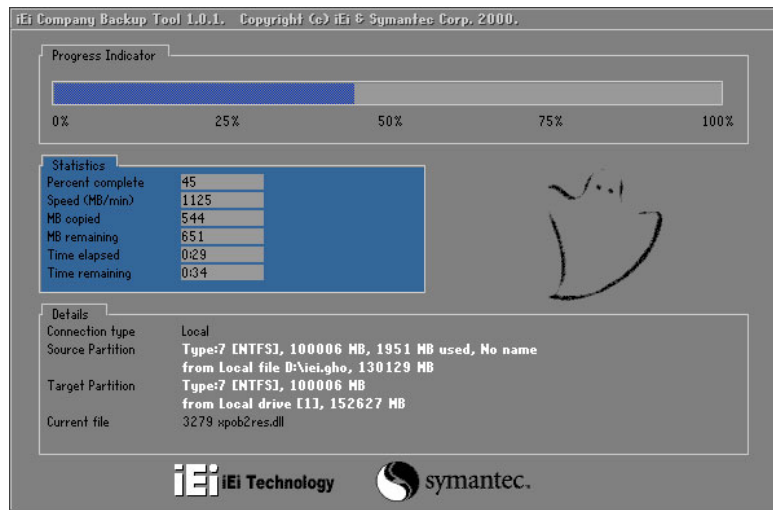

Figure B-34: Restore Factory Default

Step 3: The screen shown in **Figure B-35** appears when completed. Press any key to reboot the system.

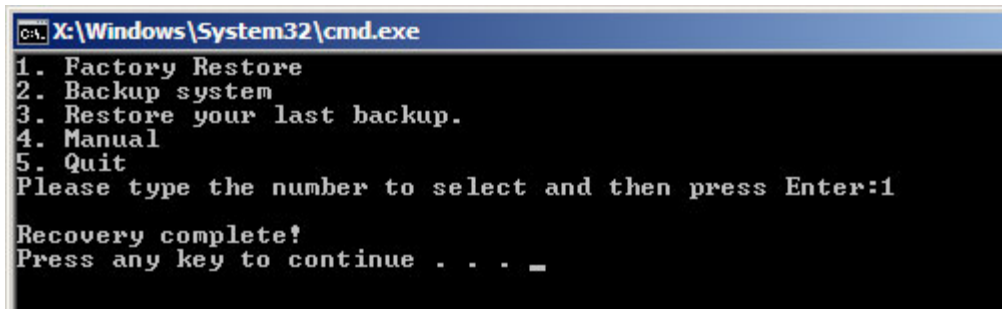

Figure B-35: Recovery Complete Window

B.5.2 Backup System

To backup the system, please follow the steps below.

Step 1: Type <2> and press <Enter> in the main menu.

Step 2: The Symantec Ghost window appears and starts to backup the system. A backup image called `iei_user.GHO` is created in the hidden Recovery partition.

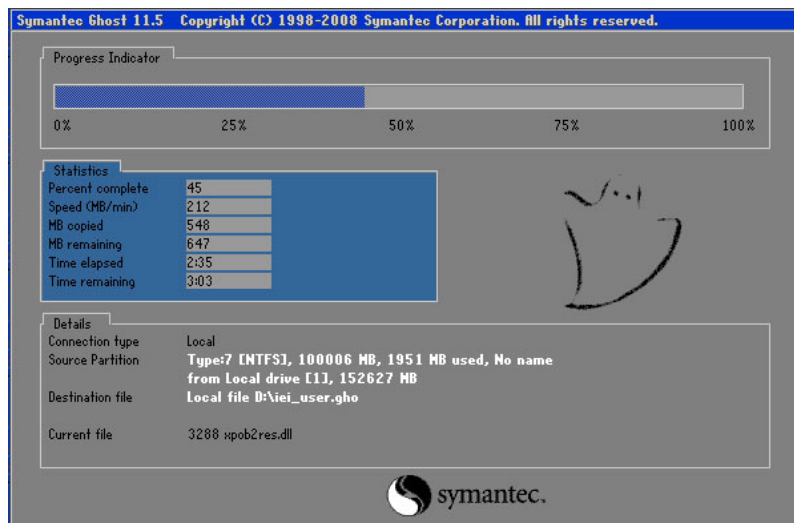

Figure B-36: Backup System

Step 3: The screen shown in **Figure B-37** appears when system backup is complete. Press any key to reboot the system.

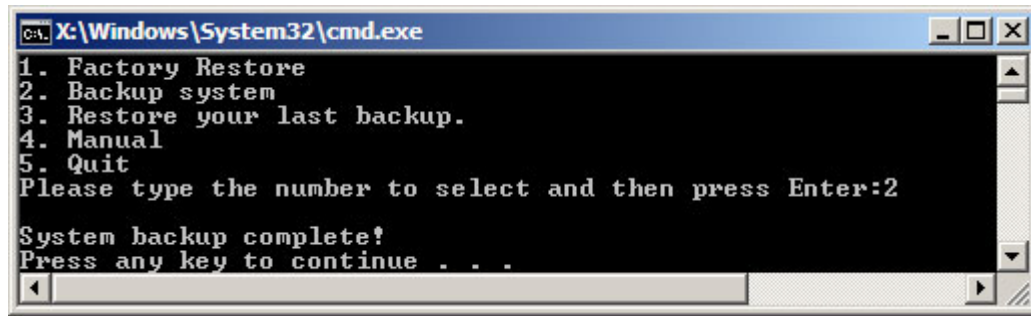

Figure B-37: System Backup Complete Window

B.5.3 Restore Your Last Backup

To restore the last system backup, please follow the steps below.

Step 1: Type <3> and press <Enter> in the main menu.

Step 2: The Symantec Ghost window appears and starts to restore the last backup image (iei_user.GHO).

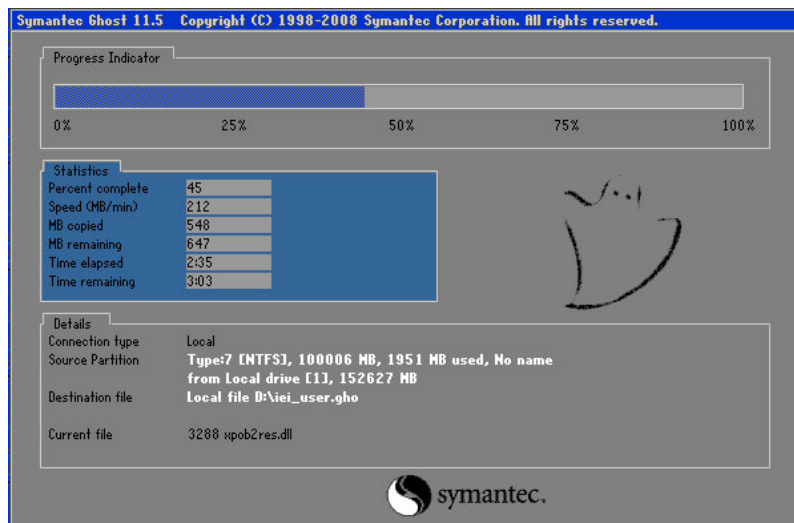

Figure B-38: Restore Backup

Step 3: The screen shown in **Figure B-39** appears when backup recovery is complete. Press any key to reboot the system.

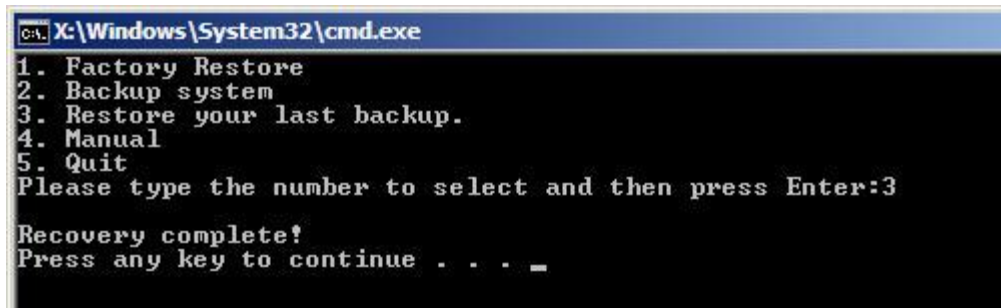

Figure B-39: Restore System Backup Complete Window

B.5.4 Manual

To restore the last system backup, please follow the steps below.

Step 1: Type <4> and press <Enter> in the main menu.

Step 2: The Symantec Ghost window appears. Use the Ghost program to backup or recover the system manually.

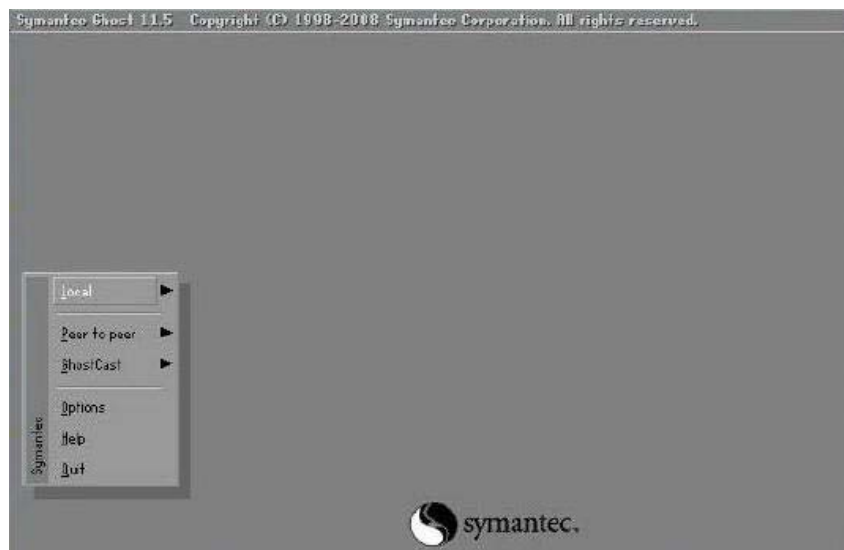
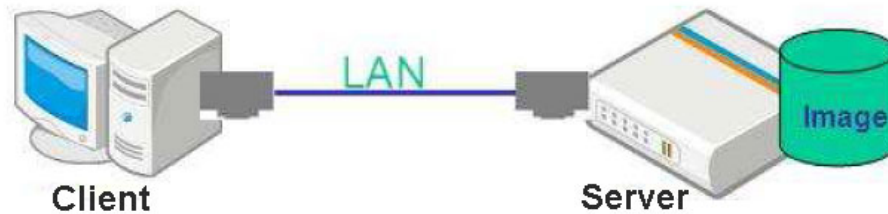

Figure B-40: Symantec Ghost Window

Step 3: When backup or recovery is completed, press any key to reboot the system.

B.6 Restore Systems from a Linux Server through LAN

The One Key Recovery allows a client system to automatically restore to a factory default image saved in a Linux system (the server) through LAN connectivity after encountering a Blue Screen of Death (BSoD) or a hang for around 10 minutes. To be able to use this function, the client system and the Linux system MUST reside in the same domain.



NOTE:

The supported client OS includes:

- Windows 2000
- Windows XP
- Windows Vista
- Windows 7
- Windows CE
- Windows XP Embedded

Prior to restoring client systems from a Linux server, a few setup procedures are required.

Step 1: Configure DHCP server settings

Step 2: Configure TFTP settings

Step 3: Configure One Key Recovery server settings

Step 4: Start DHCP, TFTP and HTTP

Step 5: Create a shared directory

Step 6: Setup a client system for auto recovery

The detailed descriptions are described in the following sections. In this document, two types of Linux OS are used as examples to explain the configuration process – CentOS 5.5 (Kernel 2.6.18) and Debian 5.0.7 (Kernel 2.6.26).

PPC-51xxA-H61 Panel PC

B.6.1 Configure DHCP Server Settings

Step 1: Install the DHCP

`#yum install dhcp` (CentOS, commands marked in red)

`#apt-get install dhcp3-server` (Debian, commands marked in blue)

Step 2: Confirm the operating system default settings: dhcpd.conf.

CentOS

Use the following command to show the DHCP server sample location:

`#vi /etc/dhcpd.conf`

The DHCP server sample location is shown as below:

```
# DHCP Server Configuration file.
# see /usr/share/doc/dhcp*/dhcpd.conf.sample
```

Use the following command to copy the DHCP server sample to etc/dhcpd.conf:

`#cp /usr/share/doc/dhcp-3.0.5/dhcpd.conf.sample /etc/dhcpd.conf`

`#vi /etc/dhcpd.conf`

```
ddns-update-style interim;
ignore client-updates;

subnet 192.168.0.0 netmask 255.255.255.0 {
# --- default gateway
    option routers                192.168.0.2;
    option subnet-mask            255.255.255.0;

    option nis-domain              "domain.org";
    option domain-name             "domain.org";
    option domain-name-servers     192.168.0.1;
    next-server 192.168.0.6;
    filename "pxelinux.0";
    option time-offset              -18000; # Eastern Standard Time
    option ntp-servers              192.168.1.1;
}
```

Debian

`#vi /etc/dhcpd.conf`

Edit “/etc/dhcpd.conf” for your environment. For example, add

`next-server PXE server IP address;`

```
filename "pxelinux.0";
```

```
ddns-update-style interim;
ignore client-updates;

subnet 192.168.0.0 netmask 255.255.255.0 {
# --- default gateway
    option routers                192.168.0.2;
    option subnet-mask            255.255.255.0;

    option nis-domain             "domain.org";
    option domain-name            "domain.org";
    option domain-name-servers    192.168.0.1;
    next-server 192.168.0.6;
    filename "pxelinux.0";
    option time-offset            -18000; # Eastern Standard Time
    option ntp-servers            192.168.1.1;
}
```

B.6.2 Configure TFTP Settings

Step 1: Install the tftp, httpd and syslinux.

```
#yum install tftp-server httpd syslinux (CentOS)
```

```
#apt-get install tftpd-hpa xinetd syslinux (Debian)
```

Step 2: Enable the TFTP server by editing the "/etc/xinetd.d/tftp" file and make it use the remap file. The "-vvv" is optional but it could definitely help on getting more information while running the remap file. For example:

CentOS

```
#vi /etc/xinetd.d/tftp
```

Modify:

```
disable = no
```

```
server_args = -s /tftpboot -m /tftpboot/tftpd.remap -vvv_
```

```
socket_type      = dgram
protocol        = udp
wait            = yes
user            = root
server          = /usr/sbin/in.tftpd
server_args     = -s /tftpboot -m /tftpboot/tftpd.remap -vvv
disable         = no
per_source      = 11
cps             = 100 2
flags           = IPv4
```

PPC-51xxA-H61 Panel PC

Debian

Replace the TFTP settings from “inetd” to “xinetd” and annotate the “inetd” by adding “#”.

`#vi /etc/inetd.conf`

Modify: `#tftp dgram udp wait root /usr/sbin.....` (as shown below)

```
#:BOOT: TFTP service is provided primarily for booting. Most sites
# run this only on machines acting as "boot servers."
#tftp dgram udp wait root /usr/sbin/in.tftpd /usr/sbin/in.tftpd -s
/var/lib/tftpboot
```

`#vi /etc/xinetd.d/tftp`

```
socket_type      = dgram
protocol        = udp
wait            = yes
user            = root
server          = /usr/sbin/in.tftpd
server_args     = -s /tftpboot -n /tftpboot/tftpd.remap -vvv
disable         = no
per_source      = 11
cps             = 100 2
flags           = IPv4
```

B.6.3 Configure One Key Recovery Server Settings

Step 1: Copy the **Utility/RECOVERYR10.TAR.BZ2** package from the One Key Recovery CD to the system (server side).



Step 2: Extract the recovery package to /.

```
#cp RecoveryR10.tar.bz2 /
#cd /
#tar -xvjf RecoveryR10.tar.bz2
```

Step 3: Copy “pxelinux.0” from “syslinux” and install to “/tftpboot”.

```
#cp /usr/lib/syslinux/pxelinux.0 /tftpboot/
```

B.6.4 Start the DHCP, TFTP and HTTP

Start the DHCP, TFTP and HTTP. For example:

CentOS

```
#service xinetd restart
```

```
#service httpd restart
```

```
#service dhcpd restart
```

Debian

```
#/etc/init.d/xinetd reload
```

```
#/etc/init.d/xinetd restart
```

```
#/etc/init.d/dhcp3-server restart
```

B.6.5 Create Shared Directory

Step 1: Install the samba.

```
#yum install samba
```

Step 2: Create a shared directory for the factory default image.

```
#mkdir /share
```

```
#cd /share
```

```
#mkdir /image
```

```
#cp iei.gho /image
```



WARNING:

The file name of the factory default image must be **iei.gho**.

Step 3: Confirm the operating system default settings: smb.conf.

```
#vi /etc/samba/smb.conf
```

PPC-51xxA-H61 Panel PC

Modify:

[image]

comment = One Key Recovery

path = /share/image

browseable = yes

writable = yes

public = yes

create mask = 0644

directory mask = 0755

Step 4: Edit “/etc/samba/smb.conf” for your environment. For example:

```
# "security = user" is always a good idea. This will require a Unix account
# in this server for every user accessing the server. See
# /usr/share/doc/samba-doc/html/docs/Samba3-HOWTO/ServerType.html
# in the samba-doc package for details.
security = share
```

```
[image]
comment = One Key Recovery
path = /share/image
browseable = yes
writable = yes
public = yes
create mask = 0644
directory mask = 0755
```

Step 5: Modify the hostname

```
#vi /etc/hostname
```

Modify: RecoveryServer

```
RecoveryServer
```

B.6.6 Setup a Client System for Auto Recovery

Step 1: Configure the following BIOS options of the client system.

Advanced → iEi Feature → Auto Recovery Function → **Enabled**

Advanced → iEi Feature → Recover from PXE → **Enabled**

Boot → Launch PXE OpROM → **Enabled**

Step 2: Continue to configure the **Boot Option Priorities** BIOS option of the client system:

Boot Option #1 → remain the default setting to boot from the original OS.

Boot Option #2 → select the boot from LAN option.

Step 3: Save changes and exit BIOS menu.

Exit → **Save Changes and Exit**

Step 4: Install the auto recovery utility into the system by double clicking the **Utility/AUTORECOVERY-SETUP.exe** in the One Key Recovery CD. This utility **MUST** be installed in the system, otherwise, the system will automatically restore from the factory default image every ten (10) minutes.



Step 5: Restart the client system from LAN. If the system encounters a Blue Screen of Death (BSoD) or a hang for around 10 minutes, it will automatically restore from the factory default image. The following screens will show when the system starts auto recovering.

```
Realtek PCIe GBE Family Controller Series v2.35 (06/14/10)
CLIENT MAC ADDR: 00 18 7D 13 E6 89  GUID: 00020003-0004-0005-0006-0007000000
DHCP . . /
```

PPC-51xxA-H61 Panel PC

```

My IP address seems to be C0A80009 192.168.0.9
ip=192.168.0.9:192.168.0.8:192.168.0.2:255.255.255.0
TFTP prefix:
Trying to load: pxelinux.cfg/00020003-0004-0005-0006-000700080009
Trying to load: pxelinux.cfg/01-00-10-7d-13-e6-89
Trying to load: pxelinux.cfg/C0A80009
Trying to load: pxelinux.cfg/C0A8000
Trying to load: pxelinux.cfg/C0A800
Trying to load: pxelinux.cfg/C0A80
Trying to load: pxelinux.cfg/C0A8
Trying to load: pxelinux.cfg/C0A
Trying to load: pxelinux.cfg/C0
Trying to load: pxelinux.cfg/C
Trying to load: pxelinux.cfg/default
boot:
  
```

Windows is loading files...

IP: 192.168.0.8, File: \Boot\WinPE.wim

Symantec Ghost 11.5 Copyright (C) 1998-2008 Symantec Corporation. All rights reserved.

Progress Indicator

0% 25% 50% 75% 100%

Statistics	
Percent complete	52
Speed (MB/min)	468
MB copied	632
MB remaining	563
Time elapsed	1:21
Time remaining	1:12

Details

Connection type	Local
Source Partition	Type:7 [NTFS], 100006 MB, 1951 MB used, No name from Local drive [80], 130129 MB
Destination file	Local file D:\iei.GHO
Current file	3891 e_869.nls

 symantec.



NOTE:

A firewall or a SELinux is not in use in the whole setup process. If there is a firewall or a SELinux protecting the system, modify the configuration information to accommodate them.

B.7 Other Information

B.7.1 Using AHCI Mode or ALi M5283 / VIA VT6421A Controller

When the system uses AHCI mode or some specific SATA controllers such as ALi M5283 or VIA VT6421A, the SATA RAID/AHCI driver must be installed before using one key recovery. Please follow the steps below to install the SATA RAID/AHCI driver.

Step 1: Copy the SATA RAID/AHCI driver to a floppy disk and insert the floppy disk into a USB floppy disk drive. The SATA RAID/AHCI driver must be especially designed for the on-board SATA controller.

Step 2: Connect the USB floppy disk drive to the system.

Step 3: Insert the One Key Recovery CD into the system and boot the system from the CD.

Step 4: When launching the recovery tool, press <F6>.

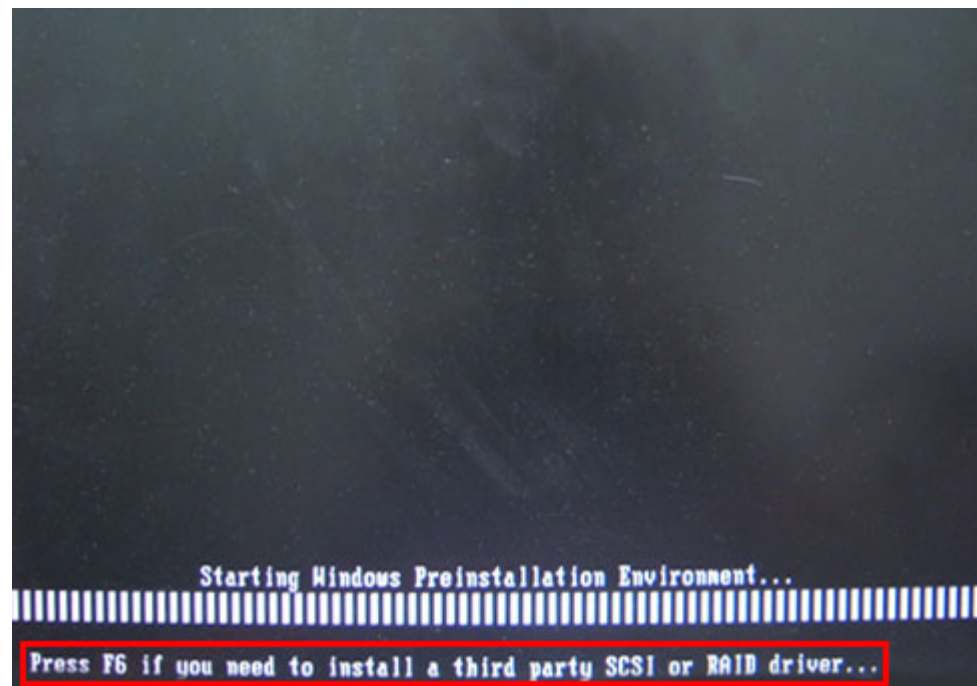

PPC-51xxA-H61 Panel PC

Step 5: When the following window appears, press <S> to select “Specify Additional Device”.

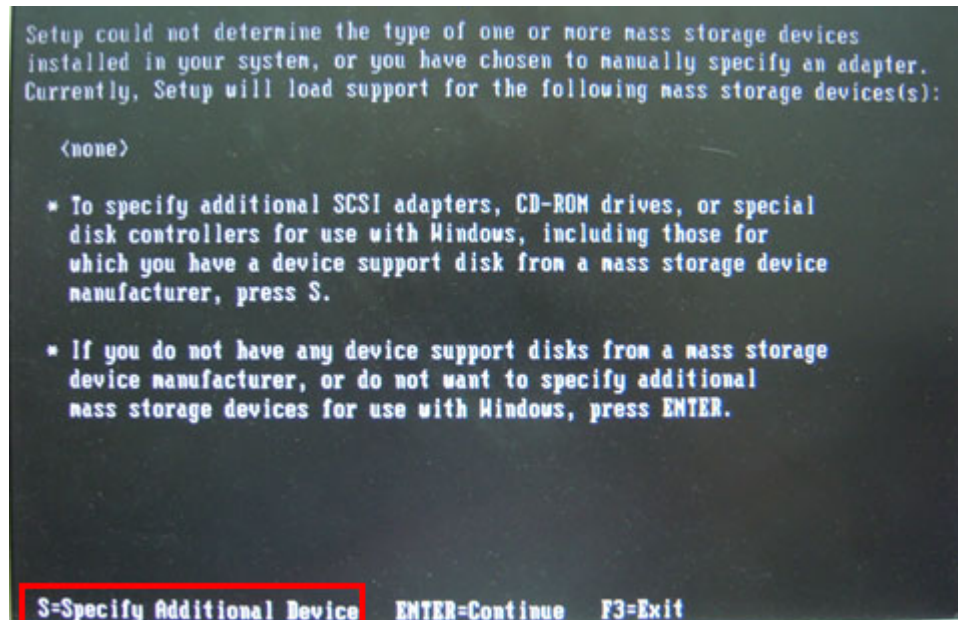

Step 6: In the following window, select a SATA controller mode used in the system. Then press <Enter>. The user can now start using the SATA HDD.

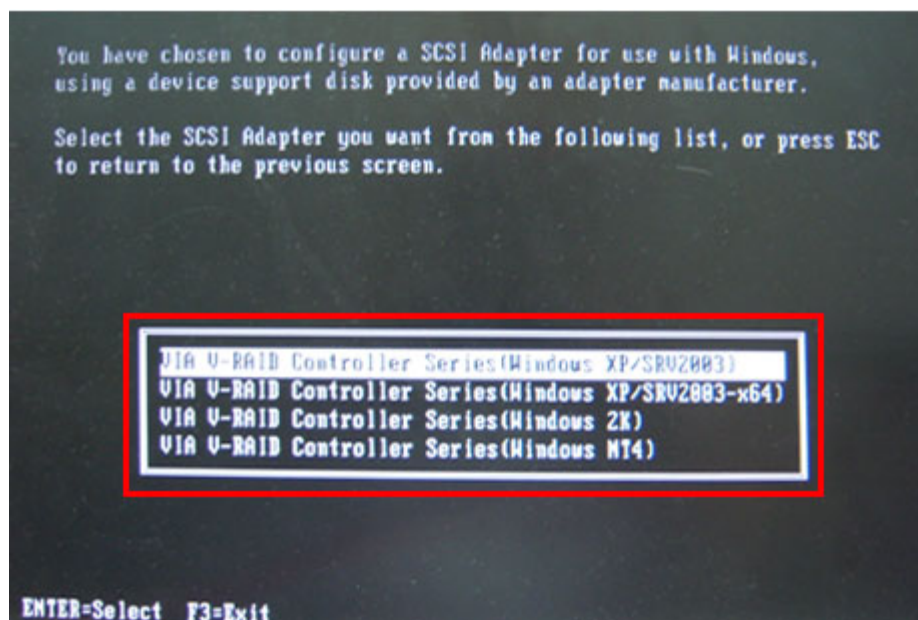

Step 7: After pressing <Enter>, the system will get into the recovery tool setup menu.

Continue to follow the setup procedure from **Step 4** in **Section B.2.2 Create**

Partitions to finish the whole setup process.

B.7.2 System Memory Requirement

To be able to access the recovery tool by pressing <F3> while booting up the system, please make sure to have enough system memory. The minimum memory requirement is listed below.

- Using Award BIOS: 128 MB system memory
- Using AMI BIOS: 512 MB system memory.

Appendix

C

Safety Precautions

WARNING:

The precautions outlined in this chapter should be strictly followed. Failure to follow these precautions may result in permanent damage to the EP series.

C.1 Safety Precautions

Please follow the safety precautions outlined in the sections that follow:

C.1.1 General Safety Precautions

Please ensure the following safety precautions are adhered to at all times.

- **Follow the electrostatic precautions** outlined below whenever the EP series is opened.
- **Make sure the power is turned off and the power cord is disconnected** whenever the EP series is being installed, moved or modified.
- **Do not apply voltage levels that exceed the specified voltage range.** Doing so may cause fire and/or an electrical shock.
- **Electric shocks can occur** if the EP series chassis is opened when the EP series is running.
- **Do not drop or insert any objects** into the ventilation openings of the EP series.
- **If considerable amounts of dust, water, or fluids enter the EP series**, turn off the power supply immediately, unplug the power cord, and contact the EP series vendor.
- **DO NOT:**
 - Drop the EP series against a hard surface.
 - Strike or exert excessive force onto the LCD panel.
 - Touch any of the LCD panels with a sharp object
 - In a site where the ambient temperature exceeds the rated temperature

C.1.2 Anti-static Precautions



WARNING:

Failure to take ESD precautions during the installation of the EP series may result in permanent damage to the EP series and severe injury to the user.

Electrostatic discharge (ESD) can cause serious damage to electronic components, including the EP series. Dry climates are especially susceptible to ESD. It is therefore critical that whenever the EP series is opened and any of the electrical components are handled, the following anti-static precautions are strictly adhered to.

- ***Wear an anti-static wristband:*** Wearing a simple anti-static wristband can help to prevent ESD from damaging any electrical component.
- ***Self-grounding:*** Before handling any electrical component, touch any grounded conducting material. During the time the electrical component is handled, frequently touch any conducting materials that are connected to the ground.
- ***Use an anti-static pad:*** When configuring or working with an electrical component, place it on an anti-static pad. This reduces the possibility of ESD damage.
- ***Only handle the edges of the electrical component:*** When handling the electrical component, hold the electrical component by its edges.

C.1.3 Product Disposal



CAUTION:

Risk of explosion if battery is replaced by an incorrect type. Only certified engineers should replace the on-board battery.

Dispose of used batteries according to instructions and local regulations.

- Outside the European Union - If you wish to dispose of used electrical and electronic products outside the European Union, please contact your local authority so as to comply with the correct disposal method.
- Within the European Union:

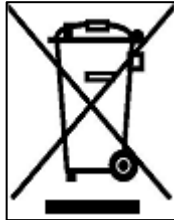

EU-wide legislation, as implemented in each Member State, requires that waste electrical and electronic products carrying the mark (left) must be disposed of separately from normal household waste. This includes monitors and electrical accessories, such as signal cables or power cords. When you need to dispose of your display products, please follow the guidance of your local authority, or ask the shop where you purchased the product. The mark on electrical and electronic products only applies to the current European Union Member States.

Please follow the national guidelines for electrical and electronic product disposal.

C.2 Maintenance and Cleaning Precautions

When maintaining or cleaning the EP series, please follow the guidelines below.

C.2.1 Maintenance and Cleaning

Prior to cleaning any part or component of the EP series, please read the details below.

- Except for the LCD panel, never spray or squirt liquids directly onto any other components. To clean the LCD panel, gently wipe it with a piece of soft dry cloth or a slightly moistened cloth.
- The interior of the EP series does not require cleaning. Keep fluids away from the EP series interior.
- Be cautious of all small removable components when vacuuming the EP series.
- Turn the EP series off before cleaning the EP series.
- Never drop any objects or liquids through the openings of the EP series.
- Be cautious of any possible allergic reactions to solvents or chemicals used when cleaning the EP series.
- Avoid eating, drinking and smoking within vicinity of the EP series.

C.2.2 Cleaning Tools

Some components in the EP series may only be cleaned using a product specifically designed for the purpose. In such case, the product will be explicitly mentioned in the cleaning tips. Below is a list of items to use when cleaning the EP series.

- **Cloth** – Although paper towels or tissues can be used, a soft, clean piece of cloth is recommended when cleaning the EP series.
- **Water or rubbing alcohol** – A cloth moistened with water or rubbing alcohol can be used to clean the EP series.
- **Using solvents** – The use of solvents is not recommended when cleaning the EP series as they may damage the plastic parts.
- **Vacuum cleaner** – Using a vacuum specifically designed for computers is one of the best methods of cleaning the EP series. Dust and dirt can restrict the airflow in the EP series and cause its circuitry to corrode.
- **Cotton swabs** - Cotton swaps moistened with rubbing alcohol or water are excellent tools for wiping hard to reach areas.
- **Foam swabs** - Whenever possible, it is best to use lint free swabs such as foam swabs for cleaning.

Appendix

D

Watchdog Timer



NOTE:

The following discussion applies to DOS environment. IEI support is contacted or the IEI website visited for specific drivers for more sophisticated operating systems, e.g., Windows and Linux.

The Watchdog Timer is provided to ensure that standalone systems can always recover from catastrophic conditions that cause the CPU to crash. This condition may have occurred by external EMI or a software bug. When the CPU stops working correctly, Watchdog Timer either performs a hardware reset (cold boot) or a Non-Maskable Interrupt (NMI) to bring the system back to a known state.

A BIOS function call (INT 15H) is used to control the Watchdog Timer:

INT 15H:

AH – 6FH Sub-function:	
AL – 2:	Sets the Watchdog Timer's period.
BL:	Time-out value (Its unit-second is dependent on the item "Watchdog Timer unit select" in CMOS setup).

Table D-1: AH-6FH Sub-function

Call sub-function 2 to set the time-out period of Watchdog Timer first. If the time-out value is not zero, the Watchdog Timer starts counting down. While the timer value reaches zero, the system resets. To ensure that this reset condition does not occur, calling sub-function 2 must periodically refresh the Watchdog Timer. However, the Watchdog timer is disabled if the time-out value is set to zero.

A tolerance of at least 10% must be maintained to avoid unknown routines within the operating system (DOS), such as disk I/O that can be very time-consuming.

**NOTE:**

When exiting a program it is necessary to disable the Watchdog Timer, otherwise the system resets.

Example program:

```
; INITIAL TIMER PERIOD COUNTER
;
W_LOOP:

    MOV     AX, 6F02H      ;setting the time-out value
    MOV     BX, 05        ;time-out value is 5 seconds
    INT     15H

;
; ADD THE APPLICATION PROGRAM HERE
;

    CMP     EXIT_AP, 1    ;is the application over?
    JNE     W_LOOP       ;No, restart the application

    MOV     AX, 6F02H    ;disable Watchdog Timer
    MOV     BX, 0        ;
    INT     15H

;
; EXIT ;
```

Appendix

E

Hazardous Materials Disclosure

E.1 Hazardous Material Disclosure Table for IPB Products Certified as RoHS Compliant Under 2002/95/EC Without Mercury

The details provided in this appendix are to ensure that the product is compliant with the Peoples Republic of China (China) RoHS standards. The table below acknowledges the presences of small quantities of certain materials in the product, and is applicable to China RoHS only.

A label will be placed on each product to indicate the estimated “Environmentally Friendly Use Period” (EFUP). This is an estimate of the number of years that these substances would “not leak out or undergo abrupt change.” This product may contain replaceable sub-assemblies/components which have a shorter EFUP such as batteries and lamps. These components will be separately marked.

Please refer to the table on the next page.

PPC-51xxA-H61 Panel PC

Part Name	Toxic or Hazardous Substances and Elements					
	Lead (Pb)	Mercury (Hg)	Cadmium (Cd)	Hexavalent Chromium (CR(VI))	Polybrominated Biphenyls (PBB)	Polybrominated Diphenyl Ethers (PBDE)
Housing	X	O	O	O	O	X
Display	X	O	O	O	O	X
Printed Circuit Board	X	O	O	O	O	X
Metal Fasteners	X	O	O	O	O	O
Cable Assembly	X	O	O	O	O	X
Fan Assembly	X	O	O	O	O	X
Power Supply Assemblies	X	O	O	O	O	X
Battery	O	O	O	O	O	O

O: This toxic or hazardous substance is contained in all of the homogeneous materials for the part is below the limit requirement in SJ/T11363-2006

X: This toxic or hazardous substance is contained in at least one of the homogeneous materials for this part is above the limit requirement in SJ/T11363-2006

此附件旨在确保本产品符合中国 RoHS 标准。以下表格标示此产品中某有毒物质的含量符合中国 RoHS 标准规定的限量要求。

本产品上会附有“环境友好使用期限”的标签，此期限是估算这些物质“不会有泄漏或突变”的年限。本产品可能包含有较短的环境友好使用期限的可替换元件，像是电池或灯管，这些元件将会单独标示出来。

部件名称	有毒有害物质或元素					
	铅 (Pb)	汞 (Hg)	镉 (Cd)	六价铬 (CR(VI))	多溴联苯 (PBB)	多溴二苯醚 (PBDE)
壳体	X	O	O	O	O	X
显示	X	O	O	O	O	X
印刷电路板	X	O	O	O	O	X
金属螺帽	X	O	O	O	O	O
电缆组装	X	O	O	O	O	X
风扇组装	X	O	O	O	O	X
电力供应组装	X	O	O	O	O	X
电池	O	O	O	O	O	O

O: 表示该有毒有害物质在该部件所有物质材料中的含量均在 SJ/T11363-2006 标准规定的限量要求以下。

X: 表示该有毒有害物质至少在该部件的某一均质材料中的含量超出 SJ/T11363-2006 标准规定的限量要求。