

Quick Installation Guide

IGPS-1411GTPA

Industrial Unmanaged Gigabit PoE Switch

Introduction

IGPS-1411GTPA is an unmanaged PoE Ethernet switch with P.S.E. function. IGPS-1411GTPA support Power over Ethernet, a system to transmit electrical power, along with data, to remote devices over standard twisted-pair cable in an Ethernet network. IGPS-1411GTPA has 4X10/100/1000Base-T(X) P.S.E. (Power Sourcing Equipment) ports. P.S.E. is a device (switch or hub for instance) that will provide power in a PoE setup. The wide operating temperature range from -40°C to 70°C can satisfy most of operating environment. Therefore, the switch is one of the most reliable choices for PoE Ethernet application.

Features

- > IGPS-1411GTPA provide 4x10/100/1000Base-T(X) PoE (P.S.E.) ports
- > Support P.S.E. based on IEEE 802.3at standard up to 30 Watts per port
- > SFP port support 100Base-FX and 1000Base-X dual speed
- > Support auto-negotiation and auto-MDI/MDI-X
- > Support store and forward transmission
- > Support flow control
- > Rigid IP-30 housing design
- > DIN-Rail and wall mounting enabled

Power Connection Guide

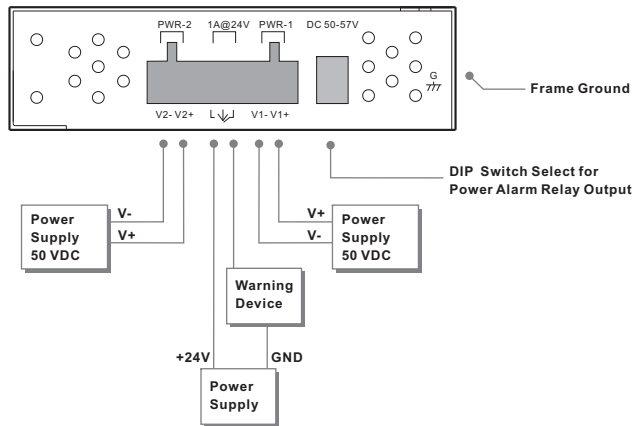

● DIP Switch Function (Power Side)

DIP-1	DIP-2	Description
OFF	OFF	Power failure relay alarm disabled
ON	OFF	PWR-1 failure, relay alarm enabled
OFF	ON	PWR-2 failure, relay alarm enabled
ON	ON	PWR-1 or PWR-2 failure, relay alarm enabled

Specifications

ORing Switch Model	IGPS-1411GTPA
Physical Ports	
10/100/1000Base-T(X) P.S.E. Port with P.S.E.	4
10/100/1000Base-T(X) Port in RJ45 Auto MDI/MDIX	1
100/1000Base-X SFP port	1
Technology	
Ethernet Standards	IEEE 802.3 for 10Base-T IEEE 802.3u for 100Base-TX and 100Base-X IEEE 802.3z for 1000Base-X IEEE 802.3ab for 1000Base-T IEEE 802.3x for Flow control IEEE 802.3at PoE specification (up to 30 Watts per port for P.S.E.)
MAC Table	8K MAC addresses
Processing	Store-and-Forward
LED Indicators	
Power Indicator	Green: Power LED x2
Fault Indicator	Amber: Indicate PWR1 or PWR2 failure
10/100/1000Base-T(X) RJ45 port and PoE Indicator (P1~P4)	Green on the left for port Link/Act. Green on the right for PoE power injected.
10/100/1000Base-T(X) RJ45 port Indicator (P5)	Green for port Link/Act. Amber for 10/100Mbps Link/Act
100/1000Base-X SFP port Indicator	Green for port Link/Act.
DIP-Switch	
DIP-Switch 1	Power-1 failed warning : (ON) enable, (OFF) disable
DIP-Switch 2	Power-2 failed warning : (ON) enable, (OFF) disable
Fault contact	
Relay	Relay output to carry capacity of 1A at 24 VDC
Power	
Redundant Input Power	Dual DC inputs 50~57VDC on 6-pin terminal block
Power Consumption (Typ.)	6.3 Watts (Power device not included)
Overload Current Protection	Present
Reverse Polarity Protection	Not Present
Physical Characteristic	
Enclosure	IP-30
Dimension (W x D x H)	26.1(W)x94.9(D)x144.3(H) mm (1.03x3.74x5.68inch.)
Weight (g)	395g
Environmental	
Storage Temperature	-40 to 85°C (-40 to 185°F)
Operating Temperature	-40 to 70°C (-40 to 158°F)
Operating Humidity	5% to 95% Non-condensing
Regulatory approvals	
EMI	FCC Part 15, CISPR (EN55022) class A
EMS	EN61000-4-2 (ESD), EN61000-4-3 (RS), EN61000-4-4 (EFT), EN61000-4-5 (Surge), EN61000-4-6 (CS), EN61000-4-8, EN61000-4-11
Shock	IEC60068-2-27
Free Fall	IEC60068-2-32
Vibration	IEC60068-2-6
Warranty	5 years

Practical Operation

IGPS-1411GTPA can be used in connecting several PoE P.D. Ethernet devices like IP-Camera or other Ethernet devices. In addition, there are two different power inputs at terminal block to avoid interruption caused by power down. When the primary DC power input fails, the backup power input will take over immediately to guarantee a non-stop operation.

● Connections of Ethernet devices

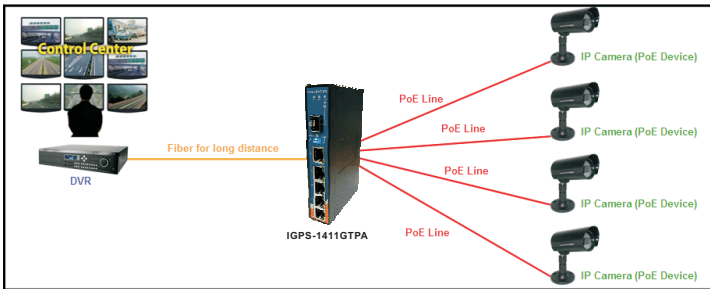

Front Panel

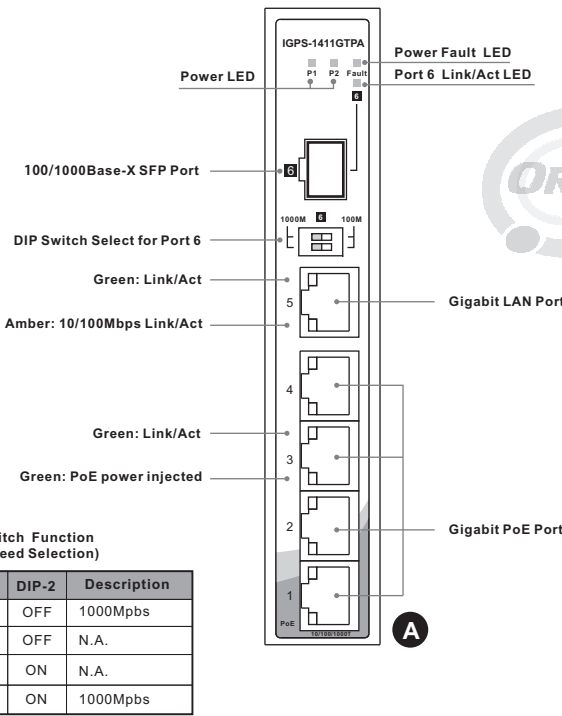

● DIP Switch Function (SFP speed Selection)

DIP-1	DIP-2	Description
OFF	OFF	1000Mbps
ON	OFF	N.A.
OFF	ON	N.A.
ON	ON	1000Mbps



Quick Installation Guide

IGPS-1411GTPA

Industrial Unmanaged Gigabit PoE Switch

Installation

DIN-Rail Install Step

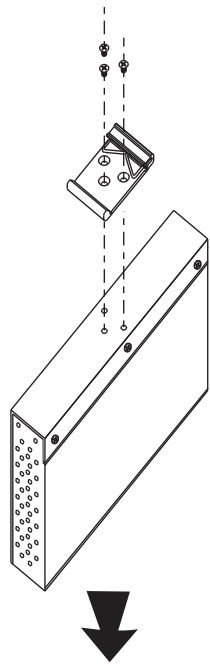

Wall-mounted Install Step

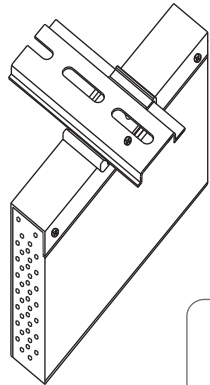
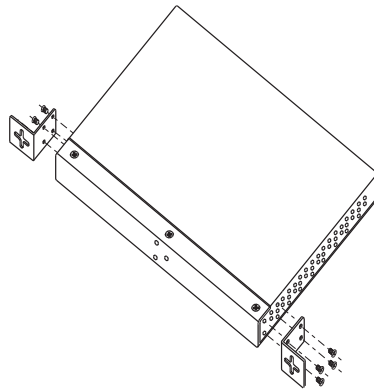

Accessory

- ① 6-Pin Terminal block
- ② Dust Cover (RJ-45)
- ③ Dust Cover (SFP)

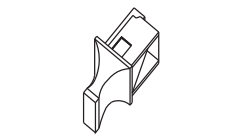
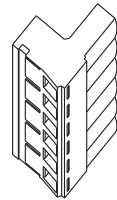

- ④ Round Screw (M3 X3)
- ⑤ Wall-mounted kit (for Slim Type)



- ⑥ 25mm DIN-Rail kit
- ⑦ QIG

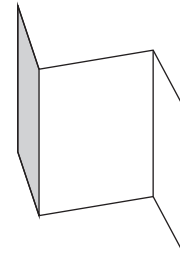
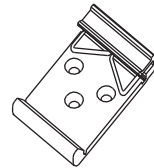

Communication Connections

100Base-T Ethernet Connection

RJ45 (8-pin, MDI) Port Pinouts

Pin	MDI
1	BI_DA+
2	BI_DA-
3	BI_DB+
4	BI_DC+
5	BI_DC-
6	BI_DB-
7	BI_DD+
8	BI_DD-

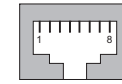

RJ45 (8-pin, MDI-X) Port Pinouts

Pin	MDI-X
1	BI_DB+
2	BI_DB-
3	BI_DA+
4	BI_DD+
5	BI_DD-
6	BI_DA-
7	BI_DC+
8	BI_DC-

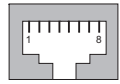

10/100Base-T(X) Ethernet Connection

RJ45 (8-pin) to RJ45 (8-Pin) Straight-Through Cable Wiring

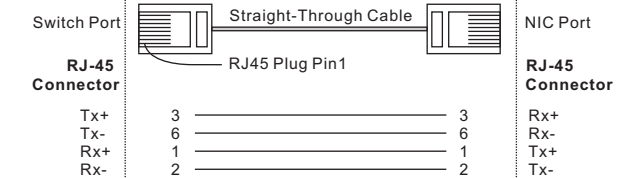

RJ45 (8-pin) to RJ45 (8-Pin) Cross-Over Cable Wiring

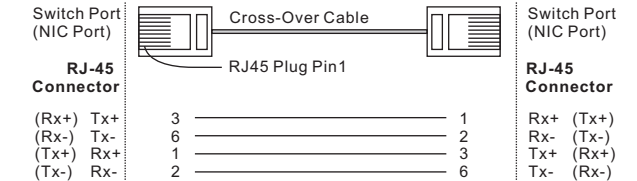

100/1000Base-X SFP Port Connection

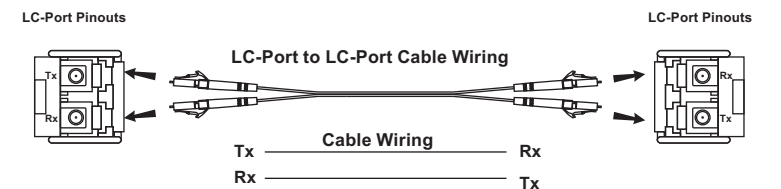

Pin Definition

10/100Base-T(X) PoE P.S.E. Port

RJ45 Pin Definition	
Pin No.	Description
# 1	TD+ with PoE Power input +
# 2	TD- with PoE Power input +
# 3	RD+ with PoE Power input -
# 6	RD- with PoE Power input -

100Base-T PoE P.S.E. Port

RJ45 Pin Definition	
Pin No.	Description
# 1	BI_DA+ with PoE Power input +
# 2	BI_DA- with PoE Power input +
# 3	BI_DB+ with PoE Power input -
# 4	BI_DC+
# 5	BI_DC-
# 6	BI_DB- with PoE Power input -
# 7	BI_DD+
# 8	BI_DD-

Packing list

Model name	Front Panel	Model Description	Accessory
IGPS-1411GTPA	A	Industrial 6-port slim type unmanaged Gigabit PoE Ethernet switch with 4x10/100/1000Base-T(X) P.S.E. and 1x10/100/1000Base-T(X) and 1x100/1000Base-X, SFP socket	①X1, ②X5, ③X1, ④X8, ⑤X2, ⑥X1, ⑦X1

ORing Industrial Networking Corp.
 Copyright© 2011 ORing All rights reserved.
 TEL: +886-2-2218-1066 Website: www.oring-networking.com
 FAX: +886-2-2218-1014 E-mail: support@oring-networking.com