

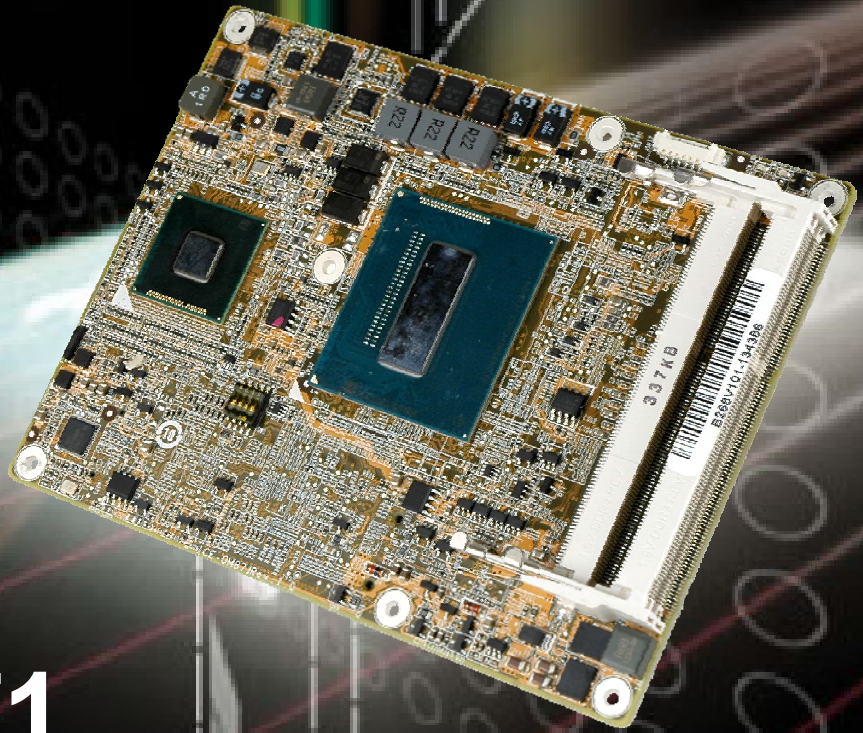

IEI Technology Corp.



MODEL:  
**ICE-QM871**

**COM Express R2.0 Module (Type 6),  
4th Generation Intel® Core™ i7/i5/i3 or Celeron® Processor,  
DDR3 and RoHS Compliant**

# User Manual

Rev. 1.00 – 24 May, 2013



# Revision

---

Date	Version	Changes
24 May, 2013	1.00	Initial release

# Copyright

---

## **COPYRIGHT NOTICE**

The information in this document is subject to change without prior notice in order to improve reliability, design and function and does not represent a commitment on the part of the manufacturer.

In no event will the manufacturer be liable for direct, indirect, special, incidental, or consequential damages arising out of the use or inability to use the product or documentation, even if advised of the possibility of such damages.

This document contains proprietary information protected by copyright. All rights are reserved. No part of this manual may be reproduced by any mechanical, electronic, or other means in any form without prior written permission of the manufacturer.

## **TRADEMARKS**

All registered trademarks and product names mentioned herein are used for identification purposes only and may be trademarks and/or registered trademarks of their respective owners.

# Table of Contents

<b>1 INTRODUCTION.....</b>	<b>1</b>
1.1 INTRODUCTION.....	2
1.2 FEATURES.....	2
1.3 CONNECTORS .....	3
1.4 DIMENSIONS.....	4
1.5 DATA FLOW .....	6
1.6 TECHNICAL SPECIFICATIONS .....	7
<b>2 PACKING LIST.....</b>	<b>9</b>
2.1 ANTI-STATIC PRECAUTIONS .....	10
2.2 UNPACKING PRECAUTIONS.....	10
2.3 PACKING LIST.....	11
2.4 OPTIONAL ITEMS .....	12
<b>3 CONNECTORS .....</b>	<b>13</b>
3.1 PERIPHERAL INTERFACE CONNECTORS.....	14
3.1.1 ICE-QM871 Layout .....	14
3.1.2 Peripheral Interface Connectors .....	15
3.2 INTERNAL PERIPHERAL CONNECTORS .....	15
3.2.1 COM Express Connector AB .....	15
3.2.2 COM Express Connector CD.....	19
3.2.3 SO-DIMM Connectors.....	24
3.2.4 SPI Flash Connector (BIOS) .....	24
3.2.5 SPI Flash Connector (EC).....	25
<b>4 INSTALLATION .....</b>	<b>27</b>
4.1 ANTI-STATIC PRECAUTIONS .....	28
4.2 INSTALLATION CONSIDERATIONS.....	28
4.3 SO-DIMM INSTALLATION .....	30
4.4 JUMPER SETTINGS .....	31
4.4.1 LVDS Panel Type Selection.....	31

## ICE-QM871 COM Express Module

4.5 MOUNTING THE ICE-QM871 TO AN OPTIONAL BASEBOARD.....	32
<b>5 BIOS.....</b>	<b>36</b>
5.1 INTRODUCTION.....	37
5.1.1 Starting Setup.....	37
5.1.2 Using Setup.....	37
5.1.3 Getting Help.....	38
5.1.4 Unable to Reboot after Configuration Changes.....	38
5.1.5 BIOS Menu Bar.....	38
5.2 MAIN.....	39
5.3 ADVANCED.....	40
5.3.1 ACPI Settings.....	41
5.3.2 RTC Wake Settings.....	42
5.3.3 Trusted Computing.....	43
5.3.4 CPU Configuration.....	45
5.3.5 SATA Configuration.....	47
5.3.6 Intel(R) Rapid Start Technology.....	48
5.3.7 AMT Configuration.....	49
5.3.8 USB Configuration.....	50
5.3.9 iWDD H/W Monitor.....	51
5.3.9.1 Smart Fan Mode Configuration.....	52
5.3.10 F81866 Super IO Configuration.....	53
5.3.10.1 Serial Port n Configuration.....	54
5.3.11 F81866 H/W Monitor.....	56
5.3.11.1 Smart Fan Mode Configuration.....	57
5.3.12 Serial Port Console Redirection.....	57
5.3.13 iEi Feature.....	60
5.4 CHIPSET.....	61
5.4.1 System Agent (SA) Configuration.....	62
5.4.1.1 Graphics Configuration.....	62
5.4.1.2 NB PCIe Configuration.....	65
5.4.1.3 Memory Configuration.....	66
5.4.2 PCH-IO Configuration.....	67
5.4.2.1 PCI Express Configuration.....	68
5.5 BOOT.....	69

5.6 SECURITY .....	71
5.7 SAVE & EXIT .....	71
<b>6 SOFTWARE DRIVERS .....</b>	<b>73</b>
6.1 AVAILABLE SOFTWARE DRIVERS .....	74
6.2 STARTING THE DRIVER PROGRAM .....	74
6.3 CHIPSET DRIVER INSTALLATION.....	76
6.4 GRAPHICS DRIVER INSTALLATION.....	79
6.5 LAN DRIVER INSTALLATION.....	82
6.6 USB 3.0 DRIVER INSTALLATION .....	87
6.7 AUDIO DRIVER INSTALLATION .....	90
6.8 INTEL® AMT DRIVER INSTALLATION .....	92
<b>A BIOS OPTIONS .....</b>	<b>95</b>
<b>B ONE KEY RECOVERY .....</b>	<b>98</b>
B.1 ONE KEY RECOVERY INTRODUCTION .....	99
<i>B.1.1 System Requirement.....</i>	<i>100</i>
<i>B.1.2 Supported Operating System.....</i>	<i>101</i>
B.2 SETUP PROCEDURE FOR WINDOWS .....	102
<i>B.2.1 Hardware and BIOS Setup .....</i>	<i>103</i>
<i>B.2.2 Create Partitions .....</i>	<i>103</i>
<i>B.2.3 Install Operating System, Drivers and Applications.....</i>	<i>107</i>
<i>B.2.4 Build-up Recovery Partition.....</i>	<i>108</i>
<i>B.2.5 Create Factory Default Image.....</i>	<i>110</i>
B.3 AUTO RECOVERY SETUP PROCEDURE .....	115
B.4 SETUP PROCEDURE FOR LINUX .....	120
B.5 RECOVERY TOOL FUNCTIONS .....	123
<i>B.5.1 Factory Restore .....</i>	<i>125</i>
<i>B.5.2 Backup System.....</i>	<i>126</i>
<i>B.5.3 Restore Your Last Backup.....</i>	<i>127</i>
<i>B.5.4 Manual.....</i>	<i>128</i>
B.6 RESTORE SYSTEMS FROM A LINUX SERVER THROUGH LAN .....	129
<i>B.6.1 Configure DHCP Server Settings .....</i>	<i>130</i>
<i>B.6.2 Configure TFTP Settings .....</i>	<i>131</i>
<i>B.6.3 Configure One Key Recovery Server Settings .....</i>	<i>132</i>

## ICE-QM871 COM Express Module

<i>B.6.4 Start the DHCP, TFTP and HTTP .....</i>	<i>133</i>
<i>B.6.5 Create Shared Directory.....</i>	<i>133</i>
<i>B.6.6 Setup a Client System for Auto Recovery .....</i>	<i>134</i>
<b>B.7 OTHER INFORMATION .....</b>	<b>137</b>
<i>B.7.1 Using AHCI Mode or ALi M5283 / VIA VT6421A Controller.....</i>	<i>137</i>
<i>B.7.2 System Memory Requirement .....</i>	<i>139</i>
<b>C INTEL® AMT CONFIGURATION.....</b>	<b>140</b>
<i>C.1 INTEL® AMT SETUP PROCEDURE .....</i>	<i>141</i>
<i>C.2 INTEL® MANAGEMENT ENGINE BIOS EXTENSION .....</i>	<i>141</i>
<i>C.3 USING THE INTEL® AMT WEB INTERFACE .....</i>	<i>146</i>
<b>D TERMINOLOGY .....</b>	<b>149</b>
<b>E WATCHDOG TIMER.....</b>	<b>153</b>
<b>F HAZARDOUS MATERIALS DISCLOSURE.....</b>	<b>156</b>
<i>F.1 HAZARDOUS MATERIALS DISCLOSURE TABLE FOR IPB PRODUCTS CERTIFIED AS ROHS COMPLIANT UNDER 2002/95/EC WITHOUT MERCURY .....</i>	<i>157</i>

# List of Figures

Figure 1-1: ICE-QM871 .....	2
Figure 1-2: Connectors .....	3
Figure 1-3: ICE-QM871 Dimensions (mm).....	4
Figure 1-4: ICE-QM871 with Heatspreader Plate and Cooler Kit Dimensions (mm).....	5
Figure 1-5: Data Flow Diagram.....	6
Figure 3-1: Connectors .....	14
Figure 3-2: COM Express Connector AB Location .....	15
Figure 3-3: COM Express Connector CD Location .....	20
Figure 3-4: SO-DIMM Connector Locations .....	24
Figure 3-5: SPI Flash Connector (BIOS) Location.....	25
Figure 3-6: SPI Flash Connector (EC) Location .....	26
Figure 4-1: SO-DIMM Installation .....	30
Figure 4-2: LVDS Panel Type Selection Switch Location.....	32
Figure 4-3: Connect the COM Express Connectors.....	33
Figure 4-4: Attach the Cooling Kit to the Heatspreader Plate.....	33
Figure 4-5: Secure the Heatspreader Plate with the Cooling Kit to the Baseboard .....	34
Figure 4-6: Connect to the CPU Fan Connector on the Baseboard .....	35
Figure 6-1: Start Up Screen .....	75
Figure 6-2: Drivers .....	75
Figure 6-3: Chipset Driver Welcome Screen.....	76
Figure 6-4: Chipset Driver License Agreement .....	77
Figure 6-5: Chipset Driver Read Me File .....	77
Figure 6-6: Chipset Driver Setup Operations .....	78
Figure 6-7: Chipset Driver Installation Finish Screen.....	79
Figure 6-8: Graphics Driver Welcome Screen .....	80
Figure 6-9: Graphics Driver License Agreement.....	80
Figure 6-10: Graphics Driver Read Me File .....	81
Figure 6-11: Graphics Driver Setup Operations .....	81
Figure 6-12: Graphics Driver Installation Finish Screen .....	82
Figure 6-13: Windows Control Panel.....	83



## ICE-QM871 COM Express Module

Figure 6-14: System Control Panel .....	83
Figure 6-15: Device Manager List .....	84
Figure 6-16: Update Driver Software Window .....	85
Figure 6-17: Locate Driver Files .....	85
Figure 6-18: LAN Driver Installation .....	86
Figure 6-19: LAN Driver Installation Complete .....	86
Figure 6-20: USB 3.0 Driver Welcome Screen .....	87
Figure 6-21: USB 3.0 Driver License Agreement .....	88
Figure 6-22: USB 3.0 Driver Read Me File .....	88
Figure 6-23: USB 3.0 Driver Setup Operations .....	89
Figure 6-24: USB 3.0 Driver Installation Finish Screen .....	89
Figure 6-25: Audio Driver Welcome Screen .....	90
Figure 6-26: Audio Driver Installation .....	91
Figure 6-27: Audio Driver Installation Complete .....	91
Figure 6-28: Intel® ME Driver Welcome Screen .....	92
Figure 6-29: Intel® ME Driver License Agreement .....	93
Figure 6-30: Intel® ME Driver Setup Operations .....	93
Figure 6-31: Intel® ME Driver Installation Finish Screen .....	94
Figure B-1: IEI One Key Recovery Tool Menu .....	99
Figure B-2: Launching the Recovery Tool .....	104
Figure B-3: Recovery Tool Setup Menu .....	104
Figure B-4: Command Prompt .....	105
Figure B-5: Partition Creation Commands .....	106
Figure B-6: Launching the Recovery Tool .....	108
Figure B-7: Manual Recovery Environment for Windows .....	108
Figure B-8: Building the Recovery Partition .....	109
Figure B-9: Press Any Key to Continue .....	109
Figure B-10: Press F3 to Boot into Recovery Mode .....	110
Figure B-11: Recovery Tool Menu .....	110
Figure B-12: About Symantec Ghost Window .....	111
Figure B-13: Symantec Ghost Path .....	111
Figure B-14: Select a Local Source Drive .....	112
Figure B-15: Select a Source Partition from Basic Drive .....	112
Figure B-16: File Name to Copy Image to .....	113
Figure B-17: Compress Image .....	113

Figure B-18: Image Creation Confirmation .....	114
Figure B-19: Image Creation Complete .....	114
Figure B-20: Image Creation Complete .....	114
Figure B-21: Press Any Key to Continue .....	115
Figure B-22: Auto Recovery Utility .....	116
Figure B-23: Disable Automatically Restart.....	116
Figure B-24: Launching the Recovery Tool .....	117
Figure B-25: Auto Recovery Environment for Windows .....	117
Figure B-26: Building the Auto Recovery Partition.....	118
Figure B-27: Factory Default Image Confirmation .....	118
Figure B-28: Image Creation Complete .....	119
Figure B-29: Press any key to continue .....	119
Figure B-30: IEI Feature .....	120
Figure B-31: Partitions for Linux.....	121
Figure B-32: System Configuration for Linux.....	122
Figure B-33: Access menu.lst in Linux (Text Mode).....	122
Figure B-34: Recovery Tool Menu .....	123
Figure B-35: Recovery Tool Main Menu .....	124
Figure B-36: Restore Factory Default.....	125
Figure B-37: Recovery Complete Window .....	125
Figure B-38: Backup System.....	126
Figure B-39: System Backup Complete Window .....	126
Figure B-40: Restore Backup .....	127
Figure B-41: Restore System Backup Complete Window .....	127
Figure B-42: Symantec Ghost Window .....	128
Figure B-43: Disable Automatically Restart.....	135
Figure C-1: Intel® Active Management Technology Status Dialog .....	141
Figure C-2: Intel® Current ME Password .....	142
Figure C-3: Change Intel® ME Password.....	143
Figure C-4: Verify New Password .....	143
Figure C-5: Intel® AMT Configuration .....	143
Figure C-6: Provision Model.....	144
Figure C-7: Intel® AMT 2.0 Mode .....	144
Figure C-8: Enterprise.....	145
Figure C-9: Enable Network Interface.....	145

## ICE-QM871 COM Express Module

Figure C-10: Exit .....	146
Figure C-11: Intel® AMT Web Address.....	147
Figure C-12: Intel® AMT Web Login Dialog .....	147
Figure C-13: Intel® AMT Web Interface .....	148

# List of Tables

---

Table 1-1: ICE-QM871 Specifications .....	8
Table 2-1: Packing List.....	12
Table 2-2: Optional Items.....	12
Table 3-1: Peripheral Interface Connectors.....	15
Table 3-2: COM Express Connector AB Pin Definitions.....	19
Table 3-3: COM Express Connector CD Pin Definitions.....	23
Table 3-4: SPI Flash Connector (BIOS) Pinouts .....	25
Table 3-5: SPI Flash Connector (EC) Pinouts.....	26
Table 4-1: LVDS Panel Type Selection .....	31
Table 5-1: BIOS Navigation Keys .....	38

# BIOS Menus

BIOS Menu 1: Main .....	39
BIOS Menu 2: Advanced .....	41
BIOS Menu 3: ACPI Settings .....	41
BIOS Menu 4: RTC Wake Settings .....	42
BIOS Menu 5: Trusted Computing .....	44
BIOS Menu 6: CPU Configuration .....	45
BIOS Menu 7: SATA Configuration .....	47
BIOS Menu 8: Intel(R) Rapid Start Technology .....	48
BIOS Menu 9: AMT Configuration .....	49
BIOS Menu 10: USB Configuration .....	50
BIOS Menu 11: iWDD H/W Monitor .....	51
BIOS Menu 12: Smar Fan Mode Configuration.....	52
BIOS Menu 13: F81866 Super IO Configuration .....	53
BIOS Menu 14: Serial Port n Configuration Menu .....	54
BIOS Menu 15: F81866 H/W Monitor .....	56
BIOS Menu 16: Smart Fan Mode Configuration .....	57
BIOS Menu 17: Serial Port Console Redirection .....	58
BIOS Menu 18: iEi Feature .....	60
BIOS Menu 19: Chipset .....	61
BIOS Menu 20: System Agent (SA) Configuration .....	62
BIOS Menu 21: Graphics Configuration .....	63
BIOS Menu 22: NB PCIe Configuration .....	65
BIOS Menu 23: Memory Configuration.....	66
BIOS Menu 24: PCH-IO Configuration .....	67
BIOS Menu 25: PCI Express Configuration .....	68
BIOS Menu 26: Boot .....	69
BIOS Menu 27: Security .....	71
BIOS Menu 28: Save & Exit.....	72

Chapter

1

# Introduction

---

## 1.1 Introduction

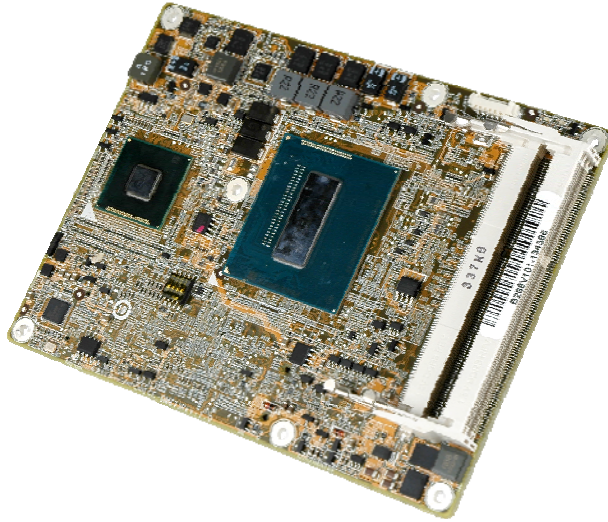

Figure 1-1: ICE-QM871

The ICE-QM871 COM Express Type 6 module provides the main processing chips and is connected to a compatible COM Express baseboard. The ICE-QM871 is equipped with the Intel® QM87 Express Chipset and the 4th generation Intel® Core™ i7/i5/i3 or Celeron® processor. The COM Express standard allows the COM Express baseboard to be designed, while leaving the choice of processor till the later stages of design. The ICE-QM871 provides a low power option with the full range of modern I/O options. The ICE-QM871 embedded module is designed for flexible integration by system developers into customized platform devices.

## 1.2 Features

Some of the ICE-QM871 COM Express module features are listed below:

- Complies with COM Express Type 6 form factor
- Supports 4th generation Intel® Core™ i7/i5/i3 or Celeron® processor
- Intel® QM87 Express Chipset
- Supports DDR3/DDR3L (1.35V) SO-DIMM
- Supports 18-/24-bit dual-channel LVDS, analog CRT (VGA) and HDTV
- Supports USB 3.0, SATA 6Gb/s and GbE
- RoHS compliant

## ICE-QM871 COM Express Module

### 1.3 Connectors

The connectors on the ICE-QM871 are shown in the figures below.

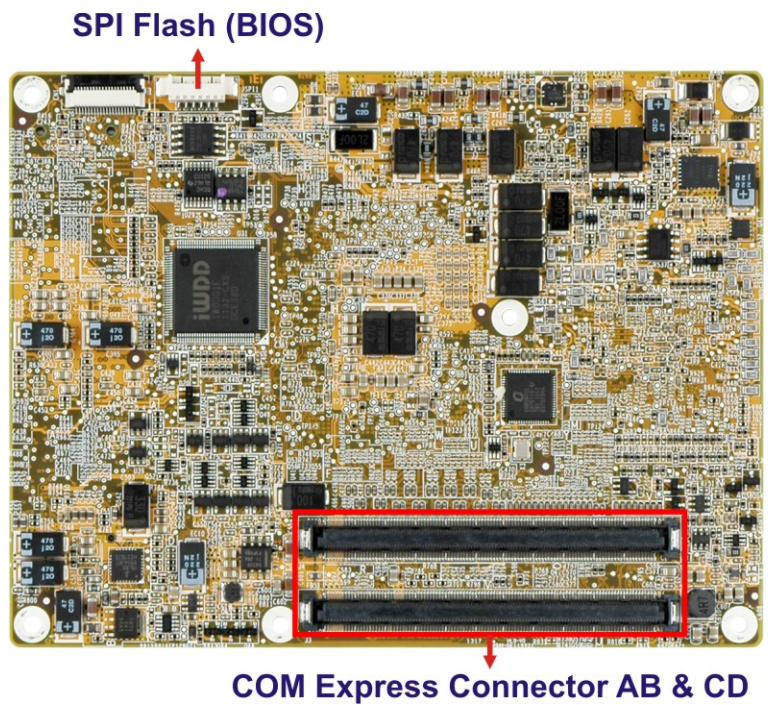
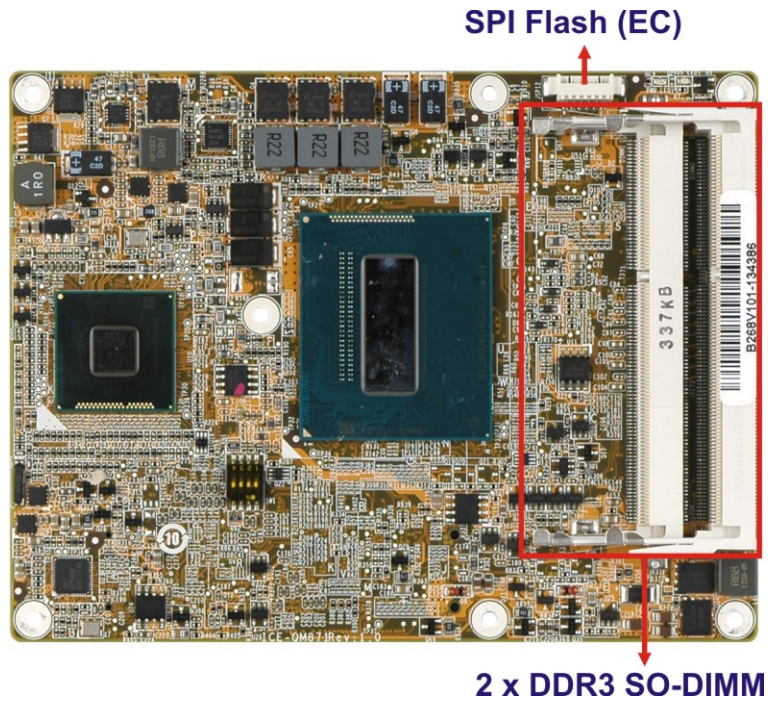

Figure 1-2: Connectors



### 1.4 Dimensions

The main dimensions of the ICE-QM871 are shown in the diagram below.

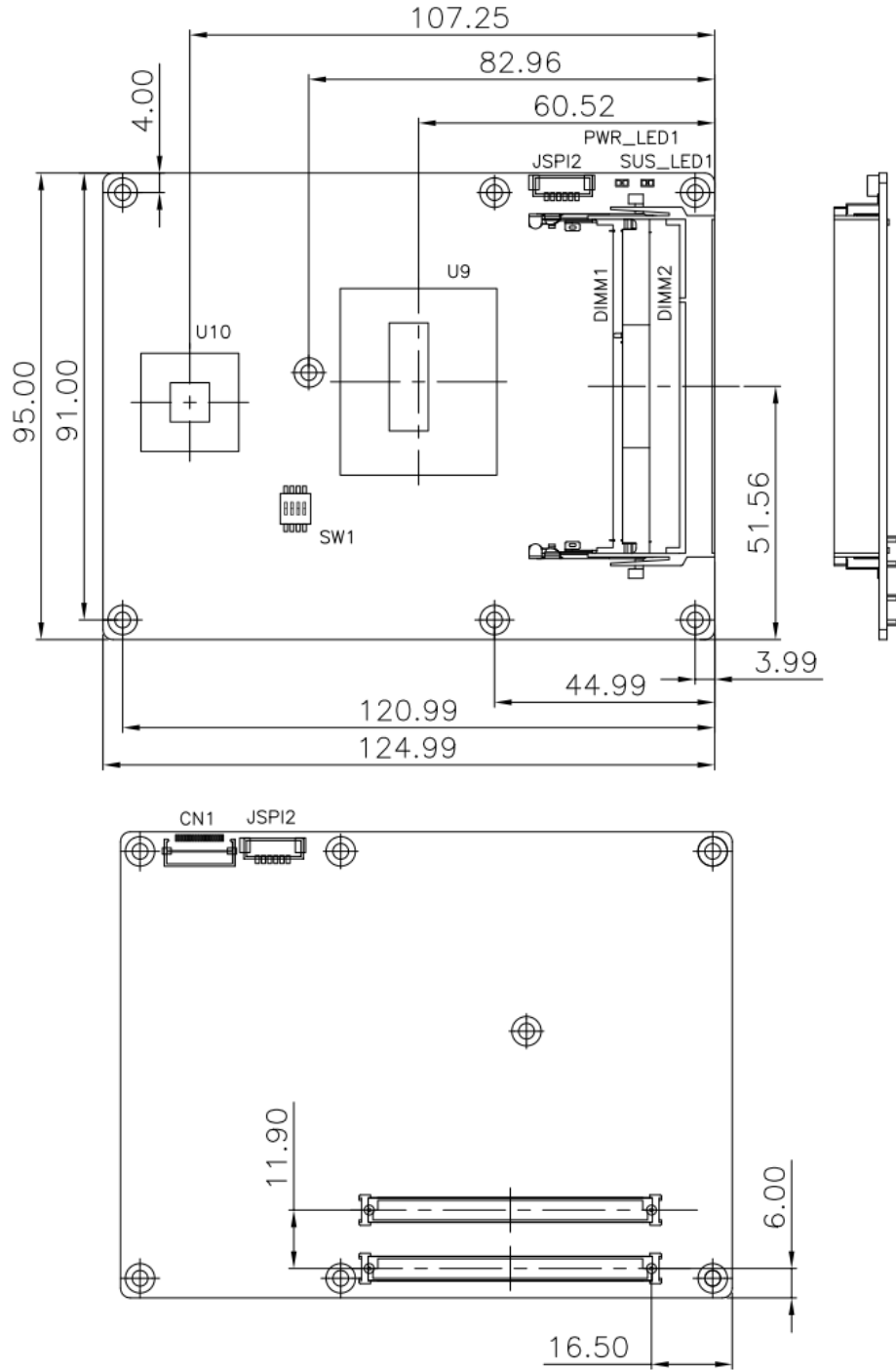

Figure 1-3: ICE-QM871 Dimensions (mm)

ICE-QM871 COM Express Module

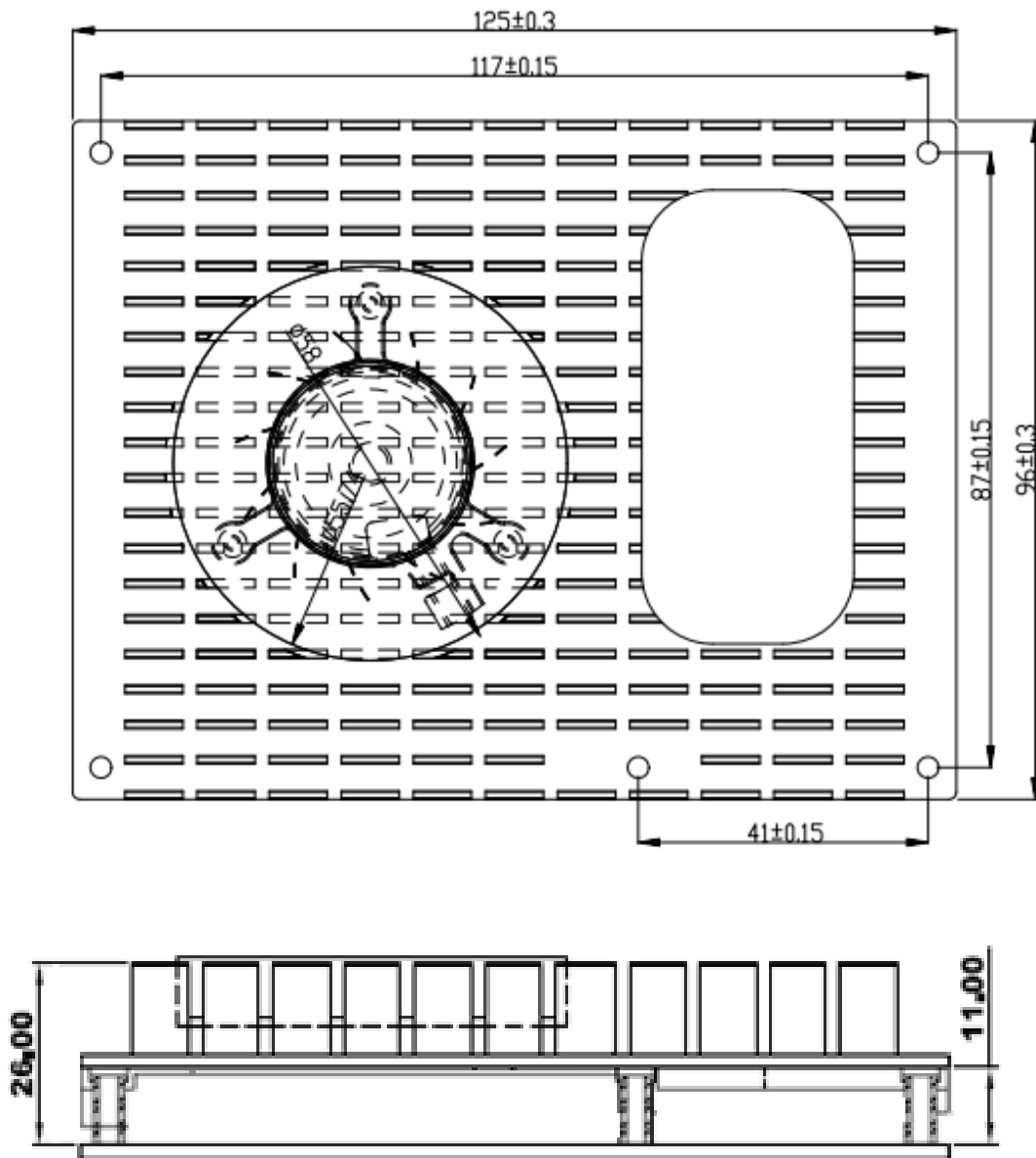

Figure 1-4: ICE-QM871 with Heatspreader Plate and Cooler Kit Dimensions (mm)

### 1.5 Data Flow

Figure 1-5 shows the data flow between the system chipset, the CPU and other components installed on the motherboard.

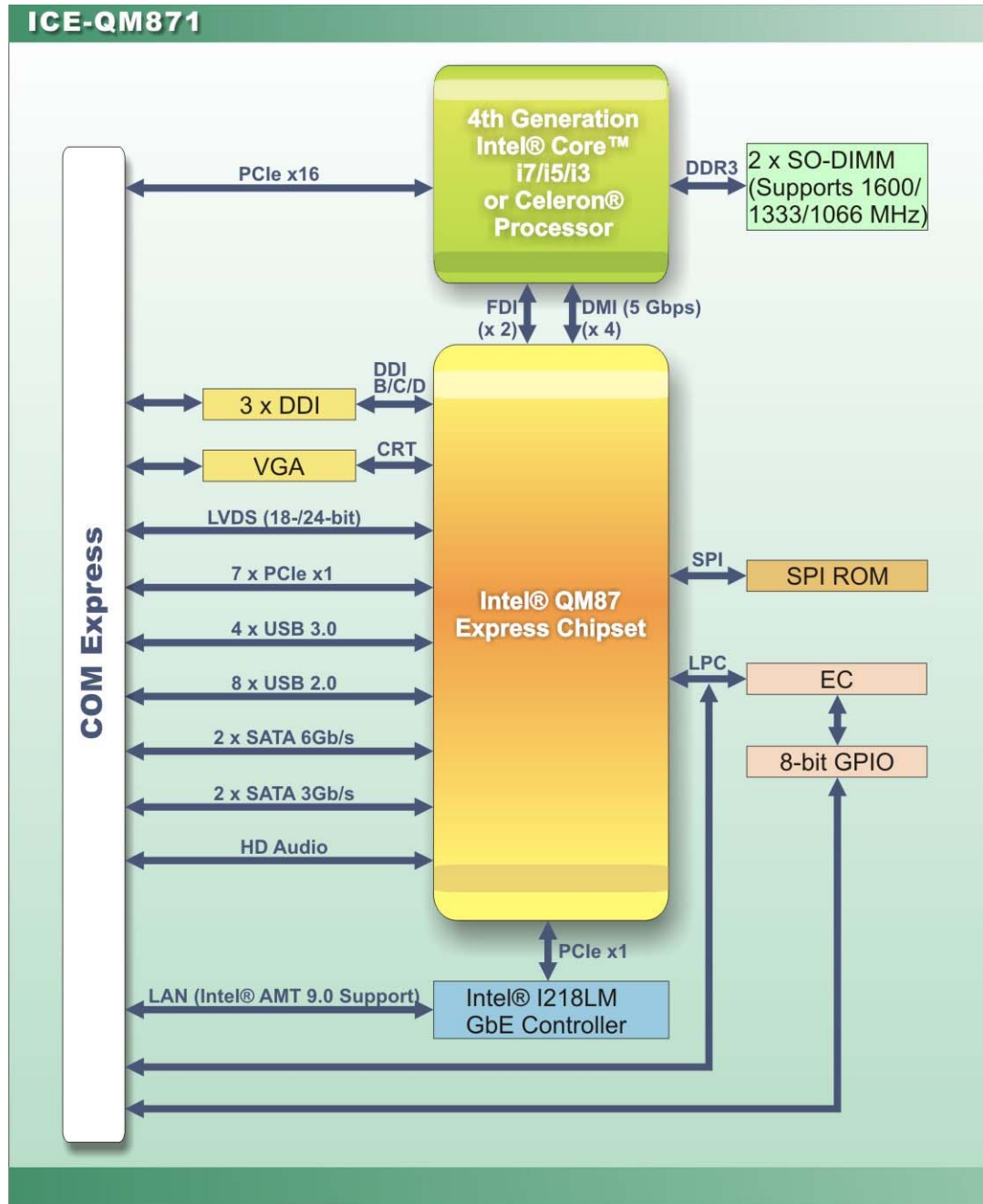

Figure 1-5: Data Flow Diagram

## ICE-QM871 COM Express Module

### 1.6 Technical Specifications

The ICE-QM871 technical specifications are listed below.

	ICE-QM871
<b>Form Factor</b>	PICMG COM Express R2.1 Type 6 for basic size (95 mm x 125 mm)
<b>CPU Supported</b>	4th generation Intel® Core™ i7/i5/i3 or Celeron® processor
<b>Express Chipset</b>	Intel® QM87
<b>Memory</b>	Two 204-pin 1600/1333/1066 MHz dual-channel DDR3/DDR3L (1.35V) unbuffered SO-DIMMs supported (system max. 16 GB)
<b>Graphics Engine</b>	Intel® HD Graphics Gen 7 Supports DirectX 11 and OpenCL 1.1 Full MPEG2, VC-1 and AVC decoding
<b>Ethernet</b>	Intel® I218LM Ethernet Controller Supports Intel® AMT 9.0
<b>BIOS</b>	UEFI BIOS
<b>Embedded Controller</b>	iWDD
<b>Watchdog Timer</b>	Software programmable supports 1~255 sec. system reset
<b>Display (Signal to Baseboard)</b>	One VGA (up to 2048 x 1536 @ 75Hz) is integrated in the Intel® QM87 One 18-/24-bit dual-channel LVDS (up to 1920 x 1200 @ 60Hz) Three DDI (up to 2560 x 1600 @ 60Hz)
<b>Expansions (Signal to Baseboard)</b>	One PCIe x16 Seven PCIe x1

	<b>ICE-QM871</b>
<b>I/O Interfaces (Signal to Baseboard)</b>	Four USB 3.0 Eight USB 2.0 Two SATA 6Gb/s Two SATA 3Gb/s Two RS-232 HD Audio 8-bit GPIO SMBus I2C LPC TPM SPI
<b>Power Consumption</b>	+12V @ 1.75 A , Vcore_12V @ 3.33A (2.30 GHz Intel® Core™ i7-3610QE CPU with two 8 GB 1600 MHz DDR3 SO-DIMMs)
<b>Operating Temperature</b>	-20°C ~ 65°C
<b>Storage Temperature</b>	-30°C ~ 75°C
<b>Humidity (Operating)</b>	5% ~ 95% (non-condensing)
<b>Dimensions</b>	125 mm x 95 mm
<b>Weight (GW/NW)</b>	700 g/250 g

**Table 1-1: ICE-QM871 Specifications**

Chapter

2

# Packing List

---

## 2.1 Anti-static Precautions

---



### **WARNING!**

Static electricity can destroy certain electronics. Make sure to follow the ESD precautions to prevent damage to the product, and injury to the user.

---

Make sure to adhere to the following guidelines:

- ***Wear an anti-static wristband:*** Wearing an anti-static wristband can prevent electrostatic discharge.
- ***Self-grounding:*** Touch a grounded conductor every few minutes to discharge any excess static buildup.
- ***Use an anti-static pad:*** When configuring any circuit board, place it on an anti-static mat.
- ***Only handle the edges of the PCB:*** Don't touch the surface of the motherboard. Hold the motherboard by the edges when handling.

## 2.2 Unpacking Precautions

When the ICE-QM871 is unpacked, please do the following:

- Follow the antistatic guidelines above.
- Make sure the packing box is facing upwards when opening.
- Make sure all the packing list items are present.

## ICE-QM871 COM Express Module





### 2.3 Packing List



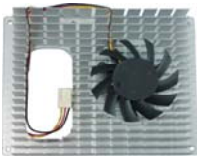

#### NOTE:

If any of the components listed in the checklist below are missing, do not proceed with the installation. Contact the IEI reseller or vendor the ICE-QM871 was purchased from or contact an IEI sales representative directly by sending an email to [sales@iei.com.tw](mailto:sales@iei.com.tw).

The ICE-QM871 is shipped with the following components:

Quantity	Item and Part Number	Image
1	ICE-QM871	
1	Heatspreader plate (P/N: 34000-000490-RS)	
1	Cooling kit (P/N: 19100-000168-00-RS)	
1	One Key Recovery CD	



Quantity	Item and Part Number	Image
1	Utility CD	
1	Quick Installation Guide	

**Table 2-1: Packing List**

## 2.4 Optional Items

The following are optional components which may be separately purchased:

Item and Part Number	Image
Baseboard for COM Express Type 6 modules (P/N: ICE-DB-T6R-R10)	

**Table 2-2: Optional Items**

Chapter

3

# Connectors

---

### 3.1 Peripheral Interface Connectors

This chapter details all the connectors.

#### 3.1.1 ICE-QM871 Layout

The figure below shows all the connectors.

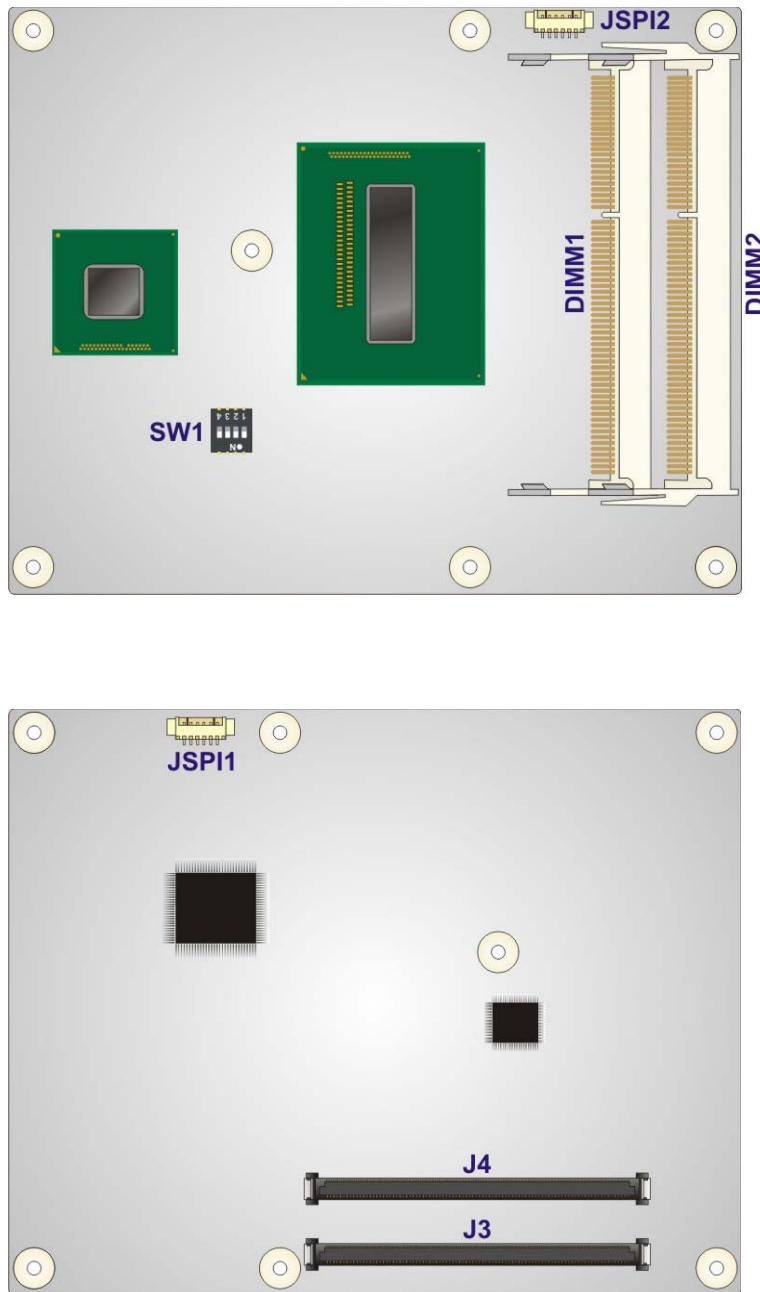

Figure 3-1: Connectors

## ICE-QM871 COM Express Module

### 3.1.2 Peripheral Interface Connectors

The table below lists all the connectors on the ICE-QM871.

Connector	Type	Label
COM Express connector AB	COM Express connector	J3
COM Express connector CD	COM Express connector	J4
SO-DIMM connectors	SO-DIMM connector	DIMM1, DIMM2
SPI Flash (BIOS)	6-pin connector	JSPI1
SPI Flash (EC)	6-pin connector	JSPI2

**Table 3-1: Peripheral Interface Connectors**

### 3.2 Internal Peripheral Connectors

The section describes all of the connectors on the ICE-QM871.

#### 3.2.1 COM Express Connector AB

- CN Label:** J3
- CN Type:** 220-pin COM Express connector
- CN Location:** See **Figure 3-2**
- CN Pinouts:** See **Table 3-2**

The standard COM Express connector AB location and pinouts are shown below.

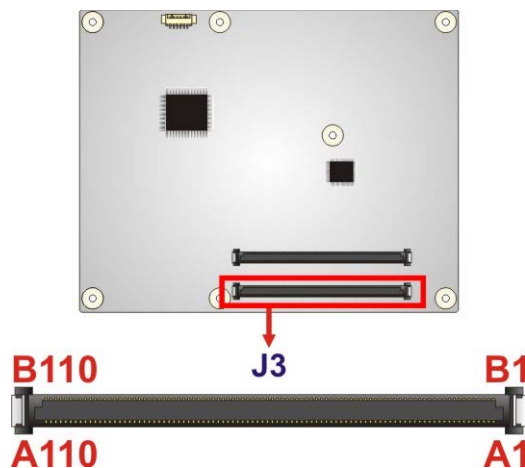

**Figure 3-2: COM Express Connector AB Location**

Pin No.	Description	Pin No.	Description
A1	GND	B1	GND15
A2	GBE0_MDI3-	B2	GBE0_ACT#
A3	GBE0_MDI3+	B3	LPC_FRAME#
A4	GBE0_LINK100#	B4	LPC_AD0
A5	GBE0_LINK1000#	B5	LPC_AD1
A6	GBE0_MDI2-	B6	LPC_AD2
A7	GBE0_MDI2+	B7	LPC_AD3
A8	GBE0_LINK#	B8	LPC_DRQ0#
A9	GBE0_MDI1-	B9	LPC_DRQ1#
A10	GBE0_MDI1+	B10	LPC_CLK
A11	GND1	B11	GND16
A12	GBE0_MDIO-	B12	PWRBTN#
A13	GBE0_MDIO+	B13	SMB_CK
A14	GBE0_CTREF	B14	SMB_DAT
A15	SUS_S3#	B15	SMB_ALERT#
A16	SATA0_TX+	B16	SATA1_TX+
A17	SATA0_TX-	B17	SATA1_TX-
A18	SUS_S4#	B18	SUS_STAT#
A19	SATA0_RX+	B19	SATA1_RX+
A20	SATA0_RX-	B20	SATA1_RX-
A21	GND2	B21	GND17
A22	SATA2_TX+	B22	SATA3_TX+
A23	SATA2_TX-	B23	SATA3_TX-
A24	SUS_S5#	B24	PWR_OK
A25	SATA2_RX+	B25	SATA3_RX+
A26	SATA2_RX-	B26	SATA3_RX-
A27	BATLOW#	B27	WDT
A28	ATA_ACT#	B28	AC/HD_SDIN2
A29	AC/HD_SYNC	B29	AC/HD_SDIN1
A30	AC/HD_RST#	B30	AC/HD_SDINO
A31	GND3	B31	GND18
A32	AC/HD_BITCLK	B32	SPKR

## ICE-QM871 COM Express Module

Pin No.	Description	Pin No.	Description
A33	AC/HD_SDOUT	B33	I2C_CK
A34	BIOS_DISABLE#	B34	I2C_DAT
A35	THRMTRIP#	B35	THRM#
A36	USB6-	B36	USB7-
A37	USB6+	B37	USB7+
A38	USB_6_7_OC#	B38	USB_4_5_OC#
A39	USB4-	B39	USB5-
A40	USB4+	B40	USB5+
A41	GND4	B41	GND
A42	USB2-	B42	USB3-
A43	USB2+	B43	USB3+
A44	USB_2_3_OC#	B44	USB_0_1_OC#
A45	USB0-	B45	USB1-
A46	USB0+	B46	USB1+
A47	VCC_RTC	B47	EXCD1_PERST#
A48	EXCD0_PERST#	B48	EXCD1_CPPE#
A49	EXCD0_CPPE#	B49	SYS_RESET#
A50	LPC_SERIRQ	B50	CB_RESET#
A51	GND5	B51	GND20
A52	PCIE_TX5+	B52	PCIE_RX5+
A53	PCIE_TX5-	B53	PCIE_RX5-
A54	GPI0	B54	GPO1
A55	PCIE_TX4+	B55	PCIE_RX4+
A56	PCIE_TX4-	B56	PCIE_RX4-
A57	GND6	B57	GPO2
A58	PCIE_TX3+	B58	PCIE_RX3+
A59	PCIE_TX3-	B59	PCIE_RX3-
A60	GND7	B60	GND
A61	PCIE_TX2+	B61	PCIE_RX2+
A62	PCIE_TX2-	B62	PCIE_RX2-
A63	GPI1	B63	GPO3
A64	PCIE_TX1+	B64	PCIE_RX1+

Pin No.	Description	Pin No.	Description
A65	PCIE_TX1-	B65	PCIE_RX1-
A66	GND8	B66	WAKE0#
A67	GPI2	B67	WAKE1#
A68	PCIE_TX0+	B68	PCIE_RX0+
A69	PCIE_TX0-	B69	PCIE_RX0-
A70	GND9	B70	GND22
A71	LVDS_A0+	B71	LVDS_B0+
A72	LVDS_A0-	B72	LVDS_B0-
A73	LVDS_A1+	B73	LVDS_B1+
A74	LVDS_A1-	B74	LVDS_B1-
A75	LVDS_A2+	B75	LVDS_B2+
A76	LVDS_A2-	B76	LVDS_B2-
A77	LVDS_VDD_EN	B77	LVDS_B3+
A78	LVDS_A3+	B78	LVDS_B3-
A79	LVDS_A3-	B79	LVDS_BKLT_EN
A80	GND10	B80	GND23
A81	LVDS_A_CK+	B81	LVDS_B_CK+
A82	LVDS_A_CK-	B82	LVDS_B_CK-
A83	LVDS_I2C_CK	B83	LVDS_BKLT_CTRL
A84	LVDS_I2C_DAT	B84	VCC5SBY1
A85	GPI3	B85	VCC5SBY2
A86	RSVD	B86	VCC5SBY3
A87	RSVD	B87	VCC5SBY4
A88	PCIE0_CK_REF+	B88	BIOS_DIS1#
A89	PCIE0_CK_REF-	B89	VGA_RED
A90	GND11	B90	GND24
A91	SPI_VCC	B91	VGA_GRN
A92	SPI_MISO	B92	VGA_BLU
A93	GPO0	B93	VGA_HSYNC
A94	SPI_CLK	B94	VGA_VSYNC
A95	SPI_MOSI	B95	VGA_I2C_CK
A96	PP_TPM	B96	VGA_I2C_DAT

## ICE-QM871 COM Express Module

Pin No.	Description	Pin No.	Description
A97	RSVD	B97	SPI_CS#
A98	RS1_TX	B98	RSVD
A99	RS1_RX	B99	RSVD
A100	GND13	B100	GND25
A101	RS2_TX	B101	FAN_PWMOUT
A102	RS2_RX	B102	FAN_TACHIN
A103	LID#	B103	SLEEP#
A104	VCC_12V7	B104	VCC_12V16
A105	VCC_12V8	B105	VCC_12V17
A106	VCC_12V9	B106	VCC_12V18
A107	VCC_12V10	B107	VCC_12V19
A108	VCC_12V11	B108	VCC_12V20
A109	VCC_12V12	B109	VCC_12V21
A110	GND14	B110	GND26

**Table 3-2: COM Express Connector AB Pin Definitions**

### 3.2.2 COM Express Connector CD

- CN Label:** J4
- CN Type:** 220-pin COM Express connector
- CN Location:** See **Figure 3-3**
- CN Pinouts:** See **Table 3-3**

The standard COM Express connector CD location and pinouts are shown below.

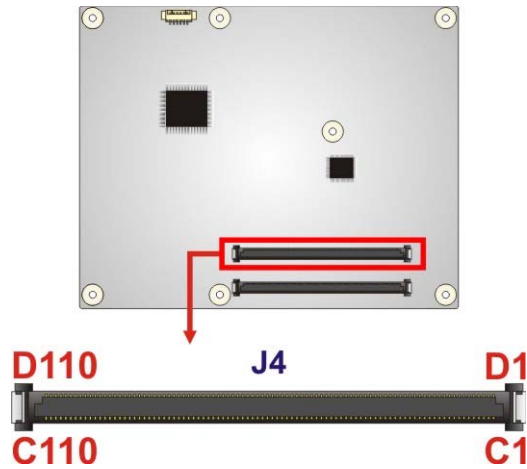

**Figure 3-3: COM Express Connector CD Location**

Pin No.	Description	Pin No.	Description
C1	GND0	D1	GND15
C2	GND	D2	GND
C3	USB_SSRX0-	D3	USB_SSTX0-
C4	USB_SSRX0+	D4	USB_SSTX0+
C5	GND	D5	GND
C6	USB_SSRX1-	D6	USB_SSTX1-
C7	USB_SSRX1+	D7	USB_SSTX1+
C8	GND	D8	GND
C9	USB_SSRX2-	D9	USB_SSTX2-
C10	USB_SSRX2+	D10	USB_SSTX2+
C11	GND1	D11	GND16
C12	USB_SSRX3-	D12	USB_SSTX3-
C13	USB_SSRX3+	D13	USB_SSTX3+
C14	GND	D14	GND
C15	RSVD	D15	DDI1_CTRLCLK_AUX+
C16	RSVD	D16	DDI1_CTRLDATA_AUX-
C17	RSVD	D17	RSVD
C18	RSVD	D18	RSVD
C19	PCIE_RX6+	D19	PCIE_TX6+
C20	PCIE_RX6-	D20	PCIE_TX6-
C21	GND2	D21	GND17

## ICE-QM871 COM Express Module

Pin No.	Description	Pin No.	Description
C22	RSVD	D22	RSVD
C23	RSVD	D23	RSVD
C24	DDI1_HPDP	D24	RSVD
C25	RSVD	D25	RSVD
C26	RSVD -	D26	DDI1_PAIR0+
C27	RSVD	D27	DDI1_PAIR0-
C28	RSVD	D28	RSVD
C29	RSVD	D29	DDI1_PAIR1+
C30	RSVD	D30	DDI1_PAIR1-
C31	GND3	D31	GND18
C32	DDI2_CTRLCLK_AUX+	D32	DDI1_PAIR2+
C33	DDI2_CTRLDATA_AUX-	D33	DDI1_PAIR2-
C34	DDI2_DDC_AUX_SEL	D34	DDI1_DDC_AUX_SEL
C35	RSVD	D35	RSVD
C36	DDI3_CTRLCLK_AUX+	D36	DDI1_PAIR3+
C37	DDI3_CTRLDATA_AUX-	D37	DDI1_PAIR3-
C38	DDI3_DDC_AUX_SEL	D38	RSVD
C39	DDI3_PAIR0+	D39	DDI2_PAIR0+
C40	DDI3_PAIR0-	D40	DDI2_PAIR0-
C41	GND4	D41	GND19
C42	DDI3_PAIR1+	D42	DDI2_PAIR1+
C43	DDI3_PAIR1-	D43	DDI2_PAIR1-
C44	DDI3_HPDP	D44	DDI2_HPDP
C45	RSVD	D45	RSVD
C46	DDI3_PAIR2+	D46	DDI2_PAIR2+
C47	DDI3_PAIR2-	D47	DDI2_PAIR2-
C48	RSVD	D48	RSVD
C49	DDI3_PAIR3+	D49	DDI2_PAIR3+
C50	DDI3_PAIR3-	D50	DDI2_PAIR3-
C51	GND5	D51	GND20
C52	PEG_RX0+	D52	PEG_TX0+
C53	PEG_RX0-	D53	PEG_TX0-

Pin No.	Description	Pin No.	Description
C54	RSVD	D54	PEG_LANE_RV#
C55	PEG_RX1+	D55	PEG_TX1+
C56	PEG_RX1-	D56	PEG_TX1-
C57	RSVD	D57	TYPE2#
C58	PEG_RX2+	D58	PEG_TX2+
C59	PEG_RX2-	D59	PEG_TX2-
C60	GND7	D60	GND21
C61	PEG_RX3+	D61	PEG_TX3+
C62	PEG_RX3-	D62	PEG_TX3-
C63	RSVD1	D63	RSVD10
C64	RSVD2	D64	RSVD9
C65	PEG_RX4+	D65	PEG_TX4+
C66	PEG_RX4-	D66	PEG_TX4-
C67	RSVD3	D67	GND28
C68	PEG_RX5+	D68	PEG_TX5+
C69	PEG_RX5-	D69	PEG_TX5-
C70	GND9	D70	GND22
C71	PEG_RX6+	D71	PEG_TX6+
C72	PEG_RX6-	D72	PEG_TX6-
C73	GND	D73	GND
C74	PEG_RX7+	D74	PEG_TX7+
C75	PEG_RX7-	D75	PEG_TX7-
C76	GND8	D76	GND29
C77	RSVD4	D77	RSVD
C78	PEG_RX8+	D78	PEG_TX8+
C79	PEG_RX8-	D79	PEG_TX8-
C80	GND10	D80	GND23
C81	PEG_RX9+	D81	PEG_TX9+
C82	PEG_RX9-	D82	PEG_TX9-
C83	RSVD5	D83	RSVD8
C84	GND6	D84	GND30
C85	PEG_RX10+	D85	PEG_TX10+

## ICE-QM871 COM Express Module

Pin No.	Description	Pin No.	Description
C86	PEG_RX10-	D86	PEG_TX10-
C87	GND35	D87	GND31
C88	PEG_RX11+	D88	PEG_TX11+
C89	PEG_RX11-	D89	PEG_TX11-
C90	GND27	D90	GND24
C91	PEG_RX12+	D91	PEG_TX12+
C92	PEG_RX12-	D92	PEG_TX12-
C93	GND11	D93	GND32
C94	PEG_RX13+	D94	PEG_TX13+
C95	PEG_RX13-	D95	PEG_TX13-
C96	GND12	D96	GND33
C97	RSVD6	D97	RSVD
C98	PEG_RX14+	D98	PEG_TX14+
C99	PEG_RX14-	D99	PEG_TX14-
C100	GND13	D100	GND25
C101	PEG_RX15+	D101	PEG_TX15+
C102	PEG_RX15-	D102	PEG_TX15-
C103	GND	D103	GND34
C104	VCC_12V1	D104	VCC_12V7
C105	VCC_12V2	D105	VCC_12V8
C106	VCC_12V3	D106	VCC_12V9
C107	VCC_12V4	D107	VCC_12V10
C108	VCC_12V5	D108	VCC_12V11
C109	VCC_12V6	D109	VCC_12V12
C110	GND14	D110	GND26

**Table 3-3: COM Express Connector CD Pin Definitions**

### 3.2.3 SO-DIMM Connectors

- CN Label:** DIMM1, DIMM2
- CN Type:** 204-pin DDR3 SO-DIMM connector
- CN Location:** See **Figure 3-4**

The SO-DIMM connectors are for installing memory on the system.

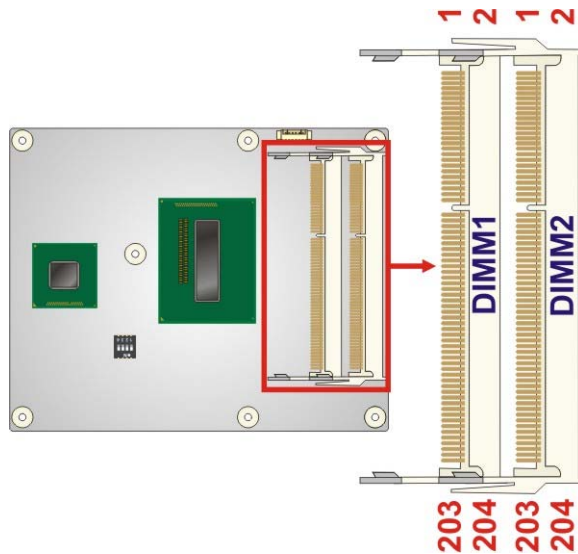

Figure 3-4: SO-DIMM Connector Locations

### 3.2.4 SPI Flash Connector (BIOS)

- CN Label:** JSPI1
- CN Type:** 6-pin connector
- CN Location:** See **Figure 3-6**
- CN Pinouts:** See **Table 3-5**

The SPI Flash connector is for flashing new BIOS onto the SPI BIOS chip.

## ICE-QM871 COM Express Module

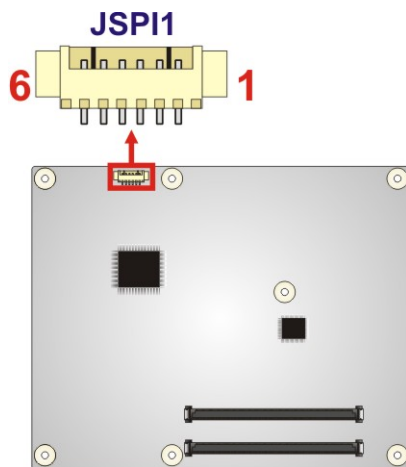

**Figure 3-5: SPI Flash Connector (BIOS) Location**

Pin	Description
1	+V3.3M_SPI_CON
2	SPI_CS
3	SPI_SO_SW
4	SPI_CLK_SW
5	SPI_SI_SW
6	GND

**Table 3-4: SPI Flash Connector (BIOS) Pinouts**

### 3.2.5 SPI Flash Connector (EC)

- CN Label:** JSPI2
- CN Type:** 6-pin connector
- CN Location:** See **Figure 3-6**
- CN Pinouts:** See **Table 3-5**

The SPI Flash connector is for flashing new BIOS onto the embedded controller.

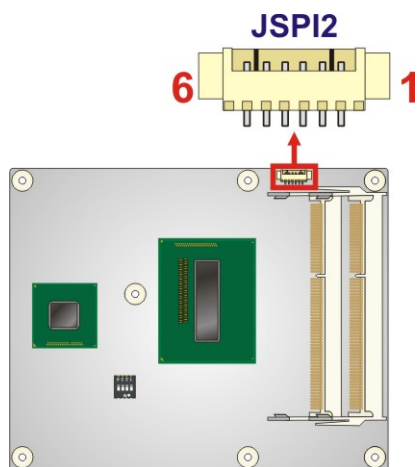

**Figure 3-6: SPI Flash Connector (EC) Location**

Pin	Description
1	+V3.3M_SPI_CON_EC
2	SPI_CS#0_CN_EC
3	SPI_SO_SW_EC
4	SPI_CLK_SW_EC
5	SPI_SI_SW_EC
6	GND

**Table 3-5: SPI Flash Connector (EC) Pinouts**

Chapter

4

# Installation

---



## 4.1 Anti-static Precautions

---



### WARNING:

Failure to take ESD precautions during the installation of the ICE-QM871 may result in permanent damage to the ICE-QM871 and severe injury to the user.

---

Electrostatic discharge (ESD) can cause serious damage to electronic components, including the ICE-QM871. Dry climates are especially susceptible to ESD. It is therefore critical that whenever the ICE-QM871 or any other electrical component is handled, the following anti-static precautions are strictly adhered to.

- **Wear an anti-static wristband:** - Wearing a simple anti-static wristband can help to prevent ESD from damaging the board.
- **Self-grounding:** - Before handling the board touch any grounded conducting material. During the time the board is handled, frequently touch any conducting materials that are connected to the ground.
- **Use an anti-static pad:** When configuring the ICE-QM871, place it on an anti-static pad. This reduces the possibility of ESD damaging the ICE-QM871.
- **Only handle the edges of the PCB:-:** When handling the PCB, hold the PCB by the edges.

## 4.2 Installation Considerations

---



### NOTE:

The following installation notices and installation considerations should be read and understood before installation. All installation notices must be strictly adhered to. Failing to adhere to these precautions may lead to severe damage and injury to the person performing the installation.

---

## ICE-QM871 COM Express Module



### **WARNING:**

The installation instructions described in this manual should be carefully followed in order to prevent damage to the components and injury to the user.

Before and during the installation please **DO** the following:

- Read the user manual:
  - The user manual provides a complete description of the ICE-QM871 installation instructions and configuration options.
- Wear an electrostatic discharge cuff (ESD):
  - Electronic components are easily damaged by ESD. Wearing an ESD cuff removes ESD from the body and helps prevent ESD damage.
- Place the ICE-QM871 on an antistatic pad:
  - When installing or configuring the motherboard, place it on an antistatic pad. This helps to prevent potential ESD damage.
- Turn all power to the ICE-QM871 off:
  - When working with the ICE-QM871, make sure that it is disconnected from all power supplies and that no electricity is being fed into the system.

Before and during the installation of the ICE-QM871 **DO NOT:**

- Remove any of the stickers on the PCB board. These stickers are required for warranty validation.
- Use the product before verifying all the cables and power connectors are properly connected.
- Allow screws to come in contact with the PCB circuit, connector pins, or its components.

### 4.3 SO-DIMM Installation



#### WARNING:

Using incorrectly specified SO-DIMM may cause permanent damage to the ICE-QM871. Please make sure the purchased SO-DIMM complies with the memory specifications of the ICE-QM871. SO-DIMM specifications compliant with the ICE-QM871 are listed in Chapter 1.

To install a SO-DIMM into a SO-DIMM socket, please follow the steps below and refer to **Figure 4-1**.

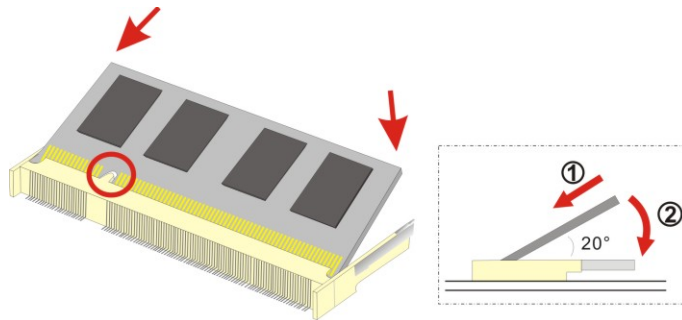

**Figure 4-1: SO-DIMM Installation**

- Step 1:** **Locate the SO-DIMM socket.** Place the ICE-QM871 on an anti-static pad with the solder side facing up.
- Step 2:** **Align the SO-DIMM with the socket.** The SO-DIMM must be oriented in such a way that the notch in the middle of the SO-DIMM must be aligned with the plastic bridge in the socket.
- Step 3:** **Insert the SO-DIMM.** Push the SO-DIMM chip into the socket at an angle. (See **Figure 4-1**)
- Step 4:** **Open the SO-DIMM socket arms.** Gently pull the arms of the SO-DIMM socket out and push the rear of the SO-DIMM down. (See **Figure 4-1**)

## ICE-QM871 COM Express Module

**Step 5: Secure the SO-DIMM.** Release the arms on the SO-DIMM socket. They clip into place and secure the SO-DIMM in the socket.

### 4.4 Jumper Settings

#### 4.4.1 LVDS Panel Type Selection

**Jumper Label:** SW1  
**Jumper Type:** DIP switch  
**Jumper Settings:** See Table 4-1  
**Jumper Location:** See Figure 4-2

This switch sets the resolution of the panel attached to the LVDS output. The pin order listed in the first column of **Table 4-1** is: 4 → 3 → 2 → 1. (ON=0, OFF=1)

SW1	EDID Resolution	Color Depth	Channel
0000	800X600	18-bit	Single
0001	1024X768	18-bit	Single
0010	1024X768	24-bit	Single
0011	1280X768	18-bit	Single
0100	1280X800	18-bit	Single
0101	1280X960	18-bit	Single
0110	1280X1024	24-bit	Dual
0111	1366X768	18-bit	Single
1000	1366X768	24-bit	Single
1001	1440X900	24-bit	Dual
1010	1400X1050	24-bit	Dual
1011	1600X900	24-bit	Dual
1100	1680X1050	24-bit	Dual
1101	1600X1200	24-bit	Dual
1110	1920X1080	24-bit	Dual
1111	1920X1200	24-bit	Dual

**Table 4-1: LVDS Panel Type Selection**

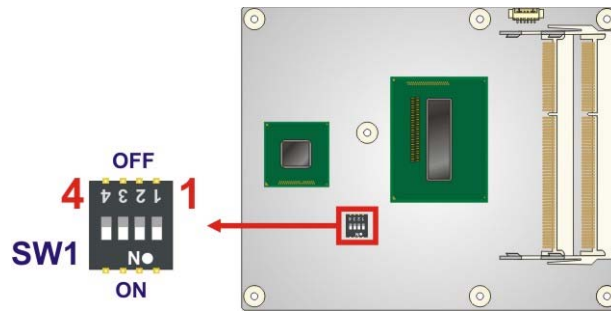

Figure 4-2: LVDS Panel Type Selection Switch Location

## 4.5 Mounting the ICE-QM871 to an Optional Baseboard



### NOTE:

Baseboard can be designed by the end user, customized by IEI, or purchased from IEI. For more information visit the IEI website ([www.ieiworld.com](http://www.ieiworld.com)) or contact an IEI sales representative.



### WARNING:

Never run the COM Express module without the cooling kit. The heatspreader plate shipped with the ICE-QM871 acts as a thermal interface between the module and the cooling kit. The cooling kit must be installed on the heatspreader plate to maintain proper operating temperatures. Make sure to maintain the heatspreader plate temperature under 60°C in operation.

Follow the steps below to install the ICE-QM871 to the optional baseboard.

- Step 1:** Align the two COM Express connectors on the reverse side of ICE-QM871 with the corresponding connectors on the baseboard. Gently push the COM Express module down to ensure the connectors are properly connected (Figure 4-3).

## ICE-QM871 COM Express Module

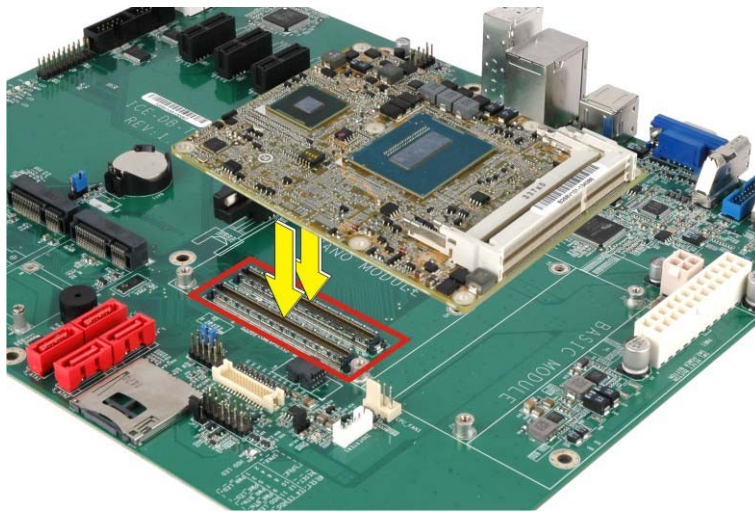

**Figure 4-3: Connect the COM Express Connectors**

**Step 2:** Place the supplied cooling kit on the heatspreader plate, aligning the retention screw holes (Figure 4-4). Ensure to apply thermal paste to the heat sink or heatspreader plate for optimum heat dissipation.

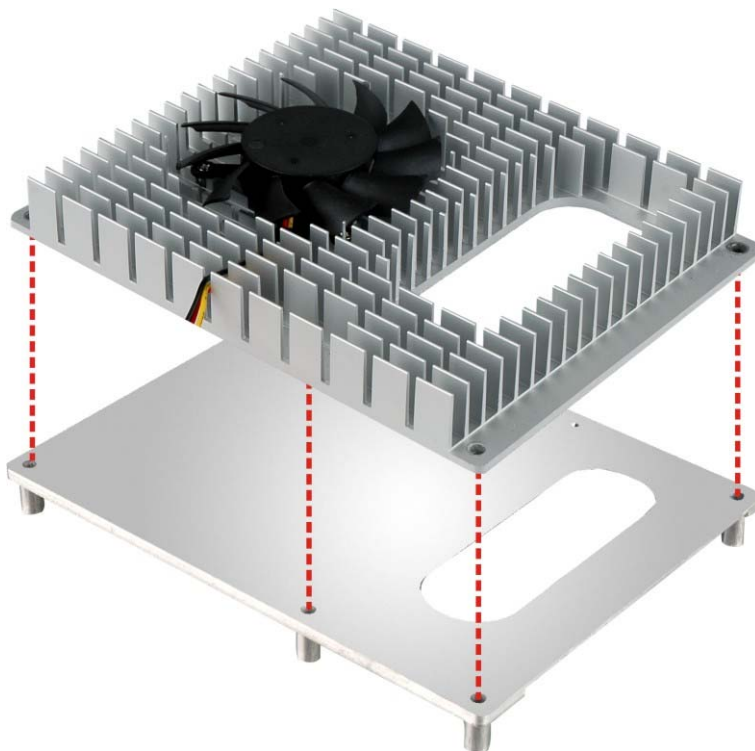

**Figure 4-4: Attach the Cooling Kit to the Heatspreader Plate**

- Step 3:** Place the heatspreader plate with the cooling kit on the ICE-QM871, aligning the retention screw holes (Figure 4-5).
- Step 4:** Secure the heatspreader plate with the cooling kit onto the baseboard with the supplied retention screws (Figure 4-5).

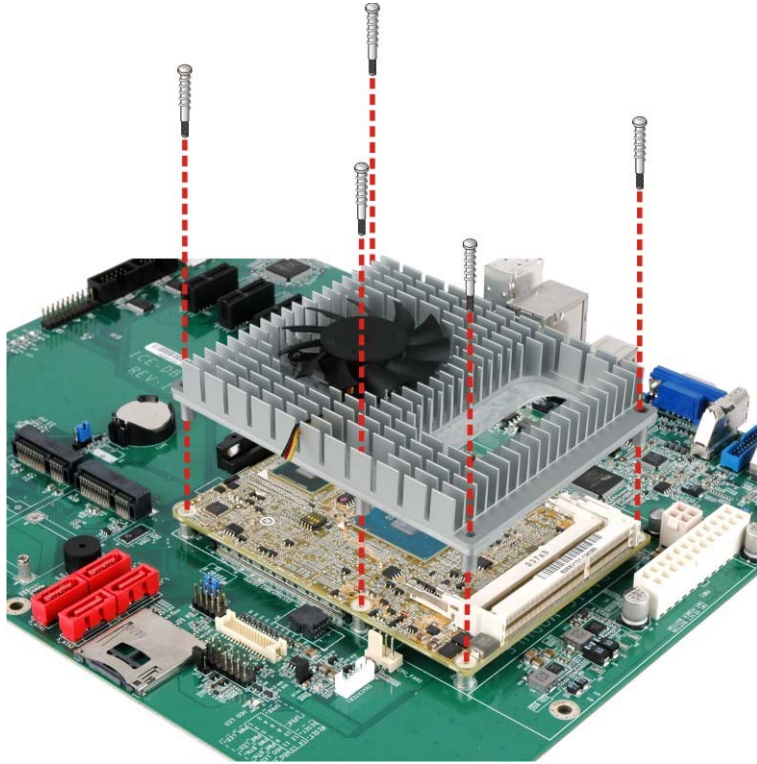

**Figure 4-5: Secure the Heatspreader Plate with the Cooling Kit to the Baseboard**

- Step 5:** Connect the cooling kit fan cable to the CPU fan connector on the baseboard (Figure 4-6).

## ICE-QM871 COM Express Module

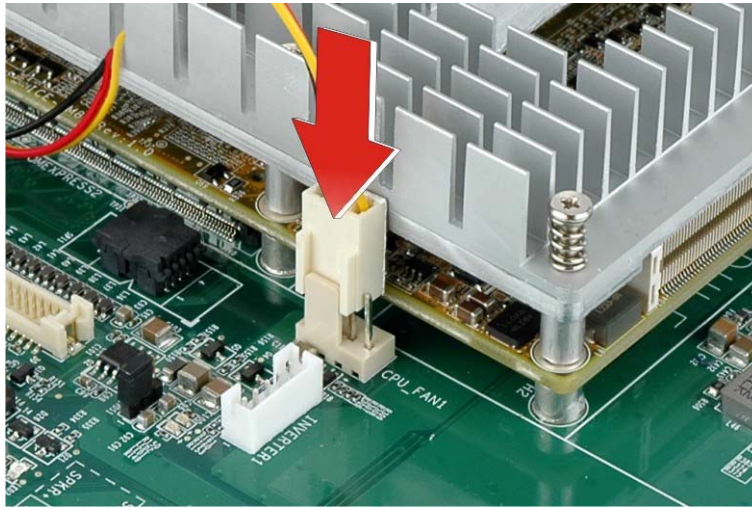

**Figure 4-6: Connect to the CPU Fan Connector on the Baseboard**



Chapter

5

**BIOS**

---

## 5.1 Introduction

The BIOS is programmed onto the BIOS chip. The BIOS setup program allows changes to certain system settings. This chapter outlines the options that can be changed.

### 5.1.1 Starting Setup

The UEFI BIOS is activated when the computer is turned on. The setup program can be activated in one of two ways.

1. Press the **DEL** or **F2** key as soon as the system is turned on or
2. Press the **DEL** or **F2** key when the “**Press DEL or F2 to enter SETUP**” message appears on the screen.

If the message disappears before the **DEL** or **F2** key is pressed, restart the computer and try again.

### 5.1.2 Using Setup

Use the arrow keys to highlight items, press **ENTER** to select, use the PageUp and PageDown keys to change entries, press **F1** for help and press **ESC** to quit. Navigation keys are shown in the following table.

Key	Function
Up arrow	Move to previous item
Down arrow	Move to next item
Left arrow	Move to the item on the left hand side
Right arrow	Move to the item on the right hand side
+	Increase the numeric value or make changes
-	Decrease the numeric value or make changes
Page Up key	Move to the next page
Page Dn key	Move to the previous page

Key	Function
Esc key	Main Menu – Quit and not save changes into CMOS Status Page Setup Menu and Option Page Setup Menu -- Exit current page and return to Main Menu
F1	General help, only for Status Page Setup Menu and Option Page Setup Menu
F2	Load previous values
F3	Load optimized defaults
F4	Save changes and Exit BIOS

**Table 5-1: BIOS Navigation Keys**

### 5.1.3 Getting Help

When **F1** is pressed a small help window describing the appropriate keys to use and the possible selections for the highlighted item appears. To exit the Help Window press **Esc** or the **F1** key again.

### 5.1.4 Unable to Reboot after Configuration Changes

If the computer cannot boot after changes to the system configuration are made, CMOS defaults. Use the jumper described in **Chapter 4**.

### 5.1.5 BIOS Menu Bar

The **menu bar** on top of the BIOS screen has the following main items:

- Main – Changes the basic system configuration.
- Advanced – Changes the advanced system settings.
- Chipset – Changes the chipset settings.
- Boot – Changes the system boot configuration.
- Security – Sets User and Supervisor Passwords.
- Save & Exit – Selects exit options and loads default settings.

The following sections completely describe the configuration options found in the menu items at the top of the BIOS screen and listed above.

## ICE-QM871 COM Express Module

### 5.2 Main

The **Main** BIOS menu (**BIOS Menu 1**) appears when the **BIOS Setup** program is entered.

The **Main** menu gives an overview of the basic system information.

Aptio Setup Utility - Copyright (C) 2012 American Megatrends, Inc.					
Main	Advanced	Chipset	Boot	Security	Save & Exit
BIOS Information			Set the Date. Use Tab to switch between Date elements.		
BIOS Vendor	American Megatrends				
Core Version	4.6.5.4				
Compliance	UEFI 2.3.1; PI 1.2				
Project Version	B268AT04.ROM				
Build Date and Time	05/15/2013 17:52:16				
iWDD Vendor			ICP		
iWDD Version			B163ER10.bin		
Processor Information					
Name			Haswell		
Brand String			Intel(R) Core(TM) i5-		
Frequency			3200 MHz		
Processor ID			306c3		
Stepping			C0		
Number of Processors			2Core(s) / 4Thread(s)		
Microcode Revision			7		
GT Info			GT2 (800 MHz)		
IGFX VBIOS Version			2167		
Memory RC Version			1.0.0.0		
Total Memory			4096 MB (DDR3)		
Memory Frequency			1600 MHz		
PCH Information					
Name			LynxPoint		
PCH SKU			QM87		
Stepping			04/C1		
LAN PHY Revision			A3		
ME FW Version			9.0.2.1345		
ME Firmware SKU			5MB		
SPI Clock Frequency					
DOFR Support			Supported		
Read Status Clock Frequency			50 MHz		
Write Status Clock Frequency			50 MHz		
Fast Read Status Clock Frequency			50 MHz		
System Date			[Tue 12/25/2012]		
System Time			[15:10:27]		
Access Level			Administrator		
-----					
→←: Select Screen					
↑ ↓: Select Item					
Enter: Select					
+/-: Change Opt.					
F1: General Help					
F2: Previous Values					
F3: Optimized Defaults					
F4: Save & Exit					
ESC: Exit					
Version 2.15.1236. Copyright (C) 2012 American Megatrends, Inc.					

**BIOS Menu 1: Main**

### → System Overview

The **BIOS Information** lists a brief summary of the BIOS. The fields in **BIOS Information** cannot be changed. The items shown in the system overview include:

- BIOS Information
- Processor Information
- Memory Information
- PCH Information
- SPI Clock Frequency

The System Overview field also has two user configurable fields:

### → System Date [xx/xx/xx]

Use the **System Date** option to set the system date. Manually enter the day, month and year.

### → System Time [xx:xx:xx]

Use the **System Time** option to set the system time. Manually enter the hours, minutes and seconds.

## 5.3 Advanced

Use the **Advanced** menu (**BIOS Menu 2**) to configure the CPU and peripheral devices through the following sub-menus:



### **WARNING:**

Setting the wrong values in the sections below may cause the system to malfunction. Make sure that the settings made are compatible with the hardware.

---

## ICE-QM871 COM Express Module

```

Aptio Setup Utility - Copyright (C) 2012 American Megatrends, Inc.
Main  Advanced  Chipset  Boot  Security  Save & Exit
-----
> ACPI Settings
> RTC Wake Settings
> Trusted Computing
> CPU Configuration
> SATA Configuration
> Intel(R) Rapid Start Technology
> AMT Configuration
> USB Configuration
> iWDD H/W Monitor
> F81866 Super IO Configuration
> F81866 H/W Monitor
> Serial Port Console Redirection
> iEi Feature

System ACPI Parameters
-----
-><: Select Screen
↑↓: Select Item
Enter: Select
+/-: Change Opt.
F1: General Help
F2: Previous Values
F3: Optimized Defaults
F4: Save & Exit
ESC: Exit

Version 2.15.1236. Copyright (C) 2012 American Megatrends, Inc.

```

### BIOS Menu 2: Advanced

#### 5.3.1 ACPI Settings

The **ACPI Settings** menu (**BIOS Menu 3**) configures the Advanced Configuration and Power Interface (ACPI) options.

```

Aptio Setup Utility - Copyright (C) 2012 American Megatrends, Inc.
Advanced
-----
ACPI Settings
ACPI Sleep State          [S1 only(CPU Stop C1...)]

Select ACPI sleep state
the system will enter
when the SUSPEND button
is pressed.
-----
-><: Select Screen
↑↓: Select Item
Enter: Select
+/-: Change Opt.
F1: General Help
F2: Previous Values
F3: Optimized Defaults
F4: Save & Exit
ESC: Exit

Version 2.15.1236. Copyright (C) 2012 American Megatrends, Inc.

```

### BIOS Menu 3: ACPI Settings

➔ **ACPI Sleep State [S1 only (CPU Stop Clock)]**

Use the **ACPI Sleep State** option to specify the sleep state the system enters when it is not being used.

- ➔ **S1 only (CPU Stop Clock)** **DEFAULT** The system enters S1 (POS) sleep state. The system appears off. The CPU is stopped; RAM is refreshed; the system is running in a low power mode.
- ➔ **S3 only (Suspend to RAM)** The caches are flushed and the CPU is powered off. Power to the RAM is maintained. The computer returns slower to a working state, but more power is saved.

### 5.3.2 RTC Wake Settings

The **RTC Wake Settings** menu (**BIOS Menu 4**) enables the system to wake at the specified time.

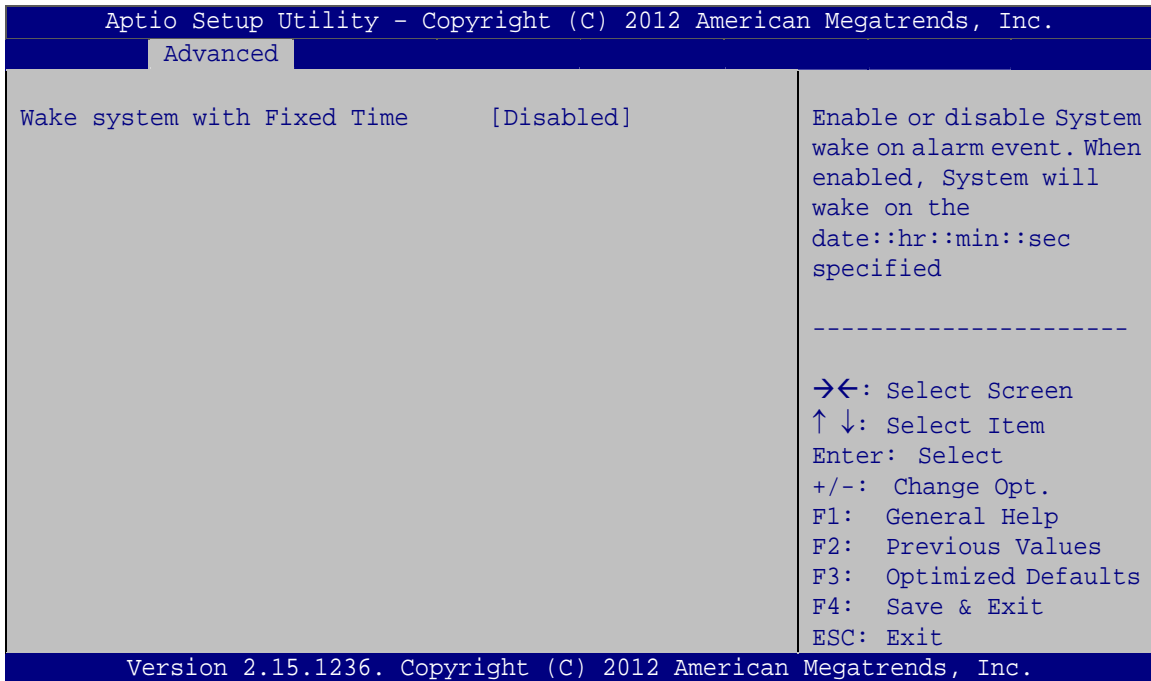

**BIOS Menu 4: RTC Wake Settings**

## ICE-QM871 COM Express Module

### → Wake system with Fixed Time [Disabled]

Use the **Wake system with Fixed Time** option to enable or disable the system wake on alarm event.

→ **Disabled**      **DEFAULT**      The real time clock (RTC) cannot generate a wake event

→ **Enabled**      If selected, the **Wake up every day** option appears allowing you to enable to disable the system to wake every day at the specified time. Besides, the following options appear with values that can be selected:

Wake up date

Wake up hour

Wake up minute

Wake up second

After setting the alarm, the computer turns itself on from a suspend state when the alarm goes off.

### 5.3.3 Trusted Computing

Use the **Trusted Computing** menu (**BIOS Menu 5**) to configure settings related to the Trusted Computing Group (TCG) Trusted Platform Module (TPM).

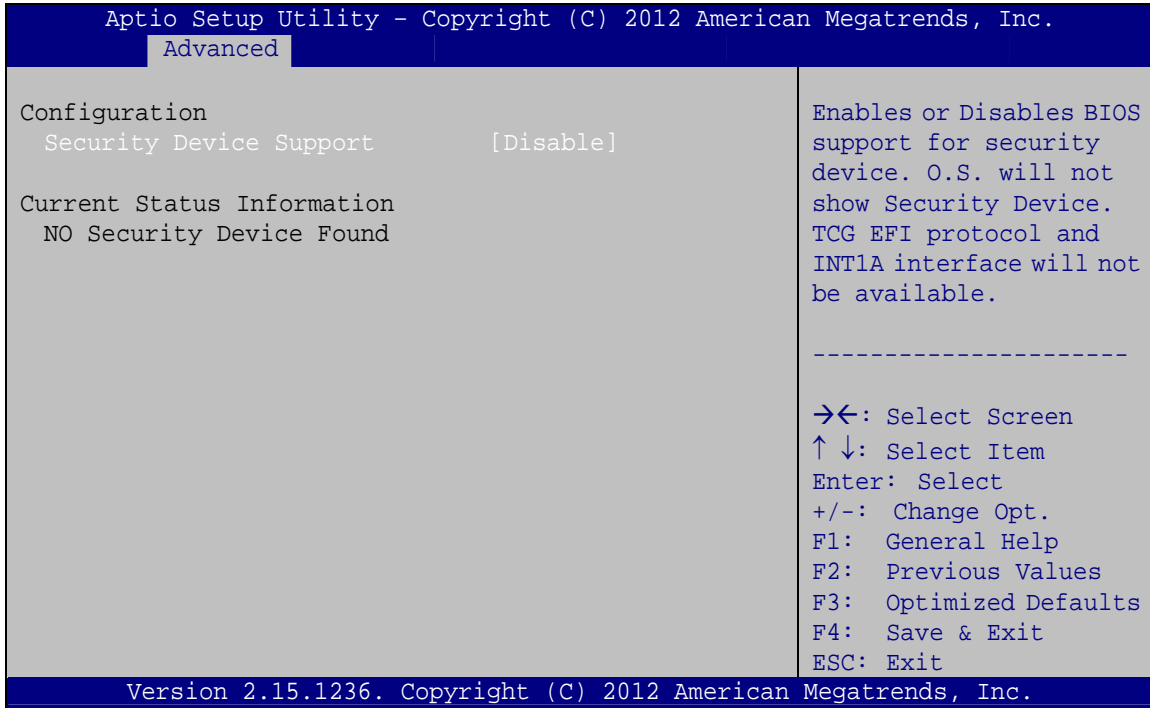

**BIOS Menu 5: Trusted Computing**
**→ Security Device Support [Disable]**

Use the **Security Device Support** option to configure support for the TPM.

- **Disable**    DEFAULT    TPM support is disabled.
- **Enable**                    TPM support is enabled.

## ICE-QM871 COM Express Module

### 5.3.4 CPU Configuration

Use the **CPU Configuration** menu (**BIOS Menu 6**) to view detailed CPU specifications and configure the CPU.

```

Aptio Setup Utility - Copyright (C) 2012 American Megatrends, Inc.
  Advanced
CPU Configuration
Intel(R) Core(TM) i5-4400E CPU @ 2.70GHz
CPU Signature          306c3
Microcode Patch       7
Max CPU Speed         2700 MHz
Min CPU Speed         800 MHz
CPU Speed             3200 MHz
Processor Cores       2
Intel HT Technology    Supported
Intel VT-x Technology Supported
Intel SMX Technology  Supported
64-bit                Supported
EIST Technology       Supported

L1 Data Cache        32 kB x 2
L1 Code Cache        32 kB x 2
L2 Cache             256 kB x 2
L3 Cache             3072 kB

Hyper-threading      [Enabled]
Intel Virtualization Technology [Disabled]
Intel TXT(LT) Support [Disabled]

-----
-><: Select Screen
↑↓: Select Item
Enter: Select
+/-: Change Opt.
F1: General Help
F2: Previous Values
F3: Optimized Defaults
F4: Save & Exit
ESC: Exit

Version 2.15.1236. Copyright (C) 2012 American Megatrends, Inc.
  
```

#### BIOS Menu 6: CPU Configuration

The CPU Configuration menu (**BIOS Menu 6**) lists the following CPU details:

- Processor Type: Lists the brand name of the CPU being used
- CPU Signature: Lists the CPU signature value.
- Microcode Patch: Lists the microcode patch being used.
- Max CPU Speed: Lists the maximum CPU processing speed.
- Min CPU Speed: Lists the minimum CPU processing speed.
- CPU Speed: Lists the CPU processing speed
- Processor Cores: Lists the number of the processor core
- Intel HT Technology: Indicates if Intel HT Technology is supported by the CPU.

- Intel VT-x Technology: Indicates if Intel VT-x Technology is supported by the CPU.
- Intel SMX Technology: Indicates if Intel SMX Technology is supported by the CPU.
- EIST Technology: Indicates if the Enhanced Intel SpeedStep® Technology (EIST) is supported by the CPU.
- 64-bit: Indicates if 64-bit is supported by the CPU.
- L1 Data Cache: Lists the amount of data storage space on the L1 cache.
- L1 Code Cache: Lists the amount of code storage space on the L1 cache.
- L2 Cache: Lists the amount of storage space on the L2 cache.
- L3 Cache: Lists the amount of storage space on the L3 cache.

#### ➔ Hyper-threading [Enabled]

Use the **Hyper-Threading** BIOS option to enable or disable the Intel Hyper-Threading Technology.

- ➔ **Disabled** Disables the Intel Hyper-Threading Technology.
- ➔ **Enabled** **DEFAULT** Enables the Intel Hyper-Threading Technology.

#### ➔ Intel Virtualization Technology [Disabled]

Use the **Intel Virtualization Technology** option to enable or disable virtualization on the system. When combined with third party software, Intel® Virtualization technology allows several OSs to run on the same system at the same time.

- ➔ **Disabled** **DEFAULT** Disables Intel Virtualization Technology.
- ➔ **Enabled** Enables Intel Virtualization Technology.

#### ➔ Intel TXT(LT) Support [Disabled]

Use the **Intel TXT(LT) Support** BIOS option to enable or disable the Intel Trusted Execution Technology.

- ➔ **Disabled** **DEFAULT** Disables the Intel Trusted Execution Technology.
- ➔ **Enabled** Enables the Intel Trusted Execution Technology.

## ICE-QM871 COM Express Module

### 5.3.5 SATA Configuration

Use the **SATA Configuration** menu (**BIOS Menu 7**) to change and/or set the configuration of the SATA devices installed in the system.

```

Aptio Setup Utility - Copyright (C) 2012 American Megatrends, Inc.
  Advanced
SATA Controller(s)          [Enabled]          Enable or disable SATA
SATA Mode Selection        [IDE]              Device.
S_ATA1                     Empty
S_ATA2                     Empty
S_ATA3                     Empty
S_ATA4(or mSATA)          Empty
                                                                    -----
                                                                    →←: Select Screen
                                                                    ↑ ↓: Select Item
                                                                    Enter: Select
                                                                    +/-: Change Opt.
                                                                    F1:  General Help
                                                                    F2:  Previous Values
                                                                    F3:  Optimized Defaults
                                                                    F4:  Save & Exit
                                                                    ESC: Exit
Version 2.15.1236. Copyright (C) 2012 American Megatrends, Inc.

```

#### BIOS Menu 7: SATA Configuration

##### → SATA Controller(s) [Enabled]

Use the **SATA Controller(s)** option to configure the SATA controller.

- **Enabled**      **DEFAULT**    Enable SATA controller.
- **Disabled**                    Disable SATA controller.

##### → SATA Mode Selection [IDE]

Use the **SATA Mode Selection** option to configure SATA devices.

- **IDE**              **DEFAULT**    Configures SATA devices as normal IDE device.
- **AHCI**                            Configures SATA devices as AHCI device.
- **RAID**                            Configures SATA devices as RAID device.

**NOTE:**

Before accessing the RAID configuration utility, ensure to set the **Option ROM Messages** BIOS option in the **Boot** menu to **Force BIOS**. This is to allow the “Press <CTRL+I> to enter Configuration Utility.....” message to appear during POST. Press Ctrl+I when prompted to enter the RAID configuration utility.

### 5.3.6 Intel(R) Rapid Start Technology

Use the **Intel(R) Rapid Start Technology (BIOS Menu 8)** menu to configure Intel® Rapid Start Technology support.

```

Aptio Setup Utility - Copyright (C) 2012 American Megatrends, Inc.
-----
Advanced
-----
Intel(R) Rapid Start Technology      [Disabled]
                                     Enable or disable
                                     Intel(R) Rapid Start
                                     Technology
                                     -----
                                     →←: Select Screen
                                     ↑↓: Select Item
                                     Enter: Select
                                     +/-: Change Opt.
                                     F1:  General Help
                                     F2:  Previous Values
                                     F3:  Optimized Defaults
                                     F4:  Save & Exit
                                     ESC: Exit
-----
Version 2.15.1236. Copyright (C) 2012 American Megatrends, Inc.
    
```

#### BIOS Menu 8: Intel(R) Rapid Start Technology

##### ➔ Intel(R) Rapid Start Technology [Disabled]

Use **Intel(R) Rapid Start Technology** option to enable or disable the Intel® Rapid Start Technology function.

- ➔ **Disabled**      **DEFAULT**      Intel® Rapid Start Technology is disabled
- ➔ **Enabled**        Intel® Rapid Start Technology is enabled

## ICE-QM871 COM Express Module

### 5.3.7 AMT Configuration

The **AMT Configuration** menu (**BIOS Menu 9**) allows the advanced power management options to be configured.

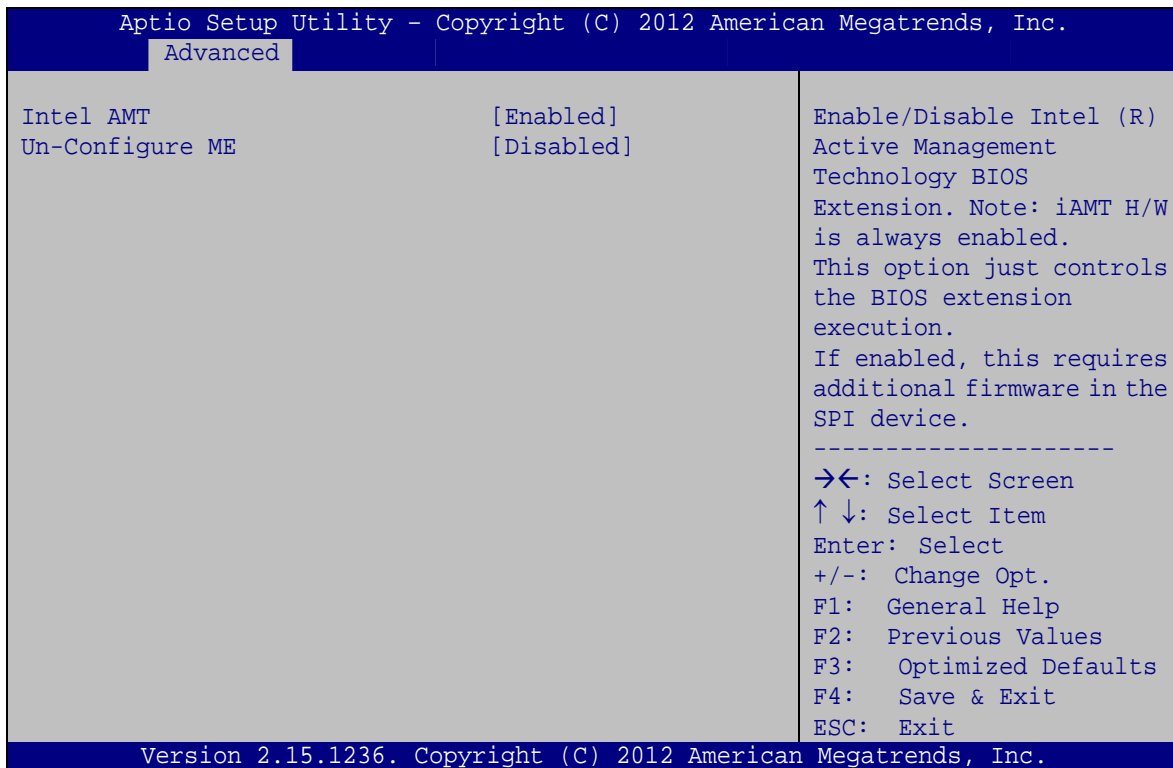

#### BIOS Menu 9: AMT Configuration

##### → Intel AMT [Enabled]

Use **Intel AMT** option to enable or disable the Intel® AMT function.

- **Disabled** Intel® AMT is disabled
- **Enabled** **DEFAULT** Intel® AMT is enabled

##### → Un-Configure ME [Disabled]

Use the **Un-Configure ME** option to perform ME unconfigure without password operation.

- **Disabled** **DEFAULT** Not perform ME unconfigure
- **Enabled** To perform ME unconfigure

### 5.3.8 USB Configuration

Use the **USB Configuration** menu (**BIOS Menu 10**) to read USB configuration information and configure the USB settings.

```

Aptio Setup Utility - Copyright (C) 2012 American Megatrends, Inc.
  Advanced
-----
USB Configuration
USB Devices:
  1 Keyboard, 2 Hubs
Legacy USB Support          [Enabled]
-----
-><: Select Screen
↑↓: Select Item
Enter: Select
+/-: Change Opt.
F1: General Help
F2: Previous Values
F3: Optimized Defaults
F4: Save & Exit
ESC: Exit
-----
Version 2.15.1236. Copyright (C) 2012 American Megatrends, Inc.

```

#### BIOS Menu 10: USB Configuration

##### ➔ USB Devices

The **USB Devices** field lists the USB devices that are enabled on the system

##### ➔ Legacy USB Support [Enabled]

Use the **Legacy USB Support** BIOS option to enable USB mouse and USB keyboard support.

Normally if this option is not enabled, any attached USB mouse or USB keyboard does not become available until a USB compatible operating system is fully booted with all USB drivers loaded. When this option is enabled, any attached USB mouse or USB keyboard can control the system even when there is no USB driver loaded onto the system.

## ICE-QM871 COM Express Module

- ➔ **Enabled**      **DEFAULT**      Legacy USB support enabled
- ➔ **Disabled**                      Legacy USB support disabled
- ➔ **Auto**                              Legacy USB support disabled if no USB devices are connected

### 5.3.9 iWDD H/W Monitor

The **iWDD H/W Monitor** menu (**BIOS Menu 11**) displays the CPU temperature and CPU fan speed, and contains the fan configuration submenu.

```

Aptio Setup Utility - Copyright (C) 2012 American Megatrends, Inc.
-----
Advanced
-----
PC Health Status
CPU temperature           : +68 C
CPU_FAN1 Speed           : 1878 RPM

VDDR                      : +1.381 V
+VCC_CORE                 : +1.741 V
+1.05S                    : +1.070 V
+V1.5S                    : +1.501 V
+V1.8S                    : +1.815 V
+V3.3A                    : +2.997 V
+V5S                      : +5.048 V
VCC12                     : +11.321 V

> Smart Fan Mode Configuration

Smart Fan Mode Select

-----
-><: Select Screen
↑↓: Select Item
Enter: Select
+/-: Change Opt.
F1: General Help
F2: Previous Values
F3: Optimized Defaults
F4: Save & Exit
ESC: Exit

Version 2.15.1236. Copyright (C) 2012 American Megatrends, Inc.

```

#### BIOS Menu 11: iWDD H/W Monitor

##### ➔ PC Health Status

The following system parameters and values are shown. The system parameters that are monitored are:

- CPU Temperature
- CPU Fan Speed
- VDDR
- +VCC\_CORE
- +1.05S
- +V1.5S



- +V1.8S
- +V3.3A
- +V5S
- VCC12

### 5.3.9.1 Smart Fan Mode Configuration

Use the **Smart Fan Mode Configuration** submenu (**BIOS Menu 12**) to configure the smart fan temperature and speed settings.

```

Aptio Setup Utility - Copyright (C) 2012 American Megatrends, Inc.
Advanced
Smart Fan Mode Configuration
Fan 1 Smart Fan Control          [Auto Mode]
Auto mode fan start temperature  50
Auto mode fan off temperature    40
Auto mode fan start PWM          30
Auto mode fan slope PWM         1

Smart Fan Mode Select
-----
<=>: Select Screen
↑↓: Select Item
EnterSelect
+ - Change Opt.
F1  General Help
F2  Previous Values
F3  Optimized Defaults
F4  Save & Exit
ESC Exit

Version 2.15.1236. Copyright (C) 2012 American Megatrends, Inc.
    
```

#### BIOS Menu 12: Smar Fan Mode Configuration

##### ➔ Fan 1 Smart Fan Control [Auto Mode]

Use the **Fan 1 Smart Fan Control** option to configure the CPU Smart Fan.

- ➔ **Manual Mode**                      The fan spins at the speed set in Manual by Duty Cycle settings
- ➔ **Auto Mode**                      **DEFAULT**      The fan adjusts its speed using Auto by Duty-Cycle settings

## ICE-QM871 COM Express Module

### ➔ Auto mode fan start/off temperature

Use the + or – key to change the **Auto mode fan start/off temperature** value. Enter a decimal number between 1 and 100.

### ➔ Auto mode fan start PWM

Use the + or – key to change the **Auto mode fan start PWM** value. Enter a decimal number between 1 and 128.

### ➔ Auto mode fan slope PWM

Use the + or – key to change the **Auto mode fan slope PWM** value. Enter a decimal number between 1 and 64.

## 5.3.10 F81866 Super IO Configuration

Use the **F81866 Super IO Configuration** menu (**BIOS Menu 13**) to set or change the configurations for the serial ports.

```

Aptio Setup Utility - Copyright (C) 2012 American Megatrends, Inc.
  Advanced
F81866 Super IO Configuration
F81866 Super IO Chip          F81866
> Serial Port 1 Configuration
> Serial Port 2 Configuration
Set Parameters of Serial
Port 1 (COMA)
-----
-><: Select Screen
↑ ↓: Select Item
Enter: Select
+/-: Change Opt.
F1:  General Help
F2:  Previous Values
F3:  Optimized Defaults
F4:  Save & Exit
ESC: Exit
Version 2.15.1236. Copyright (C) 2012 American Megatrends, Inc.

```

**BIOS Menu 13: F81866 Super IO Configuration**

### 5.3.10.1 Serial Port n Configuration

Use the **Serial Port n Configuration** menu (**BIOS Menu 14**) to configure the serial port n.

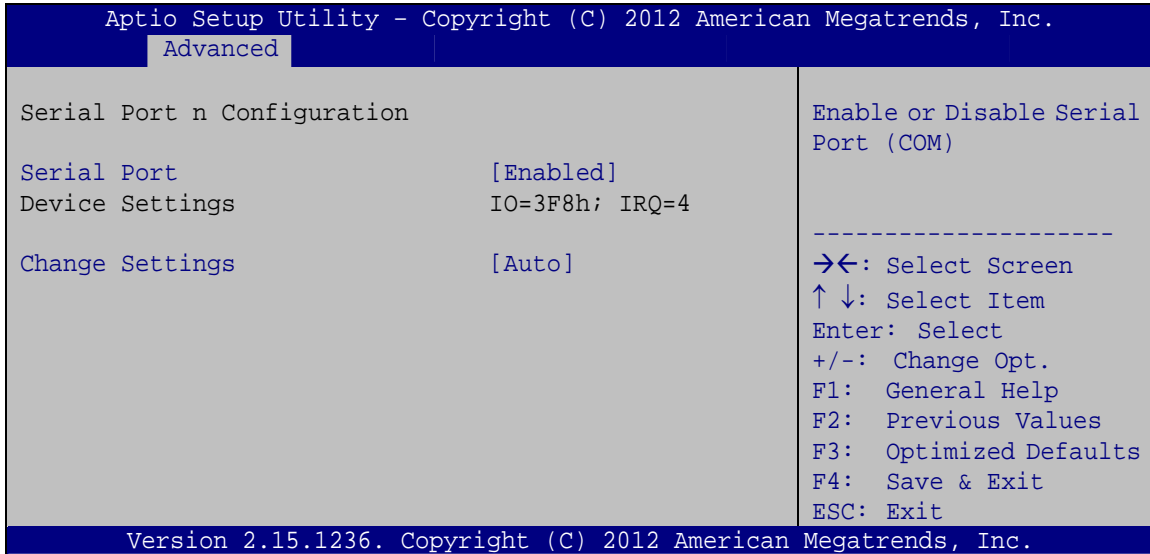

#### BIOS Menu 14: Serial Port n Configuration Menu

##### 5.3.10.1.1 Serial Port 1 Configuration

###### ➔ Serial Port [Enabled]

Use the **Serial Port** option to enable or disable the serial port.

- ➔ **Disabled**                      Disable the serial port
- ➔ **Enabled**            **DEFAULT**      Enable the serial port

###### ➔ Change Settings [Auto]

Use the **Change Settings** option to change the serial port IO port address and interrupt address.

- ➔ **Auto**            **DEFAULT**      The serial port IO port address and interrupt address are automatically detected.
- ➔ **IO=3F8h;**  
**IRQ=4**                      Serial Port I/O port address is 3F8h and the interrupt address is IRQ4

## ICE-QM871 COM Express Module

- ➔ **IO=3F8h;**  
**IRQ=3, 4**                      Serial Port I/O port address is 3F8h and the interrupt address is IRQ3, 4
- ➔ **IO=2F8h;**  
**IRQ=3, 4**                      Serial Port I/O port address is 2F8h and the interrupt address is IRQ3, 4
- ➔ **IO=2C0h;**  
**IRQ=3, 4**                      Serial Port I/O port address is 2C0h and the interrupt address is IRQ3, 4
- ➔ **IO=2C8h;**  
**IRQ=3, 4**                      Serial Port I/O port address is 2C8h and the interrupt address is IRQ3, 4

### 5.3.10.1.2 Serial Port 2 Configuration

#### ➔ Serial Port [Enabled]

Use the **Serial Port** option to enable or disable the serial port.

- ➔ **Disabled**                      Disable the serial port
- ➔ **Enabled**                      **DEFAULT**                      Enable the serial port

#### ➔ Change Settings [Auto]

Use the **Change Settings** option to change the serial port IO port address and interrupt address.

- ➔ **Auto**                      **DEFAULT**                      The serial port IO port address and interrupt address are automatically detected.
- ➔ **IO=2F8h;**  
**IRQ=3**                      Serial Port I/O port address is 2F8h and the interrupt address is IRQ3
- ➔ **IO=3F8h;**  
**IRQ=3, 4**                      Serial Port I/O port address is 3F8h and the interrupt address is IRQ3, 4
- ➔ **IO=2F8h;**  
**IRQ=3, 4**                      Serial Port I/O port address is 2F8h and the interrupt address is IRQ3, 4
- ➔ **IO=2C0h;**  
**IRQ=3, 4**                      Serial Port I/O port address is 2C0h and the interrupt address is IRQ3, 4

➔ **IO=2C8h;**  
**IRQ=3, 4**

Serial Port I/O port address is 2C8h and the interrupt address is IRQ3, 4

### 5.3.11 F81866 H/W Monitor

The **F81866 H/W Monitor** menu (**BIOS Menu 15**) contains the fan configuration submenu and displays the system fan speeds.

```

Aptio Setup Utility - Copyright (C) 2012 American Megatrends, Inc.
Advanced
PC Health Status
> Smart Fan Mode Configuration
  FAN1                : N/A
  FAN2                : N/A
Smart Fan Mode Select
-----
-><: Select Screen
↑↓: Select Item
Enter: Select
+/-: Change Opt.
F1: General Help
F2: Previous Values
F3: Optimized Defaults
F4: Save & Exit
ESC: Exit
Version 2.15.1236. Copyright (C) 2012 American Megatrends, Inc.
  
```

**BIOS Menu 15: F81866 H/W Monitor**

## ICE-QM871 COM Express Module

### 5.3.11.1 Smart Fan Mode Configuration

Use the **Smart Fan Mode Configuration** submenu (**BIOS Menu 16**) to configure fan temperature and speed settings.

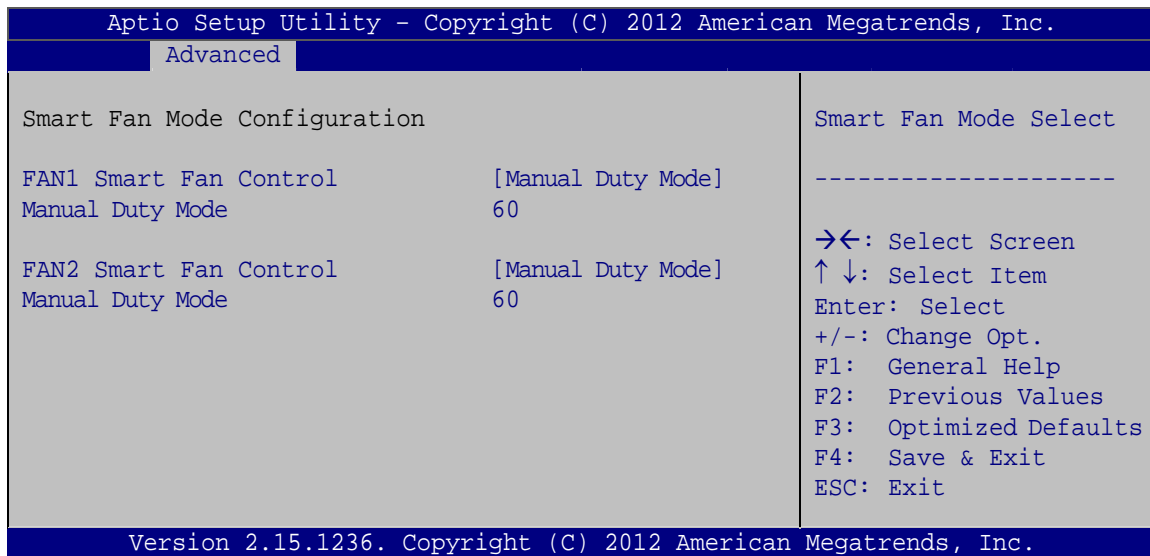

#### BIOS Menu 16: Smart Fan Mode Configuration

##### ➔ FAN1/FAN2 Smart Fan Mode [Manual Duty Mode]

Use the **FAN1/FAN2 Smart Fan Mode** option to configure the system smart fans.

➔ **Manual Duty Mode** **DEFAULT** The fan spins at the speed set in Manual Duty Mode settings (below option)

##### ➔ Manual Duty Mode

Use the + or – key to change the value. Enter a decimal number between 0 and 100.

### 5.3.12 Serial Port Console Redirection

The **Serial Port Console Redirection** menu (**BIOS Menu 17**) allows the console redirection options to be configured. Console redirection allows users to maintain a system remotely by re-directing keyboard input and text output through the serial port.

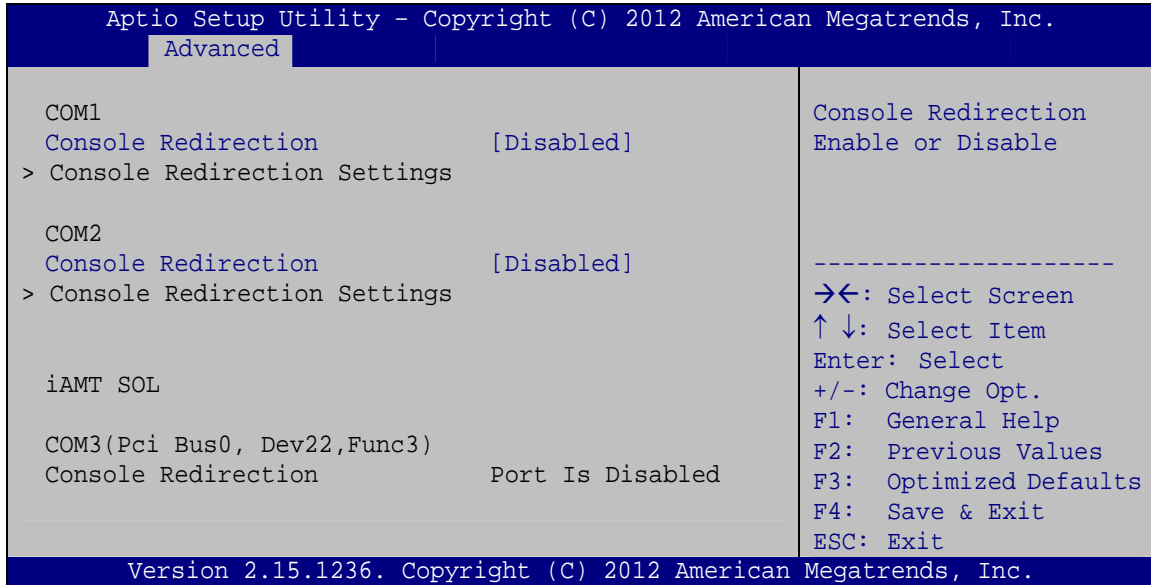

### BIOS Menu 17: Serial Port Console Redirection

#### → Console Redirection [Disabled]

Use **Console Redirection** option to enable or disable the console redirection function.

- **Disabled**      **DEFAULT**      Disabled the console redirection function
- **Enabled**                      Enabled the console redirection function



#### **NOTE:**

The following five options appear when the **Console Redirection** option is enabled.

#### → Terminal Type [ANSI]

Use the **Terminal Type** option to specify the remote terminal type.

- **VT100**                      The target terminal type is VT100
- **VT100+**                      The target terminal type is VT100+

## ICE-QM871 COM Express Module

- ➔ **VT-UTF8**                      The target terminal type is VT-UTF8
- ➔ **ANSI**                      **DEFAULT**                      The target terminal type is ANSI

### ➔ **Bits per second [115200]**

Use the **Bits per second** option to specify the serial port transmission speed. The speed must match the other side. Long or noisy lines may require lower speeds.

- ➔ **9600**                              Sets the serial port transmission speed at 9600.
- ➔ **19200**                              Sets the serial port transmission speed at 19200.
- ➔ **38400**                              Sets the serial port transmission speed at 38400.
- ➔ **57600**                              Sets the serial port transmission speed at 57600.
- ➔ **115200**                      **DEFAULT**                      Sets the serial port transmission speed at 115200.

### ➔ **Data Bits [8]**

Use the **Data Bits** option to specify the number of data bits.

- ➔ **7**                                      Sets the data bits at 7.
- ➔ **8**                                      **DEFAULT**                      Sets the data bits at 8.

### ➔ **Parity [None]**

Use the **Parity** option to specify the parity bit that can be sent with the data bits for detecting the transmission errors.

- ➔ **None**                      **DEFAULT**                      No parity bit is sent with the data bits.
- ➔ **Even**                              The parity bit is 0 if the number of ones in the data bits is even.
- ➔ **Odd**                              The parity bit is 0 if the number of ones in the data bits is odd.
- ➔ **Mark**                              The parity bit is always 1. This option does not provide error detection.



→ **Space** The parity bit is always 0. This option does not provide error detection.

→ **Stop Bits [1]**

Use the **Stop Bits** option to specify the number of stop bits used to indicate the end of a serial data packet. Communication with slow devices may require more than 1 stop bit.

→ **1**                    **DEFAULT**       Sets the number of stop bits at 1.

→ **2**                    Sets the number of stop bits at 2.

### 5.3.13 iEi Feature

Use the **iEi Feature** menu (**BIOS Menu 18**) to configure One Key Recovery function.

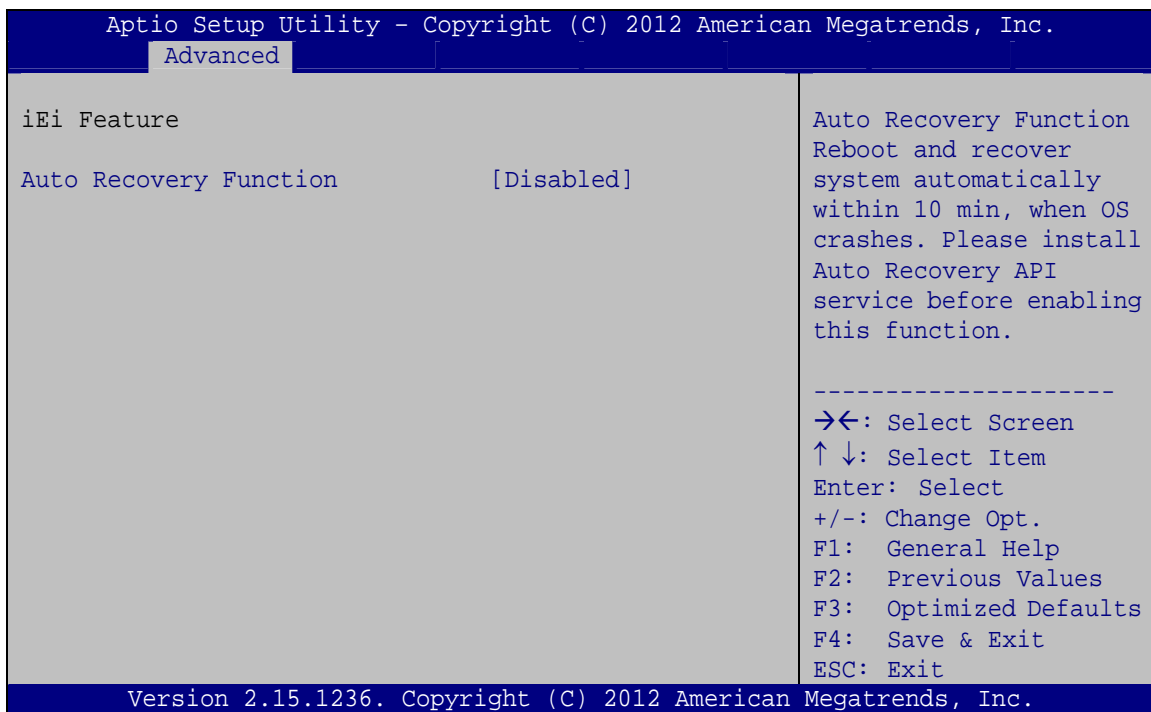

#### BIOS Menu 18: iEi Feature

→ **Auto Recovery Function [Disabled]**

Use the **Auto Recovery Function** BIOS option to enable or disable the auto recovery function of the IEI One Key Recovery.

## ICE-QM871 COM Express Module

- ➔ **Disabled**      **DEFAULT**      Auto recovery function disabled
- ➔ **Enabled**                      Auto recovery function enabled

### 5.4 Chipset

Use the **Chipset** menu (**BIOS Menu 19**) to access the PCH IO and System Agent (SA) configuration menus.



#### **WARNING!**

Setting the wrong values for the Chipset BIOS selections in the Chipset BIOS menu may cause the system to malfunction.

```

Aptio Setup Utility - Copyright (C) 2012 American Megatrends, Inc.
Main   Advanced  Chipset  Boot   Security  Save & Exit
-----
> System Agent (SA) Configuration
> PCH-IO Configuration

System Agent (SA)
Parameters

-----
-><: Select Screen
↑↓: Select Item
Enter: Select
+/-: Change Opt.
F1: General Help
F2: Previous Values
F3: Optimized Defaults
F4: Save & Exit
ESC: Exit

Version 2.15.1236. Copyright (C) 2012 American Megatrends, Inc.
  
```

**BIOS Menu 19: Chipset**

### 5.4.1 System Agent (SA) Configuration

Use the **System Agent (SA) Configuration** menu (**BIOS Menu 20**) to configure the System Agent (SA) parameters.

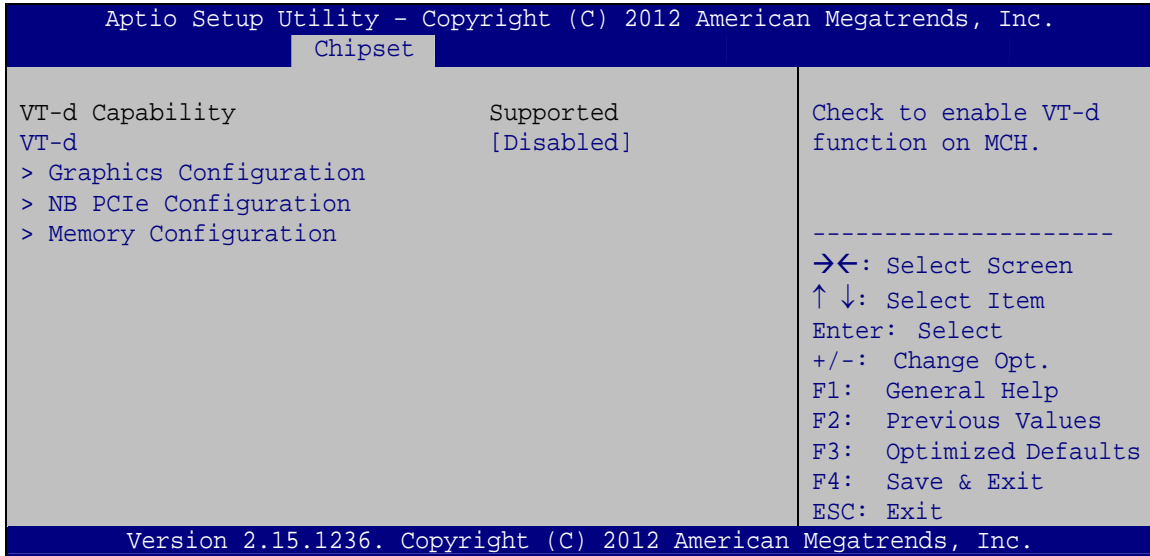

#### BIOS Menu 20: System Agent (SA) Configuration

##### ➔ VT-d [Disabled]

Use the **VT-d** option to enable or disable VT-d support.

- ➔ **Disabled**                      **DEFAULT**      Disables VT-d support.
- ➔ **Enabled**                                      Enables VT-d support.

#### 5.4.1.1 Graphics Configuration

Use the **Graphics Configuration** (**BIOS Menu 21**) menu to configure the video device connected to the system.

## ICE-QM871 COM Express Module

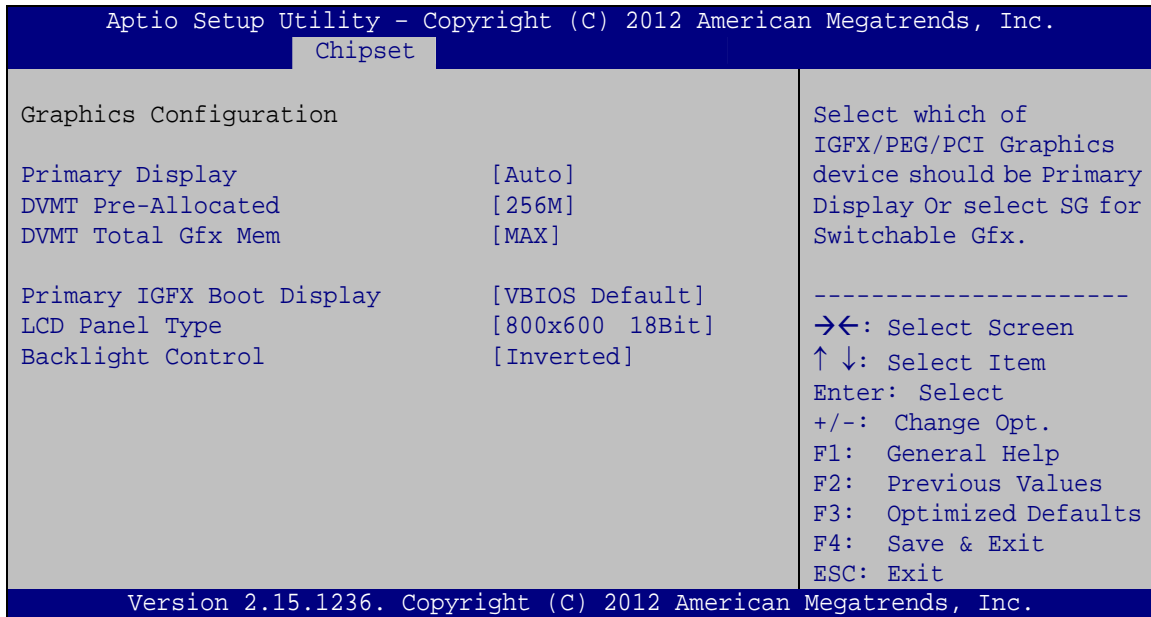

### BIOS Menu 21: Graphics Configuration

#### → Primary Display [Auto]

Use the **Primary Display** option to select the primary graphics controller the system uses.

The following options are available:

- Auto **Default**
- IGFX
- PEG
- PCIE

#### → DVMT Pre-Allocated [256M]

Use the **DVMT Pre-Allocated** option to set the amount of system memory allocated to the integrated graphics processor when the system boots. The system memory allocated can then only be used as graphics memory, and is no longer available to applications or the operating system. Configuration options are listed below:

- 32M
- 64M
- 128M
- 256M **Default**
- 512M

**→ DVMT Total Gfx Mem [MAX]**

Use the **DVMT Total Gfx Mem** option to select DVMT5.0 total graphic memory size used by the internal graphic device. The following options are available:

- 128M
- 256M
- MAX                   **Default**

**→ Primary IGFX Boot Display [VBIOS Default]**

Use the **Primary IGFX Boot Display** option to select the display device used by the system when it boots. Configuration options are listed below.

- VBIOS Default       **DEFAULT**
- CRT
- LVDS
- HDMI 1
- Display Port 2
- Display Port 3

**→ LCD Panel Type [By Hardware]**

Use the **LCD Panel Type** option to select the type of flat panel connected to the system. Configuration options are listed below.

- 640x480 18BIT
- 800x600 18BIT   **DEFAULT**
- 1024x768 18BIT
- 1024x768 24BIT
- 1280x800 24BIT
- 1280x1024 48BIT
- 1366x768 24BIT
- 1440x900 48BIT
- 1440x1050 48BIT
- 1600x900 48BIT
- 1600x1200 48BIT
- 1680x1050 48BIT

## ICE-QM871 COM Express Module

- 1920x1080 48BIT
- 1920x1200 48BIT
- 2048x1536 48BIT

### ➔ Backlight Control [Inverted]

Use the **Backlight Control** option to select the backlight control mode.

- ➔ **Normal** The LVDS backlight is brighter at low voltage level.
- ➔ **Inverted**        **DEFAULT**    The LVDS backlight is brighter at high voltage level.

### 5.4.1.2 NB PCIe Configuration

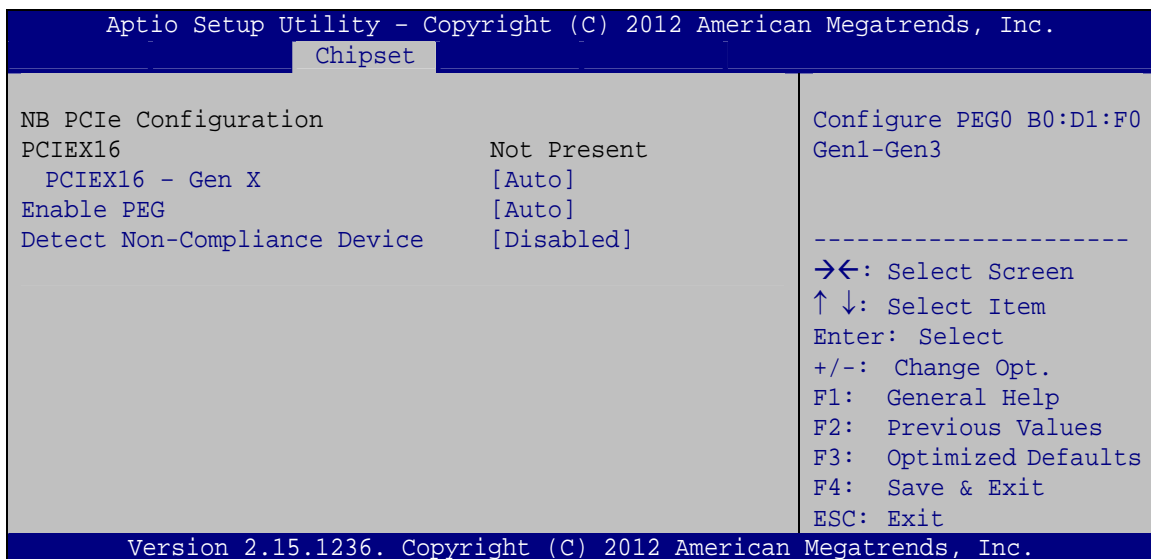

### BIOS Menu 22: NB PCIe Configuration

#### ➔ PCIEX16 – Gen X [Auto]

Use the **PCIEX16 – Gen X** option to select the support type of the PCI Express x16 slot.

The following options are available:

- Auto                    **Default**
- Gen1
- Gen2
- Gen3

**➔ Enable PEG [Auto]**

Use the **Enable PEG** option to enable or disable the PCI Express controller. The following options are available:

- Disabled
- Enabled
- Auto     **Default**

**➔ Detect Non-Compliance Device [Disabled]**

Use the **Detect Non-Compliance Device** option to enable or disable detecting a non-compliance PCI Express device in the PEG. The following options are available:

- Disabled     **Default**
- Enabled

### 5.4.1.3 Memory Configuration

Use the **Memory Configuration** submenu (**BIOS Menu 23**) to view memory information.

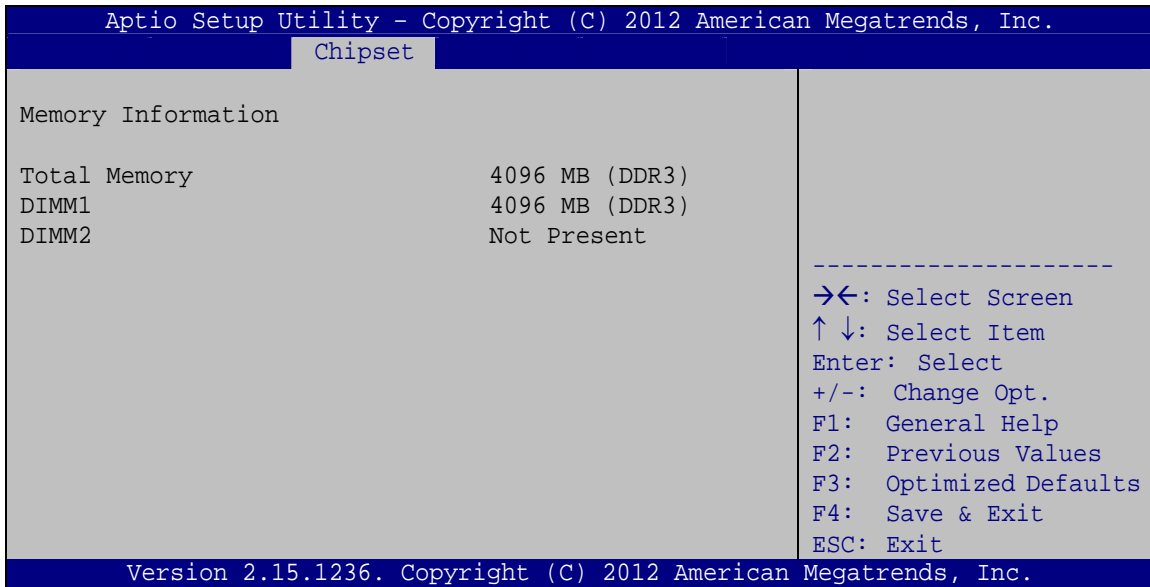

**BIOS Menu 23: Memory Configuration**

## ICE-QM871 COM Express Module

### 5.4.2 PCH-IO Configuration

Use the **PCH-IO Configuration** menu (**BIOS Menu 24**) to configure the PCH parameters.

```

Aptio Setup Utility - Copyright (C) 2012 American Megatrends, Inc.
Chipset
Restore AC Power Loss      [Last State]
Azalia                    [Enabled]
Power Saving Function(ERP) [Disabled]

> PCI Express Configuration

-----
-><: Select Screen
↑↓: Select Item
Enter: Select
+/-: Change Opt.
F1: General Help
F2: Previous Values
F3: Optimized Defaults
F4: Save & Exit
ESC: Exit

Version 2.15.1236. Copyright (C) 2012 American Megatrends, Inc.
  
```

#### BIOS Menu 24: PCH-IO Configuration

##### ➔ Restore AC Power Loss [Last State]

Use the **Restore AC Power Loss** BIOS option to specify what state the system returns to if there is a sudden loss of power to the system.

- ➔ **Power Off**                      The system remains turned off
- ➔ **Power On**                        The system turns on
- ➔ **Last State**            **DEFAULT**    The system returns to its previous state. If it was on, it turns itself on. If it was off, it remains off.

##### ➔ Azalia [Enabled]

Use the **Azalia** option to enable or disable the High Definition Audio controller.



- ➔ **Disabled**                      The onboard High Definition Audio controller is disabled
- ➔ **Enabled    DEFAULT**        The onboard High Definition Audio controller automatically detected and enabled

➔ **Power Saving Function [Disabled]**

Use the **Power Saving Function** option to enable or disable power saving function.

- ➔ **Disabled**                      Power saving function is disabled
- ➔ **Enabled    DEFAULT**        Enable to reduce power consumption in system off state.

### 5.4.2.1 PCI Express Configuration

Use the **PCI Express Configuration** menu (**BIOS Menu 25**) to select the support type of the PCI Express or PCIe Mini slots.

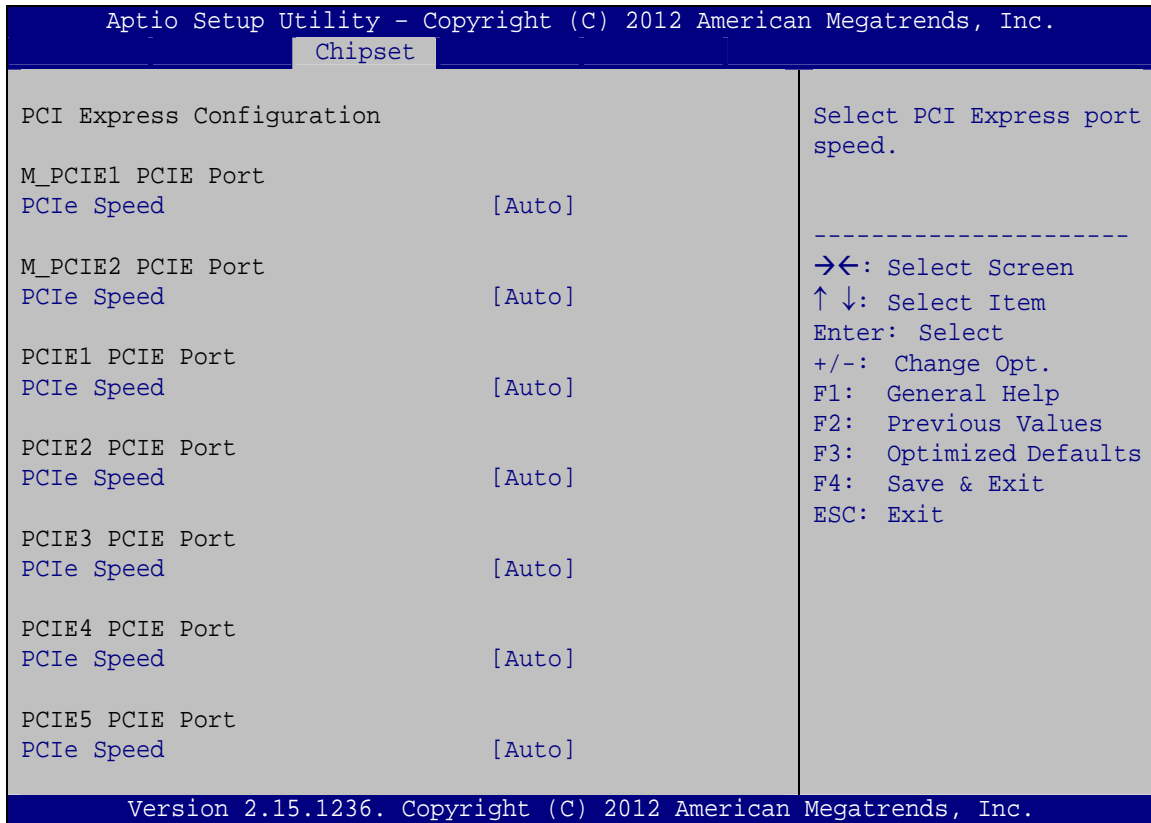

**BIOS Menu 25: PCI Express Configuration**

## ICE-QM871 COM Express Module

### → PCIe Speed

Use PCIe Speed option to select the speed type of the PCI Express or PCIe Mini slots.

The following options are available:

- Auto                   **Default**
- Gen1
- Gen2

## 5.5 Boot

Use the **Boot menu (BIOS Menu 26)** to configure system boot options.

```

Aptio Setup Utility - Copyright (C) 2012 American Megatrends, Inc.
Main   Advanced  Chipset  Boot   Security  Save & Exit
-----
Boot Configuration
Bootup NumLock State      [On]
Quiet Boot                 [Enabled]
Option ROM Messages       [Force BIOS]
Launch PXE OpROM          [Disabled]
UEFI Boot                  [Disabled]

Boot Option Priorities

-----
Select the keyboard
NumLock state

-----
-><: Select Screen
↑↓: Select Item
Enter: Select
+/-: Change Opt.
F1:  General Help
F2:  Previous Values
F3:  Optimized Defaults
F4:  Save & Exit
ESC: Exit

Version 2.15.1236. Copyright (C) 2012 American Megatrends, Inc.

```

### BIOS Menu 26: Boot

#### → Bootup NumLock State [On]

Use the **Bootup NumLock State** BIOS option to specify if the number lock setting must be modified during boot up.

- **On**                   **DEFAULT**           Allows the Number Lock on the keyboard to be enabled automatically when the computer system boots up. This allows the immediate use of the 10-key numeric keypad located on the right side of the keyboard. To confirm this, the Number Lock LED light on the keyboard is lit.

- **Off** Does not enable the keyboard Number Lock automatically. To use the 10-keys on the keyboard, press the Number Lock key located on the upper left-hand corner of the 10-key pad. The Number Lock LED on the keyboard lights up when the Number Lock is engaged.

→ **Quiet Boot [Enabled]**

Use the **Quiet Boot** BIOS option to select the screen display when the system boots.

- **Disabled** Normal POST messages displayed
- **Enabled** **DEFAULT** OEM Logo displayed instead of POST messages

→ **Option ROM Messages [Force BIOS]**

Use the **Option ROM Messages** option to set the Option ROM display mode.

- **Force BIOS** **DEFAULT** Sets display mode to force BIOS.
- **Keep Current** Sets display mode to current.

→ **Launch PXE OpROM [Disabled]**

Use the **Launch PXE OpROM** option to enable or disable boot option for legacy network devices.

- **Disabled** **DEFAULT** Ignore all PXE Option ROMs
- **Enabled** Load PXE Option ROMs.

→ **UEFI Boot [Disabled]**

Use the **UEFI Boot** BIOS option to allow the system to boot from the UEFI devices.

- **Disabled** **DEFAULT** Disables to boot from the UEFI devices.
- **Enabled** Enables to boot from the UEFI devices.

## ICE-QM871 COM Express Module

### 5.6 Security

Use the **Security** menu (**BIOS Menu 27**) to set system and user passwords.

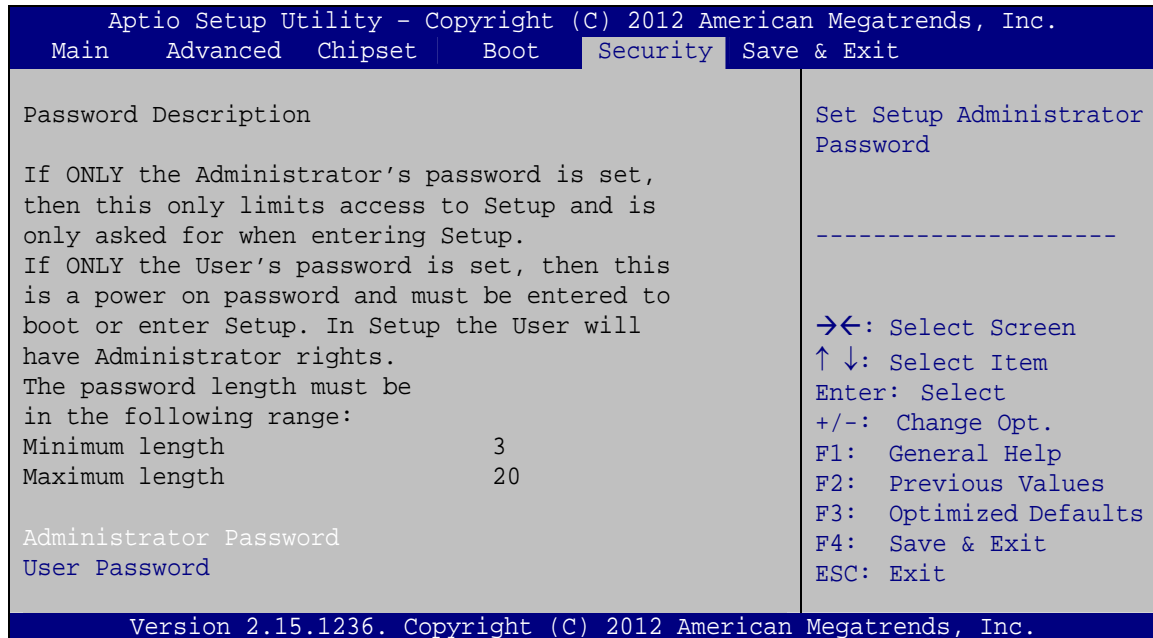

#### BIOS Menu 27: Security

##### ➔ Administrator Password

Use the **Administrator Password** to set or change an administrator password.

##### ➔ User Password

Use the **User Password** to set or change a user password.

### 5.7 Save & Exit

Use the **Save & Exit** menu (**BIOS Menu 28**) to load default BIOS values, optimal failsafe values and to save configuration changes.

```

Aptio Setup Utility - Copyright (C) 2012 American Megatrends, Inc.
Main   Advanced  Chipset  Boot   Security  Save & Exit

Save Changes and Reset
Discard Changes and Reset

Restore Defaults
Save as User Defaults
Restore User Defaults

Reset the system after
saving the changes.

-----
-><: Select Screen
↑↓: Select Item
Enter: Select
+/-: Change Opt.
F1:  General Help
F2:  Previous Values
F3:  Optimized Defaults
F4:  Save & Exit
ESC: Exit

Version 2.15.1236. Copyright (C) 2012 American Megatrends, Inc.

```

**BIOS Menu 28: Save & Exit**
**➔ Save Changes and Reset**

Use the **Save Changes and Reset** option to save the changes made to the BIOS options and reset the system.

**➔ Discard Changes and Reset**

Use the **Discard Changes and Reset** option to exit the system without saving the changes made to the BIOS configuration setup program.

**➔ Restore Defaults**

Use the **Restore Defaults** option to load the optimal default values for each of the parameters on the Setup menus. **F3 key can be used for this operation.**

**➔ Save as User Defaults**

Use the **Save as User Defaults** option to save the changes done so far as user defaults.

**➔ Restore User Defaults**

Use the **Restore User Defaults** option to restore the user defaults to all the setup options.

Chapter

6

# Software Drivers

---

## 6.1 Available Software Drivers

---

**NOTE:**

The content of the CD may vary throughout the life cycle of the product and is subject to change without prior notice. Visit the IEI website or contact technical support for the latest updates.

---

The following drivers can be installed on the system:

- Chipset
- Graphics
- LAN
- USB 3.0
- Audio
- Intel® AMT

Installation instructions are given below.

## 6.2 Starting the Driver Program

To access the driver installation programs, please do the following.

**Step 1:** Insert the CD that came with the system into a CD drive connected to the system.

---

**NOTE:**

If the installation program doesn't start automatically:  
Click "Start->Computer->CD Drive->autorun.exe"

---

**Step 2:** The driver main menu appears (**Figure 6-1**).

# ICE-QM871 COM Express Module

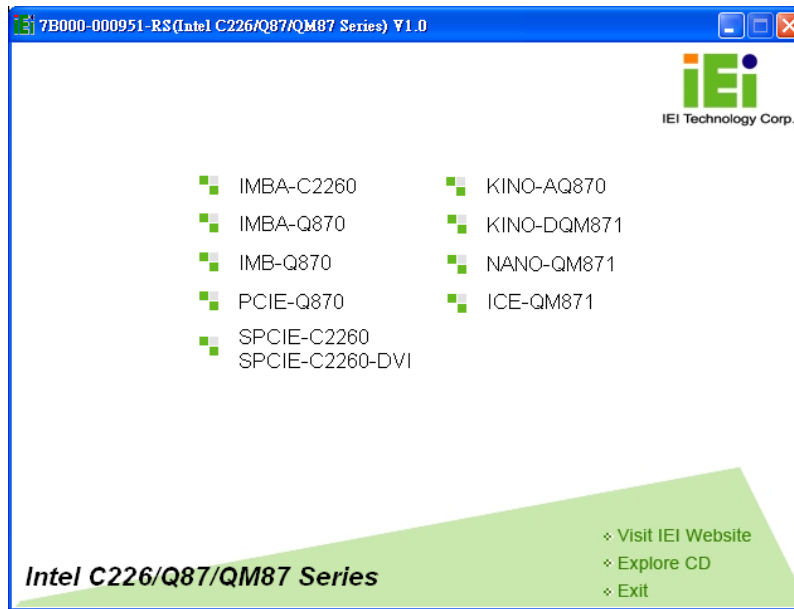

Figure 6-1: Start Up Screen

**Step 3:** Click ICE-QM871.

**Step 4:** The list of drivers in **Figure 6-2** appears.



Figure 6-2: Drivers



## 6.3 Chipset Driver Installation

To install the chipset driver, please do the following.

**Step 1:** Access the driver list. (See **Section 6.2**)

**Step 2:** Click “1-Chipset”.

**Step 3:** Locate the setup file and double click on it.

**Step 4:** The **Welcome Screen** in **Figure 6-3** appears. Click **Next** to continue.



**Figure 6-3: Chipset Driver Welcome Screen**

**Step 5:** The license agreement in **Figure 6-4** appears.

**Step 6:** Read the **License Agreement**.

**Step 7:** Click **Yes** to continue.

## ICE-QM871 COM Express Module



**Figure 6-4: Chipset Driver License Agreement**

**Step 8:** The Read Me file in **Figure 6-5** appears.

**Step 9:** Click **Next** to continue.

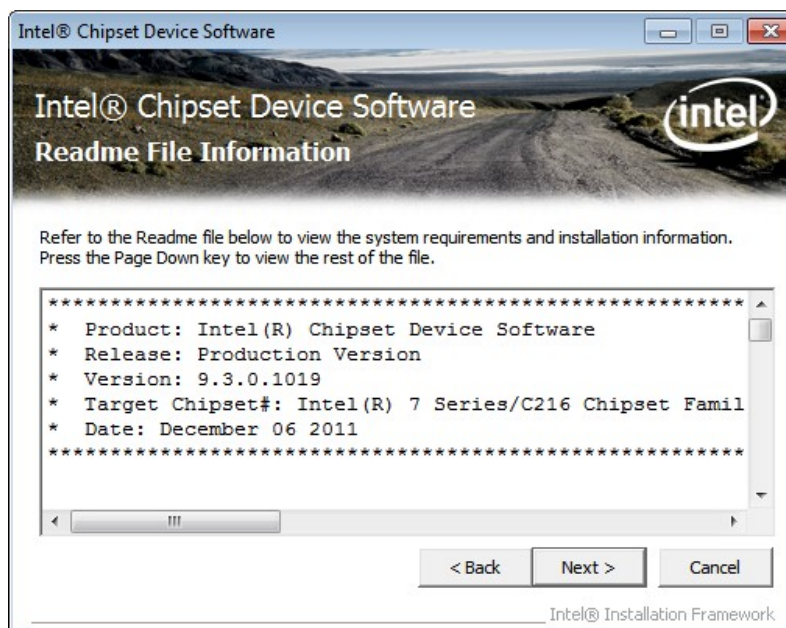

**Figure 6-5: Chipset Driver Read Me File**

**Step 10:** Setup Operations are performed as shown in **Figure 6-6**.

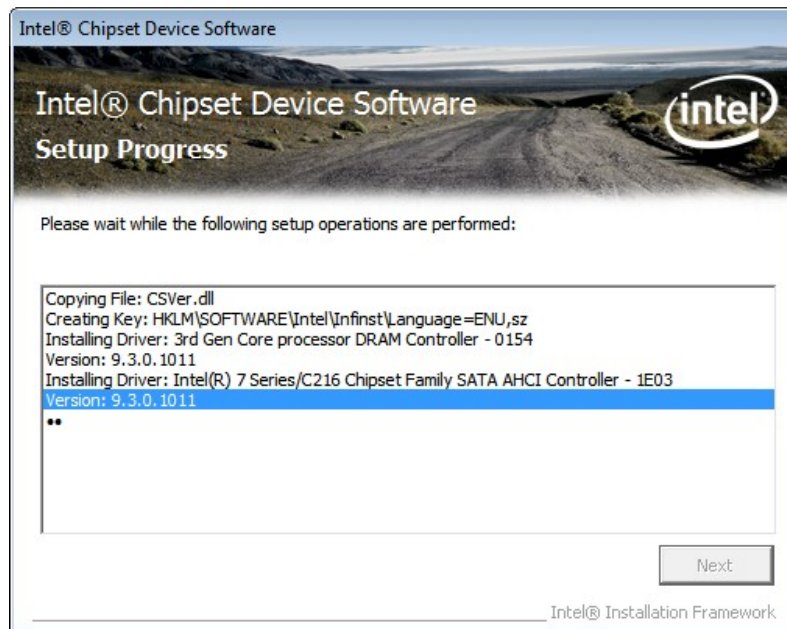

**Figure 6-6: Chipset Driver Setup Operations**

**Step 11:** Once the **Setup Operations** are complete, click **Next** to continue.

**Step 12:** The **Finish** screen in **Figure 6-7** appears.

**Step 13:** Select “**Yes, I want to restart the computer now**” and click the **Finish** icon.

See **Figure 6-7**.

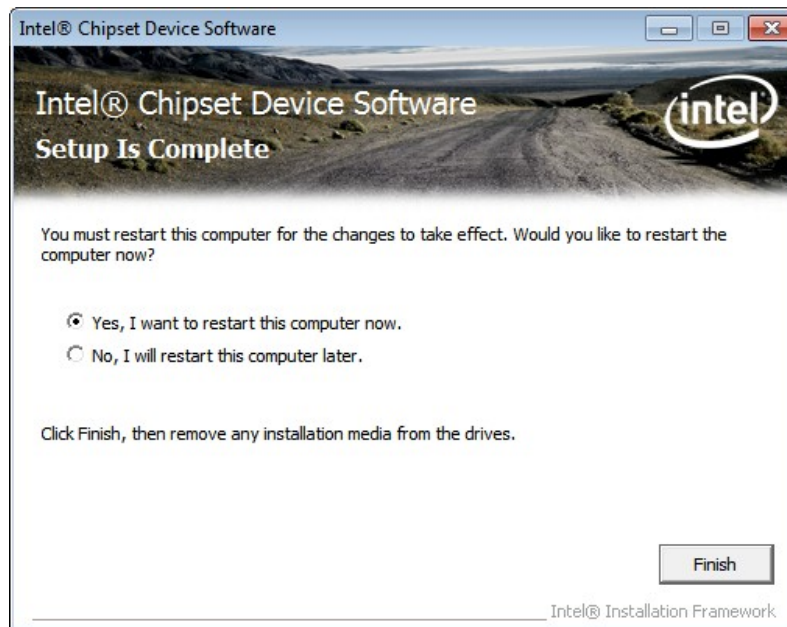

Figure 6-7: Chipset Driver Installation Finish Screen

## 6.4 Graphics Driver Installation

To install the graphics driver, please do the following.

- Step 1:** Access the driver list. (See **Section 6.2**)
- Step 2:** Click "**2-Graphics**" and select the folder which corresponds to the operating system.
- Step 3:** Double click the setup file.
- Step 4:** The **Welcome Screen** in **Figure 6-8** appears. Click **Next** to continue.

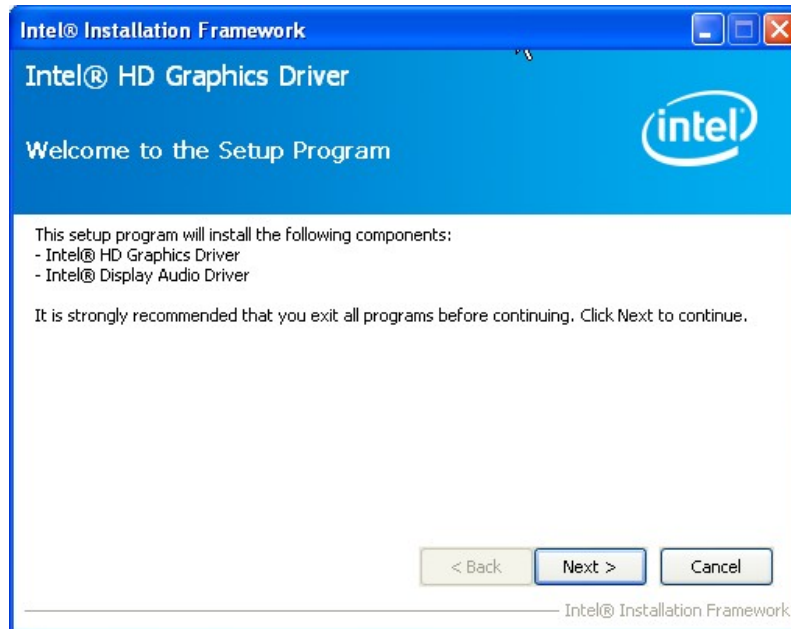

Figure 6-8: Graphics Driver Welcome Screen

**Step 5:** The license agreement in **Figure 6-9** appears. Read the **License Agreement**.

**Step 6:** Click **Yes** to continue.

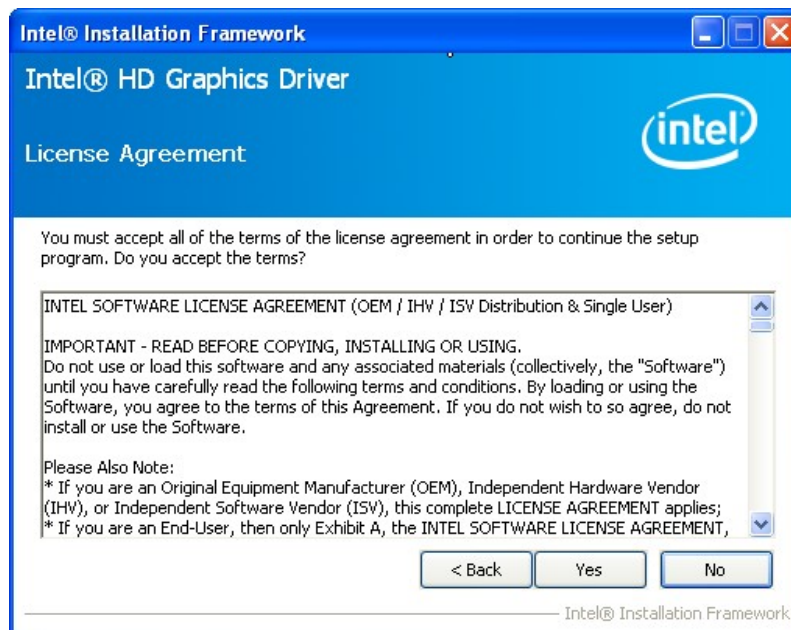
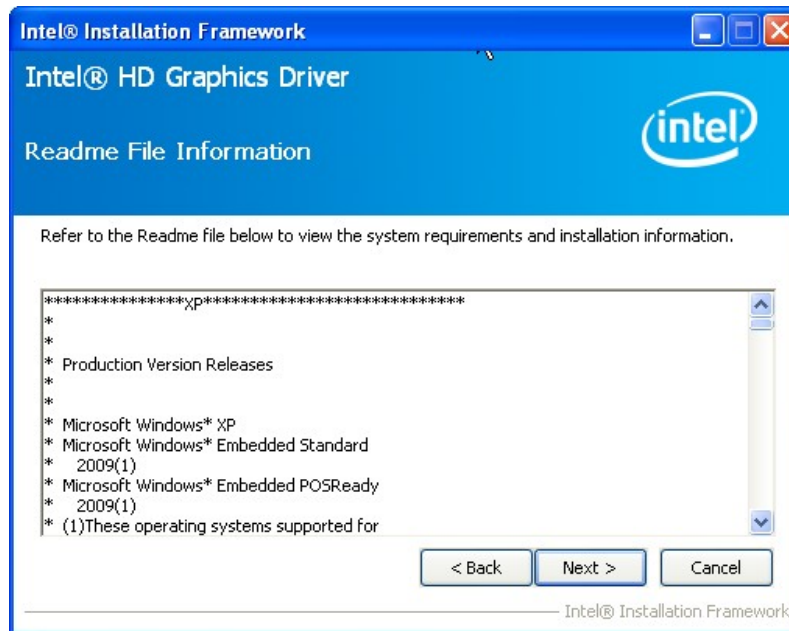

Figure 6-9: Graphics Driver License Agreement

## ICE-QM871 COM Express Module

**Step 7:** The Read Me file in **Figure 6-10** appears.

**Step 8:** Click **Next** to continue.



**Figure 6-10: Graphics Driver Read Me File**

**Step 9:** **Setup Operations** are performed as shown in **Figure 6-11**.

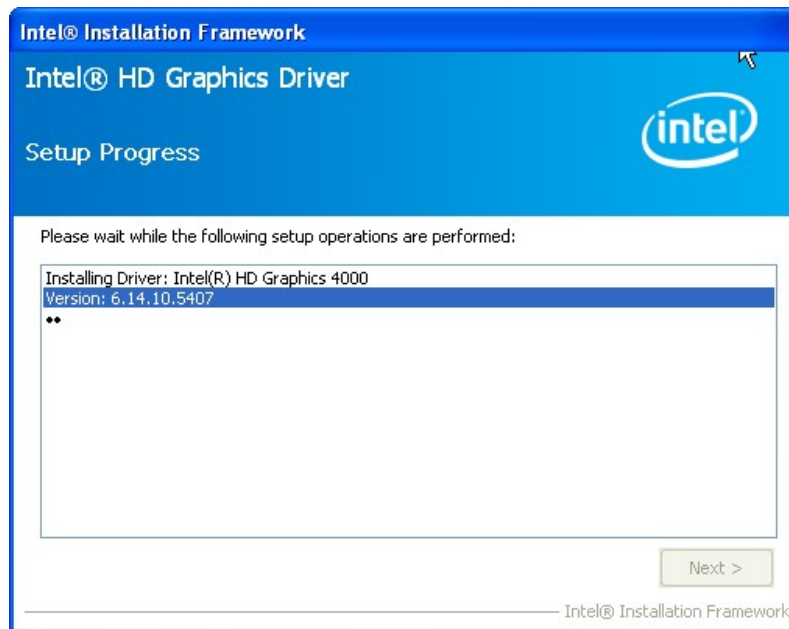

**Figure 6-11: Graphics Driver Setup Operations**

**Step 10:** Once the **Setup Operations** are complete, click the **Next** icon to continue.

**Step 11:** The **Finish** screen appears.

**Step 12:** Select “**Yes, I want to restart the computer now**” and click the **Finish** icon.

See **Figure 6-12**.

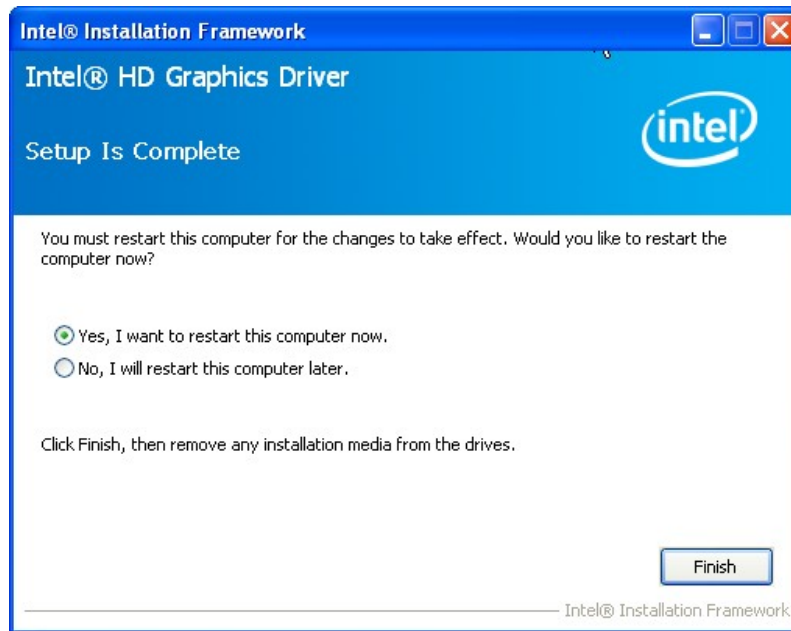

**Figure 6-12: Graphics Driver Installation Finish Screen**

## 6.5 LAN Driver Installation

To install the LAN driver, please do the following.

**Step 1:** Right-click the Computer button from the start menu and select **Properties**

(**Figure 6-13**).

## ICE-QM871 COM Express Module

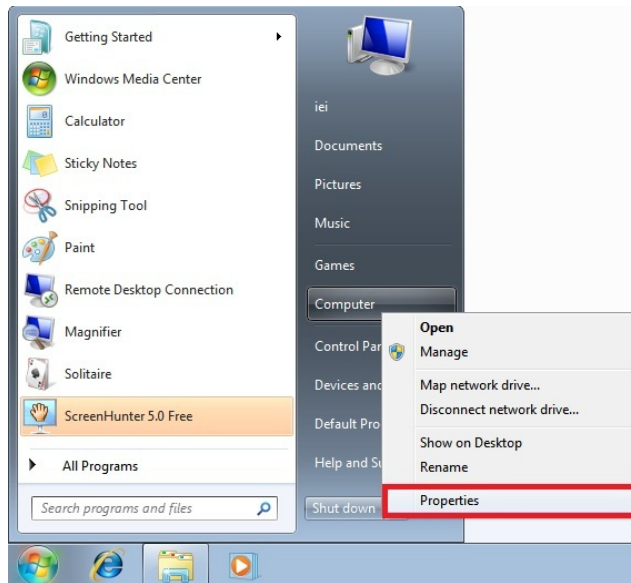

**Figure 6-13: Windows Control Panel**

**Step 2:** The system control panel window in **Figure 6-14** appears.

**Step 3:** Click the Device Manager link (**Figure 6-14**).

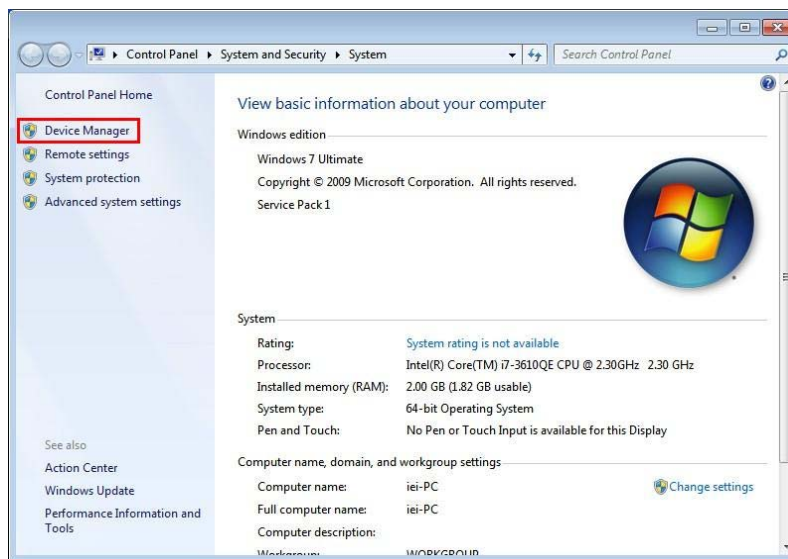

**Figure 6-14: System Control Panel**

**Step 4:** A list of system hardware devices appears (**Figure 6-15**).

**Step 5:** Right-click the Ethernet Controller that has question marks next to it (this means Windows does not recognize the device).



**Step 6:** Select Update Driver Software.

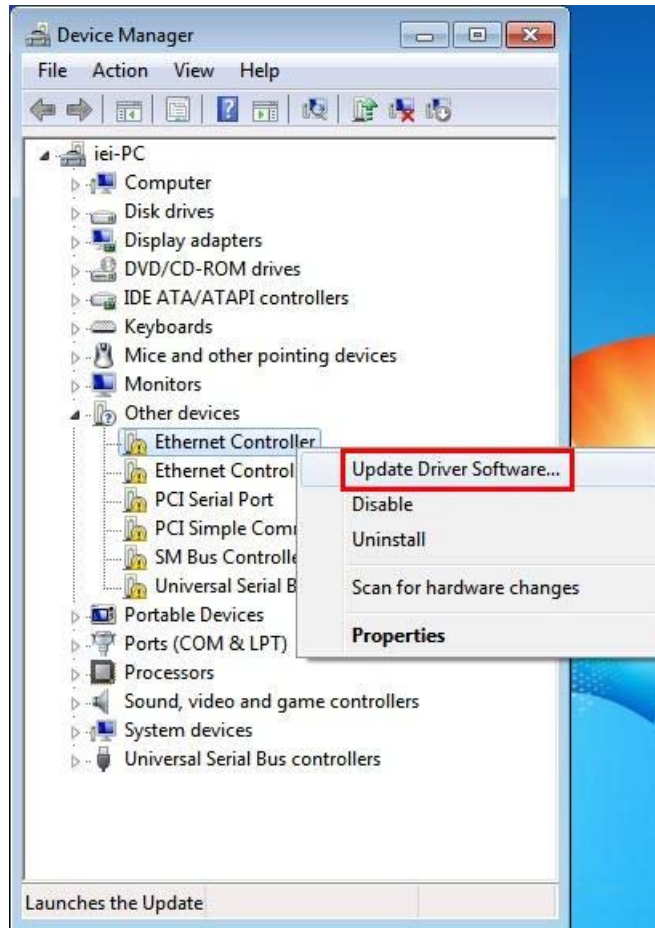

**Figure 6-15: Device Manager List**

**Step 7:** The Update Driver Software Window appears (Figure 6-16).

## ICE-QM871 COM Express Module

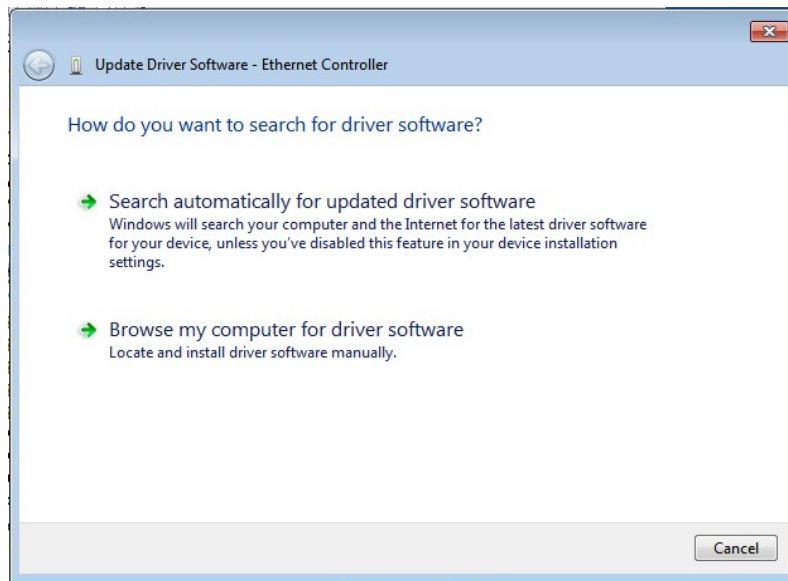

**Figure 6-16: Update Driver Software Window**

**Step 8:** Select “Browse my computer for driver software” and click **NEXT** to continue.

**Step 9:** Click Browse to select “X:\3-LAN” directory in the **Locate File** window, where “X:” is the system CD drive. (**Figure 6-17**).

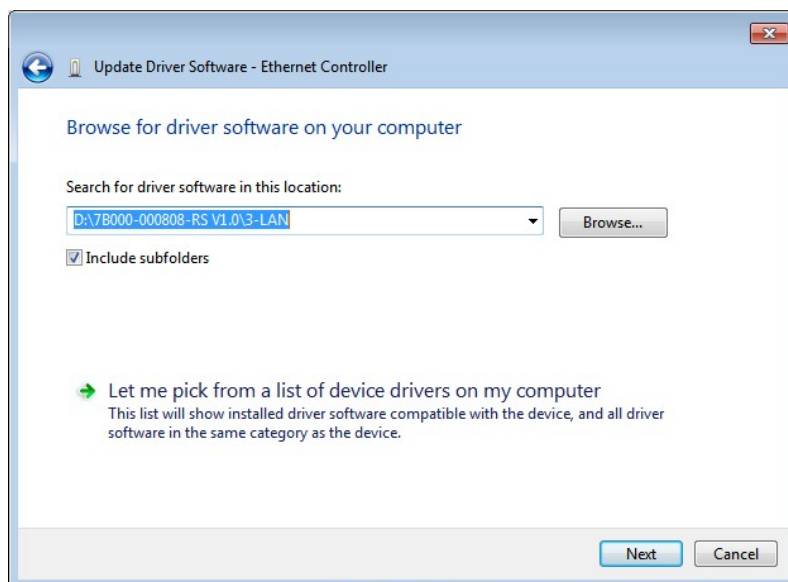

**Figure 6-17: Locate Driver Files**

**Step 10:** Click **NEXT** to continue.

**Step 11:** Driver Installation is performed as shown in **Figure 6-18**.

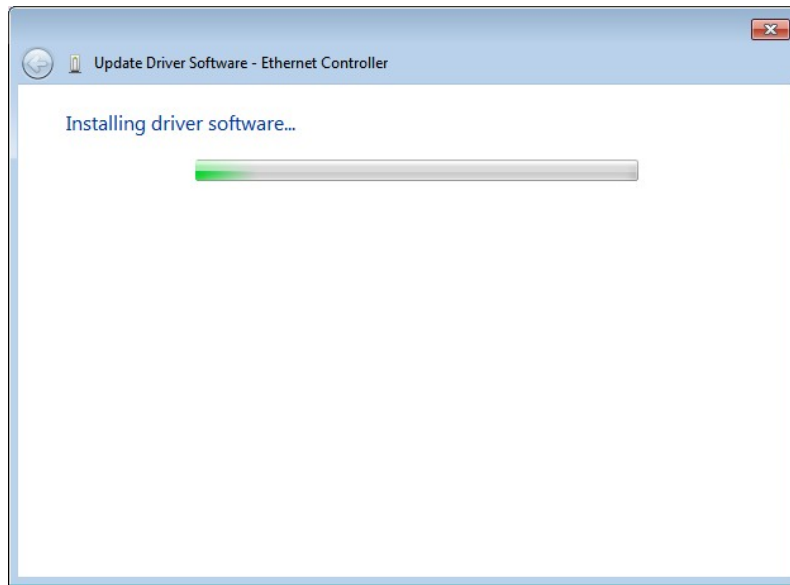

**Figure 6-18: LAN Driver Installation**

**Step 12:** The **Finish** screen in **Figure 6-19** appears. Click **Close** to exit.

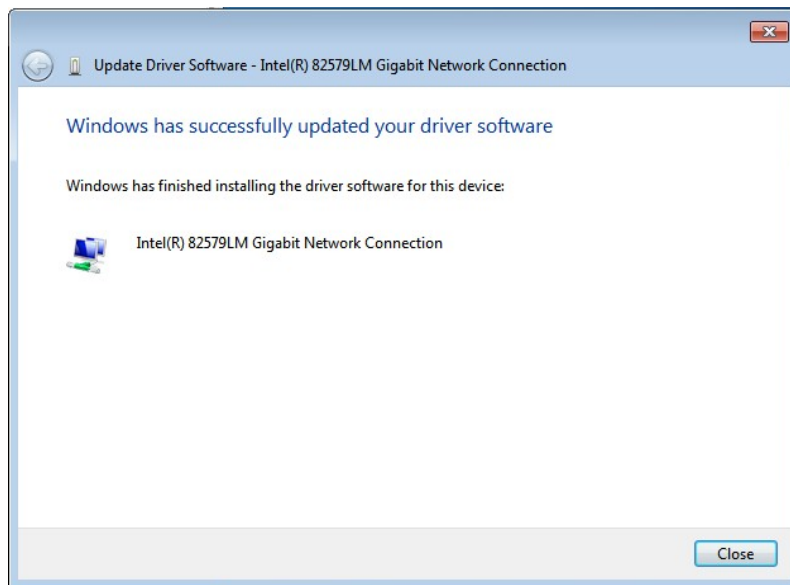

**Figure 6-19: LAN Driver Installation Complete**

## 6.6 USB 3.0 Driver Installation



### WARNING:

Do not run this driver's installer (Setup.exe) from a USB storage device (ie. external USB hard drive or USB thumb drive). For proper installation, please copy driver files to a local hard drive folder and run from there.

To install the USB 3.0 driver, please follow the steps below.

- Step 1:** Access the driver list. (See **Section 6.2**)
- Step 2:** Click “4-USB 3.0”.
- Step 3:** Locate the setup file and double click on it.
- Step 4:** The **Welcome Screen** in **Figure 6-20** appears.
- Step 5:** Click **Next** to continue.



Figure 6-20: USB 3.0 Driver Welcome Screen

**Step 6:** The license agreement in **Figure 6-21** appears.

**Step 7:** Read the **License Agreement**.

**Step 8:** Click **Yes** to continue.



**Figure 6-21: USB 3.0 Driver License Agreement**

**Step 9:** The **Read Me** file in **Figure 6-22** appears.

**Step 10:** Click **Next** to continue.

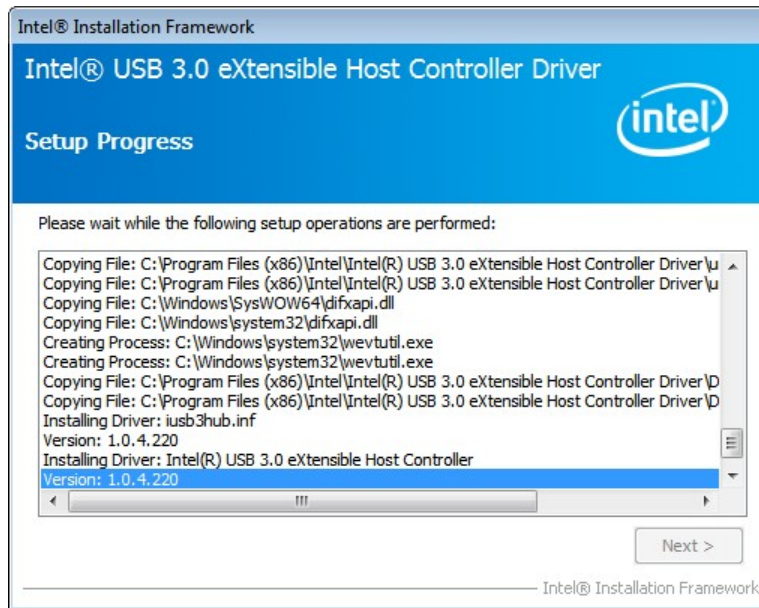

**Figure 6-22: USB 3.0 Driver Read Me File**

## ICE-QM871 COM Express Module

**Step 11:** Setup Operations are performed as shown in Figure 6-23.

**Step 12:** Once the Setup Operations are complete, click **Next** to continue.



**Figure 6-23: USB 3.0 Driver Setup Operations**

**Step 13:** The Finish screen in Figure 6-24 appears.

**Step 14:** Select “Yes, I want to restart this computer now” and click **Finish**.

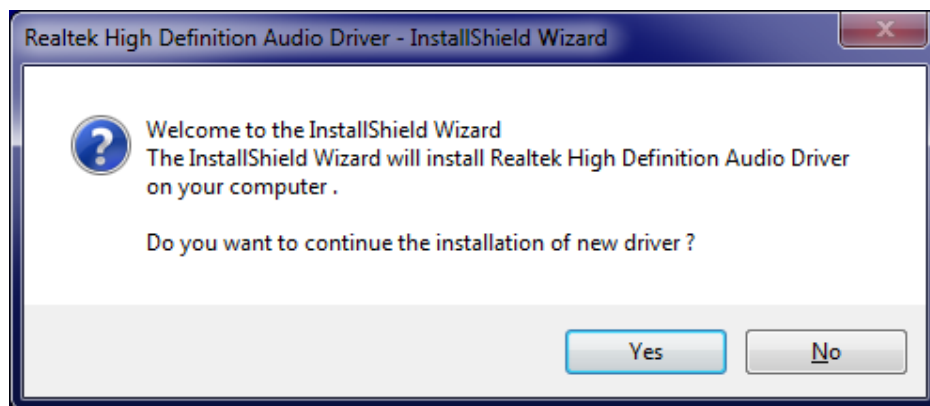

**Figure 6-24: USB 3.0 Driver Installation Finish Screen**

## 6.7 Audio Driver Installation

To install the Audio driver, please do the following.

- Step 1:** Access the driver list. (See **Section 6.2**)
- Step 2:** Click “**5-Audio**” and select the folder which corresponds to the operating system.
- Step 3:** Double click the setup file.
- Step 4:** The **InstallShield Wizard** is prepared to guide the user through the rest of the process
- Step 5:** Once initialized, the **InstallShield Wizard** welcome screen appears (**Figure 6-25**).



**Figure 6-25: Audio Driver Welcome Screen**

- Step 6:** Click **Yes** to continue.
- Step 7:** The program begins to install. See **Figure 6-26**.

## ICE-QM871 COM Express Module

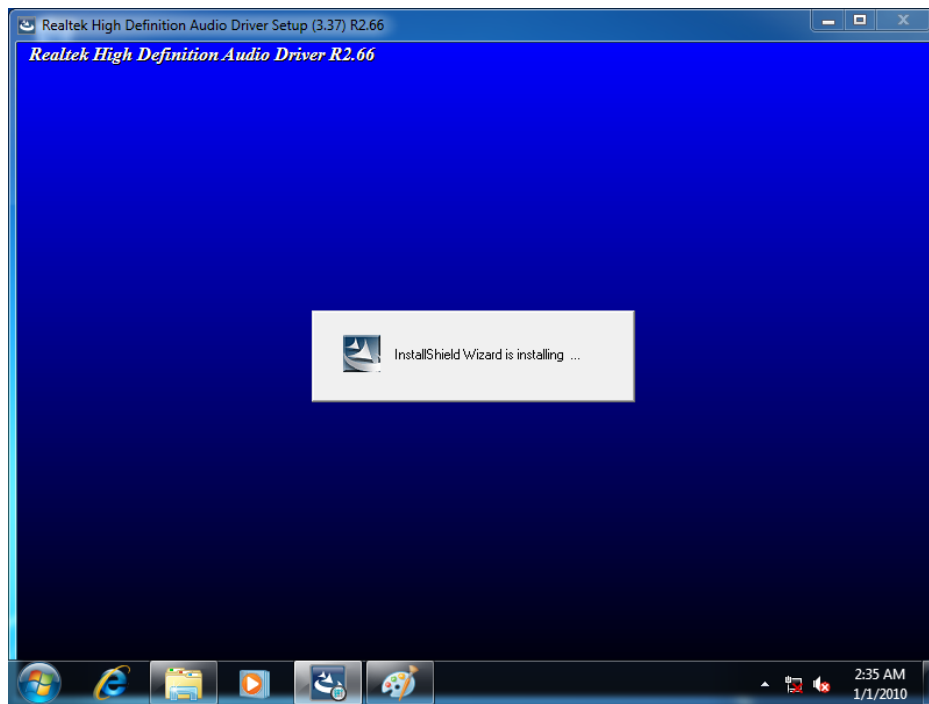

**Figure 6-26: Audio Driver Installation**

**Step 8:** When the driver installation is complete, the screen in **Figure 6-27** appears.

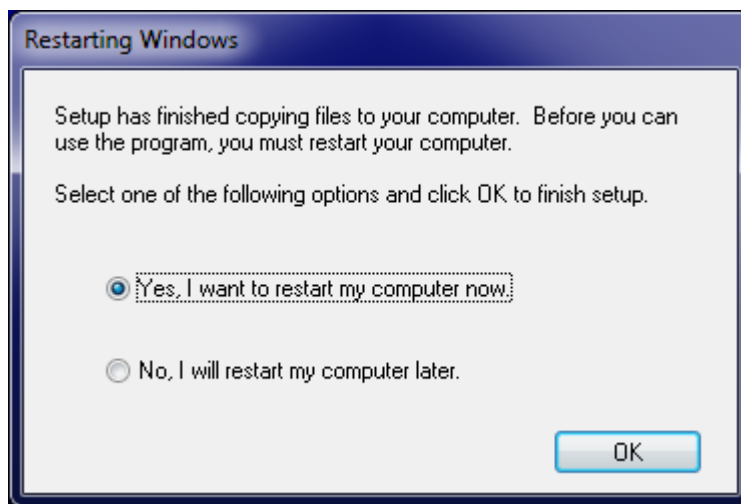

**Figure 6-27: Audio Driver Installation Complete**

**Step 9:** Select “Yes, I want to restart my computer now” and click **Finish**.

**Step 10:** The system reboots.



## 6.8 Intel® AMT Driver Installation

To install these Intel® AMT components, please do the following.

**Step 1:** Access the driver list. (See **Section 6.2**)

**Step 2:** Click “7-iAMT Driver & Utility”.

**Step 3:** Locate the setup file and double click it.

**Step 4:** When the setup files are completely extracted the **Welcome Screen** in **Figure 6-28** appears.

**Step 5:** Click **Next** to continue.

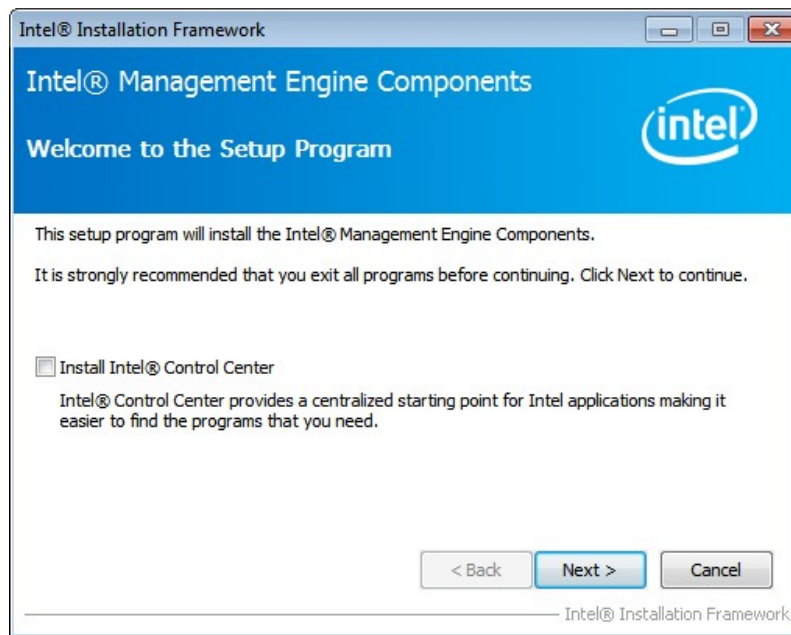
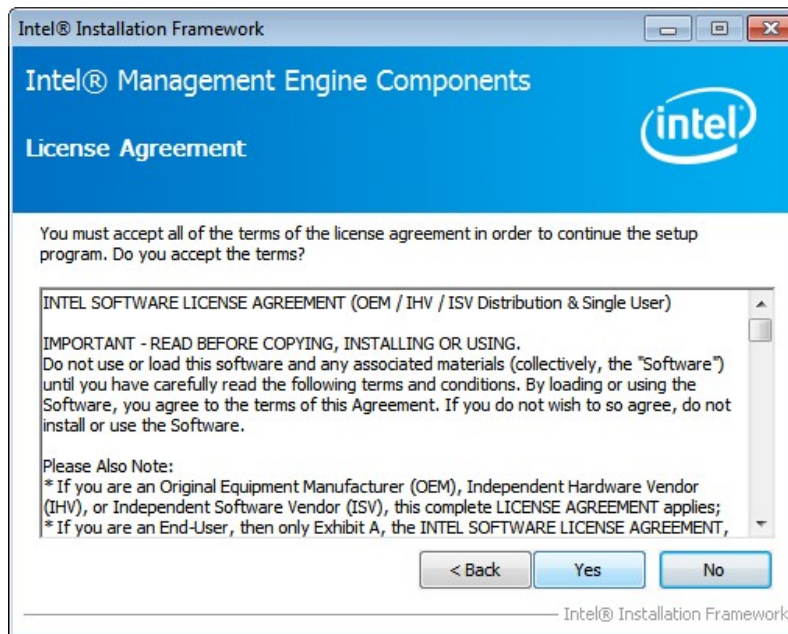

**Figure 6-28: Intel® ME Driver Welcome Screen**

**Step 6:** The license agreement in **Figure 6-29** appears.

**Step 7:** Read the **License Agreement**.

**Step 8:** Click **Yes** to continue.



**Figure 6-29: Intel® ME Driver License Agreement**

**Step 9:** Setup Operations are performed as shown in **Figure 6-30**.

**Step 10:** Once the Setup Operations are complete, click **Next** to continue.

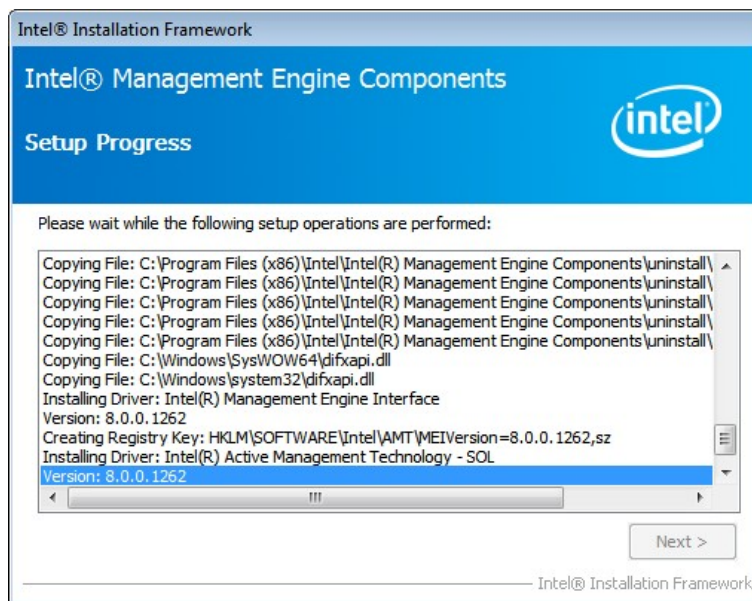

**Figure 6-30: Intel® ME Driver Setup Operations**

**Step 11:** The **Finish** screen in **Figure 6-31** appears.

**Step 12:** Select “Yes, I want to restart this computer now” and click **Finish**.

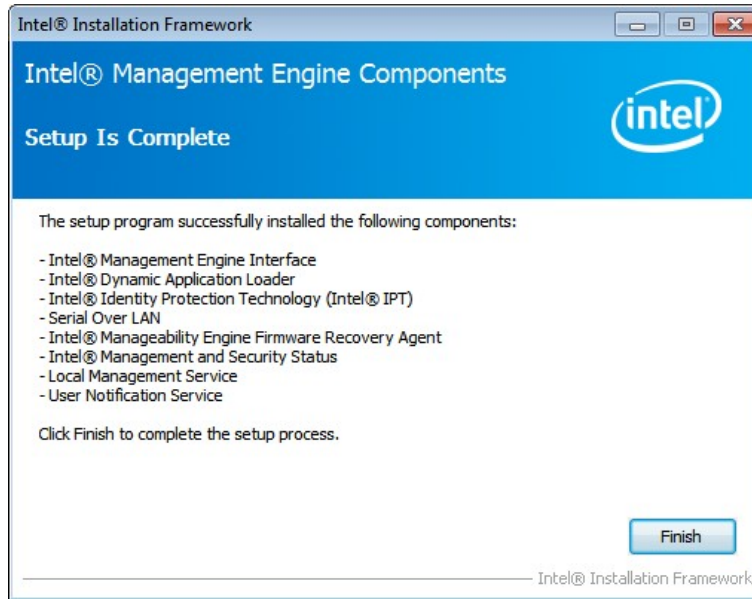

**Figure 6-31:** Intel® ME Driver Installation Finish Screen

Appendix

A

# BIOS Options

---

Below is a list of BIOS configuration options in the BIOS chapter.

<b>System Overview</b> .....	<b>40</b>
<b>System Date [xx/xx/xx]</b> .....	<b>40</b>
<b>System Time [xx:xx:xx]</b> .....	<b>40</b>
<b>ACPI Sleep State [S1 only (CPU Stop Clock)]</b> .....	<b>42</b>
<b>Wake system with Fixed Time [Disabled]</b> .....	<b>43</b>
<b>Security Device Support [Disable]</b> .....	<b>44</b>
<b>Hyper-threading [Enabled]</b> .....	<b>46</b>
<b>Intel Virtualization Technology [Disabled]</b> .....	<b>46</b>
<b>Intel TXT(LT) Support [Disabled]</b> .....	<b>46</b>
<b>SATA Controller(s) [Enabled]</b> .....	<b>47</b>
<b>SATA Mode Selection [IDE]</b> .....	<b>47</b>
<b>Intel(R) Rapid Start Technology [Disabled]</b> .....	<b>48</b>
<b>Intel AMT [Enabled]</b> .....	<b>49</b>
<b>Un-Configure ME [Disabled]</b> .....	<b>49</b>
<b>USB Devices</b> .....	<b>50</b>
<b>Legacy USB Support [Enabled]</b> .....	<b>50</b>
<b>PC Health Status</b> .....	<b>51</b>
<b>Fan 1 Smart Fan Control [Auto Mode]</b> .....	<b>52</b>
<b>Auto mode fan start/off temperature</b> .....	<b>53</b>
<b>Auto mode fan start PWM</b> .....	<b>53</b>
<b>Auto mode fan slope PWM</b> .....	<b>53</b>
<b>Serial Port [Enabled]</b> .....	<b>54</b>
<b>Change Settings [Auto]</b> .....	<b>54</b>
<b>Serial Port [Enabled]</b> .....	<b>55</b>
<b>Change Settings [Auto]</b> .....	<b>55</b>
<b>FAN1/FAN2 Smart Fan Mode [Manual Duty Mode]</b> .....	<b>57</b>
<b>Manual Duty Mode</b> .....	<b>57</b>
<b>Console Redirection [Disabled]</b> .....	<b>58</b>
<b>Terminal Type [ANSI]</b> .....	<b>58</b>
<b>Bits per second [115200]</b> .....	<b>59</b>
<b>Data Bits [8]</b> .....	<b>59</b>
<b>Parity [None]</b> .....	<b>59</b>
<b>Stop Bits [1]</b> .....	<b>60</b>

## ICE-QM871 COM Express Module

Auto Recovery Function [Disabled].....	60
VT-d [Disabled].....	62
Primary Display [Auto] .....	63
DVMT Pre-Allocated [256M] .....	63
DVMT Total Gfx Mem [MAX].....	64
Primary IGFX Boot Display [VBIOS Default] .....	64
LCD Panel Type [By Hardware] .....	64
Backlight Control [Inverted].....	65
PCIEX16 – Gen X [Auto] .....	65
Enable PEG [Auto].....	66
Detect Non-Compliance Device [Disabled] .....	66
Restore AC Power Loss [Last State] .....	67
Azalia [Enabled] .....	67
Power Saving Function [Disabled].....	68
PCIe Speed .....	69
Bootup NumLock State [On].....	69
Quiet Boot [Enabled] .....	70
Option ROM Messages [Force BIOS].....	70
Launch PXE OpROM [Disabled] .....	70
UEFI Boot [Disabled] .....	70
Administrator Password .....	71
User Password .....	71
Save Changes and Reset .....	72
Discard Changes and Reset .....	72
Restore Defaults .....	72
Save as User Defaults .....	72
Restore User Defaults .....	72



Appendix

**B**

# One Key Recovery

---

## B.1 One Key Recovery Introduction

The IEI one key recovery is an easy-to-use front end for the Norton Ghost system backup and recovery tool. This tool provides quick and easy shortcuts for creating a backup and reverting to that backup or reverting to the factory default settings.



### NOTE:

The latest One Key Recovery software provides an auto recovery function that allows a system running Microsoft Windows OS to automatically restore from the factory default image after encountering a Blue Screen of Death (BSoD) or a hang for around 10 minutes. Please refer to Section B.3 for the detailed setup procedure.

---

The IEI One Key Recovery tool menu is shown below.

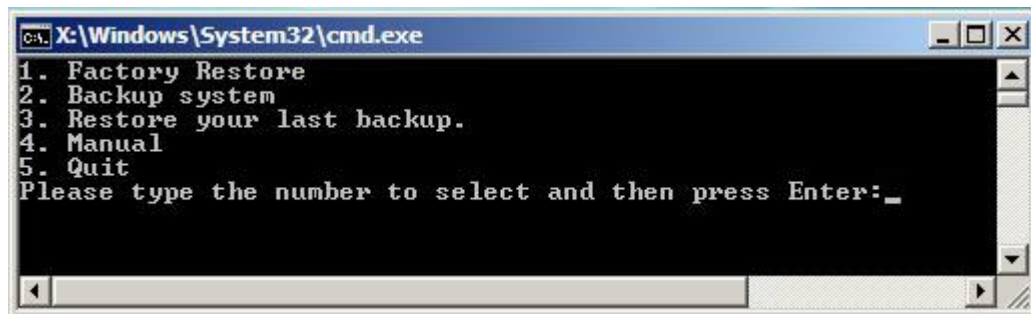

Figure B-1: IEI One Key Recovery Tool Menu

Prior to using the IEI One Key Recovery tool (as shown in **Figure B-1**) to backup or restore Windows system, five setup procedures are required.

1. Hardware and BIOS setup (see Section **B.2.1**)
2. Create partitions (see **Section B.2.2**)
3. Install operating system, drivers and system applications (see **Section B.2.3**)
4. Build-up recovery partition (see **Section B.2.4**)
5. Create factory default image (see **Section B.2.5**)



After completing the five initial setup procedures as described above, users can access the recovery tool by pressing <F3> while booting up the system. The detailed information of each function is described in **Section B.5**.

**NOTE:**

The initial setup procedures for Linux system are described in **Section B.3**.

### B.1.1 System Requirement

**NOTE:**

The recovery CD can only be used with IEI products. The software will fail to run and a warning message will appear when used on non-IEI hardware.

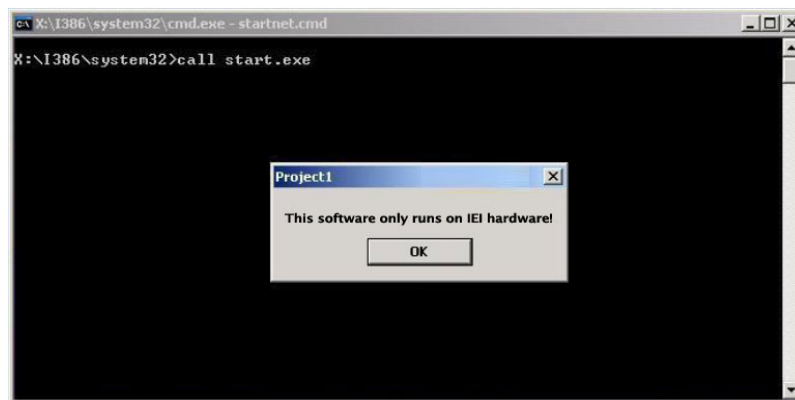

To create the system backup, the main storage device must be split into two partitions (three partitions for Linux). The first partition will be for the operating system, while the second partition will be invisible to the operating system and contain the backup made by the one key recovery software.

The partition created for recovery images must be big enough to contain both the factory default image and the user backup image. The size must be calculated before creating the

## ICE-QM871 COM Express Module

partitions. Please take the following table as a reference when calculating the size of the partition.

	OS	OS Image after Ghost	Compression Ratio
<b>Windows® 7</b>	7 GB	5 GB	70%
<b>Windows® XPE</b>	776 MB	560 MB	70%
<b>Windows® CE 6.0</b>	36 MB	28 MB	77%



### NOTE:

Specialized tools are required to change the partition size if the operating system is already installed.

### B.1.2 Supported Operating System

The recovery CD is compatible with both Microsoft Windows and Linux operating system (OS). The supported OS versions are listed below.

- Microsoft Windows
  - Windows 2000
  - Windows XP (Service Pack 2 or 3 required)
  - Windows Vista
  - Windows 7
  - Windows CE 5.0
  - Windows CE 6.0
  - Windows XP Embedded
  - Windows Embedded Standard 7



### NOTE:

The auto recovery function (described in **Section B.3**) and the restore through LAN function (described in **Section B.6**) are not supported in the Windows CE 5.0/6.0 operating system environment.

- Linux
  - Fedora Core 12 (Constantine)
  - Fedora Core 11 (Leonidas)
  - Fedora Core 10 (Cambridge)
  - Fedora Core 8 (Werewolf)
  - Fedora Core 7 (Moonshine)
  - RedHat RHEL-5.4
  - RedHat 9 (Ghirke)
  - Ubuntu 8.10 (Intrepid)
  - Ubuntu 7.10 (Gutsy)
  - Ubuntu 6.10 (Edgy)
  - Debian 5.0 (Lenny)
  - Debian 4.0 (Etch)
  - SuSe 11.2
  - SuSe 10.3

**NOTE:**

Installing unsupported OS versions may cause the recovery tool to fail.

---

## B.2 Setup Procedure for Windows

Prior to using the recovery tool to backup or restore, a few setup procedures are required.

**Step 1:** Hardware and BIOS setup (see **Section B.2.1**)

**Step 2:** Create partitions (see **Section B.2.2**)

**Step 3:** Install operating system, drivers and system applications (see **Section B.2.3**)

**Step 4:** Build the recovery partition (see **Section B.2.4**) or build the auto recovery partition (see **Section B.3**)

**Step 5:** Create factory default image (see **Section B.2.5**)

## ICE-QM871 COM Express Module

The detailed descriptions are described in the following sections.



### NOTE:

The setup procedures described below are for Microsoft Windows operating system users. For Linux, most of the setup procedures are the same except for several steps described in **Section B.3**.

### B.2.1 Hardware and BIOS Setup

- Step 1:** Make sure the system is powered off and unplugged.
- Step 2:** Install a hard drive or SSD in the system. An unformatted and unpartitioned disk is recommended.
- Step 3:** Connect an optical disk drive to the system and insert the recovery CD.
- Step 4:** Turn on the system.
- Step 5:** Press the <DELETE> key as soon as the system is turned on to enter the BIOS.
- Step 6:** Select the connected optical disk drive as the 1<sup>st</sup> boot device. (**Boot** → **Boot Device Priority** → **1<sup>st</sup> Boot Device**).
- Step 7:** Save changes and restart the computer. Continue to the next section for instructions on partitioning the internal storage.

### B.2.2 Create Partitions

To create the system backup, the main storage device must be split into two partitions (three partitions for Linux). The first partition will be for the operating system, while the second partition will be invisible to the operating system and contain the backup made by the one key recovery software.

- Step 1:** Put the recovery CD in the optical drive of the system.

**Step 2:** Boot the system from recovery CD. When prompted, press any key to boot from the recovery CD. It will take a while to launch the recovery tool. Please be patient!

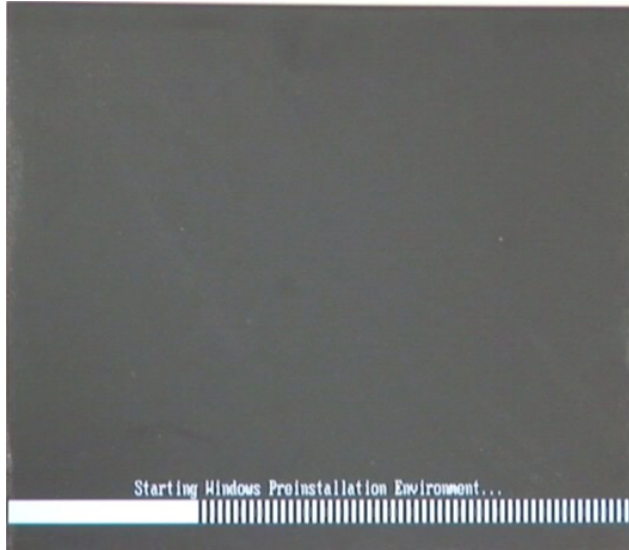

Figure B-2: Launching the Recovery Tool

**Step 3:** The recovery tool setup menu is shown as below.

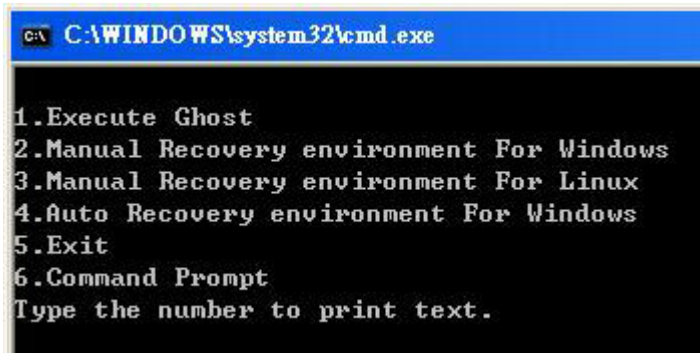
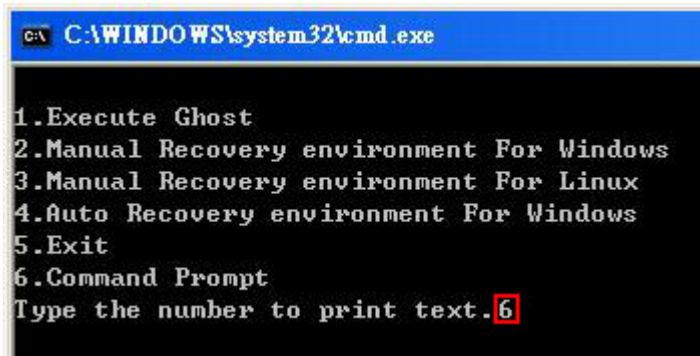

Figure B-3: Recovery Tool Setup Menu

**Step 4:** Press <6> then <Enter>.

## ICE-QM871 COM Express Module



```
C:\WINDOWS\system32\cmd.exe

1.Execute Ghost
2.Manual Recovery environment For Windows
3.Manual Recovery environment For Linux
4.Auto Recovery environment For Windows
5.Exit
6.Command Prompt
Type the number to print text.6
```

Figure B-4: Command Prompt

**Step 5:** The command prompt window appears. Type the following commands (marked in red) to create two partitions. One is for the OS installation; the other is for saving recovery files and images which will be an invisible partition. (Press <Enter> after entering each line below)

```
system32>diskpart
DISKPART>list vol
DISKPART>sel disk 0
DISKPART>create part pri size= ____
DISKPART>assign letter=N
DISKPART>create part pri size= ____
DISKPART>assign letter=F
DISKPART>exit
system32>format N: /fs:ntfs /q /y
system32>format F: /fs:ntfs /q /v:Recovery /y
system32>exit
```

```

X:\I386\SYSTEM32\CMD.EXE

X:\I386\SYSTEM32>diskpart → Starts the Microsoft disk partitioning tool.

Microsoft DiskPart version 5.2.3790.1830
Copyright (C) 1999-2001 Microsoft Corporation.
On computer: MININT-JUC

DISKPART> list vol → Show partition information

   Volume ###  Ltr  Label          Fs      Type          Size      Status       Info
   -----
   Volume 0          X  CD_ROM         CDFS    DUD-ROM       405 MB    Healthy      Boot
   Volume 1          D                FAT32    Removeable   3854 MB    Healthy

DISKPART> sel disk 0 → Select a disk

Disk 0 is now the selected disk.

DISKPART> create part pri size=2000 → Create partition 1 and assign a size.
                                       This partition is for OS installation.
DiskPart succeeded in creating the specified partition.

DISKPART> assign letter=N → Assign partition 1 a code name (N).
DiskPart successfully assigned the drive letter or mount point.

DISKPART> create part pri size=1800 → Create partition 2 and assign a size.
                                       This partition is for recovery images.
DiskPart succeeded in creating the specified partition.

DISKPART> assign letter=F → Assign partition 2 a code name (F).
DiskPart successfully assigned the drive letter or mount point.

DISKPART> exit → Exit diskpart

X:\I386\SYSTEM32>format n: /fs:ntfs /q /y → Format partition 1 (N) as NTFS format.
The type of the file system is RAW.
The new file system is NTFS.
QuickFormatting 2000M
Creating file system structures.
Format complete.
 2048254 KB total disk space.
 2035620 KB are available.

X:\I386\SYSTEM32>format f: /fs:ntfs /q /v:Recovery /y
The type of the file system is RAW.
The new file system is NTFS.
QuickFormatting 1804M
Creating file system structures.
Format complete.
 1847474 KB total disk space.
 1835860 KB are available.

X:\I386\SYSTEM32>exit → Exit Windows PE
  
```

**Figure B-5: Partition Creation Commands**



**NOTE:**

Use the following commands to check if the partitions were created successfully.

```

X:\I386\SYSTEM32>diskpart
Microsoft DiskPart version 5.2.3790.1830
Copyright (C) 1999-2001 Microsoft Corporation.
On computer: MININT-JUC

DISKPART> sel disk 0
Disk 0 is now the selected disk.

DISKPART> list part

   Partition ###   Type              Size              Offset
-----
   Partition 1     Primary           2000 MB           32 KB
   Partition 2     Primary           1804 MB          2000 MB

DISKPART> exit
    
```

**Step 6:** Press any key to exit the recovery tool and automatically reboot the system.  
Please continue to the following procedure: Build the Recovery Partition.

## B.2.3 Install Operating System, Drivers and Applications

Install the operating system onto the unlabelled partition. The partition labeled "Recovery" is for use by the system recovery tool and should not be used for installing the operating system or any applications.



**NOTE:**

The operating system installation program may offer to reformat the chosen partition. DO NOT format the partition again. The partition has already been formatted and is ready for installing the new operating system.

To install the operating system, insert the operating system installation CD into the optical drive. Restart the computer and follow the installation instructions.



## B.2.4 Build-up Recovery Partition

- Step 1:** Put the recover CD in the optical drive.
- Step 2:** Start the system.
- Step 3:** **Boot the system from the recovery CD.** When prompted, press any key to boot from the recovery CD. It will take a while to launch the recovery tool. Please be patient!

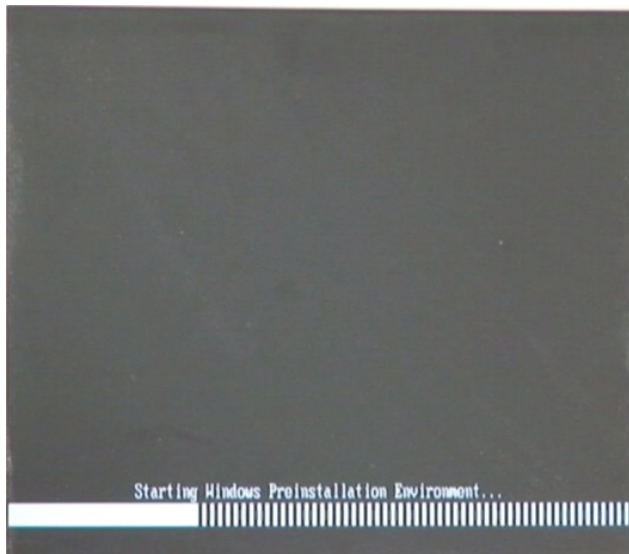

Figure B-6: Launching the Recovery Tool

- Step 4:** When the recovery tool setup menu appears, press <2> then <Enter>.

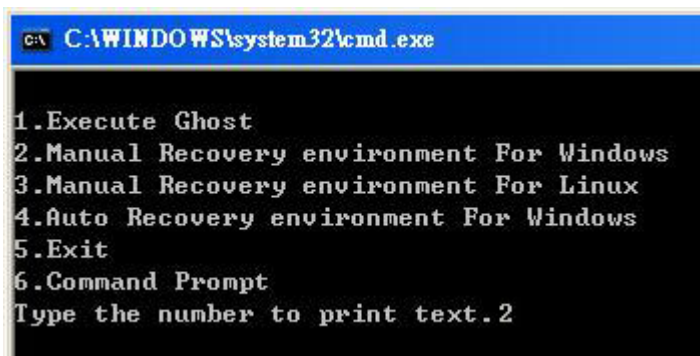
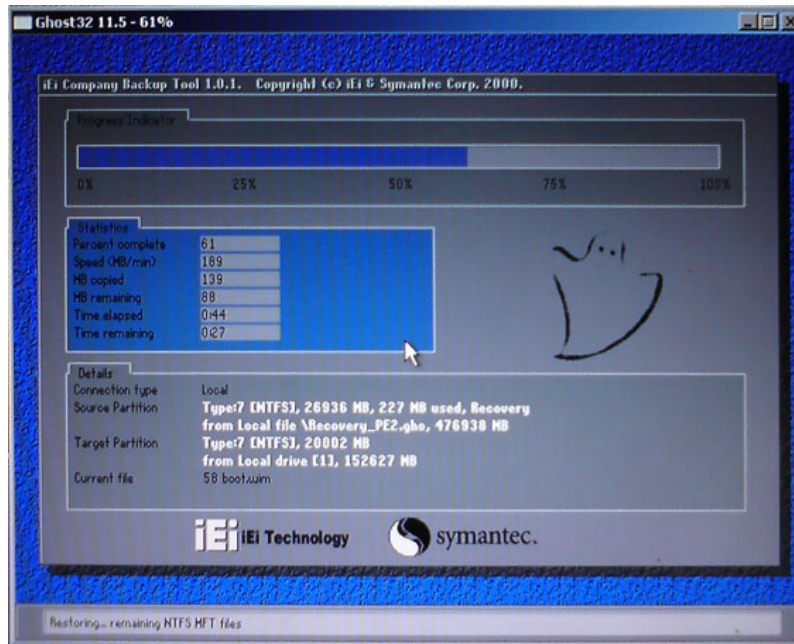

Figure B-7: Manual Recovery Environment for Windows

## ICE-QM871 COM Express Module

**Step 5:** The Symantec Ghost window appears and starts configuring the system to build a recovery partition. In this process the partition created for recovery files in **Section B.2.2** is hidden and the recovery tool is saved in this partition.



**Figure B-8: Building the Recovery Partition**

**Step 6:** After completing the system configuration, press any key in the following window to reboot the system.

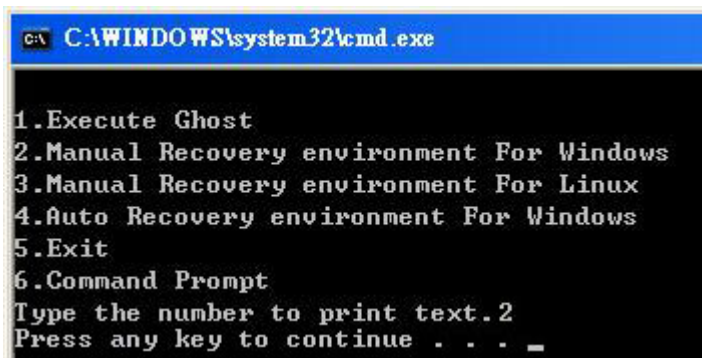

**Figure B-9: Press Any Key to Continue**

**Step 7:** Eject the recovery CD.

## B.2.5 Create Factory Default Image



### NOTE:

Before creating the factory default image, please configure the system to a factory default environment, including driver and application installations.

To create a factory default image, please follow the steps below.

**Step 1:** Turn on the system. When the following screen displays (**Figure B-10**), press the <F3> key to access the recovery tool. The message will display for 10 seconds, please press F3 before the system boots into the operating system.

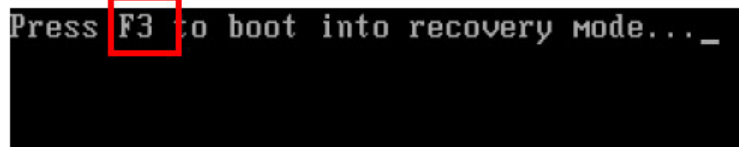

Figure B-10: Press F3 to Boot into Recovery Mode

**Step 2:** The recovery tool menu appears. Type <4> and press <Enter>. (**Figure B-11**)

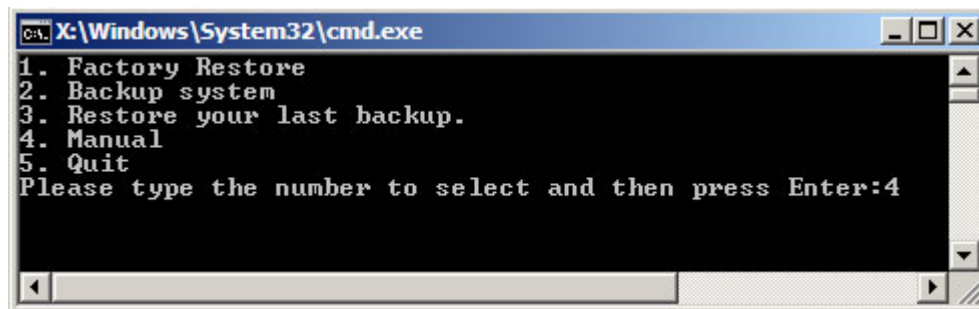

Figure B-11: Recovery Tool Menu

**Step 3:** The About Symantec Ghost window appears. Click **OK** button to continue.

## ICE-QM871 COM Express Module

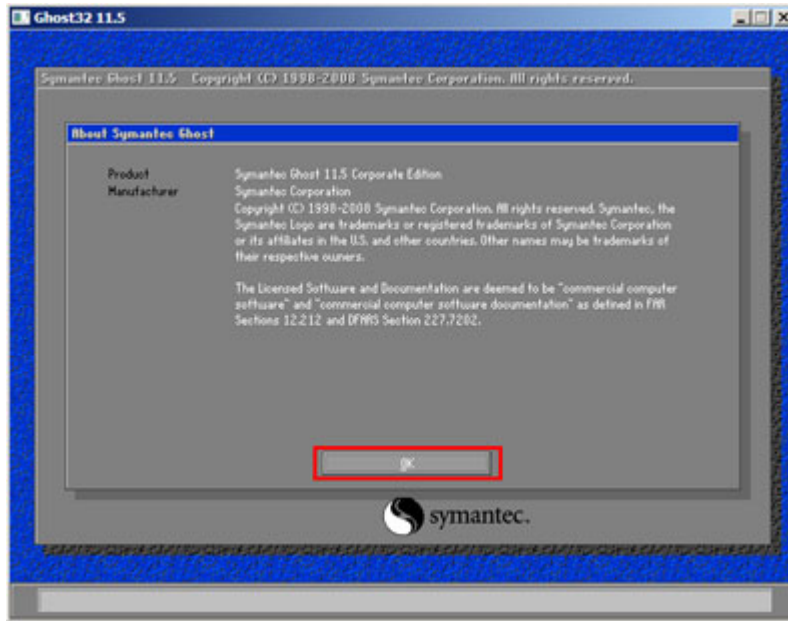

Figure B-12: About Symantec Ghost Window

**Step 4:** Use mouse to navigate to the option shown below (Figure B-13).

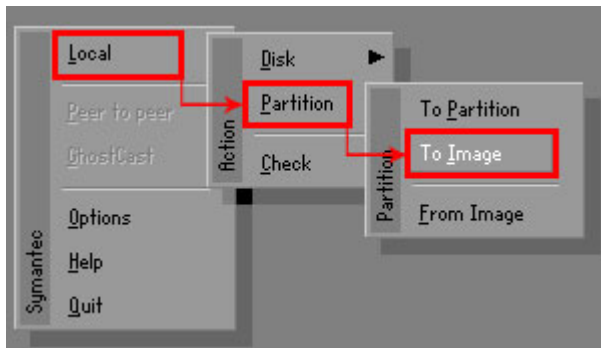
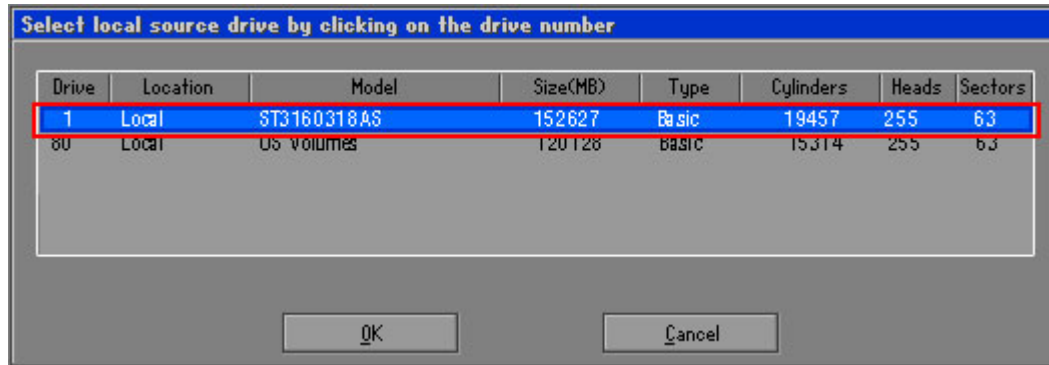

Figure B-13: Symantec Ghost Path

**Step 5:** Select the local source drive (Drive 1) as shown in Figure B-14. Then click OK.



**Figure B-14: Select a Local Source Drive**

**Step 6:** Select a source partition (Part 1) from basic drive as shown in **Figure B-15**. Then click OK.

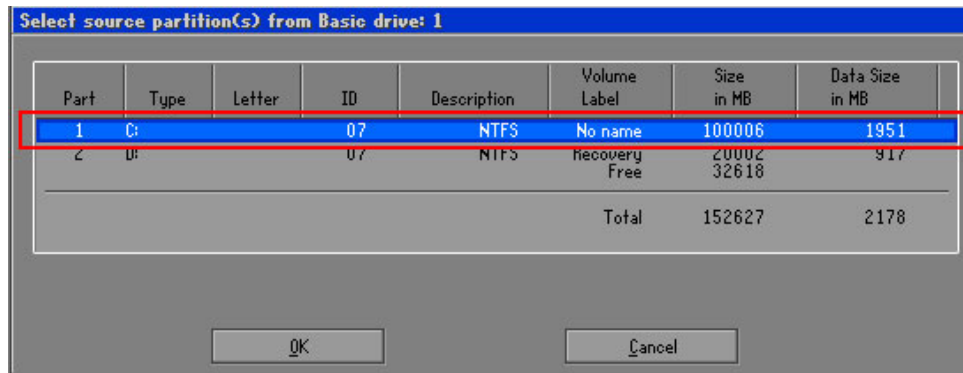

**Figure B-15: Select a Source Partition from Basic Drive**

**Step 7:** Select **1.2: [Recovery] NTFS drive** and enter a file name called **iei** (**Figure B-16**). Click **Save**. The factory default image will then be saved in the selected recovery drive and named **IEI.GHO**.



**WARNING:**

The file name of the factory default image must be **iei.GHO**.

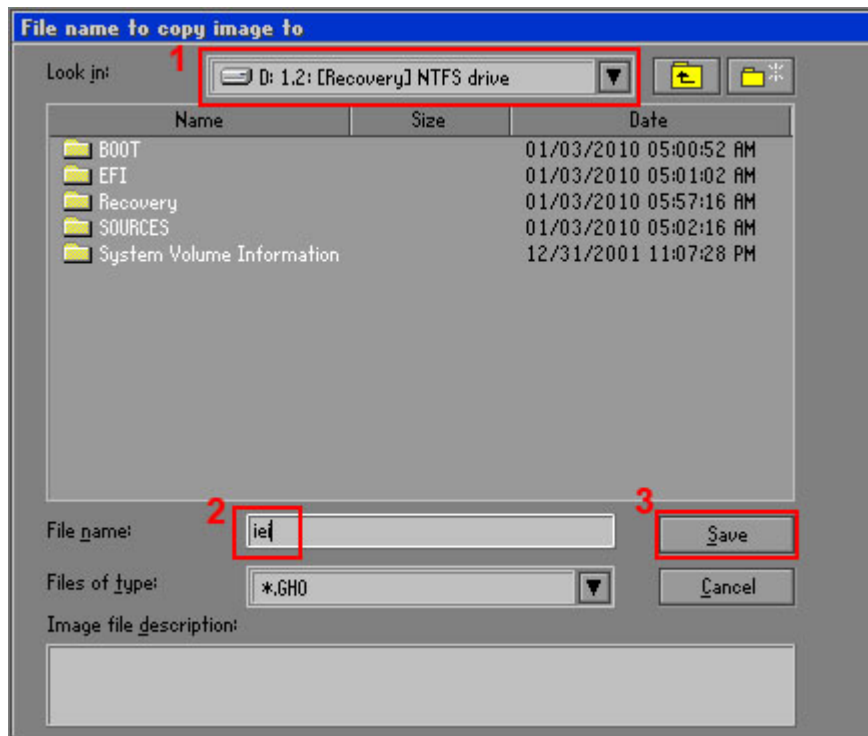

Figure B-16: File Name to Copy Image to

**Step 8:** When the Compress Image screen in **Figure B-17** prompts, click **High** to make the image file smaller.

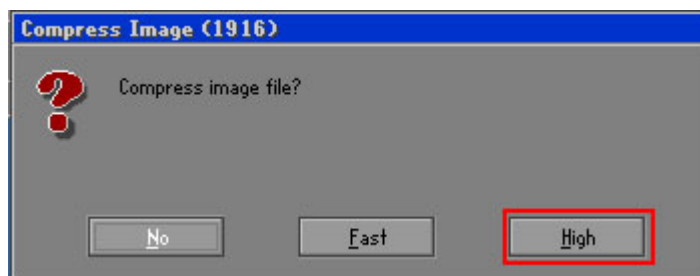
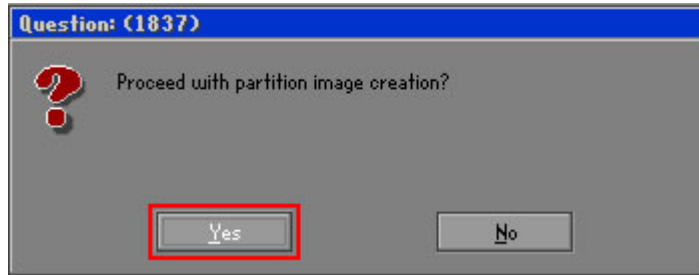

Figure B-17: Compress Image

**Step 9:** The Proceed with partition image creation window appears, click **Yes** to continue.



**Figure B-18: Image Creation Confirmation**

**Step 10:** The Symantec Ghost starts to create the factory default image (**Figure B-19**).

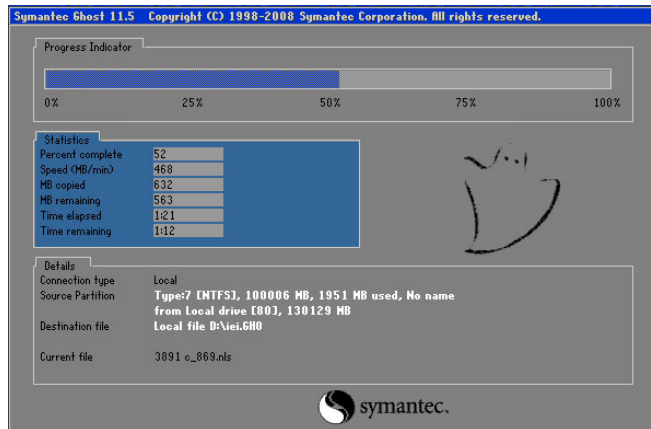

**Figure B-19: Image Creation Complete**

**Step 11:** When the image creation completes, a screen prompts as shown in **Figure B-20**.

Click **Continue** and close the Ghost window to exit the program.

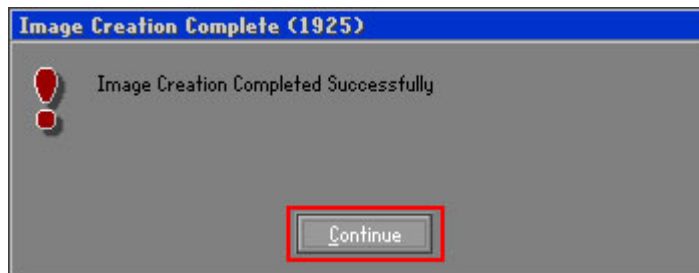

**Figure B-20: Image Creation Complete**

## ICE-QM871 COM Express Module

**Step 12:** The recovery tool main menu window is shown as below. Press any key to reboot the system.

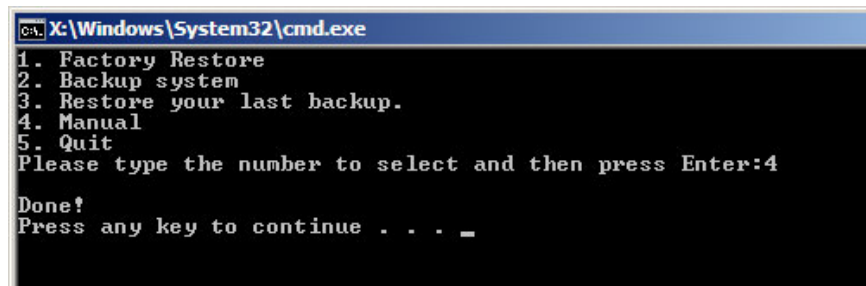

```
C:\Windows\System32\cmd.exe
1. Factory Restore
2. Backup system
3. Restore your last backup.
4. Manual
5. Quit
Please type the number to select and then press Enter:4
Done!
Press any key to continue . . . _
```

Figure B-21: Press Any Key to Continue

### B.3 Auto Recovery Setup Procedure

The auto recovery function allows a system to automatically restore from the factory default image after encountering a Blue Screen of Death (BSoD) or a hang for around 10 minutes. To use the auto recovery function, follow the steps described in the following sections.



#### CAUTION:

The auto recovery function can only run on a Microsoft Windows system with the following OS versions:

- Windows 2000
- Windows XP
- Windows Vista
- Windows 7
- Windows XP Embedded
- Windows Embedded Standard 7



#### CAUTION:

The setup procedure may include a step to create a factory default image. It is suggested to configure the system to a factory default environment before the configuration, including driver and application installations.

---



- Step 1:** Follow the steps described in **Section B.2.1 ~ Section B.2.3** to setup BIOS, create partitions and install operating system.
- Step 2:** Install the auto recovery utility into the system by double clicking the **Utility/AUTORECOVERY-SETUP.exe** in the One Key Recovery CD. This utility **MUST** be installed in the system, otherwise, the system will automatically restore from the factory default image every ten (10) minutes.



**Figure B-22: Auto Recovery Utility**

- Step 3:** **Disable the automatically restart function before creating the factory default image.** Go to: My Computer → Properties → Advanced. Click the Settings button of Startup and Recovery. Deselect “Automatically restart”. Click OK to save the settings and exit. (See **Figure B-23**)

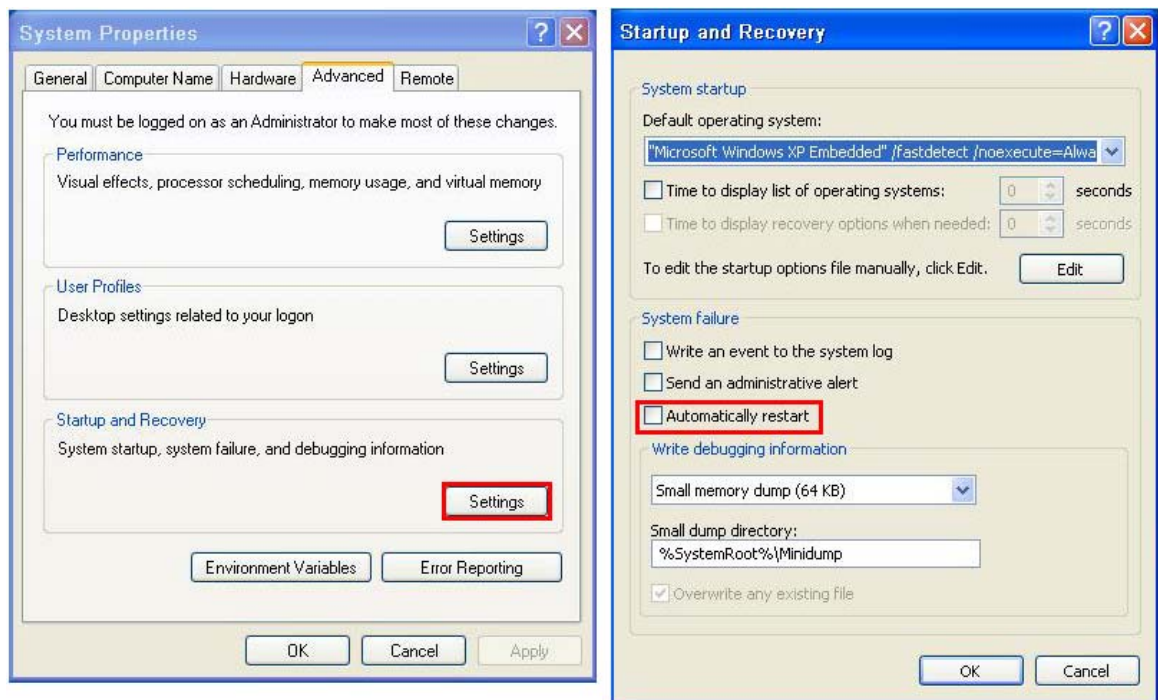

**Figure B-23: Disable Automatically Restart**

## ICE-QM871 COM Express Module

**Step 4:** Reboot the system from the recovery CD. When prompted, press any key to boot from the recovery CD. It will take a while to launch the recovery tool. Please be patient!

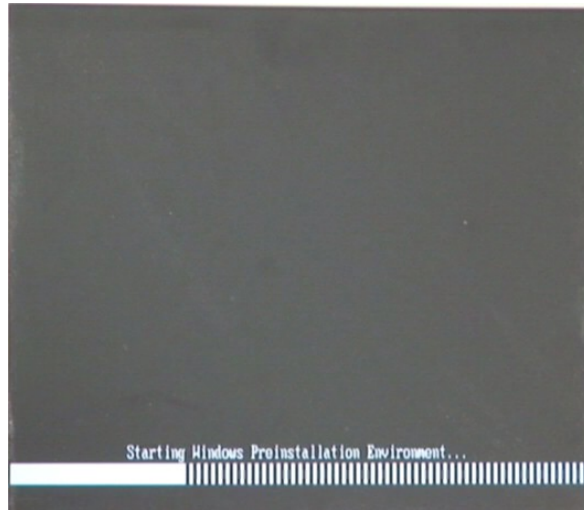

Figure B-24: Launching the Recovery Tool

**Step 5:** When the recovery tool setup menu appears, press <4> then <Enter>.

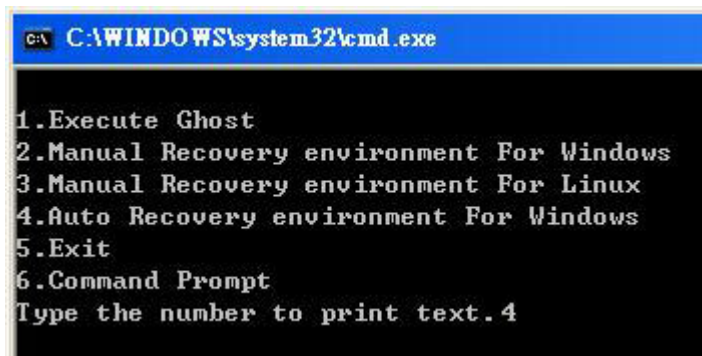
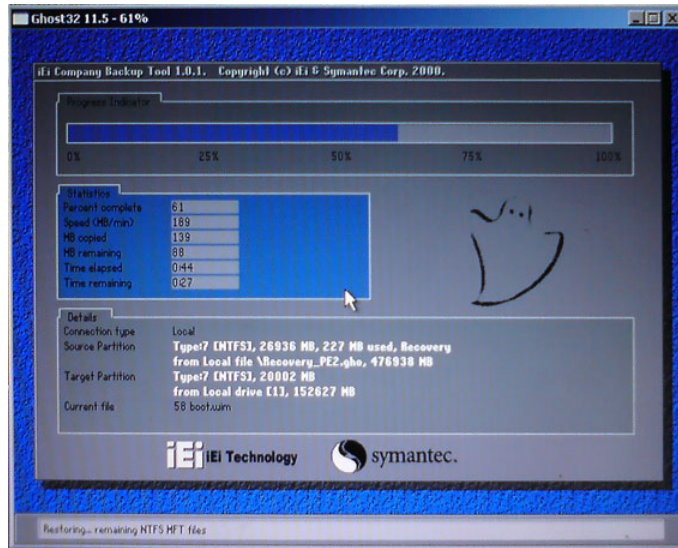

Figure B-25: Auto Recovery Environment for Windows

**Step 6:** The Symantec Ghost window appears and starts configuring the system to build an auto recovery partition. In this process the partition created for recovery files in **Section B.2.2** is hidden and the auto recovery tool is saved in this partition.



**Figure B-26: Building the Auto Recovery Partition**

**Step 7:** After completing the system configuration, the following message prompts to confirm whether to create a factory default image. Type **Y** to have the system create a factory default image automatically. Type **N** within 6 seconds to skip this process (The default option is YES). It is suggested to choose YES for this option.



**Figure B-27: Factory Default Image Confirmation**

## ICE-QM871 COM Express Module

**Step 8:** The Symantec Ghost starts to create the factory default image (**Figure B-28**).

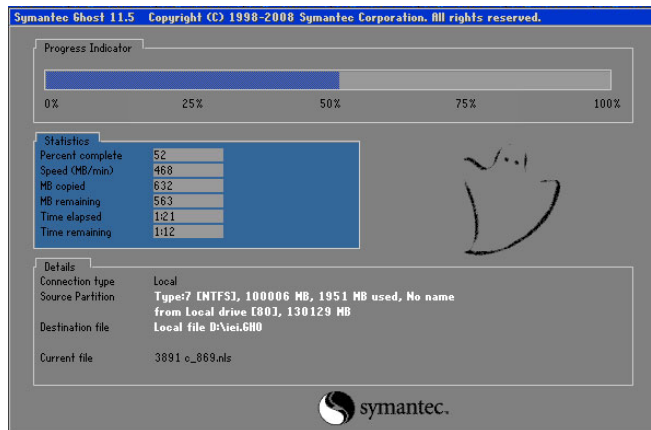

**Figure B-28: Image Creation Complete**

**Step 9:** After completing the system configuration, press any key in the following window to restart the system.

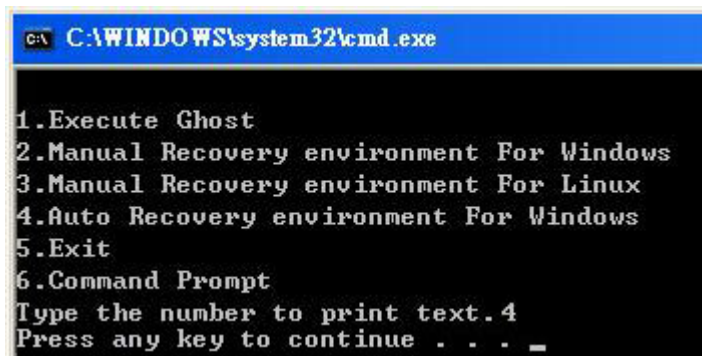
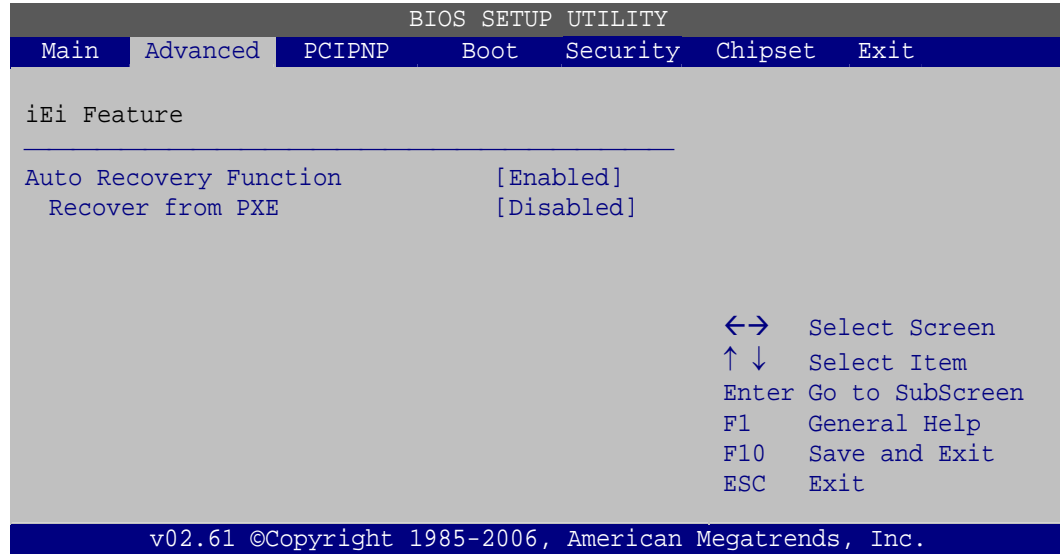

**Figure B-29: Press any key to continue**

**Step 10:** Eject the One Key Recovery CD and restart the system.

**Step 11:** Press the <DELETE> key as soon as the system is turned on to enter the BIOS.

**Step 12:** Enable the Auto Recovery Function option (**Advanced** → **iEi Feature** → **Auto Recovery Function**).



**Figure B-30: IEI Feature**

**Step 13:** Save changes and restart the system. If the system encounters a Blue Screen of Death (BSoD) or a hang for around 10 minutes, it will automatically restore from the factory default image.

## B.4 Setup Procedure for Linux

The initial setup procedures for a Linux system are mostly the same with the procedure for Microsoft Windows. Please follow the steps below to setup the recovery tool for Linux OS.

**Step 1:** Hardware and BIOS setup. Refer to **Section B.2.1**.

**Step 2: Install Linux operating system.** Make sure to install GRUB (v0.97 or earlier) MBR type and Ext3 partition type. Leave enough space on the hard drive to create the recover partition later.



**NOTE:**

If the Linux OS is not installed with GRUB (v0.97 or earlier) and Ext3, the Symantec Ghost may not function properly.

## ICE-QM871 COM Express Module

**Step 3:** While installing Linux OS, please create two partitions:

- Partition 1: /
- Partition 2: **SWAP**

**NOTE:**

Please reserve enough space for partition 3 for saving recovery images.

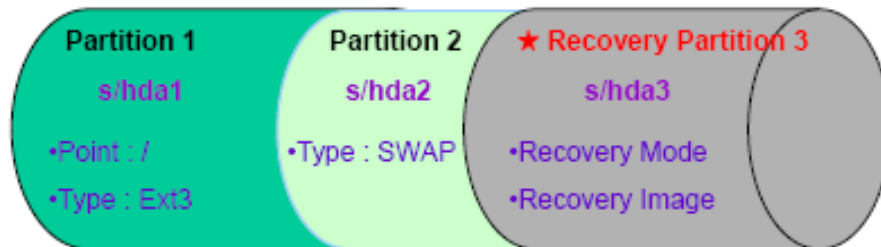

Figure B-31: Partitions for Linux

**Step 4:** **Create a recovery partition.** Insert the recovery CD into the optical disk drive.

Follow **Step 1 ~ Step 3** described in **Section B.2.2**. Then type the following commands (marked in red) to create a partition for recovery images.

```
system32>diskpart
DISKPART>list vol
DISKPART>sel disk 0
DISKPART>create part pri size= ____
DISKPART>assign letter=N
DISKPART>exit
system32>format N: /fs:ntfs /q /v:Recovery /y
system32>exit
```

**Step 5:** **Build-up recovery partition.** Press any key to boot from the recovery CD. It will take a while to launch the recovery tool. Please be patient. When the recovery tool setup menu appears, type <3> and press <Enter> (**Figure B-32**). The

Symantec Ghost window appears and starts configuring the system to build-up a recovery partition. After completing the system configuration, press any key to reboot the system. Eject the recovery CD.

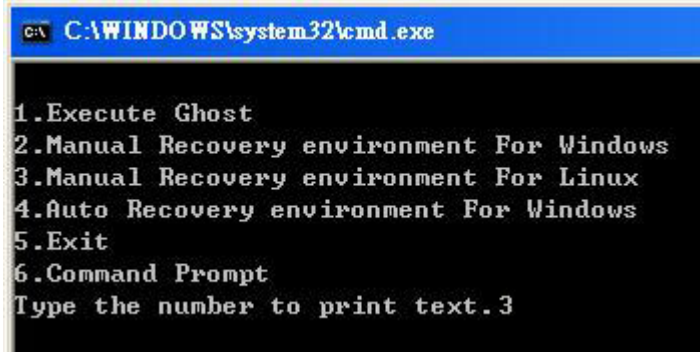

```

C:\WINDOWS\system32\cmd.exe

1.Execute Ghost
2.Manual Recovery environment For Windows
3.Manual Recovery environment For Linux
4.Auto Recovery environment For Windows
5.Exit
6.Command Prompt
Type the number to print text.3
    
```

**Figure B-32: System Configuration for Linux**

**Step 6:** Access the recovery tool main menu by modifying the “menu.lst”. To first access the recovery tool main menu, the menu.lst must be modified. In Linux, enter Administrator (root). When prompt appears, type:

**cd /boot/grub**

**vi menu.lst**

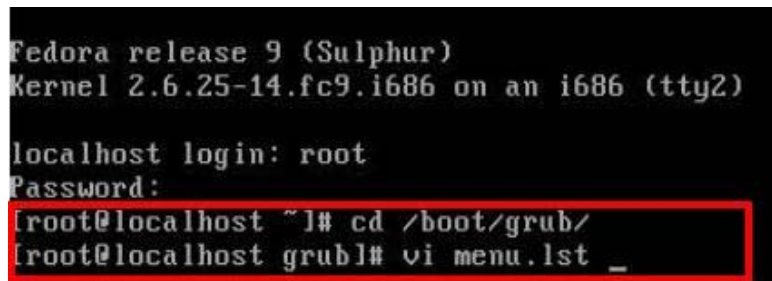

```

Fedora release 9 (Sulphur)
Kernel 2.6.25-14.fc9.i686 on an i686 (tty2)

localhost login: root
Password:
[root@localhost ~]# cd /boot/grub/
[root@localhost grub]# vi menu.lst _
    
```

**Figure B-33: Access menu.lst in Linux (Text Mode)**

**Step 7:** Modify the menu.lst as shown below.

```
#boot=/dev/sda
default=0
timeout=10
splashimage=(hd0,0)/grub/splash.xpm.gz
hiddenmenu
title Fedora (2.6.25-14.fc9.i686)
    root (hd0,0)
    kernel /vmlinuz-2.6.25-14.fc9.i686 ro root=UUID=10f1acd
ac38b5c78910 rhgb quiet
    initrd /initrd-2.6.25-14.fc9.i686.img

title Recovery Partition
    root (hd0,2)
    makeactive
    chainloader +1
```

- Type command:  
**title Recovery Partition**  
**root (hd0,2)**  
**makeactive**  
**chainloader +1**

**Step 8:** The recovery tool menu appears. (Figure B-34)

```
1. Factory Restore
2. Backup system
3. Restore your last backup.
4. Manual
5. Quit
Please type the number to select and then press Enter:
```

Figure B-34: Recovery Tool Menu

**Step 9:** Create a factory default image. Follow **Step 2 ~ Step 12** described in **Section B.2.5** to create a factory default image.

## B.5 Recovery Tool Functions

After completing the initial setup procedures as described above, users can access the recovery tool by pressing **<F3>** while booting up the system. However, if the setup procedure in Section B.3 has been completed and the auto recovery function is enabled, the system will automatically restore from the factory default image without pressing the F3 key. The recovery tool main menu is shown below.



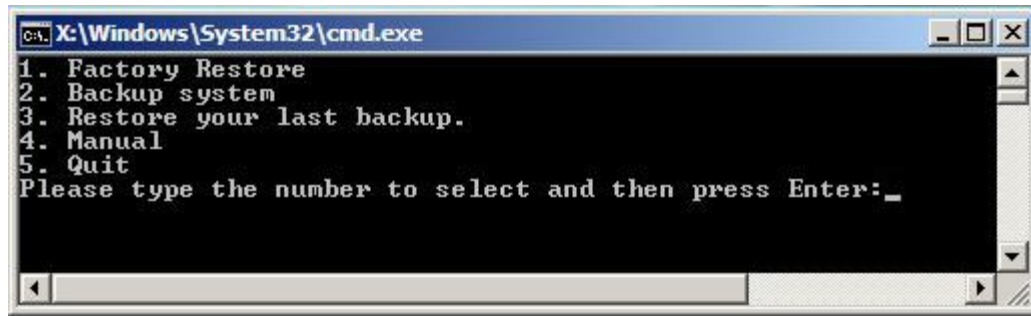

**Figure B-35: Recovery Tool Main Menu**

The recovery tool has several functions including:

1. **Factory Restore:** Restore the factory default image (iei.GHO) created in **Section B.2.5**.
2. **Backup system:** Create a system backup image (iei\_user.GHO) which will be saved in the hidden partition.
3. **Restore your last backup:** Restore the last system backup image
4. **Manual:** Enter the Symantec Ghost window to configure manually.
5. **Quit:** Exit the recovery tool and restart the system.



**WARNING:**

Please do not turn off the system power during the process of system recovery or backup.



**WARNING:**

All data in the system will be deleted during the system recovery. Please backup the system files before restoring the system (either Factory Restore or Restore Backup).

## ICE-QM871 COM Express Module

### B.5.1 Factory Restore

To restore the factory default image, please follow the steps below.

**Step 1:** Type <1> and press <Enter> in the main menu.

**Step 2:** The Symantec Ghost window appears and starts to restore the factory default. A factory default image called **iei.GHO** is created in the hidden Recovery partition.

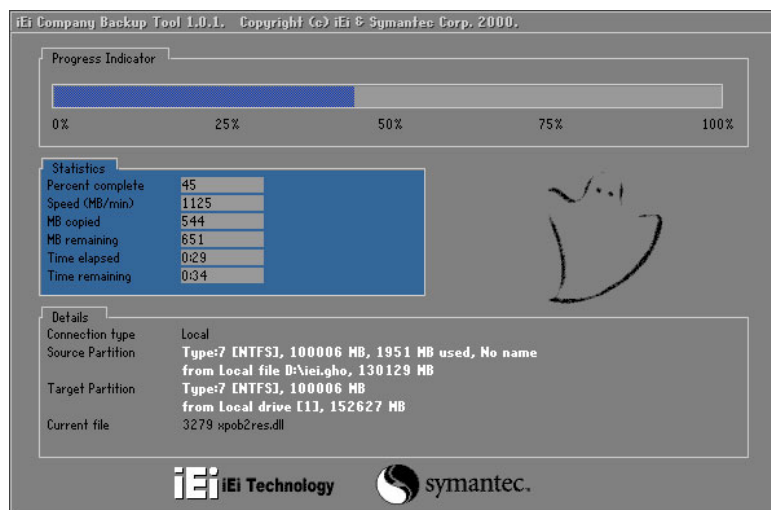

Figure B-36: Restore Factory Default

**Step 3:** The screen is shown in **Figure B-37** appears when completed. Press any key to reboot the system.

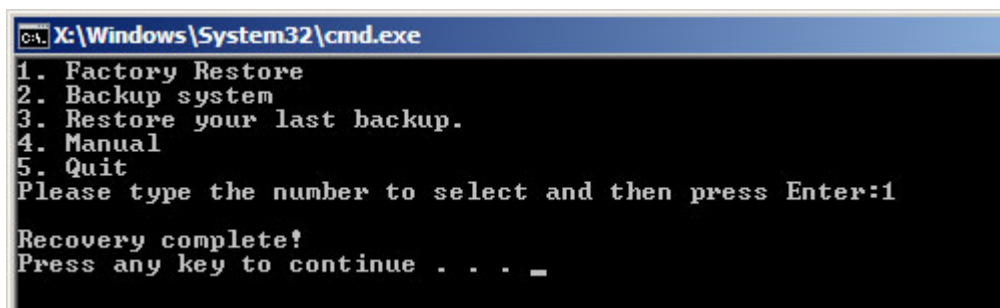

Figure B-37: Recovery Complete Window

## B.5.2 Backup System

To backup the system, please follow the steps below.

**Step 1:** Type <2> and press <Enter> in the main menu.

**Step 2:** The Symantec Ghost window appears and starts to backup the system. A backup image called `iei_user.GHO` is created in the hidden Recovery partition.

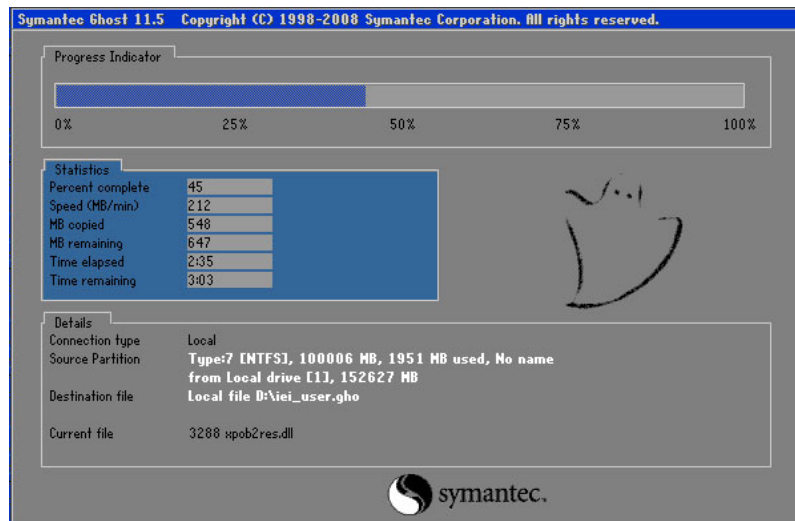

**Figure B-38: Backup System**

**Step 3:** The screen is shown in **Figure B-39** appears when system backup is complete. Press any key to reboot the system.

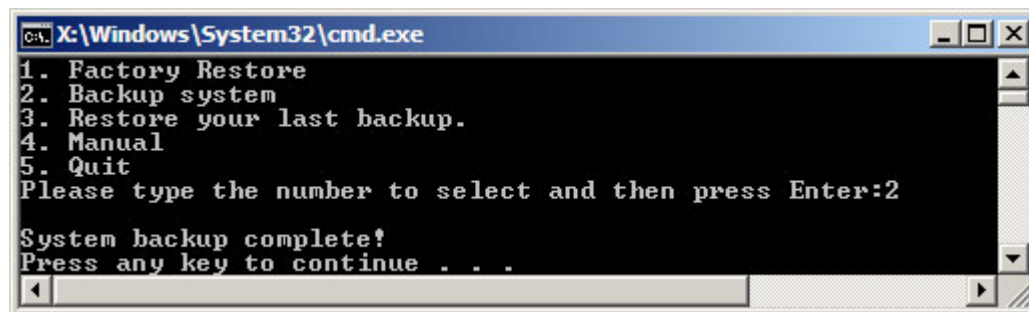

**Figure B-39: System Backup Complete Window**

## ICE-QM871 COM Express Module

### B.5.3 Restore Your Last Backup

To restore the last system backup, please follow the steps below.

**Step 1:** Type <3> and press <Enter> in the main menu.

**Step 2:** The Symantec Ghost window appears and starts to restore the last backup image (iei\_user.GHO).

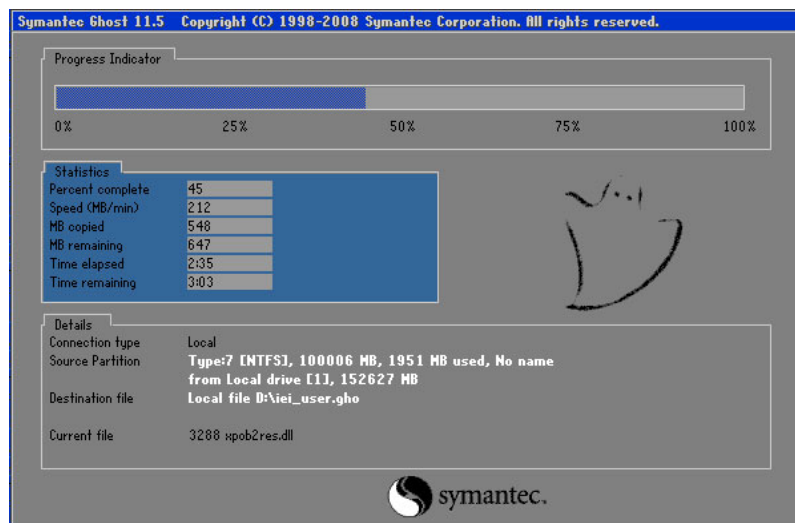

Figure B-40: Restore Backup

**Step 3:** The screen shown in **Figure B-41** appears when backup recovery is complete. Press any key to reboot the system.

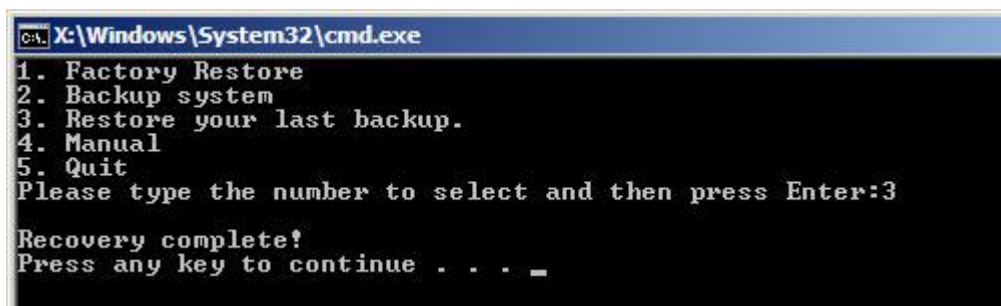

Figure B-41: Restore System Backup Complete Window

### B.5.4 Manual

To restore the last system backup, please follow the steps below.

**Step 1:** Type <4> and press <Enter> in the main menu.

**Step 2:** The Symantec Ghost window appears. Use the Ghost program to backup or recover the system manually.

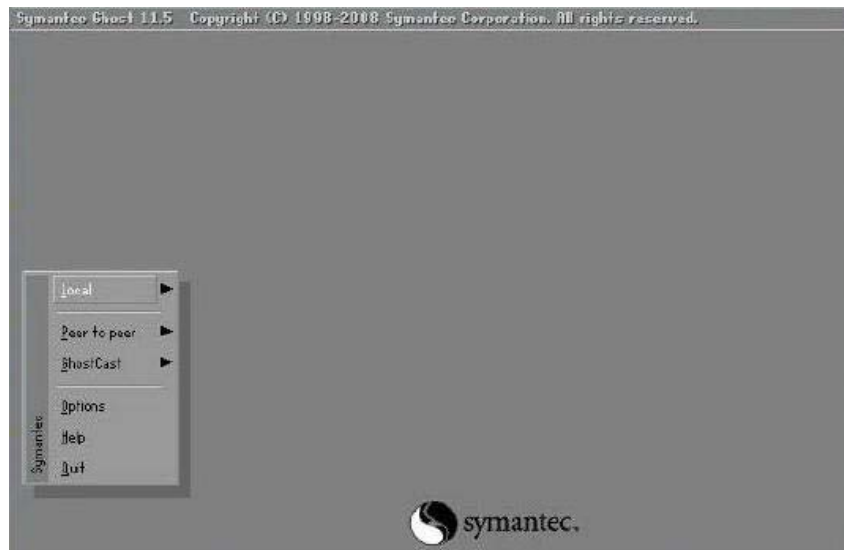
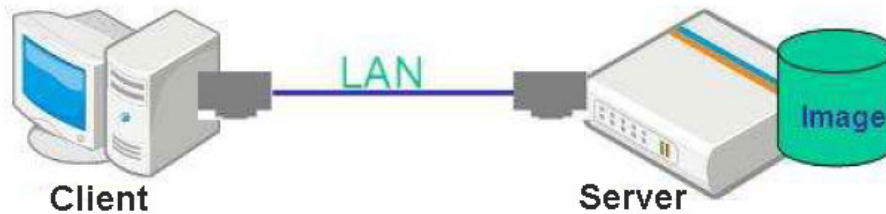

Figure B-42: Symantec Ghost Window

**Step 3:** When backup or recovery is completed, press any key to reboot the system.

## B.6 Restore Systems from a Linux Server through LAN

The One Key Recovery allows a client system to automatically restore to a factory default image saved in a Linux system (the server) through LAN connectivity after encountering a Blue Screen of Death (BSOD) or a hang for around 10 minutes. To be able to use this function, the client system and the Linux system MUST reside in the same domain.



### CAUTION:

The supported client OS includes:

- Windows 2000
- Windows XP
- Windows Vista
- Windows 7
- Windows XP Embedded
- Windows Embedded Standard 7

Prior to restoring client systems from a Linux server, a few setup procedures are required.

**Step 1:** Configure DHCP server settings

**Step 2:** Configure TFTP settings

**Step 3:** Configure One Key Recovery server settings

**Step 4:** Start DHCP, TFTP and HTTP

**Step 5:** Create a shared directory

**Step 6:** Setup a client system for auto recovery

The detailed descriptions are described in the following sections. In this document, two types of Linux OS are used as examples to explain the configuration process – CentOS 5.5 (Kernel 2.6.18) and Debian 5.0.7 (Kernel 2.6.26).

## B.6.1 Configure DHCP Server Settings

**Step 1:** Install the DHCP

`#yum install dhcp` (CentOS, commands marked in red)

`#apt-get install dhcp3-server` (Debian, commands marked in blue)

**Step 2:** Confirm the operating system default settings: dhcpd.conf.

### CentOS

Use the following command to show the DHCP server sample location:

`#vi /etc/dhcpd.conf`

The DHCP server sample location is shown as below:

```
# DHCP Server Configuration file.
# see /usr/share/doc/dhcp*/dhcpd.conf.sample
#
```

Use the following command to copy the DHCP server sample to etc/dhcpd.conf:

`#cp /usr/share/doc/dhcp-3.0.5/dhcpd.conf.sample /etc/dhcpd.conf`

`#vi /etc/dhcpd.conf`

```
ddns-update-style interim;
ignore client-updates;

subnet 192.168.0.0 netmask 255.255.255.0 {
# --- default gateway
    option routers                192.168.0.2;
    option subnet-mask            255.255.255.0;

    option nis-domain             "domain.org";
    option domain-name            "domain.org";
    option domain-name-servers   192.168.0.1;
    next-server 192.168.0.6;
    filename "pxelinux.0";
    option time-offset            -18000; # Eastern Standard Time
    option ntp-servers            192.168.1.1;
    option netbios-name-servers  192.168.1.1;
}
```

### Debian

`#vi /etc/dhcpd.conf`

Edit “/etc/dhcpd.conf” for your environment. For example, add

`next-server PXE server IP address;`

filename "pxelinux.0";

```
ddns-update-style interim;
ignore client-updates;

subnet 192.168.0.0 netmask 255.255.255.0 {
# --- default gateway
    option routers                192.168.0.2;
    option subnet-mask            255.255.255.0;

    option nis-domain             "domain.org";
    option domain-name            "domain.org";
    option domain-name-servers   192.168.0.1;
    next-server 192.168.0.6;
    filename "pxelinux.0";
    option time-offset            -18000; # Eastern Standard Time
    option ntp-servers            192.168.1.1;
}
```

## B.6.2 Configure TFTP Settings

**Step 1:** Install the tftp, httpd and syslinux.

`#yum install tftp-server httpd syslinux` (CentOS)

`#apt-get install tftpd-hpa xinetd syslinux` (Debian)

**Step 2:** Enable the TFTP server by editing the "/etc/xinetd.d/tftp" file and make it use the remap file. The "-vvv" is optional but it could definitely help on getting more information while running the remap file. For example:

### CentOS

`#vi /etc/xinetd.d/tftp`

Modify:

`disable = no`

`server_args = -s /tftpboot -m /tftpboot/tftpd.remap -vvv_`

```
socket_type      = dgram
protocol        = udp
wait            = yes
user            = root
server          = /usr/sbin/in.tftpd
server_args     = -s /tftpboot -m /tftpboot/tftpd.remap -vvv
disable         = no
per_source      = 11
cps             = 100 2
flags           = IPv4
```



### Debian

Replace the TFTP settings from “inetd” to “xinetd” and annotate the “inetd” by adding “#”.

```
#vi /etc/inetd.conf
```

Modify: #tftp dgram udp wait root /usr/sbin..... (as shown below)

```
#:BOOT: TFTP service is provided primarily for booting. Most sites
#      run this only on machines acting as "boot servers."
#tftp  dgram  udp   wait  root  /usr/sbin/in.tftpd /usr/sbin/in.tftpd -s
/var/lib/tftpboot
```

```
#vi /etc/xinetd.d/tftp
```

```
socket_type      = dgram
protocol        = udp
wait            = yes
user            = root
server          = /usr/sbin/in.tftpd
server_args     = -s /tftpboot -n /tftpboot/tftpd.remap -vvv
disable         = no
per_source      = 11
cps             = 100 2
flags           = IPv4
```

## B.6.3 Configure One Key Recovery Server Settings

**Step 1:** Copy the **Utility/RECOVERYR10.TAR.BZ2** package from the One Key Recovery CD to the system (server side).



**Step 2:** Extract the recovery package to /.

```
#cp RecoveryR10.tar.bz2 /
#cd /
#tar -xvjf RecoveryR10.tar.bz2
```

**Step 3:** Copy “pxelinux.0” from “syslinux” and install to “tftpboot”.

```
#cp /usr/lib/syslinux/pxelinux.0 /tftpboot/
```

## ICE-QM871 COM Express Module

### B.6.4 Start the DHCP, TFTP and HTTP

Start the DHCP, TFTP and HTTP. For example:

#### CentOS

```
#service xinetd restart
```

```
#service httpd restart
```

```
#service dhcpd restart
```

#### Debian

```
#/etc/init.d/xinetd reload
```

```
#/etc/init.d/xinetd restart
```

```
#/etc/init.d/dhcp3-server restart
```

### B.6.5 Create Shared Directory

**Step 1:** Install the samba.

```
#yum install samba
```

**Step 2:** Create a shared directory for the factory default image.

```
#mkdir /share
```

```
#cd /share
```

```
#mkdir /image
```

```
#cp iei.gho /image
```



#### **WARNING:**

The file name of the factory default image must be **iei.gho**.

---

**Step 3:** Confirm the operating system default settings: smb.conf.

```
#vi /etc/samba/smb.conf
```

Modify:

[image]

```
comment = One Key Recovery
```

```
path = /share/image
```

```
browseable = yes
```

```
writable = yes
```

```
public = yes
```

```
create mask = 0644
```

```
directory mask = 0755
```

**Step 4:** Edit “/etc/samba/smb.conf” for your environment. For example:

```
# "security = user" is always a good idea. This will require a Unix account
# in this server for every user accessing the server. See
# /usr/share/doc/samba-doc/htmldocs/Samba3-HOWTO/ServerType.html
# in the samba-doc package for details.
security = share
```

```
[image]
comment = One Key Recovery
path = /share/image
browseable = yes
writable = yes
public = yes
create mask = 0644
directory mask = 0755
```

**Step 5:** Modify the hostname

```
#vi /etc/hostname
```

Modify: RecoveryServer

```
RecoveryServer
```

## B.6.6 Setup a Client System for Auto Recovery

**Step 1:** Disable the automatically restart function before creating the factory default image. Go to: My Computer → Properties → Advanced. Click the Settings button of Startup and Recovery. Deselect “Automatically restart”. Click OK to save the settings and exit. (See **Figure B-43**)

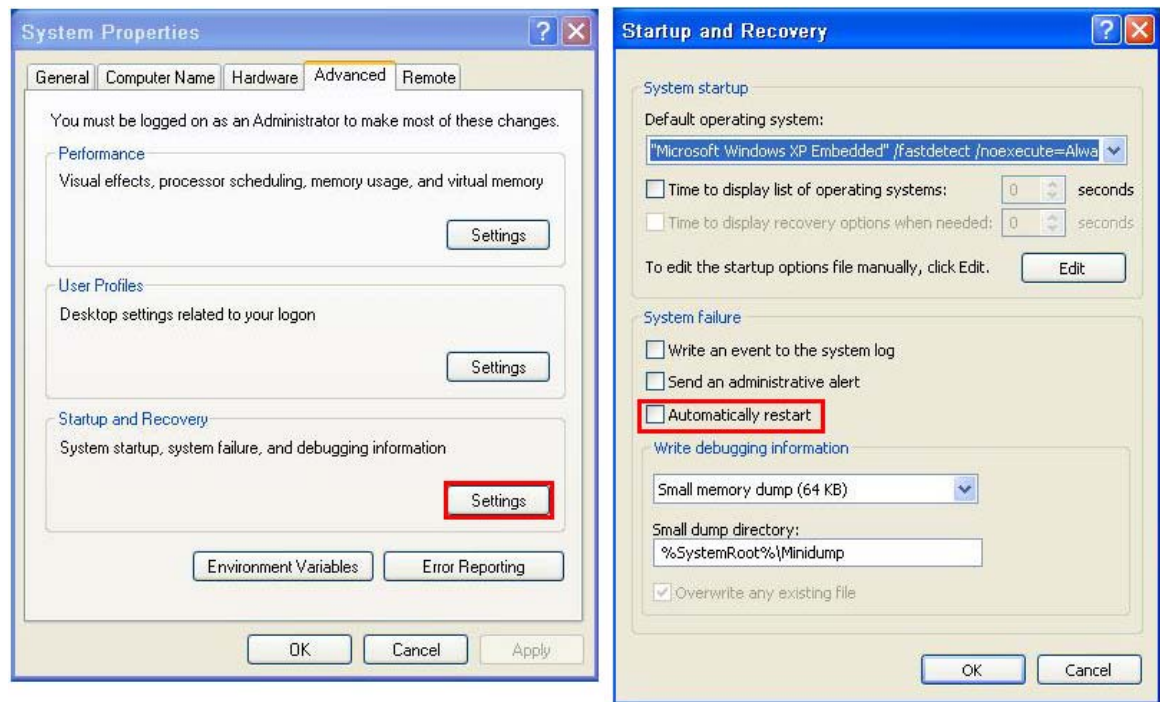

**Figure B-43: Disable Automatically Restart**

**Step 2:** Configure the following BIOS options of the client system.

Advanced → iEi Feature → Auto Recovery Function → **Enabled**

Advanced → iEi Feature → Recover from PXE → **Enabled**

Boot → Launch PXE OpROM → **Enabled**

**Step 3:** Continue to configure the **Boot Option Priorities** BIOS option of the client system:

Boot Option #1 → remain the default setting to boot from the original OS.

Boot Option #2 → select the boot from LAN option.

**Step 4:** Save changes and exit BIOS menu.

Exit → **Save Changes and Exit**

**Step 5:** Install the auto recovery utility into the system by double clicking the

**Utility/AUTORECOVERY-SETUP.exe** in the One Key Recovery CD. This utility

MUST be installed in the system, otherwise, the system will automatically restore from the factory default image every ten (10) minutes.



**Step 6:** Restart the client system from LAN. If the system encounters a Blue Screen of Death (BSoD) or a hang for around 10 minutes, it will automatically restore from the factory default image. The following screens will show when the system starts auto recovering.

```
Realtek PCIe GBE Family Controller Series v2.35 (06/14/10)
CLIENT MAC ADDR: 00 18 7D 13 E6 89  GUID: 00020003-0004-0005-0006-0007000000
DHCP.. /
```

```
My IP address seems to be C0A80009 192.168.0.9
ip=192.168.0.9:192.168.0.8:192.168.0.2:255.255.255.0
TFTP prefix:
Trying to load: pxelinux.cfg/00020003-0004-0005-0006-000700000009
Trying to load: pxelinux.cfg/01-00-18-7d-13-e6-89
Trying to load: pxelinux.cfg/C0A80009
Trying to load: pxelinux.cfg/C0A8000
Trying to load: pxelinux.cfg/C0A800
Trying to load: pxelinux.cfg/C0A80
Trying to load: pxelinux.cfg/C0A8
Trying to load: pxelinux.cfg/C0A
Trying to load: pxelinux.cfg/C0
Trying to load: pxelinux.cfg/C
Trying to load: pxelinux.cfg/default
boot:
```

```
Windows is loading files...
IP: 192.168.0.8, File: \Boot\WinPE.wim
```

## ICE-QM871 COM Express Module

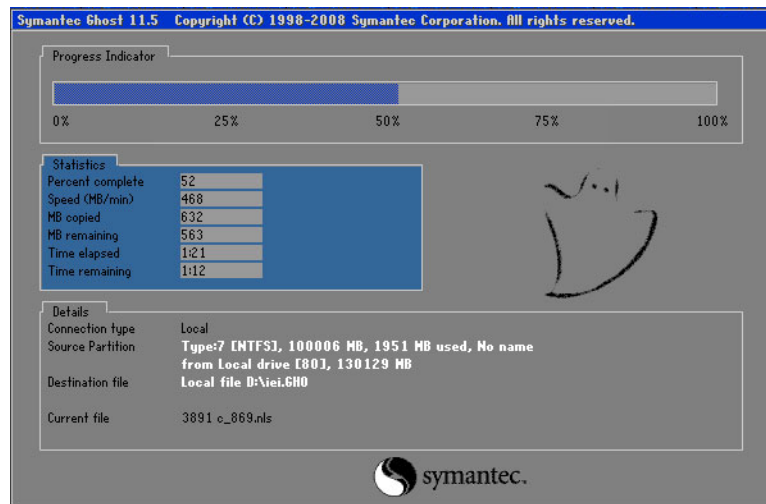

### NOTE:

A firewall or a SELinux is not in use in the whole setup process described above. If there is a firewall or a SELinux protecting the system, modify the configuration information to accommodate them.

## B.7 Other Information

### B.7.1 Using AHCI Mode or ALi M5283 / VIA VT6421A Controller

When the system uses AHCI mode or some specific SATA controllers such as ALi M5283 or VIA VT6421A, the SATA RAID/AHCI driver must be installed before using one key recovery. Please follow the steps below to install the SATA RAID/AHCI driver.

- Step 1:** Copy the SATA RAID/AHCI driver to a floppy disk and insert the floppy disk into a USB floppy disk drive. The SATA RAID/AHCI driver must be especially designed for the on-board SATA controller.
- Step 2:** Connect the USB floppy disk drive to the system.
- Step 3:** Insert the One Key Recovery CD into the system and boot the system from the CD.
- Step 4:** When launching the recovery tool, press <F6>.

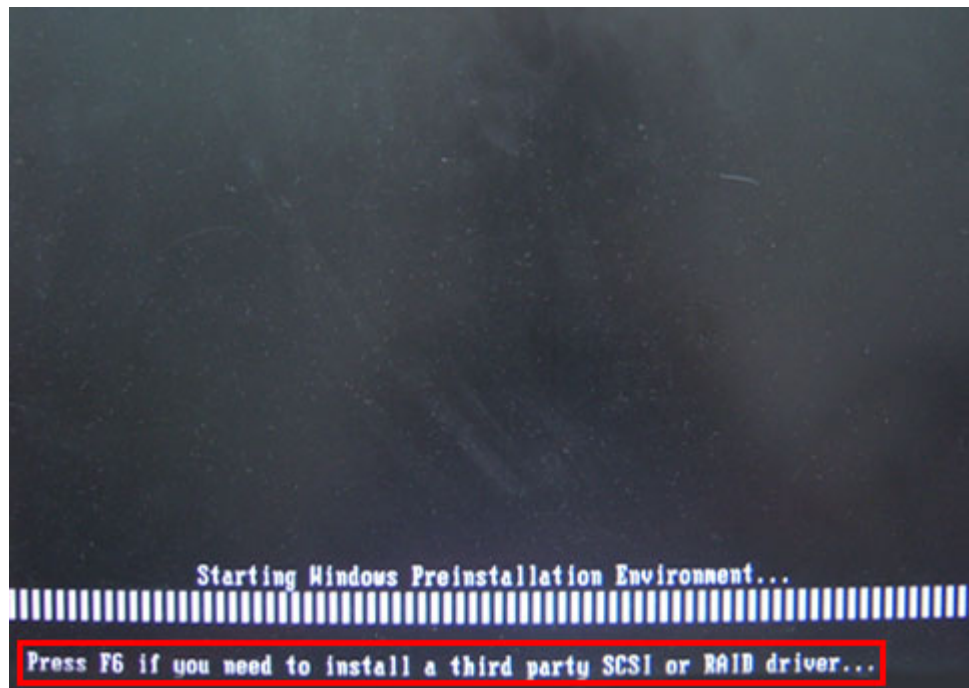

**Step 5:** When the following window appears, press <S> to select “Specify Additional Device”.

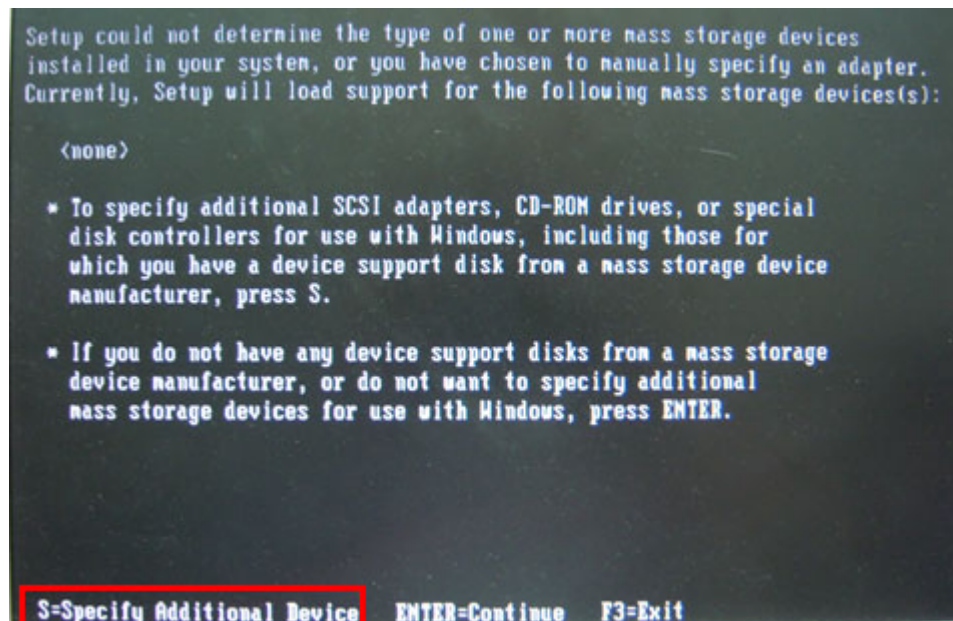

**Step 6:** In the following window, select a SATA controller mode used in the system. Then press <Enter>. The user can now start using the SATA HDD.

## ICE-QM871 COM Express Module

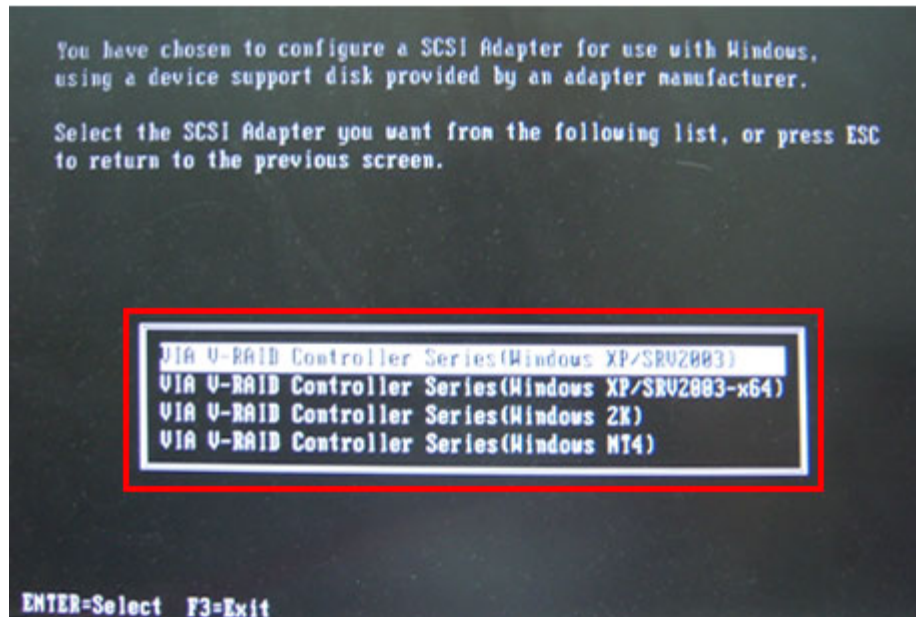

- Step 7:** After pressing <Enter>, the system will get into the recovery tool setup menu. Continue to follow the setup procedure from **Step 4** in **Section B.2.2 Create Partitions** to finish the whole setup process.

### B.7.2 System Memory Requirement

To be able to access the recovery tool by pressing <F3> while booting up the system, please make sure to have enough system memory. The minimum memory requirement is listed below.

- **Using Award BIOS:** 128 MB system memory
- **Using AMI BIOS:** 512 MB system memory.





Appendix

C

# Intel® AMT Configuration

---

## ICE-QM871 COM Express Module

### C.1 Intel® AMT Setup Procedure

The ICE-QM871 is featured with the Intel® Active Management Technology (AMT) 2.5. To enable the Intel® AMT function, follow the steps below.

- Step 1:** Make sure the SO-DIMM socket is installed with one DDR2 DIMM.
- Step 2:** Connect an Ethernet cable to the RJ-45 connector on the baseboard.
- Step 3:** The AMI BIOS option regarding the Intel® AMT must be enabled:  
Intel® AMT Configuration [Advanced]
- Step 4:** Configure the Intel® Management Engine BIOS extension (MEBx) (see Section C.2 below)
- Step 5:** Properly install the Intel® AMT drivers. Make sure to install both HECI and LMS\_SOL drivers from the iAMT Driver & Utility directory in the driver CD.
- Step 6:** The following dialog window is displayed after the OS is loaded to show the Intel® AMT status on the ICE-QM871 is enabled.



Figure C-1: Intel® Active Management Technology Status Dialog

### C.2 Intel® Management Engine BIOS Extension

This section describes the essential steps for using the Intel® Management Engine BIOS extension (MEBx).

- Step 1:** A screen prompts the user to press <Ctrl+P> after a single beep during boot-up process. To get into the Intel® MEBx settings, press <Ctrl+P>.

**Step 2:** Enter the Intel® current ME password as it requires (**Figure B-10**). Enter the IEI factory ME password: Abab12!@ (the Intel® default password is admin).

**NOTE:**

The default Intel® ME password is admin. The IEI has reset the password to Abab12!@ in quality control process. After clearing the CMOS, the ME password bound to Intel® default password (admin). Use Intel® default password to enter the Intel® ME BIOS and change the password (refer to **Step 3** below) to be able to configure the Intel® AMT and ME options.

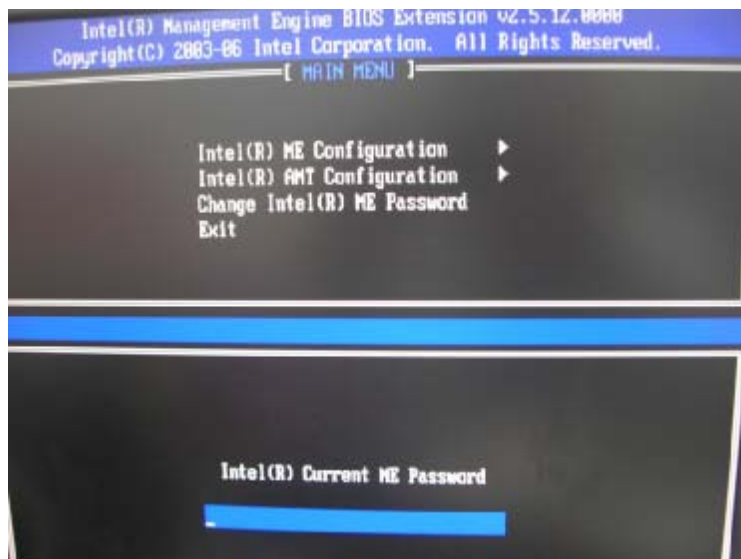

**Figure C-2: Intel® Current ME Password**

**Step 3:** To change the password, select Change Intel® ME Password. Enter a new password following the strong password rule (containing at least one upper case letter, one lower case letter, one digit and one special character, and be at least eight characters). (**Figure B-11**)

## ICE-QM871 COM Express Module

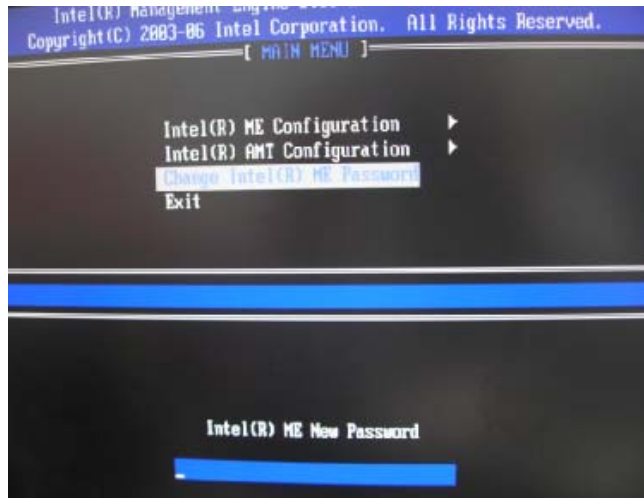

**Figure C-3: Change Intel® ME Password**

**Step 4:** Verify the new password by entering again (Figure B-13).

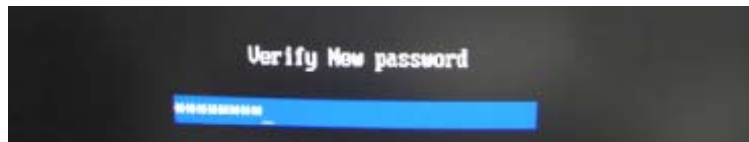

**Figure C-4: Verify New Password**

**Step 5:** Select Intel® AMT Configuration and press Enter (Figure B-15).



**Figure C-5: Intel® AMT Configuration**

**Step 6:** Select Provision Model and press Enter. (Figure B-16)

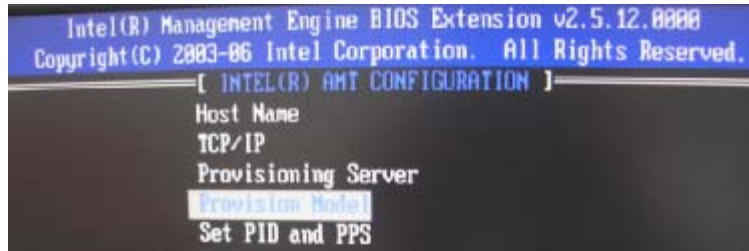

**Figure C-6: Provision Model**

**Step 7:** When the screen in Figure B-17 prompts, enter N and press Enter.

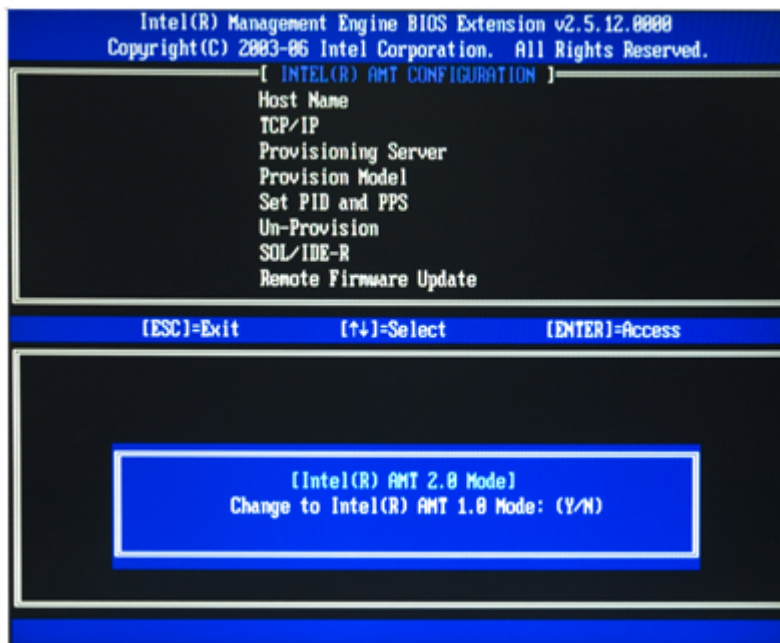

**Figure C-7: Intel® AMT 2.0 Mode**

**Step 8:** A message prompts to confirm to Change to Small Business (**Figure B-21**). Enter Y and press Enter.

## ICE-QM871 COM Express Module



Figure C-8: Enterprise

**Step 9:** Select TCP/IP (in Intel AMT Configuration) and press Enter. A message prompts for disabling network interface. Enter N to enable network interface.



Figure C-9: Enable Network Interface

**Step 10:** Enable or disable DHCP. DHCP is enabled by default. If DHCP is disabled, enter the following TCP/IP settings:

- Static TCP/IP address (the static TCP/IP address and Intel® AMI Host Name must be different from those configured in the operating system)
- Subnet mask
- Default Gateway address (optional)
- Preferred Domain Naming Services (DNS) server address (optional)
- Alternate DNS server address (optional)
- Domain name (optional)

**Step 11:** Make other necessary settings in the Intel® MEBx depending on users' need.

**Step 12:** To exit the Intel® MEBx, return to the main menu and select Exit. (**Figure B-37**)

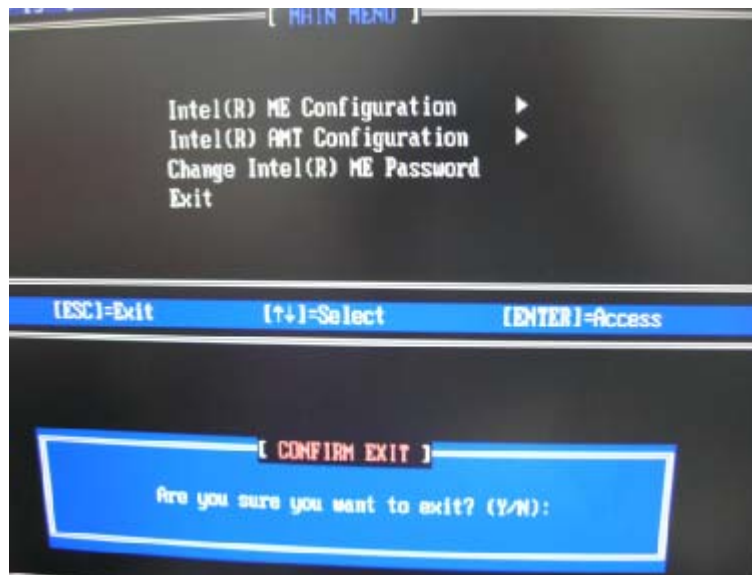

**Figure C-10:** Exit

### C.3 Using the Intel® AMT Web Interface



**NOTE:**

Prior to use the Intel® AMT web interface, please make sure the Intel® AMT drivers are properly installed in the ICE-QM871 and the Intel® AMT enabled confirmation dialog window displays after boot-up.

To access an Intel® AMT client system from a remote console, follow the steps below.

## ICE-QM871 COM Express Module

- Step 1:** Obtain the IP address of the client system.
- Step 2:** On the remote management console, open a web browser.
- Step 3:** If DHCP is enabled in the TCP/IP menu of the Intel® ME BIOS (Section C.2, Step 10), get the client system IP address in the MS DOS. Enter the client system IP address and the port number in the web browser:  
 http://ip\_address:16992 Example: http://192.168.1.7:16992 (Figure C-11)  
 Or simply enter the defined host name: http://host\_name:16992  
 Example: http://AMTsystem:16992



Figure C-11: Intel® AMT Web Address

- Step 4:** If a static IP address is defined for the Intel® AMT client system, enter the defined client system IP address and the port number in the web browser.
- Step 5:** A login window prompts (Figure C-12).

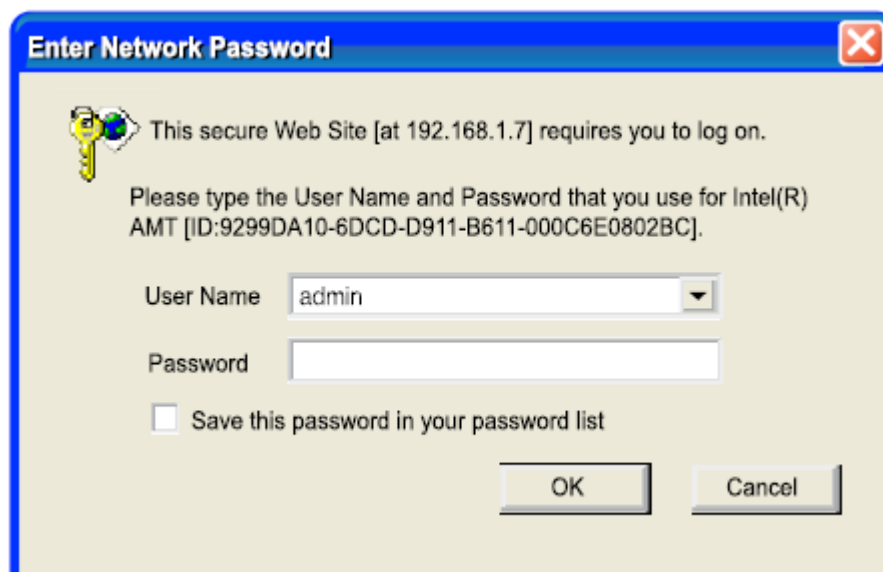
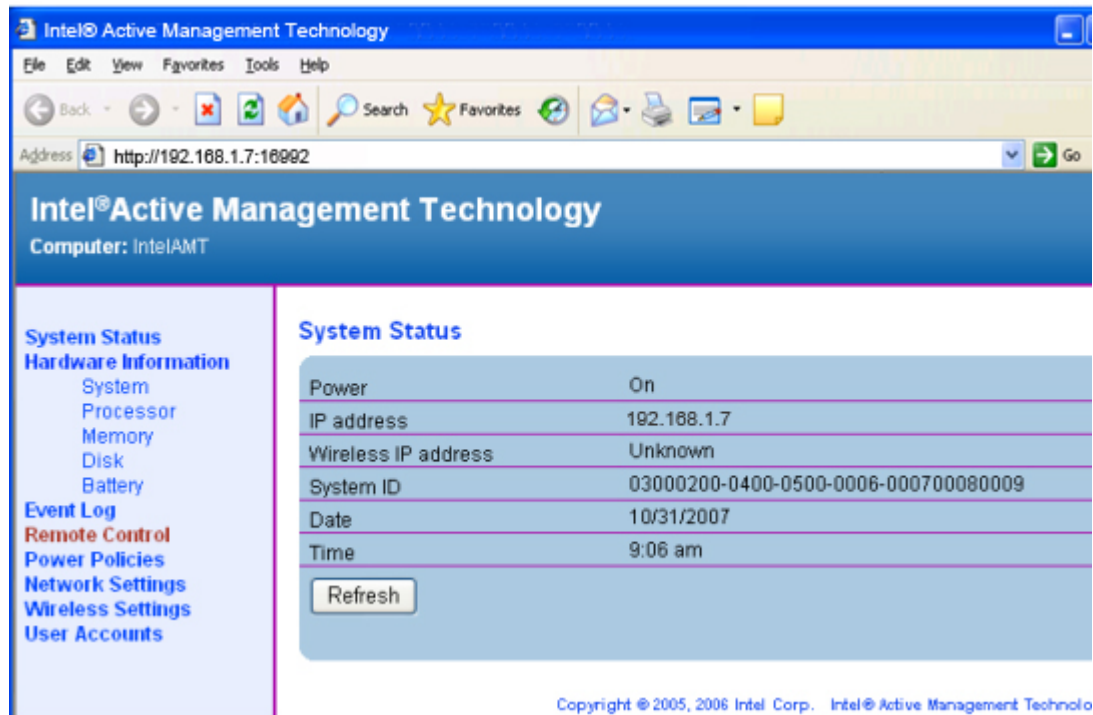

Figure C-12: Intel® AMT Web Login Dialog



- Step 6:** Enter admin as the user name (Figure C-13).
- Step 7:** Enter the password changed in the Intel® MEBx configuration (**Section C.2**, Step 3). If the password remained as default, enter Abab12!@
- Step 8:** Press OK and the Intel® AMT web interface appears (Figure C-13).



**Figure C-13: Intel® AMT Web Interface**



**NOTE:**

To enhance the platform manageability of the ICE-QM871, work with the Independent Software Vendors (ISV) to implement the Intel® AMT management utility on the system.

Appendix

D

# Terminology

---

<b>AC '97</b>	Audio Codec 97 (AC'97) refers to a codec standard developed by Intel® in 1997.
<b>ACPI</b>	Advanced Configuration and Power Interface (ACPI) is an OS-directed configuration, power management, and thermal management interface.
<b>AHCI</b>	Advanced Host Controller Interface (AHCI) is a SATA Host controller register-level interface.
<b>ATA</b>	The Advanced Technology Attachment (ATA) interface connects storage devices including hard disks and CD-ROM drives to a computer.
<b>ARMD</b>	An ATAPI Removable Media Device (ARMD) is any ATAPI device that supports removable media, besides CD and DVD drives.
<b>ASKIR</b>	Amplitude Shift Keyed Infrared (ASKIR) is a form of modulation that represents a digital signal by varying the amplitude (“volume”) of the signal. A low amplitude signal represents a binary 0, while a high amplitude signal represents a binary 1.
<b>BIOS</b>	The Basic Input/Output System (BIOS) is firmware that is first run when the computer is turned on and can be configured by the end user
<b>CODEC</b>	The Compressor-Decompressor (CODEC) encodes and decodes digital audio data on the system.
<b>CMOS</b>	Complimentary metal-oxide-conductor is an integrated circuit used in chips like static RAM and microprocessors.
<b>COM</b>	COM refers to serial ports. Serial ports offer serial communication to expansion devices. The serial port on a personal computer is usually a male DB-9 connector.
<b>DAC</b>	The Digital-to-Analog Converter (DAC) converts digital signals to analog signals.
<b>DDR</b>	Double Data Rate refers to a data bus transferring data on both the rising and falling edges of the clock signal.
<b>DMA</b>	Direct Memory Access (DMA) enables some peripheral devices to bypass the system processor and communicate directly with the system memory.

## ICE-QM871 COM Express Module

<b>DIMM</b>	Dual Inline Memory Modules are a type of RAM that offer a 64-bit data bus and have separate electrical contacts on each side of the module.
<b>DIO</b>	The digital inputs and digital outputs are general control signals that control the on/off circuit of external devices or TTL devices. Data can be read or written to the selected address to enable the DIO functions.
<b>EHCI</b>	The Enhanced Host Controller Interface (EHCI) specification is a register-level interface description for USB 2.0 Host Controllers.
<b>EIDE</b>	Enhanced IDE (EIDE) is a newer IDE interface standard that has data transfer rates between 4.0 MBps and 16.6 MBps.
<b>EIST</b>	Enhanced Intel® SpeedStep Technology (EIST) allows users to modify the power consumption levels and processor performance through application software. The application software changes the bus-to-core frequency ratio and the processor core voltage.
<b>FSB</b>	The Front Side Bus (FSB) is the bi-directional communication channel between the processor and the Northbridge chipset.
<b>GbE</b>	Gigabit Ethernet (GbE) is an Ethernet version that transfers data at 1.0 Gbps and complies with the IEEE 802.3-2005 standard.
<b>GPIO</b>	General purpose input
<b>HDD</b>	Hard disk drive (HDD) is a type of magnetic, non-volatile computer storage device that stores digitally encoded data.
<b>ICH</b>	The Input/Output Control Hub (ICH) is an Intel® Southbridge chipset.
<b>IrDA</b>	Infrared Data Association (IrDA) specify infrared data transmission protocols used to enable electronic devices to wirelessly communicate with each other.
<b>L1 Cache</b>	The Level 1 Cache (L1 Cache) is a small memory cache built into the system processor.
<b>L2 Cache</b>	The Level 2 Cache (L2 Cache) is an external processor memory cache.
<b>LCD</b>	Liquid crystal display (LCD) is a flat, low-power display device that consists of two polarizing plates with a liquid crystal panel in between.

<b>LVDS</b>	Low-voltage differential signaling (LVDS) is a dual-wire, high-speed differential electrical signaling system commonly used to connect LCD displays to a computer.
<b>POST</b>	The Power-on Self Test (POST) is the pre-boot actions the system performs when the system is turned-on.
<b>RAM</b>	Random Access Memory (RAM) is volatile memory that loses data when power is lost. RAM has very fast data transfer rates compared to other storage like hard drives.
<b>SATA</b>	Serial ATA (SATA) is a serial communications bus designed for data transfers between storage devices and the computer chipsets. The SATA bus has transfer speeds up to 1.5 Gbps and the SATA II bus has data transfer speeds of up to 3.0 Gbps.
<b>S.M.A.R.T</b>	Self Monitoring Analysis and Reporting Technology (S.M.A.R.T) refers to automatic status checking technology implemented on hard disk drives.
<b>UART</b>	Universal Asynchronous Receiver-transmitter (UART) is responsible for asynchronous communications on the system and manages the system's serial communication (COM) ports.
<b>UHCI</b>	The Universal Host Controller Interface (UHCI) specification is a register-level interface description for USB 1.1 Host Controllers.
<b>USB</b>	The Universal Serial Bus (USB) is an external bus standard for interfacing devices. USB 1.1 supports 12Mbps data transfer rates and USB 2.0 supports 480Mbps data transfer rates.
<b>VGA</b>	The Video Graphics Array (VGA) is a graphics display system developed by IBM.

Appendix

E

# Watchdog Timer

---

**NOTE:**

The following discussion applies to DOS environment. Contact IEI support or visit the IEI website for specific drivers for other operating systems.

The Watchdog Timer is provided to ensure that standalone systems can always recover from catastrophic conditions that cause the CPU to crash. This condition may have occurred by external EMIs or a software bug. When the CPU stops working correctly, Watchdog Timer either performs a hardware reset (cold boot) or a Non-Maskable Interrupt (NMI) to bring the system back to a known state.

A BIOS function call (INT 15H) is used to control the Watchdog Timer.

INT 15H:

<b>AH – 6FH Sub-function:</b>	
AL – 2:	Sets the Watchdog Timer's period.
BL:	Time-out value (Its unit-second is dependent on the item "Watchdog Timer unit select" in CMOS setup).

**Table E-1: AH-6FH Sub-function**

Call sub-function 2 to set the time-out period of Watchdog Timer first. If the time-out value is not zero, the Watchdog Timer starts counting down. When the timer value reaches zero, the system resets. To ensure that this reset condition does not occur, calling sub-function 2 must periodically refresh the Watchdog Timer. However, the watchdog timer is disabled if the time-out value is set to zero.

A tolerance of at least 10% must be maintained to avoid unknown routines within the operating system (DOS), such as disk I/O that can be very time-consuming.



## NOTE:

When exiting a program it is necessary to disable the Watchdog Timer, otherwise the system resets.

## EXAMPLE PROGRAM:

**; INITIAL TIMER PERIOD COUNTER**

;

**W\_LOOP:**

;

```

MOV      AX, 6F02H      ;setting the time-out value
MOV      BL, 30         ;time-out value is 48 seconds
INT      15H

```

;

**; ADD THE APPLICATION PROGRAM HERE**

;

```

CMP      EXIT_AP, 1     ;is the application over?
JNE      W_LOOP        ;No, restart the application

```

```

MOV      AX, 6F02H     ;disable Watchdog Timer
MOV      BL, 0         ;
INT      15H

```

;

**; EXIT ;**



Appendix

**F**

# Hazardous Materials Disclosure

---

### **F.1 Hazardous Materials Disclosure Table for IPB Products Certified as RoHS Compliant Under 2002/95/EC Without Mercury**

The details provided in this appendix are to ensure that the product is compliant with the Peoples Republic of China (China) RoHS standards. The table below acknowledges the presences of small quantities of certain materials in the product, and is applicable to China RoHS only.

A label will be placed on each product to indicate the estimated “Environmentally Friendly Use Period” (EFUP). This is an estimate of the number of years that these substances would “not leak out or undergo abrupt change.” This product may contain replaceable sub-assemblies/components which have a shorter EFUP such as batteries and lamps. These components will be separately marked.

Please refer to the table on the next page.

Part Name	Toxic or Hazardous Substances and Elements					
	Lead (Pb)	Mercury (Hg)	Cadmium (Cd)	Hexavalent Chromium (CR(VI))	Polybrominated Biphenyls (PBB)	Polybrominated Diphenyl Ethers (PBDE)
<b>Housing</b>	X	O	O	O	O	X
<b>Display</b>	X	O	O	O	O	X
<b>Printed Circuit Board</b>	X	O	O	O	O	X
<b>Metal Fasteners</b>	X	O	O	O	O	O
<b>Cable Assembly</b>	X	O	O	O	O	X
<b>Fan Assembly</b>	X	O	O	O	O	X
<b>Power Supply Assemblies</b>	X	O	O	O	O	X
<b>Battery</b>	O	O	O	O	O	O

O: This toxic or hazardous substance is contained in all of the homogeneous materials for the part is below the limit requirement in SJ/T11363-2006

X: This toxic or hazardous substance is contained in at least one of the homogeneous materials for this part is above the limit requirement in SJ/T11363-2006

## ICE-QM871 COM Express Module

此附件旨在确保本产品符合中国 RoHS 标准。以下表格标示此产品中某有毒物质的含量符合中国 RoHS 标准规定的限量要求。

本产品上会附有“环境友好使用期限”的标签，此期限是估算这些物质“不会有泄漏或突变”的年限。本产品可能包含有较短的环境友好使用期限的可替换元件，像是电池或灯管，这些元件将会单独标示出来。

部件名称	有毒有害物质或元素					
	铅 (Pb)	汞 (Hg)	镉 (Cd)	六价铬 (CR(VI))	多溴联苯 (PBB)	多溴二苯 醚 (PBDE)
壳体	X	O	O	O	O	X
显示	X	O	O	O	O	X
印刷电路板	X	O	O	O	O	X
金属螺帽	X	O	O	O	O	O
电缆组装	X	O	O	O	O	X
风扇组装	X	O	O	O	O	X
电力供应组装	X	O	O	O	O	X
电池	O	O	O	O	O	O

O: 表示该有毒有害物质在该部件所有物质材料中的含量均在 SJ/T11363-2006 标准规定的限量要求以下。  
X: 表示该有毒有害物质至少在该部件的某一均质材料中的含量超出 SJ/T11363-2006 标准规定的限量要求。