

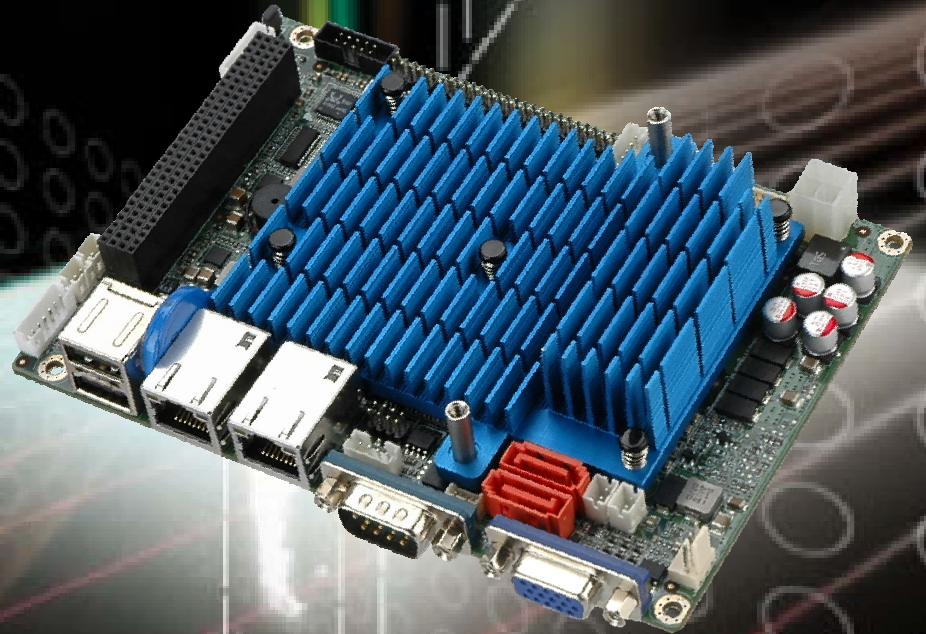

IEI Technology Corp.



MODEL:

WAFER-CV-D25502/N26002

**3.5" SBC with Intel® Atom™ D2550/N2600 Processor,
On-board 2 GB DDR3 Memory, VGA, LVDS, Dual PCIe GbE,
PCI-104, USB 2.0, PCIe Mini, SATA 3Gb/s, Audio and RoHS**

User Manual

Rev. 1.00 – 28 November, 2012



Revision

Date	Version	Changes
28 November, 2012	1.00	Initial release

Copyright

COPYRIGHT NOTICE

The information in this document is subject to change without prior notice in order to improve reliability, design and function and does not represent a commitment on the part of the manufacturer.

In no event will the manufacturer be liable for direct, indirect, special, incidental, or consequential damages arising out of the use or inability to use the product or documentation, even if advised of the possibility of such damages.

This document contains proprietary information protected by copyright. All rights are reserved. No part of this manual may be reproduced by any mechanical, electronic, or other means in any form without prior written permission of the manufacturer.

TRADEMARKS

All registered trademarks and product names mentioned herein are used for identification purposes only and may be trademarks and/or registered trademarks of their respective owners.

Table of Contents

1 INTRODUCTION.....	1
1.1 INTRODUCTION.....	2
1.2 MODEL VARIATIONS	3
1.3 FEATURES.....	3
1.4 CONNECTORS	4
1.5 DIMENSIONS.....	5
1.6 DATA FLOW	6
1.7 TECHNICAL SPECIFICATIONS	7
2 PACKING LIST.....	9
2.1 ANTI-STATIC PRECAUTIONS	10
2.2 UNPACKING PRECAUTIONS.....	10
2.3 PACKING LIST.....	11
2.4 OPTIONAL ITEMS	12
3 CONNECTORS	13
3.1 PERIPHERAL INTERFACE CONNECTORS.....	14
3.1.1 WAFER-CV-D25502/N26002 Layout	14
3.1.2 Peripheral Interface Connectors	15
3.1.3 External Interface Panel Connectors.....	16
3.2 INTERNAL PERIPHERAL CONNECTORS	16
3.2.1 5 V SATA Power Connectors.....	16
3.2.2 12 V Power Connector.....	17
3.2.3 Audio Connector	18
3.2.4 Battery Connector.....	19
3.2.5 Digital Input/Output (DIO) Connector.....	20
3.2.6 Fan Connector	20
3.2.7 Keyboard/Mouse Connector	21
3.2.8 LVDS Connector	22
3.2.9 LVDS Backlight Inverter Connector.....	23
3.2.10 PCI-104 Slot.....	24

WAFER-CV-D25502/N26002 3.5" Motherboard

3.2.11	<i>PCIe Mini Card Slot</i>	25
3.2.12	<i>Power & HDD LED Connector</i>	27
3.2.13	<i>Power Button Connector</i>	28
3.2.14	<i>Reset Button Connector</i>	28
3.2.15	<i>RS-232 Serial Port Connectors</i>	29
3.2.16	<i>RS-422/485 Serial Port Connector</i>	30
3.2.17	<i>SATA Drive Connectors</i>	31
3.2.18	<i>SMBus Connector</i>	32
3.2.19	<i>SPI ROM Connector</i>	33
3.2.20	<i>USB Connector</i>	33
3.3	EXTERNAL PERIPHERAL INTERFACE CONNECTOR PANEL	34
3.3.1	<i>Ethernet Connectors</i>	35
3.3.2	<i>Serial Port Connector (COM1)</i>	36
3.3.3	<i>USB Connector</i>	36
3.3.4	<i>VGA Connector</i>	37
4	INSTALLATION	39
4.1	ANTI-STATIC PRECAUTIONS	40
4.2	INSTALLATION CONSIDERATIONS	40
4.3	JUMPER SETTINGS	42
4.3.1	<i>AT/ATX Power Selection Jumper</i>	42
4.3.2	<i>Clear CMOS Jumper</i>	43
4.3.3	<i>LVDS Voltage Selection</i>	44
4.3.4	<i>PCI-104 VIO Voltage Selection</i>	45
4.4	CHASSIS INSTALLATION	46
4.4.1	<i>Airflow</i>	46
4.4.2	<i>Motherboard Installation</i>	46
4.5	INTERNAL PERIPHERAL DEVICE CONNECTIONS	46
4.5.1	<i>AT/ATX Power Connection</i>	47
4.5.2	<i>Audio Kit Installation</i>	48
4.5.3	<i>LVDS LCD Installation</i>	49
4.5.4	<i>PCIe Mini Card Installation</i>	51
4.5.5	<i>PCI-104 Expansion Card Installation</i>	53
4.5.6	<i>SATA Drive Connection</i>	54
4.5.7	<i>Single RS-232 Cable</i>	55



- 4.5.8 Keyboard/Mouse Y-cable Connector 56
- 4.6 EXTERNAL PERIPHERAL INTERFACE CONNECTION 58
 - 4.6.1 LAN Connection..... 58
 - 4.6.2 Serial Device Connection 59
 - 4.6.3 USB Connection (Dual Connector)..... 60
 - 4.6.4 VGA Monitor Connection 61
- 5 BIOS..... 62**
 - 5.1 INTRODUCTION..... 63
 - 5.1.1 Starting Setup..... 63
 - 5.1.2 Using Setup 63
 - 5.1.3 Getting Help..... 64
 - 5.1.4 Unable to Reboot after Configuration Changes 64
 - 5.1.5 BIOS Menu Bar..... 64
 - 5.2 MAIN..... 65
 - 5.3 ADVANCED..... 66
 - 5.3.1 ACPI Settings 66
 - 5.3.2 RTC Wake Settings 67
 - 5.3.3 CPU Configuration..... 69
 - 5.3.4 IDE Configuration 70
 - 5.3.5 USB Configuration..... 71
 - 5.3.6 F81866 Super IO Configuration..... 72
 - 5.3.6.1 Serial Port n Configuration 72
 - 5.3.7 F81866 H/W Monitor..... 78
 - 5.3.7.1 Smart Fan Mode Configuration 79
 - 5.3.8 Serial Port Console Redirection 80
 - 5.3.9 iEi Feature 83
 - 5.4 CHIPSET 84
 - 5.4.1 Host Bridge Configuration 84
 - 5.4.1.1 Intel IGD Configuration..... 85
 - 5.4.2 South Bridge Configuration..... 87
 - 5.5 BOOT..... 88
 - 5.6 SECURITY..... 90
 - 5.7 SAVE & EXIT 91
- 6 SOFTWARE DRIVERS 93**

WAFER-CV-D25502/N26002 3.5" Motherboard

6.1 AVAILABLE SOFTWARE DRIVERS	94
6.2 STARTING THE DRIVER PROGRAM	94
6.3 CHIPSET DRIVER INSTALLATION.....	96
6.4 GRAPHICS DRIVER INSTALLATION.....	100
6.5 LAN DRIVER INSTALLATION.....	104
6.6 AUDIO DRIVER INSTALLATION	106
A BIOS OPTIONS	109
B ONE KEY RECOVERY	112
B.1 ONE KEY RECOVERY INTRODUCTION	113
<i>B.1.1 System Requirement.....</i>	<i>114</i>
<i>B.1.2 Supported Operating System.....</i>	<i>115</i>
B.2 SETUP PROCEDURE FOR WINDOWS	116
<i>B.2.1 Hardware and BIOS Setup</i>	<i>117</i>
<i>B.2.2 Create Partitions</i>	<i>117</i>
<i>B.2.3 Install Operating System, Drivers and Applications.....</i>	<i>121</i>
<i>B.2.4 Build-up Recovery Partition.....</i>	<i>122</i>
<i>B.2.5 Create Factory Default Image.....</i>	<i>124</i>
B.3 AUTO RECOVERY SETUP PROCEDURE	129
B.4 SETUP PROCEDURE FOR LINUX	134
B.5 RECOVERY TOOL FUNCTIONS	137
<i>B.5.1 Factory Restore</i>	<i>139</i>
<i>B.5.2 Backup System.....</i>	<i>140</i>
<i>B.5.3 Restore Your Last Backup.....</i>	<i>141</i>
<i>B.5.4 Manual.....</i>	<i>142</i>
B.6 RESTORE SYSTEMS FROM A LINUX SERVER THROUGH LAN	143
<i>B.6.1 Configure DHCP Server Settings</i>	<i>144</i>
<i>B.6.2 Configure TFTP Settings</i>	<i>145</i>
<i>B.6.3 Configure One Key Recovery Server Settings</i>	<i>146</i>
<i>B.6.4 Start the DHCP, TFTP and HTTP</i>	<i>147</i>
<i>B.6.5 Create Shared Directory.....</i>	<i>147</i>
<i>B.6.6 Setup a Client System for Auto Recovery</i>	<i>148</i>
B.7 OTHER INFORMATION	151
<i>B.7.1 Using AHCI Mode or ALi M5283 / VIA VT6421A Controller.....</i>	<i>151</i>
<i>B.7.2 System Memory Requirement</i>	<i>153</i>

C TERMINOLOGY	154
D DIGITAL I/O INTERFACE.....	158
D.1 INTRODUCTION.....	159
D.2 DIO CONNECTOR PINOUTS	159
D.3 ASSEMBLY LANGUAGE SAMPLES.....	160
<i>D.3.1 Enable the DIO Input Function</i>	<i>160</i>
<i>D.3.2 Enable the DIO Output Function.....</i>	<i>160</i>
E WATCHDOG TIMER.....	161
F HAZARDOUS MATERIALS DISCLOSURE.....	164
F.1 HAZARDOUS MATERIALS DISCLOSURE TABLE FOR IPB PRODUCTS CERTIFIED AS ROHS COMPLIANT UNDER 2002/95/EC WITHOUT MERCURY	165

List of Figures

Figure 1-1: WAFER-CV-D25502/N26002	2
Figure 1-2: Connectors	4
Figure 1-3: WAFER-CV-D25502/N26002 Dimensions (mm).....	5
Figure 1-4: Data Flow Diagram.....	6
Figure 3-1: Connectors and Jumpers.....	14
Figure 3-2: 5 V SATA Power Connector Locations	16
Figure 3-3: 12 V Power Connector Location.....	17
Figure 3-4: Audio Connector Location	18
Figure 3-5: Battery Connector Location.....	19
Figure 3-6: Digital I/O Connector Location	20
Figure 3-7: Fan Connector Location.....	21
Figure 3-8: Keyboard/Mouse Connector Location	21
Figure 3-9: LVDS Connector Location.....	22
Figure 3-10: Backlight Inverter Connector Location.....	23
Figure 3-11: PCI-104 Slot Location	24
Figure 3-12: PCIe Mini Card Slot Location.....	26
Figure 3-13: Power & HDD LED Connector Location.....	27
Figure 3-14: Power Button Connector Location.....	28
Figure 3-15: Reset Button Connector Location.....	29
Figure 3-16: RS-232 Serial Port Connector Locations.....	29
Figure 3-17: RS-422/485 Connector Location.....	30
Figure 3-18: SATA Drive Connector Locations	31
Figure 3-19: SMBus Connector Location	32
Figure 3-20: SPI Connector Location	33
Figure 3-21: USB Connector Location.....	34
Figure 3-22: External Peripheral Interface Connector	34
Figure 3-23: RJ-45 Ethernet Connector.....	35
Figure 3-24: COM1 Pinout Locations.....	36
Figure 3-25: VGA Connector	37
Figure 4-1: AT/ATX Power Selection Jumper Location	43



Figure 4-2: Clear CMOS Jumper Location44

Figure 4-3: LVDS Voltage Selection Jumper Location45

Figure 4-4: PCI-104 VIO Voltage Selection Jumper Location45

Figure 4-5: Power Cable to Motherboard Connection47

Figure 4-6: Connect Power Cable to Power Supply48

Figure 4-7: Audio Kit Cable Connection.....49

Figure 4-8: LVDS Connector50

Figure 4-9: Backlight Inverter Connection51

Figure 4-10: Remove the Retention Screws for the PCIe Mini Card.....52

Figure 4-11: Insert the PCIe Mini Card into the Socket at an Angle52

Figure 4-12: Secure the PCIe Mini Card53

Figure 4-13: PCI-104 Expansion Card Installation53

Figure 4-14: SATA Drive Cable Connection.....54

Figure 4-15: Single RS-232 Cable Installation55

Figure 4-16: Keyboard/mouse Y-cable Connection57

Figure 4-17: LAN Connection58

Figure 4-18: Serial Device Connector59

Figure 4-19: USB Connector60

Figure 4-20: VGA Connector61

Figure 6-1: Start Up Screen95

Figure 6-2: Drivers95

Figure 6-3: Chipset Driver Screen.....96

Figure 6-4: Chipset Driver Welcome Screen.....97

Figure 6-5: Chipset Driver License Agreement98

Figure 6-6: Chipset Driver Read Me File98

Figure 6-7: Chipset Driver Setup Operations99

Figure 6-8: Chipset Driver Installation Finish Screen..... 100

Figure 6-9: Graphics Driver Welcome Screen 101

Figure 6-10: Graphics Driver License Agreement..... 102

Figure 6-11: Graphics Driver Read Me File 102

Figure 6-12: Graphics Driver Setup Operations 103

Figure 6-13: Graphics Driver Installation Finish Screen 103

Figure 6-14: LAN Driver Welcome Screen 104

Figure 6-15: LAN Driver Installation 105

Figure 6-16: LAN Driver Installation Complete..... 105

WAFER-CV-D25502/N26002 3.5" Motherboard

Figure 6-17: Audio Driver Installation File Extraction.....	106
Figure 6-18: Audio Driver Welcome Screen.....	107
Figure 6-19: Audio Driver Installation.....	107
Figure 6-20: Audio Driver Installation Complete	108
Figure B-1: IEI One Key Recovery Tool Menu	113
Figure B-2: Launching the Recovery Tool	118
Figure B-3: Recovery Tool Setup Menu	118
Figure B-4: Command Prompt	119
Figure B-5: Partition Creation Commands.....	120
Figure B-6: Launching the Recovery Tool	122
Figure B-7: Manual Recovery Environment for Windows	122
Figure B-8: Building the Recovery Partition.....	123
Figure B-9: Press Any Key to Continue	123
Figure B-10: Press F3 to Boot into Recovery Mode.....	124
Figure B-11: Recovery Tool Menu	124
Figure B-12: About Symantec Ghost Window.....	125
Figure B-13: Symantec Ghost Path	125
Figure B-14: Select a Local Source Drive	126
Figure B-15: Select a Source Partition from Basic Drive	126
Figure B-16: File Name to Copy Image to	127
Figure B-17: Compress Image.....	127
Figure B-18: Image Creation Confirmation	128
Figure B-19: Image Creation Complete	128
Figure B-20: Image Creation Complete	128
Figure B-21: Press Any Key to Continue	129
Figure B-22: Auto Recovery Utility	130
Figure B-23: Disable Automatically Restart.....	130
Figure B-24: Launching the Recovery Tool	131
Figure B-25: Auto Recovery Environment for Windows	131
Figure B-26: Building the Auto Recovery Partition.....	132
Figure B-27: Factory Default Image Confirmation	132
Figure B-28: Image Creation Complete	133
Figure B-29: Press any key to continue	133
Figure B-30: IEI Feature	134
Figure B-31: Partitions for Linux.....	135



Figure B-32: System Configuration for Linux..... 136
Figure B-33: Access menu.lst in Linux (Text Mode)..... 136
Figure B-34: Recovery Tool Menu 137
Figure B-35: Recovery Tool Main Menu 138
Figure B-36: Restore Factory Default..... 139
Figure B-37: Recovery Complete Window 139
Figure B-38: Backup System..... 140
Figure B-39: System Backup Complete Window 140
Figure B-40: Restore Backup 141
Figure B-41: Restore System Backup Complete Window 141
Figure B-42: Symantec Ghost Window 142
Figure B-43: Disable Automatically Restart..... 149

List of Tables

Table 1-1: WAFER-CV-D25502/N26002 Model Variations	3
Table 1-2: WAFER-CV-D25502/N26002 Specifications	8
Table 2-1: Packing List.....	12
Table 2-2: Optional Items	12
Table 3-1: Peripheral Interface Connectors	15
Table 3-2: Rear Panel Connectors	16
Table 3-3: 5 V SATA Power Connector Pinouts	17
Table 3-4: 12 V Power Connector Pinouts	17
Table 3-5: Audio Connector Pinouts	18
Table 3-6: Battery Connector Pinouts	19
Table 3-7: Digital I/O Connector Pinouts.....	20
Table 3-8: Fan Connector Pinouts	21
Table 3-9: Keyboard/Mouse Connector Pinouts	22
Table 3-10: LVDS Connector Pinouts.....	23
Table 3-11: Backlight Inverter Connector Pinouts	24
Table 3-12: PCI-104 Slot Pinouts.....	25
Table 3-13: PCIe Mini Card Slot Pinouts	27
Table 3-14: Power & HDD LED Connector Pinouts	27
Table 3-15: Power Button Connector Pinouts	28
Table 3-16: Reset Button Connector Pinouts	29
Table 3-17: RS-232 Serial Port Connector Pinouts	30
Table 3-18: RS-422/485 Connector Pinouts	30
Table 3-19: DB-9 RS-422/485 Pinouts.....	31
Table 3-20: SATA Drive Connector Pinouts.....	32
Table 3-21: SMBus Connector Pinouts	32
Table 3-22: SPI Connector Pinouts.....	33
Table 3-23: USB Connector Pinouts	34
Table 3-24: LAN Pinouts	35
Table 3-25: RJ-45 Ethernet Connector LEDs	35
Table 3-26: RS-232 Serial Port (COM 1) Pinouts	36

Table 3-27: USB Port Pinouts	37
Table 3-28: VGA Connector Pinouts	37
Table 4-1: Jumpers	42
Table 4-2: AT/ATX Power Selection Jumper Settings	43
Table 4-3: Clear CMOS Jumper Settings	43
Table 4-4: LVDS1 Voltage Selection Jumper Settings	44
Table 4-5: PCI-104 VIO Voltage Selection Jumper Settings	45
Table 5-1: BIOS Navigation Keys	64

BIOS Menus

BIOS Menu 1: Main	65
BIOS Menu 2: Advanced	66
BIOS Menu 3: ACPI Settings	67
BIOS Menu 4: RTC Wake Settings	68
BIOS Menu 5: CPU Configuration	69
BIOS Menu 6: IDE Configuration	70
BIOS Menu 7: USB Configuration	71
BIOS Menu 8: F81866 Super IO Configuration	72
BIOS Menu 9: Serial Port n Configuration Menu	72
BIOS Menu 10: F81866 H/W Monitor	78
BIOS Menu 11: Smart Fan Mode Configuration	79
BIOS Menu 12: Serial Port Console Redirection	81
BIOS Menu 13: IEI Feature	83
BIOS Menu 14: Chipset	84
BIOS Menu 15: Host Bridge Configuration	85
BIOS Menu 16: Intel IGD Configuration	85
BIOS Menu 17: Southbridge Chipset Configuration	87
BIOS Menu 18: Boot	88
BIOS Menu 19: Security	90
BIOS Menu 20: Save & Exit	91

Chapter

1

Introduction

1.1 Introduction

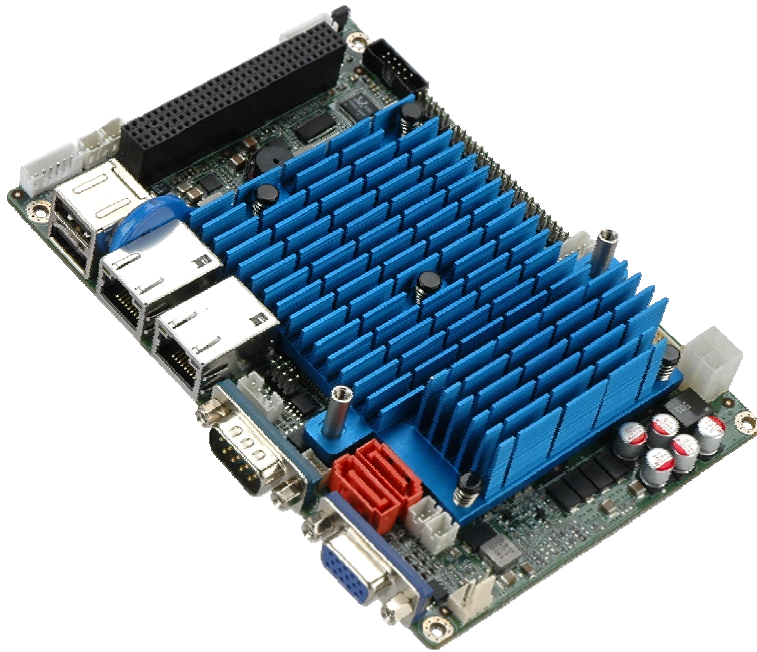

Figure 1-1: WAFER-CV-D25502/N26002

The WAFER-CV-D25502/N26002 3.5" motherboard is an Intel® Atom™ D2550/N2600 processor platform with on-board 2 GB DDR3 memory. The WAFER-CV-D25502/N26002 supports VGA display output and comes with one LVDS connector supporting 24-bit or 18-bit LVDS screen. Maximum four USB 2.0 ports, two SATA 3Gb/s connectors, one PCIe Mini card slot, six COM ports, and one audio connector provide flexible expansion options.

WAFER-CV-D25502/N26002 3.5" Motherboard

1.2 Model Variations

The model variations of the WAFER-CV-D25502/N26002 are listed below.

Model No.	CPU
WAFER-CV-D25502-R10	Intel® Atom™ D2550 1.86 GHz
WAFER-CV-N26002-R10	Intel® Atom™ N2600 1.6 GHz
WAFER-CV-N28002-R10	Intel® Atom™ N2800 1.86 GHz

Table 1-1: WAFER-CV-D25502/N26002 Model Variations

1.3 Features

Some of the WAFER-CV-D25502/N26002 motherboard features are listed below:

- 3.5" form factor
- On-board 2 GB DDR3 memory
- Supports VGA and 24-bit or 18-bit single-channel LVDS
- Full-size PCIe Mini card slot with mSATA support
- Supports PCI-104
- Dual GbE
- Complete I/O with four USB 2.0, two SATA 3Gb/s, six COM and audio
- RoHS compliant

1.4 Connectors

The connectors on the WAFER-CV-D25502/N26002 are shown in the figure below.

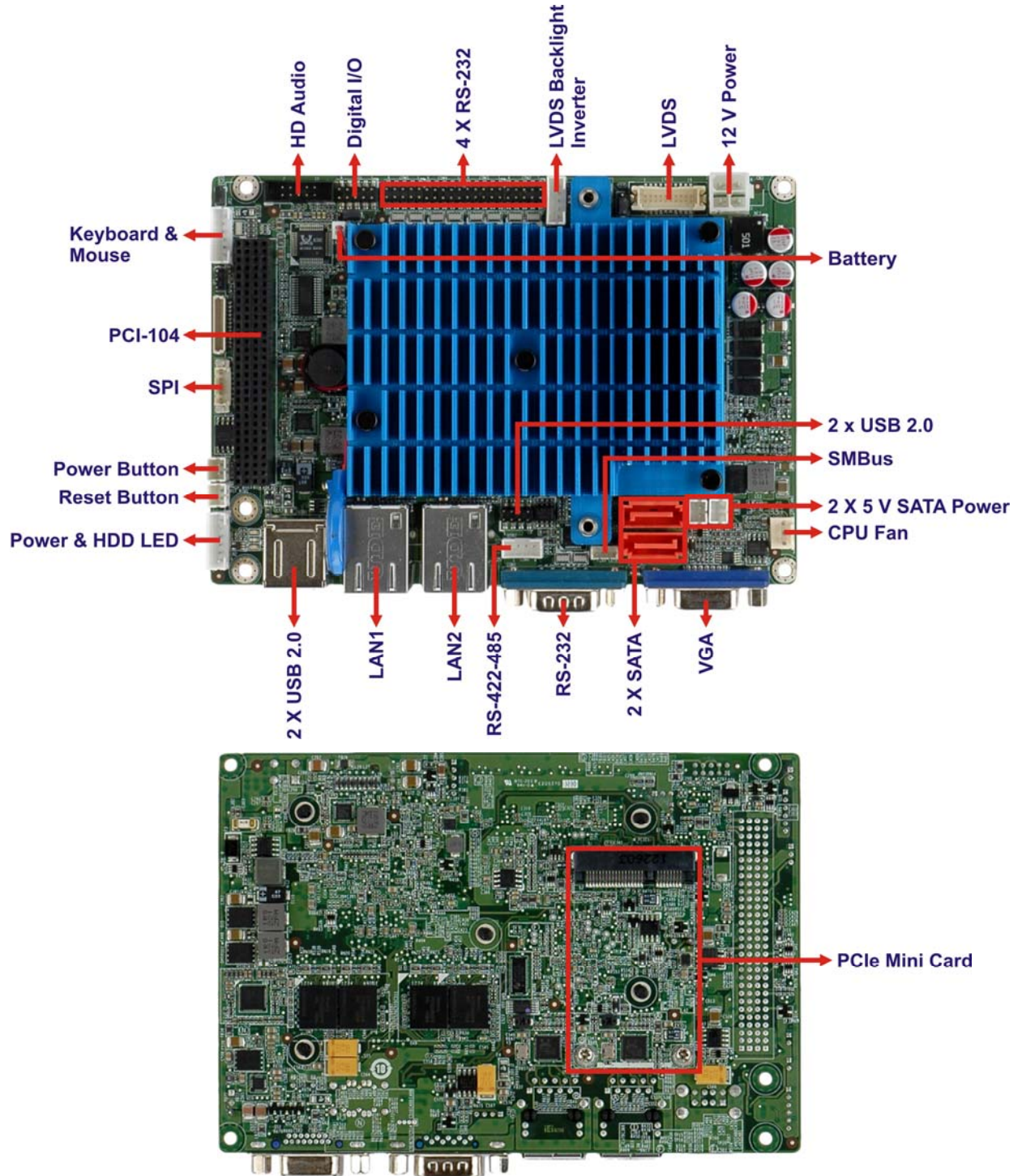

Figure 1-2: Connectors

WAFER-CV-D25502/N26002 3.5" Motherboard

1.5 Dimensions

The main dimensions of the WAFER-CV-D25502/N26002 are shown in the diagram below.

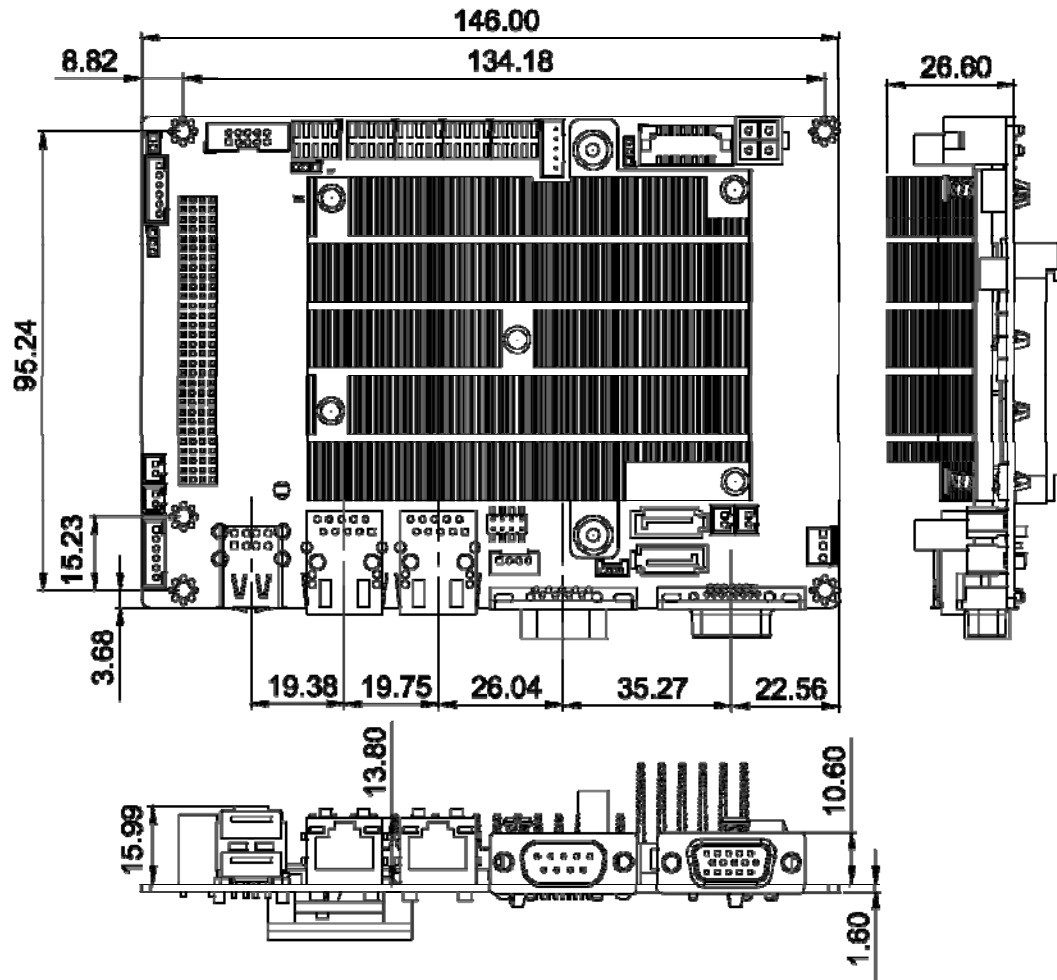

Figure 1-3: WAFER-CV-D25502/N26002 Dimensions (mm)

1.6 Data Flow

Figure 1-4 shows the data flow between the system chipset, the CPU and other components installed on the motherboard.

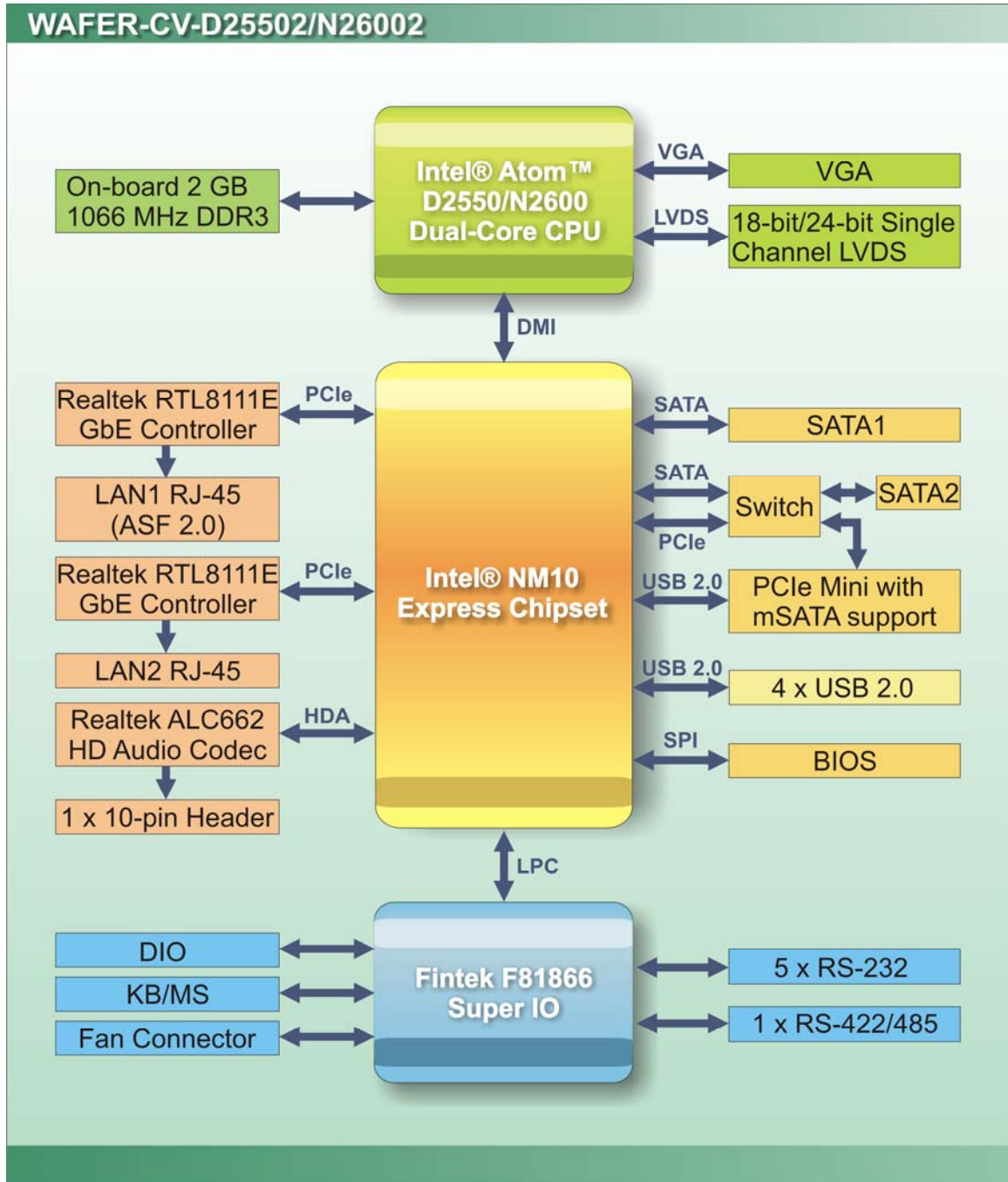

Figure 1-4: Data Flow Diagram

WAFER-CV-D25502/N26002 3.5" Motherboard

1.7 Technical Specifications

The WAFER-CV-D25502/N26002 technical specifications are listed below.

Specification/Model	WAFER-CV-D25502/N26002
Form Factor	3.5"
System CPU	Intel® Atom™ D2550 dual-core CPU, 1.86 GHz, 10 W TDP Intel® Atom™ N2600 dual-core CPU, 1.6 GHz, 3.5 W TDP Intel® Atom™ N2800 dual-core CPU, 1.86 GHz, 6.5 W TDP (optional)
System Chipset	Intel® NM10
Memory	On-board 2 GB 1066 MHz DDR3 SDRAM
Graphics Engine	D2550/N2800: Intel® GMA 3650 with 640 MHz graphics core speed N2600: Intel® GMA 3600 with 400 MHz graphics core speed
Display	One VGA is integrated in the Intel® NM10 (resolution up to 1920 x 1200) One LVDS is integrated in the CPU: <ul style="list-style-type: none"> ▪ D2550: 24-bit single-channel LVDS (resolution up to 1440 x 900) ▪ N2600/N2800: 18-bit single-channel LVDS (resolution up to 1366 x 768)
Ethernet	Dual Realtek RTL8111E PCIe GbE controller (LAN1 with ASF 2.0 support)
BIOS	UEFI BIOS
Super I/O Controller	Fintek F81866
Watchdog Timer	Software programmable supports 1~255 sec. system reset
Expansion	One full-size PCIe Mini card slot with mSATA support One PCI-104 slot supporting PCI signal
Audio	Realtek ALC662 HD Audio codec
COM	Five RS-232 (one by external connector; four by on-board pin headers) One RS-422/485 by internal 4-pin wafer connector
Digital I/O	One 8-bit digital input/output connector (4-bit input/4-bit output)
Fan	One 3-pin CPU fan connector

Specification/Model	WAFER-CV-D25502/N26002
Keyboard/mouse	One internal 6-pin wafer connector
SATA	Two SATA 3Gb/s ports with 5V power connectors
USB	Four USB 2.0/1.1 devices supported: Two by external connectors Two by on-board pin header
Power Supply	12 V only AT and ATX support One internal 4-pin (2x2) power connector
Power Consumption	12V @ 1.19A (1.86 GHz Intel® Atom™ D2550 with on-board 2 GB 1066 MHz DDR3 SDRAM) 12V @ 0.95A (1.6 GHz Intel® Atom™ N2600 with on-board 2 GB 1066 MHz DDR3 SDRAM)
Operating Temperature	D2550: -20°C ~ 60°C with free air; -20°C ~ 70°C with force air N2600/N2800: -20°C ~ 70°C with free air; -20°C ~ 75°C with force air
Storage Temperature	D2550: -30°C ~ 80°C N2600/N2800: -30°C ~ 85°C
Humidity (Operating)	5% ~ 95% (non-condensing)
Dimensions (LxW)	146 mm x 102 mm
Weight (GW/NW)	600 g/250 g

Table 1-2: WAFER-CV-D25502/N26002 Specifications

Chapter

2

Packing List

2.1 Anti-static Precautions



WARNING!

Static electricity can destroy certain electronics. Make sure to follow the ESD precautions to prevent damage to the product, and injury to the user.

Make sure to adhere to the following guidelines:

- **Wear an anti-static wristband:** Wearing an anti-static wristband can prevent electrostatic discharge.
- **Self-grounding:** Touch a grounded conductor every few minutes to discharge any excess static buildup.
- **Use an anti-static pad:** When configuring any circuit board, place it on an anti-static mat.
- **Only handle the edges of the PCB:** Don't touch the surface of the motherboard. Hold the motherboard by the edges when handling.

2.2 Unpacking Precautions

When the WAFER-CV-D25502/N26002 is unpacked, please do the following:

- Follow the antistatic guidelines above.
- Make sure the packing box is facing upwards when opening.
- Make sure all the packing list items are present.

WAFER-CV-D25502/N26002 3.5" Motherboard

2.3 Packing List



NOTE:

If any of the components listed in the checklist below are missing, do not proceed with the installation. Contact the IEI reseller or vendor the WAFER-CV-D25502/N26002 was purchased from or contact an IEI sales representative directly by sending an email to sales@iei.com.tw.

The WAFER-CV-D25502/N26002 is shipped with the following components:

Quantity	Item and Part Number	Image
1	WAFER-CV-D25502/N26002 motherboard	
2	SATA and power cable (P/N: 32801-000201-100-RS)	
1	Audio cable (P/N: 32000-072100-RS)	
1	RS-232 cable (P/N: 32200-000049-RS)	
1	PS/2 KB/MS cable (P/N: 32000-023800-RS)	
1	Power cable (P/N: 32100-087100-RS)	
1	Mini jumper pack	



Quantity	Item and Part Number	Image
1	One Key Recovery CD	
1	Utility CD	
1	Quick Installation Guide	

Table 2-1: Packing List

2.4 Optional Items

The following are optional components which may be separately purchased:



Item and Part Number	Image
Dual USB cable (wo bracket) (P/N: 32000-070301-RS)	
RS-422/485 cable (P/N: 32200-074800-RS)	

Table 2-2: Optional Items

Chapter

3

Connectors

3.1 Peripheral Interface Connectors

This chapter details all the jumpers and connectors.

3.1.1 WAFER-CV-D25502/N26002 Layout

The figure below shows all the connectors and jumpers.

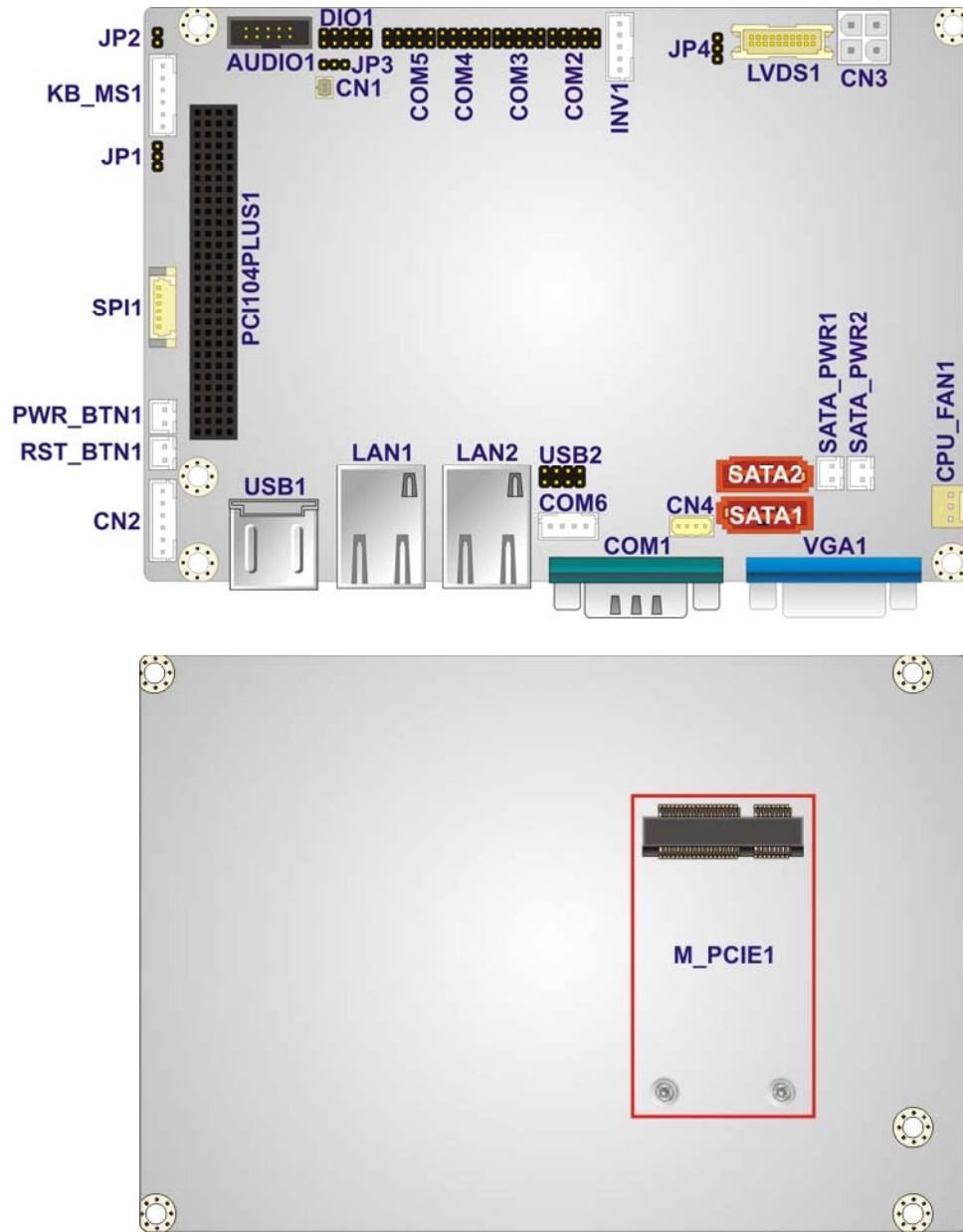

Figure 3-1: Connectors and Jumpers

WAFER-CV-D25502/N26002 3.5" Motherboard

3.1.2 Peripheral Interface Connectors

The table below lists all the connectors on the board.

Connector	Type	Label
5 V SATA power connectors	2-pin wafer	SATA_PWR1, SATA_PWR2
12 V power connector	4-pin Molex power connector	CN3
Audio connector	10-pin box header	AUDIO1
Battery connector	2-pin wafer	CN1
Digital Input/Output (DIO) connector	10-pin header	DIO1
Fan connector	3-pin wafer	CPU_FAN1
Keyboard and mouse connector	6-pin wafer	KB_MS1
LVDS connectors	20-pin crimp	LVDS1
LVDS backlight inverter connector	5-pin wafer	INV1
PCI-104 slot	120-pin PCI-104 slot	PCI104PLUS1
PCIe Mini card slot	52-pin PCIe Mini	M_PCIE1
Power & HDD LED connector	6-pin header	CN2
Power button connector	2-pin wafer	PWR_BTN1
Reset button connector	2-pin wafer	RST_BTN1
RS-232 serial port connectors	10-pin header	COM2, COM3, COM4, COM5
RS-422/485 serial port connector	4-pin wafer	COM6
Serial ATA (SATA) drive connectors	7-pin SATA	SATA1, SATA2
SMBus connector	4-pin wafer	CN4
SPI ROM connector	6-pin wafer	SPI1
USB 2.0 connector	8-pin header	USB2

Table 3-1: Peripheral Interface Connectors

3.1.3 External Interface Panel Connectors

The table below lists the connectors on the external I/O panel.

Connector	Type	Label
Dual USB port	Dual USB port	USB1
Ethernet connectors	RJ-45	LAN1, LAN2
RS-232 serial port connector	Male DB-9	COM1
VGA connector	15-pin female	VGA1

Table 3-2: Rear Panel Connectors

3.2 Internal Peripheral Connectors

The section describes all of the connectors on the WAFER-CV-D25502/N26002.

3.2.1 5 V SATA Power Connectors

CN Label: SATA_PWR1, SATA_PWR2

CN Type: 2-pin wafer

CN Location: See Figure 3-2

CN Pinouts: See Table 3-3

Use the 5 V SATA power connectors to connect to SATA device power connection.

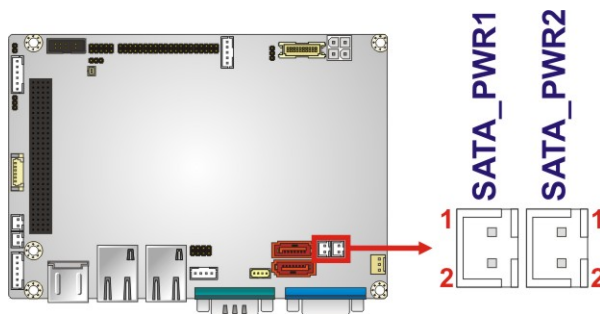

Figure 3-2: 5 V SATA Power Connector Locations

WAFER-CV-D25502/N26002 3.5" Motherboard

Pin No.	Description
1	+5V
2	Ground

Table 3-3: 5 V SATA Power Connector Pinouts

3.2.2 12 V Power Connector

- CN Label:** CN3
- CN Type:** 4-pin Molex power connector
- CN Location:** See **Figure 3-3**
- CN Pinouts:** See **Table 3-4**

The power connector is connected to an external power supply and supports 12 V power input. Power is provided to the system, from the power supply through this connector.

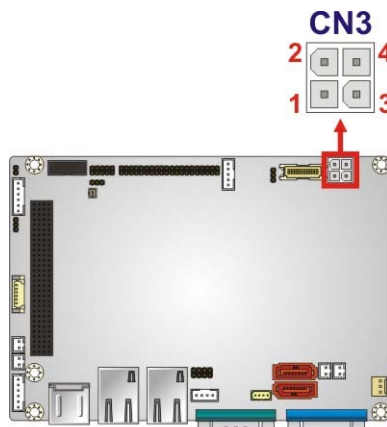

Figure 3-3: 12 V Power Connector Location

Pin	Description
1	GND
2	GND
3	+12V
4	+12V

Table 3-4: 12 V Power Connector Pinouts

3.2.3 Audio Connector

- CN Label:** AUDIO1
- CN Type:** 10-pin box header
- CN Location:** See **Figure 3-4**
- CN Pinouts:** See **Table 3-5**

The 10-pin audio connector is connected to external audio devices including speakers and microphones for the input and output of audio signals to and from the system.

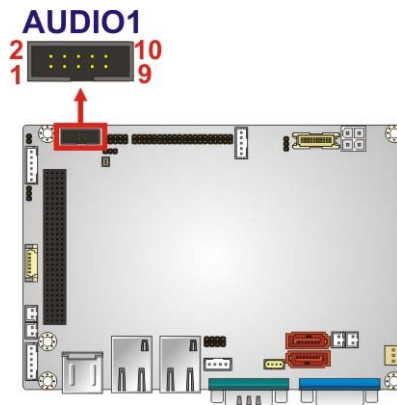

Figure 3-4: Audio Connector Location

Pin	Description	Pin	Description
1	SPK_R	2	LINE1_R
3	AUD_GND	4	AUD_GND
5	SPK_L	6	LINE1_L
7	AUD_GND	8	AUD_GND
9	MIC1_R	10	MIC1_L

Table 3-5: Audio Connector Pinouts

WAFER-CV-D25502/N26002 3.5" Motherboard

3.2.4 Battery Connector



CAUTION:

Risk of explosion if battery is replaced by an incorrect type. Only certified engineers should replace the on-board battery.

Dispose of used batteries according to instructions and local regulations.

CN Label:	CN1
CN Type:	2-pin wafer
CN Location:	See Figure 3-5
CN Pinouts:	See Table 3-6

This is connected to the system battery. The battery provides power to the system clock to retain the time when power is turned off.

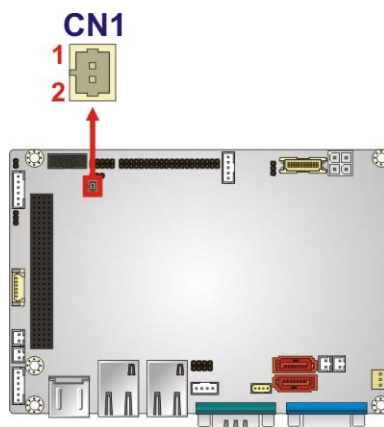

Figure 3-5: Battery Connector Location

Pin	Description
1	Battery+
2	GND

Table 3-6: Battery Connector Pinouts

3.2.5 Digital Input/Output (DIO) Connector

- CN Label:** DIO1
- CN Type:** 10-pin header
- CN Location:** See **Figure 3-6**
- CN Pinouts:** See **Table 3-7**

The digital input/output connector is managed through a Super I/O chip. The DIO connector pins are user programmable.

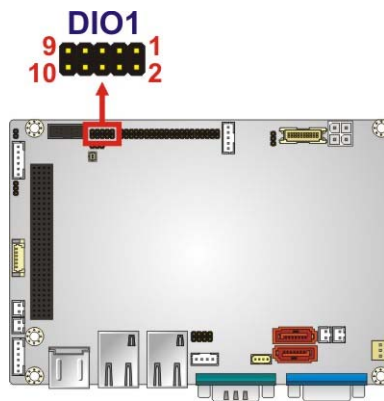

Figure 3-6: Digital I/O Connector Location

Pin	Description	Pin	Description
1	GND	2	VCC
3	Output 3	4	Output 2
5	Output 1	6	Output 0
7	Input 3	8	Input 2
9	Input 1	10	Input 0

Table 3-7: Digital I/O Connector Pinouts

3.2.6 Fan Connector

- CN Label:** CPU_FAN1
- CN Type:** 3-pin wafer
- CN Location:** See **Figure 3-7**
- CN Pinouts:** See **Table 3-8**

WAFER-CV-D25502/N26002 3.5" Motherboard

The fan connectors attach to the CPU/system cooling fans.

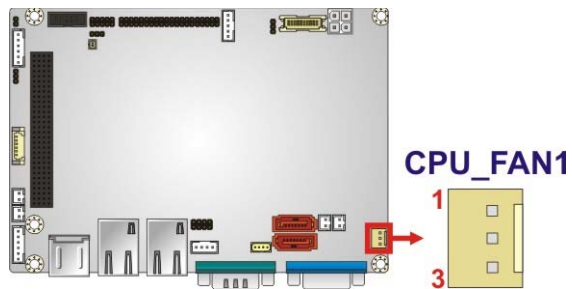

Figure 3-7: Fan Connector Location

Pin	Description
1	FANIO
2	+12 V (PWM)
3	Ground

Table 3-8: Fan Connector Pinouts

3.2.7 Keyboard/Mouse Connector

- CN Label:** KB_MS1
- CN Type:** 6-pin wafer
- CN Location:** See **Figure 3-8**
- CN Pinouts:** See **Table 3-9**

The keyboard and mouse connector can be connected to a standard PS/2 cable or PS/2 Y-cable to add keyboard and mouse functionality to the system.

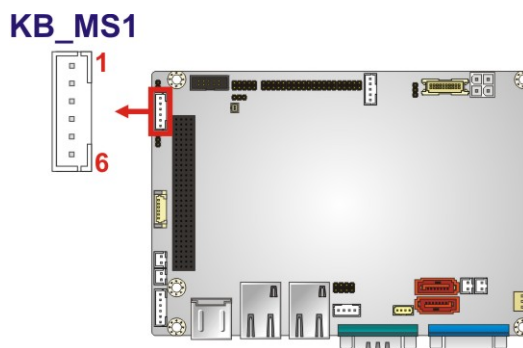

Figure 3-8: Keyboard/Mouse Connector Location

Pin	Description
1	VCC
2	MS DATA
3	MS CLK
4	KB DATA
5	KB CLK
6	GROUND

Table 3-9: Keyboard/Mouse Connector Pinouts

3.2.8 LVDS Connector

- CN Label:** LVDS1
- CN Type:** 20-pin crimp
- CN Location:** See **Figure 3-9**
- CN Pinouts:** See **Table 3-10**

The 20-pin LVDS LCD connector can be connected to an 18-bit/24-bit single-channel LVDS panel.

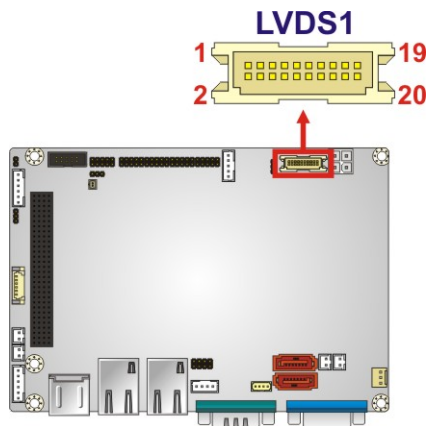

Figure 3-9: LVDS Connector Location

Pin	Description	Pin	Description
1	GND	2	GND

WAFER-CV-D25502/N26002 3.5" Motherboard

Pin	Description	Pin	Description
3	LVDS_DATA0	4	LVDS_DATA0#
5	LVDS_DATA1	6	LVDS_DATA1#
7	LVDS_DATA2	8	LVDS_DATA2#
9	LVDS_CLK	10	LVDS_CLK#
11	LVDS_DATA3	12	LVDS_DATA3#
13	GND	14	GND
15	LDDC_DATA	16	LDDC_CLK
17	VCC_LCD	18	VCC_LCD
19	VCC_LCD	20	VCC_LCD

Table 3-10: LVDS Connector Pinouts

3.2.9 LVDS Backlight Inverter Connector

- CN Label:** INV1
- CN Type:** 5-pin wafer
- CN Location:** See **Figure 3-10**
- CN Pinouts:** See **Table 3-11**

The backlight inverter connector provides the backlights on the LCD display connected to the WAFER-CV-D25502/N26002 with +12V of power.

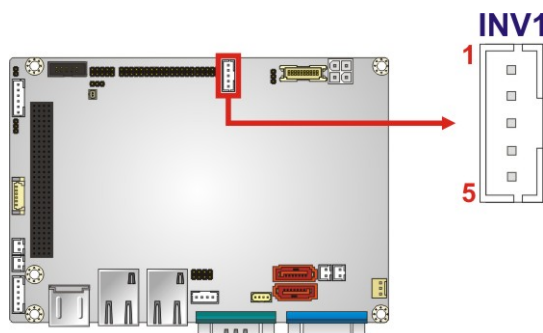

Figure 3-10: Backlight Inverter Connector Location

Pin	Description
1	LCD_BKLTCTL
2	GROUND

Pin	Description
3	+12V
4	GROUND
5	BACKLIGHT ENABLE

Table 3-11: Backlight Inverter Connector Pinouts

3.2.10 PCI-104 Slot

CN Label: PCI104PLUS1

CN Type: 120-pin PCI-104 slot

CN Location: See **Figure 3-11**

CN Pinouts: See **Table 3-12**

The PCI-104 slot is for installing a PCI-104 expansion module.

PCI104PLUS1

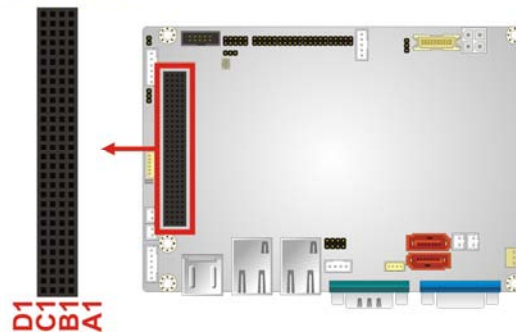
Figure 3-11: PCI-104 Slot Location

Pin	Description	Pin	Description	Pin	Description	Pin	Description
A1	GND	B1	Reserved	C1	+5V	D1	AD00
A2	VI/O	B2	AD02	C2	AD01	D2	+5V
A3	AD05	B3	GND	C3	AD04	D3	AD03
A4	C/BE0#	B4	AD07	C4	GND	D4	AD06
A5	GND	B5	AD09	C5	AD08	D5	GND
A6	AD11	B6	VI/O	C6	AD10	D6	M66EN
A7	AD14	B7	AD13	C7	GND	D7	AD12
A8	+3.3V	B8	C/BE1#	C8	AD15	D8	+3.3V

WAFER-CV-D25502/N26002 3.5" Motherboard

Pin	Description	Pin	Description	Pin	Description	Pin	Description
A9	SERR#	B9	GND	C9	Reserved	D9	PAR
A10	GND	B10	PERR#	C10	+3.3V	D10	Reserved
A11	STOP#	B11	+3.3V	C11	LOCK#	D11	GND
A12	+3.3V	B12	TRDY#	C12	GND	D12	DEVSEL#
A13	FRAME#	B13	GND	C13	IRDY#	D13	+3.3V
A14	GND	B14	AD16	C14	+3.3V	D14	C/BE2#
A15	AD18	B15	+3.3V	C15	AD17	D15	GND
A16	AD21	B16	AD20	C16	GND	D16	AD19
A17	+3.3V	B17	AD23	C17	AD22	D17	+3.3V
A18	IDSEL0	B18	GND	C18	IDSEL1	D18	IDSEL2
A19	AD24	B19	C/BE3#	C19	VI/O	D19	IDSEL3
A20	GND	B20	AD26	C20	AD25	D20	GND
A21	AD29	B21	+5V	C21	AD28	D21	AD27
A22	+5V	B22	AD30	C22	GND	D22	AD31
A23	REQ0#	B23	GND	C23	REQ1#	D23	VI/O
A24	GND	B24	REQ2#	C24	+5V	D24	GNT0#
A25	GNT1#	B25	VI/O	C25	GNT2#	D25	GND
A26	+5V	B26	CLK0	C26	GND	D26	CLK1
A27	CLK2	B27	+5V	C27	CLK3	D27	GND
A28	GND	B28	INTD#	C28	+5V	D28	RST#
A29	+12V	B29	INTA#	C29	INTB#	D29	INTC#
A30	-12V	B30	Reserved	C30	Reserved	D30	GND

Table 3-12: PCI-104 Slot Pinouts

3.2.11 PCIe Mini Card Slot

- CN Label:** M_PCIE1
- CN Type:** 52-pin PCIe Mini card slot
- CN Location:** See **Figure 3-12**
- CN Pinouts:** See **Table 3-13**

The **M_PCIE1** slot can be connected to a full-size PCIe Mini card.

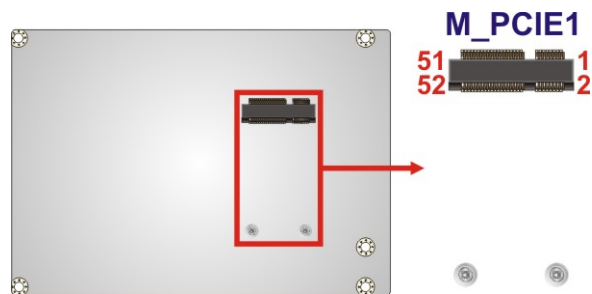
Figure 3-12: PCIe Mini Card Slot Location

Pin	Description	Pin	Description
1	PCIE_WAKE#	2	VCC3
3	N/C	4	GND
5	N/C	6	1.5V
7	N/C	8	N/C
9	GND	10	N/C
11	PCIE_CLK#	12	N/C
13	PCIE_CLK	14	N/C
15	GND	16	N/C
17	N/C	18	GND
19	N/C	20	N/C
21	GND	22	PCIRST#
23	PCIE_RXN	24	VCC3
25	PCIE_RXP	26	GND
27	GND	28	1.5V
29	GND	30	SMBCLK
31	PCIE_TXN	32	SMBDATA
33	PCIE_TXP	34	GND
35	GND	36	USB D-
37	GND	38	USB D+
39	VCC3	40	GND
41	VCC3	42	N/C
43	GND	44	N/C
45	N/C	46	N/C

WAFER-CV-D25502/N26002 3.5" Motherboard

Pin	Description	Pin	Description
47	N/C	48	1.5V
49	N/C	50	GND
51	N/C	52	VCC3

Table 3-13: PCIe Mini Card Slot Pinouts

3.2.12 Power & HDD LED Connector

- CN Label:** CN2
- CN Type:** 6-pin wafer
- CN Location:** See **Figure 3-13**
- CN Pinouts:** See **Table 3-14**

The LED connector connects to an HDD indicator LED and a power LED on the system chassis to inform the user about HDD activity and the power on/off status of the system.

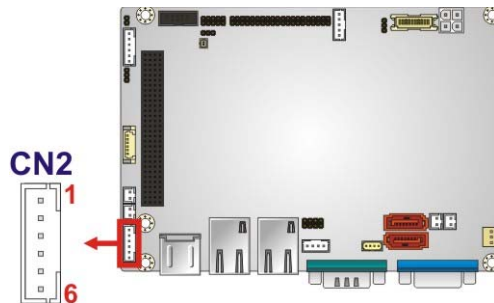

Figure 3-13: Power & HDD LED Connector Location

Function	Pin	Description
+5V	1	VCC
	2	GND
Power LED	3	Power LED+
	4	Power LED-
HDD LED	5	HDD LED+
	6	HDD LED-

Table 3-14: Power & HDD LED Connector Pinouts

3.2.13 Power Button Connector

- CN Label:** PWR_BTN1
- CN Type:** 2-pin wafer
- CN Location:** See **Figure 3-14**
- CN Pinouts:** See **Table 3-15**

The power button connector is connected to a power switch on the system chassis to enable users to turn the system on and off.

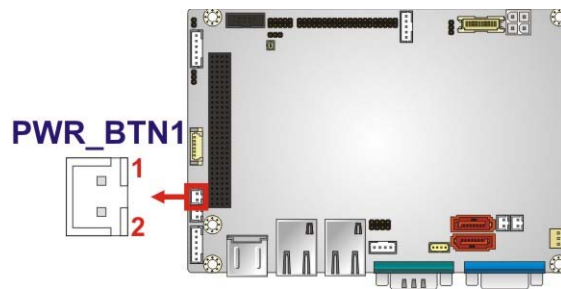

Figure 3-14: Power Button Connector Location

Pin	Description
1	PWR_BTN+
2	PWR_BTN-

Table 3-15: Power Button Connector Pinouts

3.2.14 Reset Button Connector

- CN Label:** RST_BTN1
- CN Type:** 2-pin wafer
- CN Location:** See **Figure 3-15**
- CN Pinouts:** See **Table 3-16**

The reset button connector is connected to a reset switch on the system chassis to enable users to reboot the system when the system is turned on.

WAFER-CV-D25502/N26002 3.5" Motherboard

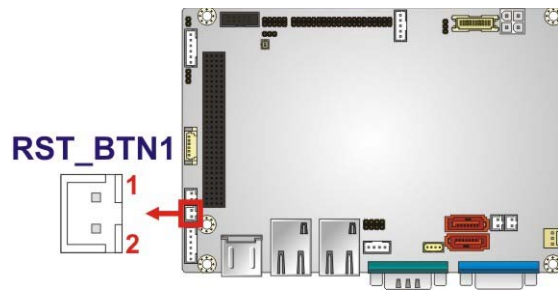

Figure 3-15: Reset Button Connector Location

Pin	Description
1	RESET+
2	RESET-

Table 3-16: Reset Button Connector Pinouts

3.2.15 RS-232 Serial Port Connectors

CN Label: COM2, COM3, COM4, COM5

CN Type: 10-pin header

CN Location: See **Figure 3-16**

CN Pinouts: See **Table 3-17**

Each of these connectors provides RS-232 connections.

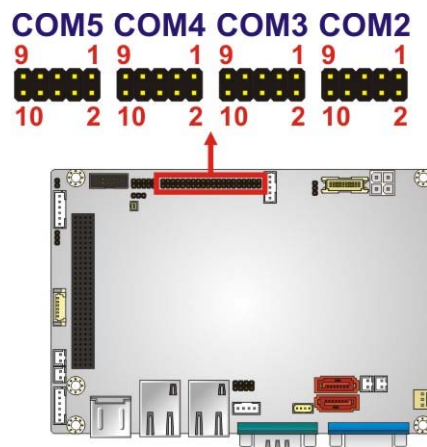

Figure 3-16: RS-232 Serial Port Connector Locations

Pin	Description	Pin	Description
1	DCD	2	DSR
3	RXD	4	RTS
5	TXD	6	CTS
7	DTR	8	RI
9	GND	10	GND

Table 3-17: RS-232 Serial Port Connector Pinouts

3.2.16 RS-422/485 Serial Port Connector

- CN Label:** COM6
- CN Type:** 4-pin wafer
- CN Location:** See **Figure 3-17**
- CN Pinouts:** See **Table 3-18**

This connector provides RS-422 or RS-485 communications.

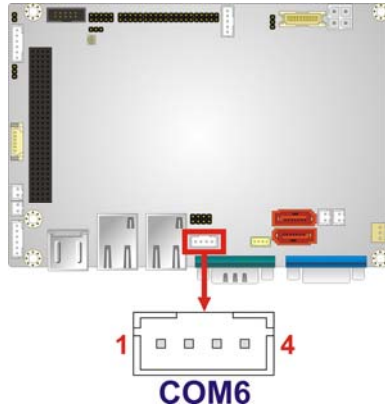

Figure 3-17: RS-422/485 Connector Location

Pin	Description	Pin	Description
1	RXD422-	3	TXD422+/TXD485+
2	RXD422+	4	TXD422-/TXD485-

Table 3-18: RS-422/485 Connector Pinouts

Use the optional RS-422/485 cable to connect to a serial device. The pinouts of the DB-9 connector are listed below.

WAFER-CV-D25502/N26002 3.5" Motherboard

RS-422 Pinouts	RS-485 Pinouts
	

Table 3-19: DB-9 RS-422/485 Pinouts

3.2.17 SATA Drive Connectors

- CN Label:** SATA1, SATA2
- CN Type:** 7-pin SATA drive connector
- CN Location:** See Figure 3-18
- CN Pinouts:** See Table 3-20

The SATA drive connectors can be connected to SATA drives and support up to 3Gb/s data transfer rate.

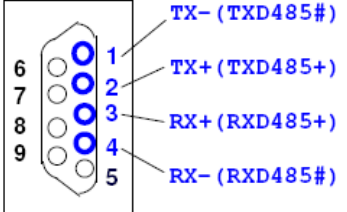
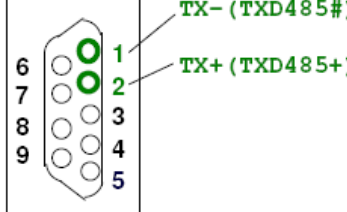
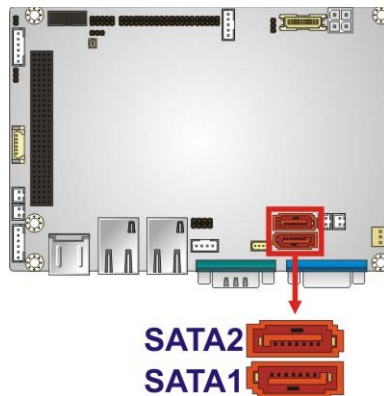

Figure 3-18: SATA Drive Connector Locations

Pin	Description
1	GND
2	TX+
3	TX-
4	GND

Pin	Description
5	RX-
6	RX+
7	GND

Table 3-20: SATA Drive Connector Pinouts

3.2.18 SMBus Connector

CN Label: SMBUS_1

CN Type: 4-pin wafer

CN Location: See **Figure 3-19**

CN Pinouts: See **Table 3-21**

The SMBus (System Management Bus) connector provides low-speed system management communications.

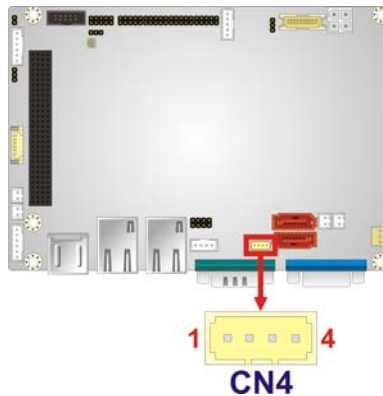
Figure 3-19: SMBus Connector Location

Pin	Description
1	GND
2	SMBDATA
3	SMBCLK
4	+V5S

Table 3-21: SMBus Connector Pinouts

WAFER-CV-D25502/N26002 3.5" Motherboard

3.2.19 SPI ROM Connector

- CN Label:** SPI1
- CN Type:** 6-pin header
- CN Location:** See **Figure 3-20**
- CN Pinouts:** See **Table 3-22**

The SPI connector is used to flash the BIOS.

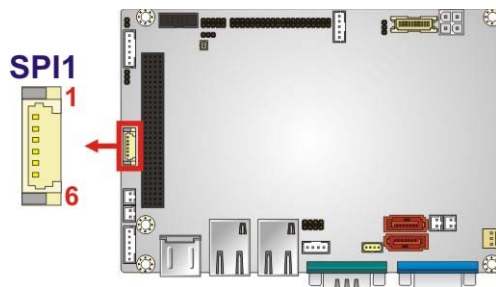

Figure 3-20: SPI Connector Location

Pin	Description
1	SPI_VCC
2	SPI_2N_CS#
3	SPI_2N_MISO
4	SPI_2N_CLK
5	SPI_2N_MOSI
6	GND

Table 3-22: SPI Connector Pinouts

3.2.20 USB Connector

- CN Label:** USB2
- CN Type:** 8-pin header
- CN Location:** See **Figure 3-21**
- CN Pinouts:** See **Table 3-23**

The USB connector provides connectivity to two USB 1.1/2.0 ports.

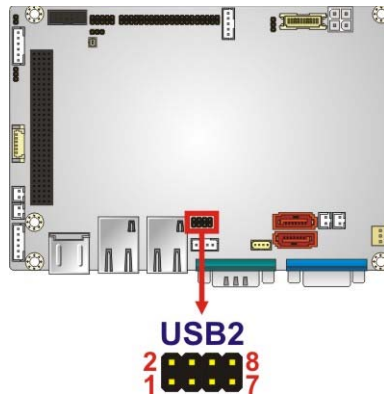

Figure 3-21: USB Connector Location

Pin	Description	Pin	Description
1	USB_VCC	2	GND
3	DATA-	4	DATA+
5	DATA+	6	DATA-
7	GND	8	USB_VCC

Table 3-23: USB Connector Pinouts

3.3 External Peripheral Interface Connector Panel

The figure below shows the external peripheral interface connector (EPIC) panel. The EPIC panel consists of the following:

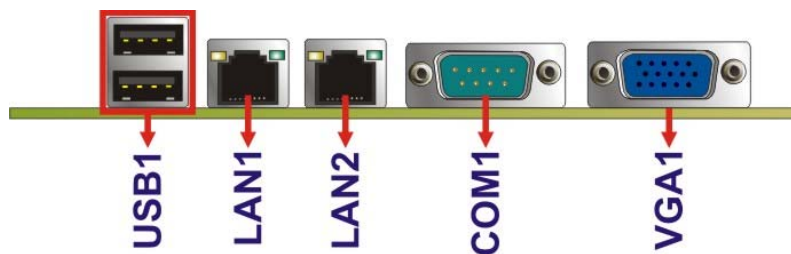

Figure 3-22: External Peripheral Interface Connector

WAFER-CV-D25502/N26002 3.5" Motherboard

3.3.1 Ethernet Connectors

- CN Label:** LAN1, LAN2
- CN Type:** RJ-45 connector
- CN Location:** See **Figure 3-22**
- CN Pinouts:** See **Table 3-24**

The WAFER-CV-D25502/N26002 is equipped with two built-in RJ-45 Ethernet controllers. Each controller can connect to the LAN through one RJ-45 LAN connector.

Pin	Description	Pin	Description
1	LAN_MDIO+	5	LAN_MDI2+
2	LAN_MDIO-	6	LAN_MDI2-
3	LAN_MDI1+	7	LAN_MDI3+
4	LAN_MDI1-	8	LAN_MDI3-

Table 3-24: LAN Pinouts

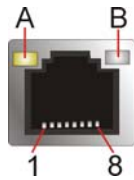

Figure 3-23: RJ-45 Ethernet Connector

LED	Description	LED	Description
A	on: linked blinking: data is being sent/received	B	off: 10 Mb/s green: 100 Mb/s orange: 1000 Mb/s

Table 3-25: RJ-45 Ethernet Connector LEDs

3.3.2 Serial Port Connector (COM1)

- CN Label:** COM1
- CN Type:** Male DB-9 connector
- CN Location:** See **Figure 3-22**
- CN Pinouts:** See **Table 3-26** and **Figure 3-24**

The serial port connects to a RS-232 serial communications device.

Pin	Description	Pin	Description
1	DATA CARRIER DETECT (DCD)	6	DATA SET READY (DSR)
2	RECEIVE DATA (RXD)	7	REQUEST TO SEND (RTS)
3	TRANSMIT DATA (TXD)	8	CLEAR TO SEND (CTS)
4	DATA TERMINAL READY (DTR)	9	RING INDICATOR (RI)
5	GND		

Table 3-26: RS-232 Serial Port (COM 1) Pinouts

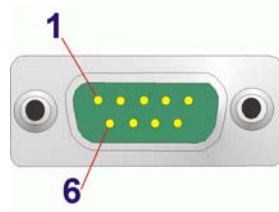

Figure 3-24: COM1 Pinout Locations

3.3.3 USB Connector

- CN Label:** USB1
- CN Type:** Dual USB port
- CN Location:** See **Figure 3-22**
- CN Pinouts:** See **Table 3-27**

The ports connect to both USB 2.0 and USB 1.1 devices.

WAFER-CV-D25502/N26002 3.5" Motherboard

Pin	Description	Pin	Description
1	USB_VCC	2	USB_VCC
3	DATA-	4	DATA-
5	DATA+	6	DATA+
7	GND	8	GND

Table 3-27: USB Port Pinouts

3.3.4 VGA Connector

CN Label: VGA1

CN Type: 15-pin Female

CN Location: See **Figure 3-22**

CN Pinouts: See **Figure 3-25** and **Table 3-28**

The VGA connector connects to a monitor that accepts a standard VGA input.

Pin	Description	Pin	Description
1	RED	2	GREEN
3	BLUE	4	NC
5	GND	6	GND
7	GND	8	GND
9	VCC	10	GND
11	NC	12	DDCDAT
13	HSYNC	14	VSYNC
15	DDCCLK		

Table 3-28: VGA Connector Pinouts

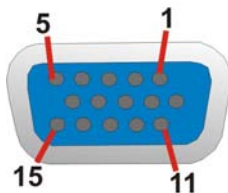

Figure 3-25: VGA Connector



NOTE:

Due to Intel® GMA driver limitation, the monitor connected to the VGA connector may become extended desktop or not have signal to it after restarting from the graphics driver installation. To work out this limitation, press the Ctrl+Alt+F1 hotkey to switch the primary display to CRT mode.

Chapter

4

Installation

4.1 Anti-static Precautions



WARNING:

Failure to take ESD precautions during the installation of the WAFER-CV-D25502/N26002 may result in permanent damage to the WAFER-CV-D25502/N26002 and severe injury to the user.

Electrostatic discharge (ESD) can cause serious damage to electronic components, including the WAFER-CV-D25502/N26002. Dry climates are especially susceptible to ESD. It is therefore critical that whenever the WAFER-CV-D25502/N26002 or any other electrical component is handled, the following anti-static precautions are strictly adhered to.

- **Wear an anti-static wristband:** - Wearing a simple anti-static wristband can help to prevent ESD from damaging the board.
- **Self-grounding:** - Before handling the board touch any grounded conducting material. During the time the board is handled, frequently touch any conducting materials that are connected to the ground.
- **Use an anti-static pad:** When configuring the WAFER-CV-D25502/N26002, place it on an anti-static pad. This reduces the possibility of ESD damaging the WAFER-CV-D25502/N26002.
- **Only handle the edges of the PCB:-** When handling the PCB, hold the PCB by the edges.

4.2 Installation Considerations



NOTE:

The following installation notices and installation considerations should be read and understood before installation. All installation notices must be strictly adhered to. Failing to adhere to these precautions may lead to severe damage and injury to the person performing the installation.

**WARNING:**

The installation instructions described in this manual should be carefully followed in order to prevent damage to the components and injury to the user.

Before and during the installation please **DO** the following:

- Read the user manual:
 - The user manual provides a complete description of the WAFER-CV-D25502/N26002 installation instructions and configuration options.
- Wear an electrostatic discharge cuff (ESD):
 - Electronic components are easily damaged by ESD. Wearing an ESD cuff removes ESD from the body and helps prevent ESD damage.
- Place the WAFER-CV-D25502/N26002 on an antistatic pad:
 - When installing or configuring the motherboard, place it on an antistatic pad. This helps to prevent potential ESD damage.
- Turn all power to the WAFER-CV-D25502/N26002 off:
 - When working with the WAFER-CV-D25502/N26002, make sure that it is disconnected from all power supplies and that no electricity is being fed into the system.

Before and during the installation of the WAFER-CV-D25502/N26002 **DO NOT:**

- Remove any of the stickers on the PCB board. These stickers are required for warranty validation.
- Use the product before verifying all the cables and power connectors are properly connected.
- Allow screws to come in contact with the PCB circuit, connector pins, or its components.

4.3 Jumper Settings

NOTE:

A jumper is a metal bridge used to close an electrical circuit. It consists of two or three metal pins and a small metal clip (often protected by a plastic cover) that slides over the pins to connect them. To CLOSE/SHORT a jumper means connecting the pins of the jumper with the plastic clip and to OPEN a jumper means removing the plastic clip from a jumper.

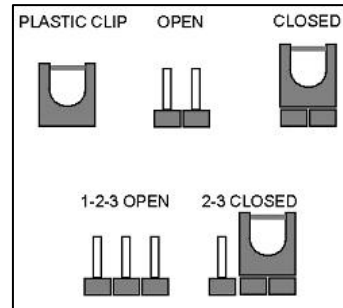

The hardware jumpers must be set before installation. Jumpers are shown in Table 4-1.

Description	Label	Type
AT/ATX power selection	JP2	2-pin header
Clear CMOS	JP3	3-pin header
LVDS1 voltage selection	JP4	3-pin header
PCI-104 VIO voltage selection	JP1	3-pin header

Table 4-1: Jumpers

4.3.1 AT/ATX Power Selection Jumper

- Jumper Label:** JP2
- Jumper Type:** 2-pin header
- Jumper Settings:** See Table 4-2
- Jumper Location:** See Figure 4-1

The AT/ATX power selection jumper specifies the system power mode as AT or ATX.

WAFER-CV-D25502/N26002 3.5" Motherboard

Setting	Description
Short 1-2	Use ATX power (Default)
Off	Use AT power

Table 4-2: AT/ATX Power Selection Jumper Settings

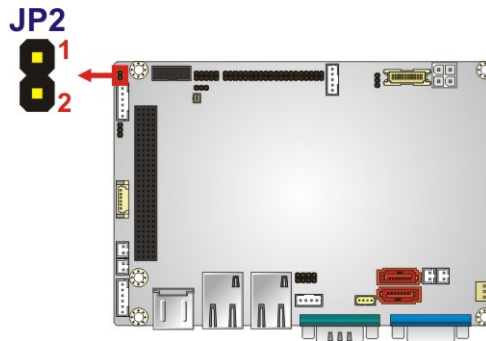

Figure 4-1: AT/ATX Power Selection Jumper Location

4.3.2 Clear CMOS Jumper

Jumper Label:	JP3
Jumper Type:	3-pin header
Jumper Settings:	See Table 4-3
Jumper Location:	See Figure 4-2

To reset the BIOS, move the jumper to the "Clear CMOS Setup" position for 3 seconds or more, and then move back to the default position.

Setting	Description
Short 1-2	Keep CMOS Setup (Default)
Short 2-3	Clear CMOS Setup

Table 4-3: Clear CMOS Jumper Settings

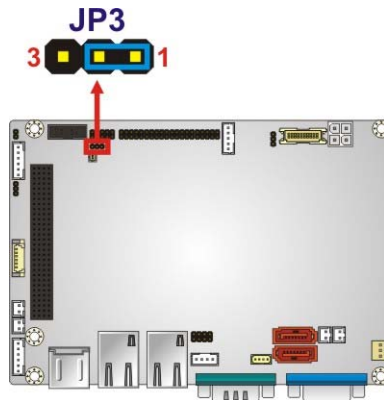

Figure 4-2: Clear CMOS Jumper Location

4.3.3 LVDS Voltage Selection



WARNING:

Permanent damage to the screen and WAFER-CV-D25502/N26002 may occur if the wrong voltage is selected with this jumper. Please refer to the user guide that came with the monitor to select the correct voltage.

- Jumper Label:** JP4
- Jumper Type:** 3-pin header
- Jumper Settings:** See Table 4-4
- Jumper Location:** See Figure 4-3

Sets the voltage provided to the monitor by LVDS1.

Setting	Description
Short 1-2	+3.3V LVDS (Default)
Short 2-3	+5V LVDS

Table 4-4: LVDS1 Voltage Selection Jumper Settings

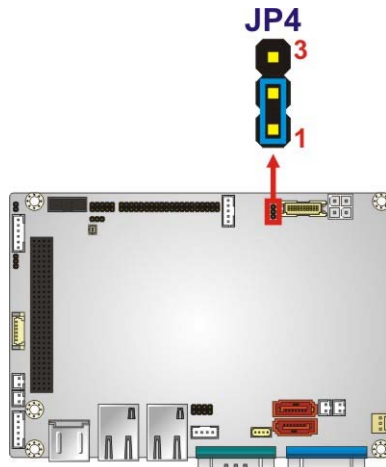

Figure 4-3: LVDS Voltage Selection Jumper Location

4.3.4 PCI-104 VIO Voltage Selection

- Jumper Label:** JP1
- Jumper Type:** 3-pin header
- Jumper Settings:** See Table 4-5
- Jumper Location:** See Figure 4-4

Sets the PCI-104 VIO voltage to +5V or +3.3V.

Setting	Description
Short 1-2	+5V
Short 2-3	+3.3V

Table 4-5: PCI-104 VIO Voltage Selection Jumper Settings

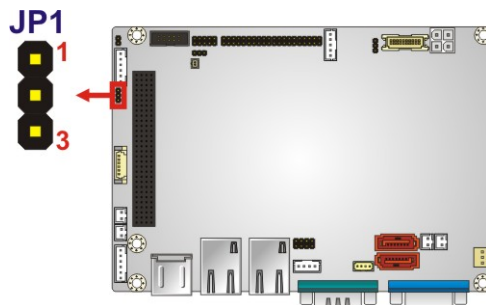

Figure 4-4: PCI-104 VIO Voltage Selection Jumper Location

4.4 Chassis Installation

4.4.1 Airflow



WARNING:

Airflow is critical to the cooling of the CPU and other on-board components. The chassis in which the WAFER-CV-D25502/N26002 must have air vents to allow cool air to move into the system and hot air to move out.

The WAFER-CV-D25502/N26002 must be installed in a chassis with ventilation holes on the sides allowing airflow to travel through the heat sink surface. In a system with an individual power supply unit, the cooling fan of a power supply can also help generate airflow through the board surface.



NOTE:

IEI has a wide range of chassis available. Please contact your WAFER-CV-D25502/N26002 vendor, reseller or an IEI sales representative at sales@iei.com.tw or visit the IEI website (<http://www.ieworld.com.tw>) to find out more about the available chassis.

4.4.2 Motherboard Installation

To install the WAFER-CV-D25502/N26002 motherboard into the chassis please refer to the reference material that came with the chassis.

4.5 Internal Peripheral Device Connections

This section outlines the installation of peripheral devices to the on-board connectors.

WAFER-CV-D25502/N26002 3.5" Motherboard

4.5.1 AT/ATX Power Connection

Follow the instructions below to connect the WAFER-CV-D25502/N26002 to an AT or ATX power supply.



WARNING:

Disconnect the power supply power cord from its AC power source to prevent a sudden power surge to the WAFER-CV-D25502/N26002.

Step 1: **Locate the power cable.** The power cable is shown in the packing list in Chapter 2.

Step 2: **Connect the power cable to the motherboard.** Connect the 4-pin (2x2) Molex type power cable connector to the power connector on the motherboard. See Figure 4-5.

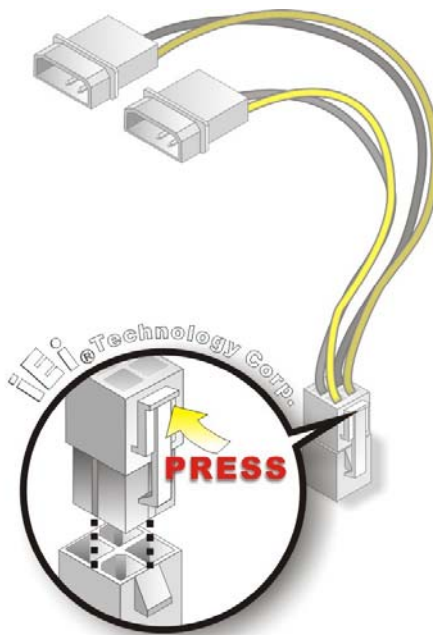

Figure 4-5: Power Cable to Motherboard Connection

Step 3: **Connect power cable to power supply.** Connect one of the 4-pin (1x4) Molex type power cable connectors to an AT/ATX power supply. See Figure 4-6.

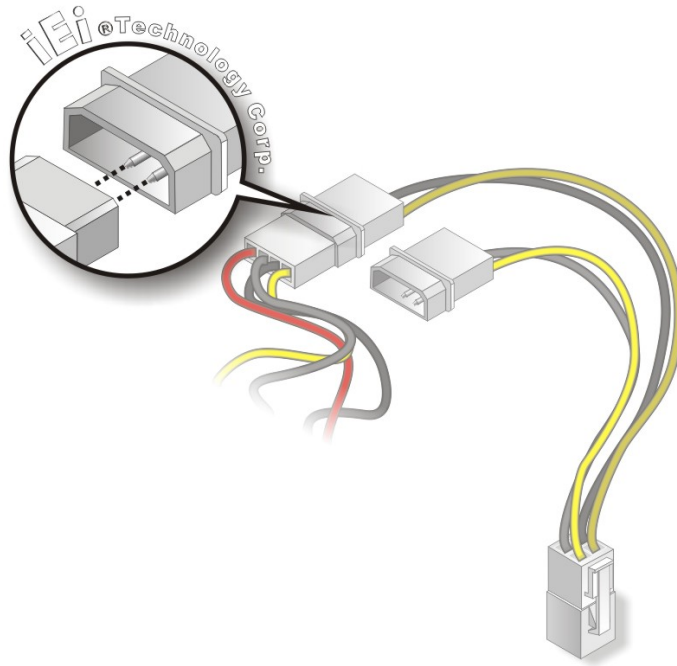

Figure 4-6: Connect Power Cable to Power Supply

4.5.2 Audio Kit Installation

The Audio Kit that came with the WAFER-CV-D25502/N26002 connects to the 10-pin audio connector on the WAFER-CV-D25502/N26002. The audio kit consists of three audio jacks. One audio jack, Mic In, connects to a microphone. The remaining two audio jacks, Line-In and Line-Out, connect to two speakers. To install the audio kit, please refer to the steps below:

Step 1: Locate the audio connector. The location of the 10-pin audio connector is shown in **Chapter 3**.

Step 2: Align pin 1. Align pin 1 on the on-board connector with pin 1 on the audio kit connector. Pin 1 on the audio kit connector is indicated with a white dot. See **Figure 4-7**.

WAFER-CV-D25502/N26002 3.5" Motherboard

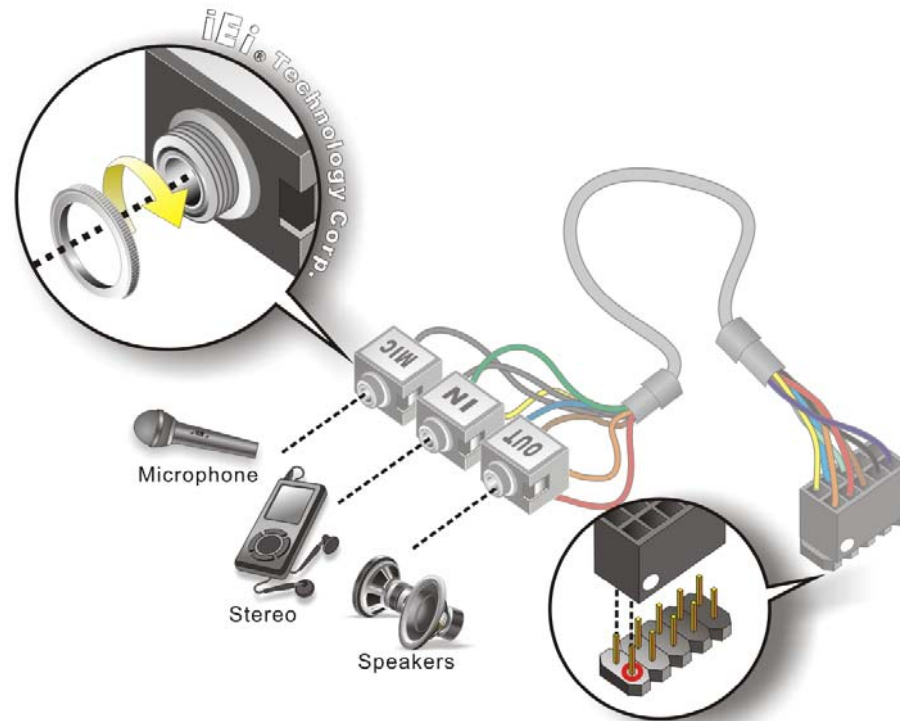

Figure 4-7: Audio Kit Cable Connection

Step 3: Connect the audio devices. Connect one speaker to the line-in audio jack, one speaker to the line-out audio jack and a microphone to the mic-in audio jack.

4.5.3 LVDS LCD Installation

The WAFER-CV-D25502/N26002 can be connected to a TFT LCD screen through the LVDS crimp connector on the board. To connect a TFT LCD to the WAFER-CV-D25502/N26002, please follow the steps below.

Step 1: Locate the connector. The location of the LVDS connector is shown in Chapter 3.

Step 2: Insert the cable connector. Insert the connector from the LVDS PCB driving board to the LVDS connector as shown in **Figure 4-8**. When connecting the connectors, make sure the pins are properly aligned.

**WARNING:**

The diagram below is merely for illustration. The configuration and connection of the cables from the TFT LCD screen being installed may be different. Please refer to the installation manual that came with the TFT LCD screen.

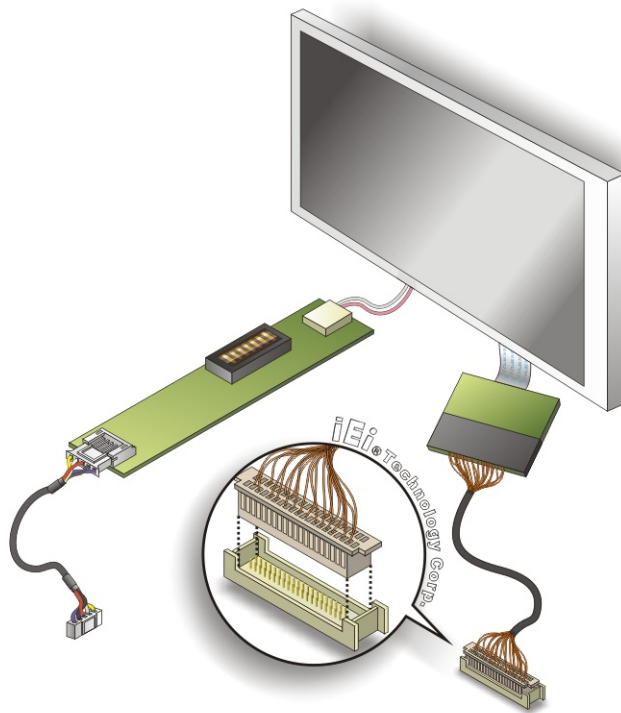

Figure 4-8: LVDS Connector

- Step 3:** **Locate the backlight inverter connector.** The location of the backlight inverter connector is shown in **Chapter 3**.
- Step 4:** **Connect backlight connector.** Connect the backlight connector to the driver TFT LCD PCB as shown in **Figure 4-9**. When inserting the cable connector, make sure the pins are properly aligned.

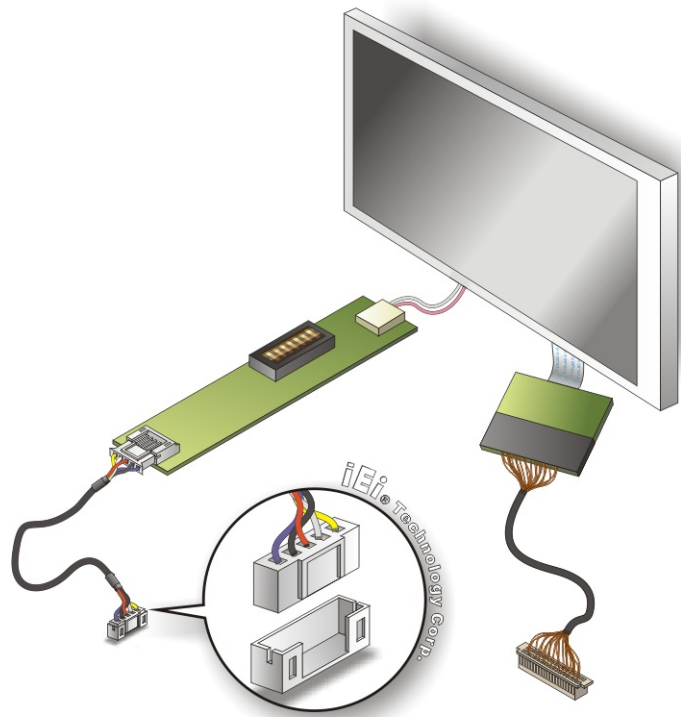

Figure 4-9: Backlight Inverter Connection

4.5.4 PCIe Mini Card Installation

To install a PCIe Mini card, please follow the steps below.

- Step 1:** Locate the PCIe Mini card slot. The location of the PCIe Mini card slot is shown in **Chapter 3**.
- Step 2:** Remove the retention screws. Remove the two retention screws secured on the motherboard as shown in **Figure 4-10**.

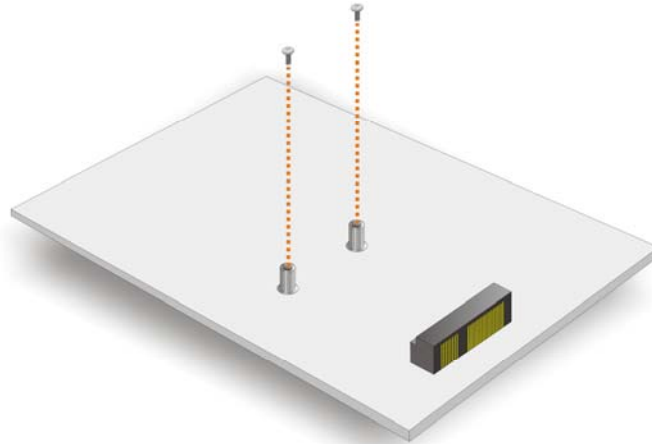

Figure 4-10: Remove the Retention Screws for the PCIe Mini Card

Step 3: **Insert into the socket at an angle.** Line up the notch on the card with the notch on the connector. Slide the PCIe Mini card into the socket at an angle of about 20° (Figure 4-11).

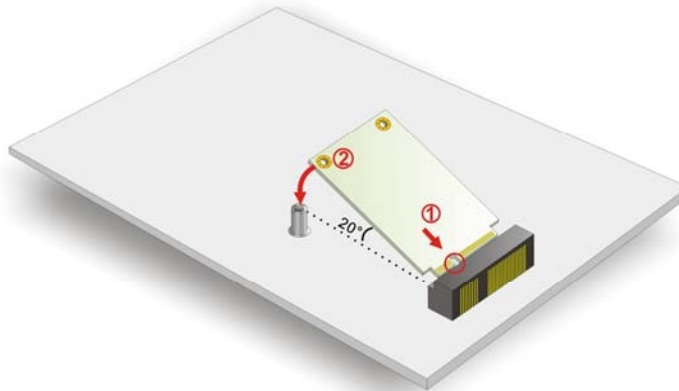

Figure 4-11: Insert the PCIe Mini Card into the Socket at an Angle

Step 4: **Secure the PCIe Mini card.** Secure the full-size PCIe Mini card with the retention screws previously removed (Figure 4-12).

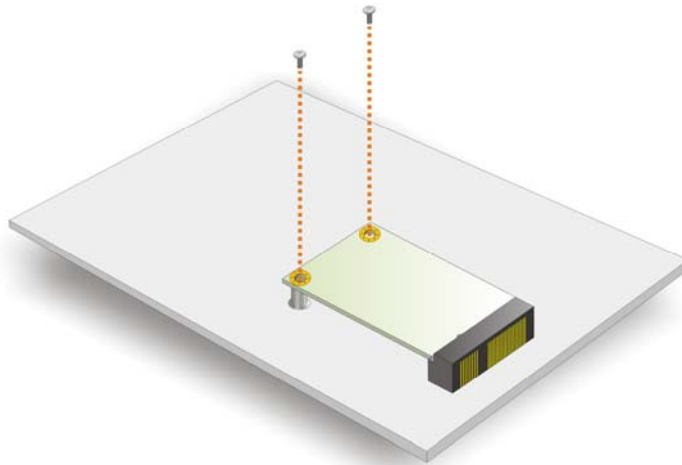

Figure 4-12: Secure the PCIe Mini Card

4.5.5 PCI-104 Expansion Card Installation

To install a PCI-104 expansion card, please refer to the diagram and instructions below.

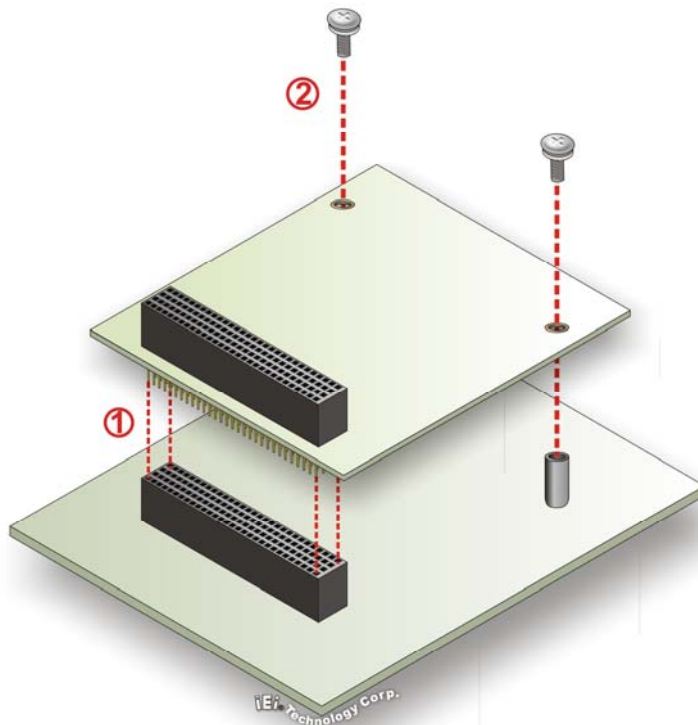

Figure 4-13: PCI-104 Expansion Card Installation

- Step 1:** **Align the connectors.** Make sure that the connectors are lined up correctly.
- Step 2:** **Push straight down until the card is properly seated.** Push the card straight downwards to connect. Use a firm pushing action to connect. When the card is connected properly, there will be no gaps between the motherboard connector and the card connector.
- Step 3:** **Secure the PCI-104 expansion card.** Secure the PCI-104 expansion card with two retention screws (**Figure 4-13**).

4.5.6 SATA Drive Connection

The WAFER-CV-D25502/N26002 is shipped with two SATA drive cables. To connect the SATA drive to the connector, please follow the steps below.

- Step 1:** **Locate the SATA connector and the SATA power connector.** The locations of the connectors are shown in **Chapter 3**.
- Step 2:** **Insert the cable connector.** Insert the cable connector into the on-board SATA drive connector and the SATA power connector. See **Figure 4-14**.

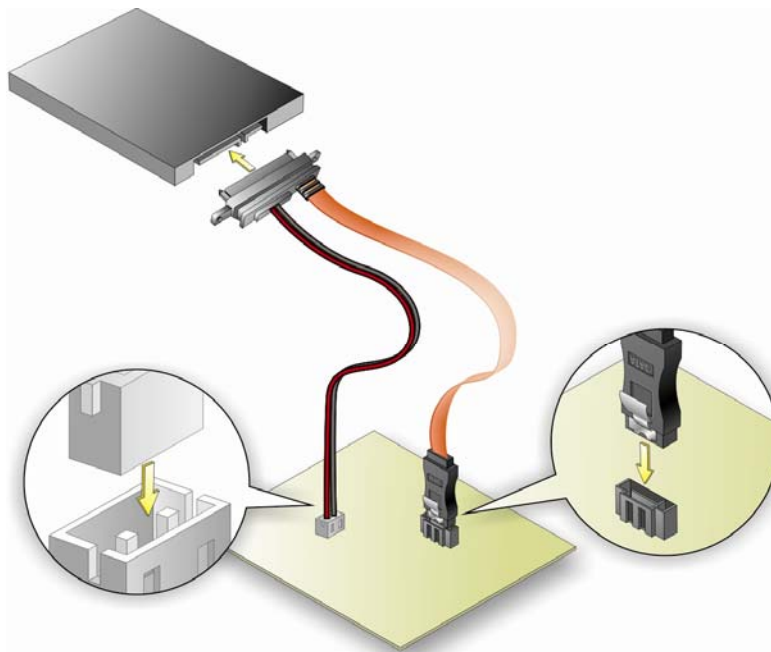

Figure 4-14: SATA Drive Cable Connection

WAFER-CV-D25502/N26002 3.5" Motherboard

Step 3: Connect the cable to the SATA disk. Connect the connector on the other end of the cable to the connector at the back of the SATA drive. See **Figure 4-14**.

Step 4: To remove the SATA cable from the SATA connector, press the clip on the connector at the end of the cable.

4.5.7 Single RS-232 Cable

The single RS-232 cable consists of one serial port connector attached to a serial communications cable that is then attached to a D-sub 9 male connector. To install the single RS-232 cable, please follow the steps below.

Step 1: Locate the connector. The locations of the RS-232 connectors are shown in **Chapter 3**.

Step 2: Insert the cable connector. Insert the connector into the serial port header. See **Figure 4-15**. A key on the front of the cable connector ensures the connector can only be installed in one direction.

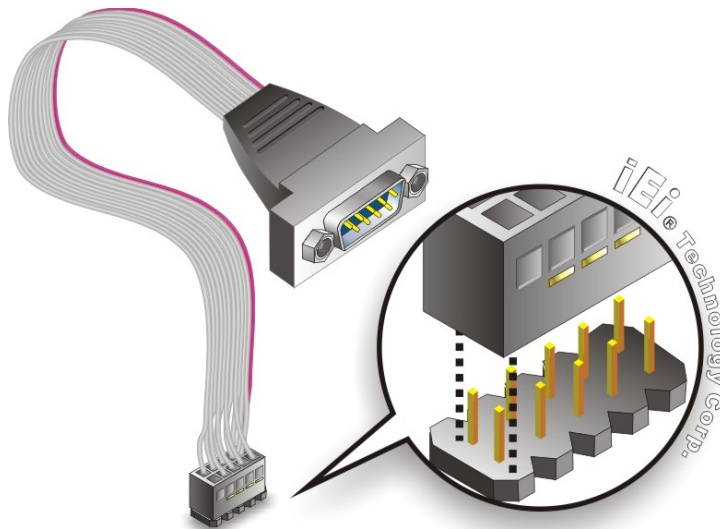

Figure 4-15: Single RS-232 Cable Installation

Step 3: Secure the bracket. The single RS-232 connector has two retention screws that must be secured to a chassis or bracket.

Step 4: Connect the serial device. Once the single RS-232 connector is connected to a chassis or bracket, a serial communications device can be connected to the system.

4.5.8 Keyboard/Mouse Y-cable Connector

The WAFER-CV-D25502/N26002 is shipped with a keyboard/mouse Y-cable connector. The keyboard/mouse Y-cable connector connects to a keyboard/mouse connector on the WAFER-CV-D25502/N26002 and branches into two cables that are each connected to a PS/2 connector, one for a mouse and one for a keyboard. To connect the keyboard/mouse Y-cable connector, please follow the steps below.

Step 1: Locate the connector. The location of the keyboard/mouse Y-cable connector is shown in **Chapter 3**.

Step 2: Align the connectors. Correctly align pin 1 on the cable connector with pin 1 on the WAFER-CV-D25502/N26002 keyboard/mouse connector. See **Figure 4-16**.

Step 3: Insert the cable connectors Once the cable connector is properly aligned with the keyboard/mouse connector on the WAFER-CV-D25502/N26002, connect the cable connector to the on-board connector. See **Figure 4-16**.

WAFER-CV-D25502/N26002 3.5" Motherboard

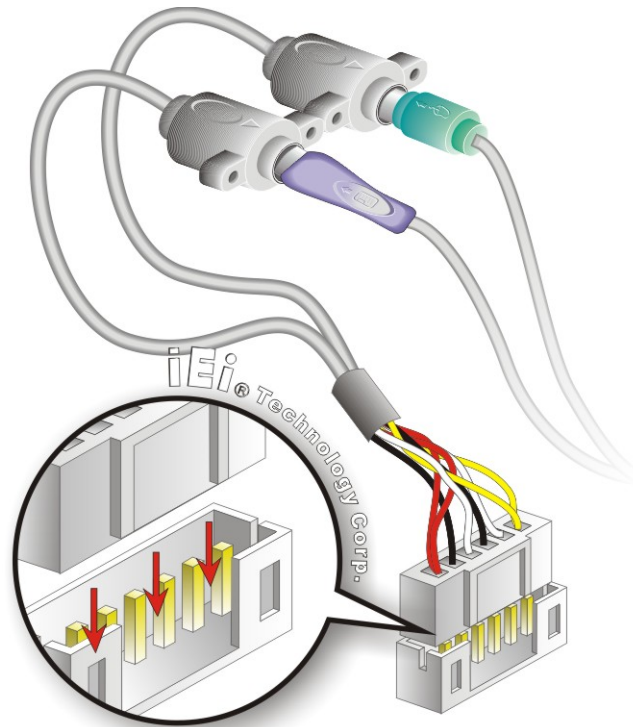

Figure 4-16: Keyboard/mouse Y-cable Connection

- Step 4:** **Attach PS/2 connectors to the chassis.** The keyboard/mouse Y-cable connector is connected to two PS/2 connectors. To secure the PS/2 connectors to the chassis please refer to the installation instructions that came with the chassis.
- Step 5:** **Connect the keyboard and mouse.** Once the PS/2 connectors are connected to the chassis, a keyboard and mouse can each be connected to one of the PS/2 connectors. The keyboard PS/2 connector and mouse PS/2 connector are both marked. Please make sure the keyboard and mouse are connected to the correct PS/2 connector.

4.6 External Peripheral Interface Connection

This section describes connecting devices to the external connectors on the WAFER-CV-D25502/N26002.

4.6.1 LAN Connection

The RJ-45 connector enables connection to an external network. To connect a LAN cable with an RJ-45 connector, please follow the instructions below.

Step 1: **Locate the RJ-45 connector.** The locations of the RJ-45 connectors are shown in **Chapter 3**.

Step 2: **Align the connectors.** Align the RJ-45 connector on the LAN cable with the RJ-45 connector on the WAFER-CV-D25502/N26002. See **Figure 4-17**.

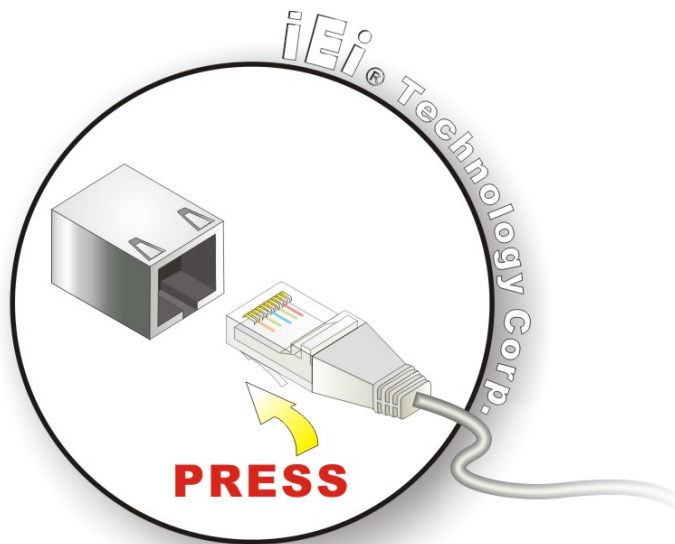

Figure 4-17: LAN Connection

Step 3: **Insert the LAN cable RJ-45 connector.** Once aligned, gently insert the LAN cable RJ-45 connector into the on-board RJ-45 connector.

WAFER-CV-D25502/N26002 3.5" Motherboard

4.6.2 Serial Device Connection

The WAFER-CV-D25502/N26002 has a single male DB-9 connector on the external peripheral interface panel for a serial device. Follow the steps below to connect a serial device to the WAFER-CV-D25502/N26002.

Step 1: Locate the DB-9 connector. The location of the DB-9 connector is shown in Chapter 3.

Step 2: Insert the serial connector. Insert the DB-9 connector of a serial device into the DB-9 connector on the external peripheral interface. See **Figure 4-18**.

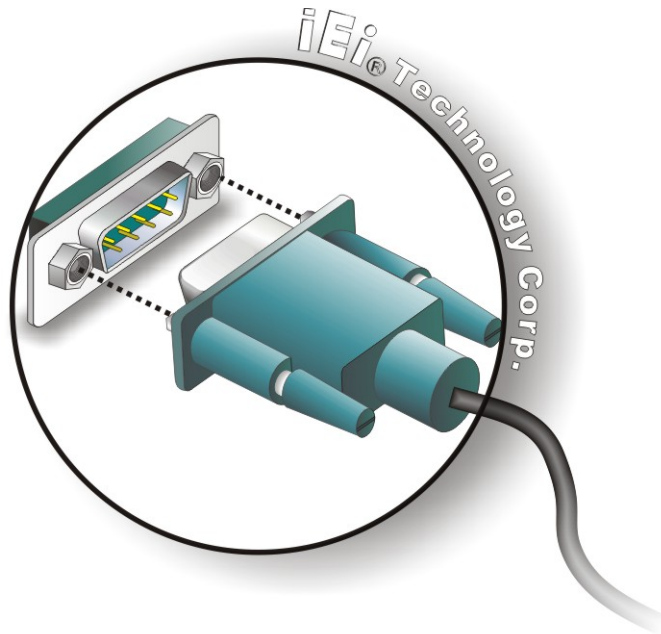

Figure 4-18: Serial Device Connector

Step 3: Secure the connector. Secure the serial device connector to the external interface by tightening the two retention screws on either side of the connector.

4.6.3 USB Connection (Dual Connector)

The external USB Series "A" receptacle connectors provide easier and quicker access to external USB devices. Follow the steps below to connect USB devices to the WAFER-CV-D25502/N26002.

Step 1: **Locate the USB Series "A" receptacle connectors.** The locations of the USB Series "A" receptacle connectors are shown in **Chapter 3**.

Step 2: **Insert a USB Series "A" plug.** Insert the USB Series "A" plug of a device into the USB Series "A" receptacle on the external peripheral interface. See **Figure 4-19**.

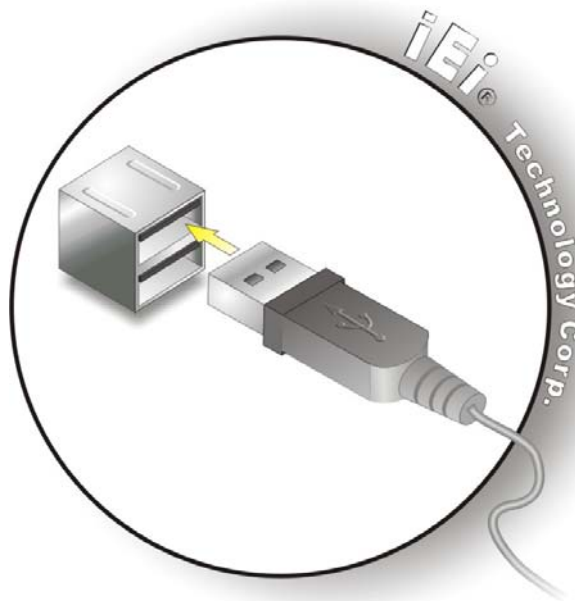

Figure 4-19: USB Connector

WAFER-CV-D25502/N26002 3.5" Motherboard

4.6.4 VGA Monitor Connection

The WAFER-CV-D25502/N26002 has a single female DB-15 connector on the external peripheral interface panel. The DB-15 connector is connected to a CRT or VGA monitor. To connect a monitor to the WAFER-CV-D25502/N26002, please follow the instructions below.

- Step 1:** **Locate the female DB-15 connector.** The location of the female DB-15 connector is shown in **Chapter 3**.
- Step 2:** **Align the VGA connector.** Align the male DB-15 connector on the VGA screen cable with the female DB-15 connector on the external peripheral interface.
- Step 3:** **Insert the VGA connector** Once the connectors are properly aligned with the insert the male connector from the VGA screen into the female connector on the WAFER-CV-D25502/N26002. See **Figure 4-20**.

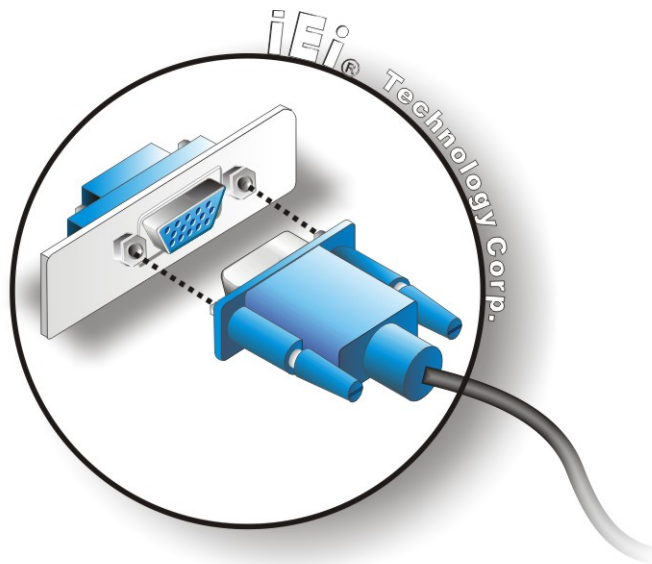

Figure 4-20: VGA Connector

- Step 4:** **Secure the connector.** Secure the DB-15 VGA connector from the VGA monitor to the external interface by tightening the two retention screws on either side of the connector.

Chapter

5

BIOS

5.1 Introduction

The BIOS is programmed onto the BIOS chip. The BIOS setup program allows changes to certain system settings. This chapter outlines the options that can be changed.

5.1.1 Starting Setup

The UEFI BIOS is activated when the computer is turned on. The setup program can be activated in one of two ways.

1. Press the **DEL** or **F2** key as soon as the system is turned on or
2. Press the **DEL** or **F2** key when the “**Press DEL or F2 to enter SETUP**” message appears on the screen.

If the message disappears before the **DEL** or **F2** key is pressed, restart the computer and try again.

5.1.2 Using Setup

Use the arrow keys to highlight items, press **ENTER** to select, use the PageUp and PageDown keys to change entries, press **F1** for help and press **ESC** to quit. Navigation keys are shown in the following table.

Key	Function
Up arrow	Move to previous item
Down arrow	Move to next item
Left arrow	Move to the item on the left hand side
Right arrow	Move to the item on the right hand side
+	Increase the numeric value or make changes
-	Decrease the numeric value or make changes
Page Up key	Move to the next page
Page Dn key	Move to the previous page

Key	Function
Esc key	Main Menu – Quit and not save changes into CMOS Status Page Setup Menu and Option Page Setup Menu -- Exit current page and return to Main Menu
F1	General help, only for Status Page Setup Menu and Option Page Setup Menu
F2	Load previous values
F3	Load optimized defaults
F4	Save changes and Exit BIOS

Table 5-1: BIOS Navigation Keys

5.1.3 Getting Help

When **F1** is pressed a small help window describing the appropriate keys to use and the possible selections for the highlighted item appears. To exit the Help Window press **Esc** or the **F1** key again.

5.1.4 Unable to Reboot after Configuration Changes

If the computer cannot boot after changes to the system configuration are made, CMOS defaults. Use the jumper described in Chapter 4.

5.1.5 BIOS Menu Bar

The **menu bar** on top of the BIOS screen has the following main items:

- Main – Changes the basic system configuration.
- Advanced – Changes the advanced system settings.
- Chipset – Changes the chipset settings.
- Boot – Changes the system boot configuration.
- Security – Sets User and Supervisor Passwords.
- Save & Exit – Selects exit options and loads default settings

The following sections completely describe the configuration options found in the menu items at the top of the BIOS screen and listed above.

WAFER-CV-D25502/N26002 3.5" Motherboard

5.2 Main

The **Main** BIOS menu (**BIOS Menu 1**) appears when the **BIOS Setup** program is entered. The **Main** menu gives an overview of the basic system information.

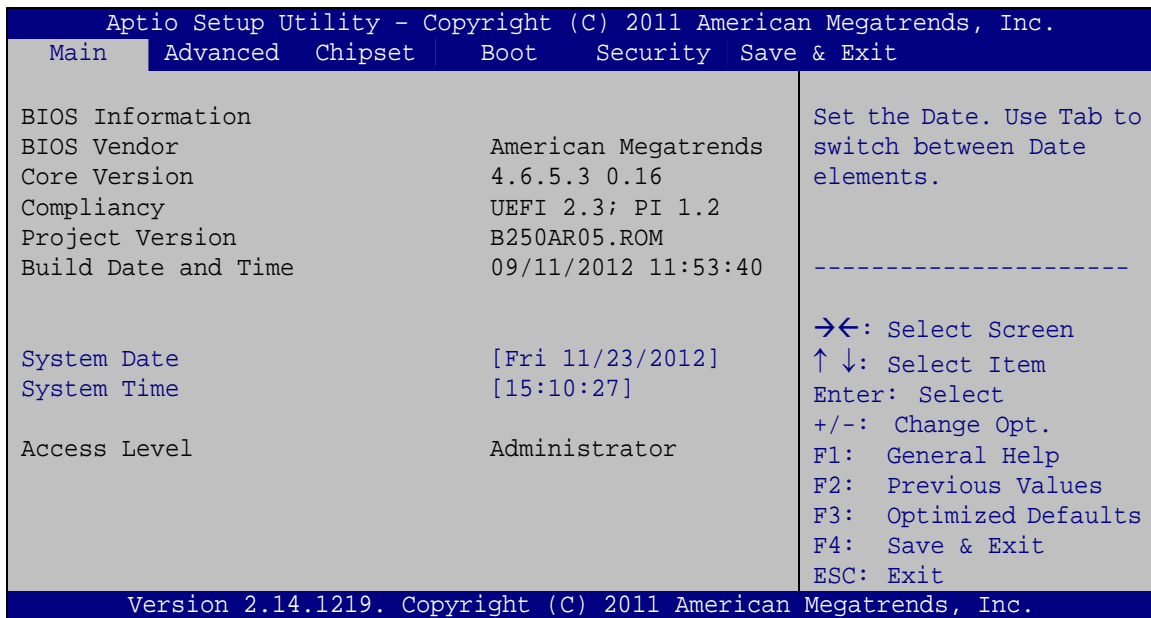

BIOS Menu 1: Main

→ System Overview

The **BIOS Information** lists a brief summary of the BIOS. The fields in **BIOS Information** cannot be changed. The items shown in the system overview include:

- **BIOS Vendor:** Installed BIOS vendor
- **Core Version:** Current BIOS version
- **Project Version:** the board version
- **Build Date and Time:** Date and time the current BIOS version was made

The System Overview field also has two user configurable fields:

→ System Date [xx/xx/xx]

Use the **System Date** option to set the system date. Manually enter the day, month and year.

→ **System Time [xx:xx:xx]**

Use the **System Time** option to set the system time. Manually enter the hours, minutes and seconds.

5.3 Advanced

Use the **Advanced** menu (**BIOS Menu 2**) to configure the CPU and peripheral devices through the sub-menus.



WARNING:

Setting the wrong values in the sections below may cause the system to malfunction. Make sure that the settings made are compatible with the hardware.

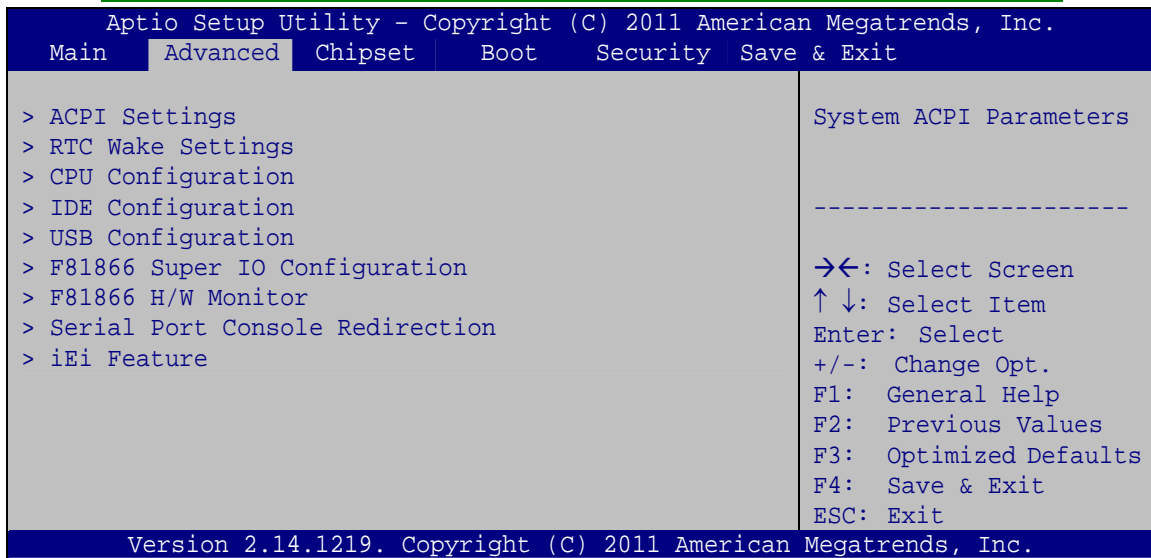

BIOS Menu 2: Advanced

5.3.1 ACPI Settings

The **ACPI Settings** menu (**BIOS Menu 3**) configures the Advanced Configuration and Power Interface (ACPI) options.

WAFER-CV-D25502/N26002 3.5" Motherboard

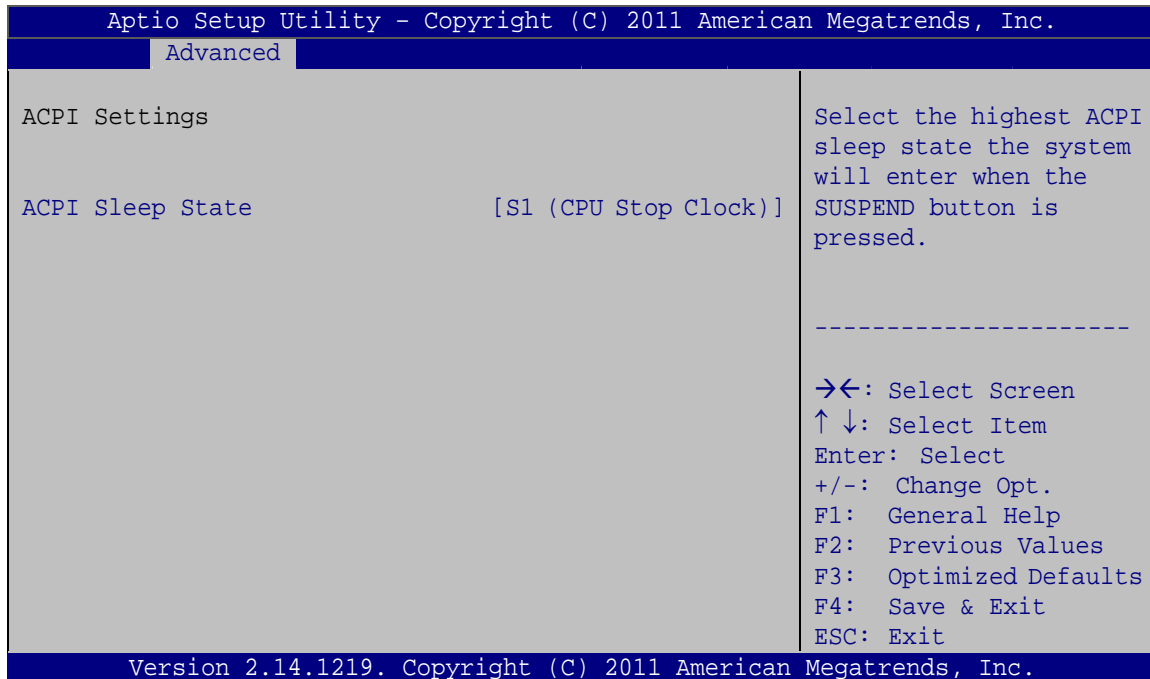

BIOS Menu 3: ACPI Settings

→ ACPI Sleep State [S1 (CPU Stop Clock)]

Use the **ACPI Sleep State** option to specify the sleep state the system enters when it is not being used.

- **S1 (CPU Stop Clock)** **DEFAULT** The system enters S1 (POS) sleep state. The system appears off. The CPU is stopped; RAM is refreshed; the system is running in a low power mode.
- **S3 (Suspend to RAM)** The caches are flushed and the CPU is powered off. Power to the RAM is maintained. The computer returns slower to a working state, but more power is saved.

5.3.2 RTC Wake Settings

The **RTC Wake Settings** menu (**BIOS Menu 4**) enables the system to wake at the specified time.

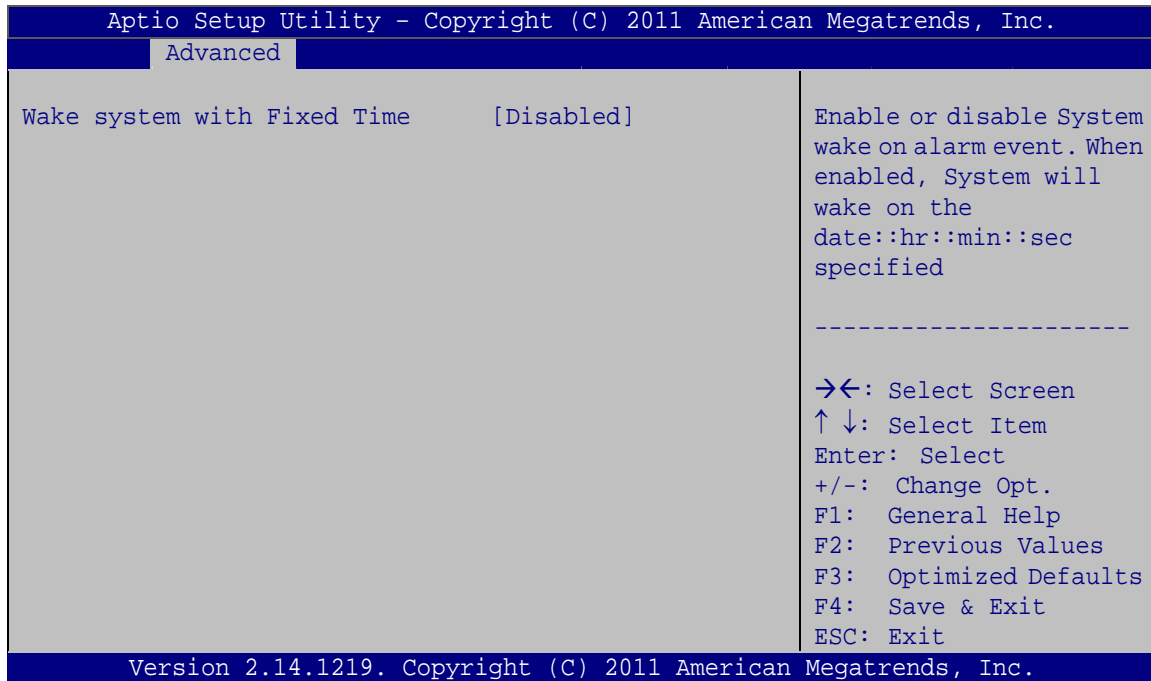
BIOS Menu 4: RTC Wake Settings
→ Wake system with Fixed Time [Disabled]

Use the **Wake system with Fixed Time** option to enable or disable the system wake on alarm event.

→ **Disabled** **DEFAULT** The real time clock (RTC) cannot generate a wake event

→ **Enabled** If selected, the **Wake up every day** option appears allowing you to enable to disable the system to wake every day at the specified time. Besides, the following options appear with values that can be selected:

Wake up date

Wake up hour

Wake up minute

Wake up second

After setting the alarm, the computer turns itself on from a suspend state when the alarm goes off.

WAFER-CV-D25502/N26002 3.5" Motherboard

5.3.3 CPU Configuration

Use the **CPU Configuration** menu (**BIOS Menu 5**) to view detailed CPU specifications and configure the CPU.

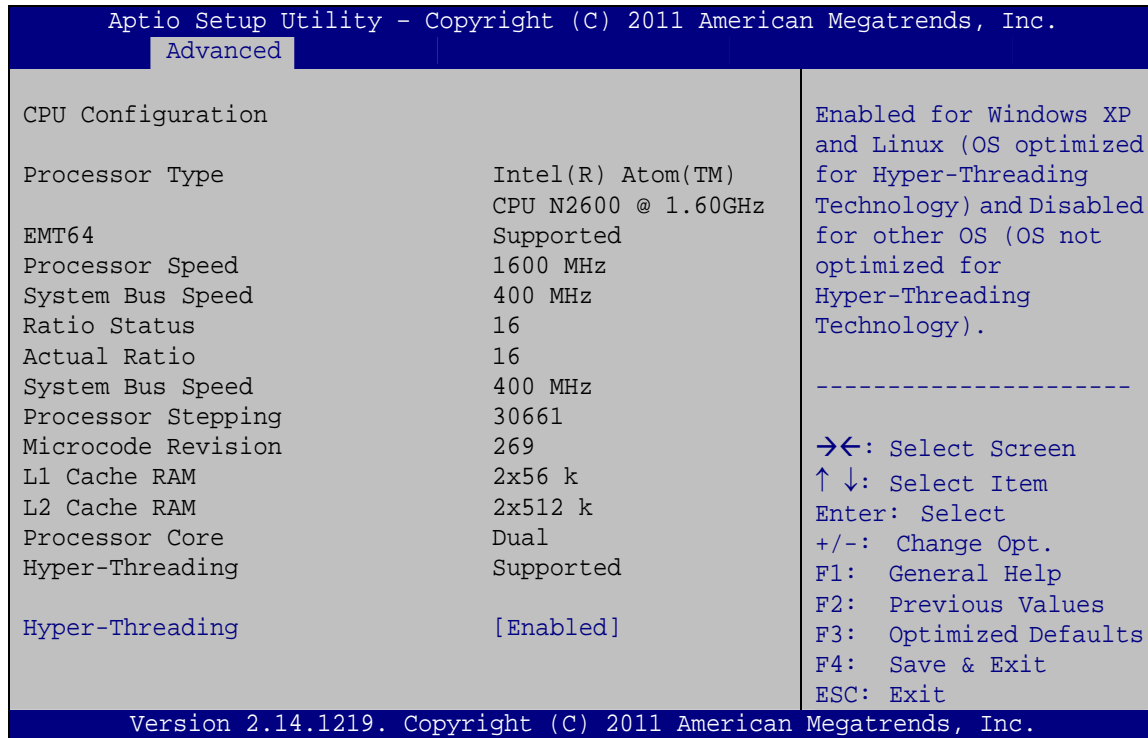

BIOS Menu 5: CPU Configuration

The CPU Configuration menu (**BIOS Menu 5**) lists the following CPU details:

- **Processor Type:** Lists the brand name of the CPU being used.
- **EMT64:** Indicates if EMT64 is supported by the CPU.
- **Processor Speed:** Lists the CPU processing speed.
- **System Bus Speed:** Lists the system bus speed.
- **Ratio Status:** Lists the ratio status.
- **Actual Ratio:** Lists the ratio of the frequency to the clock speed.
- **Processor Stepping:** Lists the CPU ID.
- **Microcode Revision:** Lists the microcode revision.
- **L1 Cache RAM:** Lists the CPU L1 cache size.
- **L2 Cache RAM:** Lists the CPU L2 cache size.
- **Processor Core:** Lists the number of the processor core.
- **Hyper-Threading:** Indicates if Intel HT Technology is supported by the CPU.

➔ **Hyper-Threading [Enabled]**

Use the **Hyper-Threading** BIOS option to enable or disable the Intel Hyper-Threading Technology.

- ➔ **Disabled** Disables the Intel Hyper-Threading Technology.
- ➔ **Enabled** **DEFAULT** Enables the Intel Hyper-Threading Technology.

5.3.4 IDE Configuration

Use the **IDE Configuration** menu (**BIOS Menu 6**) to change and/or set the configuration of the SATA devices installed in the system.

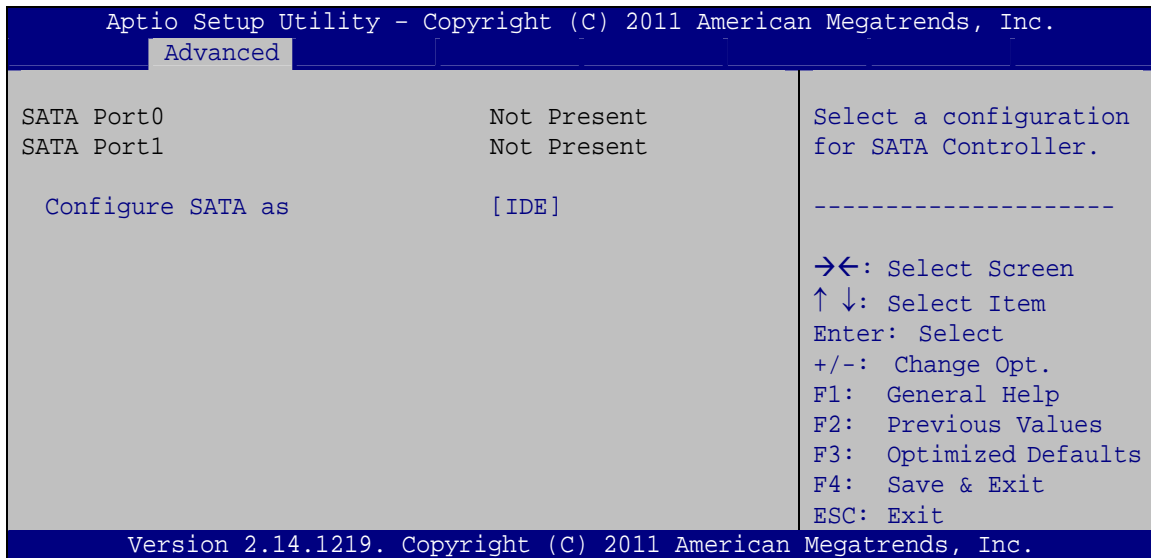

BIOS Menu 6: IDE Configuration

➔ **Configure SATA as [IDE]**

Use the **Configure SATA as** option to configure SATA devices as normal IDE or AHCI devices.

- ➔ **IDE** **DEFAULT** Configures SATA devices as normal IDE device.
- ➔ **AHCI** Configures SATA devices as AHCI device.

WAFER-CV-D25502/N26002 3.5" Motherboard

5.3.5 USB Configuration

Use the **USB Configuration** menu (**BIOS Menu 7**) to read USB configuration information and configure the USB settings.

```

Aptio Setup Utility - Copyright (C) 2011 American Megatrends, Inc.
  Advanced
-----
USB Configuration
USB Devices:
  None
Legacy USB Support          [Enabled]
-----
                                Enables Legacy USB
                                support. AUTO option
                                disables legacy support
                                if no USB devices are
                                connected. DISABLE
                                option will keep USB
                                devices available only
                                for EFI applications.
-----
                                -----
                                →←: Select Screen
                                ↑↓: Select Item
                                Enter: Select
                                +/-: Change Opt.
                                F1:  General Help
                                F2:  Previous Values
                                F3:  Optimized Defaults
                                F4:  Save & Exit
                                ESC: Exit
-----
Version 2.14.1219. Copyright (C) 2011 American Megatrends, Inc.

```

BIOS Menu 7: USB Configuration

→ Legacy USB Support [Enabled]

Use the **Legacy USB Support** BIOS option to enable USB mouse and USB keyboard support.

Normally if this option is not enabled, any attached USB mouse or USB keyboard does not become available until a USB compatible operating system is fully booted with all USB drivers loaded. When this option is enabled, any attached USB mouse or USB keyboard can control the system even when there is no USB driver loaded onto the system.

- **Disabled** Legacy USB support disabled
- **Enabled** **DEFAULT** Legacy USB support enabled
- **Auto** Legacy USB support disabled if no USB devices are connected

5.3.6 F81866 Super IO Configuration

Use the **F81866 Super IO Configuration** menu (**BIOS Menu 8**) to set or change the configurations for the serial ports.

```

Aptio Setup Utility - Copyright (C) 2011 American Megatrends, Inc.
  Advanced
F81866 Super IO Configuration                               Set Parameters of Serial
                                                           Port 1 (COMA)
F81866 Super IO Chip                                     F81866
> Serial Port 1 Configuration
> Serial Port 2 Configuration
> Serial Port 3 Configuration
> Serial Port 4 Configuration
> Serial Port 5 Configuration
> Serial Port 6 Configuration
                                                           -----
                                                           →←: Select Screen
                                                           ↑ ↓: Select Item
                                                           Enter: Select
                                                           +/-: Change Opt.
                                                           F1: General Help
                                                           F2: Previous Values
                                                           F3: Optimized Defaults
                                                           F4: Save & Exit
                                                           ESC: Exit
Version 2.14.1219. Copyright (C) 2011 American Megatrends, Inc.
  
```

BIOS Menu 8: F81866 Super IO Configuration

5.3.6.1 Serial Port n Configuration

Use the **Serial Port n Configuration** menu (**BIOS Menu 9**) to configure the serial port n.

```

Aptio Setup Utility - Copyright (C) 2011 American Megatrends, Inc.
  Advanced
Serial Port n Configuration                               Enable or Disable Serial
                                                           Port (COM)
Serial Port                                             [Enabled]
Device Settings                                         IO=3F8h; IRQ=4
Change Settings                                         [Auto]
                                                           -----
                                                           →←: Select Screen
                                                           ↑ ↓: Select Item
                                                           Enter: Select
                                                           +/-: Change Opt.
                                                           F1: General Help
                                                           F2: Previous Values
                                                           F3: Optimized Defaults
                                                           F4: Save & Exit
                                                           ESC: Exit
Version 2.14.1219. Copyright (C) 2011 American Megatrends, Inc.
  
```

BIOS Menu 9: Serial Port n Configuration Menu

WAFER-CV-D25502/N26002 3.5" Motherboard

5.3.6.1.1 Serial Port 1 Configuration

→ Serial Port [Enabled]

Use the **Serial Port** option to enable or disable the serial port.

- **Disabled** Disable the serial port
- **Enabled** **DEFAULT** Enable the serial port

→ Change Settings [Auto]

Use the **Change Settings** option to change the serial port IO port address and interrupt address.

- **Auto** **DEFAULT** The serial port IO port address and interrupt address are automatically detected.
- **IO=3F8h;**
IRQ=4 Serial Port I/O port address is 3F8h and the interrupt address is IRQ4.
- **IO=3F8h;**
IRQ=3, 4 Serial Port I/O port address is 3F8h and the interrupt address is IRQ3, 4
- **IO=2F8h;**
IRQ=3, 4 Serial Port I/O port address is 2F8h and the interrupt address is IRQ3, 4
- **IO=3E8h;**
IRQ=3, 4 Serial Port I/O port address is 3E8h and the interrupt address is IRQ3, 4
- **IO=2E8h;**
IRQ=3, 4 Serial Port I/O port address is 2E8h and the interrupt address is IRQ3, 4

5.3.6.1.2 Serial Port 2 Configuration

→ Serial Port [Enabled]

Use the **Serial Port** option to enable or disable the serial port.

- **Disabled** Disable the serial port
- **Enabled** **DEFAULT** Enable the serial port

→ Change Settings [Auto]

Use the **Change Settings** option to change the serial port IO port address and interrupt address.

- Auto** **DEFAULT** The serial port IO port address and interrupt address are automatically detected.
- IO=2F8h;**
IRQ=3 Serial Port I/O port address is 2F8h and the interrupt address is IRQ3
- IO=3F8h;**
IRQ=3, 4 Serial Port I/O port address is 3F8h and the interrupt address is IRQ3, 4
- IO=2F8h;**
IRQ=3, 4 Serial Port I/O port address is 2F8h and the interrupt address is IRQ3, 4
- IO=3E8h;**
IRQ=3, 4 Serial Port I/O port address is 3E8h and the interrupt address is IRQ3, 4
- IO=2E8h;**
IRQ=3, 4 Serial Port I/O port address is 2E8h and the interrupt address is IRQ3, 4

5.3.6.1.3 Serial Port 3 Configuration
→ Serial Port [Enabled]

Use the **Serial Port** option to enable or disable the serial port.

- Disabled** Disable the serial port
- Enabled** **DEFAULT** Enable the serial port

→ Change Settings [Auto]

Use the **Change Settings** option to change the serial port IO port address and interrupt address.

- Auto** **DEFAULT** The serial port IO port address and interrupt address are automatically detected.

WAFER-CV-D25502/N26002 3.5" Motherboard

- **IO=3E8h;**
IRQ=10 Serial Port I/O port address is 3E8h and the interrupt address is IRQ10
- **IO=3F8h;**
IRQ=10, 11 Serial Port I/O port address is 3F8h and the interrupt address is IRQ10, 11
- **IO=2F8h;**
IRQ=10, 11 Serial Port I/O port address is 2F8h and the interrupt address is IRQ10, 11
- **IO=3E8h;**
IRQ=10, 11 Serial Port I/O port address is 3E8h and the interrupt address is IRQ10, 11
- **IO=2E8h;**
IRQ=10, 11 Serial Port I/O port address is 2E8h and the interrupt address is IRQ10, 11
- **IO=250h;**
IRQ=10, 11 Serial Port I/O port address is 250h and the interrupt address is IRQ10, 11
- **IO=2E0h;**
IRQ=10, 11 Serial Port I/O port address is 2E0h and the interrupt address is IRQ10, 11

5.3.6.1.4 Serial Port 4 Configuration

→ Serial Port [Enabled]

Use the **Serial Port** option to enable or disable the serial port.

- **Disabled** Disable the serial port
- **Enabled** **DEFAULT** Enable the serial port

→ Change Settings [Auto]

Use the **Change Settings** option to change the serial port IO port address and interrupt address.

- **Auto** **DEFAULT** The serial port IO port address and interrupt address are automatically detected.
- **IO=2E8h;**
IRQ=10 Serial Port I/O port address is 2E8h and the interrupt address is IRQ10

- **IO=3F8h;**
IRQ=10, 11 Serial Port I/O port address is 3F8h and the interrupt address is IRQ10, 11
- **IO=2F8h;**
IRQ=10, 11 Serial Port I/O port address is 2F8h and the interrupt address is IRQ10, 11
- **IO=3E8h;**
IRQ=10, 11 Serial Port I/O port address is 3E8h and the interrupt address is IRQ10, 11
- **IO=2E8h;**
IRQ=10, 11 Serial Port I/O port address is 2E8h and the interrupt address is IRQ10, 11
- **IO=250h;**
IRQ=10, 11 Serial Port I/O port address is 250h and the interrupt address is IRQ10, 11
- **IO=2E0h;**
IRQ=10, 11 Serial Port I/O port address is 2E0h and the interrupt address is IRQ10, 11

5.3.6.1.5 Serial Port 5 Configuration

→ **Serial Port [Enabled]**

Use the **Serial Port** option to enable or disable the serial port.

- **Disabled** Disable the serial port
- **Enabled DEFAULT** Enable the serial port

→ **Change Settings [Auto]**

Use the **Change Settings** option to change the serial port IO port address and interrupt address.

- **Auto DEFAULT** The serial port IO port address and interrupt address are automatically detected.
- **IO=250h;**
IRQ=10 Serial Port I/O port address is 250h and the interrupt address is IRQ10
- **IO=3F8h;**
IRQ=10, 11 Serial Port I/O port address is 3F8h and the interrupt address is IRQ10, 11

WAFER-CV-D25502/N26002 3.5" Motherboard

- **IO=2F8h;**
IRQ=10, 11 Serial Port I/O port address is 2F8h and the interrupt address is IRQ10, 11
- **IO=3E8h;**
IRQ=10, 11 Serial Port I/O port address is 3E8h and the interrupt address is IRQ10, 11
- **IO=2E8h;**
IRQ=10, 11 Serial Port I/O port address is 2E8h and the interrupt address is IRQ10, 11
- **IO=250h;**
IRQ=10, 11 Serial Port I/O port address is 250h and the interrupt address is IRQ10, 11
- **IO=2E0h;**
IRQ=10, 11 Serial Port I/O port address is 2E0h and the interrupt address is IRQ10, 11

5.3.6.1.6 Serial Port 6 Configuration

→ Serial Port [Enabled]

Use the **Serial Port** option to enable or disable the serial port.

- **Disabled** Disable the serial port
- **Enabled DEFAULT** Enable the serial port

→ Change Settings [Auto]

Use the **Change Settings** option to change the serial port IO port address and interrupt address.

- **Auto DEFAULT** The serial port IO port address and interrupt address are automatically detected.
- **IO=2E8h;**
IRQ=10 Serial Port I/O port address is 2E8h and the interrupt address is IRQ10
- **IO=3F8h;**
IRQ=10, 11 Serial Port I/O port address is 3F8h and the interrupt address is IRQ10, 11
- **IO=2F8h;**
IRQ=10, 11 Serial Port I/O port address is 2F8h and the interrupt address is IRQ10, 11

- ➔ **IO=3E8h;** Serial Port I/O port address is 3E8h and the interrupt address is IRQ10, 11
IRQ=10, 11
- ➔ **IO=2E8h;** Serial Port I/O port address is 2E8h and the interrupt address is IRQ10, 11
IRQ=10, 11
- ➔ **IO=250h;** Serial Port I/O port address is 250h and the interrupt address is IRQ10, 11
IRQ=10, 11
- ➔ **IO=2E0h;** Serial Port I/O port address is 2E0h and the interrupt address is IRQ10, 11
IRQ=10, 11

5.3.7 F81866 H/W Monitor

The **F81866 H/W Monitor** menu (**BIOS Menu 10**) contains the fan configuration submenus and displays operating temperature, fan speeds and system voltages.

```

Aptio Setup Utility - Copyright (C) 2011 American Megatrends, Inc.
  Advanced
PC Health Status
> Smart Fan Mode Configuration
System Temperature      : +48 C
CPU_FAN1 Speed         : N/A
+VCC_CPU                : +0.992 V
+VCC_GFX                : +0.896 V
+V1.05S                 : +1.064 V
+1.5_DDR3               : +1.536 V
VSB5V                   : +5.112 V
+V3.3S                  : +3.360 V
VSB3V                   : +3.360 V
VBAT                    : +3.248 V

Smart Fan Mode Select
-----
-><: Select Screen
↑↓: Select Item
Enter: Select
+/-: Change Opt.
F1: General Help
F2: Previous Values
F3: Optimized Defaults
F4: Save & Exit
ESC: Exit

Version 2.14.1219. Copyright (C) 2011 American Megatrends, Inc.
  
```

BIOS Menu 10: F81866 H/W Monitor

➔ PC Health Status

The following system parameters and values are shown. The system parameters that are monitored are:

WAFER-CV-D25502/N26002 3.5" Motherboard

- System Temperatures:
 - System Temperature
- Fan Speeds:
 - CPU Fan Speed
- Voltages:
 - +VCC_CPU
 - +VCC_GFX
 - +V1.05S
 - +1.5_DDR3
 - VSB5V
 - +V3.3S
 - VSB3V
 - VBAT

5.3.7.1 Smart Fan Mode Configuration

Use the **Smart Fan Mode Configuration** submenu (**BIOS Menu 11**) to configure fan temperature and speed settings.

```

Aptio Setup Utility - Copyright (C) 2011 American Megatrends, Inc.
-----
Advanced
-----
Smart Fan Mode Configuration
CPU_FAN1 Smart Fan Control      [Auto Duty-Cycle Mode]
CPU Temperature 1                60
CPU Temperature 2                50
CPU Temperature 3                40
CPU Temperature 4                30

Smart Fan Mode Select
-----
-><: Select Screen
↑↓: Select Item
Enter: Select
+/-: Change Opt.
F1: General Help
F2: Previous Values
F3: Optimized Defaults
F4: Save & Exit
ESC: Exit

Version 2.14.1219. Copyright (C) 2011 American Megatrends, Inc.
  
```

BIOS Menu 11: Smart Fan Mode Configuration

→ CPU_FAN1 Smart Fan Control [Auto Duty-Cycle Mode]

Use the **CPU_FAN1 Smart Fan Control** option to configure the CPU Smart Fan.

- **Auto Duty-Cycle Mode** **DEFAULT** The fan adjusts its speed using Auto Duty-Cycle settings
- **Manual Duty Mode** The fan spins at the speed set in Manual Duty Mode settings

→ **CPU Temperature n**

Use the + or – key to change the fan **CPU Temperature n** value. Enter a decimal number between 1 and 100.

5.3.8 Serial Port Console Redirection

The **Serial Port Console Redirection** menu (**BIOS Menu 12**) allows the console redirection options to be configured. Console redirection allows users to maintain a system remotely by re-directing keyboard input and text output through the serial port.

WAFER-CV-D25502/N26002 3.5" Motherboard

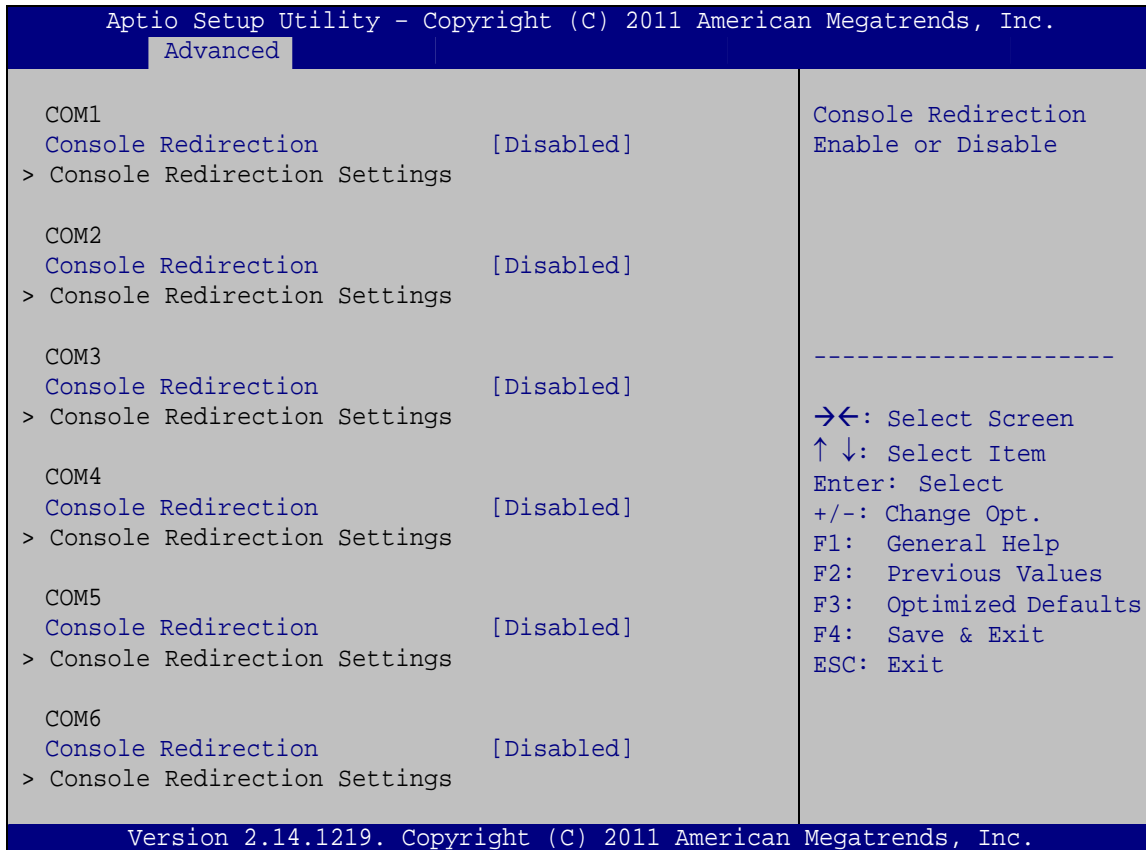

BIOS Menu 12: Serial Port Console Redirection

→ Console Redirection [Disabled]

Use **Console Redirection** option to enable or disable the console redirection function.

- **Disabled** **DEFAULT** Disabled the console redirection function
- **Enabled** Enabled the console redirection function

→ Terminal Type [ANSI]

Use the **Terminal Type** option to specify the remote terminal type.

- **VT100** The target terminal type is VT100
- **VT100+** The target terminal type is VT100+
- **VT-UTF8** The target terminal type is VT-UTF8
- **ANSI** **DEFAULT** The target terminal type is ANSI

→ Bits per second [115200]

Use the **Bits per second** option to specify the serial port transmission speed. The speed must match the other side. Long or noisy lines may require lower speeds.

- 9600** Sets the serial port transmission speed at 9600.
- 19200** Sets the serial port transmission speed at 19200.
- 38400** Sets the serial port transmission speed at 38400.
- 57600** Sets the serial port transmission speed at 57600.
- 115200** **DEFAULT** Sets the serial port transmission speed at 115200.

→ Data Bits [8]

Use the **Data Bits** option to specify the number of data bits.

- 7** Sets the data bits at 7.
- 8** **DEFAULT** Sets the data bits at 8.

→ Parity [None]

Use the **Parity** option to specify the parity bit that can be sent with the data bits for detecting the transmission errors.

- None** **DEFAULT** No parity bit is sent with the data bits.
- Even** The parity bit is 0 if the number of ones in the data bits is even.
- Odd** The parity bit is 0 if the number of ones in the data bits is odd.
- Mark** The parity bit is always 1. This option does not provide error detection.
- Space** The parity bit is always 0. This option does not provide error detection.

WAFER-CV-D25502/N26002 3.5" Motherboard

→ Stop Bits [1]

Use the **Stop Bits** option to specify the number of stop bits used to indicate the end of a serial data packet. Communication with slow devices may require more than 1 stop bit.

- 1 **DEFAULT** Sets the number of stop bits at 1.
- 2 Sets the number of stop bits at 2.

5.3.9 iEi Feature

Use the **iEi Feature** menu (**BIOS Menu 13**) to configure One Key Recovery function.

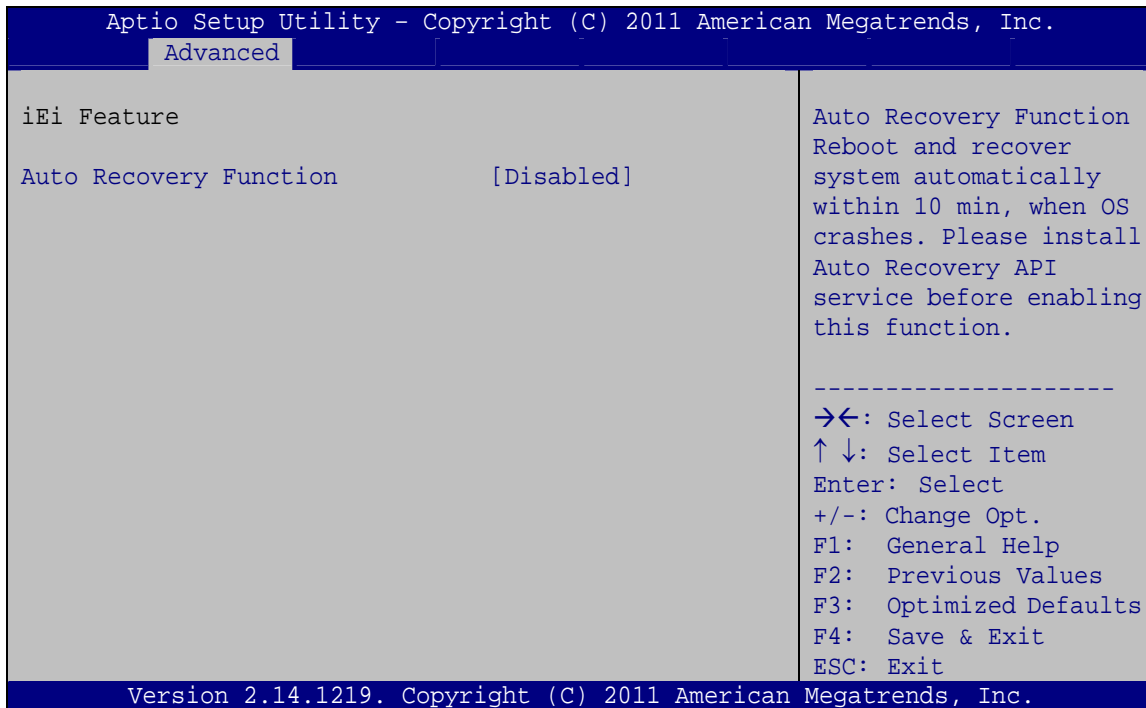

BIOS Menu 13: IEI Feature

→ Auto Recovery Function [Disabled]

Use the **Auto Recovery Function** BIOS option to enable or disable the auto recovery function of the IEI One Key Recovery.

- **Disabled** **DEFAULT** Auto recovery function disabled
- **Enabled** Auto recovery function enabled

5.4 Chipset

Use the **Chipset** menu (**BIOS Menu 14**) to access the Host Bridge and Southbridge configuration menus.



WARNING!

Setting the wrong values for the Chipset BIOS selections in the Chipset BIOS menu may cause the system to malfunction.

```
Aptio Setup Utility - Copyright (C) 2011 American Megatrends, Inc.
Main   Advanced  Chipset  Boot   Security  Save & Exit
-----
> Host Bridge
> South Bridge

Host Bridge Parameters
-----
-><: Select Screen
↑↓: Select Item
Enter: Select
+/-: Change Opt.
F1: General Help
F2: Previous Values
F3: Optimized Defaults
F4: Save & Exit
ESC: Exit

Version 2.14.1219. Copyright (C) 2011 American Megatrends, Inc.
```

BIOS Menu 14: Chipset

5.4.1 Host Bridge Configuration

Use the **Host Bridge Configuration** menu (**BIOS Menu 15**) to configure the Intel IGD Configuration and display the memory information.

WAFER-CV-D25502/N26002 3.5" Motherboard

```

Aptio Setup Utility - Copyright (C) 2011 American Megatrends, Inc.
  Chipset
  > Intel IGD Configuration
***** Memory Information *****
Memory Frequency           800 MHz(DDR3)
Total Memory                2048 MB
DIMM#1                      2048 MB

Config Intel IGD Settings
-----
-><: Select Screen
↑↓: Select Item
Enter: Select
+/-: Change Opt.
F1:  General Help
F2:  Previous Values
F3:  Optimized Defaults
F4:  Save & Exit
ESC: Exit

Version 2.14.1219. Copyright (C) 2011 American Megatrends, Inc.

```

BIOS Menu 15: Host Bridge Configuration

5.4.1.1 Intel IGD Configuration

Use the **Intel IGD Configuration** submenu (**BIOS Menu 16**) to configure the video device connected to the system.

```

Aptio Setup Utility - Copyright (C) 2011 American Megatrends, Inc.
  Advanced
  Intel IGD Configuration
  IGFX - Boot Type           [VBIOS Default]
  LVDS1 Panel Type          [800x600 LVDS]
  Backlight Control         [Inverted]
  Fixed Graphics Memory Size [128MB]

  Select the Video Device
  which will be activated
  during POST. This has no
  effect if external
  graphics present.

  -----
  -><: Select Screen
  ↑↓: Select Item
  Enter: Select
  +/-: Change Opt.
  F1:  General Help
  F2:  Previous Values
  F3:  Optimized Defaults
  F4:  Save & Exit
  ESC: Exit

  Version 2.14.1219. Copyright (C) 2011 American Megatrends, Inc.

```

BIOS Menu 16: Intel IGD Configuration

→ IGFX - Boot Type [VBIOS Default]

Use the **IGFX - Boot Type** option to select the display device used by the system when it boots. Configuration options are listed below.

- VBIOS Default **DEFAULT**
- CRT
- LVDS1

→ LVDS1 Panel Type [800x600 LVDS]

Use the **LVDS1 Panel Type** option to select the type of flat panel connected to the system. Configuration options are listed below.

- 640x480 LVDS
- 800x600 LVDS **DEFAULT**
- 1024x768 LVDS
- 1280x1024 LVDS
- 1366x768 LVDS
- 1224x600 LVDS
- 1280x800 LVDS

→ Backlight Control [Inverted]

Use the **Backlight Control** option to select the backlight control mode.

- Normal** Brightest at high voltage level
- Inverted** **DEFAULT** Brightest at low voltage level

→ Fixed Graphics Memory Size [128MB]

Use the **Fixed Graphics Memory Size** option to specify the maximum amount of memory that can be allocated as graphics memory. Configuration options are listed below.

- 128MB **DEFAULT**
- 256MB

WAFER-CV-D25502/N26002 3.5" Motherboard

5.4.2 South Bridge Configuration

Use the **South Bridge Configuration** menu (**BIOS Menu 17**) to configure the Southbridge chipset.

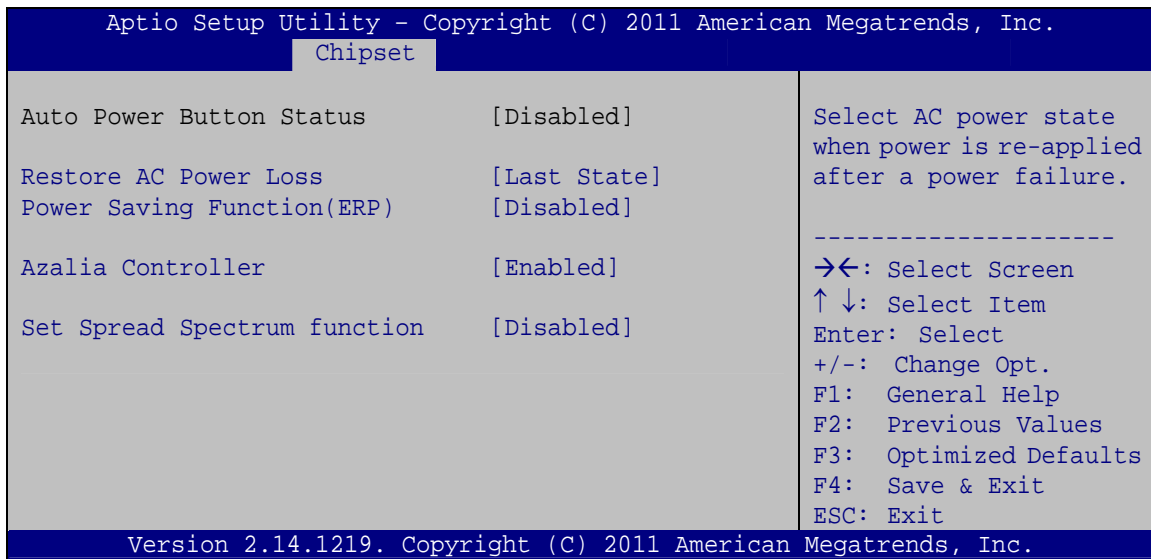

BIOS Menu 17: Southbridge Chipset Configuration

→ Restore AC Power Loss [Last State]

Use the **Restore AC Power Loss** BIOS option to specify what state the system returns to if there is a sudden loss of power to the system.

- **Power Off** The system remains turned off
- **Power On** The system turns on
- **Last State DEFAULT** The system returns to its previous state. If it was on, it turns itself on. If it was off, it remains off.

→ Power Saving Function(ERP) [Disabled]

Use the **Power Saving Function(ERP)** option to enable or disable the power saving function.

- **Disabled DEFAULT** Disables the power saving function.
- **Enabled** Enables the power saving function.

→ Azalia Controller [Enabled]

Use the **Azalia Controller** option to enable or disable the High Definition Audio controller.

- **Disabled** The onboard High Definition Audio controller is disabled
- **Enabled DEFAULT** The onboard High Definition Audio controller automatically detected and enabled

→ Set Spread Spectrum Function [Disabled]

The **Set Spread Spectrum Function** option can help to improve CPU EMI issues.

- **Disabled DEFAULT** The spread spectrum mode is disabled
- **Enabled** The spread spectrum mode is enabled

5.5 Boot

Use the **Boot menu (BIOS Menu 18)** to configure system boot options.

```

Aptio Setup Utility - Copyright (C) 2011 American Megatrends, Inc.
Main   Advanced  Chipset  Boot   Security  Save & Exit
-----
Boot Configuration
Bootup NumLock State      [On]
Quiet Boot                 [Enabled]
Launch PXE OpROM          [Disabled]
Option ROM Messages       [Force BIOS]
UEFI Boot                  [Disabled]

Boot Option Priorities

-----
Select the keyboard
NumLock state

-----
→←: Select Screen
↑↓: Select Item
Enter: Select
+/-: Change Opt.
F1: General Help
F2: Previous Values
F3: Optimized Defaults
F4: Save & Exit
ESC: Exit

Version 2.14.1219. Copyright (C) 2011 American Megatrends, Inc.

```

BIOS Menu 18: Boot
→ Bootup NumLock State [On]

Use the **Bootup NumLock State** BIOS option to specify if the number lock setting must be modified during boot up.

WAFER-CV-D25502/N26002 3.5" Motherboard

- **On** **DEFAULT** Allows the Number Lock on the keyboard to be enabled automatically when the computer system boots up. This allows the immediate use of the 10-key numeric keypad located on the right side of the keyboard. To confirm this, the Number Lock LED light on the keyboard is lit.
- **Off** Does not enable the keyboard Number Lock automatically. To use the 10-keys on the keyboard, press the Number Lock key located on the upper left-hand corner of the 10-key pad. The Number Lock LED on the keyboard lights up when the Number Lock is engaged.

→ **Quiet Boot [Enabled]**

Use the **Quiet Boot** BIOS option to select the screen display when the system boots.

- **Disabled** Normal POST messages displayed
- **Enabled** **DEFAULT** OEM Logo displayed instead of POST messages

→ **Launch PXE OpROM [Disabled]**

Use the **Launch PXE OpROM** option to enable or disable boot option for legacy network devices.

- **Disabled** **DEFAULT** Ignore all PXE Option ROMs
- **Enabled** Load PXE Option ROMs.

→ **Option ROM Messages [Force BIOS]**

Use the **Option ROM Messages** option to set the Option ROM display mode.

- **Force BIOS** **DEFAULT** Sets display mode to force BIOS.
- **Keep Current** Sets display mode to current.

➔ **UEFI Boot [Disabled]**

Use the **UEFI Boot** BIOS option to allow the system to boot from the UEFI devices.

- ➔ **Disabled** **DEFAULT** Disables to boot from the UEFI devices.
- ➔ **Enabled** Enables to boot from the UEFI devices.

5.6 Security

Use the **Security** menu (**BIOS Menu 19**) to set system and user passwords.

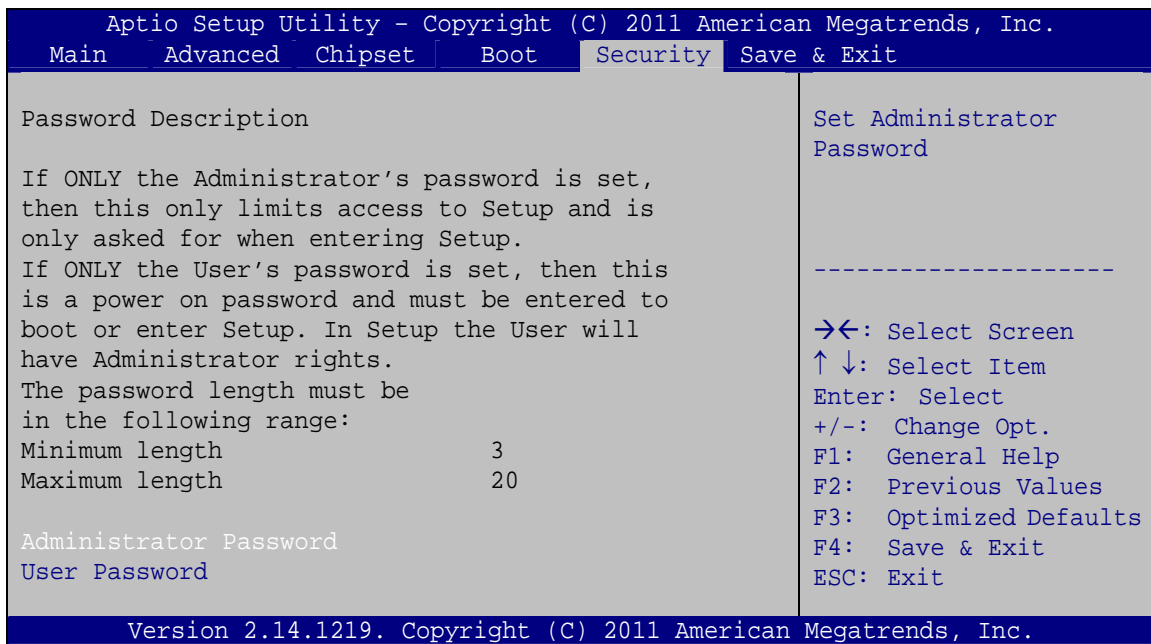

BIOS Menu 19: Security

➔ **Administrator Password**

Use the **Administrator Password** to set or change a administrator password.

➔ **User Password**

Use the **User Password** to set or change a user password.

5.7 Save & Exit

Use the **Exit** menu (**BIOS Menu 20**) to load default BIOS values, optimal failsafe values and to save configuration changes.

```

Aptio Setup Utility - Copyright (C) 2011 American Megatrends, Inc.
Main   Advanced  Chipset  Boot   Security  Save & Exit
-----
Save Changes and Reset
Discard Changes and Reset

Restore Defaults
Save as User Defaults
Restore User Defaults

Reset the system after
saving the changes.

-----
-><: Select Screen
↑↓: Select Item
Enter: Select
+/-: Change Opt.
F1:  General Help
F2:  Previous Values
F3:  Optimized Defaults
F4:  Save & Exit
ESC: Exit

Version 2.14.1219. Copyright (C) 2011 American Megatrends, Inc.

```

BIOS Menu 20: Save & Exit

→ Save Changes and Reset

Use the **Save Changes and Reset** option to save the changes made to the BIOS options and reset the system.

→ Discard Changes and Reset

Use the **Discard Changes and Reset** option to exit the system without saving the changes made to the BIOS configuration setup program.

→ Restore Defaults

Use the **Restore Defaults** option to load the optimal default values for each of the parameters on the Setup menus. **F3 key can be used for this operation.**

→ Save as User Defaults

Use the **Save as User Defaults** option to save the changes done so far as user defaults.



→ **Restore User Defaults**

Use the **Restore User Defaults** option to restore the user defaults to all the setup options.

Chapter

6

Software Drivers

6.1 Available Software Drivers



NOTE:

The content of the CD may vary throughout the life cycle of the product and is subject to change without prior notice. Visit the IEI website or contact technical support for the latest updates.

The following drivers can be installed on the system:

- Chipset
- Graphics
- LAN
- Audio

Installation instructions are given below.

6.2 Starting the Driver Program

To access the driver installation programs, please do the following.

Step 1: Insert the CD that came with the system into a CD drive connected to the system.



NOTE:

If the installation program doesn't start automatically:
Click "Start->Computer->CD Drive->autorun.exe"

Step 2: The driver main menu appears (**Figure 6-1**).

WAFER-CV-D25502/N26002 3.5" Motherboard



Figure 6-1: Start Up Screen

Step 3: Click WAFER-CV-D25502/N26002.

Step 4: The list of drivers in **Figure 6-2** appears.



Figure 6-2: Drivers

6.3 Chipset Driver Installation

To install the chipset driver, please do the following.

Step 1: Access the driver list. (See **Section 6.2**)

Step 2: Click “1-Chipset”.

Step 3: Go to the 32-bit or 64-bit folder that corresponds to your OS version.

Step 4: Open the **Intel Chipset Software Installation Utility** folder.

Step 5: Double click the **infinst_autol** icon.

Step 6: The setup files are extracted as shown in **Figure 6-3**.

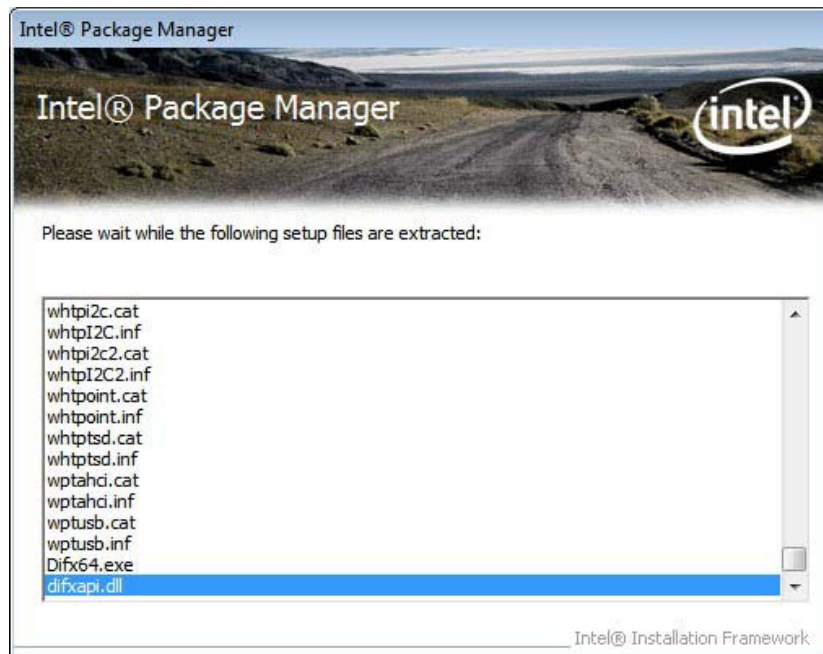

Figure 6-3: Chipset Driver Screen

Step 7: When the setup files are completely extracted, the **Welcome Screen** in **Figure 6-4** appears.

WAFER-CV-D25502/N26002 3.5" Motherboard

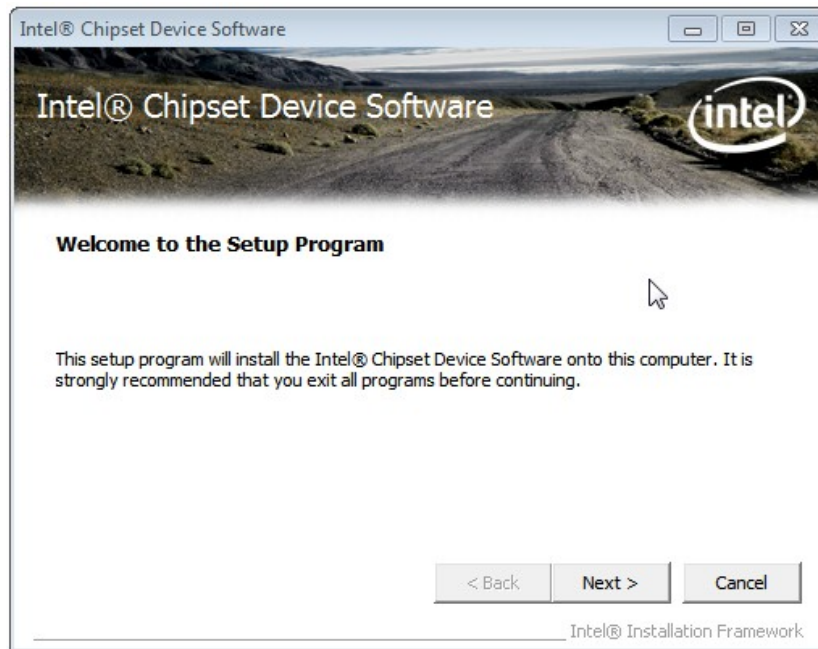

Figure 6-4: Chipset Driver Welcome Screen

Step 8: Click **Next** to continue.

Step 9: The license agreement in **Figure 6-5** appears.

Step 10: Read the **License Agreement**.

Step 11: Click **Yes** to continue.



Figure 6-5: Chipset Driver License Agreement

Step 12: The Read Me file in **Figure 6-6** appears.

Step 13: Click **Next** to continue.

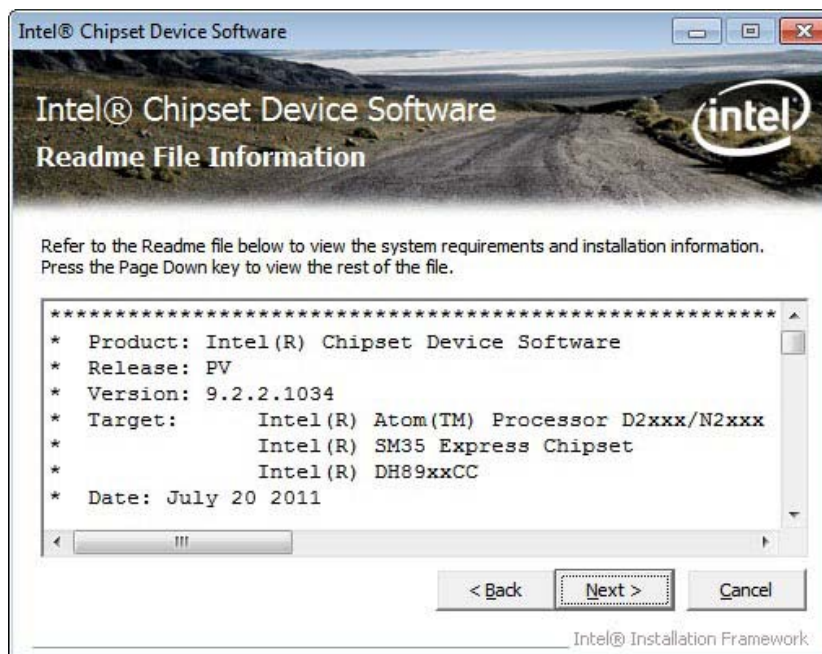

Figure 6-6: Chipset Driver Read Me File

WAFER-CV-D25502/N26002 3.5" Motherboard

Step 14: Setup Operations are performed as shown in Figure 6-7.

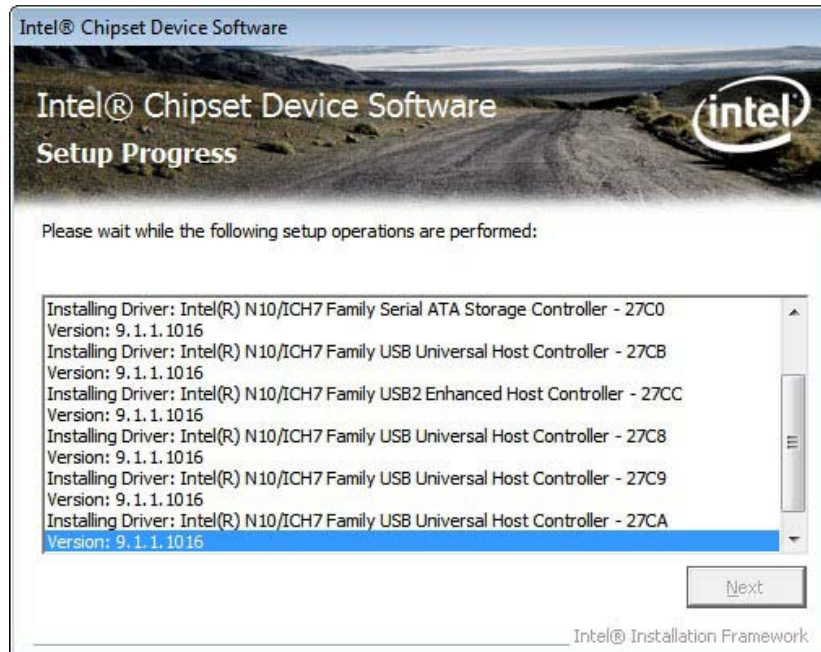

Figure 6-7: Chipset Driver Setup Operations

Step 15: Once the Setup Operations are complete, click **Next** to continue.

Step 16: The **Finish** screen appears.

Step 17: Select "Yes, I want to restart the computer now" and click the **Finish** icon.

See Figure 6-8.



Figure 6-8: Chipset Driver Installation Finish Screen

6.4 Graphics Driver Installation



NOTE:

Due to Intel® GMA driver limitation, the monitor connected to the VGA connector may become extended desktop or not have signal to it after restarting from the graphics driver installation. To work out this limitation, press the Ctrl+Alt+F1 hotkey to switch the primary display to CRT mode.

To install the graphics driver, please do the following.

- Step 1:** Access the driver list. (See **Section 6.2**)
- Step 2:** Click “**2-Graphics**”.
- Step 3:** Open the 32-bit or 64-bit folder that corresponds to your OS version.
- Step 4:** Double click the **Setup** icon.

WAFER-CV-D25502/N26002 3.5" Motherboard

Step 5: The **Welcome Screen** in **Figure 6-9** appears.



Figure 6-9: Graphics Driver Welcome Screen

Step 6: Click **Next** to continue.

Step 7: The license agreement in **Figure 6-10** appears.

Step 8: Read the **License Agreement**.

Step 9: Click **Yes** to continue.

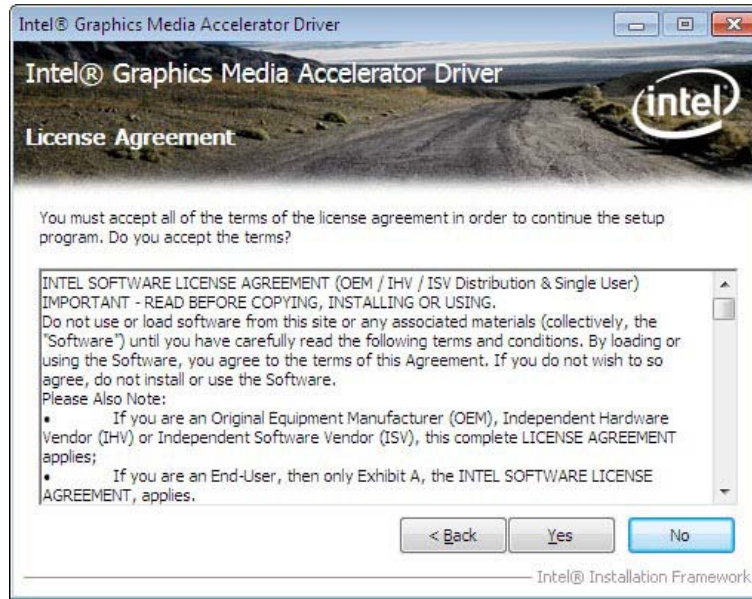

Figure 6-10: Graphics Driver License Agreement

Step 10: The Read Me file in **Figure 6-11** appears.

Step 11: Click **Next** to continue.

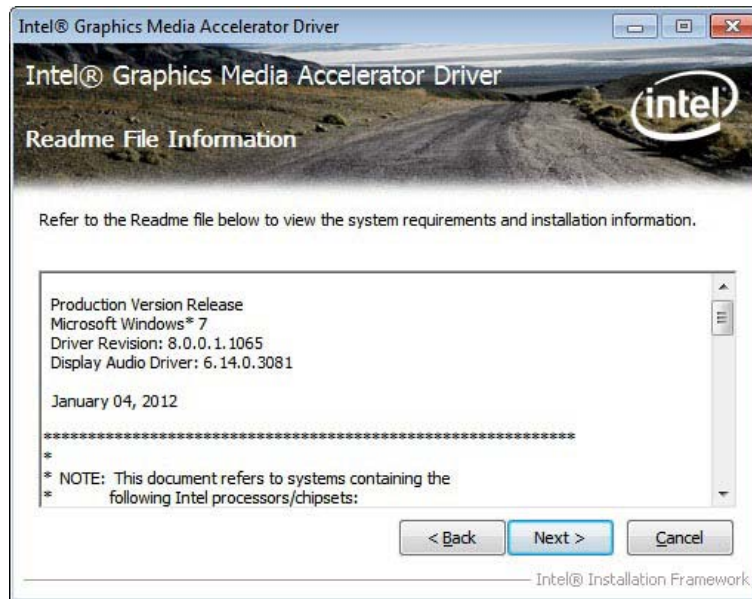

Figure 6-11: Graphics Driver Read Me File

Step 12: Setup Operations are performed as shown in **Figure 6-12**.

WAFER-CV-D25502/N26002 3.5" Motherboard

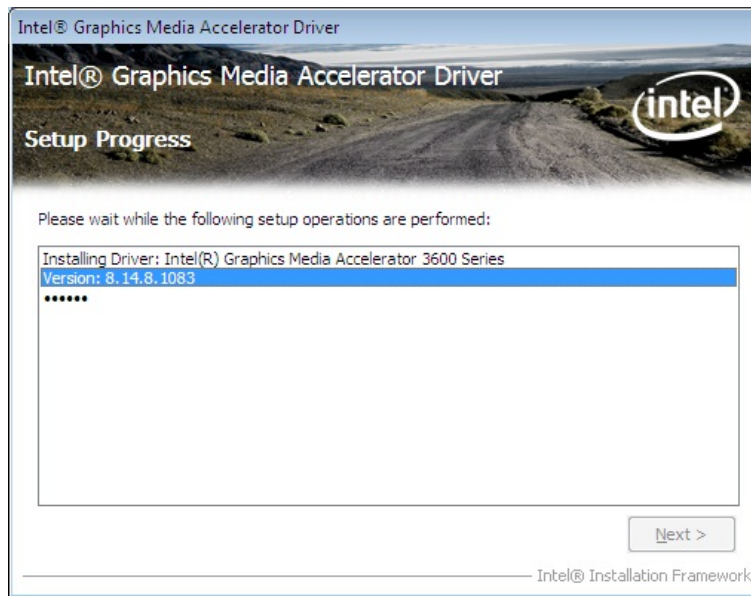

Figure 6-12: Graphics Driver Setup Operations

Step 13: Once the **Setup Operations** are complete, click the **Next** icon to continue.

Step 14: The **Finish** screen appears.

Step 15: Select “**Yes, I want to restart the computer now**” and click the **Finish** icon.

See **Figure 6-13**.

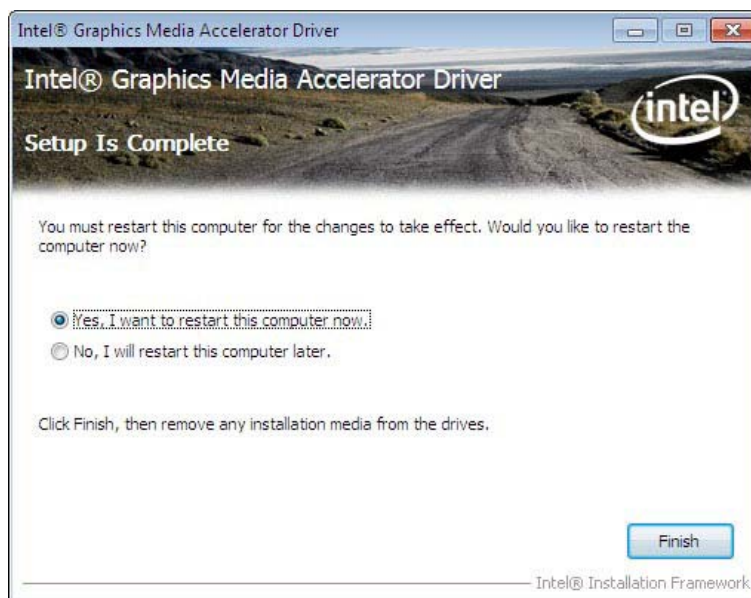

Figure 6-13: Graphics Driver Installation Finish Screen

6.5 LAN Driver Installation

To install the LAN driver, please do the following.

Step 1: Access the driver list shown in Figure 6-2. (See **Section 6.2**)

Step 2: Click “3-LAN”.

Step 3: Go to the **Win7 > Install_Win7_7048_09162011** folder.

Step 4: Double click the **setup** icon.

Step 5: The **Welcome** screen in **Figure 6-14** appears.

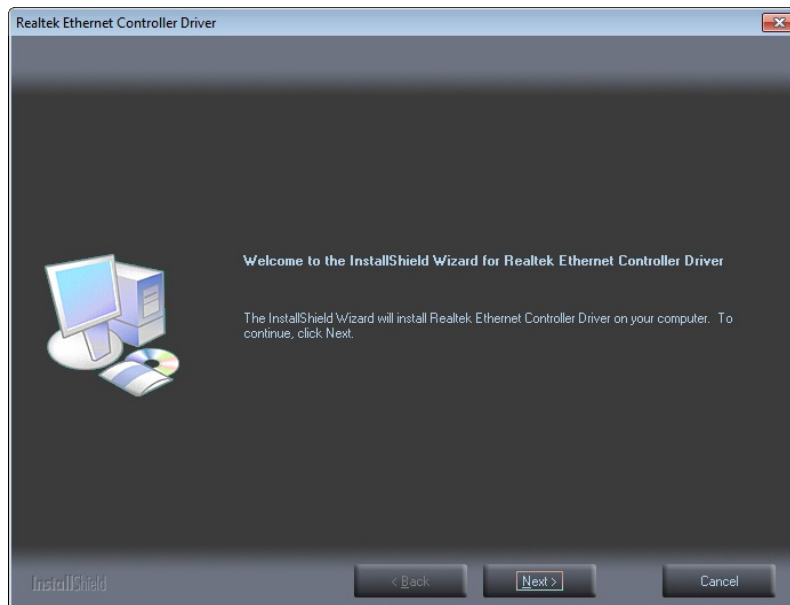

Figure 6-14: LAN Driver Welcome Screen

Step 6: Click **Next** to continue.

Step 7: The **Ready to Install** screen in **Figure 6-15** appears.

Step 8: Click **Install** to proceed with the installation.

WAFER-CV-D25502/N26002 3.5" Motherboard

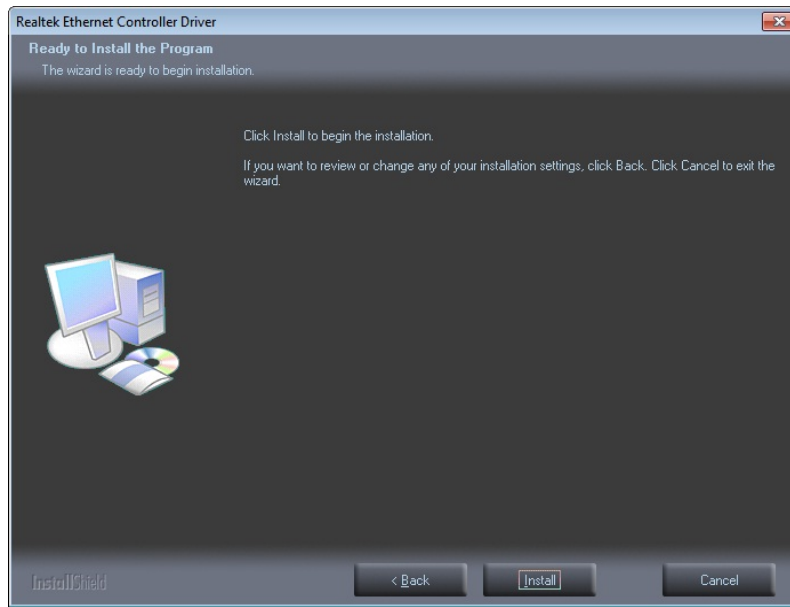

Figure 6-15: LAN Driver Installation

Step 9: The program begins to install.

Step 10: When the driver installation is complete, the screen in **Figure 6-16** appears.

Step 11: Click **Finish** to exit.

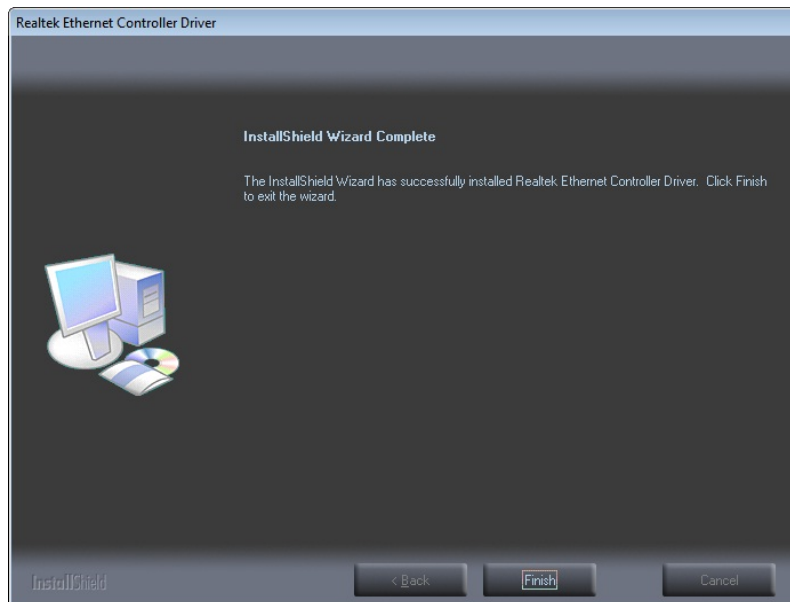

Figure 6-16: LAN Driver Installation Complete

6.6 Audio Driver Installation

To install the Audio driver, please do the following.

Step 1: Access the driver list. (See **Section 6.2**)

Step 2: Click “4-Audio”.

Step 3: Open the **Win7** folder.

Step 4: Double click the **Vista_Win7_R263** icon.

Step 5: The installation files are extracted as shown in **Figure 6-17**.

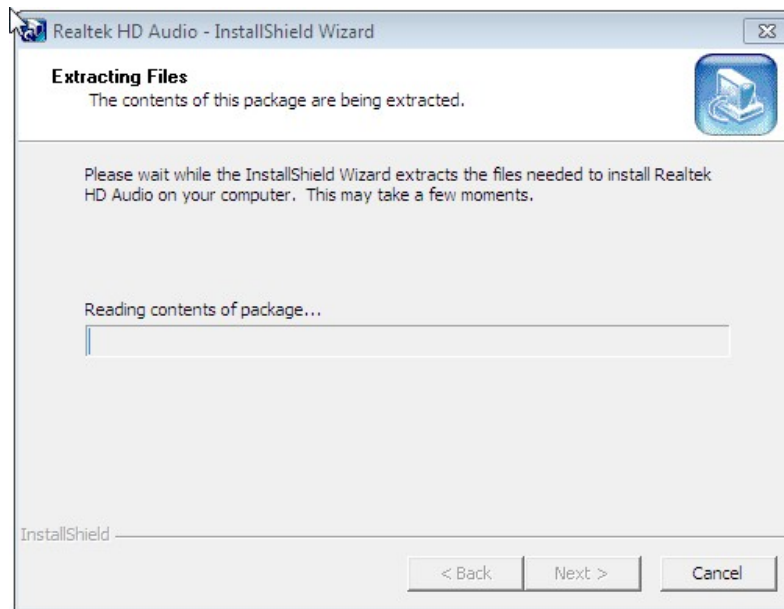

Figure 6-17: Audio Driver Installation File Extraction

Step 6: The **Welcome** screen in **Figure 6-18** appears.

WAFER-CV-D25502/N26002 3.5" Motherboard

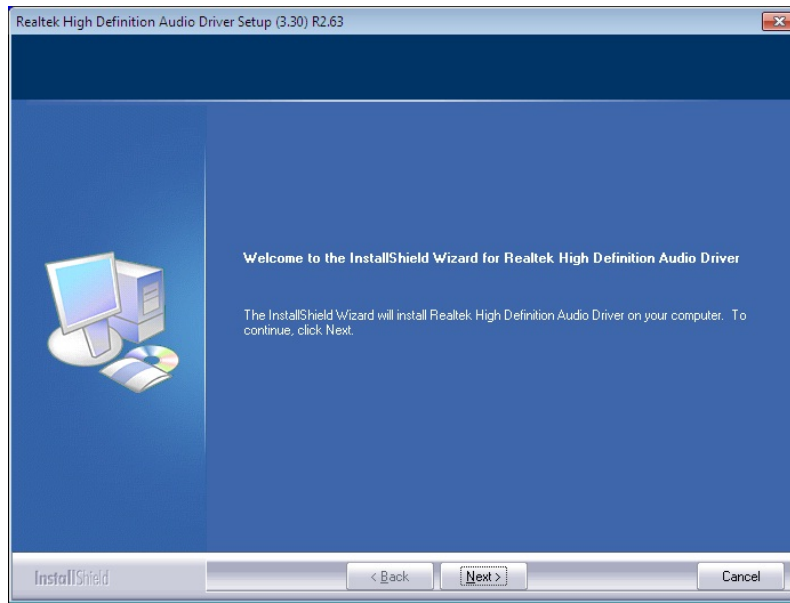

Figure 6-18: Audio Driver Welcome Screen

Step 7: Click **Next** to continue.

Step 8: The program begins to install.

Step 9: The installation progress can be monitored in the progress bar shown in **Figure 6-19**.

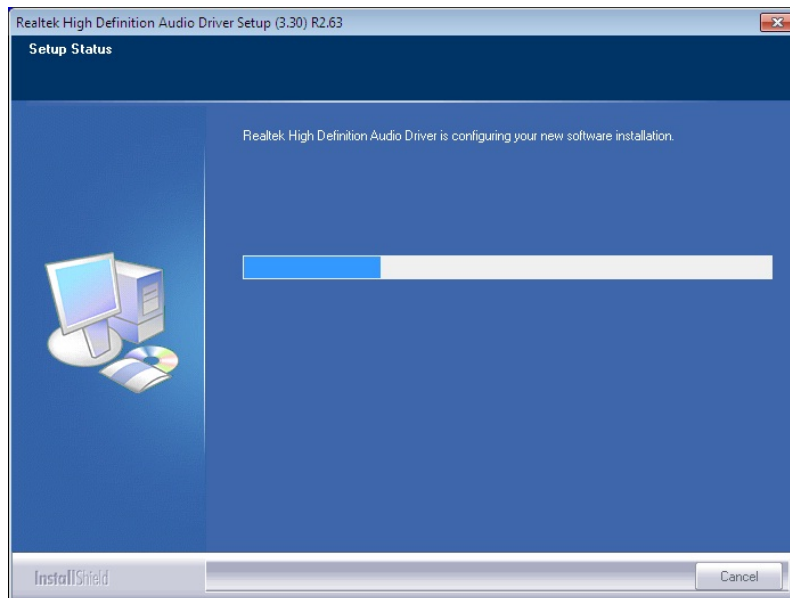

Figure 6-19: Audio Driver Installation

Step 10: When the driver installation is complete, the screen in **Figure 6-20** appears.

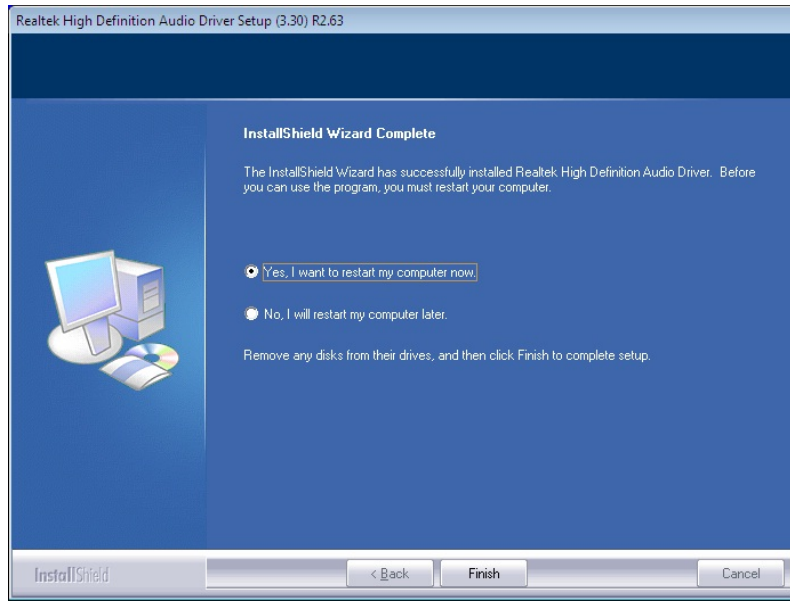

Figure 6-20: Audio Driver Installation Complete

Step 11: Select “Yes, I want to restart my computer now” and click **Finish**.

Step 12: The system reboots.

Appendix

A

BIOS Options

Below is a list of BIOS configuration options in the BIOS chapter.

System Overview	65
System Date [xx/xx/xx]	65
System Time [xx:xx:xx]	66
ACPI Sleep State [S1 (CPU Stop Clock)]	67
Wake system with Fixed Time [Disabled]	68
Hyper-Threading [Enabled]	70
Configure SATA as [IDE]	70
Legacy USB Support [Enabled]	71
Serial Port [Enabled]	73
Change Settings [Auto]	73
Serial Port [Enabled]	73
Change Settings [Auto]	74
Serial Port [Enabled]	74
Change Settings [Auto]	74
Serial Port [Enabled]	75
Change Settings [Auto]	75
Serial Port [Enabled]	76
Change Settings [Auto]	76
Serial Port [Enabled]	77
Change Settings [Auto]	77
PC Health Status	78
CPU_FAN1 Smart Fan Control [Auto Duty-Cycle Mode]	79
CPU Temperature n	80
Console Redirection [Disabled]	81
Terminal Type [ANSI]	81
Bits per second [115200]	82
Data Bits [8]	82
Parity [None]	82
Stop Bits [1]	83
Auto Recovery Function [Disabled]	83
IGFX - Boot Type [VBIOS Default]	86
LVDS1 Panel Type [800x600 LVDS]	86
Backlight Control [Inverted]	86

WAFER-CV-D25502/N26002 3.5" Motherboard

Fixed Graphics Memory Size [128MB].....	86
Restore AC Power Loss [Last State]	87
Power Saving Function(ERP) [Disabled].....	87
Azalia Controller [Enabled]	88
Set Spread Spectrum Function [Disabled].....	88
Bootup NumLock State [On].....	88
Quiet Boot [Enabled]	89
Launch PXE OpROM [Disabled]	89
Option ROM Messages [Force BIOS].....	89
UEFI Boot [Disabled]	90
Administrator Password	90
User Password	90
Save Changes and Reset	91
Discard Changes and Reset	91
Restore Defaults	91
Save as User Defaults	91
Restore User Defaults	92



Appendix

B

One Key Recovery

B.1 One Key Recovery Introduction

The IEI one key recovery is an easy-to-use front end for the Norton Ghost system backup and recovery tool. This tool provides quick and easy shortcuts for creating a backup and reverting to that backup or reverting to the factory default settings.



NOTE:

The latest One Key Recovery software provides an auto recovery function that allows a system running Microsoft Windows OS to automatically restore from the factory default image after encountering a Blue Screen of Death (BSoD) or a hang for around 10 minutes. Please refer to Section B.3 for the detailed setup procedure.

The IEI One Key Recovery tool menu is shown below.

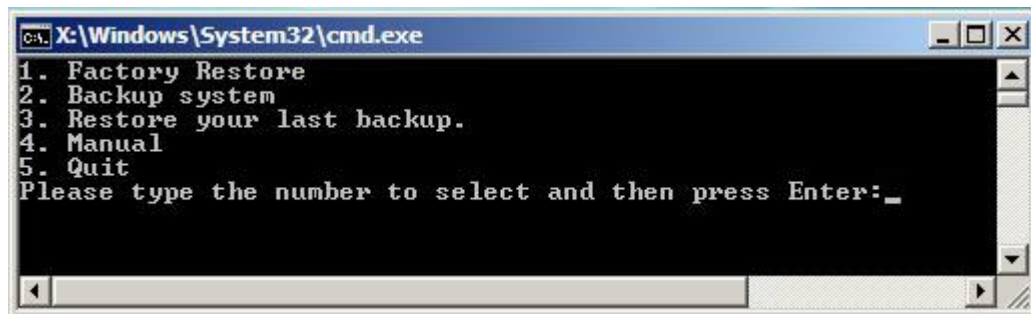

Figure B-1: IEI One Key Recovery Tool Menu

Prior to using the IEI One Key Recovery tool (as shown in **Figure B-1**) to backup or restore Windows system, five setup procedures are required.

1. Hardware and BIOS setup (see Section **B.2.1**)
2. Create partitions (see **Section B.2.2**)
3. Install operating system, drivers and system applications (see **Section B.2.3**)
4. Build-up recovery partition (see **Section B.2.4**)
5. Create factory default image (see **Section B.2.5**)

After completing the five initial setup procedures as described above, users can access the recovery tool by pressing <F3> while booting up the system. The detailed information of each function is described in **Section B.5**.

**NOTE:**

The initial setup procedures for Linux system are described in **Section B.3**.

B.1.1 System Requirement

**NOTE:**

The recovery CD can only be used with IEI products. The software will fail to run and a warning message will appear when used on non-IEI hardware.

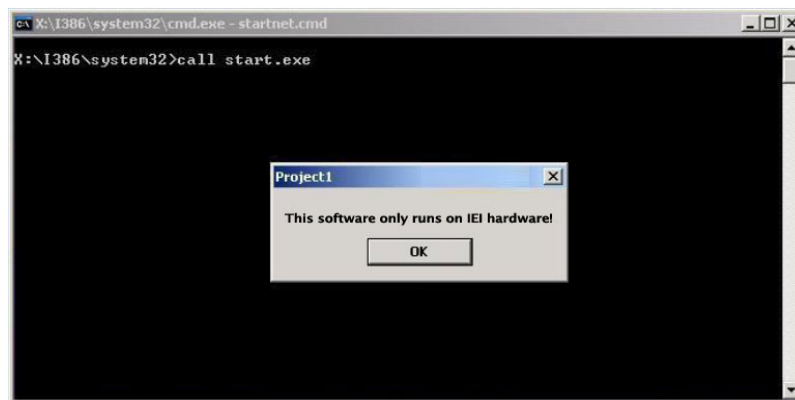

To create the system backup, the main storage device must be split into two partitions (three partitions for Linux). The first partition will be for the operating system, while the second partition will be invisible to the operating system and contain the backup made by the one key recovery software.

The partition created for recovery images must be big enough to contain both the factory default image and the user backup image. The size must be calculated before creating the

WAFER-CV-D25502/N26002 3.5" Motherboard

partitions. Please take the following table as a reference when calculating the size of the partition.

	OS	OS Image after Ghost	Compression Ratio
Windows® 7	7 GB	5 GB	70%
Windows® XPE	776 MB	560 MB	70%
Windows® CE 6.0	36 MB	28 MB	77%



NOTE:

Specialized tools are required to change the partition size if the operating system is already installed.

B.1.2 Supported Operating System

The recovery CD is compatible with both Microsoft Windows and Linux operating system (OS). The supported OS versions are listed below.

- Microsoft Windows
 - Windows 2000
 - Windows XP (Service Pack 2 or 3 required)
 - Windows Vista
 - Windows 7
 - Windows CE 5.0
 - Windows CE 6.0
 - Windows XP Embedded
 - Windows Embedded Standard 7



NOTE:

The auto recovery function (described in **Section B.3**) and the restore through LAN function (described in **Section B.6**) are not supported in the Windows CE 5.0/6.0 operating system environment.

- Linux
 - Fedora Core 12 (Constantine)
 - Fedora Core 11 (Leonidas)
 - Fedora Core 10 (Cambridge)
 - Fedora Core 8 (Werewolf)
 - Fedora Core 7 (Moonshine)
 - RedHat RHEL-5.4
 - RedHat 9 (Ghirke)
 - Ubuntu 8.10 (Intrepid)
 - Ubuntu 7.10 (Gutsy)
 - Ubuntu 6.10 (Edgy)
 - Debian 5.0 (Lenny)
 - Debian 4.0 (Etch)
 - SuSe 11.2
 - SuSe 10.3

**NOTE:**

Installing unsupported OS versions may cause the recovery tool to fail.

B.2 Setup Procedure for Windows

Prior to using the recovery tool to backup or restore, a few setup procedures are required.

Step 1: Hardware and BIOS setup (see **Section B.2.1**)

Step 2: Create partitions (see **Section B.2.2**)

Step 3: Install operating system, drivers and system applications (see **Section B.2.3**)

Step 4: Build the recovery partition (see **Section B.2.4**) or build the auto recovery partition (see **Section B.3**)

Step 5: Create factory default image (see **Section B.2.5**)

WAFER-CV-D25502/N26002 3.5" Motherboard

The detailed descriptions are described in the following sections.



NOTE:

The setup procedures described below are for Microsoft Windows operating system users. For Linux, most of the setup procedures are the same except for several steps described in **Section B.3**.

B.2.1 Hardware and BIOS Setup

- Step 1:** Make sure the system is powered off and unplugged.
- Step 2:** Install a hard drive or SSD in the system. An unformatted and unpartitioned disk is recommended.
- Step 3:** Connect an optical disk drive to the system and insert the recovery CD.
- Step 4:** Turn on the system.
- Step 5:** Press the <DELETE> key as soon as the system is turned on to enter the BIOS.
- Step 6:** Select the connected optical disk drive as the 1st boot device. (**Boot** → **Boot Device Priority** → **1st Boot Device**).
- Step 7:** Save changes and restart the computer. Continue to the next section for instructions on partitioning the internal storage.

B.2.2 Create Partitions

To create the system backup, the main storage device must be split into two partitions (three partitions for Linux). The first partition will be for the operating system, while the second partition will be invisible to the operating system and contain the backup made by the one key recovery software.

- Step 1:** Put the recovery CD in the optical drive of the system.

Step 2: Boot the system from recovery CD. When prompted, press any key to boot from the recovery CD. It will take a while to launch the recovery tool. Please be patient!

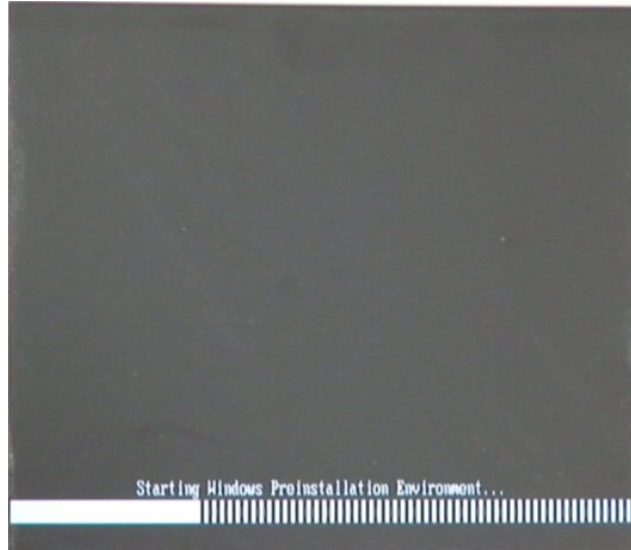

Figure B-2: Launching the Recovery Tool

Step 3: The recovery tool setup menu is shown as below.

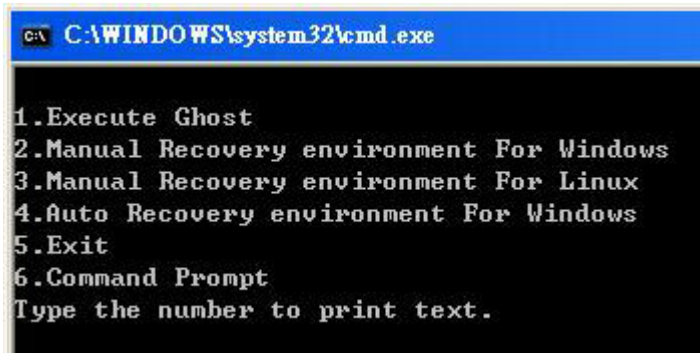
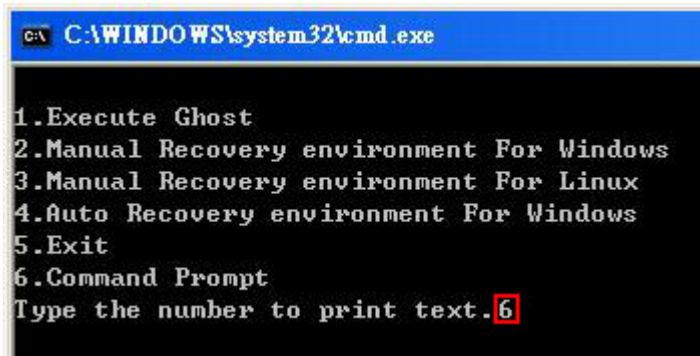

Figure B-3: Recovery Tool Setup Menu

Step 4: Press <6> then <Enter>.

WAFER-CV-D25502/N26002 3.5" Motherboard



```
C:\WINDOWS\system32\cmd.exe

1.Execute Ghost
2.Manual Recovery environment For Windows
3.Manual Recovery environment For Linux
4.Auto Recovery environment For Windows
5.Exit
6.Command Prompt
Type the number to print text.6
```

Figure B-4: Command Prompt

Step 5: The command prompt window appears. Type the following commands (marked in red) to create two partitions. One is for the OS installation; the other is for saving recovery files and images which will be an invisible partition. (Press <Enter> after entering each line below)

```
system32>diskpart
DISKPART>list vol
DISKPART>sel disk 0
DISKPART>create part pri size= ____
DISKPART>assign letter=N
DISKPART>create part pri size= ____
DISKPART>assign letter=F
DISKPART>exit
system32>format N: /fs:ntfs /q /y
system32>format F: /fs:ntfs /q /v:Recovery /y
system32>exit
```

```

X:\I386\SYSTEM32\CMD.EXE
X:\I386\SYSTEM32>diskpart → Starts the Microsoft disk partitioning tool.

Microsoft DiskPart version 5.2.3790.1830
Copyright (C) 1999-2001 Microsoft Corporation.
On computer: MININT-JUC

DISKPART>list vol → Show partition information

Volume ### Ltr Label Fs Type Size Status Info
-----
Volume 0 X CD_ROM CDFS DUD-ROM 405 MB Healthy Boot
Volume 1 D FAT32 Removeable 3854 MB Healthy

DISKPART>sel disk 0 → Select a disk
Disk 0 is now the selected disk.

DISKPART>create part pri size=2000 → Create partition 1 and assign a size.
This partition is for OS installation.
DiskPart succeeded in creating the specified partition.

DISKPART>assign letter=N → Assign partition 1 a code name (N).
DiskPart successfully assigned the drive letter or mount point.

DISKPART>create part pri size=1800 → Create partition 2 and assign a size.
This partition is for recovery images.
DiskPart succeeded in creating the specified partition.

DISKPART>assign letter=F → Assign partition 2 a code name (F).
DiskPart successfully assigned the drive letter or mount point.

DISKPART>exit → Exit diskpart

X:\I386\SYSTEM32>format n: /fs:ntfs /q /y → Format partition 1 (N) as NTFS format.
The type of the file system is RAW.
The new file system is NTFS.
QuickFormatting 2000M
Creating file system structures.
Format complete.
2048254 KB total disk space.
2035620 KB are available.

X:\I386\SYSTEM32>format f: /fs:ntfs /q /v:Recovery /y → Formate partition 2 (F) as NTFS formate and
name it as "Recovery".
The type of the file system is RAW.
The new file system is NTFS.
QuickFormatting 1804M
Creating file system structures.
Format complete.
1847474 KB total disk space.
1835860 KB are available.

X:\I386\SYSTEM32>exit → Exit Windows PE
  
```

Figure B-5: Partition Creation Commands

**NOTE:**

Use the following commands to check if the partitions were created successfully.

```
X:\I386\SYSTEM32>diskpart
Microsoft DiskPart version 5.2.3790.1830
Copyright (C) 1999-2001 Microsoft Corporation.
On computer: MININT-JUC

DISKPART> sel disk 0
Disk 0 is now the selected disk.

DISKPART> list part

   Partition ###   Type              Size              Offset
-----
   Partition 1     Primary            2000 MB            32 KB
   Partition 2     Primary            1804 MB           2000 MB

DISKPART> exit
```

Step 6: Press any key to exit the recovery tool and automatically reboot the system.

Please continue to the following procedure: Build the Recovery Partition.

B.2.3 Install Operating System, Drivers and Applications

Install the operating system onto the unlabelled partition. The partition labeled "Recovery" is for use by the system recovery tool and should not be used for installing the operating system or any applications.

**NOTE:**

The operating system installation program may offer to reformat the chosen partition. DO NOT format the partition again. The partition has already been formatted and is ready for installing the new operating system.

To install the operating system, insert the operating system installation CD into the optical drive. Restart the computer and follow the installation instructions.

B.2.4 Build-up Recovery Partition

- Step 1:** Put the recover CD in the optical drive.
- Step 2:** Start the system.
- Step 3:** **Boot the system from the recovery CD.** When prompted, press any key to boot from the recovery CD. It will take a while to launch the recovery tool. Please be patient!

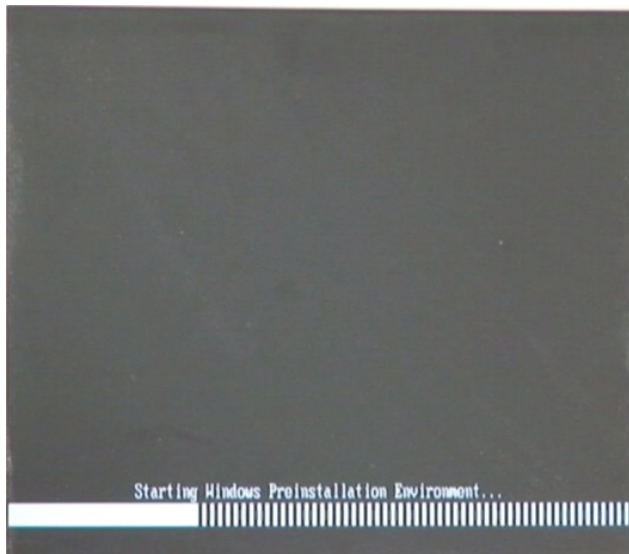

Figure B-6: Launching the Recovery Tool

- Step 4:** When the recovery tool setup menu appears, press <2> then <Enter>.

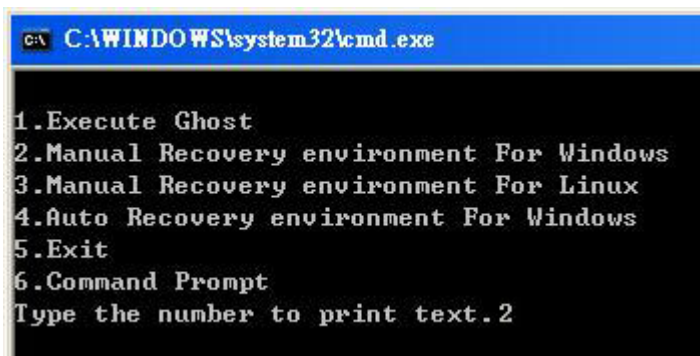

Figure B-7: Manual Recovery Environment for Windows

WAFER-CV-D25502/N26002 3.5" Motherboard

Step 5: The Symantec Ghost window appears and starts configuring the system to build a recovery partition. In this process the partition created for recovery files in **Section B.2.2** is hidden and the recovery tool is saved in this partition.

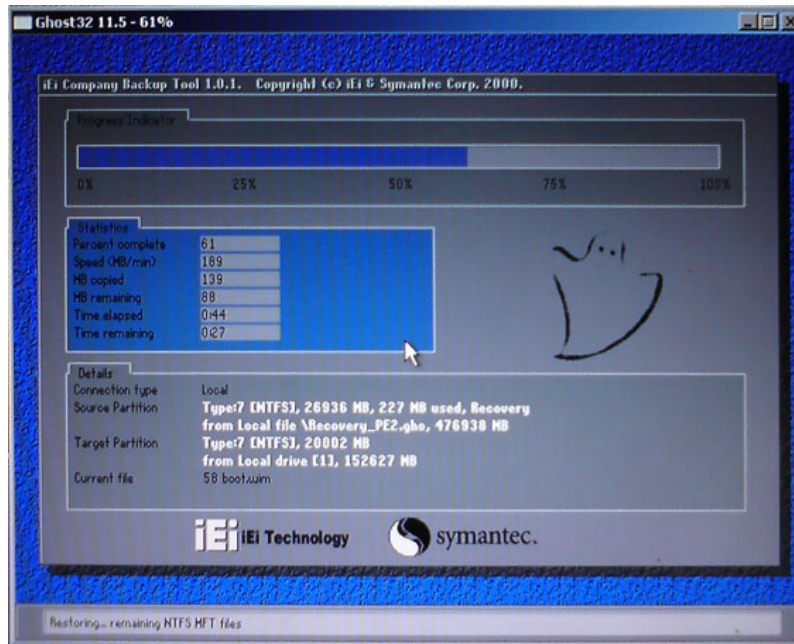

Figure B-8: Building the Recovery Partition

Step 6: After completing the system configuration, press any key in the following window to reboot the system.

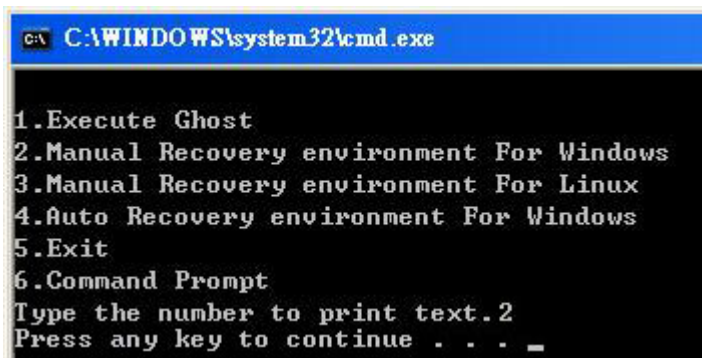

Figure B-9: Press Any Key to Continue

Step 7: Eject the recovery CD.

B.2.5 Create Factory Default Image



NOTE:

Before creating the factory default image, please configure the system to a factory default environment, including driver and application installations.

To create a factory default image, please follow the steps below.

Step 1: Turn on the system. When the following screen displays (**Figure B-10**), press the <F3> key to access the recovery tool. The message will display for 10 seconds, please press F3 before the system boots into the operating system.

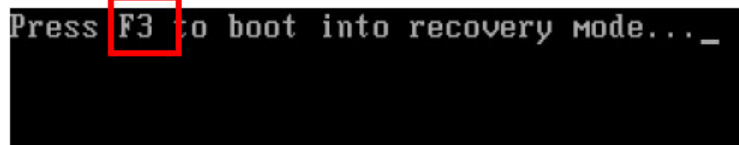

Figure B-10: Press F3 to Boot into Recovery Mode

Step 2: The recovery tool menu appears. Type <4> and press <Enter>. (**Figure B-11**)

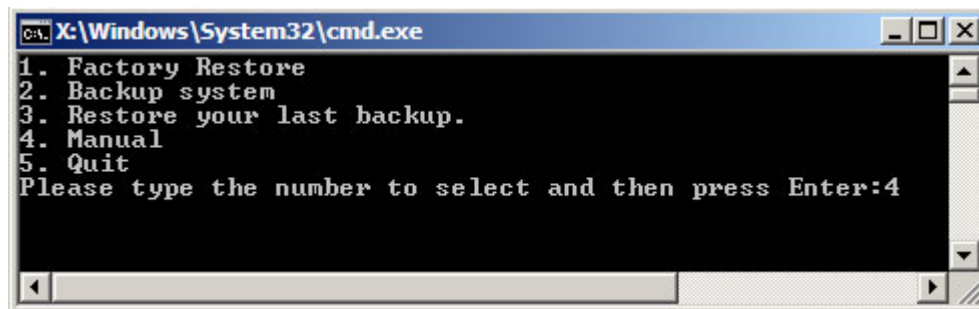

Figure B-11: Recovery Tool Menu

Step 3: The About Symantec Ghost window appears. Click **OK** button to continue.

WAFER-CV-D25502/N26002 3.5" Motherboard

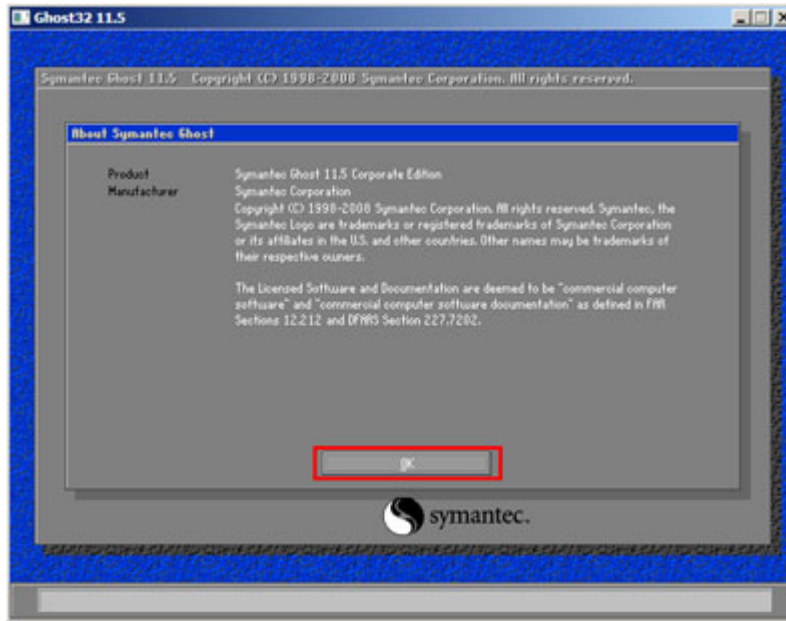

Figure B-12: About Symantec Ghost Window

Step 4: Use mouse to navigate to the option shown below (**Figure B-13**).

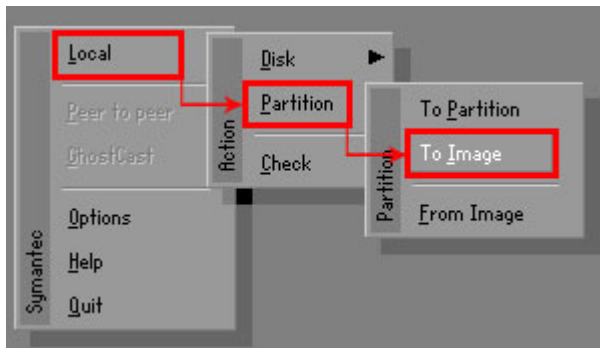

Figure B-13: Symantec Ghost Path

Step 5: Select the local source drive (Drive 1) as shown in **Figure B-14**. Then click OK.

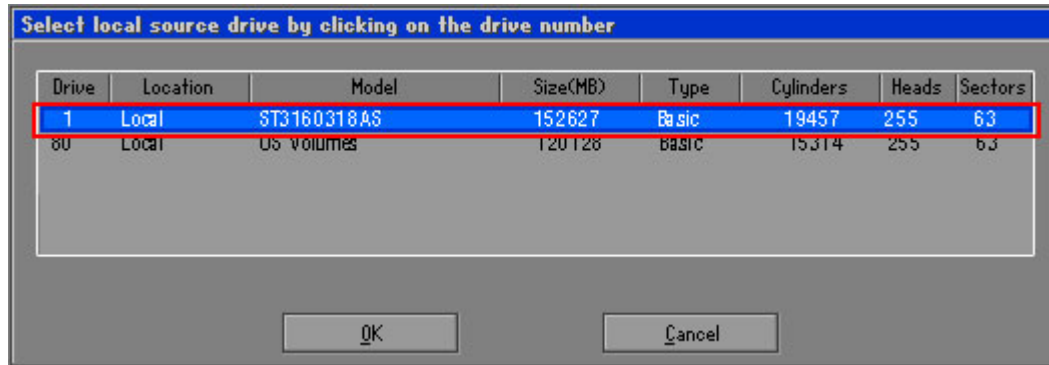

Figure B-14: Select a Local Source Drive

Step 6: Select a source partition (Part 1) from basic drive as shown in **Figure B-15**. Then click OK.

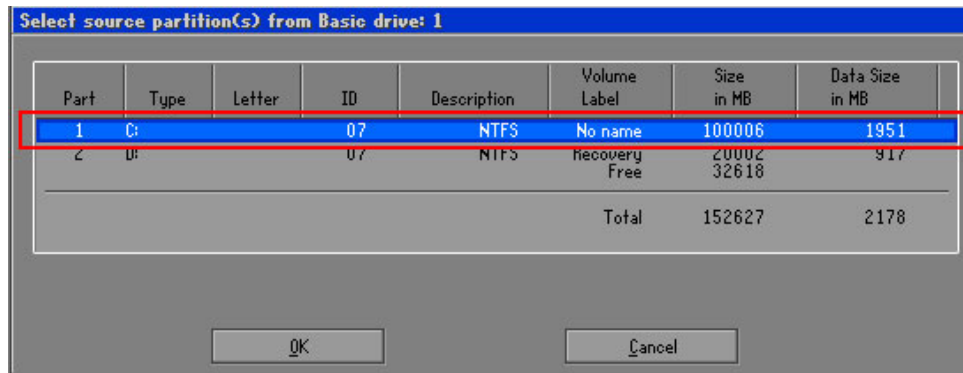

Figure B-15: Select a Source Partition from Basic Drive

Step 7: Select **1.2: [Recovery] NTFS drive** and enter a file name called **iei** (**Figure B-16**). Click **Save**. The factory default image will then be saved in the selected recovery drive and named **IEI.GHO**.



WARNING:

The file name of the factory default image must be **iei.GHO**.

WAFER-CV-D25502/N26002 3.5" Motherboard

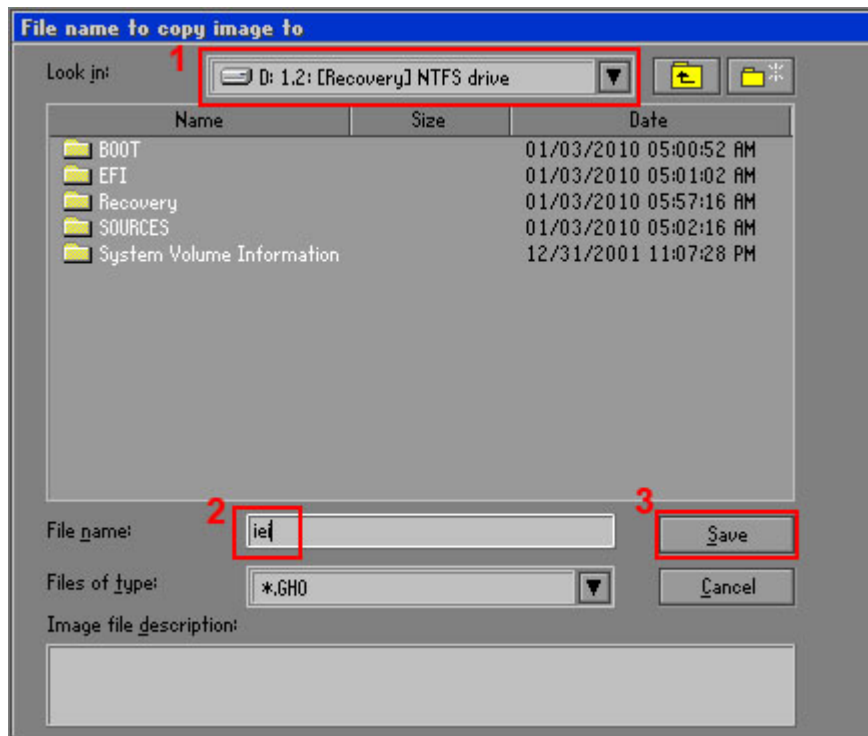

Figure B-16: File Name to Copy Image to

Step 8: When the Compress Image screen in **Figure B-17** prompts, click **High** to make the image file smaller.

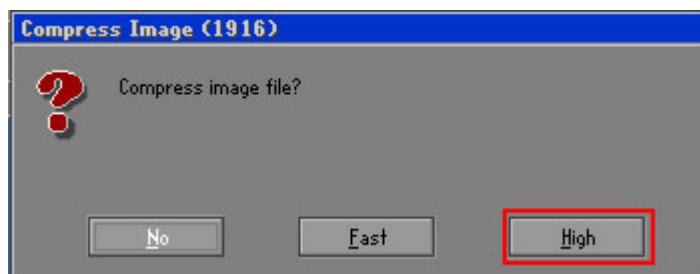

Figure B-17: Compress Image

Step 9: The Proceed with partition image creation window appears, click **Yes** to continue.

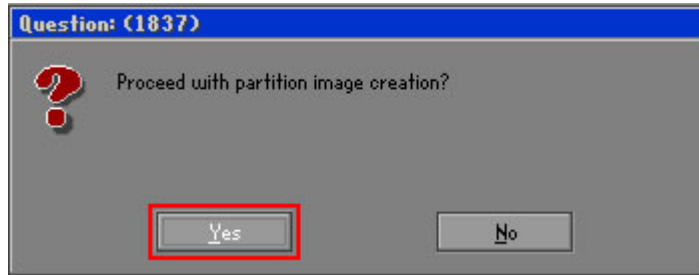

Figure B-18: Image Creation Confirmation

Step 10: The Symantec Ghost starts to create the factory default image (**Figure B-19**).

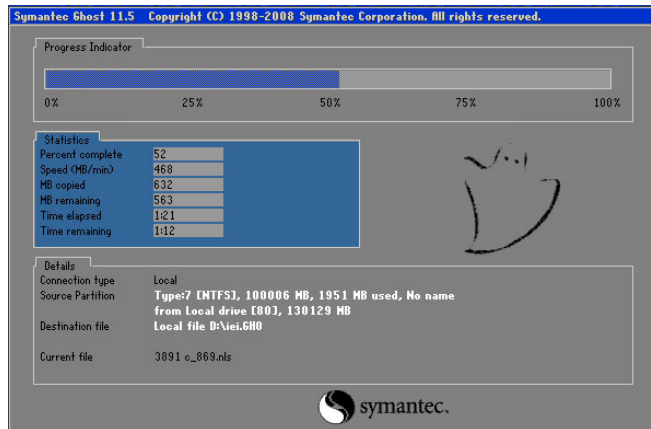

Figure B-19: Image Creation Complete

Step 11: When the image creation completes, a screen prompts as shown in **Figure B-20**.

Click **Continue** and close the Ghost window to exit the program.

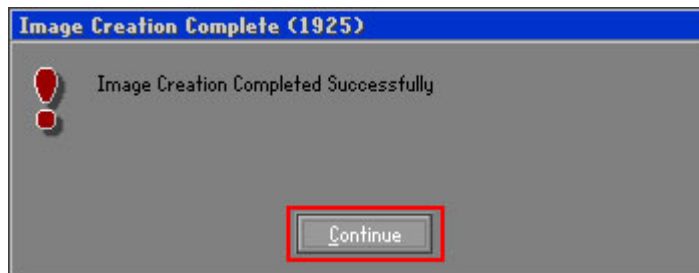
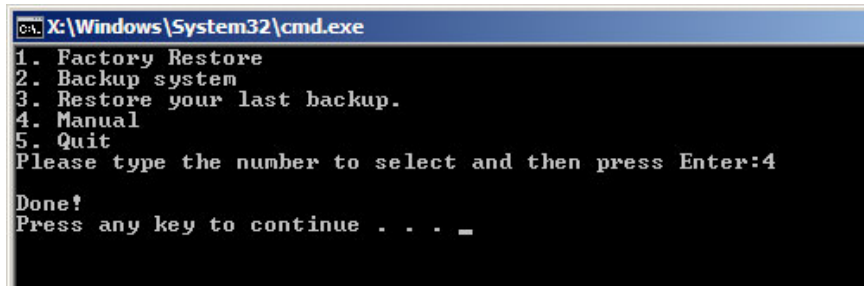

Figure B-20: Image Creation Complete

WAFER-CV-D25502/N26002 3.5" Motherboard

Step 12: The recovery tool main menu window is shown as below. Press any key to reboot the system.



```
C:\Windows\System32\cmd.exe
1. Factory Restore
2. Backup system
3. Restore your last backup.
4. Manual
5. Quit
Please type the number to select and then press Enter:4
Done!
Press any key to continue . . . _
```

Figure B-21: Press Any Key to Continue

B.3 Auto Recovery Setup Procedure

The auto recovery function allows a system to automatically restore from the factory default image after encountering a Blue Screen of Death (BSoD) or a hang for around 10 minutes. To use the auto recovery function, follow the steps described in the following sections.



CAUTION:

The auto recovery function can only run on a Microsoft Windows system with the following OS versions:

- Windows 2000
- Windows XP
- Windows Vista
- Windows 7
- Windows XP Embedded
- Windows Embedded Standard 7



CAUTION:

The setup procedure may include a step to create a factory default image. It is suggested to configure the system to a factory default environment before the configuration, including driver and application installations.

Step 1: Follow the steps described in **Section B.2.1 ~ Section B.2.3** to setup BIOS, create partitions and install operating system.

Step 2: Install the auto recovery utility into the system by double clicking the **Utility/AUTORECOVERY-SETUP.exe** in the One Key Recovery CD. This utility **MUST** be installed in the system, otherwise, the system will automatically restore from the factory default image every ten (10) minutes.



Figure B-22: Auto Recovery Utility

Step 3: **Disable the automatically restart function before creating the factory default image.** Go to: My Computer → Properties → Advanced. Click the Settings button of Startup and Recovery. Deselect “Automatically restart”. Click OK to save the settings and exit. (See **Figure B-23**)

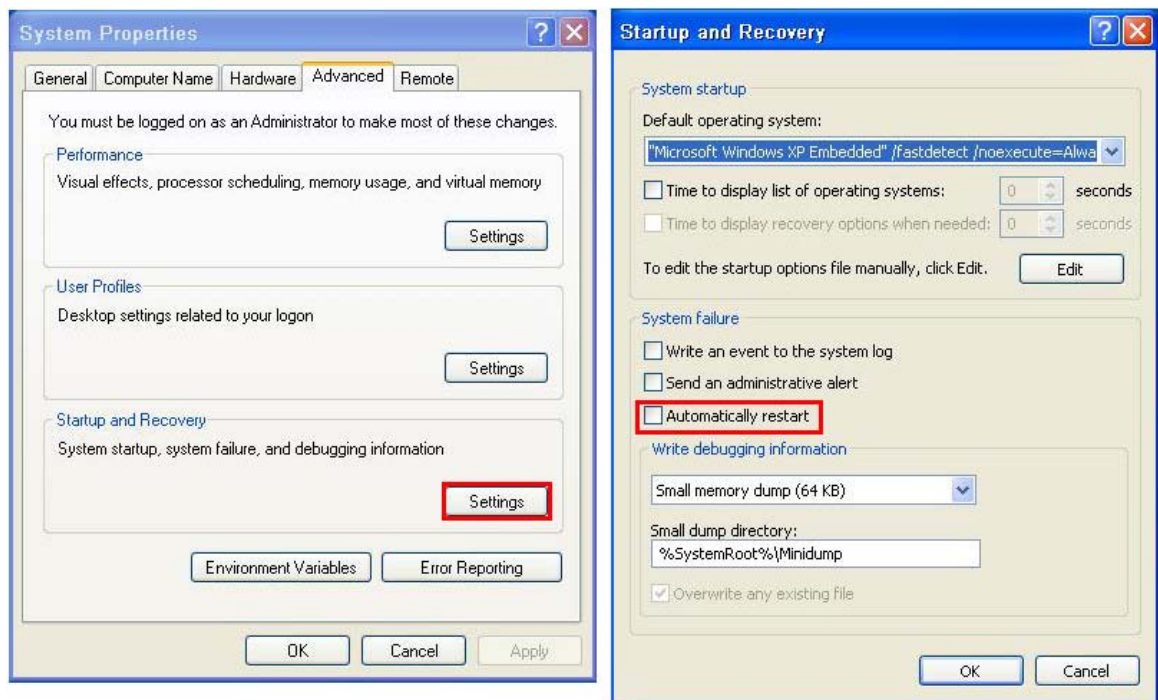

Figure B-23: Disable Automatically Restart

WAFER-CV-D25502/N26002 3.5" Motherboard

Step 4: Reboot the system from the recovery CD. When prompted, press any key to boot from the recovery CD. It will take a while to launch the recovery tool. Please be patient!

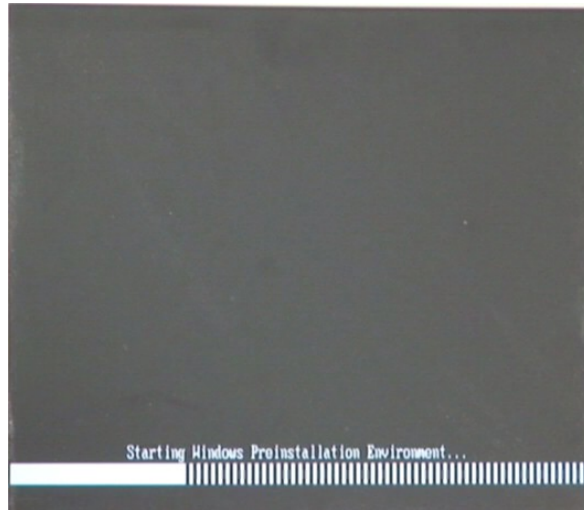

Figure B-24: Launching the Recovery Tool

Step 5: When the recovery tool setup menu appears, press <4> then <Enter>.

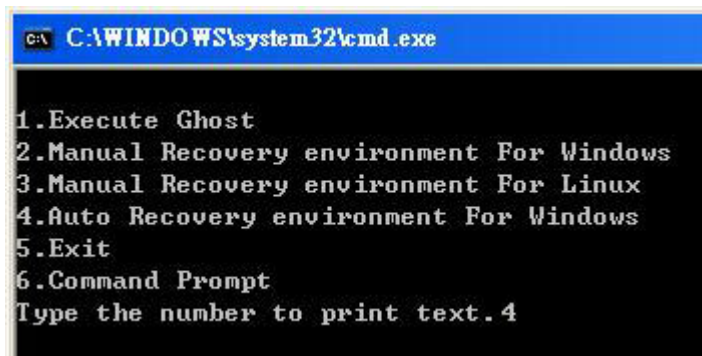

Figure B-25: Auto Recovery Environment for Windows

Step 6: The Symantec Ghost window appears and starts configuring the system to build an auto recovery partition. In this process the partition created for recovery files in **Section B.2.2** is hidden and the auto recovery tool is saved in this partition.

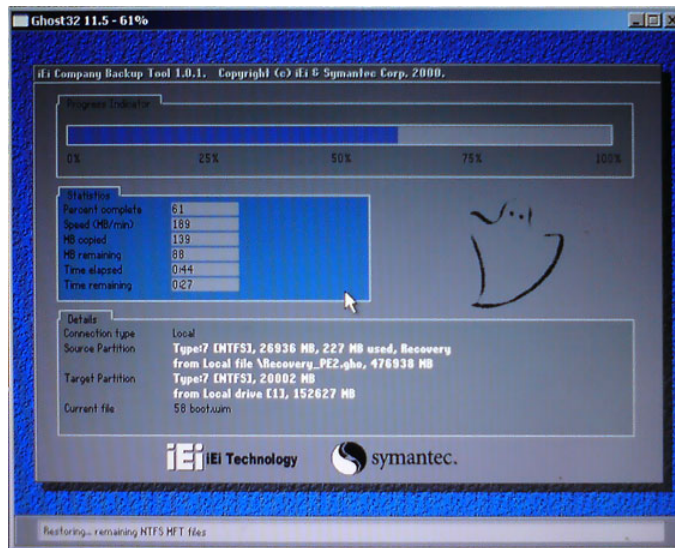

Figure B-26: Building the Auto Recovery Partition

Step 7: After completing the system configuration, the following message prompts to confirm whether to create a factory default image. Type **Y** to have the system create a factory default image automatically. Type **N** within 6 seconds to skip this process (The default option is YES). It is suggested to choose YES for this option.



Figure B-27: Factory Default Image Confirmation

WAFER-CV-D25502/N26002 3.5" Motherboard

Step 8: The Symantec Ghost starts to create the factory default image (**Figure B-28**).

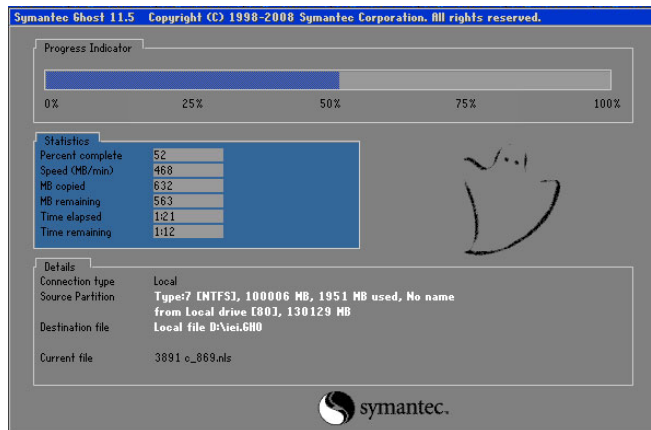

Figure B-28: Image Creation Complete

Step 9: After completing the system configuration, press any key in the following window to restart the system.

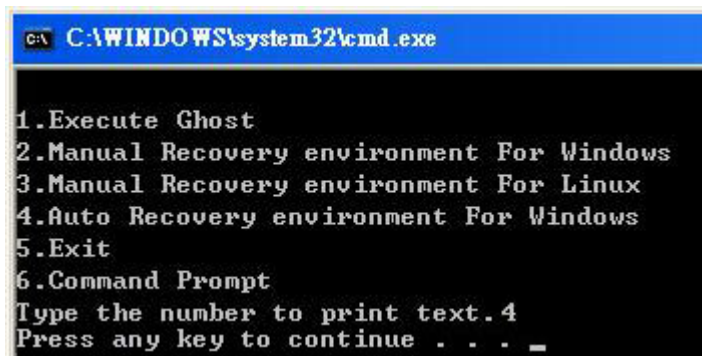

Figure B-29: Press any key to continue

Step 10: Eject the One Key Recovery CD and restart the system.

Step 11: Press the <DELETE> key as soon as the system is turned on to enter the BIOS.

Step 12: Enable the Auto Recovery Function option (**Advanced** → **iEi Feature** → **Auto Recovery Function**).

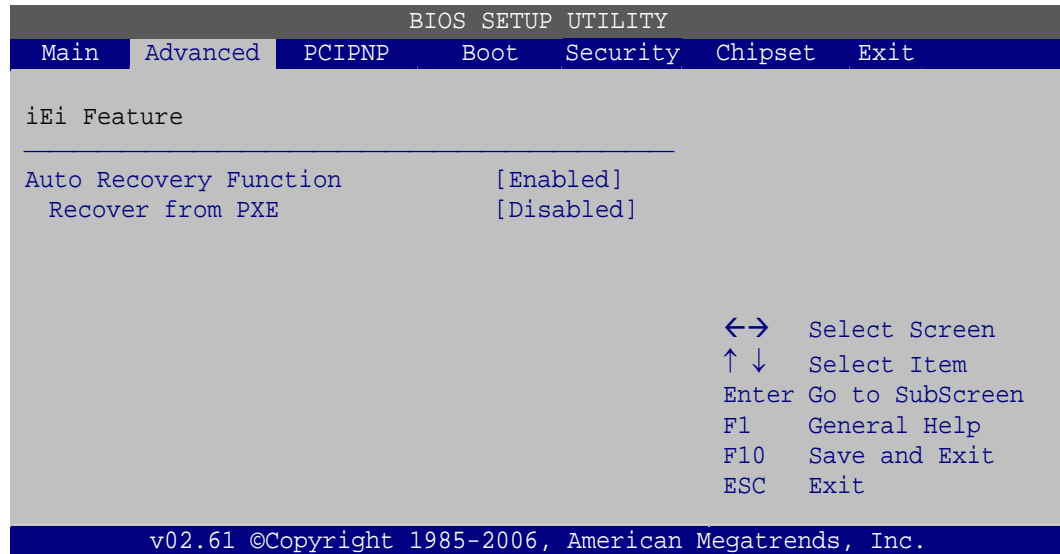

Figure B-30: IEI Feature

Step 13: Save changes and restart the system. If the system encounters a Blue Screen of Death (BSoD) or a hang for around 10 minutes, it will automatically restore from the factory default image.

B.4 Setup Procedure for Linux

The initial setup procedures for a Linux system are mostly the same with the procedure for Microsoft Windows. Please follow the steps below to setup the recovery tool for Linux OS.

Step 1: Hardware and BIOS setup. Refer to **Section B.2.1**.

Step 2: Install Linux operating system. Make sure to install GRUB (v0.97 or earlier) MBR type and Ext3 partition type. Leave enough space on the hard drive to create the recover partition later.



NOTE:

If the Linux OS is not installed with GRUB (v0.97 or earlier) and Ext3, the Symantec Ghost may not function properly.

While installing Linux OS, please create two partitions:

WAFER-CV-D25502/N26002 3.5" Motherboard

- Partition 1: /
- Partition 2: **SWAP**



NOTE:

Please reserve enough space for partition 3 for saving recovery images.

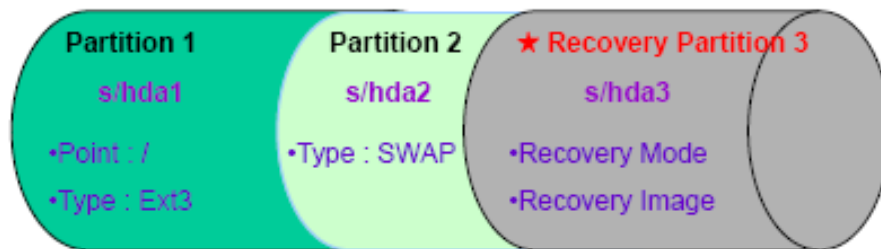

Figure B-31: Partitions for Linux

Step 3: Create a recovery partition. Insert the recovery CD into the optical disk drive.

Follow **Step 1 ~ Step 3** described in **Section B.2.2**. Then type the following commands (marked in red) to create a partition for recovery images.

```
system32>diskpart
DISKPART>list vol
DISKPART>sel disk 0
DISKPART>create part pri size= ____
DISKPART>assign letter=N
DISKPART>exit
system32>format N: /fs:ntfs /q /v:Recovery /y
system32>exit
```

Step 4: Build-up recovery partition. Press any key to boot from the recovery CD. It will take a while to launch the recovery tool. Please be patient. When the recovery tool setup menu appears, type <3> and press <Enter> (**Figure B-32**). The Symantec Ghost window appears and starts configuring the system to build-up a

recovery partition. After completing the system configuration, press any key to reboot the system. Eject the recovery CD.

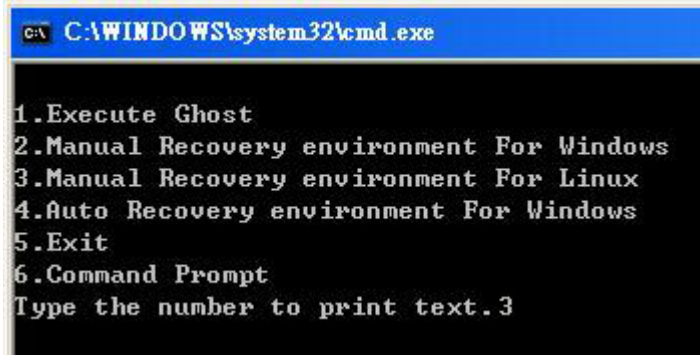

```

C:\WINDOWS\system32\cmd.exe

1.Execute Ghost
2.Manual Recovery environment For Windows
3.Manual Recovery environment For Linux
4.Auto Recovery environment For Windows
5.Exit
6.Command Prompt
Type the number to print text.3
    
```

Figure B-32: System Configuration for Linux

Step 5: Access the recovery tool main menu by modifying the “menu.lst”. To first access the recovery tool main menu, the menu.lst must be modified. In Linux, enter Administrator (root). When prompt appears, type:

cd /boot/grub

vi menu.lst

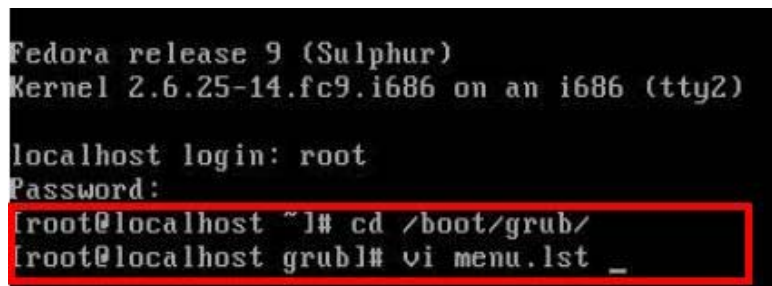

```

Fedora release 9 (Sulphur)
Kernel 2.6.25-14.fc9.i686 on an i686 (tty2)

localhost login: root
Password:
[root@localhost ~]# cd /boot/grub/
[root@localhost grub]# vi menu.lst
    
```

Figure B-33: Access menu.lst in Linux (Text Mode)

Step 6: Modify the menu.lst as shown below.

```
#boot=/dev/sda
default=0
timeout=10 ← Modify timeout=10
splashimage=(hd0,0)/grub/splash.xpm.gz
hiddenmenu
title Fedora (2.6.25-14.fc9.i686)
    root (hd0,0)
    kernel /vmlinuz-2.6.25-14.fc9.i686 ro root=UUID=10f1acd
ac38b5c78910 rhgb quiet
    initrd /initrd-2.6.25-14.fc9.i686.img

title Recovery Partition
root (hd0,2)
makeactive ← Type command
chainloader +1
```

- Type command:
title Recovery Partition
root (hd0,2)
makeactive
chainloader +1

Step 7: The recovery tool menu appears. (Figure B-34)

```
1. Factory Restore
2. Backup system
3. Restore your last backup.
4. Manual
5. Quit
Please type the number to select and then press Enter:
```

Figure B-34: Recovery Tool Menu

Step 8: Create a factory default image. Follow **Step 2 ~ Step 12** described in **Section B.2.5** to create a factory default image.

B.5 Recovery Tool Functions

After completing the initial setup procedures as described above, users can access the recovery tool by pressing **<F3>** while booting up the system. However, if the setup procedure in Section B.3 has been completed and the auto recovery function is enabled, the system will automatically restore from the factory default image without pressing the F3 key. The recovery tool main menu is shown below.

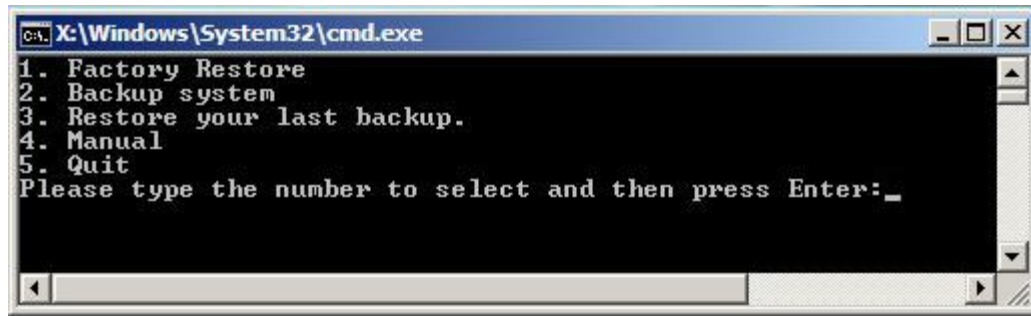

Figure B-35: Recovery Tool Main Menu

The recovery tool has several functions including:

1. **Factory Restore:** Restore the factory default image (iei.GHO) created in **Section B.2.5**.
2. **Backup system:** Create a system backup image (iei_user.GHO) which will be saved in the hidden partition.
3. **Restore your last backup:** Restore the last system backup image
4. **Manual:** Enter the Symantec Ghost window to configure manually.
5. **Quit:** Exit the recovery tool and restart the system.



WARNING:

Please do not turn off the system power during the process of system recovery or backup.



WARNING:

All data in the system will be deleted during the system recovery. Please backup the system files before restoring the system (either Factory Restore or Restore Backup).

WAFER-CV-D25502/N26002 3.5" Motherboard

B.5.1 Factory Restore

To restore the factory default image, please follow the steps below.

Step 1: Type <1> and press <Enter> in the main menu.

Step 2: The Symantec Ghost window appears and starts to restore the factory default. A factory default image called **iei.GHO** is created in the hidden Recovery partition.

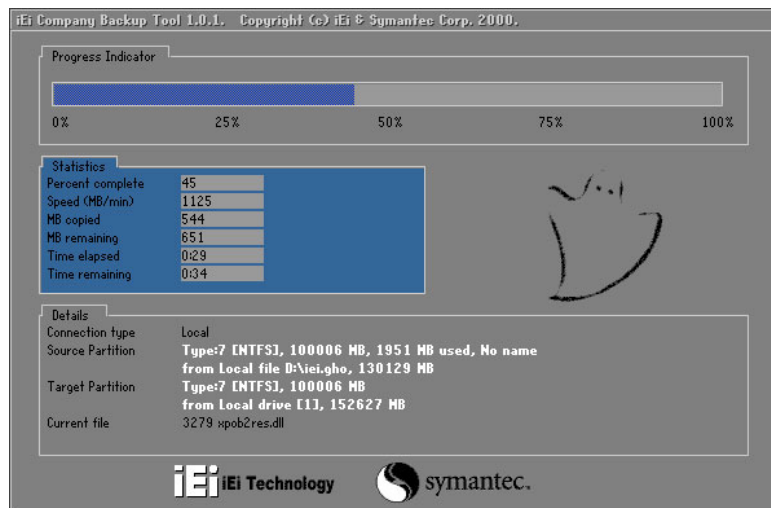

Figure B-36: Restore Factory Default

Step 3: The screen is shown in **Figure B-37** appears when completed. Press any key to reboot the system.

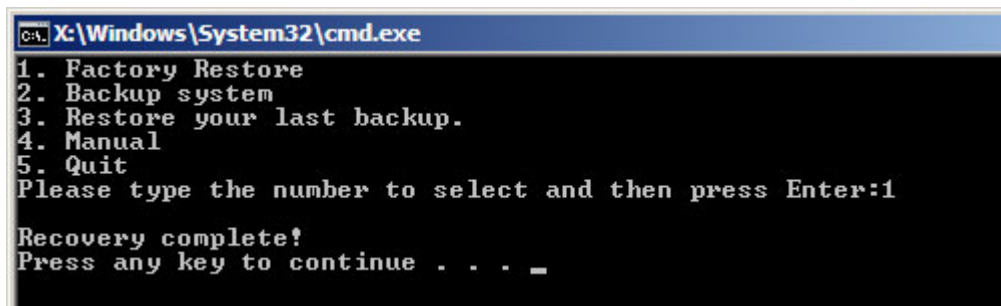

Figure B-37: Recovery Complete Window

B.5.2 Backup System

To backup the system, please follow the steps below.

Step 1: Type <2> and press <Enter> in the main menu.

Step 2: The Symantec Ghost window appears and starts to backup the system. A backup image called `iei_user.GHO` is created in the hidden Recovery partition.

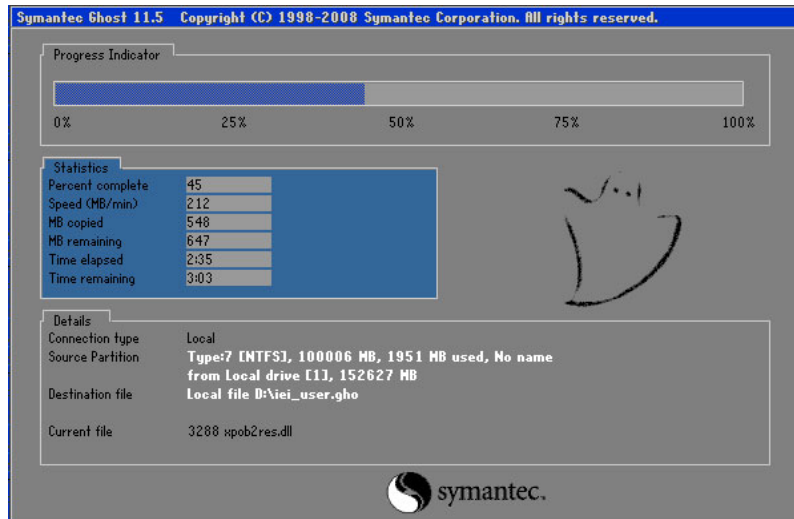

Figure B-38: Backup System

Step 3: The screen is shown in **Figure B-39** appears when system backup is complete. Press any key to reboot the system.

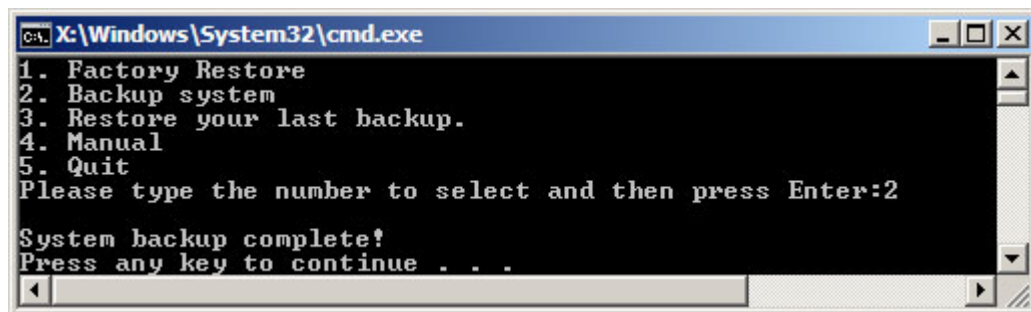

Figure B-39: System Backup Complete Window

WAFER-CV-D25502/N26002 3.5" Motherboard

B.5.3 Restore Your Last Backup

To restore the last system backup, please follow the steps below.

Step 1: Type <3> and press <Enter> in the main menu.

Step 2: The Symantec Ghost window appears and starts to restore the last backup image (iei_user.GHO).

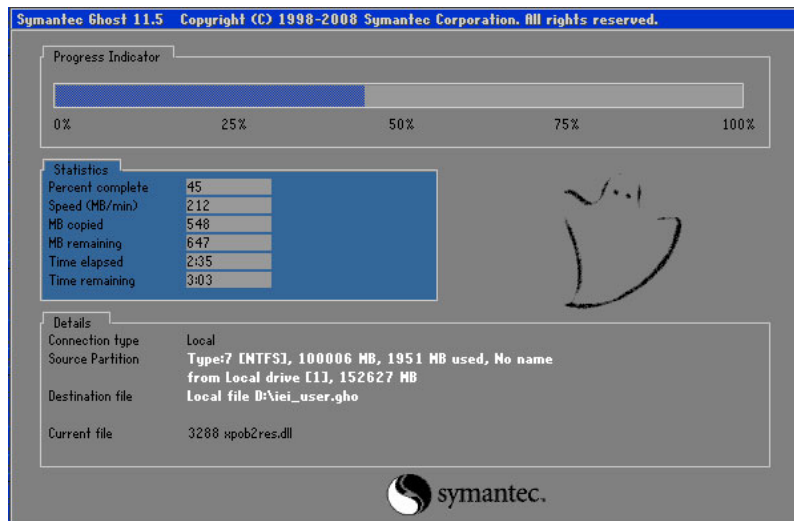

Figure B-40: Restore Backup

Step 3: The screen shown in **Figure B-41** appears when backup recovery is complete. Press any key to reboot the system.

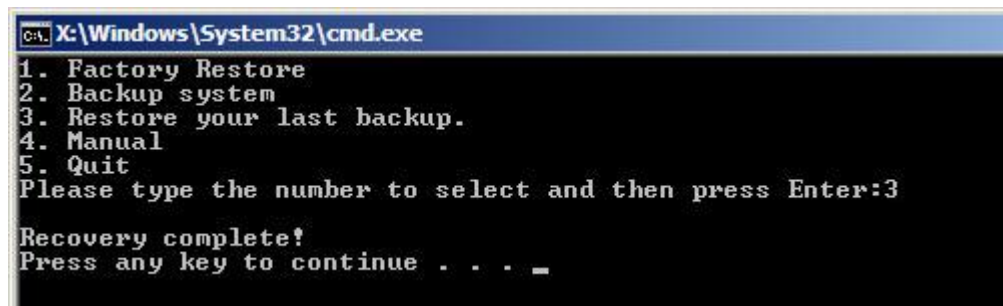

Figure B-41: Restore System Backup Complete Window

B.5.4 Manual

To restore the last system backup, please follow the steps below.

Step 1: Type <4> and press <Enter> in the main menu.

Step 2: The Symantec Ghost window appears. Use the Ghost program to backup or recover the system manually.

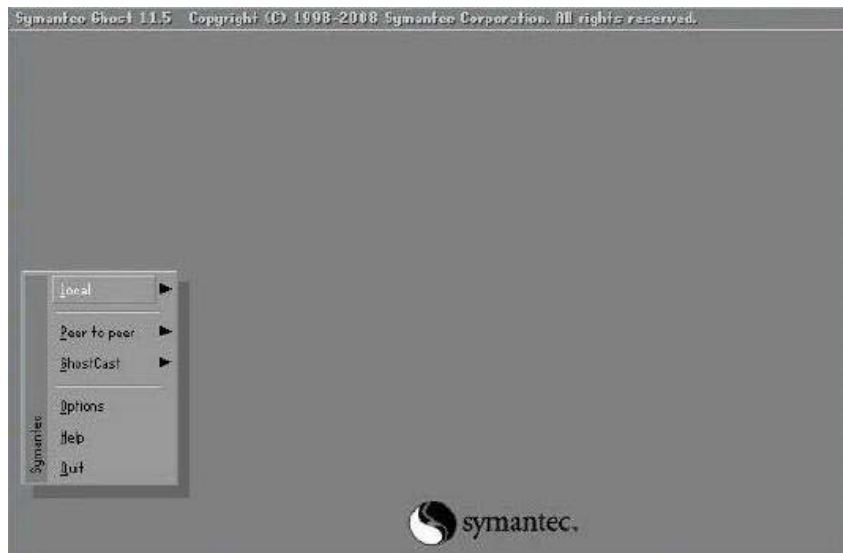
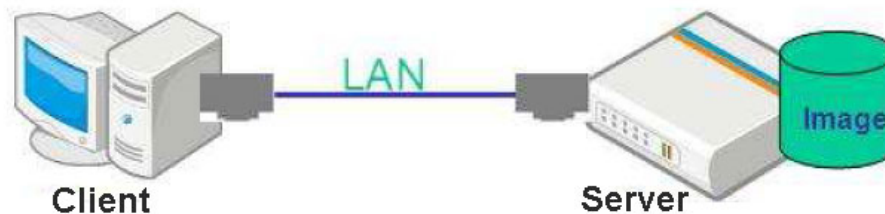

Figure B-42: Symantec Ghost Window

Step 3: When backup or recovery is completed, press any key to reboot the system.

B.6 Restore Systems from a Linux Server through LAN

The One Key Recovery allows a client system to automatically restore to a factory default image saved in a Linux system (the server) through LAN connectivity after encountering a Blue Screen of Death (BSoD) or a hang for around 10 minutes. To be able to use this function, the client system and the Linux system MUST reside in the same domain.



CAUTION:

The supported client OS includes:

- Windows 2000
- Windows XP
- Windows Vista
- Windows 7
- Windows XP Embedded
- Windows Embedded Standard 7

Prior to restoring client systems from a Linux server, a few setup procedures are required.

Step 1: Configure DHCP server settings

Step 2: Configure TFTP settings

Step 3: Configure One Key Recovery server settings

Step 4: Start DHCP, TFTP and HTTP

Step 5: Create a shared directory

Step 6: Setup a client system for auto recovery

The detailed descriptions are described in the following sections. In this document, two types of Linux OS are used as examples to explain the configuration process – CentOS 5.5 (Kernel 2.6.18) and Debian 5.0.7 (Kernel 2.6.26).

B.6.1 Configure DHCP Server Settings

Step 1: Install the DHCP

`#yum install dhcp` (CentOS, commands marked in red)

`#apt-get install dhcp3-server` (Debian, commands marked in blue)

Step 2: Confirm the operating system default settings: dhcpd.conf.

CentOS

Use the following command to show the DHCP server sample location:

`#vi /etc/dhcpd.conf`

The DHCP server sample location is shown as below:

```
# DHCP Server Configuration file.
# see /usr/share/doc/dhcp*/dhcpd.conf.sample
#
```

Use the following command to copy the DHCP server sample to etc/dhcpd.conf:

`#cp /usr/share/doc/dhcp-3.0.5/dhcpd.conf.sample /etc/dhcpd.conf`

`#vi /etc/dhcpd.conf`

```
ddns-update-style interim;
ignore client-updates;

subnet 192.168.0.0 netmask 255.255.255.0 {
# --- default gateway
    option routers                192.168.0.2;
    option subnet-mask            255.255.255.0;

    option nis-domain             "domain.org";
    option domain-name           "domain.org";
    option domain-name-servers   192.168.0.1;
    next-server 192.168.0.6;
    filename "pxelinux.0";
    option time-offset            -18000; # Eastern Standard Time
    option ntp-servers            192.168.1.1;
    option netbios-name-servers  192.168.1.1;
}
```

Debian

`#vi /etc/dhcpd.conf`

Edit “/etc/dhcpd.conf” for your environment. For example, add

`next-server PXE server IP address;`

filename "pxelinux.0";

```
ddns-update-style interim;
ignore client-updates;

subnet 192.168.0.0 netmask 255.255.255.0 {
# --- default gateway
    option routers                192.168.0.2;
    option subnet-mask            255.255.255.0;

    option nis-domain             "domain.org";
    option domain-name            "domain.org";
    option domain-name-servers   192.168.0.1;
    next-server 192.168.0.6;
    filename "pxelinux.0";
    option time-offset            -18000; # Eastern Standard Time
    option ntp-servers            192.168.1.1;
}
```

B.6.2 Configure TFTP Settings

Step 1: Install the tftp, httpd and syslinux.

`#yum install tftp-server httpd syslinux` (CentOS)

`#apt-get install tftpd-hpa xinetd syslinux` (Debian)

Step 2: Enable the TFTP server by editing the "/etc/xinetd.d/tftp" file and make it use the remap file. The "-vvv" is optional but it could definitely help on getting more information while running the remap file. For example:

CentOS

`#vi /etc/xinetd.d/tftp`

Modify:

`disable = no`

`server_args = -s /tftpboot -m /tftpboot/tftpd.remap -vvv_`

```
socket_type      = dgram
protocol        = udp
wait            = yes
user            = root
server          = /usr/sbin/in.tftpd
server_args     = -s /tftpboot -m /tftpboot/tftpd.remap -vvv
disable         = no
per_source      = 11
cps             = 100 2
flags           = IPv4
```

Debian

Replace the TFTP settings from “inetd” to “xinetd” and annotate the “inetd” by adding “#”.

`#vi /etc/inetd.conf`

Modify: `#tftp dgram udp wait root /usr/sbin.....` (as shown below)

```
#:BOOT: TFTP service is provided primarily for booting. Most sites
# run this only on machines acting as "boot servers."
#tftp dgram udp wait root /usr/sbin/in.tftpd /usr/sbin/in.tftpd -s
/var/lib/tftpboot
```

`#vi /etc/xinetd.d/tftp`

```
socket_type      = dgram
protocol        = udp
wait            = yes
user            = root
server          = /usr/sbin/in.tftpd
server_args     = -s /tftpboot -n /tftpboot/tftpd.remap -vvv
disable         = no
per_source      = 11
cps             = 100 2
flags           = IPv4
```

B.6.3 Configure One Key Recovery Server Settings

Step 1: Copy the **Utility/RECOVERYR10.TAR.BZ2** package from the One Key Recovery CD to the system (server side).



Step 2: Extract the recovery package to /.

```
#cp RecoveryR10.tar.bz2 /
#cd /
#tar -xvzf RecoveryR10.tar.bz2
```

Step 3: Copy “pxelinux.0” from “syslinux” and install to “tftpboot”.

```
#cp /usr/lib/syslinux/pxelinux.0 /tftpboot/
```

WAFER-CV-D25502/N26002 3.5" Motherboard

B.6.4 Start the DHCP, TFTP and HTTP

Start the DHCP, TFTP and HTTP. For example:

CentOS

```
#service xinetd restart
```

```
#service httpd restart
```

```
#service dhcpd restart
```

Debian

```
#/etc/init.d/xinetd reload
```

```
#/etc/init.d/xinetd restart
```

```
#/etc/init.d/dhcp3-server restart
```

B.6.5 Create Shared Directory

Step 1: Install the samba.

```
#yum install samba
```

Step 2: Create a shared directory for the factory default image.

```
#mkdir /share
```

```
#cd /share
```

```
#mkdir /image
```

```
#cp iei.gho /image
```



WARNING:

The file name of the factory default image must be **iei.gho**.

Step 3: Confirm the operating system default settings: smb.conf.

```
#vi /etc/samba/smb.conf
```

Modify:

[image]

```
comment = One Key Recovery
```

```
path = /share/image
```

```
browseable = yes
```

```
writable = yes
```

```
public = yes
```

```
create mask = 0644
```

```
directory mask = 0755
```

Step 4: Edit “/etc/samba/smb.conf” for your environment. For example:

```
# "security = user" is always a good idea. This will require a Unix account
# in this server for every user accessing the server. See
# /usr/share/doc/samba-doc/htmldocs/Samba3-HOWTO/ServerType.html
# in the samba-doc package for details.
security = share
```

```
[image]
comment = One Key Recovery
path = /share/image
browseable = yes
writable = yes
public = yes
create mask = 0644
directory mask = 0755
```

Step 5: Modify the hostname

```
#vi /etc/hostname
```

Modify: RecoveryServer

```
RecoveryServer
```

B.6.6 Setup a Client System for Auto Recovery

Step 1: Disable the automatically restart function before creating the factory default image. Go to: My Computer → Properties → Advanced. Click the Settings button of Startup and Recovery. Deselect “Automatically restart”. Click OK to save the settings and exit. (See **Figure B-43**)

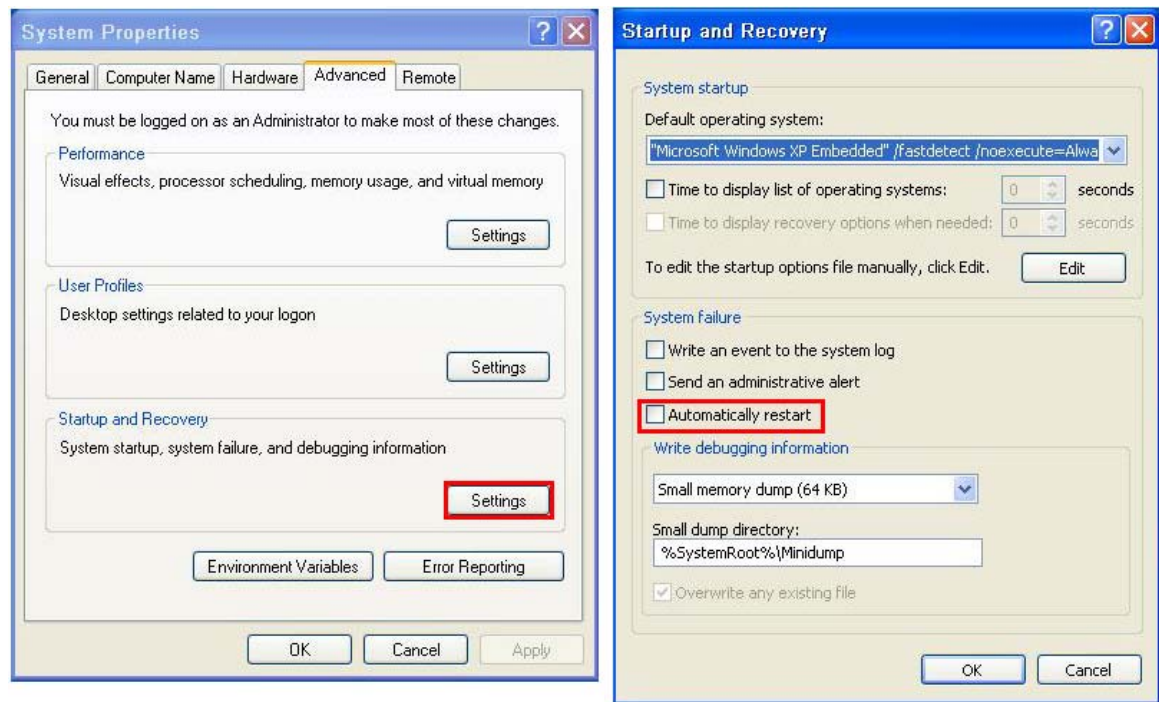

Figure B-43: Disable Automatically Restart

Step 2: Configure the following BIOS options of the client system.

Advanced → iEi Feature → Auto Recovery Function → **Enabled**

Advanced → iEi Feature → Recover from PXE → **Enabled**

Boot → Launch PXE OpROM → **Enabled**

Step 3: Continue to configure the **Boot Option Priorities** BIOS option of the client system:

Boot Option #1 → remain the default setting to boot from the original OS.

Boot Option #2 → select the boot from LAN option.

Step 4: Save changes and exit BIOS menu.

Exit → **Save Changes and Exit**

Step 5: Install the auto recovery utility into the system by double clicking the **Utility/AUTORECOVERY-SETUP.exe** in the One Key Recovery CD. This utility **MUST** be installed in the system, otherwise, the system will automatically restore from the factory default image every ten (10) minutes.



Step 6: Restart the client system from LAN. If the system encounters a Blue Screen of Death (BSoD) or a hang for around 10 minutes, it will automatically restore from the factory default image. The following screens will show when the system starts auto recovering.

```
Realtek PCIe GBE Family Controller Series v2.35 (06/14/10)
CLIENT MAC ADDR: 00 18 7D 13 E6 89  GUID: 00020003-0004-0005-0006-0007000000
DHCP . ./
```

```
My IP address seems to be C0A80009 192.168.0.9
ip=192.168.0.9:192.168.0.8:192.168.0.2:255.255.255.0
TFTP prefix:
Trying to load: pxelinux.cfg/00020003-0004-0005-0006-000700000009
Trying to load: pxelinux.cfg/01-00-18-7d-13-e6-89
Trying to load: pxelinux.cfg/C0A80009
Trying to load: pxelinux.cfg/C0A8000
Trying to load: pxelinux.cfg/C0A800
Trying to load: pxelinux.cfg/C0A80
Trying to load: pxelinux.cfg/C0A8
Trying to load: pxelinux.cfg/C0A
Trying to load: pxelinux.cfg/C0
Trying to load: pxelinux.cfg/C
Trying to load: pxelinux.cfg/default
boot:
```

```
Windows is loading files...
IP: 192.168.0.8, File: \Boot\WinPE.wim
```

WAFER-CV-D25502/N26002 3.5" Motherboard

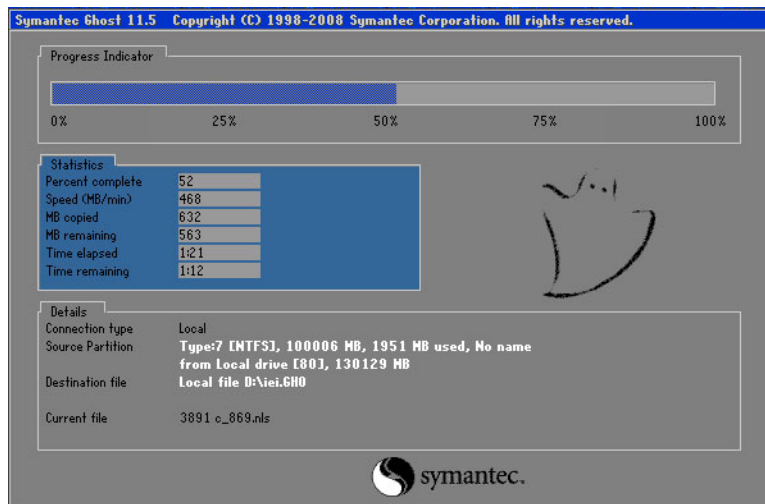

NOTE:

A firewall or a SELinux is not in use in the whole setup process described above. If there is a firewall or a SELinux protecting the system, modify the configuration information to accommodate them.

B.7 Other Information

B.7.1 Using AHCI Mode or ALi M5283 / VIA VT6421A Controller

When the system uses AHCI mode or some specific SATA controllers such as ALi M5283 or VIA VT6421A, the SATA RAID/AHCI driver must be installed before using one key recovery. Please follow the steps below to install the SATA RAID/AHCI driver.

Step 1: Copy the SATA RAID/AHCI driver to a floppy disk and insert the floppy disk into a USB floppy disk drive. The SATA RAID/AHCI driver must be especially designed for the on-board SATA controller.

Step 2: Connect the USB floppy disk drive to the system.

Step 3: Insert the One Key Recovery CD into the system and boot the system from the CD.

Step 4: When launching the recovery tool, press <F6>.

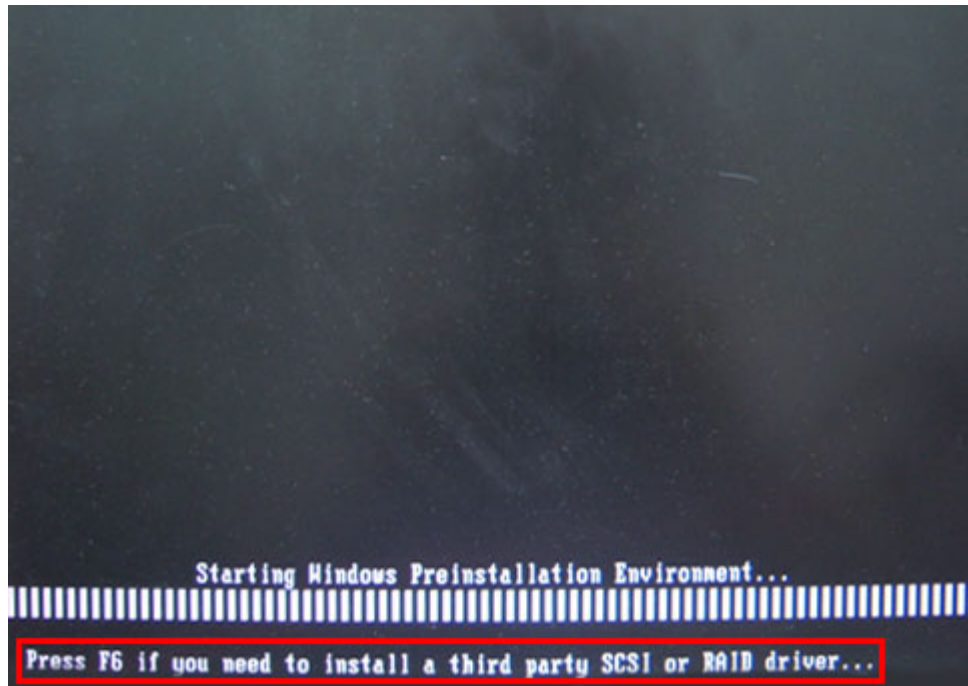

Step 5: When the following window appears, press <S> to select “Specify Additional Device”.

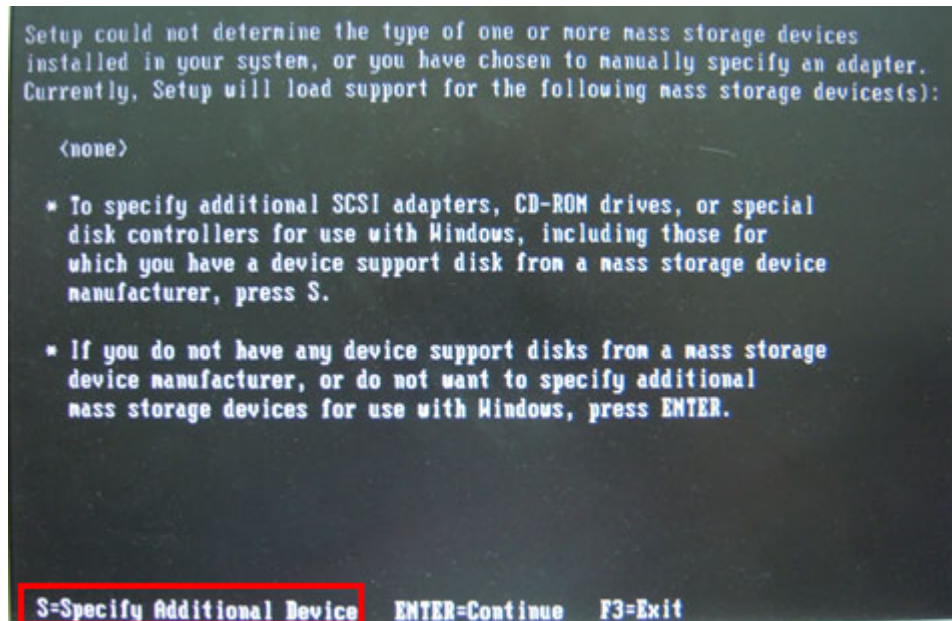

WAFER-CV-D25502/N26002 3.5" Motherboard

Step 6: In the following window, select a SATA controller mode used in the system. Then press <Enter>. The user can now start using the SATA HDD.

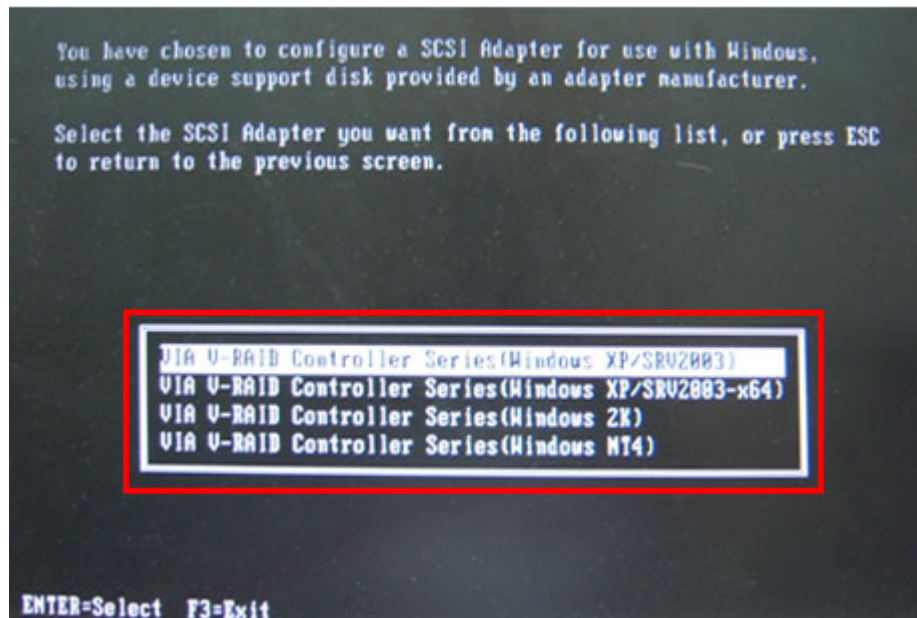

Step 7: After pressing <Enter>, the system will get into the recovery tool setup menu. Continue to follow the setup procedure from **Step 4** in **Section B.2.2 Create Partitions** to finish the whole setup process.

B.7.2 System Memory Requirement

To be able to access the recovery tool by pressing <F3> while booting up the system, please make sure to have enough system memory. The minimum memory requirement is listed below.

- **Using Award BIOS:** 128 MB system memory
- **Using AMI BIOS:** 512 MB system memory.



Appendix

C

Terminology

WAFER-CV-D25502/N26002 3.5" Motherboard

AC '97	Audio Codec 97 (AC'97) refers to a codec standard developed by Intel® in 1997.
ACPI	Advanced Configuration and Power Interface (ACPI) is an OS-directed configuration, power management, and thermal management interface.
AHCI	Advanced Host Controller Interface (AHCI) is a SATA Host controller register-level interface.
ATA	The Advanced Technology Attachment (ATA) interface connects storage devices including hard disks and CD-ROM drives to a computer.
ARMD	An ATAPI Removable Media Device (ARMD) is any ATAPI device that supports removable media, besides CD and DVD drives.
ASKIR	Amplitude Shift Keyed Infrared (ASKIR) is a form of modulation that represents a digital signal by varying the amplitude ("volume") of the signal. A low amplitude signal represents a binary 0, while a high amplitude signal represents a binary 1.
BIOS	The Basic Input/Output System (BIOS) is firmware that is first run when the computer is turned on and can be configured by the end user
CODEC	The Compressor-Decompressor (CODEC) encodes and decodes digital audio data on the system.
CMOS	Complimentary metal-oxide-conductor is an integrated circuit used in chips like static RAM and microprocessors.
COM	COM refers to serial ports. Serial ports offer serial communication to expansion devices. The serial port on a personal computer is usually a male DB-9 connector.
DAC	The Digital-to-Analog Converter (DAC) converts digital signals to analog signals.
DDR	Double Data Rate refers to a data bus transferring data on both the rising and falling edges of the clock signal.
DMA	Direct Memory Access (DMA) enables some peripheral devices to bypass the system processor and communicate directly with the system memory.

DIMM	Dual Inline Memory Modules are a type of RAM that offer a 64-bit data bus and have separate electrical contacts on each side of the module.
DIO	The digital inputs and digital outputs are general control signals that control the on/off circuit of external devices or TTL devices. Data can be read or written to the selected address to enable the DIO functions.
EHCI	The Enhanced Host Controller Interface (EHCI) specification is a register-level interface description for USB 2.0 Host Controllers.
EIDE	Enhanced IDE (EIDE) is a newer IDE interface standard that has data transfer rates between 4.0 MBps and 16.6 MBps.
EIST	Enhanced Intel® SpeedStep Technology (EIST) allows users to modify the power consumption levels and processor performance through application software. The application software changes the bus-to-core frequency ratio and the processor core voltage.
FSB	The Front Side Bus (FSB) is the bi-directional communication channel between the processor and the Northbridge chipset.
GbE	Gigabit Ethernet (GbE) is an Ethernet version that transfers data at 1.0 Gbps and complies with the IEEE 802.3-2005 standard.
GPIO	General purpose input
HDD	Hard disk drive (HDD) is a type of magnetic, non-volatile computer storage device that stores digitally encoded data.
ICH	The Input/Output Control Hub (ICH) is an Intel® Southbridge chipset.
IrDA	Infrared Data Association (IrDA) specify infrared data transmission protocols used to enable electronic devices to wirelessly communicate with each other.
L1 Cache	The Level 1 Cache (L1 Cache) is a small memory cache built into the system processor.
L2 Cache	The Level 2 Cache (L2 Cache) is an external processor memory cache.
LCD	Liquid crystal display (LCD) is a flat, low-power display device that consists of two polarizing plates with a liquid crystal panel in between.

WAFER-CV-D25502/N26002 3.5" Motherboard

LVDS	Low-voltage differential signaling (LVDS) is a dual-wire, high-speed differential electrical signaling system commonly used to connect LCD displays to a computer.
POST	The Power-on Self Test (POST) is the pre-boot actions the system performs when the system is turned-on.
RAM	Random Access Memory (RAM) is volatile memory that loses data when power is lost. RAM has very fast data transfer rates compared to other storage like hard drives.
SATA	Serial ATA (SATA) is a serial communications bus designed for data transfers between storage devices and the computer chipsets. The SATA bus has transfer speeds up to 1.5 Gbps and the SATA II bus has data transfer speeds of up to 3.0 Gbps.
S.M.A.R.T	Self Monitoring Analysis and Reporting Technology (S.M.A.R.T) refers to automatic status checking technology implemented on hard disk drives.
UART	Universal Asynchronous Receiver-transmitter (UART) is responsible for asynchronous communications on the system and manages the system's serial communication (COM) ports.
UHCI	The Universal Host Controller Interface (UHCI) specification is a register-level interface description for USB 1.1 Host Controllers.
USB	The Universal Serial Bus (USB) is an external bus standard for interfacing devices. USB 1.1 supports 12Mbps data transfer rates and USB 2.0 supports 480Mbps data transfer rates.
VGA	The Video Graphics Array (VGA) is a graphics display system developed by IBM.

Appendix

D

Digital I/O Interface

D.1 Introduction

The DIO connector on the WAFER-CV-D25502/N26002 is interfaced to GPIO ports on the Super I/O chipset. The DIO has both 4-bit digital inputs and 4-bit digital outputs. The digital inputs and digital outputs are generally control signals that control the on/off circuit of external devices or TTL devices. Data can be read or written to the selected address to enable the DIO functions.



NOTE:

For further information, please refer to the datasheet for the Super I/O chipset.

D.2 DIO Connector Pinouts

The following table describes how the DIO connector pins are connected to the Super I/O GPIO port 1.

Pin	Description	Super I/O Pin	Super I/O Pin Description
1	Ground	N/A	N/A
2	VCC	N/A	N/A
3	Output 3	GP27	General purpose I/O port 2 bit 7.
4	Output 2	GP26	General purpose I/O port 2 bit 6.
5	Output 1	GP25	General purpose I/O port 2 bit 5.
6	Output 0	GP24	General purpose I/O port 2 bit 4.
7	Input 3	GP23	General purpose I/O port 2 bit 3.
8	Input 2	GP22	General purpose I/O port 2 bit 2
9	Input 1	GP21	General purpose I/O port 2 bit 1
10	Input 0	GP20	General purpose I/O port 2 bit 0

Table D-1: Digital I/O Connector Pinouts

D.3 Assembly Language Samples

D.3.1 Enable the DIO Input Function

The BIOS interrupt call INT 15H controls the digital I/O. An assembly program to enable digital I/O input functions is listed below.

MOV	AX, 6F08H	Sets the digital port as input
INT	15H	Initiates the INT 15H BIOS call

D.3.2 Enable the DIO Output Function

The BIOS interrupt call INT 15H controls the digital I/O. An assembly program to enable digital I/O output functions is listed below.

MOV	AX, 6F09H	Sets the digital port as output
MOV	BL, 09H	
INT	15H	Initiates the INT 15H BIOS call

Appendix

E

Watchdog Timer



NOTE:

The following discussion applies to DOS environment. Contact IEI support or visit the IEI website for specific drivers for other operating systems.

The Watchdog Timer is provided to ensure that standalone systems can always recover from catastrophic conditions that cause the CPU to crash. This condition may have occurred by external EMIs or a software bug. When the CPU stops working correctly, Watchdog Timer either performs a hardware reset (cold boot) or a Non-Maskable Interrupt (NMI) to bring the system back to a known state.

A BIOS function call (INT 15H) is used to control the Watchdog Timer.

INT 15H:

AH – 6FH Sub-function:	
AL – 2:	Sets the Watchdog Timer’s period.
BL:	Time-out value (Its unit-second is dependent on the item “Watchdog Timer unit select” in CMOS setup).

Table E-1: AH-6FH Sub-function

Call sub-function 2 to set the time-out period of Watchdog Timer first. If the time-out value is not zero, the Watchdog Timer starts counting down. When the timer value reaches zero, the system resets. To ensure that this reset condition does not occur, calling sub-function 2 must periodically refresh the Watchdog Timer. However, the watchdog timer is disabled if the time-out value is set to zero.

A tolerance of at least 10% must be maintained to avoid unknown routines within the operating system (DOS), such as disk I/O that can be very time-consuming.



NOTE:

When exiting a program it is necessary to disable the Watchdog Timer, otherwise the system resets.

EXAMPLE PROGRAM:

; INITIAL TIMER PERIOD COUNTER

;

W_LOOP:

;

```

MOV     AX, 6F02H      ;setting the time-out value
MOV     BL, 30         ;time-out value is 48 seconds
INT     15H

```

;

; ADD THE APPLICATION PROGRAM HERE

;

```

CMP     EXIT_AP, 1     ;is the application over?
JNE     W_LOOP         ;No, restart the application

MOV     AX, 6F02H      ;disable Watchdog Timer
MOV     BL, 0          ;
INT     15H

```

;

; EXIT ;



Appendix

F

Hazardous Materials Disclosure

F.1 Hazardous Materials Disclosure Table for IPB Products Certified as RoHS Compliant Under 2002/95/EC Without Mercury

The details provided in this appendix are to ensure that the product is compliant with the Peoples Republic of China (China) RoHS standards. The table below acknowledges the presences of small quantities of certain materials in the product, and is applicable to China RoHS only.

A label will be placed on each product to indicate the estimated “Environmentally Friendly Use Period” (EFUP). This is an estimate of the number of years that these substances would “not leak out or undergo abrupt change.” This product may contain replaceable sub-assemblies/components which have a shorter EFUP such as batteries and lamps. These components will be separately marked.

Please refer to the table on the next page.

Part Name	Toxic or Hazardous Substances and Elements					
	Lead (Pb)	Mercury (Hg)	Cadmium (Cd)	Hexavalent Chromium (CR(VI))	Polybrominated Biphenyls (PBB)	Polybrominated Diphenyl Ethers (PBDE)
Housing	X	O	O	O	O	X
Display	X	O	O	O	O	X
Printed Circuit Board	X	O	O	O	O	X
Metal Fasteners	X	O	O	O	O	O
Cable Assembly	X	O	O	O	O	X
Fan Assembly	X	O	O	O	O	X
Power Supply Assemblies	X	O	O	O	O	X
Battery	O	O	O	O	O	O

O: This toxic or hazardous substance is contained in all of the homogeneous materials for the part is below the limit requirement in SJ/T11363-2006

X: This toxic or hazardous substance is contained in at least one of the homogeneous materials for this part is above the limit requirement in SJ/T11363-2006

WAFER-CV-D25502/N26002 3.5" Motherboard

此附件旨在确保本产品符合中国 RoHS 标准。以下表格标示此产品中某有毒物质的含量符合中国 RoHS 标准规定的限量要求。

本产品上会附有“环境友好使用期限”的标签，此期限是估算这些物质“不会有泄漏或突变”的年限。本产品可能包含有较短的环境友好使用期限的可替换元件，像是电池或灯管，这些元件将会单独标示出来。

部件名称	有毒有害物质或元素					
	铅 (Pb)	汞 (Hg)	镉 (Cd)	六价铬 (CR(VI))	多溴联苯 (PBB)	多溴二苯 醚 (PBDE)
壳体	X	O	O	O	O	X
显示	X	O	O	O	O	X
印刷电路板	X	O	O	O	O	X
金属螺帽	X	O	O	O	O	O
电缆组装	X	O	O	O	O	X
风扇组装	X	O	O	O	O	X
电力供应组装	X	O	O	O	O	X
电池	O	O	O	O	O	O

O: 表示该有毒有害物质在该部件所有物质材料中的含量均在 SJ/T11363-2006 标准规定的限量要求以下。
X: 表示该有毒有害物质至少在该部件的某一均质材料中的含量超出 SJ/T11363-2006 标准规定的限量要求。