

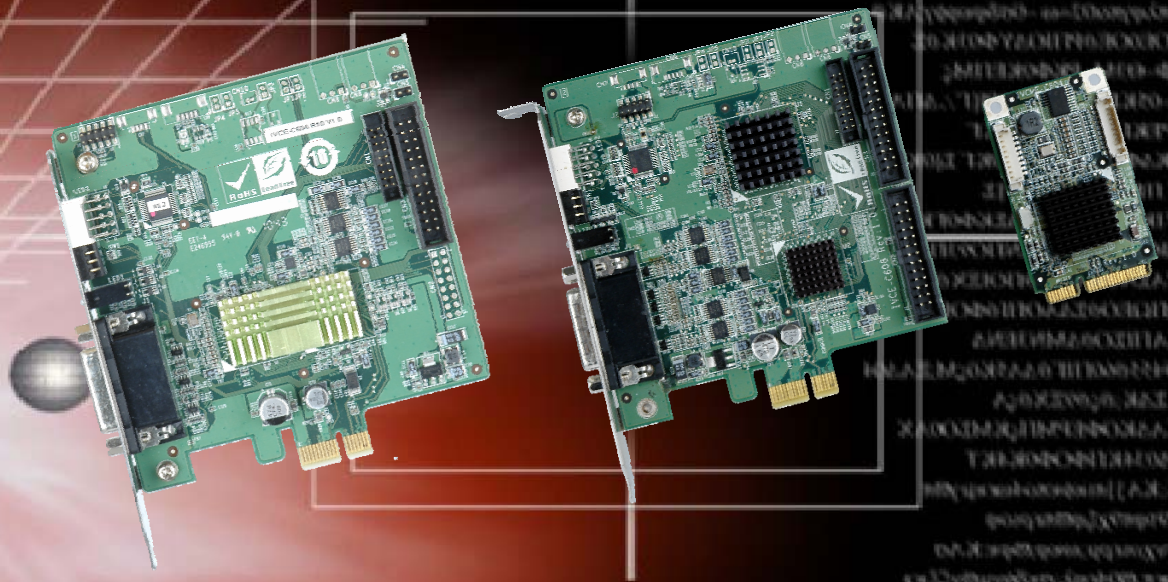

IEI Technology Corp.



MODEL:

IVCE-C608/IVCE-C604/IVCME-C604

**Video Capture Card with PCIe/PCIe Mini Interface
8-Channel/4-Channel Input, RoHS Compliant**

User Manual

Rev. 1.00 – 6 February, 2012



Revision

Date	Version	Changes
6 February, 2012	1.00	Initial release

Copyright

COPYRIGHT NOTICE

The information in this document is subject to change without prior notice in order to improve reliability, design and function and does not represent a commitment on the part of the manufacturer.

In no event will the manufacturer be liable for direct, indirect, special, incidental, or consequential damages arising out of the use or inability to use the product or documentation, even if advised of the possibility of such damages.

This document contains proprietary information protected by copyright. All rights are reserved. No part of this manual may be reproduced by any mechanical, electronic, or other means in any form without prior written permission of the manufacturer.

TRADEMARKS

All registered trademarks and product names mentioned herein are used for identification purposes only and may be trademarks and/or registered trademarks of their respective owners.

Table of Contents

1 INTRODUCTION.....	10
1.1 OVERVIEW.....	11
1.1.1 Model Variations.....	12
1.1.2 Features.....	12
1.1.3 Software Support.....	12
1.2 OVERVIEW PHOTO.....	13
1.2.1 IVCE-C608 Overview.....	13
1.2.2 IVCE-C604 Overview.....	14
1.2.3 IVCME-C604 Overview.....	15
2 PRODUCT SPECIFICATIONS.....	16
2.1 SPECIFICATIONS.....	17
2.1.1 Video Interfaces.....	17
2.1.2 Video Processing.....	18
2.1.3 Audio Processing.....	19
2.1.4 System Requirements.....	19
2.1.5 Mechanical and Environmental Specifications.....	20
2.2 DIMENSIONS.....	21
2.2.1 IVCE-C608 Dimension Drawing.....	21
2.2.2 IVCE-C604 Dimension Drawing.....	22
2.2.3 IVCME-C604 Dimension Drawing.....	23
3 PACKING LIST.....	24
3.1 ANTI-STATIC PRECAUTIONS.....	25
3.2 UNPACKING PRECAUTIONS.....	25
3.3 PACKING LIST.....	26
3.4 OPTIONAL ITEMS.....	28
4 CONNECTORS AND JUMPERS.....	29
4.1 VIDEO CAPTURE CARD CONNECTOR DIAGRAMS.....	2
4.1.1 IVCE-C608 Pinouts.....	2

IVCE-C608/IVCE-C604/IVCME-C604 Capture Card

4.1.1.1	IVCE-C608 Switch (SW1)	3
4.1.1.2	IVCE-C608 LED Screen (LED2)	3
4.1.1.3	IVCE-C608 LED Indicators (LED1)	3
4.1.1.4	IVCE-C608 Reset Input Connector (CN4)	4
4.1.1.5	IVCE-C608 Reset Output Connector (CN5)	4
4.1.1.6	IVCE-C608 Video/Audio Input/Output Connector (J1)	4
4.1.1.7	IVCE-C608 GPIO Connector (CN2, CN3)	5
4.1.2	<i>IVCE-C604 Pinouts</i>	6
4.1.2.1	IVCE-C604 Switch (SW1)	7
4.1.2.2	IVCE-C604 LED Screen (LED2)	7
4.1.2.3	IVCE-C604 LED Indicators (LED1)	7
4.1.2.4	IVCE-C604 Reset Input Connector (CN4)	8
4.1.2.5	IVCE-C604 Reset Output Connector (CN5)	8
4.1.2.6	IVCE-C604 Video/Audio Input/Output Connector (J1)	8
4.1.2.7	IVCE-C604 GPIO Connector (CN3)	9
4.1.3	<i>IVCME-C604 Pinouts</i>	10
4.1.3.1	IVCME-C604 Video/Audio Input Connector (CN1)	11
4.1.3.2	IVCME-C604 GPIO Connector (CN2)	11
5	HARDWARE INSTALLATION.....	12
5.1	ANTI-STATIC PRECAUTIONS	13
5.2	INSTALLATION CONSIDERATIONS.....	14
5.3	SYSTEM REQUIREMENT	15
5.4	IVCE-C608/IVCE-C604 HARDWARE INSTALLATION	15
5.4.1	<i>Hardware Installation Procedures</i>	15
5.4.2	<i>Video Capture Card Installation</i>	15
5.4.3	<i>Install the Reset Cables (Optional)</i>	16
5.4.4	<i>Install the GPIO Card (Optional)</i>	17
5.4.4.1	GPIO Card Pinouts	18
5.4.5	<i>Set the Rotary Switch ID Settings</i>	19
5.4.6	<i>Video and Audio Input Connection</i>	20
5.4.7	<i>Video Output Connection</i>	21
5.5	IVCME-C604 HARDWARE INSTALLATION	22
5.5.1	<i>Hardware Installation Procedures</i>	22
5.5.2	<i>Video Capture Card Installation</i>	23

5.5.3 Video and Audio Input Connection	23
5.5.4 Install the GPIO Card (Optional).....	25
6 SOFTWARE AND DRIVER.....	26
6.1 OVERVIEW.....	27
6.2 DRIVER AND APPLICATION INSTALLATION.....	27
6.2.1 FFDSHow Installation.....	31
6.2.2 Uninstall Driver and Application	33
6.3 IEI VIDEO CAPTURE TEST SUITE.....	34
6.3.1 Video Capture.....	34
6.3.2 Video Bypass (IVCE-C608 and IVCE-C604 Only).....	40
6.3.3 Video Out (IVCE-C608 and IVCE-C604 Only)	42
6.3.4 Other Functions	44
6.3.4.1 Frame Rate	45
6.3.4.2 Color Control	46
6.3.4.3 GPIO	47
6.3.4.4 Watchdog Timer (WDT)	48
6.3.4.5 General Information.....	49
A HAZARDOUS MATERIALS DISCLOSURE	50
A.1 HAZARDOUS MATERIAL DISCLOSURE TABLE FOR IPB PRODUCTS CERTIFIED AS ROHS COMPLIANT UNDER 2002/95/EC WITHOUT MERCURY	51

List of Figures

Figure 1-1: IVCE-C608/IVCE-C604/IVCME-C604 Capture Cards	11
Figure 1-2: IVCE-C608 Overview	13
Figure 1-3: IVCE-C604 Overview	14
Figure 1-4: IVCME-C604 Overview	15
Figure 2-1: IVCE-C608 Dimension Drawing	21
Figure 2-2: IVCE-C604 Dimension Drawing	22
Figure 2-3: IVCME-C604 Dimension Drawing	23
Figure 4-1: IVCE-C608 Connectors and Pinouts (pin numbers in red)	3
Figure 4-2: IVCE-C604 Connectors and Pinouts (pin numbers in red)	7
Figure 4-3: IVCME-C604 Connectors and Pinouts (pin numbers in red)	10
Figure 5-1: IVCE-C608 and IVCE-C604 Installation	16
Figure 5-2: Cascade Reset Connection.....	17
Figure 5-3: GPIO Cable for IVCE-C608 and IVCE-C604.....	18
Figure 5-4: GPIO Card Pinouts.....	18
Figure 5-5: LED Screen and ID Rotary Switch.....	19
Figure 5-6: Video and Audio Input Connection	20
Figure 5-7: Video Output Connection.....	22
Figure 5-8: IVCME-C604 Installation.....	23
Figure 5-9: Video and Audio Input Connection (IVCME-C604)	24
Figure 5-10: GPIO Cable for IVCME-C604	25
Figure 6-1: Autorun Startup Screen.....	27
Figure 6-2: Driver Directory Icon.....	28
Figure 6-3: Driver Installation - Select Card ID	29
Figure 6-4: Windows Warning Window	29
Figure 6-5: Driver Installing	30
Figure 6-6: Driver Installation Complete	30
Figure 6-7: Device Manager.....	31
Figure 6-8: IEI Video Capture Test Suite Shortcut Icon.....	31
Figure 6-9: FFDSHOW - VFW Configuration.....	32
Figure 6-10: FFDSHOW Video Encoder Configuration Window.....	32

Figure 6-11: Uninstall IEI Video Capture Test Suite (Start Menu)	33
Figure 6-12: Device Manager – Uninstall Driver	34
Figure 6-13: IEI Video Capture Test Suite	35
Figure 6-14: Available Cards	36
Figure 6-15: Capture Settings Window	36
Figure 6-16: Audio Preview Selection	38
Figure 6-17: Recording File Path Selection	39
Figure 6-18: Start Video Capture	39
Figure 6-19: Capturing Video	40
Figure 6-20: Video Out Window	41
Figure 6-21: Video Out – By pass	41
Figure 6-22: Video Out Window (Upper)	43
Figure 6-23: Video Out Window (Bottom)	44
Figure 6-24: Frame Rate Window	45
Figure 6-25: Color Settings	46
Figure 6-26: GPIO Control	47
Figure 6-27: WDT Window	48
Figure 6-28: WDT Options for Multiple Cards	48
Figure 6-29: General Window	49
Figure 6-30: LED Function Test	49
Figure 6-31: AES Check - Pass	49

List of Tables

Table 1-1: IVCE-C608/IVCE-C604/IVCME-C604 Video Capture Card Models.....	12
Table 2-1: Video Interfaces	17
Table 2-2: Video Processing.....	18
Table 2-3: Audio Processing	19
Table 2-4: System Requirements	19
Table 2-5: Mechanical and Environmental Specifications	20
Table 3-1: Packing List.....	27
Table 3-2: Optional Items	28
Table 4-1: IVCE-C608 Connectors.....	2
Table 4-2: IVCE-C608 Reset Input Connector Pinouts.....	4
Table 4-3: IVCE-C608 Reset Output Connector Pinouts.....	4
Table 4-4: IVCE-C608 Video/Audio Input Connector Pinouts	5
Table 4-5: IVCE-C608 GPIO Connector Pinouts	5
Table 4-6: IVCE-C604 Connectors.....	6
Table 4-7: IVCE-C604 Reset Input Connector Pinouts.....	8
Table 4-8: IVCE-C604 Reset Output Connector Pinouts.....	8
Table 4-9: IVCE-C604 Video/Audio Input Connector Pinouts	9
Table 4-10: IVCE-C604 GPIO Connector Pinouts	9
Table 4-11: IVCME-C604 Connectors.....	10
Table 4-12: IVCME-C604 Video/Audio Input Connector Pinouts	11
Table 4-13: IVCME-C604 GPIO Connector Pinouts	11
Table 6-1: Supported Resolutions	37

Chapter

1

Introduction

IVCE-C608/IVCE-C604/IVCME-C604 Capture Card

1.1 Overview



Figure 1-1: IVCE-C608/IVCE-C604/IVCME-C604 Capture Cards

The low power IVCE-C608/IVCE-C604/IVCME-C604 video capture cards are essential surveillance system components. The IVCE-C608/IVCE-C604/IVCME-C604 video capture cards are equipped with the high-performing Conexant video capture controllers with up to eight video and audio input channels.

A software development kit (SDK) and a demo application are shipped with each card and the flexible system architecture simplifies the integration of cameras, video signal processing, storage and video management as well as security applications.

1.1.1 Model Variations

There are three video capture card models with different connecting interfaces. These models are listed below:

Model Name	Interface	Video Input	Audio Input
IVCE-C608	PCIe	8 channels	8 channels
IVCE-C604	PCIe	4 channels	4 channels
IVCME-C604	PCIe Mini	4 channels	4 channels

Table 1-1: IVCE-C608/IVCE-C604/IVCME-C604 Video Capture Card Models

1.1.2 Features

Some of the IVCE-C608/IVCE-C604/IVCME-C604 video capture card features are listed below.

- Low power
- Multiple card support
- Easy ID programming
- PCIe/PCIe Mini connection interface
- Software development kit (SDK)
- Demo application

1.1.3 Software Support

IEI provides the following software support for the IVCE-C608/IVCE-C604/IVCME-C604:

- **Device Driver:** for Windows XP or Windows 7
- **SDK:** SDK and demo program with source code in C++

IVCE-C608/IVCE-C604/IVCME-C604 Capture Card

1.2 Overview Photo

The IVCE-C608/IVCE-C604/IVCME-C604 video capture cards have a wide variety of peripheral interface connectors. The following sections give an overview of each model.

1.2.1 IVCE-C608 Overview

The IVCE-C608 comes with one Conexant CX25853 video capture controller, two GPIO connectors, one rotary switch, LED indicators and one DB-26 video/audio connector. A PCIe edge connector on the bottom of the capture card enables the IVCE-C608 to interface with a motherboard or CPU card. An overview can be seen in Figure 1-2: IVCE-C608 Overview.

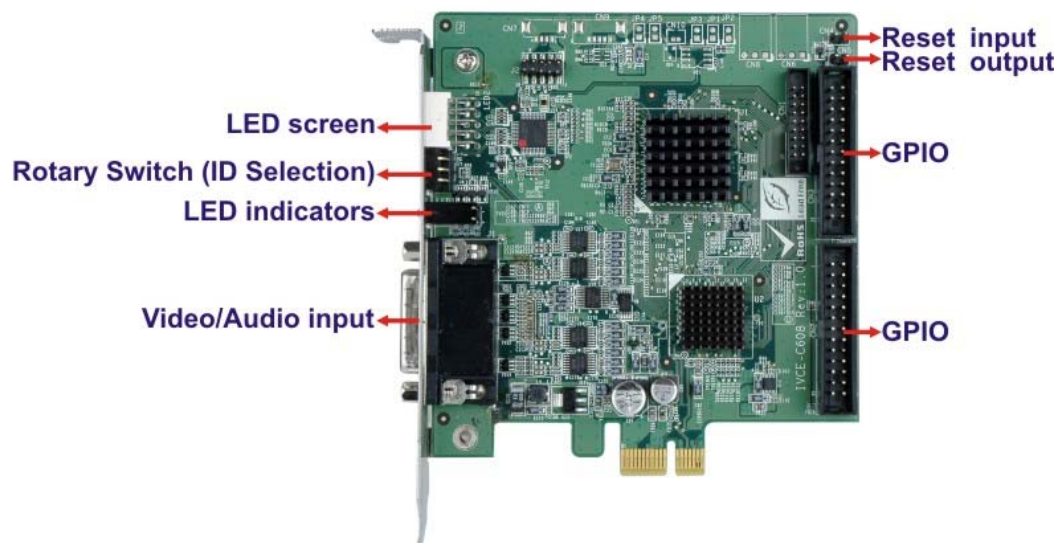

Figure 1-2: IVCE-C608 Overview

1.2.2 IVCE-C604 Overview

The IVCE-C604 comes with one Conexant CX25850 video capture controller, one GPIO connector, one rotary switch, LED indicators and one DB-26 video/audio connector. A PCIe edge connector on the bottom of the capture card enables the IVCE-C604 to interface with a motherboard or CPU card. An overview can be seen in Figure 1-3: IVCE-C604 Overview.

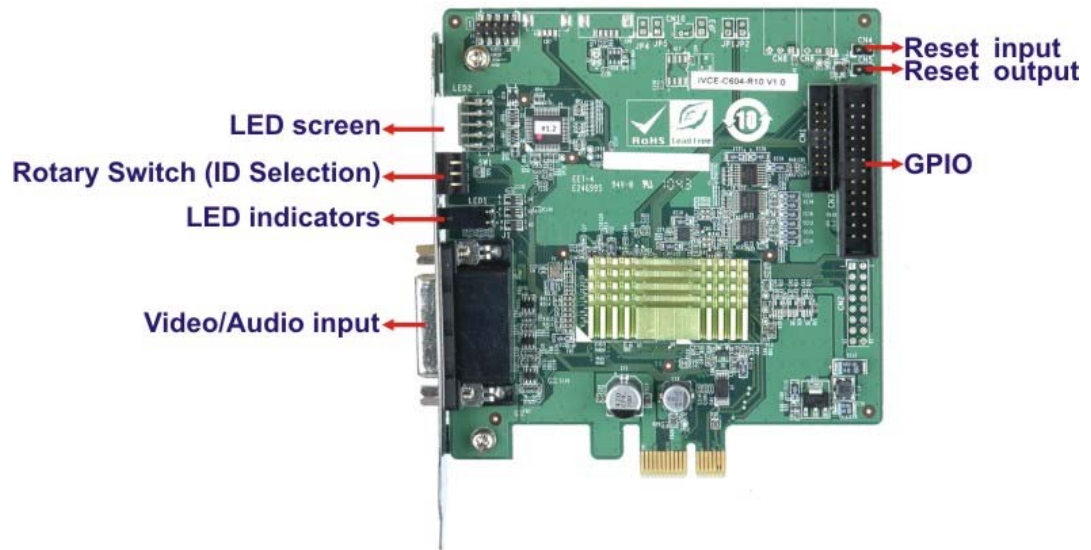

Figure 1-3: IVCE-C604 Overview

IVCE-C608/IVCE-C604/IVCME-C604 Capture Card

1.2.3 IVCME-C604 Overview

The IVCME-C604 comes with one Conexant CX25854 video capture controller, one GPIO connector and one video/audio connector. The PCIe Mini interface of the capture card enables the IVCME-C604 to interface with a motherboard. An overview can be seen in Figure 1-4: IVCME-C604 Overview.

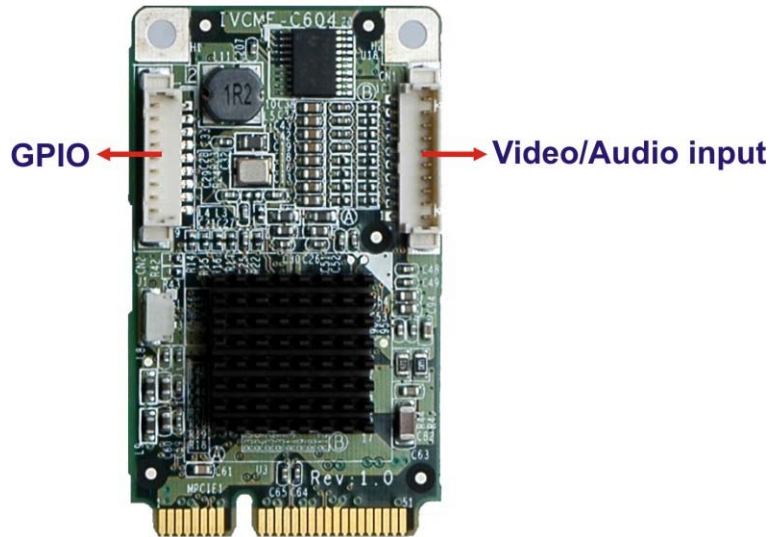

Figure 1-4: IVCME-C604 Overview

Chapter

2

Product Specifications

IVCE-C608/IVCE-C604/IVCME-C604 Capture Card

2.1 Specifications

The following specifications are listed in the tables below:

- Table 2-1: Video Interfaces
- Table 2-2: Video Processing
- Table 2-3: Audio Processing
- Table 2-4: System Requirements
- Table 2-5: Mechanical and Environmental Specifications

2.1.1 Video Interfaces

The following table lists detailed specifications for the interfaces on the three video capture cards.

	IVCE-C608	IVCE-C604	IVCME-C604
Video Input Channels	Eight	Four	Four
Video Input Format	NTSC or PAL	NTSC or PAL	NTSC or PAL
Video Input Type	BNC	BNC	BNC
Audio Input Channels	Eight	Four	Four
Audio Input Connector	RCA	RCA	RCA
Video Output Channels	Two	Two	N/A
Video Output Type	BNC	BNC	N/A
PCI/PCIe	PCIe x1	PCIe x1	PCIe Mini
Alarm I/O	Yes	Yes	Yes
Card ID	Rotary switch selectable with LED for ID indication	Rotary switch selectable with LED for ID indication	N/A
LED Indicators	Red: self-defined* Green: self-defined* Amber: watchdog alarm	Red: self-defined* Green: self-defined* Amber: watchdog alarm	N/A

*API will be provided for users to define the LED function.

Table 2-1: Video Interfaces

2.1.2 Video Processing

The following table lists detailed specifications for the video processing features on the three video capture cards.

VIDEO PROCESSING		IVCE-C608	IVCE-C604	IVCME-C604
Video Compression		Software compression	Software compression	Software compression
Video Engine		One Conexant CX25853	One Conexant CX25850	One Conexant CX25854
Resolution	NTSC	720x480	720x480	720x480
		720x240	720x240	720x240
		640x480	640x480	640x480
		640x240	640x240	640x240
		352x240	352x240	352x240
		320x240	320x240	320x240
		160x120	160x120	160x120
	PAL	720x576	720x576	720x576
		720x288	720x288	720x288
		352x288	352x288	352x288
Frame Rate	NTSC	Total 240fps @ D1 for eight channels	Total 120fps @ D1 for four channels	Total 120fps @ D1 for four channels
	PAL	Total 200fps @ D1 for eight channels	Total 100fps @ D1 for four channels	Total 100fps @ D1 for four channels
On-screen Display		Yes	Yes	Yes

Table 2-2: Video Processing

IVCE-C608/IVCE-C604/IVCME-C604 Capture Card

2.1.3 Audio Processing

The following table lists detailed specifications for the audio processing features on the three video capture cards.

AUDIO PROCESSING	IVCE-C608	IVCE-C604	IVCME-C604
Audio Compression	Software compression	Software compression	Software compression
Sampling rates (hardware spec.)	32 kHz	32 kHz	8 kHz
	44.1 kHz	44.1 kHz	16 kHz
	48 kHz	48 kHz	32 kHz
	96 kHz	96 kHz	44.1 kHz
Quantization (hardware spec.)	24-bit	24-bit	16-bit

Table 2-3: Audio Processing

2.1.4 System Requirements

The following table lists detailed system requirements for the three video capture cards.

SYSTEM REQUIREMENTS	IVCE-C608	IVCE-C604	IVCME-C604
System	x86 compatible computer	x86 compatible computer	x86 compatible computer
PCIe	PCIe x1 lane compatible with PCIe x1, x4, x8 and x16 slots	PCIe x1 lane compatible with PCIe x1, x4, x8 and x16 slots	PCIe Mini
Minimum Memory	512 MB	512 MB	512 MB
Graphics	DirectX compatible VGA card with YUV overlay mode support	DirectX compatible VGA card with YUV overlay mode support	DirectX compatible VGA card with YUV overlay mode support

Table 2-4: System Requirements

2.1.5 Mechanical and Environmental Specifications

The following table lists the dimensions, operating temperature and power consumption for each model.

OTHERS	IVCE-C608	IVCE-C604	IVCME-C604
Dimensions (mm)	111.00 x 102.40	111.23 x 102.39	50.92 x 30.00
Operating Temperature	-5°C – 65°C, non-condensing	-5°C – 65°C, non-condensing	-5°C – 65°C, non-condensing
Power Consumption	5.3 W (3.3V @1.39 A, 12V @0.06 A)	3.51 W (3.3V @0.9 A, 12V @0.045 A)	1.65 W (3.3V @500mA)

Table 2-5: Mechanical and Environmental Specifications

2.2 Dimensions

The dimensions for each model are listed in **Table 2-5: Mechanical and Environmental Specifications** above. Detailed dimension drawings for each model are shown in the sections below.

2.2.1 IVCE-C608 Dimension Drawing

The dimensions for the IVCE-C608 are listed below:

- Length: 111.0 mm
- Width: 102.4 mm

The dimensions are shown in **Figure 2-1: IVCE-C608 Dimension Drawing**.

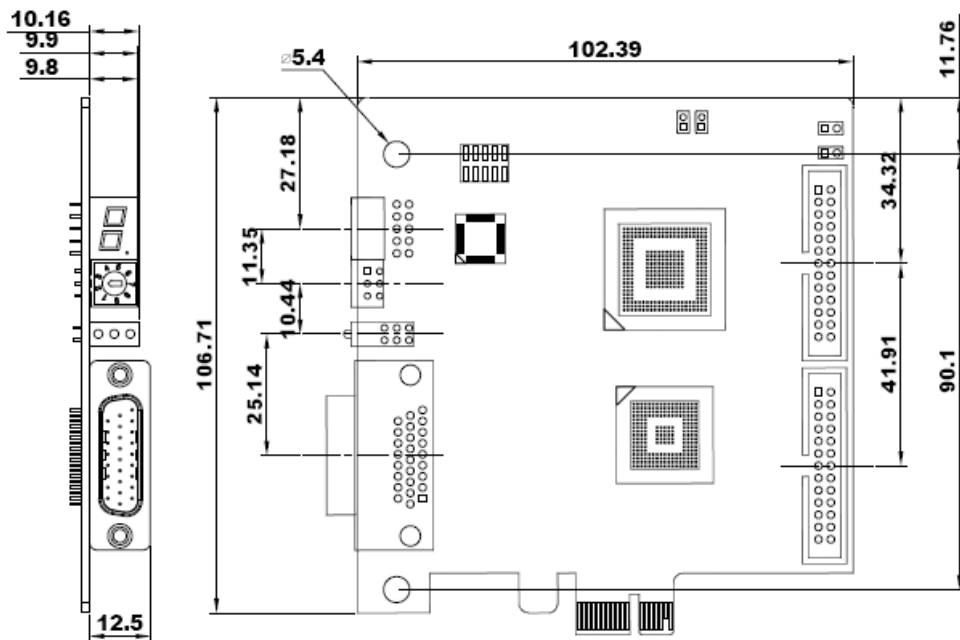

Figure 2-1: IVCE-C608 Dimension Drawing

2.2.2 IVCE-C604 Dimension Drawing

The dimensions for the IVCE-C604 are listed below:

- Length: 111.23 mm
- Width: 102.39 mm

The dimensions are shown in **Figure 2-2: IVCE-C604 Dimension Drawing**.

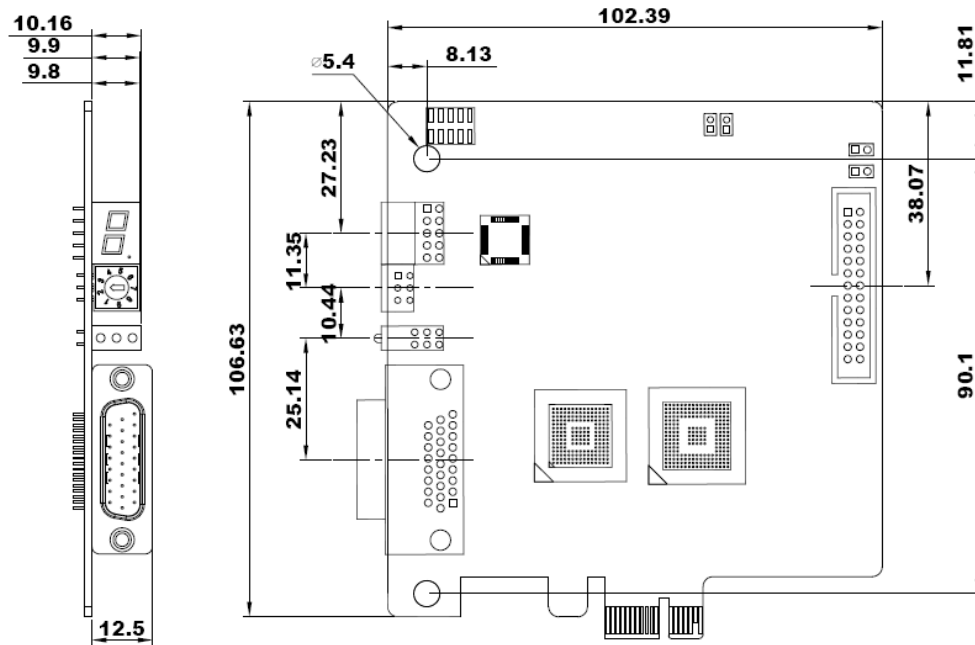

Figure 2-2: IVCE-C604 Dimension Drawing

2.2.3 IVCME-C604 Dimension Drawing

The dimensions for the IVCME-C604 are listed below:

- Length: 50.92 mm
- Width: 30.00 mm

The dimensions are shown in **Figure 2-3: IVCME-C604 Dimension Drawing**.

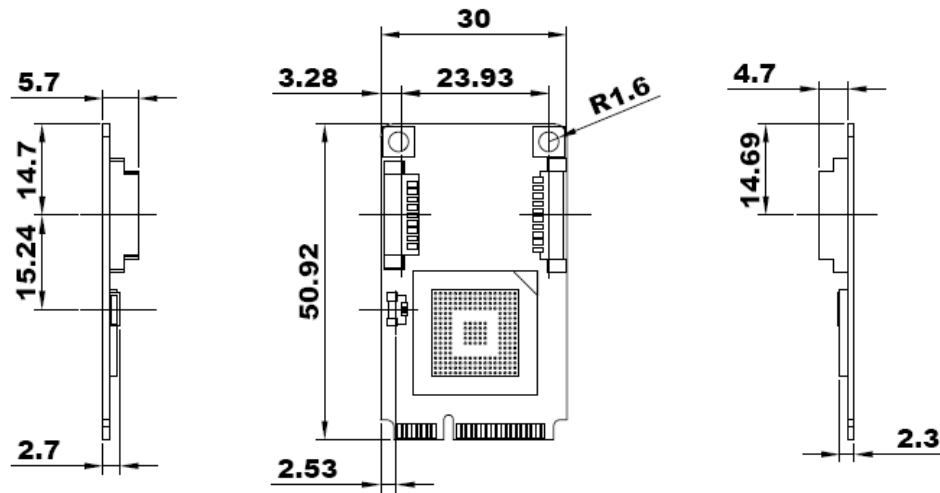

Figure 2-3: IVCME-C604 Dimension Drawing

Chapter

3

Packing List

3.1 Anti-static Precautions

**WARNING:**

Static electricity can destroy certain electronics. Make sure to follow the ESD precautions to prevent damage to the product, and injury to the user.

Make sure to adhere to the following guidelines:

- ***Wear an anti-static wristband:*** Wearing an anti-static wristband can prevent electrostatic discharge.
- ***Self-grounding:*** Touch a grounded conductor every few minutes to discharge any excess static buildup.
- ***Use an anti-static pad:*** When configuring any circuit board, place it on an anti-static mat.
- ***Only handle the edges of the PCB:*** Don't touch the surface of the motherboard. Hold the motherboard by the edges when handling.

3.2 Unpacking Precautions

When the IVCE-C608/IVCE-C604/IVCME-C604 is unpacked, please do the following:





- Follow the antistatic guidelines above.
- Make sure the packing box is facing upwards when opening.
- Make sure all the packing list items are present.

3.3 Packing List

NOTE:

If any of the components listed in the checklist below are missing, do not proceed with the installation. Contact the IEI reseller or vendor the IVCE-C608/IVCE-C604/IVCME-C604 was purchased from or contact an IEI sales representative directly by sending an email to sales@iei.com.tw.

The IVCE-C608/IVCE-C604/IVCME-C604 is shipped with the following components:

Quantity	Item and Part Number	Image
1	IVCE-C608/IVCE-C604/IVCME-C604 video capture card	
1	Video and audio input cable DB-26 to 8-channel video and 8-channel audio (IVCE-C608 only)	
1	Video and audio input cable DB-26 to 4-channel video and 4-channel audio (IVCE-C604 only)	
1	Video and audio input cable (IVCME-C604 only)	

IVCE-C608/IVCE-C604/IVCME-C604 Capture Card





Quantity	Item and Part Number	Image
1	Video input cable DB-9 to 4-channel BNC connector (IVCME-C604 only)	
1	Audio input cable DB-9 to 4-channel RCA connector (IVCME-C604 only)	
2	Reset cable (IVCE-C608 and IVCE-C604 only)	
1	Utility CD	
1	Quick installation guide	

Table 3-1: Packing List

3.4 Optional Items

The following items are optional:



Item and Part Number	Image
8-channel GPIO card (four digital output and four relay output) (P/N: VIOCARD-GPIO-RS-R10)	
GPIO cable (for IVCE-C608 and IVCE-C604) (P/N: 32200-000012-RS)	
GPIO cable (for IVCME-C604) (P/N: 32031-000100-100-RS)	

Table 3-2: Optional Items

Chapter

4

Connectors and Jumpers

4.1 Video Capture Card Connector Diagrams

The connector diagrams for both models are shown in the sections below:

4.1.1 IVCE-C608 Pinouts



WARNING:

The other connectors, jumpers and interfaces on the board not specified below are for R&D diagnostic purposes and should not be used by the end user.

The IVCE-C608 has the following connectors and interfaces on board:

Quantity	Connector Name	Connector Type	Labels
1	Rotary Switch (ID Selection)	16-position switch	SW1
1	LED screen	LED screen	LED2
1	LED indicators	Red, amber, green LED	LED1
2	GPIO connector	26-pin box header	CN2, CN3
1	Video/Audio input/output connector	DB-26 female	J1
1	Reset input connector	2-pin header	CN4
1	Reset output connector	2-pin header	CN5

Table 4-1: IVCE-C608 Connectors

Figure 4-1 shows the connectors, jumpers and interfaces on the IVCE-C608.

IVCE-C608/IVCE-C604/IVCME-C604 Capture Card

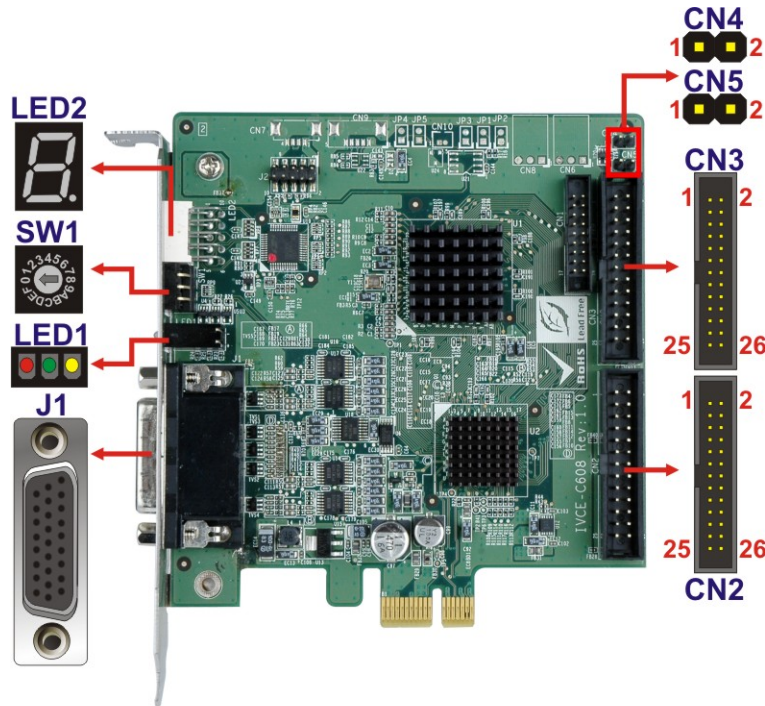

Figure 4-1: IVCE-C608 Connectors and Pinouts (pin numbers in red)

4.1.1.1 IVCE-C608 Switch (SW1)

Use the 16-position rotary switch (SW1) to set the ID for the board. Up to 16 IVCE-C608 can be installed in a single system. Each card must be allocated a unique ID. Switch ID settings are explained in more detail in **Section 5.4.5**.

4.1.1.2 IVCE-C608 LED Screen (LED2)

The LED screen shows the ID number of the IVCE-C608. Sixteen IVCE-C608 cards can be connected together in a single system. Each card has a unique ID setting as specified by the unique rotary switch (SW1) setting described above and in **Section 5.4.5**. The unique card ID specified by the rotary switch (SW1) is specified on the screen.

4.1.1.3 IVCE-C608 LED Indicators (LED1)

The LED indicator (LED1) includes three LED indicators: Amber, green and red. These LED indicators show the system status as described below:

- Amber: watchdog alarm

- Green: self-defined
- Red: self-defined

4.1.1.4 IVCE-C608 Reset Input Connector (CN4)

Use the reset input connector (CN4) to connect to the reset button of the system chassis to enable the multiple card cascade reset function. Pinouts for the connector are shown in **Table 4-2**.

Pin No.	Signal
1	Reset input
2	GND

Table 4-2: IVCE-C608 Reset Input Connector Pinouts

4.1.1.5 IVCE-C608 Reset Output Connector (CN5)

Use the reset output connector (CN5) to connect to the reset connector on the motherboard to enable the multiple card cascade reset function. Pinouts for the connector are shown in **Table 4-3**.

Pin No.	Signal
1	Reset output
2	GND

Table 4-3: IVCE-C608 Reset Output Connector Pinouts

4.1.1.6 IVCE-C608 Video/Audio Input/Output Connector (J1)

Compatible cameras connect to the IVCE-C608 through the DB-26 female connector (via the D-SUB to BNC and RCA cable). Pinouts for the connector are shown in **Table 4-4**.

Pin No.	Signal	Pin No.	Signal
1	Video In CH1	2	Video In CH2
3	Video In CH3	4	Video In CH4
5	Video In CH5	6	Video In CH6
7	Video In CH7	8	Video In CH8
9	Video Output 1	10	NC

IVCE-C608/IVCE-C604/IVCME-C604 Capture Card

11	GND	12	GND
13	GND	14	GND
15	GND	16	GND
17	GND	18	Video Output 2
19	Audio In CH1	20	Audio In CH2
21	Audio In CH3	22	Audio In CH4
23	Audio In CH5	24	Audio In CH6
25	Audio In CH7	26	Audio In CH8

Table 4-4: IVCE-C608 Video/Audio Input Connector Pinouts

Each IVCE-C608 can support up to eight video inputs, eight audio inputs and two video outputs . If 16 systems are connected together, a total of 128 cameras can be strung together in a single system.

4.1.1.7 IVCE-C608 GPIO Connector (CN2, CN3)

The IVCE-C608 contains two 26-pin box header GPIO connectors. The GPIO connector pinouts are shown in **Table 4-5**.

Pin No.	Signal	Pin No.	Signal
1	NC	2	NC
3	NC	4	NC
5	NC	6	NC
7	NC	8	NC
9	NC	10	GND
11	DO0	12	GND
13	DO1	14	GND
15	DO2	16	GND
17	DO3	18	GND
19	DIO	20	GND
21	DI1	22	GND
23	DI2	24	GND
25	DI3	26	NC

Table 4-5: IVCE-C608 GPIO Connector Pinouts

4.1.2 IVCE-C604 Pinouts



WARNING:

The other connectors, jumpers and interfaces on the board not specified below are for R&D diagnostic purposes and should not be used by the end user.

The IVCE-C604 has the following connectors and interfaces on board:

Quantity	Connector Name	Connector Type	Labels
1	Rotary Switch (ID Selection)	16-position switch	SW1
1	LED screen	LED screen	LED2
1	LED indicators	Red, amber, green LED	LED1
1	GPIO connectors	26-pin box header	CN3
1	Video/Audio input/output connector	DB-26 female	J1
1	Reset input connector	2-pin header	CN4
1	Reset output connector	2-pin header	CN5

Table 4-6: IVCE-C604 Connectors

Figure 4-2 shows the connectors and interfaces on the IVCE-C604.

IVCE-C608/IVCE-C604/IVCME-C604 Capture Card

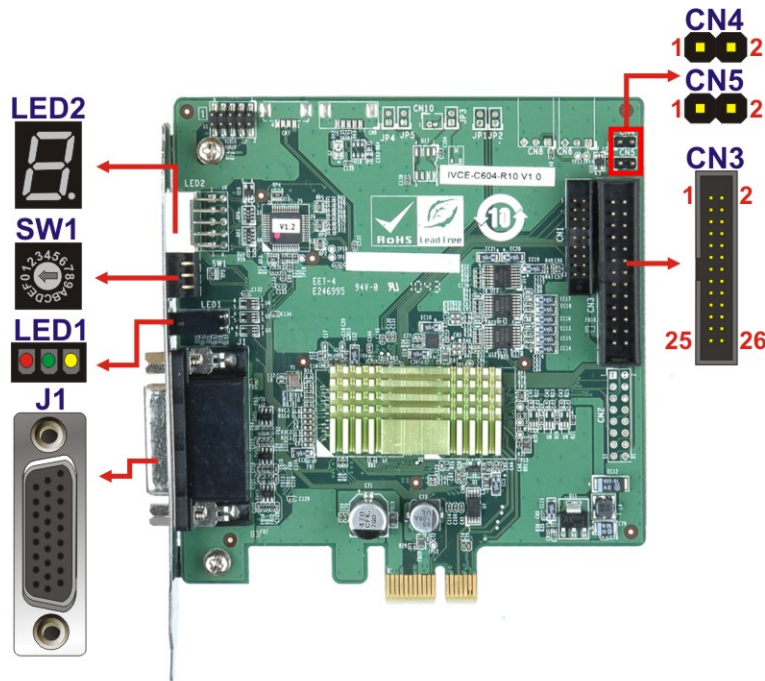

Figure 4-2: IVCE-C604 Connectors and Pinouts (pin numbers in red)

4.1.2.1 IVCE-C604 Switch (SW1)

Use the 16-position rotary switch (SW1) to set the ID for the board. Up to 16 IVCE-C604 can be installed in a single system. Each card must be allocated a unique ID. Switch ID settings are explained in more detail in **Section 5.4.5**.

4.1.2.2 IVCE-C604 LED Screen (LED2)

The LED screen shows the ID number of the IVCE-C604. Sixteen IVCE-C604 cards can be connected together in a single system. Each card has a unique ID setting as specified by the unique rotary switch (SW1) setting described above and in **Section 5.4.5**. The unique card ID specified by the rotary switch (SW1) is specified on the screen.

4.1.2.3 IVCE-C604 LED Indicators (LED1)

The LED indicator (LED1) includes three LED indicators: amber, green and red. These LED indicators show the system status as described below:

- Amber: watchdog timer alarm

- Green: self-defined
- Red: self-defined

4.1.2.4 IVCE-C604 Reset Input Connector (CN4)

Use the reset input connector (CN4) to connect to the reset button of the system chassis to enable the multiple card cascade reset function. Pinouts for the connector are shown in **Table 4-7**.

Pin No.	Signal
1	Reset input
2	GND

Table 4-7: IVCE-C604 Reset Input Connector Pinouts

4.1.2.5 IVCE-C604 Reset Output Connector (CN5)

Use the reset output connector (CN5) to connect to the reset connector on the motherboard to enable the multiple card cascade reset function. Pinouts for the connector are shown in **Table 4-8**.

Pin No.	Signal
1	Reset output
2	GND

Table 4-8: IVCE-C604 Reset Output Connector Pinouts

4.1.2.6 IVCE-C604 Video/Audio Input/Output Connector (J1)

Compatible cameras connect to the IVCE-C604 through the DB-26 female connector (via the D-SUB to BNC and RCA cable). Pinouts for the connector are shown in **Table 4-9**.

Pin No.	Signal	Pin No.	Signal
1	Video In CH1	2	Video In CH2
3	Video In CH3	4	Video In CH4
5	NC	6	NC
7	NC	8	NC
9	Video Output 1	10	NC

IVCE-C608/IVCE-C604/IVCME-C604 Capture Card

11	GND	12	GND
13	GND	14	GND
15	GND	16	GND
17	GND	18	Video Output 2
19	Audio In CH1	20	Audio In CH2
21	Audio In CH3	22	Audio In CH4
23	NC	24	NC
25	NC	26	NC

Table 4-9: IVCE-C604 Video/Audio Input Connector Pinouts

Each IVCE-C604 can support up to four video inputs, four audio inputs and two video outputs . If 16 systems are connected together, a total of 64 cameras can be strung together in a single system.

4.1.2.7 IVCE-C604 GPIO Connector (CN3)

The IVCE-C604 contains one 26-pin box header GPIO connector. The GPIO connector pinouts are shown in **Table 4-10**.

Pin No.	Signal	Pin No.	Signal
1	NC	2	NC
3	NC	4	NC
5	NC	6	NC
7	NC	8	NC
9	NC	10	GND
11	DO0	12	GND
13	DO1	14	GND
15	DO2	16	GND
17	DO3	18	GND
19	DIO	20	GND
21	DI1	22	GND
23	DI2	24	GND
25	DI3	26	NC

Table 4-10: IVCE-C604 GPIO Connector Pinouts

4.1.3 IVCME-C604 Pinouts



WARNING:

The other connectors, jumpers and interfaces on the board not specified below are for R&D diagnostic purposes and should not be used by the end user.

The IVCME-C604 has the following connectors and interfaces on board:

Quantity	Connector Name	Connector Type	Labels
1	GPIO connectors	9-pin wafer	CN2
1	Video/Audio input/output connector	10-pin wafer	CN1

Table 4-11: IVCME-C604 Connectors

Figure 4-2 shows the connectors and interfaces on the IVCME-C604.

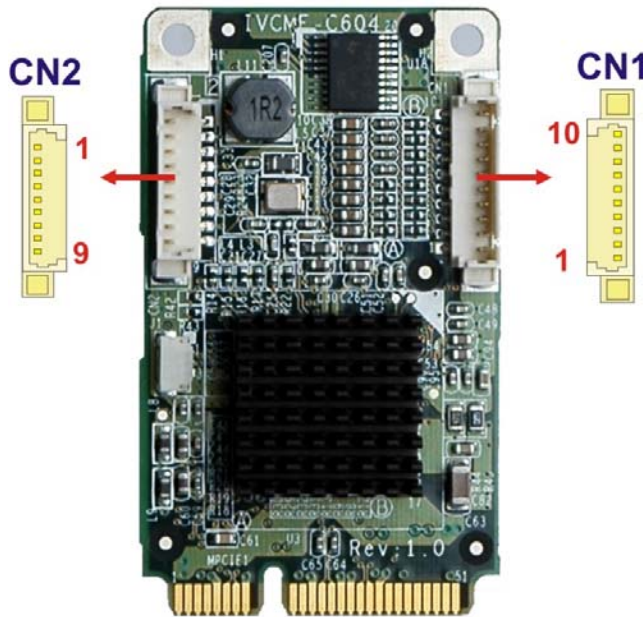

Figure 4-3: IVCME-C604 Connectors and Pinouts (pin numbers in red)

4.1.3.1 IVCME-C604 Video/Audio Input Connector (CN1)

Compatible cameras connect to the IVCME-C604 through the 10-pin wafer connector (via the D-SUB to BNC and RCA cables). Each IVCME-C604 can support up to four video inputs and four audio inputs. Pinouts for the connector are shown in **Table 4-9**.

Pin No.	Signal
1	GND
2	Video In CH1
3	Video In CH2
4	Video In CH3
5	Video In CH4
6	Audio In CH1
7	Audio In CH2
8	Audio In CH3
9	Audio In CH4
10	GND

Table 4-12: IVCME-C604 Video/Audio Input Connector Pinouts

4.1.3.2 IVCME-C604 GPIO Connector (CN2)

The IVCME-C604 contains one 9-pin wafer GPIO connector. The GPIO connector pinouts are shown in **Table 4-10**.

Pin No.	Signal
1	GND
2	DI1
3	DI2
4	DI3
5	DI4
6	DO1
7	DO2
8	DO3
9	DO4

Table 4-13: IVCME-C604 GPIO Connector Pinouts



Chapter

5

Hardware Installation

5.1 Anti-static Precautions



WARNING:

Failure to take ESD precautions during the installation of the IVCE-C608/IVCE-C604/IVCME-C604 may result in permanent damage to the IVCE-C608/IVCE-C604/IVCME-C604 and severe injury to the user.

Electrostatic discharge (ESD) can cause serious damage to electronic components, including the IVCE-C608/IVCE-C604/IVCME-C604. Dry climates are especially susceptible to ESD. It is therefore critical that whenever the IVCE-C608/IVCE-C604/IVCME-C604, or any other electrical component is handled, the following anti-static precautions are strictly adhered to.

- **Wear an anti-static wristband:** Wearing a simple anti-static wristband can help to prevent ESD from damaging the board.
- **Self-grounding:** Before handling the board, touch any grounded conducting material. During the time the board is handled, frequently touch any conducting materials that are connected to the ground.
- **Use an anti-static pad:** When configuring the IVCE-C608/IVCE-C604/IVCME-C604, place it on an anti-static pad. This reduces the possibility of ESD damaging the IVCE-C608/IVCE-C604/IVCME-C604.
- **Only handle the edges of the PCB:** When handling the PCB, hold the PCB by the edges.

5.2 Installation Considerations



NOTE:

The following installation notices and installation considerations should be read and understood before installation. All installation notices must be strictly adhered to. Failing to adhere to these precautions may lead to severe damage and injury to the person performing the installation.



WARNING:

The installation instructions described in this manual should be carefully followed in order to prevent damage to the components and injury to the user.

Before and during the installation please **DO** the following:

- **Read the user manual:**
 - The user manual provides a complete description of the IVCE-C608/IVCE-C604/IVCME-C604 installation instructions and configuration options.
- **Wear an electrostatic discharge cuff (ESD):**
 - Electronic components are easily damaged by ESD. Wearing an ESD cuff removes ESD from the body and helps prevent ESD damage.
- **Place the IVCE-C608/IVCE-C604/IVCME-C604 on an antistatic pad:**
 - When installing or configuring the motherboard, place it on an antistatic pad. This helps to prevent potential ESD damage.
- **Turn all power to the IVCE-C608/IVCE-C604/IVCME-C604 off:**
 - When working with the IVCE-C608/IVCE-C604/IVCME-C604, make sure that it is disconnected from all power supplies and that no electricity is being fed into the system.

Before and during the installation of the IVCE-C608/IVCE-C604/IVCME-C604 **DO NOT**:

IVCE-C608/IVCE-C604/IVCME-C604 Capture Card

- Remove any of the stickers on the PCB board. These stickers are required for warranty validation.
- Use the product before verifying all the cables and power connectors are properly connected.
- Allow screws to come in contact with the PCB circuit, connector pins, or its components.

5.3 System Requirement

- Microsoft Windows XP
- Microsoft Windows 7
- Microsoft DirectX 9.0c

5.4 IVCE-C608/IVCE-C604 Hardware Installation

5.4.1 Hardware Installation Procedures

To install the video capture card hardware, the following steps must be followed:

- Step 1:** Install the video capture card.
- Step 2:** Install the reset cables (optional).
- Step 3:** Install the GPIO card (optional).
- Step 4:** Set the rotary switch ID settings.
- Step 5:** Connect the video and audio devices.

Once the steps above have been completed, the hardware installation procedures are complete.

5.4.2 Video Capture Card Installation

The IVCE-C608 and IVCE-C604 have a PCIe x1 interface. To install the IVCE-C608 and IVCE-C604, please follow the steps below:

- Step 1:** Align the PCIe edge connector on the bottom of the video capture card with the PCIe slot on the system motherboard or a backplane.

Step 2: Gently insert the video capture card into the PCIe slot.

Step 3: Push down gently on the video card to make sure it is firmly inserted into the PCIe slot.



Figure 5-1: IVCE-C608 and IVCE-C604 Installation

Step 4: Insert a retention screw through the top of the video capture card external bracket into the chassis to secure the card to the chassis.

5.4.3 Install the Reset Cables (Optional)

The IVCE-C608 and IVCE-C604 are shipped with two reset cables to support cascade reset. To install the reset cables, please follow the instructions below.

Step 1: Locate the reset input connector on the first video capture card.

Step 2: Connect the reset button from the chassis to the reset input connector on the first video card.

Step 3: Use a reset cable to connect the reset output connector on the first video card to the reset input connector on the second video card.

IVCE-C608/IVCE-C604/IVCME-C604 Capture Card

- Step 4:** Repeat **Step 3** to connect multiple video capture cards in a system. Up to 16 cards can be added in a system.
- Step 5:** Use a reset cable to connect the reset output connector on the last video card to the reset connector on the system motherboard.

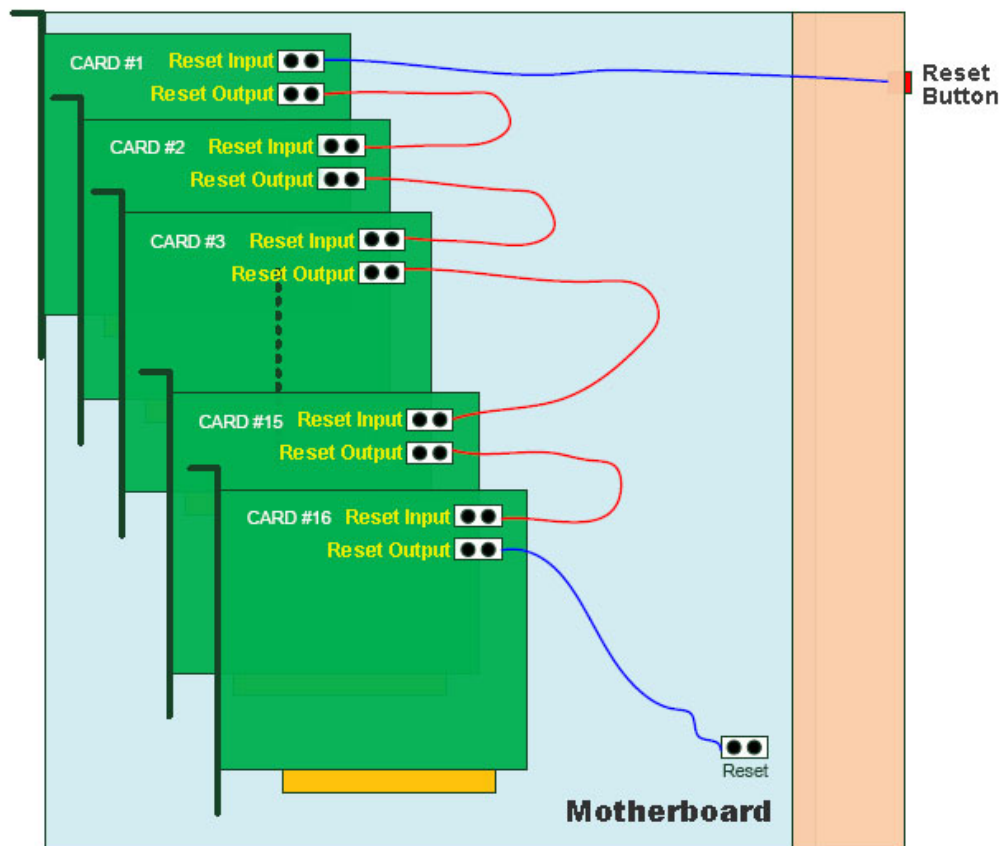

Figure 5-2: Cascade Reset Connection

5.4.4 Install the GPIO Card (Optional)

The IVCE-C608 and IVCE-C604 support 8-bit GPIO (4-bit input and 4-bit output) via an optional GPIO card. To install the GPIO card, please follow the instructions below.

- Step 1:** Locate the GPIO connector on the video capture card (see **Section 1.2**).
- Step 2:** Align the cable connector from the GPIO cable with the GPIO connector on the video capture card.



Figure 5-3: GPIO Cable for IVCE-C608 and IVCE-C604

Step 3: Push the cable connector onto the video capture card GPIO connector making sure the pins are correctly aligned.

Step 4: Next, connect the GPIO cable connector to the GPIO connector on the GPIO card (CN6).

5.4.4.1 GPIO Card Pinouts

The following diagram shows the pinouts of the two terminal blocks of the optional GPIO card.

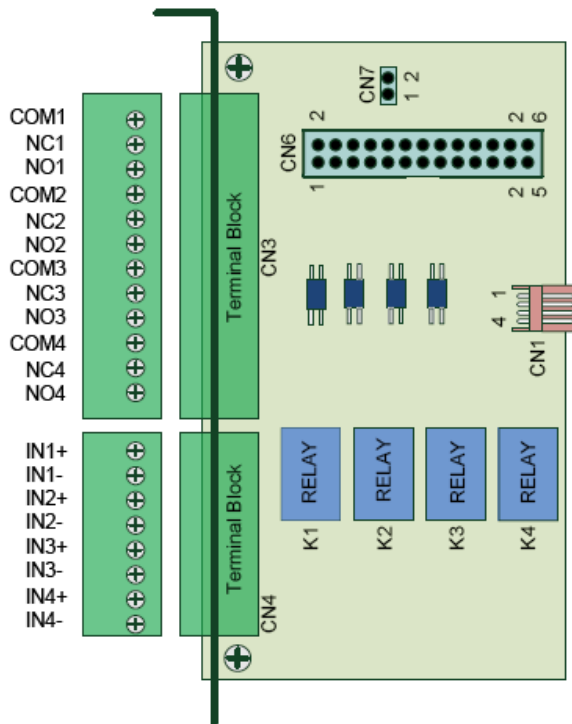

Figure 5-4: GPIO Card Pinouts

IVCE-C608/IVCE-C604/IVCME-C604 Capture Card

5.4.5 Set the Rotary Switch ID Settings

Up to 16 IVC video cards can be installed simultaneously on a single system. However, to ensure the system is able to detect the different cards, each card must be assigned a unique ID. The unique ID is assigned using the 16-position rotary switch (0~F) on each IVC video card. The ID number of the video card will show on the LED screen.

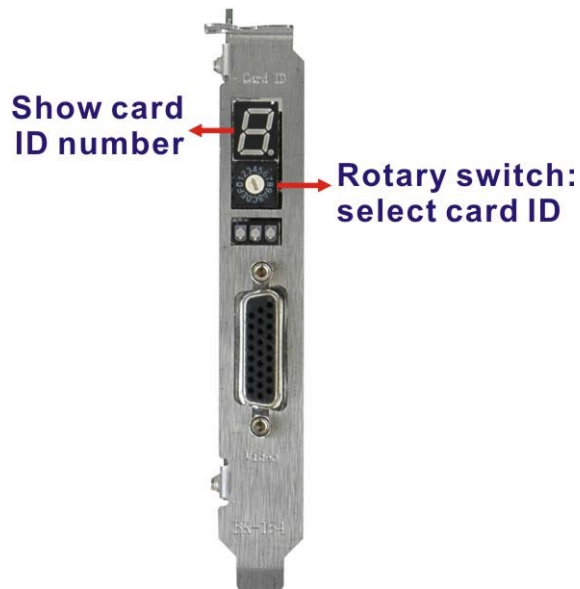

Figure 5-5: LED Screen and ID Rotary Switch



NOTE:

1. If the card ID shown on the application is different from the number shown on the LED screen, please restart the system.
2. DO NOT change the card ID during operation.

5.4.6 Video and Audio Input Connection

Both IVCE-C608 and IVCE-C604 are shipped with a video and audio input cable. To install the video and audio input cable, please follow the instructions below.



NOTE:

The IVCE-C608 is shipped with an 8-channel video and 8-channel audio input cable whereas the IVCE-C604 is shipped with a 4-channel video and 4-channel audio input cable.

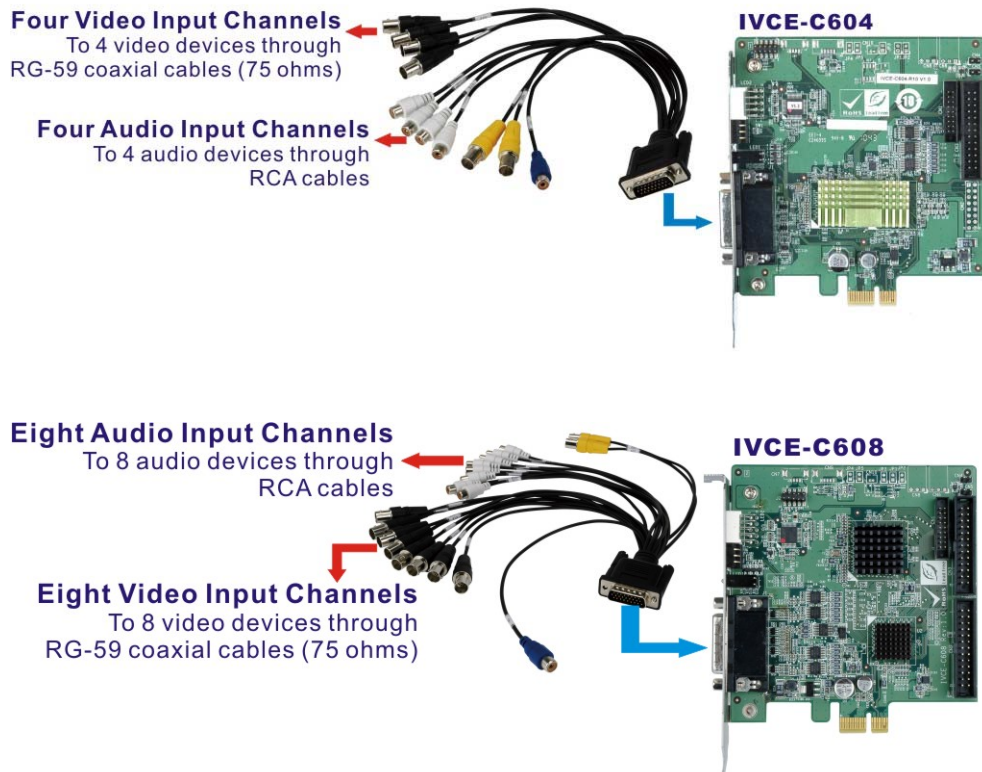

Figure 5-6: Video and Audio Input Connection

- Step 1:** Align and insert the DB-26 male connector from the cable to the DB-26 female connector on the board.
- Step 2:** Make sure the connection is secure.

IVCE-C608/IVCE-C604/IVCME-C604 Capture Card

- Step 3:** Connect the video input BNC connector (black) from the cable to a video device with the **RG-59 coaxial cable (75 ohms)**.
- Step 4:** Connect the audio input RCA connector (white) from the cable to an audio device.
- Step 5:** Repeat **Step 3** and **Step 4** until all video and audio devices are connected.



NOTE:

Up to eight video devices and eight audio devices can be connected to the IVCE-C608 video capture card.

Up to four video devices and four audio devices can be connected to the IVCE-C604 video capture card.

5.4.7 Video Output Connection

The IVCE-C608 and IVCE-C604 are shipped with a video cable that provides 2-channel video output. To install the video cable, please follow the instructions below.

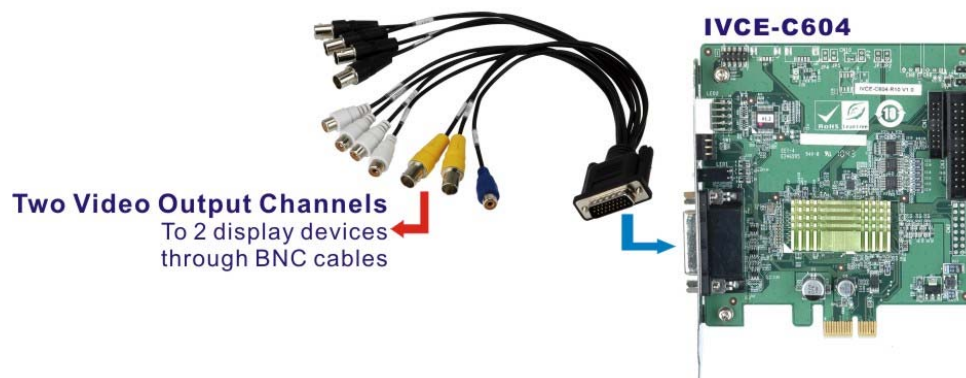

Two Video Output Channels
To 2 display devices through BNC cables

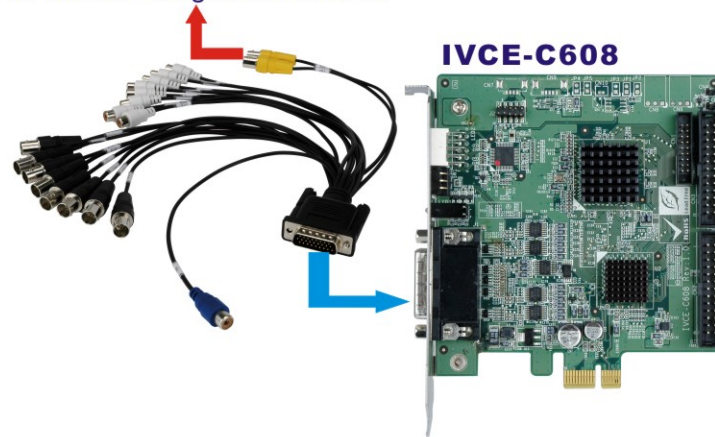

Figure 5-7: Video Output Connection

- Step 1:** Align and insert the DB-26 male connector from the cable to the DB-26 female connector on the board.
- Step 2:** Make sure the connection is secure.
- Step 3:** Connect the video output BNC connector (yellow) from the cable to a video device with the BNC cables.
- Step 4:** Repeat **Step 3** to connect the second video output device.

5.5 IVCME-C604 Hardware Installation

5.5.1 Hardware Installation Procedures

To install the video capture card hardware, the following steps must be followed:

- Step 1:** Install the video capture card.
- Step 2:** Install the GPIO card (optional).
- Step 3:** Connect the video and audio devices.

Once the steps above have been completed, the hardware installation procedures are complete.

IVCE-C608/IVCE-C604/IVCME-C604 Capture Card

5.5.2 Video Capture Card Installation

To install the IVCME-C604, please refer to the diagram and instructions below.

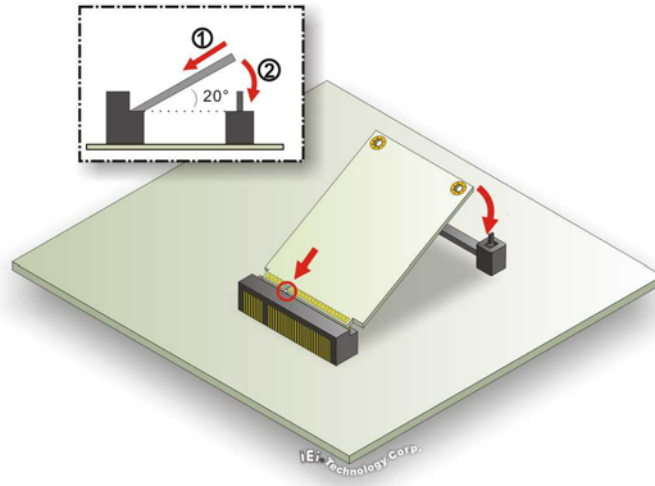

Figure 5-8: IVCME-C604 Installation

- Step 1:** **Insert into the socket at an angle.** Line up the notch on the card with the notch on the connector. Slide the IVCME-C604 into the socket at an angle of about 20°.
- Step 2:** **Push down until the card clips into place.** Push the other end of the card down until it clips into place on the plastic connector.

5.5.3 Video and Audio Input Connection

The IVCME-C604 is shipped with a video/audio input cable, a 4-channel video input cable and a 4-channel audio input cable. To install the video and audio input cable, please follow the instructions below.

IVCME-C604

Figure 5-9: Video and Audio Input Connection (IVCME-C604)

- Step 1:** Align and insert the wafer connector from the video/audio input cable to the 10-pin wafer connector (CN1) on the board.
- Step 2:** Make sure the connection is secure.
- Step 3:** Connect the 4-channel video input cable to the video connector of the video/audio input cable.
- Step 4:** Connect the 4-channel audio input cable to the audio connector of the video/audio input cable.
- Step 5:** Connect the video input BNC connector (black) from the cable to a video device with the **RG-59 coaxial cable (75 ohms)**.
- Step 6:** Connect the audio input RCA connector (white) from the cable to an audio device.
- Step 7:** Repeat **Step 5** and **Step 6** until all video and audio devices are connected.

IVCE-C608/IVCE-C604/IVCME-C604 Capture Card

5.5.4 Install the GPIO Card (Optional)

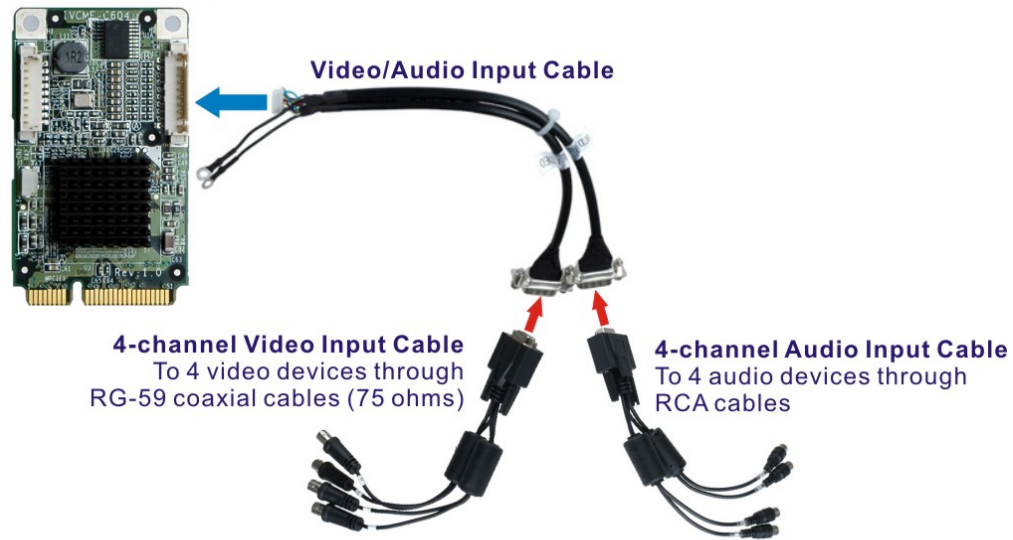
The IVCME-C604 supports 8-bit GPIO (4-bit input and 4-bit output) via an optional GPIO card. To install the GPIO card, please follow the instructions below.

Step 1: Locate the GPIO connector on the IVCME-C604 video capture card (see **Section 1.2.3**).

Step 2: Align the cable connector from the GPIO cable with the GPIO connector on the video capture card.

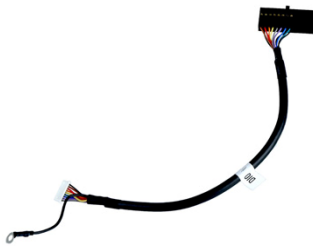

Figure 5-10: GPIO Cable for IVCME-C604

Step 3: Push the cable connector onto the video capture card GPIO connector making sure the pins are correctly aligned.

Step 4: Next, connect the GPIO cable connector to GPIO connector on the GPIO card (CN6). Please refer to **Section 5.4.4.1** for the GPIO card pinouts.

Chapter

6

Software and Driver

IVCE-C608/IVCE-C604/IVCME-C604 Capture Card

6.1 Overview

A CD is shipped with the video capture card. The CD contains a driver for the Conexant video capture controllers on the card. When the video capture card is installed on the system, the driver must be installed. Failure to install the driver means the video capture card cannot be detected by the system.

6.2 Driver and Application Installation

To install the driver and the IEI video capture test suite, please follow the steps below:

Step 1: Insert the disk into a CD disk drive connected to the system. An autorun file starts. The screen in **Figure 6-1** appears.



Figure 6-1: Autorun Startup Screen

Step 2: Select the model installed on the system from the menu in **Figure 6-1**.

Step 3: The screen in **Figure 6-2** appears.

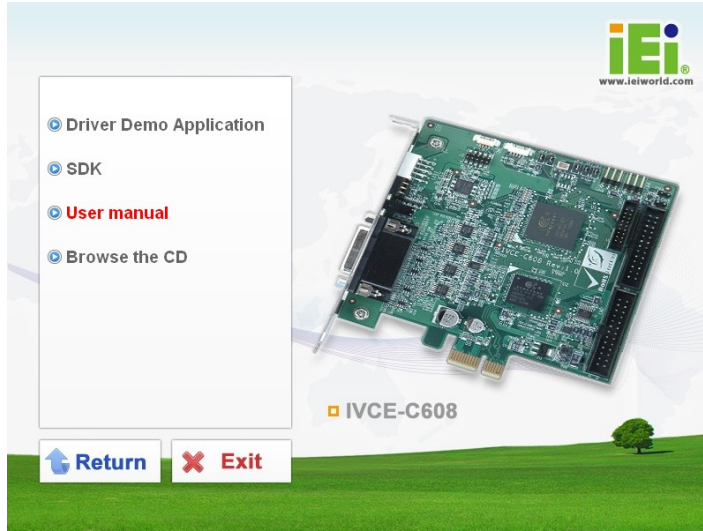

Figure 6-2: Driver Directory Icon

Step 4: Double click the **Driver Demo Application** directory icon in **Figure 6-2**.

Step 5: The driver folder appears. Choose a driver installation file (.exe) that matches the capture card model and the system OS. Double click the file to start the driver installation. For example, to install the IVCE-C604 driver in a Windows XP system, double click the **IVCE-C6XX_Series_32Bit_V1.2.0_20111213.exe** icon in the driver folder.



NOTE:

To be able to install the driver and the IEI Video Capture Test Suite in a 64-bit operating system (such as Windows 7), please do the followings:

1. Login the system as “administrator” and run “ReallyDisableUAC-Win7.reg” from the driver CD. Then, restart the system.
2. When the system is booting, press **F8** to enter the Advanced Boot Options menu. Choose “**Disable Driver Signature Enforcement**” and press **Enter**.
3. Login the system as “administrator” and start to install the driver and application.

IVCE-C608/IVCE-C604/IVCME-C604 Capture Card

Step 6: The screen in **Figure 6-3** appears. Select components to install. Click the + button to expand the card ID option list. Select the video capture card ID to install the driver. Click the **INSTALL** button in **Figure 6-3** to continue the installation process.

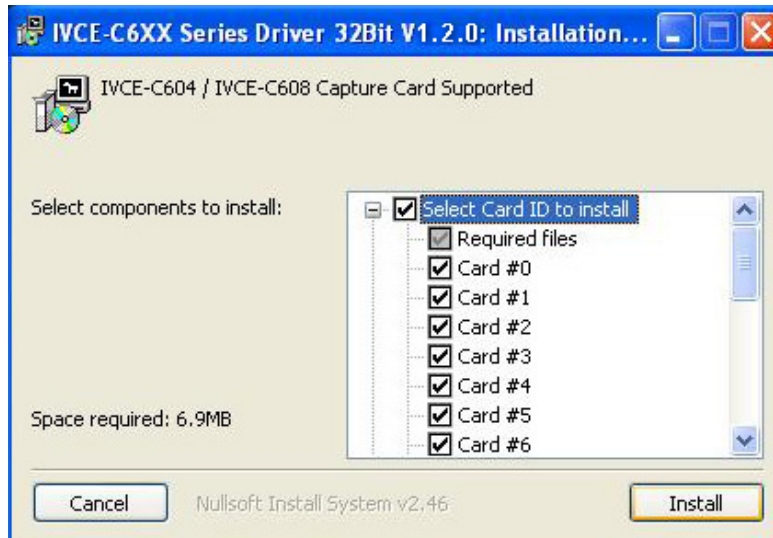

Figure 6-3: Driver Installation - Select Card ID

Step 7: If the following window appears, click **Continue Anyway**.



Figure 6-4: Windows Warning Window

Step 8: The driver starts to install and the screen in **Figure 6-5** appears.

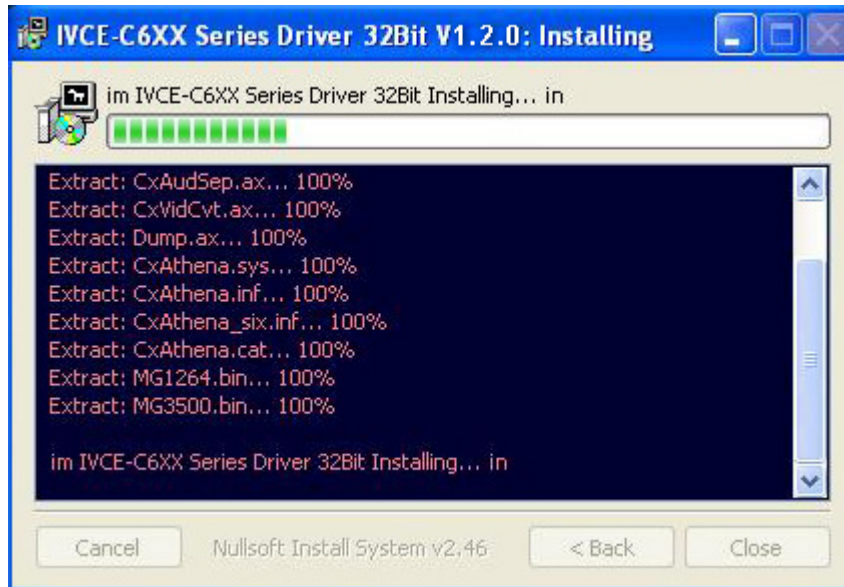

Figure 6-5: Driver Installing

Step 9: When the driver installation is complete, the screen in **Figure 6-6** appears.

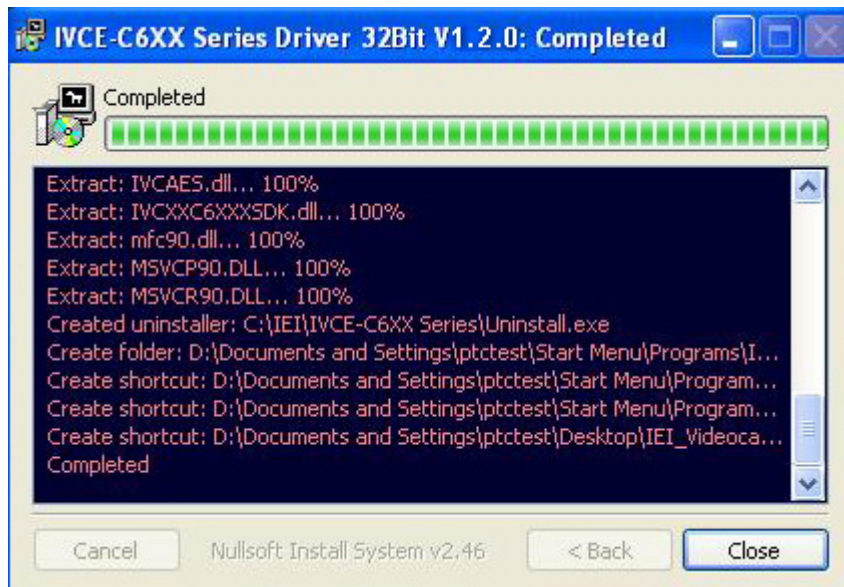

Figure 6-6: Driver Installation Complete

Step 10: Click **CLOSE** to finish. Restart the computer.

Step 11: Check the device manager in the Windows control panel to ensure the drivers

IVCE-C608/IVCE-C604/IVCME-C604 Capture Card

have been properly installed (**Figure 6-7**).

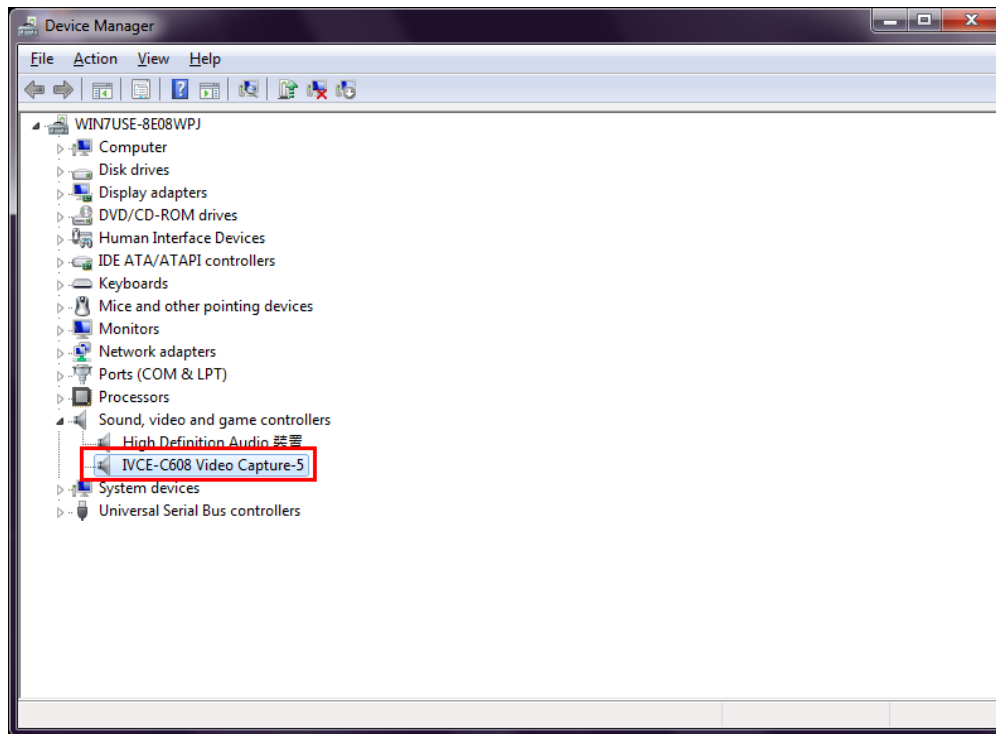

Figure 6-7: Device Manager

Step 12: The IEI Video Capture Test Suite shortcut is shown on the desktop (**Figure 6-8**).

The test suite can also be accessed from the following directory:

C:\IEI\IVCE-C6XX Series.



Figure 6-8: IEI Video Capture Test Suite Shortcut Icon

6.2.1 FFDSHow Installation

Step 1: Download the FFDSHow video encoder from the Internet. Install the FFDSHow in the system.

Step 2: Launch the “FFDShow video encoder configuration” from the start menu. Start menu → ffdshow → VFW configuration.

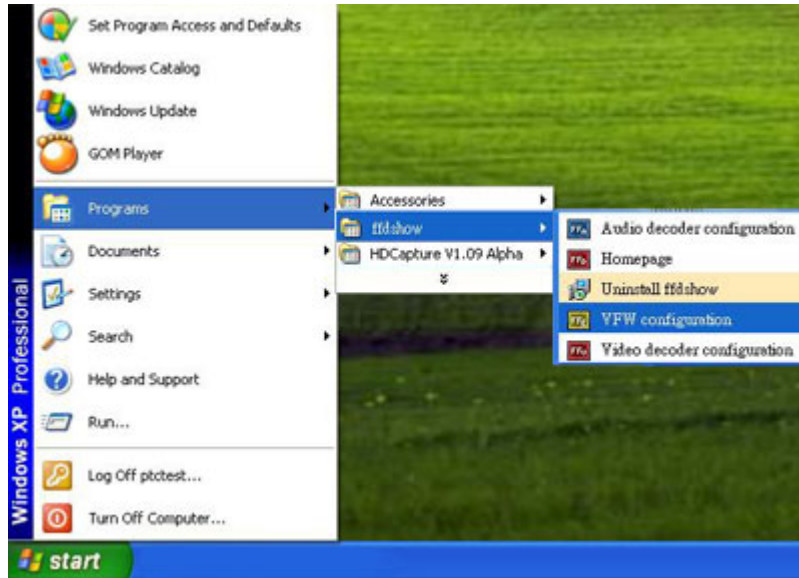

Figure 6-9: FFDShow - VFW Configuration

Step 3: The ffdshow video encoder configuration window appears. Select MJPEG encoder.

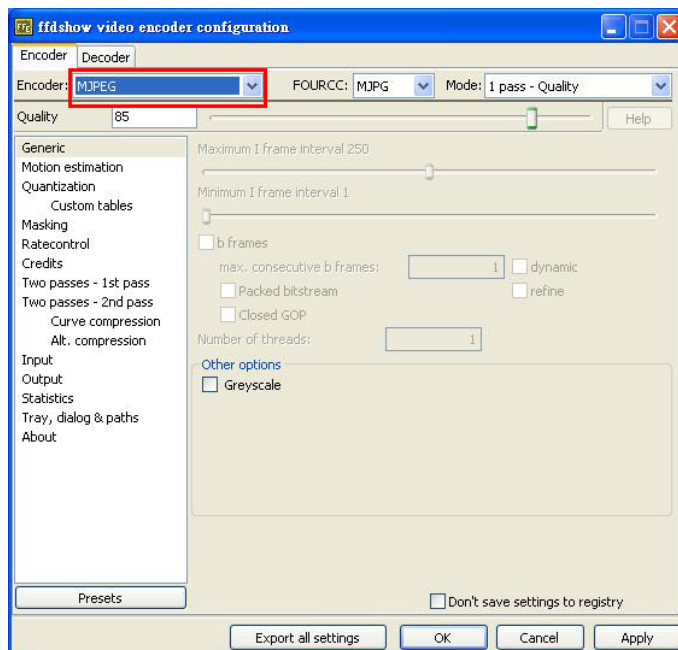

Figure 6-10: FFDShow Video Encoder Configuration Window

IVCE-C608/IVCE-C604/IVCME-C604 Capture Card

6.2.2 Uninstall Driver and Application

Step 1: To uninstall the test suite, select **Uninstall** in the “IVCE-C6XX Series” folder from the start-up menu (**Figure 6-11**).

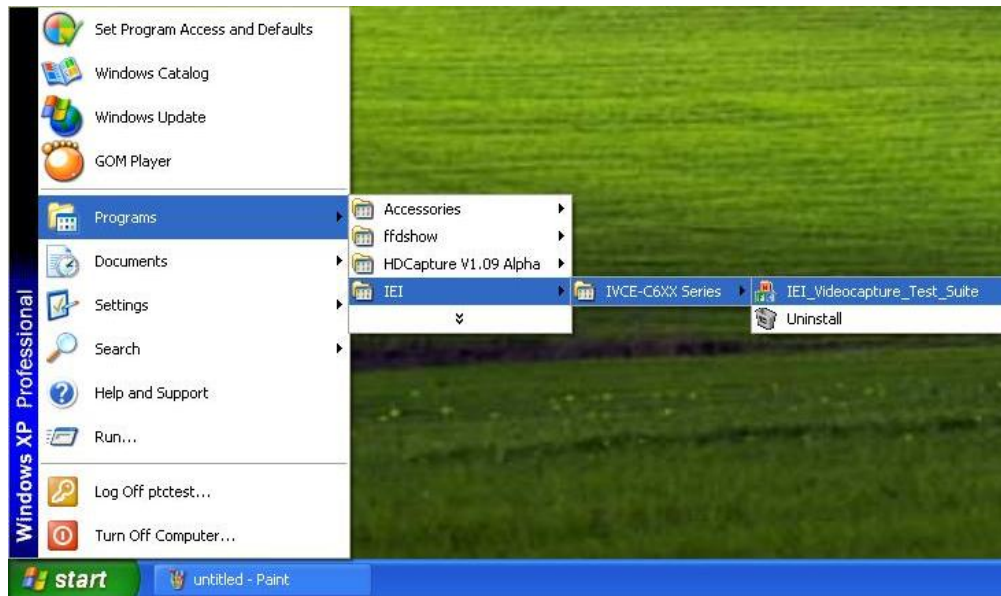

Figure 6-11: Uninstall IEI Video Capture Test Suite (Start Menu)

Step 2: To uninstall the driver, right click the video capture card and select **Uninstall** in the Device Manager window as shown in **Figure 6-11**.

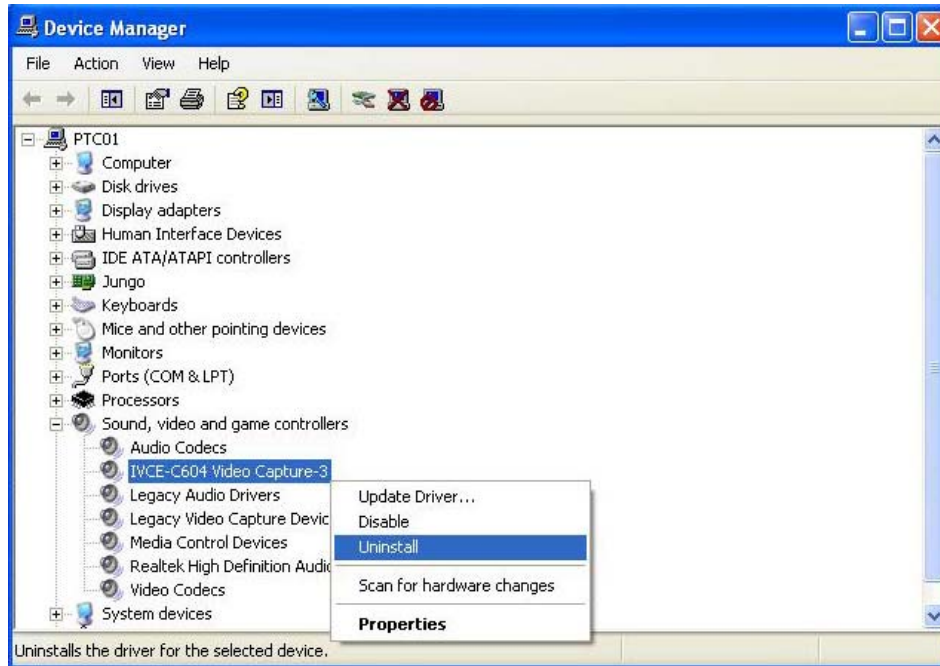



Figure 6-12: Device Manager – Uninstall Driver

6.3 IEI Video Capture Test Suite

The IEI Video Capture Test Suite is a demonstration application for the IVCE-C608/IVCE-C604/IVCME-C604 video capture card. Before using the IEI Video Capture Test Suite, please complete the hardware installation and the software installation described in the previous sections.

6.3.1 Video Capture

To use the IEI Video Capture Test Suite to capture video, follow the steps below.

- Step 1:** Launch the Test Suite by double clicking the desktop icon . The window in **Figure 6-13** appears. The setting buttons are on the left side panel of the interface.

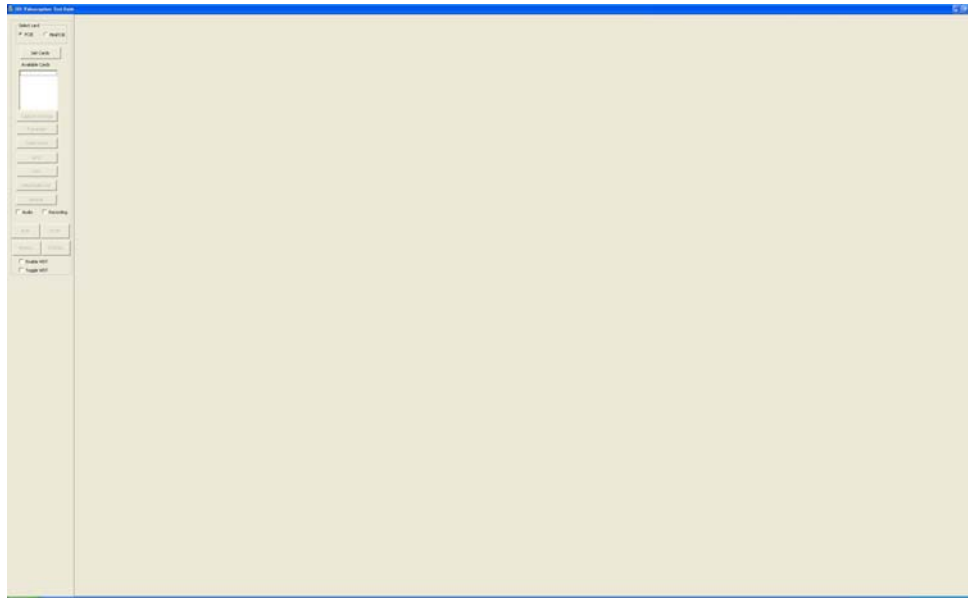

Figure 6-13: IEI Video Capture Test Suite

- Step 2:** Select the capture card type: PCIE or MiniPCIE.
- Step 3:** Click the **Get Cards** button. The capture cards connected to the system shows. Select one capture card from the list. The card number is corresponding to the card ID shown on the card, which is selected by the rotary switch.
- Step 4:** Configure the capture settings by clicking the **Capture Settings** button.



Figure 6-14: Available Cards

Step 5: The Capture Settings window appears.

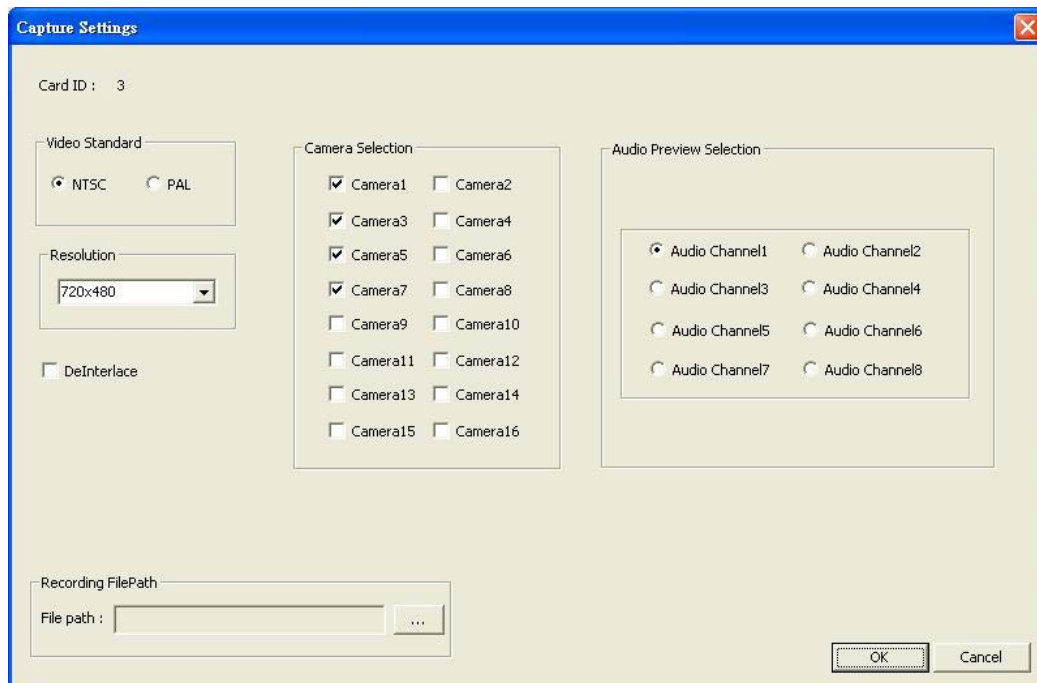

Figure 6-15: Capture Settings Window

IVCE-C608/IVCE-C604/IVCME-C604 Capture Card

Step 6: Select a video standard (NTSC or PAL) and video resolutions. The supported resolutions of the two video standards are listed below.

NTSC	PAL
720x480	720x576
720x240	720x288
640x480	352x288
640x240	
352x240	
320x240	
160x120	

Table 6-1: Supported Resolutions

Step 7: Select camera channel(s) to capture the video from.



NOTE:

If the IVCE-C608 or IVCE-C604 capture card is used, select camera1, 3, 5, 7, 9, 11, 13 or 15 (as shown below).

Camera Selection

Camera1 Camera2

Camera3 Camera4

Camera5 Camera6

Camera7 Camera8

If the IVCME-C604 capture card is used, select camera1, 2, 3 or 4 (as shown below).

Camera Selection

Camera1 Camera2

Camera3 Camera4

Camera5 Camera6

Camera7 Camera8

Step 8: Select one audio channel (1~8) for preview, which mean the user can hear the sound from the selected audio channel when capturing video and audio.

However, if the user chooses to record the captured video (see **Step 11**), all of the connected audio channels will be captured and saved in separate audio files (e.g., four audio files will be saved if four audio channels are connected).



Figure 6-16: Audio Preview Selection



NOTE:

The IVCE-C608/IVCE-C604/IVCME-C604 supports mono audio capture. However, the sound captured by the IVCME-C604 can only be heard from one speaker.

Step 9: To record and save the captured video (AVI format), choose a file path for saving the files in the Capture Settings window.

IVCE-C608/IVCE-C604/IVCME-C604 Capture Card

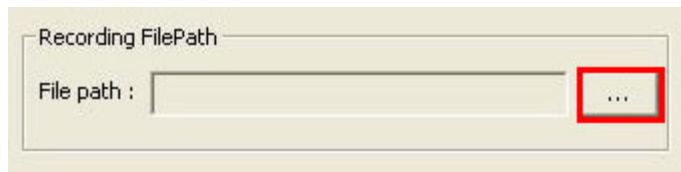

Figure 6-17: Recording File Path Selection

Step 10: Click **OK** to save settings and exit the Capture Settings window.

Step 11: In the main interface, check the Audio checkbox to capture audio. Check the Recording checkbox to record the video and save in AVI format (see **Figure 6-28**).

Step 12: Click the **RUN** button to start capturing videos. Click the **STOP** button to stop.

Step 13: To capture all channels from multiple capture cards, click the RUNALL button on the test suite interface (see **Figure 6-28**). Click the STOPALL button to stop capturing all channels.



Figure 6-18: Start Video Capture

Step 14: The Test Suite starts capturing.



Figure 6-19: Capturing Video

6.3.2 Video Bypass (IVCE-C608 and IVCE-C604 Only)

To view the video input source on another display device in real time, please follow the steps below.

- Step 1:** Connect the video input source to the video input port of the IVCE-C608 or the IVCE-C604.
- Step 2:** Connect the BNC cable from the display device to the BNC output port of the IVCE-C608 or the IVCE-C60.
- Step 3:** Launch the IEI Video Capture Test Suite.
- Step 4:** Select the capture card type: PCIE or MiniPCIE. Click the **Get Cards** button. The capture cards connected to the system shows. Select one capture card from the list.

IVCE-C608/IVCE-C604/IVCME-C604 Capture Card

Step 5: Click the **Video Out** button:



Step 6: The Video Out window appears.

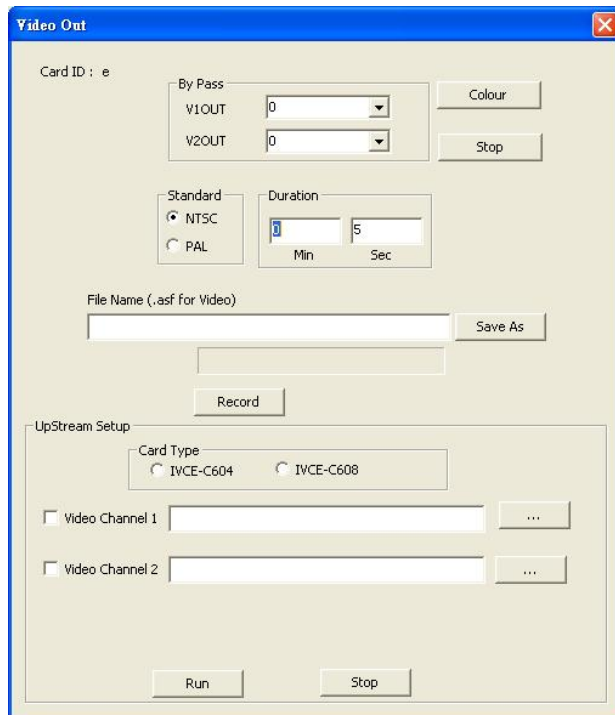

Figure 6-20: Video Out Window

Step 7: Select which channel to bypass. Once a channel is selected, it will start bypass the video to the display device. Click the Colour button to adjust the bypass video. (See **Figure 6-21**).

Step 8: Click the **Stop** button to stop video bypass.



Figure 6-21: Video Out – By pass

**NOTE:**

Audio bypass is not available in the current version.

6.3.3 Video Out (IVCE-C608 and IVCE-C604 Only)

The Video Out function allows users to display video (recorded by the test suite) on display devices through the output ports of the IVCE-C608 or the IVCE-C604. To do this, follow the steps below.

**NOTE:**

Please make sure to stop the video by pass before using the video out function.

Step 1: Connect the video input source to the video input port of the IVCE-C608 or the IVCE-C604.

Step 2: Connect the BNC cable from the display device to the BNC output port of the IVCE-C608 or the IVCE-C604.

Step 3: Launch the IEI Video Capture Test Suite.

Step 4: Select the capture card type: PCIE. Click the **Get Cards** button. The capture cards connected to the system shows. Select one capture card from the list.

Step 5: Click the **Video Out** button:



Step 6: The Video Out window appears.

IVCE-C608/IVCE-C604/IVCME-C604 Capture Card

Step 7: Record a video clip first for video out. Select a standard (NTSC or PAL).
Setup the duration. Specify a path to save the recorded files. Click the **Record** button to start recording.

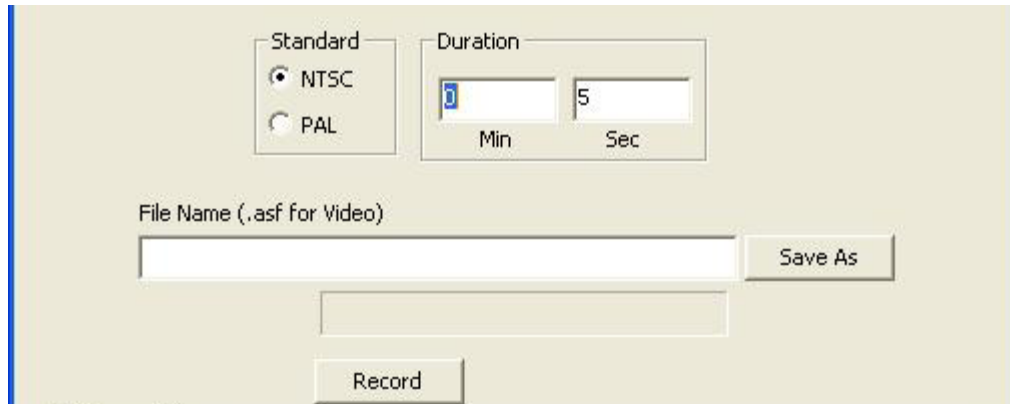

Figure 6-22: Video Out Window (Upper)



WARNING:

To ensure the video quality, it is highly recommended to save the recorded files in a drive which is not installed with an operating system.



NOTE:

If an issue occurs when recording the video, install a codec pack to solve the problem, such as the FFDSHOW video decoder (it is a freeware).

Step 8: Select a card type – IVCE-C604 or IVCE-C608.

Step 9: Select the video channel 1/2.

Step 10: Click  button to select a video file recorded in **Step 7**.

Step 11: Click **Run** to start displaying the video through the output port.

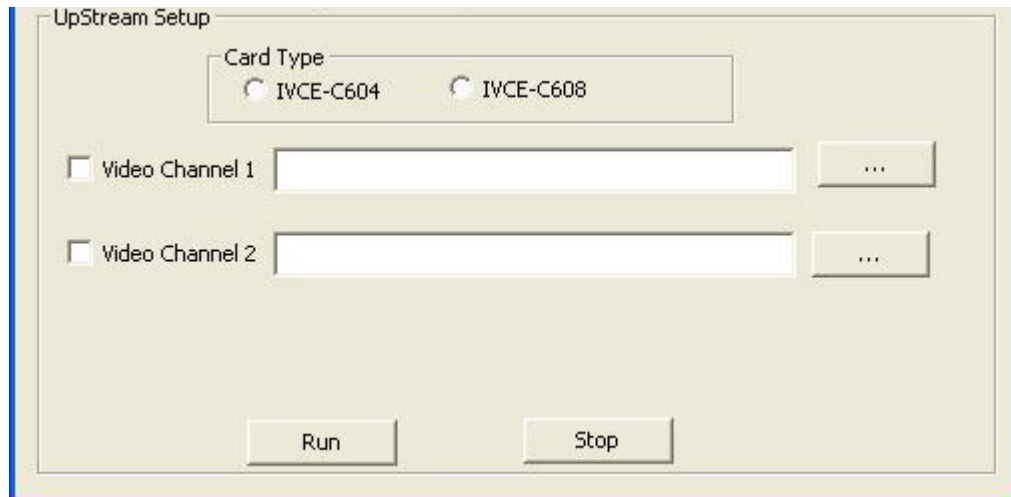

Figure 6-23: Video Out Window (Bottom)

6.3.4 Other Functions

The IEI Video Capture Test Suite also includes some other functions, including

- Frame rate
- Color control
- GPIO control
- Watchdog timer
- General information

These functions are described in the following sections.

6.3.4.1 Frame Rate

The user can view the frame rate when capturing video. Click the **Framerate** button

 to bring up the Frame Rate window. The frame rate of each camera channel show (refer to **Figure 6-24**).

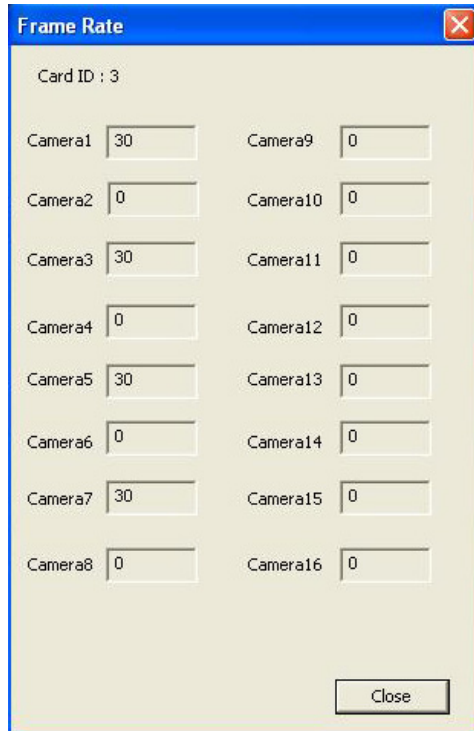



Figure 6-24: Frame Rate Window

6.3.4.2 Color Control

Click the **ColorControl** button  to bring up the Color Control window (Figure 6-25).

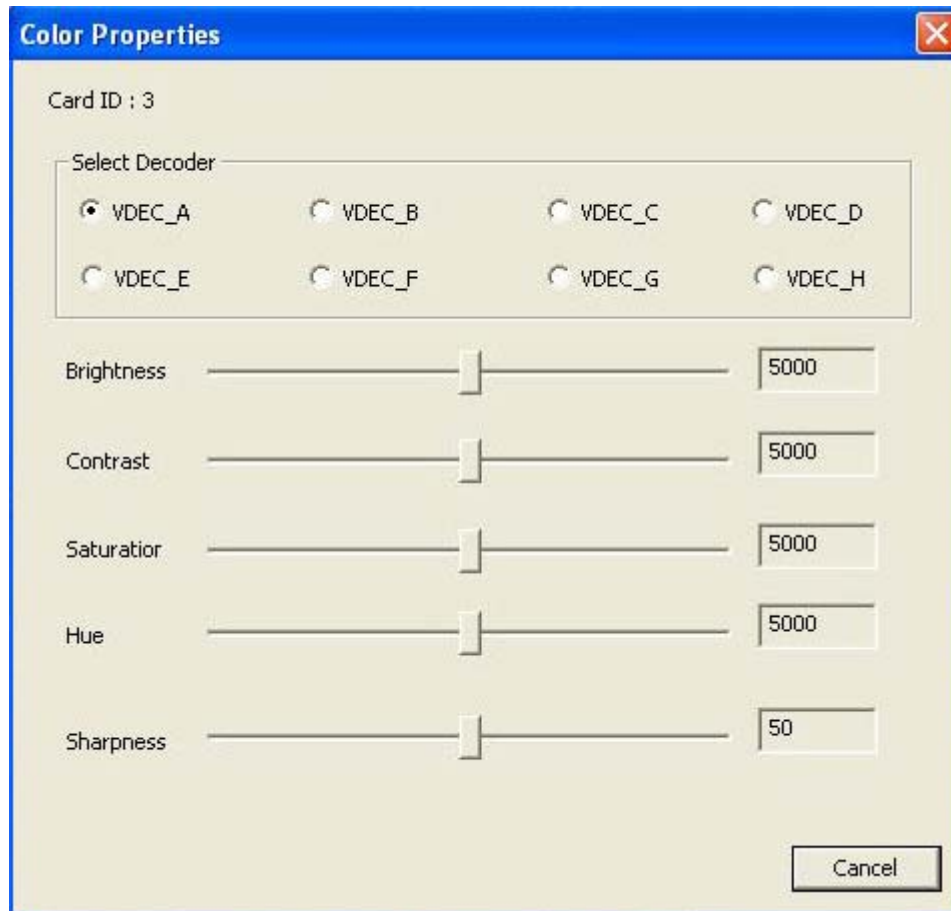
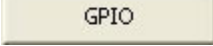

Figure 6-25: Color Settings

Use the Color Control settings to adjust the image properties of the displayed video of a single channel. Select the video channel to be adjusted by clicking the corresponding channel number (VDEC_A~H). The image properties include brightness, contrast, saturation, hue and sharpness. Adjust the image properties by dragging the control bar. Close the window to apply the settings to the selected channel.

IVCE-C608/IVCE-C604/IVCME-C604 Capture Card

6.3.4.3 GPIO

Click the **GPIO** button  to bring up the GPIO control window (Figure 6-26).

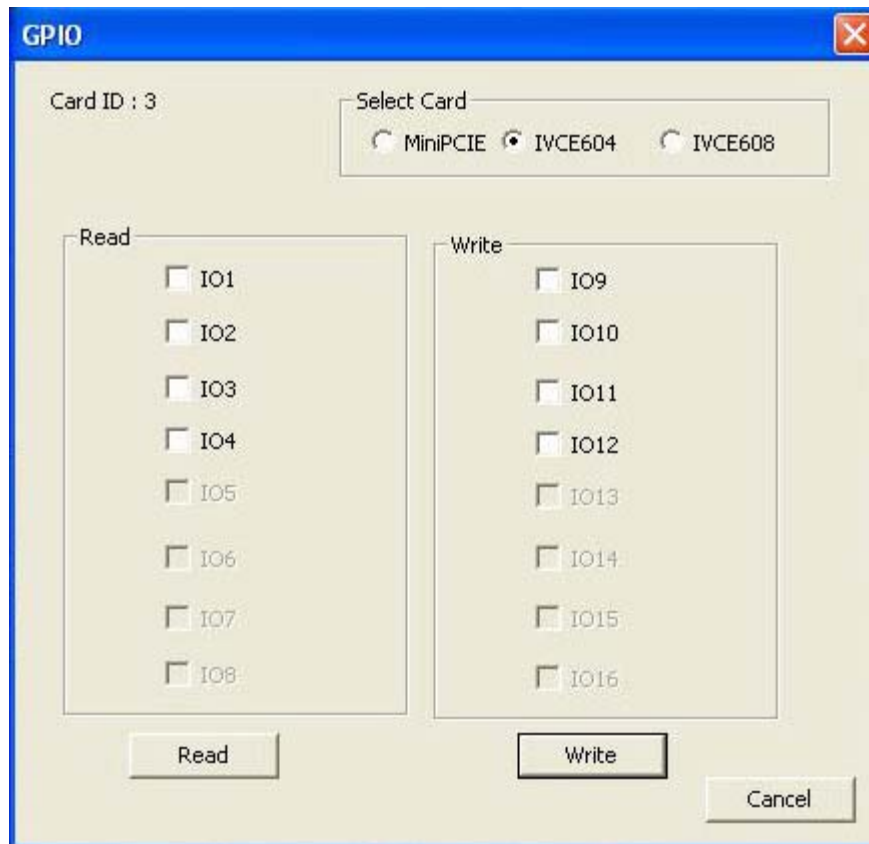



Figure 6-26: GPIO Control

The GPIO function allows users to configure GPIO output signals and read GPIO input signal if the GPIO connector(s) of the IVCE-C608/IVCE-C604/IVCME-C604 is connected to an optional GPIO card.

6.3.4.4 Watchdog Timer (WDT)

To enable watchdog timer, click the **WDT** button  to bring up the WDT window. Check Enable WDT and/or Toggle WDT options, then click OK. The amber LED on the capture card lights on indicating that the WDT is enabled.

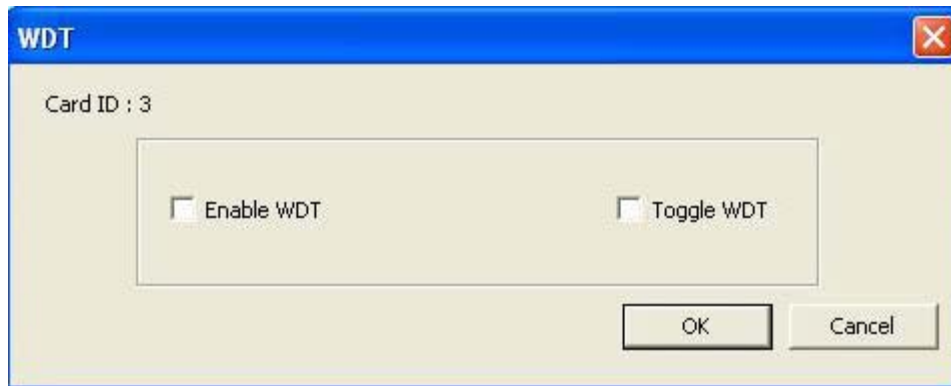

Figure 6-27: WDT Window

To enable watchdog timer for multiple capture cards, check the checkboxes of the Enable WDT and/or Toggle WDT options on the test suite main interface (see **Figure 6-28**).

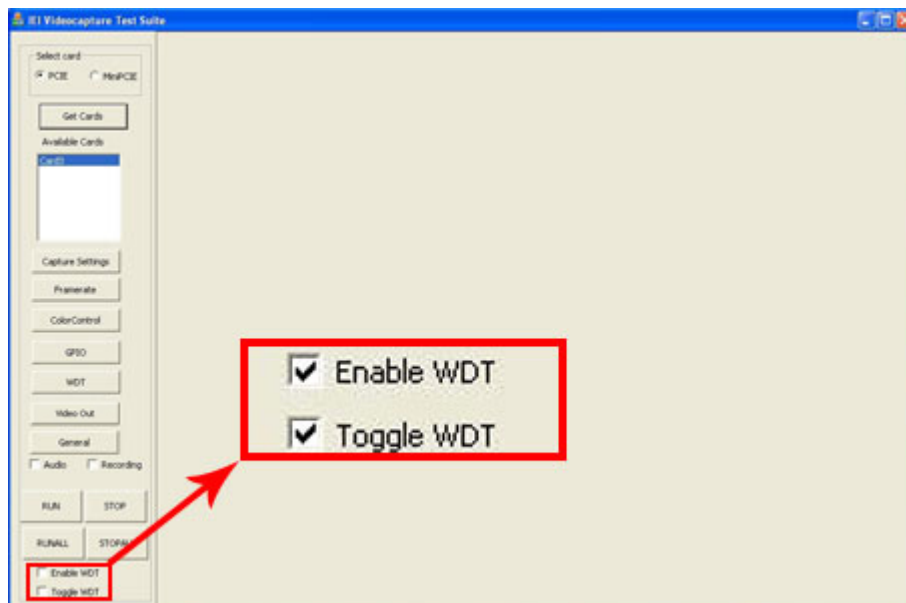



Figure 6-28: WDT Options for Multiple Cards

6.3.4.5 General Information

Click the **General** button  to bring up the General window. To view the general information (board ID and firmware version) of the capture card, click the **Get Info** button.

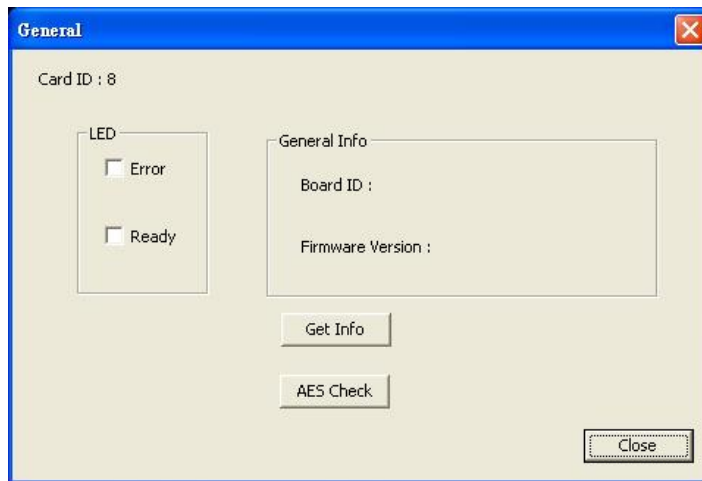

Figure 6-29: General Window

To test the LED function on the IVCE-C608 or the IVCE-C604, select the checkbox of the LEDs. Select **Error**, the red LED lights on. Select **Ready**, the green LED lights on.

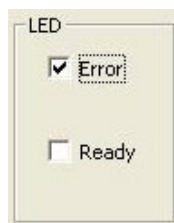

Figure 6-30: LED Function Test

The IEI Video Capture Test Suite can only be used with IEI IVCE-C608/IVCE-C604/IVCME-C604 capture cards. Click the AES Check button to check if the capture card is compatible with the test suite.



Figure 6-31: AES Check - Pass

Appendix

A

Hazardous Materials Disclosure

A.1 Hazardous Material Disclosure Table for IPB Products Certified as RoHS Compliant Under 2002/95/EC Without Mercury

The details provided in this appendix are to ensure that the product is compliant with the Peoples Republic of China (China) RoHS standards. The table below acknowledges the presences of small quantities of certain materials in the product, and is applicable to China RoHS only.

A label will be placed on each product to indicate the estimated “Environmentally Friendly Use Period” (EFUP). This is an estimate of the number of years that these substances would “not leak out or undergo abrupt change.” This product may contain replaceable sub-assemblies/components which have a shorter EFUP such as batteries and lamps. These components will be separately marked.

Please refer to the table on the next page.

Part Name	Toxic or Hazardous Substances and Elements					
	Lead (Pb)	Mercury (Hg)	Cadmium (Cd)	Hexavalent Chromium (CR(VI))	Polybrominated Biphenyls (PBB)	Polybrominated Diphenyl Ethers (PBDE)
Housing	X	O	O	O	O	X
Display	X	O	O	O	O	X
Printed Circuit Board	X	O	O	O	O	X
Metal Fasteners	X	O	O	O	O	O
Cable Assembly	X	O	O	O	O	X
Fan Assembly	X	O	O	O	O	X
Power Supply Assemblies	X	O	O	O	O	X
Battery	O	O	O	O	O	O

O: This toxic or hazardous substance is contained in all of the homogeneous materials for the part is below the limit requirement in SJ/T11363-2006

X: This toxic or hazardous substance is contained in at least one of the homogeneous materials for this part is above the limit requirement in SJ/T11363-2006

IVCE-C608/IVCE-C604/IVCME-C604 Capture Card

此附件旨在确保本产品符合中国 RoHS 标准。以下表格标示此产品中某有毒物质的含量符合中国 RoHS 标准规定的限量要求。

本产品上会附有“环境友好使用期限”的标签，此期限是估算这些物质“不会有泄漏或突变”的年限。本产品可能包含有较短的环境友好使用期限的可替换元件，像是电池或灯管，这些元件将会单独标示出来。

部件名称	有毒有害物质或元素					
	铅 (Pb)	汞 (Hg)	镉 (Cd)	六价铬 (CR(VI))	多溴联苯 (PBB)	多溴二苯醚 (PBDE)
壳体	X	O	O	O	O	X
显示	X	O	O	O	O	X
印刷电路板	X	O	O	O	O	X
金属螺帽	X	O	O	O	O	O
电缆组装	X	O	O	O	O	X
风扇组装	X	O	O	O	O	X
电力供应组装	X	O	O	O	O	X
电池	O	O	O	O	O	O

O: 表示该有毒有害物质在该部件所有物质材料中的含量均在SJ/T11363-2006 标准规定的限量要求以下。
X: 表示该有毒有害物质至少在该部件的某一均质材料中的含量超出SJ/T11363-2006 标准规定的限量要求。