

MODEL:

NANO-QM770

**EPIC SBC with 3rd Generation 22nm Intel® Mobile CPU
Up to 8.0 GB DDR3, DVI, HDMI, LVDS, Dual GbE,
SATA 6Gb/s, USB 3.0, PCIe Mini, Intel® AMT, RoHS**

User Manual

Revision

Date	Version	Changes
August 12, 2015	1.04	Modified Table 2-2: Optional Items
July 14, 2015	1.03	Modified Table 3-8: Front Panel Connector Pinouts
April 23, 2014	1.02	Modified Table 3-24: LAN Pinouts
December 9, 2013	1.01	Updated Appendix D: Digital I/O Interface
May 24, 2012	1.00	Initial release

Copyright

COPYRIGHT NOTICE

The information in this document is subject to change without prior notice in order to improve reliability, design and function and does not represent a commitment on the part of the manufacturer.

In no event will the manufacturer be liable for direct, indirect, special, incidental, or consequential damages arising out of the use or inability to use the product or documentation, even if advised of the possibility of such damages.

This document contains proprietary information protected by copyright. All rights are reserved. No part of this manual may be reproduced by any mechanical, electronic, or other means in any form without prior written permission of the manufacturer.

TRADEMARKS

All registered trademarks and product names mentioned herein are used for identification purposes only and may be trademarks and/or registered trademarks of their respective owners.

Manual Conventions



WARNING

Warnings appear where overlooked details may cause damage to the equipment or result in personal injury. Warnings should be taken seriously.



CAUTION

Cautionary messages should be heeded to help reduce the chance of losing data or damaging the product.



NOTE

These messages inform the reader of essential but non-critical information. These messages should be read carefully as any directions or instructions contained therein can help avoid making mistakes.



HOT SURFACE

This symbol indicates a hot surface that should not be touched without taking care.

Table of Contents

1 INTRODUCTION.....	1
1.1 INTRODUCTION.....	2
1.2 BENEFITS	2
1.3 FEATURES.....	2
1.4 CONNECTORS	3
1.5 DIMENSIONS.....	5
1.6 DATA FLOW	6
1.7 TECHNICAL SPECIFICATIONS	7
2 PACKING LIST.....	9
2.1 ANTI-STATIC PRECAUTIONS	10
2.2 UNPACKING PRECAUTIONS.....	10
2.3 PACKING LIST.....	11
2.4 OPTIONAL ITEMS	12
3 CONNECTOR PINOUTS.....	14
3.1 PERIPHERAL INTERFACE CONNECTORS.....	15
3.1.1 <i>Layout</i>	15
3.1.2 <i>Peripheral Interface Connectors</i>	16
3.1.3 <i>External Interface Panel Connectors</i>	17
3.2 INTERNAL PERIPHERAL CONNECTORS	18
3.2.1 <i>Audio Connector</i>	18
3.2.2 <i>Battery Connector</i>	19
3.2.3 <i>Digital I/O Connector</i>	20
3.2.4 <i>Fan Connector (CPU)</i>	20
3.2.5 <i>Fan Connector (System)</i>	21
3.2.6 <i>Front Panel Connector</i>	22
3.2.7 <i>Keyboard/Mouse Connector</i>	23
3.2.8 <i>LVDS Connector</i>	23
3.2.9 <i>LVDS Backlight Connector</i>	25
3.2.10 <i>PCIe Mini Card Slot</i>	25

3.2.11 Power Connector (12V)	27
3.2.12 RS-232 Serial Port Connectors (COM1, COM2)	28
3.2.13 RS-422/485 Serial Port Connector (COM3).....	28
3.2.14 SATA Drive Connectors	29
3.2.15 SATA Power Connectors	30
3.2.16 SMBus Connector	31
3.2.17 SO-DIMM Connector.....	32
3.2.18 SPI Flash Connector.....	32
3.2.19 TPM Connector.....	33
3.2.20 USB 2.0 Connector	34
3.3 EXTERNAL INTERFACE CONNECTORS	35
3.3.1 DVI Connector	35
3.3.2 Ethernet Connectors	36
3.3.3 HDMI Connectors.....	37
3.3.4 USB 3.0 Connectors.....	38
4 INSTALLATION	40
4.1 ANTI-STATIC PRECAUTIONS	41
4.2 INSTALLATION CONSIDERATIONS.....	41
4.3 SO-DIMM INSTALLATION	43
4.4 PCIE MINI CARD INSTALLATION	43
4.5 JUMPER SETTINGS	44
4.5.1 AT/ATX Mode Selection	45
4.5.2 Clear CMOS.....	46
4.5.3 Clear ME RTC Registers	47
4.5.4 Flash Descriptor Security Override.....	48
4.5.5 LVDS Voltage Selection.....	49
4.5.6 LVDS Resolution Selection	49
4.5.7 PCIe Mini/mSATA Mode Selection	50
4.6 CHASSIS INSTALLATION.....	51
4.6.1 Airflow.....	51
4.6.2 Motherboard Installation.....	51
4.7 INTERNAL PERIPHERAL DEVICE CONNECTIONS.....	52
4.7.1 AT Power Connection	52
4.7.2 Audio Kit Installation.....	53

NANO-QM770 EPIC SBC

4.7.3 SATA Drive Connection	54
4.7.4 Single RS-232 Cable (w/o Bracket)	55
4.8 INTEL® AMT SETUP PROCEDURE	56
5 BIOS	58
5.1 INTRODUCTION	59
5.1.1 Starting Setup	59
5.1.2 Using Setup	59
5.1.3 Getting Help	60
5.1.4 Unable to Reboot After Configuration Changes	60
5.1.5 BIOS Menu Bar	60
5.2 MAIN	61
5.3 ADVANCED	62
5.3.1 ACPI Configuration	63
5.3.2 RTC Wake Settings	64
5.3.3 Trusted Computing	65
5.3.4 CPU Configuration	66
5.3.5 SATA Configuration	68
5.3.6 Intel(R) Rapid Start Technology	69
5.3.7 Intel TXT(LT) Configuration	69
5.3.8 AMT Configuration	70
5.3.9 USB Configuration	71
5.3.10 F81866 Super IO Configuration	72
5.3.10.1 Serial Port n Configuration	73
5.3.11 F81866 H/W Monitor	76
5.3.11.1 Smart Fan Mode Configuration	77
5.3.12 Serial Port Console Redirection	78
5.3.13 IEI Feature	79
5.4 CHIPSET	80
5.4.1 PCH-IO Configuration	81
5.4.2 System Agent (SA) Configuration	82
5.4.2.1 Graphics Configuration	83
5.4.2.2 Memory Configuration	86
5.5 BOOT	87
5.6 SECURITY	90

5.7 EXIT	90
6 SOFTWARE DRIVERS	92
6.1 AVAILABLE SOFTWARE DRIVERS	93
6.2 SOFTWARE INSTALLATION	93
6.3 CHIPSET DRIVER INSTALLATION.....	95
6.4 GRAPHICS DRIVER INSTALLATION.....	98
6.5 LAN DRIVER INSTALLATION	101
6.6 AUDIO DRIVER INSTALLATION	104
6.7 INTEL® RAPID STORAGE TECHNOLOGY DRIVER INSTALLATION	107
6.8 USB 3.0 DRIVER INSTALLATION	110
6.9 INTEL® AMT DRIVER INSTALLATION	113
A REGULATORY COMPLIANCE	116
B BIOS OPTIONS	118
C TERMINOLOGY	121
D DIGITAL I/O INTERFACE.....	125
D.1 INTRODUCTION.....	126
D.2 ASSEMBLY LANGUAGE SAMPLE 1.....	127
D.3 ASSEMBLY LANGUAGE SAMPLE 2.....	127
E HAZARDOUS MATERIALS DISCLOSURE	128
E.1 HAZARDOUS MATERIALS DISCLOSURE TABLE FOR IPB PRODUCTS CERTIFIED AS ROHS COMPLIANT UNDER 2002/95/EC WITHOUT MERCURY	129

List of Figures

Figure 1-1: NANO-QM770.....	2
Figure 1-2: Connectors (Front).....	3
Figure 1-3: Connectors (Solder Side).....	4
Figure 1-4: Dimensions (mm).....	5
Figure 1-5: Data Flow Diagram.....	6
Figure 3-1: Connector and Jumper Locations.....	15
Figure 3-2: Connector and Jumper Locations (Solder Side)	16
Figure 3-3: Audio Connector Location	18
Figure 3-4: Battery Connector Location.....	19
Figure 3-5: Digital I/O Connector Location	20
Figure 3-6: CPU Fan Connector Location	21
Figure 3-7: System Fan Connector Location.....	21
Figure 3-8: Front Panel Connector Location	22
Figure 3-9: Keyboard/Mouse Connector Location	23
Figure 3-10: LVDS Connector Location.....	24
Figure 3-11: LVDS Backlight Inverter Connector	25
Figure 3-12: PCIe Mini Card Slot Location	26
Figure 3-13: Power Connector Location	27
Figure 3-14: RS-232 Serial Port Connector Locations.....	28
Figure 3-15: RS-422/485 Serial Port Connector Location.....	29
Figure 3-16: SATA Drive Connector Locations	30
Figure 3-17: SATA Power Connector Locations	31
Figure 3-18: SMBus Connector Location	31
Figure 3-19: SO-DIMM Connector Location	32
Figure 3-20: SPI Flash Connector Location.....	33
Figure 3-21: TPM Connector Location.....	34
Figure 3-22: USB Connector Location.....	35
Figure 3-23: External Interface Connectors.....	35
Figure 3-24: DVI-I Connector	36
Figure 3-25: Ethernet Connector.....	37

Figure 3-26: HDMI Connector	38
Figure 4-1: SO-DIMM Installation	43
Figure 4-2: PCIe Mini Card Installation.....	44
Figure 4-3: AT/ATX Mode Selection Jumper Location.....	46
Figure 4-4: Clear CMOS Jumper Location	47
Figure 4-5: Clear ME RTC Registers Jumper Location.....	48
Figure 4-6: Flash Descriptor Security Override Jumper Location	48
Figure 4-7: LVDS Voltage Selection Jumper Location	49
Figure 4-8: LVDS Resolution Selection Jumper Location.....	50
Figure 4-9: PCIe Mini/mSATA Mode Selection Jumper Location	51
Figure 4-10: Power Cable to Motherboard Connection	52
Figure 4-11: Connect Power Cable to Power Supply.....	53
Figure 4-12: Audio Kit Cable Connection	54
Figure 4-13: SATA Drive Cable Connection.....	55
Figure 4-14: Single RS-232 Cable Installation	56
Figure 6-1: Introduction Screen	94
Figure 6-2: Available Drivers	94
Figure 6-3: Chipset Driver Welcome Screen.....	95
Figure 6-4: Chipset Driver License Agreement	96
Figure 6-5: Chipset Driver Read Me File	96
Figure 6-6: Chipset Driver Setup Operations	97
Figure 6-7: Chipset Driver Installation Finish Screen.....	98
Figure 6-8: Graphics Driver Welcome Screen	99
Figure 6-9: Graphics Driver License Agreement.....	99
Figure 6-10: Graphics Driver Setup Operations	100
Figure 6-11: Graphics Driver Installation Finish Screen	100
Figure 6-12: Windows Control Panel.....	101
Figure 6-13: System Control Panel.....	101
Figure 6-14: Device Manager List	102
Figure 6-15: Update Driver Software Window	103
Figure 6-16: Locate Driver Files.....	103
Figure 6-17: LAN Driver Installation	104
Figure 6-18: LAN Driver Installation Complete.....	104
Figure 6-19: InstallShield Wizard Welcome Screen	105
Figure 6-20: Audio Driver Software Configuration.....	106

NANO-QM770 EPIC SBC

Figure 6-21: Restart the Computer	106
Figure 6-22: SATA RAID Driver Welcome Screen	107
Figure 6-23: SATA RAID Driver License Agreement.....	108
Figure 6-24: SATA RAID Driver Read Me File	108
Figure 6-25: SATA RAID Driver Setup Operations	109
Figure 6-26: SATA RAID Driver Installation Finish Screen	109
Figure 6-27: USB 3.0 Driver Welcome Screen	110
Figure 6-28: USB 3.0 Driver License Agreement.....	111
Figure 6-29: USB 3.0 Driver Read Me File	111
Figure 6-30: USB 3.0 Driver Setup Operations	112
Figure 6-31: USB 3.0 Driver Installation Finish Screen	112
Figure 6-32: Intel® ME Driver Welcome Screen	114
Figure 6-33: Intel® ME Driver License Agreement.....	114
Figure 6-34: Intel® ME Driver Setup Operations	115
Figure 6-35: Intel® ME Driver Installation Finish Screen	115

List of Tables

Table 1-1: Technical Specifications.....	8
Table 2-1: Packing List.....	12
Table 2-2: Optional Items.....	13
Table 3-1: Peripheral Interface Connectors.....	17
Table 3-2: Rear Panel Connectors.....	17
Table 3-3: Audio Connector Pinouts.....	18
Table 3-4: Battery Connector Pinouts.....	19
Table 3-5: Digital I/O Connector Pinouts.....	20
Table 3-6: CPU Fan Connector Pinouts.....	21
Table 3-7: System Fan Connector Pinouts.....	22
Table 3-8: Front Panel Connector Pinouts.....	22
Table 3-9: Keyboard/Mouse Connector Pinouts.....	23
Table 3-10: LVDS Connector Pinouts.....	24
Table 3-11: Backlight Inverter Connector Pinouts.....	25
Table 3-12: PCIe Mini Card Slot Pinouts.....	27
Table 3-13: Power Connector Pinouts.....	27
Table 3-14: Serial Port Connector Pinouts.....	28
Table 3-15: RS-422/485 Serial Port Connector Pinouts.....	29
Table 3-16: D-sub 9 RS-422/485 Pinouts.....	29
Table 3-17: SATA Drive Connector Pinouts.....	30
Table 3-18: SATA Power Connector Pinouts.....	31
Table 3-19: SMBus Connector Pinouts.....	32
Table 3-20: SPI Flash Connector Pinouts.....	33
Table 3-21: TPM Connector Pinouts.....	34
Table 3-22: USB Port Connector Pinouts.....	35
Table 3-23: DVI Connector Pinouts.....	36
Table 3-24: LAN Pinouts.....	37
Table 3-25: Connector LEDs.....	37
Table 3-26: HDMI Connector Pinouts.....	38
Table 3-27: USB Port Pinouts.....	39

NANO-QM770 EPIC SBC

Table 4-1: Jumpers	45
Table 4-2: AT/ATX Mode Selection Jumper Settings	45
Table 4-3: Clear CMOS Jumper Settings.....	47
Table 4-4: Clear ME RTC Registers Jumper Settings	47
Table 4-5: Flash Descriptor Security Override Jumper Settings	48
Table 4-6: LVDS Voltage Selection Jumper Settings.....	49
Table 4-7: LVDS Screen Resolution Jumper Settings	50
Table 4-8: PCIe Mini/mSATA Mode Selection Jumper Settings.....	51
Table 5-1: BIOS Navigation Keys	60

BIOS Menus

BIOS Menu 1: Main	61
BIOS Menu 2: Advanced	62
BIOS Menu 3: ACPI Configuration	63
BIOS Menu 4: RTC Wake Settings	64
BIOS Menu 5: Trusted Computing	65
BIOS Menu 6: CPU Configuration	66
BIOS Menu 7: SATA Configuration	68
BIOS Menu 8: Intel(R) Rapid Start Technology	69
BIOS Menu 9: Intel TXT(LT) Configuration	70
BIOS Menu 10: AMT Configuration	70
BIOS Menu 11: USB Configuration	71
BIOS Menu 12: Super IO Configuration.....	72
BIOS Menu 13: Serial Port n Configuration Menu	73
BIOS Menu 14: Hardware Health Configuration	76
BIOS Menu 15: FAN 1 Configuration	77
BIOS Menu 16: Serial Port Console Redirection	78
BIOS Menu 17: IEI Feature	79
BIOS Menu 18: Chipset	80
BIOS Menu 19:PCH-IO Configuration	81
BIOS Menu 20: System Agent (SA) Configuration	83
BIOS Menu 21: Graphics Configuration	84
BIOS Menu 22: Memory Configuration.....	87
BIOS Menu 23: Boot	87
BIOS Menu 24: Security	90
BIOS Menu 25:Exit.....	91

Chapter

1

Introduction

1.1 Introduction

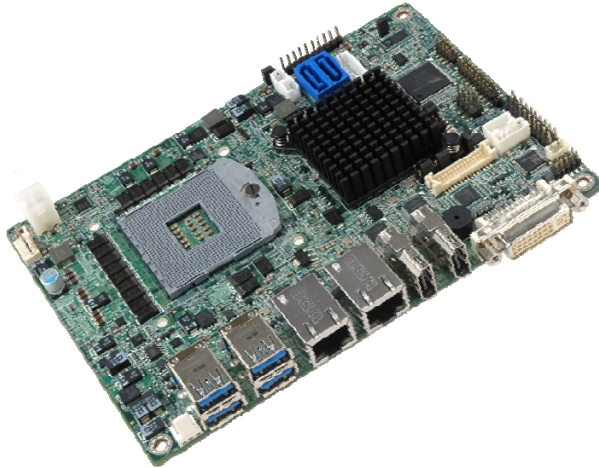

Figure 1-1: NANO-QM770

The NANO-QM770 is an EPIC SBC with a 3rd generation 22nm Intel® mobile CPU and Intel® QM77 Express Chipset. Storage on the board is handled by the SATA 6Gb/s ports for connecting a hard drive, optical drive or SSD. The PCIe Mini slot allows an mSATA card to be installed.

The board has three types of graphics outputs. A DVI-I output connects to a DVI monitor or a traditional VGA monitor. One LVDS connector supports 24-bit dual-channel display and two HDMI connectors support HDMI 1080p display.

Other slots and connectors include RS-232, RS-422/485, gigabit Ethernet, USB 3.0 ports, USB 2.0 ports and digital I/O.

1.2 Benefits

Some of the NANO-QM770 motherboard benefits include:

- Low power consumption
- Wide range of I/O interfaces
- Triple independent display support

1.3 Features

Some of the NANO-QM770 motherboard features are listed below:

NANO-QM770 EPIC SBC

- EPIC form factor
- RoHS compliant
- Intel® AMT 8.0 support
- Dual GbE
- Supports HDMI, LVDS and DVI-I interface for triple independent display (HDMI V1.3a compliant)
- Six USB ports (two USB 2.0, four USB 3.0)
- Three serial ports
- PCIe Mini card slot

1.4 Connectors

The connectors on the NANO-QM770 are shown in the figure below.

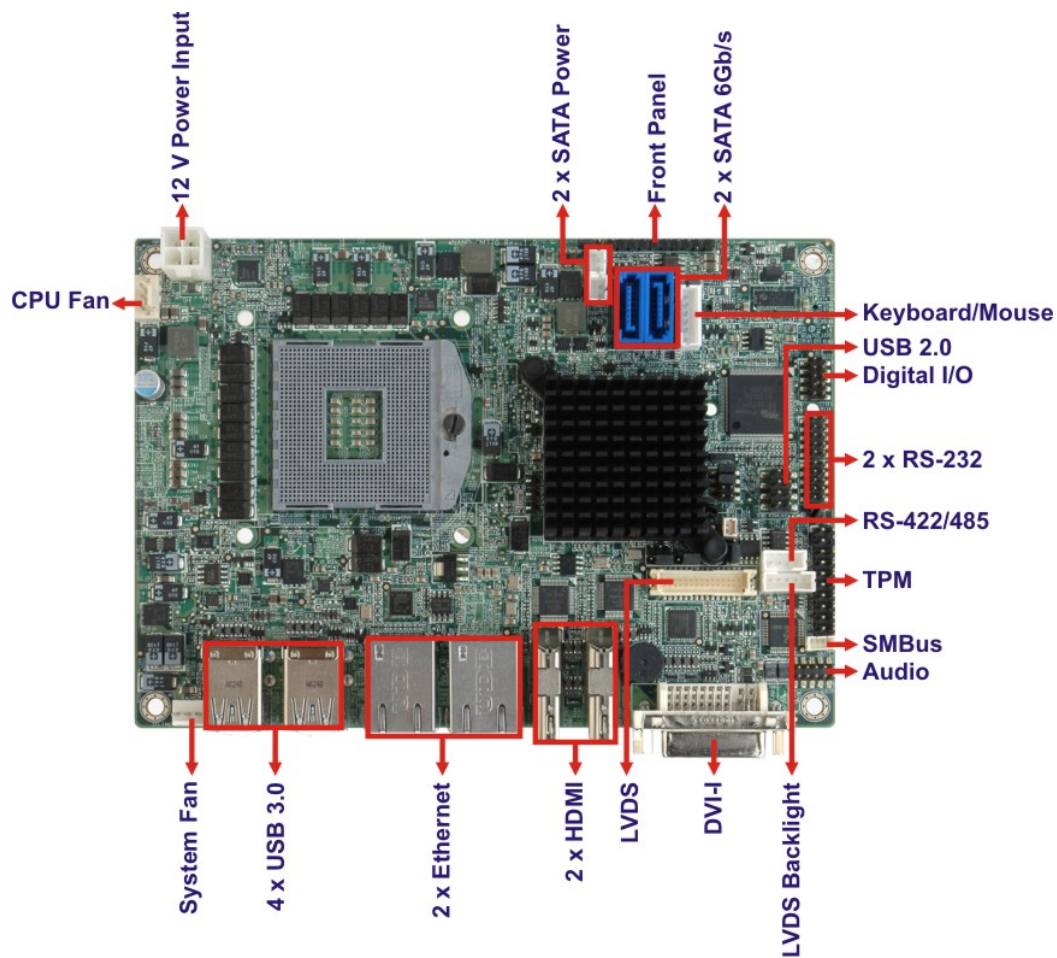

Figure 1-2: Connectors (Front)

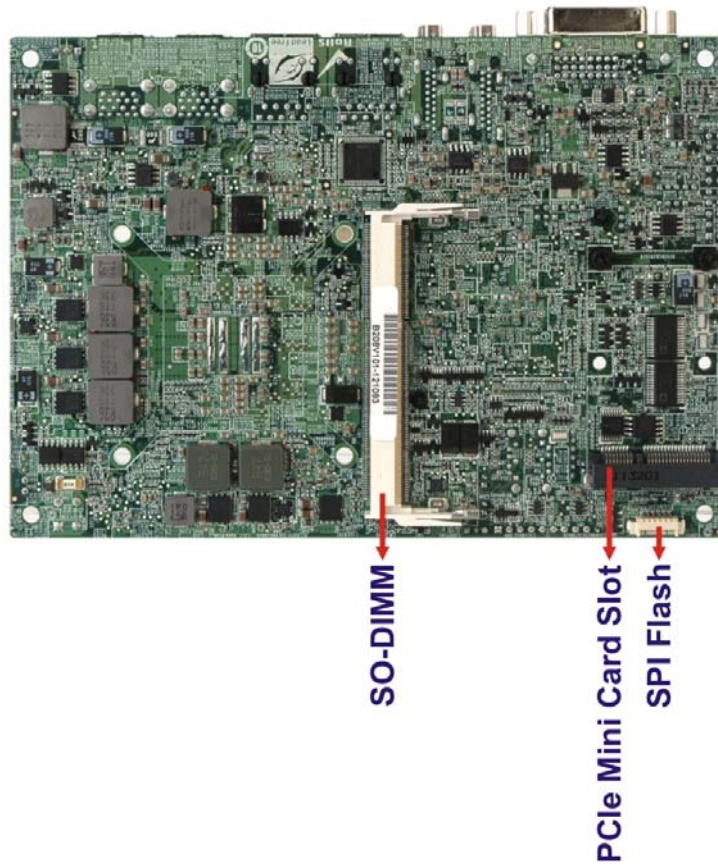

Figure 1-3: Connectors (Solder Side)

NANO-QM770 EPIC SBC

1.5 Dimensions

The main dimensions of the NANO-QM770 are shown in the diagram below.

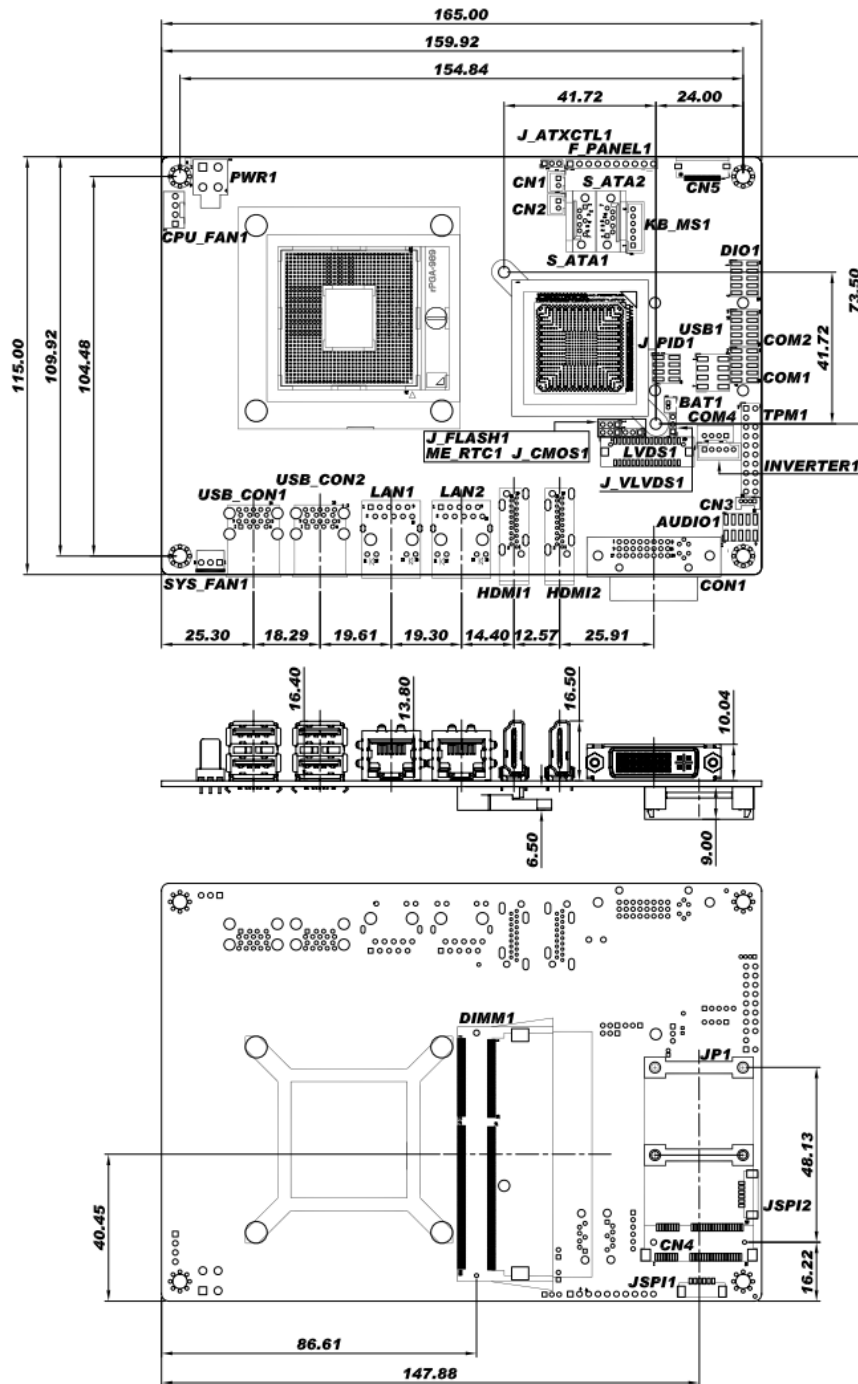

Figure 1-4: Dimensions (mm)

1.6 Data Flow

Figure 1-5 shows the data flow between the system chipset, the CPU and other components installed on the motherboard.

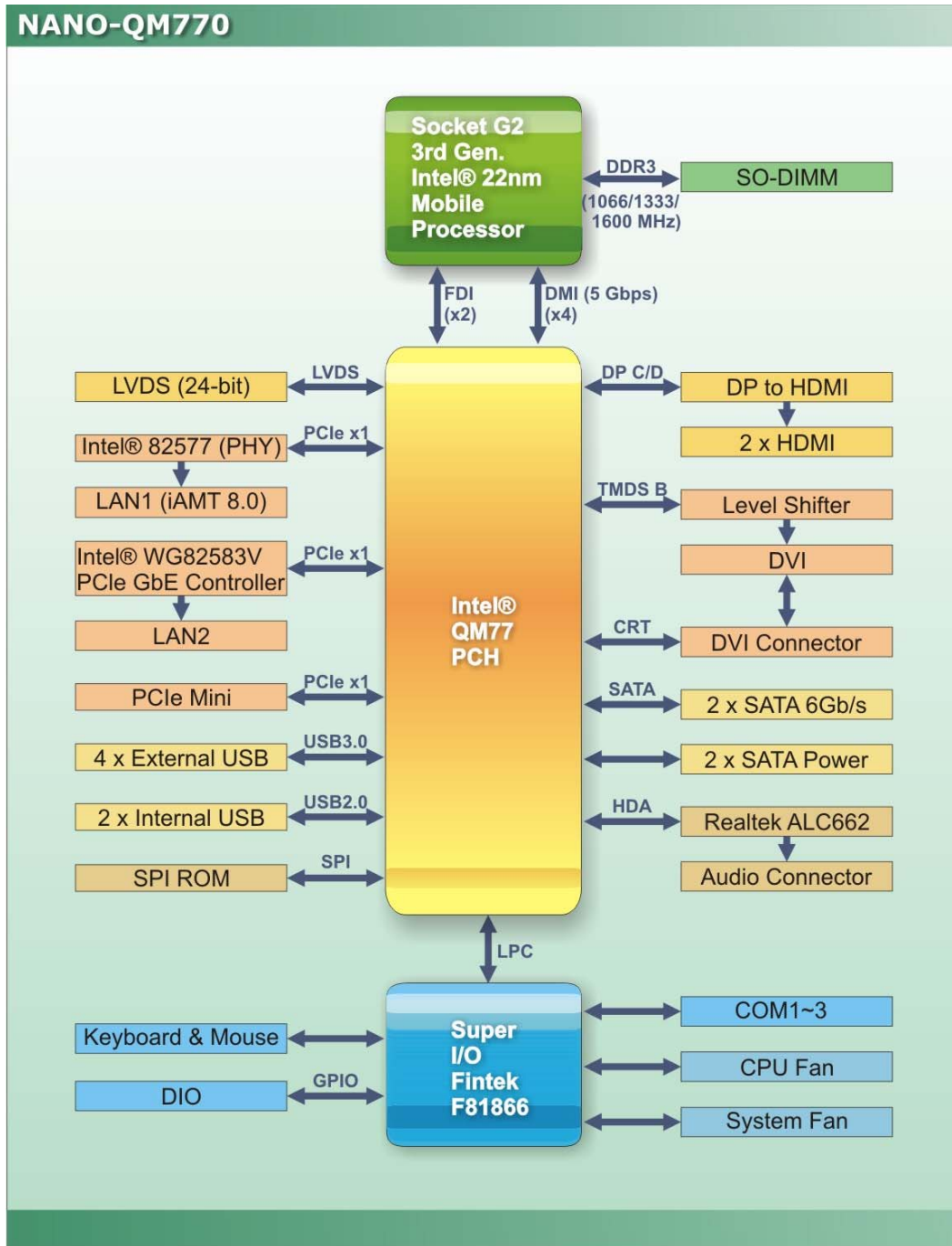

Figure 1-5: Data Flow Diagram

NANO-QM770 EPIC SBC

1.7 Technical Specifications

NANO-QM770 technical specifications are listed in Table 1-1.

Specification	NANO-QM770
Form Factor	EPIC
CPU Socket	Socket G2
CPU	3 rd generation 22nm Intel® mobile CPU
System Chipset	Intel® QM77
Memory	One 204-pin 1600/1333/1066 MHz DDR3 SO-DIMM supported (system max. 8GB)
Graphics Engine	Intel® Gen 7 with DirectX 11, OGL 3.1, OCL 1.1
BIOS	UEFI BIOS
Digital I/O	8-bit, 4-bit input/4-bit output
Ethernet Controllers	Intel® 82579 PHY with Intel® AMT 8.0 support (LAN1) Intel® 82583V PCIe Ethernet controller
Audio	Realtek ALC662 HD Audio codec
Super I/O Controller	Fintek F81866
Watchdog Timer	Software programmable supports 1 – 255 sec. system reset
Expansion	1 x Full-size PCIe Mini slot supports mSATA SSD
I/O Interface Connectors	
Display Output Ports (Triple Display Supported)	1 x DVI-I with analog CRT and DVI support 2 x HDMI (1080p) Dual-channel 24-bit LVDS, resolution up to 1600x1200
Fan connector	One 4-pin wafer for CPU fan One 3-pin wafer for system fan
Keyboard/Mouse	One internal 6-pin wafer connector
Serial Ports	Two RS-232 COM connectors (10-pin header) One RS-422/485 COM connector (4-pin wafer)

USB Ports	Two USB 2.0 (via pin header) Four external USB 3.0 ports
SMBus	One 4-pin wafer connector
Storage	
SATA	Two independent SATA channels with 6Gb/s data transfer rates
Environmental and Power Specifications	
Power Supply	12 V only, AT/ATX support
Power Connector	1 x Internal 4-pin (2x2) power connector
Power Consumption	12 V @ 5.87 A (2.30 GHz Intel® Core™ i7-3610QE CPU with 4 GB 1333 MHz DDR3 memory)
Operating Temperature	-10°C – 60°C
Storage Temperature	-20°C – 70°C
Operating Humidity	5% – 95% (non-condensing)
Physical Specifications	
Dimensions	115 mm x 165 mm
Weight GW/NW	850 g/350 g

Table 1-1: Technical Specifications

Chapter

2

Packing List

2.1 Anti-static Precautions



WARNING!

Static electricity can destroy certain electronics. Make sure to follow the ESD precautions to prevent damage to the product, and injury to the user.

Make sure to adhere to the following guidelines:

- **Wear an anti-static wristband:** - Wearing an anti-static wristband can prevent electrostatic discharge.
- **Self-grounding:**- Touch a grounded conductor every few minutes to discharge any excess static buildup.
- **Use an anti-static pad:** When configuring any circuit board, place it on an anti-static mat.
- **Only handle the edges of the PCB:**- Don't touch the surface of the motherboard. Hold the motherboard by the edges when handling.

2.2 Unpacking Precautions

When the NANO-QM770 is unpacked, please do the following:

- Follow the antistatic guidelines above.
- Make sure the packing box is facing upwards when opening.
- Make sure all the packing list items are present.

NANO-QM770 EPIC SBC







2.3 Packing List



NOTE:

If any of the components listed in the checklist below are missing, do not proceed with the installation. Contact the IEI reseller or vendor the NANO-QM770 was purchased from or contact an IEI sales representative directly by sending an email to sales@ieiworld.com.tw.

The NANO-QM770 is shipped with the following components:

Quantity	Item and Part Number	Image
1	NANO-QM770 SBC	
2	SATA and power cable (P/N: 32801-000201-300-RS)	
2	RS-232 cable (P/N: 32200-000049-RS)	
1	Audio cable (P/N: 32000-072100-RS)	
1	AT 12V Cable (P/N: 32100-087100-RS)	
1	Mini jumper pack (2.0mm) (P/N: 33101-000657-RS)	







Quantity	Item and Part Number	Image
1	Utility CD	
1	One Key Recovery CD	
1	Quick installation guide	

Table 2-1: Packing List

2.4 Optional Items

These optional items are available.

Item and Part Number	Image
RS-422/485 cable (P/N: 32205-003800-300-RS)	
Dual USB cable (wo bracket) (P/N: 32000-044300-RS)	
KB/MS PS/2 Y-cable (P/N: 32000-023800-RS)	
CPU cooler (P/N: CF-989A-RS-R12)	

NANO-QM770 EPIC SBC

Item and Part Number	Image
Infineon TPM module (P/N: TPM-IN01-R11)	 A photograph of an Infineon TPM module, which is a small green printed circuit board (PCB) with a central black integrated circuit (chip) and several gold-plated pins along one edge. The board is mounted on a black carrier or connector.

Table 2-2: Optional Items

Chapter

3

Connector Pinouts

NANO-QM770 EPIC SBC

3.1 Peripheral Interface Connectors

Section 3.1.1 shows peripheral interface connector locations. **Section 3.1.2** lists all the peripheral interface connectors seen in **Section 3.1.1**.

3.1.1 Layout

The figure below shows the on-board peripheral connectors, rear panel peripheral connectors and on-board jumpers.

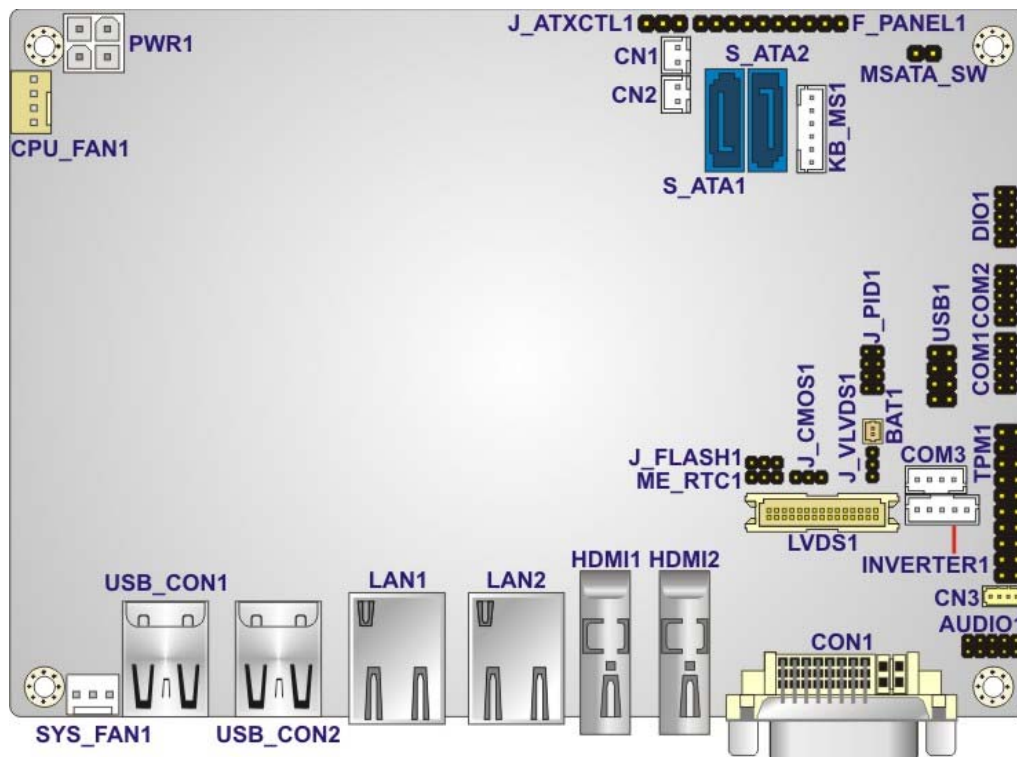

Figure 3-1: Connector and Jumper Locations

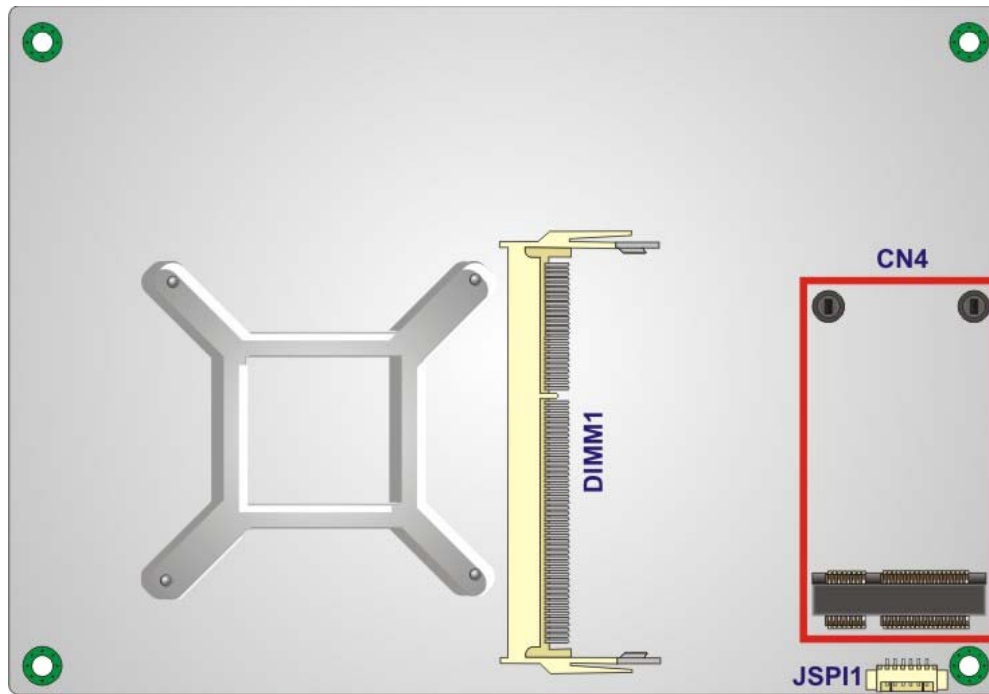

Figure 3-2: Connector and Jumper Locations (Solder Side)

3.1.2 Peripheral Interface Connectors

The table below shows a list of the peripheral interface connectors on the NANO-QM770. Detailed descriptions of these connectors can be found below.

Connector	Type	Label
Audio connector	10-pin header	AUDIO1
Battery connector	2-pin wafer	BAT1
Digital I/O connector	10-pin header	DIO1
Fan connector (CPU)	4-pin wafer	CPU_FAN1
Fan connector (system)	3-pin wafer	SYS_FAN1
Front panel connector	10-pin header	F_PANEL1
Keyboard/mouse connector	6-pin wafer	KB_MS1
LVDS connector	30-pin crimp	LVDS1
LVDS backlight connector	5-pin wafer	INVERTER1

NANO-QM770 EPIC SBC

Connector	Type	Label
PCIe Mini card slot	PCIe Mini card slot	CN4
Power connector (12V)	4-pin connector	PWR1
RS-232 serial ports (COM1, COM2)	10-pin header	COM1, COM2
RS-422/485 serial port (COM3)	4-pin wafer	COM3
SATA connectors	SATA connector	S_ATA1, S_ATA2
SATA power connectors	2-pin wafer	CN1, CN2
SMBus connector	4-pin wafer	CN3
SO-DIMM connector	SO-DIMM connector	DIMM1
SPI Flash	6-pin wafer	JSPI1
TPM connector	20-pin header	TPM1
USB 2.0 connector	8-pin header	USB1

Table 3-1: Peripheral Interface Connectors

3.1.3 External Interface Panel Connectors

The table below lists the rear panel connectors on the NANO-QM770. Detailed descriptions of these connectors can be found in a later section.

Connector	Type	Label
DVI-I connector	DVI-I	CON1
Ethernet connectors	RJ-45	LAN1, LAN2
HDMI connectors	HDMI	HDMI1, HDMI2
USB 3.0 connectors	USB 3.0	USB_CON1 USB_CON2

Table 3-2: Rear Panel Connectors

3.2 Internal Peripheral Connectors

Internal peripheral connectors are found on the motherboard and are only accessible when the motherboard is outside of the chassis. This section has complete descriptions of all the internal, peripheral connectors on the NANO-QM770.

3.2.1 Audio Connector

- CN Label:** AUDIO1
- CN Type:** 10-pin header, p=2.00mm
- CN Location:** See **Figure 3-3**
- CN Pinouts:** See **Table 3-3**

This connector connects to speaker, microphone and audio input connectors on the front panel.

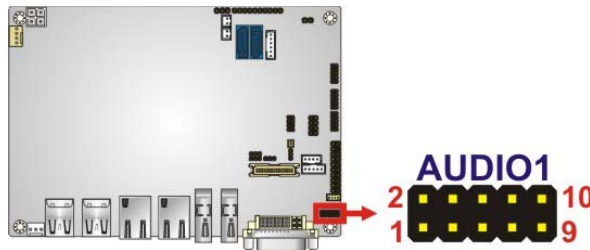

Figure 3-3: Audio Connector Location

Pin	Description	Pin	Description
1	LFRONT-R	2	LLINE-R
3	GND	4	GND
5	LFRONT-L	6	LLINE-L
7	GND	8	GND
9	LMIC1-CONN-R	10	LMIC1-CONN-L

Table 3-3: Audio Connector Pinouts

NANO-QM770 EPIC SBC

3.2.2 Battery Connector



CAUTION:

Risk of explosion if battery is replaced by an incorrect type. Only certified engineers should replace the on-board battery.

Dispose of used batteries according to instructions and local regulations.

- CN Label:** **BAT1**
- CN Type:** 2-pin wafer, p=1.25mm
- CN Location:** See **Figure 3-4**
- CN Pinouts:** See **Table 3-4**

This is connected to the system battery. The battery provides power to the system clock to retain the time when power is turned off.

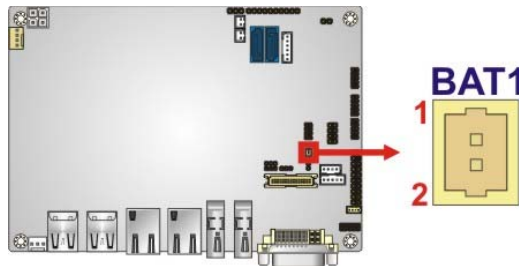

Figure 3-4: Battery Connector Location

Pin	Description
1	Battery+
2	Ground

Table 3-4: Battery Connector Pinouts

3.2.3 Digital I/O Connector

- CN Label:** DIO1
- CN Type:** 10-pin header, p=2.00mm
- CN Location:** See **Figure 3-5**
- CN Pinouts:** See **Table 3-5**

The digital I/O connector provides programmable input and output for external devices. The digital I/O provides 4-bit output and 4-bit input.

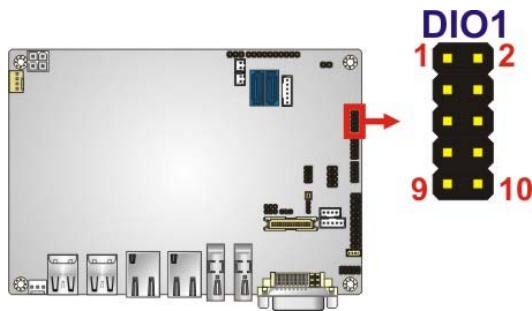

Figure 3-5: Digital I/O Connector Location

Pin	Description	Pin	Description
1	GND	2	+V5S
3	Output 3	4	Output 2
5	Output 1	6	Output 0
7	Input 3	8	Input 2
9	Input 1	10	Input 0

Table 3-5: Digital I/O Connector Pinouts

3.2.4 Fan Connector (CPU)

- CN Label:** CPU_FAN1
- CN Type:** 4-pin wafer, p=2.54mm
- CN Location:** See **Figure 3-6**
- CN Pinouts:** See **Table 3-6**

NANO-QM770 EPIC SBC

The fan connector attaches to a CPU cooling fan.

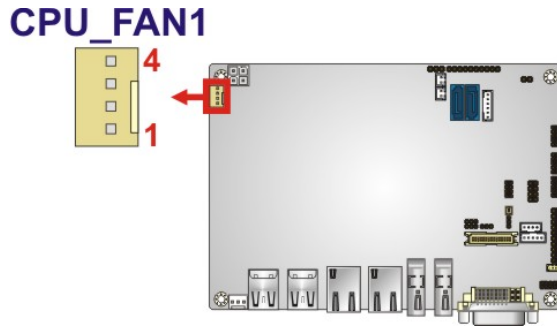

Figure 3-6: CPU Fan Connector Location

Pin	Description
1	GND
2	+V12S
3	Rotation Signal
4	PWM Control Signal

Table 3-6: CPU Fan Connector Pinouts

3.2.5 Fan Connector (System)

- CN Label:** SYS_FAN1
- CN Type:** 3-pin wafer, p=2.54mm
- CN Location:** See Figure 3-7
- CN Pinouts:** See Table 3-7

The fan connector attaches to a system cooling fan.

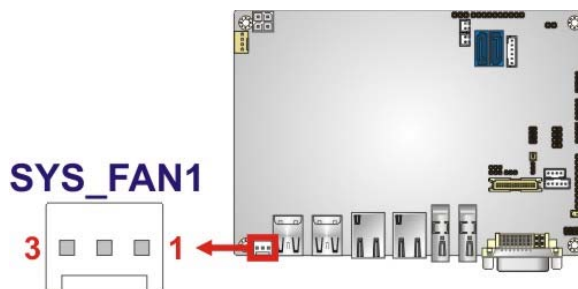

Figure 3-7: System Fan Connector Location

Pin	Description
1	Rotation Signal
2	+12V
3	GND

Table 3-7: System Fan Connector Pinouts

3.2.6 Front Panel Connector

- CN Label:** F_PANEL1
- CN Type:** 10-pin header, p=2.54mm
- CN Location:** See **Figure 3-8**
- CN Pinouts:** See **Table 3-8**

The front panel connector connects to the indicator LEDs and buttons on the computer's front panel.

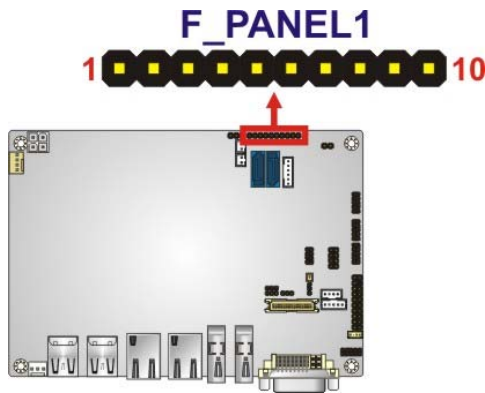

Figure 3-8: Front Panel Connector Location

	Pin	Description		Pin	Description
	1	NC	Power	6	LED_PWR
Power	2	PWR_BTN-		LED	7
Button	3	GROUND			8
HDD	4	IDE_LED_PWR	Reset	9	EXTRST-
LED	5	SATA_LED#			10

Table 3-8: Front Panel Connector Pinouts

NANO-QM770 EPIC SBC

3.2.7 Keyboard/Mouse Connector

- CN Label:** KB_MS1
- CN Type:** 6-pin wafer, p=2.00mm
- CN Location:** See **Figure 3-9**
- CN Pinouts:** See **Table 3-9**

The keyboard/mouse connector connects to a PS/2 Y-cable that can be connected to a PS/2 keyboard and mouse.

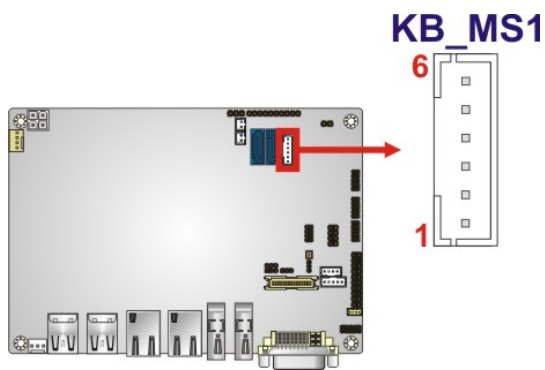

Figure 3-9: Keyboard/Mouse Connector Location

Pin	Description
1	VCC5_KBMS
2	Mouse Data
3	Mouse Clock
4	Keyboard Data
5	Keyboard Clock
6	GND

Table 3-9: Keyboard/Mouse Connector Pinouts

3.2.8 LVDS Connector

- CN Label:** LVDS1
- CN Type:** 30-pin crimp, p=1.25mm
- CN Location:** See **Figure 3-10**

CN Pinouts: See **Table 3-10**

The LVDS connector is for an LCD panel connected to the board.

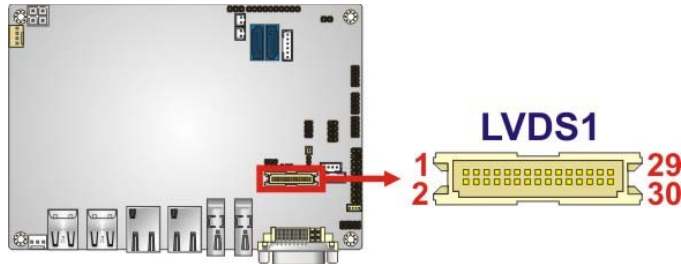

Figure 3-10: LVDS Connector Location

Pin	Description	Pin	Description
1	GROUND	2	GROUND
3	LVDS_A_TX0-P	4	LVDS_A_TX0-N
5	LVDS_A_TX1-P	6	LVDS_A_TX1-N
7	LVDS_A_TX2-P	8	LVDS_A_TX2-N
9	LVDS_A_TXCLK-P	10	LVDS_A_TXCLK-N
11	LVDS_A_TX3-P	12	LVDS_A_TX3-N
13	GROUND	14	GROUND
15	LVDS_B_TX0-P	16	LVDS_B_TX0-N
17	LVDS_B_TX1-P	18	LVDS_B_TX1-N
19	LVDS_B_TX2-P	20	LVDS_B_TX2-N
21	LVDS_B_TXCLK-P	22	LVDS_B_TXCLK-N
23	LVDS_B_TX3-P	24	LVDS_B_TX3-N
25	GROUND	26	GROUND
27	+LCD VCC	28	+LCD VCC
29	+LCD VCC	30	+LCD VCC

Table 3-10: LVDS Connector Pinouts

NANO-QM770 EPIC SBC

3.2.9 LVDS Backlight Connector

- CN Label:** INVERTER1
- CN Type:** 5-pin wafer, p=2.00mm
- CN Location:** See **Figure 3-11**
- CN Pinouts:** See **Table 3-11**

The backlight inverter connectors provide power to LCD panels.

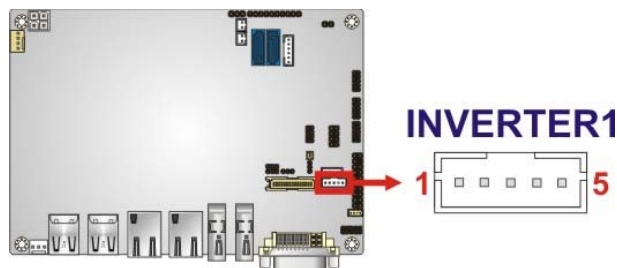

Figure 3-11: LVDS Backlight Inverter Connector

Pin	Description
1	BRIGHTNESS
2	GROUND
3	+12VS_LCD_BKL
4	GROUND
5	BACKLIGHT ENABLE

Table 3-11: Backlight Inverter Connector Pinouts

3.2.10 PCIe Mini Card Slot

- CN Label:** CN4
- CN Type:** PCIe Mini card slot
- CN Location:** See **Figure 3-12**
- CN Pinouts:** See **Table 3-12**

The PCIe Mini card slot enables a PCIe Mini card expansion module to be connected to the board. Cards supported include among others wireless LAN (WLAN) cards and IEI PCIe Mini disk on module (DOM) SSD cards.

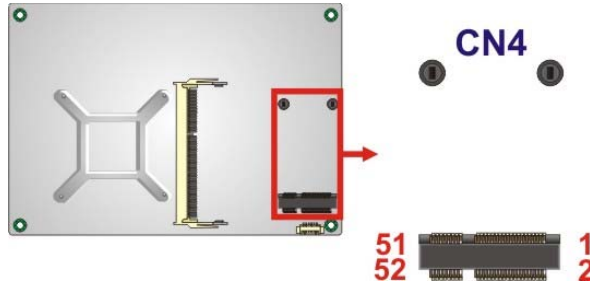

Figure 3-12: PCIe Mini Card Slot Location

Pin	Description	Pin	Description
1	PCIE_WAKE#	2	VCC3
3	N/C	4	GND
5	N/C	6	1.5V
7	N/C	8	N/C
9	GND	10	N/C
11	CLK-	12	N/C
13	CLK+	14	N/C
15	GND	16	N/C
17	PCIRST#	18	GND
19	N/C	20	VCC3
21	GND	22	PCIRST#
23	PERN2	24	3VDual
25	PERP2	26	GND
27	GND	28	1.5V
29	GND	30	SMBCLK
31	PETN2	32	SMBDATA
33	PETP2	34	GND
35	GND	36	USBD-
37	N/C	38	USBD+
39	N/C	40	GND

NANO-QM770 EPIC SBC

Pin	Description	Pin	Description
41	N/C	42	N/C
43	N/C	44	N/C
45	N/C	46	N/C
47	N/C	48	1.5V
49	N/C	50	GND
51	N/C	52	VCC3

Table 3-12: PCIe Mini Card Slot Pinouts

3.2.11 Power Connector (12V)

- CN Label:** PWR1
- CN Type:** 4-pin connector, p=4.20mm
- CN Location:** See **Figure 3-13**
- CN Pinouts:** See **Table 3-13**

The power connector is connected to an external power supply and supports 12V power input. Power is provided to the system, from the power supply through this connector.

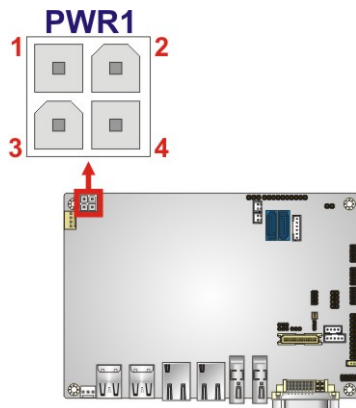

Figure 3-13: Power Connector Location

Pin	Description	Pin	Description
1	Ground	2	Ground
3	+12V	4	+12V

Table 3-13: Power Connector Pinouts

3.2.12 RS-232 Serial Port Connectors (COM1, COM2)

- CN Label:** COM1, COM2
- CN Type:** 10-pin header, p=2.00mm
- CN Location:** See **Figure 3-14**
- CN Pinouts:** See **Table 3-14**

The 10-pin serial port connectors provide two RS-232 serial communications channels. The COM serial port connectors can be connected to external RS-232 serial port devices.

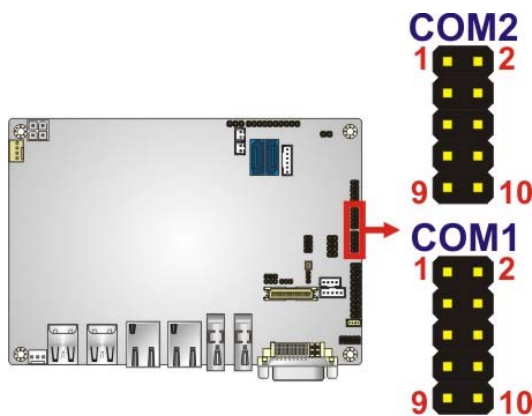

Figure 3-14: RS-232 Serial Port Connector Locations

Pin	Description	Pin	Description
1	-ND CD	2	-ND SR
3	NSIN	4	-NR TS
5	NSOUT	6	-NC TS
7	-ND TR	8	-XR I
9	GND	10	GND

Table 3-14: Serial Port Connector Pinouts

3.2.13 RS-422/485 Serial Port Connector (COM3)

- CN Label:** COM3
- CN Type:** 4-pin wafer, p=2.00mm
- CN Location:** See **Figure 3-15**

NANO-QM770 EPIC SBC

CN Pinouts: See Table 3-15

This connector provides RS-422 or RS-485 communications.

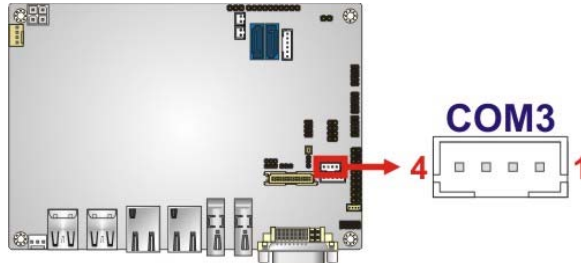

Figure 3-15: RS-422/485 Serial Port Connector Location

Pin	Description
1	RXD422-
2	RXD422+
3	TXD422+/TXD485+
4	TXD422-/TXD485-

Table 3-15: RS-422/485 Serial Port Connector Pinouts

Use the optional RS-422/485 cable to connect to a serial device. The pinouts of the D-sub 9 connector are listed below.

RS-422 Pinouts	RS-485 Pinouts

Table 3-16: D-sub 9 RS-422/485 Pinouts

3.2.14 SATA Drive Connectors

CN Label: S_ATA1, S_ATA2

CN Type: 7-pin SATA drive connectors

CN Location: See **Figure 3-16**

CN Pinouts: See **Table 3-17**

The SATA connectors connect to SATA hard drives or optical drives with data transfer speeds as high as 6Gb/s.

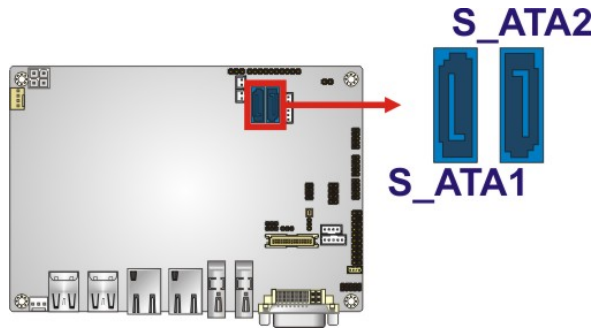

Figure 3-16: SATA Drive Connector Locations

Pin	Description
1	GND
2	TX+
3	TX-
4	GND
5	RX-
6	RX+
7	GND

Table 3-17: SATA Drive Connector Pinouts

3.2.15 SATA Power Connectors

CN Label: **CN1, CN2**

CN Type: 2-pin wafer, p=2.00mm

CN Location: See **Figure 3-17**

CN Pinouts: See **Table 3-18**

Use the SATA Power Connector to connect to SATA device power connections.

NANO-QM770 EPIC SBC

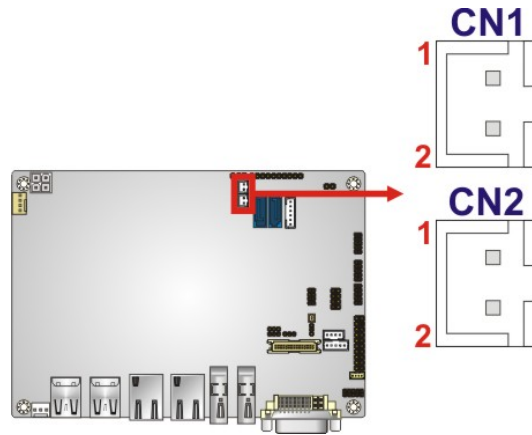

Figure 3-17: SATA Power Connector Locations

Pin	Description
1	+V5S
2	GND

Table 3-18: SATA Power Connector Pinouts

3.2.16 SMBus Connector

- CN Label:** CN3
- CN Type:** 4-pin wafer, p=1.25mm
- CN Location:** See **Figure 3-18**
- CN Pinouts:** See **Table 3-19**

The SMBus (System Management Bus) connector provides low-speed system management communications.

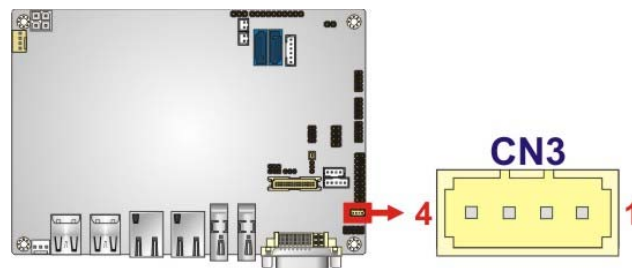

Figure 3-18: SMBus Connector Location

Pin	Description
1	GND
2	SMB_DATA
3	SMB_CLK
4	+V5S

Table 3-19: SMBus Connector Pinouts

3.2.17 SO-DIMM Connector

- CN Label:** DIMM1
- CN Type:** 204-pin DDR3 SO-DIMM connector
- CN Location:** See **Figure 3-19**

The SO-DIMM connector is for installing memory on the system.

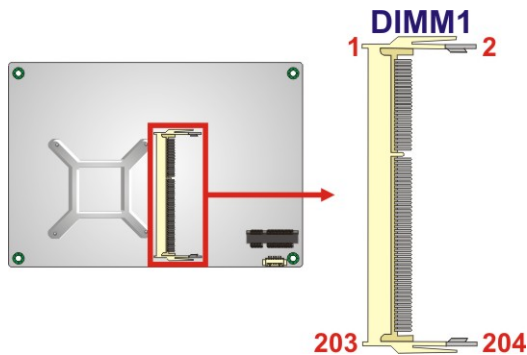

Figure 3-19: SO-DIMM Connector Location

3.2.18 SPI Flash Connector

- CN Label:** JSPI1
- CN Type:** 6-pin header, p=1.25mm
- CN Location:** See **Figure 3-20**
- CN Pinouts:** See **Table 3-20**

The 6-pin SPI Flash connector is used to flash the BIOS.

NANO-QM770 EPIC SBC

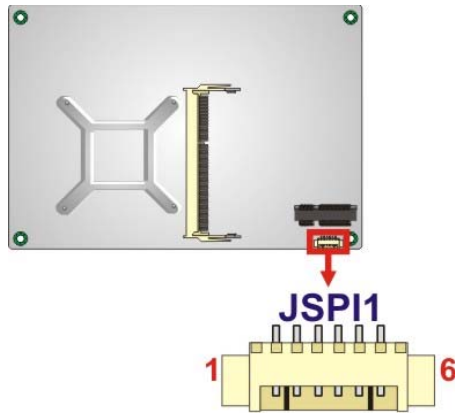

Figure 3-20: SPI Flash Connector Location

Pin	Description
1	+V3.3M_SPI_CON
2	SPI_CS
3	SPI_SO_SW
4	SPI_CLK_SW
5	SPI_SI_SW
6	GND

Table 3-20: SPI Flash Connector Pinouts

3.2.19 TPM Connector

- CN Label:** TPM1
- CN Type:** 20-pin header, p=2.54mm
- CN Location:** See **Figure 3-21**
- CN Pinouts:** See **Table 3-21**

The Trusted Platform Module (TPM) connector secures the system on bootup.

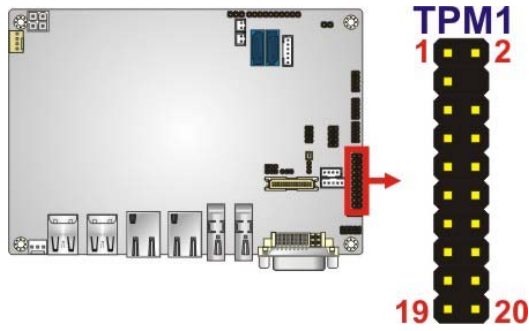

Figure 3-21: TPM Connector Location

Pin	Description	Pin	Description
1	LCLK	2	GND
3	LFRAME#	4	KEY
5	LRERST#	6	+5V
7	LAD3	8	LAD2
9	+3V	10	LAD1
11	LAD0	12	GND
13	SCL	14	SDA
15	SB3V	16	SERIRQ
17	GND	18	GLKRUN#
19	LPCPD#	20	LDRQ#

Table 3-21: TPM Connector Pinouts

3.2.20 USB 2.0 Connector

- CN Label:** USB1
- CN Type:** 8-pin header, p=2.54mm
- CN Location:** See **Figure 3-22**
- CN Pinouts:** See **Table 3-22**

The USB header can connect to two USB devices.

NANO-QM770 EPIC SBC

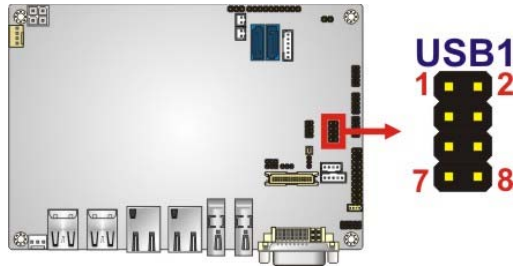

Figure 3-22: USB Connector Location

Pin	Description	Pin	Description
1	VCC	2	GND
3	DATA-	4	DATA+
5	DATA+	6	DATA-
7	GND	8	VCC

Table 3-22: USB Port Connector Pinouts

3.3 External Interface Connectors

Figure 3-23 shows the NANO-QM770 motherboard external interface connectors. The NANO-QM770 on-board external interface connectors are shown in Figure 3-23.

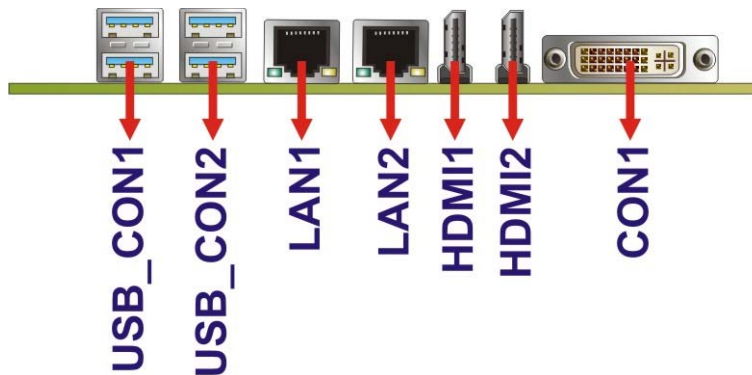

Figure 3-23: External Interface Connectors

3.3.1 DVI Connector

CN Label: CON1
CN Type: DVI connector

CN Location: See **Figure 3-23**

CN Pinouts: See **Table 3-23** and **Figure 3-24**

The 24-pin Digital Visual Interface (DVI) connector connects to high-speed, high-resolution digital displays. The DVI-I connector supports both digital and analog signals.

Pin	Description	Pin	Description	Pin	Description
1	TMDS Data2-	9	TMDS Data1-	17	TMDS Data0-
2	TMDS Data2+	10	TMDS Data1+	18	TMDS Data0+
3	GND	11	GND	19	GND
4	N/C	12	NC	20	NC
5	N/C	13	NC	21	NC
6	DDC Clock [SCL]	14	5V	22	GND
7	DDC Data [SDA]	15	GND	23	TMDS Clock +
8	5VSYNC	16	HPD	24	TMDS Clock -
C1	BR	--	--	--	--
C2	BG	--	--	--	--
C3	BB	--	--	--	--
C4	5HSync	--	--	--	--
C5	GND	--	--	--	--

Table 3-23: DVI Connector Pinouts

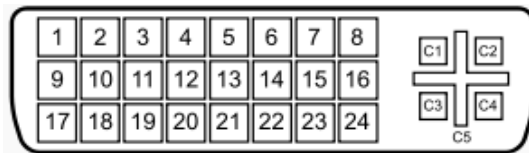

Figure 3-24: DVI-I Connector

3.3.2 Ethernet Connectors

CN Label: LAN1, LAN2

CN Type: RJ-45

CN Location: See **Figure 3-23**

NANO-QM770 EPIC SBC

CN Pinouts: See **Table 3-24**

The LAN connector connects to a local network.

PIN	DESCRIPTION	PIN	DESCRIPTION
1	MDIA3-	5	MDIA2+
2	MDIA3+	6	MDIA1+
3	MDIA1-	7	MDIA0-
4	MDIA2-	8	MDIA0+

Table 3-24: LAN Pinouts

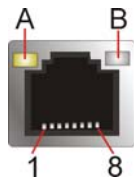

Figure 3-25: Ethernet Connector

LED	Description	LED	Description
A	on: linked blinking: data is being sent/received	B	off: 10 Mb/s green: 100 Mb/s orange: 1000 Mb/s

Table 3-25: Connector LEDs

3.3.3 HDMI Connectors

CN Label: HDMI1, HDMI2

CN Type: HDMI connector

CN Location: See **Figure 3-23**

CN Pinouts: See **Table 3-26** and **Figure 3-26**

The HDMI connector connects to a display device with HDMI interface.

Pin	Description	Pin	Description
1	HDMI_DATA2	13	N/C
2	GND	14	N/C
3	HDMI_DATA2#	15	HDMI_SCL
4	HDMI_DATA1	16	HDMI_SDA
5	GND	17	GND
6	HDMI_DATA1#	18	+5V
7	HDMI_DATA0	19	HDMI_HPD
8	GND	20	HDMI_GND
9	HDMI_DATA0#	21	HDMI_GND
10	HDMI_CLK	22	HDMI_GND
11	GND	23	HDMI_GND
12	HDMI_CLK#		

Table 3-26: HDMI Connector Pinouts

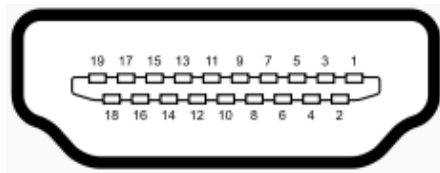

Figure 3-26: HDMI Connector

3.3.4 USB 3.0 Connectors

CN Label: USB_CON1, USB_CON2

CN Type: USB 3.0 port

CN Location: See **Figure 3-23**

CN Pinouts: See **Table 3-27**

The USB 3.0 connector can be connected to a USB device.

NANO-QM770 EPIC SBC

Pin	Description	Pin	Description
1	VBUS	2	DATA1-
3	DATA1+	4	GND
5	SSRX1-	6	SSRX1+
7	GND	8	SSTX1-
9	SSTX1+	10	VBUS
11	DATA2-	12	DATA2+
13	GND	14	SSRX2-
15	SSRX2+	16	GND
17	SSTX2-	18	SSTX2+

Table 3-27: USB Port Pinouts

Chapter

4

Installation

NANO-QM770 EPIC SBC

4.1 Anti-static Precautions



WARNING:

Failure to take ESD precautions during installation may result in permanent damage to the product and severe injury to the user.

Electrostatic discharge (ESD) can cause serious damage to electronic components, including the NANO-QM770. Dry climates are especially susceptible to ESD. It is therefore critical to strictly adhere to the following anti-static precautions whenever the NANO-QM770, or any other electrical component, is handled.

- **Wear an anti-static wristband:** - Wearing a simple anti-static wristband can help to prevent ESD from damaging the board.
- **Self-grounding:**- Before handling the board touch any grounded conducting material. During the time the board is handled, frequently touch any conducting materials that are connected to the ground.
- **Use an anti-static pad:** When configuring the NANO-QM770, place it on an anti-static pad. This reduces the possibility of ESD damaging the NANO-QM770.
- **Only handle the edges of the PCB:-** When handling the PCB, hold it by the edges.

4.2 Installation Considerations



NOTE:

The following installation notices and installation considerations should be read and understood before the NANO-QM770 is installed. All installation notices pertaining to the installation of NANO-QM770 should be strictly adhered to. Failing to adhere to these precautions may lead to severe damage of the NANO-QM770 and injury to the person installing the motherboard.

**WARNING:**

The installation instructions described in this manual should be carefully followed in order to prevent damage to the NANO-QM770, NANO-QM770 components and injury to the user.

Before and during the installation please **DO** the following:

- **Read the user manual:**
 - The user manual provides a complete description of the installation instructions and configuration options.
- **Wear an electrostatic discharge cuff (ESD):**
 - Electronic components are easily damaged by ESD. Wearing an ESD cuff removes ESD from the body and helps prevent ESD damage.
- **Place on an antistatic pad:**
 - When installing or configuring the motherboard, place it on an antistatic pad. This helps to prevent potential ESD damage.
- **Turn all power off:**
 - Make sure the product is disconnected from all power supplies and that no electricity is being fed into the system.

Before and during the installation of the NANO-QM770 **DO NOT**:

- **DO NOT** remove any of the stickers on the PCB board. These stickers are required for warranty validation.
- **DO NOT** use the product before verifying all the cables and power connectors are properly connected.
- **DO NOT** allow screws to come in contact with the PCB circuit, connector pins, or its components.

NANO-QM770 EPIC SBC

4.3 SO-DIMM Installation

To install an SO-DIMM, please follow the steps below and refer to Figure 4-1.

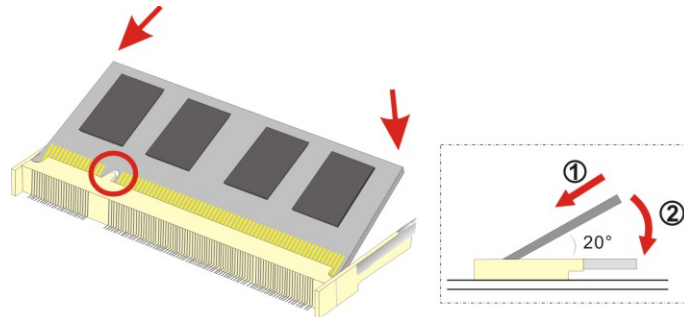

Figure 4-1: SO-DIMM Installation

- Step 1:** Locate the **SO-DIMM socket**. Place the board on an anti-static mat.
- Step 2:** Align the **SO-DIMM with the socket**. Align the notch on the memory with the notch on the memory socket.
- Step 3:** Insert the **SO-DIMM**. Push the memory in at a 20° angle. (See Figure 4-1)
- Step 4:** Seat the **SO-DIMM**. Gently push downwards and the arms clip into place. (See Figure 4-1)

4.4 PCIe Mini Card Installation

A PCIe Mini card slot is located on the solder side of the NANO-QM770. To install the PCIe Mini card, please refer to the diagram and instructions below.

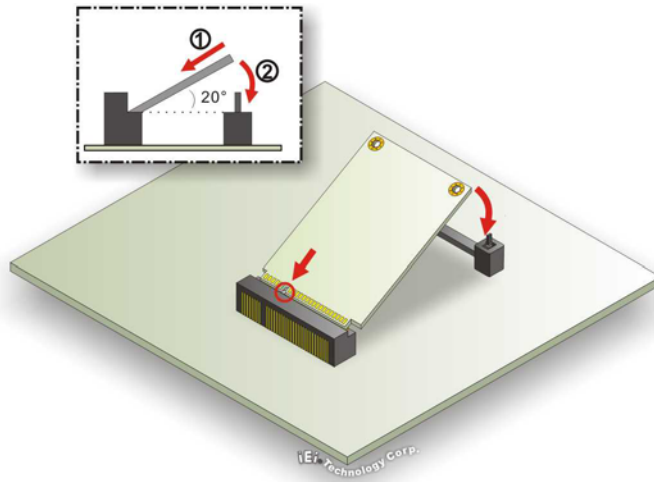

Figure 4-2: PCIe Mini Card Installation

- Step 1:** Insert into the socket at an angle. Line up the notch on the card with the notch on the connector. Slide the PCIe Mini card into the socket at an angle of about 20°.
- Step 2:** Push down until the card clips into place. Push the other end of the card down until it clips into place on the plastic connector.

4.5 Jumper Settings



NOTE:

A jumper is a metal bridge that is used to close an electrical circuit. It consists of two metal pins and a small metal clip (often protected by a plastic cover) that slides over the pins to connect them. To CLOSE/SHORT a jumper means connecting the pins of the jumper with the plastic clip and to OPEN a jumper means removing the plastic clip from a jumper.

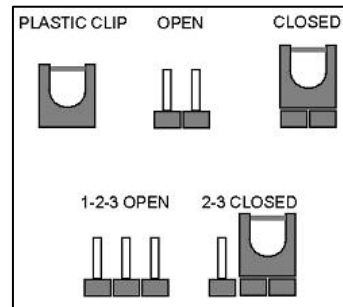

NANO-QM770 EPIC SBC

Before the NANO-QM770 is installed in the system, the jumpers must be set in accordance with the desired configuration. The jumpers on the NANO-QM770 are listed in Table 4-1.

Description	Label	Type
AT/ATX mode selection	J_ATXCTL1	3-pin header
Clear CMOS	J_CMOS1	3-pin header
Clear ME RTC registers	ME_RTC1	3-pin header
Flash descriptor security override	J_FLASH1	3-pin header
LVDS voltage selection	J_VLVDS1	3-pin header
LVDS resolution selection	J_PID1	8-pin header
PCIe Mini/mSATA mode selection	MSATA_SW	2-pin header

Table 4-1: Jumpers

4.5.1 AT/ATX Mode Selection

Jumper Label:	J_ATXCTL1
Jumper Type:	3-pin header, p=2.00mm
Jumper Settings:	See Table 4-2
Jumper Location:	See Figure 4-3

Set both of the jumpers select AT or ATX power mode for the NANO-QM770. AT power mode limits the system to on/off. ATX allows the system to use various power saving states and enter a standby state, so the system can be turned on remotely over a network. The settings on both jumpers should be the same.

Pin	Description
Short 1-2	ATX mode (Default)
Short 2-3	AT mode

Table 4-2: AT/ATX Mode Selection Jumper Settings

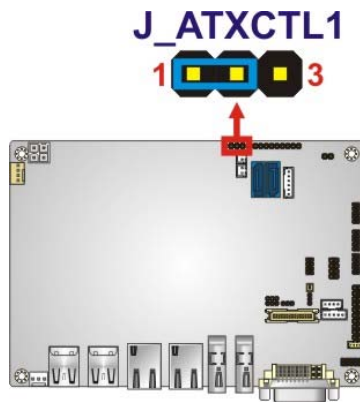

Figure 4-3: AT/ATX Mode Selection Jumper Location

4.5.2 Clear CMOS

Jumper Label:	J_CMOS1
Jumper Type:	3-pin header, p=2.00mm
Jumper Settings:	See Table 4-3
Jumper Location:	See Figure 4-4

If the NANO-QM770 fails to boot due to improper BIOS settings, the clear CMOS jumper clears the CMOS data and resets the system BIOS information. To do this, use the jumper cap to close pins 2 and 3 for a few seconds then reinstall the jumper clip back to pins 1 and 2.

If the “CMOS Settings Wrong” message is displayed during the boot up process, the fault may be corrected by pressing the F1 to enter the CMOS Setup menu. Do one of the following:

- Enter the correct CMOS setting
- Load Optimal Defaults
- Load Failsafe Defaults.

After having done one of the above, save the changes and exit the CMOS Setup menu.

The clear CMOS jumper settings are shown in Table 4-3.

NANO-QM770 EPIC SBC

Pin	Description
Short 1-2	Keep CMOS Setup (Default)
Short 2-3	Clear CMOS Setup

Table 4-3: Clear CMOS Jumper Settings

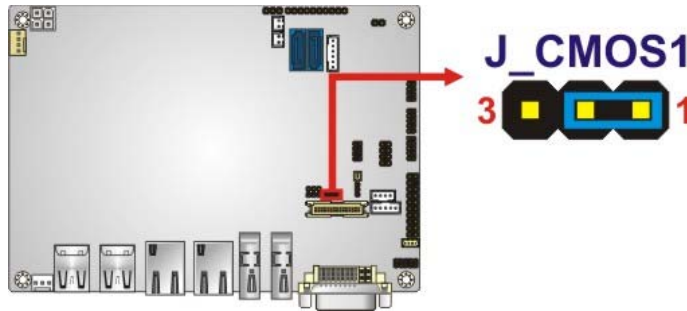

Figure 4-4: Clear CMOS Jumper Location

4.5.3 Clear ME RTC Registers

- Jumper Label:** ME_RTC1
- Jumper Type:** 3-pin header, p=2.00mm
- Jumper Settings:** See **Table 4-4**
- Jumper Location:** See **Figure 4-5**

Resets the RTC registers used for the Intel® Management Engine when the on-board battery is changed.

Pin	Description
Short 1-2	Save ME RTC registers (Default)
Short 2-3	Clear ME RTC registers

Table 4-4: Clear ME RTC Registers Jumper Settings

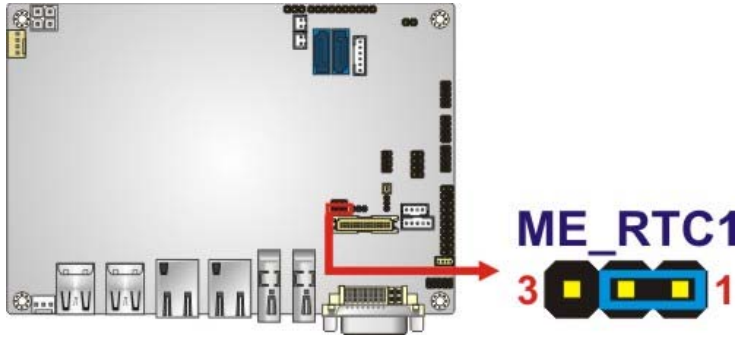

Figure 4-5: Clear ME RTC Registers Jumper Location

4.5.4 Flash Descriptor Security Override

- Jumper Label:** J_FLASH1
- Jumper Type:** 3-pin header, p=2.00mm
- Jumper Settings:** See Table 4-5
- Jumper Location:** See Figure 4-6

The Flash Descriptor Security Override jumper specifies whether to override the flash descriptor.

Setting	Description
Short 1-2	No override
Short 2-3	Override

Table 4-5: Flash Descriptor Security Override Jumper Settings

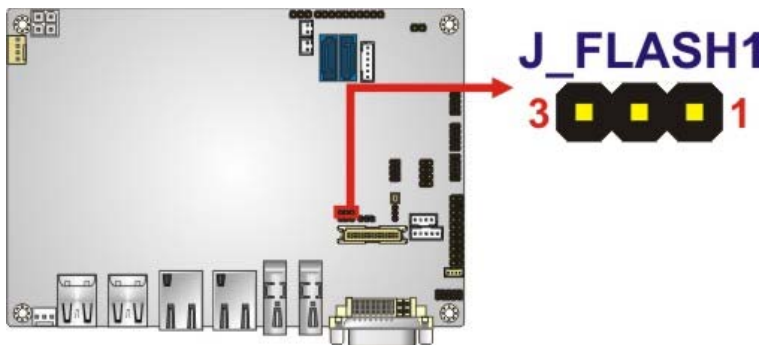

Figure 4-6: Flash Descriptor Security Override Jumper Location

NANO-QM770 EPIC SBC

4.5.5 LVDS Voltage Selection

Jumper Label:	J_VLVDS1
Jumper Type:	3-pin header, p=2.00mm
Jumper Settings:	See Table 4-6
Jumper Location:	See Figure 4-7

Selects the voltage of the LVDS connector.

Pin	Description
Short 1-2	+3.3 V (Default)
Short 2-3	+5 V

Table 4-6: LVDS Voltage Selection Jumper Settings

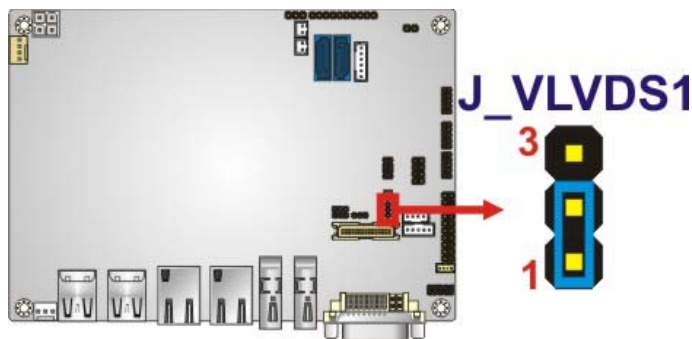

Figure 4-7: LVDS Voltage Selection Jumper Location

4.5.6 LVDS Resolution Selection

Jumper Label:	J_PID1
Jumper Type:	8-pin header, p=2.00mm
Jumper Settings:	See Table 4-7
Jumper Location:	See Figure 4-8

Selects the resolution of the LCD panel connected to the LVDS connector.

Pin	Description
OPEN	640 X 480 (18bit)
1-2	800 X 600 (18bit)

Pin	Description
3-4	1024 X 768 (18bit)
1-2 & 3-4	1024 X 768 (24bit) Default
5-6	1280 X 800 (24bit)
1-2 & 5-6	1280 X 1024 (48bit)
3-4 & 5-6	1366 X 768 (24bit)
1-2 & 3-4 & 5-6	1440 X 900 (48bit)
7-8	1400 X 1050 (48bit)
1-2 & 7-8	1600 X 900 (48bit)
3-4 & 7-8	1600 X 1200 (48bit)
1-2 & 3-4 & 7-8	1680 X 1050 (48bit)
5-6 & 7-8	1920 X 1080 (48bit)
1-2 & 5-6 & 7-8	1920 X 1200 (48bit)
3-4 & 5-6 & 7-8	2048 X 1536 (48bit)
1-2 & 3-4 & 5-6 & 7-8	LVDS disabled

Table 4-7: LVDS Screen Resolution Jumper Settings

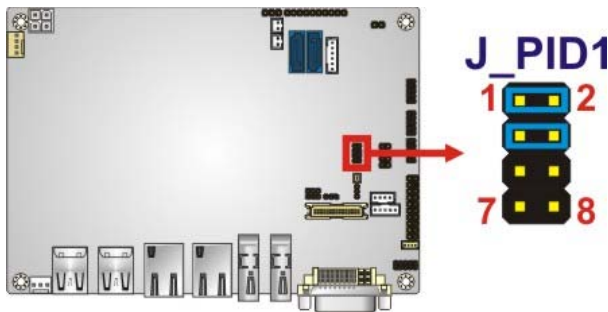

Figure 4-8: LVDS Resolution Selection Jumper Location

4.5.7 PCIe Mini/mSATA Mode Selection

- Jumper Label:** MSATA_SW
- Jumper Type:** 2-pin header, p=2.00mm
- Jumper Settings:** See Table 4-8
- Jumper Location:** See Figure 4-9

Sets the PCIe Mini slot (M_PCIE1) as the PCIe Mini card slot or mSATA drive slot.

NANO-QM770 EPIC SBC

Pin	Description
Closed	PCIe Mini (Default)
Open	mSATA

Table 4-8: PCIe Mini/mSATA Mode Selection Jumper Settings

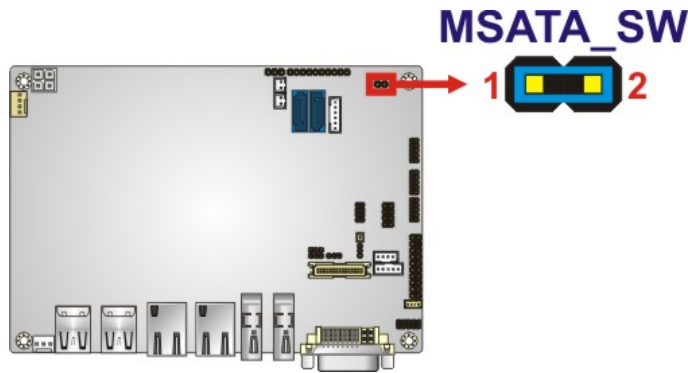

Figure 4-9: PCIe Mini/mSATA Mode Selection Jumper Location

4.6 Chassis Installation

4.6.1 Airflow



WARNING:

Airflow is critical for keeping components within recommended operating temperatures. The chassis should have fans and vents as necessary to keep things cool.

The NANO-QM770 must be installed in a chassis with ventilation holes on the sides allowing airflow to travel through the heat sink surface. In a system with an individual power supply unit, the cooling fan of a power supply can also help generate airflow through the board surface.

4.6.2 Motherboard Installation

To install the NANO-QM770 motherboard into the chassis please refer to the reference material that came with the chassis.

4.7 Internal Peripheral Device Connections

This section outlines the installation of peripheral devices to the onboard connectors.

4.7.1 AT Power Connection

Follow the instructions below to connect the NANO-QM770 to an AT power supply.



WARNING:

Disconnect the power supply power cord from its AC power source to prevent a sudden power surge to the NANO-QM770.

Step 1: **Locate the power cable.** The power cable is shown in the packing list in Chapter 2.

Step 2: **Connect the Power Cable to the Motherboard.** Connect the 4-pin (2x2) Molex type power cable connector to the AT power connector on the motherboard. See Figure 4-10.

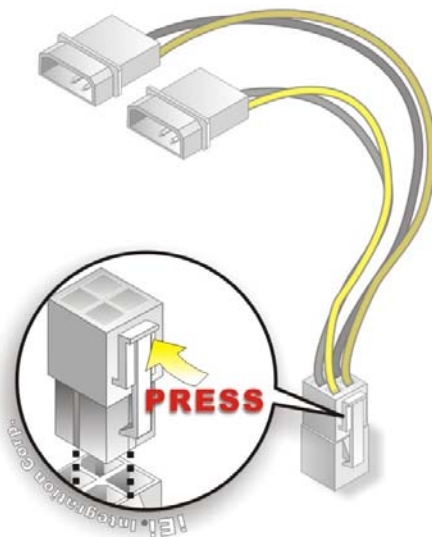

Figure 4-10: Power Cable to Motherboard Connection

NANO-QM770 EPIC SBC

Step 3: Connect Power Cable to Power Supply. Connect one of the 4-pin (1x4) Molex type power cable connectors to an AT power supply. See Figure 4-11.

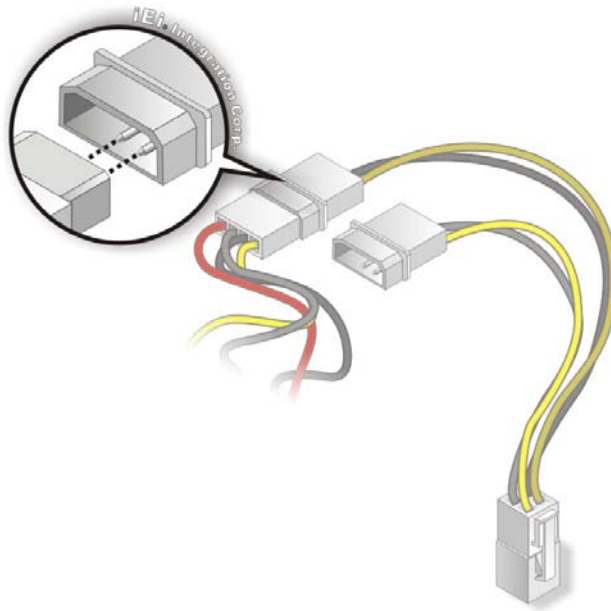

Figure 4-11: Connect Power Cable to Power Supply

4.7.2 Audio Kit Installation

The Audio Kit that came with the NANO-QM770 connects to the audio connector on the NANO-QM770. The audio kit consists of three audio jacks. Mic-in connects to a microphone. Line-in provides a stereo line-level input to connect to the output of an audio device. Line-out, a stereo line-level output, connects to two amplified speakers. To install the audio kit, please refer to the steps below:

Step 1: Locate the audio connector. The location of the 10-pin audio connector is shown in **Chapter 3**.

Step 2: Align pin 1. Align pin 1 on the on-board connector with pin 1 on the audio kit connector. Pin 1 on the audio kit connector is indicated with a white dot. See Figure 4-12.

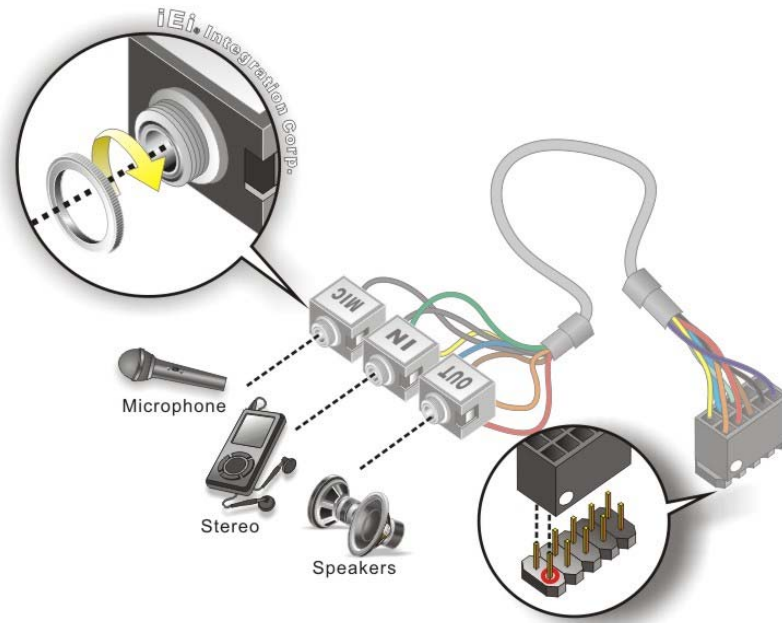

Figure 4-12: Audio Kit Cable Connection

Step 3: **Connect the audio devices.** Connect speakers to the line-out audio jack. Connect the output of an audio device to the line-in audio jack. Connect a microphone to the mic-in audio jack.

4.7.3 SATA Drive Connection

The NANO-QM770 is shipped with two SATA drive cable. To connect the SATA drive to the connector, please follow the steps below.

Step 1: **Locate the SATA connector and the SATA power connector.** The locations of the connectors are shown in **Chapter 3**.

Step 2: **Insert the cable connector.** Insert the cable connector into the on-board SATA drive connector and the SATA power connector. See **Figure 4-13**.

NANO-QM770 EPIC SBC

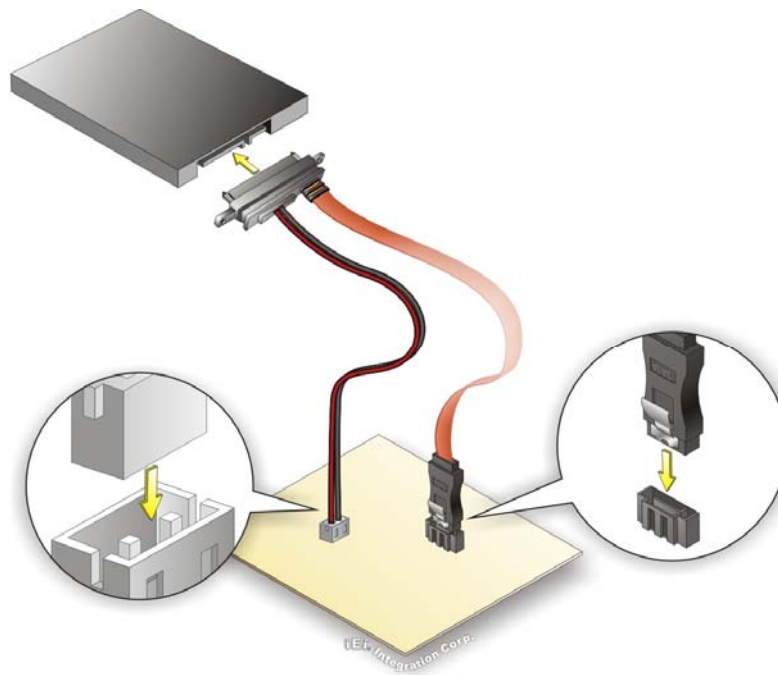

Figure 4-13: SATA Drive Cable Connection

Step 3: **Connect the cable to the SATA disk.** Connect the connector on the other end of the cable to the connector at the back of the SATA drive. See **Figure 4-13**.

Step 4: To remove the SATA cable from the SATA connector, press the clip on the connector at the end of the cable.

4.7.4 Single RS-232 Cable (w/o Bracket)

The single RS-232 cable consists of one serial port connector attached to a serial communications cable that is then attached to a D-sub 9 male connector. To install the single RS-232 cable, please follow the steps below.

Step 1: **Locate the connector.** The location of the RS-232 connector is shown in **Chapter 3**.

Step 2: **Insert the cable connector.** Insert the connector into the serial port pin header. See **Figure 4-14**. A key on the front of the cable connectors ensures the connector can only be installed in one direction.

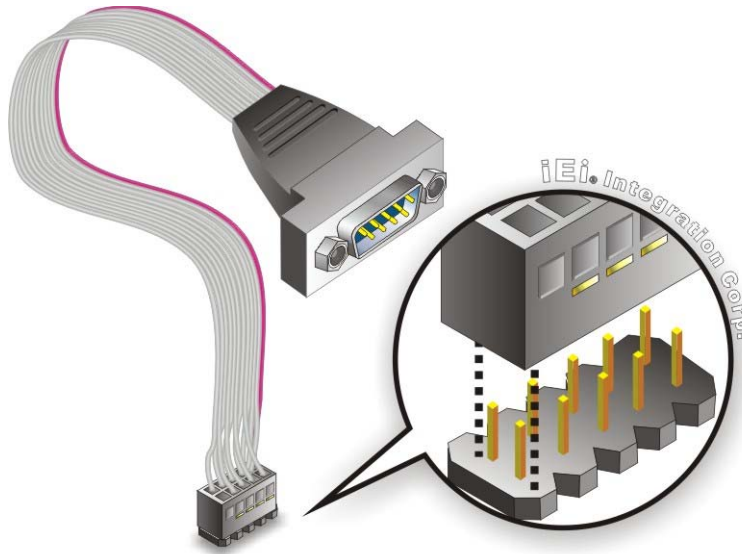

Figure 4-14: Single RS-232 Cable Installation

- Step 3:** **Secure the bracket.** The single RS-232 connector has two retention screws that must be secured to a chassis or bracket.
- Step 4:** **Connect the serial device.** Once the single RS-232 connector is connected to a chassis or bracket, a serial communications device can be connected to the system.

4.8 Intel® AMT Setup Procedure

The NANO-QM770 is featured with the Intel® Active Management Technology (AMT). To enable the Intel® AMT function, follow the steps below.

- Step 1:** Make sure the **DIMM1** socket is installed with one DDR3 SO-DIMM.
- Step 2:** Connect an Ethernet cable to the RJ-45 connector labeled **LAN1**.
- Step 3:** The AMI BIOS options regarding the Intel® ME or Intel® AMT must be enabled,
- Step 4:** Properly install the Intel® Management Engine Components drivers from the iAMT Driver & Utility directory in the driver CD. See **Section 6.9**.
- Step 5:** Configure the Intel® Management Engine BIOS extension (MEBx). To get into the Intel® MEBx settings, press <Ctrl+P> after a single beep during boot-up

NANO-QM770 EPIC SBC

process. Enter the Intel® current ME password as it requires (the Intel® default password is **admin**).



NOTE:

To change the password, enter a new password following the strong password rule (containing at least one upper case letter, one lower case letter, one digit and one special character, and be at least eight characters).

Chapter

5

BIOS

NANO-QM770 EPIC SBC

5.1 Introduction

The BIOS is programmed onto the BIOS chip. The BIOS setup program allows changes to certain system settings. This chapter outlines the options that can be changed.



NOTE:

Some of the BIOS options may vary throughout the life cycle of the product and are subject to change without prior notice.

5.1.1 Starting Setup

The UEFI BIOS is activated when the computer is turned on. The setup program can be activated in one of two ways.

1. Press the **DELETE** or **F2** key as soon as the system is turned on or
2. Press the **DELETE** or **F2** key when the “**Press Del to enter SETUP**” message appears on the screen.

If the message disappears before the **DELETE** or **F2** key is pressed, restart the computer and try again.

5.1.2 Using Setup

Use the arrow keys to highlight items, press **ENTER** to select, use the PageUp and PageDown keys to change entries, press **F1** for help and press **ESC** to quit. Navigation keys are shown in.

Key	Function
Up arrow	Move to the item above
Down arrow	Move to the item below
Left arrow	Move to the item on the left hand side
Right arrow	Move to the item on the right hand side

Key	Function
+	Increase the numeric value or make changes
-	Decrease the numeric value or make changes
Page up	Move to the next page
Page down	Move to the previous page
Esc	Main Menu – Quit and do not save changes into CMOS Status Page Setup Menu and Option Page Setup Menu -- Exit current page and return to Main Menu
F1	General help, only for Status Page Setup Menu and Option Page Setup Menu
F9	Load optimized defaults
F10	Save changes and Exit BIOS

Table 5-1: BIOS Navigation Keys

5.1.3 Getting Help

When **F1** is pressed a small help window describing the appropriate keys to use and the possible selections for the highlighted item appears. To exit the Help Window press **Esc** or the **F1** key again.

5.1.4 Unable to Reboot After Configuration Changes

If the computer cannot boot after changes to the system configuration is made, CMOS defaults. Use the jumper described in **Chapter 4**.

5.1.5 BIOS Menu Bar

The **menu bar** on top of the BIOS screen has the following main items:

- Main – Changes the basic system configuration.
- Advanced – Changes the advanced system settings.
- Chipset – Changes the chipset settings.
- Boot – Changes the system boot configuration.

NANO-QM770 EPIC SBC

- Security – Sets User and Supervisor Passwords.
- Save & Exit – Selects exit options and loads default settings

The following sections completely describe the configuration options found in the menu items at the top of the BIOS screen and listed above.

5.2 Main

The **Main** BIOS menu (**BIOS Menu 1**) appears when the **BIOS Setup** program is entered.

The **Main** menu gives an overview of the basic system information.

Aptio Setup Utility - Copyright (C) 2011 American Megatrends, Inc.					
Main	Advanced	Chipset	Boot	Security	Save & Exit
BIOS Information					Set the Date. Use Tab to switch between Date elements.
BIOS Vendor			American Megatrends		
Core Version			4.6.5.3 0.18		
Compliancy			UEFI 2.3; PI 1.2		
Project Version			B208AR01.ROM		
Build Date			05/10/2012 10:09:44		-----
System Date			[Tue 01/02/2012]		←→: Select Screen
System Time			[14:20:27]		↑ ↓: Select Item
Access Level			Administrator		EnterSelect
					F1 General Help
					F2 Previous Values
					F3 Optimized Defaults
					F4 Save
					ESC Exit
Version 2.14.1219. Copyright (C) 2011 American Megatrends, Inc.					

BIOS Menu 1: Main

→ BIOS Information

The **BIOS Information** lists a brief summary of the BIOS. The fields in **BIOS Information** cannot be changed. The items shown in the system overview include:

- **BIOS Vendor:** Installed BIOS vendor
- **Core Version:** Current BIOS version
- **Project Version:** the board version
- **Build Date and Time:** Date and time the current BIOS version was made

The System Overview field also has two user configurable fields:

➔ **System Date [xx/xx/xx]**

Use the **System Date** option to set the system date. Manually enter the day, month and year.

➔ **System Time [xx:xx:xx]**

Use the **System Time** option to set the system time. Manually enter the hours, minutes and seconds.

5.3 Advanced

Use the **Advanced** menu (**BIOS Menu 2**) to configure the CPU and peripheral devices through the following sub-menus:



WARNING!

Setting the wrong values in the sections below may cause the system to malfunction. Make sure that the settings made are compatible with the hardware.

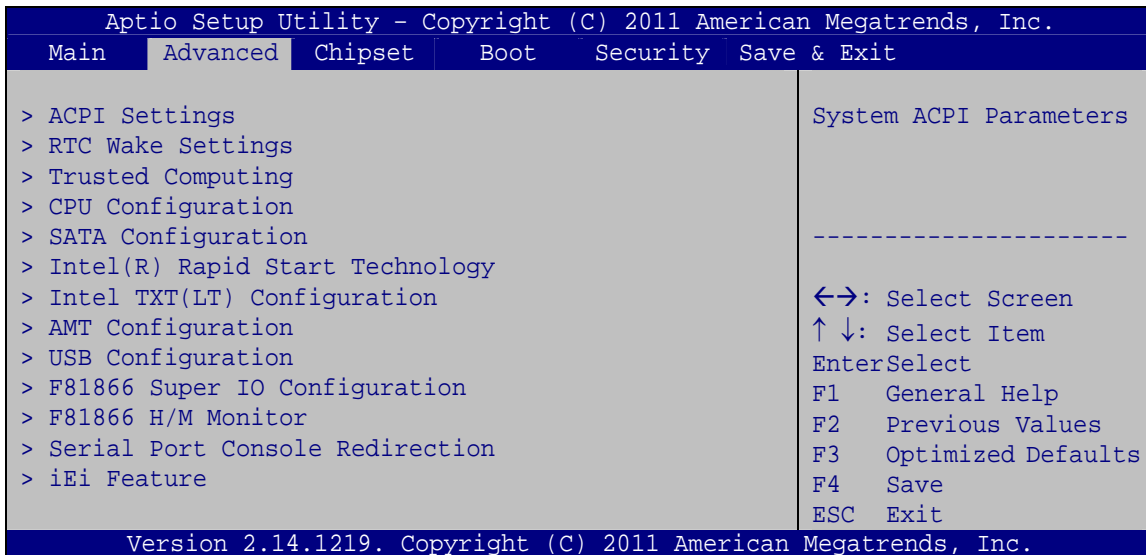

BIOS Menu 2: Advanced

NANO-QM770 EPIC SBC

5.3.1 ACPI Configuration

The **ACPI Configuration** menu (**BIOS Menu 3**) configures the Advanced Configuration and Power Interface (ACPI) options.

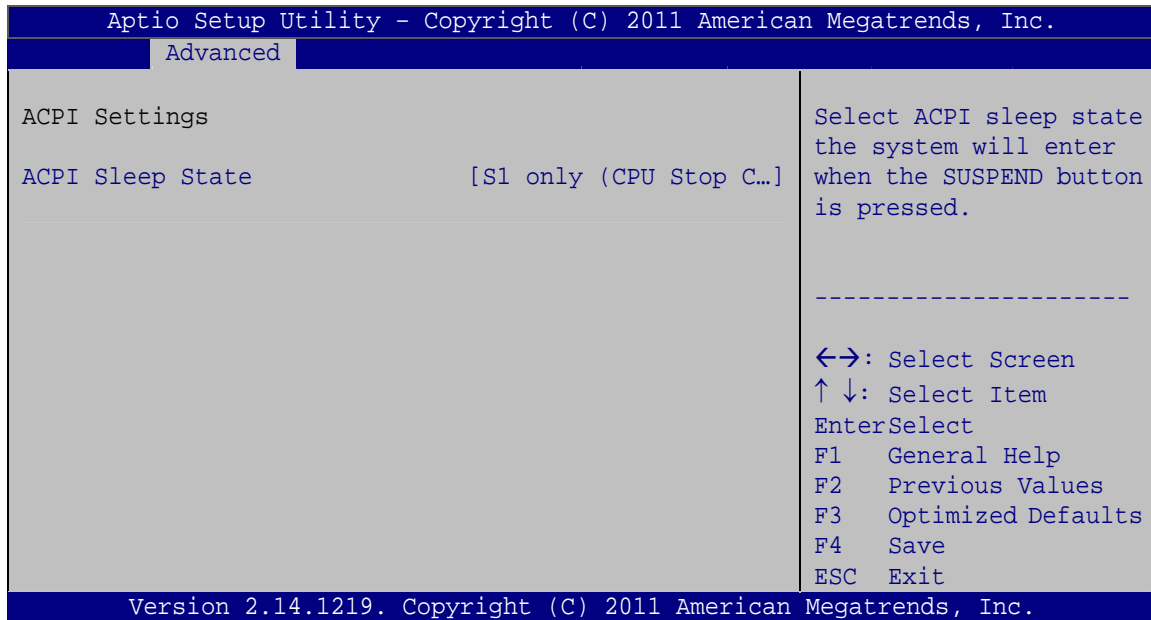

BIOS Menu 3: ACPI Configuration

→ ACPI Sleep State [S1 only (CPU Stop Clock)]

Use the **ACPI Sleep State** option to specify the sleep state the system enters when it is not being used.

- **S1 only (CPU Stop Clock) DEFAULT** The system enters S1(POS) sleep state. The system appears off. The CPU is stopped; RAM is refreshed; the system is running in a low power mode.
- **S3 only (Suspend to RAM)** The caches are flushed and the CPU is powered off. Power to the RAM is maintained. The computer returns slower to a working state, but more power is saved.

5.3.2 RTC Wake Settings

The **RTC Wake Settings** menu (**BIOS Menu 4**) configures RTC wake event.

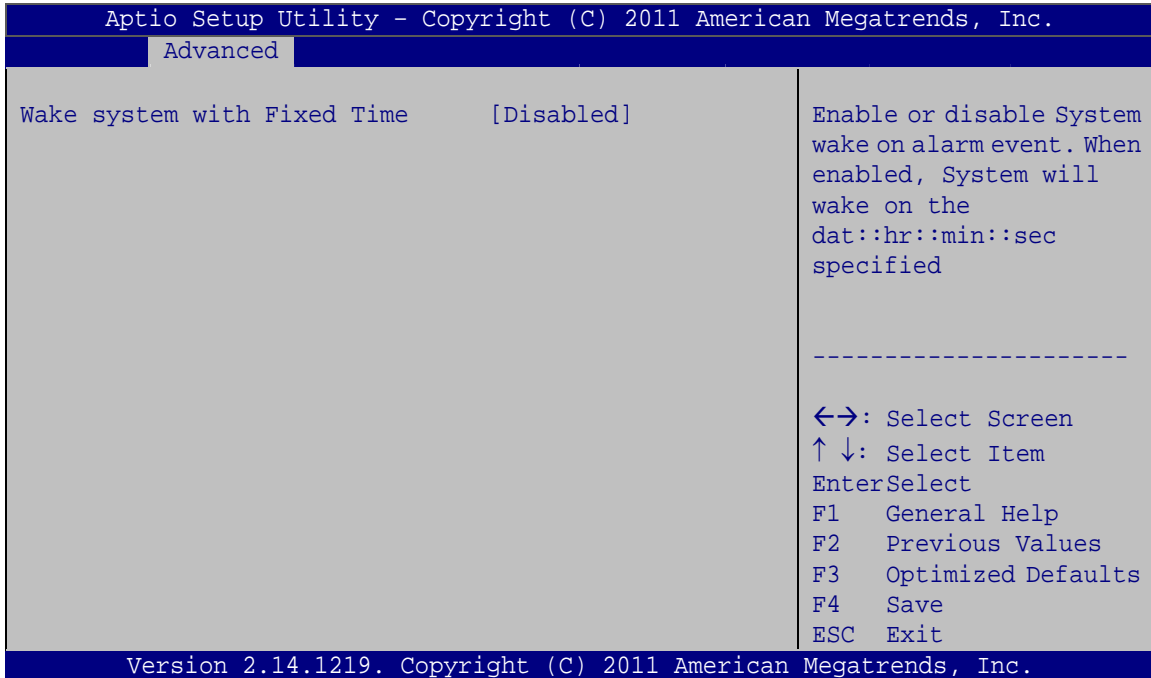

BIOS Menu 4: RTC Wake Settings

→ Wake System with Fixed Time [Disabled]

Use the **Wake System with Fixed Time** option to specify the time the system should be roused from a suspended state.

- **Disabled** **DEFAULT** The real time clock (RTC) cannot generate a wake event

NANO-QM770 EPIC SBC

➔ **Enabled**

If selected, the following appears with values that can be selected:

*Wake up every day

*Wake up date

*Wake up hour

*Wake up minute

*Wake up second

After setting the alarm, the computer turns itself on from a suspend state when the alarm goes off.

5.3.3 Trusted Computing

Use the **Trusted Computing** menu (**BIOS Menu 5**) to configure settings related to the Trusted Computing Group (TCG) Trusted Platform Module (TPM).

```

Aptio Setup Utility - Copyright (C) 2011 American Megatrends, Inc.
  Advanced
-----
Configuration
Security Device Support          [Disable]
Current Status Information
NO Security Device Found
-----
Enables or Disables BIOS
support for security
device. O.S. will not
show Security Device.
TCG EFI protocol and
INT1A interface will not
be available.

-----

<=>: Select Screen
↑ ↓: Select Item
Enter>Select
F1   General Help
F2   Previous Values
F3   Optimized
Defaults
F4   Save
ESC  Exit

Version 2.14.1219. Copyright (C) 2011 American Megatrends, Inc.
  
```

BIOS Menu 5: Trusted Computing

➔ **Security Device Support [Disable]**

Use the **Security Device Support** option to configure support for the TPM.

➔ **Disable** **DEFAULT** TPM support is disabled.

➔ **Enable** TPM support is enabled.

5.3.4 CPU Configuration

Use the **CPU Configuration** menu (**BIOS Menu 6**) to view detailed CPU specifications and configure the CPU.

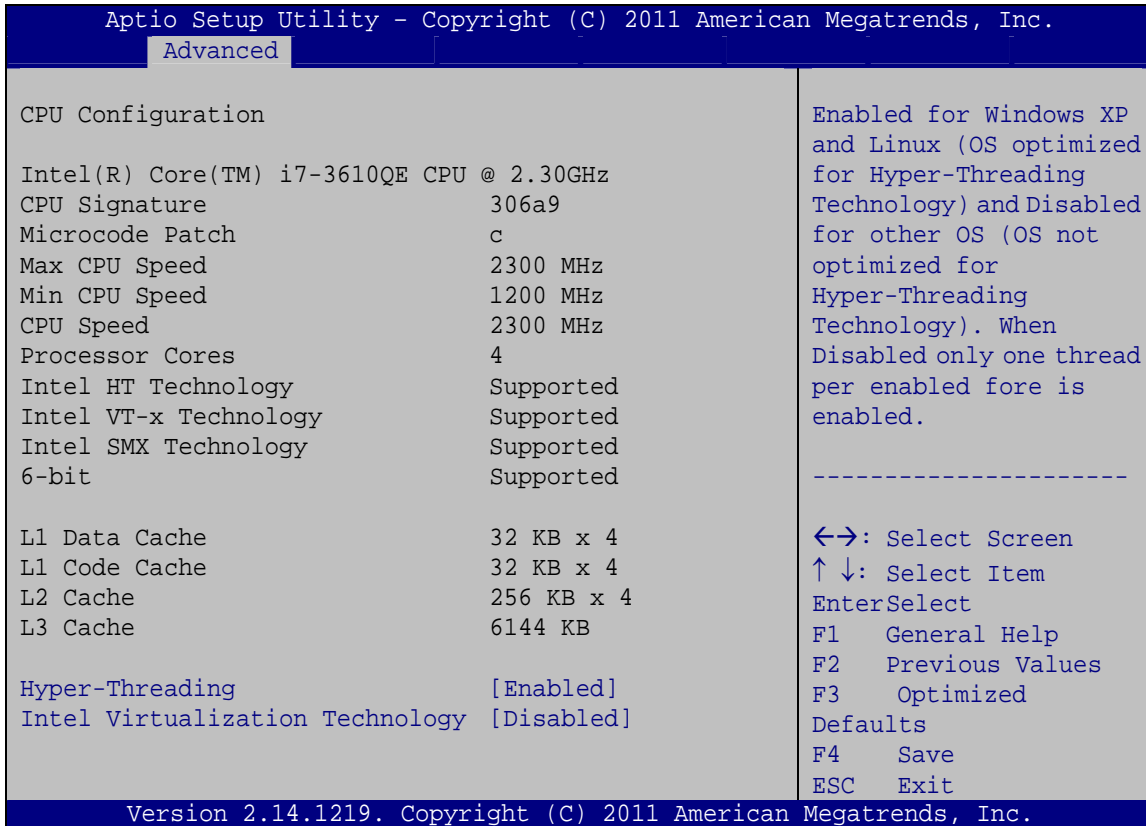

BIOS Menu 6: CPU Configuration

The CPU Configuration menu (**BIOS Menu 6**) lists the following CPU details:

- Processor Type: Lists the brand name of the CPU being used
- CPU Signature: Lists the CPU signature value.
- Microcode Patch: Lists the microcode patch being used.

NANO-QM770 EPIC SBC

- Max CPU Speed: Lists the maximum CPU processing speed.
- Min CPU Speed: Lists the minimum CPU processing speed.
- CPU Speed: Lists the CPU processing speed
- Processor Core: Lists the number of the processor cores
- Intel HT Technology: Indicates if Intel HT Technology is supported by the CPU.
- Intel VT-x Technology: Indicates if Intel VT-x Technology is supported by the CPU.
- Intel SMX Technology: Indicates if Intel SMX Technology is supported by the CPU.
- 64-bit: Indicates if 64-bit is supported by the CPU.
- L1 Data Cache: Lists the amount of data storage space on the L1 cache.
- L1 Code Cache: Lists the amount of code storage space on the L1 cache.
- L2 Cache: Lists the amount of storage space on the L2 cache.
- L3 Cache: Lists the amount of storage space on the L3 cache.

→ Hyper Threading [Enabled]

Use the **Hyper Threading** to enable or disable the CPU hyper threading function.

- **Disabled** Disables the use of hyper threading technology
- **Enabled** **DEFAULT** Enables the use of hyper threading technology

→ Intel Virtualization Technology [Disabled]

Use the **Intel Virtualization Technology** option to enable or disable virtualization on the system. When combined with third party software, Intel Virtualization technology allows several OSs to run on the same system at the same time.

- **Disabled** **DEFAULT** Disables Intel Virtualization Technology.
- **Enabled** Enables Intel Virtualization Technology.

5.3.5 SATA Configuration

Use the **SATA Configuration** menu (**BIOS Menu 7**) to change and/or set the configuration of the SATA devices installed in the system.

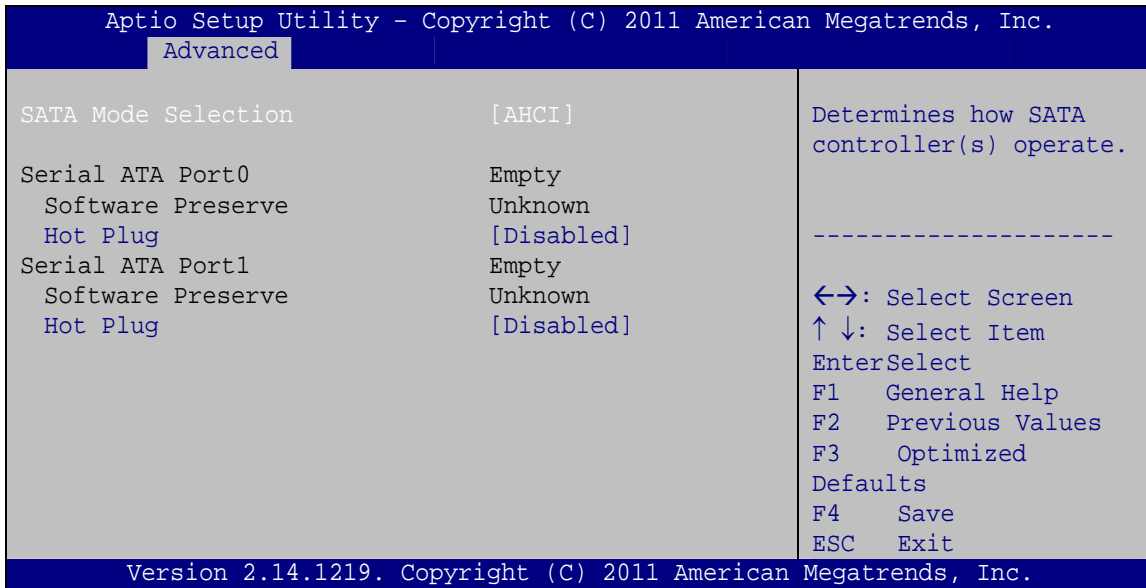

BIOS Menu 7: SATA Configuration

→ SATA Mode Selection [AHCI]

Use the **SATA Mode Selection** option to configure SATA devices as normal IDE devices.

- **IDE** Configures SATA devices as normal IDE device.
- **AHCI** **DEFAULT** Configures SATA devices as AHCI device.
- **RAID** Configures SATA devices as RAID device.

→ Hot Plug [Disabled]

Use the **Hot Plug** option to enable or disable the hot plug function.

- **Disabled** **DEFAULT** Disables the hot plug function.
- **Enabled** Enables the hot plug function.

NANO-QM770 EPIC SBC

5.3.6 Intel(R) Rapid Start Technology

Use the **Intel(R) Rapid Start Technology** menu to configure Intel® Rapid Start Technology support.

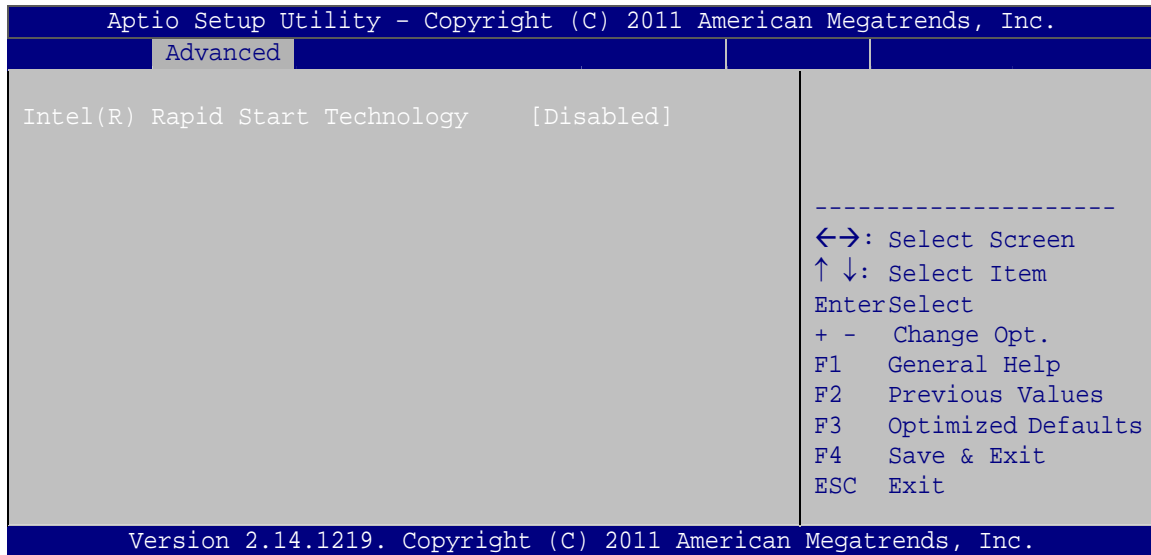

BIOS Menu 8: Intel(R) Rapid Start Technology

→ Intel(R) Rapid Start Technology [Disabled]

Use **Intel(R) Rapid Start Technology** option to enable or disable the Intel® Rapid Start Technology function.

- **Disabled** **DEFAULT** Intel® Rapid Start Technology is disabled
- **Enabled** Intel® Rapid Start Technology is enabled

5.3.7 Intel TXT(LT) Configuration

Use the **Intel TXT(LT) Configuration** menu to configure Intel® Trusted Execution Technology support.

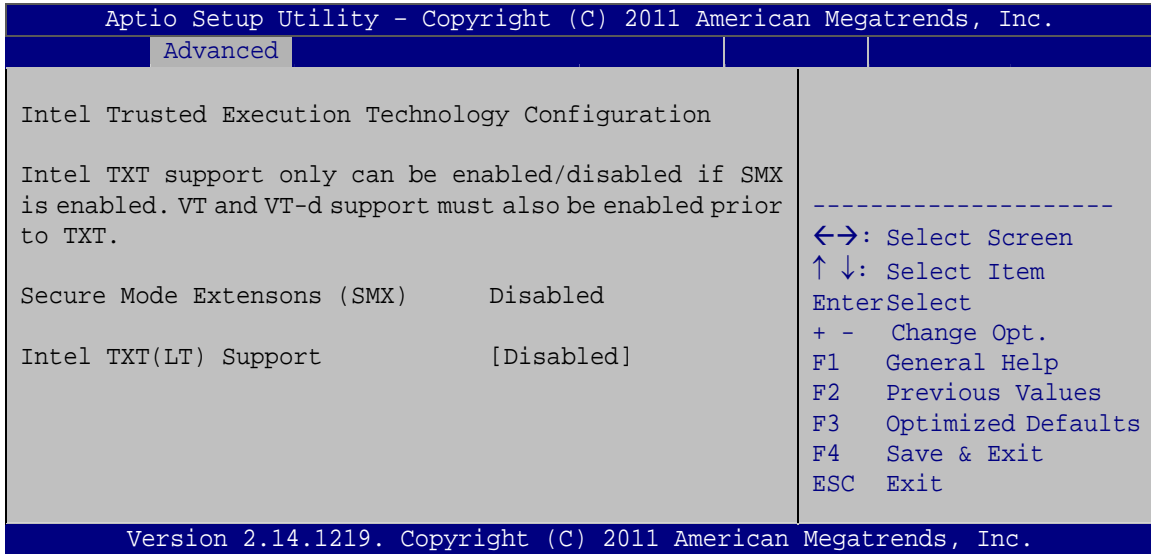

BIOS Menu 9: Intel TXT(LT) Configuration

5.3.8 AMT Configuration

The **AMT Configuration** menu (**BIOS Menu 10**) allows the advanced power management options to be configured.

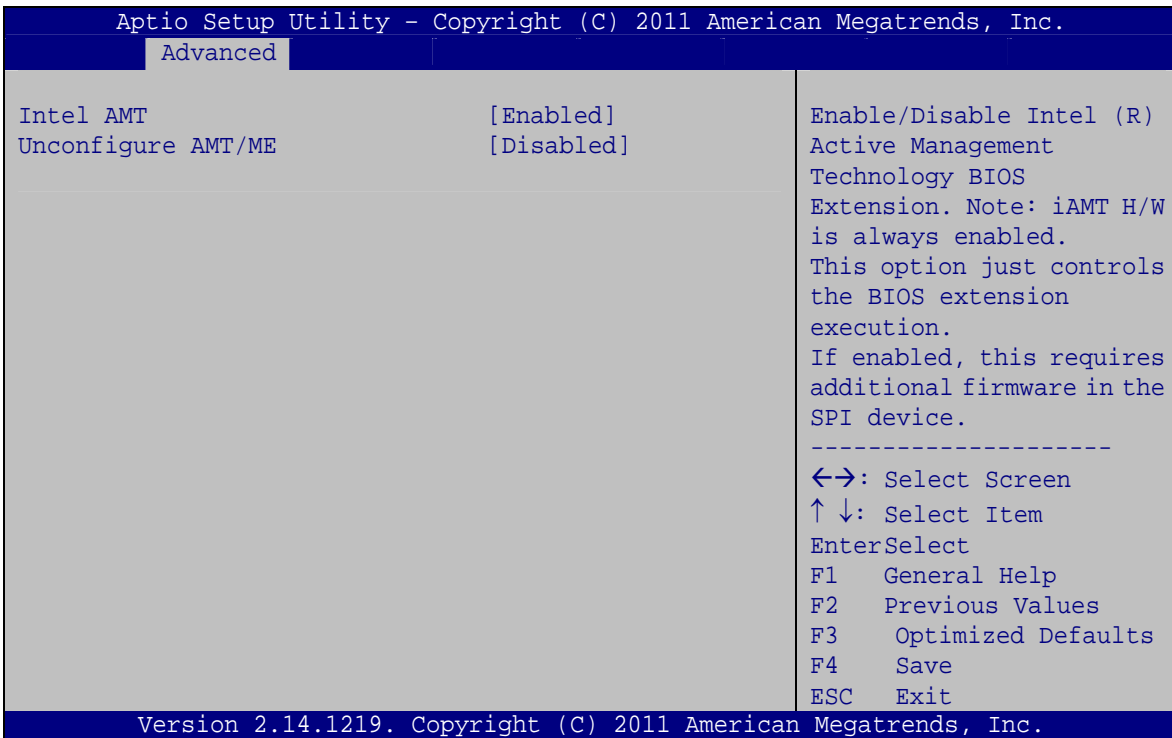

BIOS Menu 10: AMT Configuration

NANO-QM770 EPIC SBC

→ Intel AMT [Enabled]

Use **Intel AMT** option to enable or disable the Intel® AMT function.

- **Disabled** Intel® AMT is disabled
- **Enabled** **DEFAULT** Intel® AMT is enabled

→ Unconfigure ME [Disabled]

Use the **Unconfigure ME** option to perform ME unconfigure without password operation.

- **Disabled** **DEFAULT** Not perform ME unconfigure
- **Enabled** To perform ME unconfigure

5.3.9 USB Configuration

Use the **USB Configuration** menu (**BIOS Menu 11**) to read USB configuration information and configure the USB settings.

```

Aptio Setup Utility - Copyright (C) 2011 American Megatrends, Inc.
  Advanced
-----
USB Configuration
USB Devices:
  1 Keyboard, 2 Hubs
Legacy USB Support          [Enabled]
-----
Enables Legacy USB
support. AUTO option
disables legacy support
if no USB devices are
connected. DISABLE
option will keep USB
devices available only
for EFI applications.

-----
←→: Select Screen
↑↓: Select Item
Enter>Select
F1  General Help
F2  Previous Values
F3  Optimized
Defaults
F4  Save
ESC Exit

Version 2.14.1219. Copyright (C) 2011 American Megatrends, Inc.

```

BIOS Menu 11: USB Configuration

➔ **USB Devices**

The **USB Devices Enabled** field lists the USB devices that are enabled on the system

➔ **Legacy USB Support [Enabled]**

Use the **Legacy USB Support** BIOS option to enable USB mouse and USB keyboard support. Normally if this option is not enabled, any attached USB mouse or USB keyboard does not become available until a USB compatible operating system is fully booted with all USB drivers loaded. When this option is enabled, any attached USB mouse or USB keyboard can control the system even when there is no USB driver loaded onto the system.

- ➔ **Enabled** **DEFAULT** Legacy USB support enabled
- ➔ **Disabled** Legacy USB support disabled
- ➔ **Auto** Legacy USB support disabled if no USB devices are connected

5.3.10 F81866 Super IO Configuration

Use the **F81866 Super IO Configuration** menu (**BIOS Menu 12**) to set or change the configurations for the FDD controllers, parallel ports and serial ports.

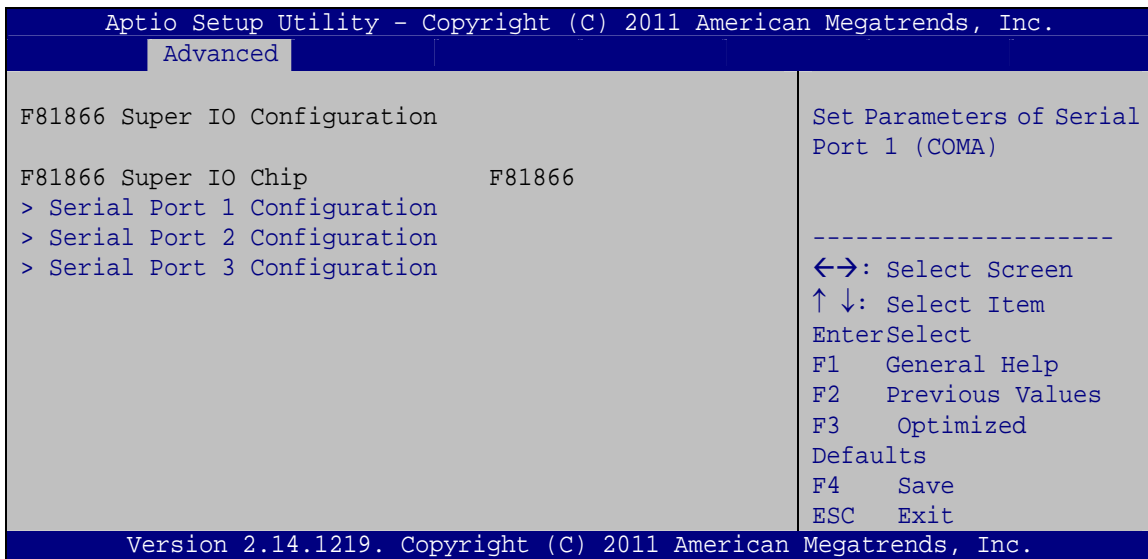

BIOS Menu 12: Super IO Configuration

NANO-QM770 EPIC SBC

5.3.10.1 Serial Port n Configuration

Use the **Serial Port n Configuration** menu (**BIOS Menu 13**) to configure the serial port n.

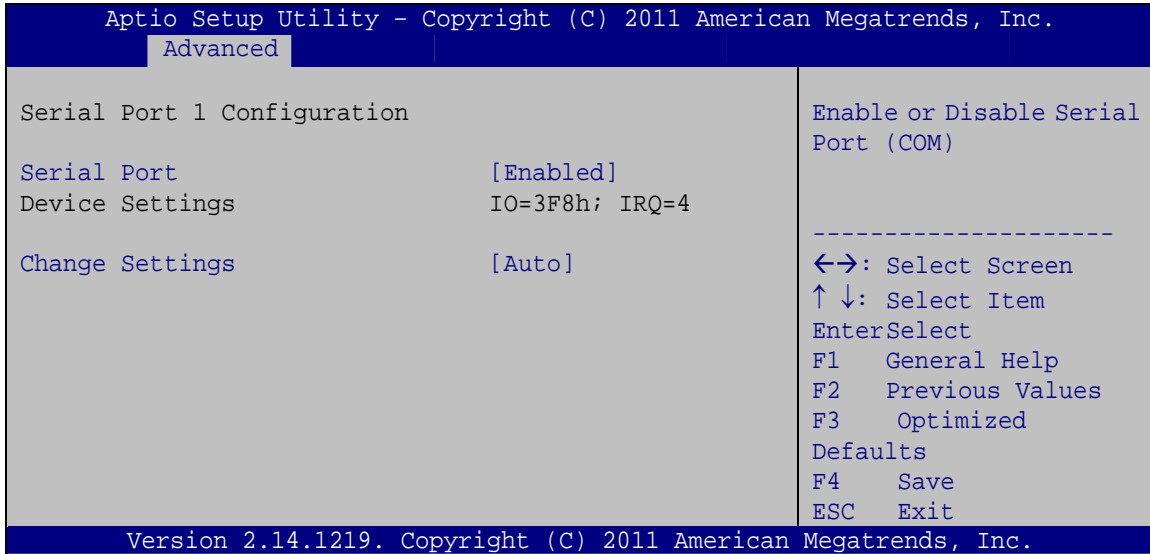

BIOS Menu 13: Serial Port n Configuration Menu

5.3.10.1.1 Serial Port 1 Configuration

→ Serial Port [Enabled]

Use the **Serial Port** option to enable or disable the serial port.

- **Disabled** Disable the serial port
- **Enabled** **DEFAULT** Enable the serial port

→ Change Settings [Auto]

Use the **Change Settings** option to change the serial port IO port address and interrupt address.

- **Auto** **DEFAULT** The serial port IO port address and interrupt address are automatically detected.
- **IO=3F8h;**
IRQ=4 Serial Port I/O port address is 3F8h and the interrupt address is IRQ4

- ➔ **IO=3F8h;**
IRQ=3, 4 Serial Port I/O port address is 3E8h and the interrupt address is IRQ3, 4
- ➔ **IO=2F8h;**
IRQ=3, 4 Serial Port I/O port address is 2F8h and the interrupt address is IRQ3, 4
- ➔ **IO=3E8h;**
IRQ=3, 4 Serial Port I/O port address is 3E8h and the interrupt address is IRQ3, 4
- ➔ **IO=2E8h;**
IRQ=3, 4 Serial Port I/O port address is 2E8h and the interrupt address is IRQ3, 4

5.3.10.1.2 Serial Port 2 Configuration

➔ **Serial Port [Enabled]**

Use the **Serial Port** option to enable or disable the serial port.

- ➔ **Disabled** Disable the serial port
- ➔ **Enabled DEFAULT** Enable the serial port

➔ **Change Settings [Auto]**

Use the **Change Settings** option to change the serial port IO port address and interrupt address.

- ➔ **Auto DEFAULT** The serial port IO port address and interrupt address are automatically detected.
- ➔ **IO=2F8h;**
IRQ=3 Serial Port I/O port address is 2F8h and the interrupt address is IRQ3
- ➔ **IO=3F8h;**
IRQ=3, 4 Serial Port I/O port address is 3F8h and the interrupt address is IRQ3, 4
- ➔ **IO=2E8h;**
IRQ=3, 4 Serial Port I/O port address is 2E8h and the interrupt address is IRQ3, 4
- ➔ **IO=3E8h;**
IRQ=3, 4 Serial Port I/O port address is 3E8h and the interrupt address is IRQ3, 4

NANO-QM770 EPIC SBC

- **IO=2E8h;** Serial Port I/O port address is 2E8h and the interrupt
IRQ=3, 4 address is IRQ3, 4

5.3.10.1.3 Serial Port 3 Configuration

→ Serial Port [Enabled]

Use the **Serial Port** option to enable or disable the serial port.

- **Disabled** Disable the serial port
- **Enabled** **DEFAULT** Enable the serial port

→ Change Settings [Auto]

Use the **Change Settings** option to change the serial port IO port address and interrupt address.

- **Auto** **DEFAULT** The serial port IO port address and interrupt address are automatically detected.
- **IO=3E8h;** Serial Port I/O port address is 3E8h and the interrupt
IRQ=5 address is IRQ5
- **IO=3F8h;** Serial Port I/O port address is 3F8h and the interrupt
IRQ=3, 4 address is IRQ3, 4
- **IO=2F8h;** Serial Port I/O port address is 2F8h and the interrupt
IRQ=3, 4 address is IRQ3, 4
- **IO=3E8h;** Serial Port I/O port address is 3E8h and the interrupt
IRQ=5, 7 address is IRQ5, 7
- **IO=2E8h;** Serial Port I/O port address is 2E8h and the interrupt
IRQ=5, 7 address is IRQ5, 7
- **IO=2E0h;** Serial Port I/O port address is 2E0h and the interrupt
IRQ=5, 7 address is IRQ5, 7

5.3.11 F81866 H/W Monitor

The **F8186 H/W Monitor** menu (**BIOS Menu 14**) shows the operating temperature, fan speeds and system voltages.

```

Aptio Setup Utility - Copyright (C) 2011 American Megatrends, Inc.
Advanced
PC Health Status
CPU temperature           :+62 C
Accuracy: 1. -5~ +10 degree around 100 degree.
          2. -10~ +15 degree around 50 degree.
System temperature       :+37 C
CPU Fan Speed            :2325 RPM
SYS Fan Speed            :N/A
+5VS                     :+5.171 V
+V12S                    :+12.056 V
+V1.5                    :+1.632 V
VSB5V                    :+5.016 V
VCC3V                    :+3.360 V
VSB3V                    :+3.344 V
VBAT                     :+3.312 V
> Smart Fan Mode Configuration

Smart Fan Mode Select
-----
<->: Select Screen
↑ ↓: Select Item
EnterSelect
F1   General Help
F2   Previous Values
F3   Optimized
Defaults
F4   Save
ESC  Exit

Version 2.14.1219. Copyright (C) 2011 American Megatrends, Inc.
    
```

BIOS Menu 14: Hardware Health Configuration

→ PC Health Status

The following system parameters and values are shown. The system parameters that are monitored are:

- System Temperatures:
 - CPU Temperature
 - System Temperature
- Fan Speeds:
 - CPU Fan Speed
 - System Fan Speed
- Voltages:
 - +5VS
 - +V12S
 - +V1.5

NANO-QM770 EPIC SBC

- VSB5V
- VCC3V
- VSB3V
- VBAT

5.3.11.1 Smart Fan Mode Configuration

Use the **Smart Fan Mode Configuration** submenu (**BIOS Menu 15**) to configure the smart fan temperature and speed settings.

```

Aptio Setup Utility - Copyright (C) 2011 American Megatrends, Inc.
Advanced
Smart Fan Mode Configuration
CPU_FAN1 Smart Fan Control      [Auto Duty-Cycle Mode]
CPU Temperature 1                60
CPU Temperature 2                50
CPU Temperature 3                40
CPU Temperature 4                30
SYS_FAN1 Smart Fan Control      [Auto Duty-Cycle Mode]
System Temperature 1             60
System Temperature 2             50
System Temperature 3             40
System Temperature 4             30
Smart Fan Mode Select
(Reference System
Temperature)
-----
<=>: Select Screen
↑ ↓: Select Item
Enter>Select
+ - Change Opt.
F1  General Help
F2  Previous Values
F3  Optimized Defaults
F4  Save & Exit
ESC Exit
Version 2.14.1219. Copyright (C) 2011 American Megatrends, Inc.
  
```

BIOS Menu 15: FAN 1 Configuration

→ CPU_FAN1 Smart Fan Control [Auto Duty-Cycle Mode]

Use the **CPU_FAN1 Smart Fan Control** option to configure the CPU Smart Fan (CPU_FAN1).

- **Manual Duty Mode** The fan spins at the speed set in Manual by Duty Cycle settings
- **Auto Duty-Cycle Mode** The fan adjusts its speed using Auto by Duty-Cycle settings

➔ **SYS_FAN1 Smart Fan Control [Auto Duty-Cycle Mode]**

Use the **SYS_FAN1 Smart Fan Control** option to configure the System Smart Fan (SYS_FAN1).

- ➔ **Manual Duty Mode** The fan spins at the speed set in Manual by Duty Cycle settings
- ➔ **Auto Duty-Cycle Mode** The fan adjusts its speed using Auto by Duty-Cycle settings

➔ **Temperature n**

Use the + or – key to change the fan **Temperature n** value. Enter a decimal number between 0 and 85.

5.3.12 Serial Port Console Redirection

The **Serial Port Console Redirection** menu (**BIOS Menu 16**) allows the console redirection options to be configured. Console redirection allows users to maintain a system remotely by re-directing keyboard input and text output through the serial port.

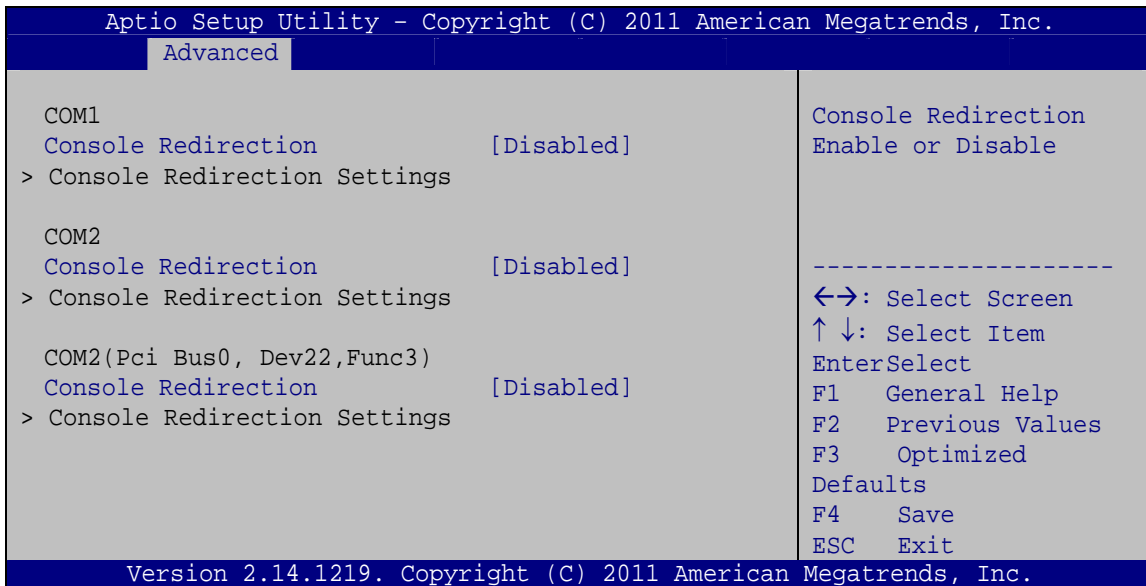

BIOS Menu 16: Serial Port Console Redirection

NANO-QM770 EPIC SBC

→ Console Redirection [Disabled]

Use **Console Redirection** option to enable or disable the console redirection function.

- **Disabled** **DEFAULT** Disabled the console redirection function
- **Enabled** Enabled the console redirection function

5.3.13 IEI Feature

Use the **IEI Feature** menu (**BIOS Menu 17**) to configure One Key Recovery function.

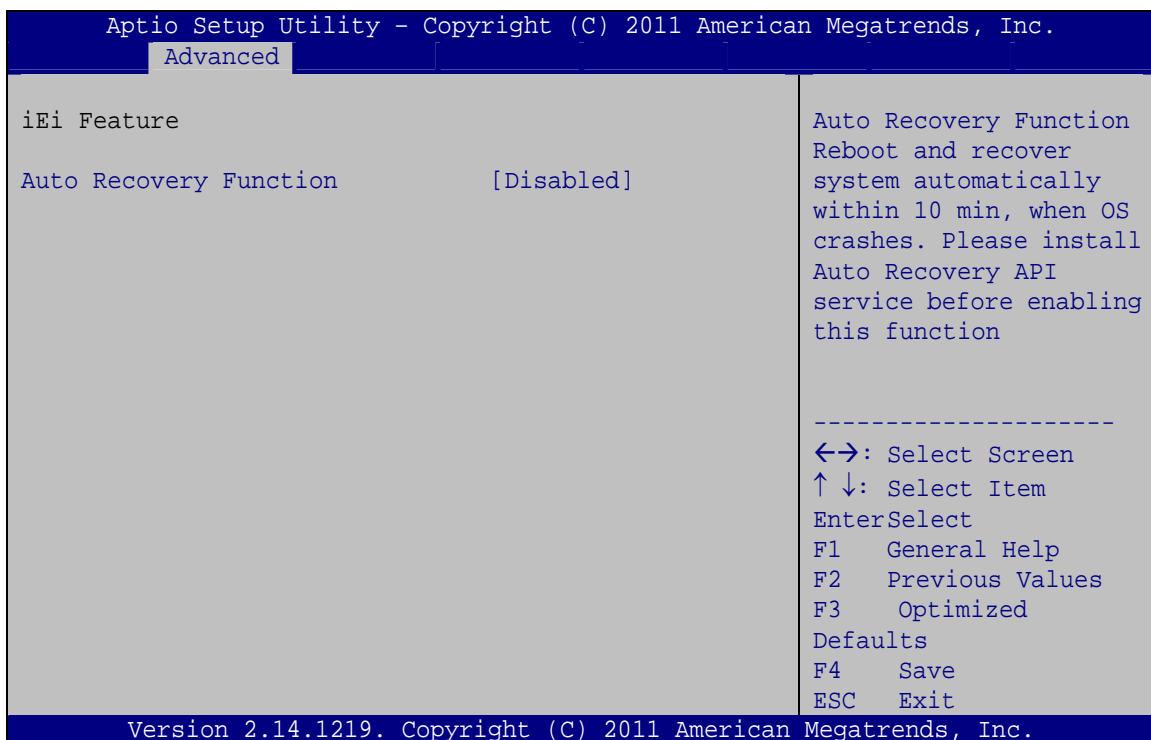

BIOS Menu 17: IEI Feature

→ Auto Recovery Function [Disabled]

Use the **Auto Recovery Function** BIOS option to enable or disable the auto recovery function of the IEI One Key Recovery.

- **Disabled** **DEFAULT** Auto recovery function disabled
- **Enabled** Auto recovery function enabled

5.4 Chipset

Use the **Chipset** menu (**BIOS Menu 18**) to access the Hostbridge and Southbridge configuration menus.



WARNING!

Setting the wrong values for the Chipset BIOS selections in the Chipset BIOS menu may cause the system to malfunction.

```
Aptio Setup Utility - Copyright (C) 2011 American Megatrends, Inc.
Main   Advanced  Chipset  Boot   Security  Save & Exit
-----
> PCH-IO Configuration
> System Agent (SA) Configuration

Host Bridge Parameters
-----
<->: Select Screen
↑ ↓: Select Item
Enter>Select
F1   General Help
F2   Previous Values
F3   Optimized
Defaults
F4   Save
ESC  Exit

Version 2.14.1219. Copyright (C) 2011 American Megatrends, Inc.
```

BIOS Menu 18: Chipset

NANO-QM770 EPIC SBC

5.4.1 PCH-IO Configuration

Use the **PCH-IO Configuration** menu (**BIOS Menu 19**) to configure the PCH chipset.

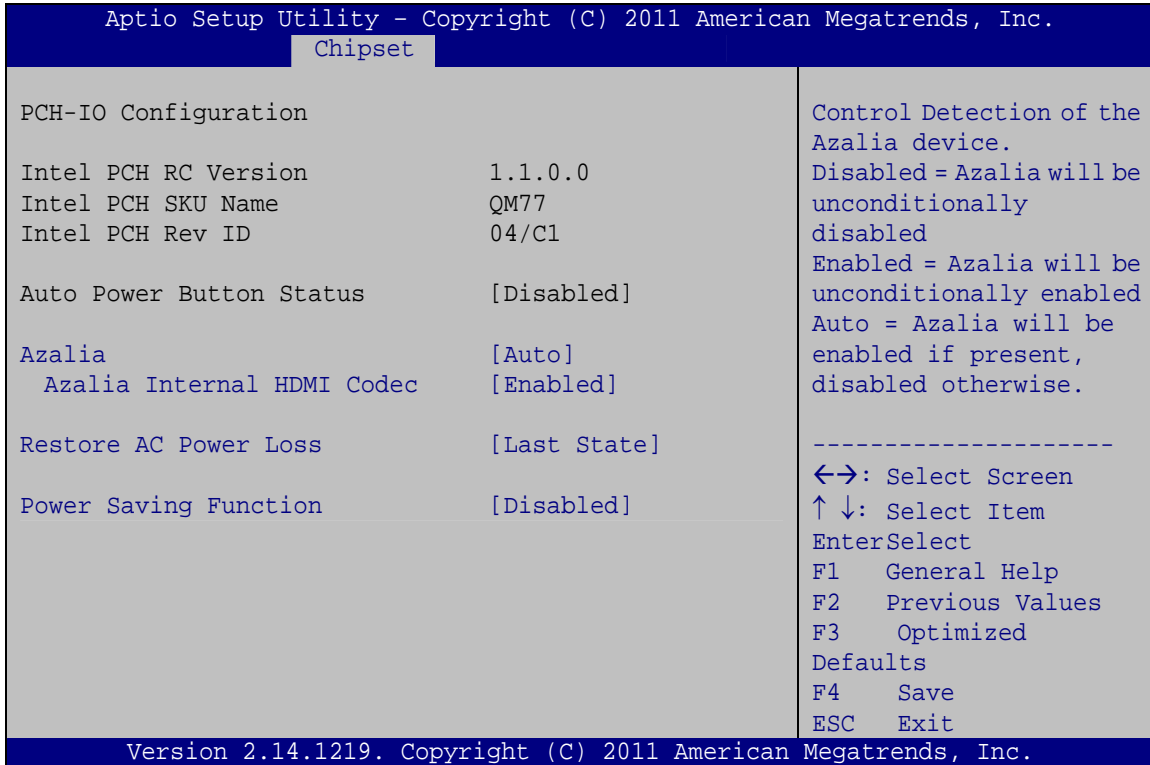

BIOS Menu 19:PCH-IO Configuration

→ Azalia [Auto]

Use the **Azalia** option to enable or disable the High Definition Audio controller.

- **Disabled** The onboard High Definition Audio controller is disabled
- **Enabled** The onboard High Definition Audio controller automatically detected and enabled
- **Auto DEFAULT** The onboard High Definition Audio controller automatically detected and enabled

→ Azalia internal HDMI codec [Enabled]

Use the **Azalia internal HDMI codec** option to enable or disable the internal HDMI codec for High Definition Audio.

- **Disabled** Disable internal HDMI codec for High Definition Audio
- **Enabled** **DEFAULT** Enable internal HDMI codec for High Definition Audio

→ **Restore AC Power Loss [Last State]**

Use the **Restore AC Power Loss** BIOS option to specify what state the system returns to if there is a sudden loss of power to the system.

- **Power Off** The system remains turned off
- **Power On** The system turns on
- **Last State** **DEFAULT** The system returns to its previous state. If it was on, it turns itself on. If it was off, it remains off.

→ **Power Saving Function [Disabled]**

Use the **Power Saving Function** BIOS option to enable or disable the power saving function.

- **Disabled** **DEFAULT** Power saving function is disabled.
- **Enabled** Power saving function is enabled. It will reduce power consumption when the system is off.

5.4.2 System Agent (SA) Configuration

Use the **System Agent (SA) Configuration** menu (**BIOS Menu 20**) to configure the Southbridge chipset.

NANO-QM770 EPIC SBC

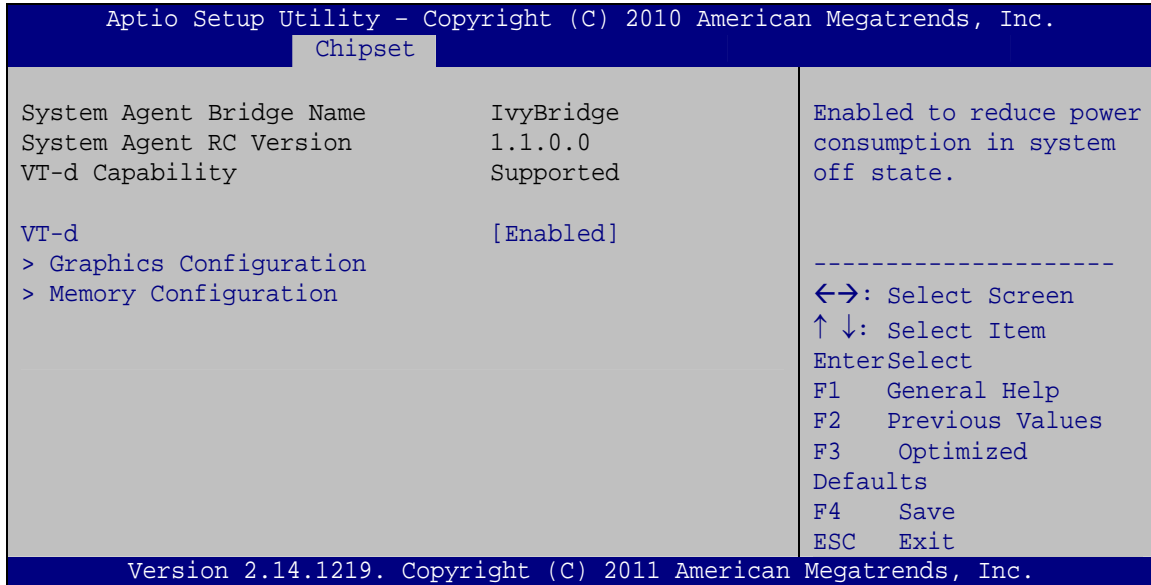

BIOS Menu 20: System Agent (SA) Configuration

→ VT-d [Enabled]

Use the **VT-d** option to enable or disable VT-d support.

- **Disabled** Disables VT-d support.
- **Enabled** **DEFAULT** Enables VT-d support.

5.4.2.1 Graphics Configuration

Use the **Graphics Configuration** menu to configure the video device connected to the system.

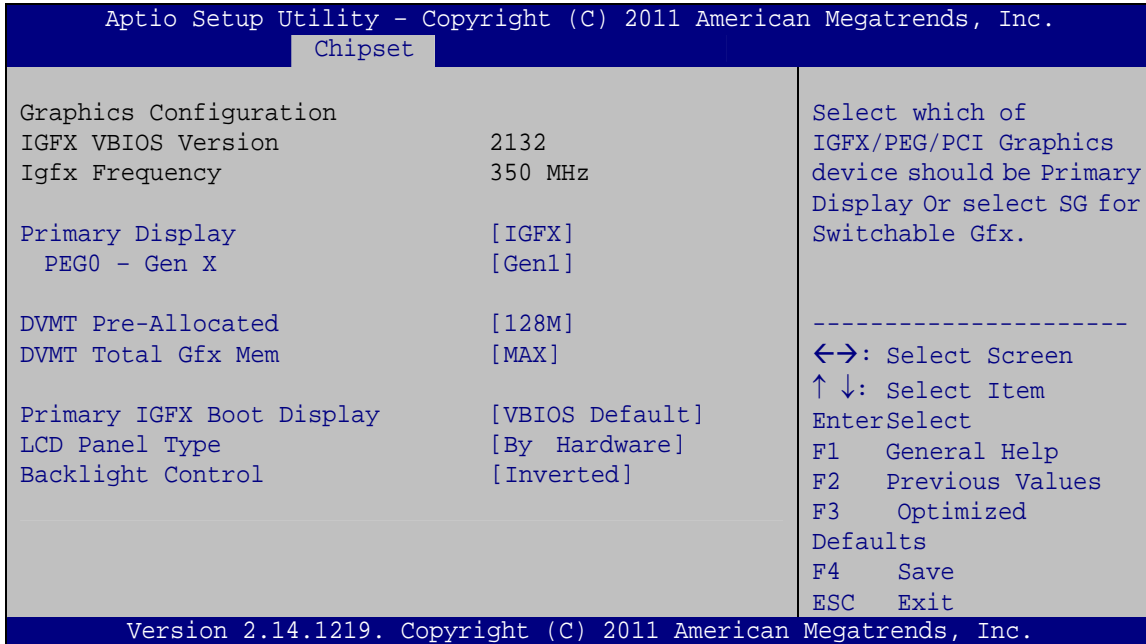

BIOS Menu 21: Graphics Configuration

→ **Primary Display [IGFX]**

Use the **Primary Display** option to select the primary graphics controller the system uses. The following options are available:

- IGFX **Default**
- PEG

→ **PEG0 – Gen X [Gen1]**

Use the **PEG0 – Gen X** option to configure PEG0 B0:D1:F0. The following options are available:

- Gen1 **Default**
- Gen2
- Gen3

→ **DVMT Pre-Allocated [128MB]**

Use the **DVMT Pre-Allocated** option to set the amount of system memory allocated to the integrated graphics processor when the system boots. The system memory allocated can

NANO-QM770 EPIC SBC

then only be used as graphics memory, and is no longer available to applications or the operating system. Configuration options are listed below:

- 32M
- 64M
- 96M
- 128M **Default**
- 256M
- 512M
- 1024M

→ DVMT Total Gfx Mem [MAX]

Use the **DVMT Total Gfx Mem** option to select DVMT5.0 total graphic memory size used by the internal graphic device. The following options are available:

- 128M
- 256M
- MAX **Default**

→ Primary IGFX Boot Display [VBIOS Default]

Use the **Primary IGFX Boot Display** option to select the display device used by the system when it boots. Configuration options are listed below.

- VBIOS Default **DEFAULT**
- DVI
- LVDS
- HDMI 1
- HDMI 2

→ LCD Panel Type [By Hardware]

Use the **LCD Panel Type** option to select the type of flat panel connected to the system. Configuration options are listed below.

- By Hardware **DEFAULT**
- 640x480 18BIT

- 800x600 18BIT
- 1024x768 18BIT
- 1024x768 24BIT
- 1280x800 24BIT
- 1280x1024 48BIT
- 1366x768 24BIT
- 1440x900 48BIT
- 1400x1050 48BIT
- 1600x900 48BIT
- 1600x1200 48BIT
- 1680x1050 48BIT
- 1920x1080 48BIT
- 1920x1200 48BIT
- 2048x1536 48BIT

→ **Backlight Control [Inverted]**

Use the **Backlight Control** option to select the backlight control mode.

- **Inverted** **DEFAULT** The LVDS backlight is brighter at high voltage level.
- **Normal** The LVDS backlight is brighter at low voltage level.

5.4.2.2 Memory Configuration

Use the **Memory Configuration** submenu (**BIOS Menu 22**) to view memory information.

NANO-QM770 EPIC SBC

Aptio Setup Utility - Copyright (C) 2011 American Megatrends, Inc.		
Chipset		
Memory Information		
Memory RC Version	1.1.0.0	
Memory Frequency	1333 MHz	
Total Memory	2048 MB (DDR3)	
DIMM#0	2048 MB (DDR3)	
CAS Latency (tCL)	9	
Minimum delay time		
CAS to RAS (tRCDmin)	9	
Row Precharge (tRPmin)	9	
Active to Precharge (tRASmin)	24	
XMP Profile 1	Not Supported	
XMP Profile 2	Not Supported	

		←→: Select Screen
		↑ ↓: Select Item
		Enter>Select
		+/-: Change Opt.
		F1 General Help
		F2 Previous Values
		F3 Optimized Defaults
		F4 Save & Exit
		ESC Exit
Version 2.14.1219. Copyright (C) 2011 American Megatrends, Inc.		

BIOS Menu 22: Memory Configuration

5.5 Boot

Use the **Boot** menu (**BIOS Menu 23**) to configure system boot options.

Aptio Setup Utility - Copyright (C) 2011 American Megatrends, Inc.					
Main	Advanced	Chipset	Boot	Security	Save & Exit
Boot Configuration					Select the keyboard NumLock state
		Bootup NumLock State	[On]		
		Quiet Boot	[Enabled]		
		Fast Boot	[Disabled]		
		CSM16 Module Version	07.69		-----
		Option ROM Messages	[Force BIOS]		←→: Select Screen
		Launch PXE OpROM	[Disabled]		↑ ↓: Select Item
		UEFI Boot	[Disabled]		Enter>Select
		Boot Option Priorities			F1 General Help
					F2 Previous Values
					F3 Optimized Defaults
					F4 Save
					ESC Exit
Version 2.14.1219. Copyright (C) 2011 American Megatrends, Inc.					

BIOS Menu 23: Boot

→ Bootup NumLock State [On]

Use the **Bootup NumLock State** BIOS option to specify if the number lock setting must be modified during boot up.

→ On **DEFAULT** Allows the Number Lock on the keyboard to be enabled automatically when the computer system boots up. This allows the immediate use of the 10-key numeric keypad located on the right side of the keyboard. To confirm this, the Number Lock LED light on the keyboard is lit.

→ Off Does not enable the keyboard Number Lock automatically. To use the 10-keys on the keyboard, press the Number Lock key located on the upper left-hand corner of the 10-key pad. The Number Lock LED on the keyboard lights up when the Number Lock is engaged.

→ Quiet Boot [Enabled]

Use the **Quiet Boot** BIOS option to select the screen display when the system boots.

→ Disabled Normal POST messages displayed

→ Enabled **DEFAULT** OEM Logo displayed instead of POST messages

→ Fast Boot [Disabled]

Use the **Fast Boot** option to enable or disable boot with initialization of a minimal set of devices required to launch active boot option. It has no effect for BBS boot options.

→ Disabled **DEFAULT** Disable fast boot.

→ Enabled Enable fast boot

NANO-QM770 EPIC SBC

→ Option ROM Messages [Force BIOS]

Use the **Option ROM Messages** option to set the Option ROM display mode.

- **Force BIOS** **DEFAULT** Sets display mode to force BIOS.
- **Keep Current** Sets display mode to current.

→ Launch PXE OpROM [Disabled]

Use the **Launch PXE OpROM** option to enable or disable boot option for legacy network devices.

- **Disabled** **DEFAULT** Ignore all PXE Option ROMs
- **Enabled** Load PXE Option ROMs.

→ UEFI Boot [Disabled]

Use the **UEFI Boot** option to enable or disable to boot from the UEFI devices.

- **Enabled** Boot from UEFI devices is enabled.
- **Disabled** **DEFAULT** Boot from UEFI devices is disabled.

5.6 Security

Use the **Security** menu (**BIOS Menu 24**) to set system and user passwords.

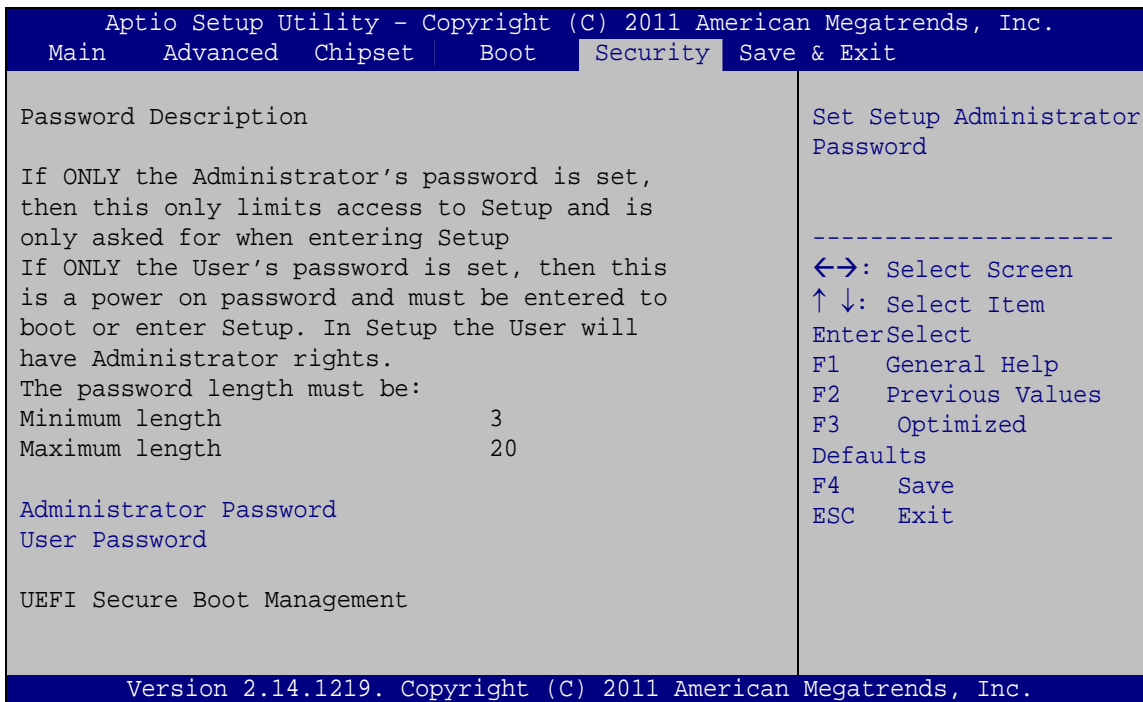

BIOS Menu 24: Security

→ Administrator Password

Use the **Administrator Password** to set or change a administrator password.

→ User Password

Use the **User Password** to set or change a user password.

5.7 Exit

Use the **Exit** menu (**BIOS Menu 25**) to load default BIOS values, optimal failsafe values and to save configuration changes.

NANO-QM770 EPIC SBC

```

Aptio Setup Utility - Copyright (C) 2011 American Megatrends, Inc.
Main   Advanced  Chipset  Boot   Security  Save & Exit

Save Changes and Reset
Discard Changes and Reset

Restore Defaults
Save as User Defaults
Restore User Defaults

Reset the system after
saving the changes.

-----
<->: Select Screen
↑ ↓: Select Item
EnterSelect
F1   General Help
F2   Previous Values
F3   Optimized
Defaults
F4   Save
ESC  Exit

Version 2.14.1219. Copyright (C) 2011 American Megatrends, Inc.

```

BIOS Menu 25:Exit**→ Save Changes and Reset**

Use the **Save Changes and Reset** option to save the changes made to the BIOS options and to exit the BIOS configuration setup program.

→ Discard Changes and Reset

Use the **Discard Changes and Reset** option to exit the system without saving the changes made to the BIOS configuration setup program.

→ Restore Defaults

Use the **Restore Defaults** option to load the optimal default values for each of the parameters on the Setup menus. **F3 key can be used for this operation.**

→ Save as User Defaults

Use the **Save as User Defaults** option to save the changes done so far as user defaults.

→ Restore User Defaults

Use the **Restore User Defaults** option to restore the user defaults to all the setup options.

Chapter

6

Software Drivers

NANO-QM770 EPIC SBC

6.1 Available Software Drivers

**NOTE:**

The content of the CD may vary throughout the life cycle of the product and is subject to change without prior notice. Visit the IEI website or contact technical support for the latest updates.

The following drivers can be installed on the system:

- Chipset
- Graphics
- LAN
- Audio
- SATA (Intel® Rapid Storage Technology)
- USB 3.0
- Intel® AMT

Installation instructions are given below.

6.2 Software Installation

All the drivers for the NANO-QM770 are on the CD that came with the system. To install the drivers, please follow the steps below.

Step 1: Insert the CD into a CD drive connected to the system.

**NOTE:**

If the installation program doesn't start automatically:
Click "Start->My Computer->CD Drive->autorun.exe"

Step 2: The driver main menu appears (**Figure 6-1**).



Figure 6-1: Introduction Screen

Step 3: Click NANO-QM770.

Step 4: A new screen with a list of available drivers appears (**Figure 6-2**).



Figure 6-2: Available Drivers

Step 5: Install all of the necessary drivers in this menu.

NANO-QM770 EPIC SBC

6.3 Chipset Driver Installation

To install the chipset driver, please do the following.

Step 1: Access the driver list. (See **Section 6.2**)

Step 2: Click “**Chipset**”.

Step 3: Locate the setup file and double click on it.

Step 4: The **Welcome Screen** in **Figure 6-3** appears.

Step 5: Click **Next** to continue.



Figure 6-3: Chipset Driver Welcome Screen

Step 6: The license agreement in **Figure 6-4** appears.

Step 7: Read the **License Agreement**.

Step 8: Click **Yes** to continue.



Figure 6-4: Chipset Driver License Agreement

Step 9: The Read Me file in Figure 6-5 appears.

Step 10: Click **Next** to continue.

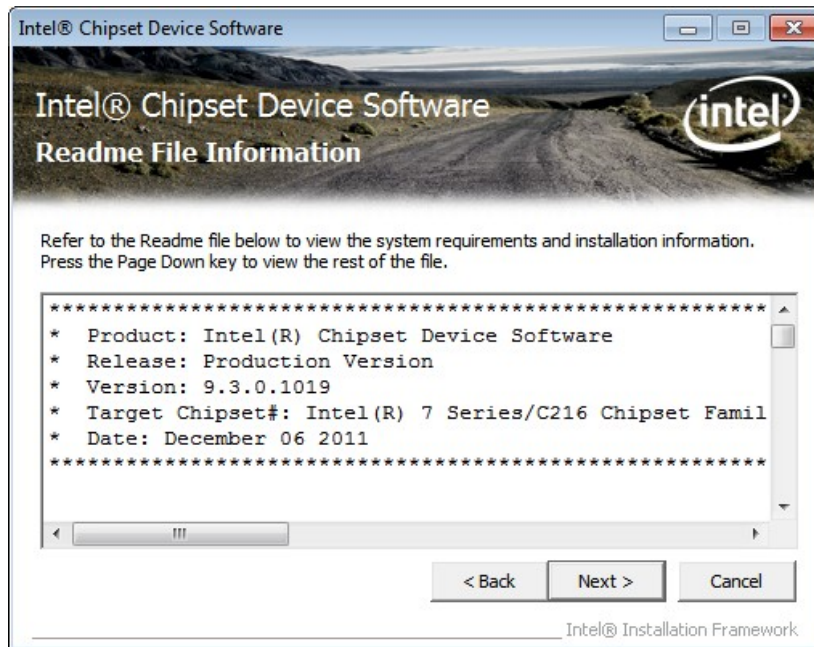

Figure 6-5: Chipset Driver Read Me File

NANO-QM770 EPIC SBC

Step 11: Setup Operations are performed as shown in Figure 6-6.

Step 12: Once the Setup Operations are complete, click **Next** to continue.

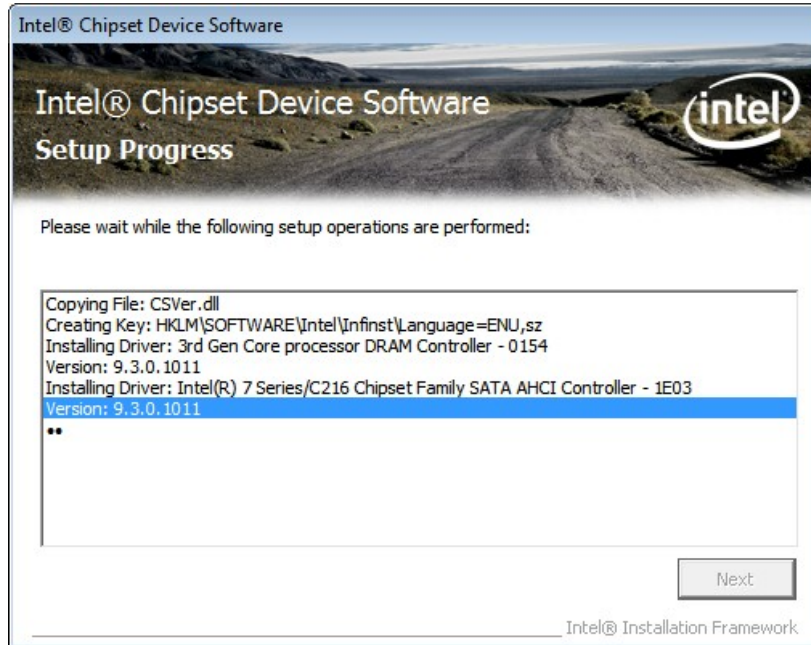

Figure 6-6: Chipset Driver Setup Operations

Step 13: The **Finish** screen in Figure 6-7 appears.

Step 14: Select “**Yes, I want to restart this computer now**” and click **Finish**.



Figure 6-7: Chipset Driver Installation Finish Screen

6.4 Graphics Driver Installation

To install the Graphics driver, please do the following.

- Step 1:** Access the driver list. (See **Section 6.2**)
- Step 2:** Click "**Graphics**" and select the folder which corresponds to the operating system.
- Step 3:** Double click the setup file.
- Step 4:** The **Welcome Screen** in **Figure 6-8** appears.
- Step 5:** Click **Next** to continue.

NANO-QM770 EPIC SBC

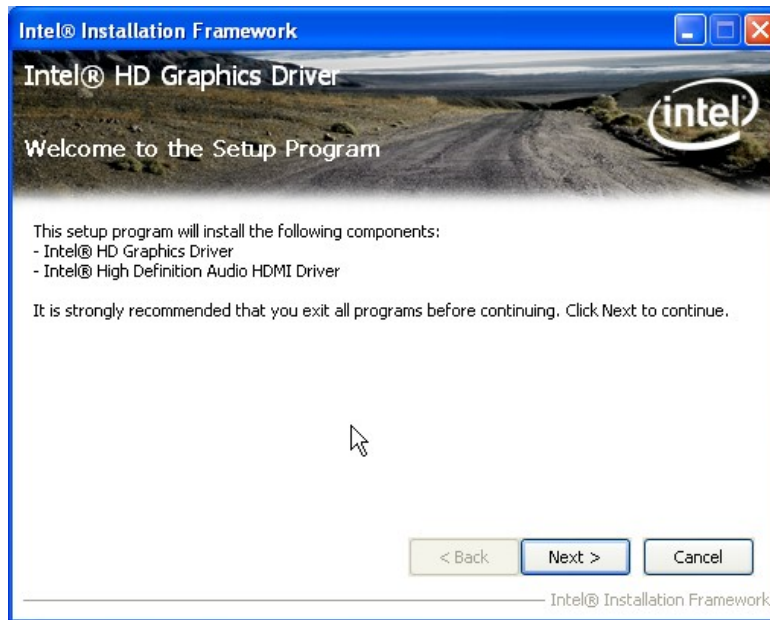

Figure 6-8: Graphics Driver Welcome Screen

Step 6: The License Agreement in Figure 6-9 appears.

Step 7: Click Yes to accept the agreement and continue.

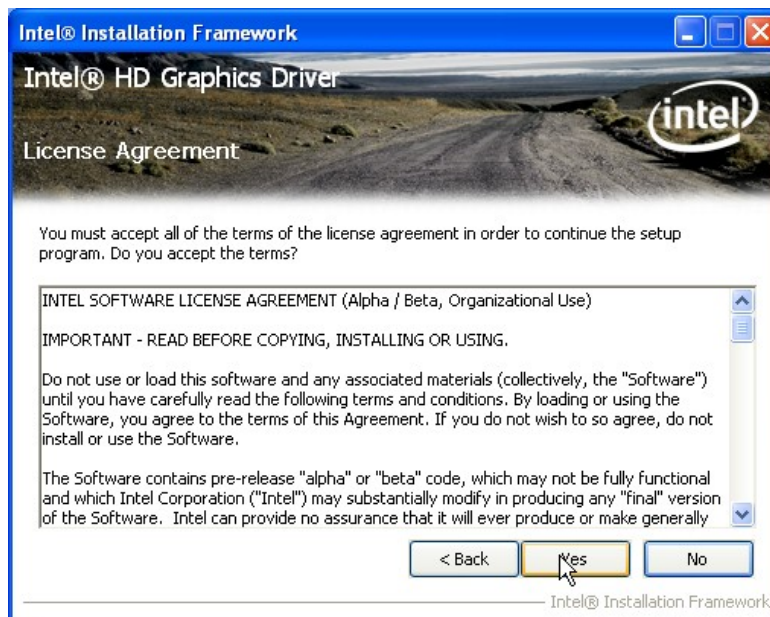

Figure 6-9: Graphics Driver License Agreement

Step 8: Setup Operations are performed as shown in Figure 6-10.

Step 9: Once the **Setup Operations** are complete, click **Next** to continue.

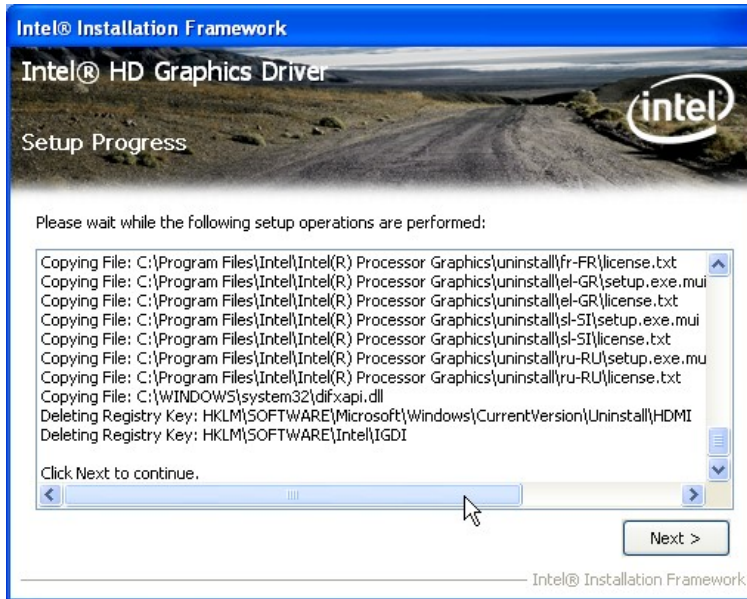

Figure 6-10: Graphics Driver Setup Operations

Step 10: The **Finish** screen in **Figure 6-11** appears.

Step 11: Select “**Yes, I want to restart this computer now**” and click **Finish**.

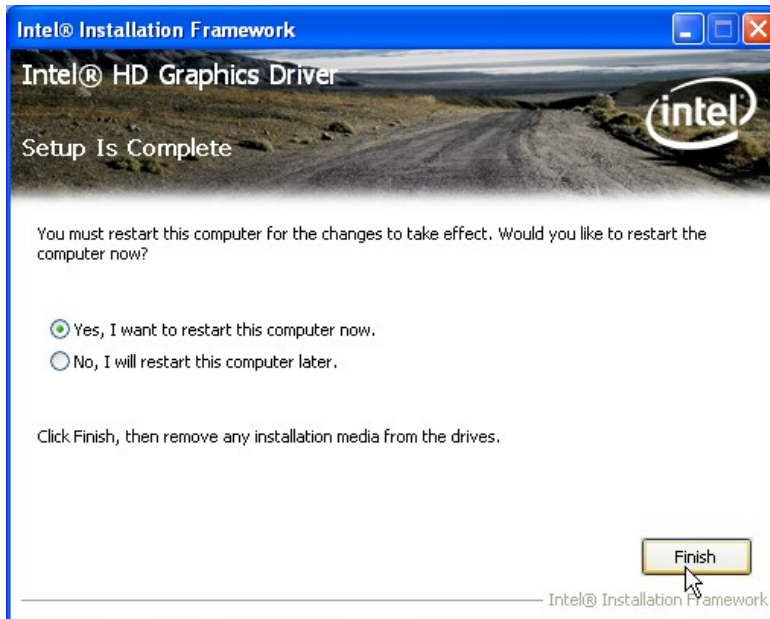

Figure 6-11: Graphics Driver Installation Finish Screen

NANO-QM770 EPIC SBC

6.5 LAN Driver Installation

Step 1: Right-click the Computer button from the start menu and select **Properties**.

(Figure 6-12).

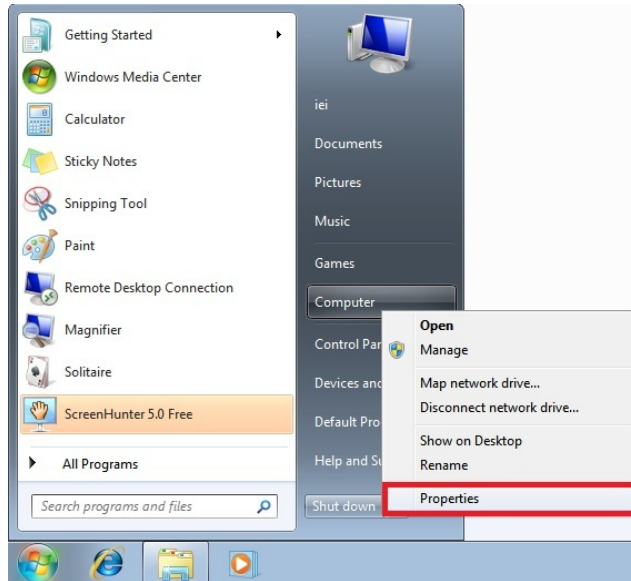

Figure 6-12: Windows Control Panel

Step 2: The system control panel window in Figure 6-13 appears.

Step 3: Click the Device Manager link (Figure 6-13).

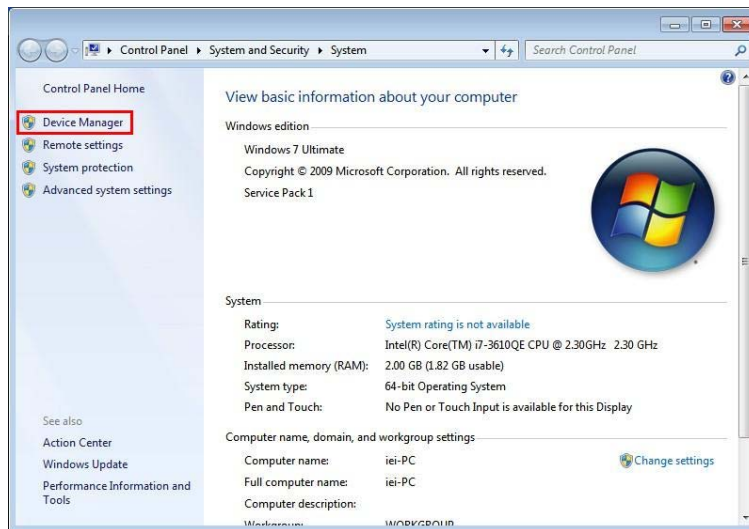

Figure 6-13: System Control Panel

Step 4: A list of system hardware devices appears (**Figure 6-14**).

Step 5: Right-click the Ethernet Controller that has question marks next to it (this means Windows does not recognize the device).

Step 6: Select **Update Driver Software**.

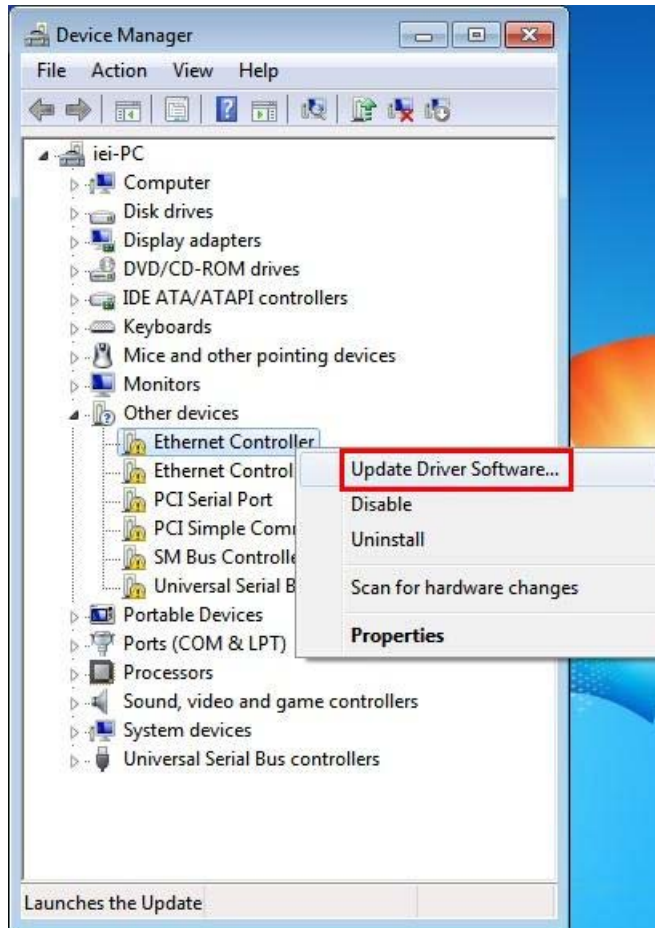

Figure 6-14: Device Manager List

Step 7: The Update Driver Software Window appears (**Figure 6-15**).

NANO-QM770 EPIC SBC

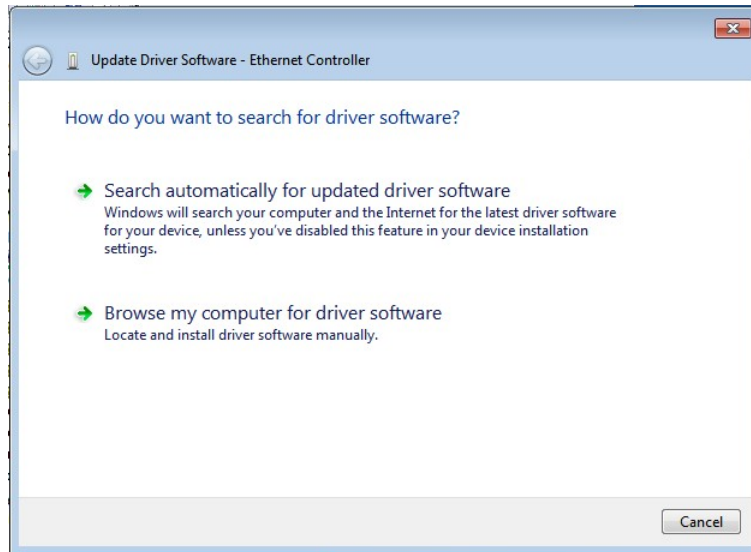

Figure 6-15: Update Driver Software Window

Step 8: Select “Browse my computer for driver software” and click **NEXT** to continue.

Step 9: Click Browse to select “X:\3-LAN” directory in the **Locate File** window, where “X:\” is the system CD drive. (Figure 6-16).

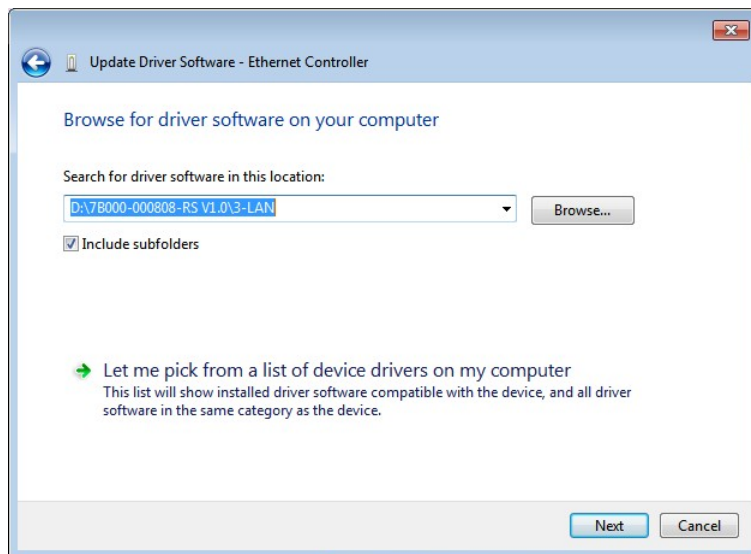

Figure 6-16: Locate Driver Files

Step 10: Click **NEXT** to continue.

Step 11: Driver Installation is performed as shown in Figure 6-17.

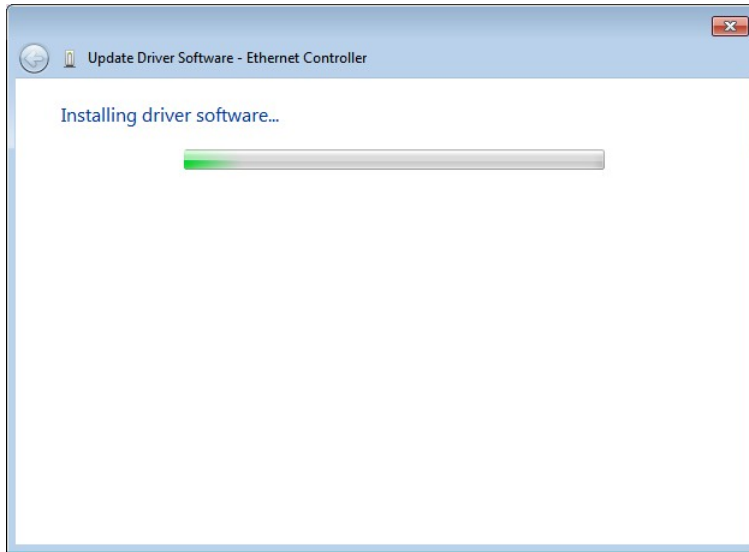

Figure 6-17: LAN Driver Installation

Step 12: The **Finish** screen in **Figure 6-18** appears. Click **Close** to exit.

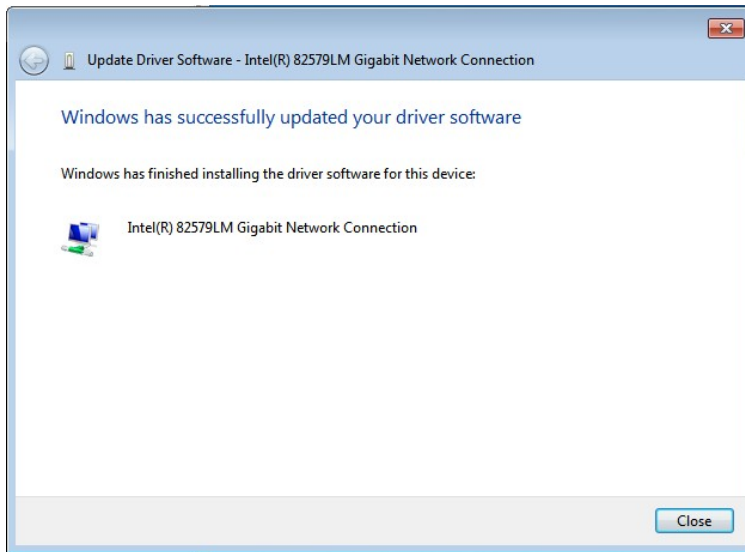

Figure 6-18: LAN Driver Installation Complete

6.6 Audio Driver Installation

To install the audio driver, please do the following.

Step 1: Access the driver list. (See **Section 6.2**)

NANO-QM770 EPIC SBC

Step 2: Click “**Audio**” and select the folder which corresponds to the operating system.

Step 3: Double click the setup file.

Step 4: The **InstallShield Wizard** is prepared to guide the user through the rest of the process.

Step 5: Once initialized, the **InstallShield Wizard** welcome screen appears (Figure 6-19).

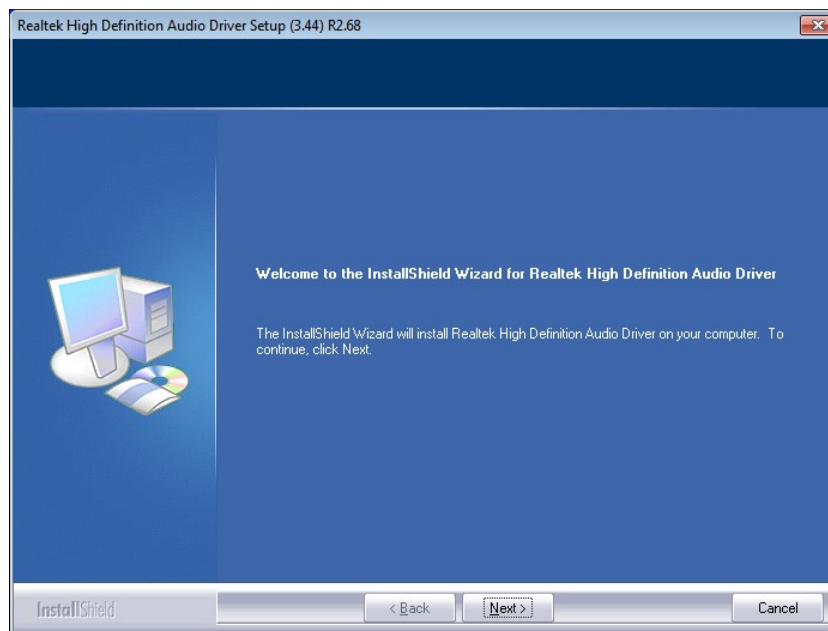

Figure 6-19: InstallShield Wizard Welcome Screen

Step 6: Click **NEXT** to continue the installation.

Step 7: InstallShield starts to install the new software as shown in **Figure 6-20**.

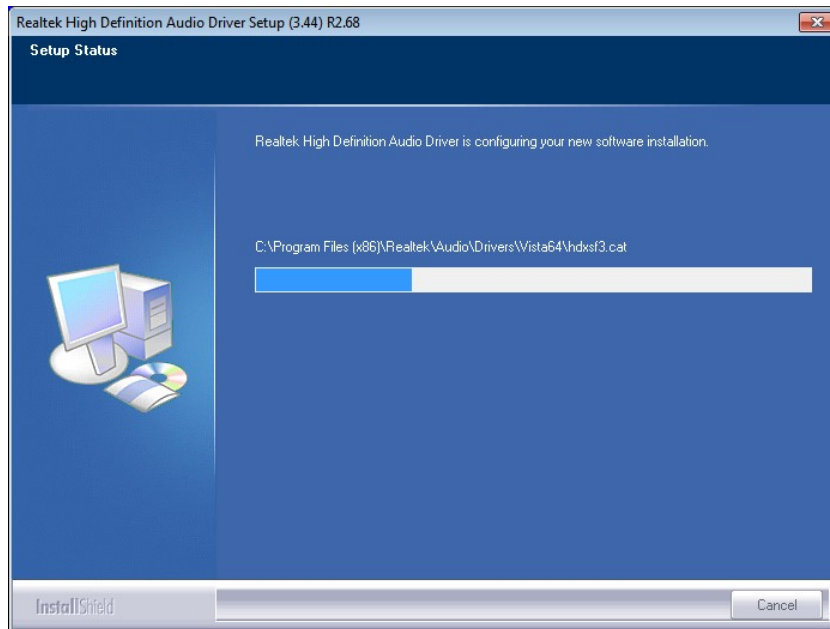

Figure 6-20: Audio Driver Software Configuration

Step 8: After the driver installation process is complete, a confirmation screen appears (Figure 6-21).

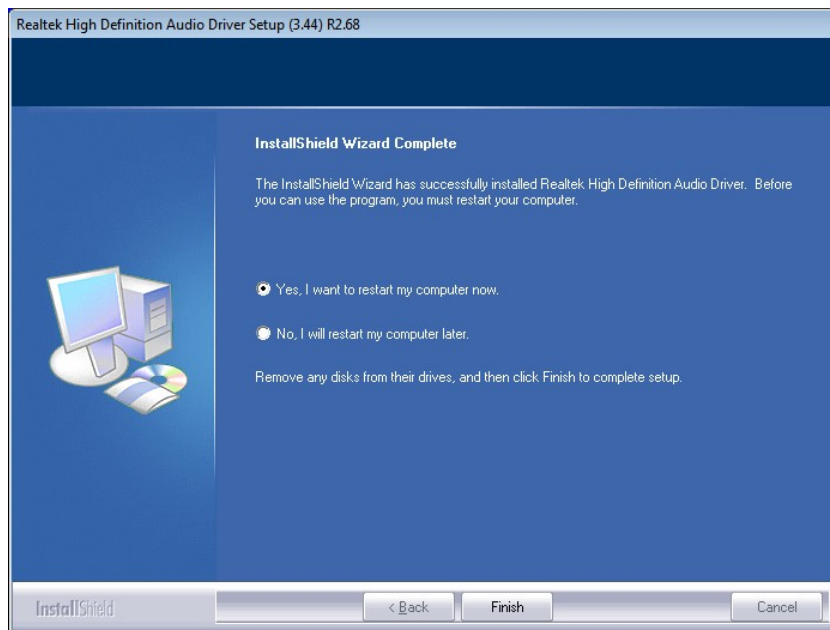

Figure 6-21: Restart the Computer

NANO-QM770 EPIC SBC

Step 9: The confirmation screen offers the option of restarting the computer now or later. For the settings to take effect, the computer must be restarted. Click **FINISH** to restart the computer.

6.7 Intel® Rapid Storage Technology Driver Installation

To install the Intel® Rapid Storage Technology driver, please do the following.

Step 1: Access the driver list. (See **Section 6.2**)

Step 2: Click “**SATA**”.

Step 3: Locate the setup file and double click on it.

Step 4: The **Welcome Screen** in **Figure 6-22** appears.

Step 5: Click **Next** to continue.

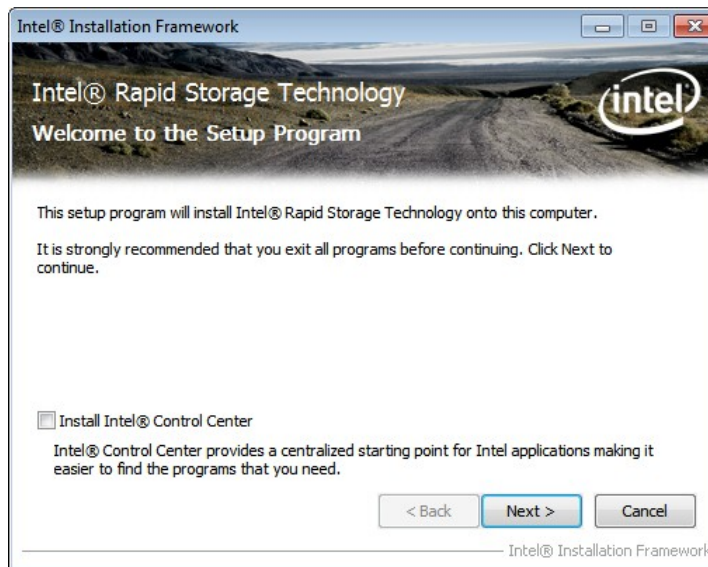

Figure 6-22: SATA RAID Driver Welcome Screen

Step 6: The license agreement in **Figure 6-23** appears.

Step 7: Read the **License Agreement**.

Step 8: Click **Yes** to continue.

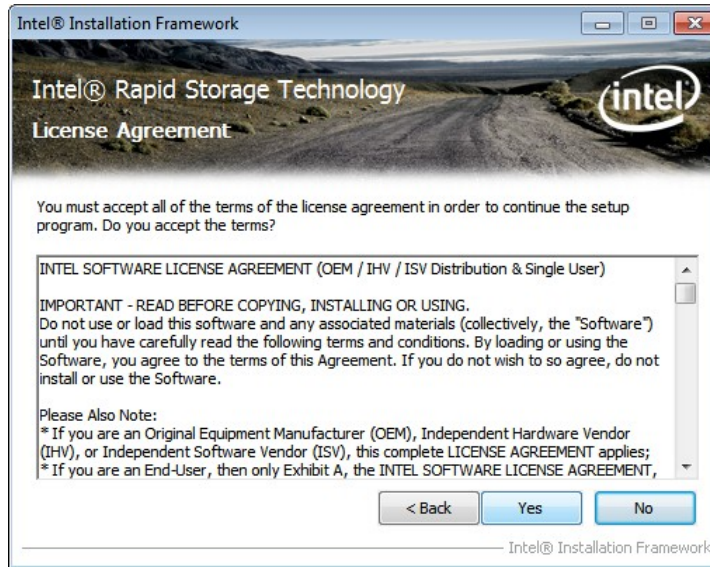

Figure 6-23: SATA RAID Driver License Agreement

Step 9: The **Read Me** file in **Figure 6-24** appears.

Step 10: Click **Next** to continue.

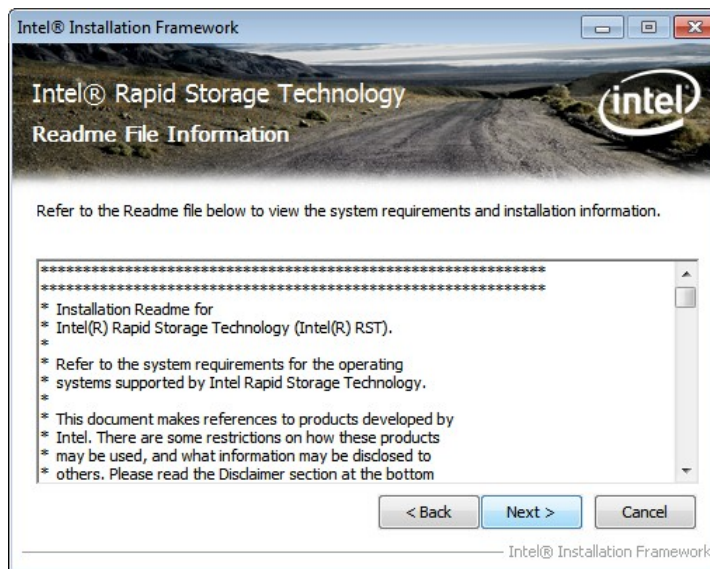

Figure 6-24: SATA RAID Driver Read Me File

Step 11: **Setup Operations** are performed as shown in **Figure 6-25**.

Step 12: Once the **Setup Operations** are complete, click **Next** to continue.

NANO-QM770 EPIC SBC

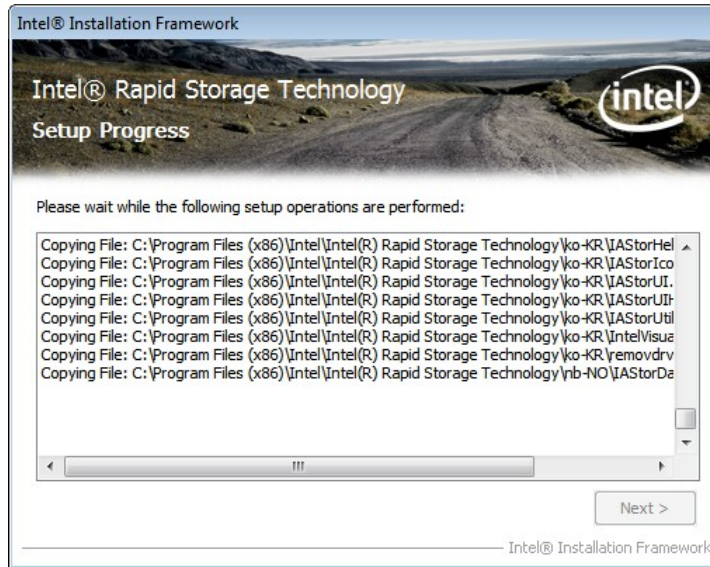

Figure 6-25: SATA RAID Driver Setup Operations

Step 13: The **Finish** screen in Figure 6-26 appears.

Step 14: Select “**Yes, I want to restart this computer now**” and click **Finish**.

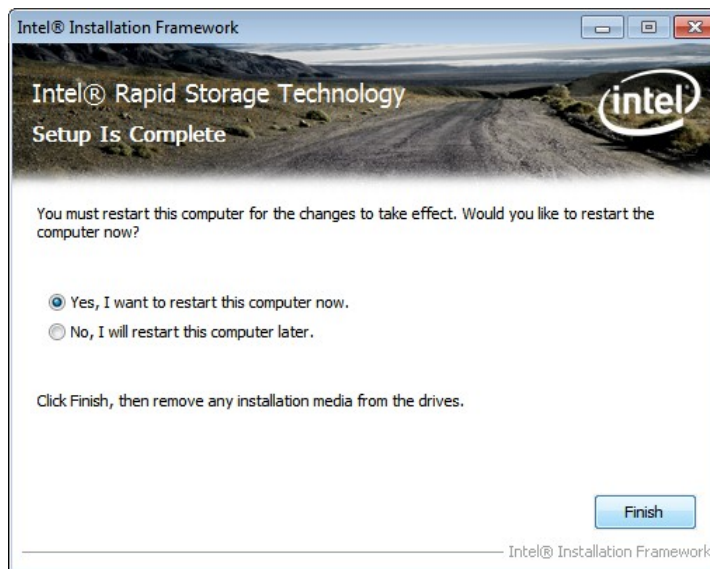

Figure 6-26: SATA RAID Driver Installation Finish Screen

6.8 USB 3.0 Driver Installation



WARNING:

Do not run this driver's installer (Setup.exe) from a USB storage device (ie. external USB hard drive or USB thumb drive). For proper installation, please copy driver files to a local hard drive folder and run from there.

To install the touch panel software driver, please follow the steps below.

- Step 1:** Access the driver list. (See **Section 6.2**)
- Step 2:** Click “**USB 3.0**”.
- Step 3:** Locate the setup file and double click on it.
- Step 4:** The **Welcome Screen** in **Figure 6-27** appears.
- Step 5:** Click **Next** to continue.



Figure 6-27: USB 3.0 Driver Welcome Screen

- Step 6:** The license agreement in **Figure 6-28** appears.

NANO-QM770 EPIC SBC

Step 7: Read the **License Agreement**.

Step 8: Click **Yes** to continue.



Figure 6-28: USB 3.0 Driver License Agreement

Step 9: The **Read Me** file in **Figure 6-29** appears.

Step 10: Click **Next** to continue.



Figure 6-29: USB 3.0 Driver Read Me File

Step 11: Setup Operations are performed as shown in Figure 6-30.

Step 12: Once the Setup Operations are complete, click **Next** to continue.

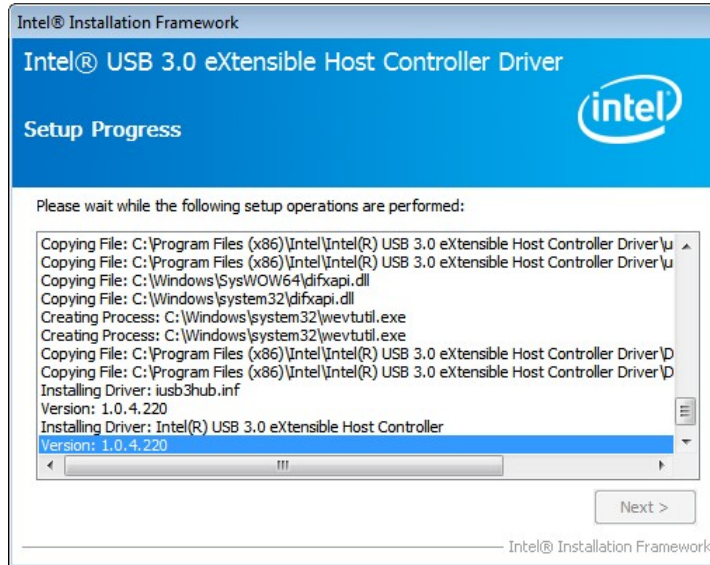

Figure 6-30: USB 3.0 Driver Setup Operations

Step 13: The Finish screen in Figure 6-31 appears.

Step 14: Select “Yes, I want to restart this computer now” and click **Finish**.



Figure 6-31: USB 3.0 Driver Installation Finish Screen

6.9 Intel® AMT Driver Installation

The package of the Intel® AMT components includes

- Intel® Management Engine Interface (Intel® ME Interface)
- Intel® Dynamic Application Loader
- Intel® Identity Protection Technology (Intel® IPT)
- Serial Over LAN (SOL)
- Intel® Manageability Engine Firmware Recovery Agent
- Intel® Management and Security Status
- Local Management Service (LMS)
- User Notification Service (UNS)

To install these Intel® AMT components, please do the following.

Step 1: Access the driver list. (See **Section 6.2**)

Step 2: Click “**iAMT**”.

Step 3: Locate the setup file and double click it.

Step 4: When the setup files are completely extracted the **Welcome Screen** in **Figure 6-32** appears.

Step 5: Click **Next** to continue.



Figure 6-32: Intel® ME Driver Welcome Screen

Step 6: The license agreement in **Figure 6-33** appears.

Step 7: Read the **License Agreement**.

Step 8: Click **Yes** to continue.

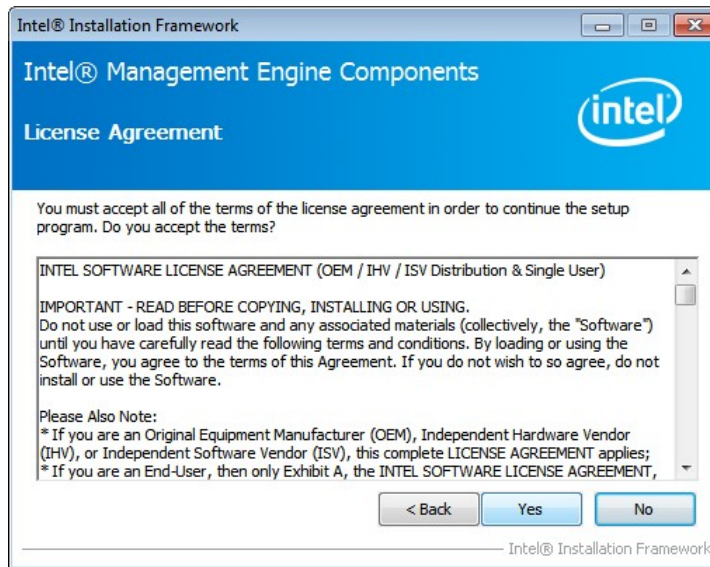

Figure 6-33: Intel® ME Driver License Agreement

Step 9: **Setup Operations** are performed as shown in **Figure 6-34**.

Step 10: Once the **Setup Operations** are complete, click **Next** to continue.

NANO-QM770 EPIC SBC

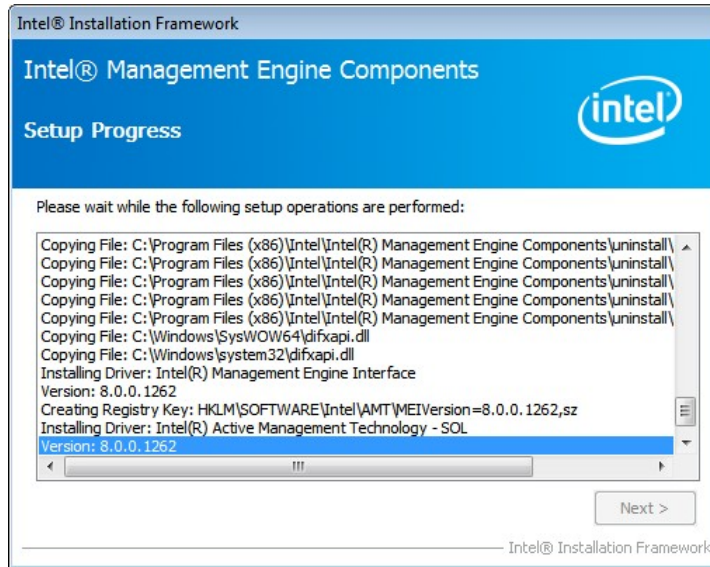

Figure 6-34: Intel® ME Driver Setup Operations

Step 11: The **Finish** screen in Figure 6-35 appears.

Step 12: Select “**Yes, I want to restart this computer now**” and click **Finish**.

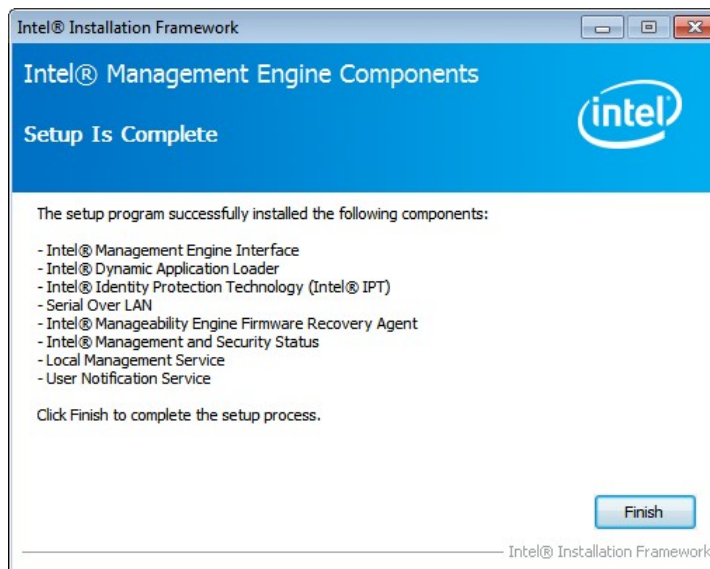

Figure 6-35: Intel® ME Driver Installation Finish Screen

Appendix

A

Regulatory Compliance

DECLARATION OF CONFORMITY



This equipment has been tested and found to comply with specifications for CE marking. If the user modifies and/or installs other devices in the equipment, the CE conformity declaration may no longer apply.

FCC WARNING



This equipment complies with Part 15 of the FCC Rules. Operation is subject to the following two conditions:

- This device may not cause harmful interference, and
- This device must accept any interference received, including interference that may cause undesired operation.

This equipment has been tested and found to comply with the limits for a Class A digital device, pursuant to part 15 of the FCC Rules. These limits are designed to provide reasonable protection against harmful interference when the equipment is operated in a commercial environment. This equipment generates, uses, and can radiate radio frequency energy and, if not installed and used in accordance with the instruction manual, may cause harmful interference to radio communications. Operation of this equipment in a residential area is likely to cause harmful interference in which case the user will be required to correct the interference at his own expense.

Appendix

B

BIOS Options

NANO-QM770 EPIC SBC

Below is a list of BIOS configuration options in the BIOS chapter.

BIOS Information	61
System Date [xx/xx/xx]	62
System Time [xx:xx:xx]	62
ACPI Sleep State [S1 only (CPU Stop Clock)]	63
Wake System with Fixed Time [Disabled]	64
Security Device Support [Disable]	66
Hyper Threading [Enabled]	67
Intel Virtualization Technology [Disabled]	67
SATA Mode Selection [AHCI]	68
Hot Plug [Disabled]	68
Intel(R) Rapid Start Technology [Disabled]	69
Intel AMT [Enabled]	71
Unconfigure ME [Disabled]	71
USB Devices	72
Legacy USB Support [Enabled]	72
Serial Port [Enabled]	73
Change Settings [Auto]	73
Serial Port [Enabled]	74
Change Settings [Auto]	74
Serial Port [Enabled]	75
Change Settings [Auto]	75
PC Health Status	76
CPU_FAN1 Smart Fan Control [Auto Duty-Cycle Mode]	77
SYS_FAN1 Smart Fan Control [Auto Duty-Cycle Mode]	78
Temperature n	78
Console Redirection [Disabled]	79
Auto Recovery Function [Disabled]	79
Azalia [Auto]	81
Azalia internal HDMI codec [Enabled]	81
Restore AC Power Loss [Last State]	82
Power Saving Function [Disabled]	82
VT-d [Enabled]	83
Primary Display [IGFX]	84

PEG0 – Gen X [Gen1].....	84
DVMT Pre-Allocated [128MB].....	84
DVMT Total Gfx Mem [MAX].....	85
Primary IGFX Boot Display [VBIOS Default]	85
LCD Panel Type [By Hardware]	85
Backlight Control [Inverted].....	86
Bootup NumLock State [On].....	88
Quiet Boot [Enabled]	88
Fast Boot [Disabled]	88
Option ROM Messages [Force BIOS].....	89
Launch PXE OpROM [Disabled]	89
UEFI Boot [Disabled]	89
Administrator Password	90
User Password	90
Save Changes and Reset	91
Discard Changes and Reset	91
Restore Defaults	91
Save as User Defaults	91
Restore User Defaults	91

Appendix

C

Terminology

AC '97	Audio Codec 97 (AC'97) refers to a codec standard developed by Intel® in 1997.
ACPI	Advanced Configuration and Power Interface (ACPI) is an OS-directed configuration, power management, and thermal management interface.
AHCI	Advanced Host Controller Interface (AHCI) is a SATA Host controller register-level interface.
ATA	The Advanced Technology Attachment (ATA) interface connects storage devices including hard disks and CD-ROM drives to a computer.
ARMD	An ATAPI Removable Media Device (ARMD) is any ATAPI device that supports removable media, besides CD and DVD drives.
ASKIR	Amplitude Shift Keyed Infrared (ASKIR) is a form of modulation that represents a digital signal by varying the amplitude (“volume”) of the signal. A low amplitude signal represents a binary 0, while a high amplitude signal represents a binary 1.
BIOS	The Basic Input/Output System (BIOS) is firmware that is first run when the computer is turned on and can be configured by the end user
CODEC	The Compressor-Decompressor (CODEC) encodes and decodes digital audio data on the system.
CompactFlash®	CompactFlash® is a solid-state storage device. CompactFlash® devices use flash memory in a standard size enclosure. Type II is thicker than Type I, but a Type II slot can support both types.
CMOS	Complimentary metal-oxide-conductor is an integrated circuit used in chips like static RAM and microprocessors.
COM	COM refers to serial ports. Serial ports offer serial communication to expansion devices. The serial port on a personal computer is usually a male D-sub 9 connector.
DAC	The Digital-to-Analog Converter (DAC) converts digital signals to analog signals.
DDR	Double Data Rate refers to a data bus transferring data on both the rising and falling edges of the clock signal.

NANO-QM770 EPIC SBC

DMA	Direct Memory Access (DMA) enables some peripheral devices to bypass the system processor and communicate directly with the system memory.
DIMM	Dual Inline Memory Modules are a type of RAM that offer a 64-bit data bus and have separate electrical contacts on each side of the module.
DIO	The digital inputs and digital outputs are general control signals that control the on/off circuit of external devices or TTL devices. Data can be read or written to the selected address to enable the DIO functions.
EHCI	The Enhanced Host Controller Interface (EHCI) specification is a register-level interface description for USB 2.0 Host Controllers.
EIDE	Enhanced IDE (EIDE) is a newer IDE interface standard that has data transfer rates between 4.0 MBps and 16.6 MBps.
EIST	Enhanced Intel® SpeedStep Technology (EIST) allows users to modify the power consumption levels and processor performance through application software. The application software changes the bus-to-core frequency ratio and the processor core voltage.
FSB	The Front Side Bus (FSB) is the bi-directional communication channel between the processor and the Northbridge chipset.
GbE	Gigabit Ethernet (GbE) is an Ethernet version that transfers data at 1.0 Gbps and complies with the IEEE 802.3-2005 standard.
GPIO	General purpose input
HDD	Hard disk drive (HDD) is a type of magnetic, non-volatile computer storage device that stores digitally encoded data.
ICH	The Input/Output Control Hub (ICH) is an Intel® Southbridge chipset.
IrDA	Infrared Data Association (IrDA) specify infrared data transmission protocols used to enable electronic devices to wirelessly communicate with each other.
L1 Cache	The Level 1 Cache (L1 Cache) is a small memory cache built into the system processor.
L2 Cache	The Level 2 Cache (L2 Cache) is an external processor memory cache.

LCD	Liquid crystal display (LCD) is a flat, low-power display device that consists of two polarizing plates with a liquid crystal panel in between.
LVDS	Low-voltage differential signaling (LVDS) is a dual-wire, high-speed differential electrical signaling system commonly used to connect LCD displays to a computer.
POST	The Power-on Self Test (POST) is the pre-boot actions the system performs when the system is turned-on.
RAM	Random Access Memory (RAM) is volatile memory that loses data when power is lost. RAM has very fast data transfer rates compared to other storage like hard drives.
SATA	Serial ATA (SATA) is a serial communications bus designed for data transfers between storage devices and the computer chipsets. The SATA bus has transfer speeds up to 1.5 Gbps and the SATA II bus has data transfer speeds of up to 3.0 Gbps.
S.M.A.R.T	Self Monitoring Analysis and Reporting Technology (S.M.A.R.T) refers to automatic status checking technology implemented on hard disk drives.
UART	Universal Asynchronous Receiver-transmitter (UART) is responsible for asynchronous communications on the system and manages the system's serial communication (COM) ports.
UHCI	The Universal Host Controller Interface (UHCI) specification is a register-level interface description for USB 1.1 Host Controllers.
USB	The Universal Serial Bus (USB) is an external bus standard for interfacing devices. USB 1.1 supports 12Mbps data transfer rates and USB 2.0 supports 480Mbps data transfer rates.
VGA	The Video Graphics Array (VGA) is a graphics display system developed by IBM.

Appendix

D

Digital I/O Interface

D.1 Introduction

The DIO connector on the NANO-QM770 is interfaced to GPIO ports on the Super I/O chipset. The DIO has both 4-bit digital inputs and 4-bit digital outputs. The digital inputs and digital outputs are generally control signals that control the on/off circuit of external devices or TTL devices. Data can be read or written to the selected address to enable the DIO functions.



NOTE:

For further information, please refer to the datasheet for the Super I/O chipset.

The BIOS interrupt call **INT 15H** controls the digital I/O.

INT 15H:

AH – 6FH	
<u>Sub-function:</u>	
AL – 8	: Set the digital port as INPUT
AL	: Digital I/O input value

NANO-QM770 EPIC SBC

D.2 Assembly Language Sample 1

```

MOV     AX, 6F08H      ;setting the digital port as input
INT     15H           ;

```

AL low byte = value

AH – 6FH
<u>Sub-function:</u>
AL – 9 : Set the digital port as OUTPUT
BL : Digital I/O input value

D.3 Assembly Language Sample 2

```

MOV     AX, 6F09H      ;setting the digital port as output
MOV     BL, 09H        ;digital value is 09H
INT     15H           ;

```

Digital Output is 1001b

Appendix

E

Hazardous Materials Disclosure

E.1 Hazardous Materials Disclosure Table for IPB Products Certified as RoHS Compliant Under 2002/95/EC Without Mercury

The details provided in this appendix are to ensure that the product is compliant with the Peoples Republic of China (China) RoHS standards. The table below acknowledges the presences of small quantities of certain materials in the product, and is applicable to China RoHS only.

A label will be placed on each product to indicate the estimated “Environmentally Friendly Use Period” (EFUP). This is an estimate of the number of years that these substances would “not leak out or undergo abrupt change.” This product may contain replaceable sub-assemblies/components which have a shorter EFUP such as batteries and lamps. These components will be separately marked.

Please refer to the table on the next page.

Part Name	Toxic or Hazardous Substances and Elements					
	Lead (Pb)	Mercury (Hg)	Cadmium (Cd)	Hexavalent Chromium (CR(VI))	Polybrominated Biphenyls (PBB)	Polybrominated Diphenyl Ethers (PBDE)
Housing	<input type="radio"/>	<input type="radio"/>	<input type="radio"/>	<input type="radio"/>	<input type="radio"/>	<input type="radio"/>
Display	<input type="radio"/>	<input type="radio"/>	<input type="radio"/>	<input type="radio"/>	<input type="radio"/>	<input type="radio"/>
Printed Circuit Board	<input type="radio"/>	<input type="radio"/>	<input type="radio"/>	<input type="radio"/>	<input type="radio"/>	<input type="radio"/>
Metal Fasteners	<input type="radio"/>	<input type="radio"/>	<input type="radio"/>	<input type="radio"/>	<input type="radio"/>	<input type="radio"/>
Cable Assembly	<input type="radio"/>	<input type="radio"/>	<input type="radio"/>	<input type="radio"/>	<input type="radio"/>	<input type="radio"/>
Fan Assembly	<input type="radio"/>	<input type="radio"/>	<input type="radio"/>	<input type="radio"/>	<input type="radio"/>	<input type="radio"/>
Power Supply Assemblies	<input type="radio"/>	<input type="radio"/>	<input type="radio"/>	<input type="radio"/>	<input type="radio"/>	<input type="radio"/>
Battery	<input type="radio"/>	<input type="radio"/>	<input type="radio"/>	<input type="radio"/>	<input type="radio"/>	<input type="radio"/>

O: This toxic or hazardous substance is contained in all of the homogeneous materials for the part is below the limit requirement in SJ/T11363-2006

X: This toxic or hazardous substance is contained in at least one of the homogeneous materials for this part is above the limit requirement in SJ/T11363-2006

NANO-QM770 EPIC SBC

此附件旨在确保本产品符合中国 RoHS 标准。以下表格标示此产品中某有毒物质的含量符合中国 RoHS 标准规定的限量要求。

本产品上会附有“环境友好使用期限”的标签，此期限是估算这些物质“不会有泄漏或突变”的年限。本产品可能包含有较短的环境友好使用期限的可替换元件，像是电池或灯管，这些元件将会单独标示出来。

部件名称	有毒有害物质或元素					
	铅 (Pb)	汞 (Hg)	镉 (Cd)	六价铬 (CR(VI))	多溴联苯 (PBB)	多溴二苯 醚 (PBDE)
壳体	○	○	○	○	○	○
显示	○	○	○	○	○	○
印刷电路板	○	○	○	○	○	○
金属螺帽	○	○	○	○	○	○
电缆组装	○	○	○	○	○	○
风扇组装	○	○	○	○	○	○
电力供应组装	○	○	○	○	○	○
电池	○	○	○	○	○	○

○: 表示该有毒有害物质在该部件所有物质材料中的含量均在 SJ/T11363-2006 标准规定的限量要求以下。
X: 表示该有毒有害物质至少在该部件的某一均质材料中的含量超出 SJ/T11363-2006 标准规定的限量要求。