



MODEL:
AFL2-12A-D525

**Fanless Flat Bezel Panel PC with 1.8 GHz Intel® Atom™ Processor
TFT LCD, Wi-Fi, Touch Screen, RFID Reader, Dual GbE LAN
RS-232/422/485, Camera, RoHS**

User Manual

Revision

Date	Version	Changes
25 July, 2013	1.02	Added information of the CPU temperature alert LED in Section 1.2.1.1
9 December, 2011	1.01	Added Warning page IV Revised Section 1.4 System Specifications Revised Section 3.1.1 Packing List Added Section 4.9.2 Stand Mounting Updated Section 4.10.2.1 DB-9 Serial Port Connection Updated Section 4.10.2.2 RJ-45 Serial Port Connection Updated Section 4.10.3 RS-422/485 Serial Port Added Section A.1.3 Product Disposal Updated Appendix C: One Key Recovery to Version 1.3
16 September, 2011	1.00	Initial release

Copyright

COPYRIGHT NOTICE

The information in this document is subject to change without prior notice in order to improve reliability, design and function and does not represent a commitment on the part of the manufacturer.

In no event will the manufacturer be liable for direct, indirect, special, incidental, or consequential damages arising out of the use or inability to use the product or documentation, even if advised of the possibility of such damages.

This document contains proprietary information protected by copyright. All rights are reserved. No part of this manual may be reproduced by any mechanical, electronic, or other means in any form without prior written permission of the manufacturer.

TRADEMARKS

All registered trademarks and product names mentioned herein are used for identification purposes only and may be trademarks and/or registered trademarks of their respective owners.

**WARNING:**

This equipment has been tested and found to comply with the limits for a Class A digital device, pursuant to Part 15 of the FCC Rules. These limits are designed to provide reasonable protection against harmful interference in a residential installation. This equipment generates, uses and can radiate radio frequency energy and, if not installed and used in accordance with the instructions, may cause harmful interference to radio communications. However, there is no guarantee that interference will not occur in a particular installation. If this equipment does cause harmful interference to radio or television reception, which can be determined by turning the equipment off and on, the user is encouraged to try to correct the interference by one or more of the following measures:

- Reorient or relocate the receiving antenna.
- Increase the separation between the equipment and receiver.
- Connect the equipment into an outlet on a circuit different from that to which the receiver is connected.
- Consult the dealer or an experienced radio/TV technician for help.

FCC Caution: Any changes or modifications not expressly approved by the party responsible for compliance could void the user's authority to operate this equipment.

This device and its antenna(s) must not be co-located or operating in conjunction with any other antenna or transmitter.

IMPORTANT NOTE:

For products available in the USA/Canada market, only channel 1~11 can be operated. Selection of other channels is not possible.

This device complies with Part 15 of the FCC Rules. Operation is subject to the following two conditions: (1) This device may not cause harmful interference, and (2) this device must accept any interference received, including interference that may cause undesired operation.

Table of Contents

1 INTRODUCTION.....	15
1.1 AFL2-12A-D525 FLAT BEZEL PANEL PC OVERVIEW	16
1.1.1 Model Variations	16
1.1.2 Features	17
1.1.3 Applications	17
1.2 EXTERNAL OVERVIEW	18
1.2.1 Front Panel	18
1.2.1.1 LED Indicators	19
1.2.2 Rear Panel	21
1.2.3 I/O Interface Panel	22
1.2.4 Top Panel and Side Panels	23
1.3 INTERNAL OVERVIEW	24
1.4 SYSTEM SPECIFICATIONS	24
2 DETAILED SPECIFICATIONS	27
2.1 DIMENSIONS	28
2.2 INTEL® ATOM™ PROCESSOR	29
2.3 MOTHERBOARD COMPONENTS	29
2.3.1 Memory Support	30
2.3.1.1 Installed Memory	30
2.3.2 Storage Capacity	30
2.4 EXTERNAL PERIPHERAL INTERFACE CONNECTORS	30
2.4.1 Serial Port Connectors	30
2.4.2 LAN Connectivity	31
2.4.3 External USB Connectors	31
2.5 TOUCHSCREEN LCD	31
2.5.1 Monitor	31
2.5.2 Touch-Screen Module	32
2.6 AUDIO	32
2.6.1 Audio Codec Controller	32
2.6.2 Stereo Speakers	33

2.7 SYSTEM POWER	33
2.7.1 Power Mode	33
2.7.1.1 ATX Power Mode (Default).....	33
2.7.1.2 AT Power Mode	33
2.7.2 Power Adapter	34
3 UNPACKING	35
3.1 UNPACKING.....	36
3.1.1 Packing List	36
4 INSTALLATION	40
4.1 ANTI-STATIC PRECAUTIONS	41
4.2 INSTALLATION PRECAUTIONS	41
4.3 INSTALLATION AND CONFIGURATION STEPS	42
4.4 HDD INSTALLATION.....	42
4.5 CF CARD INSTALLATION	45
4.6 AT/ATX MODE SELECTION	47
4.6.1 AT Power Mode.....	47
4.6.2 ATX Power Mode	48
4.7 POWERING ON THE SYSTEM.....	48
4.8 POWERING OFF THE SYSTEM.....	48
4.9 MOUNTING THE SYSTEM	49
4.9.1 Wall Mounting.....	49
4.9.2 Stand Mounting	52
4.9.3 Arm Mounting	53
4.9.4 Cabinet and Rack Installation	54
4.10 BOTTOM PANEL CONNECTORS.....	56
4.10.1 LAN Connection.....	56
4.10.2 Serial Device Connection	57
4.10.2.1 DB-9 Serial Port Connection	57
4.10.2.2 RJ-45 Serial Port Connection.....	59
4.10.3 RS-422/485 Serial Port.....	61
4.10.4 USB Device Connection.....	62
5 SYSTEM MAINTENANCE	64
5.1 SYSTEM MAINTENANCE INTRODUCTION	65

AFL2-12A-D525 Series Panel PC

5.2 ANTI-STATIC PRECAUTIONS	65
5.3 TURN OFF THE POWER	66
5.4 OPENING THE SYSTEM.....	66
5.4.1 <i>Removing the Back Cover</i>	66
5.4.2 <i>Removing the Internal Aluminum Cover</i>	67
5.5 REPLACING COMPONENTS.....	68
5.5.1 <i>Memory Module Replacement</i>	68
5.5.2 <i>WLAN Card Replacement</i>	69
5.6 REINSTALLING THE COVERS	73
6 AMI BIOS SETUP	74
6.1 INTRODUCTION.....	75
6.1.1 <i>Starting Setup</i>	75
6.1.2 <i>Using Setup</i>	75
6.1.3 <i>Getting Help</i>	76
6.1.4 <i>Unable to Reboot After Configuration Changes</i>	76
6.1.5 <i>BIOS Menu Bar</i>	76
6.2 MAIN.....	77
6.3 ADVANCED	78
6.3.1 <i>ACPI Settings</i>	79
6.3.2 <i>CPU Configuration</i>	80
6.3.3 <i>IDE Configuration</i>	82
6.3.4 <i>USB Configuration</i>	83
6.3.5 <i>Super IO Configuration</i>	85
6.3.5.1 <i>Serial Port n Configuration</i>	85
6.3.6 <i>H/W Monitor</i>	88
6.3.7 <i>Serial Port Console Redirection</i>	89
6.4 iEi FEATURE	91
6.5 CHIPSET	92
6.5.1 <i>Host Bridge Configuration</i>	93
6.5.2 <i>South Bridge Configuration</i>	94
6.5.3 <i>Intel IGD SWSCI OpRegion</i>	96
6.6 BOOT.....	98
6.7 SECURITY	100
6.8 SAVE & EXIT	102

7 SOFTWARE DRIVERS	104
7.1 AVAILABLE SOFTWARE DRIVERS	105
7.2 STARTING THE DRIVER PROGRAM	105
7.3 CHIPSET DRIVER INSTALLATION.....	105
7.4 GRAPHICS DRIVER INSTALLATION.....	109
7.5 AUDIO DRIVER INSTALLATION	113
7.6 TOUCH SCREEN DRIVER.....	115
7.6.1 <i>Calibrating the Touch Screen</i>	119
7.7 AMCAP DRIVER INSTALLATION	121
A SAFETY PRECAUTIONS	124
A.1 SAFETY PRECAUTIONS	125
A.1.1 <i>General Safety Precautions</i>	125
A.1.2 <i>CPU Temperature Warning</i>	126
A.1.3 <i>Product Disposal</i>	126
A.1.4 <i>Anti-static Precautions</i>	127
A.1.5 <i>Product Disposal</i>	128
A.2 MAINTENANCE AND CLEANING PRECAUTIONS	128
A.2.1 <i>Maintenance and Cleaning</i>	128
A.2.2 <i>Cleaning Tools</i>	129
B BIOS CONFIGURATION OPTIONS.....	130
B.1 BIOS CONFIGURATION OPTIONS	131
C ONE KEY RECOVERY.....	133
C.1 ONE KEY RECOVERY INTRODUCTION	134
C.1.1 <i>System Requirement</i>	135
C.1.2 <i>Supported Operating System</i>	136
C.2 SETUP PROCEDURE FOR WINDOWS	137
C.2.1 <i>Hardware and BIOS Setup</i>	138
C.2.2 <i>Create Partitions</i>	138
C.2.3 <i>Install Operating System, Drivers and Applications</i>	142
C.2.4 <i>Building the Recovery Partition</i>	143
C.2.5 <i>Create Factory Default Image</i>	145
C.3 AUTO RECOVERY SETUP PROCEDURE	150

AFL2-12A-D525 Series Panel PC

C.4 SETUP PROCEDURE FOR LINUX	154
C.5 RECOVERY TOOL FUNCTIONS	158
<i>C.5.1 Factory Restore</i>	159
<i>C.5.2 Backup System</i>	160
<i>C.5.3 Restore Your Last Backup</i>	161
<i>C.5.4 Manual</i>	162
C.6 RESTORE SYSTEMS FROM A LINUX SERVER THROUGH LAN	163
<i>C.6.1 Configure DHCP Server Settings</i>	164
<i>C.6.2 Configure TFTP Settings</i>	165
<i>C.6.3 Configure One Key Recovery Server Settings</i>	166
<i>C.6.4 Start the DHCP, TFTP and HTTP</i>	167
<i>C.6.5 Create Shared Directory</i>	167
<i>C.6.6 Setup a Client System for Auto Recovery</i>	168
C.7 OTHER INFORMATION	171
<i>C.7.1 Using AHCI Mode or ALi M5283 / VIA VT6421A Controller</i>	171
<i>C.7.2 System Memory Requirement</i>	173
D WATCHDOG TIMER	174
E HAZARDOUS MATERIALS DISCLOSURE	177
E.1 HAZARDOUS MATERIAL DISCLOSURE TABLE FOR IPB PRODUCTS CERTIFIED AS ROHS COMPLIANT UNDER 2002/95/EC WITHOUT MERCURY	178

List of Figures

Figure 1-1: AFL2-12A-D525 Flat Bezel Panel PC	16
Figure 1-2: AFL2-12A-D525 Front View	18
Figure 1-3: LED Indicators	19
Figure 1-4: Function Keys	20
Figure 1-5: AFL2-12A-D525 Rear View	21
Figure 1-6: AFL2-12A-D525 I/O Interface Panel	23
Figure 1-7: Top Panel View	23
Figure 1-8: Side Panel Views.....	24
Figure 2-1: AFL2-12A-D525 Dimensions (mm)	28
Figure 2-2: AFL2-12A-D525 Dimensions (mm) cont.....	29
Figure 2-3: COM Ports.....	30
Figure 2-4: RJ-45 Ethernet Connectors.....	31
Figure 2-5: External USB Ports	31
Figure 2-6: LCD Screen	32
Figure 2-7: Audio Jack.....	32
Figure 4-1: HDD Cover Retention Screws.....	43
Figure4-2: HDD Bracket Screw.....	43
Figure4-3: Removing the HDD Bracket	44
Figure 4-4: Inserting the HDD.....	44
Figure4-5: Securing the HDD.....	45
Figure 4-6: HDD Cover Retention Screws.....	46
Figure4-7: CF Card Slot Location	46
Figure 4-8: Inserting the CF Card.....	47
Figure 4-9: AT/ATX Switch Location.....	47
Figure 4-10: Wall-mounting Bracket.....	50
Figure 4-11: Chassis Support Screws.....	51
Figure 4-12: Secure the Panel PC	52
Figure 4-13: Mounting screw location	52
Figure 4-14: Arm Mounting Retention Screw Holes.....	54
Figure 4-15: The Rack/Cabinet Bracket.....	55
Figure 4-16: Secure the Rack/Cabinet Bracket.....	55

AFL2-12A-D525 Series Panel PC

Figure 4-17: Install into a Rack/Cabinet	56
Figure 4-18: LAN Connection	57
Figure 4-19: DB-9 Connector.....	58
Figure 4-20: DB-9 Serial Port Connector.....	59
Figure 4-21: Ethernet Connector.....	60
Figure 4-22: RJ-45 Serial Port Connector	60
Figure 4-23: RS-422/485 Serial Port.....	61
Figure 4-24: RS-422/485 Cable	61
Figure 4-25: DB-9 Connector.....	62
Figure 4-26: USB Device Connection	63
Figure 5-1: Back Cover Retention Screws	67
Figure5-2: Internal Cover Retention Screws.....	68
Figure 5-3: DDR SO-DIMM Module Installation.....	69
Figure5-4: Removing the Antennas	70
Figure5-5: Releasing the WLAN Card.....	70
Figure5-6: Removing the WLAN card.....	71
Figure5-7: Attaching the Antennas.....	72
Figure 7-1: Chipset Driver Screen.....	106
Figure 7-2: Chipset Driver Welcome Screen.....	106
Figure 7-3: Chipset Driver License Agreement	107
Figure 7-4: Chipset Driver Read Me File	108
Figure 7-5: Chipset Driver Setup Operations	108
Figure 7-6: Chipset Driver Installation Finish Screen.....	109
Figure 7-7: Graphics Driver Read Me File	110
Figure 7-8: Graphics Driver Setup Files Extracted	110
Figure 7-9: Graphics Driver Welcome Screen	111
Figure 7-10: Graphics Driver License Agreement.....	111
Figure 7-11: Graphics Driver Read Me File	112
Figure 7-12: Graphics Driver Setup Operations	112
Figure 7-13: Graphics Driver Installation Finish Screen	113
Figure 7-14: Audio Driver Welcome Screen.....	114
Figure 7-15: Audio Driver Installation.....	114
Figure 7-16: AC'97 Driver Installation Complete	115
Figure 7-17: Touch Screen Driver Welcome Screen	116
Figure 7-18: Touch Screen Driver License Agreement.....	116

Figure 7-19: Touch Screen Driver Choose Install Location	117
Figure 7-20: Touch Screen Driver Installation Screen.....	118
Figure 7-21: Touch Screen Driver Update Complete	118
Figure 7-22: PenMount Monitor Icon	119
Figure 7-23: PenMount Monitor Popup Menu.....	119
Figure 7-24: Configuration Screen.....	120
Figure 7-25: Calibration Initiation Screen	120
Figure 7-26: Calibration Screen	121
Figure 7-27: AMCap Driver Welcome Screen	122
Figure 7-28: AMCap Driver Choose Install Location.....	122
Figure 7-29: AMCap Driver Installation Complete.....	123
Figure C-1: IEI One Key Recovery Tool Menu	134
Figure C-2: Launching the Recovery Tool	139
Figure C-3: Recovery Tool Setup Menu	139
Figure C-4: Command Prompt	140
Figure C-5: Partition Creation Commands.....	141
Figure C-6: Launching the Recovery Tool	143
Figure C-7: Manual Recovery Environment for Windows	143
Figure C-8: Building the Recovery Partition.....	144
Figure C-9: Press Any Key to Continue	144
Figure C-10: Press F3 to Boot into Recovery Mode.....	145
Figure C-11: Recovery Tool Menu	145
Figure C-12: About Symantec Ghost Window.....	146
Figure C-13: Symantec Ghost Path	146
Figure C-14: Select a Local Source Drive	147
Figure C-15: Select a Source Partition from Basic Drive	147
Figure C-16: File Name to Copy Image to	148
Figure C-17: Compress Image.....	148
Figure C-18: Image Creation Confirmation	149
Figure C-19: Image Creation Complete	149
Figure C-20: Image Creation Complete	149
Figure C-21: Press Any Key to Continue	150
Figure C-22: Auto Recovery Utility	151
Figure C-23: Launching the Recovery Tool.....	151
Figure C-24: Auto Recovery Environment for Windows	151

AFL2-12A-D525 Series Panel PC

Figure C-25: Building the Auto Recovery Partition.....	152
Figure C-26: Factory Default Image Confirmation	152
Figure C-27: Image Creation Complete	153
Figure C-28: Press any key to continue	153
Figure C-29: Partitions for Linux.....	155
Figure C-30: Manual Recovery Environment for Linux	156
Figure C-31: Access menu.lst in Linux (Text Mode).....	157
Figure C-32: Recovery Tool Menu	157
Figure C-33: Recovery Tool Main Menu	158
Figure C-34: Restore Factory Default.....	159
Figure C-35: Recovery Complete Window	160
Figure C-36: Backup System.....	160
Figure C-37: System Backup Complete Window	161
Figure C-38: Restore Backup	161
Figure C-39: Restore System Backup Complete Window	162
Figure C-40: Symantec Ghost Window	162

List of Tables

Table 1-1: AFL2-12A-D525 Model Variations	17
Table 1-2: LED Indicators	20
Table 1-3: Function Key Descriptions	21
Table 1-4: System Specifications.....	26
Table 4-1: DB-9 Connector Pinouts	58
Table 4-2: Ethernet Connector Pinouts.....	60
Table 4-3: RS-422/485 Serial Port Pinouts	61
Table 4-4: DB-9 Connector Pinouts	62
Table 6-1: BIOS Navigation Keys	76

Chapter

1

Introduction

1.1 AFL2-12A-D525 Flat Bezel Panel PC Overview



Figure 1-1: AFL2-12A-D525 Flat Bezel Panel PC

The AFL2-12A-D525 is an Intel® Atom™ powered flat bezel panel PC with a rich variety of functions and peripherals. The AFL2-12A-D525 is designed for easy and simplified integration into kiosk and point-of-sales (POS) applications.

An Intel® Atom™ D525 graphics memory controller hub (GMCH) coupled with an Intel® ICH8-M input/output controller hub ensures optimal memory, graphics, and peripheral I/O support. The system comes with 1.0 GB of preinstalled DDR3 SDRAM ensuring smooth data throughputs with reduced bottlenecks and fast system access.

Three serial ports and four external USB 2.0 ports ensure simplified connectivity to a variety of external peripheral devices. Wi-Fi capabilities and dual RJ-45 Ethernet connector provide the system with smooth connection to an external LAN. An optional MSR card reader can equip the system for scanning credit cards, identification cards, loyalty cards, gift cards, and more.

1.1.1 Model Variations

The model variations of the AFL2-12A-D525 Series are listed below.

AFL2-12A-D525 Series Panel PC

Model No.	Touch Screen Type	Optional Features
AFL2-12A-D525/PC-EM/1G-R10	Projective capacitive	EM card reader
AFL2-12A-D525/PC-MF/1G-R10	Projective capacitive	MIFARE card reader
AFL2-12A-D525/PC/1G-R10	Projective capacitive	N/A
AFL2-12A-D525/R-EM/1G-R10	5-Wire Resistive	EM card reader
AFL2-12A-D525/R-MF/1G-R10	5-Wire Resistive	MIFARE card reader
AFL2-12A-D525/R/1G-R10	5-Wire Resistive	N/A

Table 1-1: AFL2-12A-D525 Model Variations

1.1.2 Features

The AFL2-12A-D525 features are listed below:

- 12.1" 600 cd/m² XGA LCD
- Intel® Atom™ D525 processor
- Intel® ICH8M chipset
- 1.0 GB 800 MHz DDR3 SO-DIMM preinstalled (4 GB maximum)
- RFID module compatible with EM or MIFARE cards
- Watchdog timer that triggers a system reset if the system hangs for some reason
- IP 64 compliant front panel
- AT or ATX power mode
- 5-Wire Resistive or Projected Capacitive type touch screen
- RoHS compliance
- Auto-dimming control
- 1.3 megapixel webcam

1.1.3 Applications

AFL2-12A-D525 Series panel PCs are elegant, sophisticated systems that can be easily implemented in commercial, industrial and corporate environments.

1.2 External Overview

1.2.1 Front Panel

The front side of the AFL2-12A-D525 is a flat bezel panel TFT LCD screen surrounded by an ABS/PC plastic frame.

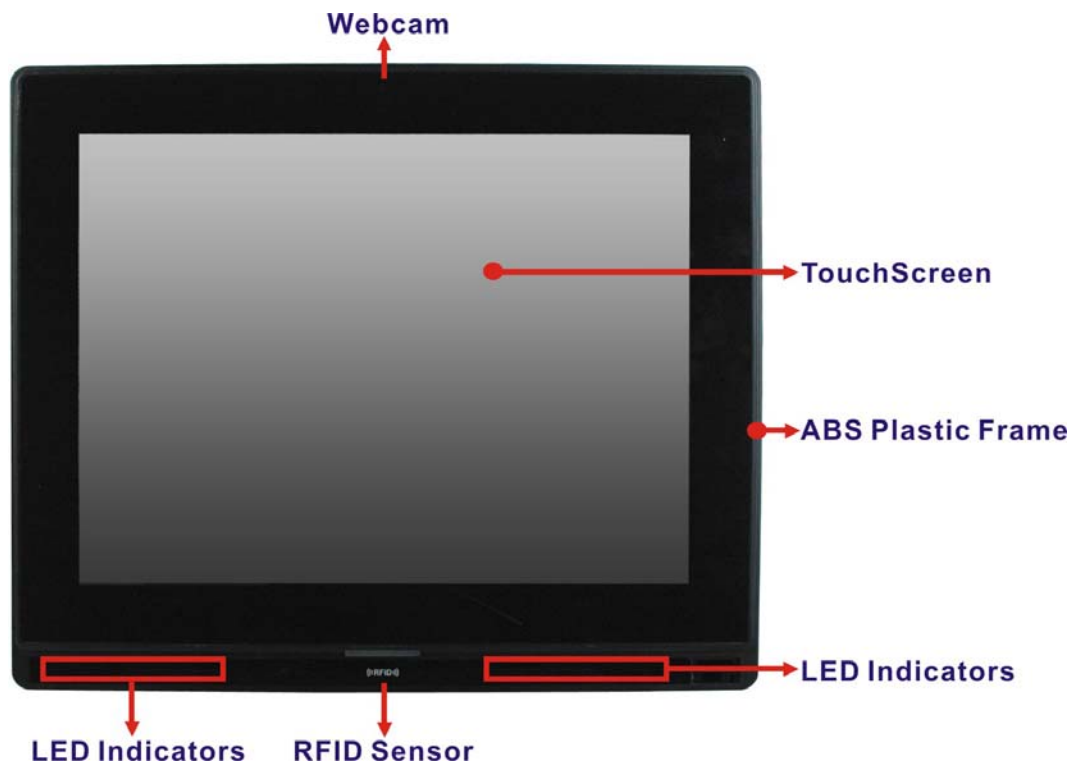

Figure 1-2: AFL2-12A-D525 Front View

AFL2-12A-D525 Series Panel PC

1.2.1.1 LED Indicators

There are fifteen LED indicator lights located along the front of the LCD screen (**Figure 1-3**).

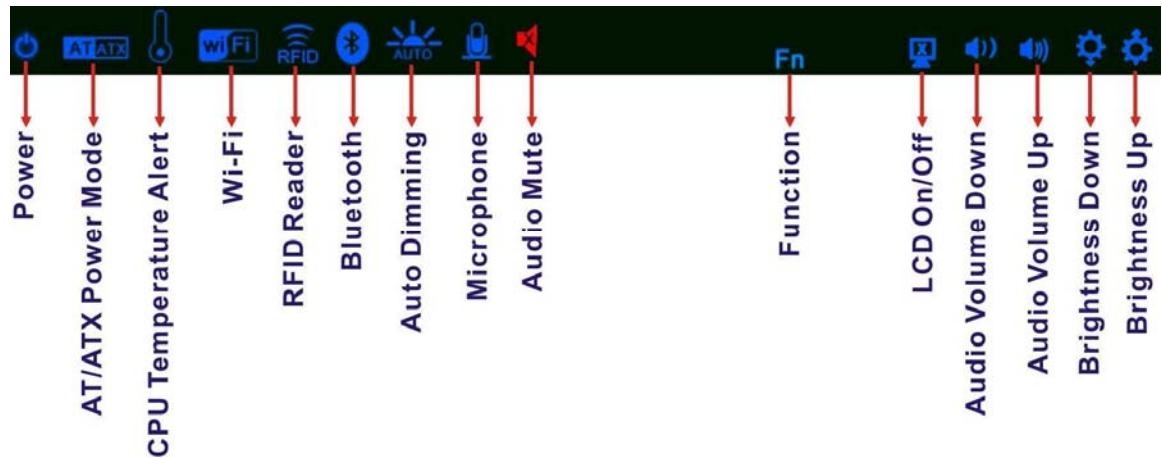

Figure 1-3: LED Indicators

The descriptions of each LED indicator are listed below.

LED Indicator	Description
Power	Shows power on/off status.
AT/ATX Mode	Shows the power mode status. Controlled by the AT/ATX power mode switch.
CPU Temperature Alert	BLUE: CPU temperature is normal. RED: CPU temperature is at or over 95°C.
Wi-Fi	The Wi-Fi module is enabled or disabled. Controlled by the BIOS. See Section 6.5.2
RFID	The optional RFID reader is enabled or disabled. Controlled by the hot keys. See Table 1-3
Bluetooth	The Bluetooth module is enabled or disabled. Controlled by the BIOS. See Section 6.5.2
Auto-Dimming	The auto-dimming function is enabled or disabled. Controlled by the remote control
Microphone	The microphone is enabled or disabled. Controlled by the BIOS. See Section 6.5.2

LED Indicator	Description
Audio Mute	Lights on when the audio is turned off. Controlled by the hot keys. See Table 1-3
Function	Shows the status of the function key below the LED indicator. Blinks when the corresponding button is pushed.
LCD On/Off	
Audio Volume Down	
Audio Volume Up	
Brightness Down	
Brightness Up	

Table 1-2: LED Indicators



NOTE:

When the CPU temperature is at or over 95°C, the CPU temperature alert LED shows in red. If the alert LED turns red, the user must lower the environment temperature or close some running applications to cool down the CPU.

The corresponding Function Keys are located under the bottom right hand corner of the LCD screen (**Figure 1-4**).

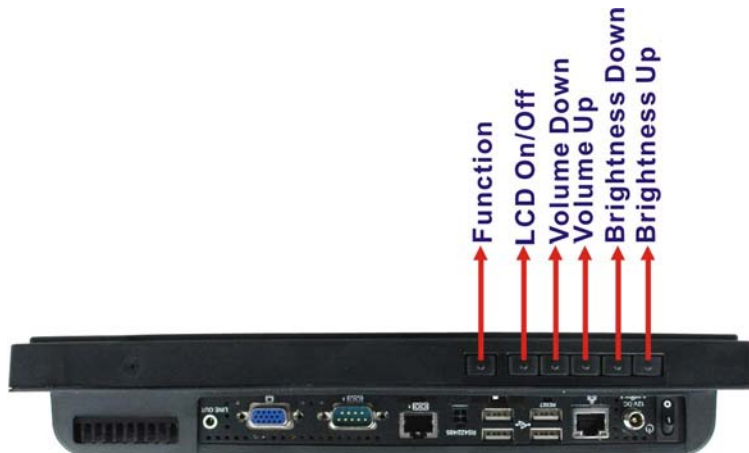

Figure 1-4: Function Keys

AFL2-12A-D525 Series Panel PC

The Function Keys are described in **Table 1-3**:

Key Combination	Function Key Description
Fn + LCD On/Off	RFID Enable/Disable
Fn + Audio Volume Down	Audio Mute
Fn + Audio Volume Up	Camera Enable/Disable
Fn + Brightness Down	Mini USB / MicroSD Enable/Disable
Fn + Brightness Up	Power On/Off Note: To power on the system, hold down the Fn + Brightness buttons for 3 seconds. To power down the system, hold down the FN + Brightness buttons for six seconds.

Table 1-3: Function Key Descriptions

1.2.2 Rear Panel

The rear panel provides access to retention screw holes that support the wall mounting. Refer to **Figure 1-5**.



Figure 1-5: AFL2-12A-D525 Rear View

1.2.3 I/O Interface Panel

The I/O interface panel located on the bottom of the AFL2-12A-D525 has the following features:

- 1 x Audio jack
- 1 x 9V ~ 36V DC-IN power jack
- 1 x VGA port
- 1 x RS-232 DB-9 connector
- 1 x RS-422/485 connector
- 2 x GbE connectors
- 4 x USB 2.0 connectors (MSR card reader connects to one of the USB ports)
- 1 x Power switch
- 1 x Reset button
- 1 x Clear CMOS switch
- 1 x AT/ATX Switch
- 6 x Function Keys

AFL2-12A-D525 Series Panel PC

The external I/O interface connector panel is shown in **Figure 1-6**.

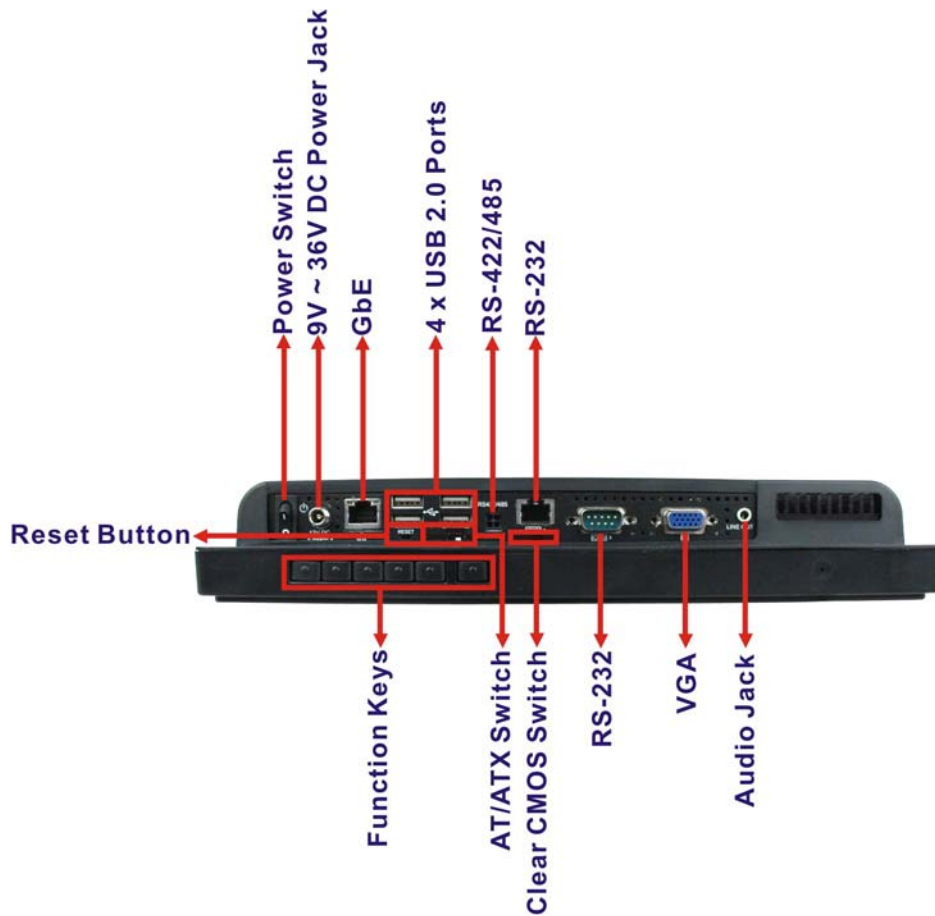

Figure 1-6: AFL2-12A-D525 I/O Interface Panel

1.2.4 Top Panel and Side Panels

The top panel and side panels of AFL2-12A-D525 provide access to slots that support the panel mount and rack mount (**Figure 1-7**).



Figure 1-7: Top Panel View



Figure 1-8: Side Panel Views

1.3 Internal Overview

The AFL2-12A-D525 has the following components installed internally:

- 1 x Motherboard
- 1 x 1.0 GB 800 MHz DDR3 SO-DIMM

1.4 System Specifications

The technical specifications for the AFL2-12A-D525 systems are listed in **Table 1-4.**

Specification	AFL2-12A-D525
LCD Size	12.1"
Max. Resolution	1024 (W) x 768 (H)
Brightness (cd/m ²)	600

AFL2-12A-D525 Series Panel PC

Contrast Ratio	700:1
LCD Color	16.2M
Pixel Pitch (H x V) (mm)	0.240 (H) x 0.240 (V)
Viewing Angle (H-V)	176 / 176
Backlight MTBF (hr)	50,000
Touch Screen	5-Wire resistive type touchscreen (select models only) Projected capacitive type touchscreen (select models only)
SBC Model	AFL2MB2-PV-D525
CPU	Intel® Atom™ D525 1.8 GHz Dual Core Processor
Chipset	Intel® ICH8M
Ethernet	Realtek RTL8111E PCIe GbE controller supports ASF2.0
Memory	One 204-pin DDR3 SO-DIMM slot pre-installed (4 GB system max.)
Expansion	One PCIe x1 slot One PCIe x1 slot for LAN card expansion
Drive Bay	One CF Type II socket One 2.5" SATA HDD bay One PCIe mini slot with SATA signal and IEI MiniDOM support
SSD	One 2.5" SATA SSD
Watchdog Timer	Software Programmable supports 1 sec. ~ 255 sec. system reset
Audio	AMP 1.5 W + 1.5 W (built-in stereo speakers)
Wi-Fi	Wi-Fi module 802.11 b/g/n
RFID	EM or MIFARE card reader
MSR Module	MSR card reader (Optional)
Construction Material	ABS + PC plastic front frame
Mounting	Wall Rack Stand Arm (VESA 100 mm x 100 mm)
Front Panel Color	Black
Net Weight	3.2 kg / 3.6 kg
Dimensions (W x H x D) (mm)	310 x 265 x 52.6
Operation Temperature	-20°C ~ 50°C
Storage Temperature	-20°C ~ 60°C
IP level	IP 64 compliant front panel

Power Adapter	65W
	Input: 100V AC ~ 240V AC @ 50 / 60 Hz
	Output: 19V DC
Power Requirement	9V ~ 36V DC
Power Consumption	42W
LED Functions	Power / RFID / MIC / Auto-dimming / Wi-Fi / RFID device / AT/ATX mode / Camera / Bluetooth / USB port / CPU temperature alert
I/O Ports and Switches	1 x RS-232 (DB-9 connector)
	1 x RS-232 (RJ-45 connector)
	1 x RS-422/485 (4-pin box header)
	2 x GbE LAN (RJ-45 connector)
	4 x USB 2.0 connector
	1 x Mini USB 2.0 connector (on front panel)
	1 x Audio jack (line-out)
	1 x VGA port (15-pin connector)
	1 x SD card slot (on front panel)
	1 x Reset button
	1 x Power switch
	1 x AT/ATX switch
	1 x DC input jack
	1 x Clear CMOS button

Table 1-4: System Specifications

Chapter

2

Detailed Specifications

2.1 Dimensions

The AFL2-12A-D525 dimensions are shown below.

- **Width:** 310.0 mm
- **Height:** 265.0 mm
- **Depth:** 52.6 mm

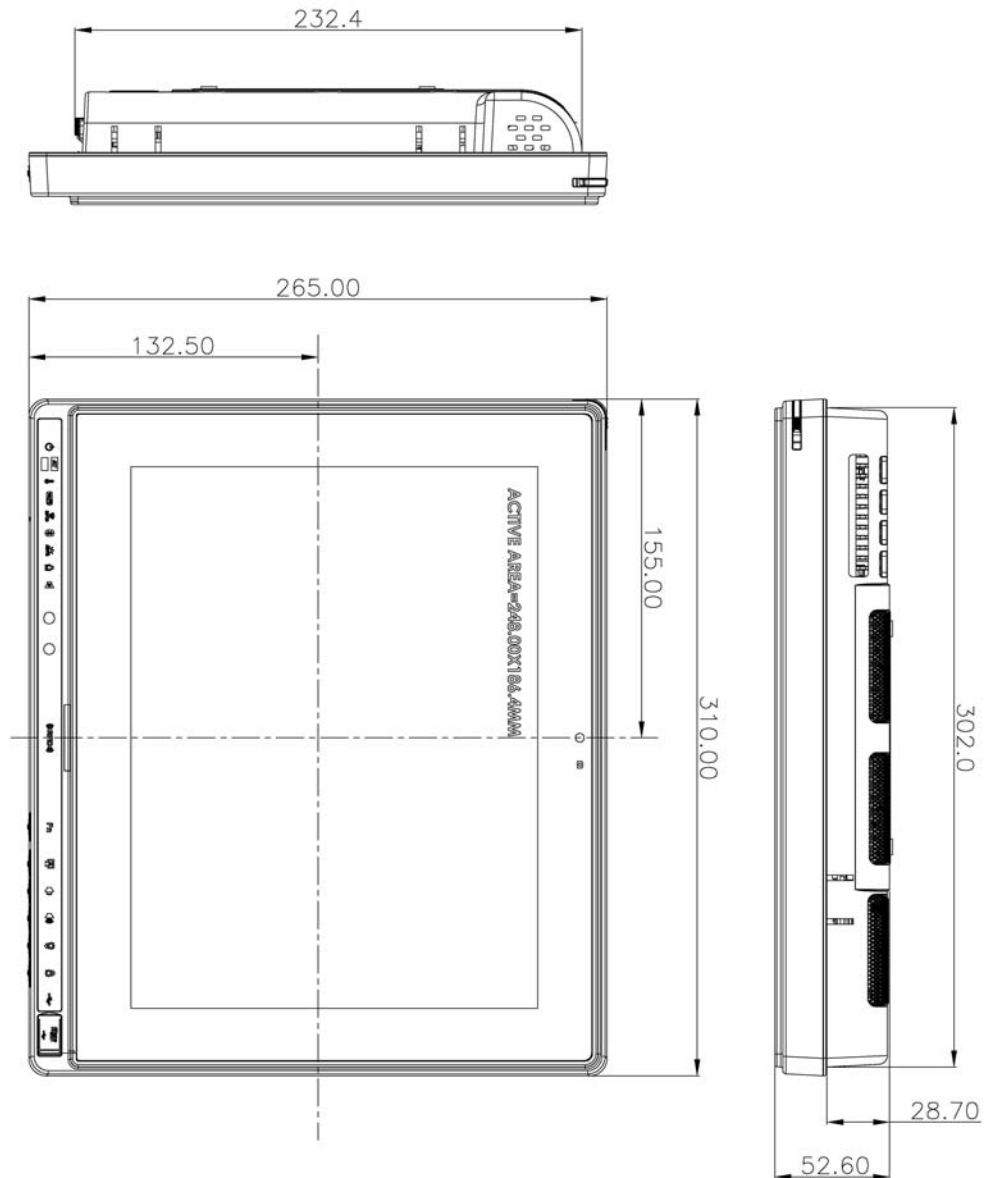

Figure 2-1: AFL2-12A-D525 Dimensions (mm)

AFL2-12A-D525 Series Panel PC

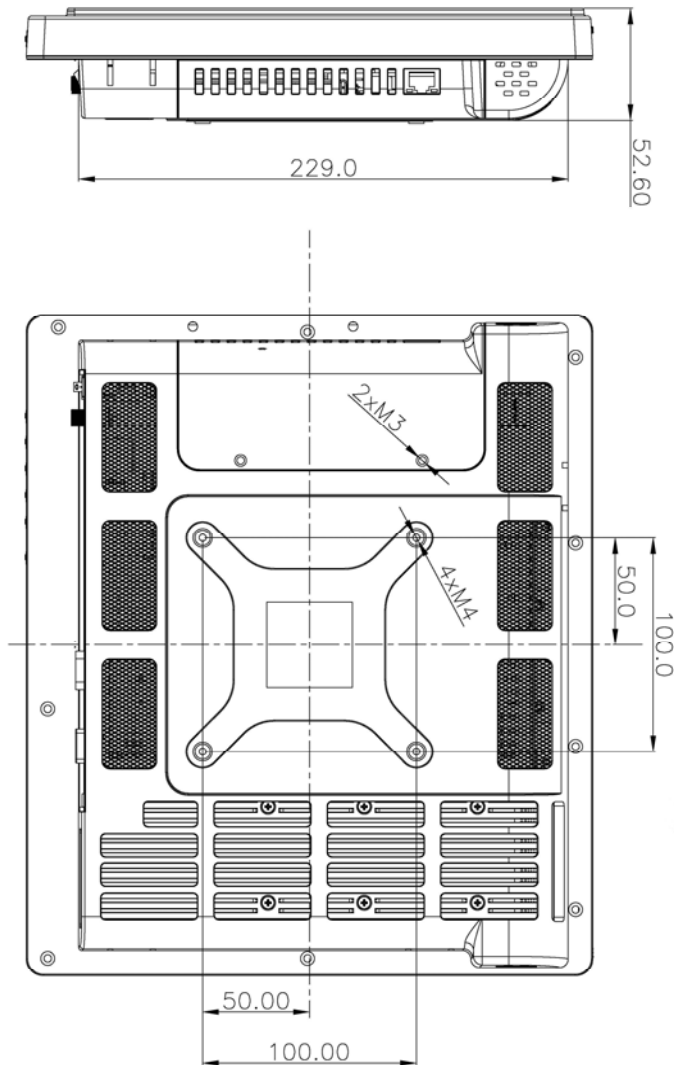

Figure 2-2: AFL2-12A-D525 Dimensions (mm) cont.

2.2 Intel® Atom™ Processor

An Intel® Atom™ D525 processor is installed in the system. The D525 CPU is a 1.8 GHz dual core processor with Direct Media Interface (DMI) speed of 2.5 GT/s. The CPU also features a 1.0 MB L2 cache.

2.3 Motherboard Components

The following sections describe some of the features on the motherboard.

2.3.1 Memory Support

2.3.1.1 Installed Memory

One 204-pin 1.0 GB 800 MHz DDR3 SO-DIMM is installed in the AFL2-12A-D525 and controlled by the Intel® Atom™ D525 CPU installed on the internal motherboard.

2.3.2 Storage Capacity

The AFL2-12A-D525 comes equipped with a CompactFlash® Type II (CF Type II) memory disk slot. The AFL2-12A-D525 also supports a 2.5" SATA HDD drive bay which can be easily accessed by removing two screws on the HDD cover.

2.4 External Peripheral Interface Connectors

The following section describes the external peripheral interface connectors on the bottom panel of the subsystem.

2.4.1 Serial Port Connectors

The AFL2-12A-D525 has three serial ports. COM1 and COM3 support only RS-232 serial communications. The other serial port (COM6) can be configured as an RS-422 or RS-485 serial port. Enabling COM devices to be powered through the COM port eliminates unnecessary and messy cabling.



Figure 2-3: COM Ports

AFL2-12A-D525 Series Panel PC

2.4.2 LAN Connectivity

The AFL2-12A-D525 has one RJ-45 LAN connector on the bottom panel.

GbE RJ-45 Connector



Figure 2-4: RJ-45 Ethernet Connectors

The PCIe LAN from the Intel® ICH8M chipset of the AFL2-12A-D525 is interfaced to the Realtek RTL8111E PCIe gigabit Ethernet (GbE) controllers. The RTL8111E controller is connected directly to the RJ-45 connector on the bottom panel and provides external GbE connectivity.

2.4.3 External USB Connectors

There are four USB 2.0 connectors on the bottom panel of the AFL2-12A-D525. All USB 2.0 connectors are interfaced directly to the USB controllers on the ICH8M southbridge. These USB connectors are fully compliant with USB specification Revision 2.0 and USB specification Revision 1.1 and can be interfaced to both USB 1.1 and USB 2.0 compliant devices.

Four USB 2.0 Ports



Figure 2-5: External USB Ports

2.5 Touchscreen LCD

2.5.1 Monitor

A 12.1" LCD screen is installed on the front of the AFL2-12A-D525. The screen is shown in **Figure 2-6** below.

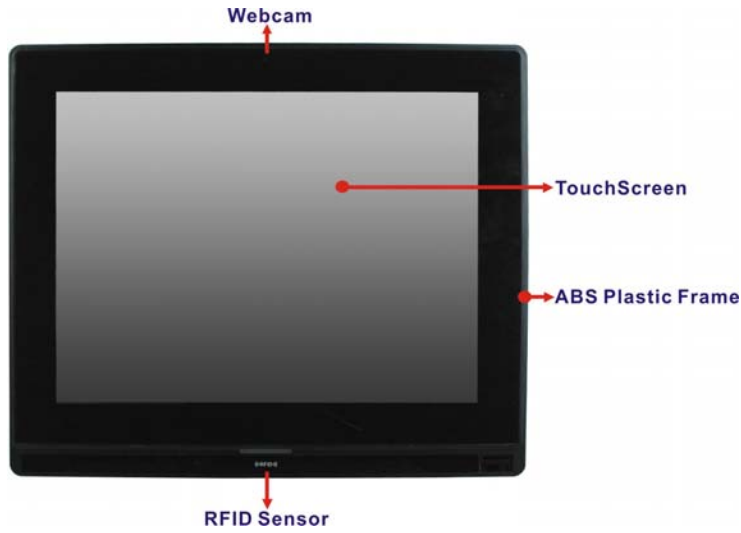

Figure 2-6: LCD Screen

2.5.2 Touch-Screen Module

A controller for the touch screen is installed on the motherboard. The sensitive touch screen is accurate, reliable and durable.

2.6 Audio

2.6.1 Audio Codec Controller

The integrated HD Audio compliant audio controller on the Intel® ICH8-M Southbridge is integrated to a Realtek ALC888 audio codec. The Realtek ALC888 is connected to an external audio jack, which is then connected to compliant audio devices. The Realtek ALC888 is a 7.1+2 channel high definition audio codec with ten DAC channels. It supports 7.1 sound playback and 2 channels of independent stereo sound output. The audio connector is shown in **Figure 2-7**.



Figure 2-7: Audio Jack

AFL2-12A-D525 Series Panel PC

2.6.2 Stereo Speakers

Two internal 1.5 W stereo speakers on the sides of the AFL2-12A-D525 are interfaced to the system.

2.7 System Power

2.7.1 Power Mode

The system can be run in the AT power mode or the ATX power mode. Both these power modes are described below.

2.7.1.1 ATX Power Mode (Default)

With the ATX mode selected, the AFL2-12A-D525 panel PC goes in a standby mode when it is turned off. The panel PC can be easily turned on via network or a power switch in standby mode. Remote power control is perfect for advertising applications since the broadcasting time for each panel PC can be set individually and controlled remotely. Other possible application includes

- Security surveillance
- Point-of-Sale (POS)
- Advertising terminal

2.7.1.2 AT Power Mode

With the AT mode selected, the power is controlled by a central power unit rather than a power switch. The AFL2-12A-D525 panel PC turns on automatically when the power is connected. The AT mode benefits a production line to control multiple panel PCs from a central management center and other applications including:

- ATM
- Self-service kiosk
- Plant environment monitoring system
- Factory automation platform
- Manufacturing shop flow

2.7.2 Power Adapter

The system is shipped with a 100 V to 240 V AC power adapter that has a maximum power output of 65 W. The power adapter has a 19 V DC output connector.

Chapter

3

Unpacking

3.1 Unpacking

To unpack the flat bezel panel PC, follow the steps below:



WARNING!

The front side LCD screen has a protective plastic cover stuck to the screen. Only remove the plastic cover after the flat bezel panel PC has been properly installed. This ensures the screen is protected during the installation process.

- Step 1:** Use box cutters, a knife or a sharp pair of scissors that seals the top side of the external (second) box.
- Step 2:** Open the external (second) box.
- Step 3:** Use box cutters, a knife or a sharp pair of scissors that seals the top side of the internal (first) box.
- Step 4:** Lift the monitor out of the boxes.
- Step 5:** Remove both polystyrene ends, one from each side.
- Step 6:** Pull the plastic cover off the flat bezel panel PC.
- Step 7:** Make sure all the components listed in the packing list are present.

3.1.1 Packing List

The AFL2-12A-D525 flat bezel panel PC is shipped with the following components:

Quantity	Item	Image
Standard		
1	AFL2-12A-D525 panel PC	

AFL2-12A-D525 Series Panel PC

1	Power adapter (P/N: 63040-010065-010-RS)	
1	Power cord (P/N: 32702-000401-100-RS)	
1	Power Transfer Cord (P/N:32000-089400-RS)	
4	M3 Screws Pack (P/N: 44013-030041-RS)	
4	M4 Screws Pack (P/N: 44403-040061-RS)	
1	Touch Pen (P/N: 43125-0002C0-00-RS)	
1	RJ-45 to DB-9 COM Port Cable (P/N: 32005-000200-200-RS)	
1	RS-422 cable (P/N: 32205-002400-100-RS)	
1	IR Remote Control (P/N: 7Z000-8T00320ICP05G-RS)	
1	User manual CD and driver CD	
1	One Key Recovery CD (P/N: 7B000-000724-RS)	

Optional	
Wall mounting kit (P/N: AFLWK-19/AFLWK-19B)	
Arm (P/N: ARM-11-RS)	
Stand (P/N: STAND-A12)	
V-Stand (P/N: VSTAND-A12)	
Hybrid Card Reader (P/N: AFL2P-12AMSI-U-R10)	
Magnetic Stripe Reader (P/N: AFL2P-12AMSR-U-R10)	
Rack Mounting Kit (P/N: AFL2RK-12)	
OS: Win CE 6.0 (128MB CF Card) (P/N: AFL2CF-12-D525-CE060-128M-R10)	

AFL2-12A-D525 Series Panel PC

OS: Win XPE (2GB CF Card) (P/N: AFL2CF-12-D525-XPE-2G-R10)	
OS: Win XPE (4GB CF Card) (P/N: AFL2CF-12-D525-XPE-4G-R10)	
OS: Linux (2GB CF Card) (P/N: AFL2CF-12A-D525-LNX-R10)	
OS: Win 7 Embedded (4GB CF Card) (P/N: AFL2CF-12-D525-WES7P-4G-R10 AFL2CF-12-D525-WES7E-4G-R10)	

If any of these items are missing or damaged, contact the distributor or sales representative immediately.

Chapter

4

Installation

AFL2-12A-D525 Series Panel PC

4.1 Anti-static Precautions



WARNING:

Failure to take ESD precautions during the maintenance of the AFL2-12A-D525 may result in permanent damage to the AFL2-12A-D525 and severe injury to the user.

Electrostatic discharge (ESD) can cause serious damage to electronic components, including the AFL2-12A-D525. Dry climates are especially susceptible to ESD. It is therefore critical that whenever the AFL2-12A-D525 is accessed internally, or any other electrical component is handled, the following anti-static precautions are strictly adhered to.

- **Wear an anti-static wristband:** - Wearing a simple anti-static wristband can help to prevent ESD from damaging the board.
- **Self-grounding:** - Before handling the board touch any grounded conducting material. During the time the board is handled, frequently touch any conducting materials that are connected to the ground.
- **Use an anti-static pad:** - When configuring the AFL2-12A-D525, place it on an anti-static pad. This reduces the possibility of ESD damaging the AFL2-12A-D525.
- **Only handle the edges of the PCB:** - When handling the PCB, hold the PCB by the edges.

4.2 Installation Precautions

When installing the flat bezel panel PC, please follow the precautions listed below:

- **Power turned off:** When installing the flat bezel panel PC, make sure the power is off. Failing to turn off the power may cause severe injury to the body and/or damage to the system.
- **Certified Engineers:** Only certified engineers should install and modify onboard functionalities.

- **Anti-static Discharge:** If a user open the rear panel of the flat bezel panel PC, to configure the jumpers or plug in added peripheral devices, ground themselves first and wear an anti-static wristband.

4.3 Installation and Configuration Steps

The following installation steps must be followed.

Step 1: Unpack the flat bezel panel PC

Step 2: Install an HDD

Step 3: Configure the system

Step 4: Connect peripheral devices to the bottom panel of the flat bezel panel PC

Step 5: Mount the flat bezel panel PC

4.4 HDD Installation



WARNING:

Over-tightening back cover screws will crack the plastic frame.
Maximum torque for cover screws is 5 kg-cm (0.36 lb-ft/0.49 Nm).

To install the HDD into the AFL2-12A-D525, please follow the steps below:

Step 1: Remove two (2) retention screws from the HDD cover (**Figure 4-1**).

AFL2-12A-D525 Series Panel PC



Figure 4-1: HDD Cover Retention Screws

Step 2: Remove the HDD cover from the device.

Step 3: Loosen the captive screw to release the HDD bracket from the chassis
(Figure 4-2).



Figure 4-2: HDD Bracket Screw

Step 4: Slide the HDD bracket out of the device as shown (Figure 4-3).



Figure 4-3: Removing the HDD Bracket

Step 5: Insert an HDD into the bracket as shown (Figure 4-4).



Figure 4-4: Inserting the HDD

AFL2-12A-D525 Series Panel PC

Step 6: Secure the HDD to the bracket using four (4) retention screws (two screws on each side) (Figure 4-5).



Figure 4-5: Securing the HDD

Step 7: Slide the HDD module back into the device.

Step 8: Tighten the captive screw.

Step 9: Replace the HDD cover and secure it using two (2) retention screws.

4.5 CF Card Installation

To install a CF Card into the AFL2-12A-D525, please follow the steps below:



NOTE:

Before installation, it is recommended that a piece of tape be applied to the CF card to aid in removal. See below:



Step 1: Remove two (2) retention screws from the HDD cover (Figure 4-6).



Figure 4-6: HDD Cover Retention Screws

Step 2: Remove the HDD cover from the device.

Step 3: The CF card slot is located underneath the HDD bracket. (Figure 4-7).

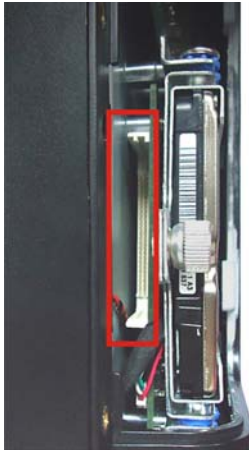

Figure 4-7: CF Card Slot Location

Step 4: Insert the CF card into the slot until it cannot be pushed in any further. (Figure 4-8).

AFL2-12A-D525 Series Panel PC

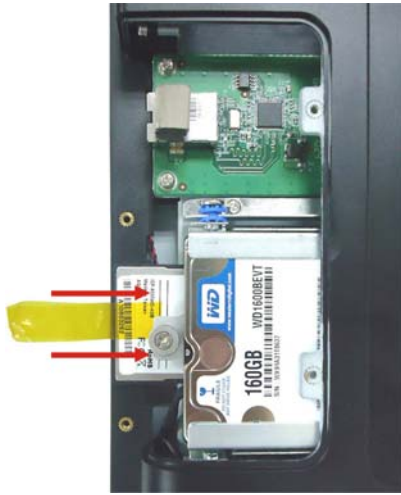

Figure 4-8: Inserting the CF Card

Step 5: Replace the HDD cover and secure it using two (2) retention screws.

4.6 AT/ATX Mode Selection

AT and ATX power modes can both be used on the AFL2-12A-D525. The selection is made through an AT/ATX switch located on the I/O panel (Figure 4-9). To select AT mode or ATX mode, follow the steps below.

Step 1: Locate the AT/ATX switch on the I/O panel (**Figure 4-9**).



Figure 4-9: AT/ATX Switch Location

Step 2: Adjust the AT/ATX switch.

4.6.1 AT Power Mode

With the AT mode selected, the power is controlled by a central power unit rather than a power switch. The AFL2-12A-D525 panel PC turns on automatically when the power is connected. The AT mode benefits a production line to control multiple panel PCs from a central management center and other applications including:

- ATM
- Self-service kiosk
- Plant environment monitoring system
- Factory automation platform
- Manufacturing shop flow

4.6.2 ATX Power Mode

With the ATX mode selected, the AFL2-12A-D525 panel PC goes in a standby mode when it is turned off. The panel PC can be easily turned on via network or a power switch in standby mode. Remote power control is perfect for advertising applications since the broadcasting time for each panel PC can be set individually and controlled remotely. Other possible application includes

- Security surveillance
- Point-of-Sale (POS)
- Advertising terminal

4.7 Powering On the System

To power on the system, follow the steps below:

Step 1: Locate the **Function** and **Brightness Up** function keys. See **Section 1.2.1.1**.

Step 2: Hold down the Function and Brightness Up buttons for **three** seconds to power on the system.

4.8 Powering Off the System

To power off the system, follow the steps below:

Step 1: Locate the **Function** and **Brightness Up** function keys. See **Section 1.2.1.1**.

Step 2: Hold down the Function and Brightness Up buttons for **six** seconds to power off the system.

AFL2-12A-D525 Series Panel PC

4.9 Mounting the System



WARNING!

When mounting the flat bezel panel PC onto an arm, onto the wall or onto a panel, it is better to have more than one person to help with the installation to make sure the panel PC does not fall down and get damaged.

The four methods of mounting the AFL2-12A-D525 are listed below.

- Wall mounting
- Stand mounting
- Arm mounting
- Rack mounting

The four mounting methods are described below.

4.9.1 Wall Mounting

To mount the flat bezel panel PC onto the wall, please follow the steps below.

- Step 1:** Select the location on the wall for the wall-mounting bracket.
- Step 2:** Carefully mark the locations of the four screw holes in the bracket on the wall.
- Step 3:** Drill four pilot holes at the marked locations on the wall for the bracket retention screws.
- Step 4:** Align the wall-mounting bracket screw holes with the pilot holes.
- Step 5:** Secure the mounting-bracket to the wall by inserting the retention screws into the four pilot holes and tightening them (**Figure 4-10**).

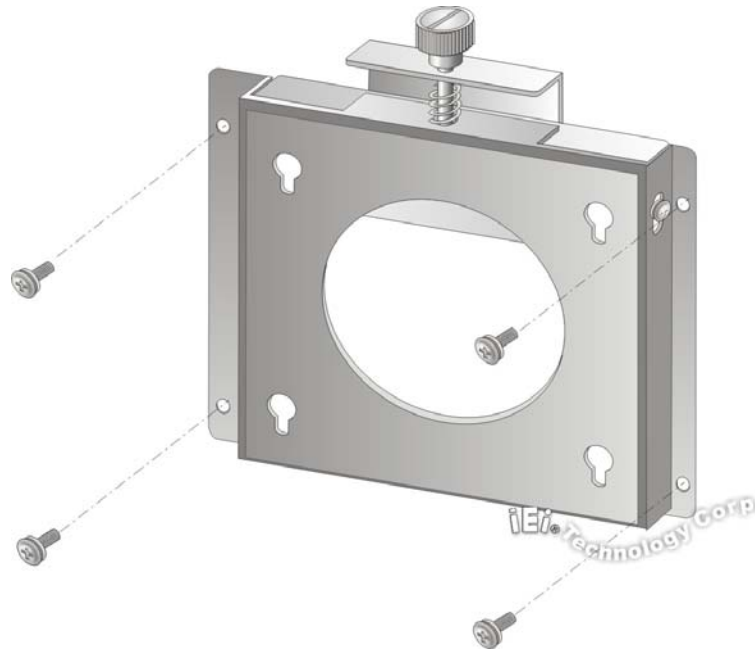

Figure 4-10: Wall-mounting Bracket

Step 6: Insert the four monitor mounting screws provided in the wall mount kit into the four screw holes on the rear panel of the flat bezel panel PC and tighten until the screw shank is secured against the rear panel (**Figure 4-11**).



WARNING:

Please use the M4 screws provided in the wall mount kit for the rear panel. If the screw is missing, the thread depth of the replacement screw should be not more than 4 mm.

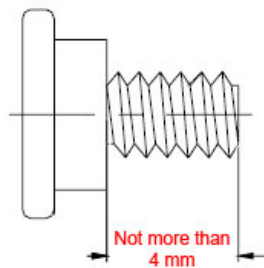

AFL2-12A-D525 Series Panel PC

Step 7: Align the mounting screws on the monitor rear panel with the mounting holes on the bracket.

Step 8: Carefully insert the screws through the holes and gently pull the monitor downwards until the monitor rests securely in the slotted holes (**Figure 4-11**). Ensure that all four of the mounting screws fit snugly into their respective slotted holes.



NOTE:

In the diagram below the bracket is already installed on the wall.

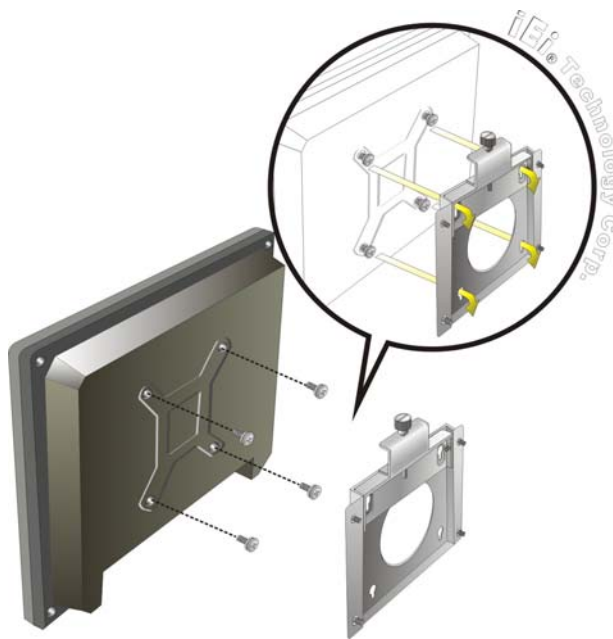

Figure 4-11: Chassis Support Screws

Step 9: Secure the panel PC by fastening the retention screw of the wall-mounting bracket. (**Figure 4-12**).

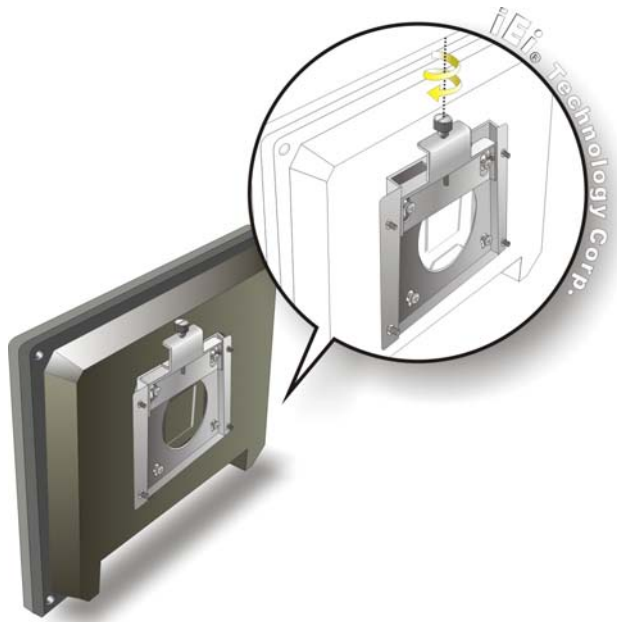

Figure 4-12: Secure the Panel PC

4.9.2 Stand Mounting

To mount the AFL2-12A-D525 using the stand mounting kit, please follow the steps below.

Step 1: Locate the screw holes on the rear of the AFL2-12A-D525. This is where the bracket will be attached. **(Figure 4-13)**



Figure 4-13: Mounting screw location

Step 2: Align the bracket with the screw holes.

AFL2-12A-D525 Series Panel PC

Step 3: To secure the bracket to the AFL2-12A-D525, insert the retention screws into the screw holes and tighten them.

4.9.3 Arm Mounting

The AFL2-12A-D525 is VESA (Video Electronics Standards Association) compliant and can be mounted on an arm with a 100mm interface pad. To mount the AFL2-12A-D525 on an arm, please follow the steps below.

Step 1: The arm is a separately purchased item. Please correctly mount the arm onto the surface it uses as a base. To do this, refer to the installation documentation that came with the mounting arm.



NOTE:

When purchasing the arm please ensure that it is VESA compliant and that the arm has a 75 mm or 100 mm interface pad. If the mounting arm is not VESA compliant it cannot be used to support the AFL2-12A-D525 flat bezel panel PC.

Step 2: Once the mounting arm has been firmly attached to the surface, lift the flat bezel panel PC onto the interface pad of the mounting arm.

Step 3: Align the retention screw holes on the mounting arm interface with those in the flat bezel panel PC (**Figure 4-14**).



Figure 4-14: Arm Mounting Retention Screw Holes

Step 4: Secure the flat bezel panel PC to the interface pad by inserting four retention screws through the bottom of the mounting arm interface pad and into the flat bezel panel PC.

4.9.4 Cabinet and Rack Installation

The AFL2-12A-D525 flat bezel panel PC can be installed into a cabinet or rack. The installation procedures are similar to the panel mounting installation. To do this, please follow the steps below:



NOTE:

When purchasing the cabinet/rack installation bracket, make sure it is compatible with both the AFL2-12A-D525 flat bezel panel PC and the rack/cabinet into which the AFL2-12A-D525 is installed.

Step 1: Slide the rear chassis of the AFL2-12A-D525 flat bezel panel PC through the rack/cabinet bracket until the aluminum frame is flush against the front of the bracket (**Figure 4-15**).

AFL2-12A-D525 Series Panel PC

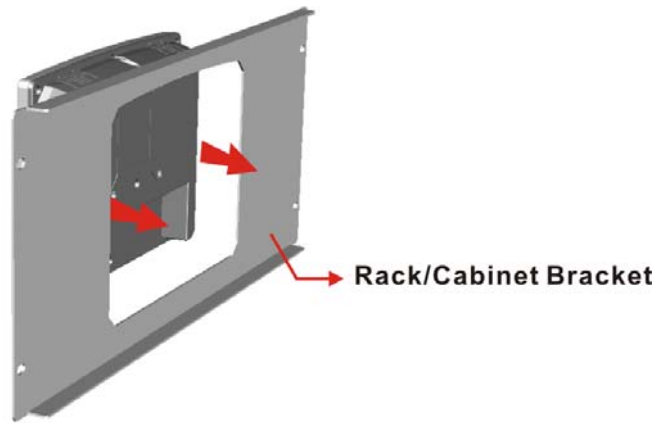

Figure 4-15: The Rack/Cabinet Bracket

Step 2: Insert the rack mounting clamps into the pre-formed holes along the edges of the flat bezel panel PC, behind the ABS/PC plastic frame. There are a total of 6 rack mounting clamps.

Step 3: Tighten the screws that pass through the rack mounting clamps until the plastic caps at the front of all the screws are firmly secured to the bracket (**Figure 4-16**).

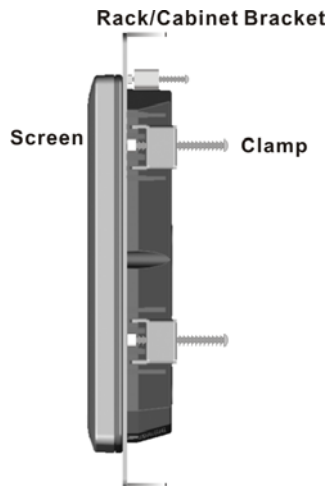

Figure 4-16: Secure the Rack/Cabinet Bracket

Step 4: Slide the flat bezel panel PC with the attached rack/cabinet bracket into a rack or cabinet (**Figure 4-17**).

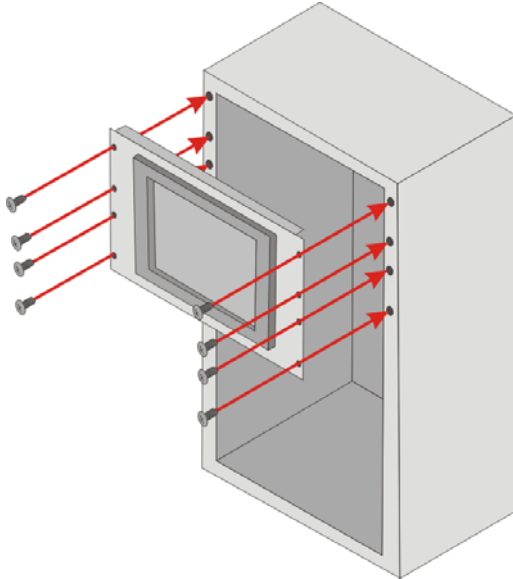

Figure 4-17: Install into a Rack/Cabinet

Step 5: Once the flat bezel panel PC with the attached rack/cabinet bracket has been properly inserted into the rack or cabinet, secure the front of the rack/cabinet bracket to the front of the rack or cabinet (**Figure 4-17**).

4.10 Bottom Panel Connectors

4.10.1 LAN Connection

There are two external RJ-45 LAN connectors. The RJ-45 connector enables connection to an external network. To connect a LAN cable with an RJ-45 connector, please follow the instructions below.

Step 1: Locate the RJ-45 connectors on the bottom panel of the AFL2-12A-D525.

Step 2: Align the connectors. Align the RJ-45 connector on the LAN cable with one of the RJ-45 connectors on the bottom panel of the AFL2-12A-D525. See **Figure 4-18**.

AFL2-12A-D525 Series Panel PC

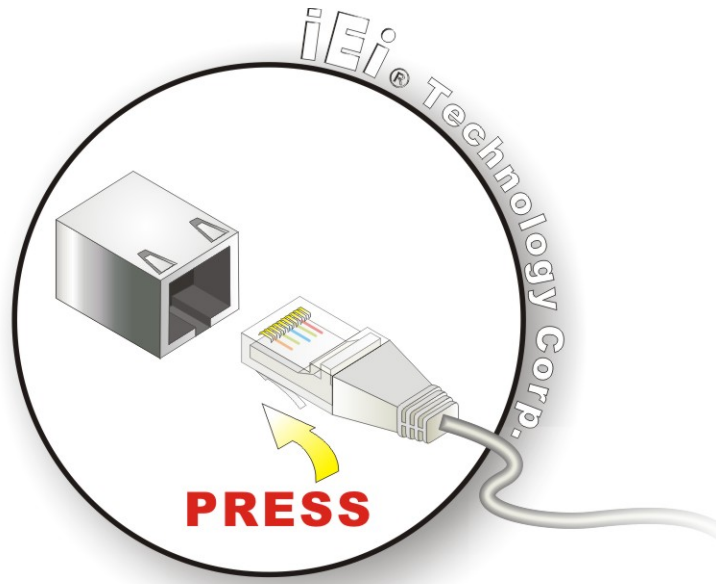

Figure 4-18: LAN Connection

Step 3: Insert the LAN cable RJ-45 connector. Once aligned, gently insert the LAN cable RJ-45 connector into the onboard RJ-45 connector.

4.10.2 Serial Device Connection

The AFL2-12A-D525 has one male DB-9 port connector and one RJ-45 serial port connector on the I/O panel for serial device connection.

4.10.2.1 DB-9 Serial Port Connection

CN Label:	DB-9
CN Type:	9-pin connector
CN Location:	See Figure 4-19
CN Pinouts:	See Table 4-1

A DB-9 serial port device can be connected to the DB-9 serial port on the bottom panel. The pinouts of the DB-9 serial port are shown below.

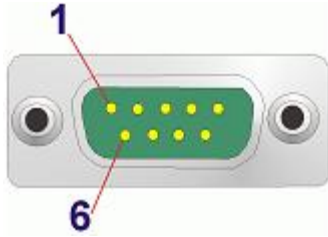

Figure 4-19: DB-9 Connector

Pin	Description	Pin	Description
1	DCD1	2	RX1
3	TX1	4	DTR1
5	GND	6	DSR1
7	RTS1	8	CTS1
9	RI1		

Table 4-1: DB-9 Connector Pinouts

Follow the steps below to connect a serial device to the DB-9 connector of the AFL2-12A-D525 panel PC.

Step 1: Locate the DB-9 connector. The location of the DB-9 connector is shown in **Chapter 2**.

Step 2: Insert the serial connector. Insert the DB-9 connector of a serial device into the DB-9 connector on the bottom panel. See **Figure 4-20**.

AFL2-12A-D525 Series Panel PC

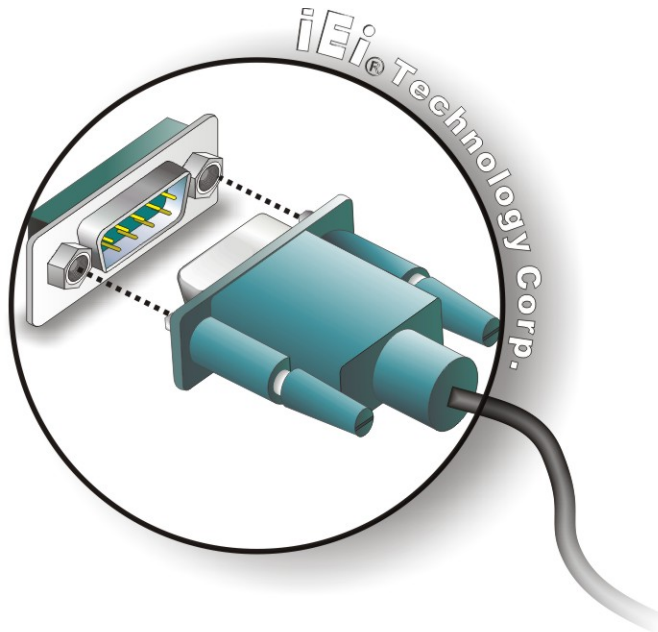

Figure 4-20: DB-9 Serial Port Connector

Step 3: Secure the connector. Secure the serial device connector to the external interface by tightening the two retention screws on either side of the connector.

4.10.2.2 RJ-45 Serial Port Connection

- CN Label:** COM3
- CN Type:** RJ-45
- CN Location:** See **Figure 4-21**
- CN Pinouts:** See Table 4-2

A 10/100/1000 Mb/s connection can be made to a Local Area Network.

Pin	Description	Pin	Description
1	DCD3	5	TXD3
2	DSR3	6	CTS3
3	RXD3	7	DTR3

Pin	Description	Pin	Description
4	RTS3	8	RI3

Table 4-2: Ethernet Connector Pinouts

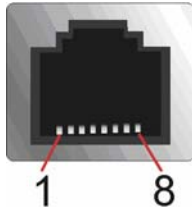

Figure 4-21: Ethernet Connector

Follow the steps below to connect a serial device to the RJ-45 serial port connector of the AFL2-12A-D525 panel PC.

- Step 1:** Locate the RJ-45 serial port. The location of the RJ-45 serial port is shown in Chapter 2.
- Step 2:** Connect the RJ-45 to COM port cable to the panel PC. Insert the RJ-45 connector end of cable into the RJ-45 serial port. See **Figure 4-22**
- Step 3:** Connect the serial device. Connect a serial device to the DB-9 connector end of the cable. See **Figure 4-22**

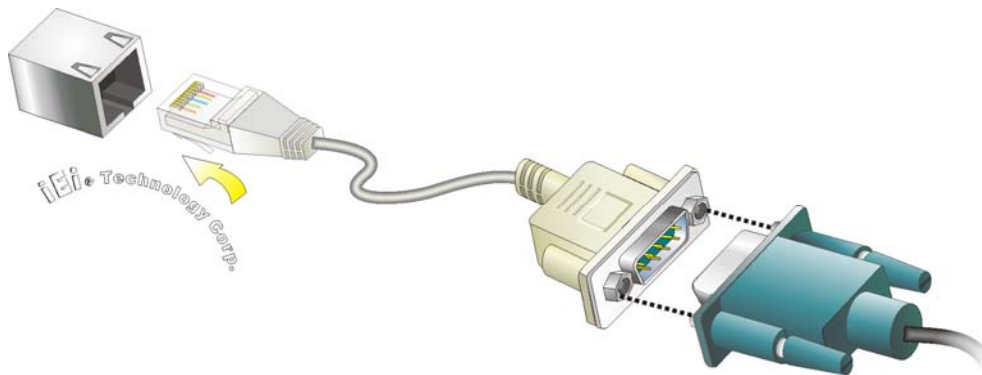

Figure 4-22: RJ-45 Serial Port Connector

- Step 4:** Secure the connector. Secure the serial device connector to the external interface by tightening the two retention screws on either side of the connector.

AFL2-12A-D525 Series Panel PC

4.10.3 RS-422/485 Serial Port

- CN Label:** RS 422/485
- CN Type:** 4-pin connector
- CN Location:** See **Figure 4-23**
- CN Pinouts:** See **Table 4-3** and **Figure 4-24**

A RS-422/485 serial port device can be connected to the RS-422/485 serial port on the bottom panel. The pinouts of the RS-422/485 serial port are shown below.



Figure 4-23: RS-422/485 Serial Port

Pin	RS-422	RS-485
1	RX+	
2	RX-	
3	TX+	DATA+
4	TX-	DATA-

Table 4-3: RS-422/485 Serial Port Pinouts

To install the RS-422/485 devices, follow the steps below.

Step 1: **Locate the RS-422/RS485 connector.** The location of the RS-422/RS-485 connector is shown in **Figure 1-6**.

Step 2: **Connect the RS-422/485 connector to the RS-422/485 cable.** The RS-422/485 cable can be found in the packing list and is shown in **Figure 4-24**.



Figure 4-24: RS-422/485 Cable

Step 3: Insert the serial connector. Insert the DB-9 connector of a serial device into the DB-9 connector on the RS-422/485 cable.

Step 4: Secure the connector. Secure the serial device connector to the external interface by tightening the two retention screws on either side of the connector.

Step 5: The DB-9 connector pinouts are listed below.

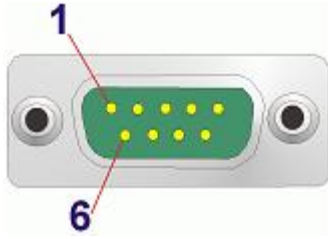

Figure 4-25: DB-9 Connector

Pin	RS-422	RS-485
1	TX-	DATA-
2	TX+	DATA+
3	RX+	
4	RX-	

Table 4-4: DB-9 Connector Pinouts

4.10.4 USB Device Connection

There are two external USB 2.0 connectors. All connectors are perpendicular to the AFL2-12A-D525. To connect a USB 2.0 or USB 1.1 device, please follow the instructions below.

Step 1: Located the USB connectors. The locations of the USB connectors are shown in **Chapter 2**.

Step 2: Align the connectors. Align the USB device connector with one of the connectors on the bottom panel. See **Figure 4-26**.

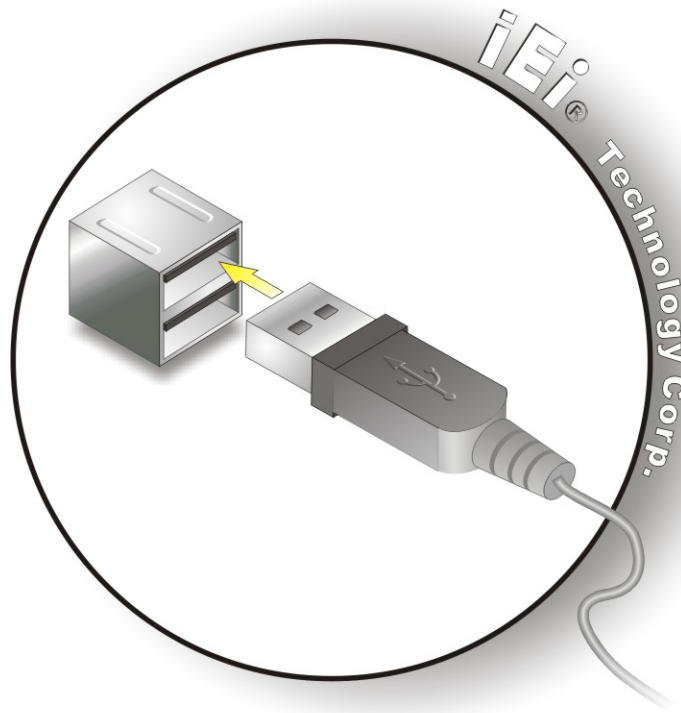

Figure 4-26: USB Device Connection

Step 3: Insert the device connector. Once aligned, gently insert the USB device connector into the onboard connector.

Chapter

5

System Maintenance

AFL2-12A-D525 Series Panel PC

5.1 System Maintenance Introduction

If the components of the AFL2-12A-D525 fail they must be replaced. Components that can be replaced include:

- SO-DIMM module
- WLAN Module

Please contact the system reseller or vendor to purchase the replacement parts. Back cover removal instructions for the AFL2-12A-D525 are described below.

5.2 Anti-static Precautions



WARNING:

Failure to take ESD precautions during the maintenance of the AFL2-12A-D525 may result in permanent damage to the AFL2-12A-D525 and severe injury to the user.

Electrostatic discharge (ESD) can cause serious damage to electronic components, including the AFL2-12A-D525. Dry climates are especially susceptible to ESD. It is therefore critical that whenever the AFL2-12A-D525 is accessed internally, or any other electrical component is handled, the following anti-static precautions are strictly adhered to.

- ***Wear an anti-static wristband:*** - Wearing a simple anti-static wristband can help to prevent ESD from damaging the board.
- ***Self-grounding:*** - Before handling the board touch any grounded conducting material. During the time the board is handled, frequently touch any conducting materials that are connected to the ground.
- ***Use an anti-static pad:*** - When configuring the AFL2-12A-D525, place it on an anti-static pad. This reduces the possibility of ESD damaging the AFL2-12A-D525.
- ***Only handle the edges of the PCB:*** - When handling the PCB, hold the PCB by the edges.

5.3 Turn off the Power



WARNING:

Failing to turn off the system before opening it can cause permanent damage to the system and serious or fatal injury to the user.

Before any maintenance procedures are carried out on the system, make sure the system is turned off.

To power off the system, follow the steps below:

Step 1: Locate the **Function** and **Brightness Up** function keys. See **Section 1.2.1.1**.

Step 2: Hold down the Function and Brightness Up buttons for **six** seconds to power off the system.

5.4 Opening the System

5.4.1 Removing the Back Cover



WARNING:

Over-tightening back cover screws will crack the plastic frame.
Maximum torque for cover screws is 5 kg-cm (0.36 lb-ft/0.49 Nm).

To access the AFL2-12A-D525 internally the back cover must be removed. To remove the back cover, please follow the steps below.

Step 1: Follow all anti-static procedures. See **Section 5.2**.

Step 2: Turn off the power. See **Section 5.3**.

AFL2-12A-D525 Series Panel PC

Step 3: Remove a total of nine (9) retention screws from the back cover (**Figure 5-1**).



Figure 5-1: Back Cover Retention Screws

Step 4: Carefully separate the back cover from the chassis and lift the cover clear of the device

5.4.2 Removing the Internal Aluminum Cover

To remove the internal aluminum cover, follow the steps below.

Step 1: Remove the six (6) retention screws securing the internal aluminum cover to the chassis (**Figure 5-2**).



Figure 5-2: Internal Cover Retention Screws

Step 2: Lift the aluminum cover off the AFL2-12A-D525.

5.5 Replacing Components

5.5.1 Memory Module Replacement

The flat bezel panel PC is preinstalled with a 1.0 GB DDR3 memory module. If the memory module fails, follow the instructions below to replace the memory module.

Step 1: Follow all anti-static procedures. See **Section 5.2**.

Step 2: Turn off the power. See **Section 5.3**.

Step 3: Remove the back cover. See **Section 5.4.1** above.

Step 4: Remove the internal aluminum back cover. See **Section 5.4.2** above.

Step 5: Locate the DDR3 SO-DIMM on the motherboard.

Step 6: Remove the DDR3 memory module by pulling both the spring retainer clips outward from the socket.

Step 7: Grasp the DDR3 memory module by the edges and carefully pull it out of the socket.

AFL2-12A-D525 Series Panel PC

- Step 8:** Install the new DDR3 memory module by pushing it into the socket at an angle (Figure 5-3).
- Step 9:** Gently pull the spring retainer clips of the SO-DIMM socket out and push the rear of the DDR memory module down (Figure 5-3).
- Step 10:** Release the spring retainer clips on the SO-DIMM socket. They clip into place and secure the DDR memory module in the socket.

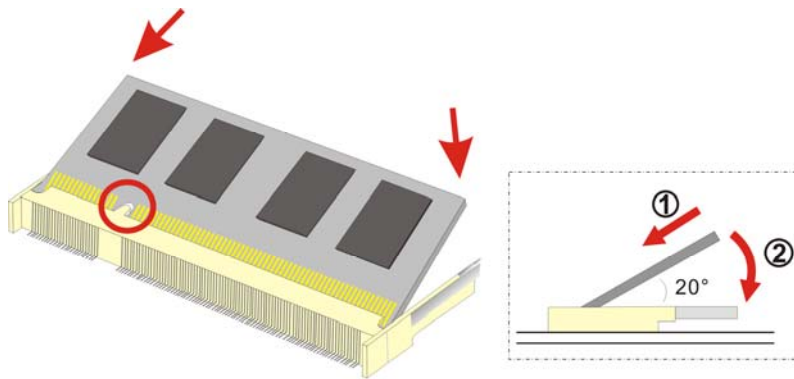

Figure 5-3: DDR SO-DIMM Module Installation

- Step 11:** Replace the internal aluminum cover and secure it to the chassis using six (6) retention screws.
- Step 12:** Replace the back cover and secure it using nine (9) previously removed retention screws.

5.5.2 WLAN Card Replacement

The AFL2-12A-D525 has one WLAN card slot. To replace the WLAN card, follow the instructions below.

- Step 1:** Follow all anti-static procedures. See **Section 5.2**.
- Step 2:** Turn off the power. See **Section 5.3**.
- Step 3:** Remove the back cover. See **Section 5.4.1**.
- Step 4:** Remove the internal aluminum back cover. See **Section 5.4.2**.

Step 5: Locate the WLAN card.

Step 6: Disconnect the main and auxiliary antennas on the WLAN module
(Figure 5-4).



Figure 5-4: Removing the Antennas

Step 7: Push the two spring clips in to release the WLAN card.

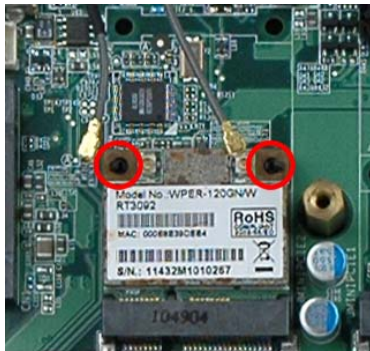

Figure 5-5: Releasing the WLAN Card

AFL2-12A-D525 Series Panel PC

- Step 8:** Grasp the WLAN card by the edges and carefully pull it out of the socket (Figure 5-6).

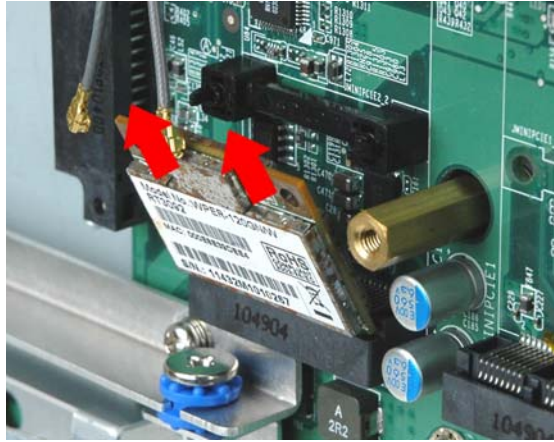

Figure 5-6: Removing the WLAN card

- Step 9:** Install a new WLAN card by inserting the card into the slot at an angle
- Step 10:** Push the WLAN card down until the spring retainer clips lock into place.

Step 11: Connect the main (1) and auxiliary (2) antennas. The main antenna is indicated with a strip of black electrical tape. See **Figure 5-7**.



NOTE:

To ensure the WLAN module functions correctly, please make sure the WLAN antennas are attached in the proper configuration.



Figure 5-7: Attaching the Antennas

Step 12: Replace the internal aluminum cover and secure it to the chassis using six (6) retention screws.

Step 13: Replace the back cover and secure it using nine (9) previously removed retention screws.

5.6 Reinstalling the Covers

**WARNING:**

Failing to reinstall the covers may result in permanent damage to the system. Please make sure all coverings are properly installed.

When maintenance procedures are complete, please make sure all the covers are replaced, including the following:

- Aluminum internal cover
- Plastic back cover
- Plastic HDD cover

Chapter

6

AMI BIOS Setup

AFL2-12A-D525 Series Panel PC

6.1 Introduction

A licensed copy of the BIOS is preprogrammed into the ROM BIOS. The BIOS setup program allows users to modify the basic system configuration. This chapter describes how to access the BIOS setup program and the configuration options that may be changed.

6.1.1 Starting Setup

The UEFI BIOS is activated when the computer is turned on. The setup program can be activated in one of two ways.

1. Press the **F2** key as soon as the system is turned on or
2. Press the **F2** key when the “**Press F2 to enter SETUP**” message appears on the screen.

If the message disappears before the **F2** key is pressed, restart the computer and try again.

6.1.2 Using Setup

Use the arrow keys to highlight items, press **ENTER** to select, use the PageUp and PageDown keys to change entries, press **F1** for help and press **ESC** to quit. Navigation keys are shown in the following table.

Key	Function
Up arrow	Move to the item above
Down arrow	Move to the item below
Left arrow	Move to the item on the left hand side
Right arrow	Move to the item on the right hand side
+	Increase the numeric value or make changes
-	Decrease the numeric value or make changes
Page Up key	Move to the next page
Page Dn key	Move to the previous page

Esc key	Main Menu – Quit and do not save changes into CMOS Status Page Setup Menu and Option Page Setup Menu -- Exit current page and return to Main Menu
F1 key	General help, only for Status Page Setup Menu and Option Page Setup Menu
F9 key	Load optimized defaults
F10 key	Save changes and Exit BIOS

Table 6-1: BIOS Navigation Keys

6.1.3 Getting Help

When **F1** is pressed a small help window describing the appropriate keys to use and the possible selections for the highlighted item appears. To exit the Help Window press **Esc** or the **F1** key again.

6.1.4 Unable to Reboot After Configuration Changes

If the computer cannot boot after changes to the system configuration are made, CMOS defaults. Use the jumper described in **Chapter 4**.

6.1.5 BIOS Menu Bar

The **menu bar** on top of the BIOS screen has the following main items:

- **Main** Changes the basic system configuration.
- **Advanced** Changes the advanced system settings.
- **Chipset** Changes the chipset settings
- **Boot** Changes the system boot configuration.
- **Security** Sets User and Supervisor Passwords.
- **Save & Exit** Selects exit options and loads default settings

The following sections completely describe the configuration options found in the menu items at the top of the BIOS screen and listed above.

AFL2-12A-D525 Series Panel PC

6.2 Main

The **Main** BIOS menu (**BIOS Menu 1**) appears when the **BIOS Setup** program is entered. The **Main** menu gives an overview of the basic system information.

Aptio Setup Utility - Copyright (C) 2010 American Megatrends, Inc.					
Main	Advanced	Chipset	Boot	Security	Save & Exit
BIOS Information					Set the Date. Use Tab to switch between Data elements.
BIOS Vendor			American Megatrends		
Core Version			4.6.4.0 0.20		
Compliancy			UEFI 2.0		
Project Version			SC55AR11.ROM		
Build Date and Time			07/20/2011 16:55:39		-----
iWDD Vendor			ICP		←→: Select Screen
iWDD Version			SC55ER13.bin		↑ ↓: Select Item
System Date			[Fri 01/01/2010]		EnterSelect
System Time			[00:21:27]		+/-: Change Opt.
Access Level			Administrator		F1: General Help
					F2: Previous Values
					F3: Optimized Defaults
					F4: Save & Exit
					ESC: Exit
Version 2.10.1208. Copyright (C) 2010 American Megatrends, Inc.					

BIOS Menu 1: Main

→ System Overview

The **System Overview** lists a brief summary of different system components. The fields in **System Overview** cannot be changed. The items shown in the system overview include:

- **BIOS Vendor:** Installed BIOS vendor
- **Core Version:** Current BIOS version
- **Compliancy:** Current BIOS compliant version
- **Project Version:** The board version
- **Build Date and Time:** Date the current BIOS version was made
- **Access Level:** User access level

The **System Overview** field also has two user configurable fields:

→ System Date [xx/xx/xx]

Use the **System Date** option to set the system date. Manually enter the day, month and year.

→ **System Time [xx:xx:xx]**

Use the **System Time** option to set the system time. Manually enter the hours, minutes and seconds.

6.3 Advanced

Use the **Advanced** menu (**BIOS Menu 2**) to configure the CPU and peripheral devices through the following sub-menus:



WARNING:

Setting the wrong values in the sections below may cause the system to malfunction. Make sure that the settings made are compatible with the hardware.

- ACPI Settings
- CPU Configuration
- IDE Configuration
- USB Configuration
- Super IO Configuration
- H/W Monitor
- Serial Port Console Redirection
- iEi Feature

AFL2-12A-D525 Series Panel PC

```

Aptio Setup Utility - Copyright (C) 2010 American Megatrends, Inc.
Main  Advanced  Chipset  Boot  Security  Save & Exit

> ACPI Settings
> CPU Configuration
> IDE Configuration
> USB Configuration
> Super IO Configuration
> H/M Monitor
> Serial Port Console Redirection
> iEi Feature

System ACPI Parameters.

-----

<=>: Select Screen
↑↓: Select Item
Enter>Select
+/-: Change Opt.
F1: General Help
F2: Previous Values
F3: Optimized Defaults
F4: Save & Exit
ESC: Exit

Version 2.10.1208. Copyright (C) 2010 American Megatrends, Inc.
  
```

BIOS Menu 2: Advanced

6.3.1 ACPI Settings

The **ACPI Settings** menu (**BIOS Menu 3**) configures the Advanced Configuration and Power Interface (ACPI) options.

```

Aptio Setup Utility - Copyright (C) 2010 American Megatrends, Inc.
Advanced

ACPI Sleep State          [S1 (CPU Stop Clock)]
Power Saving Function     [Disabled]

Select the highest ACPI
sleep state the system
will enter, when the
SUSPEND button is
pressed.

-----

<=>: Select Screen
↑↓: Select Item
Enter>Select
+/-: Change Opt.
F1: General Help
F2: Previous Values
F3: Optimized Defaults
F4: Save & Exit
ESC: Exit

Version 2.10.1208. Copyright (C) 2010 American Megatrends, Inc.
  
```

BIOS Menu 3: ACPI Configuration

➔ **ACPI Sleep State [S1 (CPU Stop Clock)]**

Use the **ACPI Sleep State** option to specify the sleep state the system enters when it is not being used.

- ➔ **S1 (CPU Stop Clock)** **DEFAULT** The system enters S1 (POS) sleep state. The system appears off. The CPU is stopped; RAM is refreshed; the system is running in a low power mode.
- ➔ **S3 (Suspend to RAM)** The caches are flushed and the CPU is powered off. Power to the RAM is maintained. The computer returns slower to a working state, but more power is saved.

➔ **Power Saving Function [Disabled]**

Use the **Power Saving Function** option to enable power saving.

- ➔ **Disabled** **DEFAULT** Power saving disabled.
- ➔ **Enabled** Power saving is enabled.

6.3.2 CPU Configuration

Use the **CPU Configuration** menu (**BIOS Menu 4**) to view detailed CPU specifications and configure the CPU.

AFL2-12A-D525 Series Panel PC

Aptio Setup Utility - Copyright (C) 2010 American Megatrends, Inc.

Advanced

CPU Configuration		Enabled for Windows XP and Linux (OS optimized for Hyper-Threading Technology) and Disabled for other OS (OS not optimized for Hyper-Threading Technology).
Processor Type	Intel(R) Atom(TM) CPU D525 @ 1.80GHz	
EMT64	Supported	
Processor Speed	1800 MHz	
System Bus Speed	800 MHz	
Ratio Status	9	
Actual Ratio	9	
Processor Stepping	106ca	
Microcode Revision	263	
L1 Cache RAM	2x56 k	←→: Select Screen
L2 Cache RAM	2x512 k	↑ ↓: Select Item
Processor Core	Dual	Enter>Select
Hyper-Threading	Supported	+/-: Change Opt.
Hyper-Threading	[Enabled]	F1: General Help
		F2: Previous Values
		F3: Optimized Defaults
		F4: Save & Exit
		ESC: Exit

Version 2.10.1208. Copyright (C) 2010 American Megatrends, Inc.

BIOS Menu 4: CPU Configuration

The CPU Configuration menu (**BIOS Menu 4**) lists the following CPU details:

- Processor Type: Lists the brand name of the CPU being used
- EMT64: Indicates if EM64T is supported by the CPU.
- Processor Speed: Lists the CPU processing speed
- System Bus Speed: Lists the system bus speed
- Ratio Status: Lists the ratio status
- Actual Ratio: Lists the actual ratio
- Processor Stepping: Lists the CPU processing stepping
- Microcode Revision: Lists the microcode revision
- L1 Cache RAM: Lists the amount of storage space on the L1 Cache
- L2 Cache RAM: Lists the amount of storage space on the L2 Cache
- Processor Core: Lists the number of the processor cores
- Hyper-Threading: Indicates if Hyper-Threading is supported by the CPU.

6.3.3 IDE Configuration

Use the **IDE Configuration** menu (**BIOS Menu 5**) to change and/or set the configuration of the SATA devices installed in the system.

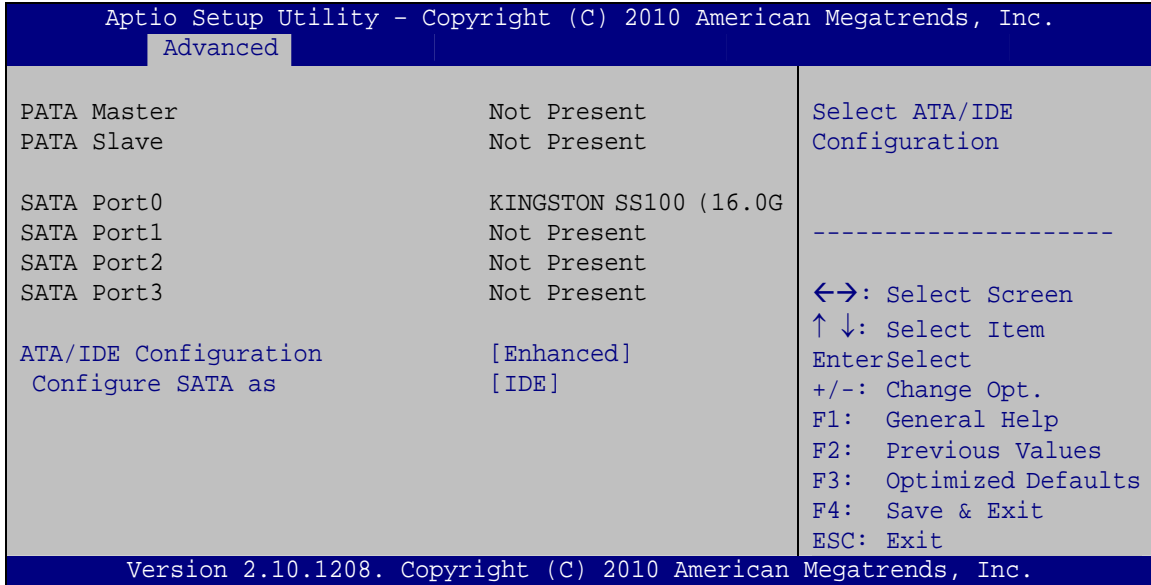

BIOS Menu 5: IDE Configuration

→ ATA/IDE Configuration [Enhanced]

Use the **ATA/IDE Configuration** option to configure the SATA controller.

- **Disabled** Disables the on-board SATA controller.
- **Compatible** **DEFAULT** Configures the on-board SATA controller to be in compatible mode. In this mode, a SATA channel will replace one of the IDE channels. This mode supports up to 6 storage devices.
- **Enhanced** Configures the on-board SATA controller to be in Enhanced mode. In this mode, IDE channels and SATA channels are separated.

→ Configure SATA as [IDE]

Use the **SATA Mode** option to configure SATA devices as normal IDE devices.

AFL2-12A-D525 Series Panel PC

- ➔ **IDE** **DEFAULT** Configures SATA devices as normal IDE device.
- ➔ **AHCI** Configures SATA devices as AHCI device.

6.3.4 USB Configuration

Use the **USB Configuration** menu (**BIOS Menu 6**) to read USB configuration information and configure the USB settings.

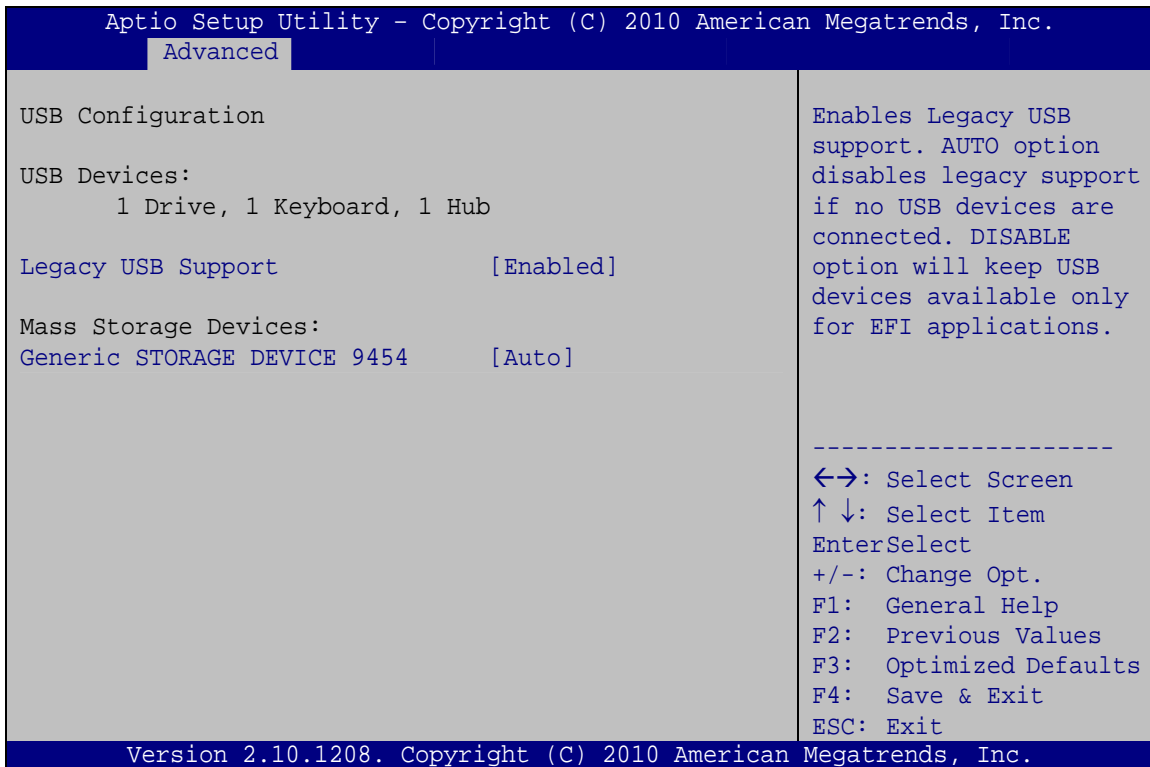

BIOS Menu 6: USB Configuration

➔ **USB Devices**

The **USB Devices Enabled** field lists the USB devices that are enabled on the system

➔ **Legacy USB Support [Enabled]**

Use the **Legacy USB Support** BIOS option to enable USB mouse and USB keyboard support. Normally if this option is not enabled, any attached USB mouse or USB keyboard does not become available until a USB compatible operating system is fully booted with all USB drivers loaded. When this option is enabled, any attached USB mouse or USB

keyboard can control the system even when there is no USB driver loaded onto the system.

- ➔ **Enabled** **DEFAULT** Legacy USB support enabled
- ➔ **Disabled** Legacy USB support disabled
- ➔ **Auto** Legacy USB support disabled if no USB devices are connected

➔ **Generic STORAGE DEVICE 9454 [Auto]**

Use the **Generic STORAGE DEVICE 9454** BIOS option to configure the storage device.

- ➔ **Auto** **DEFAULT** Automatically detects storage device.
- ➔ **Floppy** Sets the storage device as floppy.
- ➔ **Forced FDD** Sets the storage device as forced FDD.
- ➔ **Hard Disk** Sets the storage device as HDD.
- ➔ **CD-ROM** Sets the storage device as CD-ROM.

AFL2-12A-D525 Series Panel PC

6.3.5 Super IO Configuration

Use the **Super IO Configuration** menu (**BIOS Menu 7**) to set or change the configurations for the FDD controllers, parallel ports and serial ports.

```

Aptio Setup Utility - Copyright (C) 2010 American Megatrends, Inc.
  Advanced
-----
Super IO Configuration                               Set Parameters of Serial
                                                    Port 0 (COMA)
                                                    -----
Super IO Chip                                     Fintek F81865
> Serial Port 0 Configuration
> Serial Port 2 Configuration
> Serial Port 5 Configuration
                                                    <=>: Select Screen
                                                    ↑ ↓: Select Item
                                                    EnterSelect
                                                    +/-: Change Opt.
                                                    F1:  General Help
                                                    F2:  Previous Values
                                                    F3:  Optimized Defaults
                                                    F4:  Save & Exit
                                                    ESC: Exit
Version 2.10.1208. Copyright (C) 2010 American Megatrends, Inc.
  
```

BIOS Menu 7: Super IO Configuration

6.3.5.1 Serial Port n Configuration

Use the **Serial Port n Configuration** menu (**BIOS Menu 8**) to configure the serial port n.

```

Aptio Setup Utility - Copyright (C) 2010 American Megatrends, Inc.
  Advanced
-----
Serial Port 0 Configuration                       Enable or Disable Serial
                                                    Port (COM)
                                                    -----
Serial Port                                     [Enabled]
Device Settings                                IO=3F8h; IRQ=4
Change Settings                                 [Auto]
                                                    <=>: Select Screen
                                                    ↑ ↓: Select Item
                                                    EnterSelect
                                                    +/-: Change Opt.
                                                    F1:  General Help
                                                    F2:  Previous Values
                                                    F3:  Optimized Defaults
                                                    F4:  Save & Exit
                                                    ESC: Exit
Version 2.10.1208. Copyright (C) 2010 American Megatrends, Inc.
  
```

BIOS Menu 8: Serial Port n Configuration Menu

AFL2-12A-D525 Series Panel PC

- ➔ **Auto** **DEFAULT** The serial port IO port address and interrupt address are automatically detected.
- ➔ **IO=3E8h;**
IRQ=11 Serial Port I/O port address is 3E8h and the interrupt address is IRQ11
- ➔ **IO=3E8h;**
IRQ=10,11 Serial Port I/O port address is 3E8h and the interrupt address is IRQ10,11
- ➔ **IO=2E8h;**
IRQ=10, 11 Serial Port I/O port address is 2E8h and the interrupt address is IRQ10,11

6.3.5.1.3 Serial Port 5 Configuration

➔ Serial Port [Enabled]

Use the **Serial Port** option to enable or disable the serial port.

- ➔ **Disabled** Disable the serial port
- ➔ **Enabled** **DEFAULT** Enable the serial port

➔ Select Serial Mode [Auto]

Use the **Select Serial Mode** option to set the serial port communication mode.

- ➔ **RS422** Serial port mode is set to RS-422 communications.
- ➔ **RS485** Serial port mode is set to RS-485 communications.
- ➔ **Auto** **DEFAULT** Serial port mode is set to Auto.

➔ Change Settings [Auto]

Use the **Change Settings** option to change the serial port IO port address and interrupt address.

- ➔ **Auto** **DEFAULT** The serial port IO port address and interrupt address are automatically detected.

- ➔ **IO=2D0h;**
IRQ=10 Serial Port I/O port address is 2D0h and the interrupt address is IRQ10
- ➔ **IO=2E0h;**
IRQ=10, 11 Serial Port I/O port address is 2E0h and the interrupt address is IRQ10, 11
- ➔ **IO=2D0h;**
IRQ=10, 11 Serial Port I/O port address is 2D0h and the interrupt address is IRQ10, 11
- ➔ **IO=2D8h;**
IRQ=10, 11 Serial Port I/O port address is 2D8h and the interrupt address is IRQ10, 11
- ➔ **IO=2B0h;**
IRQ=10, 11 Serial Port I/O port address is 2B0h and the interrupt address is IRQ10, 11

6.3.6 H/W Monitor

The H/W Monitor menu (**BIOS Menu 9**) shows the operating temperature, fan speeds and system voltages.

```

Aptio Setup Utility - Copyright (C) 2010 American Megatrends, Inc.
  Advanced
PC Health Status
CPU Temperature           :+49 C
Accuracy: 1. -5 ~ +10 degree around 100 degree.
                2. -10 ~ +15 degree around 50 degree.
SYS Temperature           :+37 C
CPU FAN Speed             :N/A
VCC3V                     :+3.328 V
V_core                    :+1.144 V
+1.05S                    :+1.040 V
Vcc3S                     :+3.357 V
Vcc5V                     :+5.045 V
VSB3V                    :+3.328 V
VBAT                      :+3.232 V
-----
<->: Select Screen
↑ ↓: Select Item
Enter>Select
+/-: Change Opt.
F1:  General Help
F2:  Previous Values
F3:  Optimized Defaults
F4:  Save & Exit
ESC: Exit
Version 2.10.1208. Copyright (C) 2010 American Megatrends, Inc.
  
```

BIOS Menu 9: Hardware Health Configuration

AFL2-12A-D525 Series Panel PC

→ PC Health Status

The following system parameters and values are shown. The system parameters that are monitored are:

- System Temperatures:
 - CPU Temperature
 - System Temperature
- Fan Speeds:
 - CPU Fan Speed
- Voltages:
 - VCC3V
 - V_core
 - +V1.05S
 - +Vcc3S
 - +Vcc5V
 - VSB3V
 - VBAT

6.3.7 Serial Port Console Redirection

The **Serial Port Console Redirection** menu (**BIOS Menu 10**) allows the console redirection options to be configured. Console redirection allows users to maintain a system remotely by re-directing keyboard input and text output through the serial port.

```

Aptio Setup Utility - Copyright (C) 2010 American Megatrends, Inc.
  Advanced
COM1
Console Redirection          [Disabled]      Console Redirection
> Console Redirection Settings      Enable or Disable.

COM3
Console Redirection          [Disabled]
> Console Redirection Settings

-----
<=>: Select Screen
↑↓: Select Item
Enter/Select
+/-: Change Opt.
F1:  General Help
F2:  Previous Values
F3:  Optimized Defaults
F4:  Save & Exit
ESC: Exit

Version 2.10.1208. Copyright (C) 2010 American Megatrends, Inc.
  
```

BIOS Menu 10: Serial Port Console Redirection

→ Console Redirection [Disabled]

Use **Console Redirection** option to enable or disable the console redirection function.

- **Disabled** **DEFAULT** Disabled the console redirection function
- **Enabled** Enabled the console redirection function

AFL2-12A-D525 Series Panel PC

6.4 iEi Feature

Use the **iEi Feature** menu (**BIOS Menu 11**) to configure the auto recovery function.

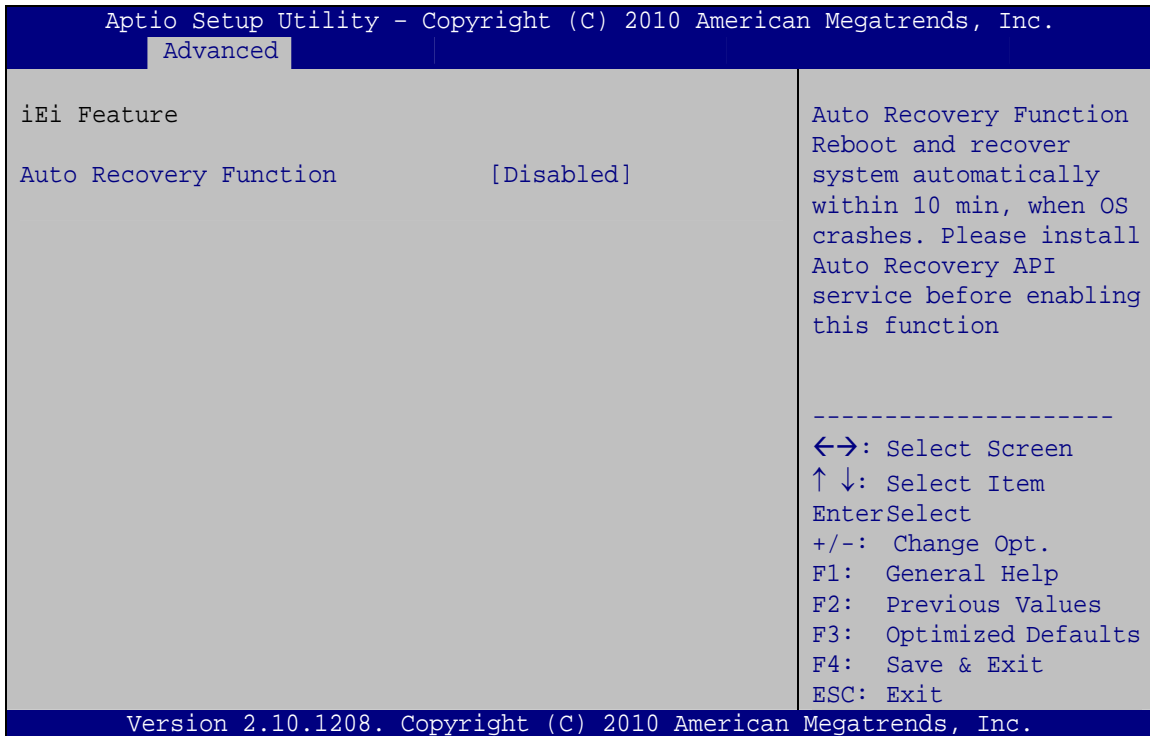

BIOS Menu 11: iEi Feature

➔ Auto Recovery Function [Disabled]

Use the **Auto Recovery Function** option to enable or disable auto recovery on the system.

- ➔ **Disabled** **DEFAULT** Auto Recovery Function support disabled
- ➔ **Enabled** Auto Recovery Function support enabled

6.5 Chipset

Use the **Chipset** menu (**BIOS Menu 12**) to access the Northbridge and Southbridge configuration menus



WARNING!

Setting the wrong values for the Chipset BIOS selections in the Chipset BIOS menu may cause the system to malfunction.

```
Aptio Setup Utility - Copyright (C) 2010 American Megatrends, Inc.
Main   Advanced  Chipset  Boot   Security  Save & Exit
-----
> Host Bridge                Host Bridge Parameters
> South Bridge
> Intel IGD SWSCI OpRegion

-----
<=>: Select Screen
↑ ↓: Select Item
EnterSelect
+/-: Change Opt.
F1:  General Help
F2:  Previous Values
F3:  Optimized Defaults
F4:  Save & Exit
ESC: Exit

Version 2.10.1208. Copyright (C) 2010 American Megatrends, Inc.
```

BIOS Menu 12: Chipset

AFL2-12A-D525 Series Panel PC

6.5.1 Host Bridge Configuration

Use the **Host Bridge Configuration** menu (**BIOS Menu 13**) to configure the host bridge chipset.

```

Aptio Setup Utility - Copyright (C) 2010 American Megatrends, Inc.
  Chipset
*****Memory Information*****
Memory Frequency           800 Mhz
Total Memory               1024 MB
DIMM#0                     1024 MB

-----
<->: Select Screen
↑ ↓: Select Item
EnterSelect
+/-: Change Opt.
F1:  General Help
F2:  Previous Values
F3:  Optimized Defaults
F4:  Save & Exit
ESC: Exit

Version 2.10.1208. Copyright (C) 2010 American Megatrends, Inc.
  
```

BIOS Menu 13: Host Bridge Chipset Configuration

6.5.2 South Bridge Configuration

Use the **South Bridge Configuration** menu (**BIOS Menu 14**) to configure the south bridge chipset.

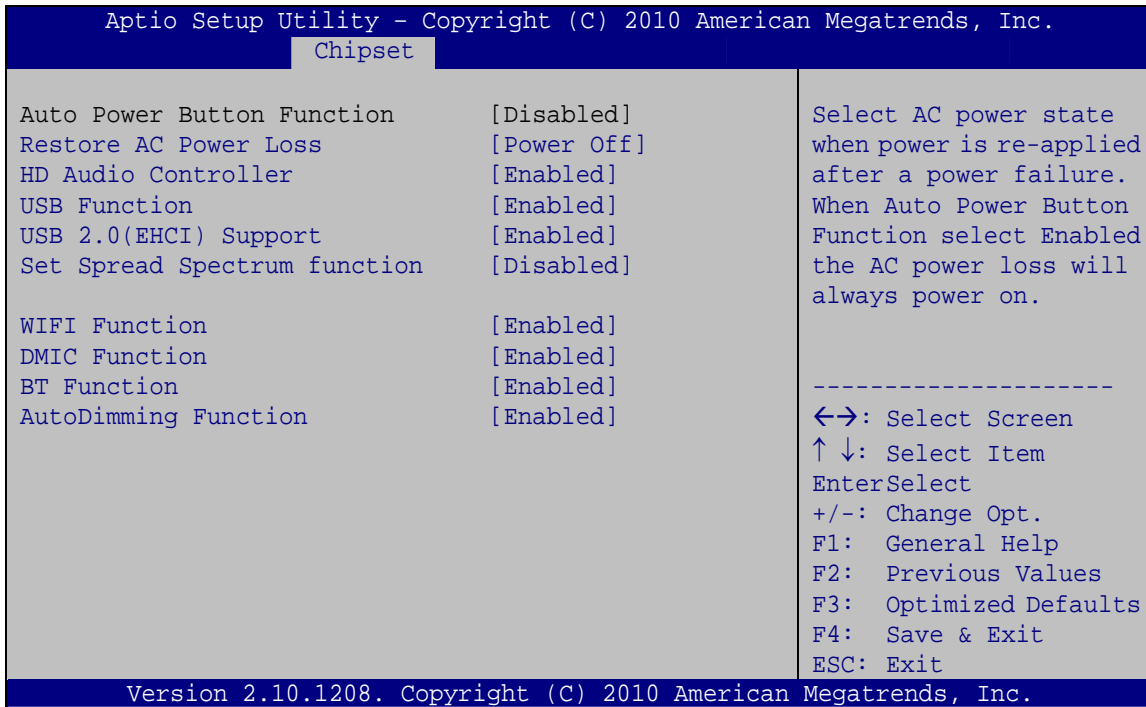

BIOS Menu 14: Southbridge Chipset Configuration

→ Restore AC Power Loss [Power Off]

Use the **Restore AC Power Loss** BIOS option to specify what state the system returns to if there is a sudden loss of power to the system.

- **Power Off** **DEFAULT** The system remains turned off
- **Power On** The system turns on
- **Last State** The system returns to its previous state. If it was on, it turns itself on. If it was off, it remains off.

→ HD Audio Controller [Enabled]

Use the **HD Audio Controller** option to enable or disable the High Definition Audio controller.

AFL2-12A-D525 Series Panel PC

- **Disabled** The onboard High Definition Audio controller is disabled
- **Enabled DEFAULT** The onboard High Definition Audio controller automatically detected and enabled

→ **USB Function [Enabled]**

Use the **USB Function** BIOS option to enable or disable USB function support.

- **Disabled** USB function support disabled
- **Enabled DEFAULT** USB function support enabled

→ **USB 2.0(EHCI) Support [Enabled]**

Use the **USB 2.0 (EHCI) Support** BIOS option to enable or disable the USB 2.0 controller

- **Disabled** USB 2.0 controller disabled
- **Enabled DEFAULT** USB 2.0 controller enabled

→ **Set Spread Spectrum function [Disabled]**

Use the **Set Spread Spectrum function** option to enable or disable the Set Spread Spectrum function.

- **Disabled DEFAULT** Set Spread Spectrum is disabled
- **Enabled** Set Spread Spectrum is enabled

→ **WIFI Function [Enabled]**

Use the **WIFI Function** option to enable or disable the Wi-Fi function.

- **Disabled** Wi-Fi function disabled
- **Enabled DEFAULT** Wi-Fi function enabled

→ **DMIC Function [Enabled]**

Use the **DMIC Function** option to enable or disable the DMIC function.

- ➔ Disabled DMIC function disabled
- ➔ Enabled **DEFAULT** DMIC function enabled

➔ BT Function [Enabled]

Use the **BT Function** option to enable or disable the BT function.

- ➔ Disabled BT function disabled
- ➔ Enabled **DEFAULT** BT function enabled

➔ AutoDimming Function [Enabled]

Use the **AutoDimming Function** option to enable or disable the auto dimming function.

- ➔ Disabled Auto dimming function disabled
- ➔ Enabled **DEFAULT** Auto dimming function enabled

6.5.3 Intel IGD SWSCI OpRegion

Use the **Intel IGD SWSCI OpRegion** menu (**BIOS Menu 15**) to configure the video device connected to the system.

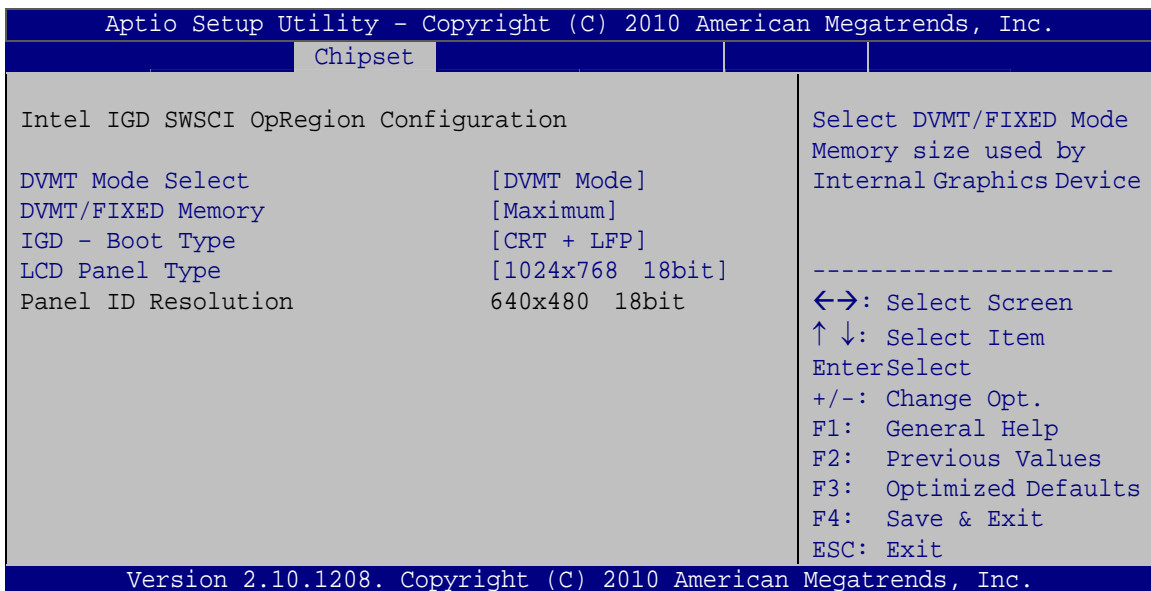

BIOS Menu 15: Intel IGD SWSCI OpRegion

AFL2-12A-D525 Series Panel PC

→ DVMT Mode Select [DVMT Mode]

Use the **DVMT Mode Select** option to select the Intel Dynamic Video Memory Technology (DVMT) operating mode.

- **Fixed Mode** **DEFAULT** A fixed portion of graphics memory is reserved as graphics memory.
- **DVMT Mode** Graphics memory is dynamically allocated according to the system and graphics needs.

→ DVMT/FIXED Memory [Maximum]

Use the **DVMT/FIXED Memory** option to specify the maximum amount of memory that can be allocated as graphics memory. Configuration options are listed below.

- 128 MB
- 256 MB
- Maximum **Default**

→ IGD - Boot Type [CRT + LFP]

Use the **IGD - Boot Type** option to select the display device used by the system when it boots. Configuration options are listed below.

- VBIOS Default
- CRT
- LFP
- CRT + LFP **DEFAULT**

→ LCD Panel Type [1024x768 18bit]

Use the **LCD Panel Type** option to select the type of flat bezel panel connected to the system. Configuration options are listed below.

- Select by Panel ID
- 640x480 18bit
- 800x480 18bit
- 800x600 18bit

- 1024x768 18bit **DEFAULT**
- 1280x1024 18bit
- 1366x768 18bit
- 1280x800 18bit
- 1280x600 18bit

6.6 Boot

Use the **Boot** menu (**BIOS Menu 16**) to configure system boot options.

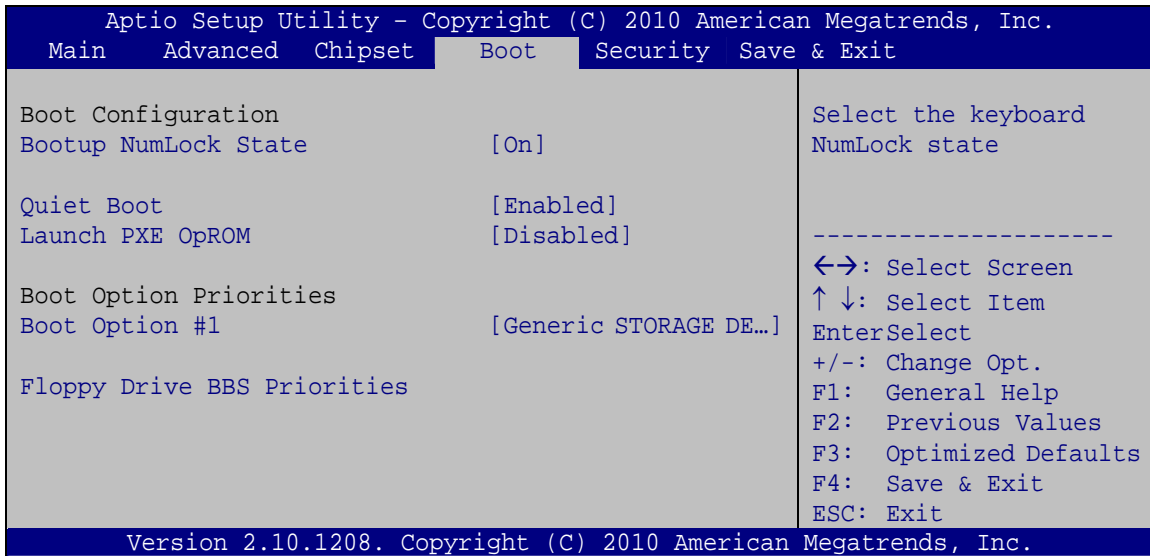

BIOS Menu 16: Boot

→ Bootup NumLock State [On]

Use the **Bootup NumLock State** BIOS option to specify if the number lock setting must be modified during boot up.

- **On** **DEFAULT** Allows the Number Lock on the keyboard to be enabled automatically when the computer system boots up. This allows the immediate use of the 10-key numeric keypad located on the right side of the keyboard. To confirm this, the Number Lock LED light on the keyboard is lit.

AFL2-12A-D525 Series Panel PC

→ **Off** Does not enable the keyboard Number Lock automatically. To use the 10-keys on the keyboard, press the Number Lock key located on the upper left-hand corner of the 10-key pad. The Number Lock LED on the keyboard lights up when the Number Lock is engaged.

→ **Quiet Boot [Enabled]**

Use the **Quiet Boot** BIOS option to select the screen display when the system boots.

→ **Disabled** Normal POST messages displayed

→ **Enabled** **DEFAULT** OEM Logo displayed instead of POST messages

→ **Launch PXE OpROM [Disabled]**

Use the **Launch PXE OpROM** option to enable or disable boot option for legacy network devices.

→ **Disabled** **DEFAULT** Ignore all PXE Option ROMs

→ **Enabled** Load PXE Option ROMs

→ **Boot Option #1 [Generic STORAGE DE...]**

Use **Boot Option #1** to enable or disable booting from the detected drive.

→ **Generic** **DEFAULT** Enables booting from the detected storage device.
STORAGE DE...

→ **Disabled** Disables boot option.

→ **Hard Drive BBS Priorities**

Use **Hard Drive BBS Priorities** option to set the system boot order.

6.7 Security

Use the **Security** menu (**BIOS Menu 17**) to set system and user passwords.

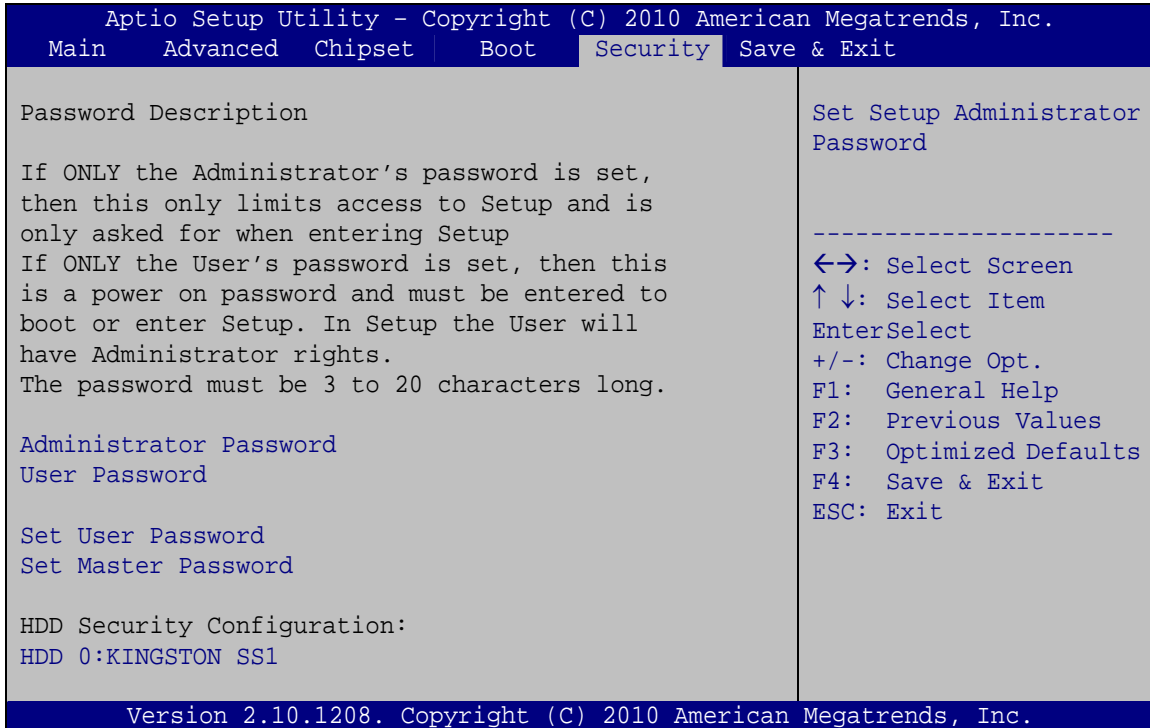

BIOS Menu 17: Security

→ Administrator Password

Use the **Administrator Password** field to set or change an administrator password.

→ User Password

Use the **User Password** field to set or change a user password.

→ Set User Password

Use the **Set User Password** field to set or change an HDD user password.

AFL2-12A-D525 Series Panel PC



NOTE:

It is recommended that the system be reset after setting a new HDD password.

→ Set Master Password

Use the **Set Master Password** field to set or change the master HDD password.



NOTE:

It is recommended that the system be reset after setting a new master HDD password.

→ HDD Password Configuration

The **HDD 0:KINGSTON SS1** submenu displays the HDD password security features supported by the system.

- **Security Supported:** Yes
- **Security Enabled:** No
- **Security Locked:** No
- **Security Frozen:** No
- **HDD User Pwd Status:** Not installed
- **HDD Master Pwd Status:** Installed

6.8 Save & Exit

Use the **Save & Exit** menu (**BIOS Menu 18**) to load default BIOS values, optimal failsafe values and to save configuration changes.

```
Aptio Setup Utility - Copyright (C) 2010 American Megatrends, Inc.
Main   Advanced  Chipset  Boot   Security  Save & Exit

Save Changes and Reset
Discard Changes and Reset

Restore Defaults
Save as User Defaults
Restore User Defaults

Reset the system after
saving the changes.

-----
<->: Select Screen
↑ ↓: Select Item
Enter>Select
+/-: Change Opt.
F1:  General Help
F2:  Previous Values
F3:  Optimized Defaults
F4:  Save & Exit
ESC: Exit

Version 2.10.1208. Copyright (C) 2010 American Megatrends, Inc.
```

BIOS Menu 18: Exit

→ Save Changes and Reset

Use the **Save Changes and Reset** option to save the changes made to the BIOS options and reset the system.

→ Discard Changes and Reset

Use the **Discard Changes and Reset** option to exit the system without saving the changes made to the BIOS configuration setup program.

→ Restore Defaults

Use the **Restore Defaults** option to load the optimal default values for each of the parameters on the Setup menus. **F3 key can be used for this operation.**

AFL2-12A-D525 Series Panel PC

→ Save as User Defaults

Use the **Save as User Defaults** option to save the changes done so far as user defaults.

→ Restore User Defaults

Use the **Restore User Defaults** option to restore the user defaults to all the setup options.

Chapter

7

Software Drivers

AFL2-12A-D525 Series Panel PC

7.1 Available Software Drivers

**NOTE:**

The content of the CD may vary throughout the life cycle of the product and is subject to change without prior notice. Visit the IEI website or contact technical support for the latest updates.

The following drivers can be installed on the system:

- Chipset
- Graphic
- Audio
- Touch Screen
- AMCap

Installation instructions are given below.

7.2 Starting the Driver Program

To access the driver installation programs, please do the following.

Step 1: Insert the CD-ROM that came with the system into a CD-ROM drive attached to the system.

Step 2: Click **AFL2-12A-D525**.

Step 3: A list of available drivers appears.

7.3 Chipset Driver Installation

To install the chipset driver, please do the following.

Step 1: Access the driver list. (See **Section 7.2**)

Step 2: Click **“Chipset.”**

Step 3: Locate the setup file and double click on it.

Step 4: The setup files are extracted as shown in **Figure 7-1**.



Figure 7-1: Chipset Driver Screen

Step 5: When the setup files are completely extracted the **Welcome Screen** in **Figure 7-2** appears.

Step 6: Click **Next** to continue.



Figure 7-2: Chipset Driver Welcome Screen

AFL2-12A-D525 Series Panel PC

Step 7: The license agreement in **Figure 7-3** appears.

Step 8: Read the **License Agreement**.

Step 9: Click **Yes** to continue.



Figure 7-3: Chipset Driver License Agreement

Step 10: The **Read Me** file in **Figure 7-4** appears.

Step 11: Click **Next** to continue.



Figure 7-4: Chipset Driver Read Me File

Step 12: Setup Operations are performed as shown in Figure 7-5.

Step 13: Once the Setup Operations are complete, click Next to continue.



Figure 7-5: Chipset Driver Setup Operations

Step 14: The Finish screen in Figure 7-6 appears.

AFL2-12A-D525 Series Panel PC

Step 15: Select “Yes, I want to restart this computer now” and click **Finish**.



Figure 7-6: Chipset Driver Installation Finish Screen

7.4 Graphics Driver Installation

To install the Graphics driver, please do the following.

Step 1: Access the driver list. (See **Section 7.2**)

Step 2: Click “**Graphic**” and select the folder which corresponds to your operating system.

Step 3: Double click the setup file.

Step 4: The **Read Me** file in **Figure 7-7** appears.

Step 5: Click **Next** to continue.

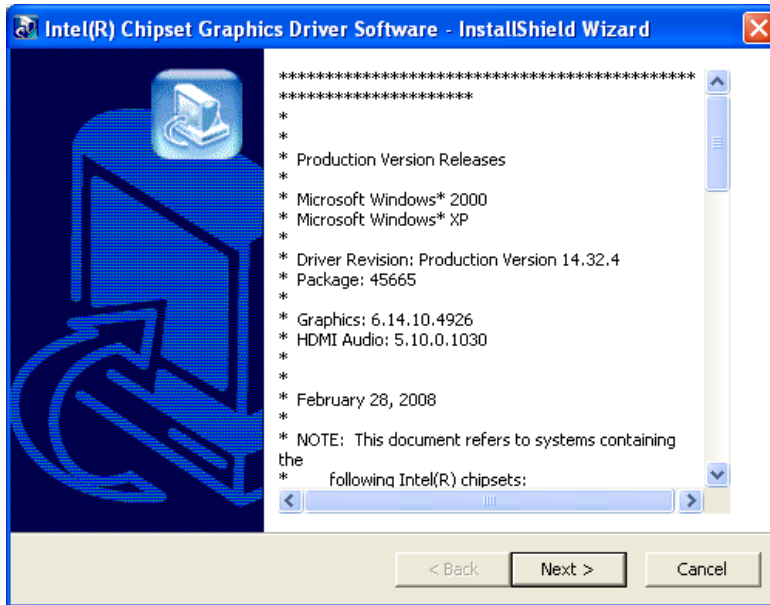

Figure 7-7: Graphics Driver Read Me File

Step 6: The installation files are extracted. See Figure 7-8.

Step 7: Click **Next** to continue.

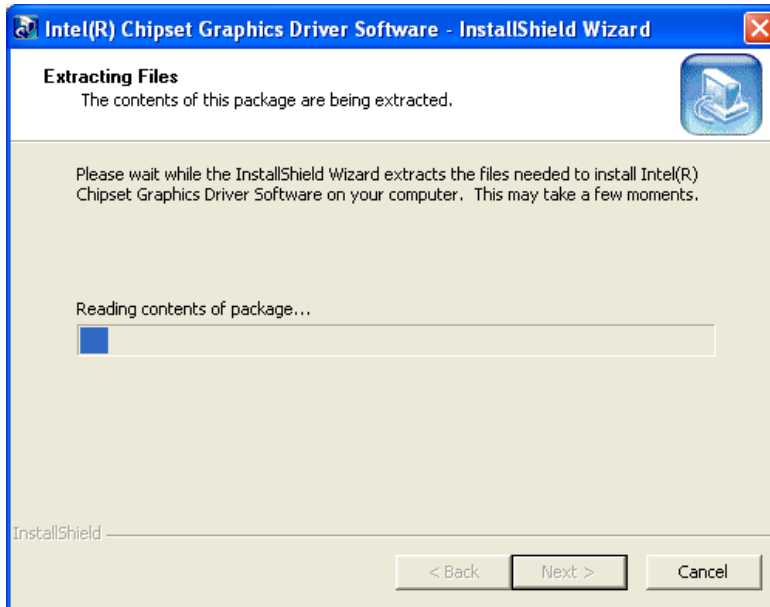

Figure 7-8: Graphics Driver Setup Files Extracted

Step 8: The **Welcome Screen** in Figure 7-9 appears.

Step 9: Click **Next** to continue.

AFL2-12A-D525 Series Panel PC



Figure 7-9: Graphics Driver Welcome Screen

Step 10: The License Agreement in Figure 7-10 appears.

Step 11: Click **Yes** to accept the agreement and continue.

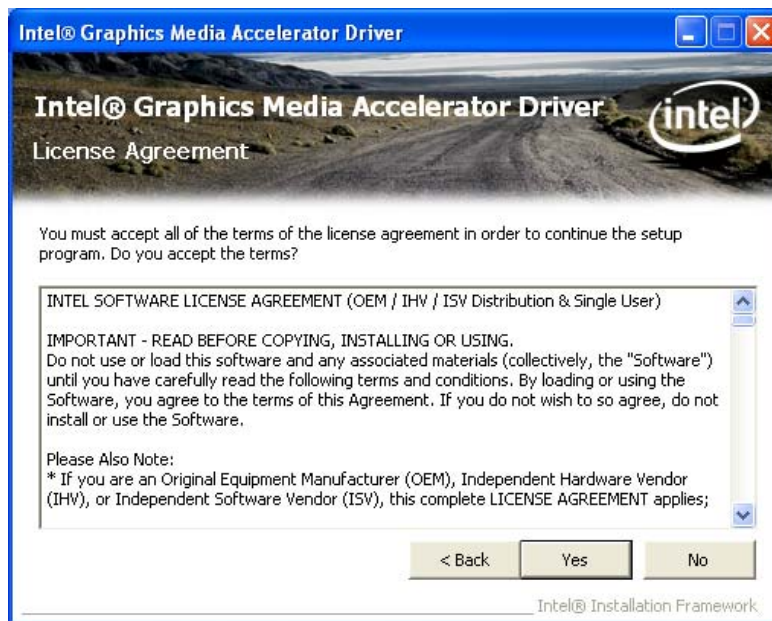

Figure 7-10: Graphics Driver License Agreement

Step 12: The Read Me file in Figure 7-11 appears.

Step 13: Click **Next** to continue.

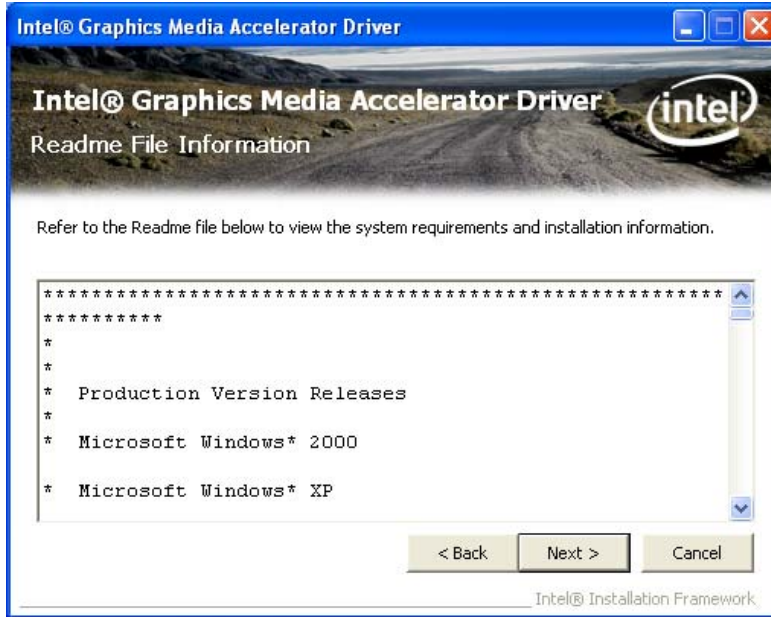

Figure 7-11: Graphics Driver Read Me File

Step 14: Setup Operations are performed as shown in Figure 7-12.

Step 15: Once the Setup Operations are complete, click **Next** to continue.

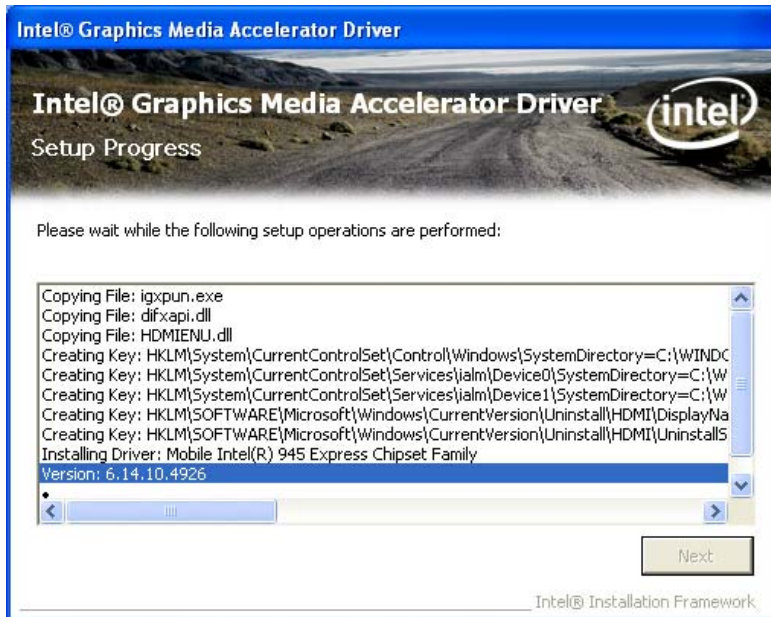

Figure 7-12: Graphics Driver Setup Operations

Step 16: The Finish screen in Figure 7-13 appears.

Step 17: Select “Yes, I want to restart this computer now” and click **Finish**.



Figure 7-13: Graphics Driver Installation Finish Screen

7.5 Audio Driver Installation

To install the audio driver, please do the following.

- Step 1:** Access the driver list. (See **Section 7.2**)
- Step 2:** Click **“Audio”** and select the folder which corresponds to your operating system.
- Step 3:** Double click the setup file.
- Step 4:** The **Audio Driver Welcome Screen** in **Figure 7-14** appears.
- Step 5:** Click **Next** to continue.

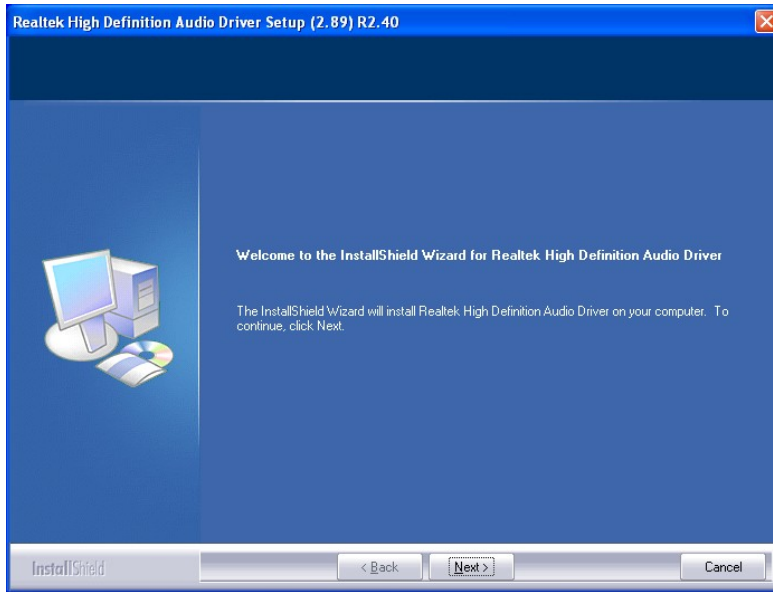

Figure 7-14: Audio Driver Welcome Screen

Step 6: The audio driver installation begins. See **Figure 7-15**.

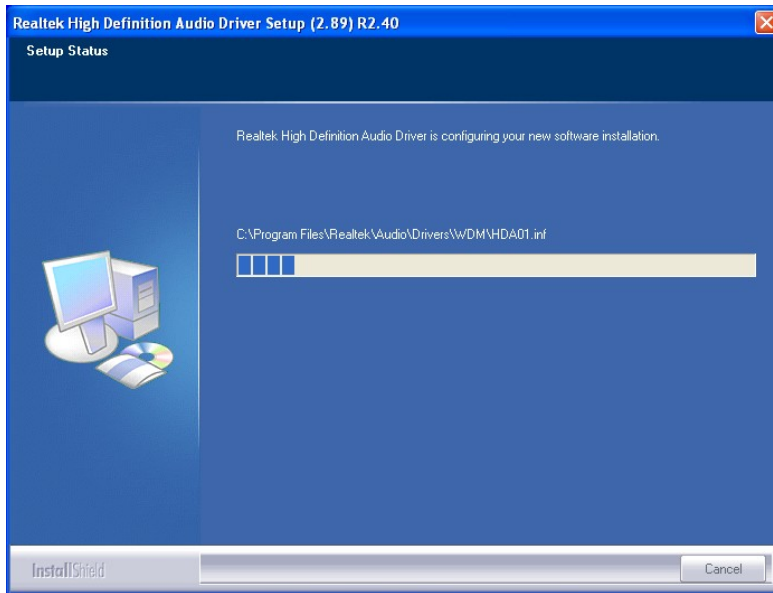

Figure 7-15: Audio Driver Installation

AFL2-12A-D525 Series Panel PC

Step 7: When the installation is complete, the screen in **Figure 7-16** appears.

Step 8: Select “**Yes, I want to restart my computer now**” and click **Finish**.

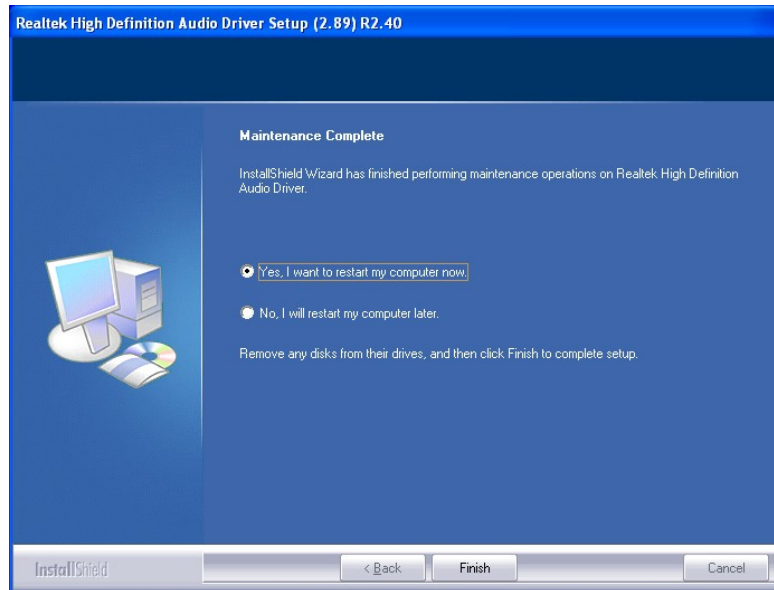

Figure 7-16: AC'97 Driver Installation Complete

7.6 Touch Screen Driver

To install the touch panel software driver, please follow the steps below.

Step 1: Access the driver list. (See **Section 7.2**)

Step 2: Click “**Touch Screen.**”

Step 3: Locate the setup file and double click on it.

Step 4: A **Welcome Screen** appears (**Figure 7-17**).

Step 5: Click **NEXT** to continue.

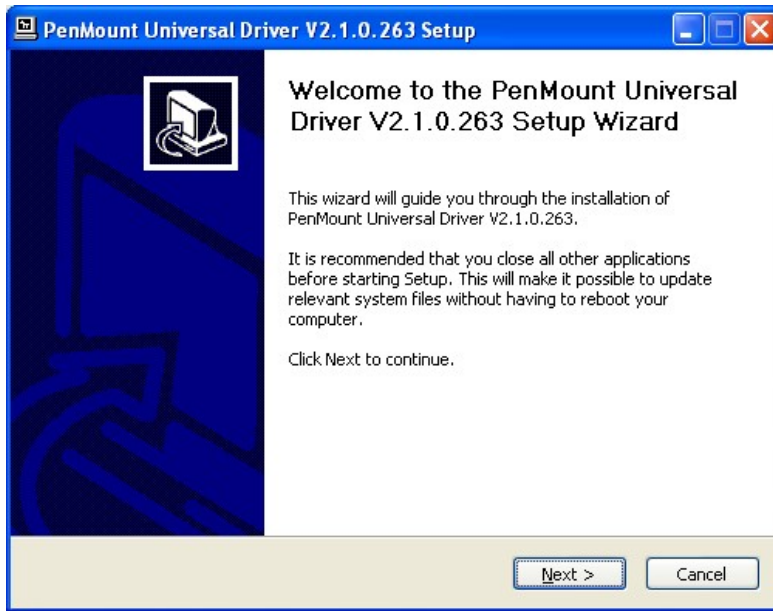

Figure 7-17: Touch Screen Driver Welcome Screen

Step 6: The **License Agreement** shown in **Figure 7-18** appears.

Step 7: Click **I AGREE** to accept and continue.

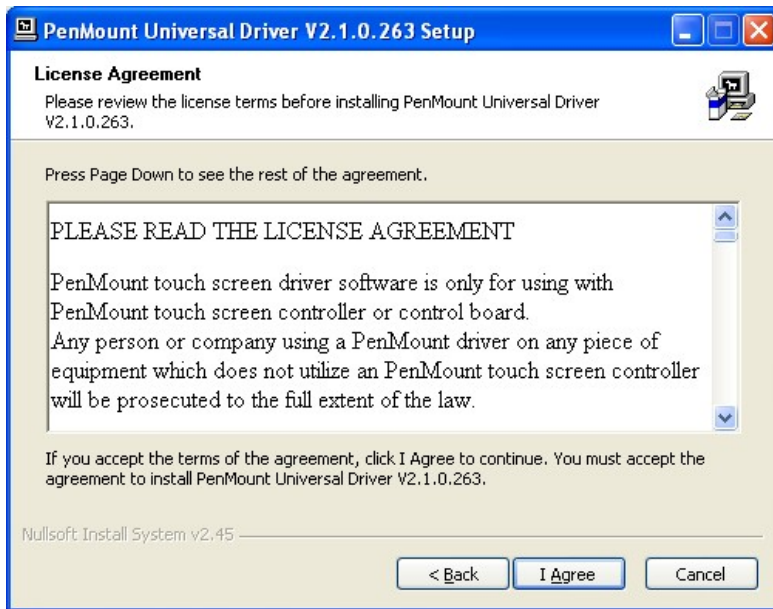

Figure 7-18: Touch Screen Driver License Agreement

Step 8: Browse for an install location or use the one suggested (**Figure 7-19**).

Step 9: Click **INSTALL** to continue.

AFL2-12A-D525 Series Panel PC

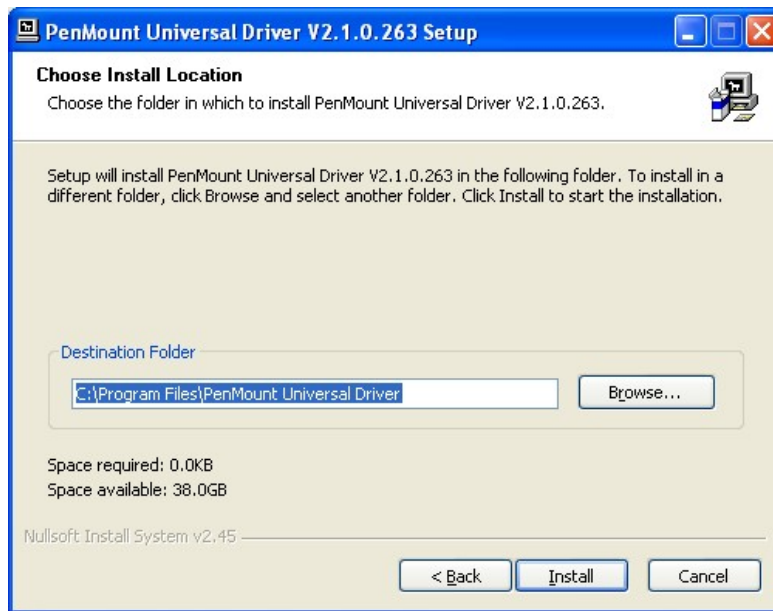

Figure 7-19: Touch Screen Driver Choose Install Location

Step 10: The **Install** screen appears and displays the progress of the installation (**Figure 7-20**).

Step 11: Click **NEXT** to continue.

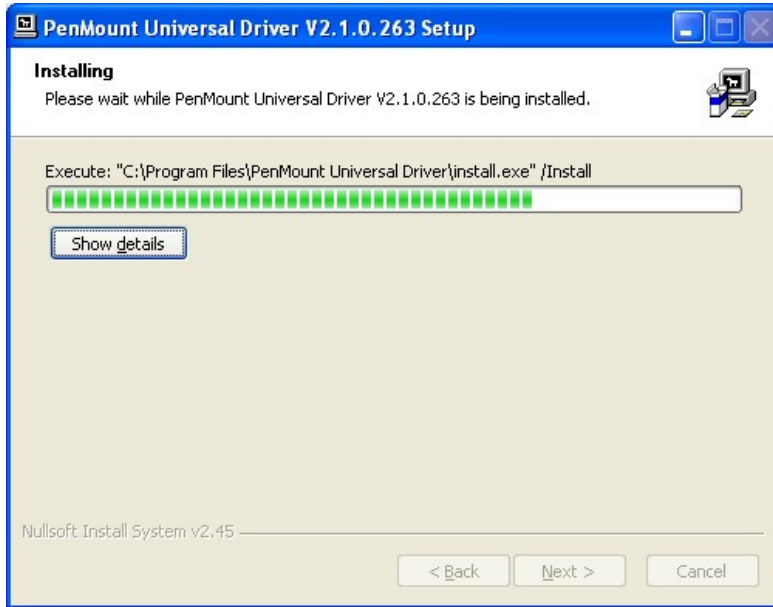

Figure 7-20: Touch Screen Driver Installation Screen

Step 12: When the installation is complete, click **FINISH** to exit setup. (Figure 7-21).

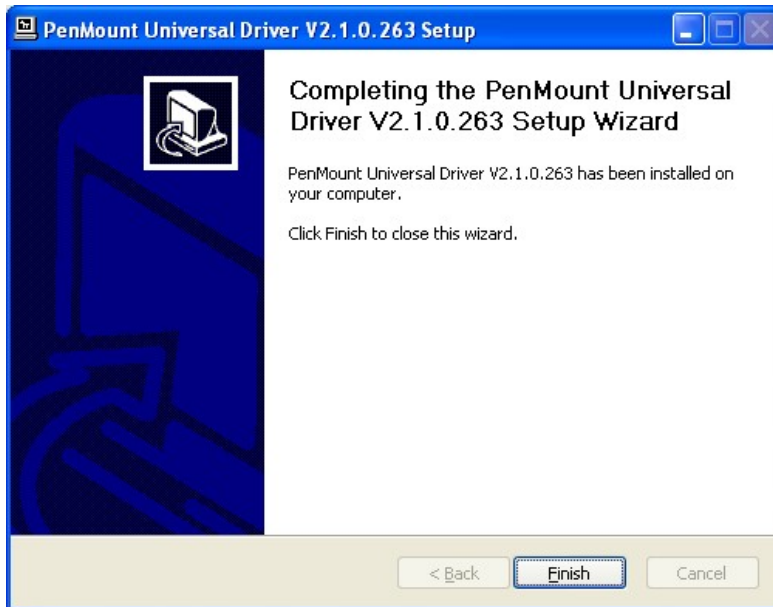

Figure 7-21: Touch Screen Driver Update Complete

AFL2-12A-D525 Series Panel PC

7.6.1 Calibrating the Touch Screen

To calibrate the touch screen cursor with the motion of the touch screen pen (or finger), please follow the steps below:

Step 1: Make sure the touch screen driver is properly installed.

Step 2: Locate the PenMount Monitor icon in the bottom right corner of the screen.



Figure 7-22: PenMount Monitor Icon

Step 3: Click the icon. A pop up menu appears. See **Figure 7-23**.

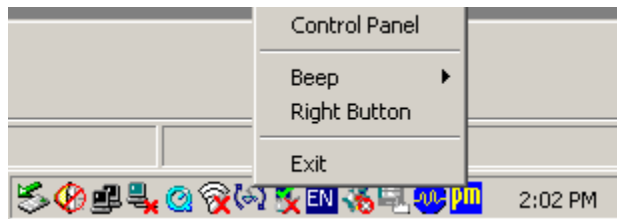

Figure 7-23: PenMount Monitor Popup Menu

Step 4: Click Control Panel in the pop up menu shown in **Figure 7-23**.

Step 5: The configuration screen in **Figure 7-24** appears.

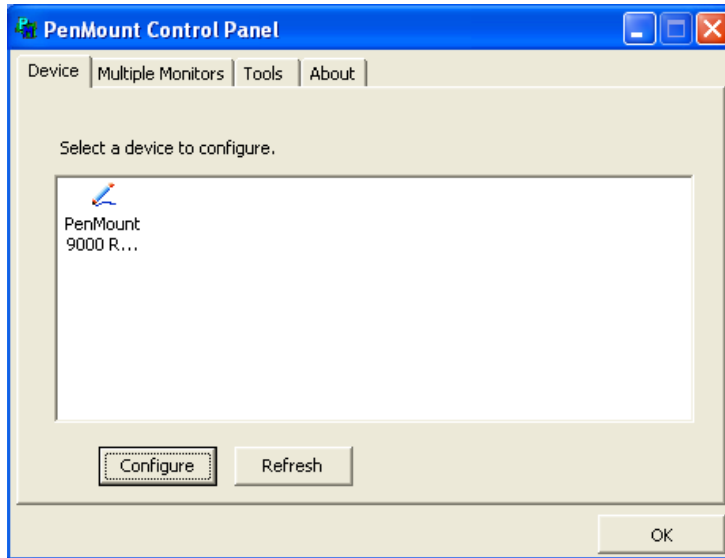

Figure 7-24: Configuration Screen

Step 6: Double click the PenMount 9000 icon as shown in **Figure 7-24**.

Step 7: The calibration initiation screen in **Figure 7-25** appears.

Step 8: Select the **Standard Calibration** button as shown in **Figure 7-25**.

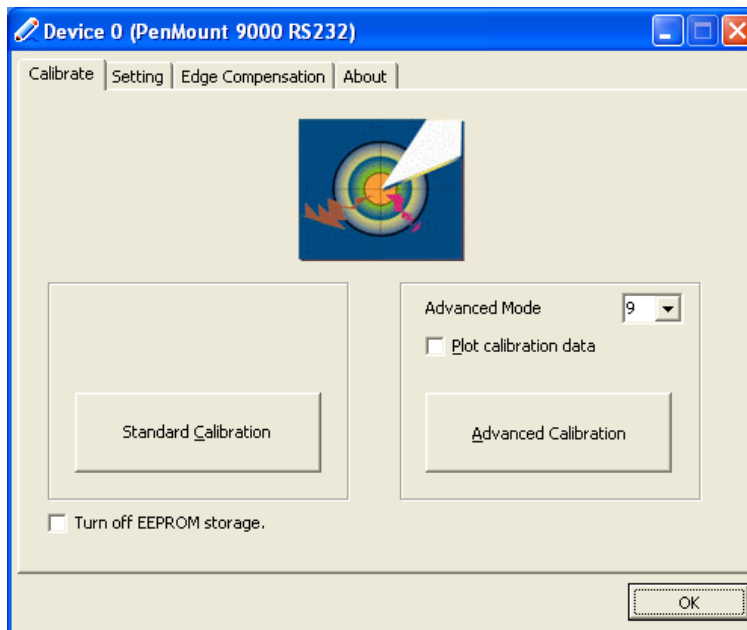

Figure 7-25: Calibration Initiation Screen

Step 9: The calibration screen in is shown. See **Figure 7-26**.

AFL2-12A-D525 Series Panel PC

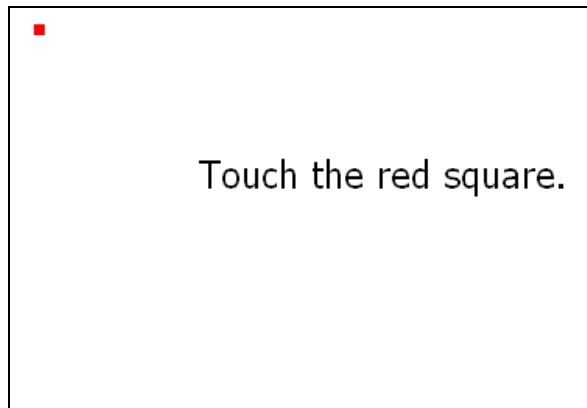

Figure 7-26: Calibration Screen

Step 10: Follow the instructions. The user is asked touch the screen at five specified points after which the screen is calibrated.

7.7 AMCap Driver Installation

To install the AMCap driver, please do the following.

Step 1: Access the driver list. (See **Section 7.2**)

Step 2: Click “**AMCap**” and select the folder which corresponds to your operating system.

Step 3: Double click the setup file.

Step 4: The **Welcome Screen** in **Figure 7-27** appears.

Step 5: Click **Next** to continue.

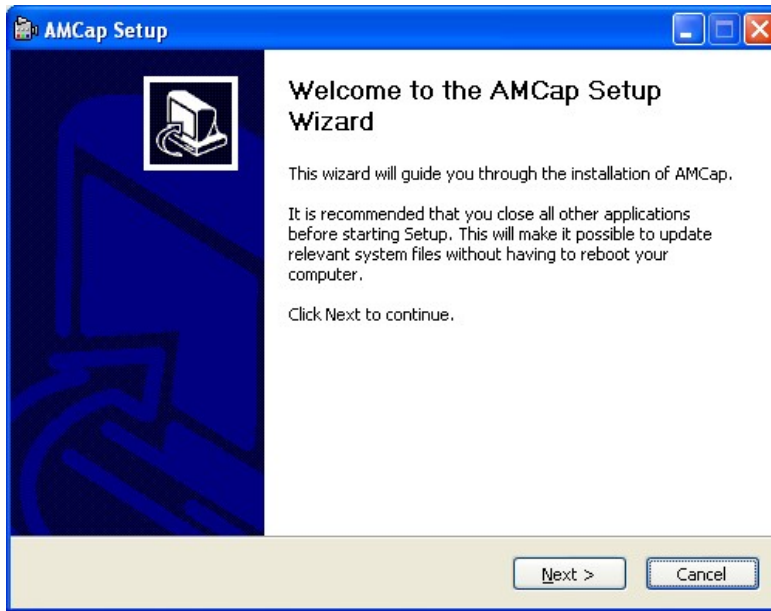

Figure 7-27: AMCap Driver Welcome Screen

Step 6: Browse for an install location or use the one suggested (**Figure 7-28**).

Step 7: Click **INSTALL** to continue.

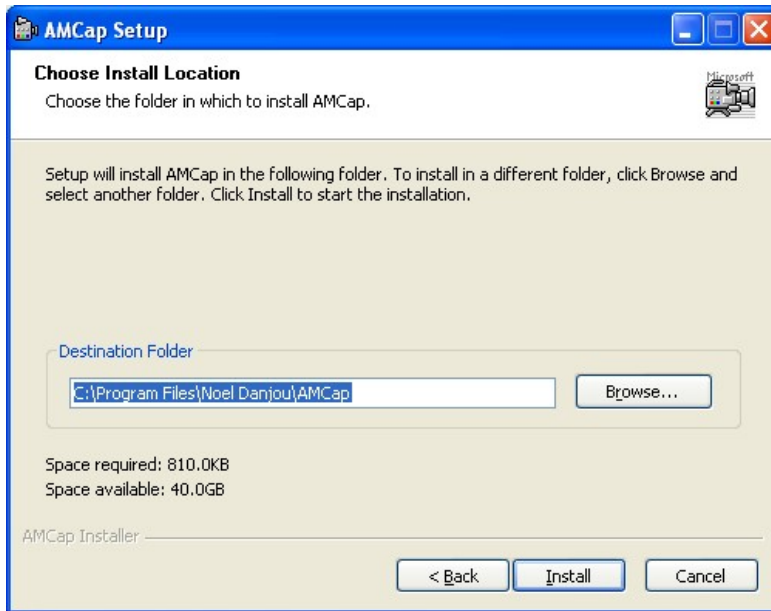

Figure 7-28: AMCap Driver Choose Install Location

Step 8: The program begins to install.

AFL2-12A-D525 Series Panel PC

Step 9: When the driver installation is complete, the screen in **Figure 7-29** appears.

Step 10: Click **Finish** to save and exit.

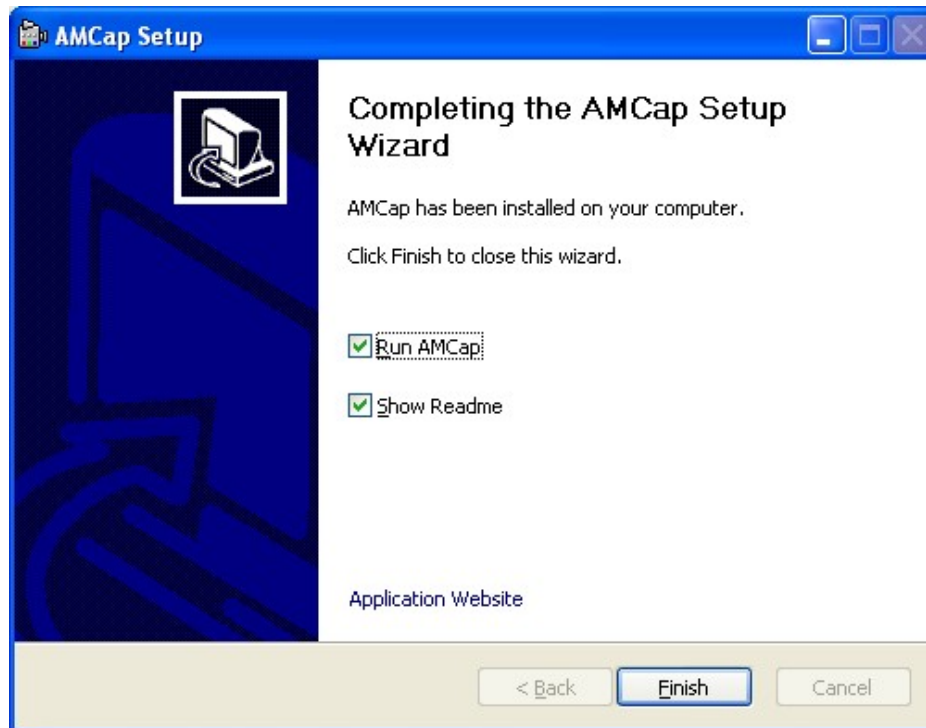

Figure 7-29: AMCap Driver Installation Complete

Appendix

A

Safety Precautions

**WARNING:**

The precautions outlined in this chapter should be strictly followed. Failure to follow these precautions may result in permanent damage to the AFL2-12A-D525.

A.1 Safety Precautions

Please follow the safety precautions outlined in the sections that follow:

A.1.1 General Safety Precautions

Please ensure the following safety precautions are adhered to at all times.

- **Follow the electrostatic precautions** outlined below whenever the AFL2-12A-D525 is opened.
- **Make sure the power is turned off and the power cord is disconnected** whenever the AFL2-12A-D525 is being installed, moved or modified.
- **Do not apply voltage levels that exceed the specified voltage range.** Doing so may cause fire and/or an electrical shock.
- **Electric shocks can occur** if the AFL2-12A-D525 chassis is opened when the AFL2-12A-D525 is running.
- **Do not drop or insert any objects** into the ventilation openings of the AFL2-12A-D525.
- **If considerable amounts of dust, water, or fluids enter the AFL2-12A-D525**, turn off the power supply immediately, unplug the power cord, and contact the AFL2-12A-D525 vendor.
- **DO NOT:**
 - Drop the AFL2-12A-D525 against a hard surface.
 - Strike or exert excessive force onto the LCD panel.
 - Touch any of the LCD panels with a sharp object
 - In a site where the ambient temperature exceeds the rated temperature

A.1.2 CPU Temperature Warning

**WARNING:**

If the CPU Temperature Alert LED shows **RED**, the CPU core temperature is too high. To lower the CPU temperature, lower the environment temperature or decrease the amount of running programs.

A.1.3 Product Disposal

**CAUTION:**

Risk of explosion if battery is replaced by an incorrect type. Only certified engineers should replace the on-board battery.

Dispose of used batteries according to instructions and local regulations.

- Outside the European Union - If you wish to dispose of used electrical and electronic products outside the European Union, please contact your local authority so as to comply with the correct disposal method.
- Within the European Union:

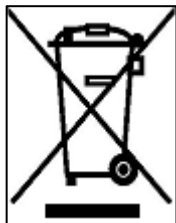

EU-wide legislation, as implemented in each Member State, requires that waste electrical and electronic products carrying the mark (left) must be disposed of separately from normal household waste. This includes monitors and electrical accessories, such as signal cables or power cords. When you need to dispose of your display products, please follow the guidance of your local authority, or ask the shop where you purchased the product. The mark on electrical and electronic products only applies to the current European Union Member States.

Please follow the national guidelines for electrical and electronic product disposal.

AFL2-12A-D525 Series Panel PC

A.1.4 Anti-static Precautions

**WARNING:**

Failure to take ESD precautions during the installation of the AFL2-12A-D525 may result in permanent damage to the AFL2-12A-D525 and severe injury to the user.

Electrostatic discharge (ESD) can cause serious damage to electronic components, including the AFL2-12A-D525. Dry climates are especially susceptible to ESD. It is therefore critical that whenever the AFL2-12A-D525 is opened and any of the electrical components are handled, the following anti-static precautions are strictly adhered to.

- ***Wear an anti-static wristband:*** Wearing a simple anti-static wristband can help to prevent ESD from damaging any electrical component.
- ***Self-grounding:*** Before handling any electrical component, touch any grounded conducting material. During the time the electrical component is handled, frequently touch any conducting materials that are connected to the ground.
- ***Use an anti-static pad:*** When configuring or working with an electrical component, place it on an anti-static pad. This reduces the possibility of ESD damage.
- ***Only handle the edges of the electrical component:*** When handling the electrical component, hold the electrical component by its edges.

A.1.5 Product Disposal

**CAUTION:**

Risk of explosion if battery is replaced by and incorrect type. Only certified engineers should replace the on-board battery.

Dispose of used batteries according to instructions and local regulations.

- Outside the European Union - If you wish to dispose of used electrical and electronic products outside the European Union, please contact your local authority so as to comply with the correct disposal method.
- Within the European Union:

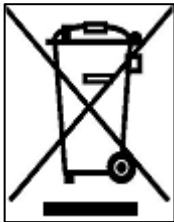

EU-wide legislation, as implemented in each Member State, requires that waste electrical and electronic products carrying the mark (left) must be disposed of separately from normal household waste. This includes monitors and electrical accessories, such as signal cables or power cords.

When you need to dispose of your display products, please follow the guidance of your local authority, or ask the shop where you purchased the product. The mark on electrical and electronic products only applies to the current European Union Member States.

Please follow the national guidelines for electrical and electronic product disposal.

A.2 Maintenance and Cleaning Precautions

When maintaining or cleaning the AFL2-12A-D525, please follow the guidelines below.

A.2.1 Maintenance and Cleaning

Prior to cleaning any part or component of the AFL2-12A-D525, please read the details below.

AFL2-12A-D525 Series Panel PC

- Except for the LCD panel, never spray or squirt liquids directly onto any other components. To clean the LCD panel, gently wipe it with a piece of soft dry cloth or a slightly moistened cloth.
- The interior of the AFL2-12A-D525X does not require cleaning. Keep fluids away from the AFL2-12A-D525 interior.
- Be cautious of all small removable components when vacuuming the AFL2-12A-D525.
- Turn the AFL2-12A-D525 off before cleaning the AFL2-12A-D525.
- Never drop any objects or liquids through the openings of the AFL2-12A-D525.
- Be cautious of any possible allergic reactions to solvents or chemicals used when cleaning the AFL2-12A-D525.
- Avoid eating, drinking and smoking within vicinity of the AFL2-12A-D525.

A.2.2 Cleaning Tools

Some components in the AFL2-12A-D525 may only be cleaned using a product specifically designed for the purpose. In such case, the product will be explicitly mentioned in the cleaning tips. Below is a list of items to use when cleaning the AFL2-12A-D525.

- **Cloth** – Although paper towels or tissues can be used, a soft, clean piece of cloth is recommended when cleaning the AFL2-12A-D525.
- **Water or rubbing alcohol** – A cloth moistened with water or rubbing alcohol can be used to clean the AFL2-12A-D525.
- **Using solvents** – The use of solvents is not recommended when cleaning the AFL2-12A-D525 as they may damage the plastic parts.
- **Vacuum cleaner** – Using a vacuum specifically designed for computers is one of the best methods of cleaning the AFL2-12A-D525. Dust and dirt can restrict the airflow in the AFL2-12A-D525 and cause its circuitry to corrode.
- **Cotton swabs** - Cotton swabs moistened with rubbing alcohol or water are excellent tools for wiping hard to reach areas.
- **Foam swabs** - Whenever possible, it is best to use lint free swabs such as foam swabs for cleaning.

Appendix

B

BIOS Configuration Options

AFL2-12A-D525 Series Panel PC

B.1 BIOS Configuration Options

Below is a list of BIOS configuration options described in **Chapter 6**.

System Overview	77
System Date [xx/xx/xx]	77
System Time [xx:xx:xx]	78
ACPI Sleep State [S1 (CPU Stop Clock)]	80
Power Saving Function [Disabled]	80
ATA/IDE Configuration [Enhanced]	82
Configure SATA as [IDE]	82
USB Devices	83
Legacy USB Support [Enabled]	83
Generic STORAGE DEVICE 9454 [Auto]	84
Serial Port [Enabled]	86
Change Settings [Auto]	86
Serial Port [Enabled]	86
Change Settings [Auto]	86
Serial Port [Enabled]	87
Select Serial Mode [Auto]	87
Change Settings [Auto]	87
PC Health Status	89
Console Redirection [Disabled]	90
Auto Recovery Function [Disabled]	91
Restore AC Power Loss [Power Off]	94
HD Audio Controller [Enabled]	94
USB Function [Enabled]	95
USB 2.0(EHCI) Support [Enabled]	95
Set Spread Spectrum function [Disabled]	95
WIFI Function [Enabled]	95
DMIC Function [Enabled]	95
BT Function [Enabled]	96
AutoDimming Function [Enabled]	96
DVMT Mode Select [DVMT Mode]	97
DVMT/FIXED Memory [Maximum]	97

IGD - Boot Type [CRT + LFP]	97
LCD Panel Type [1024x768 18bit].....	97
Bootup NumLock State [On].....	98
Quiet Boot [Enabled]	99
Launch PXE OpROM [Disabled]	99
Boot Option #1 [Generic STORAGE DE...].....	99
Hard Drive BBS Priorities.....	99
Administrator Password	100
User Password	100
Set User Password	100
Set Master Password.....	101
HDD Password Configuration.....	101
Save Changes and Reset	102
Discard Changes and Reset	102
Restore Defaults	102
Save as User Defaults	103
Restore User Defaults	103

Appendix

C

One Key Recovery

C.1 One Key Recovery Introduction

The IEI one key recovery is an easy-to-use front end for the Norton Ghost system backup and recovery tool. This tool provides quick and easy shortcuts for creating a backup and reverting to that backup or reverting to the factory default settings.



NOTE:

The latest One Key Recovery software provides an auto recovery function that allows a system running Microsoft Windows OS to automatically restore from the factory default image after encountering a Blue Screen of Death (BSoD) or a hang for around 10 minutes. Please refer to Section C.3 for the detailed setup procedure.

The IEI One Key Recovery tool menu is shown below.

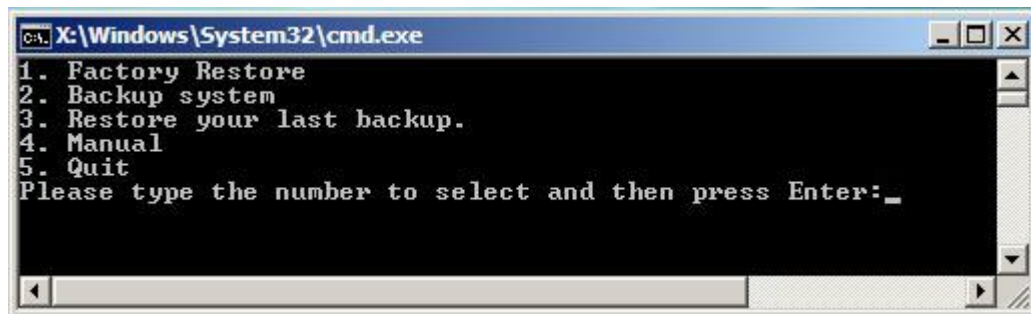

Figure C-1: IEI One Key Recovery Tool Menu

Prior to using the IEI One Key Recovery tool (as shown in **Figure C-1**) to backup or restore Windows system, five setup procedures are required.

1. Hardware and BIOS setup (see **Section C.2.1**)
2. Create partitions (see **Section C.2.2**)
3. Install operating system, drivers and system applications (see **Section C.2.3**)
4. Build the recovery partition (see **Section C.2.4**)
5. Create factory default image (see **Section C.2.5**)

AFL2-12A-D525 Series Panel PC

After completing the five initial setup procedures as described above, users can access the recovery tool by pressing <F3> while booting up the system. The detailed information of each function is described in **Section C.5**.



NOTE:

The initial setup procedures for Linux system are described in **Section C.3**.

C.1.1 System Requirement



NOTE:

The recovery CD can only be used with IEI products. The software will fail to run and a warning message will appear when used on non-IEI hardware.

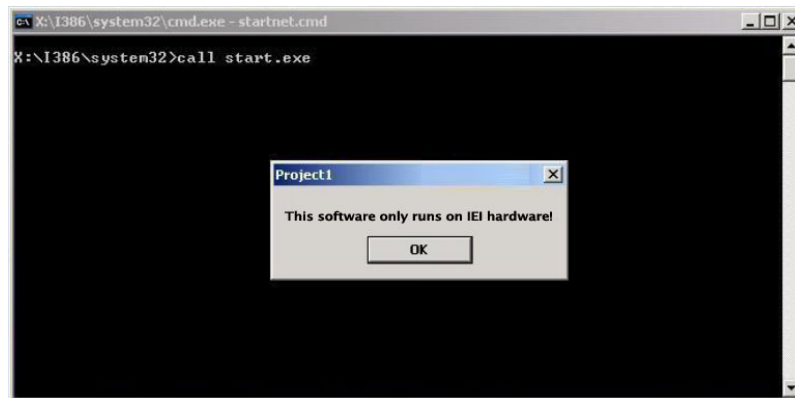

To create the system backup, the main storage device must be split into two partitions (three partitions for Linux). The first partition will be for the operating system, while the second partition will be invisible to the operating system and contain the backup made by the one key recovery software.

The partition created for recovery images must be big enough to contain both the factory default image and the user backup image. The size must be calculated before creating the

partitions. Please take the following table as a reference when calculating the size of the partition.

	OS	OS Image after Ghost	Compression Ratio
Windows® 7	7 GB	5 GB	70%
Windows® XPE	776 MB	560 MB	70%
Windows® CE 6.0	36 MB	28 MB	77%



NOTE:

Specialized tools are required to change the partition size if the operating system is already installed.

C.1.2 Supported Operating System

The recovery CD is compatible with both Microsoft Windows and Linux operating systems (OS). The supported OS versions are listed below.

- Microsoft Windows
 - Windows XP (Service Pack 2 or 3 required)
 - Windows Vista
 - Windows 7
 - Windows CE 5.0
 - Windows CE 6.0
 - Windows XP Embedded
- Linux
 - Fedora Core 12 (Constantine)
 - Fedora Core 11 (Leonidas)
 - Fedora Core 10 (Cambridge)
 - Fedora Core 8 (Werewolf)
 - Fedora Core 7 (Moonshine)
 - RedHat RHEL-5.4
 - RedHat 9 (Ghirke)

AFL2-12A-D525 Series Panel PC

- Ubuntu 8.10 (Intrepid)
- Ubuntu 7.10 (Gutsy)
- Ubuntu 6.10 (Edgy)
- Debian 5.0 (Lenny)
- Debian 4.0 (Etch)
- SuSe 11.2
- SuSe 10.3



NOTE:

Installing unsupported OS versions may cause the recovery tool to fail.

C.2 Setup Procedure for Windows

Prior to using the recovery tool to backup or restore, a few setup procedures are required.

Step 1: Hardware and BIOS setup (see **Section C.2.1**)

Step 2: Create partitions (see **Section C.2.2**)

Step 3: Install operating system, drivers and system applications (see **Section C.2.3**)

Step 4: Build the recovery partition (see **Section C.2.4**) or build the auto recovery partition (see **Section C.3**)

Step 5: Create factory default image (see **Section C.2.5**)

The detailed descriptions are described in the following sections.



NOTE:

The setup procedures described below are for Microsoft Windows operating system users. For Linux, most of the setup procedures are the same except for several steps described in **Section C.3**.

C.2.1 Hardware and BIOS Setup

- Step 1:** Make sure the system is powered off and unplugged.
- Step 2:** Install a hard drive or SSD in the system. An unformatted and unpartitioned disk is recommended.
- Step 3:** Connect an optical disk drive to the system and insert the recovery CD.
- Step 4:** Turn on the system.
- Step 5:** Press the <DELETE> key as soon as the system is turned on to enter the BIOS.
- Step 6:** Select the connected optical disk drive as the 1st boot device. (**Boot → Boot Device Priority → 1st Boot Device**).
- Step 7:** Save changes and restart the computer. Continue to the next section for instructions on partitioning the internal storage.

C.2.2 Create Partitions

To create the system backup, the main storage device must be split into two partitions (three partitions for Linux). The first partition will be for the operating system, while the second partition will be invisible to the operating system and contain the backup made by the one key recovery software.

- Step 1:** Put the recovery CD in the optical drive of the system.
- Step 2:** **Boot the system from recovery CD.** When prompted, press any key to boot from the recovery CD. It will take a while to launch the recovery tool. Please be patient!

AFL2-12A-D525 Series Panel PC

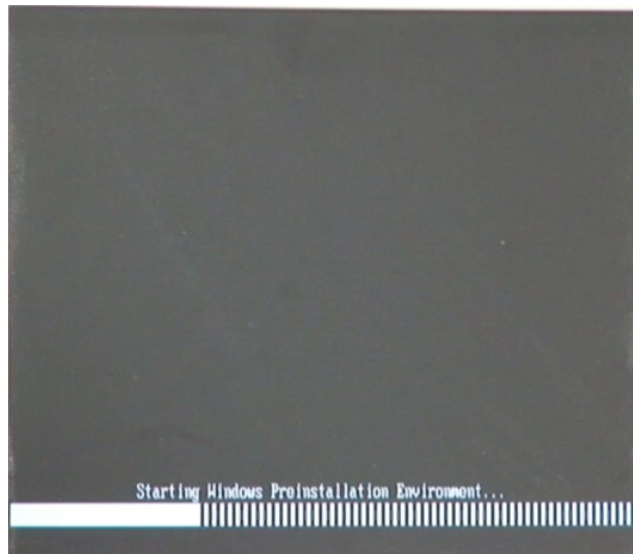

Figure C-2: Launching the Recovery Tool

Step 3: The recovery tool setup menu is shown as below.

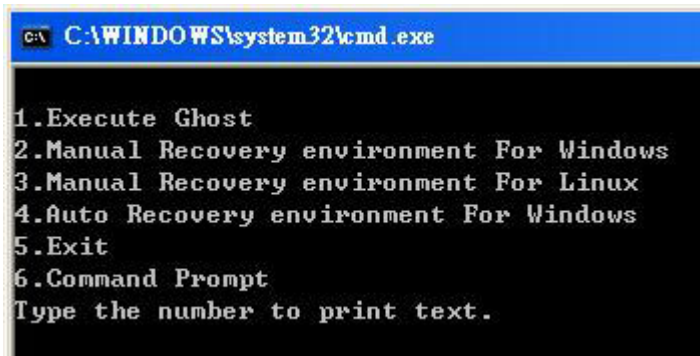
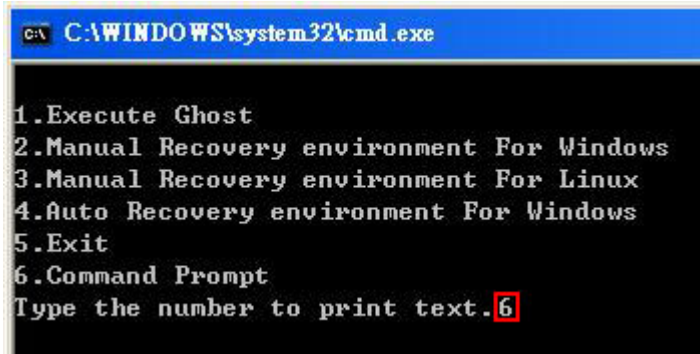

Figure C-3: Recovery Tool Setup Menu

Step 4: Press <6> then <Enter>.



```
C:\WINDOWS\system32\cmd.exe

1.Execute Ghost
2.Manual Recovery environment For Windows
3.Manual Recovery environment For Linux
4.Auto Recovery environment For Windows
5.Exit
6.Command Prompt
Type the number to print text. 6
```

Figure C-4: Command Prompt

Step 5: The command prompt window appears. Type the following commands (marked in red) to create two partitions. One is for the OS installation; the other is for saving recovery files and images which will be an invisible partition. (Press <Enter> after entering each line below)

```
system32>diskpart
DISKPART>list vol
DISKPART>sel disk 0
DISKPART>create part pri size= ____
DISKPART>assign letter=N
DISKPART>create part pri size= ____
DISKPART>assign letter=F
DISKPART>exit
system32>format N: /fs:ntfs /q /y
system32>format F: /fs:ntfs /q /v:Recovery /y
system32>exit
```

AFL2-12A-D525 Series Panel PC

```

X:\I386\SYSTEM32\CMD.EXE
X:\I386\SYSTEM32>diskpart → Starts the Microsoft disk partitioning tool.

Microsoft DiskPart version 5.2.3790.1830
Copyright (C) 1999-2001 Microsoft Corporation.
On computer: MININT-JUC

DISKPART> list vol → Show partition information

   Volume ###  Ltr  Label          Fs          Type          Size         Status       Info
   -----
   Volume 0          X  CD_ROM         CDFS        DUD-ROM       405 MB       Healthy      Boot
   Volume 1          D                   FAT32       Removeable   3854 MB       Healthy

DISKPART> sel disk 0 → Select a disk
Disk 0 is now the selected disk.

DISKPART> create part pri size=2000 → Create partition 1 and assign a size.
                                     This partition is for OS installation.
DiskPart succeeded in creating the specified partition.

DISKPART> assign letter=N → Assign partition 1 a code name (N).
DiskPart successfully assigned the drive letter or mount point.

DISKPART> create part pri size=1800 → Create partition 2 and assign a size.
                                     This partition is for recovery images.
DiskPart succeeded in creating the specified partition.

DISKPART> assign letter=F → Assign partition 2 a code name (F).
DiskPart successfully assigned the drive letter or mount point.

DISKPART> exit → Exit diskpart

X:\I386\SYSTEM32>format n: /fs:ntfs /q /y → Format partition 1 (N) as NTFS format.
The type of the file system is RAW.
The new file system is NTFS.
QuickFormatting 2000M
Creating file system structures.
Format complete.
 2048254 KB total disk space.
 2035620 KB are available.

X:\I386\SYSTEM32>format f: /fs:ntfs /q /v:Recovery /y
The type of the file system is RAW.
The new file system is NTFS.
QuickFormatting 1804M
Creating file system structures.
Format complete.
 1847474 KB total disk space.
 1835860 KB are available.

X:\I386\SYSTEM32>exit → Exit Windows PE

```

Figure C-5: Partition Creation Commands

**NOTE:**

Use the following commands to check if the partitions were created successfully.

```
X:\I386\SYSTEM32>diskpart
Microsoft DiskPart version 5.2.3790.1830
Copyright (C) 1999-2001 Microsoft Corporation.
On computer: MININT-JUC
DISKPART> sel disk 0
Disk 0 is now the selected disk.
DISKPART> list part
  Partition ###  Type              Size      Offset
-----
  Partition 1    Primary           2000 MB    32 KB
  Partition 2    Primary           1804 MB    2000 MB
DISKPART> exit
```

Step 6: Press any key to exit the recovery tool and automatically reboot the system.

Please continue to the following procedure: Build the Recovery Partition.

C.2.3 Install Operating System, Drivers and Applications

Install the operating system onto the unlabelled partition. The partition labeled "Recovery" is for use by the system recovery tool and should not be used for installing the operating system or any applications.

**NOTE:**

The operating system installation program may offer to reformat the chosen partition. DO NOT format the partition again. The partition has already been formatted and is ready for installing the new operating system.

To install the operating system, insert the operating system installation CD into the optical drive. Restart the computer and follow the installation instructions.

AFL2-12A-D525 Series Panel PC

C.2.4 Building the Recovery Partition

- Step 1:** Put the recover CD in the optical drive.
- Step 2:** Start the system.
- Step 3:** **Boot the system from the recovery CD.** When prompted, press any key to boot from the recovery CD. It will take a while to launch the recovery tool. Please be patient!

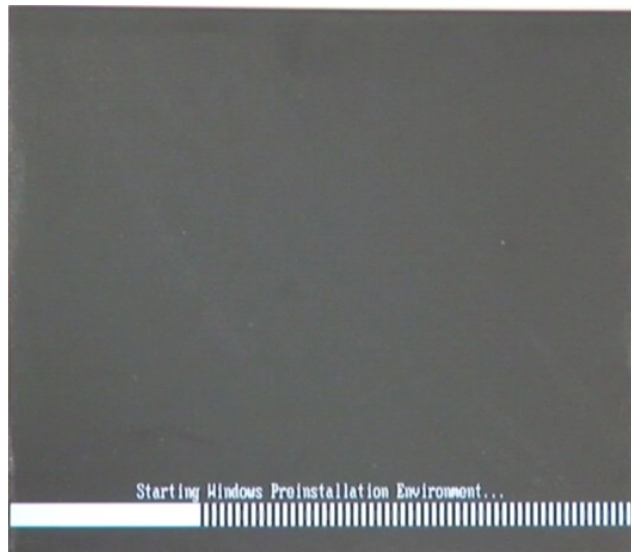

Figure C-6: Launching the Recovery Tool

- Step 4:** When the recovery tool setup menu appears, press <2> then <Enter>.

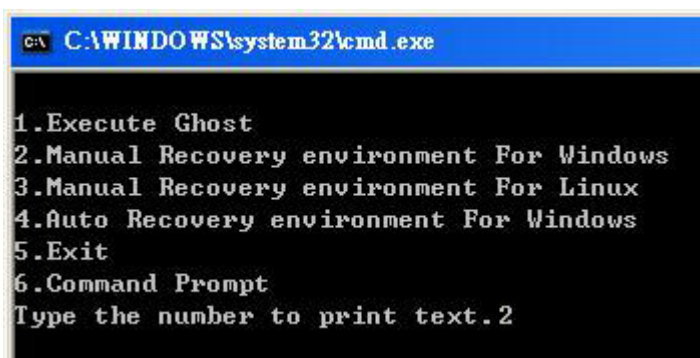

Figure C-7: Manual Recovery Environment for Windows

Step 5: The Symantec Ghost window appears and starts configuring the system to build a recovery partition. In this process the partition created for recovery files in **Section C.2.2** is hidden and the recovery tool is saved in this partition.

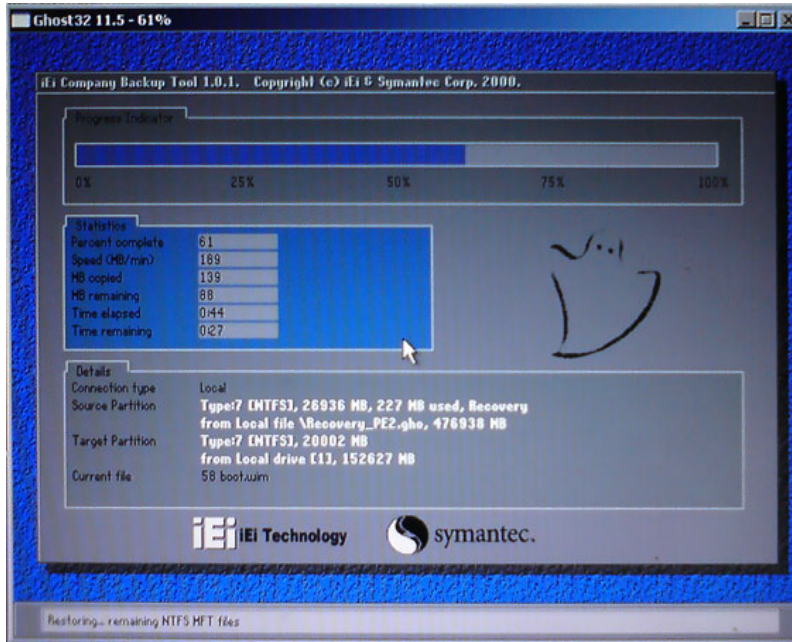

Figure C-8: Building the Recovery Partition

Step 6: After completing the system configuration, press any key in the following window to reboot the system.

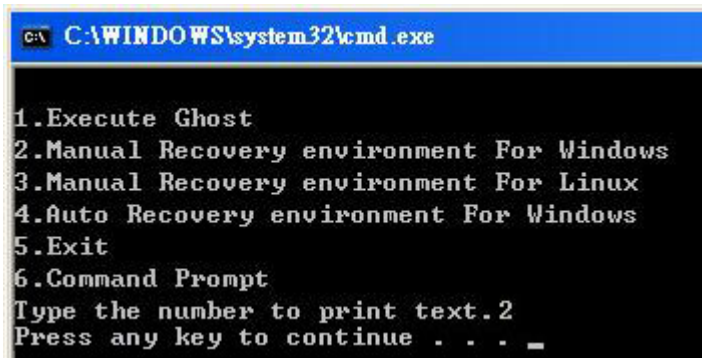

Figure C-9: Press Any Key to Continue

Step 7: Eject the recovery CD.

AFL2-12A-D525 Series Panel PC

C.2.5 Create Factory Default Image

**NOTE:**

Before creating the factory default image, please configure the system to a factory default environment, including driver and application installations.

To create a factory default image, please follow the steps below.

Step 1: Turn on the system. When the following screen displays (**Figure C-10**), press the <F3> key to access the recovery tool. The message will display for 10 seconds, please press F3 before the system boots into the operating system.

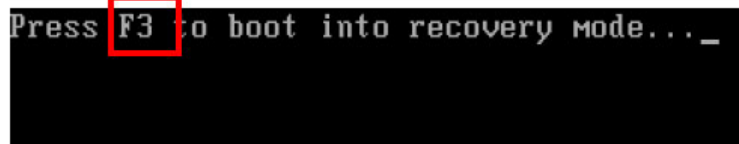

```
Press F3 to boot into recovery mode... _
```

Figure C-10: Press F3 to Boot into Recovery Mode

Step 2: The recovery tool menu appears. Type <4> and press <Enter>. (**Figure C-11**)

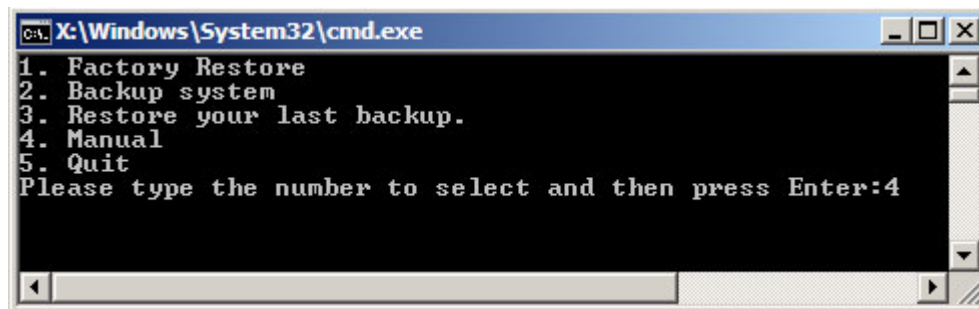

Figure C-11: Recovery Tool Menu

Step 3: The About Symantec Ghost window appears. Click **OK** button to continue.

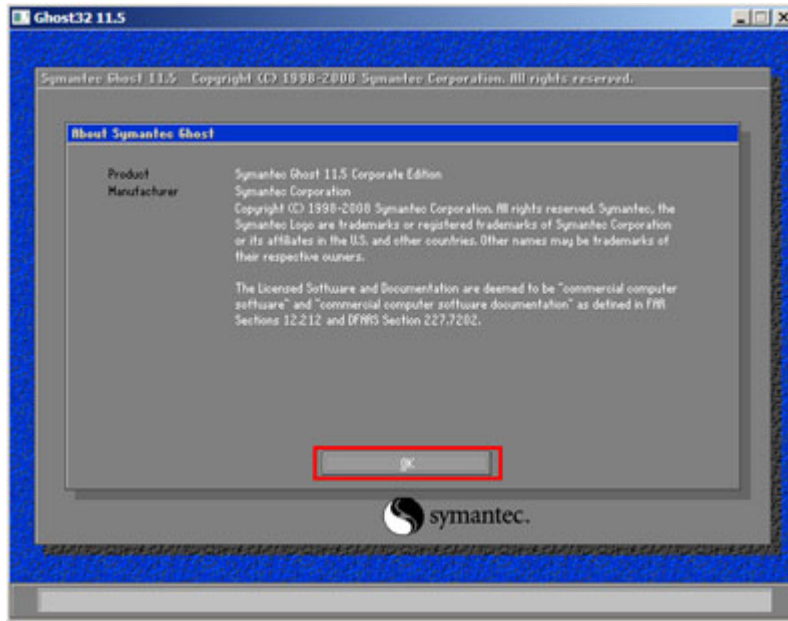

Figure C-12: About Symantec Ghost Window

Step 4: Use mouse to navigate to the option shown below (Figure C-13).

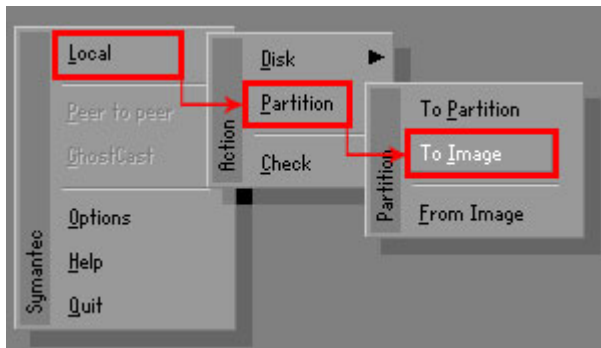

Figure C-13: Symantec Ghost Path

Step 5: Select the local source drive (Drive 1) as shown in Figure C-14. Then click OK.

AFL2-12A-D525 Series Panel PC

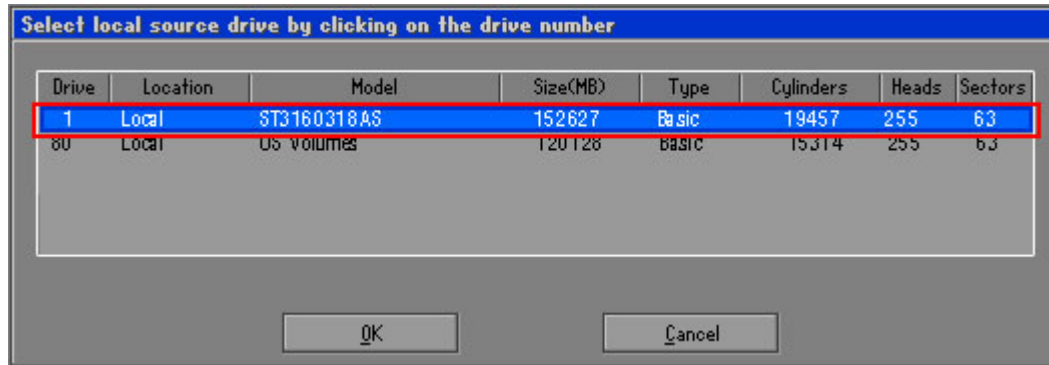

Figure C-14: Select a Local Source Drive

Step 6: Select a source partition (Part 1) from basic drive as shown in **Figure C-15**. Then click OK.

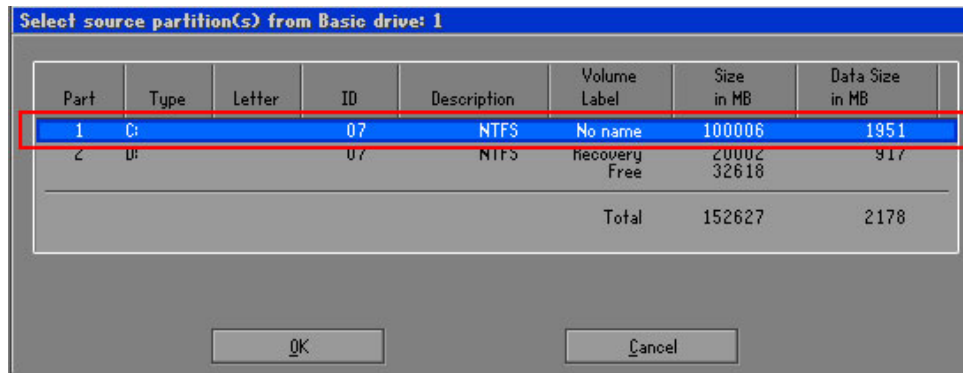

Figure C-15: Select a Source Partition from Basic Drive

Step 7: Select **1.2: [Recovery] NTFS drive** and enter a file name called **iei** (**Figure C-16**). Click **Save**. The factory default image will then be saved in the selected recovery drive and named **IEI.GHO**.



WARNING:

The file name of the factory default image must be **iei.GHO**.

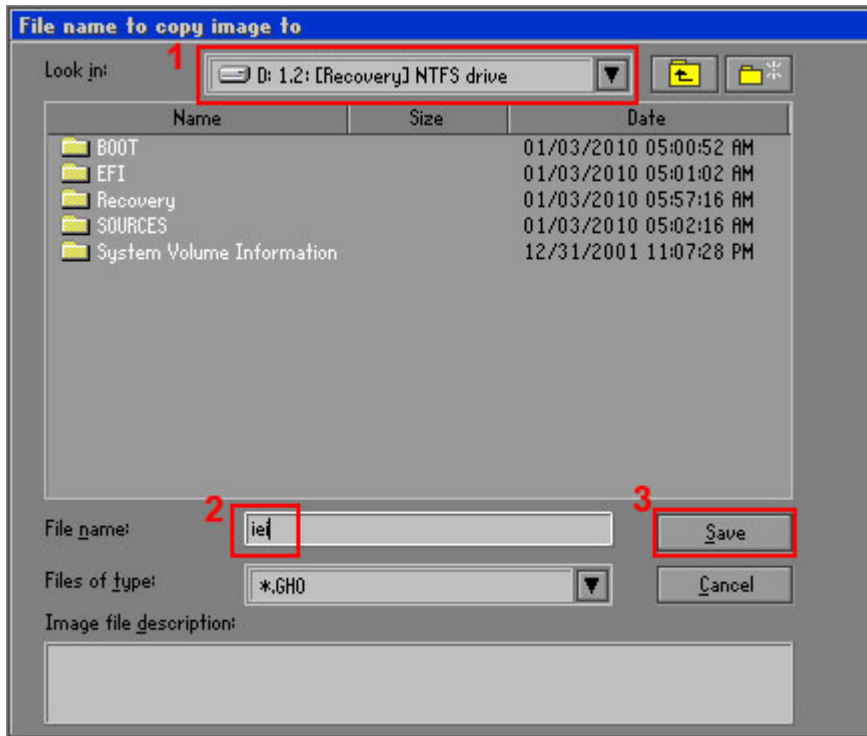

Figure C-16: File Name to Copy Image to

Step 8: When the Compress Image screen in **Figure C-17** prompts, click **High** to make the image file smaller.

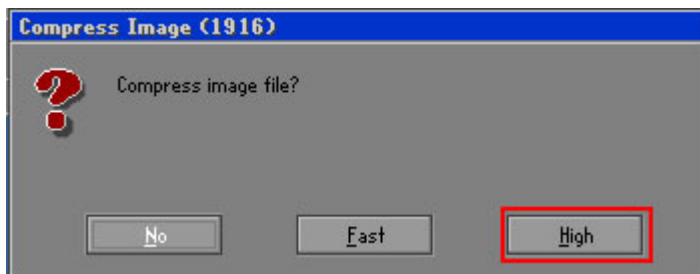

Figure C-17: Compress Image

AFL2-12A-D525 Series Panel PC

Step 9: The Proceed with partition image creation window appears, click **Yes** to continue.

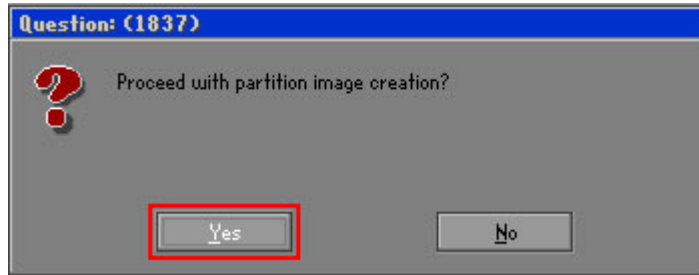

Figure C-18: Image Creation Confirmation

Step 10: The Symantec Ghost starts to create the factory default image (**Figure C-19**).

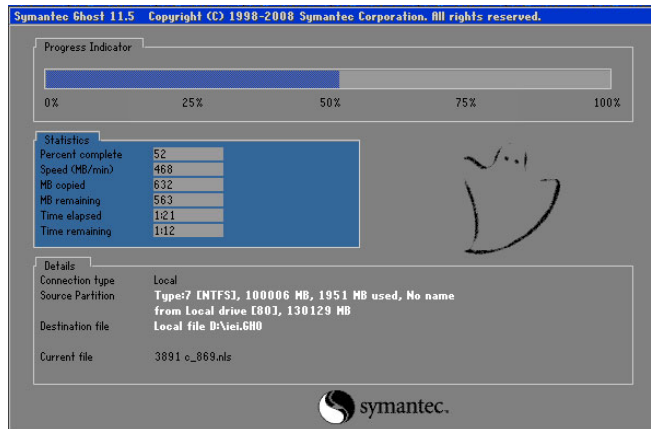

Figure C-19: Image Creation Complete

Step 11: When the image creation completes, a screen prompts as shown in **Figure C-20**.

Click **Continue** and close the Ghost window to exit the program.

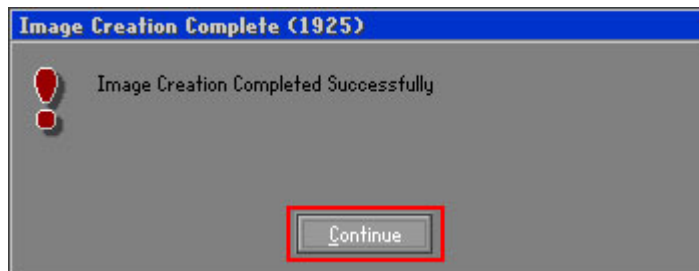
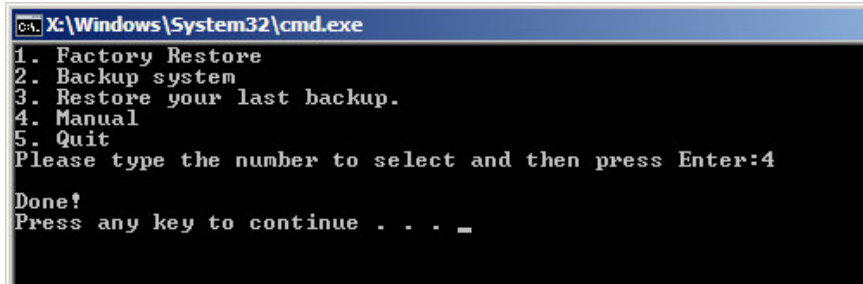

Figure C-20: Image Creation Complete

Step 12: The recovery tool main menu window is shown as below. Press any key to reboot the system.

A screenshot of a Windows command prompt window titled "C:\Windows\System32\cmd.exe". The window contains a list of five numbered options: 1. Factory Restore, 2. Backup system, 3. Restore your last backup., 4. Manual, and 5. Quit. Below the list, it says "Please type the number to select and then press Enter:4". At the bottom, it says "Done!" and "Press any key to continue . . . _".

```
C:\Windows\System32\cmd.exe
1. Factory Restore
2. Backup system
3. Restore your last backup.
4. Manual
5. Quit
Please type the number to select and then press Enter:4
Done!
Press any key to continue . . . _
```

Figure C-21: Press Any Key to Continue

C.3 Auto Recovery Setup Procedure

The auto recovery function allows a system to automatically restore from the factory default image after encountering a Blue Screen of Death (BSoD) or a hang for around 10 minutes. To use the auto recovery function, follow the steps described in the following sections.



CAUTION:

The setup procedure may include a step to create a factory default image. It is suggested to configure the system to a factory default environment before the configuration, including driver and application installations.

Step 1: Follow the steps described in **Section C.2.1 ~ Section C.2.3** to setup BIOS, create partitions and install operating system.

Step 2: Install the auto recovery utility into the system by double clicking the **Utility/AUTORECOVERY-SETUP.exe** in the One Key Recovery CD. This utility **MUST** be installed in the system, otherwise, the system will automatically restore from the factory default image every ten (10) minutes.

AFL2-12A-D525 Series Panel PC



Figure C-22: Auto Recovery Utility

Step 3: Reboot the system from the recovery CD. When prompted, press any key to boot from the recovery CD. It will take a while to launch the recovery tool. Please be patient!

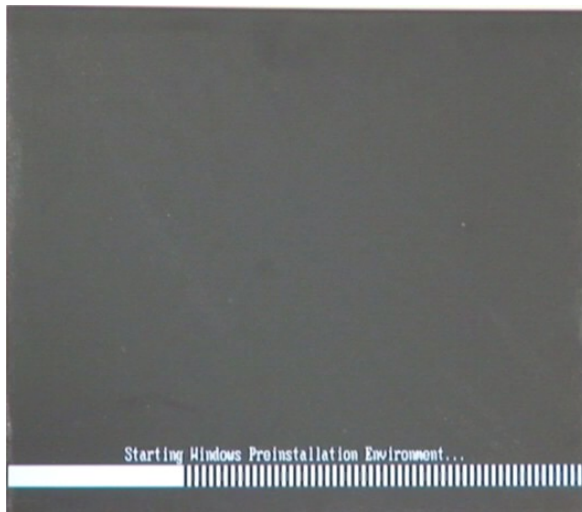

Figure C-23: Launching the Recovery Tool

Step 4: When the recovery tool setup menu appears, press <4> then <Enter>.

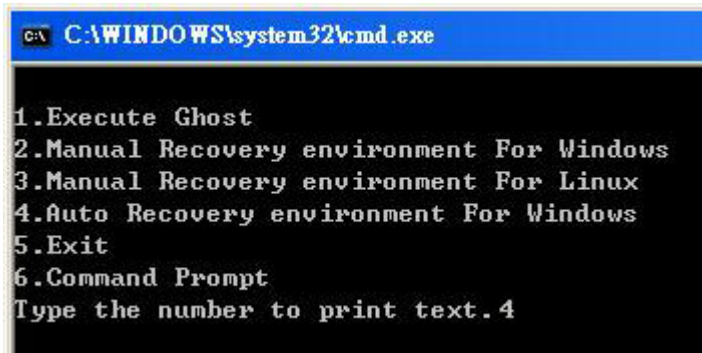

Figure C-24: Auto Recovery Environment for Windows

Step 5: The Symantec Ghost window appears and starts configuring the system to build an auto recovery partition. In this process the partition created for recovery files in **Section C.2.2** is hidden and the auto recovery tool is saved in this partition.

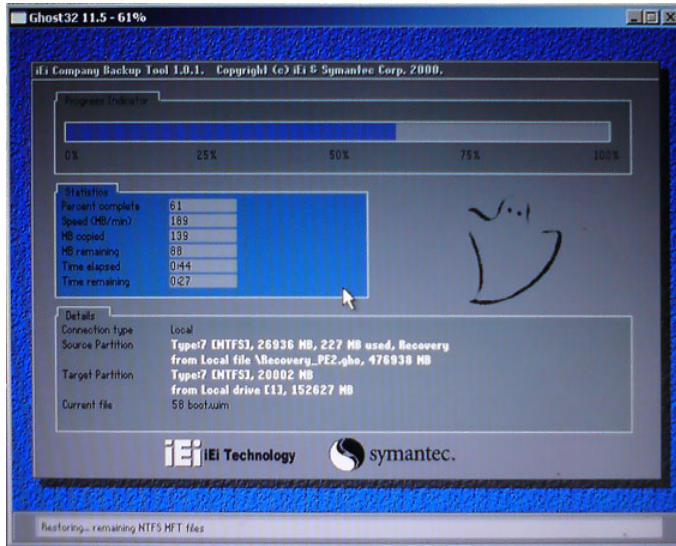

Figure C-25: Building the Auto Recovery Partition

Step 6: After completing the system configuration, the following message prompts to confirm whether to create a factory default image. Type **Y** to have the system create a factory default image automatically. Type **N** within 6 seconds to skip this process (The default option is YES). It is suggested to choose YES for this option.



Figure C-26: Factory Default Image Confirmation

AFL2-12A-D525 Series Panel PC

Step 7: The Symantec Ghost starts to create the factory default image (Figure C-27).

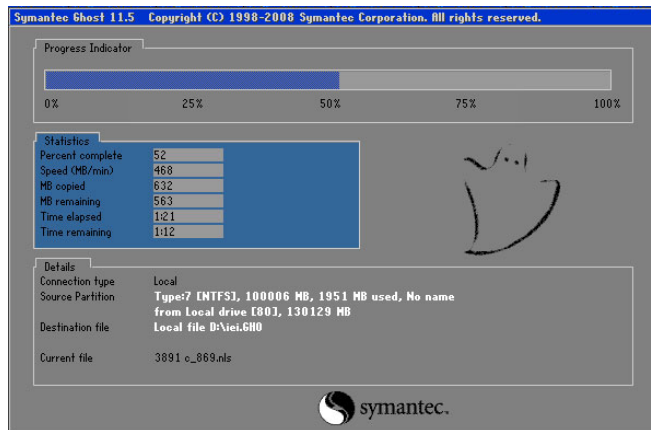

Figure C-27: Image Creation Complete

Step 8: After completing the system configuration, press any key in the following window to restart the system.

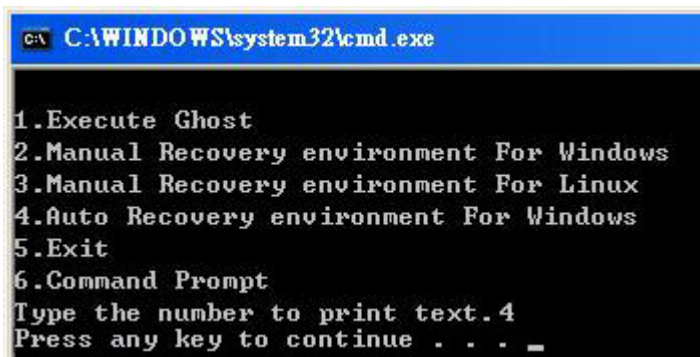
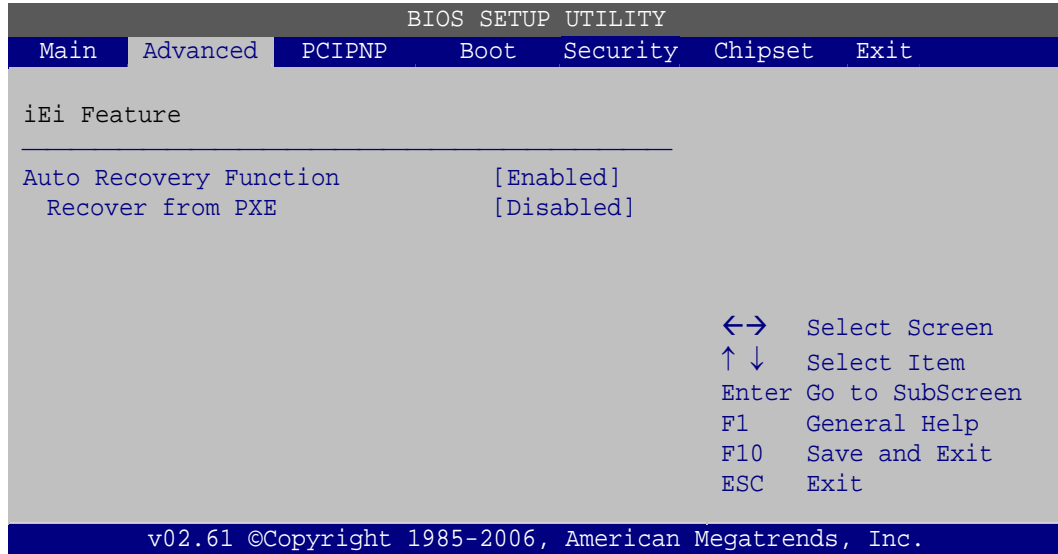

Figure C-28: Press any key to continue

Step 9: Eject the One Key Recovery CD and restart the system.

Step 10: Press the <DELETE> key as soon as the system is turned on to enter the BIOS.

Step 11: Enable the Auto Recovery Function option (**Advanced** → **iEi Feature** → **Auto Recovery Function**).



BIOS Menu 19: IEI Feature

Step 12: Save changes and restart the system. If the system encounters a Blue Screen of Death (BSoD) or a hang for around 10 minutes, it will automatically restore from the factory default image.



CAUTION:

The auto recovery function can only apply on a Microsoft Windows system running the following OS versions:

- Windows XP
- Windows Vista
- Windows 7

C.4 Setup Procedure for Linux

The initial setup procedure for Linux system is mostly the same with the procedure for Microsoft Windows. Please follow the steps below to setup recovery tool for Linux OS.

Step 1: Hardware and BIOS setup. Refer to **Section C.2.1**.

AFL2-12A-D525 Series Panel PC

Step 2: Install Linux operating system. Make sure to install GRUB (v0.97 or earlier) MBR type and Ext3 partition type. Leave enough space on the hard drive to create the recover partition later.

**NOTE:**

If the Linux OS is not installed with GRUB (v0.97 or earlier) and Ext3, the Symantec Ghost may not function properly.

While installing Linux OS, please create two partitions:

- Partition 1: /
- Partition 2: **SWAP**

**NOTE:**

Please reserve enough space for partition 3 for saving recovery images.

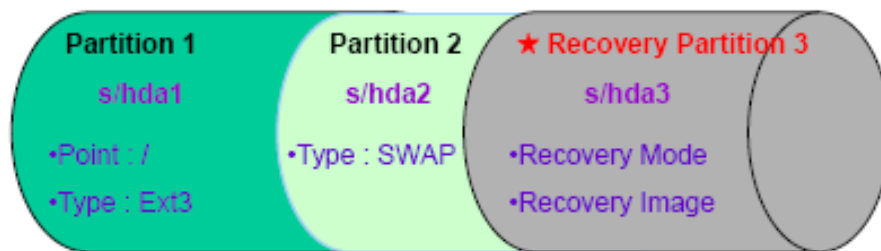

Figure C-29: Partitions for Linux

Step 3: Create a recovery partition. Insert the recovery CD into the optical disk drive. Follow **Step 1 ~ Step 3** described in **Section C.2.2**. Then type the following commands (marked in red) to create a partition for recovery images.

```
system32>diskpart
```

```
DISKPART>list vol
```

```
DISKPART>sel disk 0
```

```
DISKPART>create part pri size= ____  
DISKPART>assign letter=N  
DISKPART>exit  
system32>format N: /fs:ntfs /q /v:Recovery /y  
system32>exit
```

Step 4: Build the recovery partition. Press any key to boot from the recovery CD. It will take a while to launch the recovery tool. Please be patient. When the recovery tool setup menu appears, type <3> and press <Enter> (Figure C-30). The Symantec Ghost window appears and starts configuring the system to build a recovery partition. After completing the system configuration, press any key to reboot the system. Eject the recovery CD.

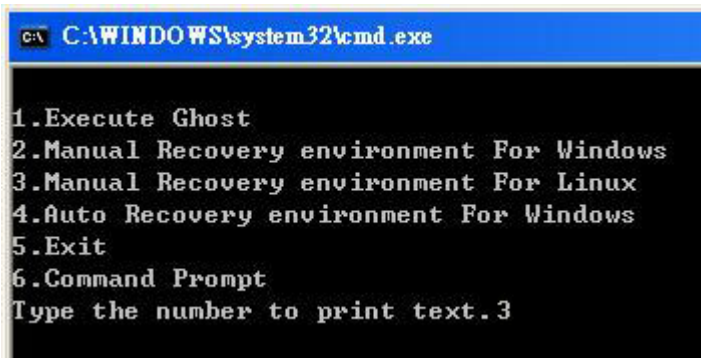
A screenshot of a Windows command prompt window. The title bar reads "C:\WINDOWS\system32\cmd.exe". The command prompt displays a menu with the following options:
1. Execute Ghost
2. Manual Recovery environment For Windows
3. Manual Recovery environment For Linux
4. Auto Recovery environment For Windows
5. Exit
6. Command Prompt
Below the menu, it says "Type the number to print text.3".

```
C:\WINDOWS\system32\cmd.exe  
1. Execute Ghost  
2. Manual Recovery environment For Windows  
3. Manual Recovery environment For Linux  
4. Auto Recovery environment For Windows  
5. Exit  
6. Command Prompt  
Type the number to print text.3
```

Figure C-30: Manual Recovery Environment for Linux

Step 5: Access the recovery tool main menu by modifying the “menu.lst”. To first access the recovery tool main menu, the menu.lst must be modified. In Linux, enter Administrator (root). When prompt appears, type:

```
cd /boot/grub  
vi menu.lst
```

AFL2-12A-D525 Series Panel PC

```
Fedora release 9 (Sulphur)
Kernel 2.6.25-14.fc9.i686 on an i686 (tty2)

localhost login: root
Password:
[root@localhost ~]# cd /boot/grub/
[root@localhost grub]# vi menu.lst _
```

Figure C-31: Access menu.lst in Linux (Text Mode)

Step 6: Modify the menu.lst as shown below.

```
#boot=/dev/sda
default=0
timeout=10 ← Modify timeout=10
splashimage=(hd0,0)/grub/splash.xpm.gz
hiddenmenu
title Fedora (2.6.25-14.fc9.i686)
    root (hd0,0)
    kernel /vmlinuz-2.6.25-14.fc9.i686 ro root=UUID=10f1acd
ac38b5c78910 rhgb quiet
    initrd /initrd-2.6.25-14.fc9.i686.img

title Recovery Partition
root (hd0,2)
makeactive ← Type command
chainloader +1
```

- **Type command:**
title Recovery Partition
root (hd0,2)
makeactive
chainloader +1

Step 7: The recovery tool menu appears. (Figure C-32)

```
1. Factory Restore
2. Backup system
3. Restore your last backup.
4. Manual
5. Quit
Please type the number to select and then press Enter:
```

Figure C-32: Recovery Tool Menu

Step 8: Create a factory default image. Follow **Step 2 ~ Step 12** described in **Section C.2.5** to create a factory default image.

C.5 Recovery Tool Functions

After completing the initial setup procedures as described above, users can access the recovery tool by pressing <F3> while booting up the system. However, if the setup procedure in Section C.3 has been completed and the auto recovery function is enabled, the system will automatically restore from the factory default image without pressing the F3 key. The recovery tool main menu is shown below.

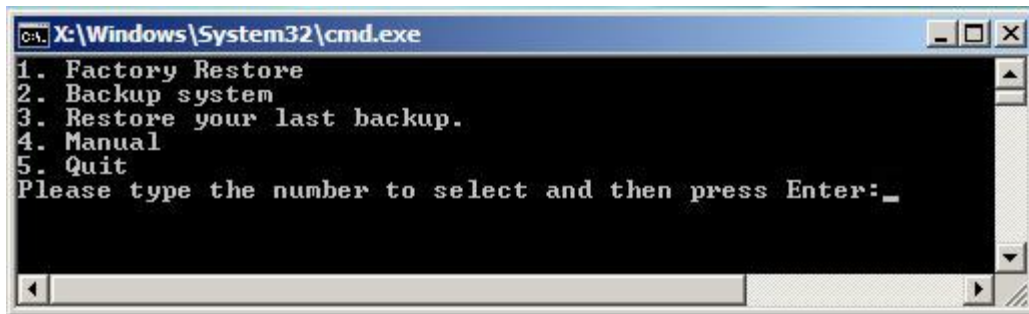

Figure C-33: Recovery Tool Main Menu

The recovery tool has several functions including:

1. **Factory Restore:** Restore the factory default image (iei.GHO) created in Section C.2.5.
2. **Backup system:** Create a system backup image (iei_user.GHO) which will be saved in the hidden partition.
3. **Restore your last backup:** Restore the last system backup image
4. **Manual:** Enter the Symantec Ghost window to configure manually.
5. **Quit:** Exit the recovery tool and restart the system.



WARNING:

Please do not turn off the system power during the process of system recovery or backup.

AFL2-12A-D525 Series Panel PC

**WARNING:**

All data in the system will be deleted during the system recovery. Please backup the system files before restoring the system (either Factory Restore or Restore Backup).

C.5.1 Factory Restore

To restore the factory default image, please follow the steps below.

Step 1: Type <1> and press <Enter> in the main menu.

Step 2: The Symantec Ghost window appears and starts to restore the factory default. A factory default image called **iei.GHO** is created in the hidden Recovery partition.

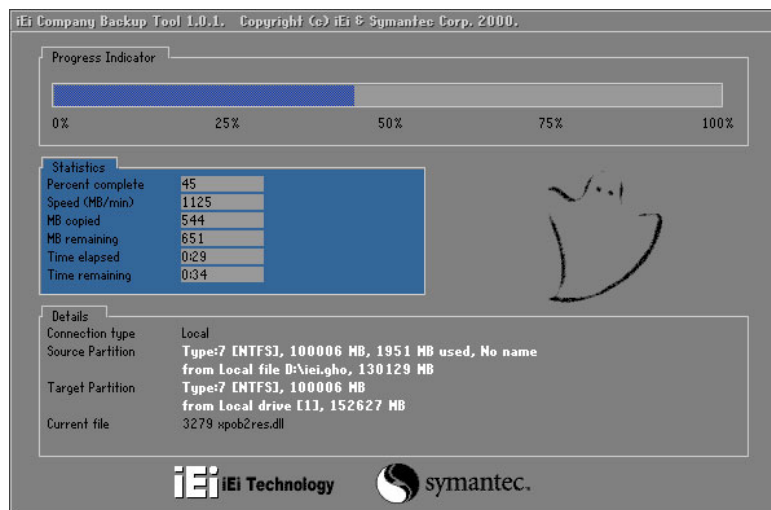

Figure C-34: Restore Factory Default

Step 3: The screen shown in **Figure C-35** appears when completed. Press any key to reboot the system.

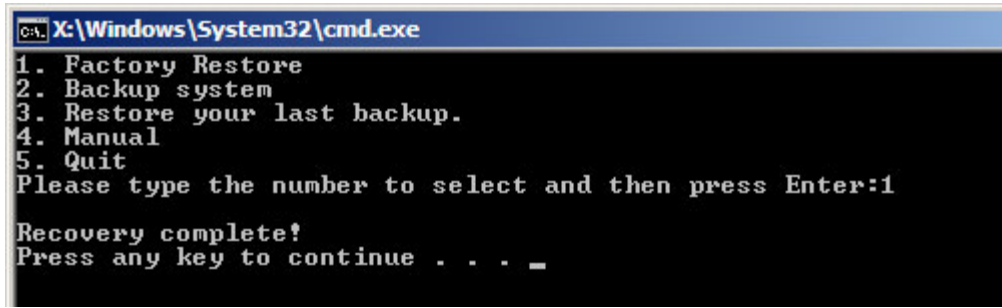

Figure C-35: Recovery Complete Window

C.5.2 Backup System

To backup the system, please follow the steps below.

Step 4: Type <2> and press <Enter> in the main menu.

Step 5: The Symantec Ghost window appears and starts to backup the system. A backup image called **iei_user.GHO** is created in the hidden Recovery partition.

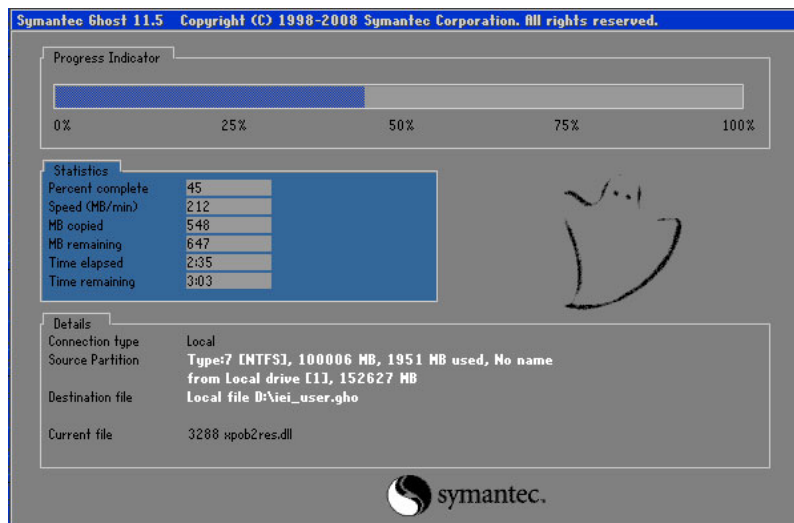

Figure C-36: Backup System

Step 6: The screen shown in **Figure C-37** appears when system backup is complete. Press any key to reboot the system.

AFL2-12A-D525 Series Panel PC

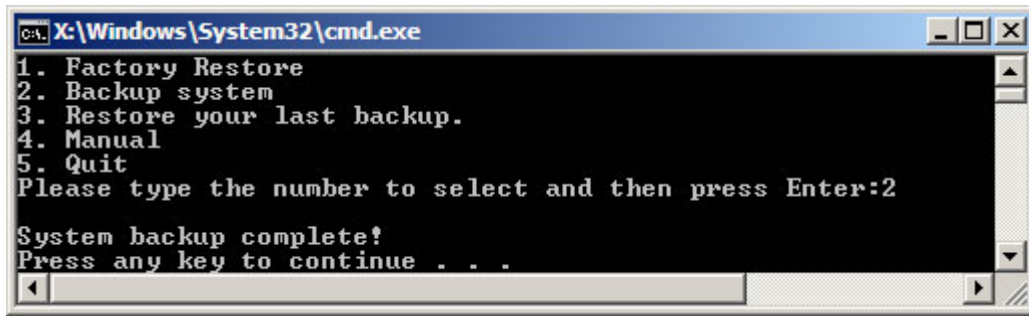

Figure C-37: System Backup Complete Window

C.5.3 Restore Your Last Backup

To restore the last system backup, please follow the steps below.

Step 1: Type <3> and press <Enter> in the main menu.

Step 2: The Symantec Ghost window appears and starts to restore the last backup image (iei_user.GHO).

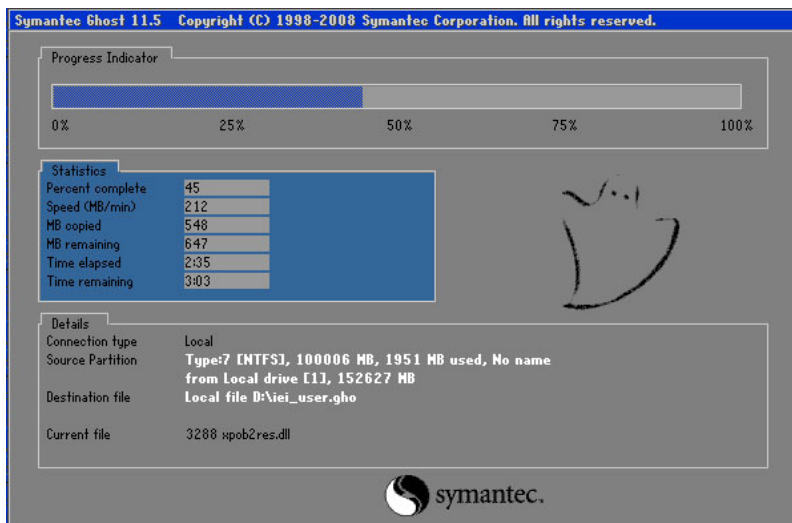
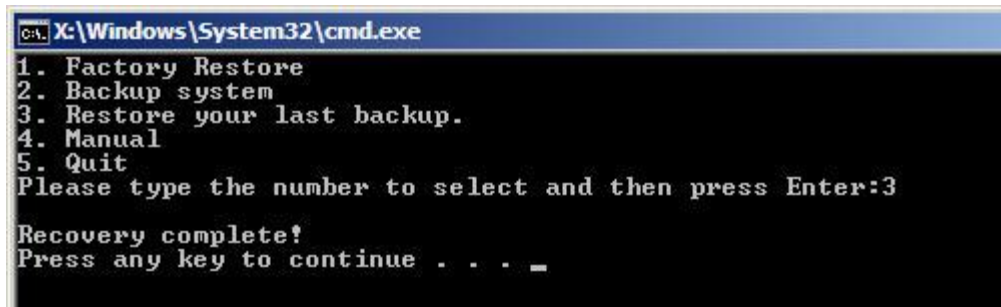

Figure C-38: Restore Backup

Step 3: The screen shown in **Figure C-39** appears when backup recovery is complete. Press any key to reboot the system.



```
C:\X:\Windows\System32\cmd.exe
1. Factory Restore
2. Backup system
3. Restore your last backup.
4. Manual
5. Quit
Please type the number to select and then press Enter:3
Recovery complete!
Press any key to continue . . . _
```

Figure C-39: Restore System Backup Complete Window

C.5.4 Manual

To restore the last system backup, please follow the steps below.

Step 4: Type <4> and press <Enter> in the main menu.

Step 5: The Symantec Ghost window appears. Use the Ghost program to backup or recover the system manually.

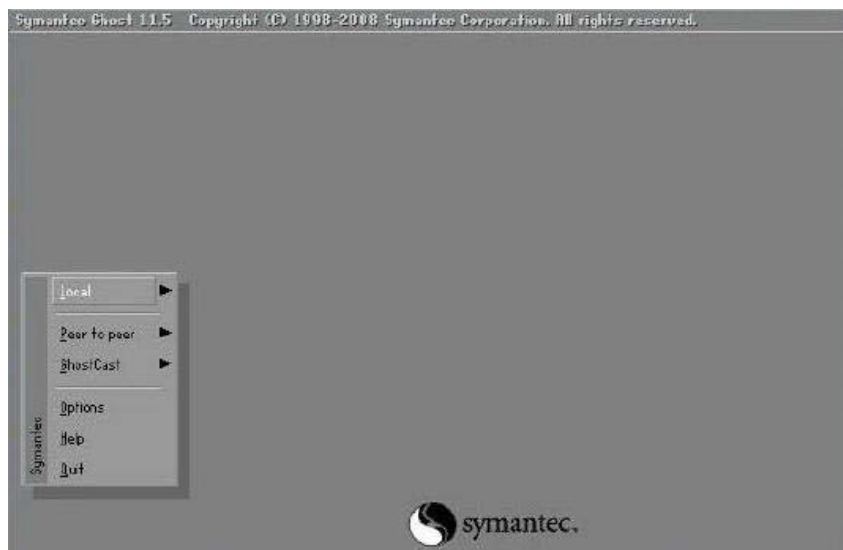
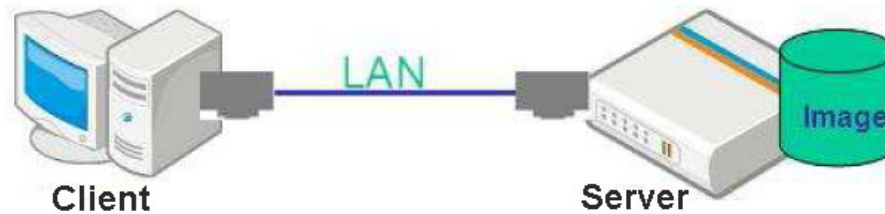

Figure C-40: Symantec Ghost Window

Step 6: When backup or recovery is completed, press any key to reboot the system.

C.6 Restore Systems from a Linux Server through LAN

The One Key Recovery allows a client system to automatically restore to a factory default image saved in a Linux system (the server) through LAN connectivity after encountering a Blue Screen of Death (BSOD) or a hang for around 10 minutes. To be able to use this function, the client system and the Linux system MUST reside in the same domain.



NOTE:

The supported client OS includes:

- Windows 2000
- Windows XP
- Windows Vista
- Windows 7
- Windows CE
- Windows XP Embedded

Prior to restoring client systems from a Linux server, a few setup procedures are required.

Step 1: Configure DHCP server settings

Step 2: Configure TFTP settings

Step 3: Configure One Key Recovery server settings

Step 4: Start DHCP, TFTP and HTTP

Step 5: Create a shared directory

Step 6: Setup a client system for auto recovery

The detailed descriptions are described in the following sections. In this document, two types of Linux OS are used as examples to explain the configuration process – CentOS 5.5 (Kernel 2.6.18) and Debian 5.0.7 (Kernel 2.6.26).

C.6.1 Configure DHCP Server Settings

Step 7: Install the DHCP

`#yum install dhcp` (CentOS, commands marked in red)

`#apt-get install dhcp3-server` (Debian, commands marked in blue)

Step 8: Confirm the operating system default settings: dhcpd.conf.

CentOS

Use the following command to show the DHCP server sample location:

`#vi /etc/dhcpd.conf`

The DHCP server sample location is shown as below:

```
# DHCP Server Configuration file.
# see /usr/share/doc/dhcp*/dhcpd.conf.sample
```

Use the following command to copy the DHCP server sample to etc/dhcpd.conf:

`#cp /usr/share/doc/dhcp-3.0.5/dhcpd.conf.sample /etc/dhcpd.conf`

`#vi /etc/dhcpd.conf`

```
ddns-update-style interim;
ignore client-updates;

subnet 192.168.0.0 netmask 255.255.255.0 {
# --- default gateway
    option routers                192.168.0.2;
    option subnet-mask            255.255.255.0;

    option nis-domain             "domain.org";
    option domain-name            "domain.org";
    option domain-name-servers    192.168.0.1;
    next-server 192.168.0.6;
    filename "pxelinux.0";
    option time-offset            -18000; # Eastern Standard Time
    option ntp-servers            192.168.1.1;
}
```

Debian

`#vi /etc/dhcpd.conf`

Edit “/etc/dhcpd.conf” for your environment. For example, add

`next-server PXE server IP address;`

AFL2-12A-D525 Series Panel PC

```
filename "pxelinux.0";
```

```
ddns-update-style interim;
ignore client-updates;

subnet 192.168.0.0 netmask 255.255.255.0 {

# --- default gateway
    option routers                192.168.0.2;
    option subnet-mask            255.255.255.0;

    option nis-domain             "domain.org";
    option domain-name            "domain.org";
    option domain-name-servers   192.168.0.1;
    next-server 192.168.0.6;
    filename "pxelinux.0";
    option time-offset            -18000; # Eastern Standard Time
    option ntp-servers            192.168.1.1;
}
```

C.6.2 Configure TFTP Settings

Step 9: Install the tftp, httpd and syslinux.

```
#yum install tftp-server httpd syslinux (CentOS)
```

```
#apt-get install tftpd-hpa xinetd syslinux (Debian)
```

Step 10: Enable the TFTP server by editing the "/etc/xinetd.d/tftp" file and make it use the remap file. The "-vvv" is optional but it could definitely help on getting more information while running the remap file. For example:

CentOS

```
#vi /etc/xinetd.d/tftp
```

Modify:

```
disable = no
```

```
server_args = -s /tftpboot -m /tftpboot/tftpd.remap -vvv_
```

```
socket_type      = dgram
protocol         = udp
wait             = yes
user             = root
server           = /usr/sbin/in.tftpd
server_args      = -s /tftpboot -m /tftpboot/tftpd.remap -vvv
disable         = no
per_source       = 11
cps              = 100 2
flags            = IPv4
```

Debian

Replace the TFTP settings from “inetd” to “xinetd” and annotate the “inetd” by adding “#”.

`#vi /etc/inetd.conf`

Modify: `#tftp dgram udp wait root /usr/sbin.....` (as shown below)

```
#:BOOT: TFTP service is provided primarily for booting. Most sites
# run this only on machines acting as "boot servers."
#tftp dgram udp wait root /usr/sbin/in.tftpd /usr/sbin/in.tftpd -s
/var/lib/tftpboot
```

`#vi /etc/xinetd.d/tftp`

```
socket_type = dgram
protocol = udp
wait = yes
user = root
server = /usr/sbin/in.tftpd
server_args = -s /tftpboot -n /tftpboot/tftpd.remap -vvv
disable = no
per_source = 11
cps = 100 2
flags = IPv4
```

C.6.3 Configure One Key Recovery Server Settings

Step 11: Copy the **Utility/RECOVERYR10.TAR.BZ2** package from the One Key Recovery CD to the system (server side).



Step 12: Extract the recovery package to /.

```
#cp RecoveryR10.tar.bz2 /
#cd /
#tar -xvjf RecoveryR10.tar.bz2
```

Step 13: Copy “pxelinux.0” from “syslinux” and install to “tftpboot”.

```
#cp /usr/lib/syslinux/pxelinux.0 /tftpboot/
```

AFL2-12A-D525 Series Panel PC

C.6.4 Start the DHCP, TFTP and HTTP

Start the DHCP, TFTP and HTTP. For example:

CentOS

```
#service xinetd restart
```

```
#service httpd restart
```

```
#service dhcpd restart
```

Debian

```
#/etc/init.d/xinetd reload
```

```
#/etc/init.d/xinetd restart
```

```
#/etc/init.d/dhcp3-server restart
```

C.6.5 Create Shared Directory

Step 14: Install the samba.

```
#yum install samba
```

Step 15: Create a shared directory for the factory default image.

```
#mkdir /share
```

```
#cd /share
```

```
#mkdir /image
```

```
#cp iei.gho /image
```



WARNING:

The file name of the factory default image must be **iei.gho**.

Step 16: Confirm the operating system default settings: smb.conf.

```
#vi /etc/samba/smb.conf
```

Modify:

[image]

```
comment = One Key Recovery
```

```
path = /share/image
```

```
browseable = yes
```

```
writable = yes
```

```
public = yes
```

```
create mask = 0644
```

```
directory mask = 0755
```

Step 17: Edit “/etc/samba/smb.conf” for your environment. For example:

```
# "security = user" is always a good idea. This will require a Unix account
# in this server for every user accessing the server. See
# /usr/share/doc/samba-doc/html/docs/Samba3-HOWTO/ServerType.html
# in the samba-doc package for details.
security = share
```

```
[image]
comment = One Key Recovery
path = /share/image
browseable = yes
writable = yes
public = yes
create mask = 0644
directory mask = 0755
```

Step 18: Modify the hostname

```
#vi /etc/hostname
```

Modify: RecoveryServer

```
RecoveryServer
```

C.6.6 Setup a Client System for Auto Recovery

Step 19: Configure the following BIOS options of the client system.

Advanced → iEi Feature → Auto Recovery Function → **Enabled**

Advanced → iEi Feature → Recover from PXE → **Enabled**

Boot → Launch PXE OpROM → **Enabled**

AFL2-12A-D525 Series Panel PC

Step 20: Continue to configure the **Boot Option Priorities** BIOS option of the client system:

Boot Option #1 → remain the default setting to boot from the original OS.

Boot Option #2 → select the boot from LAN option.

Step 21: Save changes and exit BIOS menu.

Exit → **Save Changes and Exit**

Step 22: Install the auto recovery utility into the system by double clicking the **Utility/AUTORECOVERY-SETUP.exe** in the One Key Recovery CD. This utility **MUST** be installed in the system, otherwise, the system will automatically restore from the factory default image every ten (10) minutes.



Step 23: Restart the client system from LAN. If the system encounters a Blue Screen of Death (BSoD) or a hang for around 10 minutes, it will automatically restore from the factory default image. The following screens will show when the system starts auto recovering.

```
Realtek PCIe GBE Family Controller Series v2.35 (06/14/10)
CLIENT MAC ADDR: 00 18 7D 13 E6 89  GUID: 00020003-0004-0005-0006-0007000000
DHCP . . /
```

```
My IP address seems to be C0A80009 192.168.0.9
ip=192.168.0.9:192.168.0.8:192.168.0.2:255.255.255.0
TFTP prefix:
Trying to load: pxelinux.cfg/00020003-0004-0005-0006-000700080009
Trying to load: pxelinux.cfg/01-00-10-7d-13-e6-89
Trying to load: pxelinux.cfg/C0A80009
Trying to load: pxelinux.cfg/C0A8000
Trying to load: pxelinux.cfg/C0A800
Trying to load: pxelinux.cfg/C0A80
Trying to load: pxelinux.cfg/C0A8
Trying to load: pxelinux.cfg/C0A
Trying to load: pxelinux.cfg/C0
Trying to load: pxelinux.cfg/C
Trying to load: pxelinux.cfg/default
boot:
```

```
Windows is loading files...

IP: 192.168.0.8, File: \Boot\WinPE.wim
```

Symantec Ghost 11.5 Copyright (C) 1998-2008 Symantec Corporation. All rights reserved.

Progress Indicator: 0% 25% 50% 75% 100%

Statistics	
Percent complete	52
Speed (MB/min)	468
MB copied	632
MB remaining	563
Time elapsed	1:21
Time remaining	1:12

Details

Connection type	Local
Source Partition	Type:7 [NTFS], 100006 MB, 1951 MB used, No name from Local drive [80], 130129 MB
Destination file	Local file D:\iei.GHO
Current file	3891 e_869.nls

symantec.



NOTE:

A firewall or a SELinux is not in use in the whole setup process. If there is a firewall or a SELinux protecting the system, modify the configuration information to accommodate them.

C.7 Other Information

C.7.1 Using AHCI Mode or ALi M5283 / VIA VT6421A Controller

When the system uses AHCI mode or some specific SATA controllers such as ALi M5283 or VIA VT6421A, the SATA RAID/AHCI driver must be installed before using one key recovery. Please follow the steps below to install the SATA RAID/AHCI driver.

Step 24: Copy the SATA RAID/AHCI driver to a floppy disk and insert the floppy disk into a USB floppy disk drive. The SATA RAID/AHCI driver must be especially designed for the on-board SATA controller.

Step 25: Connect the USB floppy disk drive to the system.

Step 26: Insert the One Key Recovery CD into the system and boot the system from the CD.

Step 27: When launching the recovery tool, press <F6>.

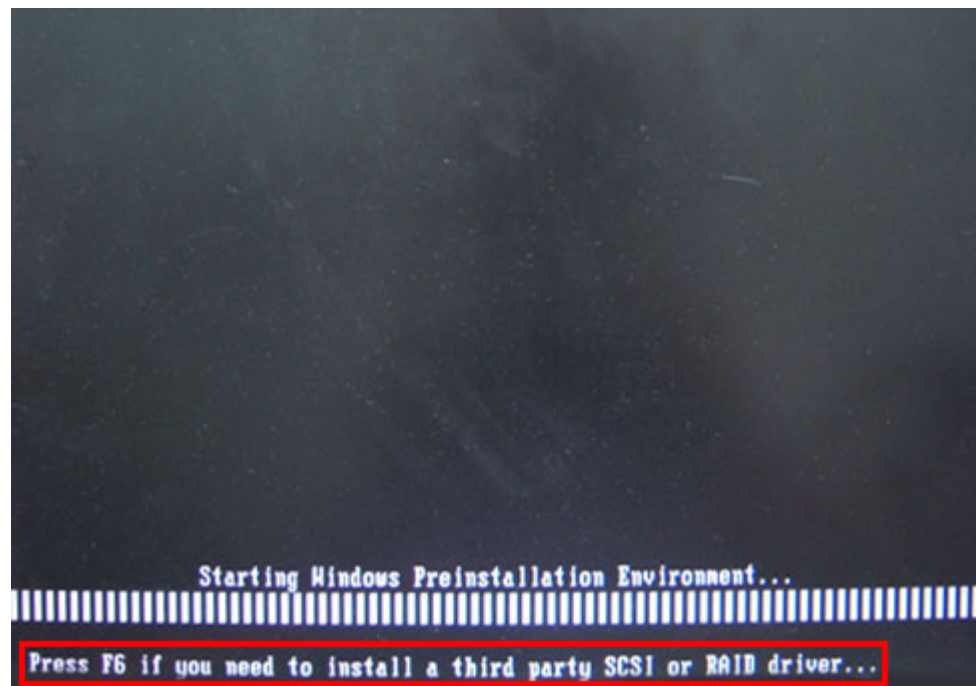

Step 28: When the following window appears, press <S> to select “Specify Additional Device”.

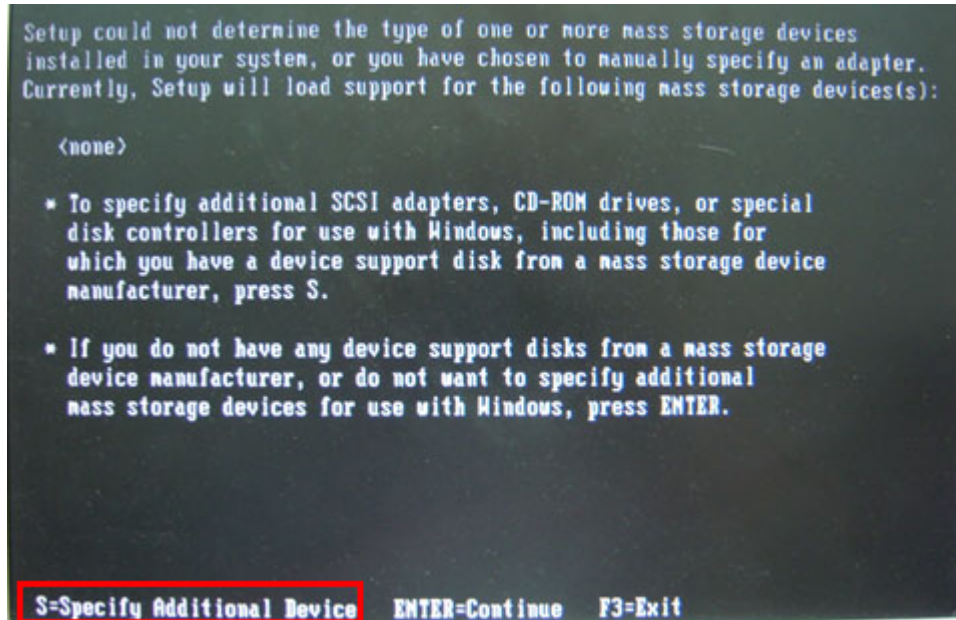

Step 29: In the following window, select a SATA controller mode used in the system. Then press <Enter>. The user can now start using the SATA HDD.

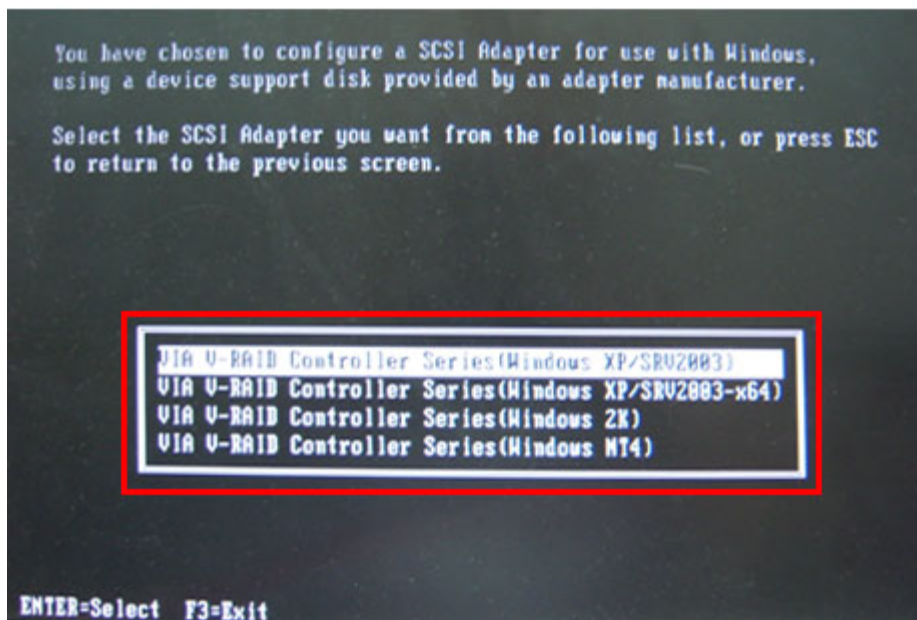

AFL2-12A-D525 Series Panel PC

Step 30: After pressing <Enter>, the system will get into the recovery tool setup menu.

Continue to follow the setup procedure from **Step 4** in **Section C.2.2 Create Partitions** to finish the whole setup process.

C.7.2 System Memory Requirement

To be able to access the recovery tool by pressing <F3> while booting up the system, please make sure to have enough system memory. The minimum memory requirement is listed below.

- **Using Award BIOS:** 128 MB system memory
- **Using AMI BIOS:** 512 MB system memory.

Appendix

D

Watchdog Timer



NOTE:

The following discussion applies to DOS environment. IEI support is contacted or the IEI website visited for specific drivers for more sophisticated operating systems, e.g., Windows and Linux.

The Watchdog Timer is provided to ensure that standalone systems can always recover from catastrophic conditions that cause the CPU to crash. This condition may have occurred by external EMI or a software bug. When the CPU stops working correctly, Watchdog Timer either performs a hardware reset (cold boot) or a Non-Maskable Interrupt (NMI) to bring the system back to a known state.

A BIOS function call (INT 15H) is used to control the Watchdog Timer:

INT 15H:

AH – 6FH Sub-function:	
AL – 2:	Sets the Watchdog Timer's period.
BL:	Time-out value (Its unit-second is dependent on the item "Watchdog Timer unit select" in CMOS setup).

Table D-1: AH-6FH Sub-function

Call sub-function 2 to set the time-out period of Watchdog Timer first. If the time-out value is not zero, the Watchdog Timer starts counting down. While the timer value reaches zero, the system resets. To ensure that this reset condition does not occur, calling sub-function 2 must periodically refresh the Watchdog Timer. However, the Watchdog timer is disabled if the time-out value is set to zero.

A tolerance of at least 10% must be maintained to avoid unknown routines within the operating system (DOS), such as disk I/O that can be very time-consuming.

**NOTE:**

When exiting a program it is necessary to disable the Watchdog Timer, otherwise the system resets.

Example program:

```
; INITIAL TIMER PERIOD COUNTER
;
W_LOOP:

    MOV     AX, 6F02H      ;setting the time-out value
    MOV     BX, 05        ;time-out value is 5 seconds
    INT     15H

;
; ADD THE APPLICATION PROGRAM HERE
;

    CMP     EXIT_AP, 1    ;is the application over?
    JNE     W_LOOP       ;No, restart the application

    MOV     AX, 6F02H    ;disable Watchdog Timer
    MOV     BX, 0        ;
    INT     15H

;
; EXIT ;
```

Appendix

E

Hazardous Materials Disclosure

E.1 Hazardous Material Disclosure Table for IPB Products Certified as RoHS Compliant Under 2002/95/EC Without Mercury

The details provided in this appendix are to ensure that the product is compliant with the Peoples Republic of China (China) RoHS standards. The table below acknowledges the presences of small quantities of certain materials in the product, and is applicable to China RoHS only.

A label will be placed on each product to indicate the estimated “Environmentally Friendly Use Period” (EFUP). This is an estimate of the number of years that these substances would “not leak out or undergo abrupt change.” This product may contain replaceable sub-assemblies/components which have a shorter EFUP such as batteries and lamps. These components will be separately marked.

Please refer to the table on the next page.

AFL2-12A-D525 Series Panel PC

Part Name	Toxic or Hazardous Substances and Elements					
	Lead (Pb)	Mercury (Hg)	Cadmium (Cd)	Hexavalent Chromium (CR(VI))	Polybrominated Biphenyls (PBB)	Polybrominated Diphenyl Ethers (PBDE)
Housing	X	O	O	O	O	X
Display	X	O	O	O	O	X
Printed Circuit Board	X	O	O	O	O	X
Metal Fasteners	X	O	O	O	O	O
Cable Assembly	X	O	O	O	O	X
Fan Assembly	X	O	O	O	O	X
Power Supply Assemblies	X	O	O	O	O	X
Battery	O	O	O	O	O	O

O: This toxic or hazardous substance is contained in all of the homogeneous materials for the part is below the limit requirement in SJ/T11363-2006

X: This toxic or hazardous substance is contained in at least one of the homogeneous materials for this part is above the limit requirement in SJ/T11363-2006

此附件旨在确保本产品符合中国 RoHS 标准。以下表格标示此产品中某有毒物质的含量符合中国 RoHS 标准规定的限量要求。

本产品上会附有“环境友好使用期限”的标签，此期限是估算这些物质“不会有泄漏或突变”的年限。本产品可能包含有较短的环境友好使用期限的可替换元件，像是电池或灯管，这些元件将会单独标示出来。

部件名称	有毒有害物质或元素					
	铅 (Pb)	汞 (Hg)	镉 (Cd)	六价铬 (CR(VI))	多溴联苯 (PBB)	多溴二苯醚 (PBDE)
壳体	X	O	O	O	O	X
显示	X	O	O	O	O	X
印刷电路板	X	O	O	O	O	X
金属螺帽	X	O	O	O	O	O
电缆组装	X	O	O	O	O	X
风扇组装	X	O	O	O	O	X
电力供应组装	X	O	O	O	O	X
电池	O	O	O	O	O	O

O: 表示该有毒有害物质在该部件所有物质材料中的含量均在 SJ/T11363-2006 标准规定的限量要求以下。

X: 表示该有毒有害物质至少在该部件的某一均质材料中的含量超出 SJ/T11363-2006 标准规定的限量要求。