



IEI Technology Corp .



# MODEL: LKM Series

**15"/17" LCD Monitor/Keyboard/Mouse Console Drawer  
1U High with Speakers and Optional 8-Port Switch**

## User Manual

Rev. 1.01 August 2007



# Revision

---

Date	Version	Changes
2007-08-15	1.01	Added LKM-927 series Updated formatting
2006-11-06	1.00	Initial release

# Copyright

---

## COPYRIGHT NOTICE

The information in this document is subject to change without prior notice in order to improve reliability, design and function and does not represent a commitment on the part of the manufacturer.

In no event will the manufacturer be liable for direct, indirect, special, incidental, or consequential damages arising out of the use or inability to use the product or documentation, even if advised of the possibility of such damages.

This document contains proprietary information protected by copyright. All rights are reserved. No part of this manual may be reproduced by any mechanical, electronic, or other means in any form without prior written permission of the manufacturer.

## TRADEMARKS

All registered trademarks and product names mentioned herein are used for identification purposes only and may be trademarks and/or registered trademarks of their respective owners.

# Manual Conventions

---



## **WARNING!**

Warnings appear where overlooked details may cause damage to the equipment or result in personal injury. Warnings should be taken seriously. Warnings are easy to recognize. The word “warning” is written as “**WARNING**,” both capitalized and bold and is followed by text. The text is the warning message. A warning message is shown below:

---



## **WARNING:**

This is an example of a warning message. Failure to adhere to warning messages may result in permanent damage to the LKM series console or personal injury to the user. Please take warning messages seriously.

---



## **CAUTION!**

Cautionary messages should also be heeded to help reduce the chance of losing data or damaging the LKM series console. Cautions are easy to recognize. The word “caution” is written as “**CAUTION**,” both capitalized and bold and is followed. The italicized text is the cautionary message. A caution message is shown below:

## LKM Series Console Drawer



### **CAUTION:**

This is an example of a caution message. Failure to adhere to cautions messages may result in permanent damage to the LKM series console. Please take caution messages seriously.



### **NOTE:**

These messages inform the reader of essential but non-critical information. These messages should be read carefully as any directions or instructions contained therein can help avoid making mistakes. Notes are easy to recognize. The word “note” is written as “**NOTE**,” both capitalized and bold and is followed by text. The text is the cautionary message. A note message is shown below:



### **NOTE:**

This is an example of a note message. Notes should always be read. Notes contain critical information about the LKM series console. Please take note messages seriously.

---

# Packing List

---

**NOTE:**

If any of the components listed in the checklist below are missing, please do not proceed with the installation. Contact the IEI reseller or vendor you purchased the LKM series console from or contact an IEI sales representative directly. To contact an IEI sales representative, please send an email to [sales@iei.com.tw](mailto:sales@iei.com.tw).

---

The items listed below should all be included in the package.

- 1 x LKM series console drawer
- 1 x Power adapter
- 1 x Power cable
- 2 x Rack mounting brackets (long)
- 2 x Rack mounting brackets (short)
- 1 x 1.8M Cable set (VGA, keyboard, mouse and audio - single port model )
- 1 x Screw set
- 1 x User Manual

Images of the above items are shown in **Chapter 3**.

# Table of Contents

<b>1</b>	<b>INTRODUCTION.....</b>	<b>1</b>
1.1	LKM SERIES CONSOLE DRAWER OVERVIEW.....	2
1.1.1	<i>LKM Series Console Drawer Introduction.....</i>	2
1.1.2	<i>LKM Series Console Drawer Features.....</i>	3
1.1.3	<i>LKM Series Console Drawer Benefits.....</i>	3
1.1.4	<i>Model Variations.....</i>	4
1.1.5	<i>Model Options.....</i>	5
1.2	MECHANICAL OVERVIEW.....	5
1.2.1	<i>LKM Series Overview.....</i>	5
1.2.2	<i>LKM Keyboard Tray.....</i>	6
1.2.3	<i>LKM Side View.....</i>	8
1.2.3.1	<i>LKM-926 Side View.....</i>	8
1.2.3.2	<i>LKM-935 Side View.....</i>	9
1.2.4	<i>LKM Access Door.....</i>	10
1.2.5	<i>LKM Rear View.....</i>	11
1.2.5.1	<i>Single Port KVMA.....</i>	11
1.2.5.2	<i>KVMA 8-Port Switch.....</i>	11
1.3	CERTIFICATIONS.....	12
1.4	MAINTENANCE AND TROUBLESHOOTING.....	12
<b>2</b>	<b>DETAILED SPECIFICATIONS.....</b>	<b>13</b>
2.1	SERIES SPECIFICATIONS.....	14
2.2	PHYSICAL DIMENSIONS.....	16
2.2.1	<i>General Physical Dimensions.....</i>	16
2.2.2	<i>LKM-926 Physical Dimensions.....</i>	17
2.2.3	<i>LKM-927 Physical Dimensions.....</i>	18
2.2.4	<i>LKM-935 Physical Dimensions.....</i>	19
2.2.5	<i>LCD Specifications.....</i>	20
2.3	POWER ADAPTERS.....	21
2.3.1	<i>5V/12V AC/DC Power Adapter.....</i>	21
2.3.2	<i>24V/48V DC Input Power Adapters.....</i>	23

<b>3</b>	<b>INSTALLATION .....</b>	<b>25</b>
3.1	INSTALLATION PRECAUTIONS.....	26
3.2	UNPACKING.....	26
3.2.1	<i>Packaging</i> .....	26
3.2.2	<i>Unpacking Procedure</i> .....	27
3.2.3	<i>Packing List</i> .....	28
3.2.4	<i>Optional Accessories</i> .....	28
3.3	PRE-INSTALLATION PREPARATION .....	28
3.3.1	<i>Tools</i> .....	28
3.4	CONNECTORS .....	29
3.4.1	<i>Audio Connector</i> .....	29
3.4.2	<i>Keyboard Connector</i> .....	30
3.4.3	<i>Mouse Connector</i> .....	31
3.4.4	<i>Power Connector</i> .....	32
3.4.5	<i>VGA Connector</i> .....	33
3.5	MOUNTING THE LKM SERIES CONSOLE DRAWER .....	34
3.5.1	<i>Rack Mounting</i> .....	34
3.6	CABLING .....	39
<b>4</b>	<b>ON-SCREEN-DISPLAY AND LCD MODULE CONTROLS .....</b>	<b>41</b>
4.1	OSD CONTROLS .....	42
4.1.1	<i>OSD Buttons</i> .....	42
4.1.2	<i>OSD Menu Structure</i> .....	42
4.1.3	<i>Brightness and Contrast Menu</i> .....	44
4.1.4	<i>Color Menu</i> .....	45
4.1.4.1	<i>Color Temperature Sub-Menu</i> .....	46
4.1.4.2	<i>User Sub-Menu</i> .....	47
4.1.5	<i>Image Menu</i> .....	48
4.1.6	<i>Tools Menu</i> .....	49
4.1.6.1	<i>OSD Sub-Menu</i> .....	50
4.2	LCM CONTROLS (8-PORT KVMA MODELS).....	51
4.2.1	<i>LCM Buttons</i> .....	51
4.2.2	<i>LCM Functions</i> .....	52
4.2.2.1	<i>Manually Switching Stations</i> .....	52
4.2.2.2	<i>Cycling Through Stations</i> .....	52



## LKM Series Console Drawer

4.2.2.3 Station Name Editing .....	52
<b>A SAFETY PRECAUTIONS.....</b>	<b>55</b>
A.1 SAFETY PRECAUTIONS .....	56
A.1.1 General Safety Precautions .....	56
A.1.2 Anti-static Precautions .....	57
A.2 MAINTENANCE AND CLEANING PRECAUTIONS.....	58
A.2.1 Maintenance and Cleaning.....	58
A.2.2 Cleaning Tools.....	58
<b>B HAZARDOUS MATERIALS DISCLOSURE .....</b>	<b>61</b>
B.1 HAZARDOUS MATERIAL DISCLOSURE TABLE FOR IPB PRODUCTS CERTIFIED AS ROHS COMPLIANT UNDER 2002/95/EC WITHOUT MERCURY.....	62
<b>C INDEX.....</b>	<b>65</b>

# List of Figures

---

Figure 1-1: LKM Console Drawer .....	2
Figure 1-2: LKM General Overview .....	6
Figure 1-3: LKM Keyboard Tray .....	7
Figure 1-4: LKM-926 Side View .....	8
Figure 1-5: LKM-935 Series Overview .....	9
Figure 1-6: LKM-926/927 Access Door .....	10
Figure 1-7: Single Port KVMA Rear View .....	11
Figure 1-8: 8-Port KVMA Rear View .....	11
Figure 2-1: LKM-926 Physical Dimensions (millimeters) .....	17
Figure 2-2: LKM-927 Physical Dimensions (millimeters) .....	18
Figure 2-3: LKM-935 Physical Dimensions (millimeters) .....	19
Figure 2-4: 5V/12V AC/DC Power Adapter .....	22
Figure 2-5: 5V/12V AC/DC Power Adapter Dimensions (millimeters [inches]) .....	22
Figure 2-6: 24V/48V DC Power Adapter Dimensions (millimeters).....	24
Figure 3-1: Keyboard Connector .....	30
Figure 3-2: Mouse Connector.....	31
Figure 3-3: 5V/12V Power Connector .....	32
Figure 3-4: VGA Connector .....	33
Figure 3-5: Attach the Rack Mounting Bracket .....	35
Figure 3-6: Attach the Angle Bracket .....	36
Figure 3-7: Secure Front of Console to Rack .....	37
Figure 3-8: Secure Rear of Console to Rack .....	38
Figure 3-9: Rear Panel Connections.....	39
Figure 4-1: OSD Control Buttons .....	42
Figure 4-2: Brightness and Contrast Menu.....	44
Figure 4-3: Color Menu .....	45
Figure 4-4: Color Temperature Sub-Menu .....	46

## LKM Series Console Drawer

Figure 4-5: User Sub-Menu.....	47
Figure 4-6: Image Menu .....	48
Figure 4-7: Tools Menu .....	49
Figure 4-8: OSD Sub-Menu .....	50
Figure 4-9: LCM Control Buttons .....	51

# List of Tables

---

Table 1-1: LKM Series Console Drawer Model Variations.....	4
Table 2-1: LKM Series Specifications.....	15
Table 2-2: General Physical Dimensions .....	16
Table 2-3: LKM Series console drawer LCD Specifications.....	20
Table 2-4: 5V/12V AC/DC Power Adapter Specifications .....	21
Table 2-5: 24V/48V DC Power Adapter Specifications.....	23
Table 3-1: Rear Panel Connectors .....	29
Table 3-2: Keyboard Connector Pinouts.....	30
Table 3-3: Mouse Connector Pinouts .....	31
Table 3-4: 5V/12V Power Connector Pinouts.....	32
Table 3-5: VGA Connector Pinouts.....	33
Table 4-1: OSD Menu Structure.....	43

# Glossary

AC '97	Audio Codec 97	HDD	Hard Disk Drive
ACPI	Advanced Configuration and Power Interface	IDE	Integrated Data Electronics
APM	Advanced Power Management	I/O	Input/Output
ARMD	ATAPI Removable Media Device	ICH4	I/O Controller Hub 4
ASKIR	Shift Keyed Infrared	L1 Cache	Level 1 Cache
ATA	Advanced Technology Attachments	L2 Cache	Level 2 Cache
BIOS	Basic Input/Output System	LCD	Liquid Crystal Display
CFII	Compact Flash Type 2	LPT	Parallel Port Connector
CMOS	Complementary Metal Oxide Semiconductor	LVDS	Low Voltage Differential Signaling
CPU	Central Processing Unit	MAC	Media Access Controller
Codec	Compressor/Decompressor	OS	Operating System
COM	Serial Port	PCI	Peripheral Connect Interface
DAC	Digital to Analog Converter	PIO	Programmed Input Output
DDR	Double Data Rate	PnP	Plug and Play
DIMM	Dual Inline Memory Module	POST	Power On Self Test
DIO	Digital Input/Output	RAM	Random Access Memory
DMA	Direct Memory Access	SATA	Serial ATA
EIDE	Enhanced IDE	S.M.A.R.T	Self Monitoring Analysis and Reporting Technology
EIST	Enhanced Intel SpeedStep Technology	SPD	Serial Presence Detect
FDD	Floppy Disk Drive	S/PDI	Sony/Philips Digital Interface
FDC	Floppy Disk Connector	SDRAM	Synchronous Dynamic Random Access Memory
FFIO	Flexible File Input/Output	SIR	Serial Infrared
FIFO	First In/First Out	UART	Universal Asynchronous Receiver-transmitter
FSB	Front Side Bus	USB	Universal Serial Bus
IrDA	Infrared Data Association	VGA	Video Graphics Adapter



**THIS PAGE IS INTENTIONALLY LEFT BLANK**

Chapter

1

# Introduction

---

**WARNING:**

All safety guidelines are specified in Appendix A. Failure to adhere to the safety and maintenance guidelines in Appendix A may result in permanent damage to the LKM series console drawer and/or serious or fatal injuries to the user.

## 1.1 LKM Series Console Drawer Overview



Figure 1-1: LKM Console Drawer

### 1.1.1 LKM Series Console Drawer Introduction

The LKM Series console drawer is designed for IT professionals with up to eight ports for leveraging the power of existing server networks with minimal intrusion. Highly efficient, the LKM Series console drawer allows centralized access and control of up to eight computers from an integrated 1U console with a built-in 15" or 17" LCD display, one or eight port KVMA switch, keyboard and touch pad.



## LKM Series Console Drawer

The LKM Series console drawer is designed to deliver considerable return on investment. Saving time, money and valuable server room real estate, it can be rack mounted at any user-height. With a host of advanced features designed to protect your investment, the series includes: intelligent OSD (On Screen Display) menus, hot key switching, auto-sensing of computers and multi-language support.

Whether it's in educational, government, or corporate sectors, the LKM Series console drawer provides network and IT managers a stable management tool for multiple computer access and control.

### 1.1.2 LKM Series Console Drawer Features

Some of the features of the LKM Series console drawer include:

- Ability to connect up to 8 computers
- Keyboard, mouse, audio and VGA connection ports for each computer
- 15" or 17" high brightness TFT LCD display
- Standard keyboard and touch pad
- Keyboard languages supported: German, English, French, Italian, Japanese, Russian, Spanish and Traditional Chinese
- Two internal speakers for stereo audio output
- 1U high slim body design saves rack space
- LCD module (LCM) - channel change control, auto scan control, programmable station naming (8-port KVMA models only)
- Hot Pluggable - add or remove computers without having to power down the switch
- Supported OSes: Windows 98SE, 2000, XP, ME, Linux and Unix

### 1.1.3 LKM Series Console Drawer Benefits

Some of the benefits of the LKM Series console drawer include:

- Control and access multiple computers from a central user console instead of moving from one to another.
- Save hundreds of dollars in equipment, space, and power costs as there is no need for additional peripherals for each computer.

- Installation is as simple as connecting cables between the KVMA switch and computers.
- Ideal for an Internet data center, server room, testing lab, and network-operating center where multiple computers are required.

### 1.1.4 Model Variations

The LKM Series console drawer comes in a variety of models. The models have special features as identified by their model name. The LKM Series console drawer model variations are listed in **Table 1-1**.

	LKM-926(8)G(C) - (L)			LKM-926(8)G(C) - T - (L)			LKM-926(8)G(C) - C - (L)			LKM-927(8)G(C) - (L)			LKM-927(8)G(C) - T - (L)			LKM-927(8)G(C) - C - (L)			LKM-935(8)G(C) - (L)			LKM-935(8)G(C) - T - (L)			LKM-935(8)G(C) - C - (L)		
<b>LCD Size</b>	15"			17"			15"			17"			15"			17"			15"			17"					
<b>Keyboard</b>	Yes			Yes			Yes			Yes			Yes			Yes			Yes			Yes					
<b>Mouse</b>	Yes			Yes			Yes			Yes			Yes			Yes			Yes			Yes					
<b>Speaker</b>	Yes			Yes			Yes			Yes			Yes			Yes			Yes			Yes					
<b>Drawer Size</b>	1U			1U			1U			1U			1U			1U			1U			1U					
<b>Power Input</b>	AC	48VDC	24VDC	AC	48VDC	24VDC	AC	48VDC	24VDC	AC	48VDC	24VDC	AC	48VDC	24VDC	AC	48VDC	24VDC	AC	48VDC	24VDC	AC	48VDC	24VDC			
<b>Separate LCD and Keyboard Accessibility</b>	No			No			No			No			No			Yes			Yes			Yes					

**Table 1-1: LKM Series Console Drawer Model Variations**

### 1.1.5 Model Options

**Table 1-1** lists the standard features for the LKM Series console drawer model variations. However, there are a variety of additional options available for the LKM Series console drawer as identified by specific product codes. The product code options for the LKM Series console drawer are:

- (8) – specifies an eight port KVMA switch; these models also include an LCD module (LCM) on the keyboard tray.
- (C) – specifies color
  - B: black
  - W: white
- (L) – specifies keyboard language
  - DE: German
  - EN: English
  - FR: French
  - IT: Italian
  - JP: Japanese
  - RU: Russian
  - SP: Spanish
  - TW: Traditional Chinese

For example, **LKM-9268GB-EN** would indicate an LKM-926 model with an eight-port KVMA switch, black color with an English keyboard.

## 1.2 Mechanical Overview

This section describes a general physical overview of the LKM series console drawers.

### 1.2.1 LKM Series Overview

The LKM series console drawer consists of a rail-mounted TFT LCD and keyboard tray within a heavy-duty steel drawer. With the use of a mounting kit, the console drawer can easily be mounted to a standard 19" rack. Figure 1-2 shows an overview of the LKM series console drawer.



**Figure 1-2: LKM General Overview**

### **1.2.2 LKM Keyboard Tray**

The keyboard tray consists of the following items:

- 87-key keyboard
- Left and right speakers
- LCD ON/OFF button
- Speaker ON/OFF button
- OSD control buttons
- Keyboard lock LEDs
- Touchpad with left and right-click buttons
- LCM display and control buttons (8-port KVMA models only)

# LKM Series Console Drawer

Figure 1-3 shows the LKM series console drawer keyboard tray.



Figure 1-3: LKM Keyboard Tray

### 1.2.3 LKM Side View

#### 1.2.3.1 LKM-926 Side View

The sides of the console drawer have holes for rack mounting. Refer to **Section 3.5** for complete mounting details. **Figure 1-4** shows the side view of the LKM-926 series console drawer.

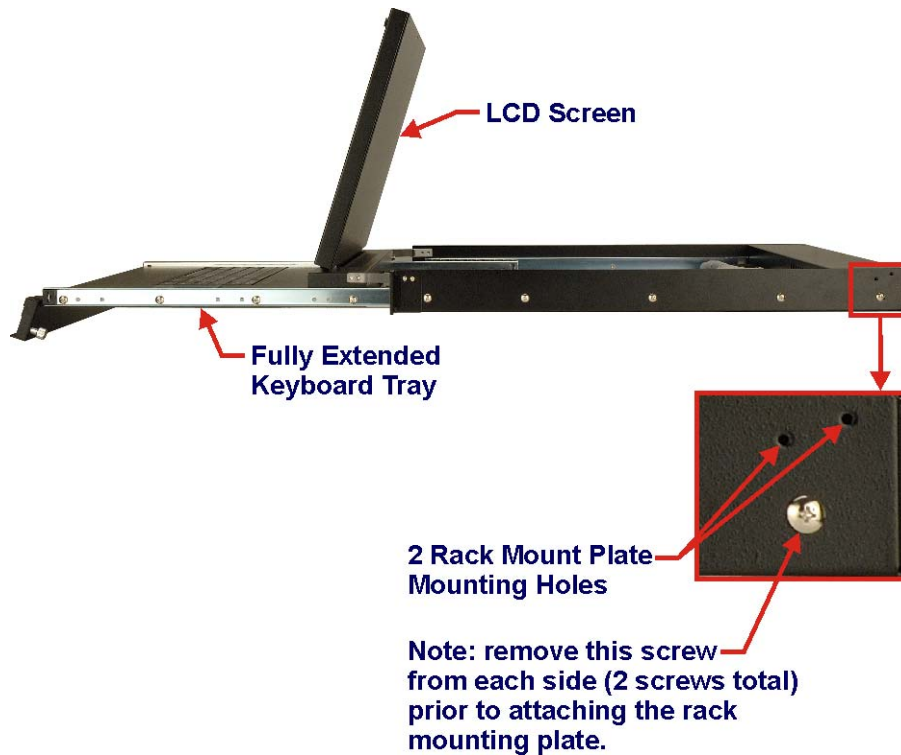

Figure 1-4: LKM-926 Side View

## LKM Series Console Drawer

### 1.2.3.2 LKM-935 Side View

The LKM-935 series console drawer is similar to the LKM-926 series with the following notable exceptions:

- The access door and LCD screen each have an additional handle for easy access.
- The LCD screen and keyboard tray can move independently of one another so that the LCD screen can be viewed while the keyboard tray is in the stowed position. Note that the keyboard tray cannot be accessed independently of the LCD screen.
- The sides of the drawer each have four holes for rack mounting.

Figure 1-5 shows the side view of the LKM-935 series console drawer.

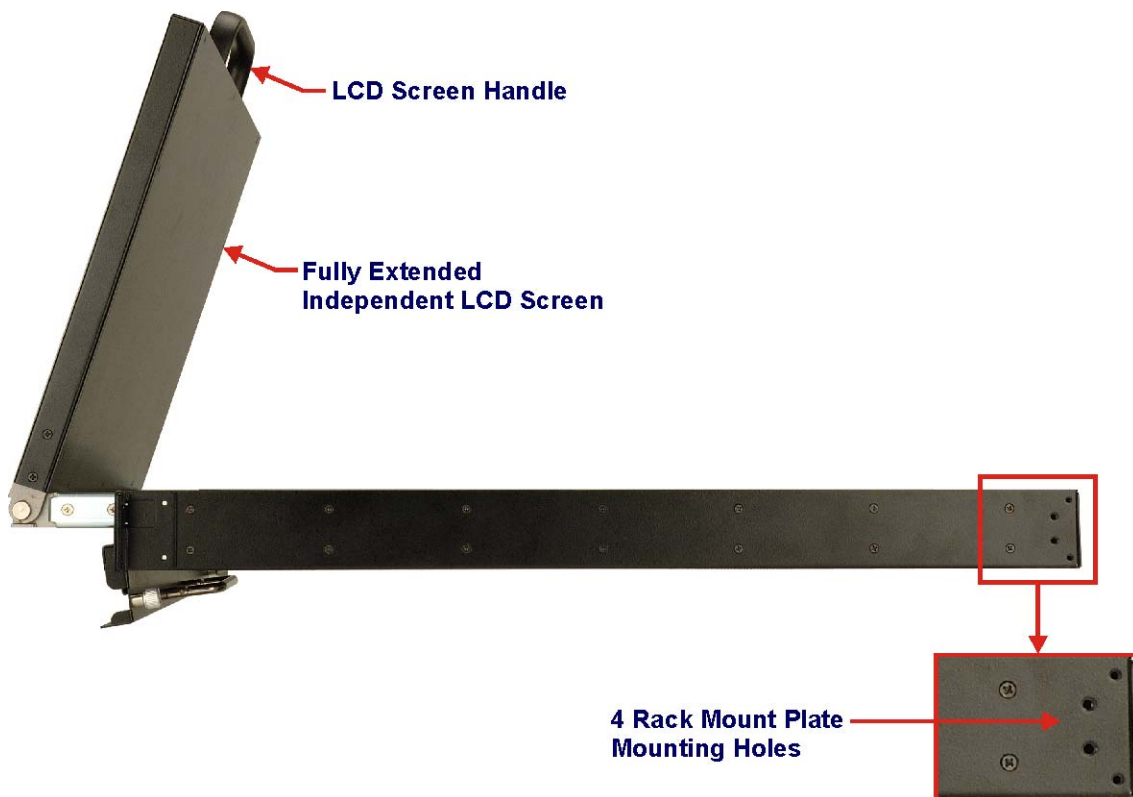

Figure 1-5: LKM-935 Series Overview

### 1.2.4 LKM Access Door

The front of the console drawer consists of an access door with two spring-loaded, freewheeling retention screws for securing the access door when the LCD and keyboard are in the stowed position. Also located on the front of the console drawer are two metal clips with slotted holes for rack mounting. Refer to **Section 3.5** for complete mounting details. Figure 1-6 shows the access door of the LKM-926 series console drawer.

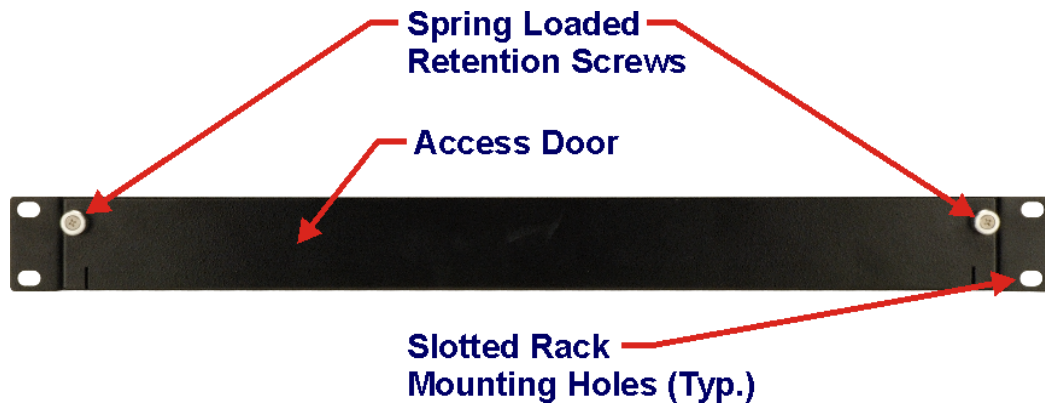

Figure 1-6: LKM-926/927 Access Door



## 1.2.5 LKM Rear View

### 1.2.5.1 Single Port KVMA

The rear panel of the drawer consists of industry standard VGA, keyboard, mouse and audio connectors, as well as a power connector and cooling vents. Figure 1-7 shows the rear view of the LKM-926 series console drawer.

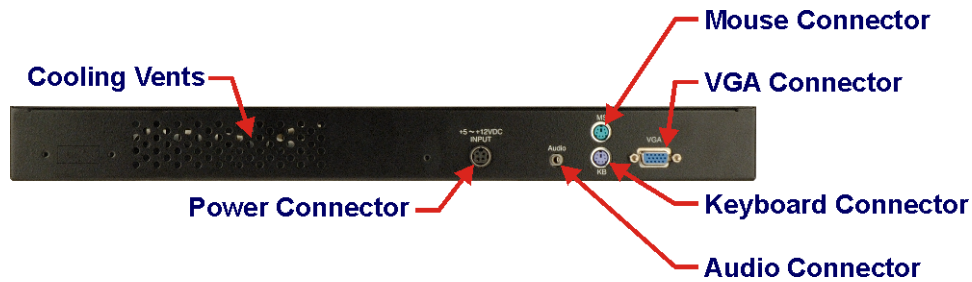

**Figure 1-7: Single Port KVMA Rear View**

### 1.2.5.2 KVMA 8-Port Switch

The KVMA 8-port switch can be used to connect up to eight systems to the LKM series console drawer. Each system can be connected to the console via its own standard audio, VGA, keyboard and mouse connectors. Each system can be easily accessed through the LCM on the keyboard tray (see Figure 1-3). Figure 1-8 shows the KVMA 8-port switch.

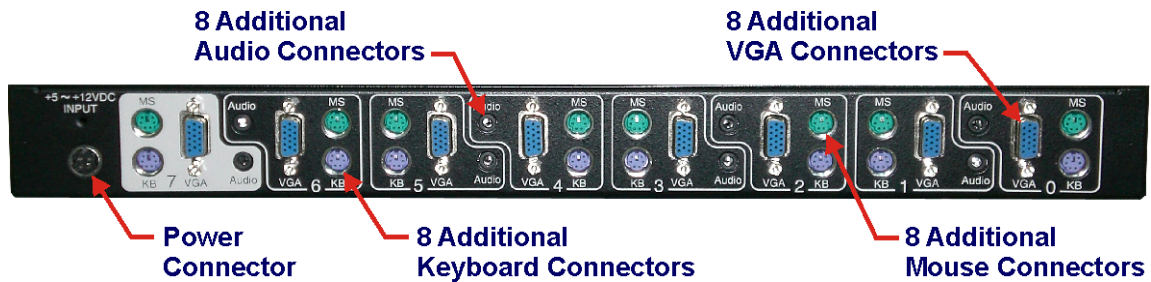

**Figure 1-8: 8-Port KVMA Rear View**

## 1.3 Certifications

All LKM series console drawer models comply with the following international standard:

- RoHS

For a more detailed description of this standard, please refer to **Appendix B**.

## 1.4 Maintenance and Troubleshooting

All LKM series console drawer models require no maintenance and should provide trouble-free service. If any component of an LKM series console drawer fails to operate, malfunctions, or otherwise appears to be broken, do not attempt to fix it. Return the malfunctioning LKM series console drawer in its entirety to the original reseller, vendor or to IEI for repair or replacement.

Chapter

2

# Detailed Specifications

---

## 2.1 Series Specifications

Table 2-1 shows the LKM Series console drawer specifications.

	LKM-926 series	LKM-927 series	LKM-935 series
<b>LCD Type</b>	15" TFT	17" TFT	15" TFT
<b>Input Interface</b>	XGA	SXGA	XGA
<b>Max. Resolution</b>	1024x768	1280x1024	1024x768
<b>Backlight MTBF</b>	50,000 Hrs	50,000 Hrs	50,000 Hrs
<b>Contrast</b>	400:1	800:1	400:1
<b>LCD Color</b>	262K	16.7M	262K
<b>Brightness (cd/m2)</b>	350	300	350
<b>Power Adapter</b>	42W AC/DC Adapter		
<b>Chassis</b>	Heavy-duty steel		
<b>View Angle (H/V)</b>	120°/100°	160°/160°	120°/100°
<b>OSD function</b>	Yes		
<b>Mounting</b>	19" Rack Mount		
<b>Rack Height</b>	1U		
<b>Keyboard</b>	87 Keys – Slim Size		
<b>Touch Pad</b>	Yes – with 2 buttons		
<b>LCM</b>	8 Port KVMA Models Only		

## LKM Series Console Drawer

	LKM-926 series	LKM-927 series	LKM-935 series
<b>Independent KB/LCD Trays</b>	No	No	Yes
<b>Dimensions (L x W x H) (mm)</b>	521 x 432.6 x 44	572 x 436 x 44	536 x 433.6 x 44
<b>Weight (Gross/Net)</b>	17Kg	17Kg	17Kg
<b>Color</b>	Black (Pantone Black C), White (Pantone 413C)		
<b>Vibration</b>	5 ~ 17 Hz, 0.1" double amplitude displacement 17 ~ 640 Hz, 1.5G acceleration peak to peak		
<b>Shock</b>	10G acceleration peak to peak (11ms)		
<b>Humidity</b>	5 ~ 95%, non-condensing		
<b>Operation Temperature</b>	0~50°C		

**Table 2-1: LKM Series Specifications**

## 2.2 Physical Dimensions

The following sections describe the physical dimensions for each model of the LKM Series console drawer.

### 2.2.1 General Physical Dimensions

General physical dimensions for the LKM Series console drawers are shown in **Table 2-2**.

<b>Model</b>	<b>Length (mm)</b>	<b>Width (mm)</b>	<b>Height (mm)</b>
<b>LKM-926</b>	<b>521</b>	<b>432.6</b>	<b>44</b>
<b>LKM-927</b>	<b>572</b>	<b>436</b>	<b>44</b>
<b>LKM-935</b>	<b>536</b>	<b>433.6</b>	<b>44</b>

**Table 2-2: General Physical Dimensions**

**LKM Series Console Drawer**

**2.2.2 LKM-926 Physical Dimensions**

The physical dimensions of the LKM-926 are shown in Figure 2-1.

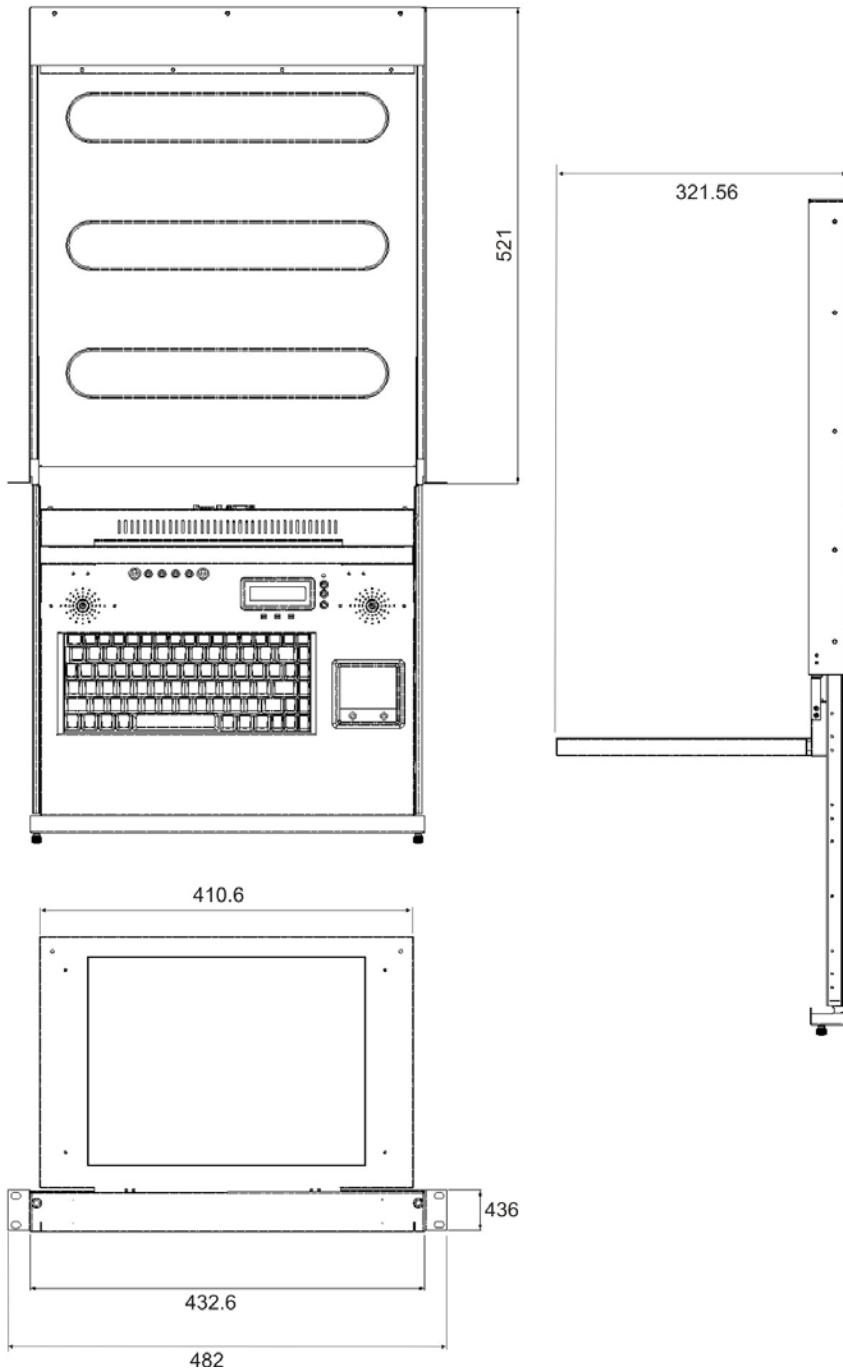

**Figure 2-1: LKM-926 Physical Dimensions (millimeters)**

### 2.2.3 LKM-927 Physical Dimensions

The physical dimensions of the LKM-927 are shown in Figure 2-2.

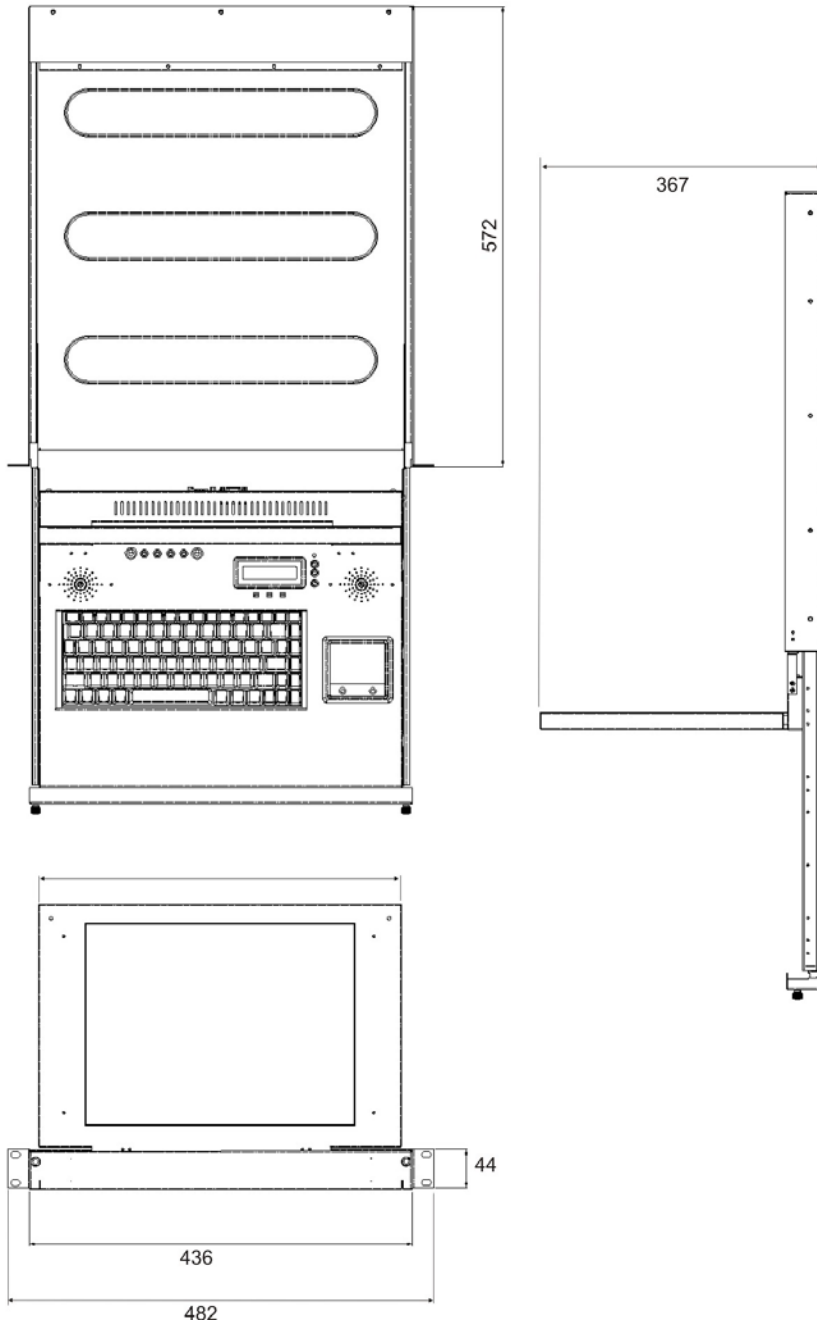

**Figure 2-2: LKM-927 Physical Dimensions (millimeters)**



## LKM Series Console Drawer

### 2.2.4 LKM-935 Physical Dimensions

The physical dimensions of the LKM-935 are shown in Figure 2-3.

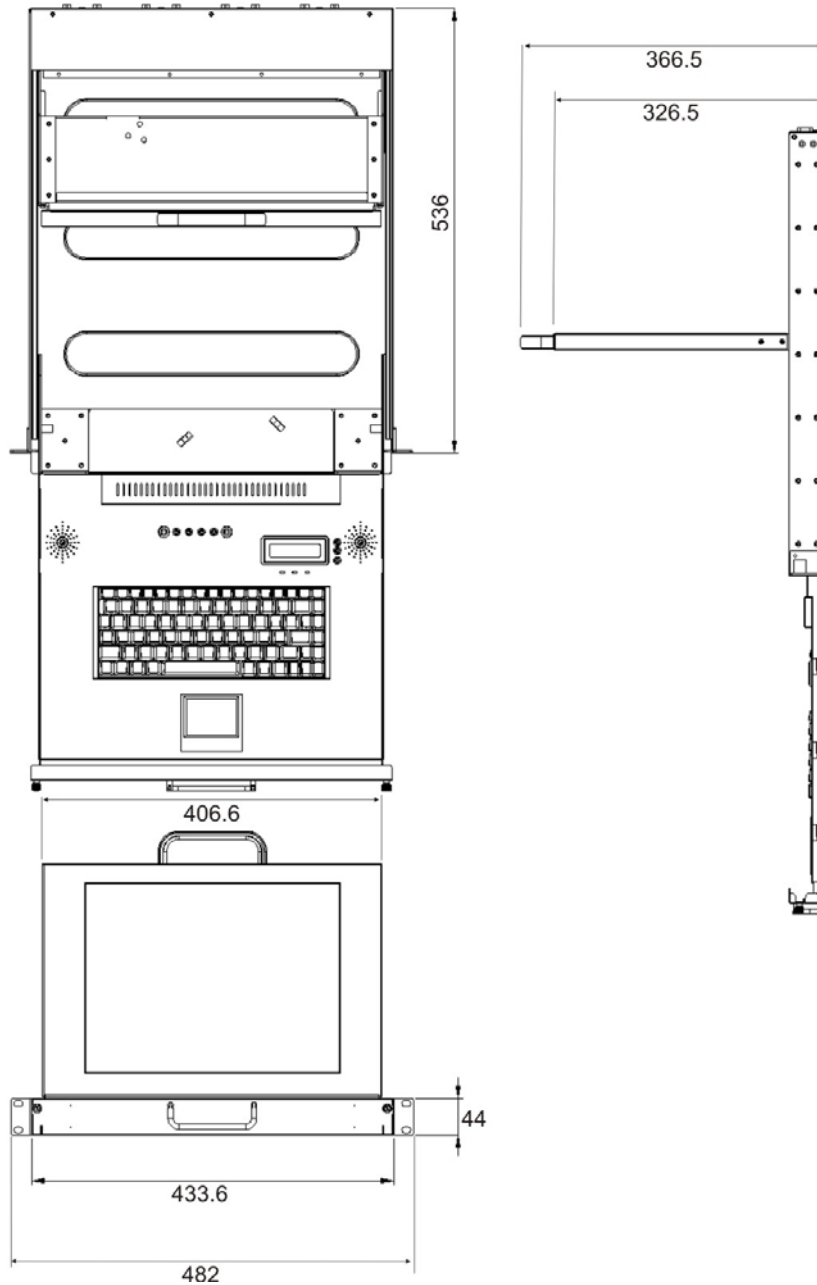

Figure 2-3: LKM-935 Physical Dimensions (millimeters)

## 2.2.5 LCD Specifications

Table 2-3 lists the LKM Series console drawer LCD specifications.

Size	15"	17"
<b>Mfr./Model</b>	AUO / G150XG01	AUO / M170EG01 VD
<b>Resolution (pixel)</b>	XGA (1024 x 768)	SXGA (1280 x 1024)
<b>Active Area (H x V)(mm)</b>	304.1 x 228.1	337.920 x 270.336
<b>Pixel Pitch (mm)</b>	0.297	0.264
<b>Mode</b>	TN	TN
<b>Number of Colors</b>	262K	16.7M
<b>View Angle (H/V)</b>	120°/100°	160°/160°
<b>Brightness (cd/m<sup>2</sup>)</b>	350	300
<b>Contrast Ratio</b>	400:1	800:1
<b>Response Time (ms) (at 25°C)</b>	16ms (Tr+Tf)	5ms (Tr+Tf)
<b>Power Consumption</b>	11.5W	25.8W
<b>Interface</b>	Single Channel LVDS	Dual Channel LVDS
<b>Backlight</b>	2 CCFL	4 CCFL
<b>Lamp Life (hrs)</b>	50,000	50,000

Table 2-3: LKM Series console drawer LCD Specifications

## 2.3 Power Adapters

### 2.3.1 5V/12V AC/DC Power Adapter

Table 2-4 lists the 5V/12V AC/DC power adapter specifications.

<b>MFR./Model</b>	<b>Sinpro/SPU45E-201</b>
<b>Power</b>	<b>42 Watt AC/DC Adapter</b>
<b>General Description</b>	<b>Universal Input 90 to 264 VAC EMI Meets FCC Part-15/CISPR 22 Class B MTBF 100Khrs</b>
<b>Input Voltage Range</b>	<b>90-264VAC</b>
<b>Input Frequency</b>	<b>47-63 Hz</b>
<b>Inrush Current</b>	<b>30A max. (Cold Start)</b>
<b>Hold-up Time</b>	<b>10mS typical</b>
<b>Leakage Current</b>	<b>0.75mA max.</b>
<b>Short Circuit Protection</b>	<b>Continuous</b>
<b>Over-voltage Protection</b>	<b>Yes</b>
<b>Continuous Output Power</b>	<b>42W max.</b>
<b>Hi-pot Isolation: Input / Output</b>	<b>42/42VDC</b>

Table 2-4: 5V/12V AC/DC Power Adapter Specifications

The 5V/12V AC/DC power adapter is shown in Figure 2-4.



**Figure 2-4: 5V/12V AC/DC Power Adapter**

The physical dimensions of the 5V/12V AC/DC power adapter are shown in Figure 2-5.

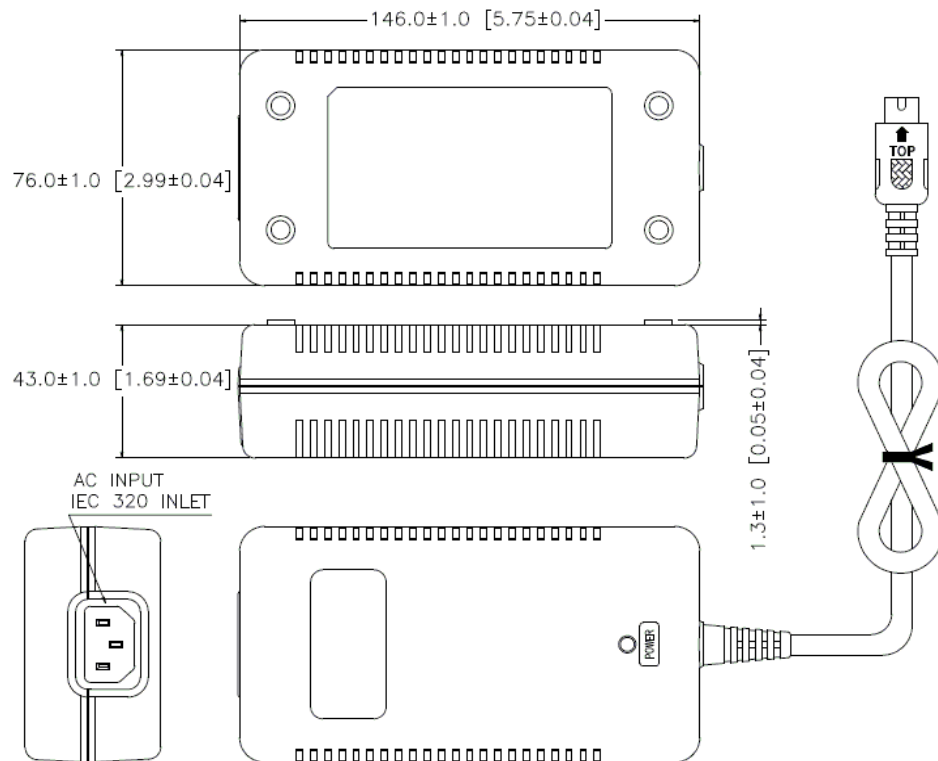

**Figure 2-5: 5V/12V AC/DC Power Adapter Dimensions (millimeters [inches])**

### 2.3.2 24V/48V DC Input Power Adapters

Table 2-5 lists the 24V/48V DC power adapter specifications.

	24V DC Input	48V DC Input
<b>MFR./Model</b>	Skynet / ACE-023C	Skynet / ACE-023T
<b>EMI Standards</b>	FCC Docket 20780 curve "B" EN 55022 "B"	
<b>EMS Standards</b>	IEC-61000-4-2: 4KV contact; 8KV air discharge criterion B IEC-61000-4-3: 3V/M with 80% AM criterion A IEC-61000-4-4: 2KV criterion B	
<b>Input Voltage Range</b>	18VDC - 32VDC	36VDC - 72VDC
<b>Input Current</b>	2.5A max. at 24VDC	
<b>Inrush Current</b>	15A max. at 24VDC (25° Cold Start)	
<b>Output Load Range</b>	+5V output, 4A rated load +12V output, 0.75A rated load	
<b>Output Power</b>	>30W at 24VDC	
<b>Ripple and Noise</b>	>1.2% of output voltage peak to peak	
<b>Line Regulation</b>	>±1% at rated load	
<b>Load Regulation</b>	5V >±5% and 12V >±4% at 60% rated load, 24VDC input	
<b>Short Circuit Protection</b>	Continuous	
<b>Over-voltage Protection</b>	Yes	
<b>Humidity</b>	20 ~ 95%, non-condensing	
<b>Operation Temperature</b>	0 ~ 50°C	
<b>Storage Temperature</b>	-40 ~ 85°C	

Table 2-5: 24V/48V DC Power Adapter Specifications

The physical dimensions of the 24V/48V DC power adapter are shown in Figure 2-6.

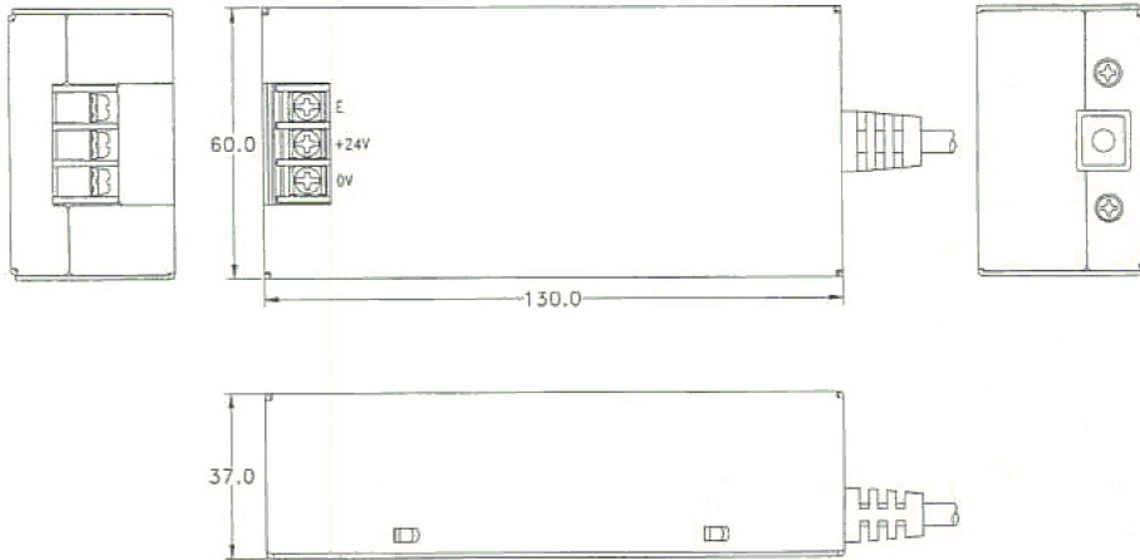

**Figure 2-6: 24V/48V DC Power Adapter Dimensions (millimeters)**

Chapter

3

# Installation

---

## 3.1 Installation Precautions

When installing the LKM series console drawer, please follow the precautions listed below:

- **Read the user manual:** The user manual provides a complete description of the LKM series console drawer, installation instructions and configuration options.
- **DANGER! Disconnect Power:** Power to the console drawer must be disconnected when installing the LKM series console drawer.
- **Qualified Personnel:** The LKM series console drawer must be installed and operated only by trained and qualified personnel. Maintenance may only be carried out by qualified personnel who are familiar with the associated dangers.
- **Mounting:** Since the LKM series console drawer may weigh up to 11Kg, please ensure at least two people assist with mounting the drawer.
- **Air Circulation:** Make sure there is sufficient air circulation when installing the LKM series console drawer. The LKM series console drawer's cooling vents must not be obstructed by any objects. Blocking the vents can cause overheating of the LKM series console drawer.
- **Grounding:** The LKM series console drawer should be properly grounded. The voltage feeds must not be overloaded. Adjust the cabling and provide external overcharge protection per the electrical values indicated on the label attached to the power adapter.

## 3.2 Unpacking

### 3.2.1 Packaging

When shipped, the LKM series console drawer is wrapped in a plastic bag. Two polystyrene ends are placed on either side of the console drawer. The console drawer is then placed into a first (internal) cardboard box. This box is then sealed and placed into a second (external) cardboard box. The second box is also sealed. Two bags containing accessory items are placed with the console drawer in the internal (first) box.



## LKM Series Console Drawer

### 3.2.2 Unpacking Procedure

To unpack the LKM series console drawer, follow the steps below:



#### **WARNING:**

The LCD screen has a protective plastic cover stuck to the screen. Remove the plastic cover only after the LKM series console drawer has been properly installed. This ensures the screen is protected during the installation process.

---

- Step 1:** Use a box cutter, a knife or a sharp pair of scissors to cut the tape that seals the top side of the external (second) box.
- Step 2:** Open the external (second) box.
- Step 3:** Use a box cutter, a knife or a sharp pair of scissors to cut the tape that seals the top side of the internal (first) box.
- Step 4:** Lift the console drawer out of the boxes.
- Step 5:** Remove both polystyrene ends, one from each side.
- Step 6:** Pull the plastic cover off the console drawer.
- Step 7:** Make sure all the components listed in the packing list are present.

### 3.2.3 Packing List

All the console drawers in the LKM series are shipped with the following components:



Quantity	Item and Part Number	Image
1	LKM Console Drawer	
1 (single-port model)	1.8m Cable Set, Including VGA, Keyboard, Mouse and Audio Cable (P/N: LKM-CB18A-RS)	
1	175cm Round Cable Power Cord (P/N: 32000-000002-RS)	
1	Power Supply (P/N: 63SPU45E201-000-RS)	
2	Rack Mounting Bracket (Long) (P/N: 41020-009001-01-RS)	
2	Rack Mounting Bracket (Short) (P/N: 41020-009501-00-RS)	
1	Screw Set (8x Rack Mounting Screws)	
1	Quick installation guide	

## LKM Series Console Drawer

If any of these items is missing or damaged, contact the distributor or sales representative immediately.

### 3.2.4 Optional Accessories

The following optional accessories for the LKM series console drawers can be ordered separately:

Item and Part Number	Image
1.8m Cable Set, Including VGA, Keyboard, Mouse and Audio Cable (P/N: LKM-CB18A-RS)	
3.0m Cable Set, Including VGA, Keyboard, Mouse and Audio Cable (P/N: LKM-CB30A-RS)	
5.0m Cable Set, Including VGA, Keyboard, Mouse and Audio Cable (P/N: LKM-CB50A-RS)	

## 3.3 Pre-installation Preparation

### 3.3.1 Tools

Before installing the LKM series console drawer, make sure the following tools are on hand:

- **Philips (crosshead) screwdriver:** All the retention screws on the system are Philips screws.

### 3.4 Connectors

Table 3-1 lists the rear panel connectors for the LKM series console drawers.

Connector	Type
Audio connector	1 x audio jack
Keyboard connector	PS/2 connector
Mouse connector	PS/2 connector
Power connector	Mini DIN Plug With Lock (Thick Pin, 4 PIN) connector
VGA connector	HD-D-sub 15 female connector

**Table 3-1: Rear Panel Connectors**

#### 3.4.1 Audio Connector

To receive audio signals from a system, use the rear panel audio jack to connect to a system's line out audio jack connector.

## LKM Series Console Drawer

### 3.4.2 Keyboard Connector

Use the rear panel PS/2 keyboard connector to connect the console keyboard to a system.

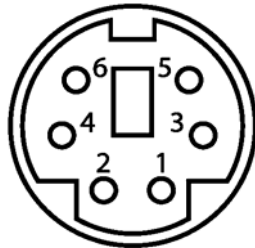

Figure 3-1: Keyboard Connector

PIN	DESCRIPTION
1	L_KDAT
2	NC
3	GND
4	5V
5	L_KCLK
6	NC

Table 3-2: Keyboard Connector Pinouts

### 3.4.3 Mouse Connector

Use the rear panel PS/2 mouse connector to connect the console mouse to a system.

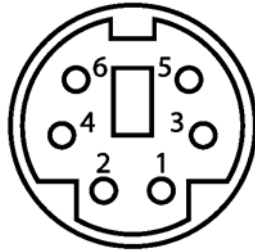

**Figure 3-2: Mouse Connector**

PIN	DESCRIPTION
1	L_MDAT
2	NC
3	GND
4	5V
5	L_MCLK
6	NC

**Table 3-3: Mouse Connector Pinouts**

### 3.4.4 Power Connector

Use the rear panel power connector to connect the console to the power adapter.

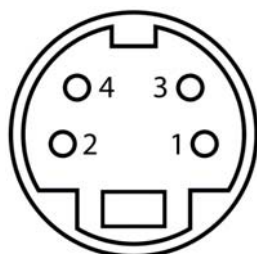

Figure 3-3: 5V/12V Power Connector

PIN	DESCRIPTION	PIN	DESCRIPTION
2	COMMON	1	+5V
4	COMMON	3	+12V
Shell	GND		

Table 3-4: 5V/12V Power Connector Pinouts

### 3.4.5 VGA Connector

Use the rear panel standard 15-pin female VGA connector to connect the monitor to the system graphics interface.

PIN	DESCRIPTION	PIN	DESCRIPTION	PIN	DESCRIPTION
1	RED	6	GROUND	11	NC
2	GREEN	7	GROUND	12	DDCDAT
3	BLUE	8	GROUND	13	HSYNC
4	NC	9	NC	14	VSYNC
5	GROUND	10	GROUND	15	DDCCLK

Table 3-5: VGA Connector Pinouts

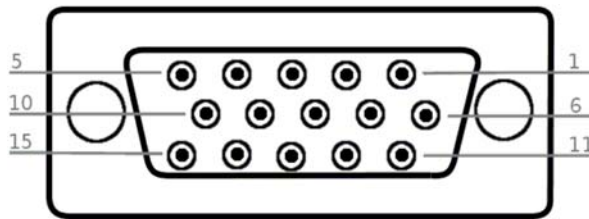

Figure 3-4: VGA Connector



## 3.5 Mounting the LKM Series Console Drawer

Each LKM series console drawer is shipped with an installation kit for mounting the drawer into a rack. Refer to the following section for instructions on rack mounting the LKM series console drawer.

### 3.5.1 Rack Mounting

The LKM series console drawer can be mounted to the rack posts of a standard 19" rack cabinet. Make sure that all cabling is correctly attached and carefully routed when installing the LKM series console drawer. Follow the steps below to mount the LKM series console drawer into a rack.



#### NOTE:

At least two people are required to mount the LKM series console drawer. The rack or cabinet into which the LKM series console drawer is installed should provide adequate and sufficient ventilation, grounding, power source, and stability features.

---

**Step 1:** Find the rack mounting kit in the box that the LKM series console drawer was shipped in.



#### NOTE:

In order to attach a rack-mounting bracket to an LKM-926 series console drawer, the rearmost cap screw must be removed from the side panel. Refer to **Figure 1-4** for more information.

---

**Step 2:** Attach one of the rack mounting brackets to the side of the console drawer with either two or four screws as required (see **Figure 3-5**).

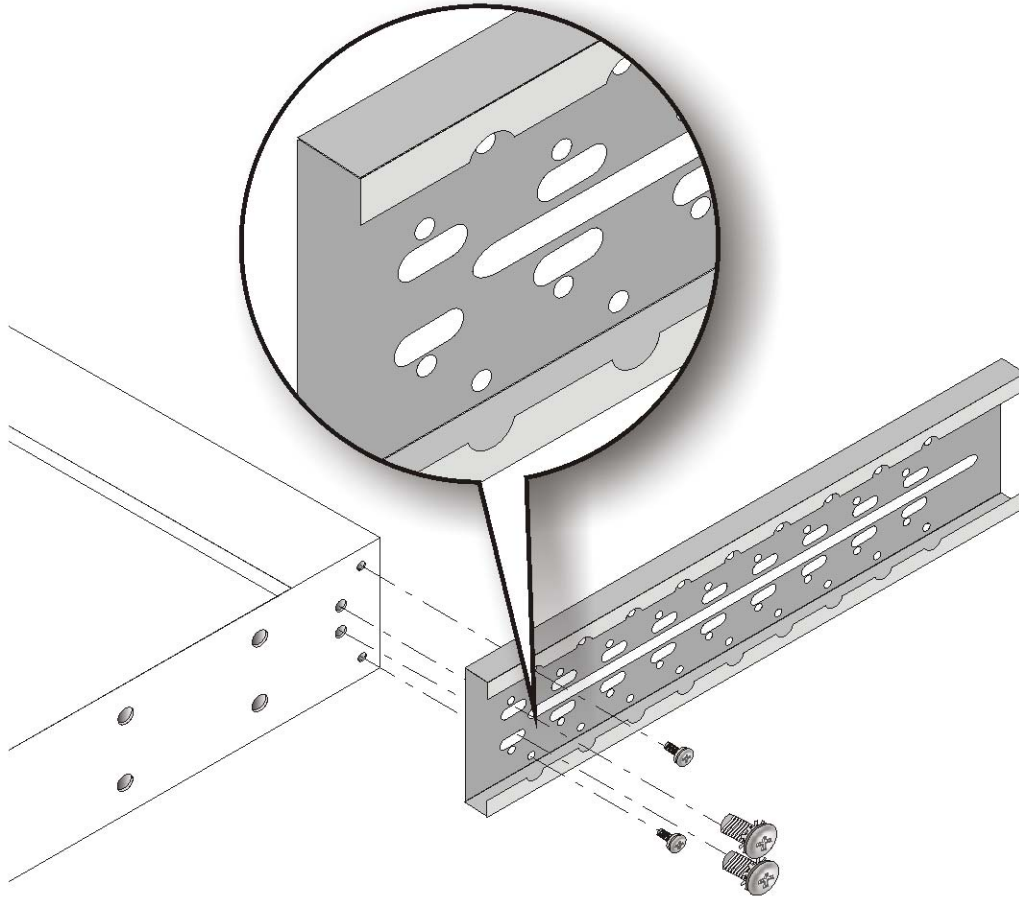
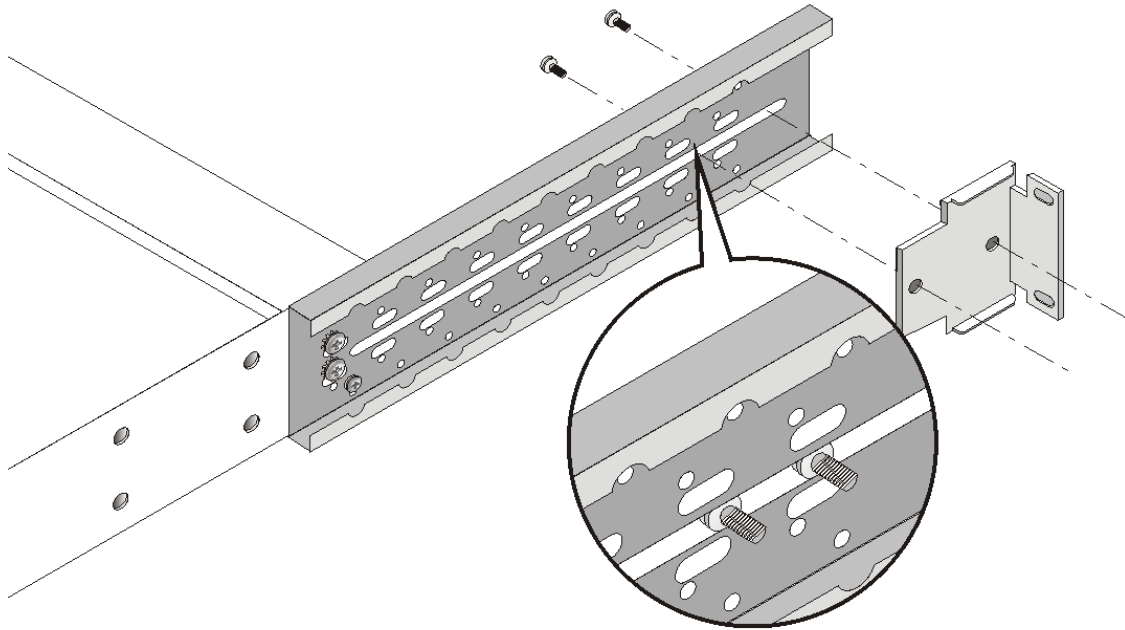

**Figure 3-5: Attach the Rack Mounting Bracket**

**Step 3:** Repeat **Step 2** for the other side of the console drawer.

## LKM Series Console Drawer

**Step 4:** Attach an angle bracket to the one of the rack mounting brackets with two screws as shown in Figure 3-6.

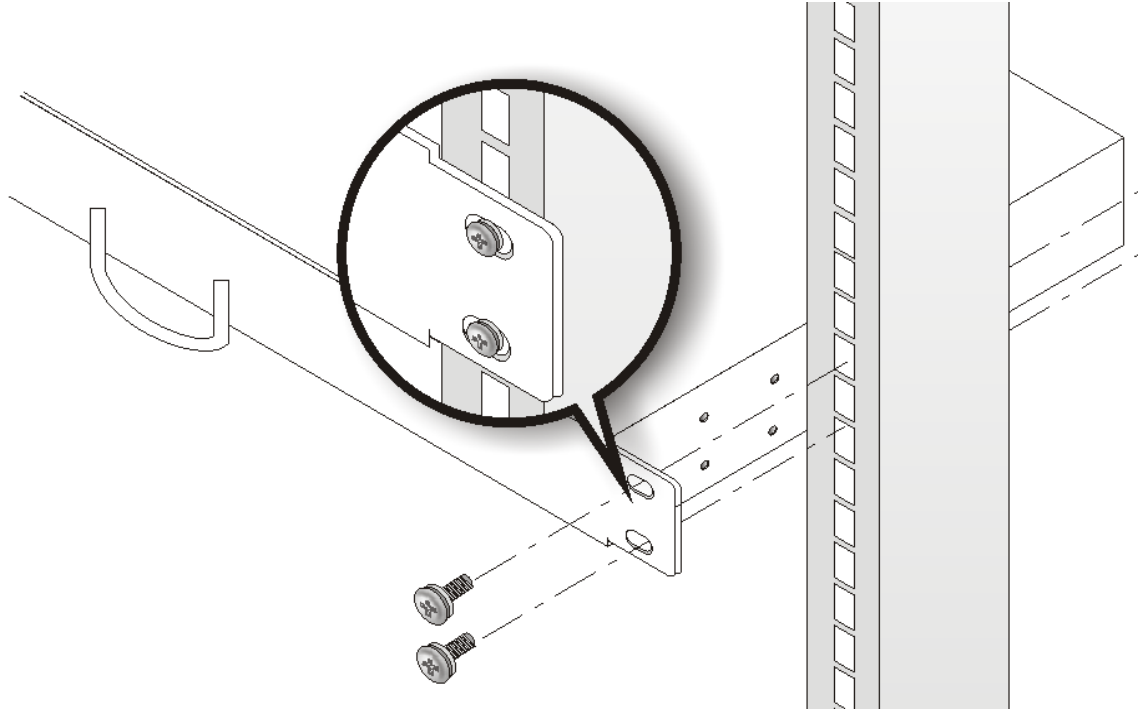

**Figure 3-6: Attach the Angle Bracket**

**Step 5:** Repeat **Step 4** for the other side of the console drawer.

**Step 6:** With the help of another person, insert the console drawer into a rack and align the slotted holes on the front face of the drawer with the holes in the rack.

**Step 7:** Insert four screws (two on each side of the drawer's front face) through the holes in the drawer's front face and into the rack as seen in Figure 3-7.



**Figure 3-7: Secure Front of Console to Rack**

## LKM Series Console Drawer

**Step 8:** Insert four screws (two on each side of the drawer) through the holes in the angle mounting bracket and into the rack as seen in **Figure 3-8**.

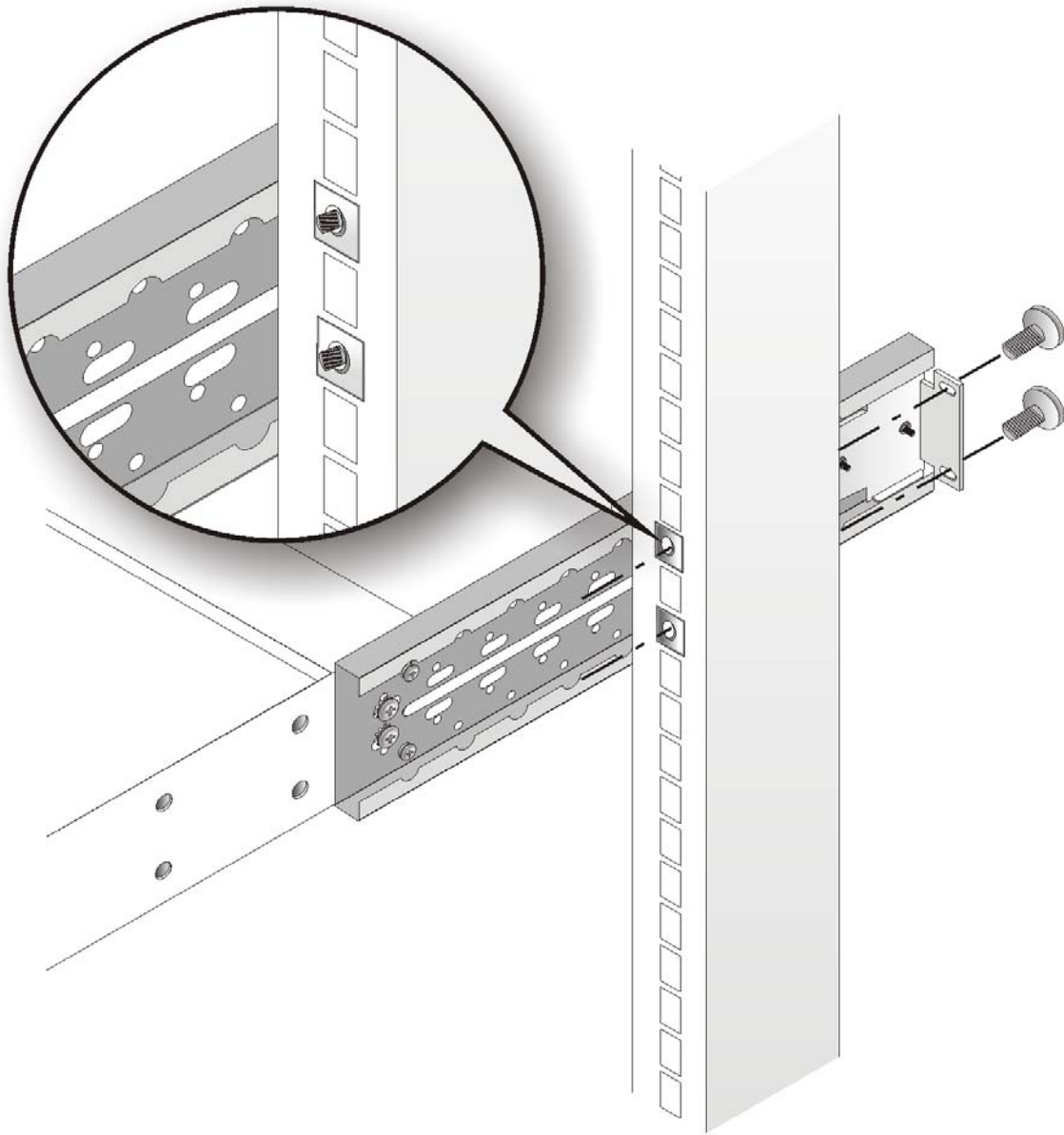

**Figure 3-8: Secure Rear of Console to Rack**

### 3.6 Cabling

Each LKM series console drawer is shipped with a set of cables for connecting a system to the console. **Figure 3-9** shows a detail of the cable connections on the LKM series console drawer rear panel. Up to eight systems can be connected to the console drawer with the use of a KVMA switch model. All cable connections to the KVMA switch are similar to those seen in **Figure 3-9**.

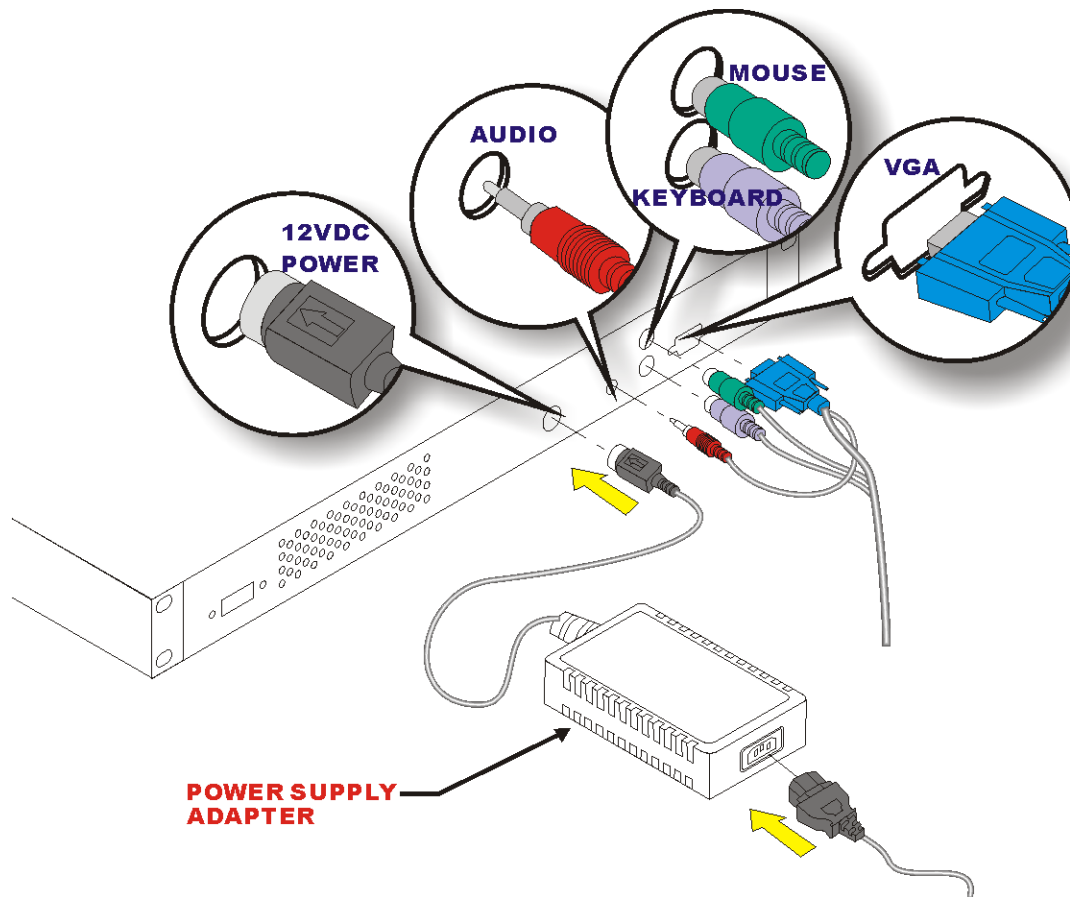

**Figure 3-9: Rear Panel Connections**

Chapter

4

# On-Screen-Display and LCD Module Controls

---

## 4.1 OSD Controls

### 4.1.1 OSD Buttons

There are several on-screen-display (OSD) control buttons on the keyboard tray of the LKM series console drawers (**Figure 4-1**). Use the **Menu/Enter** button to initiate the OSD controls menu or to enter adjusted values for OSD options. Use the **Left** and **Right** buttons to navigate through the OSD menu structure.

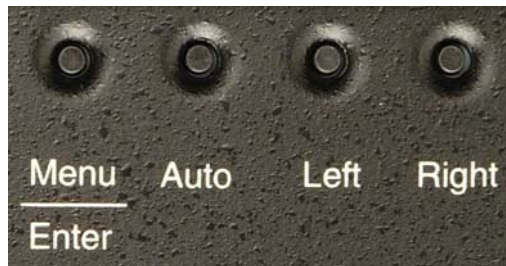

**Figure 4-1: OSD Control Buttons**



#### **NOTE:**

Pressing the “Left” key while the OSD control menu is inactive brings up the brightness adjustment menu. Pressing the “Auto” key while the OSD control menu is inactive will automatically adjust the display for optimum view on the LCD screen.

### 4.1.2 OSD Menu Structure

shows the OSD menu structure for all models of the LKM series console drawers.



## LKM Series Console Drawer

Level 0	Level 1	Level 2	Level 3	Value	
Brightness and Contrast Menu	Brightness			0 to 100	
	Contrast			0 to 100	
	Exit			Return to Main Menu	
Color Menu	AutoColor			Auto-adjusts the color	
	sRGB			Standard RGB mode	
	ColorTemp	User	R		0 to 255
			G		0 to 255
			B		0 to 255
		4200k			Preset NTSC value
		5000k			Preset NTSC value
		6500k			Preset NTSC value
		7500k			Preset NTSC value
		9300k			Preset NTSC value
	Exit			Return to Color Menu	
Exit			Return to Main Menu		
Image Menu	AutoAdjust			Auto-adjusts display values	
	Width			0 to 100	
	Clock Phase			0 to 32	
	HPos			0 to 255	
	VPos			0 to 255	
	Exit			Return to Main Menu	
Tools Menu	OSD	OSDTimeOut		0 to 60	
		OSDHPos		0 to 255	
		OSDVPos		0 to 255	
		Exit		Return to Tools Menu	
	Factory Reset			Reset all display values to factory settings	
	Sharpness			0 to 6	
	Overlapped Mode			640/720 Mode change	
	Exit			Return to Main Menu	

Table 4-1: OSD Menu Structure

### 4.1.3 Brightness and Contrast Menu

The Brightness and Contrast menu is shown in Figure 4-2.



Figure 4-2: Brightness and Contrast Menu

- Brightness:
  - This item sets the brightness of screen, adjusting the offset value of ADC. Setting this value too high or too low will affect the quality of image.
- Contrast:
  - This item sets the gain value of ADC. Adjusting this value too high or too low will worsen the quality of image.
- Exit:
  - This item exits the **Brightness and Contrast** menu.

## LKM Series Console Drawer

### 4.1.4 Color Menu

The Color menu is shown in Figure 4-3.

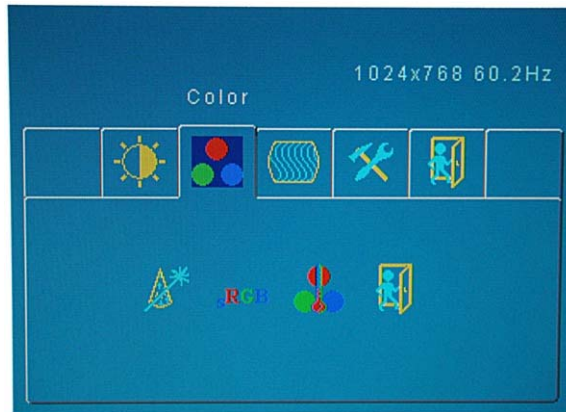

**Figure 4-3: Color Menu**

The **Color** menu fine-tunes the palette of color hues for the LCD.

- AutoColor:
  - This item automatically adjusts the color.
- sRGB:
  - This item sets the color to standard RGB mode.
- ColorTemp:
  - This enters the **Color Temperature** sub-menu (see **Section 4.1.4.1**).
- Exit:
  - This item exits the **Color** menu.

#### 4.1.4.1 Color Temperature Sub-Menu

The Color Temperature sub-menu is shown in Figure 4-4.

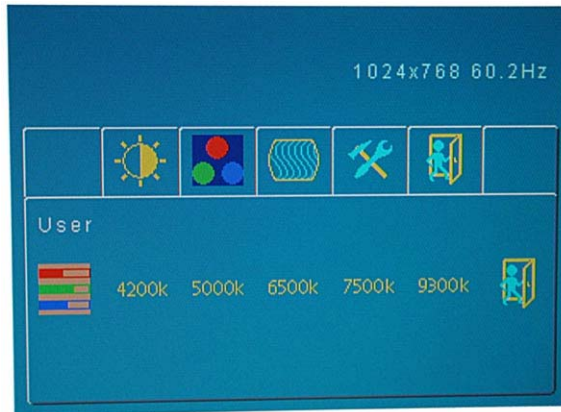

**Figure 4-4: Color Temperature Sub-Menu**

- User:
  - This enters the **User** sub-menu (see **Section 4.1.4.2**).
- 4200:
  - This item sets the display color temperature to NTSC standard 4200K.
- 5000:
  - This item sets the display color temperature to NTSC standard 5000K.
- 6500:
  - This item sets the display color temperature to NTSC standard 6500K.
- 7500:
  - This item sets the display color temperature to NTSC standard 7500K.
- 9300:
  - This item sets the display color temperature to NTSC standard 9300K.

## LKM Series Console Drawer

### 4.1.4.2 User Sub-Menu

The **User** sub-menu is shown in Figure 4-5.

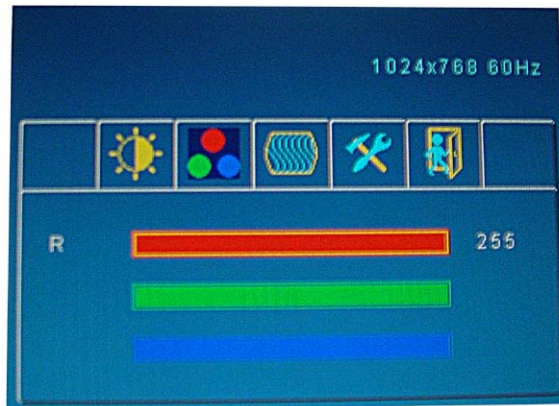
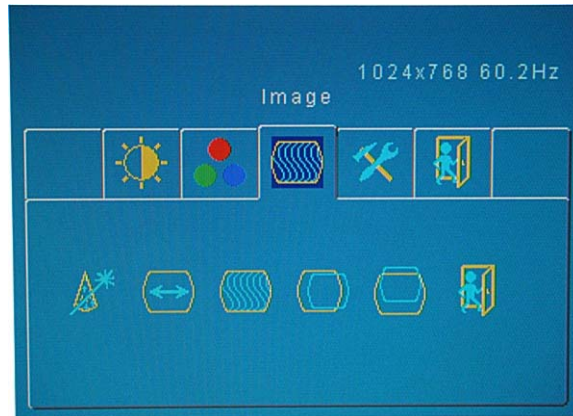

**Figure 4-5: User Sub-Menu**

- User:
  - This item adjusts the balance among Red, Green, and Blue color hues if images look garish or unrealistic.

### 4.1.5 Image Menu

The **Image** menu is shown in Figure 4-6.



**Figure 4-6: Image Menu**

The **Image** menu adjusts the screen position options.

- AutoAdjust:
  - This item automatically adjusts the screen position.
- Width:
  - This item adjusts the screen size in the horizontal direction.
- Clock Phase:
  - This item adjusts the input signal and dot clock position (Analog only).
- HPos:
  - This item adjusts the horizontal position of the display screen.
- VPos:
  - This item adjusts the vertical position of the display screen.
- Exit:
  - This item exits the **Image** menu.

### 4.1.6 Tools Menu

The **Tools** menu is shown in Figure 4-7.

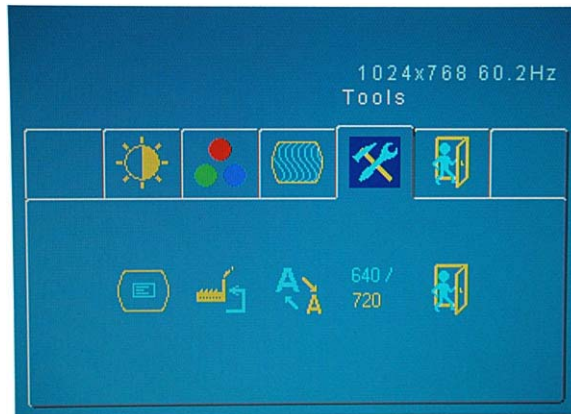

**Figure 4-7: Tools Menu**

The **Tools** menu has the following options:

- **OSD:**
  - This enters the **OSD** sub-menu (see **Section 4.1.6.1**).
- **Factory Reset:**
  - This item resets all display values to their factory settings.
- **Sharpness:**
  - This item adjusts the sharpness level to preset values. This option may help reducing the softening edges around displayed objects.
- **Overlapped Mode:**
  - This item toggles the DOS mode pixel resolution between 640 and 720.
- **Exit:**
  - This item exits the **Tools** menu.

#### 4.1.6.1 OSD Sub-Menu

The **OSD** sub-menu is shown in Figure 4-8.

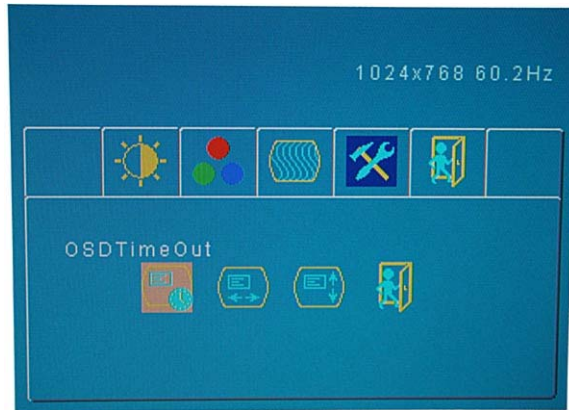

**Figure 4-8: OSD Sub-Menu**

- OSDTimeOut:
  - This item adjusts how many seconds the OSD screen stays visible before it disappears when OSD is left unattended.
- OSDHPos:
  - This item adjusts the horizontal position of the OSD display screen.
- OSDVPos:
  - This item adjusts the vertical position of the OSD display screen.
- Exit:
  - This item exits the **OSD** sub-menu.



## 4.2 LCM Controls (8-Port KVMA Models)

The LCM is used to control the display and switching status of systems connected to the console.

### 4.2.1 LCM Buttons

There are three LCD module (LCM) control buttons and one LED (Figure 4-9) on the keyboard tray of the LKM series console drawers that have eight port connectors.



Figure 4-9: LCM Control Buttons

- LED:
  - This item indicates that the LCD is either in Auto Scan mode or Edit mode.
- AUTO / EDIT:
  - This item initiates an auto-scan sequence for systems connected to the console and can be used to edit station names.
- UP:
  - This item scrolls up through available stations and options.
- DOWN:
  - This item scrolls down through available stations and options.

## 4.2.2 LCM Functions

The following sections describe the LCM functions.

### 4.2.2.1 Manually Switching Stations

When the LKM series console drawer is initially connected to a power source, "Power On" is displayed on the LCM; afterwards, "Station 001" is displayed indicating that the system connected to station 1 ports is currently active. Use the "UP" and "Down" button to activate control over other stations. The station range is from "station 000" to "station 007".

### 4.2.2.2 Cycling Through Stations

Press the "AUTO/EDIT" button to activate the automatic switching function. Press the "AUTO/EDIT" button and the console will continuously cycle through all available stations at an interval of 10 seconds. Press the "AUTO/EDIT" button again to stop the cycling sequence.

### 4.2.2.3 Station Name Editing

The station name editing functions allow users to input the name of each computer station on the LCM. The maximum number of input characters is 16. The following procedure is used as an example of how to change "STATION 001" to "ICP ALPHA SERVER". Available characters for naming are: A to Z, 0 to 9, space and the following symbols: ! " # \$ % & / ( ) \* + , - . / = < > ? @ [ ] \_

**Step 1:** Switch to "Station 001" on the LCM (see **Section 4.2.2.1**).

**Step 2:** Press the "AUTO/EDIT" button for more than 3 seconds, or until a blinking cursor is seen on the LCM, to enter edit mode.

**Step 3:** Press the "UP" or "DOWN" button until reaching the character "I".

**Step 4:** Press the "AUTO/EDIT" button to select the "I" character.

**Step 5:** Press the "UP" or "DOWN" button until reaching the character "C".

## LKM Series Console Drawer

- Step 6:** Press the "AUTO/EDIT" button to select the "C" character.
- Step 7:** Repeat steps 5 and 6 until "ICP ALPHA SERVER" is written on the LCM.
- Step 8:** Press the "AUTO/EDIT" button for more than 3 seconds, or until the blinking cursor disappears from the LCM, to exit edit mode.

**THIS PAGE IS INTENTIONALLY LEFT BLANK**

Appendix

A

# Safety Precautions

---

**WARNING:**

The precautions outlined in this chapter should be strictly followed. Failure to follow these precautions may result in permanent damage to the LKM Series console drawer.

## A.1 Safety Precautions

Please follow the safety precautions outlined in the sections that follow:

### A.1.1 General Safety Precautions

Please ensure the following safety precautions are adhered to at all times.

- **Follow the electrostatic precautions** outlined below whenever the LKM Series console drawer is opened.
- **Make sure the power is turned off and the power cord is disconnected** whenever the LKM Series console drawer is being installed, moved or modified.
- Do not apply voltage levels that exceed the specified voltage range. Doing so may cause fire and/or an electrical shock.
- **Electric shocks can occur** if the LKM Series console drawer chassis is opened when the LKM Series console drawer is running.
- **Do not drop or insert any objects** into the ventilation openings of the LKM Series console drawer.
- **If considerable amounts of dust, water, or fluids enter the LKM Series console drawer**, turn off the power supply immediately, unplug the power cord, and contact the LKM Series console drawer vendor.
- DO NOT:
  - Drop the LKM Series console drawer against a hard surface.
  - Strike or exert excessive force onto the LCD panel.
  - Touch any of the LCD panels with a sharp object
  - In a site where the ambient temperature exceeds the rated temperature

## LKM Series Console Drawer

### A.1.2 Anti-static Precautions

---



#### **WARNING:**

Failure to take ESD precautions during the installation of the LKM Series console drawer may result in permanent damage to the LKM Series console drawer and severe injury to the user.

---

Electrostatic discharge (ESD) can cause serious damage to electronic components, including the LKM Series console drawer. Dry climates are especially susceptible to ESD. It is therefore critical that whenever the LKM Series console drawer is opened and any of the electrical components are handled, the following anti-static precautions are strictly adhered to.

- ***Wear an anti-static wristband:*** Wearing a simple anti-static wristband can help to prevent ESD from damaging any electrical component.
- ***Self-grounding:*** Before handling any electrical component, touch any grounded conducting material. During the time the electrical component is handled, frequently touch any conducting materials that are connected to the ground.
- ***Use an anti-static pad:*** When configuring or working with an electrical component, place it on an anti-static pad. This reduces the possibility of ESD damage.
- ***Only handle the edges of the electrical component:*** When handling the electrical component, hold the electrical component by its edges.

## A.2 Maintenance and Cleaning Precautions

When maintaining or cleaning the LKM Series console drawer, please follow the guidelines below.

### A.2.1 Maintenance and Cleaning

Prior to cleaning any part or component of the LKM Series console drawer, please read the details below.

- Except for the LCD panel, never spray or squirt liquids directly onto any other components. To clean the LCD panel, gently wipe it with a piece of soft dry cloth or a slightly moistened cloth.
- The interior of the LKM Series console drawer does not require cleaning. Keep fluids away from the LKM Series console drawer interior.
- Be cautious of all small removable components when vacuuming the LKM Series console drawer.
- Turn the LKM Series console drawer off before cleaning the LKM Series console drawer.
- Never drop any objects or liquids through the openings of the LKM Series console drawer.
- Be cautious of any possible allergic reactions to solvents or chemicals used when cleaning the LKM Series console drawer.
- Avoid eating, drinking and smoking within vicinity of the LKM Series console drawer.

### A.2.2 Cleaning Tools

Some components in the LKM Series console drawer may only be cleaned using a product specifically designed for the purpose. In such case, the product will be explicitly mentioned in the cleaning tips. Below is a list of items to use when cleaning the LKM Series console drawer.

- **Cloth** – Although paper towels or tissues can be used, a soft, clean piece of cloth is recommended when cleaning the LKM Series console drawer.



## LKM Series Console Drawer

- **Water or rubbing alcohol** – A cloth moistened with water or rubbing alcohol can be used to clean the LKM Series console drawer.
- **Using solvents** – The use of solvents is not recommended when cleaning the LKM Series console drawer as they may damage the plastic parts.
- **Vacuum cleaner** – Using a vacuum specifically designed for computers is one of the best methods of cleaning the LKM Series console drawer. Dust and dirt can restrict the airflow in the LKM Series console drawer and cause its circuitry to corrode.
- **Cotton swabs** - Cotton swabs moistened with rubbing alcohol or water are excellent tools for wiping hard to reach areas.
- **Foam swabs** - Whenever possible, it is best to use lint free swabs such as foam swabs for cleaning.

**THIS PAGE IS INTENTIONALLY LEFT BLANK**

Appendix

**B**

# Hazardous Materials Disclosure

---

## **B.1 Hazardous Material Disclosure Table for IPB Products Certified as RoHS Compliant Under 2002/95/EC Without Mercury**

The details provided in this appendix are to ensure that the product is compliant with the Peoples Republic of China (China) RoHS standards. The table below acknowledges the presences of small quantities of certain materials in the product, and is applicable to China RoHS only.

A label will be placed on each product to indicate the estimated “Environmentally Friendly Use Period” (EFUP). This is an estimate of the number of years that these substances would “not leak out or undergo abrupt change.” This product may contain replaceable sub-assemblies/components which have a shorter EFUP such as batteries and lamps. These components will be separately marked.

Please refer to the table on the next page.

## LKM Series Console Drawer

Part Name	Toxic or Hazardous Substances and Elements					
	Lead (Pb)	Mercury (Hg)	Cadmium (Cd)	Hexavalent Chromium (CR(VI))	Polybrominated Biphenyls (PBB)	Polybrominated Diphenyl Ethers (PBDE)
Housing	X	O	O	O	O	X
Display	X	O	O	O	O	X
Printed Circuit Board	X	O	O	O	O	X
Metal Fasteners	X	O	O	O	O	O
Cable Assembly	X	O	O	O	O	X
Fan Assembly	X	O	O	O	O	X
Power Supply Assemblies	X	O	O	O	O	X
Battery	O	O	O	O	O	O

O: This toxic or hazardous substance is contained in all of the homogeneous materials for the part is below the limit requirement in SJ/T11363-2006

X: This toxic or hazardous substance is contained in at least one of the homogeneous materials for this part is above the limit requirement in SJ/T11363-2006

此附件旨在确保本产品符合中国 RoHS 标准。以下表格标示此产品中某有毒物质的含量符合中国 RoHS 标准规定的限量要求。

本产品上会附有“环境友好使用期限”的标签，此期限是估算这些物质“不会有泄漏或突变”的年限。本产品可能包含有较短的环境友好使用期限的可替换元件，像是电池或灯管，这些元件将会单独标示出来。

部件名称	有毒有害物质或元素					
	铅 (Pb)	汞 (Hg)	镉 (Cd)	六价铬 (CR(VI))	多溴联苯 (PBB)	多溴二苯醚 (PBDE)
壳体	X	O	O	O	O	X
显示	X	O	O	O	O	X
印刷电路板	X	O	O	O	O	X
金属螺帽	X	O	O	O	O	O
电缆组装	X	O	O	O	O	X
风扇组装	X	O	O	O	O	X
电力供应组装	X	O	O	O	O	X
电池	O	O	O	O	O	O

O: 表示该有毒有害物质在该部件所有物质材料中的含量均在 SJ/T11363-2006 标准规定的限量要求以下。  
X: 表示该有毒有害物质至少在该部件的某一均质材料中的含量超出 SJ/T11363-2006 标准规定的限量要求。

# Index

---

**A**

anti-static precautions

- anti-static pad ..... 57
- anti-static wristband ..... 57
- handling ..... 57
- self-grounding ..... 57

**B**

- Backlight MTBF ..... 14
- Benefits ..... 3
- Brightness ..... 14

**C**

- Cabling ..... 39
- Certifications ..... 12
- Chassis ..... 14
- Color ..... 15
- Contrast ..... 14

**D**

- Dimensions ..... 16
  - LKM-926 ..... 17, 18
  - LKM-935 ..... 19

**E**

External Connectors

- Audio ..... 29
- Keyboard ..... 30
- Mouse ..... 31
- Power ..... 32

- VGA ..... 33

**F**

- Features ..... 3

**H**

- Humidity ..... 15

**I**

- Input Interface ..... 14
- Installation
  - Tools ..... 28
  - Unpacking ..... 26

**K**

- Keyboard ..... 14
- KVMA 8-Port Switch ..... 11

**L**

- LCD Color ..... 14
- LCD Type ..... 14
- LCM Controls
  - LCM Buttons ..... 51
- LCM Controls ..... 51
- LCM Functions ..... 52
  - Cycling Through Stations ..... 52
  - Manually Switching Stations ..... 52
  - Station Name Editing ..... 52

**M**

- Maintenance ..... 12



## LKM Series Console Drawer

Max. Resolution.....	14
Mechanical Overview .....	5
LKM-926 Series.....	5
LKM-935 Series.....	9
Model Options .....	5
Model Variations.....	4
Mounting.....	34

### O

Operation Temperature .....	15
Optional Accessories.....	28
OSD Controls.....	42
Brightness and Contrast Menu.....	44
Buttons .....	42
Color Menu .....	45
Color Temperature Menu .....	46
Image Menu .....	48
OSD Menu .....	50
Tools Menu .....	49
User Menu.....	47
OSD Menu Structure.....	42

### P

Packing List.....	28
Power Adapter.....	14
24V/48V DC Input.....	23
5V/12V AC/DC.....	21

### R

Rack Height .....	14
RoHS.....	12

### S

Safety Precautions.....	56
Shock .....	15

### T

Touch Pad.....	14
Troubleshooting .....	12

### V

Vibration .....	15
View Angle.....	14