

**MODEL:**

**WAFER-PV-D4251/D5251/N4551**

**3.5" SBC with Intel® Atom™ Processor  
2 GB DDR3 Memory On Board, VGA,  
LVDS, PCIe Mini, RS-232/422/485, SATA 3Gb/s,  
CompactFlash®, Eight USB, RoHS**

## **User Manual**

# Revision

---

Date	Version	Changes
July 11, 2014	1.10	Modified on-board memory from 1 GB to 2 GB
November 28, 2011	1.00	Initial release

# Copyright

---

## **COPYRIGHT NOTICE**

The information in this document is subject to change without prior notice in order to improve reliability, design and function and does not represent a commitment on the part of the manufacturer.

In no event will the manufacturer be liable for direct, indirect, special, incidental, or consequential damages arising out of the use or inability to use the product or documentation, even if advised of the possibility of such damages.

This document contains proprietary information protected by copyright. All rights are reserved. No part of this manual may be reproduced by any mechanical, electronic, or other means in any form without prior written permission of the manufacturer.

## **TRADEMARKS**

All registered trademarks and product names mentioned herein are used for identification purposes only and may be trademarks and/or registered trademarks of their respective owners.

# Table of Contents

<b>1 INTRODUCTION.....</b>	<b>1</b>
1.1 INTRODUCTION.....	2
1.2 BENEFITS .....	2
1.3 FEATURES.....	3
1.4 CONNECTORS .....	4
1.5 DIMENSIONS.....	6
1.6 DATA FLOW .....	7
1.7 TECHNICAL SPECIFICATIONS .....	7
<b>2 PACKING LIST.....</b>	<b>10</b>
2.1 ANTI-STATIC PRECAUTIONS .....	11
2.2 UNPACKING PRECAUTIONS.....	11
2.3 PACKING LIST.....	12
2.4 OPTIONAL ITEMS .....	13
<b>3 CONNECTOR PINOUTS.....</b>	<b>14</b>
3.1 PERIPHERAL INTERFACE CONNECTORS.....	15
3.1.1 <i>Layout</i> .....	15
3.1.2 <i>Peripheral Interface Connectors</i> .....	16
3.1.3 <i>External Interface Panel Connectors</i> .....	17
3.2 INTERNAL PERIPHERAL CONNECTORS .....	17
3.2.1 <i>Audio Connector</i> .....	18
3.2.2 <i>CompactFlash® Slot</i> .....	18
3.2.3 <i>Digital I/O Connector</i> .....	20
3.2.4 <i>Fan Connectors</i> .....	21
3.2.5 <i>Keyboard/Mouse Connector</i> .....	21
3.2.6 <i>LVDS Connector</i> .....	22
3.2.7 <i>LVDS Backlight Connector</i> .....	23
3.2.8 <i>PCIe Mini Card Slot</i> .....	24
3.2.9 <i>Power Button Connector</i> .....	25
3.2.10 <i>Reset Button Connector</i> .....	26

## WAFER-PV-D4251/D5251/N4551 SBC

3.2.11	<i>Power Output and HDD LED Connector</i>	27
3.2.12	<i>Power Source Connector</i>	27
3.2.13	<i>Serial Port Connector (COM2)</i>	28
3.2.14	<i>RS-232 Serial Port Connector (COM3, COM4)</i>	29
3.2.15	<i>SATA Drive Connectors</i>	30
3.2.16	<i>SATA Power Connectors</i>	31
3.2.17	<i>USB Connectors</i>	31
3.3	<b>EXTERNAL INTERFACE CONNECTORS</b>	32
3.3.1	<i>Ethernet Connectors</i>	33
3.3.2	<i>Serial Port Connector</i>	34
3.3.3	<i>USB Ports</i>	35
3.3.4	<i>VGA Connector</i>	35
<b>4</b>	<b>INSTALLATION</b>	<b>37</b>
4.1	<b>ANTI-STATIC PRECAUTIONS</b>	38
4.2	<b>INSTALLATION CONSIDERATIONS</b>	39
4.3	<b>COMPACTFLASH® INSTALLATION</b>	40
4.4	<b>JUMPER SETTINGS</b>	41
4.4.1	<i>LVDS1 Voltage Selection Jumper</i>	42
4.4.2	<i>Clear CMOS Jumper</i>	43
4.4.3	<i>COM2 Port Mode Setting Jumper</i>	44
4.4.4	<i>AT/ATX Power Mode Setting Jumper</i>	44
4.5	<b>CHASSIS INSTALLATION</b>	45
4.5.1	<i>Airflow</i>	45
4.5.2	<i>Motherboard Installation</i>	45
4.6	<b>INTERNAL PERIPHERAL DEVICE CONNECTIONS</b>	45
4.6.1	<i>AT Power Connection</i>	46
4.6.2	<i>Audio Kit Installation</i>	47
4.6.3	<i>Keyboard/Mouse Connector</i>	48
4.7	<b>EXTERNAL PERIPHERAL INTERFACE CONNECTION</b>	50
4.7.1	<i>LAN Connection</i>	50
4.7.2	<i>Serial Device Connection</i>	51
4.7.3	<i>USB Connection</i>	51
4.7.4	<i>VGA Monitor Connection</i>	52
4.8	<b>SOFTWARE INSTALLATION</b>	53

<b>5 BIOS</b> .....	<b>55</b>
5.1 INTRODUCTION.....	56
5.1.1 Starting Setup.....	56
5.1.2 Using Setup.....	56
5.1.3 Getting Help.....	57
5.1.4 Unable to Reboot After Configuration Changes.....	57
5.1.5 BIOS Menu Bar.....	57
5.2 MAIN.....	58
5.3 ADVANCED.....	59
5.3.1 ACPI Configuration.....	60
5.3.2 CPU Configuration.....	61
5.3.3 IDE Configuration.....	62
5.3.4 USB Configuration.....	63
5.3.5 Super IO Configuration.....	65
5.3.5.1 Serial Port n Configuration.....	65
5.3.6 H/W Monitor.....	69
5.3.7 Serial Port Console Redirection.....	70
5.4 CHIPSET.....	71
5.4.1 Host Bridge.....	72
5.4.2 South Bridge.....	73
5.4.3 Intel IGD SWSCI OpRegion.....	74
5.5 BOOT.....	76
5.6 SECURITY.....	78
5.7 EXIT.....	78
<b>A BIOS OPTIONS</b> .....	<b>80</b>
<b>B TERMINOLOGY</b> .....	<b>83</b>
<b>C HAZARDOUS MATERIALS DISCLOSURE</b> .....	<b>87</b>
C.1 HAZARDOUS MATERIALS DISCLOSURE TABLE FOR IPB PRODUCTS CERTIFIED AS ROHS COMPLIANT UNDER 2002/95/EC WITHOUT MERCURY.....	88

# List of Figures

Figure 1-1: WAFER-PV-D4251/D5251/N4551 .....	2
Figure 1-2: Connectors (Top side) .....	4
Figure 1-3: Connectors (Solder side) .....	5
Figure 1-4: Dimensions without Heatsink (mm) .....	6
Figure 1-5: Data Flow Diagram .....	7
Figure 3-1: Connector and Jumper Locations (Front Side) .....	15
Figure 3-2: Connector and Jumper Locations (Solder Side) .....	16
Figure 3-3: Audio Connector Location .....	18
Figure 3-4: CompactFlash® Slot Location .....	19
Figure 3-5: Digital I/O Connector Location .....	20
Figure 3-6: Fan Connector Locations .....	21
Figure 3-7: Keyboard/Mouse Connector Location .....	22
Figure 3-8: LVDS Connector Location .....	23
Figure 3-9: Backlight Inverter Connector .....	24
Figure 3-10: PCIe Mini Card Slot Location .....	24
Figure 3-11: Power Button Connector Location .....	26
Figure 3-12: Reset Button Connector Location .....	26
Figure 3-13: LED and +5 V Power Output Connector Location .....	27
Figure 3-14: LED and +5 V Power Output Connector Location .....	28
Figure 3-15: RS-232/422/485 Serial Port Connector Location .....	29
Figure 3-16: RS-232 Serial Port Connector Location .....	29
Figure 3-17: SATA Drive Connector Location .....	30
Figure 3-18: SATA Power Connector Locations .....	31
Figure 3-19: USB Connector Location .....	32
Figure 3-20: External Interface Connectors .....	32
Figure 3-21: Ethernet Connector .....	33
Figure 3-22: Serial Port Pinout Locations .....	34
Figure 3-23: VGA Connector .....	36
Figure 4-1: CompactFlash® Card Installation .....	41
Figure 4-2: LVDS1 Voltage Selection Jumper Location .....	42

<b>Figure 4-3: Clear CMOS Jumper Location .....</b>	<b>43</b>
<b>Figure 4-4: COM2 Port Mode Setting Jumper Location.....</b>	<b>44</b>
<b>Figure 4-5: AT/ATX Power Mode Setting Jumper Location .....</b>	<b>45</b>
<b>Figure 4-6: Power Cable to Motherboard Connection .....</b>	<b>46</b>
<b>Figure 4-8: Connect Power Cable to Power Supply.....</b>	<b>47</b>
<b>Figure 4-7: Audio Kit Cable Connection.....</b>	<b>48</b>
<b>Figure 4-9: Keyboard/mouse Y-cable Connection .....</b>	<b>49</b>
<b>Figure 4-10: LAN Connection .....</b>	<b>50</b>
<b>Figure 4-11: Serial Device Connector.....</b>	<b>51</b>
<b>Figure 4-12: USB Connector.....</b>	<b>52</b>
<b>Figure 4-13: VGA Connector .....</b>	<b>53</b>
<b>Figure 4-14: Introduction Screen .....</b>	<b>54</b>
<b>Figure 4-15: Available Drivers .....</b>	<b>54</b>



# List of Tables

Table 1-1: Technical Specifications.....	9
Table 2-1: Packing List.....	13
Table 2-2: Optional Items.....	13
Table 3-1: Peripheral Interface Connectors.....	17
Table 3-2: Rear Panel Connectors.....	17
Table 3-3: Audio Connector Pinouts.....	18
Table 3-4: CompactFlash® Slot Pinouts.....	20
Table 3-5: Digital I/O Connector Pinouts.....	21
Table 3-6: Fan Connector Pinouts.....	21
Table 3-7: Keyboard/Mouse Connector Pinouts.....	22
Table 3-8: LVDS1 Connector Pinouts.....	23
Table 3-9: Backlight Inverter Connector.....	24
Table 3-10: PCIe Mini Card Slot Pinouts.....	25
Table 3-11: Power Button Connector Pinouts.....	26
Table 3-12: Reset Button Connector Pinouts.....	27
Table 3-13: LED and +5 V Power Output Connector Pinouts.....	27
Table 3-14: LED and +5 V Power Output Connector Pinouts.....	28
Table 3-15: RS-232/422/485 Serial Port Connector Pinouts.....	29
Table 3-16: Serial Port Connector Pinouts.....	30
Table 3-17: SATA Drive Connector Pinouts.....	30
Table 3-18: SATA Power Connector Pinouts.....	31
Table 3-19: USB Port Connector Pinouts.....	32
Table 3-20: LAN1 Connector Pinouts.....	33
Table 3-21: LAN2 Connector Pinouts.....	33
Table 3-22: RJ-45 Ethernet Connector LEDs.....	34
Table 3-23: Serial Port Pinouts.....	34
Table 3-24: USB Connector Pinouts.....	35
Table 3-25: VGA Connector Pinouts.....	36
Table 4-1: Jumpers.....	42
Table 4-2: LVDS1 Voltage Selection.....	42

<b>Table 4-3: Clear CMOS Jumper Settings.....</b>	<b>43</b>
<b>Table 4-4: COM2 Port Mode Settings.....</b>	<b>44</b>
<b>Table 4-5: AT/ATX Power Mode Settings .....</b>	<b>45</b>
<b>Table 5-1: BIOS Navigation Keys .....</b>	<b>57</b>

# BIOS Menus

---

BIOS Menu 1: Main .....	58
BIOS Menu 2: Advanced .....	59
BIOS Menu 3: ACPI Configuration .....	60
BIOS Menu 4: CPU Configuration .....	61
BIOS Menu 5: IDE Configuration .....	62
BIOS Menu 6: USB Configuration .....	63
BIOS Menu 7: Super IO Configuration.....	65
BIOS Menu 8: Serial Port n Configuration Menu.....	65
BIOS Menu 9: Hardware Health Configuration .....	69
BIOS Menu 10: Serial Port Console Redirection .....	71
BIOS Menu 11: Chipset .....	72
BIOS Menu 12:Host Bridge Configuration .....	72
BIOS Menu 13:Southbridge Chipset Configuration .....	73
BIOS Menu 14: Intel IGD SWSCI OpRegion .....	74
BIOS Menu 15: Boot .....	76
BIOS Menu 16: Security .....	78
BIOS Menu 17:Exit.....	79



Chapter

1

# Introduction

---

## 1.1 Introduction

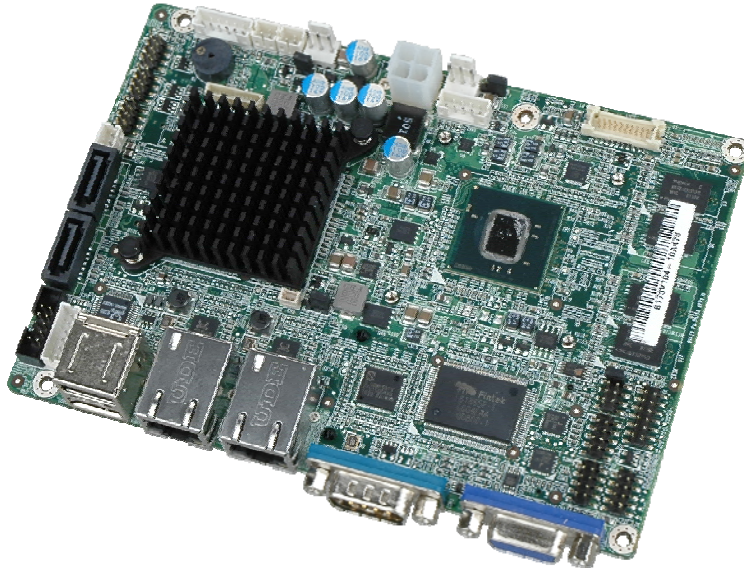

**Figure 1-1: WAFER-PV-D4251/D5251/N4551**

The WAFER-PV-D4251/D5251/N4551 is a 3.5" SBC with an Intel® Atom™ D425, D525 or N455 CPU. It features onboard 2 GB 1333 MHz DDR3 SDRAM.

On-board storage is handled by two SATA 3Gb/s ports for connecting a hard drive, optical drive or SSD. The CompactFlash® slot allows a Type II CompactFlash® card to be installed.

The board has two graphics outputs. A VGA output connects to a traditional VGA monitor and one LVDS connector supports 18-bit single-channel display.

Other slots and connectors include a PCIe Mini card slot, three RS-232 ports, one RS-232/422/485 port with auto flow control, dual gigabit Ethernet ports, eight USB 2.0 ports, and a digital I/O port.

## 1.2 Benefits

Some of the WAFER-PV-D4251/D5251/N4551 motherboard benefits include:

- Low power consumption
- Wide range of I/O interfaces
- Dual display support

## WAFER-PV-D4251/D5251/N4551 SBC

### 1.3 Features

Some of the WAFER-PV-D4251/D5251/N4551 motherboard features are listed below:

- 3.5" form factor
- 2 GB DDR3 memory on board
- RoHS compliant
- Eight USB 2.0 ports
- Four serial ports
- Two SATA 3Gb/s ports
- PCIe Mini card slot
- CompactFlash® Type II slot
- Gigabit Ethernet

## 1.4 Connectors

The connectors on the WAFER-PV-D4251/D5251/N4551 are shown in the following figure.

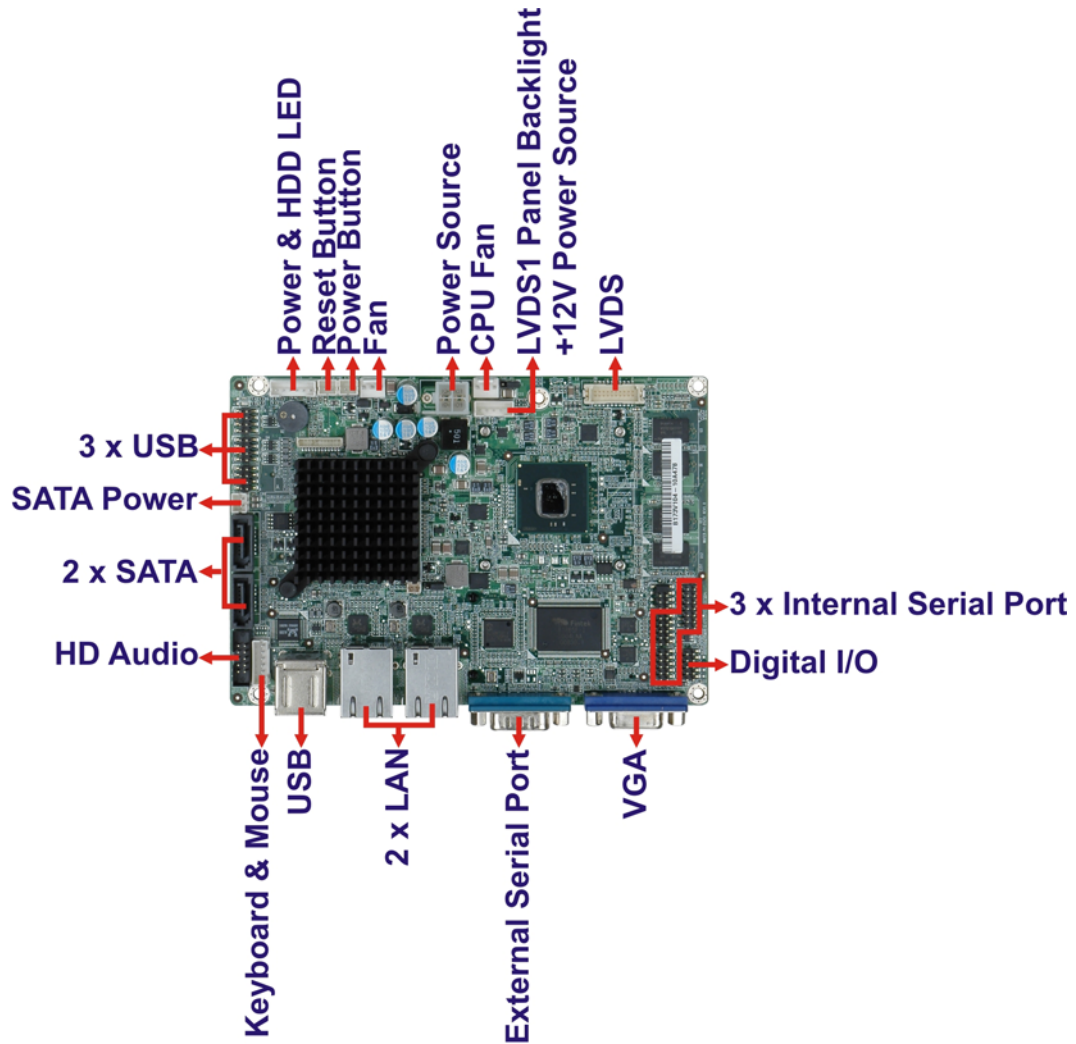
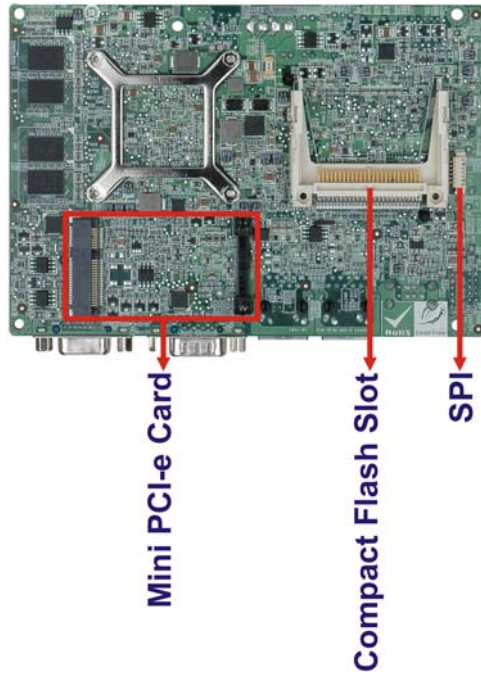

Figure 1-2: Connectors (Top side)



**WAFER-PV-D4251/D5251/N4551 SBC**



**Figure 1-3: Connectors (Solder side)**

### 1.5 Dimensions

The main dimensions of the WAFER-PV-D4251/D5251/N4551 are shown in the diagram below.

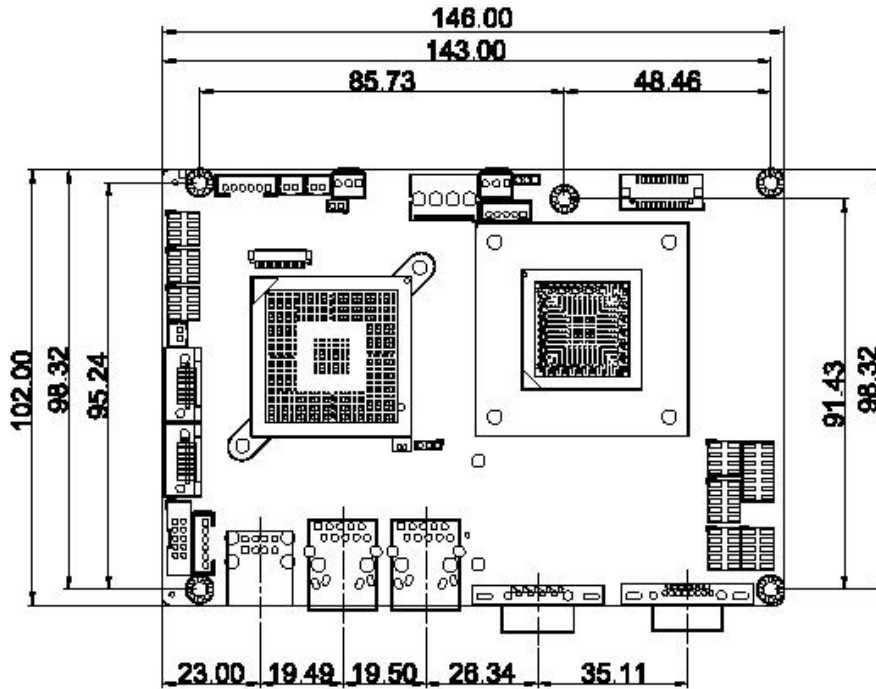

Figure 1-4: Dimensions without Heatsink (mm)

WAFER-PV-D4251/D5251/N4551 SBC

1.6 Data Flow

Figure 1-5 shows the data flow between the system chipset, the CPU and other components installed on the motherboard.

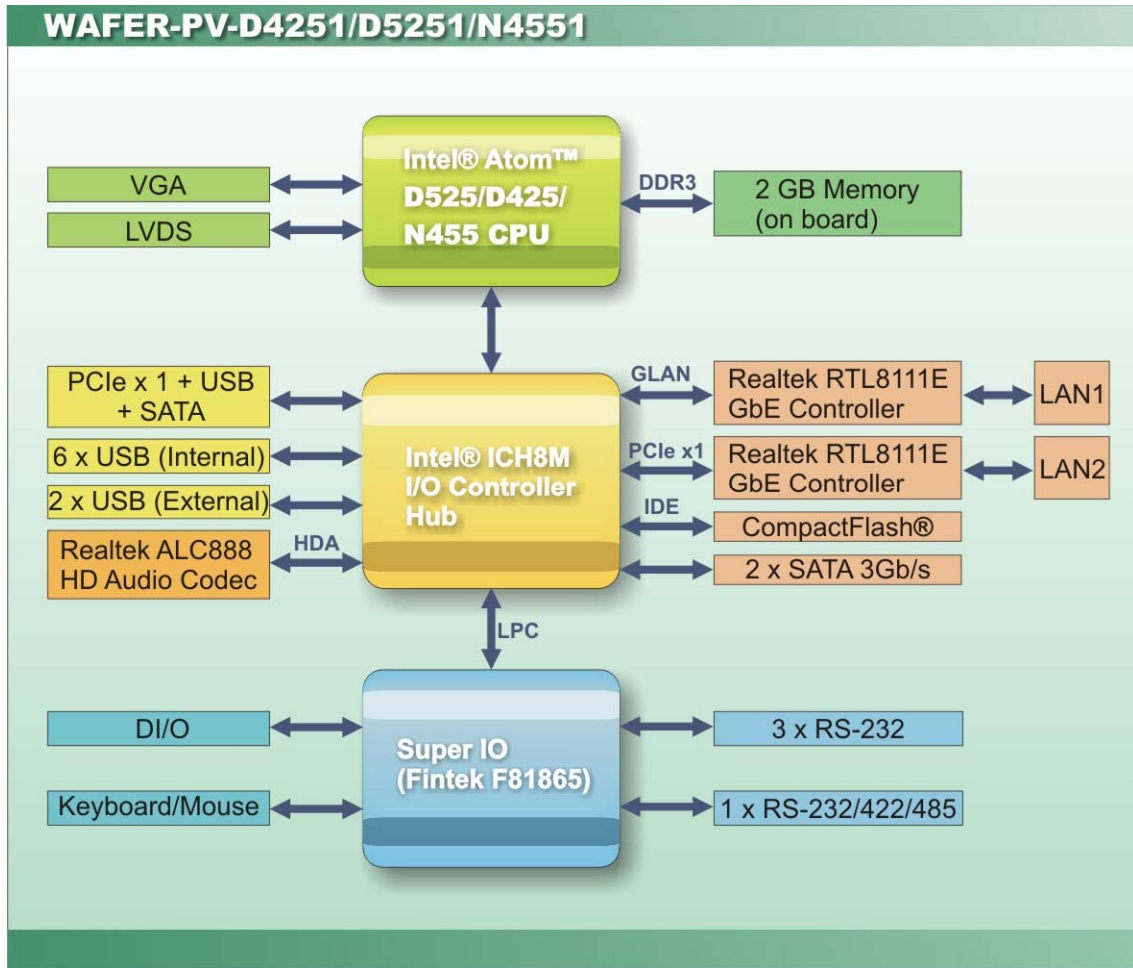

Figure 1-5: Data Flow Diagram

1.7 Technical Specifications

WAFER-PV-D4251/D5251/N4551 technical specifications are listed in Table 1-1.

Specification	WAFER-PV-D4251/D5251/N4551
Form Factor	3.5"
Socket	Embedded

<b>CPU Supported</b>	1.8 GHz Intel® Atom™ D525 dual-core CPU with 1 MB L2 cache 1.8 GHz Intel® Atom™ D425 single-core CPU with 512 KB L2 cache 1.66 GHz Intel® Atom™ N455 single-core CPU with 512 KB L2 cache
<b>System Chipset</b>	Intel® ICH8M
<b>Memory</b>	On-board 2 GB 1333 MHz DDR3 SDRAM
<b>Graphic Engine</b>	Intel® GMA3150 <ul style="list-style-type: none"> <li>▪ D525/D425: Gen 3.5 DX9, 400 MHz</li> <li>▪ N455: Gen 3.5 DX9, 200 MHz</li> </ul>
<b>Integrated Graphics</b>	Analog CRT (CRT hot plug supported) <ul style="list-style-type: none"> <li>▪ D525/D425: up to 2048 x 1536</li> <li>▪ N455: up to 1400 x 1050</li> </ul> 18-bit single-channel LVDS supports up to 1366 x 768 or 1024 x 768
<b>BIOS</b>	UEFI BIOS
<b>Digital I/O</b>	8-bit, 4-bit input/4-bit output
<b>Ethernet Controllers</b>	Two Realtek RTL8111E PCIe GbE controllers (LAN1 supports ASF2.0)
<b>Audio</b>	Realtek ALC888 HD Audio codec
<b>Super I/O Controller</b>	Fintek F81865
<b>Watchdog Timer</b>	Software programmable supports 1~255 sec. system reset
<b>Expansion</b>	PCIe Mini slot (PCIe + USB + SATA signal) supports IEI PCIe Mini disk on module (DOM) cards
<b>I/O Interface Connectors</b>	
<b>Fan connector</b>	One 3-pin wafer CPU fan One 3-pin wafer system fan
<b>Keyboard/Mouse</b>	One internal 6-pin wafer connector
<b>Serial Ports</b>	Three RS-232 COM connectors One RS-232/422/485 COM connector
<b>USB 2.0/1.1 ports</b>	Six internal via pin header Two external USB ports

## WAFER-PV-D4251/D5251/N4551 SBC

<b>Storage</b>	
<b>IDE</b>	CompactFlash® Type II slot
<b>SATA</b>	Two independent SATA channels with 3.0 Gb/s data transfer rates
<b>Environmental and Power Specifications</b>	
<b>Power Supply</b>	AT or ATX 12 V input only One 4-pin internal power connector
<b>Power Consumption</b>	12 V @ 1.70A (1.8 GHz Intel® Atom™ D525 CPU with 2 GB DDR3) 12 V @ 1.52A (1.8 GHz Intel® Atom™ D425 CPU with 2 GB DDR3) 12 V @ 1.33A (1.66 GHz Intel® Atom™ N455 CPU with 2 GB DDR3)
<b>Operating temperature</b>	D525: -20°C ~ 60°C with free air; -20°C ~ 70°C with force air D425: -20°C ~ 65°C with free air; -20°C ~ 70°C with force air N455: -20°C ~ 70°C with free air; -20°C ~ 75°C with force air
<b>Humidity</b>	5% ~ 95% (non-condensing)
<b>Physical Specifications</b>	
<b>Dimensions</b>	146 mm x 102 mm
<b>Weight GW/NW</b>	650 g / 170 g

**Table 1-1: Technical Specifications**

Chapter

**2**

# Packing List

---

## 2.1 Anti-static Precautions

---



### WARNING!

Static electricity can destroy certain electronics. Make sure to follow the ESD precautions to prevent damage to the product, and injury to the user.

---

Make sure to adhere to the following guidelines:

- **Wear an anti-static wristband:** - Wearing an anti-static wristband can prevent electrostatic discharge.
- **Self-grounding:** - Touch a grounded conductor every few minutes to discharge any excess static buildup.
- **Use an anti-static pad:** When configuring any circuit board, place it on an anti-static mat.
- **Only handle the edges of the PCB:** Don't touch the surface of the motherboard. Hold the motherboard by the edges when handling.

## 2.2 Unpacking Precautions

When the WAFER-PV-D4251/D5251/N4551 is unpacked, please do the following:

- Follow the antistatic guidelines above.
- Make sure the packing box is facing upwards when opening.
- Make sure all the packing list items are present.







## 2.3 Packing List



**NOTE:**



If any of the components listed in the checklist below are missing, do not proceed with the installation. Contact the IEI reseller or vendor the WAFER-PV-D4251/D5251/N4551 was purchased from or contact an IEI sales representative directly by sending an email to [sales@ieiworld.com](mailto:sales@ieiworld.com).

The WAFER-PV-D4251/D5251/N4551 is shipped with the following components:

Quantity	Item and Part Number	Image
1	WAFER--PV-D4251, WAFER-PV-D5251 or WAFER--PV-N4551	
1	SATA and power cable (P/N: 32801-000201-300-RS)	
1	KB/MS PS/2 Y-cable (P/N: 32000-023800-RS)	
1	Power cable (P/N: 32100-087100-RS)	
1	Audio cable (P/N: 32000-072100-RS)	
1	Mini jumper pack (2.0mm) (P/N:33101-000657-RS)	
1	Utility CD (P/N: IEI-7B000-000395-RS)	





## WAFER-PV-D4251/D5251/N4551 SBC

Quantity	Item and Part Number	Image
	One Key Recovery CD (P/N: 7B000-000781-RS)	
1	Quick installation guide	

**Table 2-1: Packing List**

## 2.4 Optional Items

These optional items are available.

Item and Part Number	Image
Dual USB cable (wo bracket) (P/N: 32000-070301-RS)	
RS-232/422/485 cable (P/N: 32200-026500-RS)	

**Table 2-2: Optional Items**

Chapter

**3**

# Connector Pinouts

---

WAFER-PV-D4251/D5251/N4551 SBC

### 3.1 Peripheral Interface Connectors

Section 3.1.2 shows peripheral interface connector locations. Section 3.1.2 lists all the peripheral interface connectors seen in Section 3.1.2.

#### 3.1.1 Layout

The figure below shows the on-board peripheral connectors, rear panel peripheral connectors and on-board jumpers.

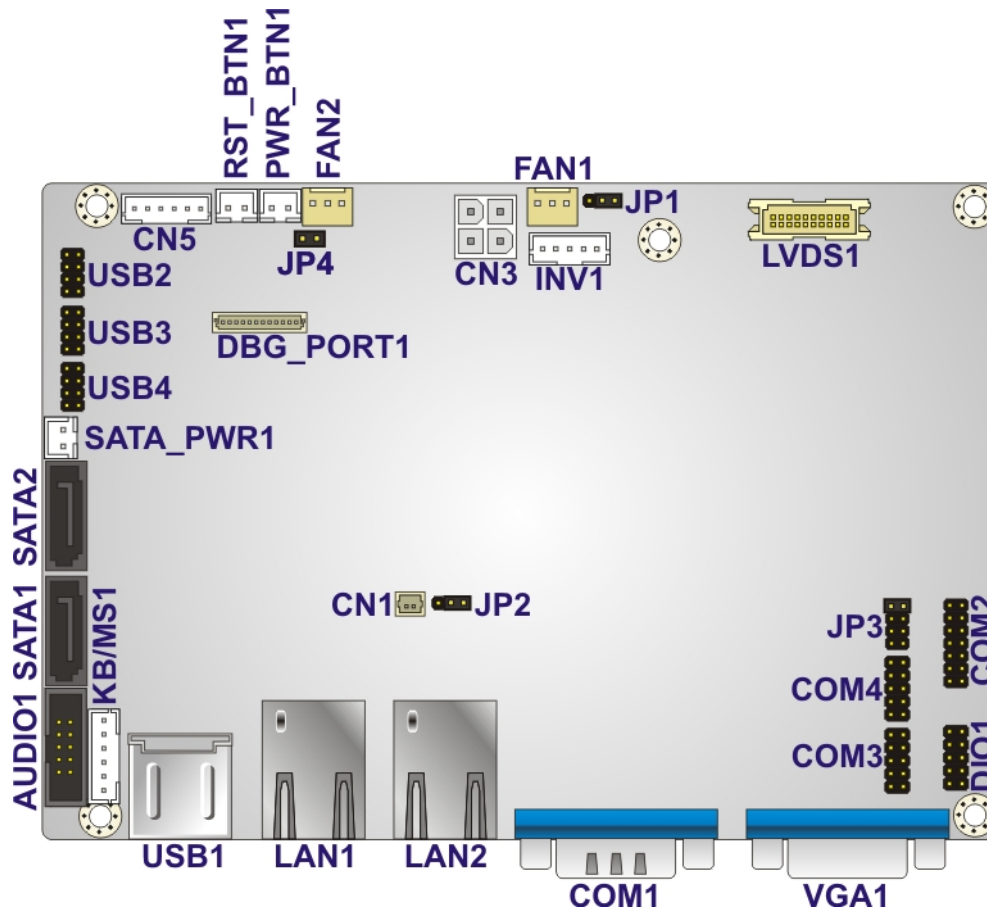
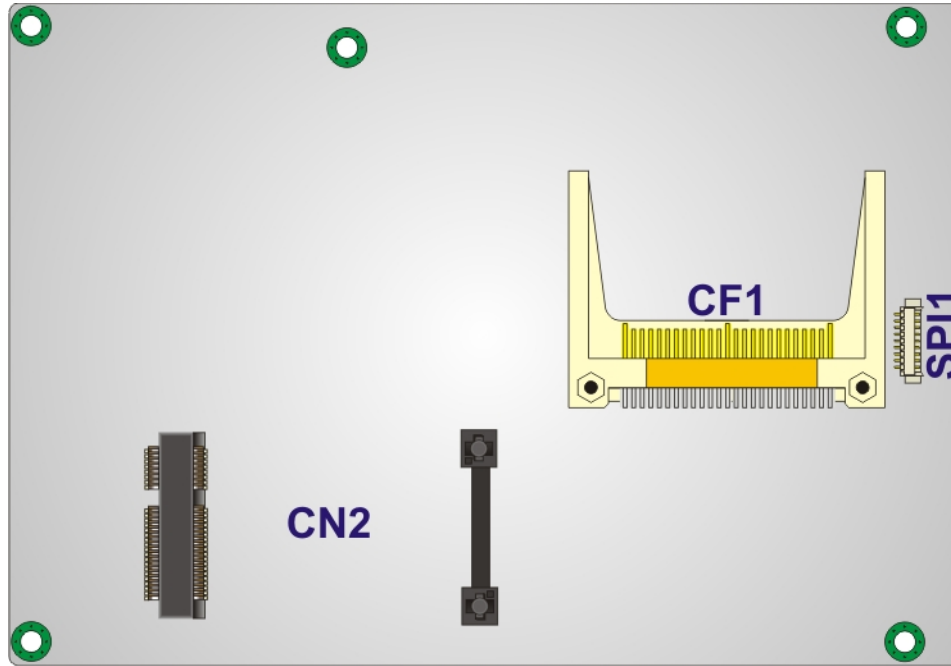

Figure 3-1: Connector and Jumper Locations (Front Side)



**Figure 3-2: Connector and Jumper Locations (Solder Side)**

### 3.1.2 Peripheral Interface Connectors

The table below shows a list of the peripheral interface connectors on the WAFER-PV-D4251/D5251/N4551. Detailed descriptions of these connectors can be found below.

Connector	Type	Label
Audio connector	10-pin box header	AUDIO1
CompactFlash® card slot	CF card slot	CF1
Digital I/O connector	10-pin header	DIO1
Fan connectors	3-pin wafer	FAN1, FAN2
Keyboard/mouse connector	6-pin wafer	KB/MS1
LVDS connector	20-pin crimp	LVDS1
LVDS1 Panel backlight + 12 V power source	5-pin box header	INV1
PCIe Mini card slot	PCIe Mini card slot	CN2
Power button connector	2-pin wafer	PWR_BTN1

## WAFER-PV-D4251/D5251/N4551 SBC

Connector	Type	Label
Reset button connector	2-pin wafer	RST_BTN1
Power output and HDD LED connector	6-pin wafer	CN5
Power source connector	4-pin connector	CN3
RS-232 serial port	14-pin header	COM2
Serial port connector	10-pin header	COM3, COM4
SATA drive connectors	SATA connector	SATA1, SATA2
SATA power connectors	2-pin wafer	SATA_PWR1
USB connectors	8-pin header	USB2, USB3, USB4

**Table 3-1: Peripheral Interface Connectors**

### 3.1.3 External Interface Panel Connectors

The table below lists the rear panel connectors on the WAFER-PV-D4251/D5251/N4551. Detailed descriptions of these connectors can be found in a later section.

Connector	Type	Label
USB connectors	Dual-USB	USB1
LAN connectors	RJ-45	LAN1, LAN2
Serial port connector	DB-9	COM1
VGA connector	15-pin female VGA	VGA1

**Table 3-2: Rear Panel Connectors**

### 3.2 Internal Peripheral Connectors

Internal peripheral connectors are found on the motherboard and are only accessible when the motherboard is outside of the chassis. This section has complete descriptions of all the internal, peripheral connectors on the WAFER-PV-D4251/D5251/N4551.

### 3.2.1 Audio Connector

- CN Label:** AUDIO1
- CN Type:** 10-pin header
- CN Location:** See **Figure 3-3**
- CN Pinouts:** See **Table 3-3**

This connector connects to speakers, a microphone and an audio input.

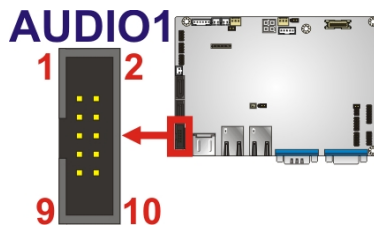

**Figure 3-3: Audio Connector Location**

Pin	Description	Pin	Description
1	SPK_R	2	LINEIN_R
3	AUD_GND	4	AUD_GND
5	SPK_L	6	LINE1_L
7	AUD_GND	8	AUD_GND
9	MIC1_R	10	MIC1_L

**Table 3-3: Audio Connector Pinouts**

### 3.2.2 CompactFlash® Slot

- CN Label:** CF1
- CN Type:** CompactFlash® card slot
- CN Location:** See **Figure 3-4**
- CN Pinouts:** See **Table 3-4**

WAFER-PV-D4251/D5251/N4551 SBC



**NOTE:**

1. Both CompactFlash® Type I and Type II cards are supported.
2. To use SATA and CF, CF must be set to slave.

A CompactFlash® Type I or Type II card can be used in this slot.

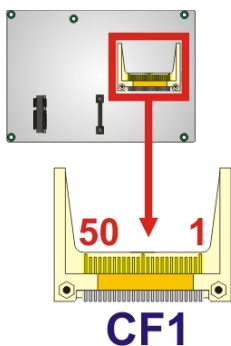

**Figure 3-4: CompactFlash® Slot Location**

Pin	Description	Pin	Description
1	GND	26	CD1#
2	D3	27	D11
3	D4	28	D12
4	D5	29	D13
5	D6	30	D14
6	D7	31	D15
7	CE#	32	CE2#
8	A10	33	VS1#
9	OE#	34	IOR#
10	A9	35	IOW#
11	A8	36	WE#
12	A7	37	IRQ
13	VCC	38	VCC
14	A6	39	CSEL#
15	A5	40	VS2#
16	A4	41	RESET#

Pin	Description	Pin	Description
17	A3	42	WAIT#
18	A2	43	INPACK#
19	A1	44	REG#
20	A0	45	BVD2
21	D0	46	BVD1
22	D1	47	D8
23	D2	48	D9
24	IOCS16#	49	D10
25	CD2#	50	GND2

Table 3-4: CompactFlash® Slot Pinouts

### 3.2.3 Digital I/O Connector

- CN Label:** DIO1
- CN Type:** 10-pin header
- CN Location:** See Figure 3-5
- CN Pinouts:** See Table 3-5

The digital I/O connector provides programmable input and output for external devices. The digital I/O provides 4-bit output and 4-bit input.

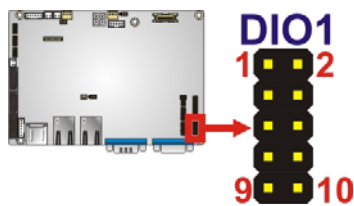

Figure 3-5: Digital I/O Connector Location

Pin	Description	Pin	Description
1	Ground	2	VCC
3	Output 3	4	Output 2
5	Output 1	6	Output 0
7	Input 3	8	Input 2



**WAFER-PV-D4251/D5251/N4551 SBC**

Pin	Description	Pin	Description
9	Input 1	10	Input 0

**Table 3-5: Digital I/O Connector Pinouts**

**3.2.4 Fan Connectors**

- CN Label:** FAN1, FAN2
- CN Type:** 3-pin wafer
- CN Location:** See **Figure 3-6**
- CN Pinouts:** See **Table 3-6**

The fan connector attaches to a cooling fan.

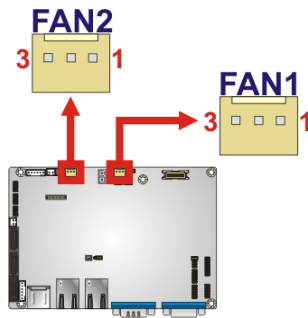

**Figure 3-6: Fan Connector Locations**

Pin	Description
1	Ground
2	+12V (PWM)
3	FANIO1

**Table 3-6: Fan Connector Pinouts**

**3.2.5 Keyboard/Mouse Connector**

- CN Label:** KB/MS1
- CN Type:** 6-pin wafer
- CN Location:** See **Figure 3-7**
- CN Pinouts:** See **Table 3-7**

The keyboard/mouse connector connects to a PS/2 Y-cable that can be connected to a PS/2 keyboard and mouse.

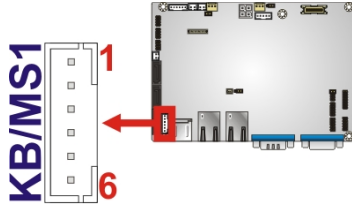

**Figure 3-7: Keyboard/Mouse Connector Location**

Pin	Description
1	VCC
2	Mouse Data
3	Mouse Clock
4	Keyboard Data
5	Keyboard Clock
6	GND

**Table 3-7: Keyboard/Mouse Connector Pinouts**

### 3.2.6 LVDS Connector

- CN Label:** LVDS1
- CN Type:** 20-pin crimp
- CN Location:** See **Figure 3-8**
- CN Pinouts:** See **Table 3-8**

The LVDS connector is for an LCD panel connected to the board.

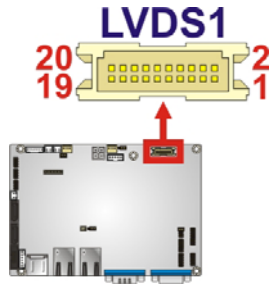

Figure 3-8: LVDS Connector Location

Pin	Description	Pin	Description
1	GND	2	GND
3	LVDS_DATA0	4	LVDS_DATA0#
5	LVDS_DATA1	6	LVDS_DATA1#
7	LVDS_DATA2	8	LVDS_DATA2#
9	LVDS_CLK	10	LVDS_CLK#
11	NC	12	NC
13	GND	14	GND
15	LDDC_DATA	16	LDDC_CLK
17	VCC_LCD	18	VCC_LCD
19	VCC_LCD	20	VCC_LCD

Table 3-8: LVDS1 Connector Pinouts

### 3.2.7 LVDS Backlight Connector

- CN Label:** INV1
- CN Type:** 5-pin header
- CN Location:** See **Figure 3-9**
- CN Pinouts:** See **Table 3-9**

The backlight inverter connector provides power to an LCD panel.

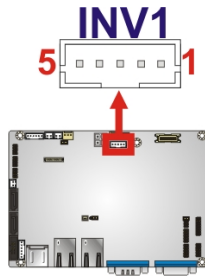

**Figure 3-9: Backlight Inverter Connector**

Pin	Description
1	LCD_BKLTCTL
2	GROUND
3	+ 12V
4	GROUND
5	BACKLIGHT ENABLE

**Table 3-9: Backlight Inverter Connector**

### 3.2.8 PCIe Mini Card Slot

- CN Label:** CN2
- CN Type:** PCIe Mini card slot
- CN Location:** See **Figure 3-10**
- CN Pinouts:** See **Table 3-10**

The PCIe mini card slot enables a PCIe mini card expansion module to be connected to the board. Cards supported include among others wireless LAN (WLAN) cards and IEI PCIe Mini disk on module (DOM) SSD cards.

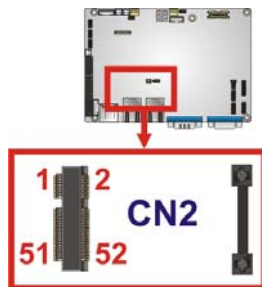

**Figure 3-10: PCIe Mini Card Slot Location**

## WAFER-PV-D4251/D5251/N4551 SBC

Pin	Description	Pin	Description
1	PCIE_WAKE#	2	VCC3
3	N/C	4	GND
5	N/C	6	1.5V
7	N/C	8	N/C
9	GND	10	N/C
11	PCIE_CLK#	12	N/C
13	PCIE_CLK	14	N/C
15	GND	16	N/C
17	N/C	18	GND
19	N/C	20	N/C
21	GND	22	PCIRST#
23	PCIE_RXN	24	VCC3
25	PCIE_RXP	26	GND
27	GND	28	1.5V
29	GND	30	SMBCLK
31	PCIE_TXN	32	SMBDATA
33	PCIE_TXP	34	GND
35	GND	36	USBD-
37	GND	38	USBD+
39	VCC3	40	GND
41	VCC3	42	N/C
43	GND	44	N/C
45	SATA_TXP	46	N/C
47	SATA_TXN	48	1.5V
49	SATA_RXN	50	GND
51	SATA_RXP	52	VCC3

**Table 3-10: PCIe Mini Card Slot Pinouts**

### 3.2.9 Power Button Connector

**CN Label:** PWR\_BTN

**CN Type:** 2-pin wafer

**CN Location:** See **Figure 3-11**

**CN Pinouts:** See **Table 3-11**

The power button connector is connected to a power switch on the system chassis.

**PWR\_BTN1**

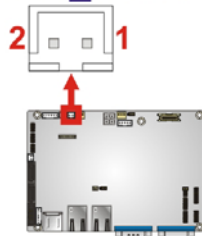

**Figure 3-11: Power Button Connector Location**

Pin	Description
1	PWR_BTN+
2	PWR_BTN-

**Table 3-11: Power Button Connector Pinouts**

**3.2.10 Reset Button Connector**

**CN Label:** RST\_BTN

**CN Type:** 2-pin wafer

**CN Location:** See **Figure 3-12**

**CN Pinouts:** See **Table 3-12**

The reset button connector is connected to a reset switch on the system chassis.

**RST\_BTN1**

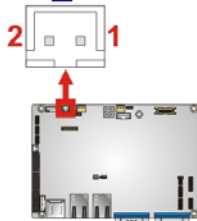

**Figure 3-12: Reset Button Connector Location**

## WAFER-PV-D4251/D5251/N4551 SBC

Pin	Description
1	RESET+
2	RESET-

**Table 3-12: Reset Button Connector Pinouts**

### 3.2.11 Power Output and HDD LED Connector

- CN Label:** CN5
- CN Type:** 6-pin wafer
- CN Location:** See **Figure 3-13**
- CN Pinouts:** See **Table 3-13**

The connector connects to the hard drive activity LED and power LED on the system front panel. +5 V power output is also provided via this connector.

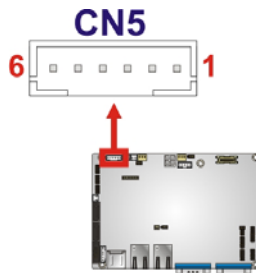

**Figure 3-13: LED and +5 V Power Output Connector Location**

	Pin	Description
+5 V Power Output	1	VCC
	2	GND
Power LED	3	PWR_LED+
	4	PWR_LED-
HDD LED	5	HDD_LED+
	6	HDD_LED-

**Table 3-13: LED and +5 V Power Output Connector Pinouts**

### 3.2.12 Power Source Connector

- CN Label:** CN3

- CN Type:** 4-pin connector
- CN Location:** See **Figure 3-14**
- CN Pinouts:** See **Table 3-14**

The connector supports a +12 V main power supply.

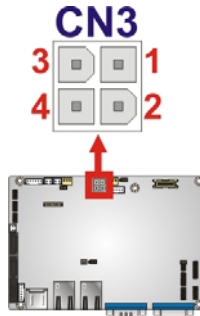

**Figure 3-14: LED and +5 V Power Output Connector Location**

Pin	Description
1	GND
2	GND
3	VCC12
4	VCC12

**Table 3-14: LED and +5 V Power Output Connector Pinouts**

### 3.2.13 Serial Port Connector (COM2)

- CN Label:** **COM2**
- CN Type:** 14-pin header
- CN Location:** See **Figure 3-15**
- CN Pinouts:** See **Table 3-15**

This connector provides RS-232, RS-422 or RS-485 communications.



WAFER-PV-D4251/D5251/N4551 SBC

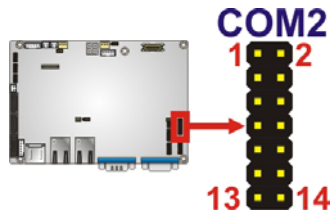

Figure 3-15: RS-232/422/485 Serial Port Connector Location

Pin	Description	Pin	Description
1	Data Carrier Direct (DCD)	2	Data Set Ready (DSR)
3	Receive Data (RXD)	4	Request To Send (RTS)
5	Transmit Data (TXD)	6	Clear To Send (CTS)
7	Data Terminal Ready (DTR)	8	Ring Indicator (RI)
9	Ground (GND)	10	Ground (GND)
11	TXD485+	12	TXD485#
13	RXD485+	14	RXD485#

Table 3-15: RS-232/422/485 Serial Port Connector Pinouts

3.2.14 RS-232 Serial Port Connector (COM3, COM4)

- CN Label:** COM3, COM4
- CN Type:** 10-pin header
- CN Location:** See Figure 3-16
- CN Pinouts:** See Table 3-16

This connector provides RS-232 connections for four serial ports (COM3, COM4).

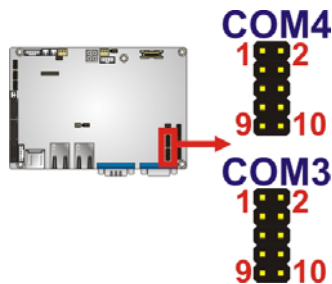

Figure 3-16: RS-232 Serial Port Connector Location

Pin	Description	Pin	Description
1	DATA CARRIER DETECT (DCD)	2	DATA SET READY (DSR)
3	RECEIVE DATA (RXD)	4	REQUEST TO SEND (RTS)
5	TRANSMIT DATA (TXD)	6	CLEAR TO SEND (CTS)
7	DATA TERMINAL READY (DTR)	8	RING INDICATOR (RI)
9	GND	10	GND

**Table 3-16: Serial Port Connector Pinouts**

### 3.2.15 SATA Drive Connectors

- CN Label:** SATA1, SATA2
- CN Type:** 8-pin SATA drive connectors
- CN Location:** See **Figure 3-17**
- CN Pinouts:** See **Table 3-17**

The SATA connectors connect to SATA hard drives or optical drives.

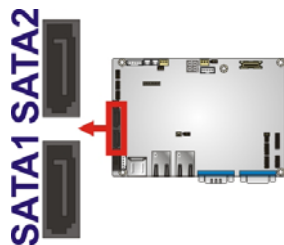

**Figure 3-17: SATA Drive Connector Location**

Pin	Description
1	GND
2	TX+
3	TX-
4	GND
5	RX-
6	RX+
7	GND
8	N/C

**Table 3-17: SATA Drive Connector Pinouts**

**WAFER-PV-D4251/D5251/N4551 SBC**

**3.2.16 SATA Power Connectors**

- CN Label:** SATA\_PWR1
- CN Type:** 2-pin wafer
- CN Location:** See **Figure 3-18**
- CN Pinouts:** See **Table 3-18**

Use the SATA Power Connector to connect to SATA device power connections.

**SATA\_PWR1**

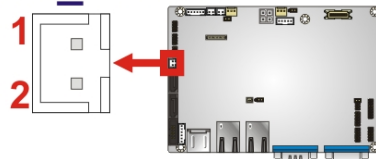

**Figure 3-18: SATA Power Connector Locations**

Pin	Description
1	VCC5
2	GND

**Table 3-18: SATA Power Connector Pinouts**

**3.2.17 USB Connectors**

- CN Label:** USB2, USB3, USB4
- CN Type:** 8-pin header
- CN Location:** See **Figure 3-19**
- CN Pinouts:** See **Table 3-19**

The USB header can connect to two USB devices.

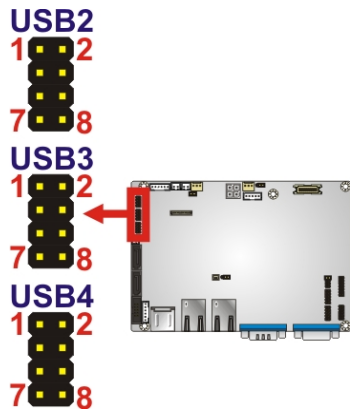

**Figure 3-19: USB Connector Location**

Pin	Description	Pin	Description
1	USB_VCC	2	GND
3	DATA-	4	DATA+
5	DATA+	6	DATA-
7	GND	8	VCC

**Table 3-19: USB Port Connector Pinouts**

### 3.3 External Interface Connectors

Figure 3-20 shows the WAFER-PV-D4251/D5251/N4551 motherboard external interface connectors. The WAFER-PV-D4251/D5251/N4551 on-board external interface connectors are shown in Figure 3-20.

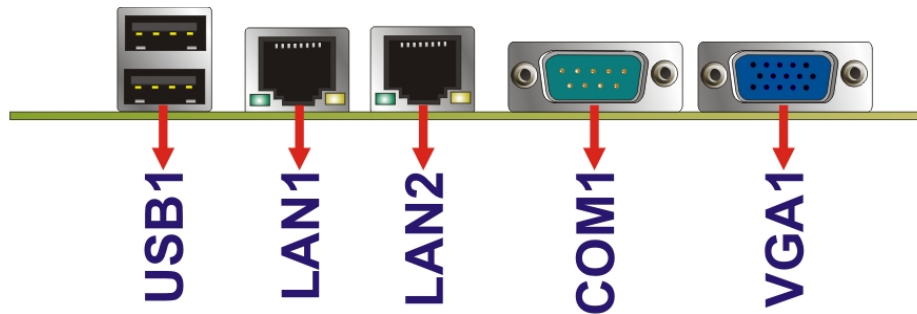

**Figure 3-20: External Interface Connectors**

## WAFER-PV-D4251/D5251/N4551 SBC

### 3.3.1 Ethernet Connectors

**CN Label:** LAN1, LAN2

**CN Type:** RJ-45

**CN Location:** See **Figure 3-20**

**CN Pinouts:** See **Table 3-20**

A 10/100/1000 Mb/s connection can be made to a Local Area Network.

Pin	Description	Pin	Description
1	LAN1_MDIO+	5	LAN1_MD12+
2	LAN1_MDIO-	6	LAN1_MD12-
3	LAN1_MDI1+	7	LAN1_MDI3+
4	LAN1_MDI1-	8	LAN1_MDI3-

**Table 3-20: LAN1 Connector Pinouts**

Pin	Description	Pin	Description
1	LAN2_MDIO+	5	LAN2_MD12+
2	LAN2_MDIO-	6	LAN2_MD12-
3	LAN2_MDI1+	7	LAN2_MDI3+
4	LAN2_MDI1-	8	LAN2_MDI3-

**Table 3-21: LAN2 Connector Pinouts**

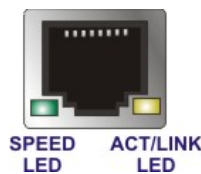

**Figure 3-21: Ethernet Connector**

The RJ-45 Ethernet connector has two status LEDs, one green and one yellow. The green LED indicates activity on the port and the yellow LED indicates the port is linked. See **Table 3-22**.

SPEED LED		ACT/LINK LED	
STATUS	DESCRIPTION	STATUS	DESCRIPTION
OFF	10Mbps connection	OFF	No link
GREEN	100Mbps connection	YELLOW	Linked
ORANGE	1Gbps connection	BLINKING	Data Activity

**Table 3-22: RJ-45 Ethernet Connector LEDs**

### 3.3.2 Serial Port Connector

- CN Label:** COM1
- CN Type:** DB-9 Male connector
- CN Location:** See **Figure 3-20**
- CN Pinouts:** See **Table 3-23** and **Figure 3-22**

The RS-232 serial connector provides serial connection in the RS-232 mode.

Pin	Description	Pin	Description
1	DCD	6	DSR
2	RXD	7	RTS
3	TXD	8	CTS
4	DTR	9	RI
5	GND		

**Table 3-23: Serial Port Pinouts**

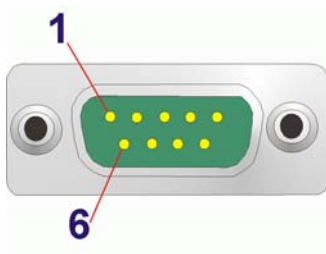

**Figure 3-22: Serial Port Pinout Locations**

## WAFER-PV-D4251/D5251/N4551 SBC

### 3.3.3 USB Ports

- CN Label:** USB1
- CN Type:** USB Combo ports
- CN Location:** See **Figure 3-20**
- CN Pinouts:** See **Table 3-24**

The USB ports attach to standard USB devices.

Pin	Description
1	USB_VCC
2	USB_VCC
3	Data1-
4	Data1-
5	Data1+
6	Data1+
7	Ground
8	Ground

**Table 3-24: USB Connector Pinouts**

### 3.3.4 VGA Connector

- CN Label:** VGA1
- CN Type:** D-sub 15-pin female connector
- CN Location:** See **Figure 3-20**
- CN Pinouts:** See **Figure 3-23** an **Table 3-25**

The standard 15-pin female VGA connector connects to a CRT or LCD monitor.

Pin	Description	Pin	Description	Pin	Description
1	RED	6	GROUND	11	NC
2	GREEN	7	GROUND	12	DDCDAT
3	BLUE	8	GROUND	13	HSYNC
4	NC	9	VCC	14	VSYNC

Pin	Description	Pin	Description	Pin	Description
5	GROUND	10	GROUND	15	DDCCLK

**Table 3-25: VGA Connector Pinouts**

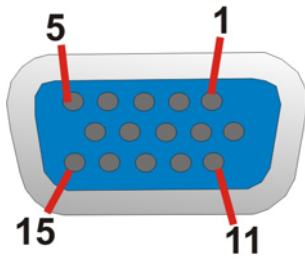

**Figure 3-23: VGA Connector**



Chapter

4

# Installation

---

## 4.1 Anti-static Precautions

---



### WARNING:

Failure to take ESD precautions during installation may result in permanent damage to the product and severe injury to the user.

---

Electrostatic discharge (ESD) can cause serious damage to electronic components, including the WAFER-PV-D4251/D5251/N4551. Dry climates are especially susceptible to ESD. It is therefore critical to strictly adhere to the following anti-static precautions whenever the WAFER-PV-D4251/D5251/N4551, or any other electrical component, is handled.

- ***Wear an anti-static wristband:*** - Wearing a simple anti-static wristband can help to prevent ESD from damaging the board.
- ***Self-grounding:***- Before handling the board touch any grounded conducting material. During the time the board is handled, frequently touch any conducting materials that are connected to the ground.
- ***Use an anti-static pad:*** When configuring the WAFER-PV-D4251/D5251/N4551, place it on an anti-static pad. This reduces the possibility of ESD damaging the WAFER-PV-D4251/D5251/N4551.
- ***Only handle the edges of the PCB:-*** When handling the PCB, hold it by the edges.

## 4.2 Installation Considerations

---



### NOTE:

The following installation notices and installation considerations should be read and understood before the WAFER-PV-D4251/D5251/N4551 is installed. All installation notices pertaining to the installation of WAFER-PV-D4251/D5251/N4551 should be strictly adhered to. Failing to adhere to these precautions may lead to severe damage of the WAFER-PV-D4251/D5251/N4551 and injury to the person installing the motherboard.

---

---



### WARNING:

The installation instructions described in this manual should be carefully followed in order to prevent damage to the WAFER-PV-D4251/D5251/N4551, WAFER-PV-D4251/D5251/N4551 components and injury to the user.

---

Before and during the installation please **DO** the following:

- **Read the user manual:**
  - The user manual provides a complete description of the installation instructions and configuration options.
- **Wear an electrostatic discharge cuff (ESD):**
  - Electronic components are easily damaged by ESD. Wearing an ESD cuff removes ESD from the body and helps prevent ESD damage.
- **Place on an antistatic pad:**
  - When installing or configuring the motherboard, place it on an antistatic pad. This helps to prevent potential ESD damage.
- **Turn all power off:**
  - Make sure the product is disconnected from all power supplies and that no electricity is being fed into the system.

Before and during the installation of the WAFER-PV-D4251/D5251/N4551 **DO NOT**:

- **DO NOT** remove any of the stickers on the PCB board. These stickers are required for warranty validation.
- **DO NOT** use the product before verifying all the cables and power connectors are properly connected.
- **DO NOT** allow screws to come in contact with the PCB circuit, connector pins, or its components.

### 4.3 CompactFlash® Installation

---



#### NOTE:

Both CompactFlash® Type I and Type II cards are supported.

---

To install the CompactFlash® card, please follow the steps below.

**Step 1: Locate the CF card socket.** Locate the CompactFlash® slot.

**Step 2: Align the CF card.** Align the CompactFlash® card. The label side should be facing away from the board. The grooves on the CompactFlash® slot ensure that the card cannot be inserted the wrong way.

**Step 3: Insert the CF card.** Push until the CompactFlash® card is firmly seated in the slot. See Figure 4-1.

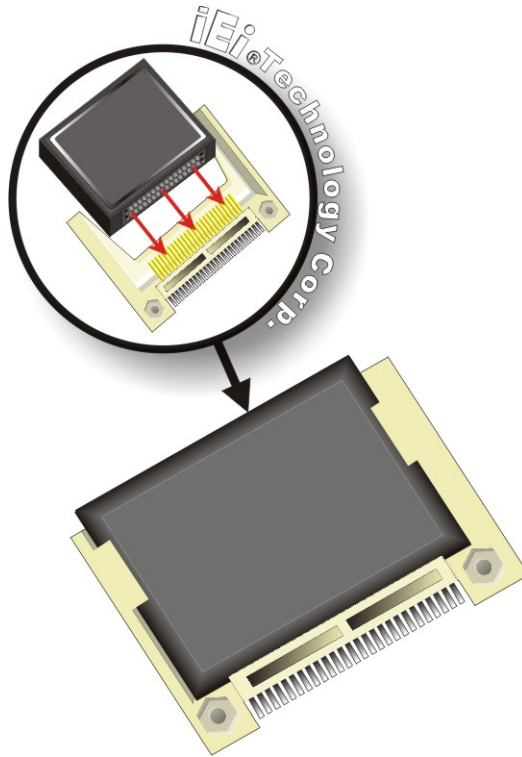

Figure 4-1: CompactFlash® Card Installation

## 4.4 Jumper Settings



### NOTE:

A jumper is a metal bridge that is used to close an electrical circuit. It consists of two metal pins and a small metal clip (often protected by a plastic cover) that slides over the pins to connect them. To CLOSE/SHORT a jumper means connecting the pins of the jumper with the plastic clip and to OPEN a jumper means removing the plastic clip from a jumper.

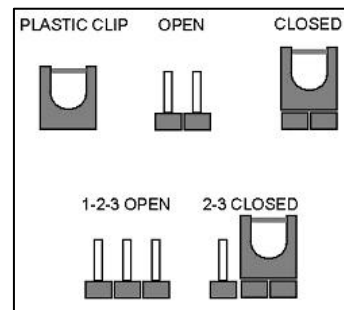

Before the WAFER-PV-D4251/D5251/N4551 is installed in the system, the jumpers must be set in accordance with the desired configuration. The jumpers on the WAFER-PV-D4251/D5251/N4551 are listed in Table 4-1.

Description	Label	Type
LVDS1 voltage selection	JP1	3-pin header
Clear CMOS	JP2	3-pin header
COM2 port mode setting	JP3	8-pin header
AT/ATX mode setting	JP4	2-pin header

**Table 4-1: Jumpers**

#### 4.4.1 LVDS1 Voltage Selection Jumper

- Jumper Label:** JP1
- Jumper Type:** 3-pin header
- Jumper Settings:** See Table 4-2
- Jumper Location:** See Figure 4-2

Selects the voltage of the LVDS connector.

Pin	Description
Short 1-2	+3.3V LVDS
Short 2-3	+5V LVDS

**Table 4-2: LVDS1 Voltage Selection**

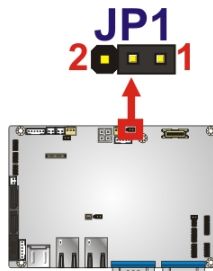

**Figure 4-2: LVDS1 Voltage Selection Jumper Location**

## WAFER-PV-D4251/D5251/N4551 SBC

### 4.4.2 Clear CMOS Jumper

<b>Jumper Label:</b>	<b>JP2</b>
<b>Jumper Type:</b>	3-pin header
<b>Jumper Settings:</b>	See <b>Table 4-3</b>
<b>Jumper Location:</b>	See <b>Figure 4-3</b>

If the WAFER-PV-D4251/D5251/N4551 fails to boot due to improper BIOS settings, the clear CMOS jumper clears the CMOS data and resets the system BIOS information. To do this, use the jumper cap to close pins 2 and 3 for a few seconds then reinstall the jumper clip back to pins 1 and 2.

If the “CMOS Settings Wrong” message is displayed during the boot up process, the fault may be corrected by pressing the F1 to enter the CMOS Setup menu. Do one of the following:

- Enter the correct CMOS setting
- Load Optimal Defaults
- Load Failsafe Defaults.

After having done one of the above, save the changes and exit the CMOS Setup menu.

The clear CMOS jumper settings are shown in Table 4-3.

Pin	Description
1-2	Keep CMOS Setup (Default)
2-3	Clear CMOS Setup

**Table 4-3: Clear CMOS Jumper Settings**

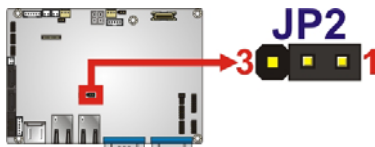

**Figure 4-3: Clear CMOS Jumper Location**

### 4.4.3 COM2 Port Mode Setting Jumper

- Jumper Label:** JP3
- Jumper Type:** 8-pin header
- Jumper Settings:** See Table 4-4
- Jumper Location:** See Figure 4-4

Selects the communication method of COM2 serial port.

Pin	Description
Short 1-2	RS-232
Short 3-4	RS-422
Short 5-6	RS-485
Short 5-6, 7-8	RS-485 with RTS Control

**Table 4-4: COM2 Port Mode Settings**

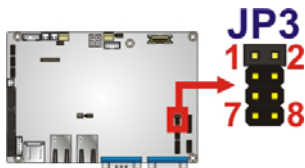

**Figure 4-4: COM2 Port Mode Setting Jumper Location**

### 4.4.4 AT/ATX Power Mode Setting Jumper

- Jumper Label:** JP4
- Jumper Type:** 2-pin header
- Jumper Settings:** See Table 4-5
- Jumper Location:** See Figure 4-5

Set both of the jumpers select AT or ATX power mode for the WAFER-PV-D4251/D5251/N4551. AT power mode limits the system to on/off. ATX allows the system to use various power saving states and enter a standby state, so the system can be turned on remotely over a network. The settings on both jumpers should be the same.



**WAFER-PV-D4251/D5251/N4551 SBC**

Pin	Description
Short 1-2	ATX Power Mode (Default)
OFF	AT Power Mode

**Table 4-5: AT/ATX Power Mode Settings**

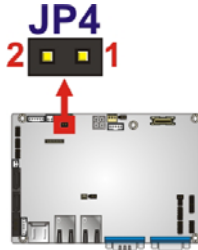

**Figure 4-5: AT/ATX Power Mode Setting Jumper Location**

## 4.5 Chassis Installation

### 4.5.1 Airflow



**WARNING:**

Airflow is critical for keeping components within recommended operating temperatures. The chassis should have fans and vents as necessary to keep things cool.

The WAFER-PV-D4251/D5251/N4551 must be installed in a chassis with ventilation holes on the sides allowing airflow to travel through the heat sink surface. In a system with an individual power supply unit, the cooling fan of a power supply can also help generate airflow through the board surface.

### 4.5.2 Motherboard Installation

To install the WAFER-PV-D4251/D5251/N4551 motherboard into the chassis please refer to the reference material that came with the chassis.

## 4.6 Internal Peripheral Device Connections

This section outlines the installation of peripheral devices to the onboard connectors.

### 4.6.1 AT Power Connection

Follow the instructions below to connect the WAFER-PV-D4251/D5251/N4551 to an AT power supply.



#### **WARNING:**

Disconnect the power supply power cord from its AC power source to prevent a sudden power surge to the WAFER-PV-D4251/D5251/N4551.

**Step 1:** **Locate the power cable.** The power cable is shown in the packing list in Chapter 3.

**Step 2:** **Connect the Power Cable to the Motherboard.** Connect the 4-pin (2x2) Molex type power cable connector to the AT power connector on the motherboard. See Figure 4-6.

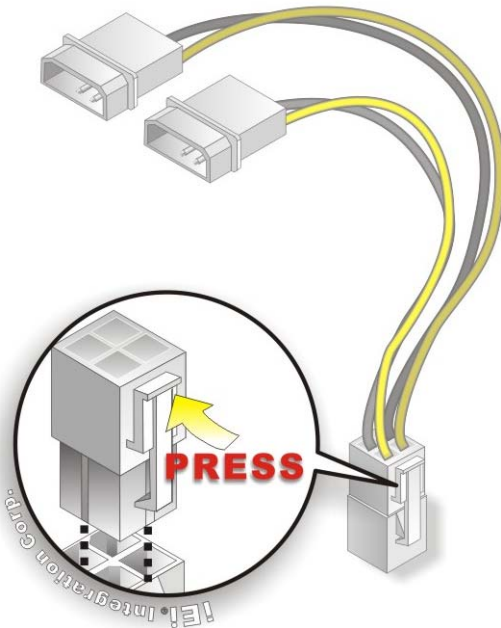

**Figure 4-6: Power Cable to Motherboard Connection**



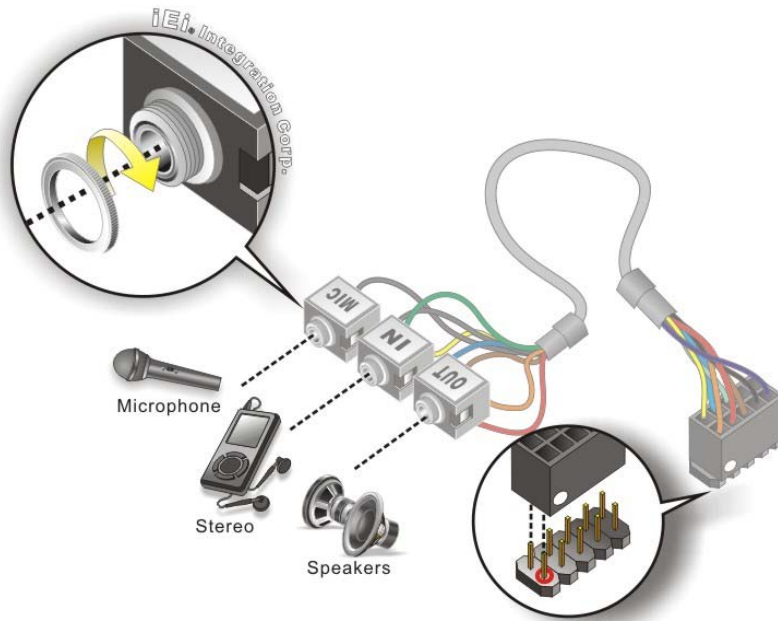

**Figure 4-8: Audio Kit Cable Connection**

**Step 3:** **Connect the audio devices.** Connect speakers to the line-out audio jack. Connect the output of an audio device to the line-in audio jack. Connect a microphone to the mic-in audio jack.

### 4.6.3 Keyboard/Mouse Connector

The WAFER-PV-D4251/D5251/N4551 is shipped with a keyboard/mouse Y-cable connector. The keyboard/mouse Y-cable connector connects to a keyboard/mouse connector on the WAFER-PV-D4251/D5251/N4551 and branches into two cables that are each connected to a PS/2 connector, one for a mouse and one for a keyboard. To connect the keyboard/mouse Y-cable connector, please follow the steps below.

**Step 1:** **Locate the connector.** The location of the keyboard/mouse Y-cable connector is shown in **Chapter 3**.

**Step 2:** **Align the connectors.** Correctly align pin 1 on the cable connector with pin 1 on the WAFER-PV-D4251/D5251/N4551 keyboard/mouse connector. See Figure 4-9.

**WAFER-PV-D4251/D5251/N4551 SBC**

**Step 3:** **Insert the cable connectors** Once the cable connector is properly aligned with the keyboard/mouse connector on the WAFER-PV-D4251/D5251/N4551, connect the cable connector to the on-board connectors. See Figure 4-9.

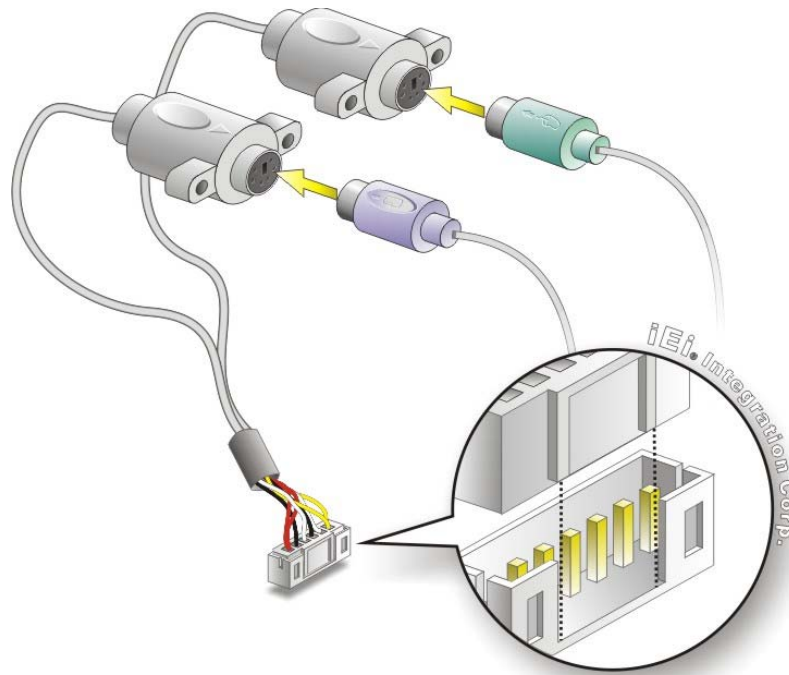

**Figure 4-9: Keyboard/mouse Y-cable Connection**

**Step 4:** **Attach PS/2 connectors to the chassis.** The keyboard/mouse Y-cable connector is connected to two PS/2 connectors. To secure the PS/2 connectors to the chassis please refer to the installation instructions that came with the chassis.

**Step 5:** **Connect the keyboard and mouse.** Once the PS/2 connectors are connected to the chassis, a keyboard and mouse can each be connected to one of the PS/2 connectors. The keyboard PS/2 connector and mouse PS/2 connector are both marked. Please make sure the keyboard and mouse are connected to the correct PS/2 connector.

## 4.7 External Peripheral Interface Connection

Devices can be connected to the external connectors. To install external devices, follow the directions in the subsections below.

### 4.7.1 LAN Connection

There are two external RJ-45 LAN connectors. The RJ-45 connectors enable connection to an external network. To connect a LAN cable with an RJ-45 connector, please follow the instructions below.

**Step 1:** **Locate the RJ-45 connectors.** The locations of the RJ-45 connectors are shown in **Chapter 3**.

**Step 2:** **Align the connectors.** Align the RJ-45 connector on the LAN cable with one of the RJ-45 connectors on the WAFER-PV-D4251/D5251/N4551. See Figure 4-10.

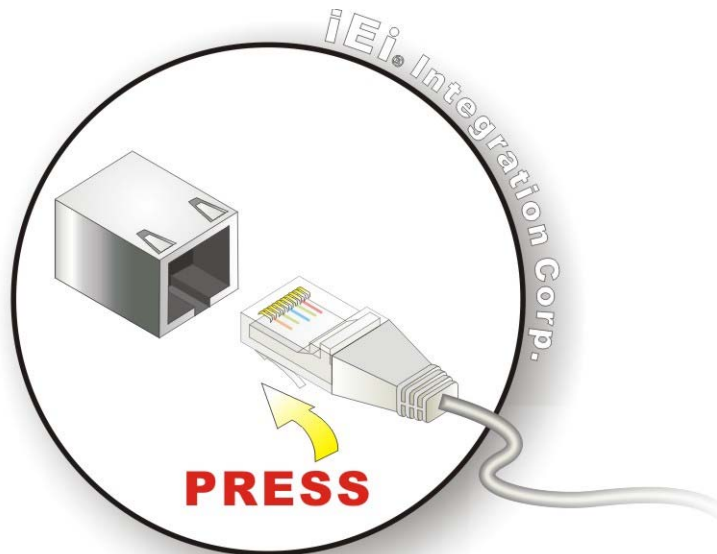

Figure 4-10: LAN Connection

**Step 3:** **Insert the LAN cable RJ-45 connector.** Once aligned, gently insert the LAN cable RJ-45 connector into the on-board RJ-45 connector.

## WAFER-PV-D4251/D5251/N4551 SBC

### 4.7.2 Serial Device Connection

The WAFER-PV-D4251/D5251/N4551 has a single male DB-9 connector on the external peripheral interface panel for a serial device. Follow the steps below to connect a serial device to the WAFER-PV-D4251/D5251/N4551.

**Step 1: Locate the DB-9 connector.** The location of the DB-9 connector is shown in Chapter 3.

**Step 2: Insert the serial connector.** Insert the DB-9 connector of a serial device into the DB-9 connector on the external peripheral interface. See Figure 4-11.

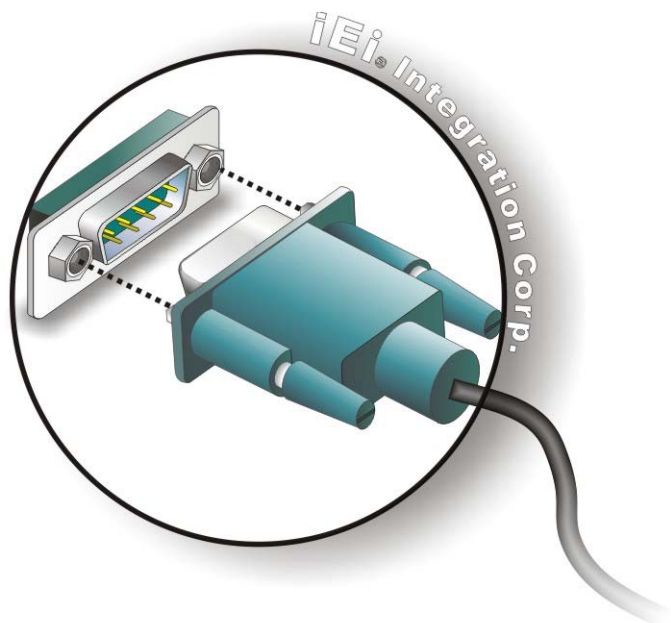

Figure 4-11: Serial Device Connector

**Step 3: Secure the connector.** Secure the serial device connector to the external interface by tightening the two retention screws on either side of the connector.

### 4.7.3 USB Connection

The external USB Series "A" receptacle connectors provide easier and quicker access to external USB devices. Follow the steps below to connect USB devices to the WAFER-PV-D4251/D5251/N4551.

**Step 1:** Locate the **USB Series "A" receptacle connectors**. The location of the USB Series "A" receptacle connectors are shown in **Chapter 3**.

**Step 2:** Insert a **USB Series "A" plug**. Insert the USB Series "A" plug of a device into the USB Series "A" receptacle on the external peripheral interface. See Figure 4-12.

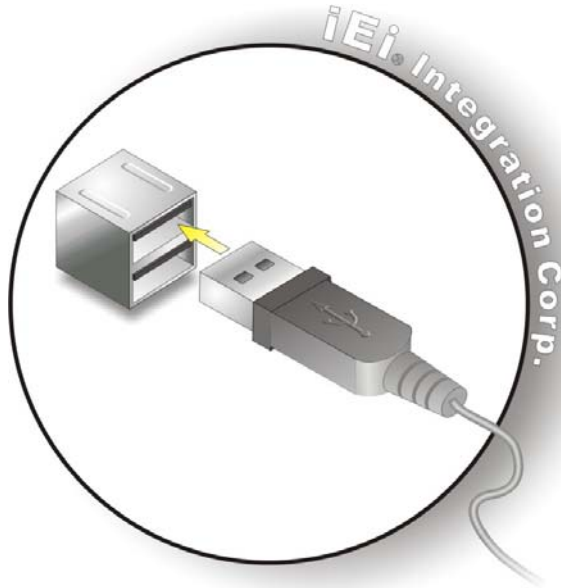

**Figure 4-12: USB Connector**

#### **4.7.4 VGA Monitor Connection**

The WAFER-PV-D4251/D5251/N4551 has a single female DB-15 connector on the external peripheral interface panel. The DB-15 connector is connected to a CRT or VGA monitor. To connect a monitor to the WAFER-PV-D4251/D5251/N4551, please follow the instructions below.

**Step 1:** Locate the **female DB-15 connector**. The location of the female DB-15 connector is shown in **Chapter 3**.

**Step 2:** **Align the VGA connector**. Align the male DB-15 connector on the VGA screen cable with the female DB-15 connector on the external peripheral interface.



## WAFER-PV-D4251/D5251/N4551 SBC

**Step 3: Insert the VGA connector** Once the connectors are properly aligned with the insert the male connector from the VGA screen into the female connector on the WAFER-PV-D4251/D5251/N4551. See Figure 4-13.

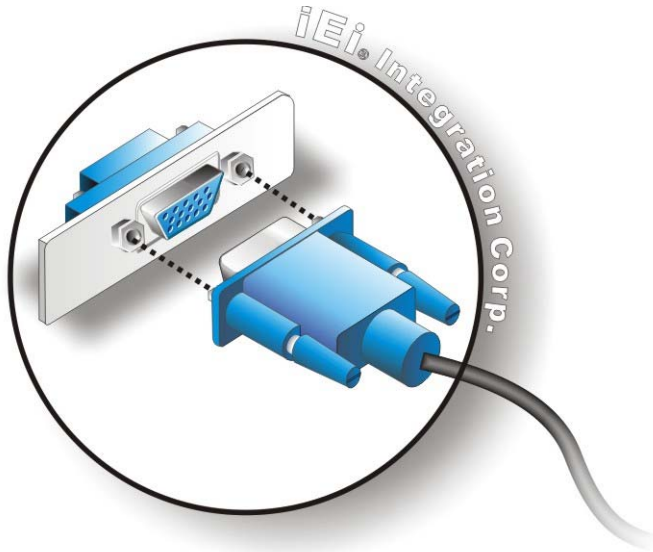

Figure 4-13: VGA Connector

**Step 4: Secure the connector.** Secure the DB-15 VGA connector from the VGA monitor to the external interface by tightening the two retention screws on either side of the connector.

## 4.8 Software Installation

All the drivers for the WAFER-PV-D4251/D5251/N4551 are on the CD that came with the system. To install the drivers, please follow the steps below.

**Step 1:** Insert the CD into a CD drive connected to the system.



### NOTE:

If the installation program doesn't start automatically:  
Click "Start->My Computer->CD Drive->autorun.exe"

**Step 2:** The driver main menu appears (Figure 4-14).



**Figure 4-14: Introduction Screen**

**Step 3:** Click WAFER-PV-D4251/D5251/N4551.

**Step 4:** A new screen with a list of available drivers appears (Figure 4-15).



**Figure 4-15: Available Drivers**

**Step 5:** Install all of the necessary drivers in this menu.

Chapter

**5**

# **BIOS**

---

## 5.1 Introduction

The BIOS is programmed onto the BIOS chip. The BIOS setup program allows changes to certain system settings. This chapter outlines the options that can be changed.



### NOTE:

Some of the BIOS options may vary throughout the life cycle of the product and are subject to change without prior notice.

---

### 5.1.1 Starting Setup

The UEFI BIOS is activated when the computer is turned on. The setup program can be activated in one of two ways.

1. Press the **F2** key as soon as the system is turned on or
2. Press the **F2** key when the “**Press F2 to enter SETUP**” message appears on the screen.

If the message disappears before the **F2** key is pressed, restart the computer and try again.

### 5.1.2 Using Setup

Use the arrow keys to highlight items, press **ENTER** to select, use the PageUp and PageDown keys to change entries, press **F1** for help and press **ESC** to quit. Navigation keys are shown in.

Key	Function
Up arrow	Move to the item above
Down arrow	Move to the item below
Left arrow	Move to the item on the left hand side
Right arrow	Move to the item on the right hand side

Key	Function
+	Increase the numeric value or make changes
-	Decrease the numeric value or make changes
Page up	Move to the next page
Page down	Move to the previous page
Esc	Main Menu – Quit and do not save changes into CMOS Status Page Setup Menu and Option Page Setup Menu -- Exit current page and return to Main Menu
F1	General help, only for Status Page Setup Menu and Option Page Setup Menu
F9	Load optimized defaults
F10	Save changes and Exit BIOS

**Table 5-1: BIOS Navigation Keys**

### 5.1.3 Getting Help

When **F1** is pressed a small help window describing the appropriate keys to use and the possible selections for the highlighted item appears. To exit the Help Window press **Esc** or the **F1** key again.

### 5.1.4 Unable to Reboot After Configuration Changes

If the computer cannot boot after changes to the system configuration is made, CMOS defaults. Use the jumper described in Chapter 4.

### 5.1.5 BIOS Menu Bar

The **menu bar** on top of the BIOS screen has the following main items:

- Main – Changes the basic system configuration.
- Advanced – Changes the advanced system settings.
- Chipset – Changes the chipset settings.
- Boot – Changes the system boot configuration.
- Security – Sets User and Supervisor Passwords.

- Save & Exit – Selects exit options and loads default settings

The following sections completely describe the configuration options found in the menu items at the top of the BIOS screen and listed above.

## 5.2 Main

The **Main** BIOS menu (**BIOS Menu 1**) appears when the **BIOS Setup** program is entered. The **Main** menu gives an overview of the basic system information.

```

Aptio Setup Utility - Copyright (C) 2010 American Megatrends, Inc.
Main  Advanced  Chipset  Boot  Security  Save & Exit
-----
BIOS Information
BIOS Vendor          American Megatrends
Core Version         4.6.4.0 0.20
Compliancy           UEFI 2.0
Project Version      B173AR11.ROM
Build Date           11/19/2010 15:39:09

System Date          [Fri 01/01/2010]
System Time          [14:20:27]

Access Level         Administrator

Set the Date. Use Tab to
switch between Data
elements.

-----
<->: Select Screen
↑ ↓: Select Item
EnterSelect
+/-: Change Opt.
F1  General Help
F2  Previous Values
F3  Optimized Defaults
F4  Save
ESC Exit

Version 2.02.1205. Copyright (C) 2010 American Megatrends, Inc.
    
```

### BIOS Menu 1: Main

#### ➔ BIOS Information

The **BIOS Information** lists a brief summary of the BIOS. The fields in **BIOS Information** cannot be changed. The items shown in the system overview include:

- **BIOS Vendor:** Installed BIOS vendor
- **Core Version:** Current BIOS version
- **Project Version:** the board version
- **Build Date:** Date the current BIOS version was made

The System Overview field also has two user configurable fields:

## WAFER-PV-D4251/D5251/N4551 SBC

### → System Date [xx/xx/xx]

Use the **System Date** option to set the system date. Manually enter the day, month and year.

### → System Time [xx:xx:xx]

Use the **System Time** option to set the system time. Manually enter the hours, minutes and seconds.

## 5.3 Advanced

Use the **Advanced** menu (**BIOS Menu 2**) to configure the CPU and peripheral devices through the following sub-menus:



### WARNING!

Setting the wrong values in the sections below may cause the system to malfunction. Make sure that the settings made are compatible with the hardware.

```

Aptio Setup Utility - Copyright (C) 2010 American Megatrends, Inc.
Main  Advanced  Chipset  Boot  Security  Save & Exit
-----
> ACPI Settings
> CPU Configuration
> IDE Configuration
> USB Configuration
> Super IO Configuration
> H/W Monitor
> Serial Port Console Redirection
System ACPI Parameters
-----
<=>: Select Screen
↑ ↓: Select Item
Enter>Select
+/-: Change Opt.
F1  General Help
F2  Previous Values
F3  Optimized Defaults
F4  Save
ESC Exit
Version 2.02.1205. Copyright (C) 2010 American Megatrends, Inc.
    
```

### BIOS Menu 2: Advanced

### 5.3.1 ACPI Configuration

The **ACPI Configuration** menu (**BIOS Menu 3**) configures the Advanced Configuration and Power Interface (ACPI) options.

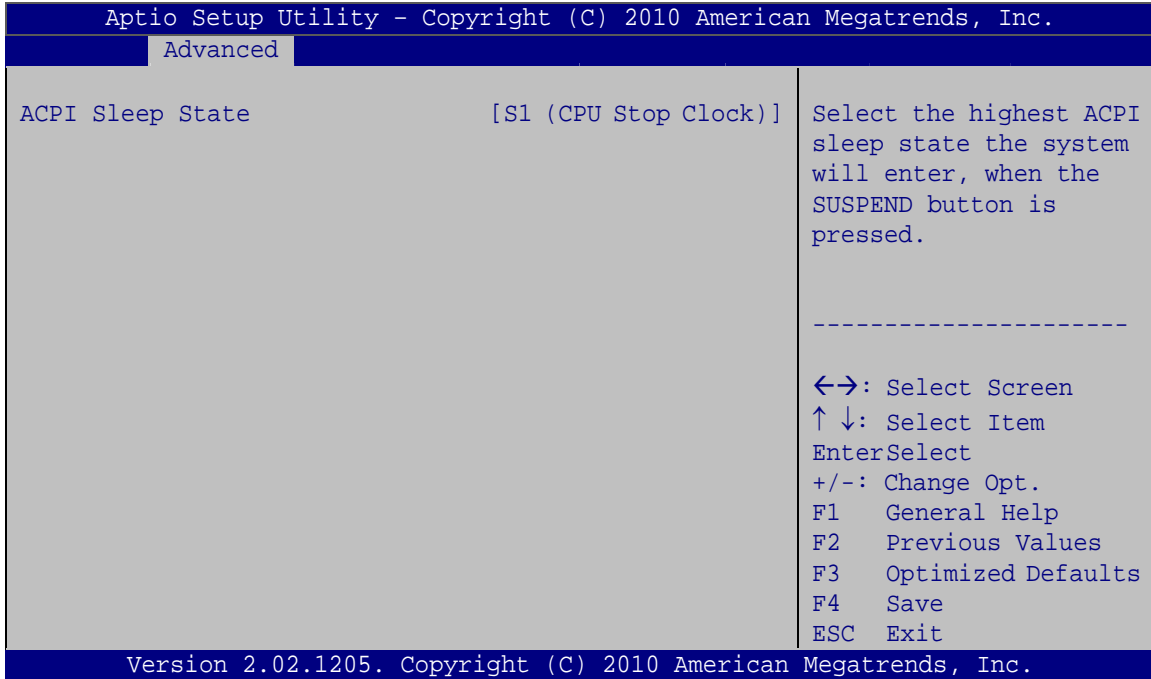

#### BIOS Menu 3: ACPI Configuration

##### → ACPI Sleep State [S1 (CPU Stop Clock)]

Use the **ACPI Sleep State** option to specify the sleep state the system enters when it is not being used.

- **S1 (CPU Stop DEFAULT Clock)** The system enters S1(POS) sleep state. The system appears off. The CPU is stopped; RAM is refreshed; the system is running in a low power mode.
- **S3 (Suspend to RAM)** The caches are flushed and the CPU is powered off. Power to the RAM is maintained. The computer returns slower to a working state, but more power is saved.



## WAFER-PV-D4251/D5251/N4551 SBC

### 5.3.2 CPU Configuration

Use the **CPU Configuration** menu (**BIOS Menu 4**) to view detailed CPU specifications and configure the CPU.

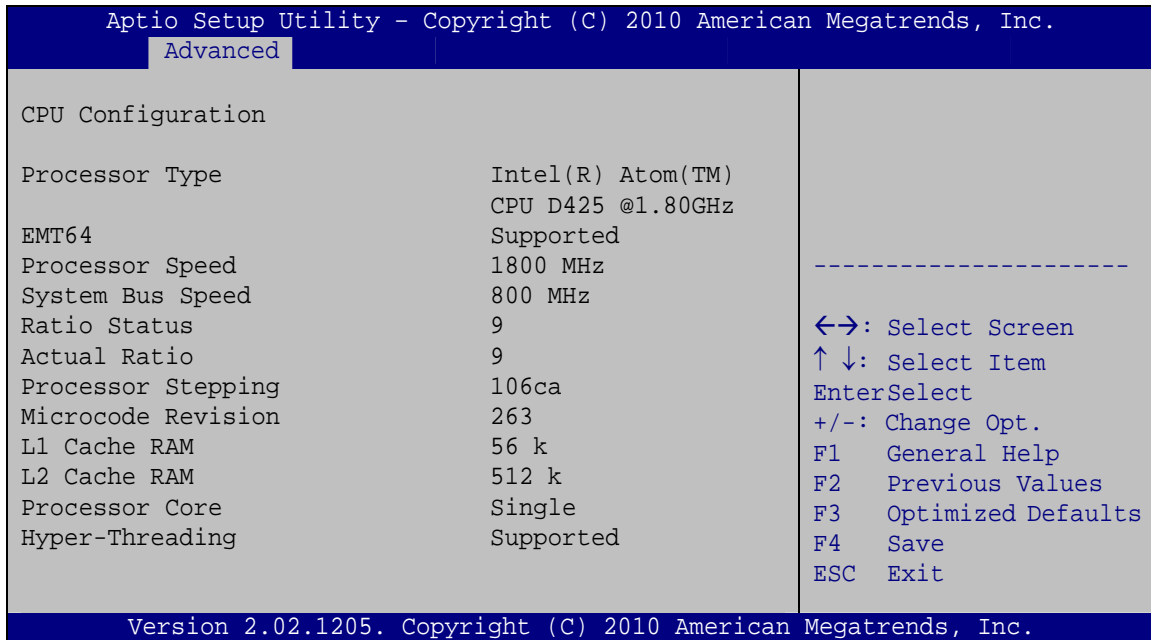

#### BIOS Menu 4: CPU Configuration

The CPU Configuration menu (**BIOS Menu 4**) lists the following CPU details:

- Processor Type: Lists the brand name of the CPU being used
- EMT64: Indicates if the EM64T is supported by the CPU.
- Processor Speed: Lists the CPU processing speed
- Actual Ratio: Lists the ratio of the frequency to the clock speed
- Processor Stepping: Lists the CPU processing stepping
- Microcode Revision: Lists the microcode revision
- L1 Cache RAM: Lists the CPU L1 cache size
- L2 Cache RAM: Lists the CPU L2 cache size
- Processor Cores: Lists the number of the processor core
- Hyper-Threading: Indicates if the Intel HT Technology is supported by the CPU.

### 5.3.3 IDE Configuration

Use the **IDE Configuration** menu (**BIOS Menu 5**) to change and/or set the configuration of the IDE devices installed in the system.

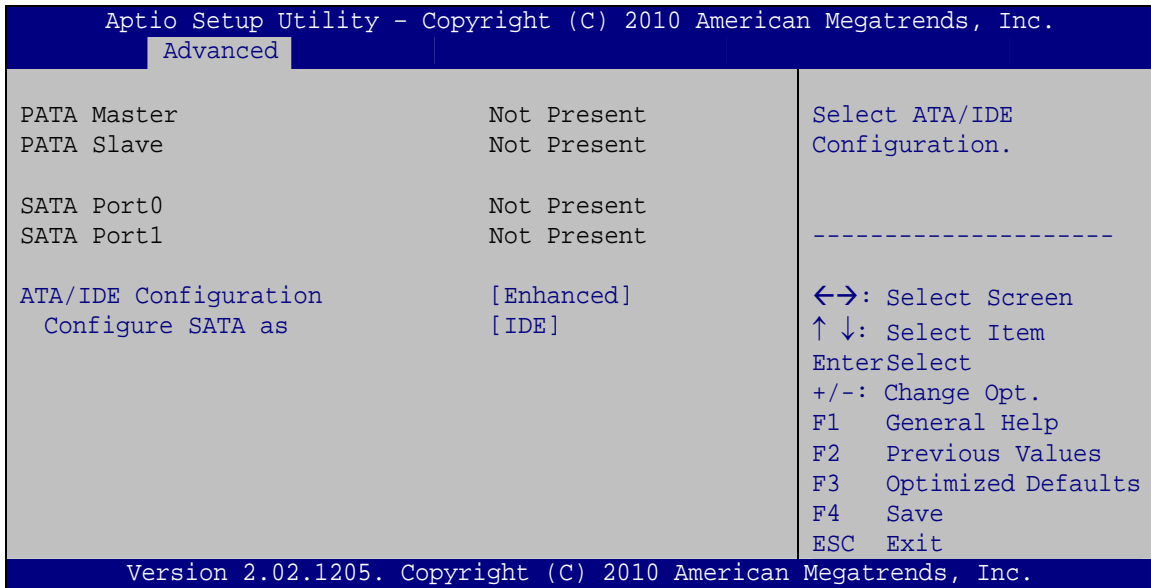

#### BIOS Menu 5: IDE Configuration

##### → ATA/IDE Configurations [Enhanced]

Use the **ATA/IDE Configurations** option to configure the ATA/IDE controller.

- **Disabled**                      Disables the on-board ATA/IDE controller.
- **Compatible**                      Configures the on-board ATA/IDE controller to be in compatible mode. In this mode, a SATA channel will replace one of the IDE channels. This mode supports up to 4 storage devices.
- **Enhanced      DEFAULT**                      Configures the on-board ATA/IDE controller to be in Enhanced mode. In this mode, IDE channels and SATA channels are separated. This mode supports up to 6 storage devices. Some legacy OS do not support this mode.

## WAFER-PV-D4251/D5251/N4551 SBC

### → Configure SATA as [IDE]

Use the **Configure SATA as** option to configure SATA devices as normal IDE devices.

- **IDE**                      **DEFAULT**      Configures SATA devices as normal IDE device.
- **AHCI**    Configures SATA devices as normal AHCI device.

### 5.3.4 USB Configuration

Use the **USB Configuration** menu (**BIOS Menu 6**) to read USB configuration information and configure the USB settings.

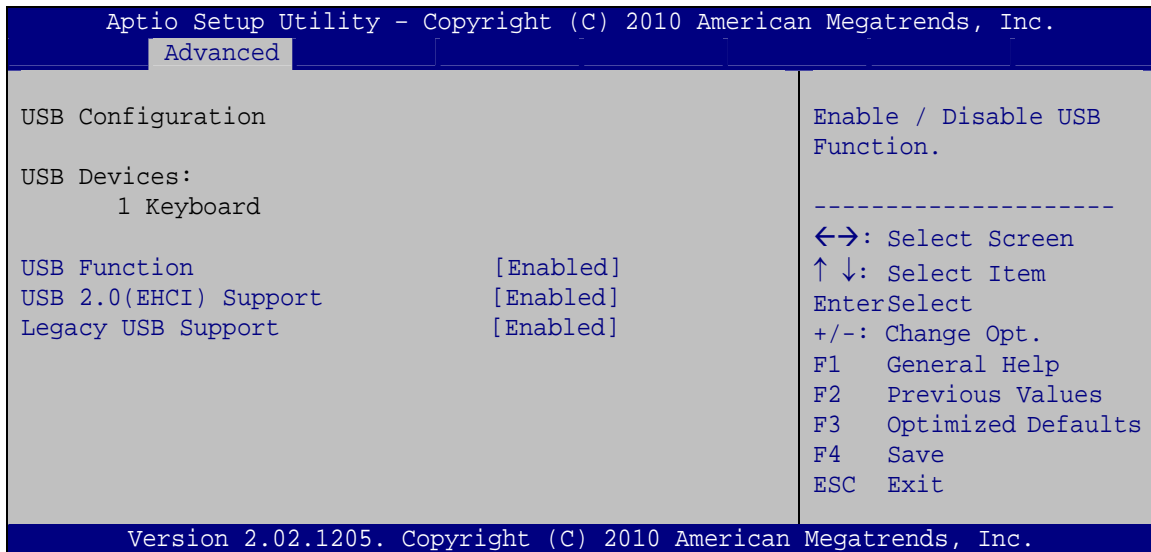

#### BIOS Menu 6: USB Configuration

### → USB Devices

The **USB Devices Enabled** field lists the USB devices that are enabled on the system

### → USB Function

Use the **USB Function** BIOS option to enable or disable USB function support.

- **Enabled**                      **DEFAULT**      USB function support enabled.
- **Disabled**    USB function support disabled.

→ **USB 2.0 (EHCI) Support**

Use the **USB 2.0 (EHCI) Support** BIOS option to enable or disable the USB 2.0 controller.

- **Enabled**      **DEFAULT**      USB 2.0 controller enabled
- **Disabled**                      USB 2.0 controller disabled

→ **Legacy USB Support [Enabled]**

Use the **Legacy USB Support** BIOS option to enable USB mouse and USB keyboard support. Normally if this option is not enabled, any attached USB mouse or USB keyboard does not become available until a USB compatible operating system is fully booted with all USB drivers loaded. When this option is enabled, any attached USB mouse or USB keyboard can control the system even when there is no USB driver loaded onto the system.

- **Enabled**      **DEFAULT**      Legacy USB support enabled
- **Disabled**                      Legacy USB support disabled
- **Auto**                      Legacy USB support disabled if no USB devices are connected

## WAFER-PV-D4251/D5251/N4551 SBC

### 5.3.5 Super IO Configuration

Use the **Super IO Configuration** menu (**BIOS Menu 7**) to set or change the configurations for the FDD controllers, parallel ports and serial ports.

```

Aptio Setup Utility - Copyright (C) 2010 American Megatrends, Inc.
  Advanced
-----
Super IO Configuration                               Set Parameters of Serial
                                                    Port 0 (COMA)
                                                    -----
Super IO Chip                                     Finteck F81865
> Serial Port 0 Configuration
> Serial Port 1 Configuration
> Serial Port 2 Configuration
> Serial Port 3 Configuration
                                                    <->: Select Screen
                                                    ↑ ↓: Select Item
                                                    EnterSelect
                                                    +/-: Change Opt.
F1   General Help
F2   Previous Values
F3   Optimized Defaults
F4   Save
ESC  Exit
Version 2.02.1205. Copyright (C) 2010 American Megatrends, Inc.
  
```

**BIOS Menu 7: Super IO Configuration**

#### 5.3.5.1 Serial Port n Configuration

Use the **Serial Port n Configuration** menu (**BIOS Menu 8**) to configure the serial port n.

```

Aptio Setup Utility - Copyright (C) 2010 American Megatrends, Inc.
  Advanced
-----
Serial Port 0 Configuration                       Enable or Disable Serial
                                                    Port (COM)
                                                    -----
Serial Port                                     [Enabled]
Device Settings                                IO=3F8h; IRQ=4
Change Settings                                 [Auto]
                                                    <->: Select Screen
                                                    ↑ ↓: Select Item
                                                    EnterSelect
                                                    +/-: Change Opt.
F1   General Help
F2   Previous Values
F3   Optimized Defaults
F4   Save
ESC  Exit
Version 2.01.1204. Copyright (C) 2010 American Megatrends, Inc.
  
```

**BIOS Menu 8: Serial Port n Configuration Menu**

### 5.3.5.1.1 Serial Port 0 Configuration

→ **Serial Port [Enabled]**

Use the **Serial Port** option to enable or disable the serial port.

- **Disabled**                      Disable the serial port
- **Enabled**      **DEFAULT**      Enable the serial port

→ **Change Settings [Auto]**

Use the **Change Settings** option to change the serial port IO port address and interrupt address.

- **Auto**              **DEFAULT**      The serial port IO port address and interrupt address are automatically detected.
- **IO=3F8h;**  
**IRQ=4**                      Serial Port I/O port address is 3F8h and the interrupt address is IRQ4
- **IO=3F8h;**  
**IRQ=3, 4**                      Serial Port I/O port address is 3E8h and the interrupt address is IRQ3, 4
- **IO=2F8h;**  
**IRQ=3, 4**                      Serial Port I/O port address is 2F8h and the interrupt address is IRQ3, 4
- **IO=2C0h;**  
**IRQ=3, 4**                      Serial Port I/O port address is 2C0h and the interrupt address is IRQ3, 4
- **IO=2C8h;**  
**IRQ=3, 4**                      Serial Port I/O port address is 2C8h and the interrupt address is IRQ3, 4

### 5.3.5.1.2 Serial Port 1 Configuration

→ **Serial Port [Enabled]**

Use the **Serial Port** option to enable or disable the serial port.

- **Disabled**                      Disable the serial port

## WAFER-PV-D4251/D5251/N4551 SBC

→ **Enabled**      **DEFAULT**      Enable the serial port

### → **Change Settings [Auto]**

Use the **Change Settings** option to change the serial port IO port address and interrupt address.

→ **Auto**      **DEFAULT**      The serial port IO port address and interrupt address are automatically detected.

→ **IO=2F8h;**  
**IRQ=3**      Serial Port I/O port address is 2F8h and the interrupt address is IRQ3

→ **IO=3F8h;**  
**IRQ=3, 4**      Serial Port I/O port address is 3F8h and the interrupt address is IRQ3, 4

→ **IO=2F8h;**  
**IRQ=3, 4**      Serial Port I/O port address is 2F8h and the interrupt address is IRQ3, 4

→ **IO=2C0h;**  
**IRQ=3, 4**      Serial Port I/O port address is 2C0h and the interrupt address is IRQ3, 4

→ **IO=2C8h;**  
**IRQ=3, 4**      Serial Port I/O port address is 2C8h and the interrupt address is IRQ3, 4

### 5.3.5.1.3 Serial Port 2 Configuration

#### → **Serial Port [Enabled]**

Use the **Serial Port** option to enable or disable the serial port.

→ **Disabled**      Disable the serial port

→ **Enabled**      **DEFAULT**      Enable the serial port

#### → **Change Settings [Auto]**

Use the **Change Settings** option to change the serial port IO port address and interrupt address.

- **Auto**      **DEFAULT**      The serial port IO port address and interrupt address are automatically detected.
- **IO=3E8h;**  
**IRQ=11**      Serial Port I/O port address is 3E8h and the interrupt address is IRQ11
- **IO=3E8h;**  
**IRQ=10, 11**      Serial Port I/O port address is 3E8h and the interrupt address is IRQ10, 11
- **IO=2E8h;**  
**IRQ=10, 11**      Serial Port I/O port address is 2E8h and the interrupt address is IRQ10, 11
- **IO=2D0h;**  
**IRQ=10, 11**      Serial Port I/O port address is 2D0h and the interrupt address is IRQ10, 11
- **IO=2D8h;**  
**IRQ=10, 11**      Serial Port I/O port address is 2D8h and the interrupt address is IRQ10, 11

#### **5.3.5.1.4 Serial Port 3 Configuration**

##### → **Serial Port [Enabled]**

Use the **Serial Port** option to enable or disable the serial port.

- **Disabled**      Disable the serial port
- **Enabled**      **DEFAULT**      Enable the serial port

##### → **Change Settings [Auto]**

Use the **Change Settings** option to change the serial port IO port address and interrupt address.

- **Auto**      **DEFAULT**      The serial port IO port address and interrupt address are automatically detected.
- **IO=2E8h;**  
**IRQ=11**      Serial Port I/O port address is 2E8h and the interrupt address is IRQ11



## WAFER-PV-D4251/D5251/N4551 SBC

- ➔ **IO=3E8h;**                      Serial Port I/O port address is 3E8h and the interrupt address is IRQ10, 11  
**IRQ=10, 11**
- ➔ **IO=2E8h;**                      Serial Port I/O port address is 2E8h and the interrupt address is IRQ10, 11  
**IRQ=10, 11**
- ➔ **IO=2D0h;**                      Serial Port I/O port address is 2D0h and the interrupt address is IRQ10, 11  
**IRQ=10, 11**
- ➔ **IO=2D8h;**                      Serial Port I/O port address is 2E8h and the interrupt address is IRQ10, 11  
**IRQ=10, 11**

### 5.3.6 H/W Monitor

The H/W Monitor menu (**BIOS Menu 9**) shows the operating temperature, fan speeds and system voltages.

```

Aptio Setup Utility - Copyright (C) 2010 American Megatrends, Inc.
-----
Advanced
-----
PC Health Status

CPU Temperature           :+77 C
SYS Temperature           :+58 C
CPU FAN Speed             :N/A
VCC3V                     :+3.328 V
V_core                    :+1.096 V
+5V                       :+5.003 V
Vcc12                     :+11.528 V
Vcc1_5VDDR                :+1.616 V
VSB3V                    :+3.328 V
VBAT                      :+3.248 V
CPU Smart Fan control     [Auto Mode]
Temperature Bound 1       80
Temperature Bound 2       70
Temperature Bound 3       60
Temperature Bound 4       50

-----
<->: Select Screen
↑ ↓: Select Item
Enter>Select
+/-: Change Opt.
F1   General Help
F2   Previous Values
F3   Optimized Defaults
F4   Save
ESC  Exit

Version 2.02.1205. Copyright (C) 2010 American Megatrends, Inc.

```

#### BIOS Menu 9: Hardware Health Configuration

##### ➔ PC Health Status

The following system parameters and values are shown. The system parameters that are monitored are:

- System Temperatures:
  - CPU Temperature
  - System Temperature
- Fan Speeds:
  - CPU Fan Speed
- Voltages:
  - VCC3V
  - V\_core
  - +5V
  - Vcc12
  - Vcc1\_5VDDR
  - VSB3V
  - VBAT

#### → CPU Smart Fan control [Auto Mode]

Use the **CPU Smart Fan control** option to configure the CPU fan.

##### → Auto Mode

The fan adjusts its speed using these settings:

Temperature Bound 1

Temperature Bound 2

Temperature Bound 3

Temperature Bound 4

##### → Manual Mode

The fan spins at the speed set in:

Manual Duty Cycle Setting

### 5.3.7 Serial Port Console Redirection

The **Serial Port Console Redirection** menu (**BIOS Menu 10**) allows the console redirection options to be configured. Console redirection allows users to maintain a system remotely by re-directing keyboard input and text output through the serial port.

## WAFER-PV-D4251/D5251/N4551 SBC

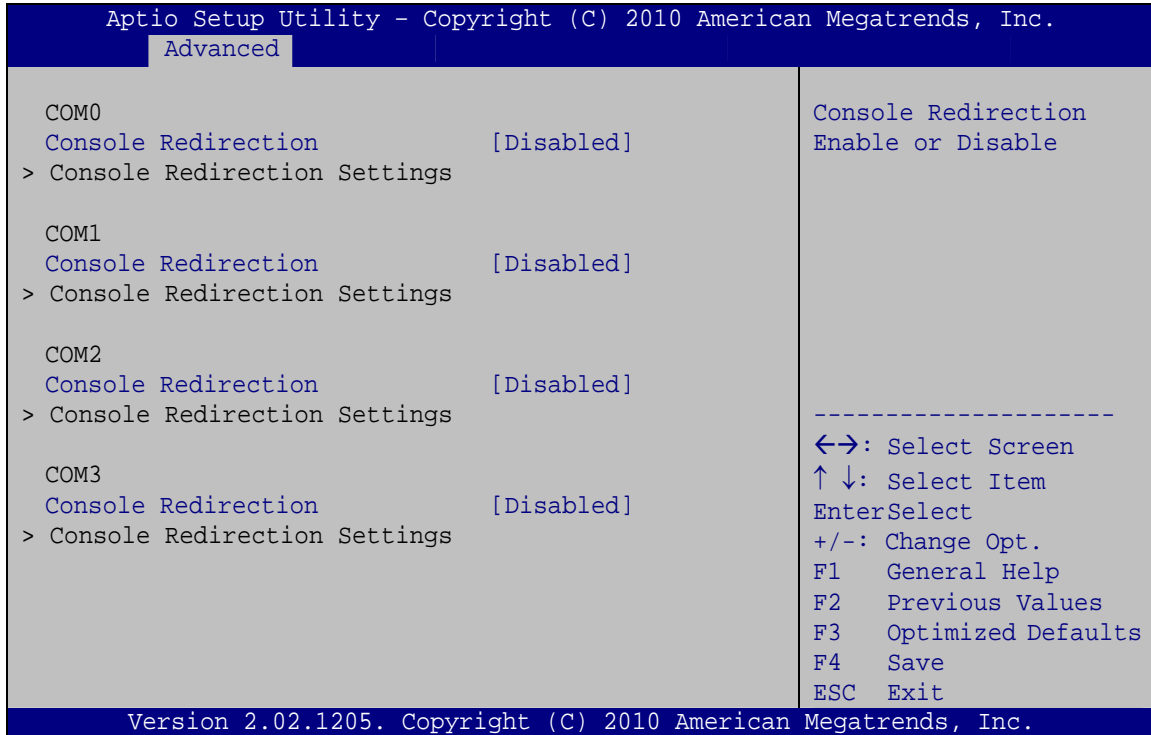

### BIOS Menu 10: Serial Port Console Redirection

#### → Console Redirection [Disabled]

Use **Console Redirection** option to enable or disable the console redirection function.

- **Disabled**    **DEFAULT**    Disabled the console redirection function
- **Enabled**                    Enabled the console redirection function

## 5.4 Chipset

Use the **Chipset** menu (**BIOS Menu 11**) to access the Northbridge and Southbridge configuration menus



### **WARNING!**

Setting the wrong values for the Chipset BIOS selections in the Chipset BIOS menu may cause the system to malfunction.

```

Aptio Setup Utility - Copyright (C) 2010 American Megatrends, Inc.
Main   Advanced  Chipset   Boot   Security  Save & Exit

> Host Bridge
> South Bridge
> Intel IGD SWSCI OpRegion

Host Bridge Parameters

-----
<=>: Select Screen
↑↓: Select Item
Enter>Select
+/-: Change Opt.
F1   General Help
F2   Previous Values
F3   Optimized Defaults
F4   Save
ESC  Exit

Version 2.02.1205. Copyright (C) 2010 American Megatrends, Inc.
  
```

**BIOS Menu 11: Chipset**

**5.4.1 Host Bridge**

Use the **Host Bridge** menu (**BIOS Menu 12**) to configure the host bridge chipset.

```

Aptio Setup Utility - Copyright (C) 2010 American Megatrends, Inc.
Chipset

> OnChip VGA Configuration

***** Memory Information *****
Memory Frequency           800 Mhz
Total Memory               1048 MB
DIMM#0                    1048 MB
Share Memory Size         [8MB]

Select Share Memory Size.

-----
<=>: Select Screen
↑↓: Select Item
Enter>Select
+/-: Change Opt.
F1   General Help
F2   Previous Values
F3   Optimized Defaults
F4   Save
ESC  Exit

Version 2.02.1205. Copyright (C) 2010 American Megatrends, Inc.
  
```

**BIOS Menu 12:Host Bridge Configuration**

➔ **Share Memory Size [8MB]**

Use the **Share Memory Size** option to set the amount of system memory allocated to the integrated graphics processor when the system boots. The system memory allocated can

## WAFER-PV-D4251/D5251/N4551 SBC

then only be used as graphics memory, and is no longer available to applications or the operating system. Configuration options are listed below:

- ➔ **Disabled** Disabled Share Memory.
- ➔ **1 MB** Sets the Share Memory size at 1 MB.
- ➔ **8 MB** **DEFAULT** Sets the Share Memory size at 8 MB.

### 5.4.2 South Bridge

Use the **South Bridge** menu (**BIOS Menu 13**) to configure the Southbridge chipset.

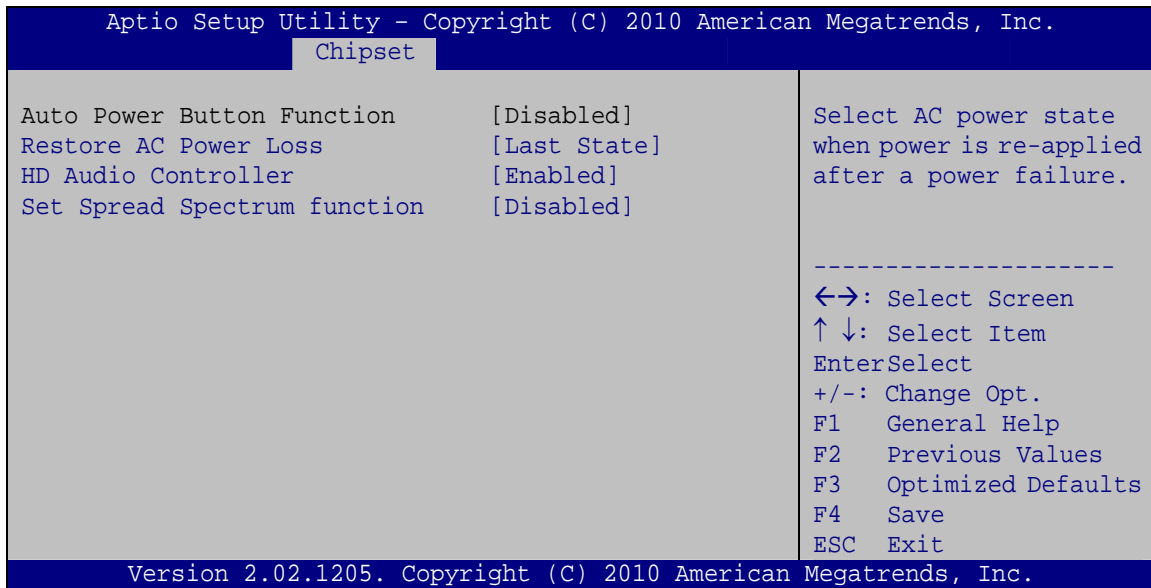

#### BIOS Menu 13: Southbridge Chipset Configuration

##### ➔ Restore on AC Power Loss [Last State]

Use the **Restore on AC Power Loss** BIOS option to specify what state the system returns to if there is a sudden loss of power to the system.

- ➔ **Power Off** The system remains turned off
- ➔ **Power On** The system turns on
- ➔ **Last State** **DEFAULT** The system returns to its previous state. If it was on, it turns itself on. If it was off, it remains off.

➔ **HD Audio Controller [Enabled]**

The **HD Audio Controller** option enables or disables the HD audio controller.

- ➔ **Enabled**      **DEFAULT**      The onboard HD audio controller automatically detected and enabled
- ➔ **Disabled**                      The onboard HD audio controller is disabled

➔ **Set Spread Spectrum Function [Disabled]**

The **Set Spread Spectrum Function** option can help to improve CPU EMI issues.

- ➔ **Disabled**      **DEFAULT**      The spread spectrum function is disabled
- ➔ **Enabled**                      The spread spectrum function is enabled

### 5.4.3 Intel IGD SWSCI OpRegion

Use the **Intel IGD SWSCI OpRegion** menu to configure the video device connected to the system.

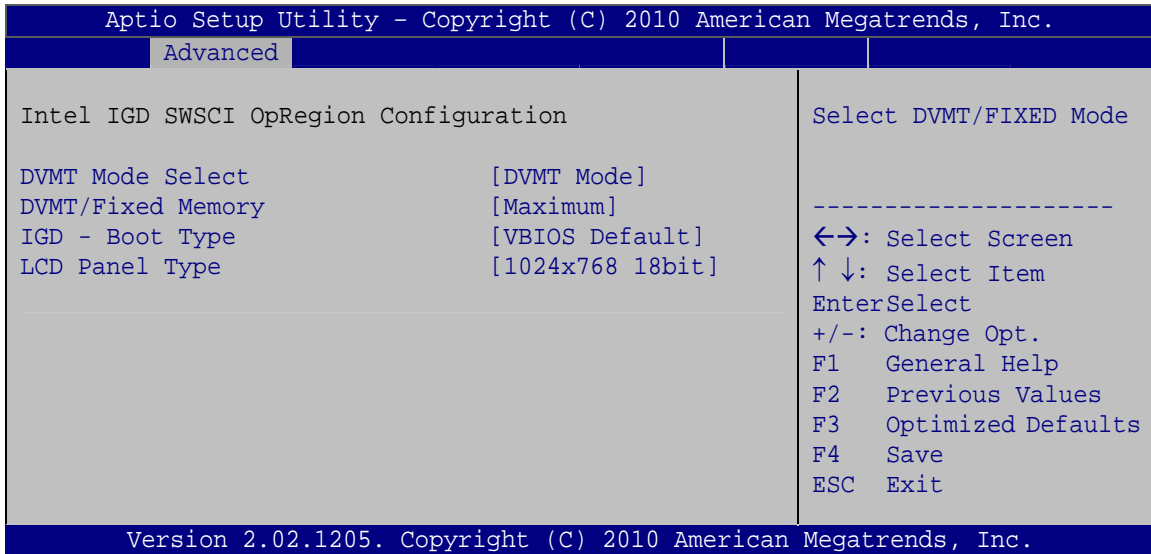

**BIOS Menu 14: Intel IGD SWSCI OpRegion**

## WAFER-PV-D4251/D5251/N4551 SBC

### → DVMT Mode Select [DVMT Mode]

Use the **DVMT Mode Select** option to select the Intel Dynamic Video Memory Technology (DVMT) operating mode.

- **Fixed Mode**                      A fixed portion of graphics memory is reserved as graphics memory.
- **DVMT Mode**    **DEFAULT**    Graphics memory is dynamically allocated according to the system and graphics needs.

### → DVMT/FIXED Memory [256 MB]

Use the **DVMT/FIXED Memory** option to specify the maximum amount of memory that can be allocated as graphics memory. Configuration options are listed below.

- 128 MB
- 256 MB
- Maximum            **Default**

### → IGD - Boot Type [VBIOS Default]

Use the **IGD - Boot Type** option to select the display device used by the system when it boots. Configuration options are listed below.

- VBIOS Default        **DEFAULT**
- CRT
- LFP
- CRT + LFP

### → LCD Panel Type [VBIOS Default]

Use the **LCD Panel Type** option to select the type of flat panel connected to the system. Configuration options are listed below.

- Select by Panel ID
- 640x480 18bit
- 800x480 18bit
- 800x600 18bit

- 1024x768 18bit **DEFAULT**
- 1280x1024 18bit
- 1366x768 18bit
- 1280x800 18bit
- 1280x600 18bit

## 5.5 Boot

Use the **Boot** menu (**BIOS Menu 15**) to configure system boot options.

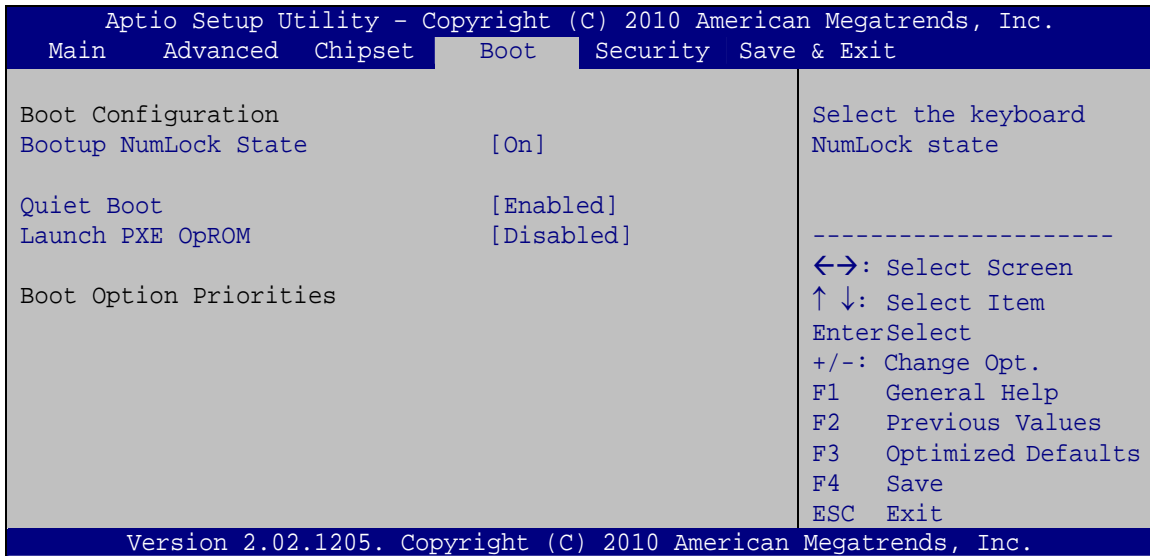

### BIOS Menu 15: Boot

#### → Bootup NumLock State [On]

Use the **Bootup NumLock State** BIOS option to specify if the number lock setting must be modified during boot up.

- **On** **DEFAULT** Allows the Number Lock on the keyboard to be enabled automatically when the computer system boots up. This allows the immediate use of the 10-key numeric keypad located on the right side of the keyboard. To confirm this, the Number Lock LED light on the keyboard is lit.



## WAFER-PV-D4251/D5251/N4551 SBC

- **Off** Does not enable the keyboard Number Lock automatically. To use the 10-keys on the keyboard, press the Number Lock key located on the upper left-hand corner of the 10-key pad. The Number Lock LED on the keyboard lights up when the Number Lock is engaged.

→ **Quiet Boot [Enabled]**

Use the **Quiet Boot** BIOS option to select the screen display when the system boots.

- **Disabled** Normal POST messages displayed
- **Enabled** **DEFAULT** OEM Logo displayed instead of POST messages

→ **Launch PXE OpROM [Disabled]**

Use the **Launch PXE OpROM** option to enable or disable boot option for legacy network devices.

- **Disabled** **DEFAULT** Ignore all PXE Option ROMs
- **Enabled** Load PXE Option ROMs.

## 5.6 Security

Use the **Security** menu (**BIOS Menu 16**) to set system and user passwords.

```

Aptio Setup Utility - Copyright (C) 2010 American Megatrends, Inc.
Main   Advanced  Chipset  Boot   Security  Save & Exit

Password Description
-----
If ONLY the Administrator's password is set,
then this only limits access to Setup and is
only asked for when entering Setup
If ONLY the User's password is set, then this
is a power on password and must be entered to
boot or enter Setup. In Setup the User will
have Administrator rights.
The password must be 3 to 20 characters long.

Administrator Password
User Password

Set User Password
Set Master Password

Set Setup Administrator
Password

-----
<->: Select Screen
↑ ↓: Select Item
Enter/Select
+/-: Change Opt.
F1   General Help
F2   Previous Values
F3   Optimized Defaults
F4   Save
ESC  Exit

Version 2.02.1205. Copyright (C) 2010 American Megatrends, Inc.

```

### BIOS Menu 16: Security

#### ➔ Administrator Password

Use the **Administrator Password** to set or change an administrator password.

#### ➔ User Password

Use the **User Password** to set or change a user password.

## 5.7 Exit

Use the **Exit** menu (**BIOS Menu 17**) to load default BIOS values, optimal failsafe values and to save configuration changes.

## WAFER-PV-D4251/D5251/N4551 SBC

```

Aptio Setup Utility - Copyright (C) 2010 American Megatrends, Inc.
Main   Advanced  Chipset  Boot   Security  Save & Exit

Save Changes and Reset
Discard Changes and Reset

Restore Defaults
Save as User Defaults
Restore User Defaults

Exit system setup after
saving the changes.

-----
<->: Select Screen
↑ ↓: Select Item
Enter>Select
F1   General Help
F2   Previous Values
F3   Optimized
Defaults
F4   Save
ESC  Exit

Version 2.01.1204. Copyright (C) 2010 American Megatrends, Inc.

```

### BIOS Menu 17:Exit

#### → Save Changes and Reset

Use the **Save Changes and Reset** option to save the changes made to the BIOS options and to exit the BIOS configuration setup program.

#### → Discard Changes and Reset

Use the **Discard Changes and Reset** option to exit the system without saving the changes made to the BIOS configuration setup program.

#### → Restore Defaults

Use the **Restore Defaults** option to load the optimal default values for each of the parameters on the Setup menus. **F3 key can be used for this operation.**

#### → Save as User Defaults

Use the **Save as User Defaults** option to save the changes done so far as user defaults.

#### → Restore User Defaults

Use the **Restore User Defaults** option to restore the user defaults to all the setup options.

Appendix

**A**

# BIOS Options

---

**WAFER-PV-D4251/D5251/N4551 SBC**

Below is a list of BIOS configuration options in the BIOS chapter.

<b>BIOS Information</b> .....	<b>58</b>
<b>System Date [xx/xx/xx]</b> .....	<b>59</b>
<b>System Time [xx:xx:xx]</b> .....	<b>59</b>
<b>ACPI Sleep State [S1 (CPU Stop Clock)]</b> .....	<b>60</b>
<b>ATA/IDE Configurations [Enhanced]</b> .....	<b>62</b>
<b>Configure SATA as [IDE]</b> .....	<b>63</b>
<b>USB Devices</b> .....	<b>63</b>
<b>USB Function</b> .....	<b>63</b>
<b>USB 2.0 (EHCI) Support</b> .....	<b>64</b>
<b>Legacy USB Support [Enabled]</b> .....	<b>64</b>
<b>Serial Port [Enabled]</b> .....	<b>66</b>
<b>Change Settings [Auto]</b> .....	<b>66</b>
<b>Serial Port [Enabled]</b> .....	<b>66</b>
<b>Change Settings [Auto]</b> .....	<b>67</b>
<b>Serial Port [Enabled]</b> .....	<b>67</b>
<b>Change Settings [Auto]</b> .....	<b>67</b>
<b>Serial Port [Enabled]</b> .....	<b>68</b>
<b>Change Settings [Auto]</b> .....	<b>68</b>
<b>PC Health Status</b> .....	<b>69</b>
<b>CPU Smart Fan control [Auto Mode]</b> .....	<b>70</b>
<b>Console Redirection [Disabled]</b> .....	<b>71</b>
<b>Share Memory Size [8MB]</b> .....	<b>72</b>
<b>Restore on AC Power Loss [Last State]</b> .....	<b>73</b>
<b>HD Audio Controller [Enabled]</b> .....	<b>74</b>
<b>Set Spread Spectrum Function [Disabled]</b> .....	<b>74</b>
<b>DVMT Mode Select [DVMT Mode]</b> .....	<b>75</b>
<b>DVMT/FIXED Memory [256 MB]</b> .....	<b>75</b>
<b>IGD - Boot Type [VBIOS Default]</b> .....	<b>75</b>
<b>LCD Panel Type [VBIOS Default]</b> .....	<b>75</b>
<b>Bootup NumLock State [On]</b> .....	<b>76</b>
<b>Quiet Boot [Enabled]</b> .....	<b>77</b>
<b>Launch PXE OpROM [Disabled]</b> .....	<b>77</b>
<b>Administrator Password</b> .....	<b>78</b>

<b>User Password .....</b>	<b>78</b>
<b>Save Changes and Reset .....</b>	<b>79</b>
<b>Discard Changes and Reset .....</b>	<b>79</b>
<b>Restore Defaults .....</b>	<b>79</b>
<b>Save as User Defaults .....</b>	<b>79</b>
<b>Restore User Defaults .....</b>	<b>79</b>

Appendix

**B**

# Terminology

---

<b>AC '97</b>	Audio Codec 97 (AC'97) refers to a codec standard developed by Intel® in 1997.
<b>ACPI</b>	Advanced Configuration and Power Interface (ACPI) is an OS-directed configuration, power management, and thermal management interface.
<b>AHCI</b>	Advanced Host Controller Interface (AHCI) is a SATA Host controller register-level interface.
<b>ATA</b>	The Advanced Technology Attachment (ATA) interface connects storage devices including hard disks and CD-ROM drives to a computer.
<b>ARMD</b>	An ATAPI Removable Media Device (ARMD) is any ATAPI device that supports removable media, besides CD and DVD drives.
<b>ASKIR</b>	Amplitude Shift Keyed Infrared (ASKIR) is a form of modulation that represents a digital signal by varying the amplitude (“volume”) of the signal. A low amplitude signal represents a binary 0, while a high amplitude signal represents a binary 1.
<b>BIOS</b>	The Basic Input/Output System (BIOS) is firmware that is first run when the computer is turned on and can be configured by the end user
<b>CODEC</b>	The Compressor-Decompressor (CODEC) encodes and decodes digital audio data on the system.
<b>CompactFlash®</b>	CompactFlash® is a solid-state storage device. CompactFlash® devices use flash memory in a standard size enclosure. Type II is thicker than Type I, but a Type II slot can support both types.
<b>CMOS</b>	Complimentary metal-oxide-conductor is an integrated circuit used in chips like static RAM and microprocessors.
<b>COM</b>	COM refers to serial ports. Serial ports offer serial communication to expansion devices. The serial port on a personal computer is usually a male DB-9 connector.
<b>DAC</b>	The Digital-to-Analog Converter (DAC) converts digital signals to analog signals.
<b>DDR</b>	Double Data Rate refers to a data bus transferring data on both the rising and falling edges of the clock signal.



**WAFER-PV-D4251/D5251/N4551 SBC**

<b>DMA</b>	Direct Memory Access (DMA) enables some peripheral devices to bypass the system processor and communicate directly with the system memory.
<b>DIMM</b>	Dual Inline Memory Modules are a type of RAM that offer a 64-bit data bus and have separate electrical contacts on each side of the module.
<b>DIO</b>	The digital inputs and digital outputs are general control signals that control the on/off circuit of external devices or TTL devices. Data can be read or written to the selected address to enable the DIO functions.
<b>EHCI</b>	The Enhanced Host Controller Interface (EHCI) specification is a register-level interface description for USB 2.0 Host Controllers.
<b>EIDE</b>	Enhanced IDE (EIDE) is a newer IDE interface standard that has data transfer rates between 4.0 MBps and 16.6 MBps.
<b>EIST</b>	Enhanced Intel® SpeedStep Technology (EIST) allows users to modify the power consumption levels and processor performance through application software. The application software changes the bus-to-core frequency ratio and the processor core voltage.
<b>FSB</b>	The Front Side Bus (FSB) is the bi-directional communication channel between the processor and the Northbridge chipset.
<b>GbE</b>	Gigabit Ethernet (GbE) is an Ethernet version that transfers data at 1.0 Gbps and complies with the IEEE 802.3-2005 standard.
<b>GPIO</b>	General purpose input
<b>HDD</b>	Hard disk drive (HDD) is a type of magnetic, non-volatile computer storage device that stores digitally encoded data.
<b>ICH</b>	The Input/Output Control Hub (ICH) is an Intel® Southbridge chipset.
<b>IrDA</b>	Infrared Data Association (IrDA) specify infrared data transmission protocols used to enable electronic devices to wirelessly communicate with each other.
<b>L1 Cache</b>	The Level 1 Cache (L1 Cache) is a small memory cache built into the system processor.
<b>L2 Cache</b>	The Level 2 Cache (L2 Cache) is an external processor memory cache.

<b>LCD</b>	Liquid crystal display (LCD) is a flat, low-power display device that consists of two polarizing plates with a liquid crystal panel in between.
<b>LVDS</b>	Low-voltage differential signaling (LVDS) is a dual-wire, high-speed differential electrical signaling system commonly used to connect LCD displays to a computer.
<b>POST</b>	The Power-on Self Test (POST) is the pre-boot actions the system performs when the system is turned-on.
<b>RAM</b>	Random Access Memory (RAM) is volatile memory that loses data when power is lost. RAM has very fast data transfer rates compared to other storage like hard drives.
<b>SATA</b>	Serial ATA (SATA) is a serial communications bus designed for data transfers between storage devices and the computer chipsets. The SATA bus has transfer speeds up to 1.5 Gbps and the SATA II bus has data transfer speeds of up to 3.0 Gbps.
<b>S.M.A.R.T</b>	Self Monitoring Analysis and Reporting Technology (S.M.A.R.T) refers to automatic status checking technology implemented on hard disk drives.
<b>UART</b>	Universal Asynchronous Receiver-transmitter (UART) is responsible for asynchronous communications on the system and manages the system's serial communication (COM) ports.
<b>UHCI</b>	The Universal Host Controller Interface (UHCI) specification is a register-level interface description for USB 1.1 Host Controllers.
<b>USB</b>	The Universal Serial Bus (USB) is an external bus standard for interfacing devices. USB 1.1 supports 12Mbps data transfer rates and USB 2.0 supports 480Mbps data transfer rates.
<b>VGA</b>	The Video Graphics Array (VGA) is a graphics display system developed by IBM.

Appendix

C

# Hazardous Materials Disclosure

---

## **C.1 Hazardous Materials Disclosure Table for IPB Products Certified as RoHS Compliant Under 2002/95/EC Without Mercury**

The details provided in this appendix are to ensure that the product is compliant with the Peoples Republic of China (China) RoHS standards. The table below acknowledges the presences of small quantities of certain materials in the product, and is applicable to China RoHS only.

A label will be placed on each product to indicate the estimated “Environmentally Friendly Use Period” (EFUP). This is an estimate of the number of years that these substances would “not leak out or undergo abrupt change.” This product may contain replaceable sub-assemblies/components which have a shorter EFUP such as batteries and lamps. These components will be separately marked.

Please refer to the table on the next page.

**WAFER-PV-D4251/D5251/N4551 SBC**

Part Name	Toxic or Hazardous Substances and Elements					
	Lead (Pb)	Mercury (Hg)	Cadmium (Cd)	Hexavalent Chromium (CR(VI))	Polybrominated Biphenyls (PBB)	Polybrominated Diphenyl Ethers (PBDE)
<b>Housing</b>	<input type="radio"/>	<input type="radio"/>	<input type="radio"/>	<input type="radio"/>	<input type="radio"/>	<input type="radio"/>
<b>Display</b>	<input type="radio"/>	<input type="radio"/>	<input type="radio"/>	<input type="radio"/>	<input type="radio"/>	<input type="radio"/>
<b>Printed Circuit Board</b>	<input type="radio"/>	<input type="radio"/>	<input type="radio"/>	<input type="radio"/>	<input type="radio"/>	<input type="radio"/>
<b>Metal Fasteners</b>	<input type="radio"/>	<input type="radio"/>	<input type="radio"/>	<input type="radio"/>	<input type="radio"/>	<input type="radio"/>
<b>Cable Assembly</b>	<input type="radio"/>	<input type="radio"/>	<input type="radio"/>	<input type="radio"/>	<input type="radio"/>	<input type="radio"/>
<b>Fan Assembly</b>	<input type="radio"/>	<input type="radio"/>	<input type="radio"/>	<input type="radio"/>	<input type="radio"/>	<input type="radio"/>
<b>Power Supply Assemblies</b>	<input type="radio"/>	<input type="radio"/>	<input type="radio"/>	<input type="radio"/>	<input type="radio"/>	<input type="radio"/>
<b>Battery</b>	<input type="radio"/>	<input type="radio"/>	<input type="radio"/>	<input type="radio"/>	<input type="radio"/>	<input type="radio"/>

O: This toxic or hazardous substance is contained in all of the homogeneous materials for the part is below the limit requirement in SJ/T11363-2006

X: This toxic or hazardous substance is contained in at least one of the homogeneous materials for this part is above the limit requirement in SJ/T11363-2006

此附件旨在确保本产品符合中国 RoHS 标准。以下表格标示此产品中某有毒物质的含量符合中国 RoHS 标准规定的限量要求。

本产品上会附有“环境友好使用期限”的标签，此期限是估算这些物质“不会有泄漏或突变”的年限。本产品可能包含有较短的环境友好使用期限的可替换元件，像是电池或灯管，这些元件将会单独标示出来。

部件名称	有毒有害物质或元素					
	铅 (Pb)	汞 (Hg)	镉 (Cd)	六价铬 (CR(VI))	多溴联苯 (PBB)	多溴二苯 醚 (PBDE)
壳体	○	○	○	○	○	○
显示	○	○	○	○	○	○
印刷电路板	○	○	○	○	○	○
金属螺帽	○	○	○	○	○	○
电缆组装	○	○	○	○	○	○
风扇组装	○	○	○	○	○	○
电力供应组装	○	○	○	○	○	○
电池	○	○	○	○	○	○

○: 表示该有毒有害物质在该部件所有物质材料中的含量均在 SJ/T11363-2006 标准规定的限量要求以下。  
 X: 表示该有毒有害物质至少在该部件的某一均质材料中的含量超出 SJ/T11363-2006 标准规定的限量要求。