

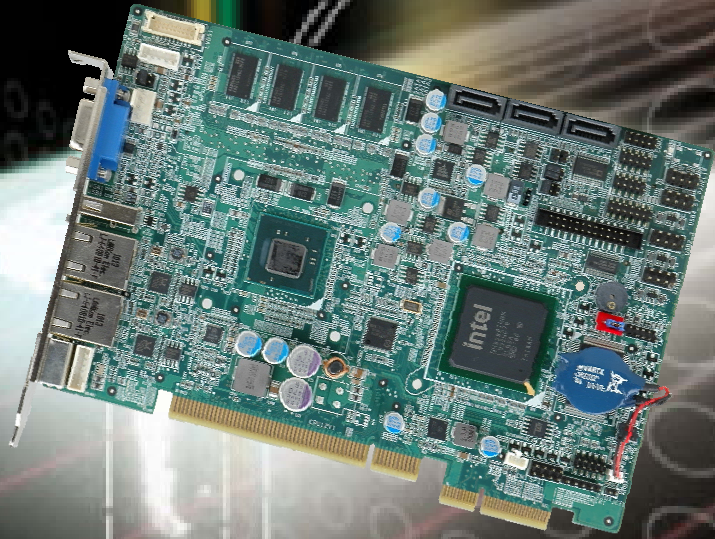

IEI Technology Corp.



**MODEL:**

# **PIC0e-PV-D4251/N4551/D5251**

**Half-size PCIe CPU Card with Intel® Atom™ D425/N455/D525 Processor, 1 GB On-board Memory, Dual Gigabit Ethernet, Seven USB, Three RS-232, One RS-232/422/485, Three SATA, CompactFlash® Type II, VGA, LVDS, RoHS Compliant**

## **User Manual**

Rev. 1.11 – 22 May, 2012



# Revision

Date	Version	Changes
22 May, 2012	1.11	Modified Table 3-3: ATX Power Supply Enable Connector Pinouts
17 August, 2011	1.10	On-board DRAM upgraded from 64MB x16 (1GB) to 128MB x8 (1GB), scalable to 256MB x8 (2GB)
14 January, 2011	1.00	Initial release

# Copyright

---

## **COPYRIGHT NOTICE**

The information in this document is subject to change without prior notice in order to improve reliability, design and function and does not represent a commitment on the part of the manufacturer.

In no event will the manufacturer be liable for direct, indirect, special, incidental, or consequential damages arising out of the use or inability to use the product or documentation, even if advised of the possibility of such damages.

This document contains proprietary information protected by copyright. All rights are reserved. No part of this manual may be reproduced by any mechanical, electronic, or other means in any form without prior written permission of the manufacturer.

## **TRADEMARKS**

All registered trademarks and product names mentioned herein are used for identification purposes only and may be trademarks and/or registered trademarks of their respective owners.

# Table of Contents

<b>1 INTRODUCTION.....</b>	<b>1</b>
1.1 INTRODUCTION.....	2
1.2 CONNECTORS .....	3
1.3 DIMENSIONS.....	4
1.4 DATA FLOW .....	5
1.5 TECHNICAL SPECIFICATIONS .....	6
<b>2 UNPACKING .....</b>	<b>9</b>
2.1 ANTI-STATIC PRECAUTIONS .....	10
2.2 UNPACKING PRECAUTIONS.....	10
2.3 UNPACKING CHECKLIST .....	11
2.3.1 <i>Package Contents</i> .....	11
2.3.2 <i>Optional Items</i> .....	12
<b>3 CONNECTORS .....</b>	<b>13</b>
3.1 PERIPHERAL INTERFACE CONNECTORS.....	14
3.1.1 <i>PIC0e-PV-D4251/N4551/D5251 Layout</i> .....	14
3.1.2 <i>Peripheral Interface Connectors</i> .....	15
3.1.3 <i>External Interface Panel Connectors</i> .....	16
3.2 INTERNAL PERIPHERAL CONNECTORS .....	16
3.2.1 <i>ATX Power Supply Enable Connector</i> .....	16
3.2.2 <i>Audio Connector (9-pin)</i> .....	17
3.2.3 <i>Backlight Inverter Connector</i> .....	18
3.2.4 <i>Battery Connector</i> .....	19
3.2.5 <i>CompactFlash® Socket</i> .....	19
3.2.6 <i>CPU Fan Connector (+12V, 4-pin)</i> .....	21
3.2.7 <i>Digital Input/Output (DIO) Connector</i> .....	22
3.2.8 <i>Front Panel Connector (8-pin)</i> .....	23
3.2.9 <i>Infrared Interface Connector</i> .....	23
3.2.10 <i>Keyboard/Mouse Connector</i> .....	24
3.2.11 <i>LVDS LCD Connector</i> .....	25

3.2.12 Parallel Port Connector .....	26
3.2.13 SATA Drive Connectors .....	27
3.2.14 Serial Port Connectors (COM 1, COM 2 and COM 4) .....	28
3.2.15 Serial Port Connector (RS-232/422/485) .....	29
3.2.16 SMBus Connector .....	30
3.2.17 SPI Flash Connector.....	31
3.2.18 USB Connectors (Internal) .....	32
3.3 EXTERNAL PERIPHERAL INTERFACE CONNECTOR PANEL .....	33
3.3.1 Keyboard/Mouse Connector .....	33
3.3.2 LAN Connectors.....	34
3.3.3 USB Connectors.....	35
3.3.4 VGA Connector.....	36
<b>4 INSTALLATION .....</b>	<b>37</b>
4.1 ANTI-STATIC PRECAUTIONS .....	38
4.2 INSTALLATION CONSIDERATIONS.....	39
4.2.1 Installation Notices .....	39
4.2.2 Installation Checklist .....	40
4.3 UNPACKING.....	41
4.4 SO-DIMM AND CF CARD INSTALLATION .....	41
4.4.1 SO-DIMM Installation.....	41
4.4.2 CF Card Installation.....	42
4.5 JUMPER SETTINGS .....	44
4.5.1 AT Power Select Jumper .....	45
4.5.2 CF Card Setup Jumper .....	46
4.5.3 CF Card Voltage Select Jumper.....	46
4.5.4 Clear CMOS Jumper.....	47
4.5.5 LVDS Voltage Select Jumper.....	48
4.5.6 PCIe Status Select Jumper .....	49
4.5.7 COM 3 Function Select Jumpers .....	50
4.5.8 COM 3 RS-422 and 485 Termination Select Jumpers .....	51
4.6 CHASSIS INSTALLATION.....	52
4.6.1 Airflow.....	52
4.6.2 Backplane Installation .....	52
4.6.3 CPU Card Installation.....	53

4.7 INTERNAL PERIPHERAL DEVICE CONNECTIONS.....	53
4.7.1 <i>Peripheral Device Cables</i> .....	53
4.7.2 <i>Audio Kit Installation</i> .....	54
4.7.3 <i>SATA Drive Connection</i> .....	55
4.7.4 <i>USB Cable (Dual Port) with Slot Bracket</i> .....	57
4.7.5 <i>Parallel Port Cable without Bracket</i> .....	58
4.7.6 <i>Dual RS-232 Cable with Slot Bracket</i> .....	60
4.8 EXTERNAL PERIPHERAL INTERFACE CONNECTION.....	61
4.8.1 <i>LAN Connection</i> .....	62
4.8.2 <i>PS/2 Y-Cable Connection</i> .....	62
4.8.3 <i>USB Connection</i> .....	63
4.8.4 <i>VGA Monitor Connection</i> .....	64
4.9 SOFTWARE INSTALLATION.....	65
<b>5 BIOS SCREENS.....</b>	<b>68</b>
5.1 INTRODUCTION.....	69
5.1.1 <i>Starting Setup</i> .....	69
5.1.2 <i>Using Setup</i> .....	69
5.1.3 <i>Getting Help</i> .....	70
5.1.4 <i>Unable to Reboot After Configuration Changes</i> .....	70
5.1.5 <i>BIOS Menu Bar</i> .....	70
5.2 MAIN.....	71
5.3 ADVANCED.....	72
5.3.1 <i>ACPI Settings</i> .....	72
5.3.2 <i>Trusted Computing</i> .....	73
5.3.3 <i>CPU Configuration</i> .....	74
5.3.4 <i>SATA Configuration</i> .....	76
5.3.5 <i>USB Configuration</i> .....	77
5.3.6 <i>Super IO Configuration</i> .....	78
5.3.6.1 <i>Serial Port n Configuration</i> .....	79
5.3.6.2 <i>IrDA Configuration</i> .....	82
5.3.6.3 <i>Parallel Port Configuration</i> .....	83
5.3.7 <i>H/W Monitor</i> .....	84
5.3.8 <i>Serial Port Console Redirection</i> .....	86
5.4 CHIPSET.....	87

5.4.1	<i>Host Bridge Configuration</i> .....	88
5.4.1.1	<i>OnChip VGA Configuration</i> .....	88
5.4.2	<i>South Bridge Configuration</i> .....	89
5.4.3	<i>Intel IGD SWSCI OpRegion</i> .....	91
5.5	BOOT .....	93
5.6	SECURITY .....	94
5.7	EXIT .....	95
<b>A BIOS OPTIONS</b> .....		<b>97</b>
<b>B ONE KEY RECOVERY</b> .....		<b>100</b>
B.1	ONE KEY RECOVERY INTRODUCTION .....	101
B.1.1	<i>System Requirement</i> .....	102
B.1.2	<i>Supported Operating System</i> .....	103
B.2	SETUP PROCEDURE FOR WINDOWS .....	104
B.2.1	<i>Hardware and BIOS Setup</i> .....	104
B.2.2	<i>Create Partitions</i> .....	105
B.2.3	<i>Install Operating System, Drivers and Applications</i> .....	108
B.2.4	<i>Build-up Recovery Partition</i> .....	109
B.2.5	<i>Create Factory Default Image</i> .....	111
B.3	SETUP PROCEDURE FOR LINUX .....	116
B.4	RECOVERY TOOL FUNCTIONS .....	119
B.4.1	<i>Factory Restore</i> .....	121
B.4.2	<i>Backup System</i> .....	122
B.4.3	<i>Restore Your Last Backup</i> .....	123
B.4.4	<i>Manual</i> .....	124
B.5	OTHER INFORMATION .....	125
B.5.1	<i>Using AHCI Mode or ALi M5283 / VIA VT6421A Controller</i> .....	125
B.5.2	<i>System Memory Requirement</i> .....	127
<b>C TERMINOLOGY</b> .....		<b>128</b>
<b>D DIGITAL I/O INTERFACE</b> .....		<b>132</b>
D.1	INTRODUCTION .....	133
D.2	DIO CONNECTOR PINOUTS .....	133
D.3	ASSEMBLY LANGUAGE SAMPLES .....	134
D.3.1	<i>Enable the DIO Input Function</i> .....	134

<i>D.3.2 Enable the DIO Output Function.....</i>	<i>134</i>
<b>E WATCHDOG TIMER.....</b>	<b>135</b>
<b>F HAZARDOUS MATERIALS DISCLOSURE.....</b>	<b>138</b>
F.1 HAZARDOUS MATERIALS DISCLOSURE TABLE FOR IPB PRODUCTS CERTIFIED AS ROHS COMPLIANT UNDER 2002/95/EC WITHOUT MERCURY .....	139



# List of Figures

Figure 1-1: PIC0e-PV-D4251/N4551/D5251 .....	2
Figure 1-2: Connectors .....	3
Figure 1-3: PIC0e-PV-D4251/N4551/D5251 Dimensions (mm).....	4
Figure 1-4: Data Flow Block Diagram.....	5
Figure 3-1: Connector and Jumper Locations [Front Side] .....	14
Figure 3-2: Connector and Jumper Locations [Solder Side] .....	15
Figure 3-3: ATX Power Supply Enable Connector Location .....	17
Figure 3-4: Audio Connector Location (9-pin).....	18
Figure 3-5: Backlight Inverter Connector Location.....	18
Figure 3-6: Battery Connector Location.....	19
Figure 3-7: CF Card Socket Location .....	20
Figure 3-8: +12V Fan Connector Location .....	21
Figure 3-9: DIO Connector Location.....	22
Figure 3-10: Front Panel Connector Pinout Locations (8-pin).....	23
Figure 3-11: Infrared Connector Pinout Locations .....	24
Figure 3-12: Keyboard/Mouse Connector Location .....	25
Figure 3-13: LVDS LCD Connector Pinout Location.....	26
Figure 3-14: Parallel Port Connector Location .....	27
Figure 3-15: SATA Drive Connector Locations .....	28
Figure 3-16: COM Connector Pinout Locations .....	29
Figure 3-17: Serial Port Connector Location .....	30
Figure 3-18: SMBus Connector Location .....	31
Figure 3-19: SPI Flash Connector .....	31
Figure 3-20: USB Connector Pinout Locations .....	32
Figure 3-21: External Peripheral Interface Connector .....	33
Figure 3-22: PS/2 Pinout and Configuration .....	33
Figure 3-23: RJ-45 Ethernet Connector.....	34
Figure 3-24: VGA Connector .....	36
Figure 4-1: SO-DIMM Installation .....	42
Figure 4-2: CF Card Installation .....	43

Figure 4-3: AT Power Select Jumper Location .....	45
Figure 4-4: CF Card Setup Jumper Location .....	46
Figure 4-5: CF Card Voltage Select Jumper Location .....	47
Figure 4-6: Clear CMOS Jumper Location .....	48
Figure 4-7: LVDS Voltage Selection Jumper Location .....	49
Figure 4-8: PCIe Status Select Jumper Location .....	50
Figure 4-9: COM 3 Function Select Jumper Locations.....	51
Figure 4-10: COM 3 RS-485 and RS422 Termination Select Jumper Locations .....	52
Figure 4-11: 7.1 Channel Audio Kit .....	55
Figure 4-12: SATA Drive Cable Connection.....	56
Figure 4-13: SATA Power Drive Connection.....	57
Figure 4-14: Dual USB Cable Connection .....	58
Figure 4-15: LPT Cable Connection.....	59
Figure 4-16: Connect the LPT Device .....	60
Figure 4-17: Dual RS-232 Cable Installation .....	61
Figure 4-18: LAN Connection .....	62
Figure 4-19: PS/2 Keyboard/Mouse Connector .....	63
Figure 4-20: USB Connector .....	64
Figure 4-21: VGA Connector .....	65
Figure 4-22: Introduction Screen .....	66
Figure 4-23: Available Drivers .....	67
Figure B-1: IEI One Key Recovery Tool Menu .....	101
Figure B-2: Launching the Recovery Tool .....	105
Figure B-3: Recovery Tool Setup Menu .....	106
Figure B-4: Command Mode.....	106
Figure B-5: Partition Creation Commands.....	107
Figure B-6: Launching the Recovery Tool .....	109
Figure B-7: System Configuration for Windows .....	109
Figure B-8: Build-up Recovery Partition .....	110
Figure B-9: Press any key to continue .....	110
Figure B-10: Press F3 to Boot into Recovery Mode.....	111
Figure B-11: Recovery Tool Menu .....	111
Figure B-12: About Symantec Ghost Window.....	112
Figure B-13: Symantec Ghost Path .....	112
Figure B-14: Select a Local Source Drive .....	113

<b>Figure B-15: Select a Source Partition from Basic Drive .....</b>	<b>113</b>
<b>Figure B-16: File Name to Copy Image to .....</b>	<b>114</b>
<b>Figure B-17: Compress Image.....</b>	<b>114</b>
<b>Figure B-18: Image Creation Confirmation .....</b>	<b>115</b>
<b>Figure B-19: Image Creation Process.....</b>	<b>115</b>
<b>Figure B-20: Image Creation Complete .....</b>	<b>115</b>
<b>Figure B-21: Press Any Key to Continue .....</b>	<b>116</b>
<b>Figure B-22: Partitions for Linux.....</b>	<b>117</b>
<b>Figure B-23: System Configuration for Linux.....</b>	<b>118</b>
<b>Figure B-24: Access menu.lst in Linux (Text Mode).....</b>	<b>118</b>
<b>Figure B-25: Recovery Tool Menu .....</b>	<b>119</b>
<b>Figure B-26: Recovery Tool Main Menu .....</b>	<b>120</b>
<b>Figure B-27: Restore Factory Default.....</b>	<b>121</b>
<b>Figure B-28: Recovery Complete Window .....</b>	<b>121</b>
<b>Figure B-29: Backup System.....</b>	<b>122</b>
<b>Figure B-30: System Backup Complete Window .....</b>	<b>122</b>
<b>Figure B-31: Restore Backup .....</b>	<b>123</b>
<b>Figure B-32: Restore System Backup Complete Window .....</b>	<b>123</b>
<b>Figure B-33: Symantec Ghost Window .....</b>	<b>124</b>

# List of Tables

---

Table 1-1: Technical Specifications.....	8
Table 3-1: Peripheral Interface Connectors.....	16
Table 3-2: Rear Panel Connectors.....	16
Table 3-3: ATX Power Supply Enable Connector Pinouts.....	17
Table 3-4: Audio Connector Pinouts (9-pin).....	18
Table 3-5: Panel Backlight Connector Pinouts.....	19
Table 3-6: Battery Connector Pinouts.....	19
Table 3-7: CF Card Socket Pinouts.....	21
Table 3-8: +12V Fan Connector Pinouts.....	22
Table 3-9: DIO Connector Pinouts.....	22
Table 3-10: Front Panel Connector Pinouts (8-pin).....	23
Table 3-11: Infrared Connector Pinouts.....	24
Table 3-12: Keyboard/Mouse Connector Pinouts.....	25
Table 3-13: TFT LCD LVDS Port Connector Pinouts.....	26
Table 3-14: Parallel Port Connector Pinouts.....	27
Table 3-15: SATA Drive Connector Pinouts.....	28
Table 3-16: COM Connector Pinouts.....	29
Table 3-17: Serial Port Connector Pinouts.....	30
Table 3-18: SMBus Connector Pinouts.....	31
Table 3-19: SPI Flash Connector.....	32
Table 3-20: USB Port Connector Pinouts.....	32
Table 3-21: Keyboard Connector Pinouts.....	34
Table 3-22: LAN Pinouts.....	34
Table 3-23: RJ-45 Ethernet Connector LEDs.....	35
Table 3-24: USB Port Pinouts.....	35
Table 3-25: VGA Connector Pinouts.....	36
Table 4-1: Jumpers.....	44
Table 4-2: AT Power Select Jumper Settings.....	45
Table 4-3: CF Card Setup Jumper Settings.....	46
Table 4-4: CF Card Voltage Select Jumper Settings.....	46

## PICOe-PV-D4251/N4551/D5251 User Manual

Table 4-5: Clear CMOS Jumper Settings.....	48
Table 4-6: LVDS Voltage Selection Jumper Settings.....	49
Table 4-7: PCIe Status Select Jumper Settings.....	49
Table 4-8: COM 3 Function Select Jumpers Settings .....	50
Table 4-9: COM 3 Function Select Jumpers Settings .....	50
Table 4-10: COM 3 RS-485 Termination Select Jumper Settings .....	51
Table 4-11: COM 3 RS-422 Termination Select Jumper Settings .....	51
Table 4-12: IEI Provided Cables .....	53
Table 5-1: BIOS Navigation Keys .....	70

# BIOS Menus

---

BIOS Menu 1: Main .....	71
BIOS Menu 2: Advanced .....	72
BIOS Menu 3: ACPI Settings .....	73
BIOS Menu 4: TPM Configuration .....	74
BIOS Menu 5: CPU Configuration .....	75
BIOS Menu 6: IDE Configuration .....	76
BIOS Menu 7: USB Configuration .....	77
BIOS Menu 8: Super IO Configuration.....	78
BIOS Menu 9: Serial Port n Configuration Menu .....	79
BIOS Menu 10: IrDA Configuration Menu.....	82
BIOS Menu 11: Parallel Port Configuration Menu .....	83
BIOS Menu 12: Hardware Health Configuration .....	85
BIOS Menu 13: Serial Port Console Redirection .....	86
BIOS Menu 14: Chipset .....	87
BIOS Menu 15: Host Bridge Chipset Configuration.....	88
BIOS Menu 16: OnChip VGA Configuration.....	88
BIOS Menu 17: South Bridge Chipset Configuration.....	89
BIOS Menu 18: South Bridge Chipset Configuration.....	91
BIOS Menu 19: Boot .....	93
BIOS Menu 20: Security .....	94
BIOS Menu 21:Exit.....	95

Chapter

1

# Introduction

---

## 1.1 Introduction

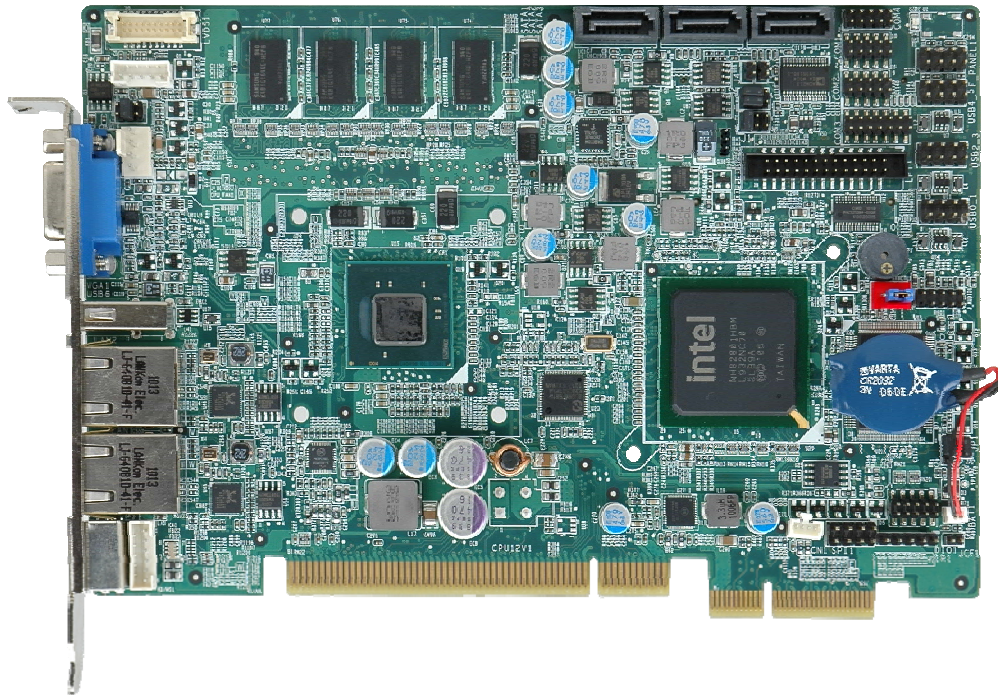

**Figure 1-1: PICOe-PV-D4251/N4551/D5251**

The PICOe-PV-D4251/N4551/D5251 half-size PCIe CPU card is an embedded 45 nm Intel® Atom™ processor D525, D425 or N455 platform. The PICOe-PV-D4251/N4551/D5251 has 1 GB 800 MHz DDR3 memory onboard and supports one 204-pin 667/800 MHz 2.0 GB (max.) DDR3 SDRAM SO-DIMM. The board includes one LVDS connector (supports an 18-bit single-channel LVDS screen), one VGA connector, and supports a dual-display configuration.

The PICOe-PV-D4251/N4551/D5251 also comes with two Gigabit Ethernet (GbE) connectors, three SATA connectors, seven USB 2.0 connectors, and one CompactFlash® Type II slot. Serial device connectivity is provided by three internal RS-232 and one internal RS-232/422/485 connectors.



## 1.2 Connectors

The connectors on the PICOe-PV-D4251/N4551/D5251 are shown in the figure below.

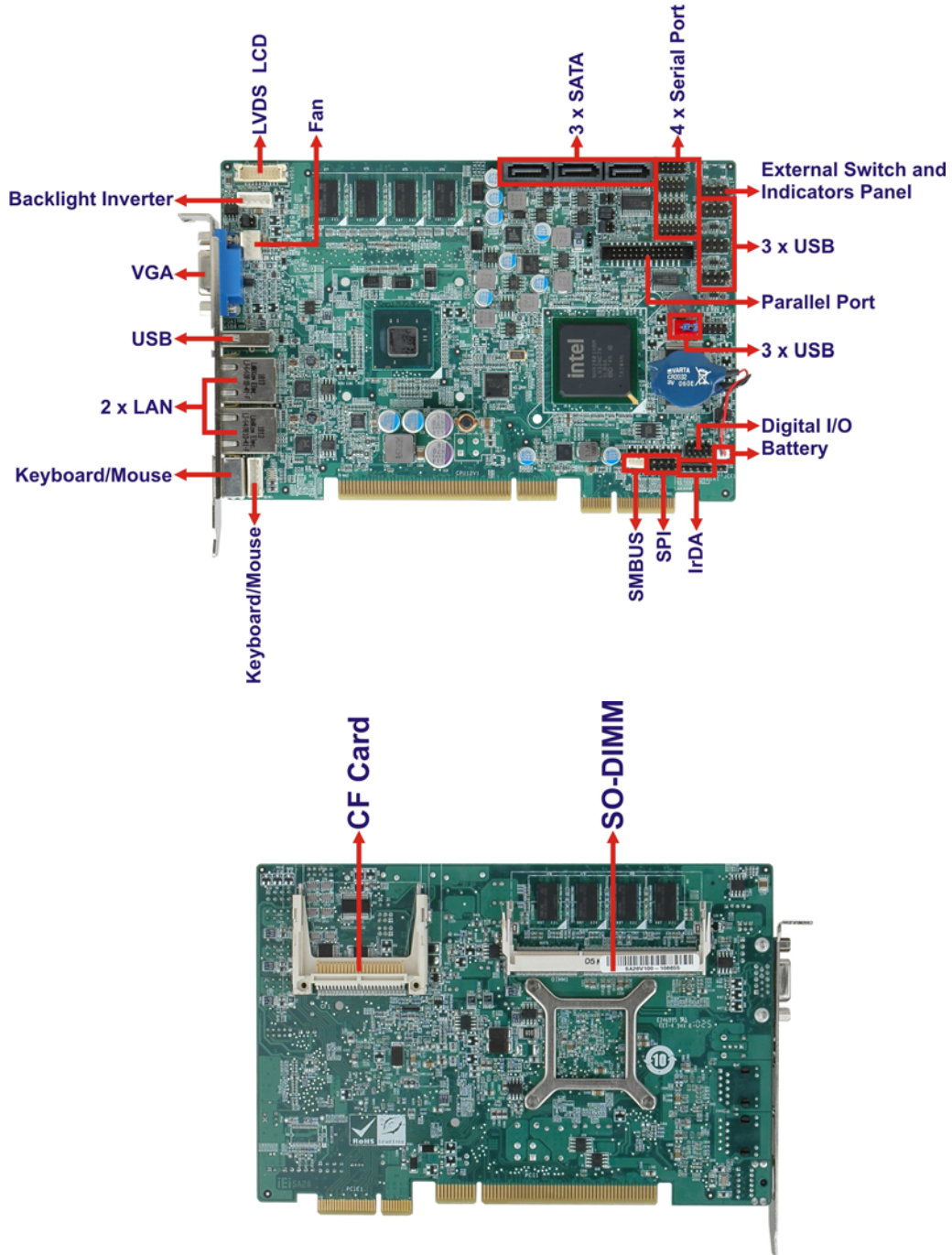

**Figure 1-2: Connectors**

### 1.3 Dimensions

The dimensions of the board are listed below:

- **Length:** 122 mm
- **Width:** 185 mm

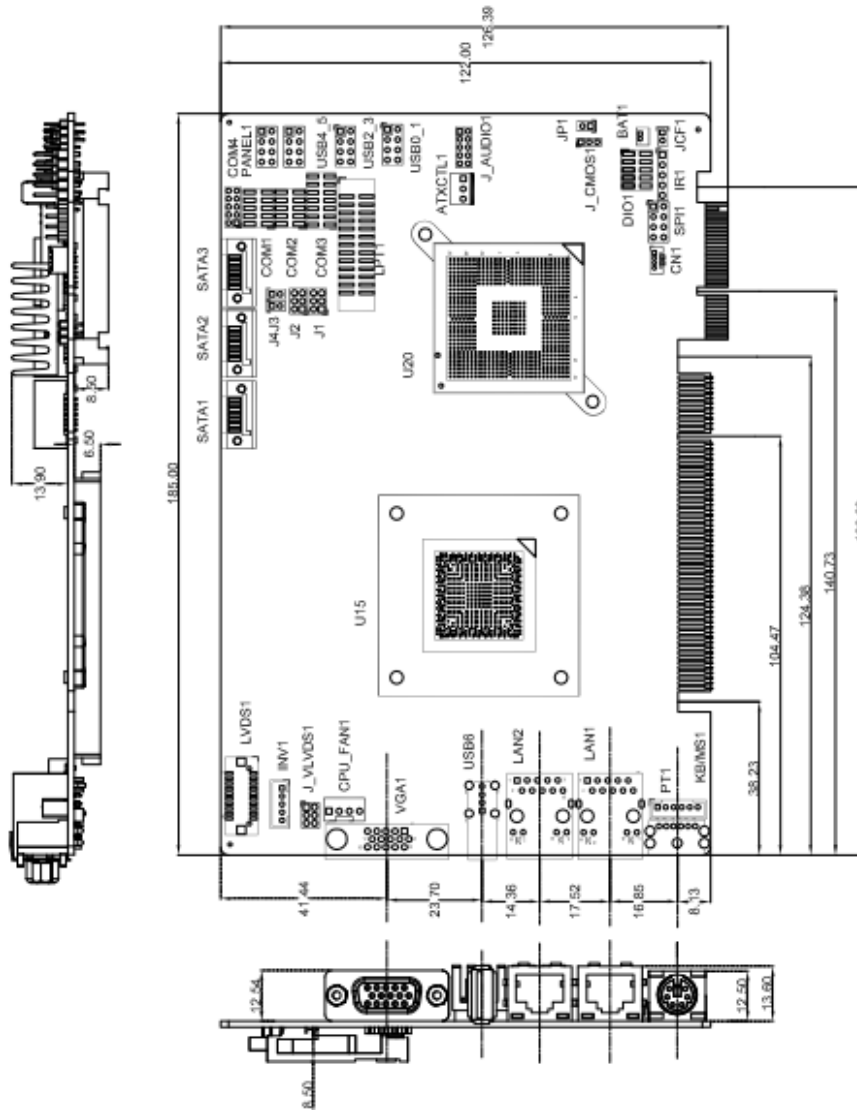

Figure 1-3: PIC0e-PV-D4251/N4551/D5251 Dimensions (mm)

## 1.4 Data Flow

Figure 1-4 shows the data flow between the two on-board chipsets and other components installed on the motherboard and described in the following sections of this chapter.

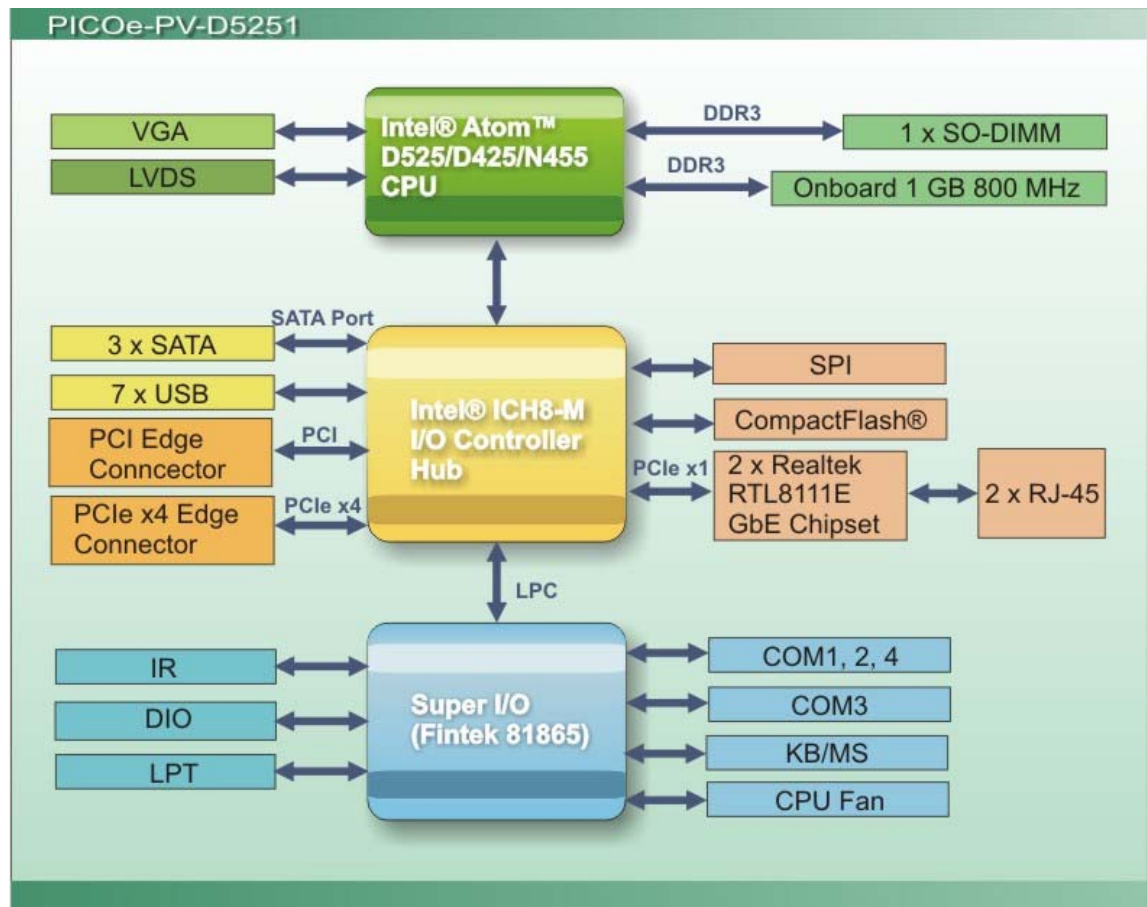

Figure 1-4: Data Flow Block Diagram

## 1.5 Technical Specifications

PIC0e-PV-D4251/N4551/D5251 technical specifications are listed in table below.

Specification	PIC0e-PV-D4251/N4551/D5251
<b>Form Factor</b>	Half-size PCIe CPU Card
<b>CPU Options</b>	Intel® Atom™ processor D525, 1.8 GHz/1 MB L2 cache Intel® Atom™ processor D425, 1.8 GHz/512 KB L2 cache Intel® Atom™ processor D455, 1.66 GHz/512 KB L2 cache
<b>System Chipset</b>	Intel® ICH8M
<b>Graphics Engine</b>	GMA3150 Gen3.5 DX9, 400MHz for D525/D425 Gen3.5 DX9, 200MHz for N455
<b>Memory</b>	On-board 1 GB DDR3 800 MHz memory One 204-pin SO-DIMM socket supports one 800 MHz DDR3 SDRAM SO-DIMM (up to 2 GB) Note: Supports 128 MB x8 (1GB) or 256 MB x8 for (2GB) SO-DIMM configuration
<b>LAN</b>	Dual Realtek RTL8111E PCIe GbE controllers, LAN1 supports ASF 2.0
<b>BIOS</b>	UEFI BIOS
<b>Super I/O</b>	Fintek F81865
<b>Watchdog Timer</b>	Software programmable supports 1~255 sec. system reset
<b>Infrared</b>	One Infrared connector via internal pin header
<b>TPM</b>	On-board Infineon SLB9635TT1.2 (option on PIC0e-PV-D4251T/N4551T/D5251T)
<b>Expansion</b>	
<b>PCI</b>	Four PCI slots via golden finger
<b>PCIe</b>	Four PCI Express x1 or One PCI Express x4 via golden finger
<b>I/O Interface Connectors</b>	

## PIC0e-PV-D4251/N4551/D5251 User Manual

Specification	PIC0e-PV-D4251/N4551/D5251
<b>Display</b>	One VGA port (supports up to 2048x1536 resolution for D525/D425 or 1400x1050 for N455) One 18-bit single-channel LVDS via internal connector (supports up to 1024x768 (XGA) and 1366x768 (WXGA) resolution)
<b>Ethernet</b>	Two RJ-45 GbE ports
<b>Audio</b>	Supports 7.1 channel HD audio via optional IEI AC-KIT883HD kit
<b>Keyboard/Mouse</b>	One PS/2 KB/MS port One KB/MS via internal header
<b>Parallel Port</b>	One Parallel (LPT) port connector
<b>Serial Ports</b>	Three RS-232 serial ports via internal box header One RS-232/422/485 serial ports via internal box header
<b>USB 2.0/1.1 ports</b>	One USB port Six USB via internal pin headers
<b>Storage</b>	
<b>CompactFlash®</b>	One CompactFlash® Type II
<b>Serial ATA</b>	Three independent Serial ATA (SATA) channels with 3.0 Gb/s data transfer rates
<b>Environmental and Power Specifications</b>	
<b>Power Supply</b>	5 V / 12 V, AT/ATX power support
<b>Power Consumption</b>	5V@3.38A, 12V@0.54A (Intel® Atom™ Dual Core D525 1.80GHz with 1GB DDR3 800MHz Memory on board) 5V@3.28A, 12V@0.43A (Intel® Atom™ Dual Core D425 1.80GHz with 1GB DDR3 800MHz Memory on board) 5V@3.13A, 12V@0.32A (Intel® Atom™ Single Core N455 1.66GHz with 1GB DDR3 800MHz Memory on board)

Specification	PIC0e-PV-D4251/N4551/D5251
<b>Operating temperature</b>	-20°C~60°C without cooler, -20°C~70°C with forced air for D525 processor -20°C~65°C without cooler, -20°C~70°C with forced air for D425 processor -20°C~70°C without cooler, -20°C~75°C with forced air for N455 processor
<b>Humidity</b>	5% ~ 95% (non-condensing)
<b>Physical Specifications</b>	
<b>Dimensions</b>	185 mm x 122 mm
<b>Weight GW/NW</b>	1000g/250g

**Table 1-1: Technical Specifications**

Chapter

2

# Unpacking

---

## 2.1 Anti-static Precautions

---



### WARNING!

Static electricity can destroy certain electronics. Make sure to follow the ESD precautions to prevent damage to the product, and injury to the user.

---

Make sure to adhere to the following guidelines:

- **Wear an anti-static wristband:** Wearing an anti-static wristband can prevent electrostatic discharge.
- **Self-grounding:** Touch a grounded conductor every few minutes to discharge any excess static buildup.
- **Use an anti-static pad:** When configuring any circuit board, place it on an anti-static mat.
- **Only handle the edges of the PCB:** Don't touch the surface of the motherboard. Hold the motherboard by the edges when handling.

## 2.2 Unpacking Precautions

When the PICOe-PV-D4251/N4551/D5251 is unpacked, please do the following:

- Follow the antistatic guidelines above.
- Make sure the packing box is facing upwards when opening.
- Make sure all the packing list items are present.



## 2.3 Unpacking Checklist











### NOTE:

If any of the components listed in the checklist below are missing, do not proceed with the installation. Contact the IEI reseller or vendor the PIC0e-PV-D4251/N4551/D5251 was purchased from or contact an IEI sales representative directly by sending an email to [sales@iei.com.tw](mailto:sales@iei.com.tw).

### 2.3.1 Package Contents





The PIC0e-PV-D4251/N4551/D5251 is shipped with the following components:

Quantity	Item and Part Number	Image
1	PIC0e-PV-D4251/N4551/D5251, or PIC0e-PV-D4251T/N4551T/D5251T	
3	SATA cable (P/N: 32000-062800-RS)	
1	KB/MS PS/2 Y-cable (P/N: 32000-133200-RS)	
1	Dual RS-232 cable (P/N: 19800-000112-RS)	
1	Dual USB cable (w bracket) (P/N: CB-USB02-RS)	
1	Mini jumper pack (P/N: 33101-000657-RS)	

1	Utility CD	
1	Quick Installation Guide	

### 2.3.2 Optional Items

Optional items are listed below:

Item and Part Number	Image
CPU fan (P/N: 19FTS00032100-000001-RS)	
SATA power cable P/N: 32102-000100-200-RS	
LPT cable (w/o bracket) (P/N: 32200-015100-RS)	
KB/MS cable (with bracket) (P/N: 19800-000075-RS)	
Audio kit_ 7.1 Channel (P/N: AC-KIT-883HD-R10)	

Chapter

3

# Connectors

---

### 3.1 Peripheral Interface Connectors

Section 3.1.1 shows peripheral interface connector locations. Section 3.2 lists all the peripheral interface connectors seen in Section 3.1.1.

#### 3.1.1 PIC0e-PV-D4251/N4551/D5251 Layout

Figure 3-1 shows the on-board peripheral connectors, rear panel peripheral connectors and on-board jumpers.

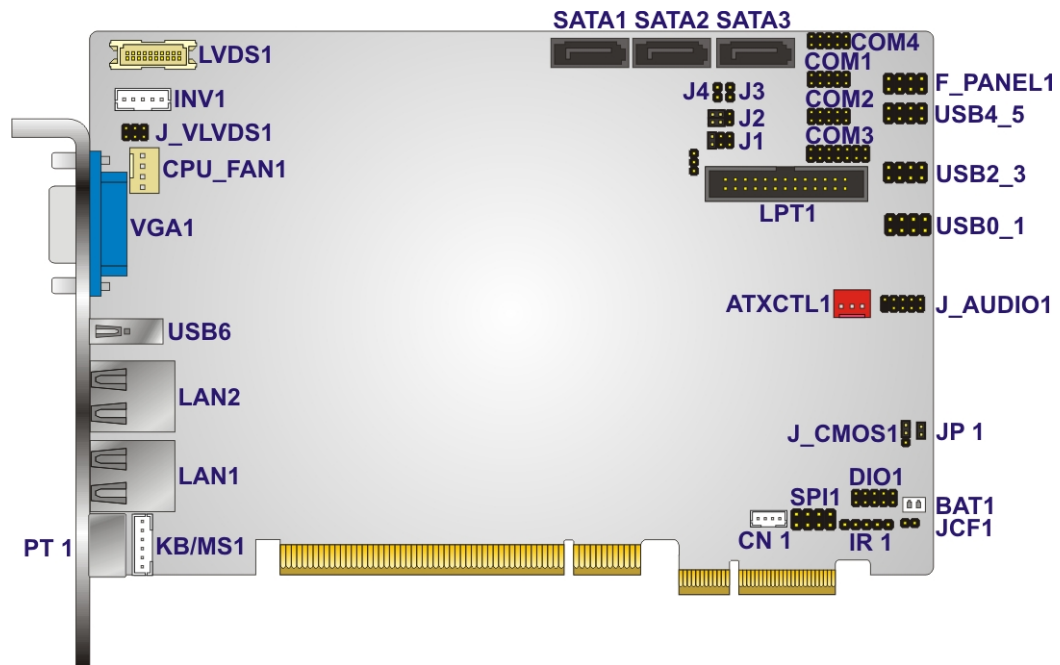

Figure 3-1: Connector and Jumper Locations [Front Side]

Figure 3-2 shows the solder side of the PIC0e-PV-D4251/N4551/D5251.

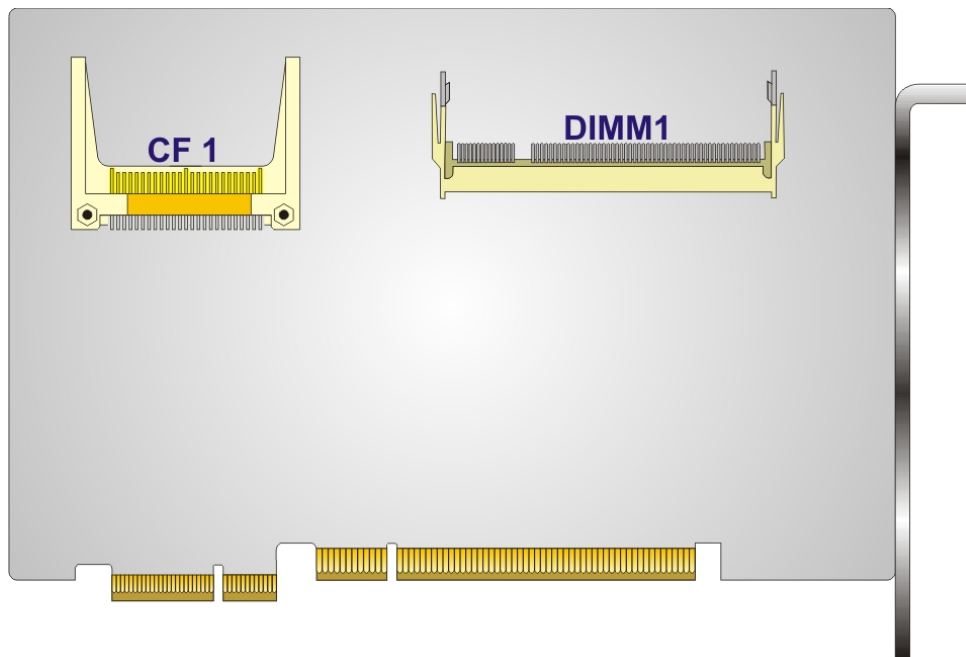

Figure 3-2: Connector and Jumper Locations [Solder Side]

### 3.1.2 Peripheral Interface Connectors

Table 3-1 shows a list of the peripheral interface connectors on the PICOe-PV-D4251/N4551/D5251. Detailed descriptions of these connectors can be found below.

Connector	Type	Label
Audio connector	9-pin header	J_AUDIO1
ATX power control connector	3-pin wafer	ATXCTL1
Backlight inverter connector	5-pin wafer	INV1
Battery connector	2-pin wafer	BAT1
CompactFlash® socket	50-pin CF socket	CF1
CPU Fan connector	4-pin wafer	CPU_FAN1
Digital input/output (DIO) connector	10-pin header	DIO1
Front panel connector	8-pin header	F_PANEL1
Infrared interface (IrDA) connector	5-pin header	IR1
Keyboard/Mouse connector	6-pin wafer	KB/MS1
LVDS LCD connector	20-pin crimp	LVDS1
Parallel port connector	26-pin box header	LPT1

Connector	Type	Label
Serial ATA (SATA) drive connectors	7-pin SATA	SATA1, SATA2, SATA3
Serial port connectors (RS-232)	10-pin header	COM1, COM2, COM4
Serial port connectors (RS-232/422-485)	14-pin header	COM3
SMBus connector	4-pin wafer	CN1
SPI flash connector	8-pin header	SPI1
USB 2.0 connectors	8-pin header	USB0_1, USB2_3, USB4_5

**Table 3-1: Peripheral Interface Connectors**

### 3.1.3 External Interface Panel Connectors

**Table 3-2** lists the rear panel connectors on the PIC0e-PV-D4251/N4551/D5251. Detailed descriptions of these connectors can be found in **Section 3.3** on **page 33**.

Connector	Type	Label
Ethernet connector	RJ-45	LAN1
Ethernet connector	RJ-45	LAN2
Keyboard/mouse	PS/2	PT1
USB port	USB port	USB6
VGA port connector	15-pin female	VGA1

**Table 3-2: Rear Panel Connectors**

## 3.2 Internal Peripheral Connectors

Internal peripheral connectors are found on the CPU card and are only accessible when the CPU card is outside of the chassis. This section has complete descriptions of all the internal, peripheral connectors on the PIC0e-PV-D4251/N4551/D5251.

### 3.2.1 ATX Power Supply Enable Connector

- CN Label:** ATXCTL1
- CN Type:** 3-pin wafer (1x3)
- CN Location:** See Figure 3-3

**CN Pinouts:** See Table 3-3

The ATX power supply enable connector enables the PIC0e-PV-D4251/N4551/D5251 to be connected to an ATX power supply. In default mode, the PIC0e-PV-D4251/N4551/D5251 can only use an AT power supply. To enable an ATX power supply the AT Power Select jumper must also be configured. Please refer to **Section 4.5.1** for more details.

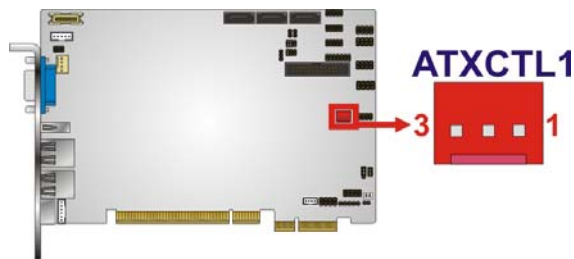

**Figure 3-3: ATX Power Supply Enable Connector Location**

Pin	Description
1	+5 Standby
2	PS-ON
3	GND

**Table 3-3: ATX Power Supply Enable Connector Pinouts**

### 3.2.2 Audio Connector (9-pin)

**CN Label:** J\_AUDIO1

**CN Type:** 9-pin header (2x5)

**CN Location:** See Figure 3-4

**CN Pinouts:** See Table 3-4

The 9-pin audio connector is connected to external audio devices including speakers and microphones for the input and output of audio signals to and from the system.

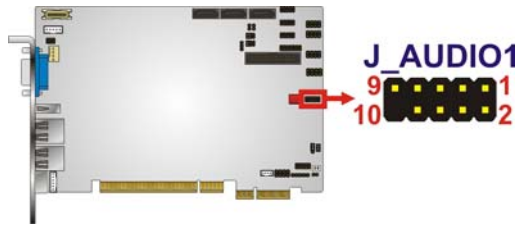
**Figure 3-4: Audio Connector Location (9-pin)**

Pin	Description	Pin	Description
1	HDA_SYNC	2	HDA_BITCLK
3	HDA_SDOUT	4	SB_SPKR
5	HDA_SDINO	6	HDA_RST#
7	VCC	8	GND
9	+12V	10	GND

**Table 3-4: Audio Connector Pinouts (9-pin)**

### 3.2.3 Backlight Inverter Connector

- CN Label:** INV1
- CN Type:** 5-pin wafer (1x5)
- CN Location:** See Figure 3-5
- CN Pinouts:** See Table 3-5

The backlight inverter connector provides the backlight on the LCD display connected to the PICOe-PV-D4251/N4551/D5251 with +12V of power.

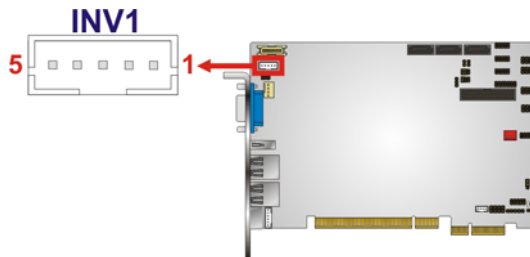
**Figure 3-5: Backlight Inverter Connector Location**



Pin	Description
1	LCD Backlight Control
2	GROUND
3	+12V
4	GROUND
5	BACKLIGHT Enable

**Table 3-5: Panel Backlight Connector Pinouts**

### 3.2.4 Battery Connector

- CN Label:** BAT1
- CN Type:** 2-pin wafer (1x2)
- CN Location:** See **Figure 3-6**
- CN Pinouts:** See **Table 3-6**

This is connected to the system battery. The battery provides power to the system clock to retain the time when power is turned off.

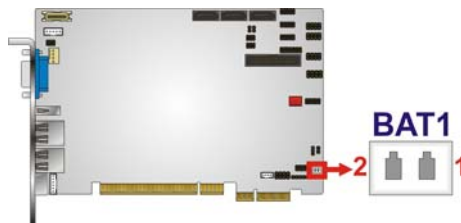

**Figure 3-6: Battery Connector Location**

Pin	Description
1	Battery+
2	Ground

**Table 3-6: Battery Connector Pinouts**

### 3.2.5 CompactFlash® Socket

- CN Label:** CF1 (solder side)
- CN Type:** 50-pin header (2x25)

**CN Location:** See Figure 3-7

**CN Pinouts:** See Table 3-7

A CF Type I or Type II memory card is inserted to the CF socket on the solder side of the PIC0e-PV-D4251/N4551/D5251.

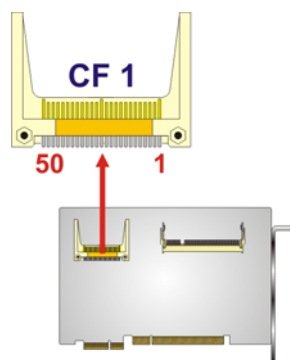

**Figure 3-7: CF Card Socket Location**

Pin	Description	Pin	Description
1	GROUND	26	VCC-IN CHECK1
2	DATA 3	27	DATA 11
3	DATA 4	28	DATA 12
4	DATA 5	29	DATA 13
5	DATA 6	30	DATA 14
6	DATA 7	31	DATA 15
7	HDC_CS0#	32	HDC_CS1
8	GROUND	33	N/C
9	GROUND	34	IOR#
10	GROUND	35	IOW#
11	GROUND	36	VCC_COM
12	GROUND	37	IRQ15
13	VCC_COM	38	VCC_COM
14	GROUND	39	CSEL
15	GROUND	40	N/C
16	GROUND	41	HDD_RESET
17	GROUND	42	IORDY

Pin	Description	Pin	Description
18	SA2	43	SDREQ
19	SA1	44	SDACK#
20	SA0	45	HDD_ACTIVE#
21	DATA 0	46	66DET
22	DATA 1	47	DATA 8
23	DATA 2	48	DATA 9
24	N/C	49	DATA 10
25	VCC-IN CHECK2	50	GROUND

Table 3-7: CF Card Socket Pinouts

### 3.2.6 CPU Fan Connector (+12V, 4-pin)

- CN Label:** CPU\_FAN1
- CN Type:** 4-pin wafer (1x4)
- CN Location:** See Figure 3-8
- CN Pinouts:** See Table 3-8

The cooling fan connector provides a 12V, 500mA current to the cooling fan. The connector has a "rotation" pin to get rotation signals from fans and notify the system so the system BIOS can recognize the fan speed. Please note that only specified fans can issue the rotation signals.

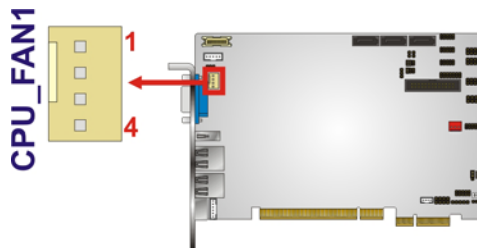

Figure 3-8: +12V Fan Connector Location

Pin	Description
1	GND
2	+12V

Pin	Description
3	FANIO1
4	FANPWM1

**Table 3-8: +12V Fan Connector Pinouts**

### 3.2.7 Digital Input/Output (DIO) Connector

- CN Label:** DIO1
- CN Type:** 10-pin header (2x5)
- CN Location:** See Figure 3-9
- CN Pinouts:** See Table 3-9

The digital input/output connector is managed through a Super I/O chip. The DIO connector pins are user programmable.

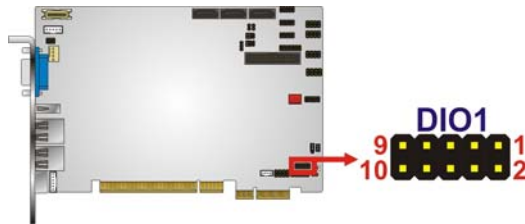
**Figure 3-9: DIO Connector Location**

Pin	Description	Pin	Description
1	GND	2	+5V
3	Output 3	4	Output 2
5	Output 1	6	Output 0
7	Input 3	8	Input 2
9	Input 1	10	Input 0

**Table 3-9: DIO Connector Pinouts**

### 3.2.8 Front Panel Connector (8-pin)

- CN Label:** F\_PANEL1
- CN Type:** 8-pin header (2x4)
- CN Location:** See Figure 3-10
- CN Pinouts:** See Table 3-10

The front panel connector connects to external switches and indicators to monitor and controls the CPU card. These indicators and switches include:

- Power button
- Reset
- Power LED
- HDD LED

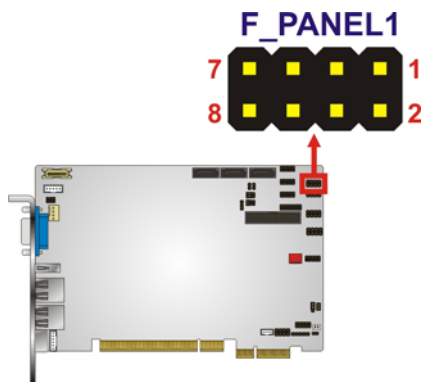

Figure 3-10: Front Panel Connector Pinout Locations (8-pin)

FUNCTION	PIN	DESCRIPTION	FUNCTION	PIN	DESCRIPTION
Power Button	1	PWR_BTN+	Power LED	2	PWR_LED+
	3	PWR_BTN-		4	PWR_LED-
HDD LED	5	HDD_LED+	Reset	6	RESET+
	7	HDD_LED-		8	RESET-

Table 3-10: Front Panel Connector Pinouts (8-pin)

### 3.2.9 Infrared Interface Connector

- CN Label:** IR1
- CN Type:** 5-pin header (1x5)

**CN Location:** See Figure 3-11

**CN Pinouts:** See Table 3-11

The infrared interface connector supports both Serial Infrared (SIR) and Amplitude Shift Key Infrared (ASKIR) interfaces.

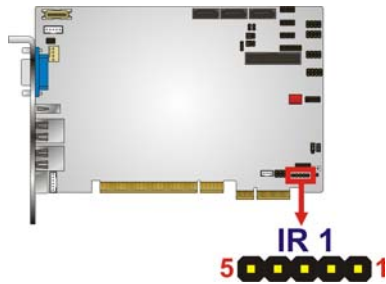

**Figure 3-11: Infrared Connector Pinout Locations**

Pin	Description
1	VCC
2	NC
3	IR-RX
4	GND
5	IR-TX

**Table 3-11: Infrared Connector Pinouts**

### 3.2.10 Keyboard/Mouse Connector

**CN Label:** KB/MS1

**CN Type:** 6-pin wafer (1x6)

**CN Location:** See Figure 3-12

**CN Pinouts:** See Table 3-12

The keyboard and mouse connector can be connected to a standard PS/2 cable or PS/2 Y-cable to add keyboard and mouse functionality to the system.

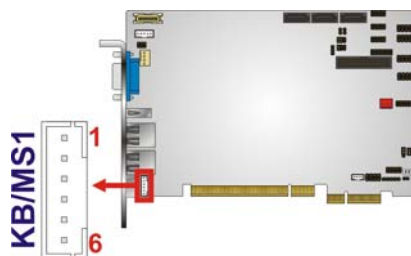

Figure 3-12: Keyboard/Mouse Connector Location

Pin	Description
1	VCC5_KBMS
2	MS DATA
3	MS CLK
4	KB DATA
5	KB CLK
6	GROUND

Table 3-12: Keyboard/Mouse Connector Pinouts

### 3.2.11 LVDS LCD Connector

**CN Label:** LVDS1

**CN Type:** 20-pin crimp (2x10)

**CN Location:** See Figure 3-13

**CN Pinouts:** See 790HTable 3-13

The 20-pin LVDS LCD connector can be connected to a single channel, 18-bit LVDS panel.

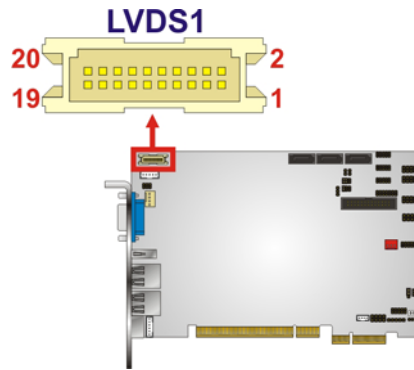
**Figure 3-13: LVDS LCD Connector Pinout Location**

Pin	Description	Pin	Description
1	GND	2	GND
3	LVDSA_DATA0	4	LVDSA_DATA#0
5	LVDSA_DATA1	6	LVDSA_DATA#1
7	LVDSA_DATA2	8	LVDSA_DATA#2
9	LVDSA_CLK	10	LVDSA_CLK#
11	NC	12	NC
13	GND	14	GND
15	L_DDC_DATA	16	L_DDC_CLK
17	VCC_LCD	18	VCC_LCD
19	VCC_LCD	20	VCC_LCD

**Table 3-13: TFT LCD LVDS Port Connector Pinouts**

### 3.2.12 Parallel Port Connector

- CN Label:** LPT1
- CN Type:** 26-pin box header (2x13)
- CN Location:** See Figure 3-14
- CN Pinouts:** See Table 3-14

The 26-pin parallel port connector connects to a parallel port connector interface or some other parallel port device such as a printer.



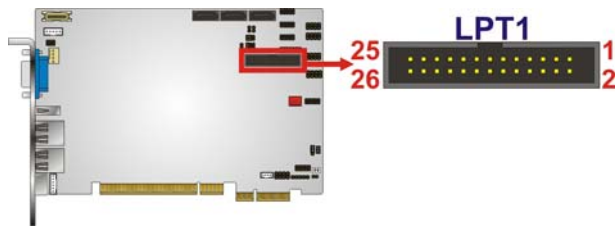

Figure 3-14: Parallel Port Connector Location

Pin	Description	Pin	Description
1	STB	2	AFD
3	PTD0	4	ERROR#
5	PTD1	6	INITIALIZE
7	PTD 2	8	SLIN
9	PTD3	10	GROUND
11	PTD 4	12	GROUND
13	PTD 5	14	GROUND
15	PTD 6	16	GROUND
17	PTD7	18	GROUND
19	ACK	20	GROUND
21	BUSY	22	GROUND
23	PE	24	GROUND
25	SLCT	26	NC

Table 3-14: Parallel Port Connector Pinouts

### 3.2.13 SATA Drive Connectors

- CN Label:** SATA1, SATA2, SATA3
- CN Type:** 7-pin SATA drive connectors
- CN Location:** See Figure 3-15
- CN Pinouts:** See Table 3-15

The SATA connectors connect to SATA hard drives or optical drives with data transfer speeds as high as 3Gb/s.

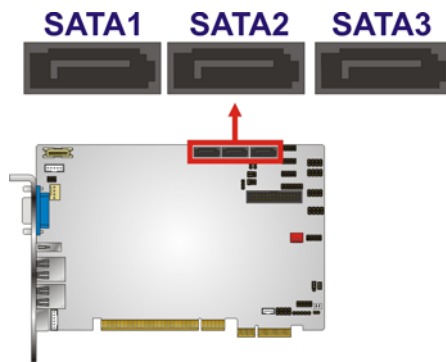
**Figure 3-15: SATA Drive Connector Locations**

Pin	Description
1	GND
2	TX+
3	TX-
4	GND
5	RX-
6	RX+
7	GND

**Table 3-15: SATA Drive Connector Pinouts**

### 3.2.14 Serial Port Connectors (COM 1, COM 2 and COM 4)

**CN Label:** COM1, COM2 and COM4

**CN Type:** 10-pin header (2x5)

**CN Location:** See Figure 3-16

**CN Pinouts:** See Table 3-16

The 10-pin serial port connectors provide three RS-232 serial communications channels. The COM serial port connectors can be connected to external RS-232 serial port devices.

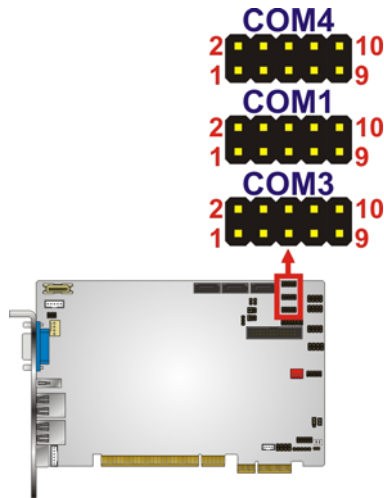

Figure 3-16: COM Connector Pinout Locations

Pin	Description	Pin	Description
1	DCD#	2	DSR#
3	RXD#	4	RTS#
5	TXD#	6	CTS#
7	DTR#	8	RI#
9	GND	10	N/A

Table 3-16: COM Connector Pinouts

### 3.2.15 Serial Port Connector (RS-232/422/485)

- CN Label:** COM3
- CN Type:** 14-pin header (2x7)
- CN Location:** See Figure 3-17
- CN Pinouts:** See Table 3-17

Used for RS-232/422/485 communications.

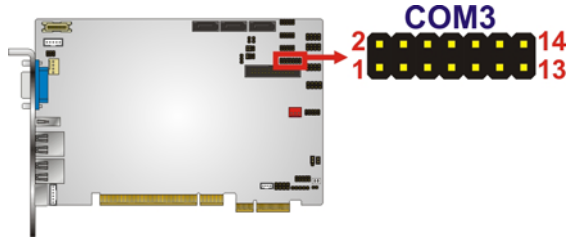
**Figure 3-17: Serial Port Connector Location**

Pin	Description	Pin	Description
1	DCD	2	DSR2
3	RXD	4	RTS2
5	TXD	6	CTS2
7	DTR	8	RI2
9	GND	10	N/A
11	RS422 TX2/485+	12	RS422 TX2/485-
13	RS422 RX2+	14	RS422 RX2-

**Table 3-17: Serial Port Connector Pinouts**

### 3.2.16 SMBus Connector

- CN Label:** CN1
- CN Type:** 4-pin wafer (1x4)
- CN Location:** See Figure 3-18
- CN Pinouts:** See Table 3-18

The SMBus Connector provides a connection to a SMBus (System Management Bus) device.

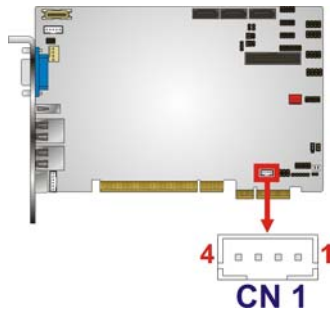

Figure 3-18: SMBus Connector Location

Pin	Description
1	GND
2	SMBDATA
3	SMBCLK
4	VCC5S

Table 3-18: SMBus Connector Pinouts

### 3.2.17 SPI Flash Connector

- CN Label:** SPI1
- CN Type:** 8-pin header (2x4)
- CN Location:** See Figure 3-19
- CN Pinouts:** See Table 3-19

The 8-pin SPI Flash connector is used to flash the BIOS.

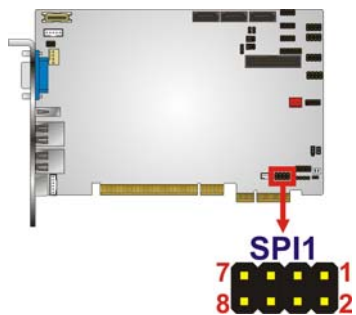

Figure 3-19: SPI Flash Connector

Pin	Description	Pin	Description
1	SPI_VCC	2	GND
3	SPI_CS	4	SPI_CLK
5	SPI_SO	6	SPI_SI
7	NC	8	NC

**Table 3-19: SPI Flash Connector**

### 3.2.18 USB Connectors (Internal)

**CN Label:** USB0\_1, USB2\_3 and USB4\_5

**CN Type:** 8-pin header (2x4)

**CN Location:** See Figure 3-20

**CN Pinouts:** See Table 3-20

The 2x4 USB pin connectors each provide connectivity to two USB 1.1 or two USB 2.0 ports. Each USB connector can support two USB devices. Additional external USB ports are found on the rear panel. The USB ports are used for I/O bus expansion.

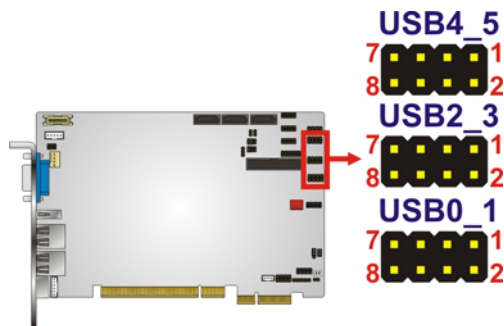
**Figure 3-20: USB Connector Pinout Locations**

Pin	Description	Pin	Description
1	VCC	2	GND
3	DATA-	4	DATA+
5	DATA+	6	DATA-
7	GND	8	VCC

**Table 3-20: USB Port Connector Pinouts**

### 3.3 External Peripheral Interface Connector Panel

Figure 3-21 shows the PICOe-PV-D4251/N4551/D5251 external peripheral interface connector (EPIC) panel. The PICOe-PV-D4251/N4551/D5251 EPIC panel consists of the following:

- 2 x RJ-45 LAN connectors
- 1 x PS/2 connector
- 1 x USB connector
- 1 x VGA connector

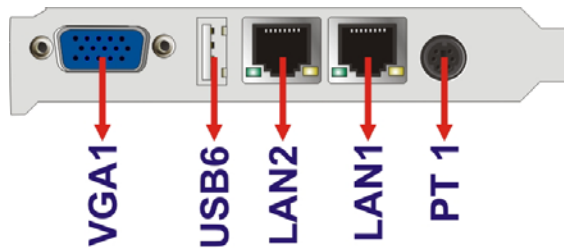

Figure 3-21: External Peripheral Interface Connector

#### 3.3.1 Keyboard/Mouse Connector

- CN Label:** PT1
- CN Type:** PS/2
- CN Location:** See Figure 3-21
- CN Pinouts:** See Figure 3-22, Table 3-21

The PICOe-PV-D4251/N4551/D5251 keyboard and mouse connector is a standard PS/2 connector.

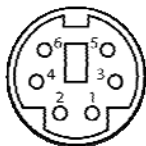

Figure 3-22: PS/2 Pinout and Configuration

Pin	Description
1	KB DATA
2	MS DATA
3	GND
4	VCC
5	KB CLOCK
6	MS CLOCK

**Table 3-21: Keyboard Connector Pinouts**

### 3.3.2 LAN Connectors

**CN Label:** LAN1 and LAN2

**CN Type:** RJ-45

**CN Location:** See Figure 3-21

**CN Pinouts:** See Table 3-22

The PIC0e-PV-D4251/N4551/D5251 is equipped with two built-in RJ-45 Ethernet controllers. The controllers can connect to the LAN through two RJ-45 LAN connectors. There are two LEDs on the connector indicating the status of LAN. The pin assignments are listed in the following table:

Pin	Description	Pin	Description
1	MDIA3-	5	MDIA1+
2	MDIA3+	6	MDIA2+
3	MDIA2-	7	MDIA0-
4	MDIA1-	8	MDIA0+

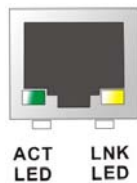
**Table 3-22: LAN Pinouts**

**Figure 3-23: RJ-45 Ethernet Connector**



The RJ-45 Ethernet connector has two status LEDs, one yellow (activity/link) and one green/orange (speed). The yellow LED indicates activity/link on the port and the green/orange LED indicates the connection speed. See **Table 3-23**.

ACT/LINK LED		SPEED LED	
STATUS	DESCRIPTION	STATUS	DESCRIPTION
OFF	No Link	OFF	10 Mbps connection
YELLOW	Link	GREEN	100 Mbps connection
BLINKING	Data activity	ORANGE	1000 Mbps connection

**Table 3-23: RJ-45 Ethernet Connector LEDs**

### 3.3.3 USB Connectors

- CN Label:** USB6
- CN Type:** USB port
- CN Location:** See Figure 3-21
- CN Pinouts:** See Table 3-24

The PIC0e-PV-D4251/N4551/D5251 has two external USB 2.0 ports. The ports connect to both USB 2.0 and USB 1.1 devices.

Pin	Description
1	VCC
2	DATA-
3	DATA+
4	GND
5	GND
6	GND
7	GND
8	GND

**Table 3-24: USB Port Pinouts**

### 3.3.4 VGA Connector

- CN Label:** VGA1
- CN Type:** 15-pin Female
- CN Location:** See Figure 3-21
- CN Pinouts:** See Figure 3-24 and Table 3-25

The PICOe-PV-D4251/N4551/D5251 has a single 15-pin female connector for connectivity to standard display devices.

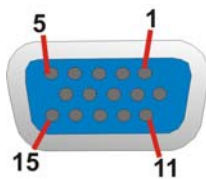

**Figure 3-24: VGA Connector**

Pin	Description	Pin	Description
1	RED	2	GREEN
3	BLUE	4	NC
5	GND	6	CRT_PLUG-
7	GND	8	GND
9	VCC	10	GND
11	NC	12	DDC DAT
13	HSYNC	14	VSYNC
15	DDCCLK		

**Table 3-25: VGA Connector Pinouts**

Chapter

4

# Installation

---

## 4.1 Anti-static Precautions

---



### WARNING:

Failure to take ESD precautions during the installation of the PICOe-PV-D4251/N4551/D5251 may result in permanent damage to the PICOe-PV-D4251/N4551/D5251 and severe injury to the user.

---

Electrostatic discharge (ESD) can cause serious damage to electronic components, including the PICOe-PV-D4251/N4551/D5251. Dry climates are especially susceptible to ESD. It is therefore critical that whenever the PICOe-PV-D4251/N4551/D5251 or any other electrical component is handled, the following anti-static precautions are strictly adhered to.

- **Wear an anti-static wristband:** Wearing a simple anti-static wristband can help to prevent ESD from damaging the board.
- **Self-grounding:** Before handling the board, touch any grounded conducting material. During the time the board is handled, frequently touch any conducting materials that are connected to the ground.
- **Use an anti-static pad:** When configuring the PICOe-PV-D4251/N4551/D5251, place it on an anti-static pad. This reduces the possibility of ESD damaging the PICOe-PV-D4251/N4551/D5251.
- **Only handle the edges of the PCB:** When handling the PCB, hold the PCB by the edges.

## 4.2 Installation Considerations

---



### NOTE:

The following installation notices and installation considerations should be read and understood before the PICOe-PV-D4251/N4551/D5251 is installed. All installation notices pertaining to the installation of the PICOe-PV-D4251/N4551/D5251 should be strictly adhered to. Failing to adhere to these precautions may lead to severe damage of the PICOe-PV-D4251/N4551/D5251 and injury to the person installing the CPU card.

---

### 4.2.1 Installation Notices

---



### WARNING:

The installation instructions described in this manual should be carefully followed in order to prevent damage to the PICOe-PV-D4251/N4551/D5251, PICOe-PV-D4251/N4551/D5251 components and injury to the user.

---

Before and during the installation please **DO** the following:

- Read the user manual:
  - The user manual provides a complete description of the PICOe-PV-D4251/N4551/D5251 installation instructions and configuration options.
- Wear an electrostatic discharge cuff (ESD):
  - Electronic components are easily damaged by ESD. Wearing an ESD cuff removes ESD from the body and helps prevent ESD damage.
- Place the PICOe-PV-D4251/N4551/D5251 on an antistatic pad:
  - When installing or configuring the CPU card, place it on an antistatic pad. This helps to prevent potential ESD damage.

- Turn all power to the PICOe-PV-D4251/N4551/D5251 off:
  - When working with the PICOe-PV-D4251/N4551/D5251, make sure that it is disconnected from all power supplies and that no electricity is being fed into the system.

Before and during the installation of the PICOe-PV-D4251/N4551/D5251 **DO NOT:**

- Remove any of the stickers on the PCB board. These stickers are required for warranty validation.
- Use the product before verifying all the cables and power connectors are properly connected.
- Allow screws to come in contact with the PCB circuit, connector pins, or its components.

#### 4.2.2 Installation Checklist

The following checklist is provided to ensure the PICOe-PV-D4251/N4551/D5251 is properly installed.

- All the items in the packing list are present
- A compatible memory module is properly inserted into the slot
- The CF Type I or CF Type II card is properly installed into the CF socket
- The jumpers have been properly configured
- The PICOe-PV-D4251/N4551/D5251 is inserted into a chassis with adequate ventilation
- The correct power supply is being used
- The following devices are properly connected
  - Primary and secondary IDE device
  - SATA drives
  - Power supply
  - USB cable
  - Serial port cable
- The following external peripheral devices are properly connected to the chassis:
  - VGA screen
  - Keyboard

- Mouse
- RS-232 serial communications device
- USB devices

### 4.3 Unpacking

When the PIC0e-PV-D4251/N4551/D5251 is unpacked, please check all the unpacking list items listed in Chapter 3 are indeed present. If any of the unpacking list items are not available please contact the PIC0e-PV-D4251/N4551/D5251 vendor reseller/vendor where the PIC0e-PV-D4251/N4551/D5251 was purchased or contact an IEI sales representative.

### 4.4 SO-DIMM and CF Card Installation

#### 4.4.1 SO-DIMM Installation



#### **WARNING:**

Using incorrectly specified SO-DIMM may cause permanently damage the PIC0e-PV-D4251/N4551/D5251. Please make sure the purchased SO-DIMM complies with the memory specifications of the PIC0e-PV-D4251/N4551/D5251. SO-DIMM specifications compliant with the PIC0e-PV-D4251/N4551/D5251 are listed in the specification table of Chapter 1.

It is required that when adding additional memory that the SO-DIMM match the DRAM organization of the onboard memory which is 128 MB x8 (or 256 MB x8 for maximum 2GB). The system will not boot if a SO-DIMM module that does not match this DRAM organization is installed.

To install a SO-DIMM into a SO-DIMM socket, please follow the steps below and refer to **Figure 4-1**.

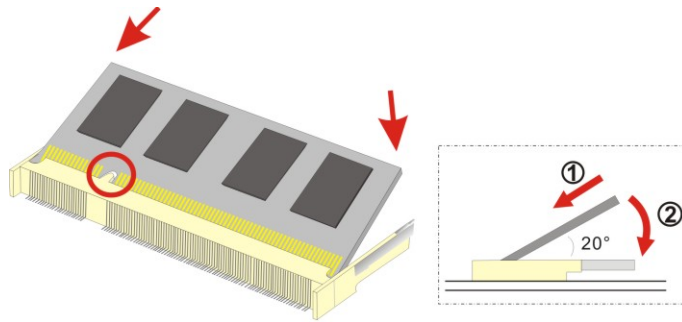

Figure 4-1: SO-DIMM Installation

- Step 1:** **Locate the SO-DIMM socket.** Place the PICOe-PV-D4251/N4551/D5251 on an anti-static pad with the solder side facing up.
- Step 2:** **Align the SO-DIMM with the socket.** The SO-DIMM must be oriented in such a way that the notch in the middle of the SO-DIMM must be aligned with the plastic bridge in the socket.
- Step 3:** **Insert the SO-DIMM.** Push the SO-DIMM chip into the socket at an angle. (See **Figure 4-1**)
- Step 4:** **Open the SO-DIMM socket arms.** Gently pull the arms of the SO-DIMM socket out and push the rear of the SO-DIMM down. (See **Figure 4-1**)
- Step 5:** **Secure the SO-DIMM.** Release the arms on the SO-DIMM socket. They clip into place and secure the SO-DIMM in the socket.

#### 4.4.2 CF Card Installation



#### NOTE:

The PICOe-PV-D4251/N4551/D5251 can support both CF Type I cards and CF Type II cards. For the complete specifications of the supported CF cards please refer to Chapter 2.

To install a CF card (Type I or Type II) onto the PICOe-PV-D4251/N4551/D5251, please follow the steps below:



## PIC0e-PV-D4251/N4551/D5251 User Manual

- Step 1:** **Locate the CF card socket.** Place the PIC0e-PV-D4251/N4551/D5251 on an anti-static pad with the solder side facing up. Locate the CF card.
- Step 2:** **Align the CF card.** Make sure the CF card is properly aligned with the CF socket.
- Step 3:** **Insert the CF card.** Gently insert the CF card into the socket making sure the socket pins are properly inserted into the socket. See **Figure 4-2**.

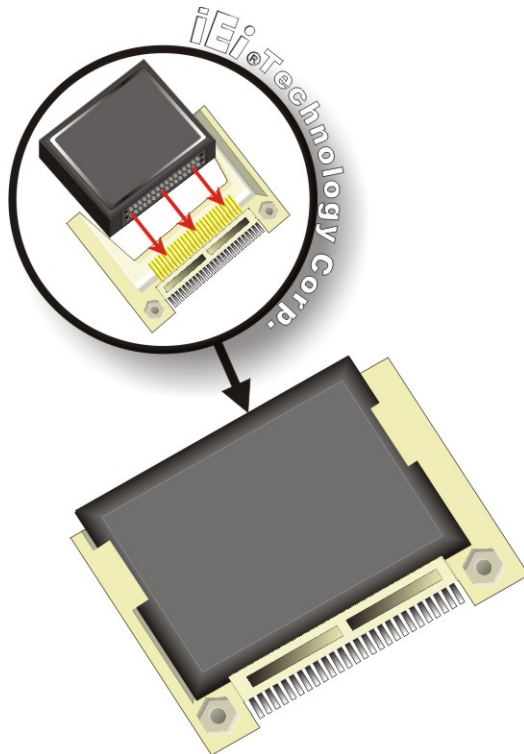

Figure 4-2: CF Card Installation

## 4.5 Jumper Settings



### NOTE:

A jumper is a metal bridge used to close an electrical circuit. It consists of two or three metal pins and a small metal clip (often protected by a plastic cover) that slides over the pins to connect them. To CLOSE/SHORT a jumper means connecting the pins of the jumper with the plastic clip and to OPEN a jumper means removing the plastic clip from a jumper.

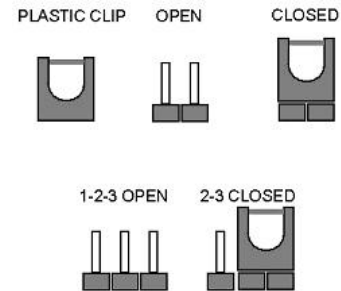

Before the PIC0e-PV-D4251/N4551/D5251 is installed in the system, the jumpers must be set in accordance with the desired configuration. The jumpers on the PIC0e-PV-D4251/N4551/D5251 are listed in **Table 4-1**.

Description	Label	Type
AT Power Mode Setting	ATXCTL1	2-pin header
CF Card Setting	JCF1	2-pin header
CF Card Voltage Select	J_VCF1	3-pin header
Clear CMOS	J_CMOS1	3-pin header
LVDS Voltage Select	J_VLVD1	3-pin header
PCIe Status Select	JP1	2-pin header
RS-232/422/485 Select	J1	6-pin header
RS-422/485 Select	J2	6-pin header
RS-422 Termination Select	J4	2-pin header
RS-485 Termination Select	J3	2-pin header

**Table 4-1: Jumpers**

### 4.5.1 AT Power Select Jumper



**NOTE:**

The AT Power Select Jumper is the same as the ATX Enable connector.

<b>Jumper Label:</b>	<b>ATXCTI1</b>
<b>Jumper Type:</b>	3-pin wafer
<b>Jumper Settings:</b>	See Table 4-2
<b>Jumper Location:</b>	See Figure 4-3

The AT Power Select jumper specifies the systems power mode as AT or ATX. Use a jumper cap to short pin 2 and 3 on the ATXCTL1 connector to enable the AT Power mode. In the ATX mode use the PS\_ON- and 5VSB cable to connect to the ATX control connector on the backplane. AT Power Select jumper settings are shown in **Table 4-2**.

AT Power Select	Description	
Short 2 – 3	Use AT power	Default
Open	Use ATX power	

**Table 4-2: AT Power Select Jumper Settings**

The location of the AT Power Select jumper is shown in **Figure 4-3** below.

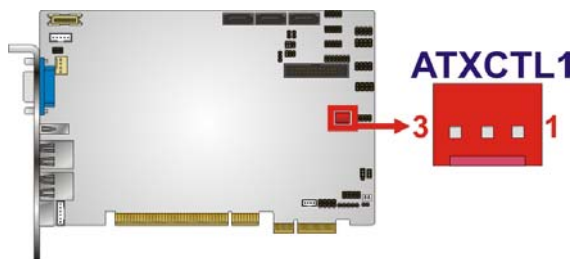

**Figure 4-3: AT Power Select Jumper Location**

### 4.5.2 CF Card Setup Jumper

- Jumper Label:** JCF1
- Jumper Type:** 2-pin header
- Jumper Settings:** See Table 4-3
- Jumper Location:** See Figure 4-4

The CF Card Setup jumper sets the CF Type I card or CF Type II cards as either the slave device or the master device. CF Card Setup jumper settings are shown in **Table 4-3**.

CF Card Setup	Description	
Open	Slave	Default
Closed	Master	

**Table 4-3: CF Card Setup Jumper Settings**

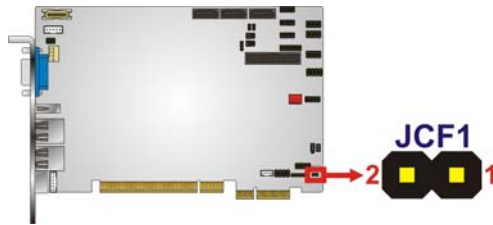

**Figure 4-4: CF Card Setup Jumper Location**

### 4.5.3 CF Card Voltage Select Jumper

- Jumper Label:** J\_VCF1
- Jumper Type:** 3-pin header
- Jumper Settings:** See Table 4-4
- Jumper Location:** See Figure 4-5

The CF Card Voltage Setup jumper sets the CF Card Voltage.

CF Card Voltage Setup	Description	
1-2	5V	
2-3	3.3V	Default

**Table 4-4: CF Card Voltage Select Jumper Settings**

The CF Card Setup jumper location is shown in **Figure 4-5**.

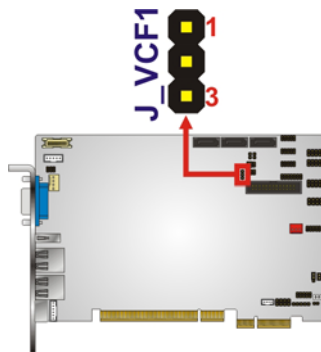

**Figure 4-5: CF Card Voltage Select Jumper Location**

#### 4.5.4 Clear CMOS Jumper

<b>Jumper Label:</b>	<b>J_CMOS1</b>
<b>Jumper Type:</b>	3-pin header
<b>Jumper Settings:</b>	See Table 4-5
<b>Jumper Location:</b>	See Figure 4-6

If the PIC0e-PV-D4251/N4551/D5251 fails to boot due to improper BIOS settings, the clear CMOS jumper clears the CMOS data and resets the system BIOS information. To do this, use the jumper cap to close pins 2 and 3 for a few seconds then reinstall the jumper clip back to pins 1 and 2.

If the “CMOS Settings Wrong” message is displayed during the boot up process, the fault may be corrected by pressing the F1 to enter the CMOS Setup menu. Do one of the following:

- Enter the correct CMOS setting
- Load Optimal Defaults
- Load Failsafe Defaults.

After having done one of the above, save the changes and exit the CMOS Setup menu.

The clear CMOS jumper settings are shown in **Table 4-5**.

Clear CMOS	Description	
Short 1 - 2	Keep CMOS Setup	Default
Short 2 - 3	Clear CMOS Setup	

**Table 4-5: Clear CMOS Jumper Settings**

The location of the clear CMOS jumper is shown in **Figure 4-6** below.

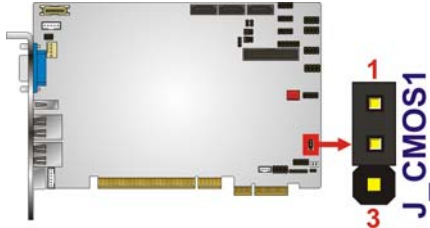
**Figure 4-6: Clear CMOS Jumper Location**

#### 4.5.5 LVDS Voltage Select Jumper

**WARNING:**

Permanent damage to the screen and PICOe-PV-D4251/N4551/D5251 may occur if the wrong voltage is selected with this jumper. Please refer to the user guide that came with the monitor to select the correct voltage.

<b>Jumper Label:</b>	<b>J_VLVDS1</b>
<b>Jumper Type:</b>	6-pin header
<b>Jumper Settings:</b>	See Table 4-6
<b>Jumper Location:</b>	See Figure 4-7

The **LVDS Voltage Selection** jumpers allow the LVDS screen voltages to be set. J\_VLVDS1 sets the voltage connected to LVDS1. The **LVDS Voltage Selection** jumper settings are shown in **Table 4-6**.

LCD Voltage Select	Description	
Short 1-2	+3.3V	Default
Short 3-4	+5V	
Short 5-6	+12V	

**Table 4-6: LVDS Voltage Selection Jumper Settings**

The LVDS Voltage Selection jumper location is shown in **Figure 4-7**.

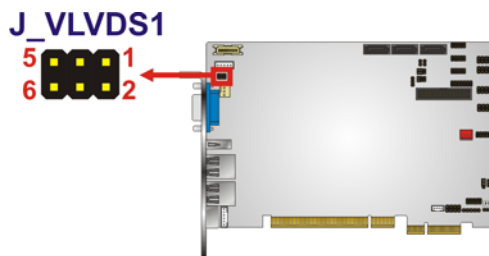

**Figure 4-7: LVDS Voltage Selection Jumper Location**

#### 4.5.6 PCIe Status Select Jumper

- Jumper Label:** JP1
- Jumper Type:** 2-pin header
- Jumper Settings:** See Table 4-7
- Jumper Location:** See Figure 4-8

The **PCIe Status Select** jumper allows the PCIe status to be configured. The **PCIe Status Select** jumper settings are shown in **Table 4-6**.

PCIe Status Select	Description	
Open	One PCIe x4	
Short	Four PCIe x1	Default

**Table 4-7: PCIe Status Select Jumper Settings**

The PCIe Status Select jumper location is shown in **Figure 4-7**.

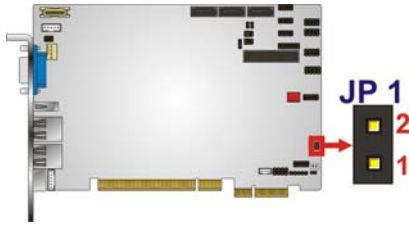

**Figure 4-8: PCIe Status Select Jumper Location**

### 4.5.7 COM 3 Function Select Jumpers

<b>Jumper Label:</b>	<b>J1 and J2</b>
<b>Jumper Type:</b>	6-pin header
<b>Jumper Settings:</b>	See Table 4-8 and Table 4-9
<b>Jumper Location:</b>	See Figure 4-9

The COM 3 Function Select jumpers set the communication protocol used by the COM 3 serial communications port as RS-232, RS-422 or RS-485. The COM 3 Function Select settings are shown in **Table 4-9**.

J1 Setting	Description
1-2	RS-232 (Default)
3-4	RS-422
5-6	RS-485

**Table 4-8: COM 3 Function Select Jumpers Settings**

J2 Setting	Description
1-3, 2-4	RS-422 (Default)
3-5, 4-6	RS-485

**Table 4-9: COM 3 Function Select Jumpers Settings**



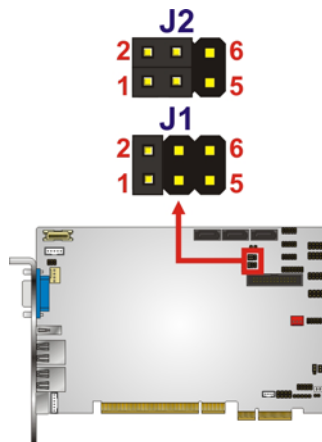

Figure 4-9: COM 3 Function Select Jumper Locations

#### 4.5.8 COM 3 RS-422 and 485 Termination Select Jumpers

- Jumper Label:** J3 and J4
- Jumper Type:** 2-pin header
- Jumper Settings:** See Table 4-10 and Table 4-11
- Jumper Location:** See Figure 4-10

The COM 3 RS-485 and RS422 Termination Select jumpers enable or disable the termination used by the serial COM 3 communications port as 120 ohm. The COM 3 RS-485 and RS-422 Termination Select settings are shown in **Table 4-10** and **Table 4-11**.

RS-485 (J3) Setting	Description
Short	120 ohm termination
Open	No 120 ohm termination

Table 4-10: COM 3 RS-485 Termination Select Jumper Settings

RS-422 (J4) Setting	Description
Short	120 ohm termination
Open	No 120 ohm termination

Table 4-11: COM 3 RS-422 Termination Select Jumper Settings

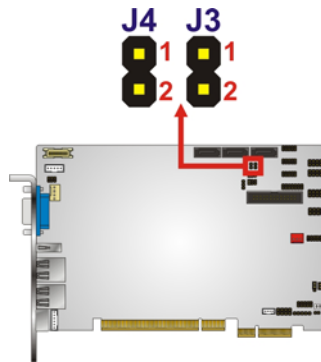

Figure 4-10: COM 3 RS-485 and RS422 Termination Select Jumper Locations

## 4.6 Chassis Installation

### 4.6.1 Airflow



#### **WARNING:**

Airflow is critical to the cooling of the CPU and other onboard components. The chassis in which the PIC0e-PV-D4251/N4551/D5251 must have air vents to allow cool air to move into the system and hot air to move out.

The PIC0e-PV-D4251/N4551/D5251 must be installed in a chassis with ventilation holes on the sides allowing airflow to travel through the heat sink surface. In a system with an individual power supply unit, the cooling fan of a power supply can also help generate airflow through the board surface.

### 4.6.2 Backplane Installation

Before the PIC0e-PV-D4251/N4551/D5251 can be installed into the chassis, a backplane must first be installed. Please refer to the installation instructions that came with the backplane and the chassis to see how to install the backplane into the chassis.



**NOTE:**

IEI has a wide range of backplanes available. Please contact your PIC0e-PV-D4251/N4551/D5251 vendor, reseller or an IEI sales representative at [sales@iei.com.tw](mailto:sales@iei.com.tw) or visit the IEI website (<http://www.ieworld.com.tw>) to find out more about the available chassis.

### 4.6.3 CPU Card Installation

To install the PIC0e-PV-D4251/N4551/D5251 CPU card onto the backplane, carefully align the CPU card interface connectors with the corresponding socket on the backplane. To do this, please refer to the reference material that came with the backplane. Next, secure the CPU card to the chassis. To do this, please refer to the reference material that came with the chassis.

## 4.7 Internal Peripheral Device Connections

### 4.7.1 Peripheral Device Cables

The cables listed in **Table 4-12** are shipped with the PIC0e-PV-D4251/N4551/D5251.

Quantity	Type
1	Keyboard and Mouse Y cable
3	SATA drive cable
1	Dual port USB cable
1	Dual RS-232 cable

**Table 4-12: IEI Provided Cables**

Some optional items that can be purchased separately and installed on the PIC0e-PV-D4251/N4551/D5251 include:

- SATA power cable
- Parallel port cable
- 7.1 channel audio kit

## 4.7.2 Audio Kit Installation



### NOTE:

This is an optional item that must be ordered separately. For further information please contact the nearest PICOe-PV-D4251/N4551/D5251 distributor, reseller or vendor or contact an iEi sales representative directly. Send any queries to [sales@iei.com.tw](mailto:sales@iei.com.tw).

The optional 7.1 channel audio kit connects to the 10-pin audio connector on the PICOe-PV-D4251/N4551/D5251. The audio kit consists of five audio jacks. One audio jack, Mic In, connects to a microphone. The remaining four audio jacks, Line-In, Front-Out, Rear-Out, and Center Subwoofer, connect to speakers. To install the audio kit, please refer to the steps below:

- Step 1: Connect the audio kit cable.** The audio kit is shipped with a cable that connects the audio kit to the PICOe-PV-D4251/N4551/D5251. Connect the cable to the connector on the back of the audio kit. Make sure the pins are properly aligned (i.e. pin 1 connects to pin 1).
- Step 2: Locate the audio connector.** The location of the 10-pin audio connector is shown in **Chapter 3**.
- Step 3: Align pin 1.** Align pin 1 on the on-board connector with pin 1 on the audio kit cable connector. Pin 1 on the audio kit cable connector is indicated with a white dot. See Figure 4-11.

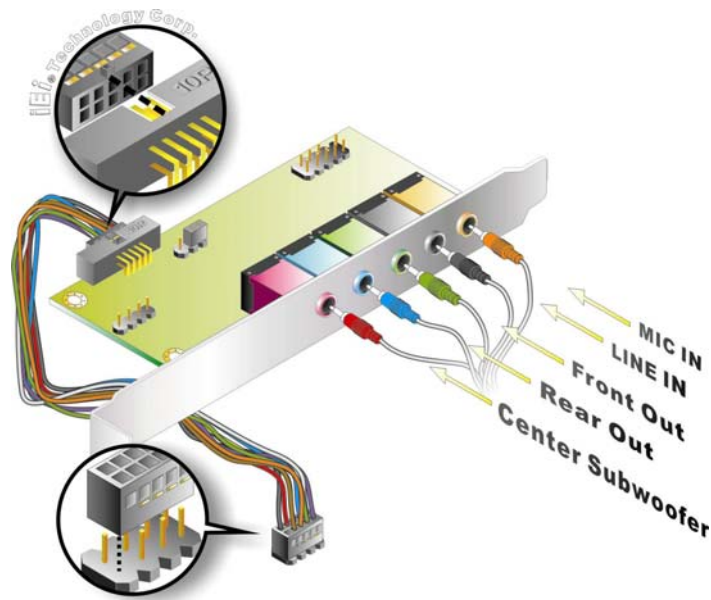

Figure 4-11: 7.1 Channel Audio Kit

**Step 4:** **Mount the audio kit onto the chassis.** Once the audio kit is connected to the PICOe-PV-D4251/N4551/D5251, secure the audio kit bracket to the system chassis.

**Step 5:** **Connect the audio devices.** Connect one speaker to the line-in audio jack, one speaker to the line-out audio jack and a microphone to the mic-in audio jack.

**Step 6:** **Install the driver.** If the 7.1 channel audio kit is used, the ALC883 Realtek codec driver must be installed. Refer to **Section 4.9** for driver installation instructions.

### 4.7.3 SATA Drive Connection

The PICOe-PV-D4251/N4551/D5251 is shipped with two SATA drive cables and one SATA drive power cable. To connect the SATA drives to the connectors, please follow the steps below.

**Step 1:** **Locate the connectors.** The locations of the SATA drive connectors are shown in **Chapter 3**.

**Step 2:** **Insert the cable connector.** Press the clip on the connector at the end of the

SATA cable and insert the cable connector into the onboard SATA drive connector. See **Figure 4-12**.

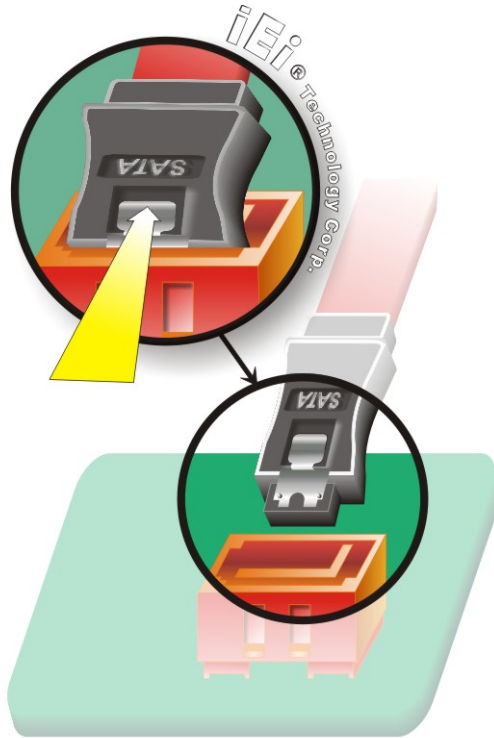

**Figure 4-12: SATA Drive Cable Connection**

- Step 3:** Connect the cable to the SATA disk. Connect the connector on the other end of the cable to the connector at the back of the SATA drive. See **Figure 4-13**.
- Step 4:** Connect the SATA power cable. Connect the SATA power connector to the back of the SATA drive. See **Figure 4-13**.



Figure 4-13: SATA Power Drive Connection

#### 4.7.4 USB Cable (Dual Port) with Slot Bracket

The PICOe-PV-D4251/N4551/D5251 is shipped with a dual port USB 2.0 cable. To connect the USB cable connector, please follow the steps below.

**Step 1: Locate the connectors.** The locations of the USB connectors are shown in Chapter 3.



#### **WARNING:**

If the USB pins are not properly aligned, the USB device can burn out.

---

**Step 2: Align the connectors.** The cable has two connectors. Correctly align pin 1 on each cable connector with pin 1 on the PICOe-PV-D4251/N4551/D5251 USB connector.

**Step 3: Insert the cable connectors** Once the cable connectors are properly aligned with the USB connectors on the PICOe-PV-D4251/N4551/D5251, connect the cable connectors to the on-board connectors. See **Figure 4-14**.

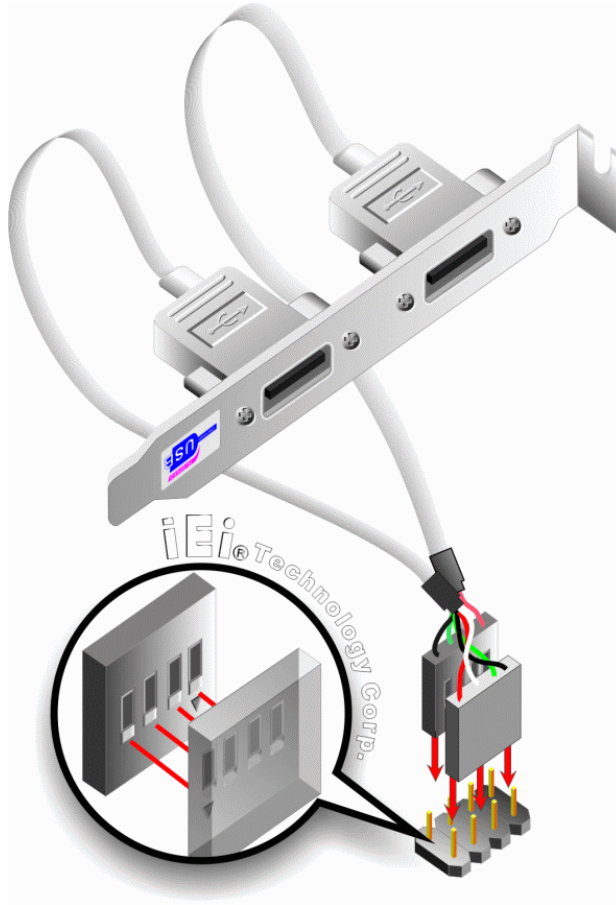

**Figure 4-14: Dual USB Cable Connection**

**Step 4:** **Attach the bracket to the chassis.** The USB 2.0 connectors are attached to a bracket. To secure the bracket to the chassis please refer to the installation instructions that came with the chassis.

#### 4.7.5 Parallel Port Cable without Bracket

The optional parallel port (LPT) cable respectively connects the on-board LPT 26-pin box header to an external LPT device (like a printer). The cable comprises a 26-pin female header, to be connected to the on-board LPT box-header, on one side and on the other side a standard external LPT connector. To connect the LPT cable, please follow the steps below.

**Step 1:** **Locate the connector.** The LPT connector location is shown in **Chapter 4**.

**Step 2:** **Align the connectors.** Correctly align pin 1 on the cable connector with pin 1 on



## PIC0e-PV-D4251/N4551/D5251 User Manual

the PIC0e-PV-D4251/N4551/D5251 LPT box-header connector. See Figure 4-15.

- Step 3: Insert the cable connectors** Once the cable connector is properly aligned with the 26-pin box-header connector on the PIC0e-PV-D4251/N4551/D5251, connect the cable connector to the on-board connector. See **Figure 4-15**.

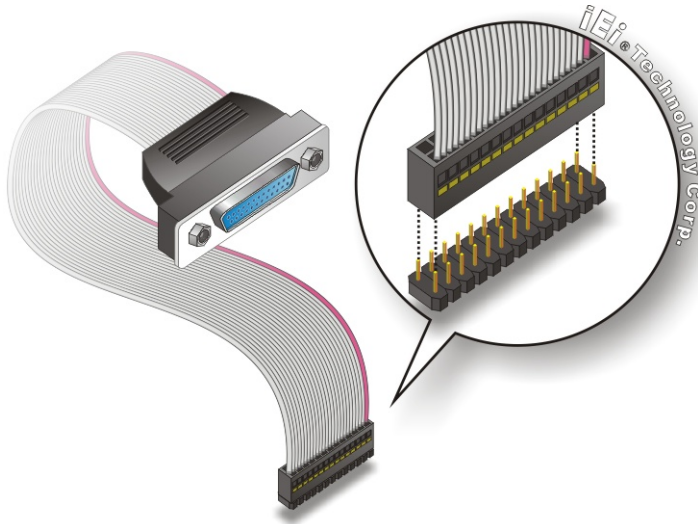

**Figure 4-15: LPT Cable Connection**

- Step 4: Attach the LPT connector to the chassis.** To secure the LPT interface connector to the chassis please refer to the installation instructions that came with the chassis.
- Step 5: Connect LPT device.** Once the LPT interface connector is connected to the chassis, the LPT device can be connected to the LPT interface connector. See **Figure 4-16**

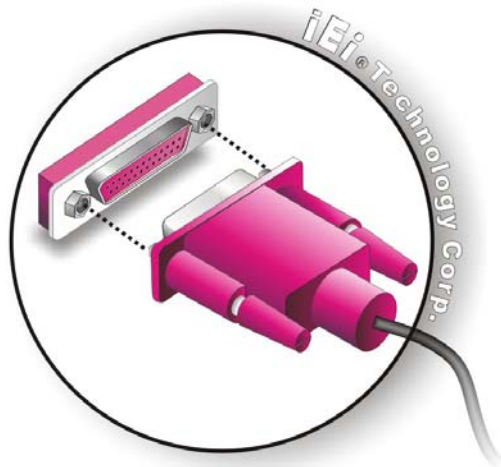

Figure 4-16: Connect the LPT Device

#### 4.7.6 Dual RS-232 Cable with Slot Bracket

The dual RS-232 cable slot connector consists of two connectors attached to two independent cables. Each cable is then attached to a D-sub 9 male connector that is mounted onto a slot. To install the dual RS-232 cable, please follow the steps below.

**Step 1: Locate the connectors.** The locations of the RS-232 connectors are shown in Chapter 3.

**Step 2: Insert the cable connectors.** Insert one connector into each serial port box headers. See Figure 4-17. A key on the front of the cable connectors ensures the connector can only be installed in one direction.

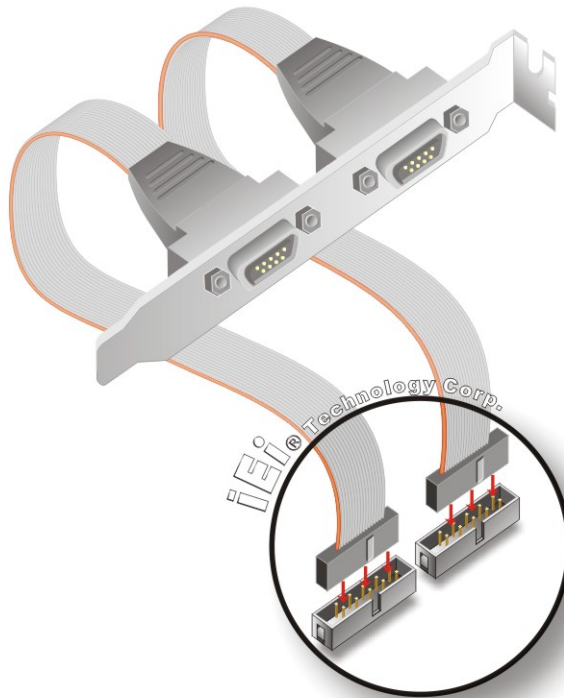

**Figure 4-17: Dual RS-232 Cable Installation**

**Step 3: Secure the bracket.** The dual RS-232 connector has two D-sub 9 male connectors secured on a bracket. To secure the bracket to the chassis please refer to the reference material that came with the chassis

## 4.8 External Peripheral Interface Connection

The following external peripheral devices can be connected to the external peripheral interface connectors.

- RJ-45 Ethernet cable connectors
- PS/2 devices
- USB devices
- VGA monitors

To install these devices, connect the corresponding cable connector from the actual device to the corresponding PICOe-PV-D4251/N4551/D5251 external peripheral interface connector making sure the pins are properly aligned.

### 4.8.1 LAN Connection

There are two external RJ-45 LAN connectors. The RJ-45 connectors enable connection to an external network. To connect a LAN cable with an RJ-45 connector, please follow the instructions below.

**Step 1:** **Locate the RJ-45 connectors.** The locations of the USB connectors are shown in **Chapter 4**.

**Step 2:** **Align the connectors.** Align the RJ-45 connector on the LAN cable with one of the RJ-45 connectors on the PICOe-PV-D4251/N4551/D5251. See **Figure 4-18**.

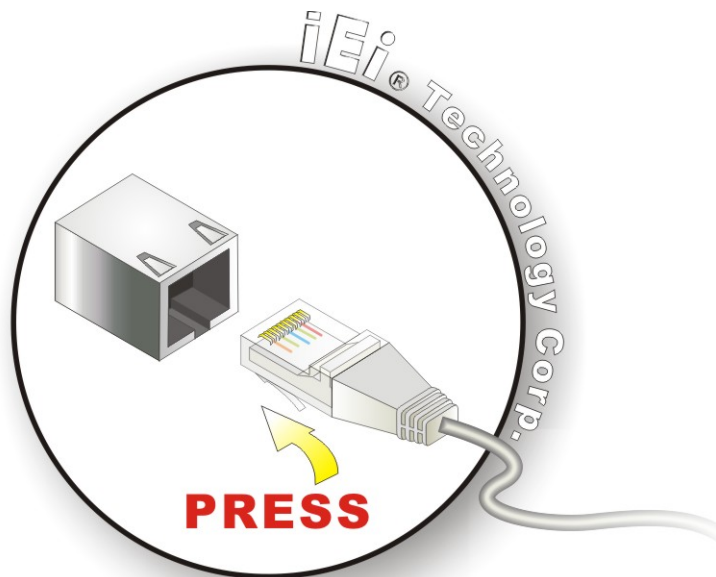

Figure 4-18: LAN Connection

**Step 3:** **Insert the LAN cable RJ-45 connector.** Once aligned, gently insert the LAN cable RJ-45 connector into the onboard RJ-45 connector.

### 4.8.2 PS/2 Y-Cable Connection

The PICOe-PV-D4251/N4551/D5251 has a PS/2 connector on the external peripheral interface panel. The dual PS/2 connector is connected to the PS/2 Y-cable that came with the PICOe-PV-D4251/N4551/D5251. One of the PS/2 cables is connected to a keyboard and the other to a mouse to the system. Follow the steps below to connect a keyboard and mouse to the PICOe-PV-D4251/N4551/D5251.

## PICOe-PV-D4251/N4551/D5251 User Manual

**Step 1:** Locate the dual PS/2 connector. The location of the PS/2 connector is shown in **Chapter 3**.

**Step 2:** Insert the keyboard/mouse connector. Insert the PS/2 connector on the end of the PS/2 y-cable into the external PS/2 connector. See **Figure 4-19**.

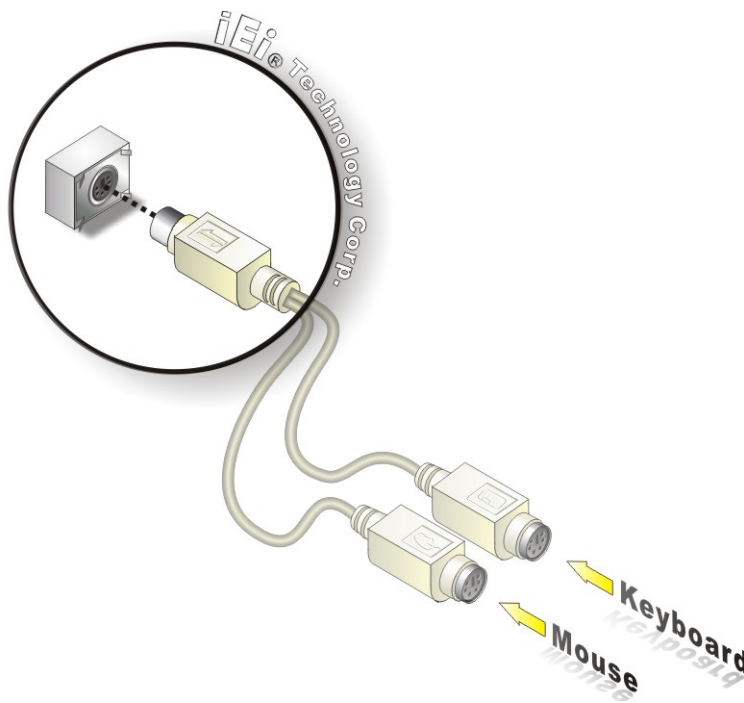

**Figure 4-19: PS/2 Keyboard/Mouse Connector**

**Step 3:** Connect the keyboard and mouse. Connect the keyboard and mouse to the appropriate connector. The keyboard and mouse connectors can be distinguished from each other by looking at the small graphic at the top of the connector.

### 4.8.3 USB Connection

The external USB Series "A" receptacle connector provides easier and quicker access to external USB devices. Follow the steps below to connect USB devices to the PICOe-PV-D4251/N4551/D5251.

**Step 1:** Locate the USB Series "A" receptacle connectors. The location of the USB

Series "A" receptacle connectors are shown in **Chapter 3**.

- Step 2:** **Insert a USB Series "A" plug.** Insert the USB Series "A" plug of a device into the USB Series "A" receptacle on the external peripheral interface. See **Figure 4-20**.

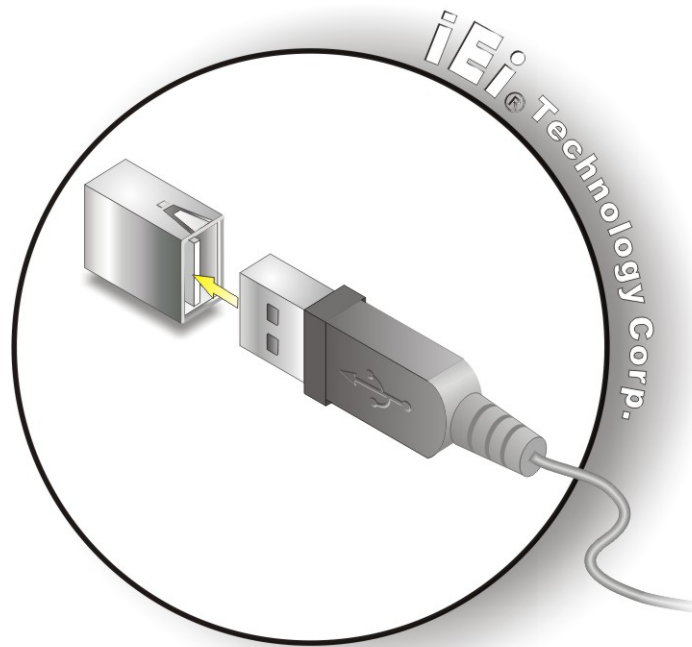

**Figure 4-20: USB Connector**

#### 4.8.4 VGA Monitor Connection

The PICOe-PV-D4251/N4551/D5251 has a single female DB-15 connector on the external peripheral interface panel. The DB-15 connector is connected to a CRT or VGA monitor. To connect a monitor to the PICOe-PV-D4251/N4551/D5251, please follow the instructions below.

- Step 1:** **Locate the female DB-15 connector.** The location of the female DB-15 connector is shown in **Chapter 3**.
- Step 2:** **Align the VGA connector.** Align the male DB-15 connector on the VGA screen cable with the female DB-15 connector on the external peripheral interface.

**Step 3:** Insert the VGA connector. Once the connectors are properly aligned with the insert the male connector from the VGA screen into the female connector on the PICOe-PV-D4251/N4551/D5251. See **Figure 4-21**.

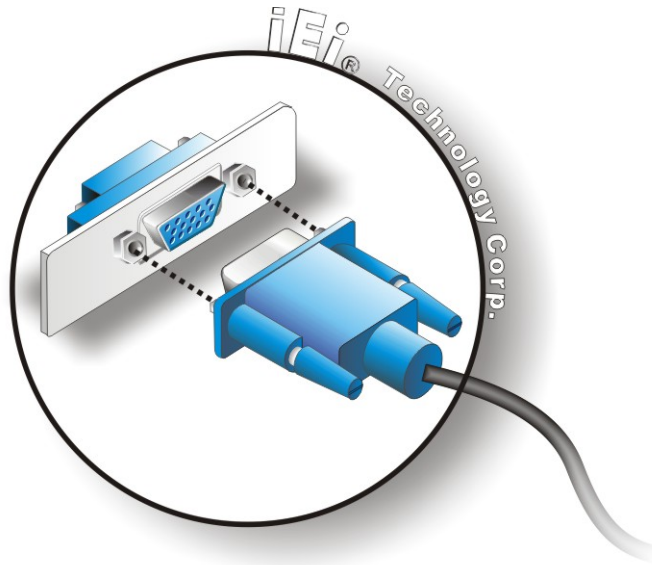

**Figure 4-21: VGA Connector**

**Step 4:** Secure the connector. Secure the DB-15 VGA connector from the VGA monitor to the external interface by tightening the two retention screws on either side of the connector.

## 4.9 Software Installation

All the drivers for the PICOe-PV-D4251/N4551/D5251 are on the CD that came with the system. To install the drivers, please follow the steps below.

**Step 1:** Insert the CD into a CD drive connected to the system.



### NOTE:

If the installation program doesn't start automatically:  
Click "Start->My Computer->CD Drive->autorun.exe"

**Step 2:** The driver main menu appears (**Figure 4-22**).

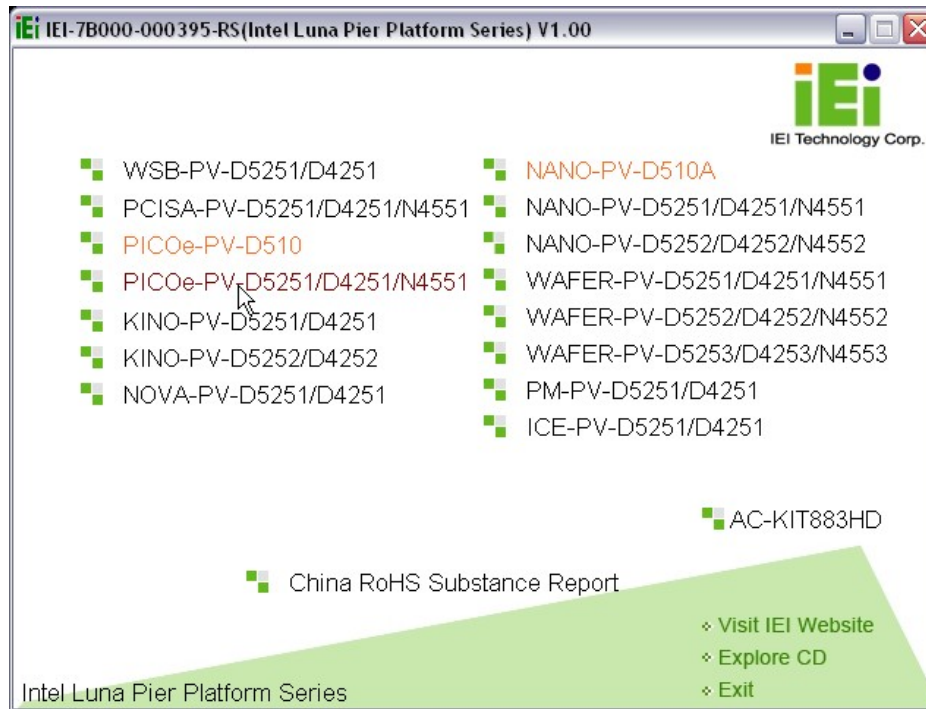
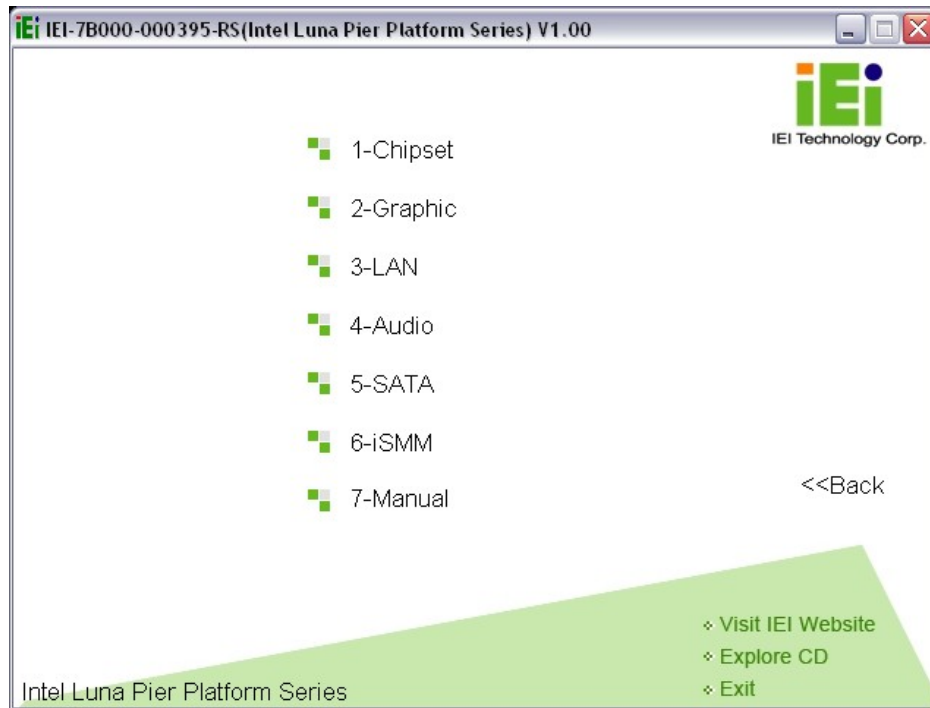

**Figure 4-22: Introduction Screen**

**Step 3:** Click **PICOe-PV-D4251/N4551/D5251**.

**Step 4:** A new screen with a list of available drivers appears (**Figure 4-23**).





**Figure 4-23: Available Drivers**

**Step 5:** Install all of the necessary drivers in this menu.



Chapter

5

# BIOS Screens

---

## 5.1 Introduction

The BIOS is programmed onto the BIOS chip. The BIOS setup program allows changes to certain system settings. This chapter outlines the options that can be changed.

### 5.1.1 Starting Setup

The AMI BIOS is activated when the computer is turned on. The setup program can be activated in one of two ways.

1. Press the **DELETE** key as soon as the system is turned on or
2. Press the **DELETE** key when the “**Press Del to enter SETUP**” message appears on the screen.

If the message disappears before the **DELETE** key is pressed, restart the computer and try again.

### 5.1.2 Using Setup

Use the arrow keys to highlight items, press **ENTER** to select, use the PageUp and PageDown keys to change entries, press **F1** for help and press **ESC** to quit. Navigation keys are shown in.

Key	Function
Up arrow	Move to previous item
Down arrow	Move to next item
Left arrow	Move to the item on the left hand side
Right arrow	Move to the item on the right hand side
F1 key	General help, only for Status Page Setup Menu and Option Page Setup Menu
F2 key	Load previous values.
F3 key	Load optimized defaults

Key	Function
F4 key	Save all the CMOS changes
Esc key	Main Menu – Quit and not save changes into CMOS Status Page Setup Menu and Option Page Setup Menu -- Exit current page and return to Main Menu

**Table 5-1: BIOS Navigation Keys**

### 5.1.3 Getting Help

When **F1** is pressed a small help window describing the appropriate keys to use and the possible selections for the highlighted item appears. To exit the Help Window press **Esc** or the **F1** key again.

### 5.1.4 Unable to Reboot After Configuration Changes

If the computer cannot boot after changes to the system configuration is made, CMOS defaults. Use the jumper described in Chapter 4.

### 5.1.5 BIOS Menu Bar

The **menu bar** on top of the BIOS screen has the following main items:

- Main – Changes the basic system configuration.
- Advanced – Changes the advanced system settings.
- Chipset – Changes the chipset settings.
- Boot – Changes the system boot configuration.
- Security – Sets User and Supervisor Passwords.
- Save & Exit – Selects exit options and loads default settings

The following sections completely describe the configuration options found in the menu items at the top of the BIOS screen and listed above.

## 5.2 Main

The **Main** BIOS menu (**BIOS Menu 1**) appears when the **BIOS Setup** program is entered. The **Main** menu gives an overview of the basic system information.

```

Aptio Setup Utility - Copyright (C) 2010 American Megatrends, Inc.
Main  Advanced  Chipset  Boot  Security  Save & Exit

BIOS Information
BIOS Vendor                American Megatrends
Core Version               4.6.4.0 0.20
Compliancy                 UEFI 2.0
Project Version            SA26AR11.ROM
Build Date                 09/13/2010 20:20:59

System Date                [Tue 09/23/2010]
System Time                [14:20:27]

Access Level               Administrator

<->: Select Screen
↑ ↓: Select Item
Enter>Select
F1  General Help
F2  Previous Values
F3  Optimized Defaults
F4  Save
ESC Exit

Version 2.02.1205. Copyright (C) 2010 American Megatrends, Inc.

```

### BIOS Menu 1: Main

#### → BIOS Information

The **BIOS Information** lists a brief summary of the BIOS. The fields in **BIOS Information** cannot be changed. The items shown in the system overview include:

- **BIOS Vendor:** Installed BIOS vendor
- **Core Version:** Current BIOS version
- **Project Version:** the board version
- **Build Date:** Date the current BIOS version was made

The System Overview field also has two user configurable fields:

#### → System Date [xx/xx/xx]

Use the **System Date** option to set the system date. Manually enter the day, month and year.

→ **System Time [xx:xx:xx]**

Use the **System Time** option to set the system time. Manually enter the hours, minutes and seconds.

## 5.3 Advanced

Use the **Advanced** menu (**BIOS Menu 2**) to configure the CPU and peripheral devices through the following sub-menus:



### **WARNING!**

Setting the wrong values in the sections below may cause the system to malfunction. Make sure that the settings made are compatible with the hardware.

```

Aptio Setup Utility - Copyright (C) 2010 American Megatrends, Inc.
Main   Advanced  Chipset  Boot    Security  Save & Exit
-----
> ACPI Settings
> Trusted Computing
> CPU Configuration
> IDE Configuration
> USB Configuration
> Super IO Configuration
> H/M Monitor
> Serial Port Console Redirection

                                  ←→: Select Screen
                                  ↑↓: Select Item
                                  Enter/Select
                                  F1   General Help
                                  F2   Previous Values
                                  F3   Optimized
                                  Defaults
                                  F4   Save
                                  ESC  Exit

Version 2.02.1205. Copyright (C) 2010 American Megatrends, Inc.
    
```

### **BIOS Menu 2: Advanced**

#### 5.3.1 ACPI Settings

The **ACPI Settings** menu (**BIOS Menu 3**) configures the Advanced Configuration and Power Interface (ACPI) options.

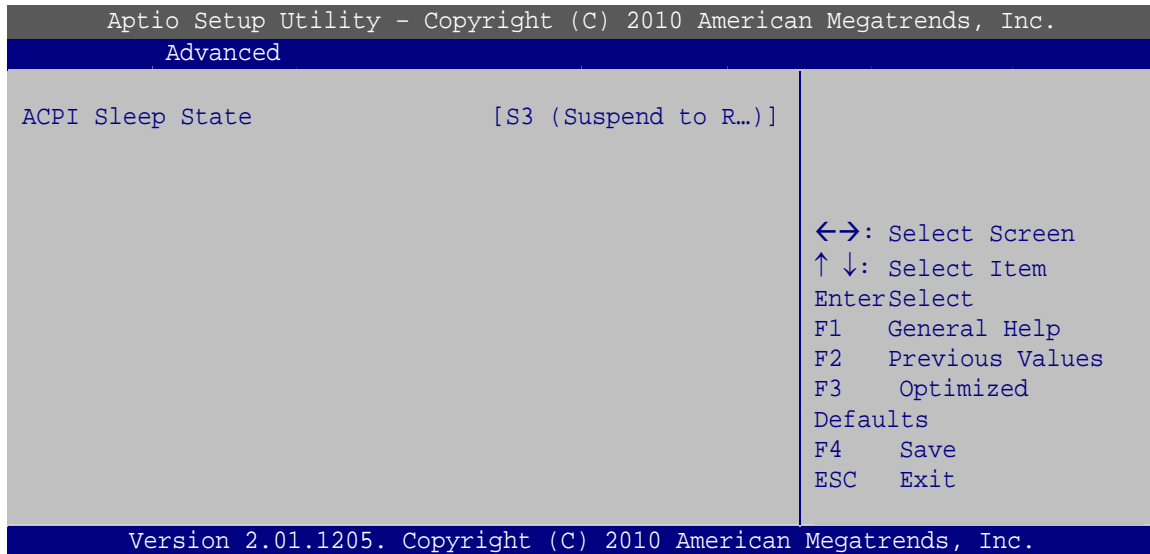

## BIOS Menu 3: ACPI Settings

### → ACPI Sleep State [S3 (Suspend to RAM)]

Use the **ACPI Sleep State** option to specify the sleep state the system enters when it is not being used.

#### → Suspend Disabled

#### → S1 (CPU Stop Clock)

The system enters S1(POS) sleep state. The system appears off. The CPU is stopped; RAM is refreshed; the system is running in a low power mode.

#### → S3 (Suspend to DEFAULT RAM)

The caches are flushed and the CPU is powered off. Power to the RAM is maintained. The computer returns slower to a working state, but more power is saved.

## 5.3.2 Trusted Computing

Use the **Trusted Computing** menu (**BIOS Menu 4**) to configure settings related to the Trusted Computing Group (TCG) Trusted Platform Module (TPM).

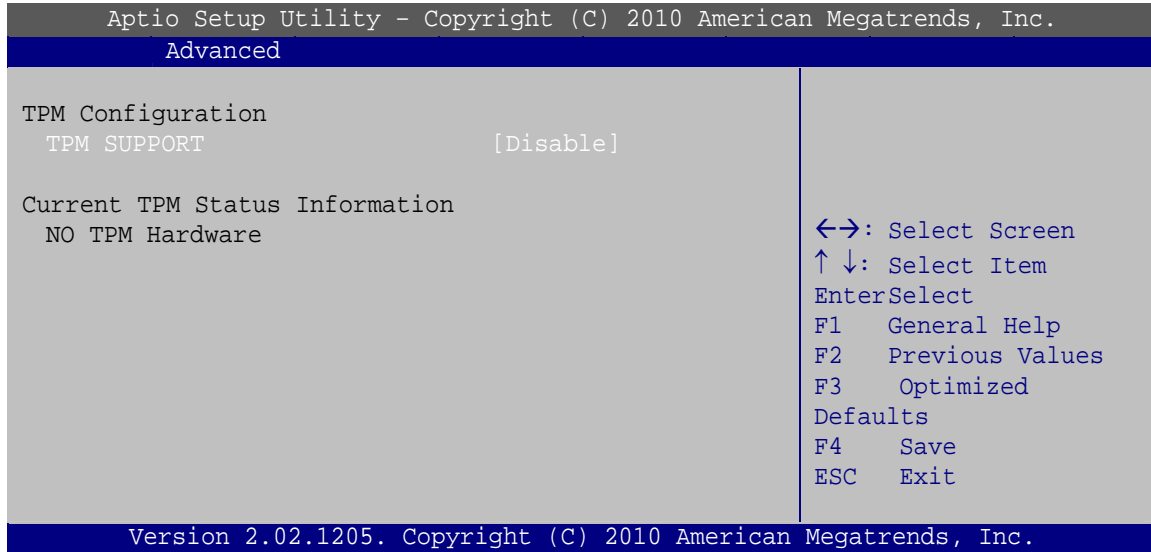

#### BIOS Menu 4: TPM Configuration

##### → TPM Support [Disable]

Use the **TPM Support** option to configure support for the TPM.

- **Disable** **DEFAULT** TPM support is disabled.
- **Enable** TPM support is enabled.

### 5.3.3 CPU Configuration

Use the **CPU Configuration** menu (**BIOS Menu 5**) to view detailed CPU specifications and configure the CPU.



## PICOe-PV-D4251/N4551/D5251 User Manual

Aptio Setup Utility - Copyright (C) 2010 American Megatrends, Inc.

Advanced

CPU Configuration	
Processor Type	Intel(R) Atom(TM) CPU CPU N525 @ 1.80 GHz
EMT64	Supported
Processor Speed	1800 MHz
System Bus Speed	800 MHz
Ratio Status	9
Actual Ratio	9
Processor Stepping	106ca
Microcode Revision	263
L1 Cache RAM	2x56 k
L2 Cache RAM	2x512 k
Processor Core	Dual
Hyper-Threading	Supported

←→: Select Screen  
 ↑ ↓: Select Item  
 Enter>Select  
 F1 General Help  
 F2 Previous Values  
 F3 Optimized  
 Defaults  
 F4 Save  
 ESC Exit

Version 2.02.1205. Copyright (C) 2010 American Megatrends, Inc.

### BIOS Menu 5: CPU Configuration

The CPU Configuration menu (**BIOS Menu 5**) lists the following CPU details:

- Processor Type: Lists the brand name of the CPU being used
- EMT64: Indicates if the EM64T is supported by the CPU.
- Processor Speed: Lists the CPU processing speed
- System Bus: Lists the system bus
- Ratio Status: List the maximum FSB divisor
- Actual Ratio: Lists current FSB divisor
- Processor Stepping: Lists the CPU processing stepping
- Microcode Revision: Lists the microcode revision
- L1 Cache RAM: Lists the CPU L1 cache size
- L2 Cache RAM: Lists the CPU L2 cache size
- Processor Core: Lists the number of the processor core
- Hyper-Threading: Indicates if the Intel Hyper-Threading Technology is supported by the CPU.

### 5.3.4 SATA Configuration

Use the **SATA Configuration** menu (**BIOS Menu 6**) to change and/or set the configuration of the SATA devices installed in the system.

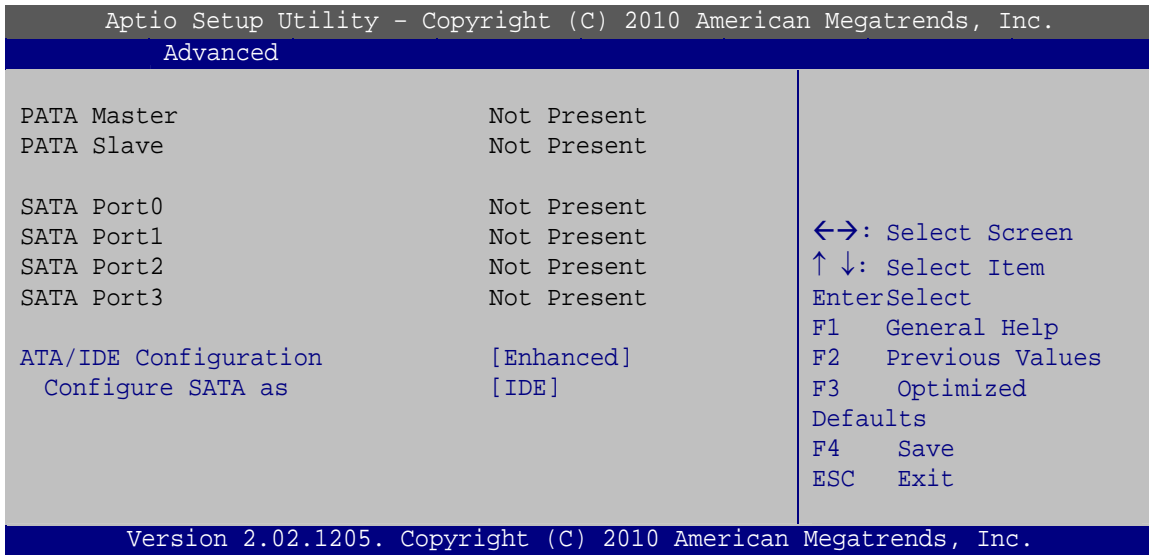

#### BIOS Menu 6: IDE Configuration

##### → ATA/IDE Configurations [Enhanced]

Use the **ATA/IDE Configurations** option to configure the ATA/IDE controller.

- **Disabled** Disables the on-board ATA/IDE controller.
- **Compatible** Configures the on-board ATA/IDE controller to be in compatible mode. In this mode, a SATA channel will replace one of the IDE channels. This mode supports up to 4 storage devices.
- **Enhanced** **DEFAULT** Configures the on-board ATA/IDE controller to be in Enhanced mode. In this mode, IDE channels and SATA channels are separated. This mode supports up to 6 storage devices. Some legacy OS do not support this mode.

## PICOe-PV-D4251/N4551/D5251 User Manual

### → Configure SATA as [IDE]

Use the **Configure SATA as** option to configure SATA devices as normal IDE devices.

- **IDE**    **DEFAULT**    Configures SATA devices as normal IDE device.
- **AHCI**                    Configures SATA devices as AHCI device.

### 5.3.5 USB Configuration

Use the **USB Configuration** menu (**BIOS Menu 7**) to read USB configuration information and configure the USB settings.

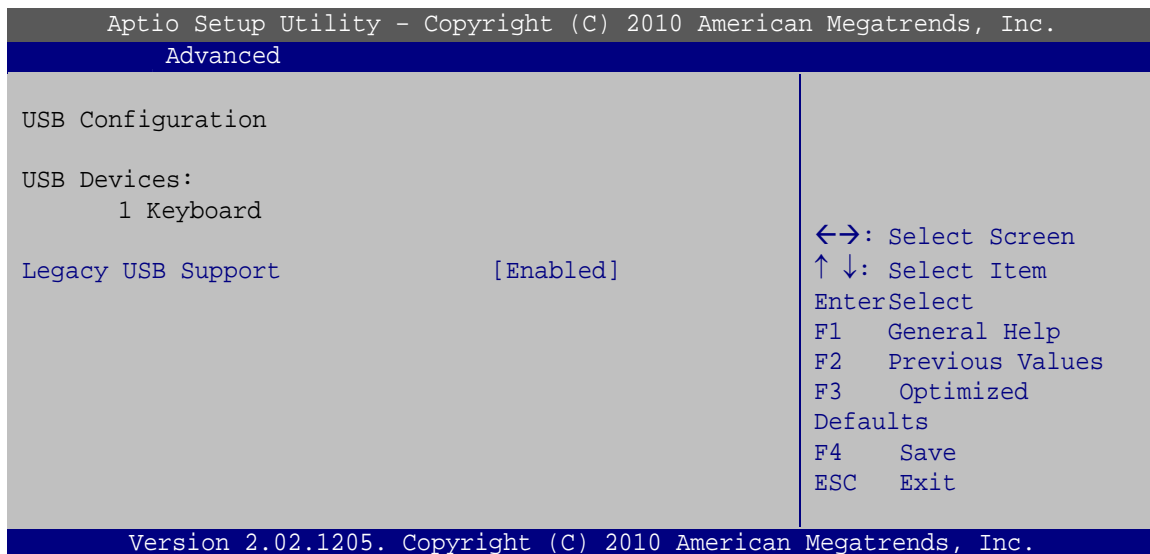

#### BIOS Menu 7: USB Configuration

### → USB Devices

The **USB Devices Enabled** field lists the USB devices that are enabled on the system

### → Legacy USB Support [Enabled]

Use the **Legacy USB Support** BIOS option to enable USB mouse and USB keyboard support. Normally if this option is not enabled, any attached USB mouse or USB keyboard does not become available until a USB compatible operating system is fully booted with all USB drivers loaded. When this option is enabled, any attached USB mouse or USB keyboard can control the system even when there is no USB driver loaded onto the system.

- ➔ **Enabled**      **DEFAULT**      Legacy USB support enabled
- ➔ **Disabled**                      Legacy USB support disabled
- ➔ **Auto**                              Legacy USB support disabled if no USB devices are connected

### 5.3.6 Super IO Configuration

Use the **Super IO Configuration** menu (**BIOS Menu 8**) to set or change the configurations for the FDD controllers, parallel ports and serial ports.

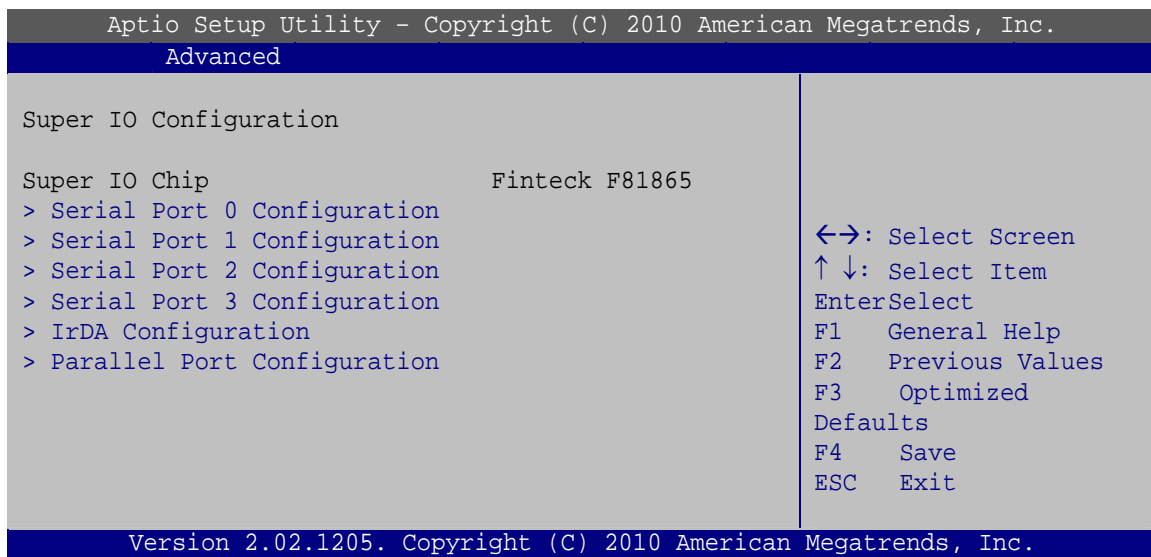

**BIOS Menu 8: Super IO Configuration**

## 5.3.6.1 Serial Port n Configuration

Use the **Serial Port n Configuration** menu (**BIOS Menu 9**) to configure the serial port n.

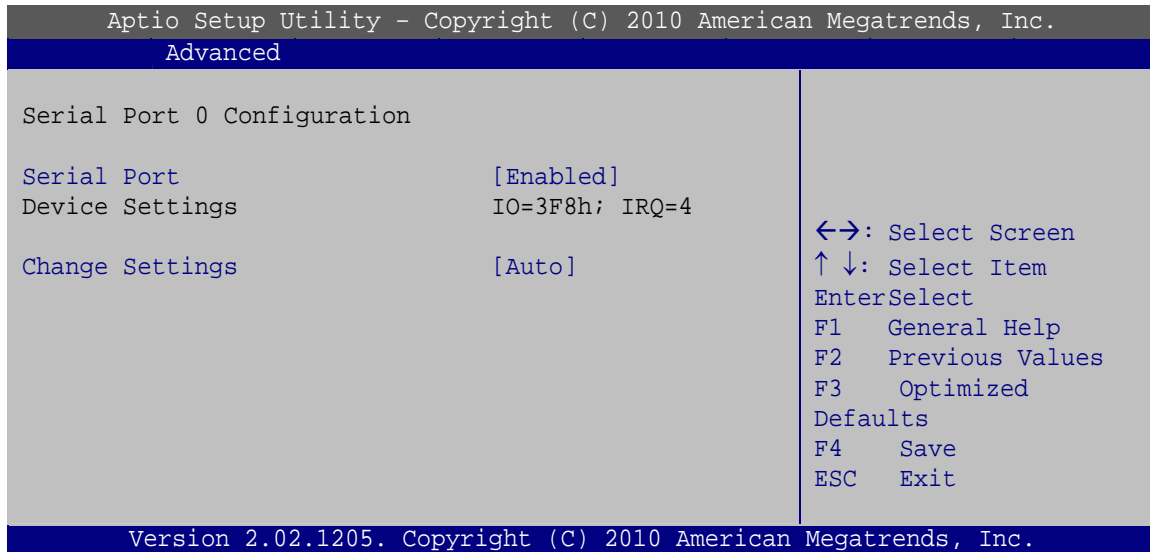

### BIOS Menu 9: Serial Port n Configuration Menu

#### 5.3.6.1.1 Serial Port 0 Configuration

##### → Serial Port [Enabled]

Use the **Serial Port** option to enable or disable the serial port.

- **Disabled** Disable the serial port
- **Enabled** **DEFAULT** Enable the serial port

##### → Change Settings [Auto]

Use the **Change Settings** option to change the serial port IO port address and interrupt address.

- **Auto** **DEFAULT** The serial port IO port address and interrupt address are automatically detected.
- **IO=3F8h;**  
**IRQ=4** Serial Port I/O port address is 3F8h and the interrupt address is IRQ4

- ➔ **IO=3F8h;**  
**IRQ=3, 4**                      Serial Port I/O port address is 3F8h and the interrupt address is IRQ3 and IRQ4
- ➔ **IO=2F8h;**  
**IRQ=3, 4**                      Serial Port I/O port address is 2F8h and the interrupt address is IRQ3 and IRQ4

### 5.3.6.1.2 Serial Port 1 Configuration

#### ➔ Serial Port [Enabled]

Use the **Serial Port** option to enable or disable the serial port.

- ➔ **Disabled**                      Disable the serial port
- ➔ **Enabled**                      **DEFAULT**                      Enable the serial port

#### ➔ Change Settings [Auto]

Use the **Change Settings** option to change the serial port IO port address and interrupt address.

- ➔ **Auto**                      **DEFAULT**                      The serial port IO port address and interrupt address are automatically detected.
- ➔ **IO=2F8h;**  
**IRQ=3**                      Serial Port I/O port address is 2F8h and the interrupt address is IRQ3
- ➔ **IO=3F8h;**  
**IRQ=3, 4**                      Serial Port I/O port address is 3F8h and the interrupt address is IRQ3 and IRQ4
- ➔ **IO=2F8h;**  
**IRQ=3, 4**                      Serial Port I/O port address is 2F8h and the interrupt address is IRQ3 and IRQ4

### 5.3.6.1.3 Serial Port 2 Configuration

#### ➔ Serial Port [Enabled]

Use the **Serial Port** option to enable or disable the serial port.

- ➔ **Disabled**                      Disable the serial port

→ **Enabled**      **DEFAULT**      Enable the serial port

→ **Change Settings [Auto]**

Use the **Change Settings** option to change the serial port IO port address and interrupt address.

- **Auto**      **DEFAULT**      The serial port IO port address and interrupt address are automatically detected.
- **IO=3E8h;**  
**IRQ=11**      Serial Port I/O port address is 3E8h and the interrupt address is IRQ11
- **IO=3E8h;**  
**IRQ=10, 11**      Serial Port I/O port address is 3E8h and the interrupt address is IRQ10, 11
- **IO=2E8h;**  
**IRQ=10, 11**      Serial Port I/O port address is 2E8h and the interrupt address is IRQ10, 11

### 5.3.6.1.4 Serial Port 3 Configuration

→ **Serial Port [Enabled]**

Use the **Serial Port** option to enable or disable the serial port.

- **Disabled**      Disable the serial port
- **Enabled**      **DEFAULT**      Enable the serial port

→ **Change Settings [Auto]**

Use the **Change Settings** option to change the serial port IO port address and interrupt address.

- **Auto**      **DEFAULT**      The serial port IO port address and interrupt address are automatically detected.

- ➔ **IO=2E8h;**  
**IRQ=10**                      Serial Port I/O port address is 2E8h and the interrupt address is IRQ10
- ➔ **IO=3E8h;**  
**IRQ=10, 11**                 Serial Port I/O port address is 3E8h and the interrupt address is IRQ10, 11
- ➔ **IO=2E8h;**  
**IRQ=10, 11**                 Serial Port I/O port address is 2E8h and the interrupt address is IRQ10, 11

### 5.3.6.2 IrDA Configuration

Use the **IrDA Configuration** menu (**BIOS Menu 10**) to configure the serial port n.

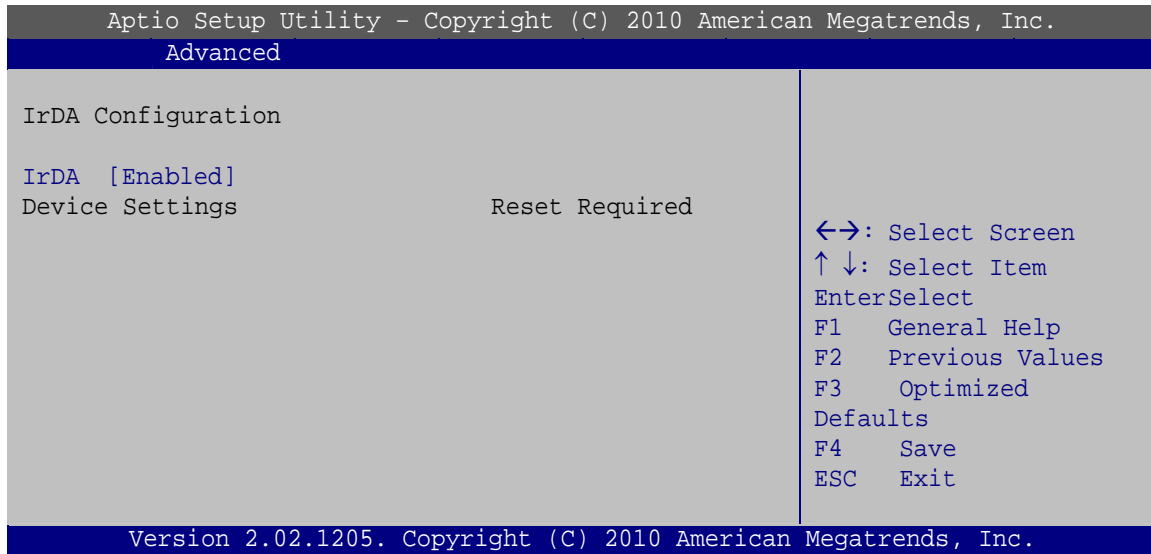

#### BIOS Menu 10: IrDA Configuration Menu

##### ➔ IrDA [Enabled]

Use the **IrDA** option to enable or disable the infrared function.

- ➔ **Disabled**                      Disable the infrared function
- ➔ **Enabled**                      **DEFAULT**                      Enable the infrared function



## 5.3.6.3 Parallel Port Configuration

Use the **Parallel Port Configuration** menu (**BIOS Menu 11**) to configure the serial port n.

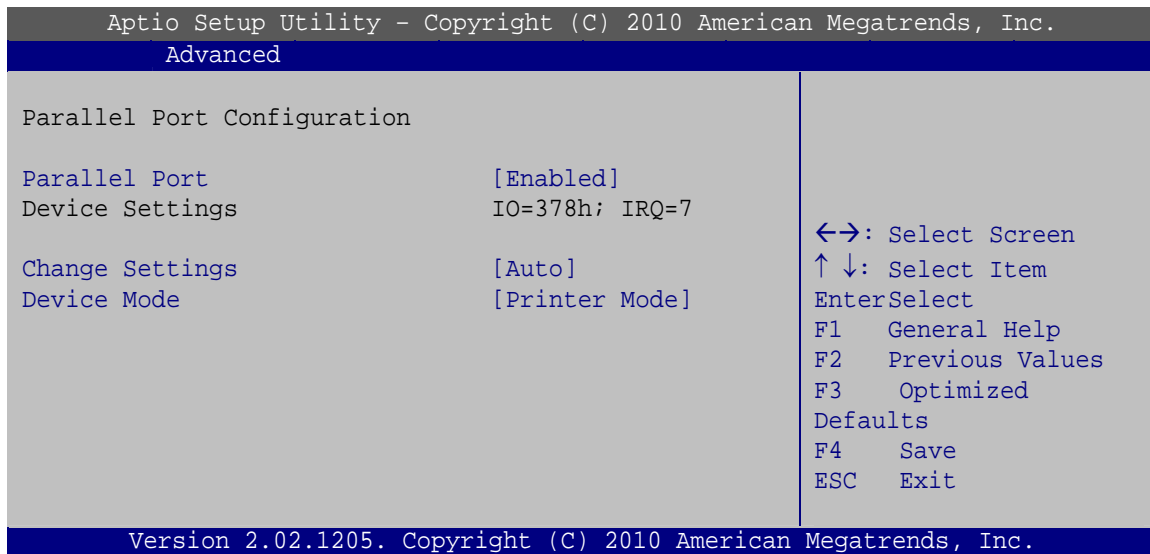

### BIOS Menu 11: Parallel Port Configuration Menu

#### → Parallel Port [Enabled]

Use the **Parallel Port** option to enable or disable the parallel port.

- **Disabled** Disable the parallel port
- **Enabled** **DEFAULT** Enable the parallel port

#### → Change Settings [Auto]

Use the **Change Settings** option to change the parallel port IO port address and interrupt address.

- **Auto** **DEFAULT** The parallel port IO port address and interrupt address are automatically detected.
- **IO=378h;**  
**IRQ=7** Parallel Port I/O port address is 378h and the interrupt address is IRQ7
- **IO=278h;**  
**IRQ=7** Parallel Port I/O port address is 278h and the interrupt address is IRQ7

- **IO=3BCh;**  
**IRQ=7** Parallel Port I/O port address is 3BCh and the interrupt address is IRQ7
- **IO=378h** Parallel Port I/O port address is 378h
- **IO=278h** Parallel Port I/O port address is 278h
- **IO=3BCh** Parallel Port I/O port address is 3BCh

#### → **Device Mode [Printer Mode]**

Use the **Device Mode** option to select the mode the parallel port operates in. Configuration options are listed below.

- Printer Mode **Default**
- SPP Mode
- EPP-1.9 and SPP Mode
- EPP-1.7 and SPP Mode
- ECP Mode
- ECP and EPP 1.9 Mode
- ECP and EPP 1.7 Mode

### 5.3.7 H/W Monitor

The H/W Monitor menu (**BIOS Menu 12**) shows the operating temperature, fan speeds and system voltages.

## PICOe-PV-D4251/N4551/D5251 User Manual

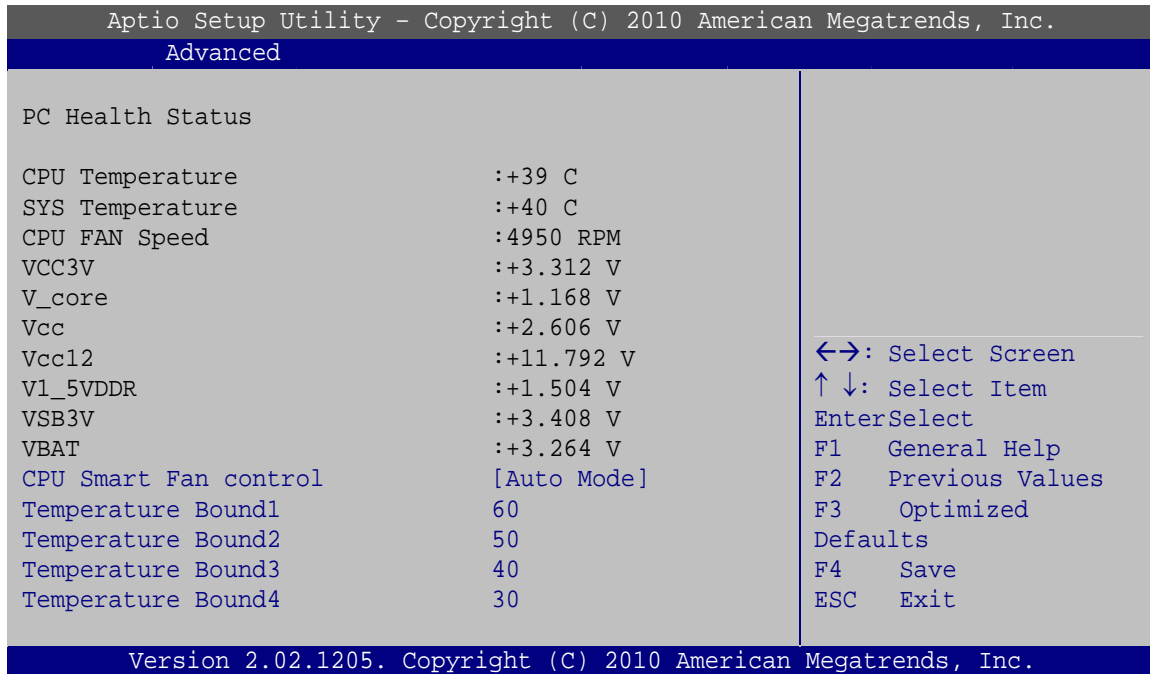

### BIOS Menu 12: Hardware Health Configuration

#### → PC Health Status

The following system parameters and values are shown. The system parameters that are monitored are:

- System Temperatures:
  - CPU Temperature
  - System Temperature
- Fan Speeds:
  - CPU Fan Speed
- Voltages:
  - V\_core
  - Vcc
  - Vcc12
  - V1\_5VDDR
  - VSB3V
  - VBAT

➔ **CPU Smart Fan control [Auto Mode]**

Use the **CPU Smart Fan control** option to configure the CPU fan.

- ➔ **Auto Mode**                      **DEFAULT**      The fan adjusts its speed using these settings:
  - Temperature Bound 1
  - Temperature Bound 2
  - Temperature Bound 3
  - Temperature Bound 4
  
- ➔ **Manual Mode**                      The fan spins at the speed set in:
  - Manual Duty Cycle Setting

### 5.3.8 Serial Port Console Redirection

The **Serial Port Console Redirection** menu (**BIOS Menu 13**) allows the console redirection options to be configured. Console redirection allows users to maintain a system remotely by re-directing keyboard input and text output through the serial port.

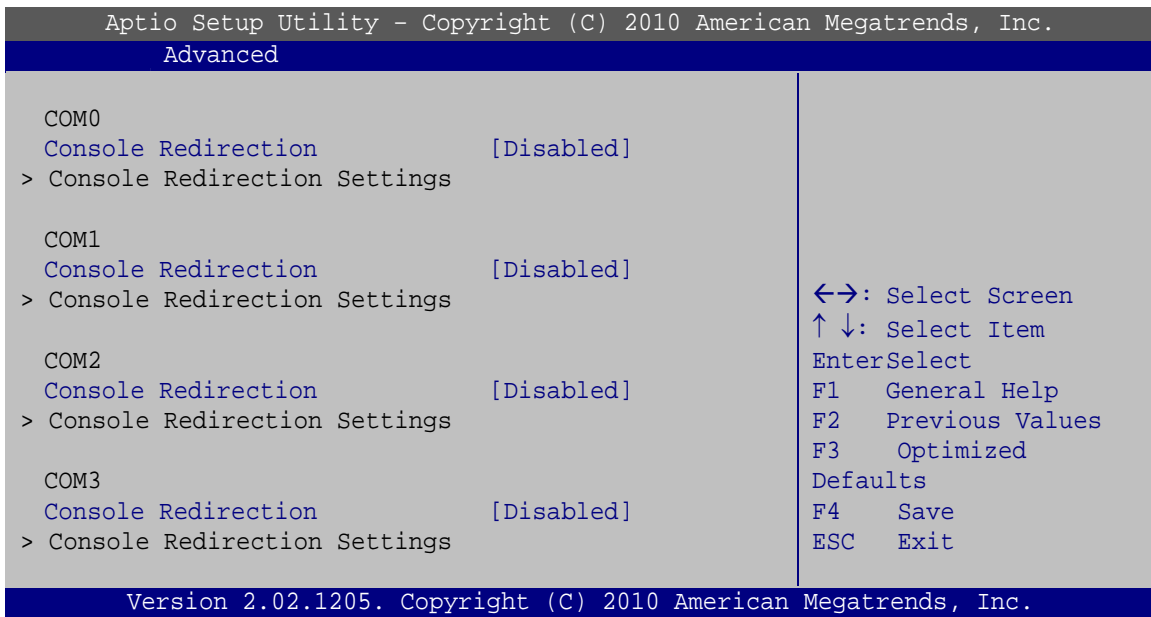

**BIOS Menu 13: Serial Port Console Redirection**

➔ **Console Redirection [Disabled]**

Use **Console Redirection** option to enable or disable the console redirection function.

## PICOe-PV-D4251/N4551/D5251 User Manual

- ➔ **Disabled**    **DEFAULT**    Disabled the console redirection function
- ➔ **Enabled**                    Enabled the console redirection function

### 5.4 Chipset

Use the **Chipset** menu (**BIOS Menu 14**) to access the Northbridge and Southbridge configuration menus



#### **WARNING!**

Setting the wrong values for the Chipset BIOS selections in the Chipset BIOS menu may cause the system to malfunction.

```

Aptio Setup Utility - Copyright (C) 2010 American Megatrends, Inc.
Main   Advanced  Chipset   Boot    Security  Save & Exit
-----
> Host Bridge
> South Bridge
> Intel IGD SWSCI OpRegion

                                  ←→: Select Screen
                                  ↑↓: Select Item
                                  Enter>Select
                                  F1   General Help
                                  F2   Previous Values
                                  F3   Optimized
                                  Defaults
                                  F4   Save
                                  ESC  Exit

Version 2.02.1205. Copyright (C) 2010 American Megatrends, Inc.
  
```

**BIOS Menu 14: Chipset**

### 5.4.1 Host Bridge Configuration

Use the **Host Bridge Configuration** menu (**BIOS Menu 15**) to configure the Northbridge chipset.

```

Aptio Setup Utility - Copyright (C) 2010 American Megatrends, Inc.
Chipset
> OnChip VGA Configuration

***** Memory Information *****
Memory Frequency           800 Mhz
Total Memory               1024 MB
DIMM#0                    Not Present
DIMM#1                    1024 MB

<=>: Select Screen
↑↓: Select Item
Enter>Select
F1  General Help
F2  Previous Values
F3  Optimized
Defaults
F4  Save
ESC Exit

Version 2.02.1205. Copyright (C) 2010 American Megatrends, Inc.
  
```

**BIOS Menu 15: Host Bridge Chipset Configuration**

#### 5.4.1.1 OnChip VGA Configuration

Use the **OnChip VGA Configuration** menu (**BIOS Menu 16**) to configure the OnChip VGA.

```

Aptio Setup Utility - Copyright (C) 2010 American Megatrends, Inc.
Chipset
OnChip VGA Configuration

Share Memory Size          [8 MB]
Multi-Monitor Support      [Enabled]

<=>: Select Screen
↑↓: Select Item
Enter>Select
F1  General Help
F2  Previous Values
F3  Optimized
Defaults
F4  Save
ESC Exit

Version 2.02.1205. Copyright (C) 2010 American Megatrends, Inc.
  
```

**BIOS Menu 16: OnChip VGA Configuration**

## PICOe-PV-D4251/N4551/D5251 User Manual

### → Share Memory Size [8 MB]

Use the **Share Memory Size** option to set the amount of system memory allocated to the integrated graphics processor when the system boots. The system memory allocated can then only be used as graphics memory, and is no longer available to applications or the operating system. Configuration options are listed below:

- Disabled
- 1 MB
- 8 MB                      **Default**

### → Multi-Monitor Support [Enabled]

Use **Multi-Monitor Support** option to enable or disable the multi-monitor function.

- **Disabled**                      Disabled the multi-monitor function
- **Enabled**                      **DEFAULT**                      Enabled the multi-monitor function

## 5.4.2 South Bridge Configuration

Use the **South Bridge Configuration** menu (**BIOS Menu 17**) to configure the Southbridge chipset.

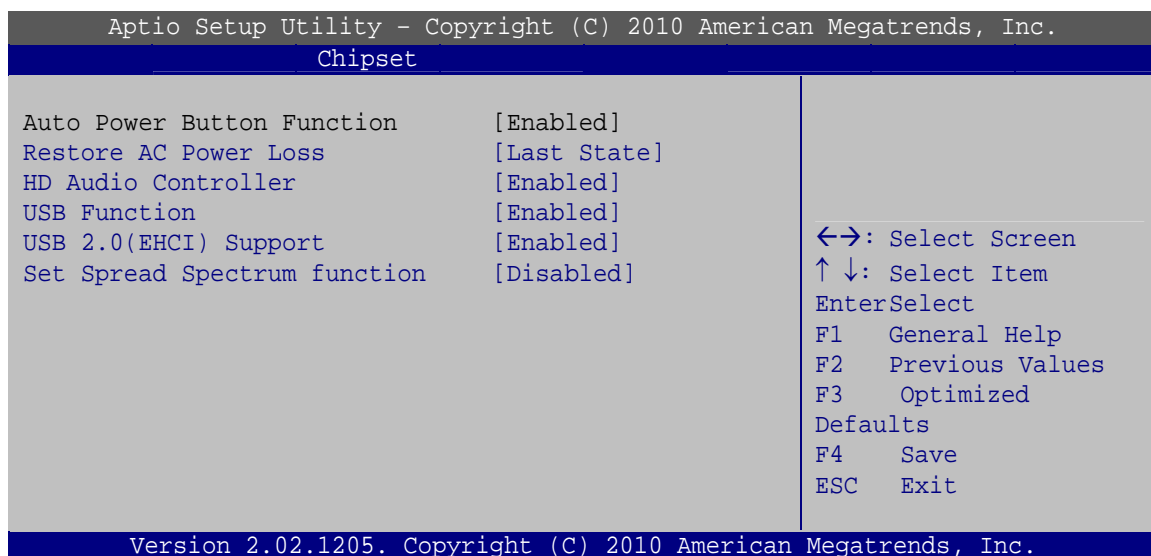

**BIOS Menu 17: South Bridge Chipset Configuration**

→ **Restore on AC Power Loss [Last State]**

Use the **Restore on AC Power Loss** BIOS option to specify what state the system returns to if there is a sudden loss of power to the system.

- **Power Off**                      The system remains turned off
- **Power On**                      The system turns on
- **Last State**    **DEFAULT**    The system returns to its previous state. If it was on, it turns itself on. If it was off, it remains off.

→ **HD Audio Controller [Enabled]**

Use the **HD Audio Controller** option to enable or disable the High Definition Audio controller.

- **Enabled**    **DEFAULT**    The onboard High Definition Audio controller automatically detected and enabled
- **Disabled**                      The onboard High Definition Audio controller is disabled

→ **USB Function [Enabled]**

Use the **USB Function** BIOS option to enable or disable USB function support.

- **Disabled**                      USB function support disabled
- **Enabled**            **DEFAULT**    USB function support enabled

→ **USB 2.0 (EHCI) Support [Enabled]**

Use the **USB 2.0 (EHCI) Support** BIOS option to enable or disable USB 2.0 support.

- **Enabled**            **DEFAULT**    USB 2.0 (EHCI) support enabled
- **Disabled**                      USB 2.0 (EHCI) support disabled

→ **Set Spread Spectrum Function [Disabled]**

The **Set Spread Spectrum Function** option can help to improve CPU EMI issues.



## PICOe-PV-D4251/N4551/D5251 User Manual

- ➔ **Disabled**      **DEFAULT**      The spread spectrum mode is disabled
- ➔ **Enabled**                              The spread spectrum mode is enabled

### 5.4.3 Intel IGD SWSCI OpRegion

Use the **Intel IGD SWSCI OpRegion** menu to configure the video device connected to the system.

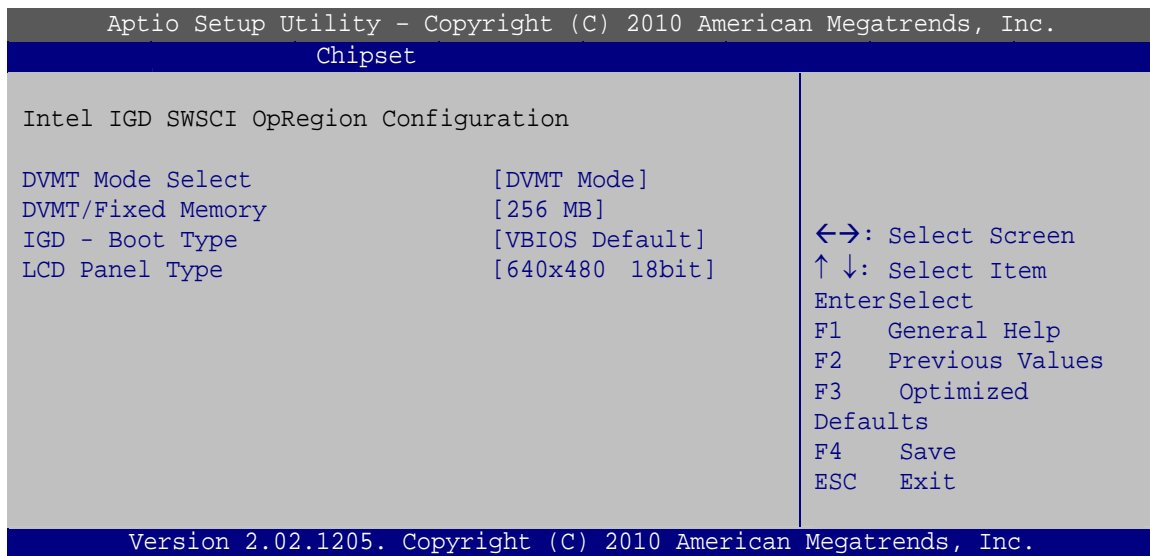

#### BIOS Menu 18: South Bridge Chipset Configuration

##### ➔ **DVMT Mode Select [DVMT Mode]**

Use the **DVMT Mode Select** option to select the Intel Dynamic Video Memory Technology (DVMT) operating mode.

- ➔ **Fixed Mode**                              A fixed portion of graphics memory is reserved as graphics memory.
- ➔ **DVMT Mode**                              **DEFAULT**      Graphics memory is dynamically allocated according to the system and graphics needs.

##### ➔ **DVMT/FIXED Memory [256 MB]**

Use the **DVMT/FIXED Memory** option to specify the maximum amount of memory that can be allocated as graphics memory. Configuration options are listed below.

- 128 MB
- 256 MB      **Default**
- Maximum

➔ **IGD - Boot Type [VBIOS Default]**

Use the **IGD - Boot Type** option to select the display device used by the system when it boots. Configuration options are listed below.

- VBIOS Default      **DEFAULT**
- CRT
- LFP
- CRT + LFP

➔ **LCD Panel Type [640x480 18bit]**

Use the **LCD Panel Type** option to select the type of flat panel connected to the system. Configuration options are listed below.

- 640x480 18bit      **DEFAULT**
- 800x480 18bit
- 800x600 18bit
- 1024x768 18bit
- 1280x1024 18bit
- 1366x768 18bit
- 1280x800 18bit
- 1280x600 18bit

## 5.5 Boot

Use the **Boot** menu (**BIOS Menu 19**) to configure system boot options.

```

Aptio Setup Utility - Copyright (C) 2010 American Megatrends, Inc.
Main   Advanced  Chipset  Boot    Security  Save & Exit

Boot Configuration
Boot NumLock State              [On]

Quiet Boot                      [Enabled]
Launch PXE OpROM               [Disabled]

Boot Option Priorities

                                  ←→: Select Screen
                                  ↑↓: Select Item
                                  EnterSelect
                                  F1   General Help
                                  F2   Previous Values
                                  F3   Optimized
                                  Defaults
                                  F4   Save
                                  ESC  Exit

Version 2.02.1205. Copyright (C) 2010 American Megatrends, Inc.

```

### BIOS Menu 19: Boot

#### → Bootup NumLock State [On]

Use the **Bootup NumLock State** BIOS option to specify if the number lock setting must be modified during boot up.

- **On**                    **DEFAULT**      Allows the Number Lock on the keyboard to be enabled automatically when the computer system boots up. This allows the immediate use of the 10-key numeric keypad located on the right side of the keyboard. To confirm this, the Number Lock LED light on the keyboard is lit.
- **Off**                    Does not enable the keyboard Number Lock automatically. To use the 10-keys on the keyboard, press the Number Lock key located on the upper left-hand corner of the 10-key pad. The Number Lock LED on the keyboard lights up when the Number Lock is engaged.

**→ Quiet Boot [Enabled]**

Use the **Quiet Boot** BIOS option to select the screen display when the system boots.

- **Disabled**                      Normal POST messages displayed
- **Enabled**      **DEFAULT**      OEM Logo displayed instead of POST messages

**→ Launch PXE OpROM [Disabled]**

Use the **Launch PXE OpROM** option to enable or disable boot option for legacy network devices.

- **Disabled**      **DEFAULT**      Ignore all PXE Option ROMs
- **Enabled**                      Load PXE Option ROMs.

## 5.6 Security

Use the **Security** menu (**BIOS Menu 20**) to set system and user passwords.

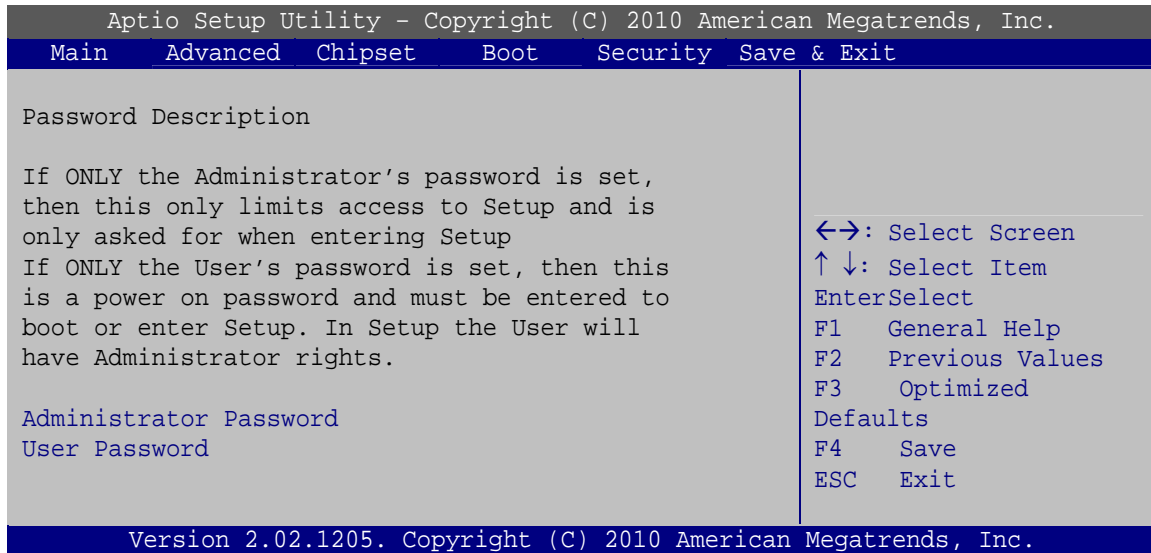
**BIOS Menu 20: Security**
**→ Administrator Password**

Use the **Administrator Password** to set or change a administrator password.

## PICOe-PV-D4251/N4551/D5251 User Manual

### → User Password

Use the **User Password** to set or change a user password.

## 5.7 Exit

Use the **Exit** menu (**BIOS Menu 21**) to load default BIOS values, optimal failsafe values and to save configuration changes.

```

Aptio Setup Utility - Copyright (C) 2010 American Megatrends, Inc.
Main   Advanced  Chipset   Boot     Security  Save & Exit
-----
Save Changes and Reset
Discard Changes and Reset

Restore Defaults
Save as User Defaults
Restore User Defaults

                                  ←→: Select Screen
                                  ↑↓: Select Item
                                  EnterSelect
                                  F1   General Help
                                  F2   Previous Values
                                  F3   Optimized
                                  Defaults
                                  F4   Save
                                  ESC  Exit

Version 2.02.1205. Copyright (C) 2010 American Megatrends, Inc.

```

### BIOS Menu 21:Exit

#### → Save Changes and Reset

Use the **Save Changes and Reset** option to save the changes made to the BIOS options and to exit the BIOS configuration setup program.

#### → Discard Changes and Reset

Use the **Discard Changes and Reset** option to exit the system without saving the changes made to the BIOS configuration setup program.

#### → Restore Defaults

Use the **Restore Defaults** option to load the optimal default values for each of the parameters on the Setup menus. **F3 key can be used for this operation.**

→ **Save as User Defaults**

Use the **Save as User Defaults** option to save the changes done so far as user defaults.

→ **Restore User Defaults**

Use the **Restore User Defaults** option to restore the user defaults to all the setup options.

Appendix

A

# BIOS Options

---

Below is a list of BIOS configuration options in the BIOS chapter.

<b>BIOS Information</b> .....	71
<b>System Date [xx/xx/xx]</b> .....	71
<b>System Time [xx:xx:xx]</b> .....	72
<b>ACPI Sleep State [S3 (Suspend to RAM)]</b> .....	73
<b>TPM Support [Disable]</b> .....	74
<b>ATA/IDE Configurations [Enhanced]</b> .....	76
<b>Configure SATA as [IDE]</b> .....	77
<b>USB Devices</b> .....	77
<b>Legacy USB Support [Enabled]</b> .....	77
<b>Serial Port [Enabled]</b> .....	79
<b>Change Settings [Auto]</b> .....	79
<b>Serial Port [Enabled]</b> .....	80
<b>Change Settings [Auto]</b> .....	80
<b>Serial Port [Enabled]</b> .....	80
<b>Change Settings [Auto]</b> .....	81
<b>Serial Port [Enabled]</b> .....	81
<b>Change Settings [Auto]</b> .....	81
<b>IrDA [Enabled]</b> .....	82
<b>Parallel Port [Enabled]</b> .....	83
<b>Change Settings [Auto]</b> .....	83
<b>Device Mode [Printer Mode]</b> .....	84
<b>PC Health Status</b> .....	85
<b>CPU Smart Fan control [Auto Mode]</b> .....	86
<b>Console Redirection [Disabled]</b> .....	86
<b>Share Memory Size [8 MB]</b> .....	89
<b>Multi-Monitor Support [Enabled]</b> .....	89
<b>Restore on AC Power Loss [Last State]</b> .....	90
<b>HD Audio Controller [Enabled]</b> .....	90
<b>USB Function [Enabled]</b> .....	90
<b>USB 2.0 (EHCI) Support [Enabled]</b> .....	90
<b>Set Spread Spectrum Function [Disabled]</b> .....	90
<b>DVMT Mode Select [DVMT Mode]</b> .....	91
<b>DVMT/FIXED Memory [256 MB]</b> .....	91



## PICOe-PV-D4251/N4551/D5251 User Manual

IGD - Boot Type [VBIOS Default].....	92
LCD Panel Type [640x480 18bit].....	92
Bootup NumLock State [On].....	93
Quiet Boot [Enabled] .....	94
Launch PXE OpROM [Disabled].....	94
Administrator Password .....	94
User Password .....	95
Save Changes and Reset .....	95
Discard Changes and Reset .....	95
Restore Defaults .....	95
Save as User Defaults .....	96
Restore User Defaults .....	96

Appendix

**B**

# One Key Recovery

---

## B.1 One Key Recovery Introduction

The IEI one key recovery is an easy-to-use front end for the Norton Ghost system backup and recovery tool. The one key recovery provides quick and easy shortcuts for creating a backup and reverting to that backup or for reverting to the factory default settings.

The IEI One Key Recovery tool menu is shown below.

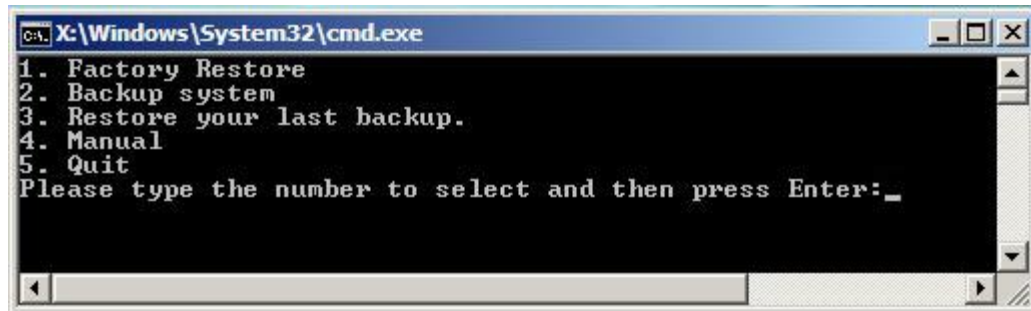

Figure B-1: IEI One Key Recovery Tool Menu

Prior to using the IEI One Key Recovery tool (as shown in **Figure B-1**) to backup or restore Windows system, five setup procedures are required.

1. Hardware and BIOS setup (see **Section B.2.1**)
2. Create partitions (see **Section B.2.2**)
3. Install operating system, drivers and system applications (see **Section B.2.3**)
4. Build-up recovery partition (see **Section B.2.4**)
5. Create factory default image (see **Section B.2.5**)

After completing the five initial setup procedures as described above, users can access the recovery tool by pressing <F3> while booting up the system. The detailed information of each function is described in **Section B.4**.



### NOTE:

The initial setup procedures for Linux system are described in **Section B.3**.

---

### B.1.1 System Requirement

**NOTE:**

The recovery CD can only be used with IEI products. The software will fail to run and a warning message will appear when used on non-IEI hardware.

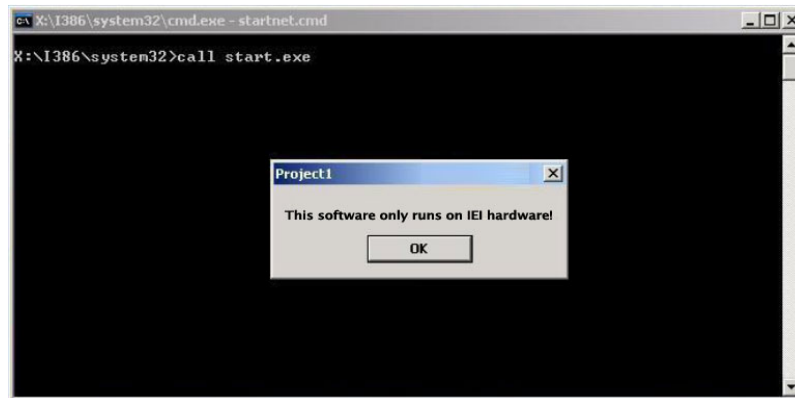

To create the system backup, the main storage device must be split into two partitions (three partitions for Linux). The first partition will be for the operating system, while the second partition will be invisible to the operating system and contain the backup made by the one key recovery software.

The partition created for recovery images must be big enough to contain both the factory default image and the user backup image. The size must be calculated before creating the partitions. Please take the following table as a reference when calculating the size of the partition.

	OS	OS Image after Ghost	Compression Ratio
<b>Windows® 7</b>	7 GB	5 GB	70%
<b>Windows® XPE</b>	776 MB	560 MB	70%
<b>Windows® CE 6.0</b>	36 MB	28 MB	77%

**NOTE:**

Specialized tools are required to change the partition size if the operating system is already installed.

**B.1.2 Supported Operating System**

The recovery CD is compatible with both Microsoft Windows and Linux operating system (OS). The supported OS versions are listed below.

- Microsoft Windows
  - Windows XP (Service Pack 2 or 3 required)
  - Windows Vista
  - Windows 7
  - Windows CE 5.0
  - Windows CE 6.0
  - Windows XP Embedded
- Linux
  - Fedora Core 12 (Constantine)
  - Fedora Core 11 (Leonidas)
  - Fedora Core 10 (Cambridge)
  - Fedora Core 8 (Werewolf)
  - Fedora Core 7 (Moonshine)
  - RedHat RHEL-5.4
  - RedHat 9 (Ghirke)
  - Ubuntu 8.10 (Intrepid)
  - Ubuntu 7.10 (Gutsy)
  - Ubuntu 6.10 (Edgy)
  - Debian 5.0 (Lenny)
  - Debian 4.0 (Etch)
  - SuSe 11.2
  - SuSe 10.3

**NOTE:**

Installing unsupported OS versions may cause the recovery tool to fail.

## B.2 Setup Procedure for Windows

Prior to using the recovery tool to backup or restore Windows system, a few setup procedures are required.

**Step 1:** Hardware and BIOS setup (see **Section B.2.1**)

**Step 2:** Create partitions (see **Section B.2.2**)

**Step 3:** Install operating system, drivers and system applications (see **Section B.2.3**)

**Step 4:** Build-up recovery partition (see **Section B.2.4**)

**Step 5:** Create factory default image (see **Section B.2.5**)

The detailed descriptions are described in the following sections.

**NOTE:**

The setup procedures described below are for Microsoft Windows operating system users. For Linux system, most setup procedures are the same with Microsoft Windows except for several steps which is described in **Section B.3**.

### B.2.1 Hardware and BIOS Setup

**Step 1:** Make sure the system is powered off and unplugged.

**Step 2:** Install a hard drive or SSD in the system. An unformatted and unpartitioned disk is recommended.

**Step 3:** Connect an optical disk drive to the system and insert the recovery CD.

- Step 4:** Turn on the system.
- Step 5:** Press the <DELETE> key as soon as the system is turned on to enter the BIOS.
- Step 6:** Select the connected optical disk drive as the 1<sup>st</sup> boot device. (**Boot → Boot Device Priority → 1<sup>st</sup> Boot Device**).
- Step 7:** Save changes and restart the computer. Continue to the next section for instructions on partitioning the internal storage.

## B.2.2 Create Partitions

To create the system backup, the main storage device must be split into two partitions (three partitions for Linux). The first partition will be for the operating system, while the second partition will be invisible to the operating system and contain the backup made by the one key recovery software.

- Step 1:** Put the recovery CD in the optical drive of the system.
- Step 2:** **Boot the system from recovery CD.** When prompted, press any key to boot from the recovery CD. It will take a while to launch the recovery tool. Please be patient!

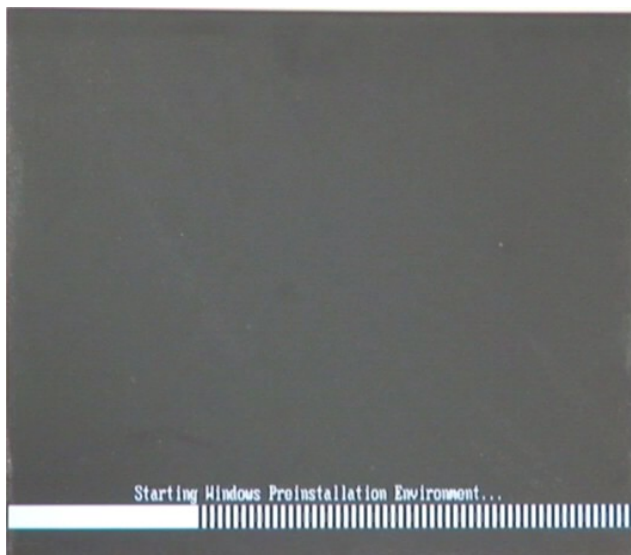
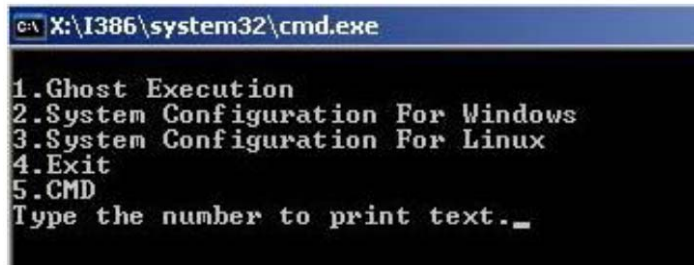

Figure B-2: Launching the Recovery Tool

**Step 3:** The recovery tool setup menu is shown as below.



```
C:\X:\I386\system32\cmd.exe
1.Ghost Execution
2.System Configuration For Windows
3.System Configuration For Linux
4.Exit
5.CMD
Type the number to print text._
```

**Figure B-3: Recovery Tool Setup Menu**

**Step 4:** Press <5> then <Enter>.

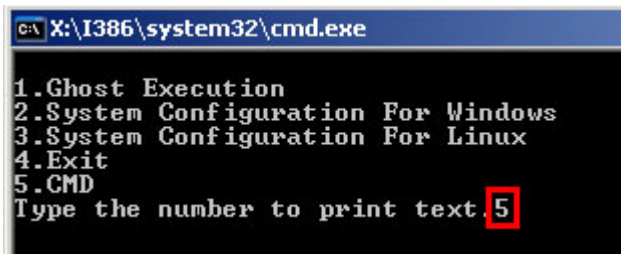

```
C:\X:\I386\system32\cmd.exe
1.Ghost Execution
2.System Configuration For Windows
3.System Configuration For Linux
4.Exit
5.CMD
Type the number to print text. 5
```

**Figure B-4: Command Mode**

**Step 5:** The command prompt window appears. Type the following commands (marked in red) to create two partitions. One is for the OS installation; the other is for saving recovery files and images which will be an invisible partition.

(Press <Enter> after entering each line below)

```
system32>diskpart
DISKPART>list vol
DISKPART>sel disk 0
DISKPART>create part pri size= ____
DISKPART>assign letter=N
DISKPART>create part pri size= ____
DISKPART>assign letter=F
DISKPART>exit
system32>format N: /fs:ntfs /q /y
```



system32>format F: /fs:ntfs /q /v:Recovery /y

system32>exit

```
X:\I386\SYSTEM32\CMD.EXE
X:\I386\SYSTEM32>diskpart → Starts the Microsoft disk partitioning tool.
Microsoft DiskPart version 5.2.3790.1830
Copyright (C) 1999-2001 Microsoft Corporation.
On computer: MININT-JUC
DISKPART> list vol → Show partition information
Volume ### Ltr Label Fs Type Size Status Info
-----
Volume 0 X CD_ROM GDFS DVD-ROM 405 MB Healthy Boot
Volume 1 D FAT32 Removeable 3854 MB Healthy
DISKPART> sel disk 0 → Select a disk
Disk 0 is now the selected disk.
DISKPART> create part pri size=2000 → Create partition 1 and assign a size.
This partition is for OS installation.
DiskPart succeeded in creating the specified partition.
DISKPART> assign letter=N → Assign partition 1 a code name (N).
DiskPart successfully assigned the drive letter or mount point.
DISKPART> create part pri size=1800 → Create partition 2 and assign a size.
This partition is for recovery images.
DiskPart succeeded in creating the specified partition.
DISKPART> assign letter=F → Assign partition 2 a code name (F).
DiskPart successfully assigned the drive letter or mount point.
DISKPART> exit → Exit diskpart
X:\I386\SYSTEM32>format n: /fs:ntfs /q /y → Format partition 1 (N) as NTFS format.
The type of the file system is ntfs.
The new file system is NTFS.
QuickFormatting 2000M
Creating file system structures.
Format complete.
2048254 KB total disk space.
2035620 KB are available.
X:\I386\SYSTEM32>format f: /fs:ntfs /q /v:Recovery /y → Formate partition 2 (F) as NTFS formate and
name it as "Recovery".
The type of the file system is ntfs.
The new file system is NTFS.
QuickFormatting 1804M
Creating file system structures.
Format complete.
1847474 KB total disk space.
1835860 KB are available.
X:\I386\SYSTEM32>exit → Exit Windows PE
```

Figure B-5: Partition Creation Commands

**NOTE:**

Use the following commands to check if the partitions were created successfully.

```

X:\I386\SYSTEM32>diskpart
Microsoft DiskPart version 5.2.3790.1830
Copyright (C) 1999-2001 Microsoft Corporation.
On computer: MININT-JUC

DISKPART> sel disk 0
Disk 0 is now the selected disk.

DISKPART> list part

   Partition ###   Type              Size              Offset
-----
   Partition 1     Primary           2000 MB           32 KB
   Partition 2     Primary           1804 MB          2000 MB

DISKPART> exit
    
```

**Step 6:** Press any key to exit the recovery tool and automatically reboot the system.

Please continue to the following procedure: Build-up Recovery Partition.

### B.2.3 Install Operating System, Drivers and Applications

Install the operating system onto the unlabelled partition. The partition labeled as "Recovery" is for use by the system recovery tool and should not be used for installing the operating system or any applications.

**NOTE:**

The operating system installation program may offer to reformat the chosen partition. DO NOT format the partition again. The partition has already been formatted and is ready for installing the new operating system.

To install the operating system, insert the operating system installation CD into the optical drive. Restart the computer and follow the installation instructions.

## B.2.4 Build-up Recovery Partition

- Step 1:** Put the recover CD in the optical drive.
- Step 2:** Start the system.
- Step 3:** **Boot the system from recovery CD.** When prompted, press any key to boot from the recovery CD. It will take a while to launch the recovery tool. Please be patient!

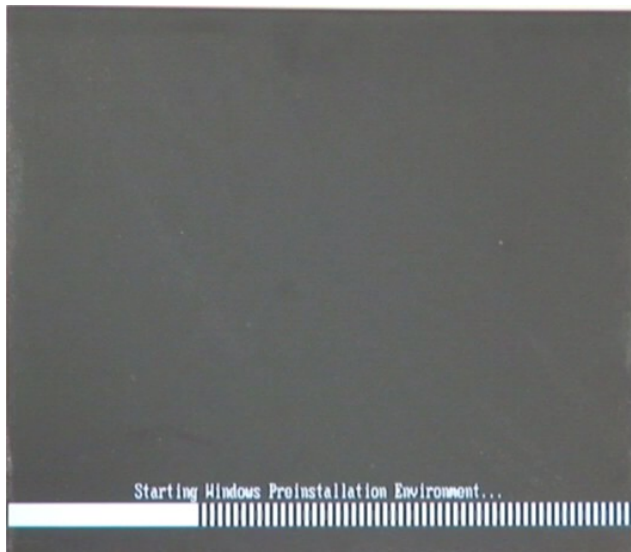

Figure B-6: Launching the Recovery Tool

- Step 4:** When the recovery tool setup menu appears, press <2> then <Enter>.

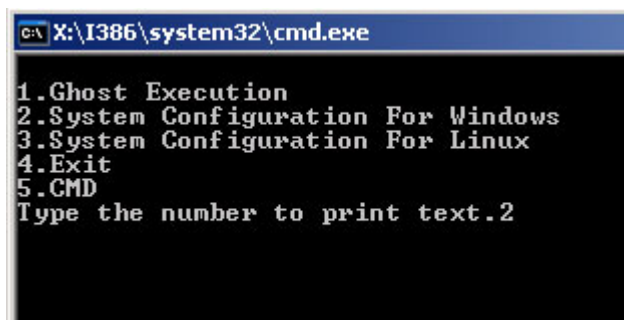
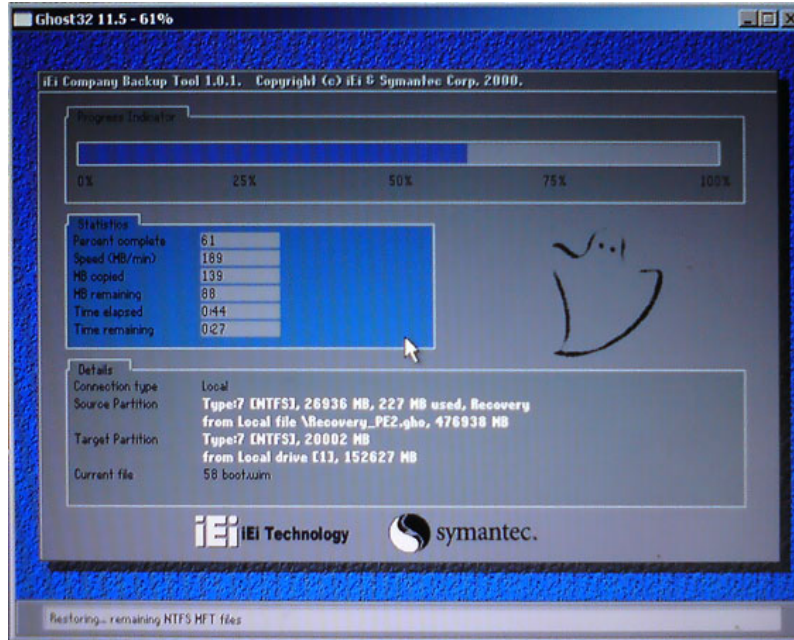

Figure B-7: System Configuration for Windows

- Step 5:** The Symantec Ghost window appears and starts configuring the system to build-up a recovery partition. In this process, the partition which is created for

recovery files in **Section B.2.2** is hidden and the recovery tool is saved in this partition.



**Figure B-8: Build-up Recovery Partition**

**Step 6:** After completing the system configuration, press any key in the following window to reboot the system.

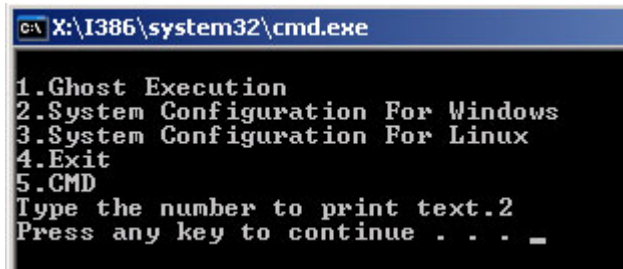

**Figure B-9: Press any key to continue**

**Step 7:** Eject the recovery CD.

## B.2.5 Create Factory Default Image



### NOTE:

Before creating the factory default image, please configure the system to a factory default environment, including driver and application installations.

To create a factory default image, please follow the steps below.

**Step 1:** Turn on the system. When the following screen displays (**Figure B-10**), press the <F3> key to access the recovery tool. The message will display for 10 seconds, please press F3 before the system boots into the operating system.

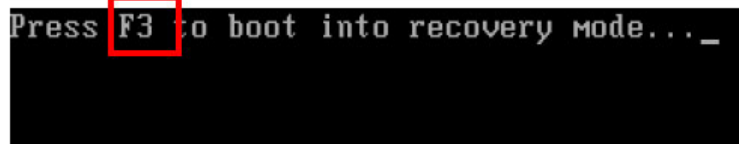

```
Press F3 to boot into recovery mode... _
```

Figure B-10: Press F3 to Boot into Recovery Mode

**Step 2:** The recovery tool menu appears. Type <4> and press <Enter>. (**Figure B-11**)

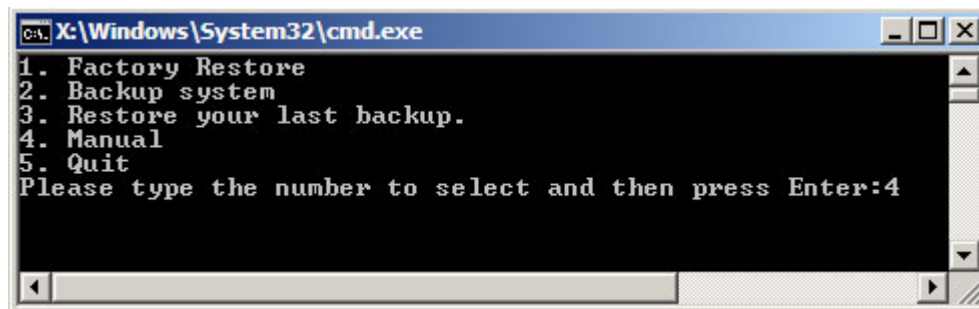

Figure B-11: Recovery Tool Menu

**Step 3:** The About Symantec Ghost window appears. Click **OK** button to continue.

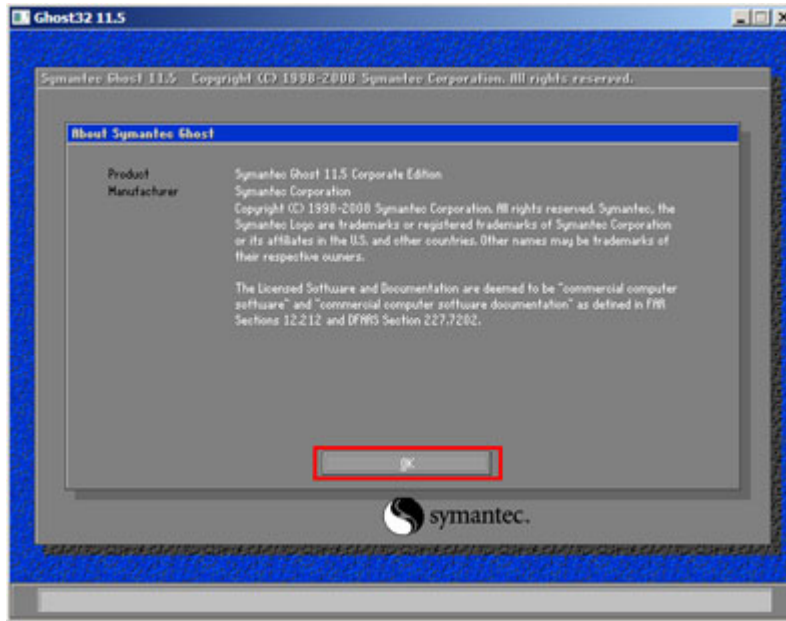

Figure B-12: About Symantec Ghost Window

**Step 4:** Use mouse to navigate to the option shown below (Figure B-13).

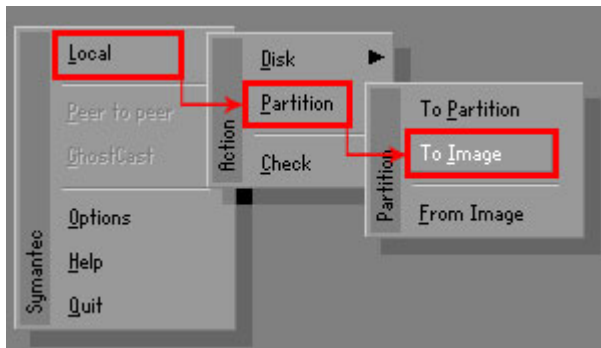

Figure B-13: Symantec Ghost Path

**Step 5:** Select the local source drive (Drive 1) as shown in Figure B-14. Then click OK.

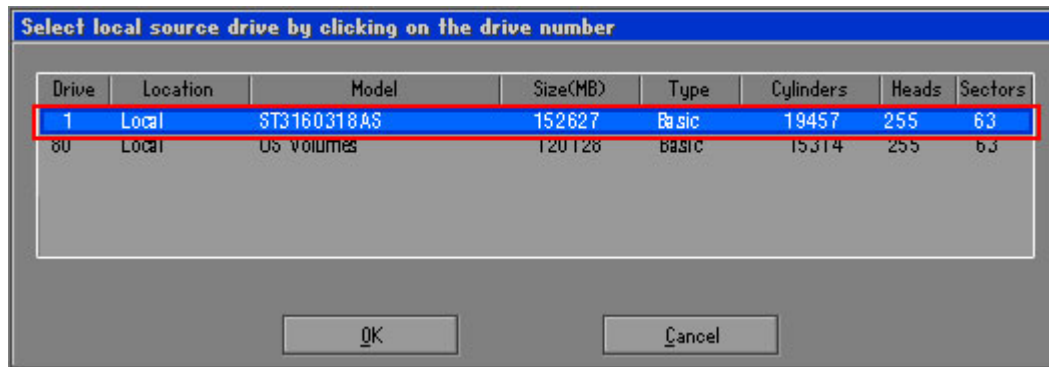

Figure B-14: Select a Local Source Drive

**Step 6:** Select a source partition (Part 1) from basic drive as shown in **Figure B-15**. Then click OK.

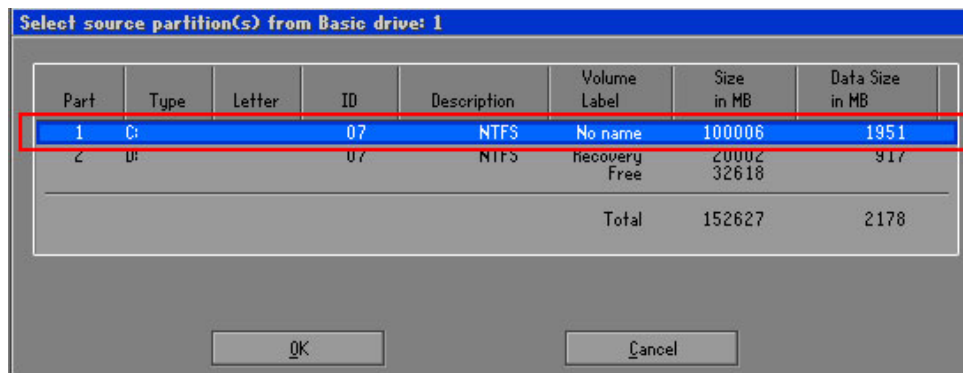

Figure B-15: Select a Source Partition from Basic Drive

**Step 7:** Select **1.2: [Recovery] NTFS drive** and enter a file name called **iei** (**Figure B-16**). Click **Save**. The factory default image will then be saved in the selected recovery drive and named **IEI.GHO**.



**WARNING:**

The file name of the factory default image must be **iei.GHO**.

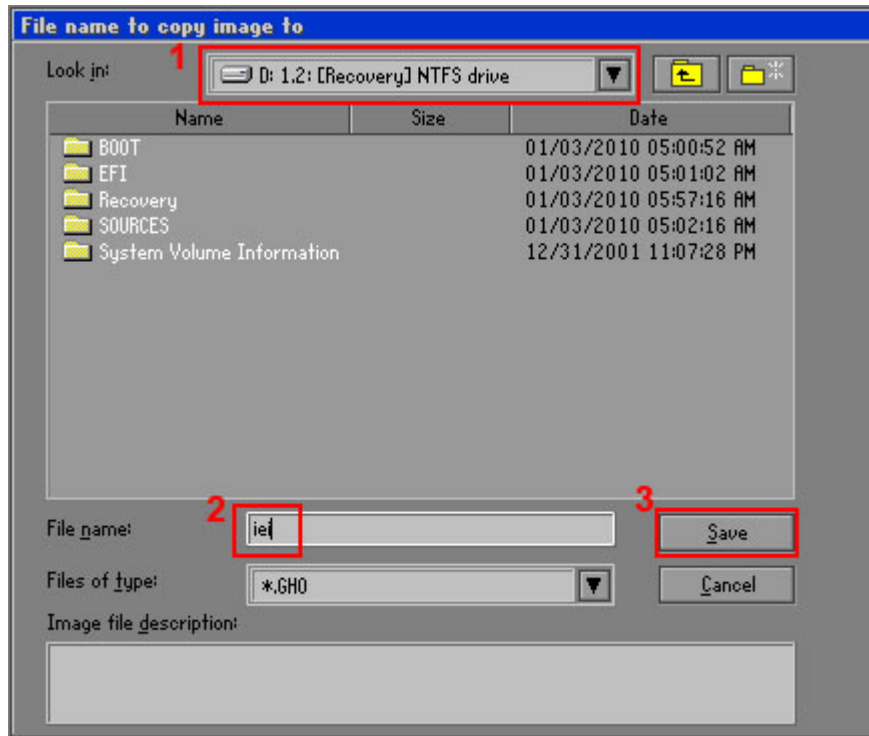

Figure B-16: File Name to Copy Image to

**Step 8:** When the Compress Image screen in **Figure B-17** prompts, click **High** to make the image file smaller.

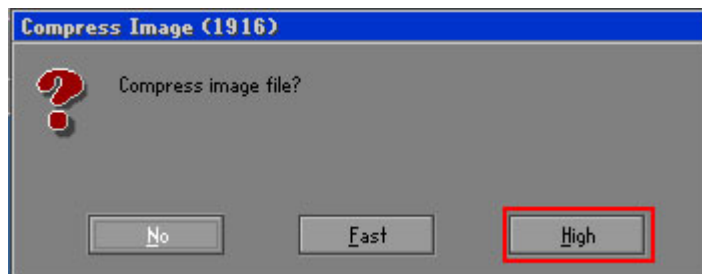
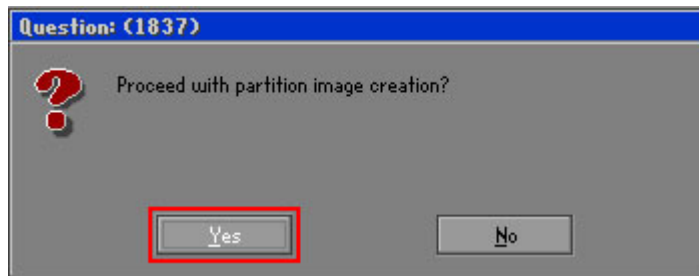

Figure B-17: Compress Image



**Step 9:** The Proceed with partition image creation window appears, click **Yes** to continue.



**Figure B-18: Image Creation Confirmation**

**Step 10:** The Symantec Ghost starts to create the factory default image (**Figure B-19**).

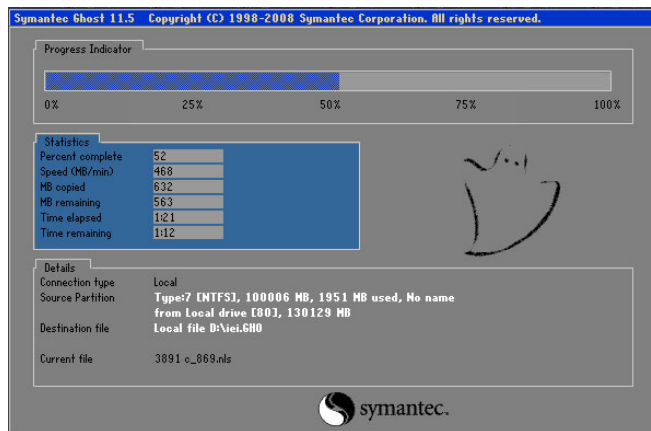

**Figure B-19: Image Creation Process**

**Step 11:** When the image creation completes, a screen prompts as shown in **Figure B-20**.

Click **Continue** and close the Ghost window to exit the program.

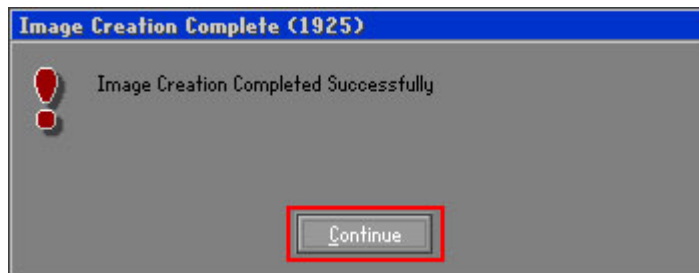

**Figure B-20: Image Creation Complete**

**Step 12:** The recovery tool main menu window is shown as below. Press any key to reboot the system.

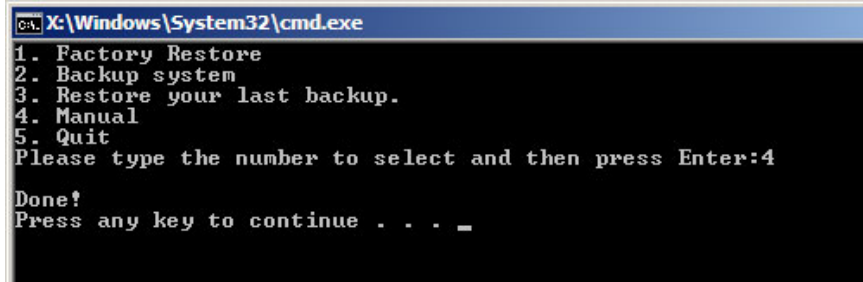

```

C:\Windows\System32\cmd.exe
1. Factory Restore
2. Backup system
3. Restore your last backup.
4. Manual
5. Quit
Please type the number to select and then press Enter:4
Done!
Press any key to continue . . . _
  
```

Figure B-21: Press Any Key to Continue

## B.3 Setup Procedure for Linux

The initial setup procedures for Linux system are mostly the same with the procedure for Microsoft Windows. Please follow the steps below to setup recovery tool for Linux OS.

**Step 1: Hardware and BIOS setup.** Refer to **Section B.2.1**.

**Step 2: Install Linux operating system.** Make sure to install GRUB (v0.97 or earlier) MBR type and Ext3 partition type. Leave enough space on the hard drive to create the recover partition later.



### NOTE:

If the Linux OS is not installed with GRUB (v0.97 or earlier) and Ext3, the Symantec Ghost may not function properly.

While installing Linux OS, please create two partitions:

- Partition 1: /
- Partition 2: **SWAP**

**NOTE:**

Please reserve enough space for partition 3 for saving recovery images.

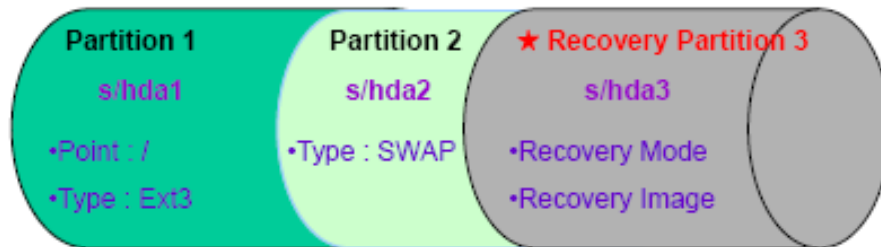

Figure B-22: Partitions for Linux

**Step 3:** Create a recovery partition. Insert the recovery CD into the optical disk drive.

Follow **Step 1 ~ Step 3** described in **Section B.2.2**. Then type the following commands (marked in red) to create a partition for recovery images.

```
system32>diskpart
DISKPART>list vol
DISKPART>sel disk 0
DISKPART>create part pri size= ____
DISKPART>assign letter=N
DISKPART>exit
system32>format N: /fs:ntfs /q /v:Recovery /y
system32>exit
```

**Step 4:** Build-up recovery partition. Press any key to boot from the recovery CD. It will take a while to launch the recovery tool. Please be patient. When the recovery tool setup menu appears, type <3> and press <Enter> (**Figure B-23**). The Symantec Ghost window appears and starts configuring the system to build-up a recovery partition. After completing the system configuration, press any key to reboot the system. Eject the recovery CD.

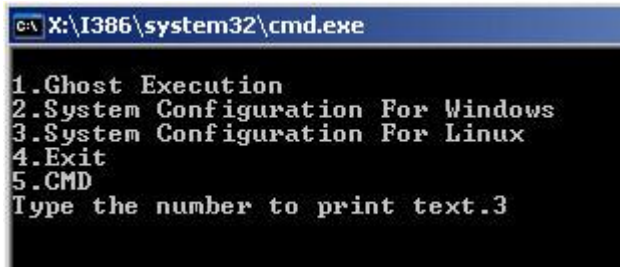

```
C:\X:\I386\system32\cmd.exe
1.Ghost Execution
2.System Configuration For Windows
3.System Configuration For Linux
4.Exit
5.CMD
Type the number to print text.3
```

Figure B-23: System Configuration for Linux

**Step 5:** Access the recovery tool main menu by modifying the “menu.lst”. To first access the recovery tool main menu, the menu.lst must be modified. In Linux system, enter Administrator (root). When prompt appears, type:

```
cd /boot/grub
```

```
vi menu.lst
```

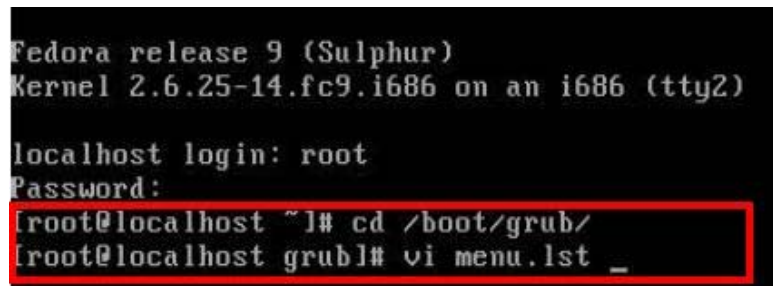

```
Fedora release 9 (Sulphur)
Kernel 2.6.25-14.fc9.i686 on an i686 (tty2)

localhost login: root
Password:
[root@localhost ~]# cd /boot/grub/
[root@localhost grub]# vi menu.lst _
```

Figure B-24: Access menu.lst in Linux (Text Mode)

**Step 6:** Modify the menu.lst as shown below.

```
#boot=/dev/sda
default=0
timeout=10 ← Modify timeout=10
splashimage=(hd0,0)/grub/splash.xpm.gz
hiddenmenu
title Fedora (2.6.25-14.fc9.i686)
    root (hd0,0)
    kernel /vmlinuz-2.6.25-14.fc9.i686 ro root=UUID=10f1acd
ac38b5c78910 rhgb quiet
    initrd /initrd-2.6.25-14.fc9.i686.img

title Recovery Partition
root (hd0,2)
makeactive ← Type command
chainloader +1
```

- Type command:  
**title Recovery Partition**  
**root (hd0,2)**  
**makeactive**  
**chainloader +1**

**Step 7:** The recovery tool menu appears. (Figure B-25)

```
1. Factory Restore
2. Backup system
3. Restore your last backup.
4. Manual
5. Quit
Please type the number to select and then press Enter:
```

Figure B-25: Recovery Tool Menu

**Step 8:** Create a factory default image. Follow **Step 2 ~ Step 12** described in **Section B.2.5** to create a factory default image.

## B.4 Recovery Tool Functions

After completing the initial setup procedures as described above, users can access the recovery tool by pressing **<F3>** while booting up the system. The main menu of the recovery tool is shown below.

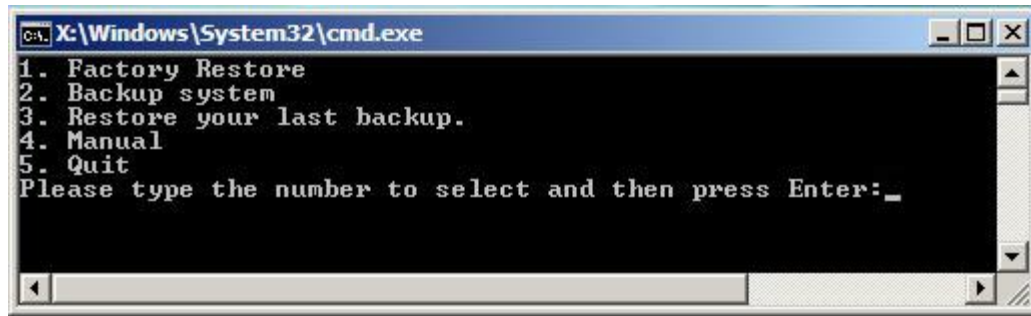

Figure B-26: Recovery Tool Main Menu

The recovery tool has several functions including:

1. **Factory Restore:** Restore the factory default image (iei.GHO) created in Section B.2.5.
2. **Backup system:** Create a system backup image (iei\_user.GHO) which will be saved in the hidden partition.
3. **Restore your last backup:** Restore the last system backup image
4. **Manual:** Enter the Symantec Ghost window to configure manually.
5. **Quit:** Exit the recovery tool and restart the system.



#### WARNING:

Please do not turn off the system power during the process of system recovery or backup.



#### WARNING:

All data in the system will be deleted during the system recovery. Please backup the system files before restoring the system (either Factory Restore or Restore Backup).

### B.4.1 Factory Restore

To restore the factory default image, please follow the steps below.

**Step 1:** Type <1> and press <Enter> in the main menu.

**Step 2:** The Symantec Ghost window appears and starts to restore the factory default. A factory default image called **iei.GHO** is created in the hidden Recovery partition.

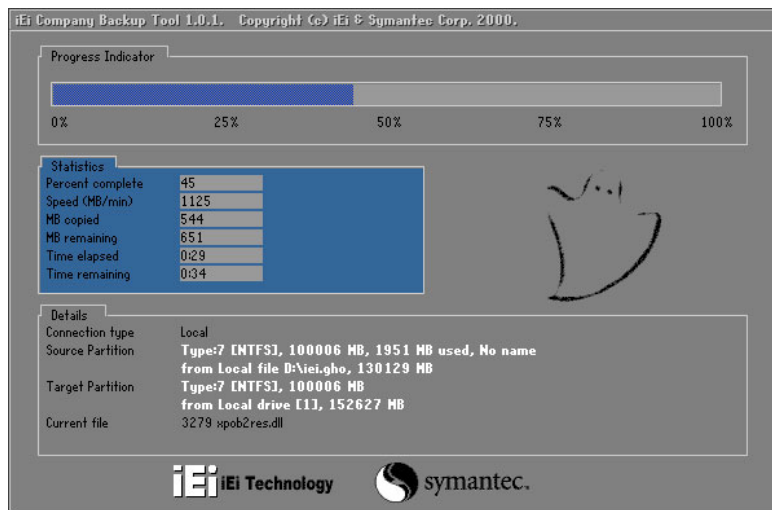

Figure B-27: Restore Factory Default

**Step 3:** The screen is shown as in **Figure B-28** when completed. Press any key to reboot the system.

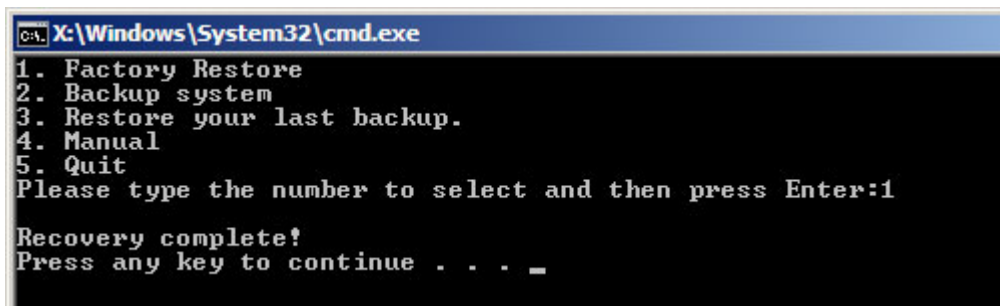

Figure B-28: Recovery Complete Window

## B.4.2 Backup System

To backup the system, please follow the steps below.

**Step 1:** Type <2> and press <Enter> in the main menu.

**Step 2:** The Symantec Ghost window appears and starts to backup the system. A backup image called **iei\_user.GHO** is created in the hidden Recovery partition.

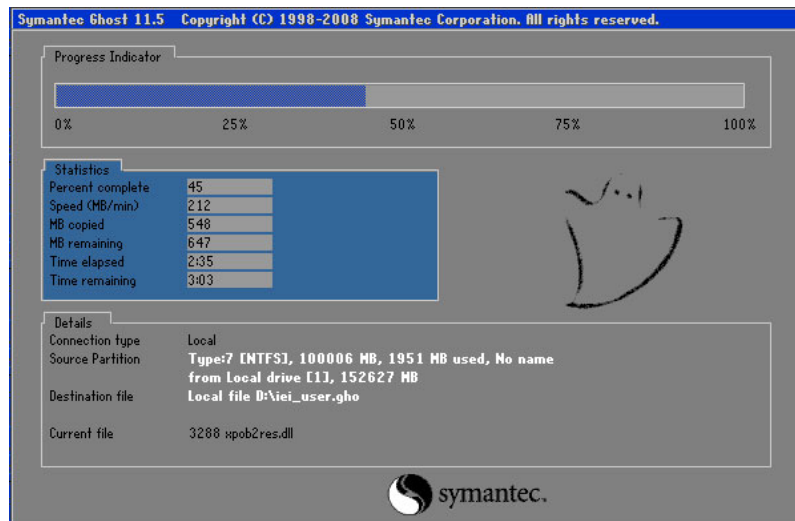

**Figure B-29: Backup System**

**Step 3:** The screen is shown as in **Figure B-30** when system backup is completed.

Press any key to reboot the system.

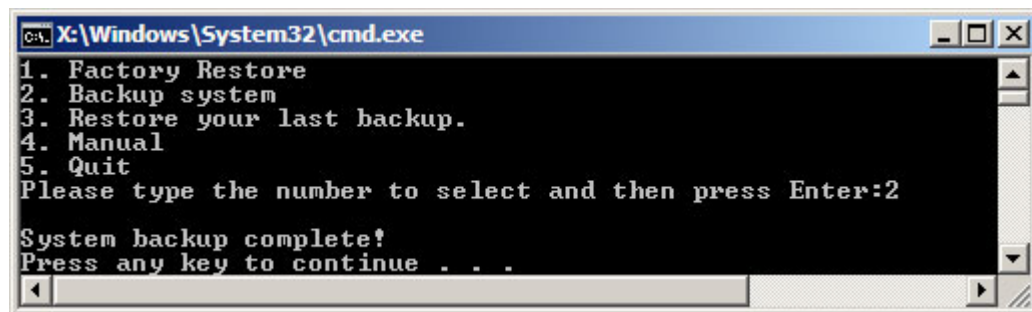

**Figure B-30: System Backup Complete Window**



### B.4.3 Restore Your Last Backup

To restore the last system backup, please follow the steps below.

**Step 1:** Type <3> and press <Enter> in the main menu.

**Step 2:** The Symantec Ghost window appears and starts to restore the last backup image (iei\_user.GHO).

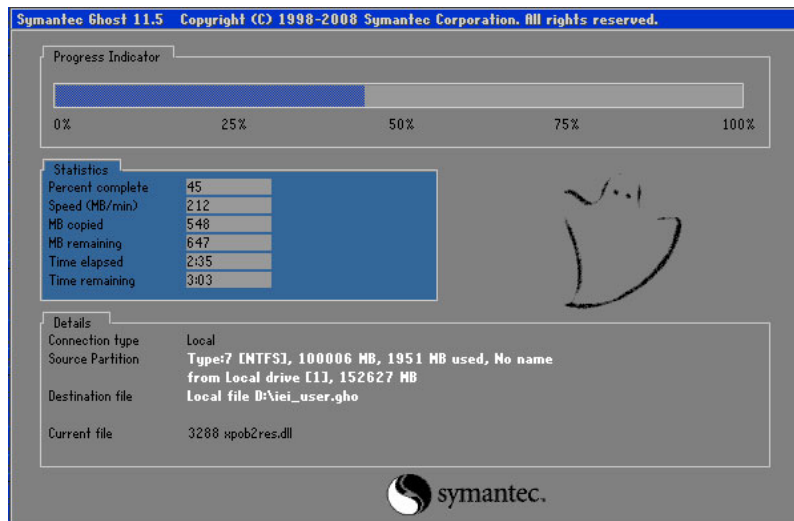

Figure B-31: Restore Backup

**Step 3:** The screen is shown as in **Figure B-32** when backup recovery is completed. Press any key to reboot the system.

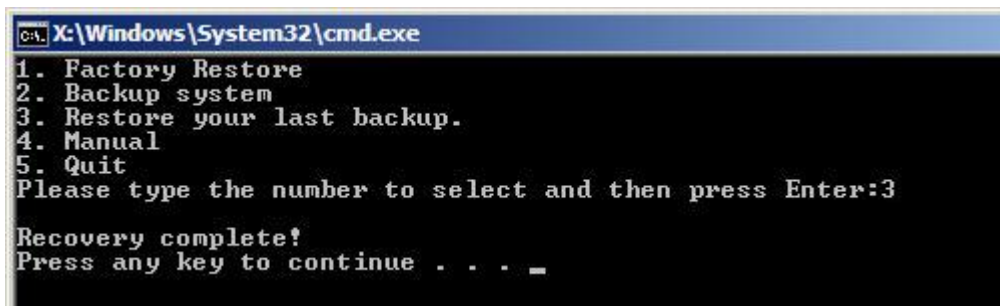

Figure B-32: Restore System Backup Complete Window

### B.4.4 Manual

To restore the last system backup, please follow the steps below.

**Step 1:** Type <4> and press <Enter> in the main menu.

**Step 2:** The Symantec Ghost window appears. Use the Ghost program to backup or recover the system manually.

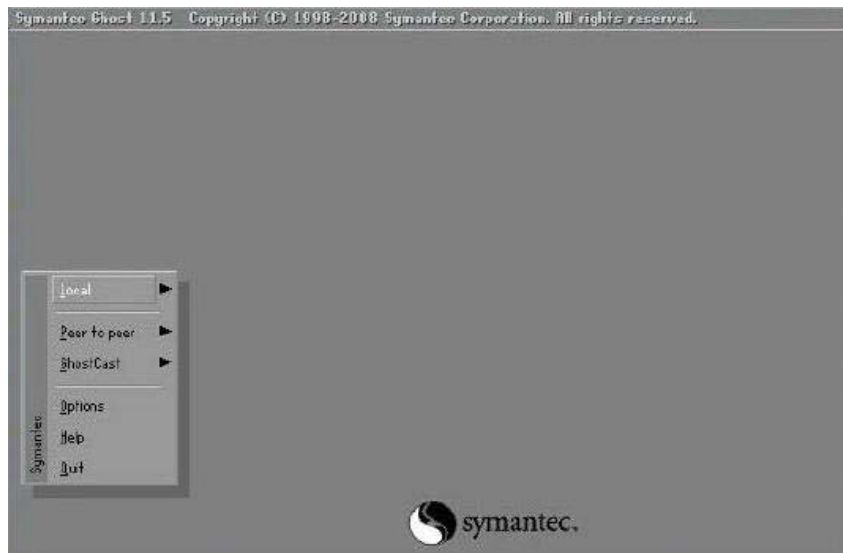

Figure B-33: Symantec Ghost Window

**Step 3:** When backup or recovery is completed, press any key to reboot the system.

## B.5 Other Information

### B.5.1 Using AHCI Mode or ALi M5283 / VIA VT6421A Controller

When the system uses AHCI mode or some specific SATA controllers such as ALi M5283 or VIA VT6421A, the SATA RAID/AHCI driver must be installed before using one key recovery. Please follow the steps below to install the SATA RAID/AHCI driver.

- Step 1:** Copy the SATA RAID/AHCI driver to a floppy disk and insert the floppy disk into a USB floppy disk drive. The SATA RAID/AHCI driver must be especially designed for the on-board SATA controller.
- Step 2:** Connect the USB floppy disk drive to the system.
- Step 3:** Insert the One Key Recovery CD into the system and boot the system from the CD.
- Step 4:** When launching the recovery tool, press <F6>.

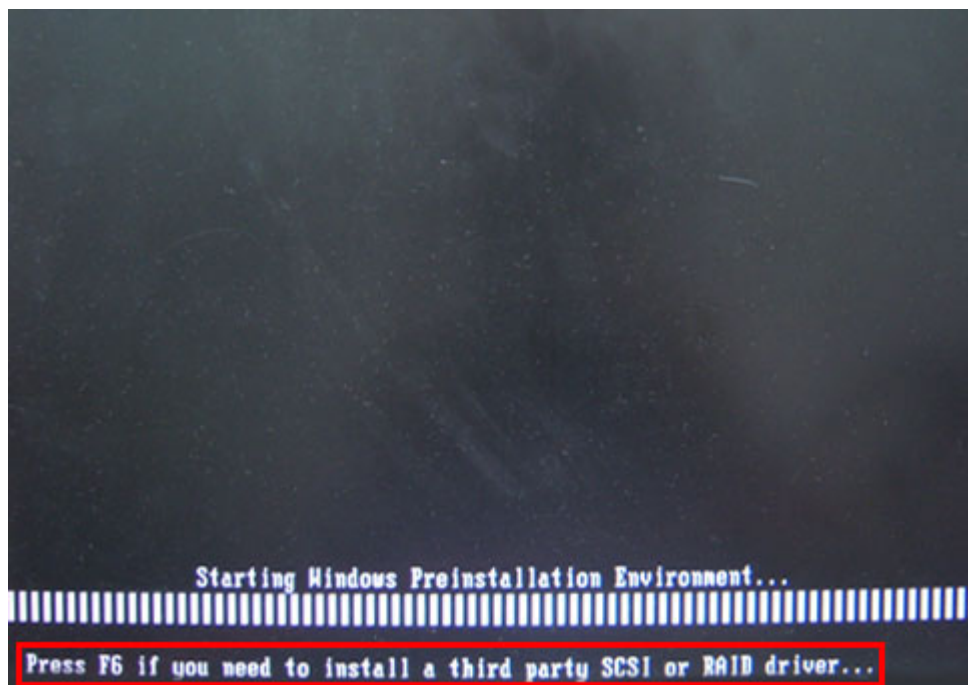

**Step 5:** When the following window appears, press <S> to select “Specify Additional Device”.

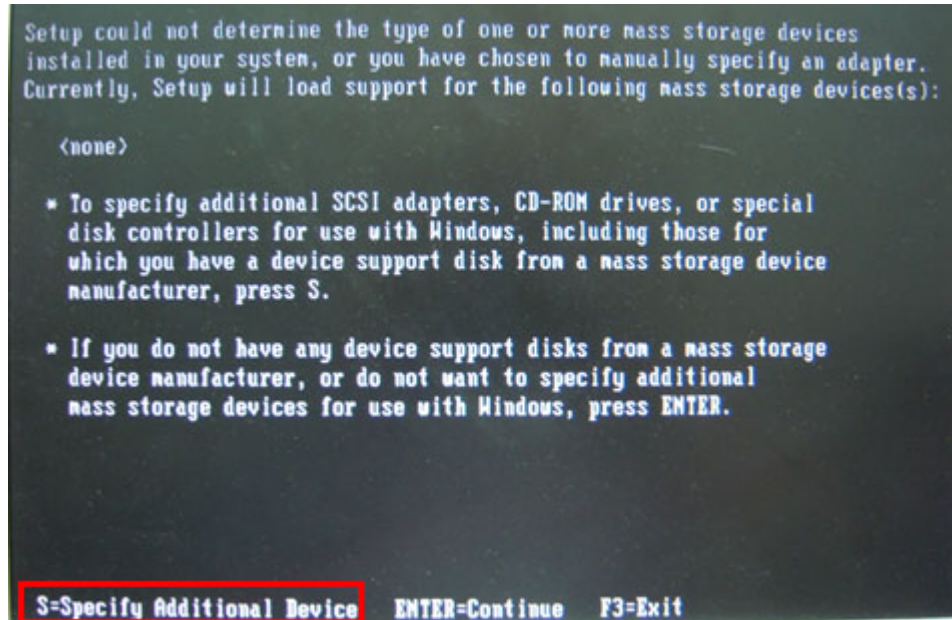

**Step 6:** In the following window, select a SATA controller mode used in the system. Then press <Enter>. The user can now start using the SATA HDD.

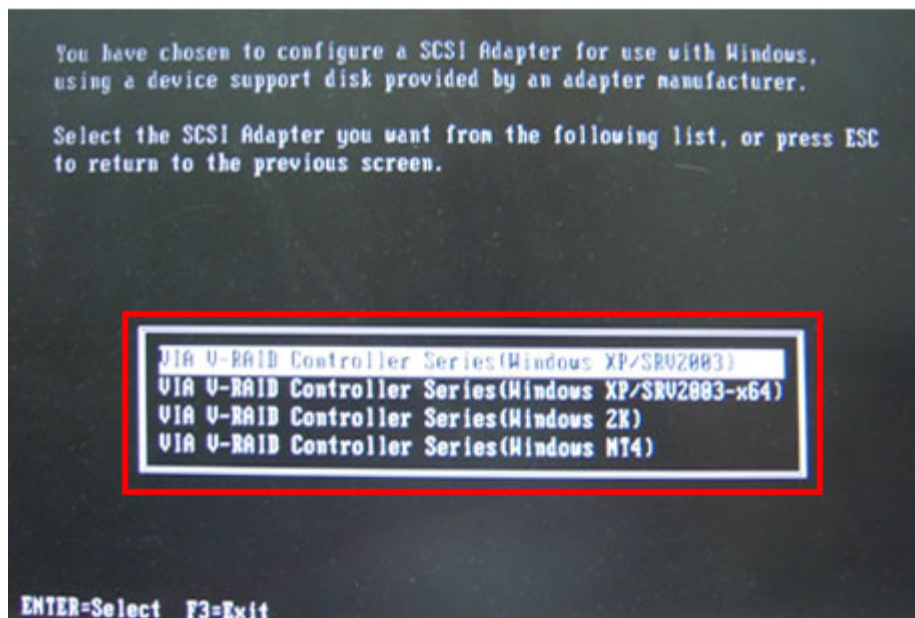

**Step 7:** After pressing <Enter>, the system will get into the recovery tool setup menu.

Continue to follow the setup procedure from **Step 4** in **Section B.2.2 Create**

**Partitions** to finish the whole setup process.

### B.5.2 System Memory Requirement

To be able to access the recovery tool by pressing <F3> while booting up the system, please make sure to have enough system memory. The minimum memory requirement is listed below.

- **Using Award BIOS:** 128 MB system memory
- **Using AMI BIOS:** 512 MB system memory.

Appendix

C

# Terminology

---

## PICOe-PV-D4251/N4551/D5251 User Manual

<b>AC '97</b>	Audio Codec 97 (AC'97) refers to a codec standard developed by Intel® in 1997.
<b>ACPI</b>	Advanced Configuration and Power Interface (ACPI) is an OS-directed configuration, power management, and thermal management interface.
<b>AHCI</b>	Advanced Host Controller Interface (AHCI) is a SATA Host controller register-level interface.
<b>ATA</b>	The Advanced Technology Attachment (ATA) interface connects storage devices including hard disks and CD-ROM drives to a computer.
<b>ARMD</b>	An ATAPI Removable Media Device (ARMD) is any ATAPI device that supports removable media, besides CD and DVD drives.
<b>ASKIR</b>	Amplitude Shift Keyed Infrared (ASKIR) is a form of modulation that represents a digital signal by varying the amplitude (“volume”) of the signal. A low amplitude signal represents a binary 0, while a high amplitude signal represents a binary 1.
<b>BIOS</b>	The Basic Input/Output System (BIOS) is firmware that is first run when the computer is turned on and can be configured by the end user
<b>CODEC</b>	The Compressor-Decompressor (CODEC) encodes and decodes digital audio data on the system.
<b>CompactFlash®</b>	CompactFlash® is a solid-state storage device. CompactFlash® devices use flash memory in a standard size enclosure. Type II is thicker than Type I, but a Type II slot can support both types.
<b>CMOS</b>	Complimentary metal-oxide-conductor is an integrated circuit used in chips like static RAM and microprocessors.
<b>COM</b>	COM refers to serial ports. Serial ports offer serial communication to expansion devices. The serial port on a personal computer is usually a male DB-9 connector.
<b>DAC</b>	The Digital-to-Analog Converter (DAC) converts digital signals to analog signals.
<b>DDR</b>	Double Data Rate refers to a data bus transferring data on both the rising and falling edges of the clock signal.

<b>DMA</b>	Direct Memory Access (DMA) enables some peripheral devices to bypass the system processor and communicate directly with the system memory.
<b>DIMM</b>	Dual Inline Memory Modules are a type of RAM that offer a 64-bit data bus and have separate electrical contacts on each side of the module.
<b>DIO</b>	The digital inputs and digital outputs are general control signals that control the on/off circuit of external devices or TTL devices. Data can be read or written to the selected address to enable the DIO functions.
<b>EHCI</b>	The Enhanced Host Controller Interface (EHCI) specification is a register-level interface description for USB 2.0 Host Controllers.
<b>EIDE</b>	Enhanced IDE (EIDE) is a newer IDE interface standard that has data transfer rates between 4.0 MBps and 16.6 MBps.
<b>EIST</b>	Enhanced Intel® SpeedStep Technology (EIST) allows users to modify the power consumption levels and processor performance through application software. The application software changes the bus-to-core frequency ratio and the processor core voltage.
<b>FSB</b>	The Front Side Bus (FSB) is the bi-directional communication channel between the processor and the Northbridge chipset.
<b>GbE</b>	Gigabit Ethernet (GbE) is an Ethernet version that transfers data at 1.0 Gbps and complies with the IEEE 802.3-2005 standard.
<b>GPIO</b>	General purpose input
<b>HDD</b>	Hard disk drive (HDD) is a type of magnetic, non-volatile computer storage device that stores digitally encoded data.
<b>ICH</b>	The Input/Output Control Hub (ICH) is an Intel® Southbridge chipset.
<b>IrDA</b>	Infrared Data Association (IrDA) specify infrared data transmission protocols used to enable electronic devices to wirelessly communicate with each other.
<b>L1 Cache</b>	The Level 1 Cache (L1 Cache) is a small memory cache built into the system processor.
<b>L2 Cache</b>	The Level 2 Cache (L2 Cache) is an external processor memory cache.



## PICOe-PV-D4251/N4551/D5251 User Manual

<b>LCD</b>	Liquid crystal display (LCD) is a flat, low-power display device that consists of two polarizing plates with a liquid crystal panel in between.
<b>LVDS</b>	Low-voltage differential signaling (LVDS) is a dual-wire, high-speed differential electrical signaling system commonly used to connect LCD displays to a computer.
<b>POST</b>	The Power-on Self Test (POST) is the pre-boot actions the system performs when the system is turned-on.
<b>RAM</b>	Random Access Memory (RAM) is volatile memory that loses data when power is lost. RAM has very fast data transfer rates compared to other storage like hard drives.
<b>SATA</b>	Serial ATA (SATA) is a serial communications bus designed for data transfers between storage devices and the computer chipsets. The SATA bus has transfer speeds up to 1.5 Gbps and the SATA II bus has data transfer speeds of up to 3.0 Gbps.
<b>S.M.A.R.T</b>	Self Monitoring Analysis and Reporting Technology (S.M.A.R.T) refers to automatic status checking technology implemented on hard disk drives.
<b>UART</b>	Universal Asynchronous Receiver-transmitter (UART) is responsible for asynchronous communications on the system and manages the system's serial communication (COM) ports.
<b>UHCI</b>	The Universal Host Controller Interface (UHCI) specification is a register-level interface description for USB 1.1 Host Controllers.
<b>USB</b>	The Universal Serial Bus (USB) is an external bus standard for interfacing devices. USB 1.1 supports 12Mbps data transfer rates and USB 2.0 supports 480Mbps data transfer rates.
<b>VGA</b>	The Video Graphics Array (VGA) is a graphics display system developed by IBM.



Appendix

D

# Digital I/O Interface

---

## D.1 Introduction

The DIO connector on the PIC0e-PV-D4251/N4551/D5251 is interfaced to GPIO ports on the Super I/O chipset. The DIO has both 4-bit digital inputs and 4-bit digital outputs. The digital inputs and digital outputs are generally control signals that control the on/off circuit of external devices or TTL devices. Data can be read or written to the selected address to enable the DIO functions.



### NOTE:

For further information, please refer to the datasheet for the Super I/O chipset.

## D.2 DIO Connector Pinouts

The following table describes how the DIO connector pins are connected to the Super I/O GPIO port 1.

Pin	Description	Super I/O Pin	Super I/O Pin Description
1	Ground	N/A	N/A
2	VCC	N/A	N/A
3	Output 3	GP27	General purpose I/O port 2 bit 7.
4	Output 2	GP26	General purpose I/O port 2 bit 6.
5	Output 1	GP25	General purpose I/O port 2 bit 5.
6	Output 0	GP24	General purpose I/O port 2 bit 4.
7	Input 3	GP23	General purpose I/O port 2 bit 3.
8	Input 2	GP22	General purpose I/O port 2 bit 2
9	Input 1	GP21	General purpose I/O port 2 bit 1
10	Input 0	GP20	General purpose I/O port 2 bit 0

**Table D-1: Digital I/O Connector Pinouts**

## D.3 Assembly Language Samples

### D.3.1 Enable the DIO Input Function

The BIOS interrupt call INT 15H controls the digital I/O. An assembly program to enable digital I/O input functions is listed below.

<b>MOV</b>	<b>AX, 6F08H</b>	Sets the digital port as input
<b>INT</b>	<b>15H</b>	Initiates the INT 15H BIOS call

### D.3.2 Enable the DIO Output Function

The BIOS interrupt call INT 15H controls the digital I/O. An assembly program to enable digital I/O output functions is listed below.

<b>MOV</b>	<b>AX, 6F09H</b>	Sets the digital port as output
<b>MOV</b>	<b>BL, 09H</b>	
<b>INT</b>	<b>15H</b>	Initiates the INT 15H BIOS call

Appendix

**E**

# Watchdog Timer

---



**NOTE:**

The following discussion applies to DOS. Contact IEI support or visit the IEI website for drivers for other operating systems.

The Watchdog Timer is a hardware-based timer that attempts to restart the system when it stops working. The system may stop working because of external EMI or software bugs. The Watchdog Timer ensures that standalone systems like ATMs will automatically attempt to restart in the case of system problems.

A BIOS function call (INT 15H) is used to control the Watchdog Timer.

INT 15H:

<b>AH – 6FH Sub-function:</b>	
AL – 2:	Sets the Watchdog Timer’s period.
BL:	Time-out value (Its unit-second is dependent on the item “Watchdog Timer unit select” in CMOS setup).

**Table E-1: AH-6FH Sub-function**

Call sub-function 2 to set the time-out period of Watchdog Timer first. If the time-out value is not zero, the Watchdog Timer starts counting down. When the timer value reaches zero, the system resets. To ensure that this reset condition does not occur, calling sub-function 2 must periodically refresh the Watchdog Timer. However, the watchdog timer is disabled if the time-out value is set to zero.

A tolerance of at least 10% must be maintained to avoid unknown routines within the operating system (DOS), such as disk I/O that can be very time-consuming.



**NOTE:**

The Watchdog Timer is activated through software. The software application that activates the Watchdog Timer must also deactivate it when closed. If the Watchdog Timer is not deactivated, the system will automatically restart after the Timer has finished its countdown.

**EXAMPLE PROGRAM:**

**; INITIAL TIMER PERIOD COUNTER**

;

**W\_LOOP:**

;

```

MOV      AX, 6F02H      ;setting the time-out value
MOV      BL, 30         ;time-out value is 48 seconds
INT      15H

```

;

**; ADD THE APPLICATION PROGRAM HERE**

;

```

CMP      EXIT_AP, 1     ;is the application over?
JNE      W_LOOP        ;No, restart the application

```

```

MOV      AX, 6F02H      ;disable Watchdog Timer
MOV      BL, 0          ;
INT      15H

```

;

**; EXIT ;**



Appendix

**F**

# Hazardous Materials Disclosure

---



## **F.1 Hazardous Materials Disclosure Table for IPB Products Certified as RoHS Compliant Under 2002/95/EC Without Mercury**

The details provided in this appendix are to ensure that the product is compliant with the Peoples Republic of China (China) RoHS standards. The table below acknowledges the presences of small quantities of certain materials in the product, and is applicable to China RoHS only.

A label will be placed on each product to indicate the estimated “Environmentally Friendly Use Period” (EFUP). This is an estimate of the number of years that these substances would “not leak out or undergo abrupt change.” This product may contain replaceable sub-assemblies/components which have a shorter EFUP such as batteries and lamps. These components will be separately marked.

Please refer to the table on the next page.

Part Name	Toxic or Hazardous Substances and Elements					
	Lead (Pb)	Mercury (Hg)	Cadmium (Cd)	Hexavalent Chromium (CR(VI))	Polybrominated Biphenyls (PBB)	Polybrominated Diphenyl Ethers (PBDE)
Housing	X	O	O	O	O	X
Display	X	O	O	O	O	X
Printed Circuit Board	X	O	O	O	O	X
Metal Fasteners	X	O	O	O	O	O
Cable Assembly	X	O	O	O	O	X
Fan Assembly	X	O	O	O	O	X
Power Supply Assemblies	X	O	O	O	O	X
Battery	O	O	O	O	O	O

O: This toxic or hazardous substance is contained in all of the homogeneous materials for the part is below the limit requirement in SJ/T11363-2006

X: This toxic or hazardous substance is contained in at least one of the homogeneous materials for this part is above the limit requirement in SJ/T11363-2006

## PICOe-PV-D4251/N4551/D5251 User Manual

此附件旨在确保本产品符合中国 RoHS 标准。以下表格标示此产品中某有毒物质的含量符合中国 RoHS 标准规定的限量要求。

本产品上会附有“环境友好使用期限”的标签，此期限是估算这些物质“不会有泄漏或突变”的年限。本产品可能包含有较短的环境友好使用期限的可替换元件，像是电池或灯管，这些元件将会单独标示出来。

部件名称	有毒有害物质或元素					
	铅 (Pb)	汞 (Hg)	镉 (Cd)	六价铬 (CR(VI))	多溴联苯 (PBB)	多溴二苯 醚 (PBDE)
壳体	X	O	O	O	O	X
显示	X	O	O	O	O	X
印刷电路板	X	O	O	O	O	X
金属螺帽	X	O	O	O	O	O
电缆组装	X	O	O	O	O	X
风扇组装	X	O	O	O	O	X
电力供应组装	X	O	O	O	O	X
电池	O	O	O	O	O	O

O: 表示该有毒有害物质在该部件所有物质材料中的含量均在 SJ/T11363-2006 标准规定的限量要求以下。  
X: 表示该有毒有害物质至少在该部件的某一均质材料中的含量超出 SJ/T11363-2006 标准规定的限量要求。