



IEI Technology Corp.



MODEL:
AFL-15A-N270

**Fanless All-in-one Panel PC with 1.6 GHz Intel® Atom™ CPU
TFT LCD, Wireless LAN, Touch Screen,
RS-232/422/485 and IP 64 Protection**

User Manual

Rev. 2.20 - 22 February, 2012



Revision

Date	Version	Changes
22 February, 2012	2.20	Updated for R22 version (optional Bluetooth support).
25 July, 2011	2.10	Updated for R21 version (change wireless module).
23 October, 2009	1.03	Modified Table 4-7 COM3 RX Function Select Jumper Settings
30 September, 2009	1.02	Added back cover screw torque warning
24 March, 2009	1.01	Changed model name
20 January, 2009	1.00	Initial release

Copyright

COPYRIGHT NOTICE

The information in this document is subject to change without prior notice in order to improve reliability, design and function and does not represent a commitment on the part of the manufacturer.

In no event will the manufacturer be liable for direct, indirect, special, incidental, or consequential damages arising out of the use or inability to use the product or documentation, even if advised of the possibility of such damages.

This document contains proprietary information protected by copyright. All rights are reserved. No part of this manual may be reproduced by any mechanical, electronic, or other means in any form without prior written permission of the manufacturer.

TRADEMARKS

All registered trademarks and product names mentioned herein are used for identification purposes only and may be trademarks and/or registered trademarks of their respective owners.

Packing List

**NOTE:**

If any of the components listed in the checklist below are missing, please do not proceed with the installation. Contact the IEI reseller or vendor you purchased the AFL-15A-N270 from or contact an IEI sales representative directly. To contact an IEI sales representative, please send an email to sales@iei.com.tw.

The items listed below should all be included in the AFL-15A-N270 package.

- 1 x AFL-15A-N270 flat panel PC
- 1 x Power adapter
- 1 x Power cord
- 1 x Screw kit
- 1 x User manual CD and driver CD
- 1 x Touch pen

Images of the above items are shown in **Chapter 3** on **page 33**.

Table of Contents

1 INTRODUCTION.....	14
1.1 AFL-15A-N270 FLAT PANEL PC OVERVIEW	15
1.1.1 Features and Model Variations.....	15
1.1.2 Applications	16
1.2 EXTERNAL OVERVIEW.....	16
1.2.1 General Description.....	16
1.2.2 Front Panel	17
1.2.3 Rear Panel	17
1.2.4 I/O Interface Panel	18
1.3 INTERNAL OVERVIEW.....	19
1.4 SYSTEM SPECIFICATIONS.....	19
2 DETAILED SPECIFICATIONS	21
2.1 AFL-15A-N270 DIMENSIONS	22
2.2 INTEL® ATOM™ PROCESSOR.....	23
2.3 MOTHERBOARD COMPONENTS.....	23
2.3.1 Memory Support.....	23
2.3.1.1 Installed Memory	23
2.3.1.2 Additional Memory.....	24
2.3.2 Storage Capacity.....	24
2.4 EXTERNAL PERIPHERAL INTERFACE CONNECTORS.....	24
2.4.1 Serial Port Connectors	24
2.4.2 LAN Connectivity.....	25
2.4.3 External USB Connectors.....	26
2.5 AFOLUX AFL-15A-N270 FRONT SIDE	26
2.5.1 Monitor	26
2.5.2 Touch-Screen Module.....	27
2.6 GRAPHICS	27
2.6.1 Intel® 945GSE Integrated Graphics Media Accelerator 950	27
2.6.2 Dual-Display.....	27
2.7 AUDIO	27

2.7.1 HD Audio Codec Controller	27
2.7.2 Stereo Speakers	28
2.8 SYSTEM POWER	28
2.8.1 Power Mode	28
2.8.1.1 ATX Power Mode (Default).....	28
2.8.1.2 AT Power Mode	29
2.8.2 Power Adapter	29
2.8.3 Power Connector	29
2.9 WIRELESS CONNECTIONS	30
2.9.1 Wireless Ethernet	30
3 UNPACKING	31
3.1 UNPACKING	32
3.1.1 Packing List	33
4 INSTALLATION	35
4.1 ANTI-STATIC PRECAUTIONS	36
4.2 INSTALLATION PRECAUTIONS	36
4.3 PREINSTALLED COMPONENTS.....	37
4.4 INSTALLATION AND CONFIGURATION STEPS	37
4.5 REMOVING THE REAR PANEL	38
4.6 CF CARD INSTALLATION	38
4.7 HDD INSTALLATION.....	39
4.8 AT/ATX MODE SELECTION	41
4.8.1 AT Power Mode.....	41
4.8.2 ATX Power Mode	41
4.9 JUMPER SETTINGS	42
4.9.1 Access the Jumpers	43
4.9.2 Preconfigured Jumpers	43
4.9.3 CF Card Setup	44
4.9.4 Clear CMOS Jumper.....	45
4.9.5 COM Port Pin 9 Select	46
4.9.6 COM3 RX Function Select Jumper.....	47
4.9.7 COM3 TX Function Select Jumper	48
4.9.8 COM3 RS-232/422/485 Serial Port Select Jumper	49

AFOLUX AFL-15A-N270 Panel PC

4.9.8.1 COM3 RS-422 and RS-485 Pinouts	51
4.10 MOUNTING THE SYSTEM	51
4.10.1 Wall Mounting.....	52
4.10.2 Panel Mounting.....	54
4.10.3 Arm Mounting	56
4.10.4 Cabinet and Rack Installation	58
4.11 BOTTOM PANEL CONNECTORS.....	59
4.11.1 LAN Connection.....	59
4.11.2 Serial Device Connection.....	60
4.11.3 USB Device Connection.....	61
5 SYSTEM MAINTENANCE	62
5.1 SYSTEM MAINTENANCE INTRODUCTION	63
5.2 ANTI-STATIC PRECAUTIONS	63
5.3 TURN OFF THE POWER	64
5.4 OPENING THE SYSTEM.....	64
5.4.1 Removing the Back Panel	64
5.4.2 Internal Aluminum Cover Removal.....	65
5.5 REPLACING COMPONENTS.....	66
5.5.1 Memory Module Replacement	66
5.5.2 CF Card Replacement.....	67
5.6 REINSTALLING THE COVERS	67
6 AMI BIOS SETUP	69
6.1 INTRODUCTION.....	70
6.1.1 Starting Setup.....	70
6.1.2 Using Setup	70
6.1.3 Getting Help.....	71
6.1.4 Unable to Reboot After Configuration Changes.....	71
6.1.5 BIOS Menu Bar.....	71
6.2 MAIN.....	72
6.3 ADVANCED.....	73
6.3.1 CPU Configuration.....	74
6.3.2 IDE Configuration	75
6.3.2.1 IDE Master, IDE Slave	77

6.3.3 Super IO Configuration	82
6.3.4 Hardware Health Configuration.....	85
6.3.5 Power Configuration.....	89
6.3.5.1 ACPI configuration	89
6.3.6 APM Configuration.....	90
6.3.7 Remote Configuration	93
6.3.8 USB Configuration.....	96
6.4 PCI/PNP.....	97
6.5 BOOT.....	100
6.5.1 Boot Settings Configuration.....	100
6.6 SECURITY.....	103
6.7 CHIPSET	104
6.7.1 North Bridge Chipset Configuration	105
6.7.2 SouthBridge Configuration.....	107
6.8 EXIT	108
7 SOFTWARE DRIVERS	110
7.1 AVAILABLE SOFTWARE DRIVERS	111
7.2 STARTING THE DRIVER PROGRAM	111
7.3 CHIPSET DRIVER INSTALLATION.....	112
7.4 VGA DRIVER INSTALLATION.....	117
7.5 AUDIO DRIVER INSTALLATION	122
7.5.1 BIOS Setup.....	122
7.5.2 Driver Installation	122
7.6 LAN DRIVER INSTALLATION	125
7.7 TOUCH SCREEN DRIVER.....	128
7.8 BLUETOOTH DRIVER (OPTIONAL)	130
7.9 WIRELESS DRIVER	135
A SYSTEM SPECIFICATIONS.....	139
A.1 MOTHERBOARD SPECIFICATIONS.....	140
A.2 PROCESSOR SPECIFICATIONS	140
B SAFETY PRECAUTIONS	142
B.1 SAFETY PRECAUTIONS.....	143
B.1.1 General Safety Precautions.....	143

AFOLUX AFL-15A-N270 Panel PC

<i>B.1.2 Anti-static Precautions</i>	144
<i>B.1.3 Product Disposal</i>	145
B.2 MAINTENANCE AND CLEANING PRECAUTIONS	145
<i>B.2.1 Maintenance and Cleaning</i>	145
<i>B.2.2 Cleaning Tools</i>	146
C BIOS CONFIGURATION OPTIONS	148
C.1 BIOS CONFIGURATION OPTIONS	149
D WATCHDOG TIMER	152
E HAZARDOUS MATERIALS DISCLOSURE	155
E.1 HAZARDOUS MATERIAL DISCLOSURE TABLE FOR IPB PRODUCTS CERTIFIED AS ROHS COMPLIANT UNDER 2002/95/EC WITHOUT MERCURY	156

List of Figures

Figure 1-1: AFL-15A-N270 Flat Panel PC	15
Figure 1-2: AFL-15A-N270 Front View	17
Figure 1-3: AFL-15A-N270 Rear View	18
Figure 1-4: AFL-15A-N270 I/O Interface Connector Panel	18
Figure 2-1: AFL-15A-N270 Dimensions (mm)	22
Figure 2-2: Preinstalled DDR2 SO-DIMM	24
Figure 2-3: COM Ports.....	25
Figure 2-4: RJ-45 Ethernet Connectors.....	25
Figure 2-5: External USB Ports	26
Figure 2-6: LCD Screen	26
Figure 2-7: VGA Connector	27
Figure 2-8: Audio Jack.....	28
Figure 2-9: Stereo Speakers	28
Figure 2-10: Power Connector	29
Figure 2-11: PIFA Antenna and Wireless Module.....	30
Figure 4-1: Back Cover Retention Screws	38
Figure 4-2: CF Card Location	39
Figure 4-3: HDD Bracket Retention Screws.....	40
Figure 4-4: AFL-15A-N270 HDD Retention Screws	40
Figure 4-5: AT/ATX Switch Location.....	41
Figure 4-6: CF Card Setup Jumper Location	44
Figure 4-7: Clear CMOS Jumper	46
Figure 4-8: COM1 and COM3 Pin 9 Setting Jumper Locations.....	47
Figure 4-9: COM3 RX Function Select Jumper Location.....	48
Figure 4-10: COM3 TX Function Select Jumper Pinout Locations.....	49
Figure 4-11: COM3 RS-232/422/485 Serial Port Select Jumper Location.....	50
Figure 4-12: Wall-mounting Bracket.....	52
Figure 4-13: Chassis Support Screws.....	53
Figure 4-14: Secure the Panel PC	54
Figure 4-15: AFL-15A-N270 Panel Opening (Unit: mm)	55
Figure 4-16: Panel Mounting	56

AFOLUX AFL-15A-N270 Panel PC

Figure 4-17: Arm Mounting Retention Screw Holes.....	57
Figure 4-18: The Rack/Cabinet Bracket.....	58
Figure 4-19: LAN Connection	59
Figure 4-20: Serial Device Connector.....	60
Figure 4-21: USB Device Connection	61
Figure 5-1: Back Cover Retention Screws	65
Figure 5-2: Aluminum Back Cover Retention Screws	65
Figure 5-3: SO-DIMM Socket Location	66
Figure 5-4: DDR SO-DIMM Module Installation.....	67
Figure 7-1: Drivers	112
Figure 7-2: Chipset Driver Screen.....	113
Figure 7-3: Chipset Driver Welcome Screen.....	113
Figure 7-4: Chipset Driver License Agreement	114
Figure 7-5: Chipset Driver Read Me File	115
Figure 7-6: Chipset Driver Setup Operations	116
Figure 7-7: Chipset Driver Installation Finish Screen.....	117
Figure 7-8: VGA Driver Read Me File.....	118
Figure 7-9: VGA Driver Setup Files Extracted	118
Figure 7-10: VGA Driver Welcome Screen	119
Figure 7-11: VGA Driver License Agreement.....	120
Figure 7-12: VGA Driver Read Me File.....	120
Figure 7-13: VGA Driver Setup Operations	121
Figure 7-14: VGA Driver Installation Finish Screen	121
Figure 7-15: The InstallShield Wizard Starts	122
Figure 7-16: Preparing Setup Screen	123
Figure 7-17: InstallShield Wizard Welcome Screen	123
Figure 7-18: Audio Driver Software Configuration.....	124
Figure 7-19: Installation Wizard Updates the System.....	124
Figure 7-20: Restart the Computer	125
Figure 7-21: LAN Driver Welcome Screen	126
Figure 7-22: LAN Driver Welcome Screen	126
Figure 7-23: LAN Driver Installation	127
Figure 7-24: LAN Driver Installation Complete.....	127
Figure 7-25: Welcome Screen	128
Figure 7-26: License Agreement.....	129

Figure 7-27: Ready to Install the Program	129
Figure 7-28: Installing PenMount DMC9000.....	130
Figure 7-29: Reboot the Computer	130
Figure 7-30: Bluetooth Driver Icon.....	131
Figure 7-31: Welcome Screen	131
Figure 7-32: License Agreement	132
Figure 7-33: Bluetooth Driver Setup Options	132
Figure 7-34: Bluetooth Driver Destination Folder	133
Figure 7-35: Ready to Install the Program	133
Figure 7-36: Installing BlueSoleil	134
Figure 7-37: Bluetooth Driver Complete Installation Screen	134
Figure 7-38: Reboot the Computer	135
Figure 7-39: Wireless Driver OS Folders.....	135
Figure 7-40: Wireless Driver License Agreement.....	136
Figure 7-41: Wireless Driver Configuration Tool Options	136
Figure 7-42: Wireless Mode Select Window	137
Figure 7-43: Wireless Driver Installation	138

List of Tables

Table 1-1: Model Variations	16
Table 1-2: AFL-15A-N270 Series System Specifications	20
Table 4-1: Jumpers	43
Table 4-2: Preconfigured Jumpers	43
Table 4-3: CF Card Setup Jumper Settings	44
Table 4-4: Clear CMOS Jumper Settings.....	45
Table 4-5: COM1 Pin 9 Setting Jumper Settings	46
Table 4-6: COM3 Pin 9 Setting Jumper Settings	47
Table 4-7: COM3 RX Function Select Jumper Settings	48
Table 4-8: COM3 TX Function Select Jumper Settings.....	49
Table 4-9: COM3 RS-232/422/485 Serial Port Select Jumper Settings	50
Table 4-10: RS-422 Pinouts	51
Table 4-11: RS-485 Pinouts	51
Table 6-1: BIOS Navigation Keys	71

Chapter

1

Introduction

AFOLUX AFL-15A-N270 Panel PC

1.1 AFL-15A-N270 Flat Panel PC Overview



Figure 1-1: AFL-15A-N270 Flat Panel PC

The AFL-15A-N270 series is Intel® Atom™ powered flat panel PCs with a rich variety of functions and peripherals. All AFL-15A-N270 models are designed for easy and simplified integration in to kiosk and point-of-sales (POS) applications.

An Intel® 945GSE graphics memory controller hub (GMCH) coupled with an Intel® ICH7-M input/output controller hub ensures optimal memory, graphics, and peripheral I/O support. The system comes with 1.0 GB of preinstalled DDR2 SDRAM and supports a maximum of 2.0 GB of DDR2 SDRAM ensuring smooth data throughputs with reduced bottlenecks and fast system access.

Two serial ports and four external USB 2.0 ports ensure simplified connectivity to a variety of external peripheral devices. Wi-Fi capabilities and two RJ-45 GbE connectors ensure smooth connection of the system to the external LAN.

1.1.1 Features and Model Variations

There are two models in the AFL-15A-N270 series. Both models feature the following:

- Intel® Atom™ processor
- Intel® 945GSE chipset
- 1.0 GB 533 MHz DDR2 SDRAM preinstalled

- 802.11 b/g/n wireless module
- Four USB 2.0 ports
- Watchdog timer that triggers a system reset if the system hangs for some reason
- IP 64 compliant front panel
- AT or ATX power mode
- Touch screen
- Optional HSDPA module support
- RoHS compliance

There are two kinds of panel size of the AFL-15A-N270 series. The model numbers and model variations are listed below.

Model	Brightness	CPU
AFL-15A-N270/R/1G-R22	350 cd/m ²	Intel® Atom™ N270
AFL-15AE-N270/R/1G-R22	250 cd/m ²	Intel® Atom™ N270

Table 1-1: Model Variations

1.1.2 Applications

The AFL-15A-N270 panel PCs are elegant yet sophisticated systems that are easily implemented in commercial environments, industrial environments and corporate environments.

1.2 External Overview

1.2.1 General Description

The stylish AFL-15A-N270 panel PC comprises of a screen, rear panel and bottom panel. An ABS/PC plastic front frame surrounds the front screen. The rear panel provides screw holes for a wall-mounting bracket compliant with VESA FDMI standard. An I/O interface panel on the bottom panel of the AFL-15A-N270 provides access to external interface connectors that include LAN, USB 2.0, serial port, reset button, VGA, audio connector, power connector and power switch.

AFOLUX AFL-15A-N270 Panel PC

1.2.2 Front Panel

The front side of the AFL-15A-N270 series is a flat panel TFT LCD screen surrounded by an ABS/PC plastic frame. The top of the front panel has a power LED.

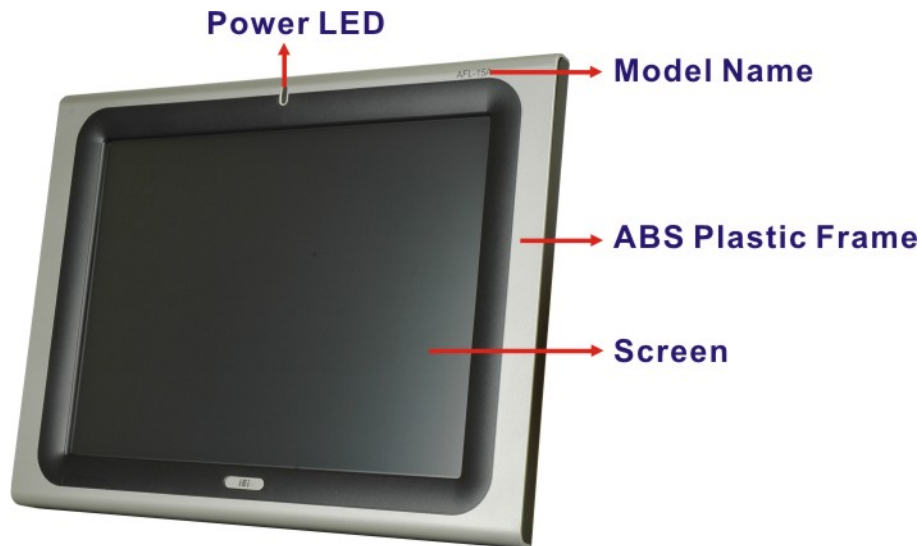

Figure 1-2: AFL-15A-N270 Front View

1.2.3 Rear Panel

The rear panel provides access to retention screw holes that support the wall mounting. Refer to **Figure 1-3**.

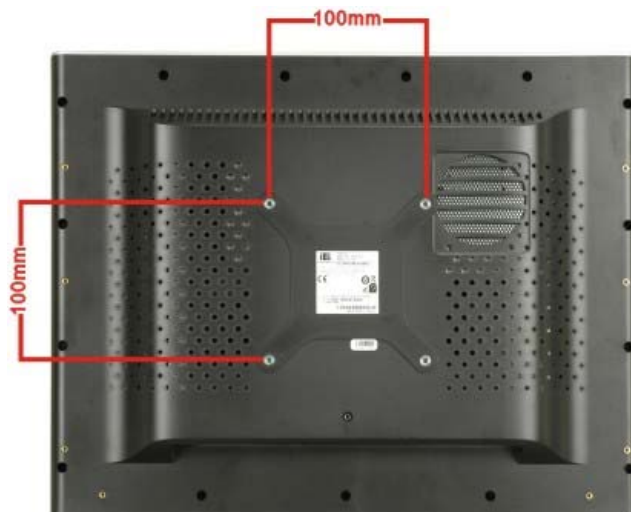

Figure 1-3: AFL-15A-N270 Rear View

1.2.4 I/O Interface Panel

The I/O interface panel located on the bottom of the AFL-15A-N270 has the following I/O interface connectors:

- 1 x 12 V DC In connector
- 1 x RS-232 connector
- 1 x RS-232/422/485 connector
- 2 x GbE LAN connectors
- 4 x USB 2.0 connectors
- 1 x Audio line-out connector
- 1 x VGA connector
- 1 x Power switch
- 1 x Reset button
- 1 x AT/ATX power mode switch

The external I/O interface connector panel is shown in **Figure 1-4**.

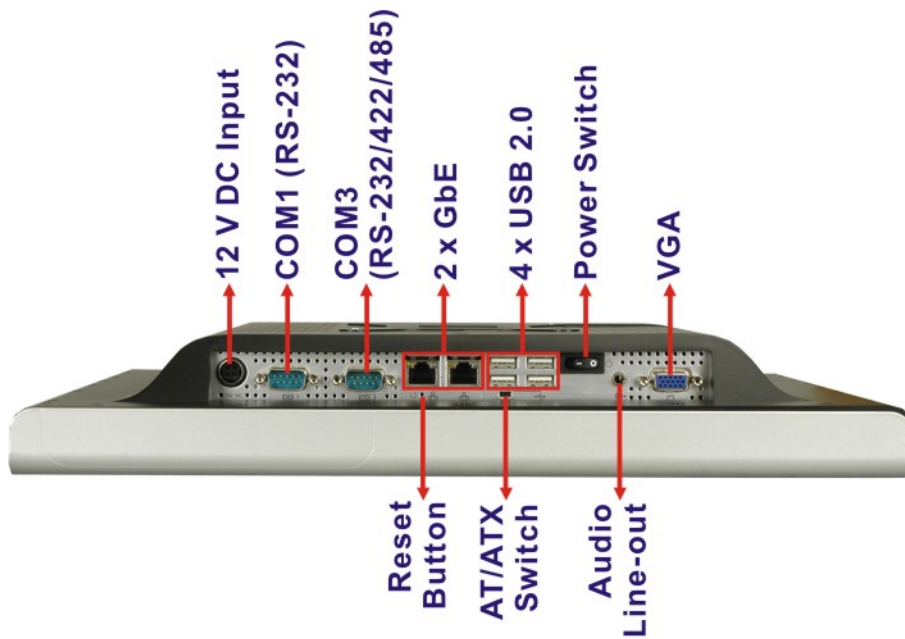

Figure 1-4: AFL-15A-N270 I/O Interface Connector Panel

AFOLUX AFL-15A-N270 Panel PC

1.3 Internal Overview

The AFOLUX AFL-15A-N270 has the following components installed internally:

- 1 x Motherboard
- 1 x 1.0 GB 533 MHz DDR2 SDRAM SO-DIMM
- 1 x Wireless module

1.4 System Specifications

The technical specifications for the AFOLUX AFL-15A-N270 series systems are listed in **Table 1-2**.

Specification	AFL-15A-N270	AFL-15AE-N270
LCD Size	15"	15"
Max. Resolution	1024 x 768	1024 x 768
Contrast Ratio	700:1	600:1
Brightness (cd/m ²)	350	250
LCD Color	262K	16.7M
Pixel Pitch (H x V) (mm)	0.297 x 0.297	0.297 x 0.297
Viewing Angle (H-V)	140 / 125	160/160
Backlight MTBF	50,000 hours	40,000 hours
SBC Model	AFLMB2-945GSE	
CPU	1.6 GHz Intel® Atom™ N270 processor	
Chipset	Intel® 945GSE + ICH7-M	
Memory	One 1.0 GB 533 MHz DDR2 SDRAM SO-DIMM pre-installed (Supports up to 2 GB 400 MHz or 533 MHz DDR2 SDRAM)	
SSD	CF Type II slot	
Watchdog Timer	Software Programmable supports 1 sec. ~ 255 sec. system reset	
Audio	AMP 1.5 W + AMP 1.5 W (built-in stereo speakers)	
Expansion	1 x PCIe mini card (wireless LAN 802.11 b/g/n module)	
	1 x Optional Bluetooth module (USB interface, Bluetooth v 2.0)	
HDD Drive Bay	1 x 2.5" SATA HDD bay or HSDPA module	
Construction Material	ABS + PC plastic front frame	
Mounting	Panel	
	Wall	

	Rack Stand Arm (VESA 75 mm x 75 mm or 100 mm x 100 mm)	
Front Panel Color	Silver and Black	
Dimensions (mm)	394 mm x 309 mm x 61 mm (W x H x D)	
Operation Temperature	0°C ~ 50°C with CF card or 2.5" SSD SATA HDD 0°C ~ 40°C with SATA HDD	
Storage Temperature	-20°C ~ 60°C	
Net weight	3.2kg	
IP level (front panel)	IP 64	
EMC	CE, FCC and CCC	
Safety	CB	
Touch Screen	Resistive Type 5-wire (touch controller is on board)	
Power Adapter	60 W Input: 90 VAC ~ 264 VAC @ 50 Hz / 60 Hz Output: 12 V DC	
Power Consumption	41 W	40 W
I/O Ports and Switches	1 x 12 V DC input jack	
	1 x Audio line-out connector	
	1 x RS-232 COM port connector	
	1 x RS-232/422/485 COM port connector	
	2 x RJ-45 for GbE LAN	
	4 x USB 2.0 ports	
	1 x VGA connector	
	1 x Power switch	
	1 x AT/ATX power mode switch	
	1 x Reset button	

Table 1-2: AFL-15A-N270 Series System Specifications

Chapter

2

Detailed Specifications

2.1 AFL-15A-N270 Dimensions

The AFL-15A-N270 dimensions are shown in **Figure 2-1** and listed below.

- **Width:** 393.04 mm
- **Height:** 308.06 mm
- **Depth:** 61.00 mm

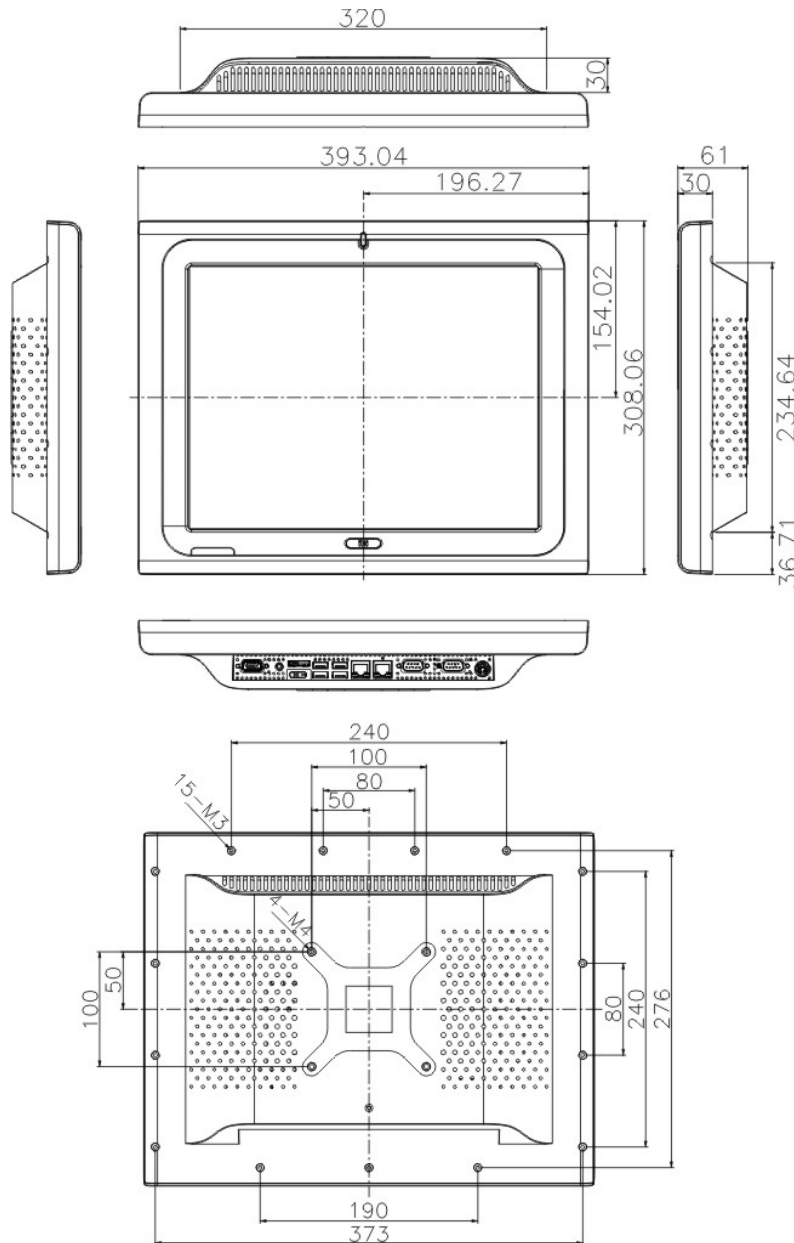

Figure 2-1: AFL-15A-N270 Dimensions (mm)

2.2 Intel® Atom™ Processor

A 45nm N270 Intel® Atom™ processor is installed in the system. The processor has a CPU speed of 1.6 GHz and a 533 MHz front side bus (FSB). The processor also comes with a 512 KB L2 cache and a 1.6 GHz L2 cache speed. Some of the features of the Intel® Atom™ processor N270 are listed below:

- On-die, primary 32-kB instructions cache and 24-kB write-back data cache
- 533-MHz source-synchronous front side bus (FSB)
- 2-Threads support
- On-die 512-kB, 8-way L2 cache
- Support for IA 32-bit architecture
- Intel® Streaming SIMD Extensions-2 and -3 (Intel® SSE2 and Intel® SSE3) support and Supplemental Streaming SIMD Extension 3 (SSSE3) support
- Micro-FCBGA8 packaging technologies
- Thermal management support via Intel® Thermal Monitor 1 and Intel Thermal Monitor 2
- FSB Lane Reversal for flexible routing
- Supports C0/C1(e)/C2(e)/C4(e)
- L2 Dynamic Cache Sizing
- Advanced power management features including Enhanced Intel SpeedStep® Technology
- Execute Disable Bit support for enhanced security

2.3 Motherboard Components

The following sections describe some of the features on the motherboard.

2.3.1 Memory Support

2.3.1.1 Installed Memory

One 200-pin 1.0 GB 533 MHz DDR2 SDRAM SO-DIMM is installed in the AFL-15A-N270 and controlled by the Intel® 945GSE GMCH installed on the internal motherboard.

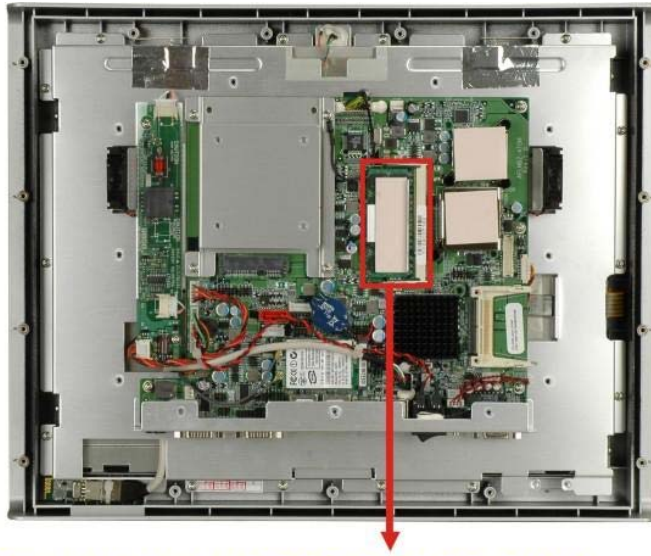

Preinstalled 1.0 GB DDR2 SO-DIMM

Figure 2-2: Preinstalled DDR2 SO-DIMM

2.3.1.2 Additional Memory

The Intel® 945GSE is capable of supporting one 200-pin 2.0 GB (max.) 400 MHz or 533 MHz DDR2 SDRAM SO-DIMM. If additional memory is required, please contact an IEL sales representative and discuss the necessary system requirement.

2.3.2 Storage Capacity

The AFL-15A-N270 series supports an easily installed CompactFlash® Type II (CF Type II) memory disk. The AFL-15A-N270 also supports a 2.5" SATA drive through the on-board SATA connector inside the chassis.

2.4 External Peripheral Interface Connectors

The following section describes the external peripheral interface connectors on the bottom panel of the subsystem.

2.4.1 Serial Port Connectors

The AFL-15A-N270 has two serial ports. One of these ports (COM1) is RS-232 only port. The other serial port (COM3) can be configured as a RS-232, RS-422 or an RS-485 serial port. Pin 9 on both ports can be set as the normal ring (RI) signal or can be designated as

AFOLUX AFL-15A-N270 Panel PC

a 5 V or 12 V power supply. Enabling COM devices to be powered through the COM port eliminates unnecessary and messy cabling.

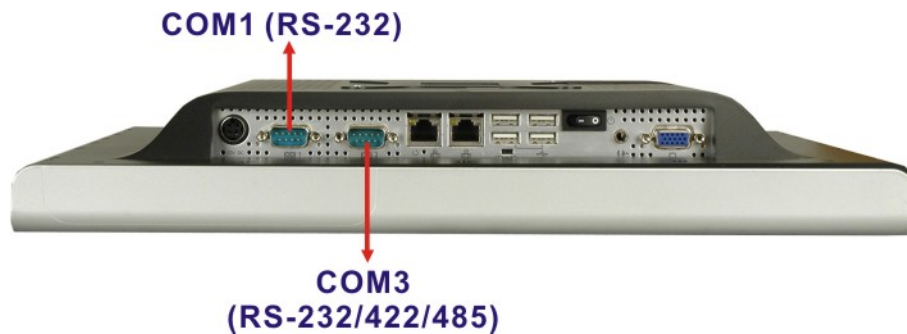

Figure 2-3: COM Ports

2.4.2 LAN Connectivity

The AFL-15A-N270 has two RJ-45 LAN connectors on the bottom panel.



Figure 2-4: RJ-45 Ethernet Connectors

The PCIe lane from the Intel® ICH7 chipset of the AFL-15A-N270 is interfaced to the Realtek RTL8111CP PCIe gigabit Ethernet (GbE) controllers. The RTL8111CP controllers are then connected directly to the RJ-45 connectors on the bottom panel and provides external GbE connectivity. Some of the RTL8111CP controller features are listed below:

- Integrated 10/100/1000 transceiver
- Supports PCI Express™ 1.1
- Fully compliant with IEEE 802.3, IEEE 802.3u, IEEE 802.3ab
- Supports IEEE 802.1P Layer 2 Priority Encoding
- Supports IEEE 802.1Q VLAN tagging
- Serial EEPROM

- Transmit/Receive on-chip buffer support
- 64-pin QFN package (Green package)

2.4.3 External USB Connectors

There are four USB 2.0 connectors on the bottom panel of the AFL-15A-N270. All USB 2.0 connectors are interfaced directly to the USB controllers on the ICH7-M southbridge. These USB connectors are fully compliant with USB specification Revision 2.0 and USB specification Revision 1.1 and can be interfaced to both USB 1.1 and USB 2.0 compliant devices.

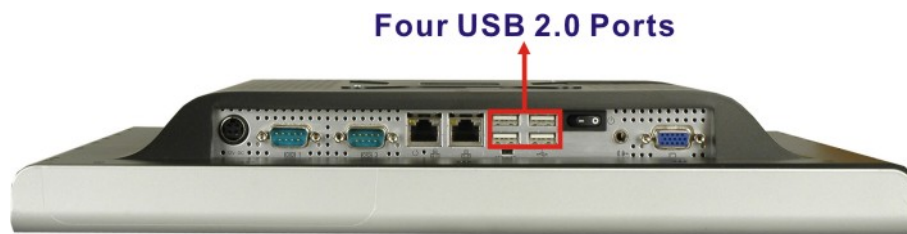

Figure 2-5: External USB Ports

2.5 AFOLUX AFL-15A-N270 Front Side

2.5.1 Monitor

A 15" XGA LCD screen is installed on the front of the AFOLUX AFL-15A-N270 series. The installed monitor has a pixel resolution of 1024 x 768 pixels. The screen is shown in **Figure 2-6** below.

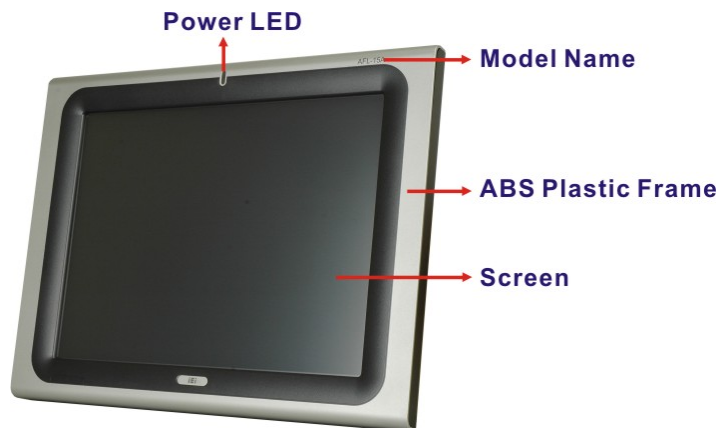

Figure 2-6: LCD Screen

AFOLUX AFL-15A-N270 Panel PC

2.5.2 Touch-Screen Module

A controller for the 5-wire resistive touch screen is installed on the motherboard. The sensitive touch screen is accurate, reliable and durable.

2.6 Graphics

2.6.1 Intel® 945GSE Integrated Graphics Media Accelerator 950

The Intel® 945GSE has the Intel® GMA 950 integrated into the chipset and interfaced to the VGA connector. The Intel® GMA 950 is a 400 MHz 256-bit graphics core and supports up to 10.6 GBps memory bandwidth with 667 MHz DDR2 system memory.



Figure 2-7: VGA Connector

2.6.2 Dual-Display

The system supports dual display capabilities. An additional monitor can be connected to the AFL-15A-N270 through the VGA connector described above.

2.7 Audio

2.7.1 HD Audio Codec Controller

The integrated HD Audio compliant audio controller on the Intel® ICH7-M Southbridge is integrated to a RealTek ALC888 audio codec. The RealTek ALC888 is connected to an external audio line-out jack, which is then connected to compliant audio devices. The RealTek ALC888 is a 7.1+2 Channel High Definition Audio codec. The audio connector is shown in **Figure 2-8**.



Figure 2-8: Audio Jack

2.7.2 Stereo Speakers

Two internal 1.5 W stereo speakers on the sides of the AFL-15A-N270 are interfaced to the system through a Philips TDA1517p integrated class-B dual output amplifier.

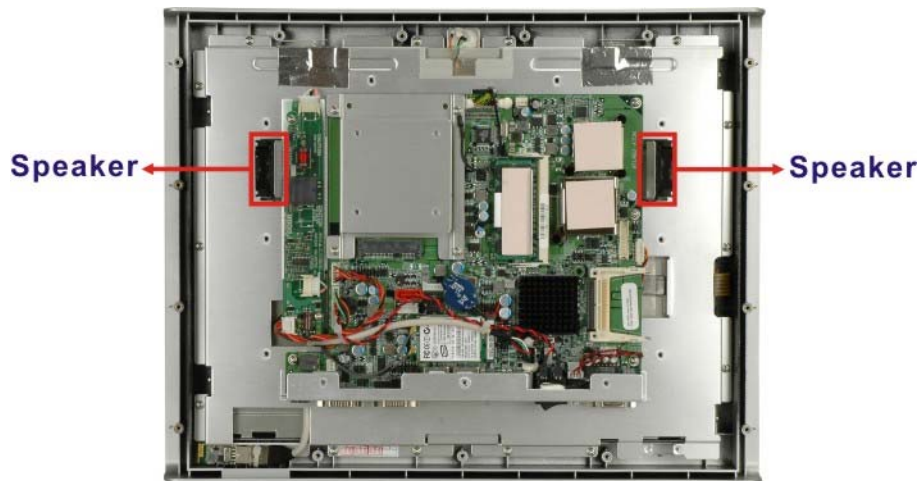

Figure 2-9: Stereo Speakers

2.8 System Power

2.8.1 Power Mode

The system can be run in the AT power mode or the ATX power mode. Both these power modes are described below.

2.8.1.1 ATX Power Mode (Default)

With the ATX mode selected, the AFOLUX AFL-15A-N270 panel PC goes in a standby mode when it is turned off. The panel PC can be easily turned on via network or a power switch in standby mode. Remote power control is perfect for advertising applications

AFOLUX AFL-15A-N270 Panel PC

since the broadcasting time for each panel PC can be set individually and controlled remotely. Other possible application includes

- Security surveillance
- Point-of-Sale (POS)
- Advertising terminal

2.8.1.2 AT Power Mode

With the AT mode selected, the power is controlled by a central power unit rather than a power switch. The AFOLUX AFL-15A-N270 panel PC turns on automatically when the power is connected. The AT mode benefits a production line to control multiple panel PCs from a central management center and other applications including:

- ATM
- Self-service kiosk
- Plant environment monitoring system
- Factory automation platform
- Manufacturing shop flow

2.8.2 Power Adapter

The system is shipped with a 90 V to 264 V AC power adapter that has a maximum power output of 60 W. The power adapter has a 12 V DC output connector.

2.8.3 Power Connector

There is one 4-pin 12 V power input connector on the bottom panel. The power connector is shown in **Figure 2-10** below.



Figure 2-10: Power Connector

2.9 Wireless Connections

The following section describes the wireless modules on the circuit.

2.9.1 Wireless Ethernet

An integrate PIFA antenna on the AFOLUX AFL-15A-N270 ensures an uninterrupted wireless connection. PIFA antennas can receive high-quality, uniform signals in any location from all directions without any signal degradation or impedance and are the most efficient antennas on the market.

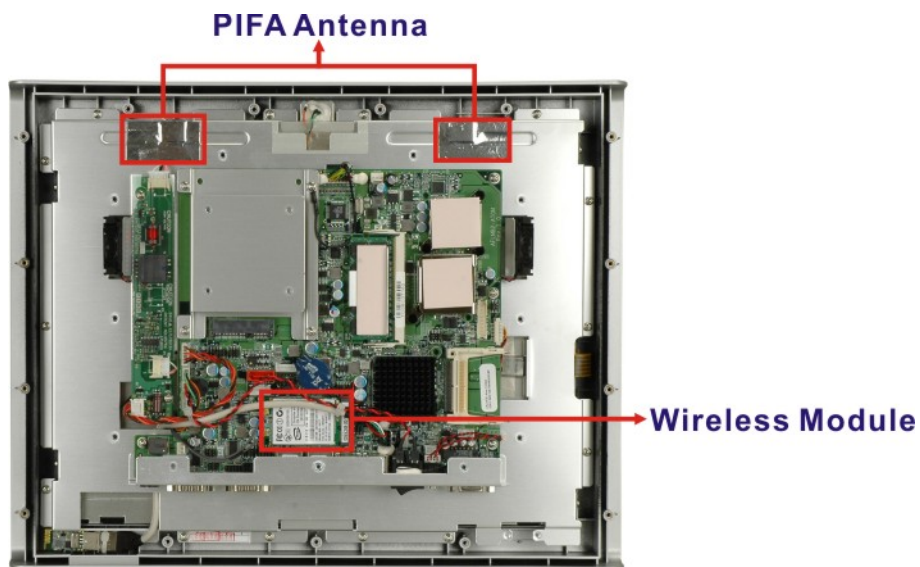

Figure 2-11: PIFA Antenna and Wireless Module

Chapter

3

Unpacking

3.1 Unpacking

To unpack the flat panel PC, follow the steps below:



WARNING!







The front side LCD screen has a protective plastic cover stuck to the screen. Only remove the plastic cover after the flat panel PC has been properly installed. This ensures the screen is protected during the installation process.

- Step 1:** Use box cutters, a knife or a sharp pair of scissors that seals the top side of the external (second) box.
- Step 2:** Open the external (second) box.
- Step 3:** Use box cutters, a knife or a sharp pair of scissors that seals the top side of the internal (first) box.
- Step 4:** Lift the monitor out of the boxes.
- Step 5:** Remove both polystyrene ends, one from each side.
- Step 6:** Pull the plastic cover off the flat panel PC.
- Step 7:** Make sure all the components listed in the packing list are present.

AFOLUX AFL-15A-N270 Panel PC

3.1.1 Packing List

The AFL-15A-N270 flat panel PC is shipped with the following components:

Quantity	Item	Image
Standard		
1	AFOLUX AFL-15A-N270 series	
1	Power adapter	
1	Power cord	
1	Screw kit	
1	User manual CD and driver CD	
1	Touch pen	
Optional		
	Panel/Rack Mount Kit (P/N: AFLPK-15)	

<p>Wall mounting kit (P/N: AFLWK-19)</p>	
<p>Stand (P/N: STAND-A19)</p>	
<p>Stand (P/N: STAND-B19)</p>	
<p>Stand (P/N: STAND-210-RS)</p>	
<p>Arm (P/N: ARM-11-RS)</p>	
<p>Arm (P/N: ARM-31-RS)</p>	

If any of these items are missing or damaged, contact the distributor or sales representative immediately.

Chapter

4

Installation

4.1 Anti-static Precautions



WARNING:

Failure to take ESD precautions during the maintenance of the AFL-15A-N270 may result in permanent damage to the AFL-15A-N270 and severe injury to the user.

Electrostatic discharge (ESD) can cause serious damage to electronic components, including the AFL-15A-N270. Dry climates are especially susceptible to ESD. It is therefore critical that whenever the AFL-15A-N270 is accessed internally, or any other electrical component is handled, the following anti-static precautions are strictly adhered to.

- **Wear an anti-static wristband:** - Wearing a simple anti-static wristband can help to prevent ESD from damaging the board.
- **Self-grounding:** - Before handling the board touch any grounded conducting material. During the time the board is handled, frequently touch any conducting materials that are connected to the ground.
- **Use an anti-static pad:** - When configuring the AFL-15A-N270, place it on an anti-static pad. This reduces the possibility of ESD damaging the AFL-15A-N270.
- **Only handle the edges of the PCB:** - When handling the PCB, hold the PCB by the edges.

4.2 Installation Precautions

When installing the flat panel PC, please follow the precautions listed below:

- **Power turned off:** When installing the flat panel PC, make sure the power is off. Failing to turn off the power may cause severe injury to the body and/or damage to the system.
- **Certified Engineers:** Only certified engineers should install and modify onboard functionalities.

AFOLUX AFL-15A-N270 Panel PC

- **Anti-static Discharge:** If a user opens the rear panel of the flat panel PC, to configure the jumpers or plug in added peripheral devices, ground themselves first and wear an anti-static wristband.

4.3 Preinstalled Components

The following components are all preinstalled.

- Motherboard
- TFT LCD screen
- 1.0 GB DDR2 memory module
- Resistive type touch screen
- Wireless LAN module
- Two 1.5 W amplifiers
- PIFA antenna

Preinstalled customizations may include the following.

- Different DDR2 memory module
- Hard disk drive
- HSDPA module

Component installation is described in **the following sections**.

4.4 Installation and Configuration Steps

The following installation steps must be followed.

Step 1: Unpack the flat panel PC

Step 2: Install a CF card

Step 3: Install a HDD

Step 4: Configure the system

Step 5: Connect peripheral devices to the bottom panel of the flat panel PC

Step 6: Mount the flat panel PC

4.5 Removing the Rear Panel



WARNING:

Over-tightening back cover screws will crack the plastic frame.
Maximum torque for cover screws is 5 kg-cm (0.36 lb-ft/0.49 Nm).

To access the AFL-15A-N270 internally the rear panel must be removed. To remove the rear panel, please follow the steps below.

Step 1: Remove the 16 retention screws (**Figure 4-1**).



Figure 4-1: Back Cover Retention Screws

Step 2: Lift the cover off the AFL-15A-N270 panel PC.

4.6 CF Card Installation

The AFL-15A-N270 series has one CF Type II slot inside the rear panel. To install the CF card, follow the instructions below.

Step 1: Remove the back cover. See **Section 4.5**.

Step 2: Locate the CF slot in the left panel.

AFOLUX AFL-15A-N270 Panel PC

Step 3: Insert a CF card into the slot (**Figure 4-2**).

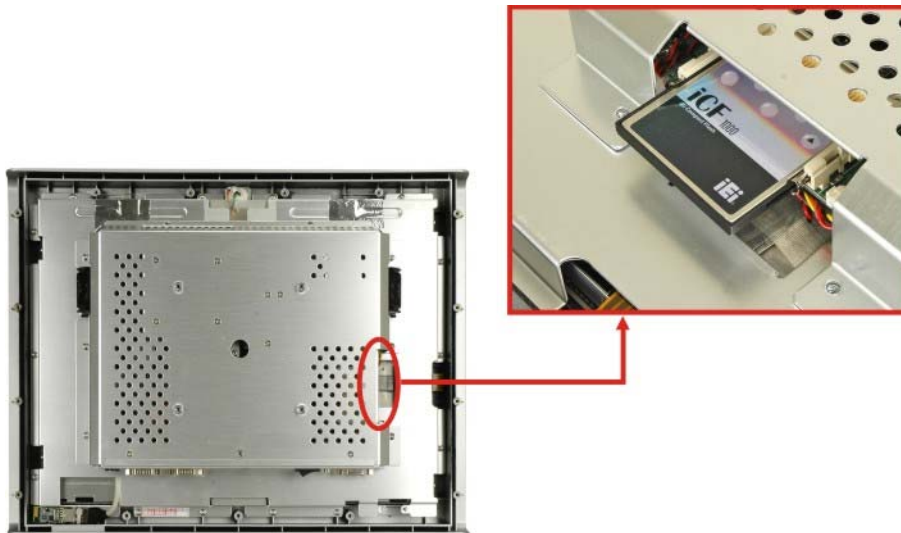

Figure 4-2: CF Card Location

Step 4: Replace the plastic back cover. Once replaced reinsert the 16 previously removed retention screws.

4.7 HDD Installation

To install the HDD into the AFL-15A-N270, please follow the steps below:

Step 1: Remove the plastic back cover. See **Section 4.5** above.

Step 2: Remove the aluminum cover. See **Section 5.4.2**.

Step 3: Remove the four HDD bracket retention screws and lift the HDD bracket off the panel PC.



Figure 4-3: HDD Bracket Retention Screws

Step 4: Attach the HDD brackets to the HDD. To do this, align the four retention screw holes in the base of the HDD bracket with the retention screw holes on the bottom of the HDD. Insert four retention screws into the HDD bracket (Figure 4-4).

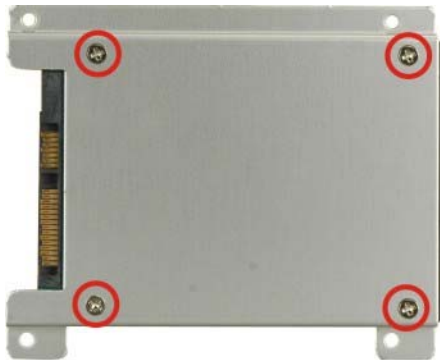

Figure 4-4: AFL-15A-N270 HDD Retention Screws

Step 5: Insert the rear of HDD into the SATA connector on the motherboard.

Step 6: Secure the HDD to the AFL-15A-N270 by aligning the retention screw holes in the HDD brackets with the retention screw holes on the chassis. Insert the four retention screws.

AFOLUX AFL-15A-N270 Panel PC

Step 7: Replace the aluminum back cover to the chassis.

Step 8: Replace the plastic back cover.

4.8 AT/ATX Mode Selection

AT and ATX power modes can both be used on the AFL-15A-N270 series. The selection is made through an AT/ATX switch on bottom panel (**Figure 4-5**). To select AT mode or ATX mode, follow the steps below.

Step 1: Locate the AT/ATX switch on the bottom panel (**Figure 4-5**).

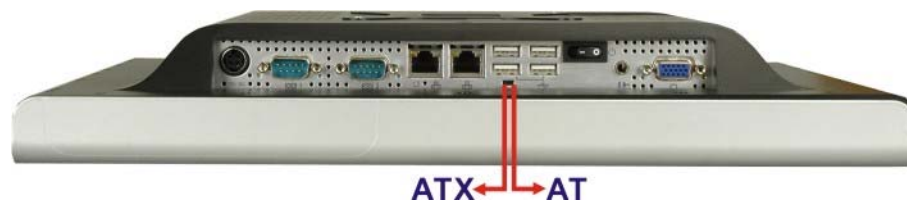

Figure 4-5: AT/ATX Switch Location

Step 2: Adjust the AT/ATX switch.

4.8.1 AT Power Mode

With the AT mode selected, the power is controlled by a central power unit rather than a power switch. The AFL-15A-N270 panel PC turns on automatically when the power is connected. The AT mode benefits a production line to control multiple panel PCs from a central management center and other applications including:

- ATM
- Self-service kiosk
- Plant environment monitoring system
- Factory automation platform
- Manufacturing shop flow

4.8.2 ATX Power Mode

With the ATX mode selected, the AFL-15A-N270 panel PC goes in a standby mode when it is turned off. The panel PC can be easily turned on via network or a power switch in

standby mode. Remote power control is perfect for advertising applications since the broadcasting time for each panel PC can be set individually and controlled remotely. Other possible application includes

- Security surveillance
- Point-of-Sale (POS)
- Advertising terminal

4.9 Jumper Settings



NOTE:

A jumper is a metal bridge used to close an electrical circuit. It consists of two or three metal pins and a small metal clip (often protected by a plastic cover) that slides over the pins to connect them. To CLOSE/SHORT a jumper means connecting the pins of the jumper with the plastic clip and to OPEN a jumper means removing the plastic clip from a jumper.

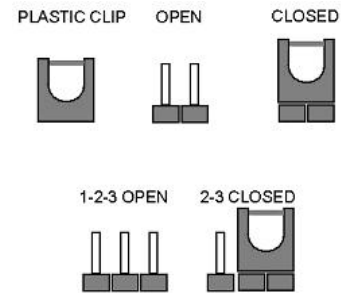

The following jumpers can be found on the motherboard installed in the AFL-15A-N270. Before the AFL-15A-N270 is installed, the jumpers must be set in accordance with the desired configuration. The jumpers on the AFL-15A-N270 motherboard are listed in **Table 4-1**.

Description	Label	Type
CF card setup	JCF1	2-pin header
Clear CMOS	J_COMS1	3-pin header
COM1 Pin 9 setting	JP6	6-pin header
COM3 Pin 9 setting	JP7	6-pin header
COM3 RX RS-232/422/485 select	JP8	8-pin header

AFOLUX AFL-15A-N270 Panel PC

COM3 TX RS-422/485 select	JP11	6-pin header
COM3 RS-232/422/485 select	JP10	12-pin header

Table 4-1: Jumpers

4.9.1 Access the Jumpers

To access the jumpers, please remove the back panel and the internal aluminum chassis (see **Section 5.4**).

4.9.2 Preconfigured Jumpers



WARNING:

Do not change the settings on the jumpers in described here. Doing so may disable or damage the system.

The following jumpers are preconfigured for the AFL-15A-N270. Users should no change these jumpers (**Table 4-2**).

Jumper Name	Label	Type
LVDS voltage selection	J_VLVDS1	4-pin header
Touch Screen Select	J1	4-pin header
Panel Type and Resolution	J_LCD_TYPE1	8-pin header

Table 4-2: Preconfigured Jumpers

4.9.3 CF Card Setup

Jumper Label:	JCF1
Jumper Type:	2-pin header
Jumper Settings:	See Table 4-3
Jumper Location:	See Figure 4-6

The CF Card Setup jumper sets the CF Type I card or CF Type II cards as either the slave device or the master device. CF Card Setup jumper settings are shown in **Table 4-3**.

CF Setup	Description	
Open	Slave	Default
Closed	Master	

Table 4-3: CF Card Setup Jumper Settings

The CF Card Setup jumper location is shown in **Figure 4-6**.

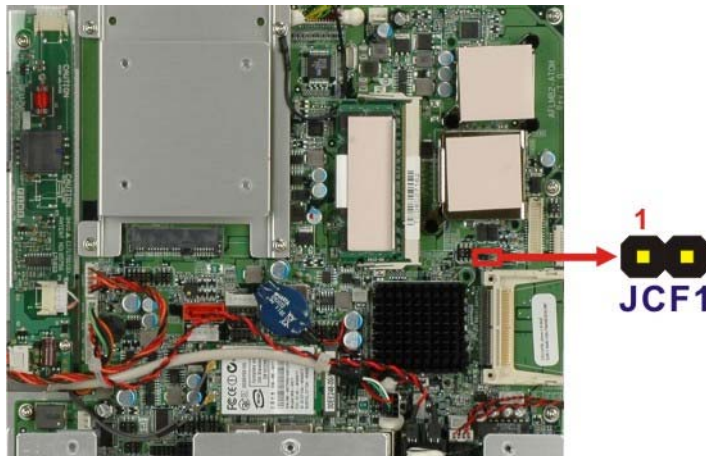

Figure 4-6: CF Card Setup Jumper Location

AFOLUX AFL-15A-N270 Panel PC

4.9.4 Clear CMOS Jumper

Jumper Label:	J_CMOS1
Jumper Type:	3-pin header
Jumper Settings:	See Table 4-4
Jumper Location:	See Figure 4-7

If the AFL-15A-N270 fails to boot due to improper BIOS settings, the clear CMOS jumper clears the CMOS data and resets the system BIOS information. To do this, use the jumper cap to close the pins for a few seconds then remove the jumper clip.

If the “CMOS Settings Wrong” message is displayed during the boot up process, the fault may be corrected by pressing the F1 to enter the CMOS Setup menu. Do one of the following:

- Enter the correct CMOS setting
- Load Optimal Defaults
- Load Failsafe Defaults.

After having done one of the above, save the changes and exit the CMOS Setup menu.

The clear CMOS jumper settings are shown in **Table 4-4**.

Clear CMOS	Description	
Short 1 - 2	Keep CMOS Setup	Default
Short 2 - 3	Clear CMOS Setup	

Table 4-4: Clear CMOS Jumper Settings

The location of the clear CMOS jumper is shown in **Figure 4-7** below.

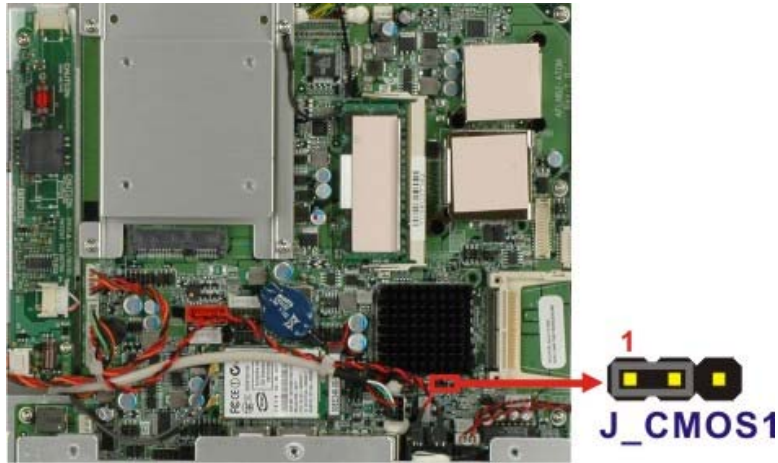

Figure 4-7: Clear CMOS Jumper

4.9.5 COM Port Pin 9 Select

- Jumper Label:** JP6 and JP7
- Jumper Settings:** See Table 4-5
- Jumper Type:** 6-pin header
- Jumper Location:** See Figure 4-8

Two jumpers (JP6 and JP7) configure pin 9 on COM1 and COM3 DB-9 connectors. Pin 9 on the COM1 and the COM3 DB-9 connectors can be set as the ring (RI) signal, +5 V or +12 V. The COM1 and COM3 Pin 9 Setting jumper selection options are shown in **Table 4-5**.

JP6	Description	
Short 1-2	COM1 RI Pin use +12 V	
Short 3-4	COM1 RI Pin use RI	Default
Short 5-6	COM1 RI Pin use +5 V	

Table 4-5: COM1 Pin 9 Setting Jumper Settings

AFOLUX AFL-15A-N270 Panel PC

JP7	Description	
Short 1-2	COM3 RI Pin use +12 V	
Short 3-4	COM3 RI Pin use RI	Default
Short 5-6	COM3 RI Pin use +5 V	

Table 4-6: COM3 Pin 9 Setting Jumper Settings

The COM1 and COM3 Pin 9 Setting jumper locations are shown in **Figure 4-8** below.

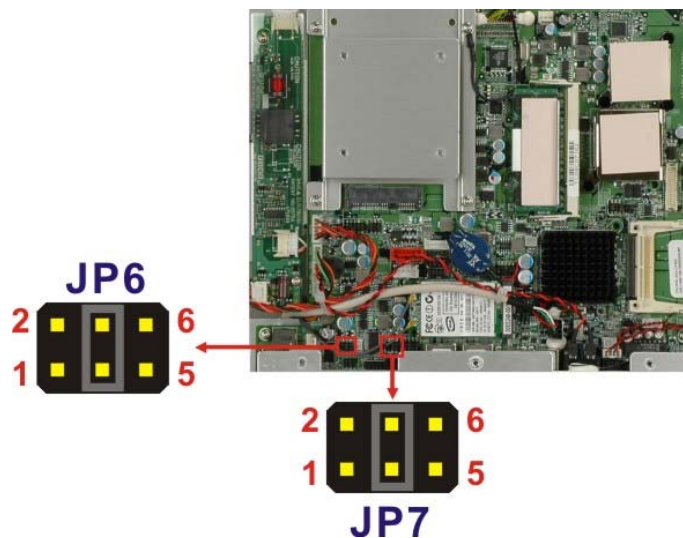

Figure 4-8: COM1 and COM3 Pin 9 Setting Jumper Locations

4.9.6 COM3 RX Function Select Jumper

Jumper Label:	JP8
Jumper Type:	8-pin header
Jumper Settings:	See Table 4-7
Jumper Location:	See Figure 4-9

The COM3 RX Function Select jumper sets the communication protocol used by the RX serial communications port COM3 as RS-232, RS-422 or RS-485. The COM3 RX Function Select jumper settings are shown in **Table 4-7**.

COM3 RX Function Select	Description	
Short 3-4	RS-232	Default
Short 1-2, 5-6	RS-422	
Short 1-2, 7-8	RS-485	

Table 4-7: COM3 RX Function Select Jumper Settings

The COM3 RX Function Select jumper location is shown in **Figure 4-9**.

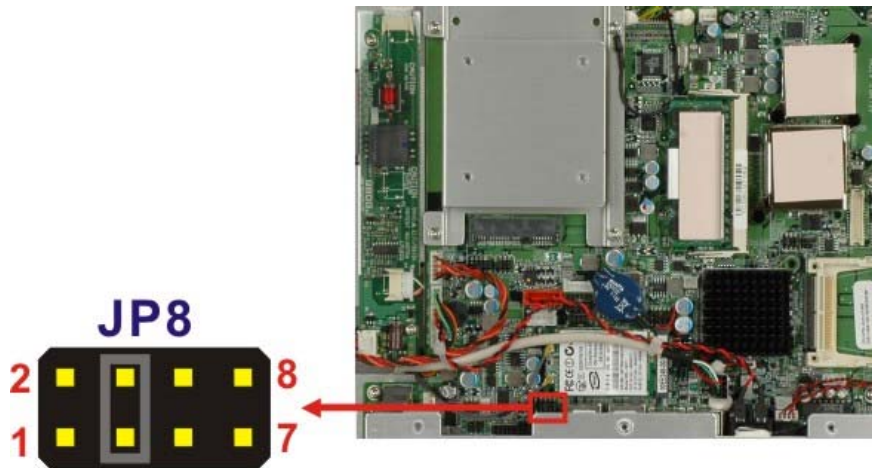

Figure 4-9: COM3 RX Function Select Jumper Location

4.9.7 COM3 TX Function Select Jumper

- Jumper Label:** JP11
- Jumper Type:** 6-pin header
- Jumper Settings:** See **Table 4-8**
- Jumper Location:** See **Figure 4-10**

The COM3 TX Function Select jumper configures the TX pin on COM3 serial port connector as RS-422 as an RS-485. The COM3 TX Function Select jumper selection options are shown in **Table 4-8**.

AFOLUX AFL-15A-N270 Panel PC

COM3 TX Function Select	Description	
Short 1 – 3	RS-422	Default
Short 2 – 4	RS-422	Default
Short 3 – 5	RS-485	
Short 4 – 6	RS-485	

Table 4-8: COM3 TX Function Select Jumper Settings

The COM3 TX Function Select jumper location is shown in **Figure 4-10** below.

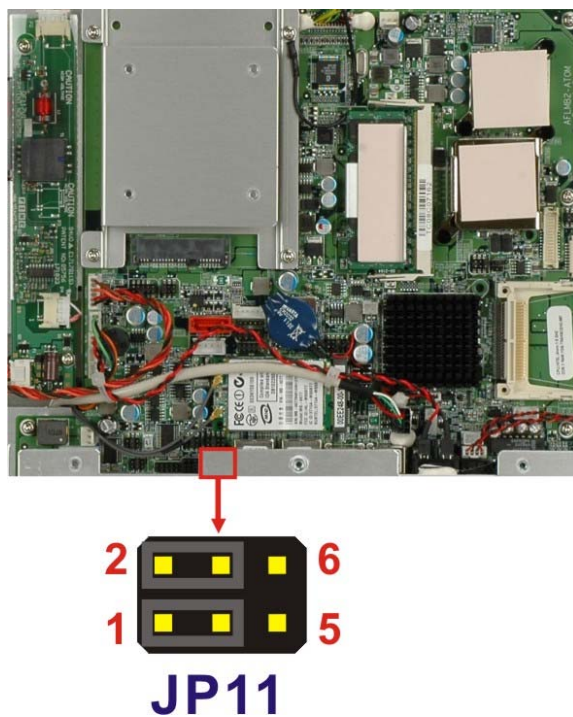

Figure 4-10: COM3 TX Function Select Jumper Pinout Locations

4.9.8 COM3 RS-232/422/485 Serial Port Select Jumper

Jumper Label:	JP10
Jumper Type:	12-pin header (four 3-pin headers combined)
Jumper Settings:	See Table 4-9
Jumper Location:	See Figure 4-11

The COM3 RS-232/422/485 Serial Port Select jumper sets the communication protocol used by the second serial communications port (COM3) as RS-232, RS-422 or RS-485. The COM3 RS-232/422/485 Serial Port Select settings are shown in **Table 4-9**.

RS-232/485 Select	Description	
Short 1-2	RS-232	Default
Short 4-5	RS-232	Default
Short 7-8	RS-232	Default
Short 10-11	RS-232	Default
Short 2-3	RS-422/485	
Short 5-6	RS-422/485	
Short 8-9	RS-422/485	
Short 11-12	RS-422/485	

Table 4-9: COM3 RS-232/422/485 Serial Port Select Jumper Settings

The COM3 RS-232/422/485 Serial Port Select jumper location is shown in **Figure 4-11**.

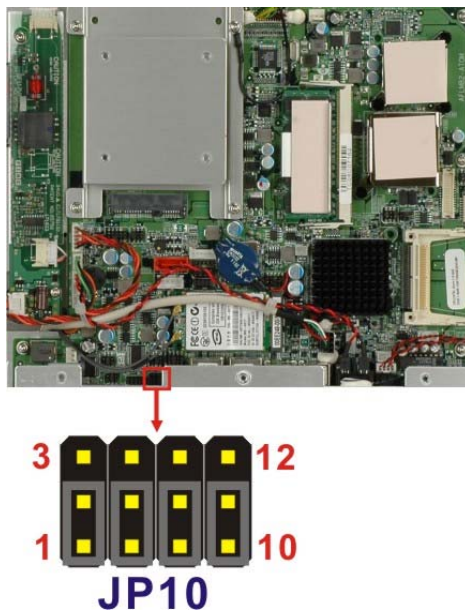

Figure 4-11: COM3 RS-232/422/485 Serial Port Select Jumper Location

AFOLUX AFL-15A-N270 Panel PC

4.9.8.1 COM3 RS-422 and RS-485 Pinouts

The pinouts for RS-422 and RS-485 operation of external serial port COM 3 are detailed below.

COM 3	RS-422 Description
Pin 1	TX-
Pin 2	TX+
Pin 6	RX-
Pin 7	RX+

Table 4-10: RS-422 Pinouts

COM 3	RS-485 Description
Pin 1	Data-
Pin 2	Data+

Table 4-11: RS-485 Pinouts

4.10 Mounting the System



WARNING!

When mounting the flat panel PC onto an arm, onto the wall or onto a panel, it is better to have more than one person to help with the installation to make sure the panel PC does not fall down and get damaged.

The four methods of mounting the AFOLUX AFL-15A-N270 are listed below.

- Wall mounting
- Panel mounting
- Arm mounting
- Rack mounting

The four mounting methods are described below.

4.10.1 Wall Mounting

To mount the flat panel PC onto the wall, please follow the steps below.

- Step 1:** Select the location on the wall for the wall-mounting bracket.
- Step 2:** Carefully mark the locations of the four screw holes in the bracket on the wall.
- Step 3:** Drill four pilot holes at the marked locations on the wall for the bracket retention screws.
- Step 4:** Align the wall-mounting bracket screw holes with the pilot holes.
- Step 5:** Secure the mounting-bracket to the wall by inserting the retention screws into the four pilot holes and tightening them (**Figure 4-12**).

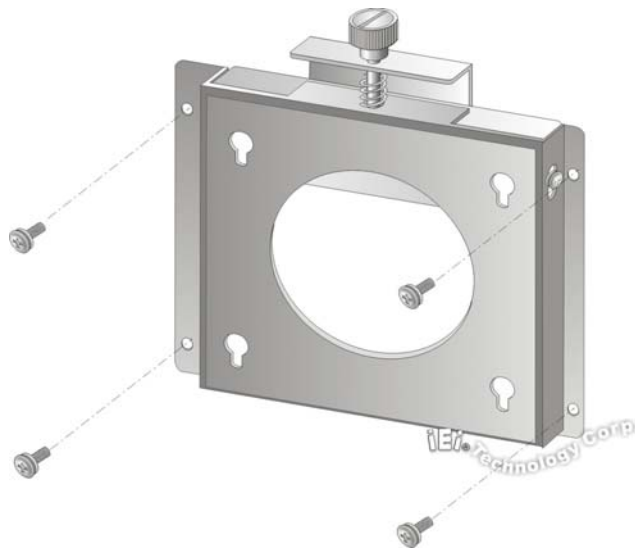

Figure 4-12: Wall-mounting Bracket

- Step 6:** Insert the four monitor mounting screws provided in the wall mounting kit into the four screw holes on the rear panel of the flat panel PC and tighten until the screw shank is secured against the rear panel (**Figure 4-13**).
- Step 7:** Align the mounting screws on the monitor rear panel with the mounting holes on the bracket.

AFOLUX AFL-15A-N270 Panel PC

Step 8: Carefully insert the screws through the holes and gently pull the monitor downwards until the monitor rests securely in the slotted holes (**Figure 4-13**). Ensure that all four of the mounting screws fit snugly into their respective slotted holes.



NOTE:

In the diagram below the bracket is already installed on the wall.

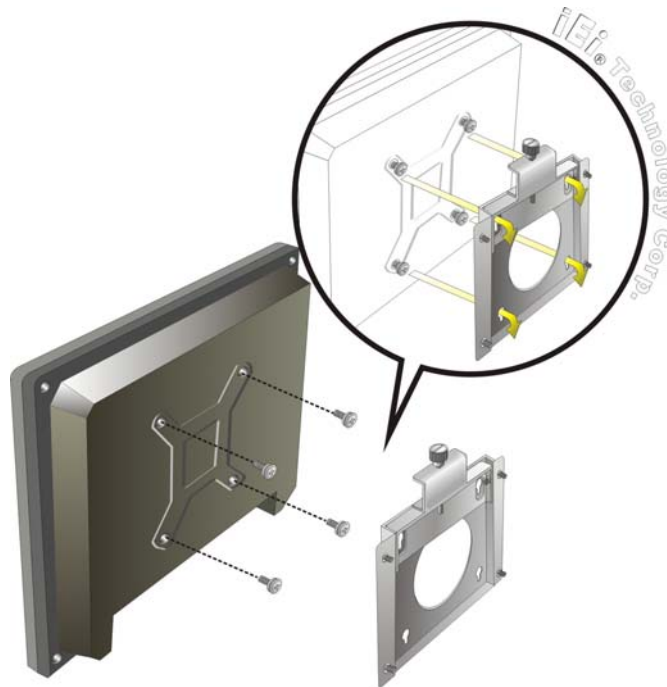

Figure 4-13: Chassis Support Screws

Step 9: Secure the panel PC by fastening the retention screw of the wall-mounting bracket. (**Figure 4-14**).

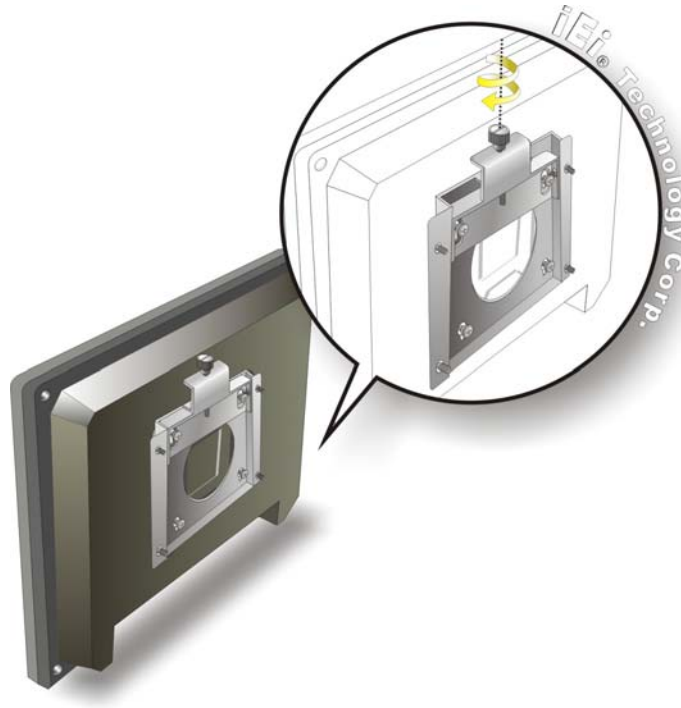

Figure 4-14: Secure the Panel PC

4.10.2 Panel Mounting

To mount the AFOLUX AFL-15A-N270 series flat panel PC into a panel, please follow the steps below.

- Step 1:** Select the position on the panel to mount the flat panel PC.
- Step 2:** Cut out a section from the panel that corresponds to the rear panel dimensions of the flat panel PC. Take care that the panel section that is cut out is smaller than the overall size of the frame that surrounds the flat panel PC but just large enough for the rear panel of the flat panel PC to fit through (see **Figure 4-15**).

AFOLUX AFL-15A-N270 Panel PC

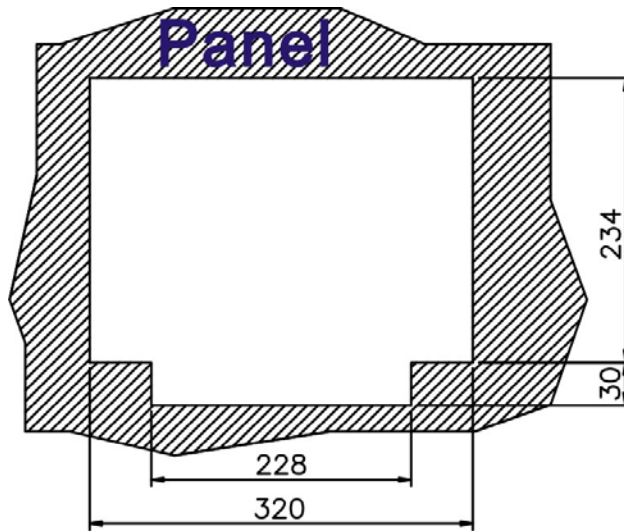

Figure 4-15: AFL-15A-N270 Panel Opening (Unit: mm)

- Step 3:** Slide the flat panel PC through the hole until the frame is flush against the panel.
- Step 4:** Align the panel mounting bracket screw holes with the VESA mounting holes on the rear of the panel PC.
- Step 5:** Secure the two panel mounting brackets to the rear of the panel PC by inserting the four retention screws into the VESA mounting holes (**Figure 4-16 ①**).
- Step 6:** Insert the panel mounting clamps into the pre-formed holes along the two edges of the panel mounting brackets (**Figure 4-16 ②**). There are a total of 4 panel mounting clamps for AFL-15A-N270.
- Step 7:** Tighten the screws that pass through the panel mounting clamps until the plastic caps at the front of all the screws are firmly secured to the panel (**Figure 4-16 ③**).

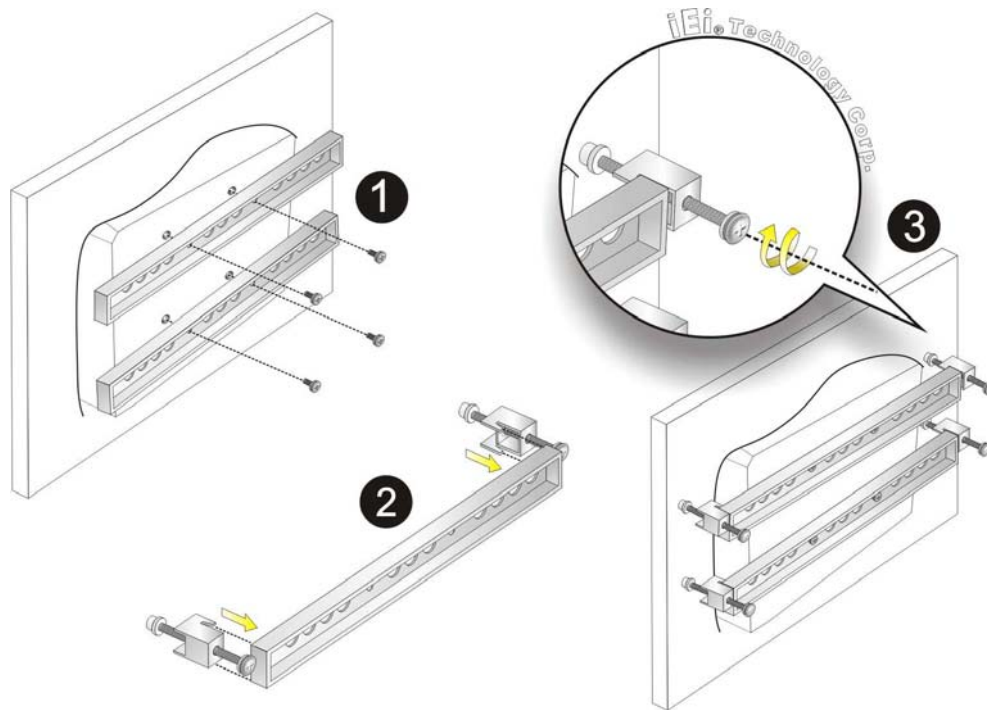

Figure 4-16: Panel Mounting

4.10.3 Arm Mounting

The AFL-15A-N270 series is VESA (Video Electronics Standards Association) compliant and can be mounted on an arm with a 75mm or 100mm interface pad. To mount the AFL-15A-N270 series on an arm, please follow the steps below.

Step 1: The arm is a separately purchased item. Please correctly mount the arm onto the surface it uses as a base. To do this, refer to the installation documentation that came with the mounting arm.



NOTE:

When purchasing the arm please ensure that it is VESA compliant and that the arm has a 100 mm interface pad. If the mounting arm is not VESA compliant it cannot be used to support the AFL-15A-N270 series flat panel PC.

AFOLUX AFL-15A-N270 Panel PC

Step 2: Once the mounting arm has been firmly attached to the surface, lift the flat panel PC onto the interface pad of the mounting arm.

Step 3: Align the retention screw holes on the mounting arm interface with those in the flat panel PC. The AFL-15A-N270 arm mount retention screw holes are shown in **Figure 4-17**.

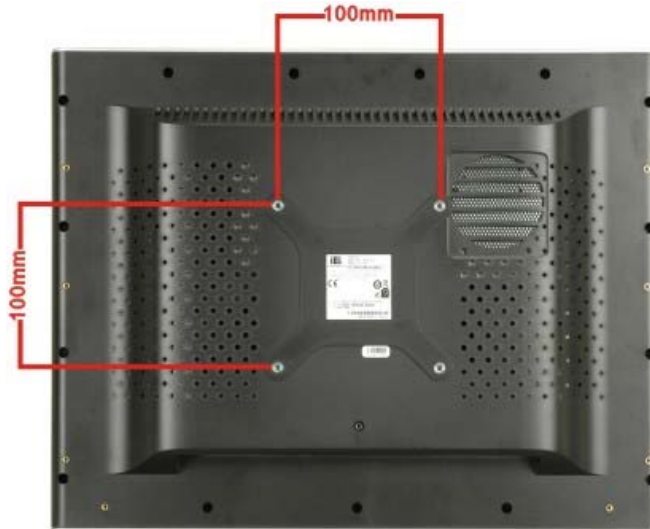

Figure 4-17: Arm Mounting Retention Screw Holes

Step 4: Secure the flat panel PC to the interface pad by inserting four retention screws through the bottom of the mounting arm interface pad and into the flat panel PC.

4.10.4 Cabinet and Rack Installation

The AFL-15A-N270 series flat panel PC can be installed into a cabinet or rack. The installation procedures are similar to the panel mounting installation. To do this, please follow the steps below:



NOTE:

When purchasing the cabinet/rack installation bracket, make sure it is compatible with both the AFL-15A-N270 series flat panel PC and the rack/cabinet into which the AFL-15A-N270 series is installed.

Step 1: Slide the rear chassis of the AFL-15A-N270 series flat panel PC through the rack/cabinet bracket until the aluminum frame is flush against the front of the bracket (**Figure 4-18**).

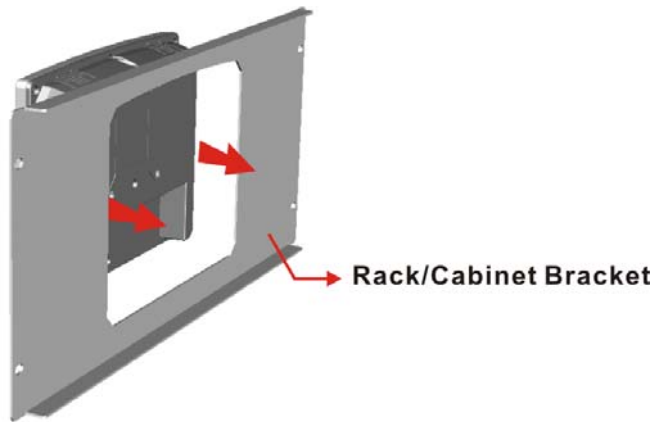

Figure 4-18: The Rack/Cabinet Bracket

Step 2: Follow the **Step 4 ~ Step 7** in **Section 4.10.2** to mount the AFL-15A-N270 into a cabinet or rack.

AFOLUX AFL-15A-N270 Panel PC

4.11 Bottom Panel Connectors

4.11.1 LAN Connection

There are two external RJ-45 LAN connectors. The RJ-45 connector enables connection to an external network. To connect a LAN cable with an RJ-45 connector, please follow the instructions below.

Step 1: Locate the RJ-45 connectors on the bottom panel of the AFOLUX AFL-15A-N270 Series.

Step 2: Align the connectors. Align the RJ-45 connector on the LAN cable with one of the RJ-45 connectors on the bottom panel of the AFOLUX AFL-15A-N270 Series. See **Figure 4-19**.

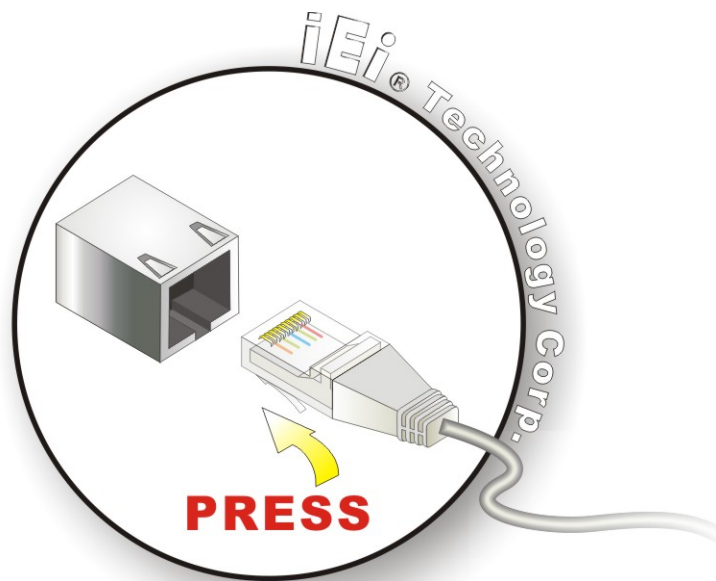

Figure 4-19: LAN Connection

Step 3: Insert the LAN cable RJ-45 connector. Once aligned, gently insert the LAN cable RJ-45 connector into the onboard RJ-45 connector.

4.11.2 Serial Device Connection

The AFL-15A-N270 Series has two male DB-9 connectors on the bottom panel for serial devices to be connected. Follow the steps below to connect a serial device to the AFL-15A-N270 panel PC.

Step 1: **Locate the DB-9 connector.** The location of the DB-9 connector is shown in Chapter 2.

Step 2: **Insert the serial connector.** Insert the DB-9 connector of a serial device into the DB-9 connector on the bottom panel. See **Figure 4-20**.

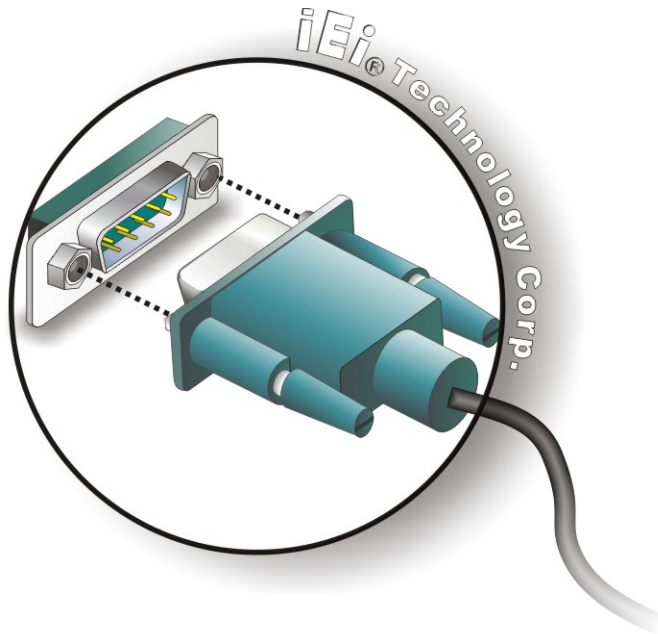

Figure 4-20: Serial Device Connector

Step 3: **Secure the connector.** Secure the serial device connector to the external interface by tightening the two retention screws on either side of the connector.

AFOLUX AFL-15A-N270 Panel PC

4.11.3 USB Device Connection

There are four external USB 2.0 connectors. All connectors are perpendicular to the AFL-15A-N270 Series. To connect a USB 2.0 or USB 1.1 device, please follow the instructions below.

Step 1: Located the USB connectors. The locations of the USB connectors are shown in **Chapter 2**.

Step 2: Align the connectors. Align the USB device connector with one of the connectors on the bottom panel. See **Figure 4-21**.

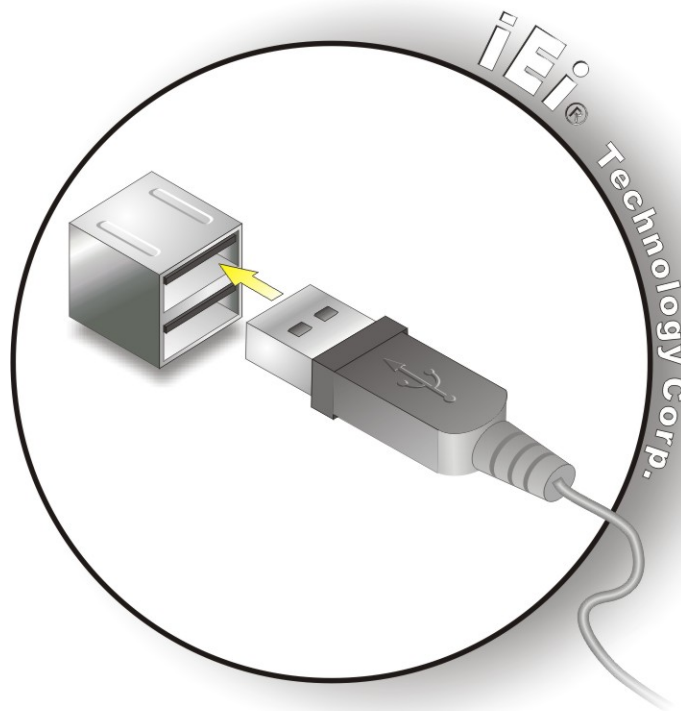

Figure 4-21: USB Device Connection

Step 3: Insert the device connector. Once aligned, gently insert the USB device connector into the onboard connector.

Chapter

5

System Maintenance

AFOLUX AFL-15A-N270 Panel PC

5.1 System Maintenance Introduction

If the components of the AFL-15A-N270 series fail they must be replaced. Components that can be replaced include:

- CF Module
- Wireless LAN module
- SO-DIMM module

Please contact the system reseller or vendor to purchase the replacement parts. Back cover removal instructions for the AFL-15A-N270 series are described below.

5.2 Anti-static Precautions



WARNING:

Failure to take ESD precautions during the maintenance of the AFL-15A-N270 may result in permanent damage to the AFL-15A-N270 and severe injury to the user.

Electrostatic discharge (ESD) can cause serious damage to electronic components, including the AFL-15A-N270. Dry climates are especially susceptible to ESD. It is therefore critical that whenever the panel PC is accessed internally, or any other electrical component is handled, the following anti-static precautions are strictly adhered to.

- ***Wear an anti-static wristband:*** - Wearing a simple anti-static wristband can help to prevent ESD from damaging the board.
- ***Self-grounding:*** - Before handling the board touch any grounded conducting material. During the time the board is handled, frequently touch any conducting materials that are connected to the ground.
- ***Use an anti-static pad:*** - When configuring the AFL-15A-N270, place it on an anti-static pad. This reduces the possibility of ESD damaging the AFL-15A-N270.
- ***Only handle the edges of the PCB:*** - When handling the PCB, hold the PCB by the edges.

5.3 Turn off the Power



WARNING:

Failing to turn off the system before opening it can cause permanent damage to the system and serious or fatal injury to the user.

Before any maintenance procedures are carried out on the system, make sure the system is turned off.

5.4 Opening the System

5.4.1 Removing the Back Panel



WARNING:

Over-tightening back cover screws will crack the plastic frame. Maximum torque for cover screws is 5 kg-cm (0.36 lb-ft/0.49 Nm).

To access the AFL-15A-N270 internally the back panel must be removed. To remove the back panel, please follow the steps below.

Step 1: Follow all anti-static procedures. See **Section 5.2**.

Step 2: Turn off the power. See **Section 5.3**.

Step 3: Remove the retention screws on the back. Remove the retention screws (Figure 5-1) from the rear panel.

AFOLUX AFL-15A-N270 Panel PC



Figure 5-1: Back Cover Retention Screws

Step 4: Lift the cover off the AFL-15A-N270.

5.4.2 Internal Aluminum Cover Removal

To remove the internal aluminum cover, follow the steps below.

Step 1: Remove the retention screws securing the internal aluminum cover. **Figure 5-2** shows the aluminum cover retention screws of the AFL-15A-N270.

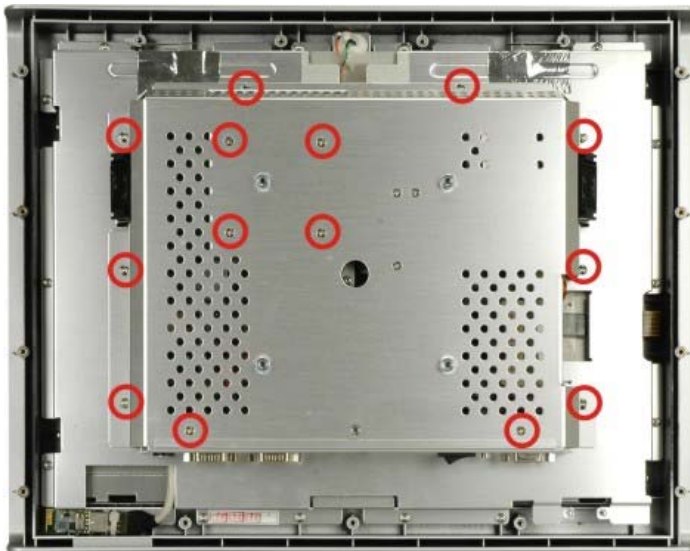

Figure 5-2: Aluminum Back Cover Retention Screws

Step 2: Lift the aluminum cover off the AFL-15A-N270 series.

5.5 Replacing Components

5.5.1 Memory Module Replacement

The flat panel PC is preinstalled with a 1.0 GB DDR2 memory module. If the memory module is fail, follow the instructions below to replace the memory module.

Step 1: Remove the back cover. See **Section 5.4.1** above.

Step 2: Remove the internal aluminum back cover. See **Section 5.4.2** above.

Step 3: Locate the DDR2 SO-DIMM on the motherboard (**Figure 5-3**).

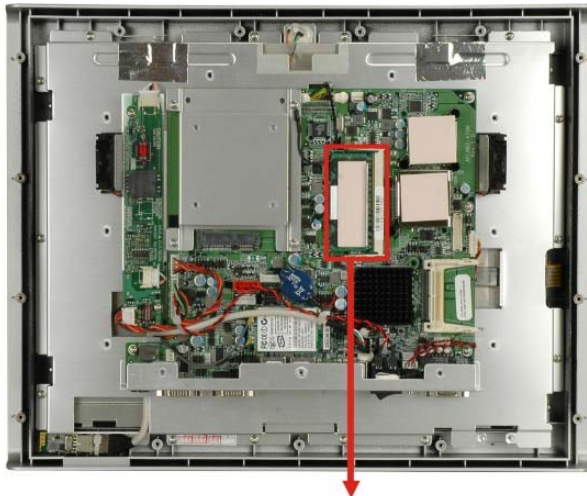

Preinstalled 1.0 GB 400 MHZ DDR2 SO-DIMM

Figure 5-3: SO-DIMM Socket Location

Step 4: Remove the DDR memory module by pulling both the spring retainer clips outward from the socket.

Step 5: Grasp the DDR memory module by the edges and carefully pull it out of the socket.

Step 6: Install the new DDR memory module by pushing it into the socket at an angle (**Figure 5-4**).

Step 7: Gently pull the spring retainer clips of the SO-DIMM socket out and push the rear of the DDR memory module down (**Figure 5-4**).

AFOLUX AFL-15A-N270 Panel PC

Step 8: Release the spring retainer clips on the SO-DIMM socket. They clip into place and secure the DDR memory module in the socket.

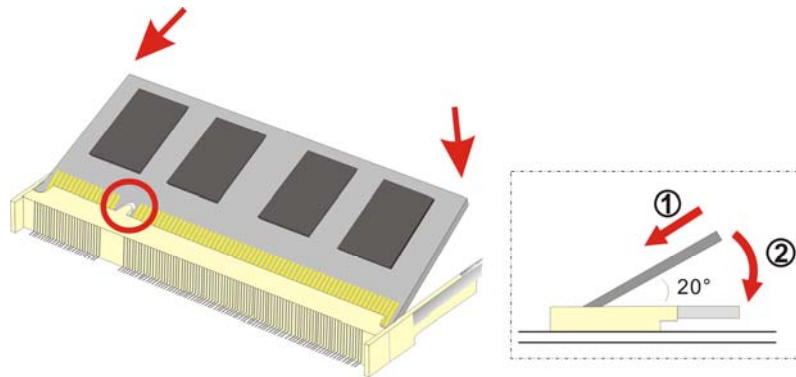

Figure 5-4: DDR SO-DIMM Module Installation

5.5.2 CF Card Replacement

The AFOLUX AFL-15A-N270 series has one CF Type II slot. To replace the CF card, follow the instructions below.

Step 1: Follow all anti-static procedures. See **Section 5.2**.

Step 2: Turn off the power. See **Section 5.3**.

Step 3: Remove the back panel. See **Section 5.4.1**.

Step 4: Follow the instruction listed in **Section 4.6** to replace the CF card.

5.6 Reinstalling the Covers



WARNING:

Failing to reinstall the covers may result in permanent damage to the system. Please make sure all coverings are properly installed.



AFOLUX AFL-15A-N270 Panel PC

When maintenance procedures are complete, please make sure all the covers are replaced, including the following:

- Aluminum cover
- Plastic cover

Chapter

6

AMI BIOS Setup

6.1 Introduction

A licensed copy of AMI BIOS is preprogrammed into the ROM BIOS. The BIOS setup program allows users to modify the basic system configuration. This chapter describes how to access the BIOS setup program and the configuration options that may be changed.

6.1.1 Starting Setup

The AMI BIOS is activated when the computer is turned on. The setup program can be activated in one of two ways.

1. Press the **DELETE** key as soon as the system is turned on or
2. Press the **DELETE** key when the “**Press Del to enter SETUP**” message appears on the screen.

If the message disappears before the **DELETE** key is pressed, restart the computer and try again.

6.1.2 Using Setup

Use the arrow keys to highlight items, press **ENTER** to select, use the PageUp and PageDown keys to change entries, press **F1** for help and press **Esc** to quit. Navigation keys are shown in.

Key	Function
Up arrow	Move to previous item
Down arrow	Move to next item
Left arrow	Move to the item on the left hand side
Right arrow	Move to the item on the right hand side
Esc key	Main Menu – Quit and not save changes into CMOS Status Page Setup Menu and Option Page Setup Menu -- Exit current page and return to Main Menu
Page Up key	Increase the numeric value or make changes
Page Dn key	Decrease the numeric value or make changes

AFOLUX AFL-15A-N270 Panel PC

F1 key	General help, only for Status Page Setup Menu and Option Page Setup Menu
F2 /F3 key	Change color from total three colors. F2 to select color forward.
F10 key	Save all the CMOS changes, only for Main Menu

Table 6-1: BIOS Navigation Keys

6.1.3 Getting Help

When **F1** is pressed a small help window describing the appropriate keys to use and the possible selections for the highlighted item appears. To exit the Help Window press **Esc** or the **F1** key again.

6.1.4 Unable to Reboot After Configuration Changes

If the computer cannot boot after changes to the system configuration is made, CMOS defaults. Use the jumper described in **Chapter 4**.

6.1.5 BIOS Menu Bar

The **menu bar** on top of the BIOS screen has the following main items:

- **Main** Changes the basic system configuration.
- **Advanced** Changes the advanced system settings.
- **PCIPnP** Changes the advanced PCI/PnP Settings
- **Boot** Changes the system boot configuration.
- **Security** Sets User and Supervisor Passwords.
- **Chipset** Changes the chipset settings.
- **Exit** Selects exit options and loads default settings

The following sections completely describe the configuration options found in the menu items at the top of the BIOS screen and listed above.

6.2 Main

The **Main** BIOS menu (**BIOS Menu 1**) appears when the **BIOS Setup** program is entered. The **Main** menu gives an overview of the basic system information.

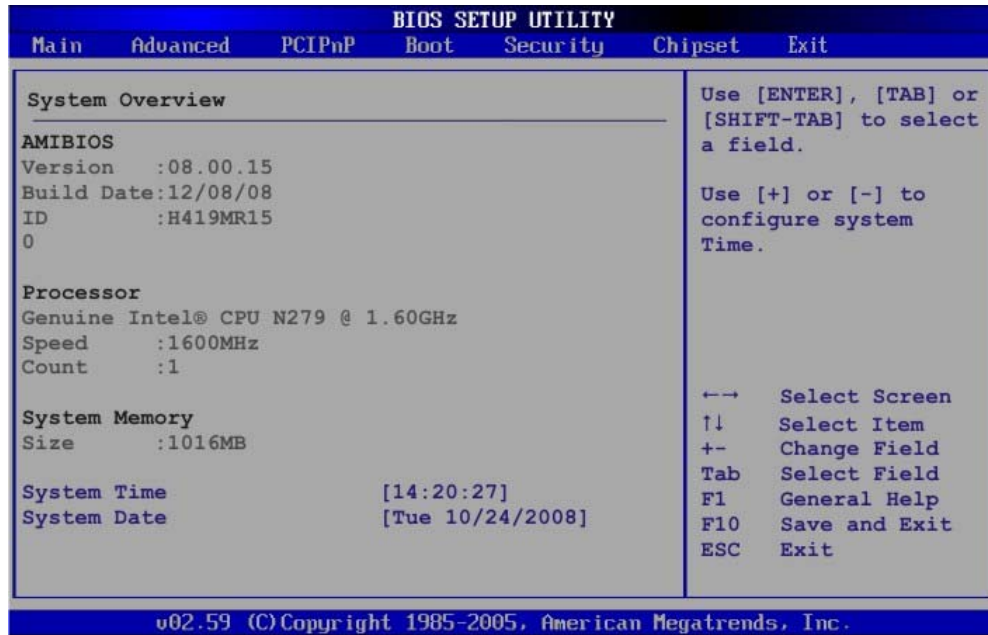

BIOS Menu 1: Main

→ System Overview

The **System Overview** lists a brief summary of different system components. The fields in **System Overview** cannot be changed. The items shown in the system overview include:

- **AMI BIOS:** Displays auto-detected BIOS information
 - Version: Current BIOS version
 - Build Date: Date the current BIOS version was made
 - ID: Installed BIOS ID
- **Processor:** Displays auto-detected CPU specifications
 - Type: Names the currently installed processor
 - Speed: Lists the processor speed
 - Count: The number of CPUs on the CPU card
- **System Memory:** Displays the auto-detected system memory.
 - Size: Lists memory size

AFOLUX AFL-15A-N270 Panel PC

The **System Overview** field also has two user configurable fields:

→ **System Time [xx:xx:xx]**

Use the **System Time** option to set the system time. Manually enter the hours, minutes and seconds.

→ **System Date [xx/xx/xx]**

Use the **System Date** option to set the system date. Manually enter the day, month and year.

6.3 Advanced

Use the **Advanced** menu (**BIOS Menu 2**) to configure the CPU and peripheral devices through the following sub-menus:



WARNING:

Setting the wrong values in the sections below may cause the system to malfunction. Make sure that the settings made are compatible with the hardware.

- CPU Configuration (see **Section 6.3.1**)
- IDE Configuration (see **Section 6.3.2**)
- SuperIO Configuration (see **Section 6.3.3**)
- Hardware Health Configuration (see **Section 6.3.4**)
- Power Configuration (see **Section 6.3.5**)
- APM Configuration (see **Section 6.3.6**)
- Remote Access Configuration (see **Section 6.3.7**)
- USB Configuration (see **Section 6.3.8**)

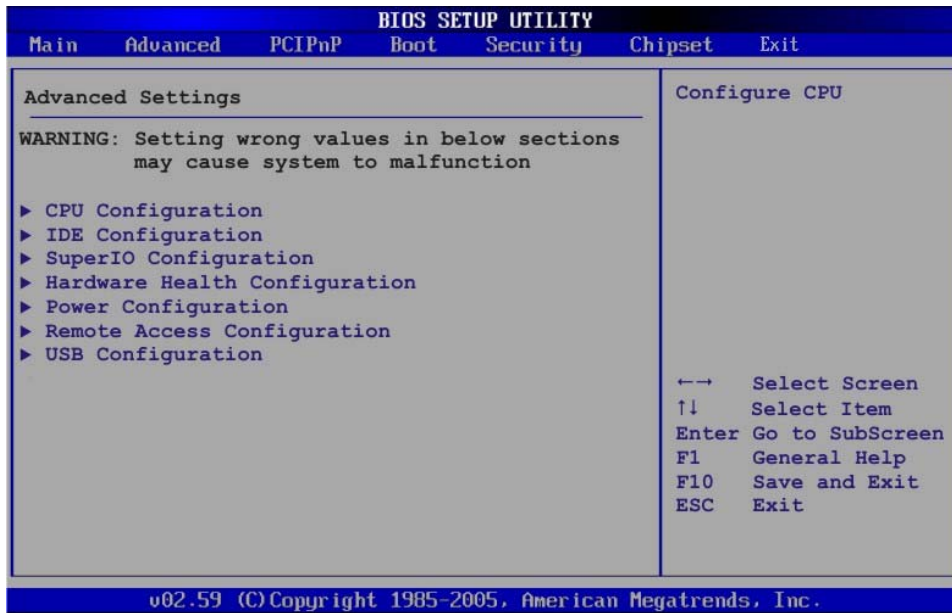

BIOS Menu 2: Advanced

6.3.1 CPU Configuration

Use the **CPU Configuration** menu (**BIOS Menu 3**) to view detailed CPU specifications and configure the CPU.

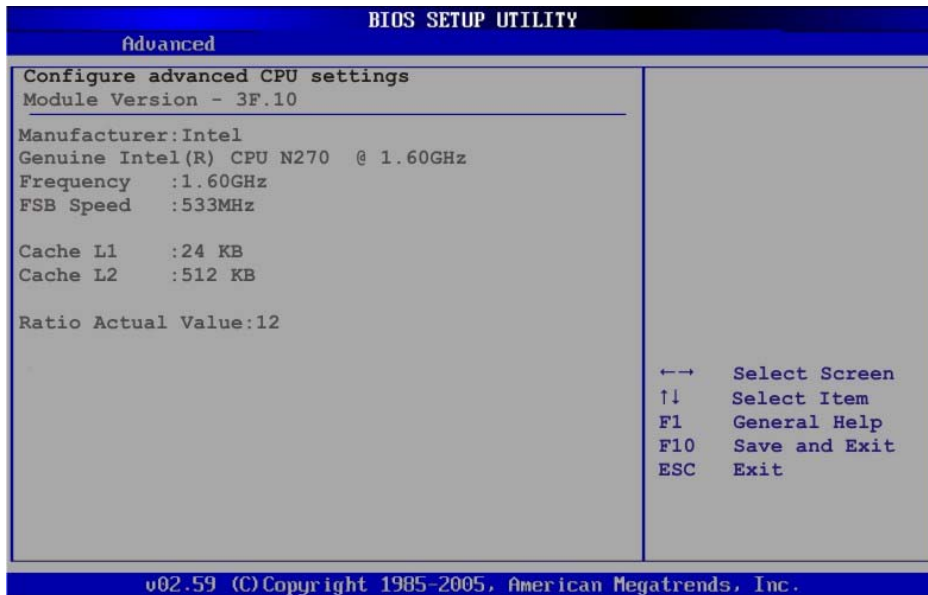

BIOS Menu 3: CPU Configuration

AFOLUX AFL-15A-N270 Panel PC

The CPU Configuration menu (**BIOS Menu 3**) lists the following CPU details:

- **Manufacturer:** Lists the name of the CPU manufacturer
- **Brand String:** Lists the brand name of the CPU being used
- **Frequency:** Lists the CPU processing speed
- **FSB Speed:** Lists the FSB speed
- **Cache L1:** Lists the CPU L1 cache size
- **Cache L2:** Lists the CPU L2 cache size

6.3.2 IDE Configuration

Use the **IDE Configuration** menu (**BIOS Menu 4**) to change and/or set the configuration of the IDE devices installed in the system.

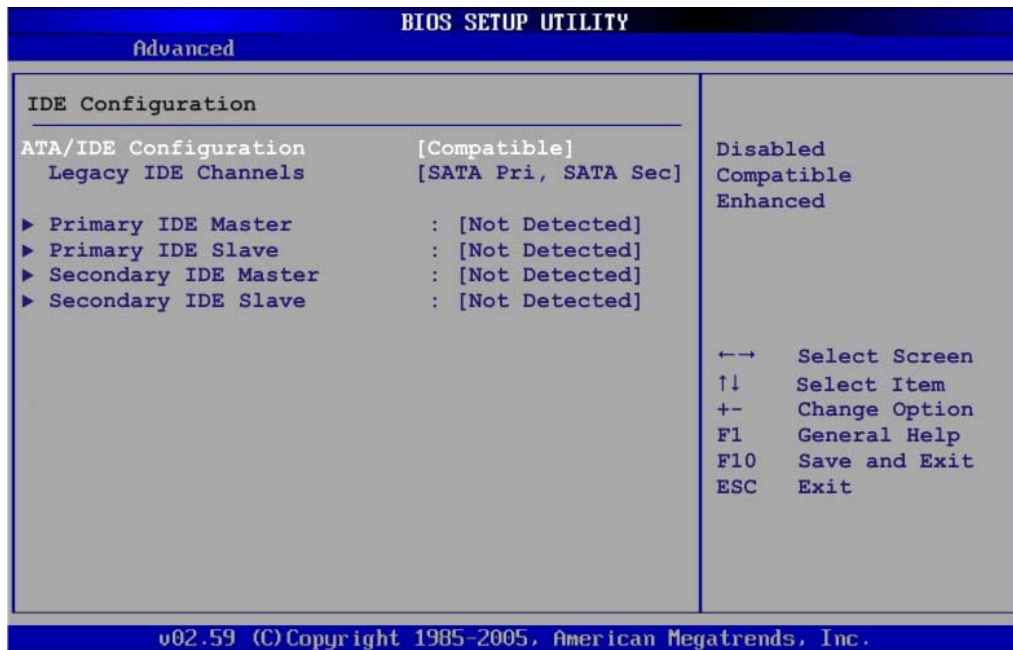

BIOS Menu 4: IDE Configuration

→ ATA/IDE Configurations [Compatible]

Use the **ATA/IDE Configurations** option to configure the ATA/IDE controller.

- **Disabled** Disables the on-board ATA/IDE controller.
- **Compatible** **DEFAULT** Configures the on-board ATA/IDE controller to be in

compatible mode. In this mode, a SATA channel will replace one of the IDE channels. This mode supports up to 4 storage devices.

→ **Enhanced**

Configures the on-board ATA/IDE controller to be in Enhanced mode. In this mode, IDE channels and SATA channels are separated. This mode supports up to 6 storage devices. Some legacy OS do not support this mode.

→ **Legacy IDE Channels [PATA Pri, SATA Sec]**

→ **SATA Only**

Only the SATA drives are enabled.

→ **SATA Pri, PATA Sec**

DEFAULT

The IDE drives are enabled on the Primary IDE channel. The SATA drives are enabled on the Secondary IDE channel.

→ **PATA Only**

The IDE drives are enabled on the primary and secondary IDE channels. SATA drives are disabled.

→ **IDE Master and IDE Slave**

When entering setup, BIOS auto detects the presence of IDE devices. BIOS displays the status of the auto detected IDE devices. The following IDE devices are detected and are shown in the **IDE Configuration** menu:

- Primary IDE Master
- Primary IDE Slave
- Secondary IDE Master
- Secondary IDE Slave

The **IDE Configuration** menu (**BIOS Menu 4**) allows changes to the configurations for the IDE devices installed in the system. If an IDE device is detected, and one of the above listed BIOS configuration options are selected, the IDE configuration options shown in **Section 6.3.2.1** appear.

AFOLUX AFL-15A-N270 Panel PC

6.3.2.1 IDE Master, IDE Slave

Use the **IDE Master** and **IDE Slave** configuration menu to view both primary and secondary IDE device details and configure the IDE devices connected to the system.

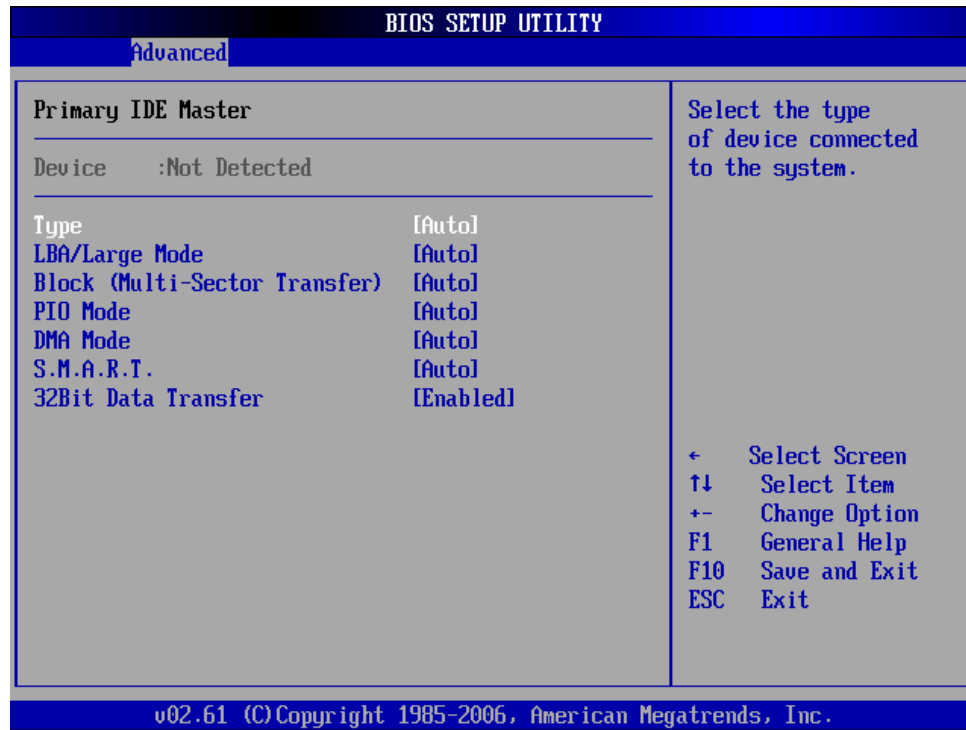

BIOS Menu 5: IDE Master and IDE Slave Configuration

➔ Auto-Detected Drive Parameters

The “grayed-out” items in the left frame are IDE disk drive parameters automatically detected from the firmware of the selected IDE disk drive. The drive parameters are listed as follows:

- **Device:** Lists the device type (e.g. hard disk, CD-ROM etc.)
- **Type:** Indicates the type of devices a user can manually select
- **Vendor:** Lists the device manufacturer
- **Size:** List the storage capacity of the device.
- **LBA Mode:** Indicates whether the LBA (Logical Block Addressing) is a method of addressing data on a disk drive is supported or not.

- **Block Mode:** Block mode boosts IDE drive performance by increasing the amount of data transferred. Only 512 bytes of data can be transferred per interrupt if block mode is not used. Block mode allows transfers of up to 64 KB per interrupt.
- **PIO Mode:** Indicates the PIO mode of the installed device.
- **Async DMA:** Indicates the highest Asynchronous DMA Mode that is supported.
- **Ultra DMA:** Indicates the highest Synchronous DMA Mode that is supported.
- **S.M.A.R.T.:** Indicates whether or not the Self-Monitoring Analysis and Reporting Technology protocol is supported.
- **32Bit Data Transfer:** Enables 32-bit data transfer.

→ **Type [Auto]**

Use the **Type** BIOS option select the type of device the AMIBIOS attempts to boot from after the Power-On Self-Test (POST) is complete.

- | | | |
|---|----------------------------|---|
| → | Not Installed | BIOS is prevented from searching for an IDE disk drive on the specified channel. |
| → | Auto DEFAULT | The BIOS auto detects the IDE disk drive type attached to the specified channel. This setting should be used if an IDE hard disk drive is attached to the specified channel. |
| → | CD/DVD | The CD/DVD option specifies that an IDE CD-ROM drive is attached to the specified IDE channel. The BIOS does not attempt to search for other types of IDE disk drives on the specified channel. |
| → | ARMD | This option specifies an ATAPI Removable Media Device. These include, but are not limited to: <ul style="list-style-type: none"> → ZIP → LS-120 |

AFOLUX AFL-15A-N270 Panel PC

→ LBA/Large Mode [Auto]

Use the **LBA/Large Mode** option to disable or enable BIOS to auto detects LBA (Logical Block Addressing). LBA is a method of addressing data on a disk drive. In LBA mode, the maximum drive capacity is 137 GB.

- **Disabled** BIOS is prevented from using the LBA mode control on the specified channel.
- **Auto** **DEFAULT** BIOS auto detects the LBA mode control on the specified channel.

→ Block (Multi Sector Transfer) [Auto]

Use the **Block (Multi Sector Transfer)** to disable or enable BIOS to auto detect if the device supports multi-sector transfers.

- **Disabled** BIOS is prevented from using Multi-Sector Transfer on the specified channel. The data to and from the device occurs one sector at a time.
- **Auto** **DEFAULT** BIOS auto detects Multi-Sector Transfer support on the drive on the specified channel. If supported the data transfer to and from the device occurs multiple sectors at a time.

→ PIO Mode [Auto]

Use the **PIO Mode** option to select the IDE PIO (Programmable I/O) mode program timing cycles between the IDE drive and the programmable IDE controller. As the PIO mode increases, the cycle time decreases.

- **Auto** **DEFAULT** BIOS auto detects the PIO mode. Use this value if the IDE disk drive support cannot be determined.
- **0** PIO mode 0 selected with a maximum transfer rate of 3.3MBps
- **1** PIO mode 1 selected with a maximum transfer rate of 5.2MBps
- **2** PIO mode 2 selected with a maximum transfer rate of 8.3MBps

- 3 PIO mode 3 selected with a maximum transfer rate of 11.1MBps
- 4 PIO mode 4 selected with a maximum transfer rate of 16.6MBps
(This setting generally works with all hard disk drives manufactured after 1999. For other disk drives, such as IDE CD-ROM drives, check the specifications of the drive.)

→ **DMA Mode [Auto]**

Use the **DMA Mode** BIOS selection to adjust the DMA mode options.

- **Auto** **DEFAULT** BIOS auto detects the DMA mode. Use this value if the IDE disk drive support cannot be determined.
- **SWDMA0** Single Word DMA mode 0 selected with a maximum data transfer rate of 2.1MBps
- **SWDMA1** Single Word DMA mode 1 selected with a maximum data transfer rate of 4.2MBps
- **SWDMA2** Single Word DMA mode 2 selected with a maximum data transfer rate of 8.3MBps
- **MWDMA0** Multi Word DMA mode 0 selected with a maximum data transfer rate of 4.2MBps
- **MWDMA1** Multi Word DMA mode 1 selected with a maximum data transfer rate of 13.3MBps
- **MWDMA2** Multi Word DMA mode 2 selected with a maximum data transfer rate of 16.6MBps
- **UDMA1** Ultra DMA mode 0 selected with a maximum data transfer rate of 16.6MBps
- **UDMA1** Ultra DMA mode 1 selected with a maximum data transfer rate of 25MBps
- **UDMA2** Ultra DMA mode 2 selected with a maximum data transfer rate of 33.3MBps
- **UDMA3** Ultra DMA mode 3 selected with a maximum data transfer

AFOLUX AFL-15A-N270 Panel PC

rate of 44MBps (To use this mode, it is required that an 80-conductor ATA cable is used.)

→ **UDMA4**

Ultra DMA mode 4 selected with a maximum data transfer rate of 66.6MBps (To use this mode, it is required that an 80-conductor ATA cable is used.)

→ **UDMA5**

Ultra DMA mode 5 selected with a maximum data transfer rate of 99.9MBps (To use this mode, it is required that an 80-conductor ATA cable is used.)

→ **S.M.A.R.T [Auto]**

Use the **S.M.A.R.T** option to auto-detect, disable or enable Self-Monitoring Analysis and Reporting Technology (SMART) on the drive on the specified channel. **S.M.A.R.T** predicts impending drive failures. The **S.M.A.R.T** BIOS option enables or disables this function.

→ **Auto** **DEFAULT** BIOS auto detects HDD SMART support.

→ **Disabled** Prevents BIOS from using the HDD SMART feature.

→ **Enabled** Allows BIOS to use the HDD SMART feature

→ **32Bit Data Transfer [Enabled]**

Use the **32Bit Data Transfer** BIOS option to enables or disable 32-bit data transfers.

→ **Disabled** Prevents the BIOS from using 32-bit data transfers.

→ **Enabled** **DEFAULT** Allows BIOS to use 32-bit data transfers on supported hard disk drives.

6.3.3 Super IO Configuration

Use the **Super IO Configuration** menu (**BIOS Menu 6**) to set or change the configurations for the FDD controllers, parallel ports and serial ports.

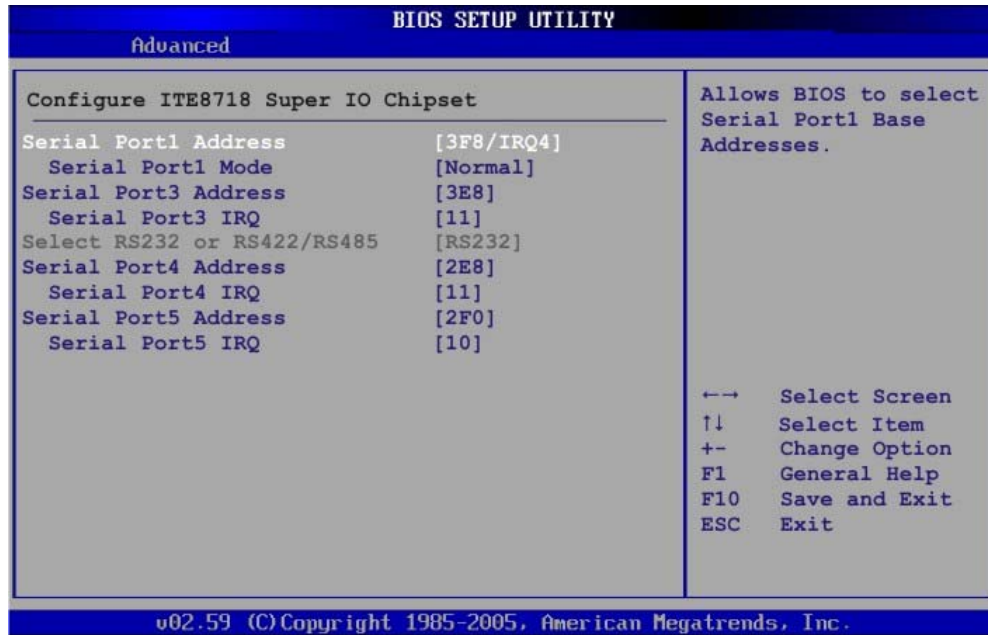

BIOS Menu 6: Super IO Configuration

→ Serial Port1 Address [3F8/IRQ4]

Use the **Serial Port1 Address** option to select the Serial Port 1 base address.

- **Disabled** No base address is assigned to Serial Port 1
- **3F8/IRQ4** **DEFAULT** Serial Port 1 I/O port address is 3F8 and the interrupt address is IRQ4
- **2F8/IRQ3** Serial Port 1 I/O port address is 2F8 and the interrupt address is IRQ3
- **3E8/IRQ4** Serial Port 1 I/O port address is 3E8 and the interrupt address is IRQ4
- **2E8/IRQ3** Serial Port 1 I/O port address is 2E8 and the interrupt address is IRQ3

AFOLUX AFL-15A-N270 Panel PC

→ Serial Port1 Mode [Normal]

Use the **Serial Port1 Mode** option to select the transmitting and receiving mode for the first serial port.

- **Normal** **DEFAULT** Serial Port 1 mode is normal
- **IrDA** Serial Port 1 mode is IrDA
- **ASK IR** Serial Port 1 mode is ASK IR

→ Serial Port3 Address [3E8]

Use the **Serial Port3 Address** option to select the Serial Port 3 base address.

- **Disabled** No base address is assigned to Serial Port 3
- **3E8** **DEFAULT** Serial Port 3 I/O port address is 3E8
- **2E8** Serial Port 3 I/O port address is 2E8
- **2F0** Serial Port 3 I/O port address is 2F0
- **2E0** Serial Port 3 I/O port address is 2E0

→ Serial Port3 IRQ [11]

Use the **Serial Port3 IRQ** option to select the interrupt address for serial port 3.

- **10** Serial port 3 IRQ address is 10
- **11** **DEFAULT** Serial port 3 IRQ address is 11

→ Serial Port4 Address [2E8]

Use the **Serial Port4 IRQ** option to select the interrupt address for serial port 4.

- **Disabled** No base address is assigned to serial port 4
- **2E8** **DEFAULT** Serial port 4 I/O port address is 2E8

→ Serial Port4 IRQ [11]

Use the **Serial Port4 IRQ** option to select the interrupt address for serial port 4.

- 10 Serial port 4 IRQ address is 10
- 11 **DEFAULT** Serial port 4 IRQ address is 11

→ Serial Port5 Address [2F0]

Use the **Serial Port5 IRQ** option to select the interrupt address for serial port 5.

- **Disabled** No base address is assigned to serial port 5
- 3E8 Serial Port 5 I/O port address is 3E8
- 2E8 Serial Port 5 I/O port address is 2E8
- 2F0 **DEFAULT** Serial Port 5 I/O port address is 2F0
- 2E0 Serial Port 5 I/O port address is 2E0

→ Serial Port5 IRQ [10]

Use the **Serial Port5 IRQ** option to select the interrupt address for serial port 5.

- 10 **DEFAULT** Serial port 5 IRQ address is 10
- 11 Serial port 5 IRQ address is 11

6.3.4 Hardware Health Configuration

The **Hardware Health Configuration** menu (**BIOS Menu 7**) shows the operating temperature, fan speeds and system voltages.

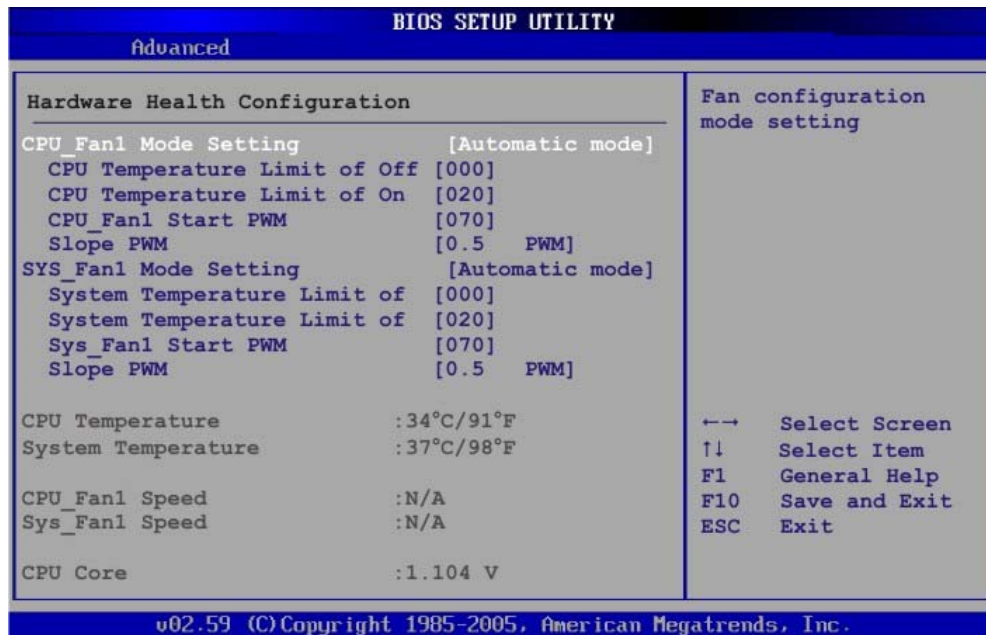

BIOS Menu 7: Hardware Health Configuration

→ CPU FAN Mode Setting [Automatic mode]

Use the **CPU FAN Mode Setting** option to configure the second fan.

- **Full On Mode** Fan is on all the time
- **Automatic mode** **DEFAULT** Fan is off when the temperature is low enough. Parameters must be set by the user.
- **PWM Manual mode** Pulse width modulation set manually

When the **CPU FAN Mode Setting** option is in the **Automatic Mode**, the following parameters can be set.

- CPU Temp. Limit of OFF

- CPU Temp. Limit of On
- CPU Fan Start PWM
- Slope PWM

When the **CPU FAN Mode Setting** option is in the **PWM Manual Mode**, the following parameters can be set.

- CPU Fan PWM control

→ **CPU Temp. Limit of OFF [000]**



WARNING:

Setting this value too high may cause the fan to stop when the CPU is at a high temperature and therefore cause the system to be damaged.

The **CPU Temp. Limit of OFF** option can only be set if the **CPU FAN Mode Setting** option is set to **Automatic Mode**. Use the **CPU Temp. Limit of OFF** option to select the CPU temperature at which the cooling fan should automatically turn off. To select a value, select the **CPU Temp. Limit of OFF** option and enter a decimal number between 000 and 127. The temperature range is specified below.

- Minimum Value: 0°C
- Maximum Value: 127°C

→ **CPU Temp. Limit of Start [020]**



WARNING:

Setting this value too high may cause the fan to start only when the CPU is at a high temperature and therefore cause the system to be damaged.

AFOLUX AFL-15A-N270 Panel PC

The **CPU Temp. Limit of Start** option can only be set if the **CPU FAN Mode Setting** option is set to **Automatic Mode**. Use the **CPU Temp. Limit of Start** option to select the CPU temperature at which the cooling fan should automatically turn on. When the fan starts, it rotates using the starting pulse width modulation (PWM) specified in the **Fan 3 Start PWM** option below. To select a value, select the **CPU Temp. Limit of Start** option and enter a decimal number between 000 and 127. The temperature range is specified below.

- Minimum Value: 0°C
- Maximum Value: 127°C

→ CPU Fan Start PWM [070]

The **Fan 3 Start PWM** option can only be set if the **CPU FAN Mode Setting** option is set to **Automatic Mode**. Use the **Fan 3 Start PWM** option to select the PWM mode the fan starts to rotate with after the temperature specified in the **Temperature 3 Limit of Start** is exceeded. The Super I/O chipset supports 128 PWM modes. To select a value, select the **Fan 3 Start PWM** option and enter a decimal number between 000 and 127. The temperature range is specified below.

- PWM Minimum Mode: 0
- PWM Maximum Mode: 127

→ Slope PWM [0.5 PWM]

The **Slope PWM 1** option can only be set if the **CPU FAN Mode Setting** option is set to **Automatic Mode**. Use the **Slope PWM 1** option to select the linear rate at which the PWM mode increases with respect to an increase in temperature. A list of available options is shown below:

- 0.125 PWM
- 0.25 PWM
- 0.5 PWM
- 1 PWM
- 2 PWM
- 4 PWM
- 8 PWM

- 15 PWM

The following system parameters and values are shown. The system parameters that are monitored are:

- **System Temperatures:** The following system temperatures are monitored
 - CPU Temperature
 - System Temperature
- **Fan Speeds:** The CPU cooling fan speed is monitored.
 - CPU Fan Speed
 - System Fan Speed
- **Voltages:** The following system voltages are monitored
 - CPU Core
 - +1.05V
 - +3.30V
 - +5.00V
 - +12.0 V
 - +1.5V
 - +1.8V
 - 5VSB
 - VBAT

AFOLUX AFL-15A-N270 Panel PC

6.3.5 Power Configuration

The **Power Configuration** menu (**BIOS Menu 8**) configures the Advanced Configuration and Power Interface (ACPI) and Power Management (APM) options.

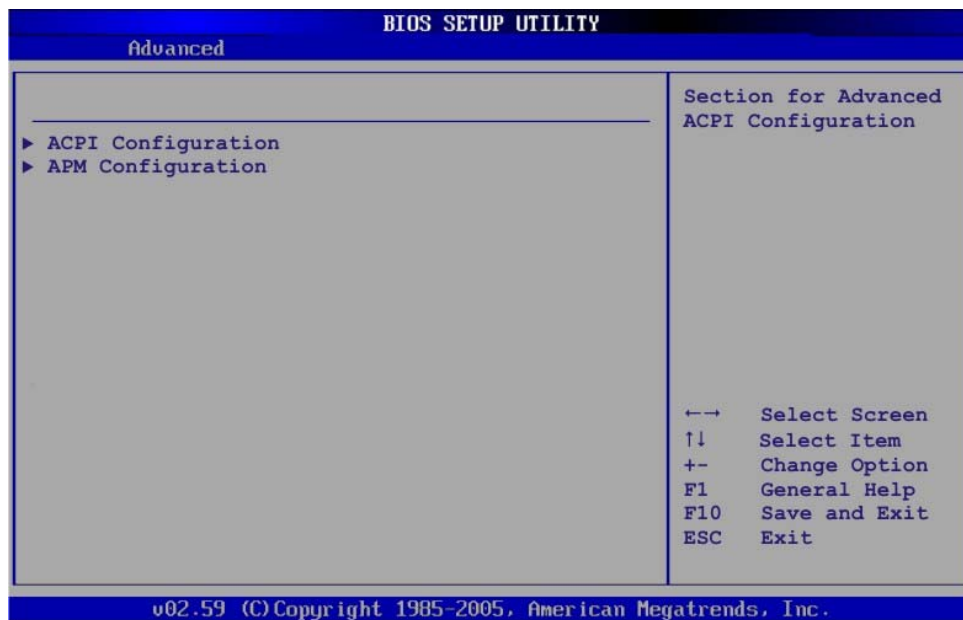

BIOS Menu 8: Power Configuration

6.3.5.1 ACPI configuration

The **ACPI Configuration** menu (**BIOS Menu 9**) configures the Advanced Configuration and Power Interface (ACPI).

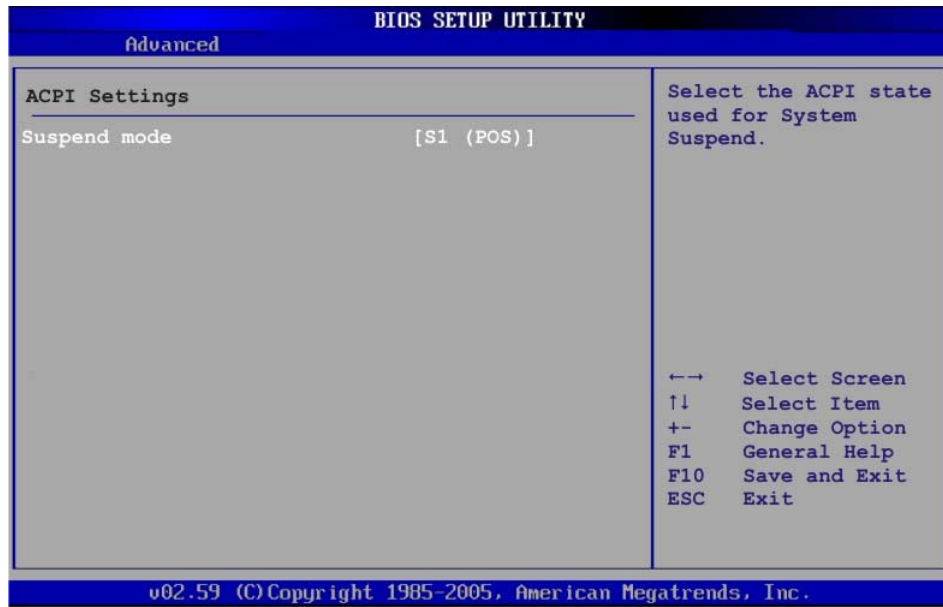

BIOS Menu 9: ACPI Configuration

→ Suspend Mode [S1(POS)]

Use the **Suspend Mode** BIOS option to specify the sleep state the system enters when it is not being used.

- **S1 (POS) DEFAULT** System appears off. The CPU is stopped; RAM is refreshed; the system is running in a low power mode.
- **S3 (STR)** System appears off. The CPU has no power; RAM is in slow refresh; the power supply is in a reduced power mode.

6.3.6 APM Configuration

The **APM Configuration** menu (**BIOS Menu 10**) allows the advanced power management options to be configured.

AFOLUX AFL-15A-N270 Panel PC

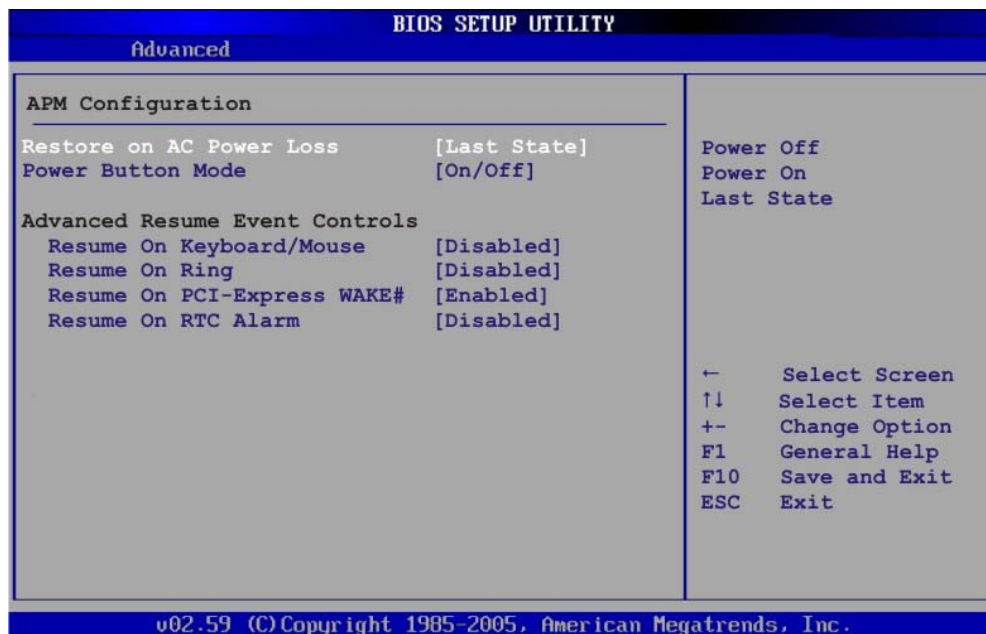

BIOS Menu 10: Advanced Power Management Configuration

→ Restore on AC Power Loss [Last State]

Use the **Restore on AC Power Loss** BIOS option to specify what state the system returns to if there is a sudden loss of power to the system.

- **Power Off** The system remains turned off
- **Power On** The system turns on
- **Last State** **DEFAULT** The system returns to its previous state. If it was on, it turns itself on. If it was off, it remains off.

→ Power Button Mode [On/Off]

Use the **Power Button Mode** BIOS to specify how the power button functions.

- **On/Off** **DEFAULT** When the power button is pressed the system is either turned on or off
- **Suspend** When the power button is pressed the system goes into suspend mode

➔ **Resume on Keyboard/Mouse [Disabled]**

Use the **Resume on Keyboard/Mouse** BIOS option to enable activity on either the keyboard or mouse to rouse the system from a suspend or standby state. That is, the system is roused when the mouse is moved or a button on the keyboard is pressed.

- ➔ **Disabled** **DEFAULT** Wake event not generated by activity on the keyboard or mouse
- ➔ **Resume On**
KeyBoard Wake event not generated by activity on the keyboard
- ➔ **Resume On**
Mouse Wake event not generated by activity on the mouse
- ➔ **Enabled** Wake event generated by activity on the keyboard or mouse

➔ **Resume on Ring [Disabled]**

Use the **Resume on Ring** BIOS option to enable activity on the RI (ring in) modem line to rouse the system from a suspend or standby state. That is, the system will be roused by an incoming call on a modem.

- ➔ **Disabled** **DEFAULT** Wake event not generated by an incoming call
- ➔ **Enabled** Wake event generated by an incoming call

➔ **Resume on PCI-Express WAKE# [Enabled]**

Use the **Resume PCI-Express WAKE#** BIOS option to enable activity on the PCI-Express WAKE# signal to rouse the system from a suspend or standby state.

- ➔ **Disabled** Wake event not generated by PCI-Express WAKE# signal activity
- ➔ **Enabled** **DEFAULT** Wake event generated by PCI-Express WAKE# signal activity

AFOLUX AFL-15A-N270 Panel PC

→ Resume On RTC Alarm [Disabled]

Use the **Resume On RTC Alarm** option to specify the time the system should be roused from a suspended state.

→ **Disabled** **DEFAULT** The real time clock (RTC) cannot generate a wake event

→ **Enabled** If selected, the following appears with values that can be selected:

→ **RTC Alarm Date (Days)**

→ **System Time**

After setting the alarm, the computer turns itself on from a suspend state when the alarm goes off.

6.3.7 Remote Configuration

Use the **Remote Access Configuration** menu (**BIOS Menu 11**) to configure remote access parameters. The **Remote Access Configuration** is an AMIBIOS feature and allows a remote host running a terminal program to display and configure the BIOS settings.

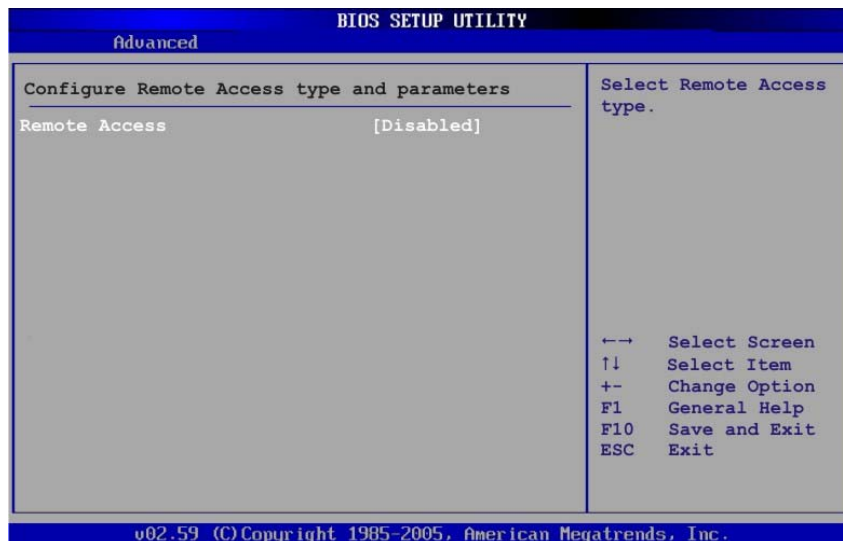

BIOS Menu 11: Remote Access Configuration [Advanced]

→ **Remote Access [Disabled]**

Use the **Remote Access** option to enable or disable access to the remote functionalities of the system.

→ **Disabled** **DEFAULT** Remote access is disabled.

→ **Enabled** Remote access configuration options shown below appear:

→ **Serial Port Number**

→ **Serial Port Mode**

→ **Redirection after BIOS POST**

→ **Terminal Type**

These configuration options are discussed below.

→ **Serial Port Number [COM1]**

Use the **Serial Port Number** option allows to select the serial port used for remote access.

→ **COM1** **DEFAULT** System is remotely accessed through COM1

→ **COM3** System is remotely accessed through COM3

→ **COM4** System is remotely accessed through COM4

NOTE: Make sure the selected COM port is enabled through the Super I/O configuration menu.

→ **Base Address, IRQ [3F8h,4]**

The **Base Address, IRQ** option cannot be configured and only shows the interrupt address of the serial port listed above.

AFOLUX AFL-15A-N270 Panel PC

→ Serial Port Mode [115200 8,n,1]

Use the **Serial Port Mode** option to select baud rate through which the console redirection is made. The following configuration options are available

- 115200 8,n,1 **DEFAULT**
- 57600 8,n,1
- 38400 8,n,1
- 19200 8,n,1
- 09600 8,n,1



NOTE:

Identical baud rate setting must be set on the host (a management computer running a terminal software) and the slave

→ Redirection After BIOS POST [Always]

Use the **Redirection After BIOS POST** option to specify when console redirection should occur.

- | | | | |
|---|--------------------|----------------|--|
| → | Disabled | DEFAULT | The console is not redirected after POST |
| → | Boot Loader | | Redirection is active during POST and during Boot Loader |
| → | Always | DEFAULT | Redirection is always active (Some OSes may not work if set to Always) |

→ Terminal Type [ANSI]

Use the **Terminal Type** BIOS option to specify the remote terminal type.

- | | | | |
|---|----------------|----------------|-------------------------------------|
| → | ANSI | DEFAULT | The target terminal type is ANSI |
| → | VT100 | | The target terminal type is VT100 |
| → | VT-UTF8 | | The target terminal type is VT-UTF8 |

6.3.8 USB Configuration

Use the **USB Configuration** menu (**BIOS Menu 12**) to read USB configuration information and configure the USB settings.

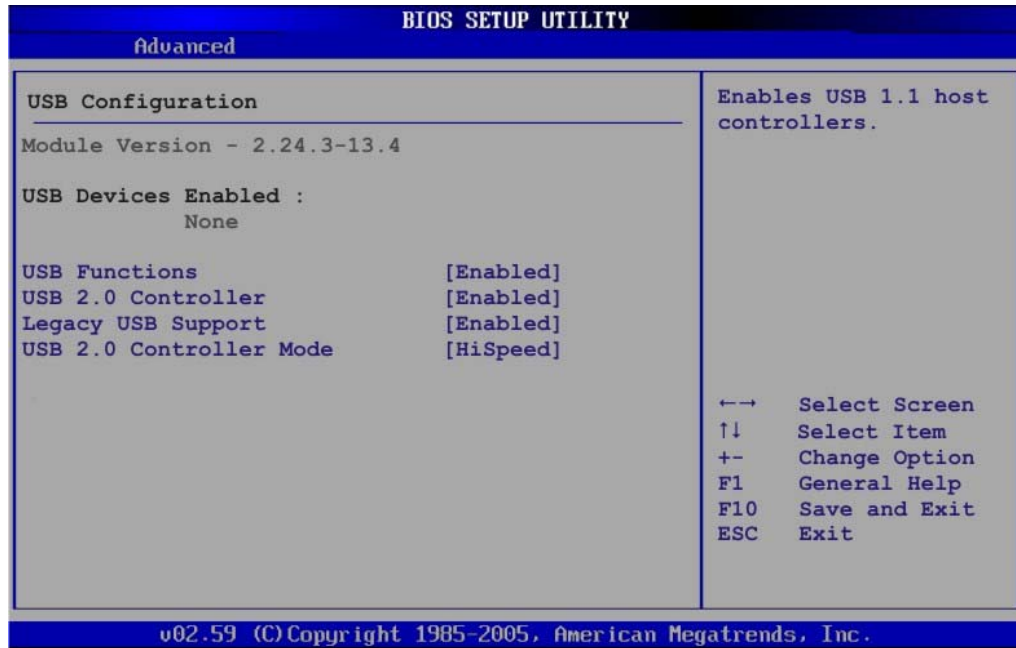

BIOS Menu 12: USB Configuration

→ USB Functions [Enabled]

Use the **USB Function** option to enable or disable the USB controllers.

- Disabled USB controllers are enabled
- Enabled **DEFAULT** USB controllers are disabled

→ USB 2.0 Controller [Enabled]

The **USB 2.0 Controller** BIOS option enables or disables the USB 2.0 controller

- Enabled **DEFAULT** USB function enabled
- Disabled USB function disabled

AFOLUX AFL-15A-N270 Panel PC

→ Legacy USB Support [Enabled]

Use the **Legacy USB Support** BIOS option to enable USB mouse and USB keyboard support.

Normally if this option is not enabled, any attached USB mouse or USB keyboard does not become available until a USB compatible operating system is fully booted with all USB drivers loaded. When this option is enabled, any attached USB mouse or USB keyboard can control the system even when there is no USB driver loaded onto the system.

- **Disabled** Legacy USB support disabled
- **Enabled** **DEFAULT** Legacy USB support enabled
- **Auto** Legacy USB support disabled if no USB devices are connected

→ USB2.0 Controller Mode [HiSpeed]

The **USB2.0 Controller Mode** BIOS option sets the speed of the USB2.0 controller.

- **FullSpeed** The controller is capable of operating at full speed 12 Mb/s
- **HiSpeed** **DEFAULT** The controller is capable of operating at high speed 480 Mb/s

6.4 PCI/PnP

Use the PCI/PnP menu (**BIOS Menu 13**) to configure advanced PCI and PnP settings.



WARNING:

Setting wrong values for the BIOS selections in the PCIPnP BIOS menu may cause the system to malfunction.

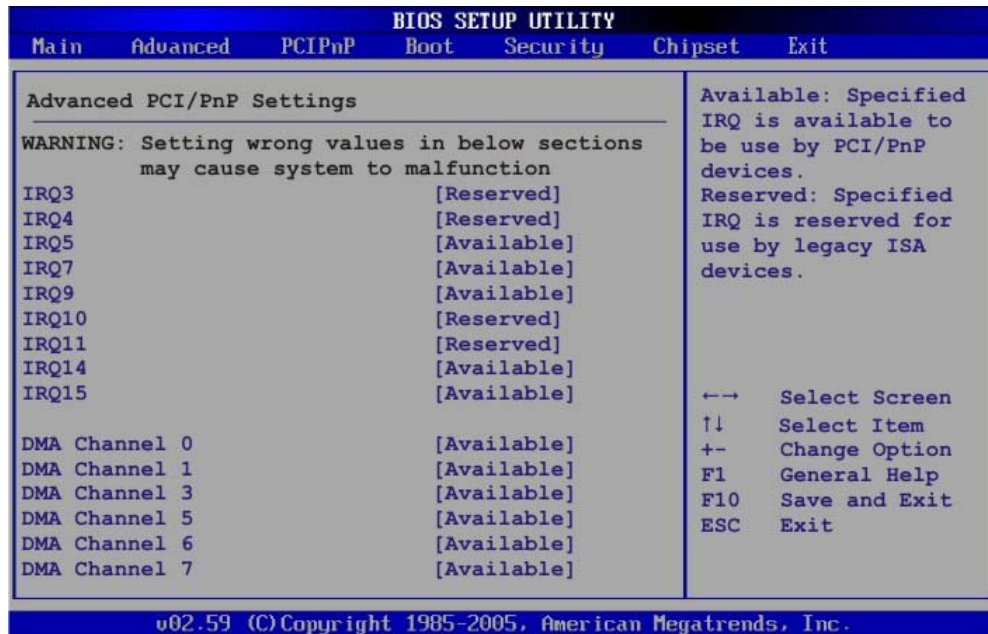

BIOS Menu 13: PCI/PnP Configuration

→ IRQ# [Available]

Use the **IRQ#** address to specify what IRQs can be assigned to a particular peripheral device.

- **Available** **DEFAULT** The specified IRQ is available to be used by PCI/PnP devices
- **Reserved** The specified IRQ is reserved for use by Legacy ISA devices

Available IRQ addresses are:

- IRQ3
- IRQ4
- IRQ5
- IRQ7
- IRQ9
- IRQ10
- IRQ 11

AFOLUX AFL-15A-N270 Panel PC

- IRQ 14
- IRQ 15

→ DMA Channel# [Available]

Use the **DMA Channel#** option to assign a specific DMA channel to a particular PCI/PnP device.

- **Available** **DEFAULT** The specified DMA is available to be used by PCI/PnP devices
- **Reserved** The specified DMA is reserved for use by Legacy ISA devices

Available DMA Channels are:

- DM Channel 0
- DM Channel 1
- DM Channel 3
- DM Channel 5
- DM Channel 6
- DM Channel 7

→ Reserved Memory Size [Disabled]

Use the **Reserved Memory Size** BIOS option to specify the amount of memory that should be reserved for legacy ISA devices.

- **Disabled** **DEFAULT** No memory block reserved for legacy ISA devices
- **16K** 16KB reserved for legacy ISA devices
- **32K** 32KB reserved for legacy ISA devices
- **64K** 54KB reserved for legacy ISA devices

6.5 Boot

Use the Boot menu (**BIOS Menu 14**) to configure system boot options.

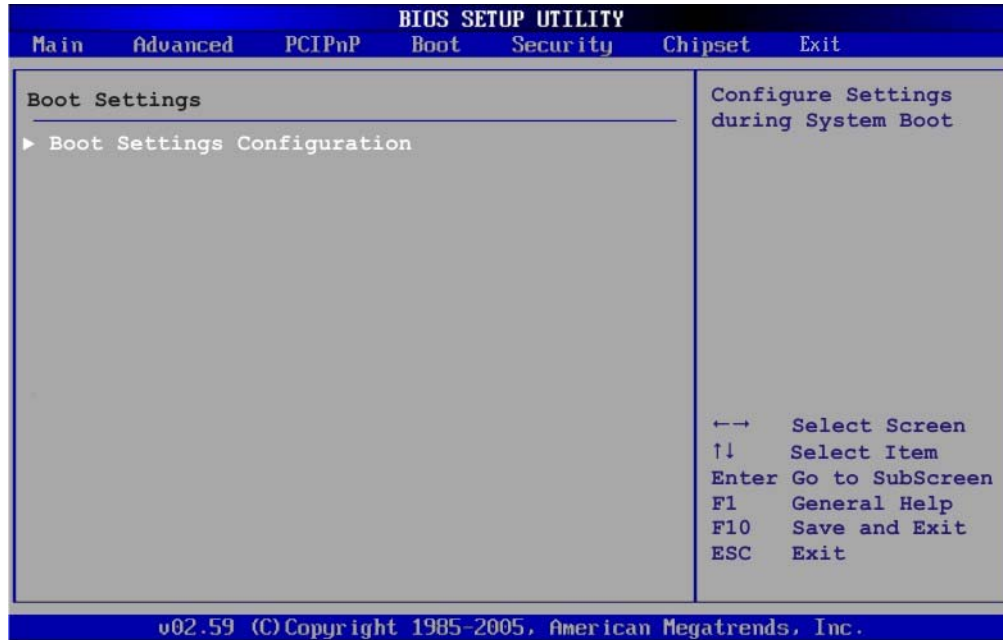

BIOS Menu 14: Boot

6.5.1 Boot Settings Configuration

Use the Boot Settings Configuration menu (**BIOS Menu 15**) to configure advanced system boot options.

AFOLUX AFL-15A-N270 Panel PC

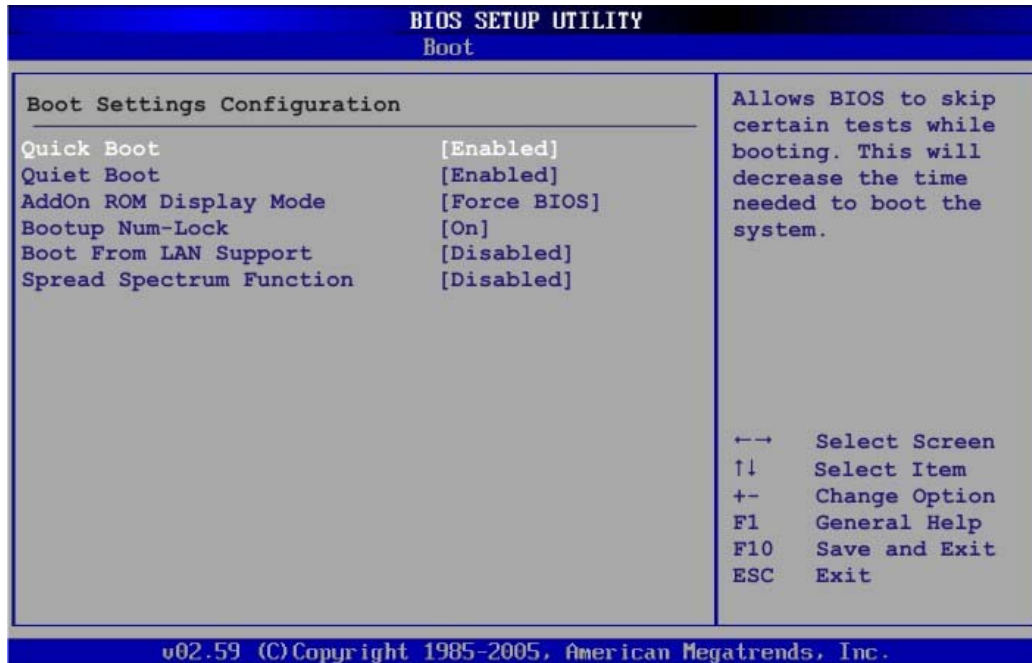

BIOS Menu 15: Boot Settings Configuration

→ Quick Boot [Enabled]

Use the **Quick Boot** BIOS option to make the computer speed up the boot process.

- **Disabled** No POST procedures are skipped
- **Enabled** **DEFAULT** Some POST procedures are skipped to decrease the system boot time

→ Quiet Boot [Disabled]

Use the **Quiet Boot** BIOS option to select the screen display when the system boots.

- **Disabled** **DEFAULT** Normal POST messages displayed
- **Enabled** OEM Logo displayed instead of POST messages

➔ **AddOn ROM Display Mode [Force BIOS]**

The **AddOn ROM Display Mode** option allows add-on ROM (read-only memory) messages to be displayed.

- ➔ **Force BIOS** **DEFAULT** Allows the computer system to force a third party BIOS to display during system boot.
- ➔ **Keep Current** Allows the computer system to display the information during system boot.

➔ **Bootup Num-Lock [On]**

The **Bootup Num-Lock** BIOS option allows the Number Lock setting to be modified during boot up.

- ➔ **Off** Does not enable the keyboard Number Lock automatically. To use the 10-keys on the keyboard, press the Number Lock key located on the upper left-hand corner of the 10-key pad. The Number Lock LED on the keyboard lights up when the Number Lock is engaged.
- ➔ **On** **DEFAULT** Allows the Number Lock on the keyboard to be enabled automatically when the computer system boots up. This allows the immediate use of the 10-key numeric keypad located on the right side of the keyboard. To confirm this, the Number Lock LED light on the keyboard is lit.

➔ **Boot From LAN Support [Disabled]**

The **BOOT From LAN Support** option enables the system to be booted from a remote system.

- ➔ **Enabled** Can be booted from a remote system through the LAN
- ➔ **Disabled** **DEFAULT** Cannot be booted from a remote system through the LAN

AFOLUX AFL-15A-N270 Panel PC

→ Spread Spectrum Function [Disabled]

The **Spread Spectrum Function** option can help to improve CPU EMI issues.

- **Disabled** **DEFAULT** The spread spectrum mode is disabled
- **Enabled** The spread spectrum mode is enabled

6.6 Security

Use the Security menu (**BIOS Menu 16**) to set system and user passwords.

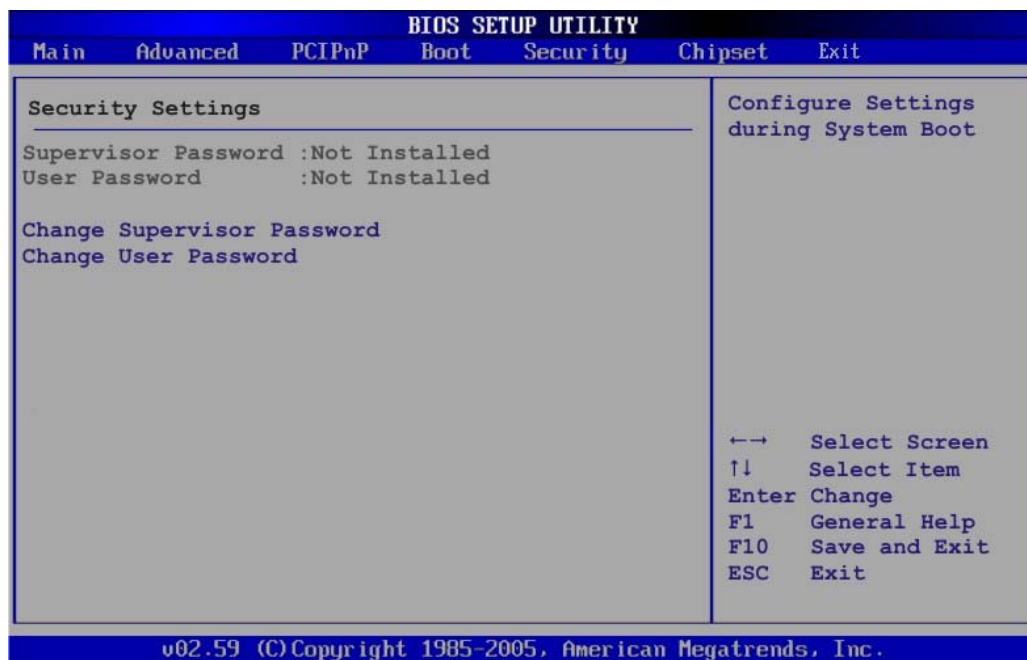

BIOS Menu 16: Security

→ Change Supervisor Password

Use the **Change Supervisor Password** to set or change a supervisor password. The default for this option is **Not Installed**. If a supervisor password must be installed, select this field and enter the password. After the password has been added, **Install** appears next to **Change Supervisor Password**.

→ **Change User Password**

Use the **Change User Password** to set or change a user password. The default for this option is **Not Installed**. If a user password must be installed, select this field and enter the password. After the password has been added, **Install** appears next to **Change User Password**.

6.7 Chipset

Use the **Chipset** menu (**BIOS Menu 17**) to access the NorthBridge and SouthBridge configuration menus



WARNING!

Setting the wrong values for the Chipset BIOS selections in the Chipset BIOS menu may cause the system to malfunction.

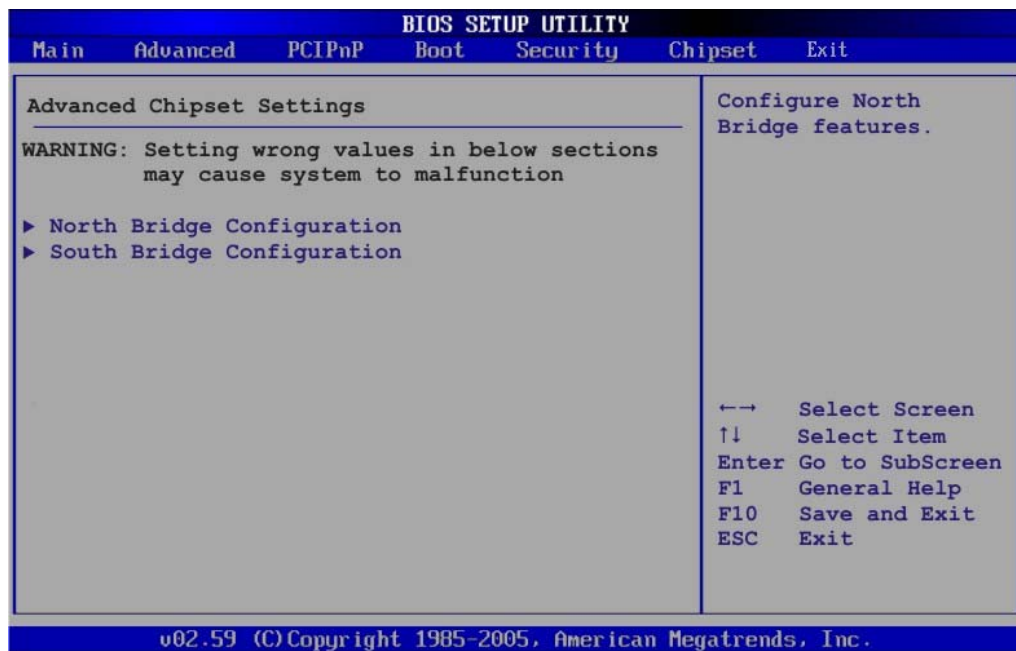

BIOS Menu 17: Chipset

AFOLUX AFL-15A-N270 Panel PC

6.7.1 North Bridge Chipset Configuration

Use the **North Bridge Chipset Configuration** menu (**BIOS Menu 18**) to configure the Northbridge chipset settings.

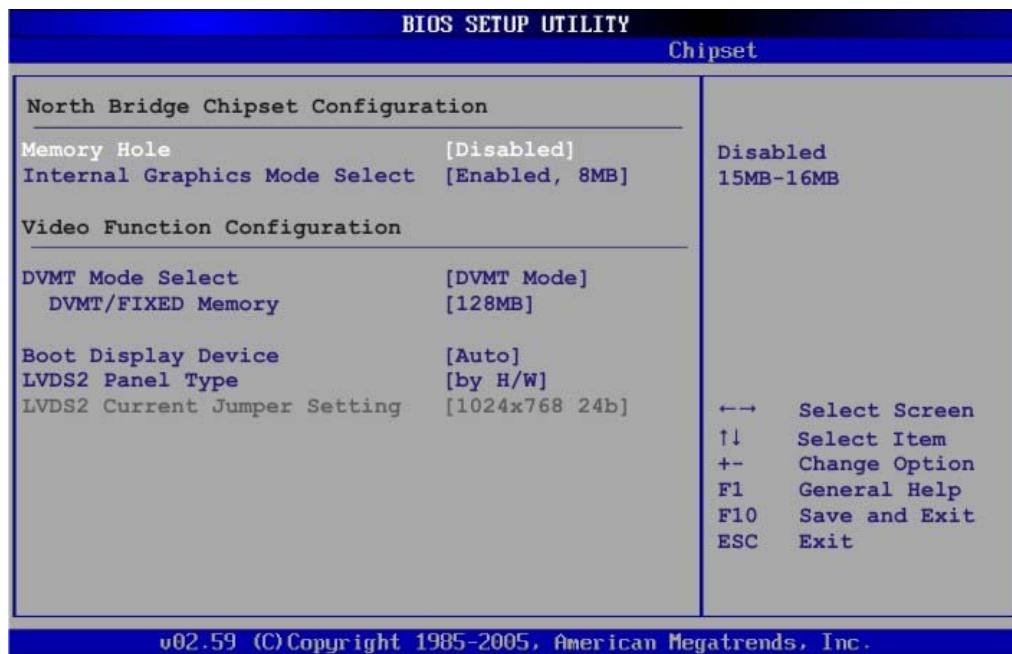

BIOS Menu 18:North Bridge Chipset Configuration

→ Memory Hole [Disabled]

The **Memory Hole** reserves the memory space between 15MB and 16MB for ISA expansion cards that require a specified area of memory to work properly. If an older ISA expansion card is used, please refer to the documentation that came with the card to see if it is necessary to reserve the space.

- **Disabled** **DEFAULT** Memory is not reserved for ISA expansion cards
- **15MB – 16MB** Between 15MB and 16MB of memory is reserved for ISA expansion cards

→ Internal Graphics Mode Select [Enable, 8MB]

The **Internal Graphic Mode Select** option determines the amount of system memory that can be used by the Internal graphics device.

- **Disable**
- **Enable, 1MB** 1MB of memory used by internal graphics device
- **Enable, 8MB** **DEFAULT** 8MB of memory used by internal graphics device

→ **DVMT Mode Select [DVMT Mode]**

Use the **DVMT Mode Select** option to select the Intel Dynamic Video Memory Technology (DVMT) operating mode.

- **Fixed Mode** A fixed portion of graphics memory is reserved as graphics memory.
- **DVMT Mode** **DEFAULT** Graphics memory is dynamically allocated according to the system and graphics needs.
- **Combo Mode** A fixed portion of graphics memory is reserved as graphics memory. If more memory is needed, graphics memory is dynamically allocated according to the system and graphics needs.

→ **DVMT/FIXED Memory**

Use the **DVMT/FIXED Memory** option to specify the maximum amount of memory that can be allocated as graphics memory. This option can only be configured for if **DVMT Mode** or **Fixed Mode** is selected in the **DVMT Mode Select** option. If **Combo Mode** is selected, the maximum amount of graphics memory is 128MB. Configuration options are listed below.

- 64MB
- 128MB **DEFAULT**
- Maximum DVMT

→ **Boot Display Device [Auto]**

Use the **Boot Display Device** option to select the display device used by the system when it boots. Configuration options are listed below.

- Auto **DEFAULT**

AFOLUX AFL-15A-N270 Panel PC

- CRT
- LVDS1

→ LVDS2 Panel Type [by H/W]

Use the **LVDS2 Panel Type** option to select the type of flat panel connected to the system. Configuration options are listed below.

- 1440x900 48b
- 1024x768 24b
- 1366x768 24b
- 1280x1024 48b
- by H/W DEFAULT

6.7.2 SouthBridge Configuration

The **SouthBridge Configuration** menu (**BIOS Menu 19**) the southbridge chipset to be configured.

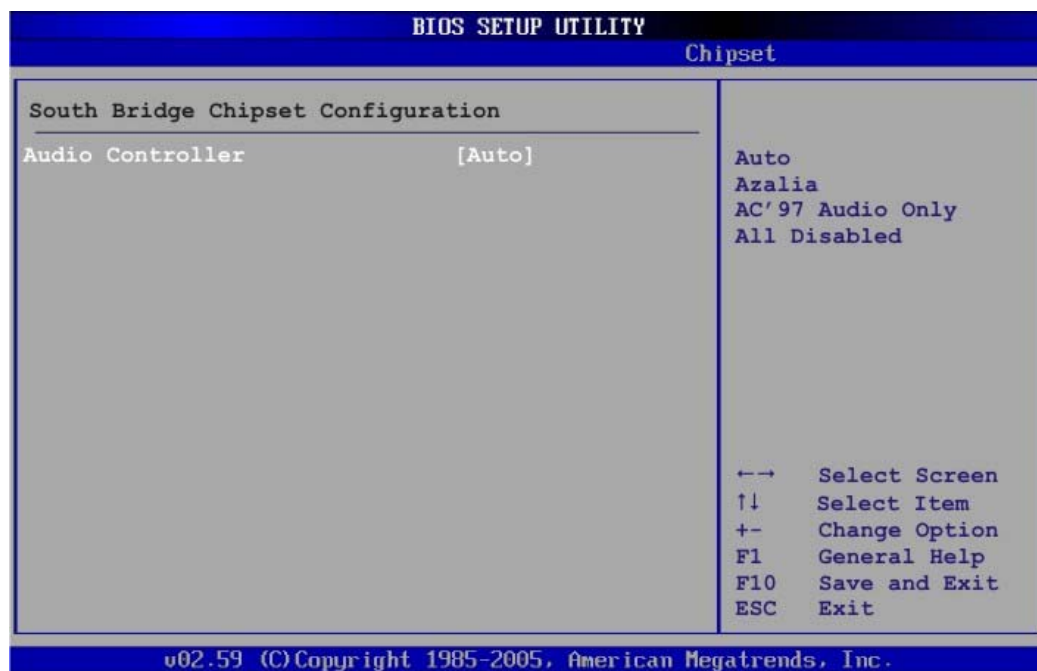

BIOS Menu 19: SouthBridge Chipset Configuration

→ Audio Controller [Auto]

The **Audio Controller** option enables or disables the audio controller.

- | | | |
|---------------------------|----------------|--|
| → Auto | DEFAULT | The onboard audio codec automatically detected and enabled |
| → Azalia | | The on-board HD Audio controller is enabled. |
| → AC'97 Audio Only | | The on-board AC'97 audio controller is enabled. |
| → All Disabled | | The on-board audio controller is disabled. |

6.8 Exit

Use the **Exit** menu (**BIOS Menu 20**) to load default BIOS values, optimal failsafe values and to save configuration changes.

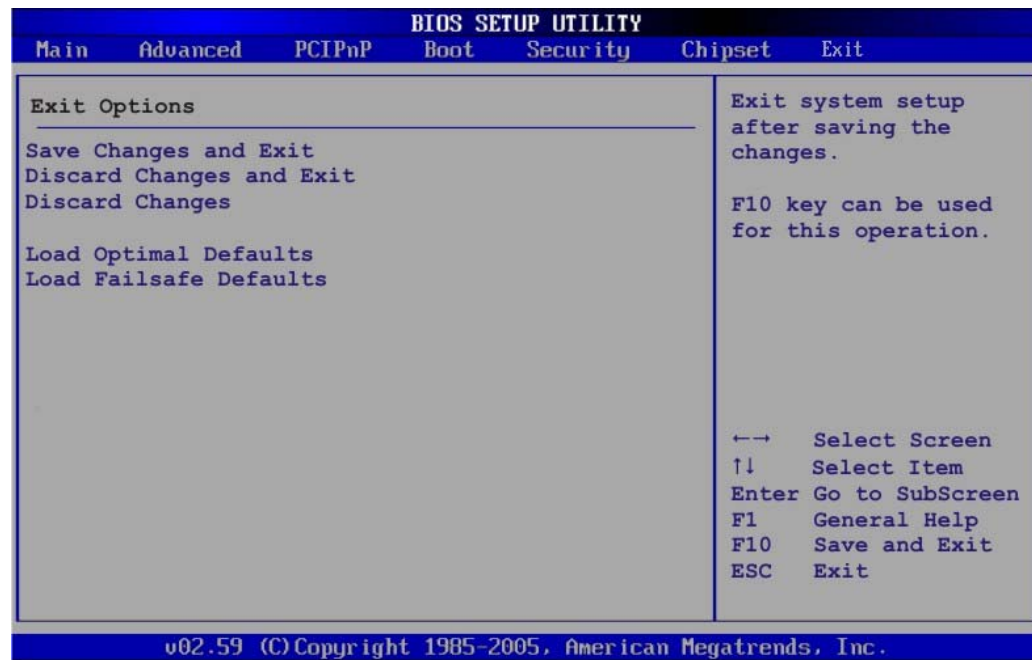
BIOS Menu 20:Exit
→ Save Changes and Exit

Use the **Save Changes and Exit** option to save the changes made to the BIOS options and to exit the BIOS configuration setup program.

AFOLUX AFL-15A-N270 Panel PC

→ Discard Changes and Exit

Use the **Discard Changes and Exit** option to exit the BIOS configuration setup program without saving the changes made to the system.

→ Discard Changes

Use the **Discard Changes** option to discard the changes and remain in the BIOS configuration setup program.

→ Load Optimal Defaults

Use the **Load Optimal Defaults** option to load the optimal default values for each of the parameters on the Setup menus. **F9 key can be used for this operation.**

→ Load Failsafe Defaults

Use the **Load Failsafe Defaults** option to load failsafe default values for each of the parameters on the Setup menus. **F8 key can be used for this operation.**

Chapter

7

Software Drivers

7.1 Available Software Drivers



NOTE:

The content of the CD may vary throughout the life cycle of the product and is subject to change without prior notice. Visit the IEI website or contact technical support for the latest updates.

The following drivers can be installed on the system:

- Chipset
- VGA
- Audio
- LAN
- Touch screen
- Wireless
- Bluetooth (Optional)

Installation instructions are given below.

7.2 Starting the Driver Program

To access the driver installation programs, please do the following.

Step 1: Insert the CD-ROM that came with the system into a CD-ROM drive attached to the system.

Step 2: Click **AFL N270 Series**.

Step 3: Select the **AFLMB2-945GSE-N270-R10 Driver**.

Step 4: The list of drivers in **Figure 7-1** appears.



Figure 7-1: Drivers

7.3 Chipset Driver Installation

To install the chipset driver, please do the following.

Step 1: Access the driver list shown in **Figure 7-1**. (See **Section 7.2**)

Step 2: Click “**Chipset**”.

Step 3: The setup files are extracted as shown in **Figure 7-2**.

AFOLUX AFL-15A-N270 Panel PC



Figure 7-2: Chipset Driver Screen

Step 4: When the setup files are completely extracted the **Welcome Screen** in **Figure 7-3** appears.



Figure 7-3: Chipset Driver Welcome Screen

Step 5: Click **Next** to continue.

Step 6: The license agreement in **Figure 7-4** appears.

Step 7: Read the **License Agreement**.

Step 8: Click the **Yes** icon to continue.



Figure 7-4: Chipset Driver License Agreement

Step 9: The Read Me file in **Figure 7-5** appears.

Step 10: Click **Next** to continue.

AFOLUX AFL-15A-N270 Panel PC



Figure 7-5: Chipset Driver Read Me File

Step 11: Setup Operations are performed as shown in **Figure 7-6**.



Figure 7-6: Chipset Driver Setup Operations

Step 12: Once the **Setup Operations** are complete, click the **Next** icon to continue.

Step 13: The **Finish** screen appears.

Step 14: Select “**Yes, I want to restart the computer now**” and click the **Finish** icon.

See **Figure 7-7**.

AFOLUX AFL-15A-N270 Panel PC



Figure 7-7: Chipset Driver Installation Finish Screen

7.4 VGA Driver Installation

To install the VGA driver, please do the following.

- Step 1:** Access the driver list shown in **Figure 7-1**. (See **Section 7.2**)
- Step 2:** Click “**VGA**”.
- Step 3:** The VGA Read Me file in **Figure 7-8** appears.
- Step 4:** Click **Next** to continue.

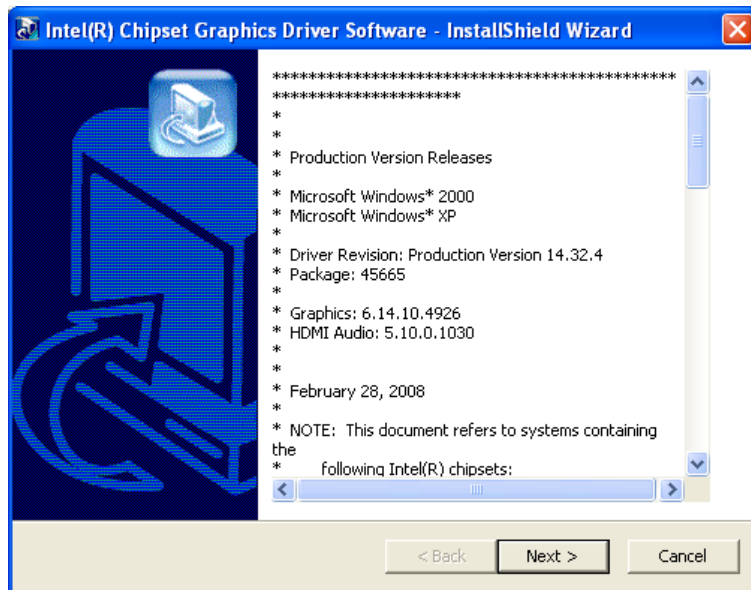

Figure 7-8: VGA Driver Read Me File

Step 5: The installation files are extracted. See Figure 7-9.

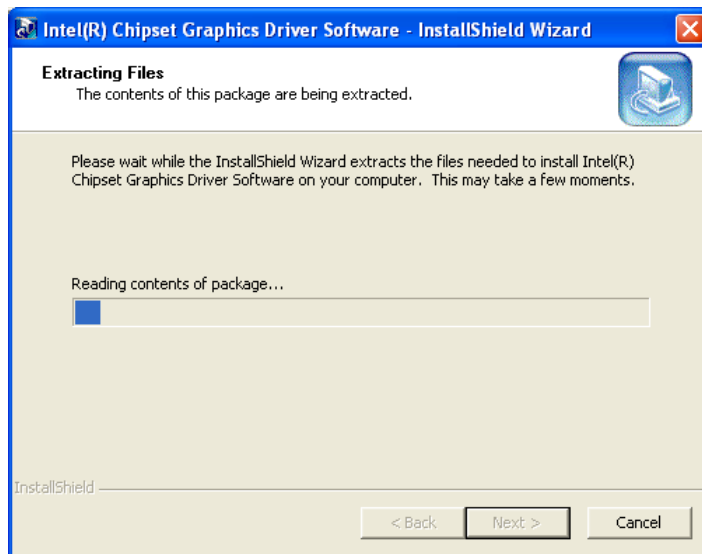

Figure 7-9: VGA Driver Setup Files Extracted

Step 6: The Welcome Screen in Figure 7-10 appears.

AFOLUX AFL-15A-N270 Panel PC



Figure 7-10: VGA Driver Welcome Screen

- Step 7:** Click **Next** to continue.
- Step 8:** The license agreement in **Figure 7-11** appears.
- Step 9:** Read the **License Agreement**.
- Step 10:** Click the **Yes** icon to continue.

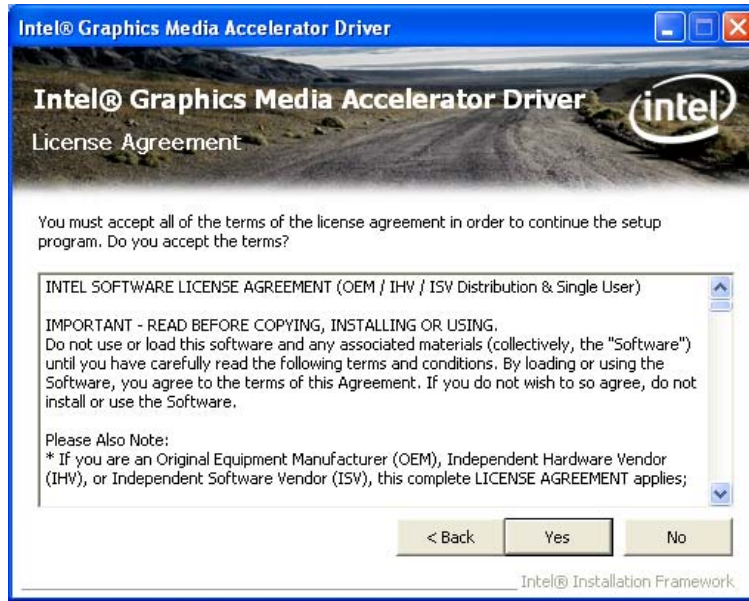

Figure 7-11: VGA Driver License Agreement

Step 11: The Read Me file in **Figure 7-12** appears.

Step 12: Click **Next** to continue.

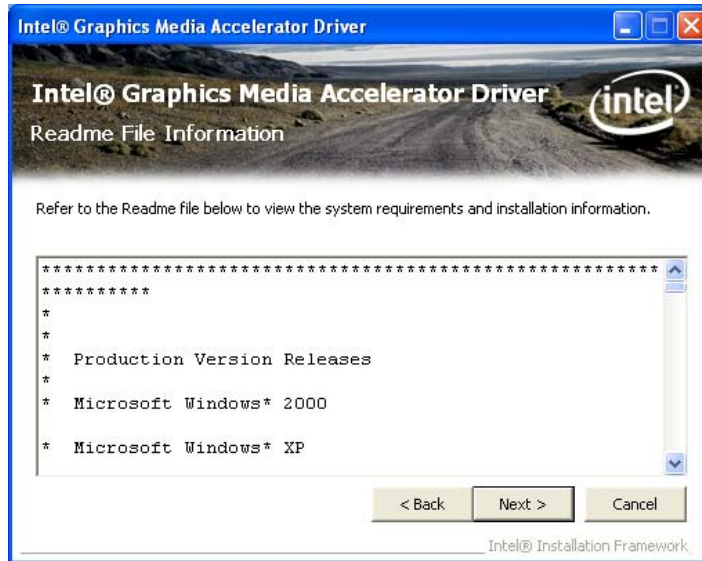

Figure 7-12: VGA Driver Read Me File

Step 13: Setup Operations are performed as shown in **Figure 7-13**.

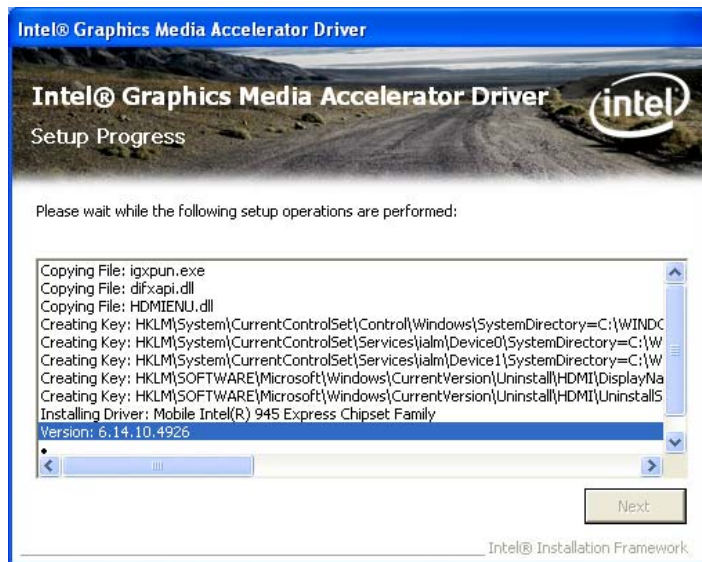

Figure 7-13: VGA Driver Setup Operations

Step 14: Once the **Setup Operations** are complete, click the **Next** icon to continue.

Step 15: The **Finish** screen appears.

Step 16: Select “**Yes, I want to restart the computer now**” and click the **Finish** icon.

See **Figure 7-14**.

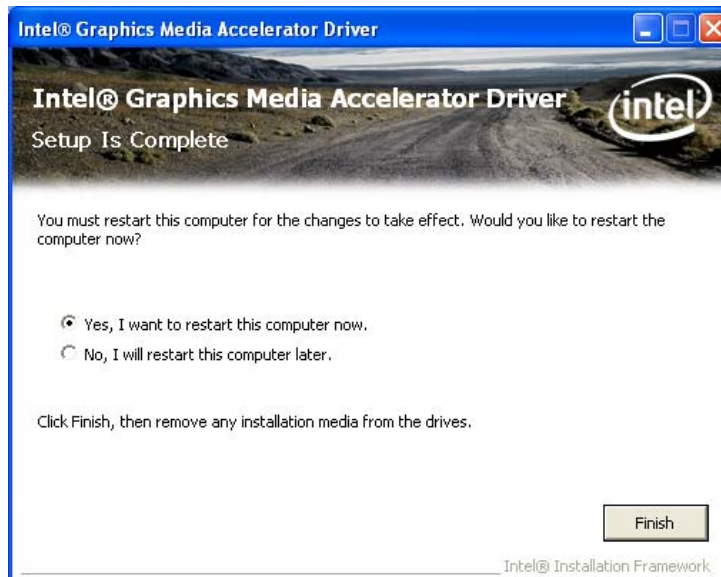

Figure 7-14: VGA Driver Installation Finish Screen

7.5 Audio Driver Installation

To install the Realtek High Definition (HD) Audio driver, please follow the steps below.

7.5.1 BIOS Setup

Step 1: Enter the BIOS setup. To do this, reboot the system and press **DEL** during POST.

Step 2: Go to the Southbridge Configuration menu. Set the **Audio Controller** option to [Azalia].

Step 3: Press **F10** to save the changes and exit the BIOS setup. The system reboots.

7.5.2 Driver Installation

To install the audio driver, please do the following.

Step 1: Access the driver list shown in **Figure 7-1**. (See **Section 7.2**)

Step 2: Click “**Audio**”

Step 3: Double click the “WDM_R205.exe” icon.

Step 4: The **InstallShield Wizard** starts (**Figure 7-15**).

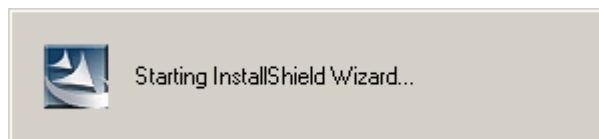

Figure 7-15: The InstallShield Wizard Starts

Step 5: The **InstallShield Wizard** is prepared to guide the user through the rest of the process (**Figure 7-16**).

AFOLUX AFL-15A-N270 Panel PC

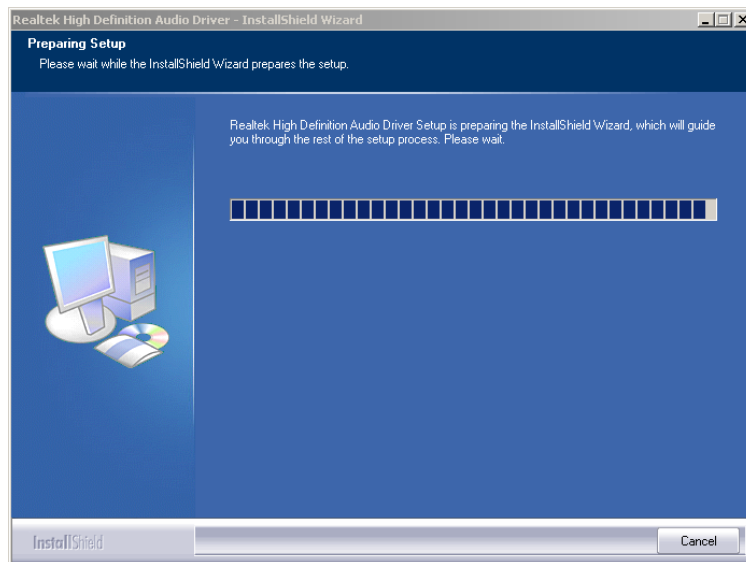

Figure 7-16: Preparing Setup Screen

Step 6: Once initialized, the **InstallShield Wizard** welcome screen appears (Figure 7-17).

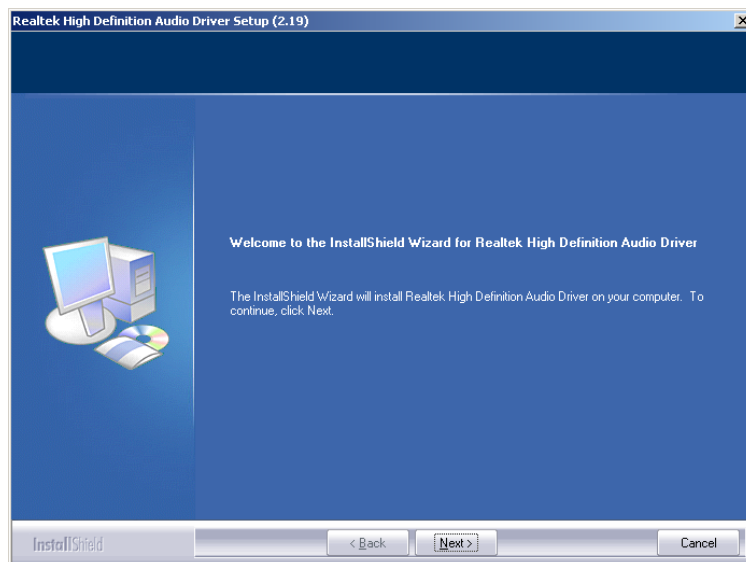

Figure 7-17: InstallShield Wizard Welcome Screen

Step 7: Click **NEXT** to continue the installation.

Step 8: InstallShield starts to install the new software as shown in **Figure 7-18**.

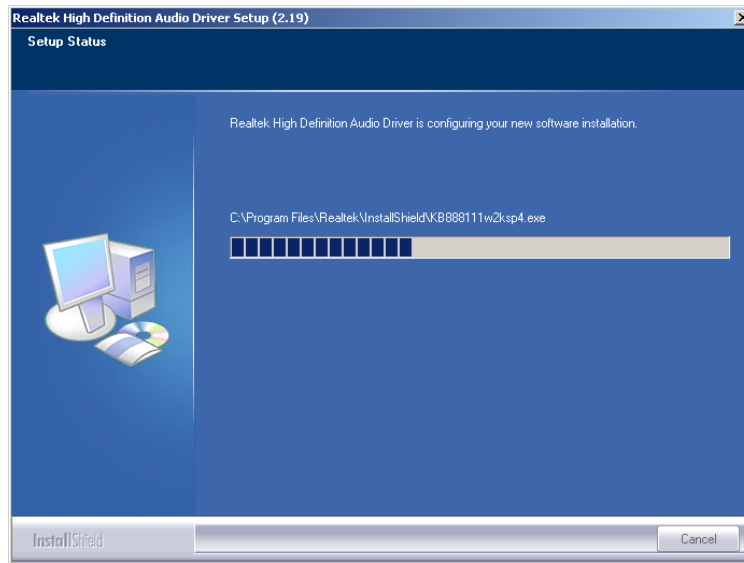

Figure 7-18: Audio Driver Software Configuration

Step 9: The Installation Wizard updates the system as shown in Figure 7-19.

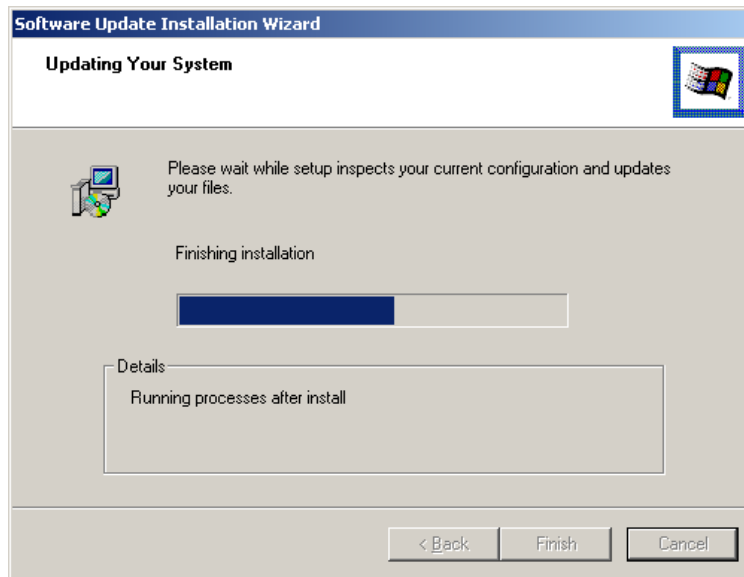

Figure 7-19: Installation Wizard Updates the System

Step 10: After the driver installation process is complete, a confirmation screen appears (Figure 7-20).

AFOLUX AFL-15A-N270 Panel PC

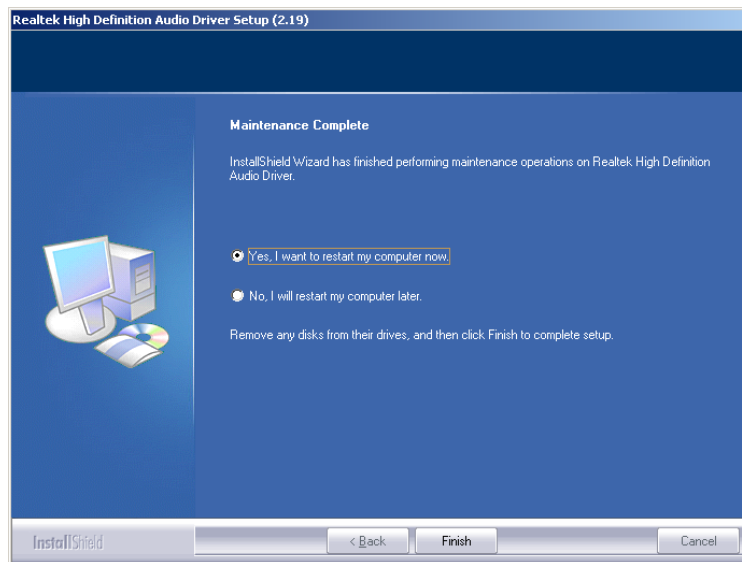

Figure 7-20: Restart the Computer

Step 11: The confirmation screen offers the option of restarting the computer now or later.

For the settings to take effect, the computer must be restarted. Click **FINISH** to restart the computer.

7.6 LAN Driver Installation

To install the LAN driver, please do the following.

Step 1: Access the driver list shown in **Figure 7-1**. (See **Section 7.2**)

Step 2: Click “LAN”.

Step 3: The **Welcome** screen in **Figure 7-21** appears.

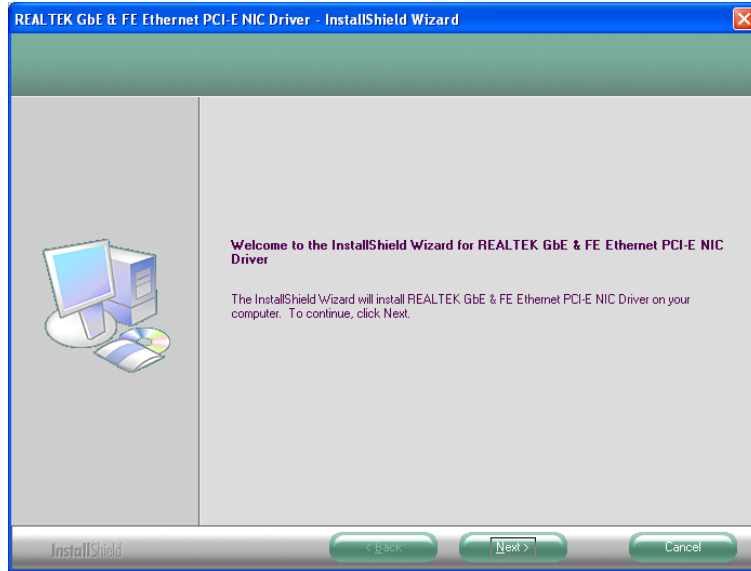

Figure 7-21: LAN Driver Welcome Screen

Step 4: Click **Next** to continue.

Step 5: The **Ready to Install** screen in **Figure 7-22** appears.

Step 6: Click **Next** to proceed with the installation.

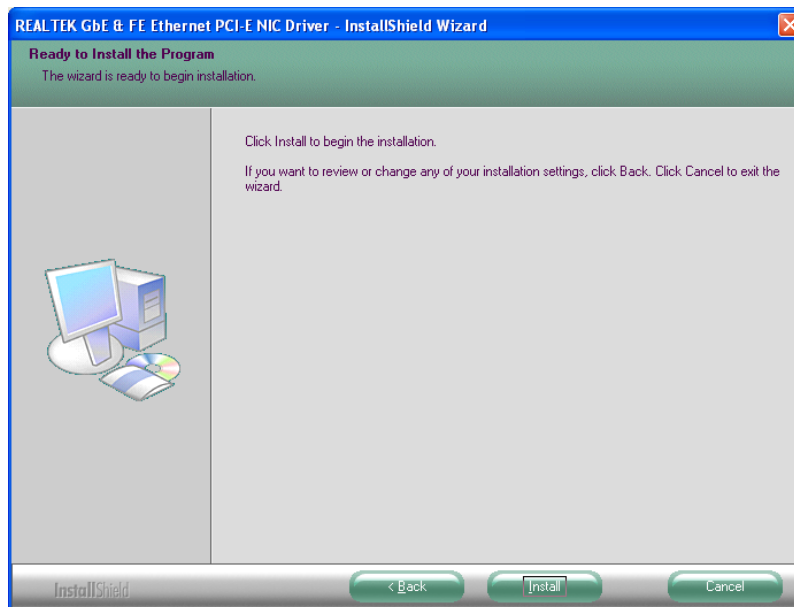

Figure 7-22: LAN Driver Welcome Screen

Step 7: The program begins to install.

AFOLUX AFL-15A-N270 Panel PC

Step 8: The installation progress can be monitored in the progress bar shown in **Figure 7-23**.

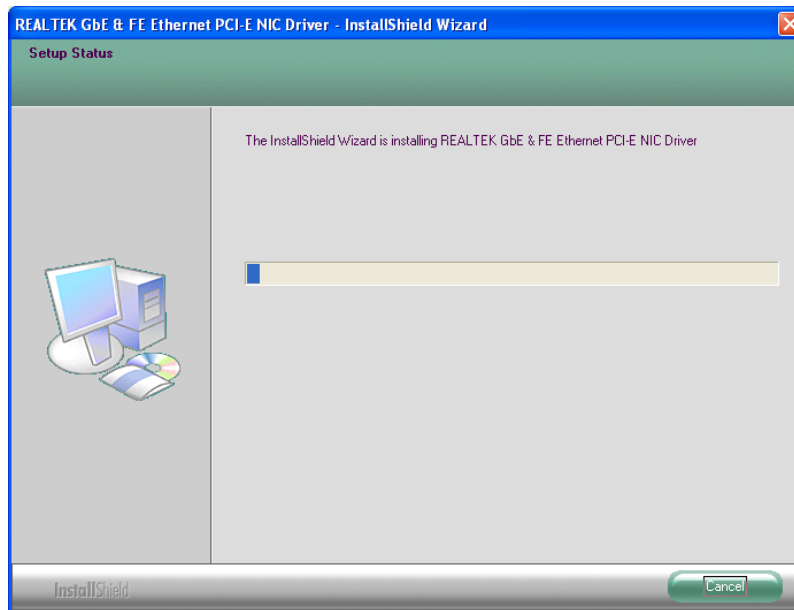

Figure 7-23: LAN Driver Installation

Step 9: When the driver installation is complete, the screen in **Figure 7-24** appears.

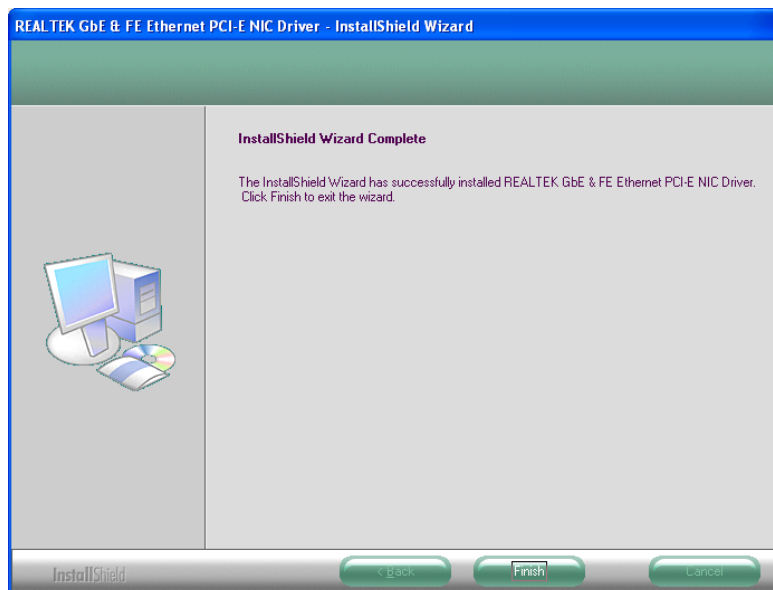

Figure 7-24: LAN Driver Installation Complete

7.7 Touch Screen Driver

To install the touch panel software driver, please follow the steps below.

Step 1: Access the driver list shown in **Figure 7-1**. (See **Section 7.2**)

Step 2: Click “**Touch Screen**”.

Step 3: A welcome screen appears (**Figure 7-25**). To continue the installation process click **NEXT**.

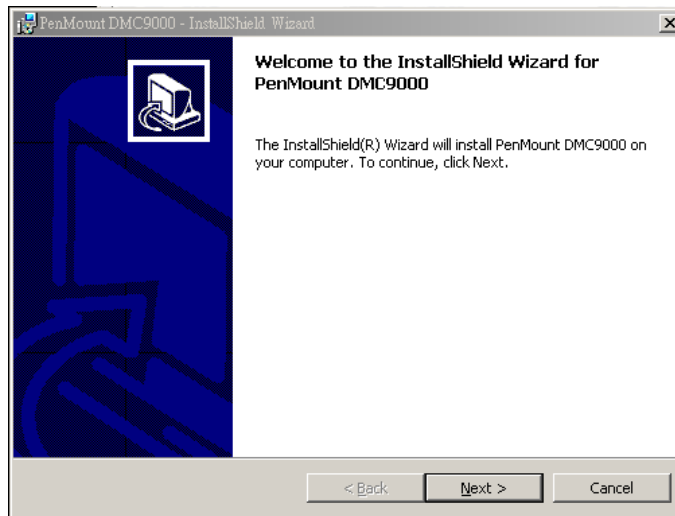

Figure 7-25: Welcome Screen

Step 4: The license agreement shown in **Figure 7-26** appears. Agree to the license by selecting “I accept the terms in the license agreement”.

AFOLUX AFL-15A-N270 Panel PC

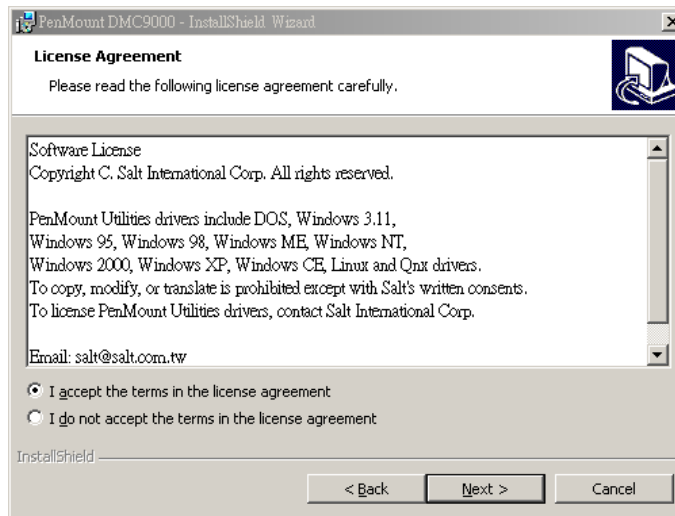

Figure 7-26: License Agreement

Step 5: Click **NEXT** and the Installshield Wizard is ready to install the program (Figure 7-27).

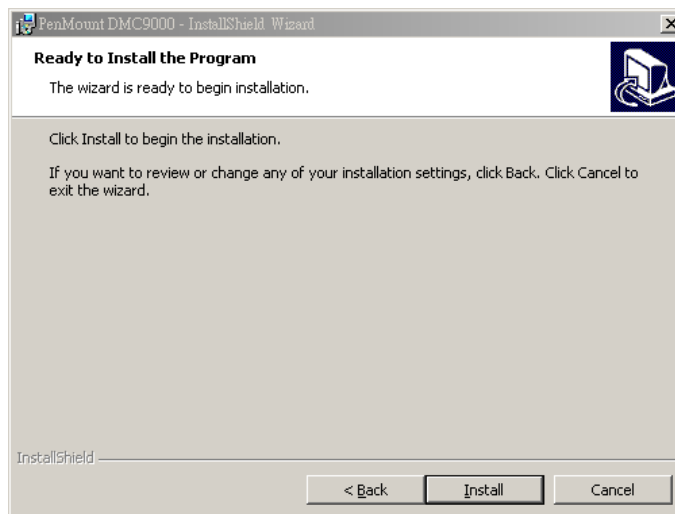

Figure 7-27: Ready to Install the Program

Step 6: Click **INSTALL** to continue. The Installing PenMount DMC9000 screen appears as the program is installed (Figure 7-28).

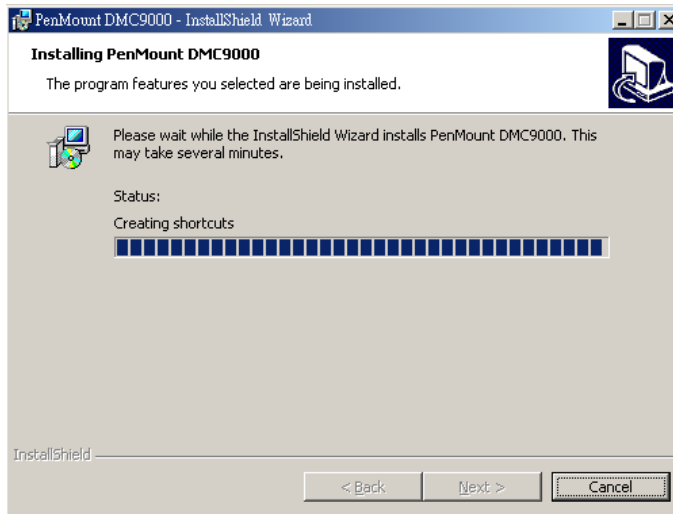

Figure 7-28: Installing PenMount DMC9000

Step 7: The user is then prompted to select to restart the computer now or later (Figure 7-29). For the settings to take effect, the computer must be restarted. Click **Yes** to restart the computer.

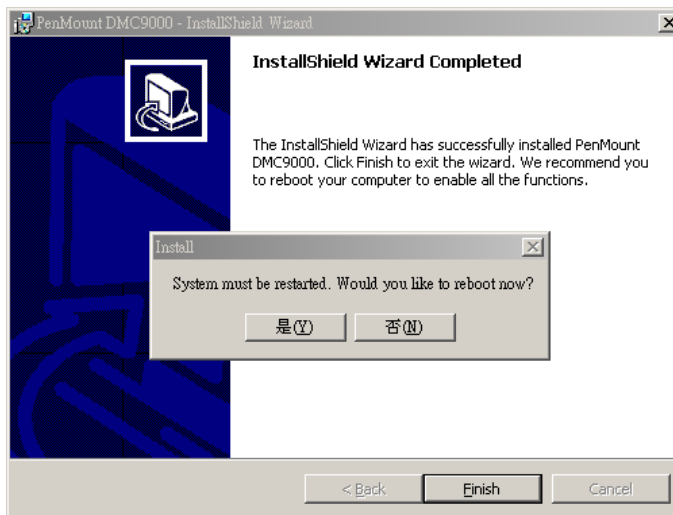

Figure 7-29: Reboot the Computer

7.8 Bluetooth Driver (Optional)

To install the Bluetooth software driver, please follow the steps below.

Step 1: Select **Bluetooth** from the list in **Figure 7-1**.

AFOLUX AFL-15A-N270 Panel PC

Step 2: A new window opens (**Figure 7-30**). Click the **Setup.exe** to install the touch screen driver.

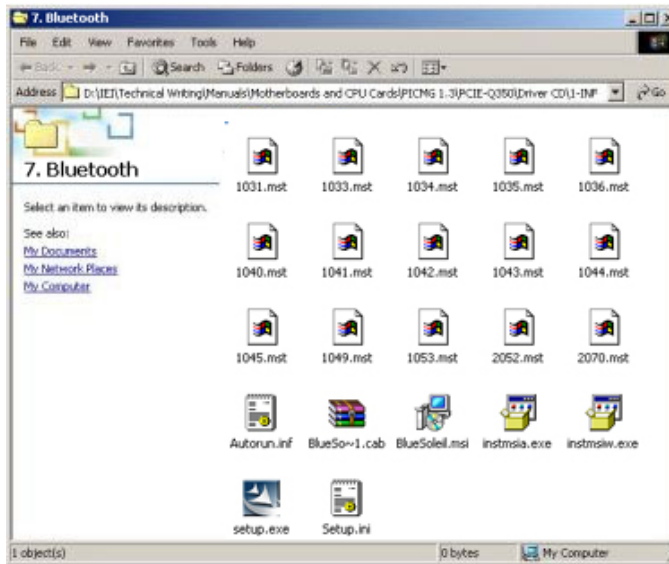

Figure 7-30: Bluetooth Driver Icon

Step 3: A welcome screen appears (**Figure 7-31**). To continue the installation process click **NEXT**.



Figure 7-31: Welcome Screen

Step 4: The license agreement shown in **Figure 7-32** appears. Agree to the license by selecting "I accept the terms in the license agreement".



Figure 7-32: License Agreement

Step 5: The **Custom Settings** screen in **Figure 7-33** appears next.

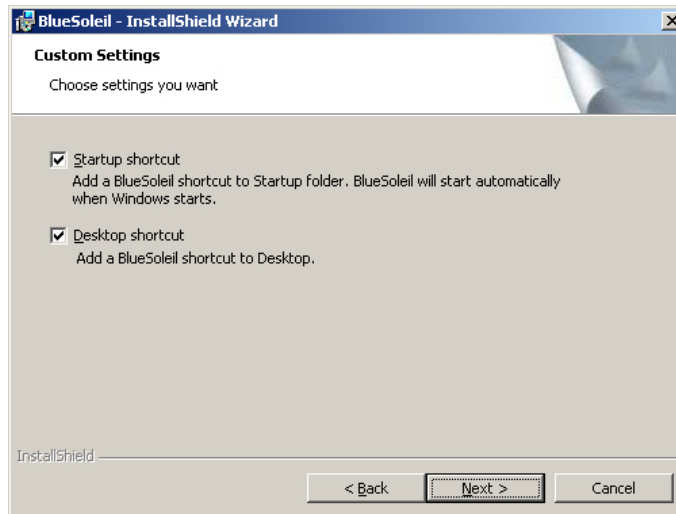

Figure 7-33: Bluetooth Driver Setup Options

Step 6: Select the required installation configuration in **Figure 7-33** and click **NEXT** to continue.

Step 7: The **Destination Folder** screen in **Figure 7-34** appears next. Confirm the destination folder to install the Bluetooth driver.

AFOLUX AFL-15A-N270 Panel PC

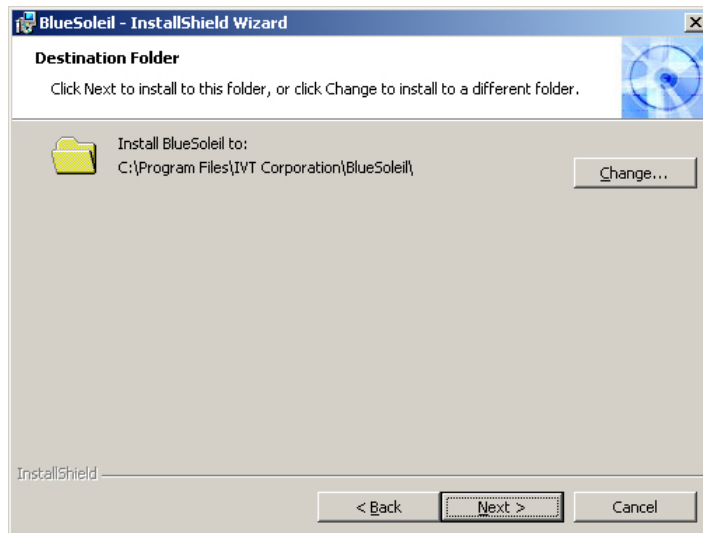

Figure 7-34: Bluetooth Driver Destination Folder

Step 8: Click **NEXT** and the Installshield Wizard is ready to install the program (**Figure 7-35**).

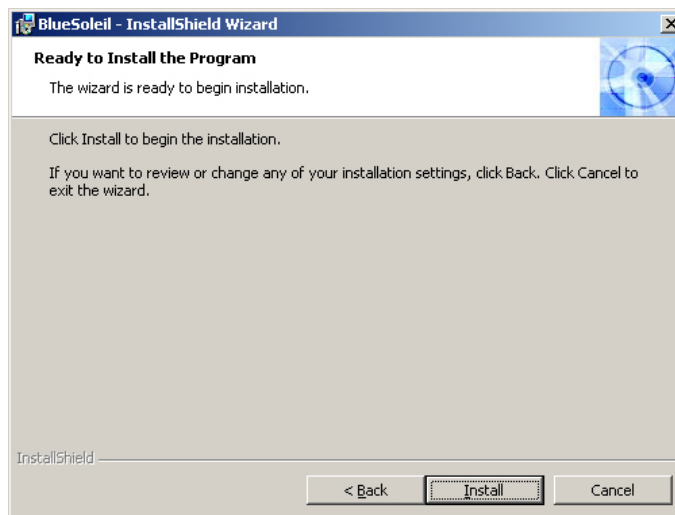

Figure 7-35: Ready to Install the Program

Step 9: Click **INSTALL** to continue. The Installing BlueSoleil screen appears as the program is installed (**Figure 7-36**).

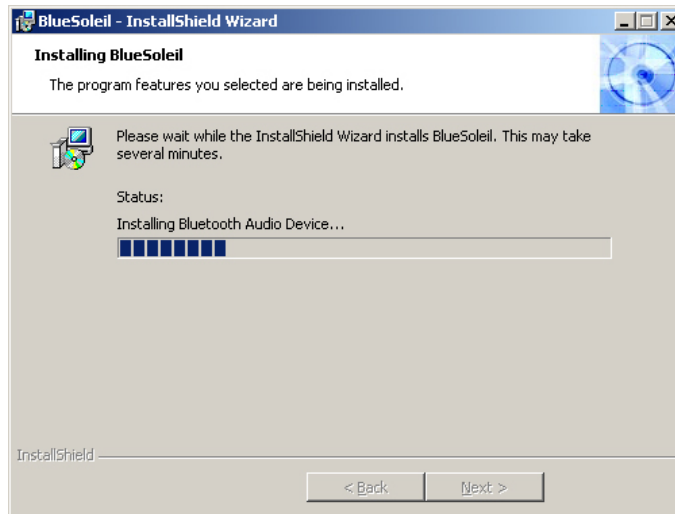

Figure 7-36: Installing BlueSoleil

Step 10: When the installation process is complete, the Setup Complete screen appears.

See **Figure 7-37**.

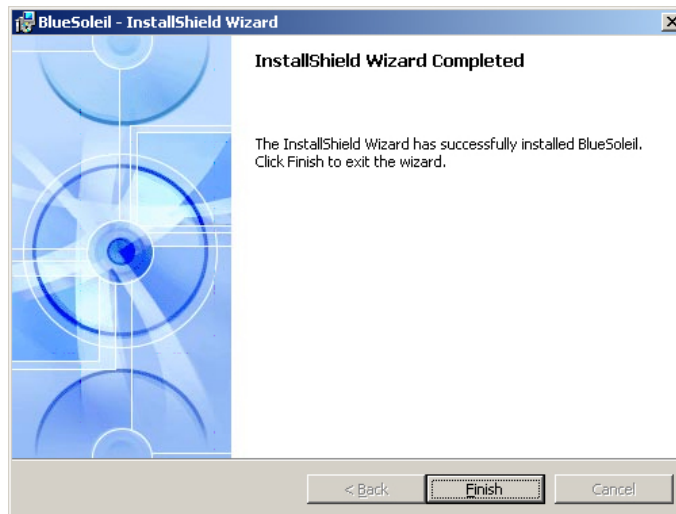

Figure 7-37: Bluetooth Driver Complete Installation Screen

Step 11: To complete the chipset driver installation, click **FINISH**. The user is then prompted to select to restart the computer now or later (**Figure 7-38**). For the settings to take effect, the computer must be restarted. Click **Yes** to restart the computer.

AFOLUX AFL-15A-N270 Panel PC

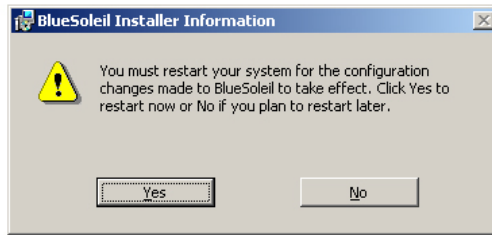

Figure 7-38: Reboot the Computer

7.9 Wireless Driver

To install the wireless driver, please follow the steps below.

Step 1: Select **Wireless LAN** from the list in **Figure 7-1**.

Step 2: A new window opens (**Figure 7-39**). Select the **RT3090** folder. Double click the .exe file to install the wireless LAN driver.

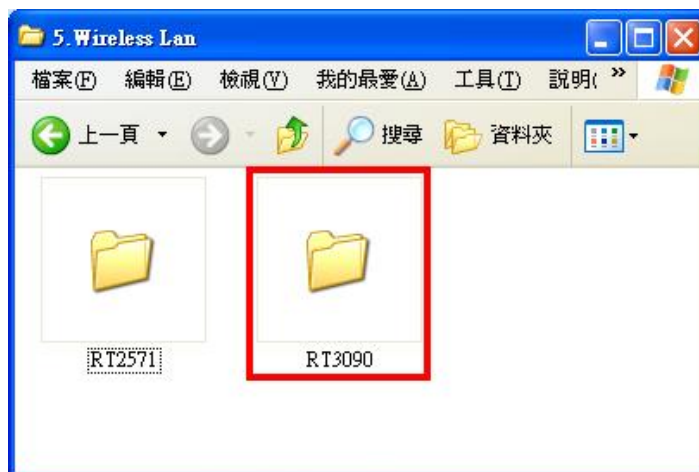

Figure 7-39: Wireless Driver OS Folders

Step 1: The license agreement in **Figure 7-40** appears.

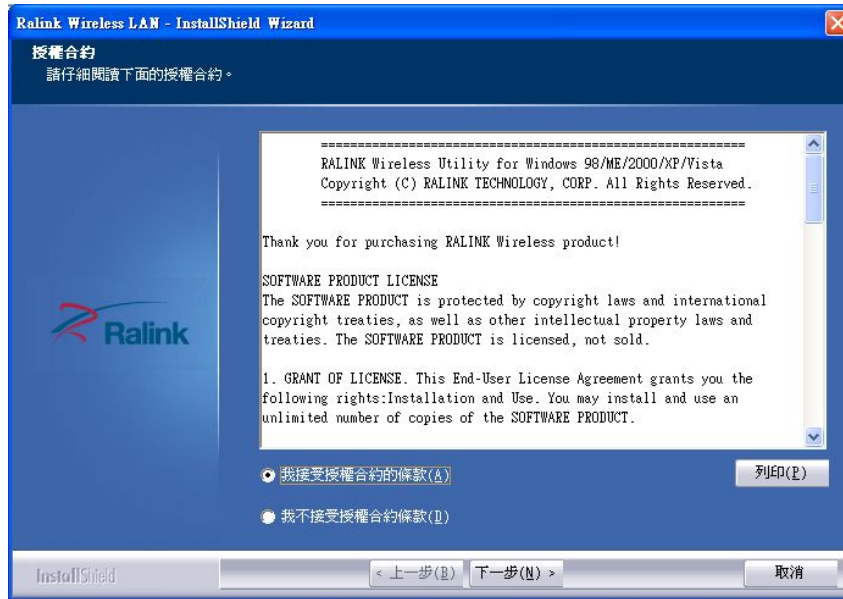

Figure 7-40: Wireless Driver License Agreement

Step 2: Accept the conditions of the license agreement and click **NEXT** to continue.

Step 3: The **Configuration Tool Options** screen in **Figure 7-41** appears next.



Figure 7-41: Wireless Driver Configuration Tool Options

Step 4: Select configuration tool in **Figure 7-41** and click **NEXT** to continue.

AFOLUX AFL-15A-N270 Panel PC

Step 5: The **Wireless Mode Options** window in **Figure 7-42** appears.



Figure 7-42: Wireless Mode Select Window

Step 6: Click **NEXT** in **Figure 7-42**.

Step 7: Click **INSTALL** in **Figure 7-43** to start to install the driver.

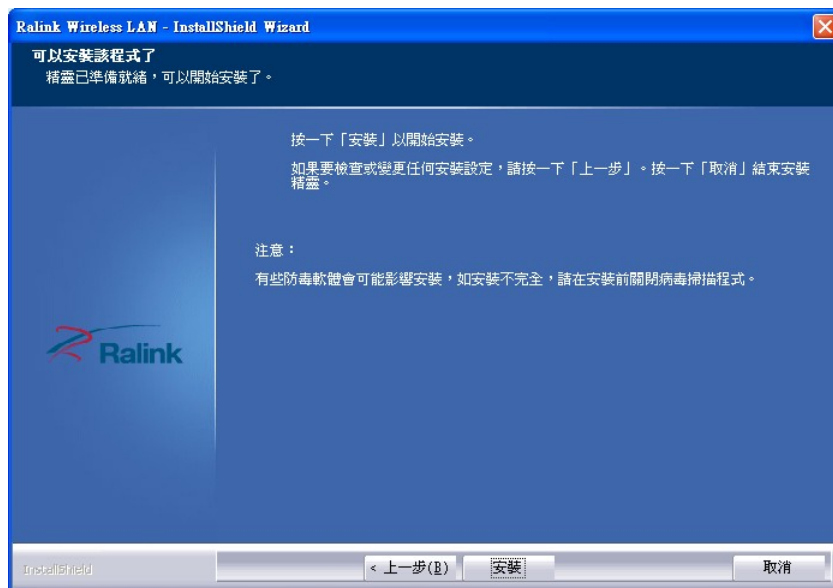

Figure 7-43: Wireless Driver Installation

Step 8: When the installation is finished. Click **FINISH** in the termination screen.

Appendix

A

System Specifications

A.1 Motherboard Specifications

The system comes with an IEI AFLMB2-945GSE motherboard. The detailed specifications for the motherboard are listed below.

Specification	AFLMB2-945GSE
Northbridge	Intel® 945GSE
Southbridge	Intel® ICH7
Processor	1.6 GHz Intel® Atom™ N270 processor
FSB Speed	533 MHz
Supported Memory	One 200-pin 2.0 GB (max.) 400 MHz or 533 MHz DDR2 SDRAM SO-DIMM (system max. 2.0 GB)
System BIOS	AMI BIOS
Hard disk drives	One SATA drive
VGA	Integrated in the Intel® 945GSE
LAN	Realtek RTL8111CP PCIe GbE Controllers
Expansion Options	One PCIe Mini
Super I/O	ITE IT8718F
Audio Codec	RealTek ALC888
Audio Amplifier	NXP TDA1517P
USB	Four external USB 2.0 ports
RS-232	Fintek
Extra-Module	Optional Bluetooth Module (USB protocol BT-330C-V2)

A.2 Processor Specifications

The N270 Intel® Atom™ processor specifications are given below.

Parameter	Specifications
CPU Speed	1.6 GHz
Bus Speed	533 MHz
L2 Cache Size	512 KB
L2 Cache Speed	1.6 GHz
Manufacturing Technology	45 nm

AFOLUX AFL-15A-N270 Panel PC

L1 Cache	32 KB instruction cache 24 KB write-back data cache
Thermal Design Power	2.5 W
Tjunction	0 to 90°C

Appendix

B

Safety Precautions

**WARNING:**

The precautions outlined in this chapter should be strictly followed. Failure to follow these precautions may result in permanent damage to the AFOLUX AFL-15A-N270 series.

B.1 Safety Precautions

Please follow the safety precautions outlined in the sections that follow:

B.1.1 General Safety Precautions

Please ensure the following safety precautions are adhered to at all times.

- **Follow the electrostatic precautions** outlined below whenever the AFOLUX AFL-15A-N270 series is opened.
- **Make sure the power is turned off and the power cord is disconnected** whenever the AFOLUX AFL-15A-N270 series is being installed, moved or modified.
- **Do not apply voltage levels that exceed the specified voltage range.** Doing so may cause fire and/or an electrical shock.
- **Electric shocks can occur** if the AFOLUX AFL-15A-N270 series chassis is opened when the AFOLUX AFL-15A-N270 series is running.
- **Do not drop or insert any objects** into the ventilation openings of the AFOLUX AFL-15A-N270 series.
- **If considerable amounts of dust, water, or fluids enter the AFOLUX AFL-15A-N270 series**, turn off the power supply immediately, unplug the power cord, and contact the AFOLUX AFL-15A-N270series vendor.
- **DO NOT:**
 - Drop the AFOLUX AFL-15A-N270 series against a hard surface.
 - Strike or exert excessive force onto the LCD panel.
 - Touch any of the LCD panels with a sharp object
 - In a site where the ambient temperature exceeds the rated temperature

B.1.2 Anti-static Precautions



WARNING:

Failure to take ESD precautions during the installation of the AFOLUX AFL-15A-N270 series may result in permanent damage to the AFOLUX AFL-15A-N270 series and severe injury to the user.

Electrostatic discharge (ESD) can cause serious damage to electronic components, including the AFOLUX AFL-15A-N270 series. Dry climates are especially susceptible to ESD. It is therefore critical that whenever the AFOLUX AFL-15A-N270 series is opened and any of the electrical components are handled, the following anti-static precautions are strictly adhered to.

- ***Wear an anti-static wristband:*** Wearing a simple anti-static wristband can help to prevent ESD from damaging any electrical component.
- ***Self-grounding:*** Before handling any electrical component, touch any grounded conducting material. During the time the electrical component is handled, frequently touch any conducting materials that are connected to the ground.
- ***Use an anti-static pad:*** When configuring or working with an electrical component, place it on an anti-static pad. This reduces the possibility of ESD damage.
- ***Only handle the edges of the electrical component:*** When handling the electrical component, hold the electrical component by its edges.

AFOLUX AFL-15A-N270 Panel PC

B.1.3 Product Disposal



CAUTION:

Risk of explosion if battery is replaced by an incorrect type. Only certified engineers should replace the on-board battery.

Dispose of used batteries according to instructions and local regulations.

- Outside the European Union - If you wish to dispose of used electrical and electronic products outside the European Union, please contact your local authority so as to comply with the correct disposal method.
- Within the European Union:

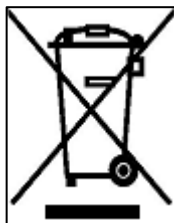

EU-wide legislation, as implemented in each Member State, requires that waste electrical and electronic products carrying the mark (left) must be disposed of separately from normal household waste. This includes monitors and electrical accessories, such as signal cables or power cords.

When you need to dispose of your display products, please follow the guidance of your local authority, or ask the shop where you purchased the product. The mark on electrical and electronic products only applies to the current European Union Member States.

Please follow the national guidelines for electrical and electronic product disposal.

B.2 Maintenance and Cleaning Precautions

When maintaining or cleaning the AFOLUX AFL-15A-N270 series, please follow the guidelines below.

B.2.1 Maintenance and Cleaning

Prior to cleaning any part or component of the AFOLUX AFL-15A-N270 series, please read the details below.

- Except for the LCD panel, never spray or squirt liquids directly onto any other components. To clean the LCD panel, gently wipe it with a piece of soft dry cloth or a slightly moistened cloth.
- The interior of the AFOLUX AFL-15A-N270X series does not require cleaning. Keep fluids away from the AFOLUX AFL-15A-N270 series interior.
- Be cautious of all small removable components when vacuuming the AFOLUX AFL-15A-N270 series.
- Turn the AFOLUX AFL-15A-N270 series off before cleaning the AFOLUX AFL-15A-N270 series.
- Never drop any objects or liquids through the openings of the AFOLUX AFL-15A-N270 series.
- Be cautious of any possible allergic reactions to solvents or chemicals used when cleaning the AFOLUX AFL-15A-N270 series.
- Avoid eating, drinking and smoking within vicinity of the AFOLUX AFL-15A-N270 series.

B.2.2 Cleaning Tools

Some components in the AFOLUX AFL-15A-N270 series may only be cleaned using a product specifically designed for the purpose. In such case, the product will be explicitly mentioned in the cleaning tips. Below is a list of items to use when cleaning the AFOLUX AFL-15A-N270 series.

- **Cloth** – Although paper towels or tissues can be used, a soft, clean piece of cloth is recommended when cleaning the AFOLUX AFL-15A-N270 series.
- **Water or rubbing alcohol** – A cloth moistened with water or rubbing alcohol can be used to clean the AFOLUX AFL-15A-N270 series.
- **Using solvents** – The use of solvents is not recommended when cleaning the AFOLUX AFL-15A-N270 series as they may damage the plastic parts.
- **Vacuum cleaner** – Using a vacuum specifically designed for computers is one of the best methods of cleaning the AFOLUX AFL-15A-N270 series. Dust and dirt can restrict the airflow in the AFOLUX AFL-15A-N270 series and cause its circuitry to corrode.
- **Cotton swabs** - Cotton swabs moistened with rubbing alcohol or water are excellent tools for wiping hard to reach areas.

AFOLUX AFL-15A-N270 Panel PC

- **Foam swabs** - Whenever possible, it is best to use lint free swabs such as foam swabs for cleaning.

Appendix

C

BIOS Configuration Options

C.1 BIOS Configuration Options

Below is a list of BIOS configuration options described in **Chapter 6**.

System Overview	72
System Time [xx:xx:xx]	73
System Date [xx/xx/xx]	73
ATA/IDE Configurations [Compatible]	75
Legacy IDE Channels [PATA Pri, SATA Sec]	76
IDE Master and IDE Slave	76
Auto-Detected Drive Parameters	77
Type [Auto]	78
ZIP	78
LS-120	78
LBA/Large Mode [Auto]	79
Block (Multi Sector Transfer) [Auto]	79
PIO Mode [Auto]	79
DMA Mode [Auto]	80
S.M.A.R.T [Auto]	81
32Bit Data Transfer [Enabled]	81
Serial Port1 Address [3F8/IRQ4]	82
Serial Port1 Mode [Normal]	83
Serial Port3 Address [3E8]	83
Serial Port3 IRQ [11]	83
Serial Port4 Address [2E8]	83
Serial Port4 IRQ [11]	84
Serial Port5 Address [2F0]	84
Serial Port5 IRQ [10]	84
CPU FAN Mode Setting [Automatic mode]	85
CPU Temp. Limit of OFF [000]	86
CPU Temp. Limit of Start [020]	86
CPU Fan Start PWM [070]	87
Slope PWM [0.5 PWM]	87
Suspend Mode [S1(POS)]	90
Restore on AC Power Loss [Last State]	91

Power Button Mode [On/Off].....	91
Resume on Keyboard/Mouse [Disabled]	92
Resume on Ring [Disabled]	92
Resume on PCI-Express WAKE# [Enabled].....	92
Resume On RTC Alarm [Disabled].....	93
RTC Alarm Date (Days).....	93
System Time	93
Remote Access [Disabled].....	94
Serial Port Number	94
Serial Port Mode.....	94
Redirection after BIOS POST.....	94
Terminal Type.....	94
Serial Port Number [COM1].....	94
Base Address, IRQ [3F8h,4].....	94
Serial Port Mode [115200 8,n,1].....	95
Redirection After BIOS POST [Always]	95
Terminal Type [ANSI].....	95
USB Functions [Enabled].....	96
USB 2.0 Controller [Enabled].....	96
Legacy USB Support [Enabled].....	97
USB2.0 Controller Mode [HiSpeed].....	97
IRQ# [Available].....	98
DMA Channel# [Available]	99
Reserved Memory Size [Disabled]	99
Quick Boot [Enabled]	101
Quiet Boot [Disabled]	101
AddOn ROM Display Mode [Force BIOS]	102
Bootup Num-Lock [On]	102
Boot From LAN Support [Disabled]	102
Spread Spectrum Function [Disabled]	103
Change Supervisor Password.....	103
Change User Password.....	104
Memory Hole [Disabled].....	105
Internal Graphics Mode Select [Enable, 8MB]	105
DVMT Mode Select [DVMT Mode].....	106

AFOLUX AFL-15A-N270 Panel PC

DVMT/FIXED Memory	106
Boot Display Device [Auto].....	106
LVDS2 Panel Type [by H/W].....	107
Audio Controller [Auto].....	108
Save Changes and Exit	108
Discard Changes and Exit.....	109
Discard Changes.....	109
Load Optimal Defaults.....	109
Load Failsafe Defaults.....	109

Appendix

D

Watchdog Timer



NOTE:

The following discussion applies to DOS environment. IEI support is contacted or the IEI website visited for specific drivers for more sophisticated operating systems, e.g., Windows and Linux.

The Watchdog Timer is provided to ensure that standalone systems can always recover from catastrophic conditions that cause the CPU to crash. This condition may have occurred by external EMI or a software bug. When the CPU stops working correctly, Watchdog Timer either performs a hardware reset (cold boot) or a Non-Maskable Interrupt (NMI) to bring the system back to a known state.

A BIOS function call (INT 15H) is used to control the Watchdog Timer:

INT 15H:

AH – 6FH Sub-function:	
AL – 2:	Sets the Watchdog Timer's period.
BL:	Time-out value (Its unit-second is dependent on the item "Watchdog Timer unit select" in CMOS setup).

Table D-1: AH-6FH Sub-function

Call sub-function 2 to set the time-out period of Watchdog Timer first. If the time-out value is not zero, the Watchdog Timer starts counting down. While the timer value reaches zero, the system resets. To ensure that this reset condition does not occur, calling sub-function 2 must periodically refresh the Watchdog Timer. However, the Watchdog timer is disabled if the time-out value is set to zero.

A tolerance of at least 10% must be maintained to avoid unknown routines within the operating system (DOS), such as disk I/O that can be very time-consuming.

**NOTE:**

When exiting a program it is necessary to disable the Watchdog Timer, otherwise the system resets.

Example program:

```
; INITIAL TIMER PERIOD COUNTER
;
W_LOOP:

    MOV     AX, 6F02H      ;setting the time-out value
    MOV     BX, 05        ;time-out value is 5 seconds
    INT     15H

;
; ADD THE APPLICATION PROGRAM HERE
;

    CMP     EXIT_AP, 1    ;is the application over?
    JNE     W_LOOP       ;No, restart the application

    MOV     AX, 6F02H     ;disable Watchdog Timer
    MOV     BX, 0         ;
    INT     15H

;
; EXIT ;
```

Appendix

E

Hazardous Materials Disclosure

E.1 Hazardous Material Disclosure Table for IPB Products Certified as RoHS Compliant Under 2002/95/EC Without Mercury

The details provided in this appendix are to ensure that the product is compliant with the Peoples Republic of China (China) RoHS standards. The table below acknowledges the presences of small quantities of certain materials in the product, and is applicable to China RoHS only.

A label will be placed on each product to indicate the estimated “Environmentally Friendly Use Period” (EFUP). This is an estimate of the number of years that these substances would “not leak out or undergo abrupt change.” This product may contain replaceable sub-assemblies/components which have a shorter EFUP such as batteries and lamps. These components will be separately marked.

Please refer to the table on the next page.

AFOLUX AFL-15A-N270 Panel PC

Part Name	Toxic or Hazardous Substances and Elements					
	Lead (Pb)	Mercury (Hg)	Cadmium (Cd)	Hexavalent Chromium (CR(VI))	Polybrominated Biphenyls (PBB)	Polybrominated Diphenyl Ethers (PBDE)
Housing	X	O	O	O	O	X
Display	X	O	O	O	O	X
Printed Circuit Board	X	O	O	O	O	X
Metal Fasteners	X	O	O	O	O	O
Cable Assembly	X	O	O	O	O	X
Fan Assembly	X	O	O	O	O	X
Power Supply Assemblies	X	O	O	O	O	X
Battery	O	O	O	O	O	O

O: This toxic or hazardous substance is contained in all of the homogeneous materials for the part is below the limit requirement in SJ/T11363-2006

X: This toxic or hazardous substance is contained in at least one of the homogeneous materials for this part is above the limit requirement in SJ/T11363-2006

此附件旨在确保本产品符合中国 RoHS 标准。以下表格标示此产品中某有毒物质的含量符合中国 RoHS 标准规定的限量要求。

本产品上会附有“环境友好使用期限”的标签，此期限是估算这些物质“不会有泄漏或突变”的年限。本产品可能包含有较短的环境友好使用期限的可替换元件，像是电池或灯管，这些元件将会单独标示出来。

部件名称	有毒有害物质或元素					
	铅 (Pb)	汞 (Hg)	镉 (Cd)	六价铬 (CR(VI))	多溴联苯 (PBB)	多溴二苯醚 (PBDE)
壳体	X	O	O	O	O	X
显示	X	O	O	O	O	X
印刷电路板	X	O	O	O	O	X
金属螺帽	X	O	O	O	O	O
电缆组装	X	O	O	O	O	X
风扇组装	X	O	O	O	O	X
电力供应组装	X	O	O	O	O	X
电池	O	O	O	O	O	O

O: 表示该有毒有害物质在该部件所有物质材料中的含量均在 SJ/T11363-2006 标准规定的限量要求以下。

X: 表示该有毒有害物质至少在该部件的某一均质材料中的含量超出 SJ/T11363-2006 标准规定的限量要求。