

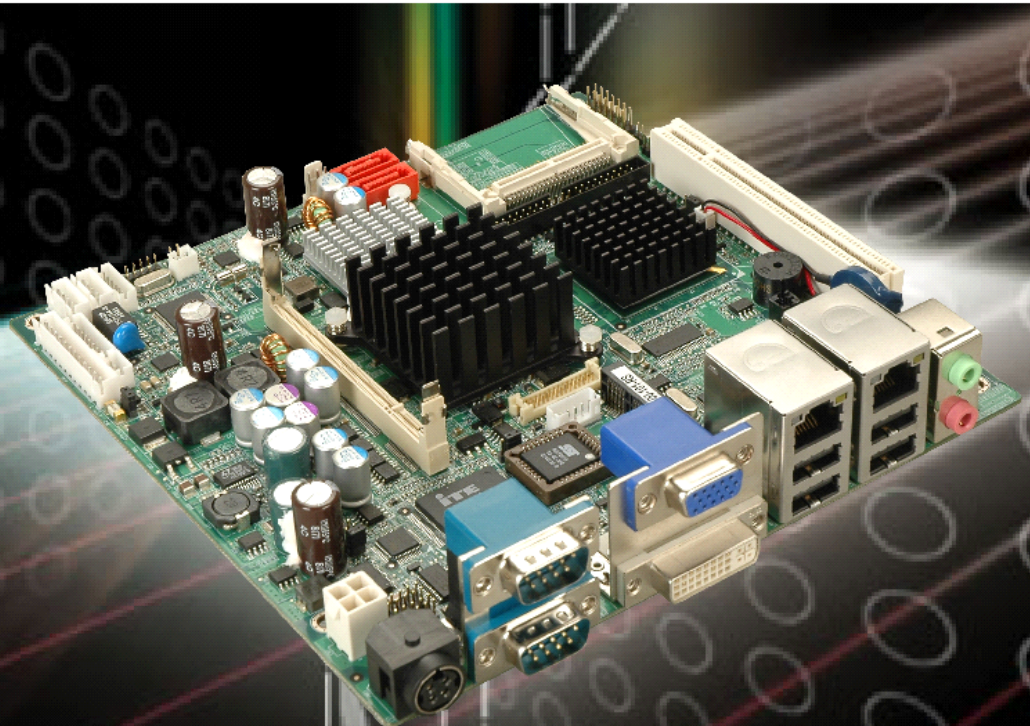

IEI Technology Corp .



MODEL:
eKINO-945GSE

**Mini-ITX Motherboard with Intel® Atom™ CPU
UPS Battery Backup, DDR2, VGA, DVI, LVDS, HDTV
Dual PCIe GbE, CompactFlash®, Dual SATA and PCIe Mini**

User Manual

Rev. 1.12 – 16 May, 2012



Revision

Date	Version	Changes
16 May, 2012	1.12	Updated Section 4.2.14: Power Connectors
4 November, 2010	1.11	Minor update
29 July, 2010	1.10	Minor update
11 March, 2009	1.01	Changed product name
23 December, 2008	1.00	Initial release

Copyright

COPYRIGHT NOTICE

The information in this document is subject to change without prior notice in order to improve reliability, design and function and does not represent a commitment on the part of the manufacturer.

In no event will the manufacturer be liable for direct, indirect, special, incidental, or consequential damages arising out of the use or inability to use the product or documentation, even if advised of the possibility of such damages.

This document contains proprietary information protected by copyright. All rights are reserved. No part of this manual may be reproduced by any mechanical, electronic, or other means in any form without prior written permission of the manufacturer.

TRADEMARKS

All registered trademarks and product names mentioned herein are used for identification purposes only and may be trademarks and/or registered trademarks of their respective owners.

Packing List



NOTE:

If any of the components listed in the checklist below are missing, please do not proceed with the installation. Contact the IEI reseller or vendor you purchased the eKINO-945GSE from or contact an IEI sales representative directly. To contact an IEI sales representative, please send an email to sales@iei.com.tw.

The items listed below should all be included in the eKINO-945GSE package.

- 1 x eKINO-945GSE Mini-ITX Motherboard
- 2 x SATA with DC output power cable kit (P/N: 32000-106100-RS)
- 1 x I/O shielding (P/N: 45014-0023C0-00-RS)
- 1 x Keyboard/mouse Y-cable (P/N: 32000-023800-RS)
- 1 x Mini jumper pack
- 1 x Utility CD
- 1 x QIG (quick installation guide)

Images of the above items are shown in **Chapter 3**.

Table of Contents

1 INTRODUCTION.....	1
1.1 INTRODUCTION.....	2
1.2 EKINO-945GSE OVERVIEW	2
1.2.1 Overview Photo.....	2
1.2.2 Peripheral Connectors and Jumpers	3
1.2.3 Technical Specifications.....	5
2 DETAILED SPECIFICATIONS	7
2.1 DIMENSIONS.....	8
2.1.1 Board Dimensions.....	8
2.1.2 External Interface Panel Dimensions	9
2.2 DATA FLOW	10
2.3 EMBEDDED INTEL® ATOM™ PROCESSOR	11
2.3.1 Features	11
2.3.2 Front Side Bus (FSB).....	12
2.4 INTEL® 945GSE NORTHBRIDGE CHIP	12
2.4.1 DDR2 Controller.....	12
2.4.2 Graphics.....	13
2.4.2.1 Analog CRT (VGA)	13
2.4.2.2 LVDS	13
2.4.2.3 TV Out	13
2.4.2.4 SDVO and DVI.....	14
2.5 INTEL® ICH7M SOUTHBRIDGE CHIPSET	14
2.5.1 Audio Codec '97 Controller.....	16
2.5.2 IDE Interface	16
2.5.2.1 IDE Connector	16
2.5.2.2 CompactFlash® Slot.....	17
2.5.3 Low Pin Count (LPC) Interface.....	17
2.5.4 PCI Bus	17
2.5.4.1 PCI Expansion Card Slot	17
2.5.5 PCIe Bus	18

2.5.5.1 PCIe GbE Ethernet.....	18
2.5.5.2 PCIe Mini Card.....	19
2.5.6 Real Time Clock.....	19
2.5.7 SATA Controller.....	19
2.5.8 USB Controller.....	19
2.6 LPC BUS COMPONENTS.....	20
2.6.1 BIOS Chipset.....	20
2.6.2 iTE IT8718F Super I/O chipset.....	20
2.6.2.1 LPC Interface.....	21
2.6.2.2 16C550 UARTs.....	21
2.6.2.3 Digital Input/Output.....	21
2.6.2.4 Enhanced Hardware Monitor.....	21
2.6.2.5 Fan Speed Controller.....	21
2.6.2.6 Keyboard/Mouse Controller.....	21
2.6.2.7 Parallel Port.....	22
2.6.3 Fintek F81216D LPC Serial Port Chip.....	22
2.7 ENVIRONMENTAL AND POWER SPECIFICATIONS.....	22
2.7.1 System Monitoring.....	22
2.7.2 Operating Temperature and Temperature Control.....	23
2.7.3 Power Consumption.....	23
3 UNPACKING.....	25
3.1 ANTI-STATIC PRECAUTIONS.....	26
3.2 UNPACKING.....	26
3.2.1 Unpacking Precautions.....	26
3.3 UNPACKING CHECKLIST.....	27
3.3.1 Package Contents.....	27
3.3.2 Optional Items.....	28
4 CONNECTORS.....	30
4.1 PERIPHERAL INTERFACE CONNECTORS.....	31
4.1.1 Layout.....	31
4.1.2 Internal Peripheral Interface Connectors.....	32
4.1.3 External Interface Panel Connectors.....	33
4.2 INTERNAL PERIPHERAL CONNECTORS.....	33

eKINO-945GSE Motherboard

4.2.1 BIOS Battery Connector	33
4.2.2 CompactFlash® Socket.....	34
4.2.3 Digital I/O Connector.....	35
4.2.4 Fan Connector	36
4.2.5 Front Panel Connector	37
4.2.6 IDE Connector.....	38
4.2.7 Infrared Interface Connector.....	39
4.2.8 Keyboard/Mouse Connector	40
4.2.9 LCD Backlight Inverter Connector.....	41
4.2.10 LED Connector	42
4.2.11 LVDS LCD Connector.....	43
4.2.12 MCU LAN Connector	45
4.2.13 PCIe Mini Card Slot	46
4.2.14 Power Connectors.....	47
4.2.15 SATA Drive Connectors	48
4.2.16 SATA Power Connectors.....	48
4.2.17 Serial Port Connectors (RS-232).....	50
4.2.18 Serial Port Connectors (RS-422/485).....	51
4.2.19 SO-DIMM Socket.....	52
4.2.20 SPDIF Connector.....	52
4.2.21 TV Out Connector	53
4.2.22 USB Connectors.....	54
4.3 EXTERNAL PERIPHERAL INTERFACE CONNECTOR PANEL	55
4.3.1 Audio Connector	56
4.3.2 DVI Connector.....	56
4.3.3 LAN Connectors.....	57
4.3.4 Serial Port Connectors	58
4.3.5 USB Connectors.....	59
4.3.6 VGA Connector.....	60
5 INSTALLATION	61
5.1 ANTI-STATIC PRECAUTIONS	62
5.2 INSTALLATION CONSIDERATIONS.....	63
5.2.1 Installation Notices	63
5.2.2 Installation Checklist.....	64

5.3 UNPACKING	64
5.4 SO-DIMM INSTALLATION	65
5.5 CF CARD INSTALLATION	66
5.6 UPS INSTALLATION	68
5.7 JUMPER SETTINGS	68
5.7.1 AT/ATX Selection	70
5.7.2 Clear CMOS Jumper.....	71
5.7.3 CF Card Setup	71
5.7.4 COM3 RS-232/422/485 Selection Jumper	72
5.7.5 LCD Panel Type Selection	72
5.7.6 LVDS Voltage Selection.....	73
5.7.7 UPS Enable/Disable	74
5.7.8 UPS/Battery Mode Selection (eKINO-945GSE-N270UPS only).....	74
5.8 CHASSIS INSTALLATION.....	75
5.8.1 Airflow.....	75
5.8.2 Motherboard Installation.....	75
5.9 INTERNAL PERIPHERAL DEVICE CONNECTIONS.....	75
5.9.1 ATA Flat Cable Connection	76
5.9.2 SATA Drive Connection	77
5.9.3 Dual RS-232 Cable with Slot Bracket.....	79
5.9.4 USB Cable (Dual Port) with Slot Bracket	80
5.9.5 Parallel Port Cable without Bracket	82
5.10 EXTERNAL PERIPHERAL INTERFACE CONNECTION	83
5.10.1 LAN Connection (Single Connector)	84
5.10.2 PS/2 Y-Cable Connection.....	84
5.10.3 Serial Device Connection	85
5.10.4 USB Connection (Dual Connector).....	86
5.10.5 VGA Monitor Connection	87
6 BIOS SETUP	89
6.1 INTRODUCTION.....	90
6.1.1 Starting Setup.....	90
6.1.2 Using Setup	90
6.1.3 Getting Help.....	91
6.1.4 Unable to Reboot After Configuration Changes.....	91

eKINO-945GSE Motherboard

6.1.5 BIOS Menu Bar.....	91
6.2 MAIN.....	92
6.3 ADVANCED.....	93
6.3.1 CPU Configuration.....	95
6.3.2 IDE Configuration.....	96
6.3.2.1 IDE Master, IDE Slave.....	98
6.3.3 Super IO Configuration.....	103
6.3.4 Hardware Health Configuration.....	106
6.3.5 Power Configuration.....	110
6.3.5.1 ACPI Configuration.....	110
6.3.5.2 APM Configuration.....	112
6.3.6 Remote Configuration.....	114
6.3.7 USB Configuration.....	118
6.4 PCI/PNP.....	119
6.5 BOOT.....	122
6.5.1 Boot Settings Configuration.....	123
6.5.2 Boot Device Priority.....	125
6.5.3 Hard Disk Drives.....	125
6.5.4 CD/DVD Drives.....	126
6.5.5 Removable Drives.....	127
6.6 SECURITY.....	128
6.7 CHIPSET.....	129
6.7.1 Northbridge Chipset Configuration.....	131
6.7.1.1 Video Function Configuration.....	133
6.7.2 Southbridge Configuration.....	136
6.8 EXIT.....	137
7 SOFTWARE INSTALLATION.....	139
7.1 AVAILABLE SOFTWARE DRIVERS.....	140
7.2 STARTING THE DRIVER PROGRAM.....	140
7.3 CHIPSET DRIVER INSTALLATION.....	142
7.4 VGA DRIVER INSTALLATION.....	146
7.5 LAN DRIVER INSTALLATION.....	150
7.6 AUDIO DRIVER INSTALLATION.....	153
8 BATTERY MONITORING.....	156

8.1 INTRODUCTION.....	157
8.2 MONITORING DC POWER AND SMART BATTERY	157
8.2.1 <i>Application Installation</i>	157
8.2.2 <i>Status Information</i>	160
8.2.2.1 DC Detection	160
8.2.2.2 Battery Detection	161
8.2.2.3 Total Battery Time	162
8.2.3 <i>Battery Information</i>	162
8.2.4 <i>LAN Setting</i>	163
8.2.5 <i>Setting</i>	164
8.3 REMOTE CONTROL AND MONITORING.....	166
A BIOS OPTIONS	171
B TERMINOLOGY.....	175
C DIGITAL I/O INTERFACE.....	179
C.1 INTRODUCTION	180
C.2 DIO CONNECTOR PINOUTS.....	180
C.3 ASSEMBLY LANGUAGE SAMPLES.....	181
C.3.1 <i>Enable the DIO Input Function</i>	181
C.3.2 <i>Enable the DIO Output Function</i>	181
D WATCHDOG TIMER	182
E ADDRESS MAPPING	185
E.1 DIRECT MEMORY ACCESS (DMA).....	186
E.2 INPUT/OUTPUT (IO).....	186
E.3 INTERRUPT REQUEST (IRQ).....	188
E.4 MEMORY.....	189
F HAZARDOUS MATERIALS DISCLOSURE.....	190
F.1 HAZARDOUS MATERIALS DISCLOSURE TABLE FOR IPB PRODUCTS CERTIFIED AS ROHS COMPLIANT UNDER 2002/95/EC WITHOUT MERCURY	191

List of Figures

Figure 1-1: eKINO-945GSE	2
Figure 1-2: eKINO-945GSE Overview	3
Figure 2-1: eKINO-945GSE Dimensions (mm)	8
Figure 2-2: External Interface Panel Dimensions (mm)	9
Figure 2-3: Data Flow Block Diagram	10
Figure 2-4: Chipset	11
Figure 2-5: Intel® ICH7M Southbridge Chipset	15
Figure 4-1: Connector and Jumper Locations.....	31
Figure 4-2: Battery Connector Location.....	34
Figure 4-3: CF Card Socket Location	35
Figure 4-4: Digital I/O Connector Locations	36
Figure 4-5: CPU Fan Connector Location	37
Figure 4-6: Front Panel Connector Pinout Locations	38
Figure 4-7: IDE Device Connector Locations	39
Figure 4-8: Infrared Connector Pinout Locations	40
Figure 4-9: Keyboard/Mouse Connector Location	41
Figure 4-10: LCD Backlight Connector Pinout Locations	42
Figure 4-11: LED Connector Location	43
Figure 4-12: LVDS LCD Connector Pinout Locations.....	44
Figure 4-13: MCU LAN Connector Location	45
Figure 4-14: PCIe Mini Card Slot Location.....	46
Figure 4-15: Power Connector Location	47
Figure 4-16: SATA Drive Connector Locations	48
Figure 4-17: SATA Power Connector Location	49
Figure 4-18: RS-232 Connector Pinout Locations.....	50
Figure 4-19: RS-422/485 Connector Pinout Locations.....	51
Figure 4-20: SO-DIMM Location	52
Figure 4-21: SPDIF Connector Location	53
Figure 4-22: TV Connector Pinout Locations	54
Figure 4-23: USB Connector Pinout Locations	55

Figure 4-24: eKINO-945GSE External Peripheral Interface Connector	56
Figure 4-25: Audio Connector	56
Figure 4-26: RJ-45 Ethernet Connector	58
Figure 4-27: RS-232 Serial Port Pinout Locations.....	59
Figure 4-28: VGA Connector	60
Figure 5-1: SO-DIMM Installation	65
Figure 5-2: CF Card Installation	67
Figure 5-3: UPS Installation.....	68
Figure 5-4: Jumpers	70
Figure 5-5: IDE Cable Connection.....	77
Figure 5-6: SATA Drive Cable Connection.....	78
Figure 5-7: SATA Power Drive Connection.....	79
Figure 5-8: Dual RS-232 Cable Installation	80
Figure 5-9: Dual USB Cable Connection	81
Figure 5-10: LPT Cable Connection.....	82
Figure 5-11: Connect the LPT Device.....	83
Figure 5-12: LAN Connection	84
Figure 5-13: PS/2 Keyboard/Mouse Connector	85
Figure 5-14: Serial Device Connector.....	86
Figure 5-15: USB Connector.....	87
Figure 5-16: VGA Connector	88
Figure 7-1: Start Up Screen	141
Figure 7-2: Select Operating System.....	141
Figure 7-3: Drivers	142
Figure 7-4: Chipset Driver Welcome Screen.....	143
Figure 7-5: Chipset Driver License Agreement	143
Figure 7-6: Chipset Driver Read Me File	144
Figure 7-7: Chipset Driver Setup Operations	145
Figure 7-8: Chipset Driver Installation Finish Screen.....	145
Figure 7-9: VGA Driver Read Me File.....	146
Figure 7-10: VGA Driver Setup Files Extracted	147
Figure 7-11: VGA Driver Welcome Screen	147
Figure 7-12: VGA Driver License Agreement.....	148
Figure 7-13: VGA Driver Read Me File.....	148
Figure 7-14: VGA Driver Setup Operations	149

eKINO-945GSE Motherboard

Figure 7-15: VGA Driver Installation Finish Screen	150
Figure 7-16: LAN Driver Welcome Screen	151
Figure 7-17: LAN Driver Welcome Screen	151
Figure 7-18: LAN Driver Installation	152
Figure 7-19: LAN Driver Installation Complete.....	152
Figure 7-20: Audio Driver Options	153
Figure 7-21: AC'97 Driver Installation Welcome Screen.....	154
Figure 7-22: AC'97 Driver Installation Verification.....	154
Figure 7-23: AC'97 Driver Installation Complete	155
Figure 8-1: Welcome Screen	157
Figure 8-2: Select Installation Folder.....	158
Figure 8-3: Ready to Install the Program	158
Figure 8-4: Installing AUPS	159
Figure 8-5: Installation Complete.....	159
Figure 8-6: AUPS Battery Status Monitor Application.....	159
Figure 8-7: Status Information	160
Figure 8-8: DC Detection.....	160
Figure 8-9: Battery Detection	161
Figure 8-10: Total Battery Time.....	162
Figure 8-11: Battery Information	162
Figure 8-12: LAN Setting.....	163
Figure 8-13: LAN Setting – Change Password	164
Figure 8-14: Application Setting	165
Figure 8-15: COM Port Status.....	165
Figure 8-16: IEI REMOTE AP	167
Figure 8-17: IEI REMOTE AP – IP Address	167
Figure 8-18: Remote Management Web Interface - Status.....	168
Figure 8-19: Remote Management Web Interface - Send Email	169
Figure 8-20: Enter User Name and Password.....	169
Figure 8-21: Board Configuration	170

List of Tables

Table 1-2: Technical Specifications.....	6
Table 2-1: Supported HDD Specifications.....	17
Table 2-2: Power Consumption.....	24
Table 3-1: Packing List.....	28
Table 3-2: Optional Items.....	29
Table 4-1: Peripheral Interface Connectors.....	33
Table 4-2: Rear Panel Connectors.....	33
Table 4-3: Battery Connector Pinouts.....	34
Table 4-4: DIO Connector Pinouts.....	36
Table 4-5: CPU Fan Connector Pinouts.....	37
Table 4-6: Front Panel Connector Pinouts.....	38
Table 4-7: Infrared Connector Pinouts.....	40
Table 4-8: Keyboard/Mouse Connector Pinouts.....	41
Table 4-9: LCD Backlight Connector Pinouts.....	42
Table 4-10: LED Connector Pinouts.....	43
Table 4-11: LVDS LCD Port Connector Pinouts.....	45
Table 4-12: MCU LAN Connector Pinouts.....	46
Table 4-13: Power Connector Pinouts.....	47
Table 4-14: SATA Power Connector Pinouts.....	49
Table 4-15: RS-232 Connector Pinouts.....	51
Table 4-16: RS-422/485 Connector Pinouts.....	51
Table 4-17: SPDIF Connector Pinouts.....	53
Table 4-18: TV Port Connector Pinouts.....	54
Table 4-19: USB Port Connector Pinouts.....	55
Table 4-20: DVI Connector Pinouts.....	57
Table 4-21: LAN Pinouts.....	58
Table 4-22: RJ-45 Ethernet Connector LEDs.....	58
Table 4-23: RS-232 Serial Port Pinouts.....	59
Table 4-24: USB Port Pinouts.....	59
Table 4-25: VGA Connector Pinouts.....	60

eKINO-945GSE Motherboard

Table 5-1: Jumpers	69
Table 5-2: AT/ATX Power Selection Jumper Settings	70
Table 5-3: Clear CMOS Jumper Settings	71
Table 5-4: CF Card Setup Jumper Settings	72
Table 5-5: COM3 RS-232/422/485 Selection Jumper Pinouts	72
Table 5-6: LCD Panel Type Selection Jumper Settings	73
Table 5-7: LVDS Voltage Selection Jumper Settings	73
Table 5-8: UPS Enable/Disable Jumper Settings	74
Table 5-9: UPS/Battery Mode Selection Jumper Settings	74
Table 5-10: IEI Provided Cables	76
Table 6-1: BIOS Navigation Keys	91
Table 8-1: Status Settings	161
Table 8-2: Status Settings	166

BIOS Menus

BIOS Menu 1: Main	92
BIOS Menu 2: Advanced	94
BIOS Menu 3: CPU Configuration	95
BIOS Menu 4: IDE Configuration	96
BIOS Menu 5: IDE Master and IDE Slave Configuration	98
BIOS Menu 6: Super IO Configuration.....	103
BIOS Menu 7: Hardware Health Configuration	106
BIOS Menu 8: Power Configuration.....	110
BIOS Menu 9: ACPI Configuration	111
BIOS Menu 10:Advanced Power Management Configuration	112
BIOS Menu 11: Remote Access Configuration.....	114
BIOS Menu 12: USB Configuration	118
BIOS Menu 13: PCI/PnP Configuration.....	120
BIOS Menu 14: Boot	122
BIOS Menu 15: Boot Settings Configuration	123
BIOS Menu 16: Boot Device Priority Settings	125
BIOS Menu 17: Hard Disk Drives	126
BIOS Menu 18: CD/DVD Drives	127
BIOS Menu 19: Removable Drives	128
BIOS Menu 20: Security	129
BIOS Menu 21: Chipset	130
BIOS Menu 22: Northbridge Chipset Configuration.....	131
BIOS Menu 23: Video Function Configuration	133
BIOS Menu 24: Southbridge Chipset Configuration	136
BIOS Menu 25: Exit.....	137

Chapter

1

Introduction

1.1 Introduction



Figure 1-1: eKINO-945GSE

The eKINO-945GSE Mini-ITX motherboards have embedded Intel® Atom™ processors. The eKINO-945GSE provides its own UPS by attaching the included battery. The embedded Intel® Atom™ N270 processor has a 1.60 GHz clock speed, a 533 MHz FSB and a 512 KB L2 cache. The eKINO-945GSE also supports one 200-pin 533 MHz 2.0 GB (max.) DDR2 SDRAM SO-DIMM. The board comes with VGA, DVI, HDTV and 18-bit dual-channel LVDS video outputs. The eKINO-945GSE also comes with two PCI Express (PCIe) Gigabit Ethernet (GbE) connectors, onboard AC'97 audio, three RS-232 serial ports, one RS-232/422/485 serial port, a CompactFlash® slot, six USB 2.0 ports, IDE connector and PCI expansion card slot.

1.2 eKINO-945GSE Overview

1.2.1 Overview Photo

The eKINO-945GSE has a wide variety of peripheral interface connectors. **Figure 1-2** is a labeled photo of the peripheral interface connectors on the eKINO-945GSE.

eKINO-945GSE Motherboard

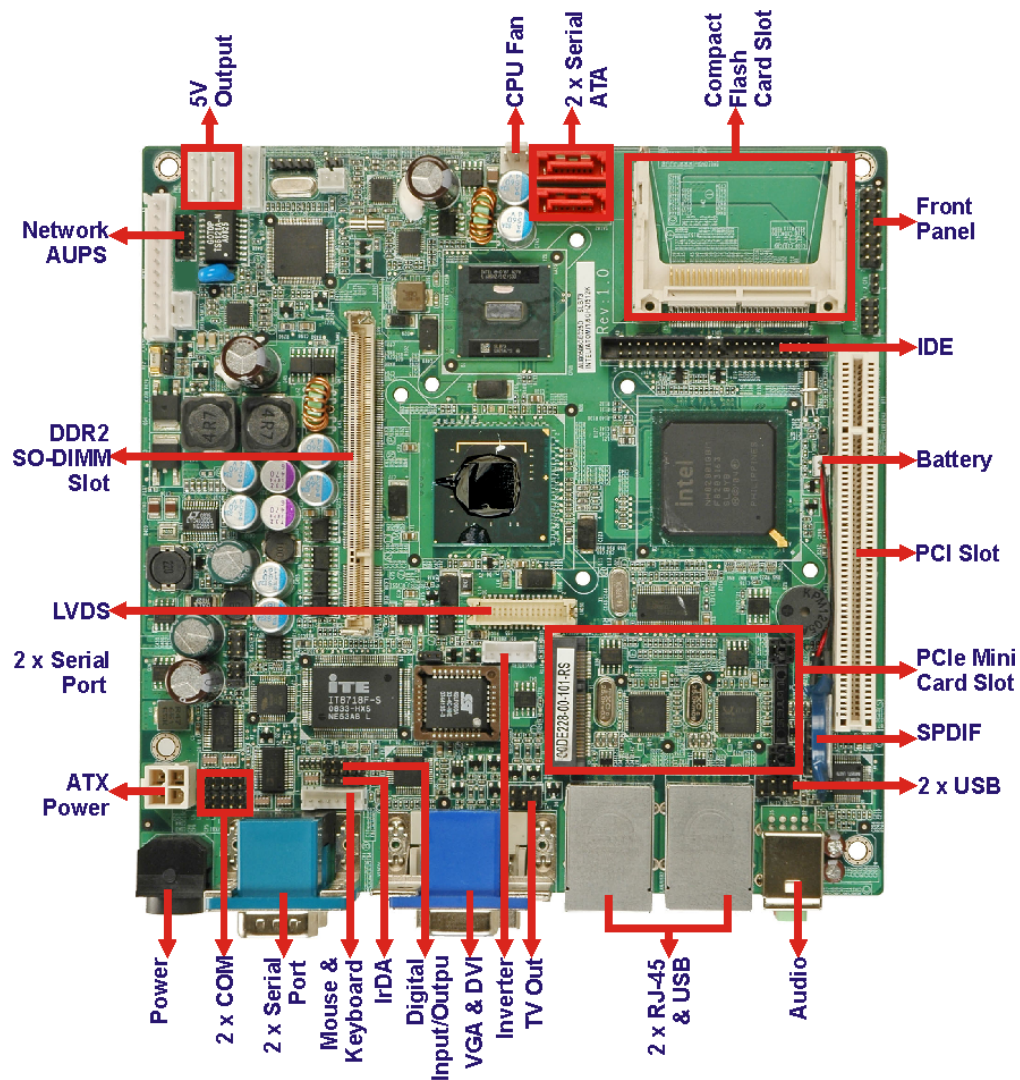

Figure 1-2: eKINO-945GSE Overview

1.2.2 Peripheral Connectors and Jumpers

The eKINO-945GSE has the following connectors on-board:

- 1 x BIOS socket connector
- 1 x CompactFlash® slot
- 1 x Digital I/O connector
- 1 x Fan connector
- 1 x Front panel connector
- 1 x IDE connector

- 1 x Infrared connector
- 1 x Keyboard/mouse connector
- 1 x LCD backlight inverter connector
- 1 x LVDS connector
- 1 x PCIe Mini slot
- 2 x SATA drive connectors
- 2 x SATA power connectors
- 2 x Serial port connectors (RS-232)
- 1 x Serial port connector (RS-422/485)
- 1 x SO-DIMM socket
- 1 x TV output connector
- 1 x USB pin header (2 ports)

The eKINO-945GSE has the following external peripheral interface connectors on the board rear panel.

- 1 x Audio stereo output
- 1 x Audio microphone input
- 1 x DVI
- 2 x LAN
- 2 x RS-232 serial ports
- 4 x USB 2.0
- 1 x VGA

The eKINO-945GSE has the following on-board jumpers:

- AT/ATX selection
- Clear CMOS
- CompactFlash® card setup
- COM3 RS-232/422/485 selection
- LCD panel type selector
- LCD voltage selector
- UPS enable/disable
- UPS/Battery mode selection (eKINO-945GSE-N270UPS only)

eKINO-945GSE Motherboard

1.2.3 Technical Specifications

eKINO-945GSE technical specifications are listed in **Table 1-1**. See **Chapter 2** for details.

Specification	eKINO-945GSE
Form Factor	Mini-ITX
System CPU	45 nm 1.60 GHz Intel® Atom™ N270
Front Side Bus (FSB)	533 MHz
System Chipset	Northbridge: Intel® 945GSE Southbridge: Intel® ICH7M
Memory	One 200-pin SO-DIMM socket supports one 533 MHz 2.0 GB (max.) DDR2 SDRAM SO-DIMM
CompactFlash®	One CompactFlash® socket
Super I/O	iTE IT8718F
Display	VGA DVI (through Silicon Image Sil1362 on SDVO) LVDS HDTV
BIOS	AMI BIOS label
Audio	Realtek ALC655 AC'97 codec
LAN	Two Realtek RTL8111C PCIe GbE controllers
COM	Three RS-232 serial ports (one internal, two external) One RS-232/422/485 serial port (internal)
USB2.0	Six USB 2.0 devices supported (two internal, four external)
Hard Drives	One 44-pin IDE connector
SATA	Two 1.5 Gb/s SATA drives supported
Keyboard/mouse	Internal pin header.
Digital I/O	One 8-bit digital input/output connector; 4-bit input/4-bit output through the iTE IT8718F super I/O

Specification	eKINO-945GSE
Watchdog Timer	Software programmable 1-255 sec. through the iTE IT8718F super I/O
Infrared	One infrared connector supports Serial Infrared (SIR) Amplitude Shift Keyed IR (ASKIR)
Power Supply	Recommended input voltage: 12-24 VDC Maximum input voltage: 9-28 VDC 1 x External 4-pin DIN jack 1 x Internal 2x2 power connector
Power Consumption	1 A @ 12 V (with 1.0 GB DDR2 memory)
Temperature	With AUPS: 0°C – 40°C (32°F – 104°F) Without AUPS: 0°C – 60°C (32°F – 140°F)
Humidity (operating)	5%~95% non-condensing
Dimensions (LxW)	170 mm x 170 mm
Weight (GW/NW)	1100 g / 370 g

Table 1-1: Technical Specifications

Chapter

2

Detailed Specifications

2.1 Dimensions

2.1.1 Board Dimensions

The dimensions of the board are listed below:

- **Length:** 170 mm
- **Width:** 170 mm

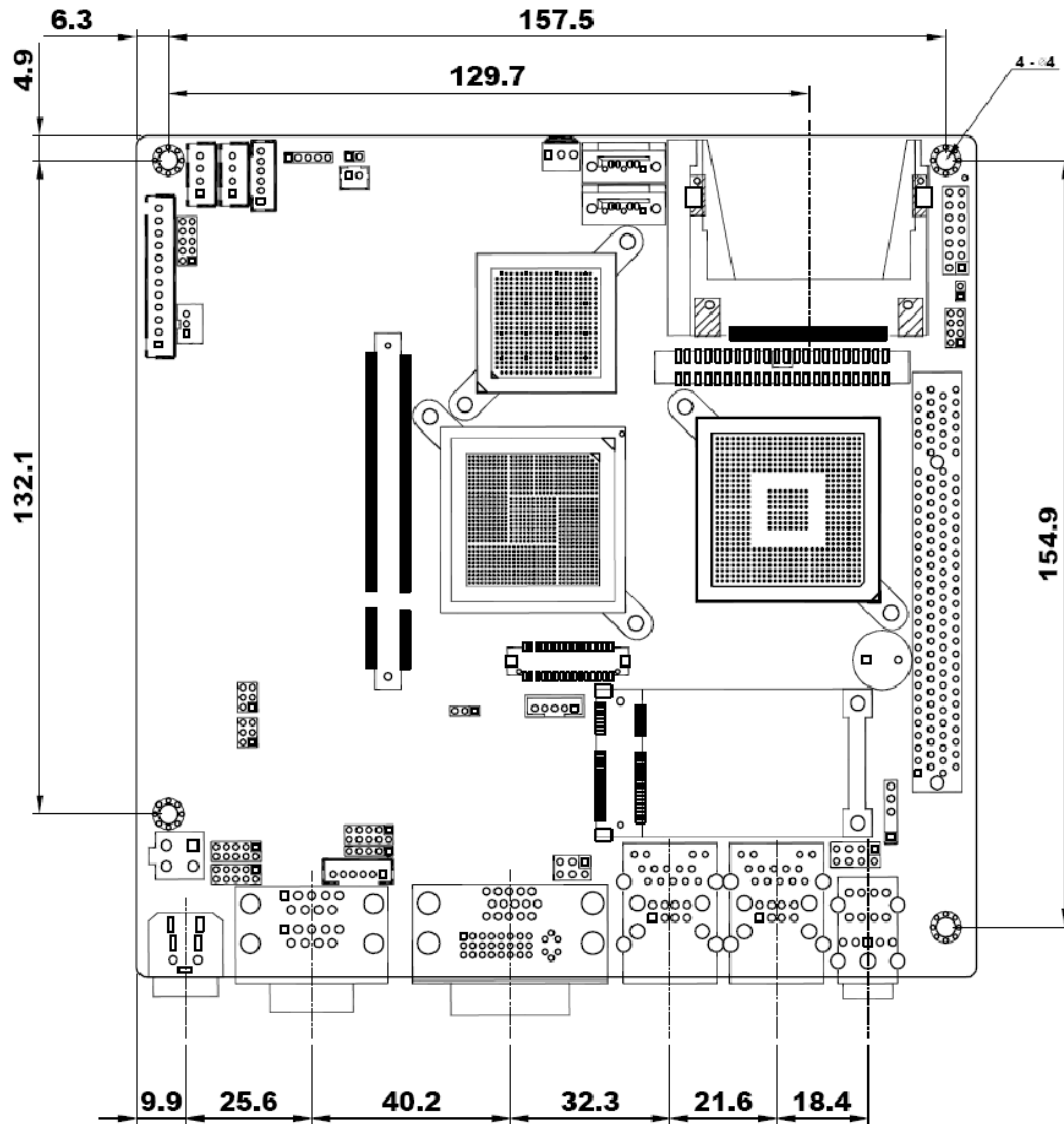

Figure 2-1: eKINO-945GSE Dimensions (mm)

eKINO-945GSE Motherboard

2.1.2 External Interface Panel Dimensions

External peripheral interface connector panel dimensions are shown in **Figure 2-2**.

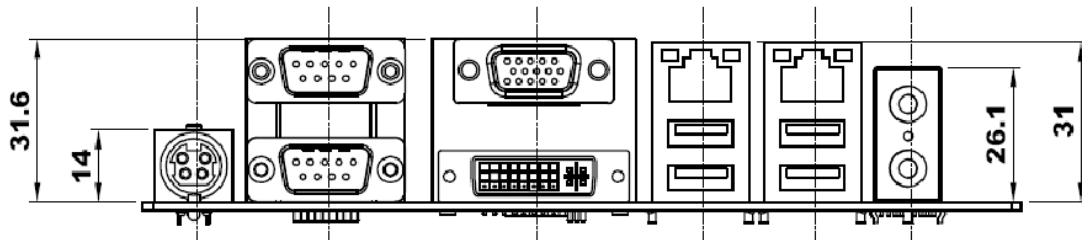

Figure 2-2: External Interface Panel Dimensions (mm)

2.2 Data Flow

Figure 2-3 shows the data flow between the two on-board chipsets and other components installed on the motherboard and described in the following sections of this chapter.

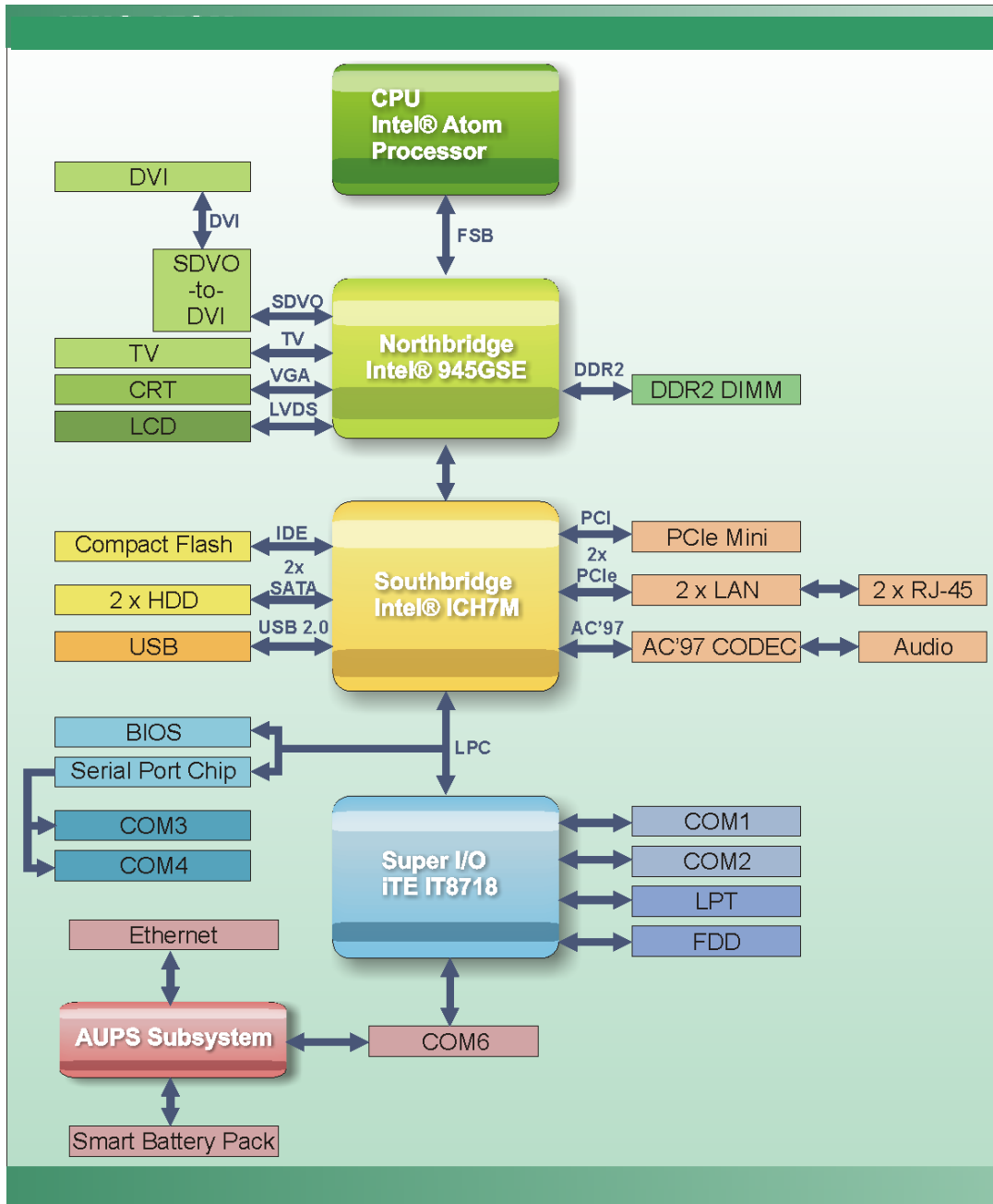

Figure 2-3: Data Flow Block Diagram

2.3 Embedded Intel® Atom™ Processor

The eKINO-945GSE comes with an embedded 45 nm 1.60 GHz Intel® Atom™ N270 processor. The processor supports a 533 MHz FSB and has a 512 KB L2 cache. The low power processor has a maximum power of 2.5 W. The processor is shown in **Figure 2-4** below.

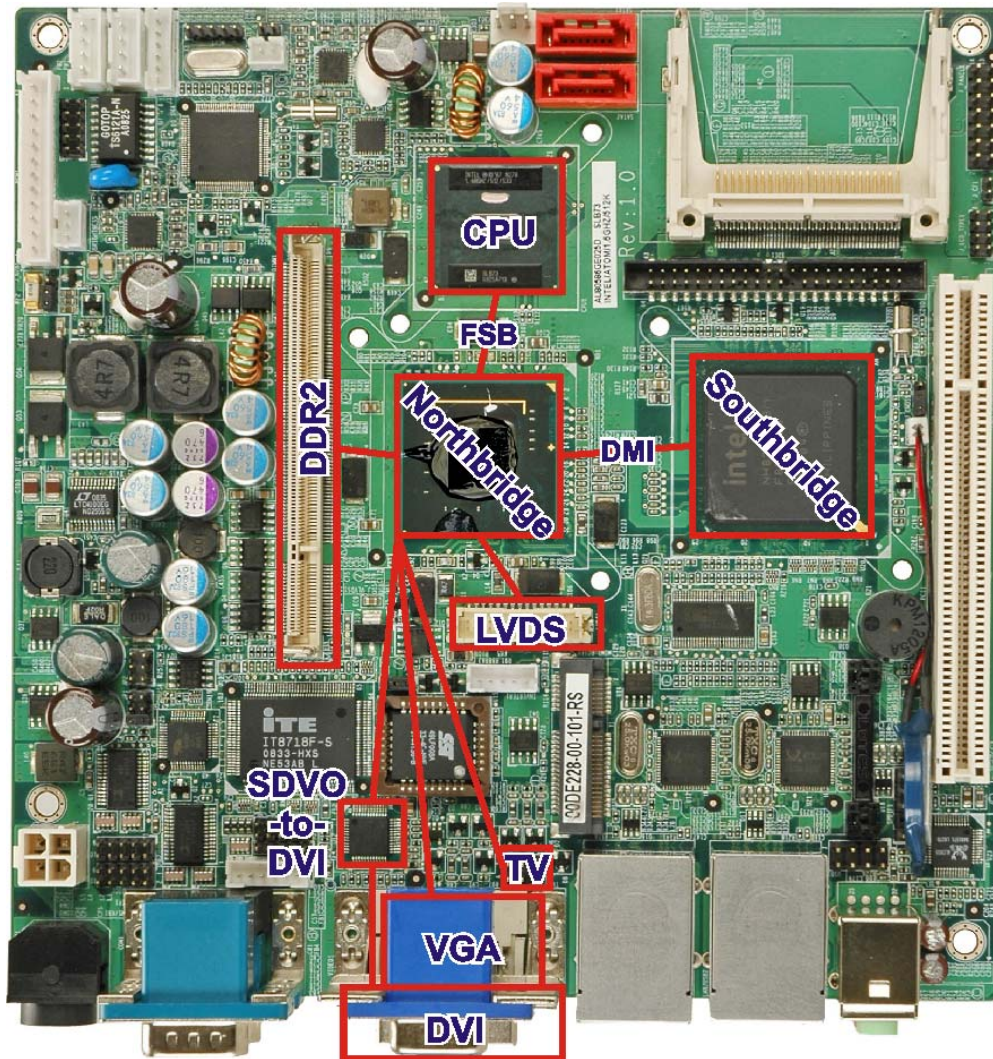

Figure 2-4: Chipset

2.3.1 Features

Some of the features of the Intel® Atom™ N270 are listed below

- On-die, primary 32-kB instructions cache and 24-kB write-back data cache
- 533 MHz source-synchronous front side bus (FSB)
- 2-Threads support
- On-die 512-kB, 8-way L2 cache
- Support for IA 32-bit architecture
- Intel® Streaming SIMD Extensions-2 and -3 (Intel® SSE2 and Intel® SSE3) support and Supplemental Streaming SIMD Extension 3 (SSSE3) support
- Micro-FCBGA8 packaging technologies
- Thermal management support via Intel® Thermal Monitor 1 and Intel Thermal Monitor 2
- FSB Lane Reversal for flexible routing
- Supports C0/C1(e)/C2(e)/C4(e)
- L2 Dynamic Cache Sizing
- Advanced power management features including Enhanced Intel SpeedStep® Technology
- Execute Disable Bit support for enhanced security

2.3.2 Front Side Bus (FSB)

The Intel® Atom™ processor on the eKINO-945GSE is interfaced to the Intel® 945GSE Northbridge through a 533 MHz front side bus (FSB). The FSB is shown in **Figure 2-4**.

2.4 Intel® 945GSE Northbridge Chip

The Intel® 945GSE Graphics and Memory Controller Hub (GMCH) supports the embedded Intel® Atom™ N270 processor. The Intel® 945GSE is interfaced to the processor through a 533 MHz FSB. The connections are shown in **Figure 2-4**.

2.4.1 DDR2 Controller

There is one 200-pin DDR2 SO-DIMM socket on the eKINO-945GSE. The socket supports DDR2 SO-DIMM with the following specifications:

- Maximum Memory supported 2 GB (1 GB per rank)
- Support for DDR2 at 400 MHz and 533 MHz
- No support for Dual-Channel Interleaved mode of operation
- Enhanced Addressing support (Swap only)

eKINO-945GSE Motherboard

The SO-DIMM socket is shown in **Figure 2-4** below.

2.4.2 Graphics

The Intel® 945GSE Northbridge chipset has an Intel® Gen. 3.5 integrated graphics engine that supports the following display devices (shown in **Figure 2-4**):

- Analog CRT
- LVDS
- TV-Out
- SDVO ports

2.4.2.1 Analog CRT (VGA)

A DB-15 VGA connector on the external peripheral interface connector panel is interfaced to the Intel® 945GSE graphics engine. The Intel® 945GSE internal graphics engine, with an integrated 400 MHz RAMDAC and hot plug CRT support, supports analog CRT monitors up to QXGA.

2.4.2.2 LVDS

A 30-pin LVDS crimp connector is interfaced to the Intel® 945GSE graphics engine. The Intel® 945GSE internal graphics engine supports LVDS displays with the following features:

- Up to UXGA monitors with a maximum resolution of 1600 x 1200
- 18-bit 25 MHz to 112 MHz single-channel or dual-channel LVDS screens
- CPIS 1.5 compliant LVDS screens

2.4.2.3 TV Out

An external 7-pin DIN TV output connector is interfaced to the Intel® 945GSE graphics engine. The Intel® 945GSE internal graphics engine has the following TV output features:

- Three integrated 10-bit DACs
- Macrovision support
- Overscaling
- NTSC and PAL formats supported

- Supports RCA or S-VIDEO connectivity
- Supports HDTV with the following resolutions:
 - 480p
 - 720p
 - 1080i
 - 1080p

2.4.2.4 SDVO and DVI

The SDVO is connected to the DVI output through the Silicon Image Sil1362. The Intel® 945GSE internal graphics engine has the following SDVO output features:

- Concurrent operation of PCIe x 1 with SDVO
- Two SDVO ports supported
 - SDVO is muxed onto the PCIe pins
 - DVI 1.0 support for external digital monitor
 - Only Downstream HDCP support
 - Supports TV and DVD formats
 - Display hot plug support

2.5 Intel® ICH7M Southbridge Chipset

The Intel® ICH7M Southbridge chipset is connected to the Intel® 945GSE Northbridge GMCH through the chip-to-chip Direct Media Interface (DMI). Some of the features of the Intel® ICH7M are listed in **Figure 2-5** below.

eKINO-945GSE Motherboard

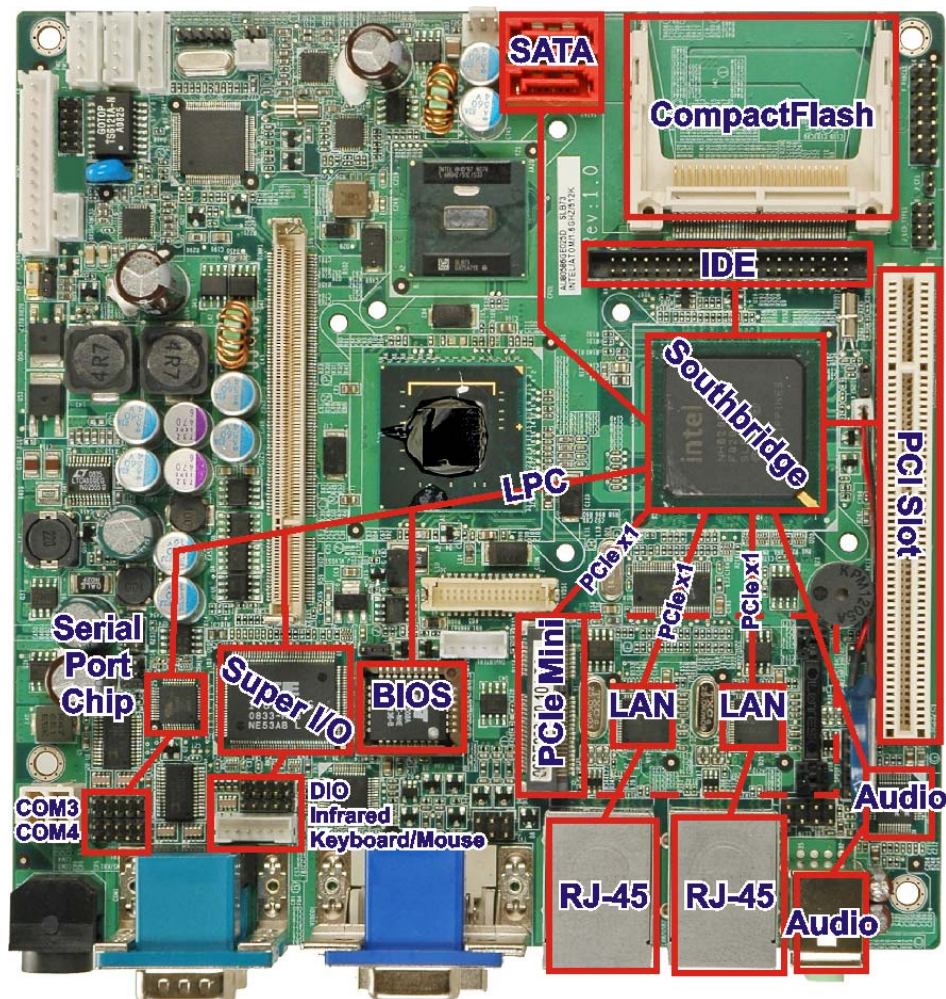

Figure 2-5: Intel® ICH7M Southbridge Chipset

- Complies with PCI Express Base Specification, Revision 1.0a
- Complies with PCI Local Bus Specification, Revision 2.3 and supports 33 MHz PCI operations
- Supports ACPI Power Management Logic
- Contains:
 - Enhanced DMA controller
 - Interrupt controller
 - Timer functions
- Integrated SATA host controller with DMA operations interfaced to two SATA connectors on the eKINO-945GSE
- Integrated IDE controller supports Ultra ATA 100/66/33

- Supports the four USB 2.0 devices on the eKINO-945GSE with four UHCI controllers and one EHCI controller
- Complies with System Management Bus (SMBus) Specification, Version 2.0
- Supports Audio Codec '97 (AC'97) Revision 2.3
- Supports Intel® High Definition Audio
- Contains Low Pin Count (LPC) interface
- Supports Firmware Hub (FWH) interface
- Serial peripheral interface support

2.5.1 Audio Codec '97 Controller

The Audio Codec '97 (AC'97) controller integrated into the Intel® ICH7M complies with AC'97 Component Specification, Version 2.3. The AC'97 controller is connected to the following audio jacks on the external connector panel.

- Stereo output
- Microphone input

2.5.2 IDE Interface

The IDE interface connects with

- 2.5.2.1 IDE Connector 16
- 2.5.2.2 CompactFlash® Slot 17

2.5.2.1 IDE Connector

The IDE connector on the Intel® ICH7M Southbridge connects to an IDE hard disk or other IDE device. The IDE connector is shown in **Figure 2-5**.

PIO IDE transfers up to 16 MB/s and Ultra ATA transfers of 100 MB/s. The integrated IDE interface is able to support the following IDE HDDs:

- **Ultra ATA/100**, with data transfer rates up to 100 MB/s
- **Ultra ATA/66**, with data transfer rates up to 66 MB/s
- **Ultra ATA/33**, with data transfer rates up to 33 MB/s

eKINO-945GSE Motherboard

Specification	Ultra ATA/100	Ultra ATA/66	Ultra ATA/33
IDE devices	2	2	2
PIO Mode	0 – 4	0 – 4	0 – 4
PIO Max Transfer Rate	16.6 MB/s	16.6 MB/s	16.6 MB/s
DMA/UDMA designation	UDMA 5	UDMA 4	UDMA 2
DMA/UDMA Max Transfer	100 MB/s	66 MB/s	33 MB/s
Controller Interface	5 V	5 V	5 V

Table 2-1: Supported HDD Specifications

2.5.2.2 CompactFlash® Slot

The CompactFlash® slot on the eKINO-945GSE is interfaced through the IDE interface on the Intel® ICH7M Southbridge. The CompactFlash® slot is shown in **Figure 2-5**.

2.5.3 Low Pin Count (LPC) Interface

The Intel® ICH7M LPC interface complies with the LPC 1.1 specifications. The LPC bus from the Intel® ICH7M is connected to the following components:

- BIOS chipset
- Super I/O chipset

2.5.4 PCI Bus

The PCI interface on the Intel® ICH7M is compliant with the PCI Revision 2.3 implementation. Some of the features of the PCI interface are listed below.

- PCI Revision 2.3 compliant
- 33 MHz
- 5 V tolerant PCI signals (except PME#)
- Integrated PCI arbiter supports up to seven PCI bus masters

2.5.4.1 PCI Expansion Card Slot

The PCI interface is connected directly to the PCI expansion card slot on the eKINO-945GSE. The location of the PCI expansion card slot is shown in **Figure 2-5**.

2.5.5 PCIe Bus

The Intel® ICH7M Southbridge chipset has four PCIe lanes. Two of the four PCIe lanes are interfaced to PCIe GbE controllers. Another land is connected to the PCIe Mini card slot.

2.5.5.1 PCIe GbE Ethernet

Two PCIe lanes are connected to two Realtek RTL8111C PCIe GbE controllers shown in **Figure 2-5**.

The Realtek RTL8111C PCIe GbE controllers combine a triple-speed IEEE 802.3 compliant Media Access Controller (MAC) with a triple-speed Ethernet transceiver, 32-bit PCIe bus controller, and embedded memory. With state-of-the-art DSP technology and mixed-mode signal technology, they offer high-speed transmission over CAT 5 UTP cable or CAT 3 UTP (10 Mb/s only) cable. Functions such as Crossover Detection & Auto-Correction, polarity correction, adaptive equalization, cross-talk cancellation, echo cancellation, timing recovery, and error correction are implemented to provide robust transmission and reception capability at high speeds.

Some of the features of the Realtek RTL8111C PCIe GbE controllers are listed below.

- Integrated 10/100/1000 transceiver
- Auto-Negotiation with Next Page capability
- Supports PCI Express™ 1.1
- Supports pair swap/polarity/skew correction
- Crossover Detection & & Auto-Correction
- Wake-on-LAN and remote wake-up support
- Microsoft® NDIS5, NDIS6 Checksum Offload (IPv4, IPv6, TCP, UDP) and Segmentation Task-offload (Large send and Giant send) support
- Supports Full Duplex flow control (IEEE 802.3x)
- Fully compliant with IEEE 802.3, IEEE 802.3u, IEEE 802.3ab
- Supports IEEE 802.1P Layer 2 Priority Encoding
- Supports IEEE 802.1Q VLAN tagging
- Serial EEPROM
- Transmit/Receive on-chip buffer support
- Supports power down/link down power saving

eKINO-945GSE Motherboard

- Supports PCI MSI (Message Signaled Interrupt) and MSI-X
- Supports Receive-Side Scaling (RSS)

2.5.5.2 PCIe Mini Card

One PCIe lane is connected to a PCIe Mini card slot shown in **Figure 2-5**.

The PCIe Mini card slot contains a PCIe x1 and USB 2.0 interface. PCIe Mini cards can utilize either of these two interfaces, depending on design requirements.

2.5.6 Real Time Clock

256 bytes of battery backed RAM is provided by the Motorola MC146818 A real time clock (RTC) integrated into the ICH6. The RTC operates on a 3 V battery and 32.768 KHz crystal. The RTC keeps track of the time and stores system data even when the system is turned off.

2.5.7 SATA Controller

The integrated SATA controller on the Intel® ICH7M Southbridge supports two SATA drives with independent DMA operations. Two SATA controllers are connected to two SATA connectors on the eKINO-945GSE. The SATA connectors are shown in **Figure 2-5**.

SATA controller specifications are listed below.

- Supports two SATA drives
- Supports 1.5 Gb/s data transfer speeds
- Supports Serial ATA Specification, Revision 1.0a

2.5.8 USB Controller

Up to six high-speed, full-speed or low-speed USB devices are supported by the Intel® ICH7M on the eKINO-945GSE. High-speed USB 2.0, with data transfers of up to 480 MB/s, is enabled with the Intel® ICH7M integrated Enhanced Host Controller Interface (EHCI) compliant host controller. USB full-speed and low-speed signaling is supported by the Intel® ICH7M integrated Universal Host Controller Interface (UHCI) controllers.

The six USB ports implemented on the eKINO-945GSE are connected to three internal connectors and one external connector shown in **Figure 2-5**.

2.6 LPC Bus Components

The iTE IT8718F LPC bus is connected to components listed below (and shown in **Figure 2-5**):

- BIOS chip
- Super I/O chip
- Serial port chip

2.6.1 BIOS Chipset

The BIOS chipset has a licensed copy of AMI BIOS installed on the chipset. Some of the BIOS features are listed below:

- AMI Flash BIOS
- SMIBIOS (DMI) compliant
- Console redirection function support
- PXE (Pre-boot Execution Environment) support
- USB booting support

2.6.2 iTE IT8718F Super I/O chipset

The iTE IT8718F Super I/O chipset is connected to the Intel® ICH7M Southbridge through the LPC bus. The iTE IT8718F is an LPC interface-based Super I/O device that comes with Environment Controller integration. Some of the features of the iTE IT8718F chipset are listed below:

- ACPI and LANdesk Compliant
- Enhanced Hardware Monitor
- Fan Speed Controller
- Two 16C550 UARTs for serial port control
- One IEEE 1284 Parallel Port
- Keyboard Controller
- Watchdog Timer

eKINO-945GSE Motherboard

Some of the Super I/O features are described in more detail below:

2.6.2.1 LPC Interface

The LPC interface on the Super I/O complies with the Intel® Low Pin Count Specification Rev. 1.0. The LPC interface supports both LDRQ# and SERIRQ protocols as well as PCI PME# interfaces.

2.6.2.2 16C550 UARTs

The onboard Super I/O has two integrated 16C550 UARTs that can support the following:

- Two standard serial ports
- IrDa 1.0 and ASKIR protocols

2.6.2.3 Digital Input/Output

The input mode supports switch debouncing or programmable external IRQ routing. The output mode supports two sets of programmable LED blinking periods.

2.6.2.4 Enhanced Hardware Monitor

The Super I/O Enhanced Hardware Monitor monitors three thermal inputs, VBAT internally, and eight voltage monitor inputs. These hardware parameters are reported in the BIOS and can be read from the BIOS Hardware Health Configuration menu.

2.6.2.5 Fan Speed Controller

The Super I/O fan speed controller enables the system to monitor the speed of the fan. One of the pins on the fan connector is reserved for fan speed detection and interfaced to the fan speed controller on the Super I/O. The fan speed is then reported in the BIOS.

2.6.2.6 Keyboard/Mouse Controller

The Super I/O keyboard/mouse controller can execute the 8042 instruction set. Some of the keyboard controller features are listed below:

- The 8042 instruction is compatible with a PS/2 keyboard and PS/2 mouse
- Gate A20 and Keyboard reset output

- Supports multiple keyboard power on events
- Supports mouse double-click and/or mouse move power on events

2.6.2.7 Parallel Port

The multi-mode high-performance parallel port supports the bi-directional Standard Parallel Port (SPP), the Enhanced Parallel Port (EPP) and the Extended Capabilities Port (ECP) modes.

2.6.3 Fintek F81216D LPC Serial Port Chip

The Fintek F81216D chipset enables the addition of two additional UART serial ports (COM3 and COM4). UART includes 16-byte send/receive FIFO. The Fintek F81216D serial port chipset is interfaced to the Southbridge chipset through the LPC bus. Some of the features of the Fintek F81216D chipset are listed below:

- Supports LPC interface
- Totally provides 4 UART (16550 asynchronous) ports
 - 3 x Pure UART
 - 1 x UART+IR
- One Watch dog timer with WDTOUT# signal
- One Frequency input 24/48 MHz
- Powered by 3 Vcc

2.7 Environmental and Power Specifications

2.7.1 System Monitoring

Two thermal inputs on the eKINO-945GSE Super I/O Enhanced Hardware Monitor monitors the following temperatures:

- CPU temperature
- System temperature

The eKINO-945GSE Super I/O Enhanced Hardware Monitor also monitors the following fan speeds:

- CPU Fan speed

eKINO-945GSE Motherboard

Voltage inputs on the eKINO-945GSE Super I/O Enhanced Hardware Monitor monitors the following voltages:

- CPU Core
- +1.05 V
- +3.30 V
- +5.00 V
- +12 V
- +1.5 V
- +1.8 V
- +5 VSB
- VBAT

The values for the above environmental parameters are all recorded in the BIOS Hardware Health Configuration menu.

2.7.2 Operating Temperature and Temperature Control

The maximum and minimum operating temperatures for the eKINO-945GSE are listed below.

- Minimum Operating Temperature: 0°C (32°F)
- Maximum Operating Temperature: 60°C (140°F)

A cooling fan and heat sink must be installed on the CPU. Thermal paste must be smeared on the lower side of the heat sink before it is mounted on the CPU. Heat sinks are also mounted on the Northbridge and Southbridge chipsets to ensure the operating temperature of these chips remain low.

2.7.3 Power Consumption

Table 2-2 shows the power consumption parameters for the eKINO-945GSE running with a 1.60 GHz Intel® Atom™ with 2.0 GB DDR2 memory.

Voltage	Current
+12 V	1.00 A

Table 2-2: Power Consumption

Chapter

3

Unpacking

3.1 Anti-static Precautions



WARNING!

Failure to take ESD precautions during the installation of the eKINO-945GSE may result in permanent damage to the eKINO-945GSE and severe injury to the user.

Electrostatic discharge (ESD) can cause serious damage to electronic components, including the eKINO-945GSE. Dry climates are especially susceptible to ESD. It is therefore critical that whenever the eKINO-945GSE, or any other electrical component is handled, the following anti-static precautions are strictly adhered to.

- **Wear an anti-static wristband:** Wearing a simple anti-static wristband can help to prevent ESD from damaging the board.
- **Self-grounding:** Before handling the board, touch any grounded conducting material. During the time the board is handled, frequently touch any conducting materials that are connected to the ground.
- **Use an anti-static pad:** When configuring the eKINO-945GSE, place it on an anti-static pad. This reduces the possibility of ESD damaging the eKINO-945GSE.
- **Only handle the edges of the PCB:** When handling the PCB, hold the PCB by the edges.

3.2 Unpacking

3.2.1 Unpacking Precautions

When the eKINO-945GSE is unpacked, please do the following:

- Follow the anti-static precautions outlined in **Section 3H3.1**.
- Make sure the packing box is facing upwards so the eKINO-945GSE does not fall out of the box.
- Make sure all the components shown in **Section 4H3.3** are present.

eKINO-945GSE Motherboard

3.3 Unpacking Checklist







NOTE:

If any of the components listed in the checklist below are missing, do not proceed with the installation. Contact the IEI reseller or vendor the eKINO-945GSE was purchased from or contact an IEI sales representative directly by sending an email to sales@iei.com.tw.

3.3.1 Package Contents

The eKINO-945GSE is shipped with the following components:

Quantity	Item and Part Number	Image
1	eKINO-945GSE-N270-R11 or eKINO-945GSE-N270UPS-R11	
1	KB/MS PS/2 Y-cable (P/N: 32000-023800-RS)	
2	SATA cable (P/N: 32000-106100-RS)	
1	I/O Shielding (P/N: 45014-0023C0-00-RS)	
1	Mini jumper pack (2.0 mm) (P/N:33100-000033-RS)	







Quantity	Item and Part Number	Image
1	Utility CD	
1	Quick Installation Guide	

Table 3-1: Packing List

3.3.2 Optional Items

The eKINO-945GSE is shipped with the following components:

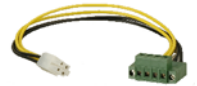
Item and Part Number	Image
HDD cable (P/N: 32200-000009-RS)	
HDTV cable set (P/N: HDTV CABLESET-01)	
Dual USB cable (w bracket) (P/N: CB-USB02-RS)	
4-pin power to terminal block cable (P/N: 32100-192900-RS)	
RS-232 cable with bracket (P/N: 19800-000300-100-RS)	
RS-422/485 cable with bracket (P/N: 32200-833600-RS)	

eKINO-945GSE Motherboard

Item and Part Number	Image
PCIe Mini wireless LAN card 802.11b/g (P/N: WMPCIE-V01-R20)	
12 V power adapter (P/N: FSP0601AD101C746-RS)	
19 V power adapter (P/N: 6300012P0AAB-RS)	
4S2P AUPS battery kit (14.8 V, 3800 mAH) (P/N: BATKIT-4S2P3800-R10) *Requires over 18 V power input	
4S2P battery (14.8 V, 3800 mAH) (P/N: BAT-LI-4S2P3800) *Requires over 18 V power input	
2S2P AUPS battery kit (7.4 V, 3800 mAH) (P/N: BATKIT-2S2P3800-R10) *Requires 12 V power input	
2S2P battery (7.4 V, 3800 mAH) (P/N: BAT-LI-2S2P3800) *Requires 12 V power input	

Table 3-2: Optional Items



Chapter

4

Connectors

eKINO-945GSE Motherboard

4.1 Peripheral Interface Connectors

This chapter outlines all internal and external connectors on the eKINO-945GSE.

4.1.1 Layout

Figure 4-1 shows the on-board peripheral connectors, rear panel peripheral connectors and on-board jumpers.

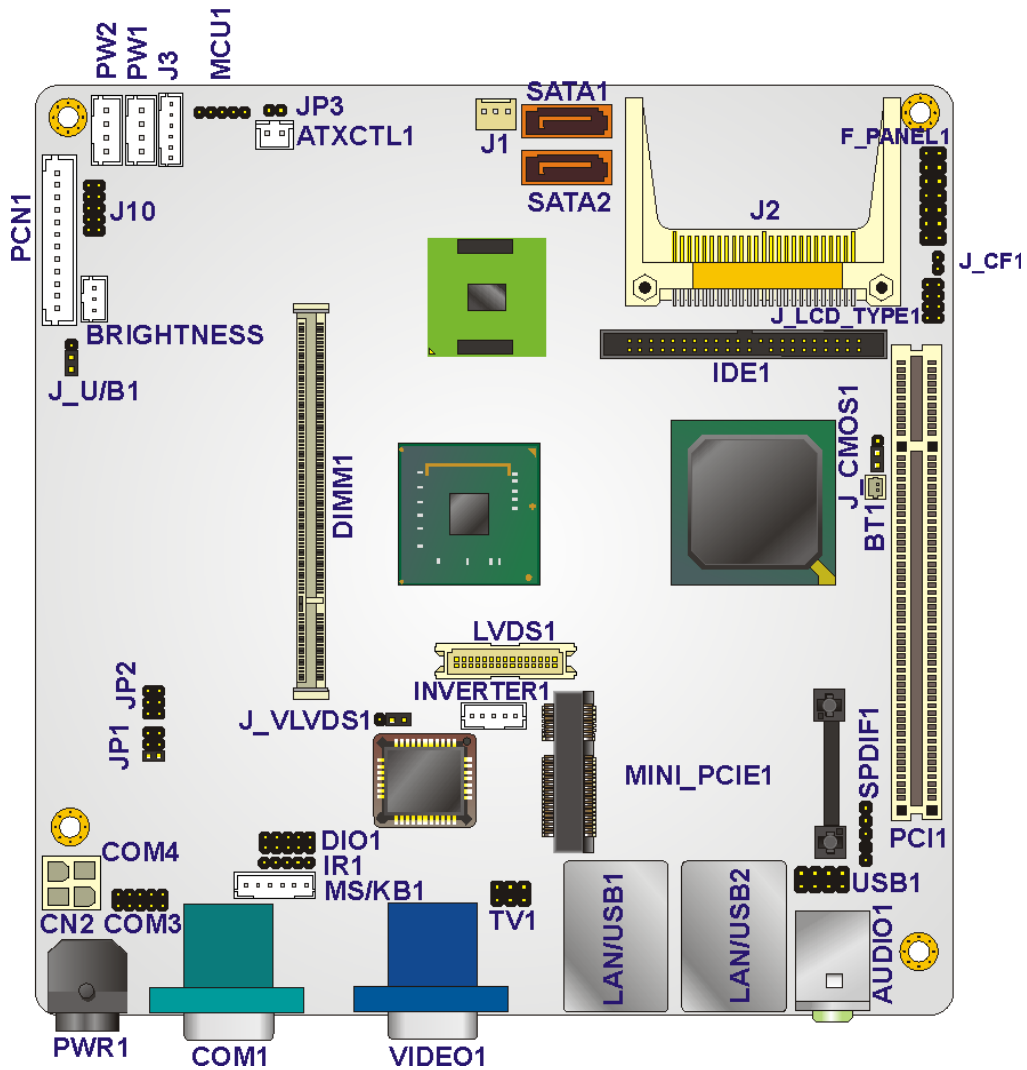

Figure 4-1: Connector and Jumper Locations

4.1.2 Internal Peripheral Interface Connectors

Table 4-1 shows a list of the peripheral interface connectors on the eKINO-945GSE. Detailed descriptions of these connectors can be found below.

Connector	Type	Label
Battery connector	2-pin box header	BT1
CompactFlash® slot	CompactFlash® slot	J2
Digital I/O connector	10-pin header	DIO1
Fan connector	3-pin wafer	J1
Front panel connector	14-pin header	F_PANEL1
IDE connector	44-pin box header	IDE1
Infrared connector	5-pin header	IR1
Keyboard/Mouse connector	6-pin box header	MS/KB1
LCD backlight inverter connector	5-pin box header	INVERTER1
LED connector	6-pin connector	J3
LVDS connector	30-pin crimp	LVDS1
MCU LAN connector	8-pin box header	J10
PCIe Mini slot	PCIe Mini connector	MINI_PCIE1
Power connectors	Power connectors	PWR1 CN2
SATA drive connectors	SATA port	SATA1 SATA2
SATA power connectors	4-pin box header	PW1 PW2
Serial port connectors (RS-232)	10-pin header	COM3 COM4
Serial port connector (RS-422/485)	6-pin header	JP2
SO-DIMM socket	SO-DIMM socket	DIMM1
SPDIF connector	5-pin header	SPDIF1

eKINO-945GSE Motherboard

Connector	Type	Label
TV output connector	6-pin header	TV1
USB connector (2 ports)	8-pin header	USB1

Table 4-1: Peripheral Interface Connectors

4.1.3 External Interface Panel Connectors

Table 4-2 lists the rear panel connectors on the eKINO-945GSE. Detailed descriptions of these connectors can be found in **Section 1H4.3** on **page 55**.

Connector	Type	Label
Audio connector	Dual audio jack	AUDIO1
VGA/DVI combo connector	VGA and DVI connector	VIDEO1
LAN/USB combo connector	LAN and 2 x USB	LAN/USB1 LAN/USB2
Serial port connector	2 x DB-9 male	COM1 (top) COM2 (bottom)

Table 4-2: Rear Panel Connectors

4.2 Internal Peripheral Connectors

Internal peripheral connectors are found on the motherboard and are only accessible when the motherboard is outside of the chassis. This section has complete descriptions of all the internal, peripheral connectors on the eKINO-945GSE.

4.2.1 BIOS Battery Connector

- CN Label:** BT1
- CN Type:** 2-pin wafer (1x2)
- CN Location:** See **Figure 4-2**
- CN Pinouts:** See **Table 4-3**

The battery connector is connected to a backup battery. The battery connector is also used to reset the CMOS memory if the incorrect BIOS settings have been made and the system cannot boot up.

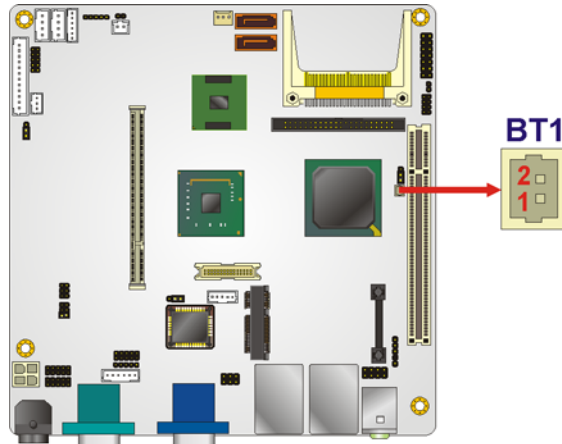

Figure 4-2: Battery Connector Location

Pin No.	Description
1	Battery+
2	Ground

Table 4-3: Battery Connector Pinouts

4.2.2 CompactFlash® Socket

- CN Label:** J2
- CN Type:** CompactFlash® slot
- CN Location:** See **Figure 4-3**

The CompactFlash® card slot allows a CompactFlash® type I or II card to be installed.

eKINO-945GSE Motherboard

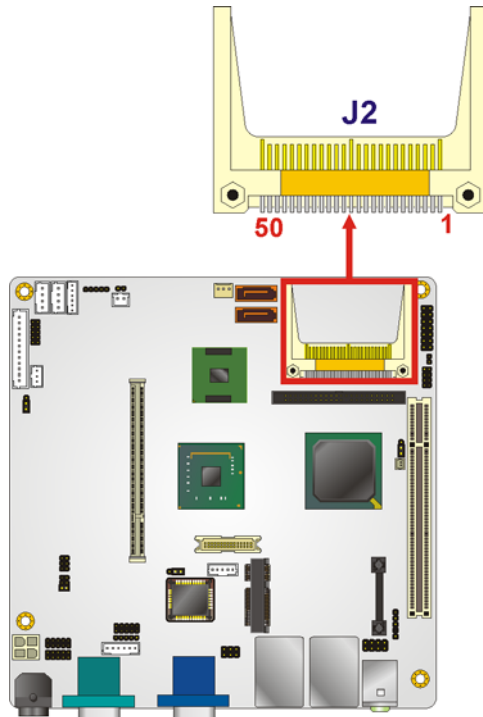

Figure 4-3: CF Card Socket Location

4.2.3 Digital I/O Connector

CN Label:	DIO1
CN Type:	10-pin header (2x5)
CN Location:	See Figure 4-4
CN Pinouts:	See Table 4-4

The digital input/output connector is managed through a Super I/O chip. The DIO connector pins are user programmable.

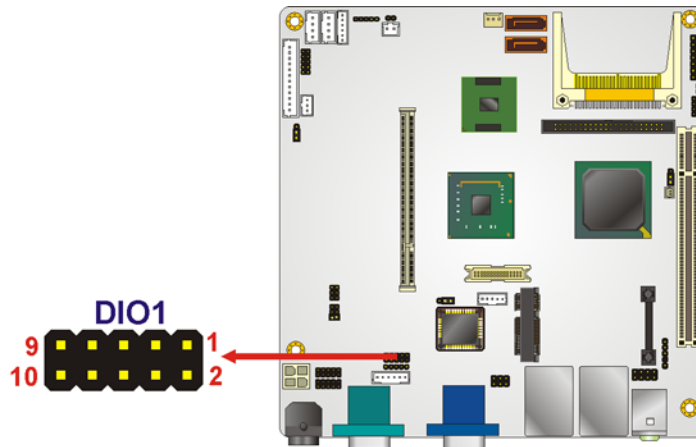

Figure 4-4: Digital I/O Connector Locations

Pin No.	Description	Pin No.	Description
1	GND	2	VCC
3	Output 3	4	Output 2
5	Output 1	6	Output 0
7	Input 3	8	Input 2
9	Input 1	10	Input 0

Table 4-4: DIO Connector Pinouts

4.2.4 Fan Connector

- CN Label:** J1
- CN Type:** 3-pin header
- CN Location:** See **Figure 4-5**
- CN Pinouts:** See **Table 4-5**

The cooling fan connector provides a 12 V, 500mA current to the cooling fan. The connector has a "rotation" pin to get rotation signals from fans and notify the system so the system BIOS can recognize the fan speed. Please note that only specified fans can issue the rotation signals.

eKINO-945GSE Motherboard

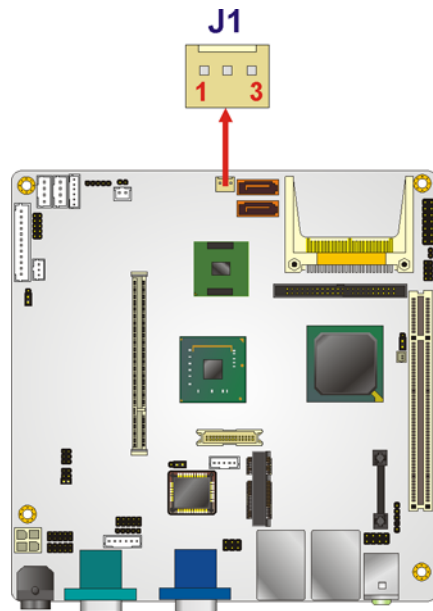

Figure 4-5: CPU Fan Connector Location

Pin No.	Description
1	Fan Speed Detect
2	+12 V
3	GND

Table 4-5: CPU Fan Connector Pinouts

4.2.5 Front Panel Connector

CN Label:	F_PANEL1
CN Type:	14-pin header (2x7)
CN Location:	See Figure 4-6
CN Pinouts:	See Table 4-6

The front panel connector connects to external switches and indicators to monitor and controls the motherboard. These indicators and switches include:

- Power button
- Reset
- Speaker

- Power LED
- HDD LED

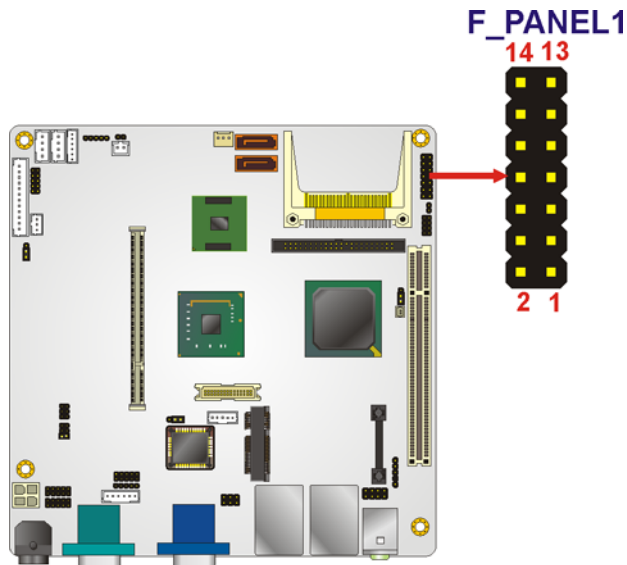

Figure 4-6: Front Panel Connector Pinout Locations

Function	Pin	Description	Function	Pin	Description
Power LED	1	Power LED +	Speaker	2	Speaker +
	3	N/C		4	N/C
	5	Power LED -		6	N/C
Power Button	7	Power button +	8	Speaker -	
	9	Power button -	Reset	10	N/C
HDD LED	11	HDD LED +		12	Reset +
	13	HDD LED -		14	Reset -

Table 4-6: Front Panel Connector Pinouts

4.2.6 IDE Connector

- CN Label:** IDE1
- CN Type:** 44-pin header (2x22)
- CN Location:** See **Figure 4-7**

One 44-pin IDE device connector on the eKINO-945GSE supports connectivity to two hard disk drives.

eKINO-945GSE Motherboard

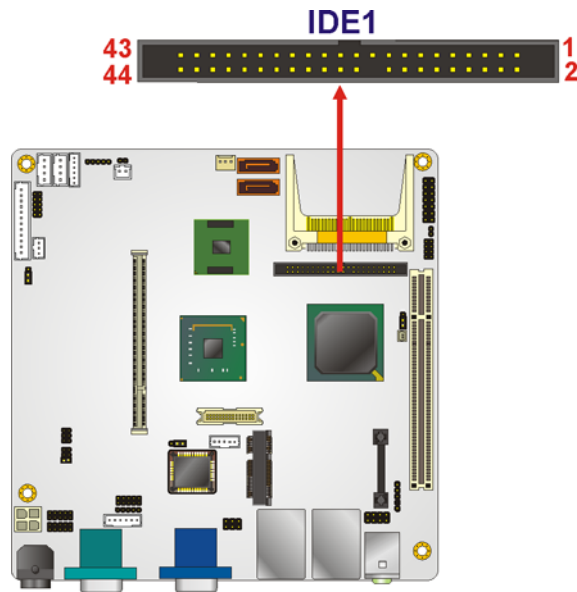

Figure 4-7: IDE Device Connector Locations

4.2.7 Infrared Interface Connector

- CN Label:** IR1
- CN Type:** 5-pin header (1x5)
- CN Location:** See **Figure 4-8**
- CN Pinouts:** See **Table 4-7**

The infrared interface connector supports both Serial Infrared (SIR) and Amplitude Shift Key Infrared (ASKIR) interfaces.

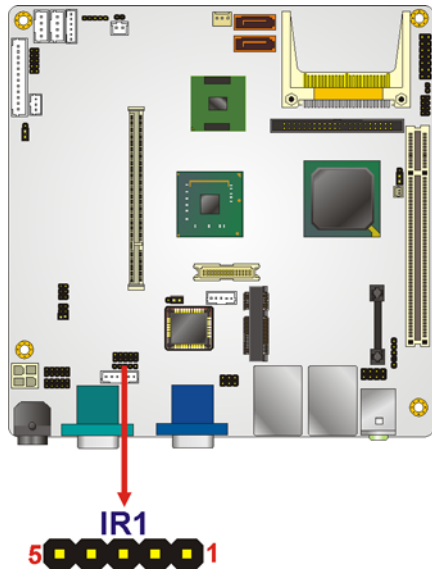

Figure 4-8: Infrared Connector Pinout Locations

Pin No.	Description
1	VCC
2	NC
3	IR-RX
4	GND
5	IR-TX

Table 4-7: Infrared Connector Pinouts

4.2.8 Keyboard/Mouse Connector

- CN Label:** MS/KB1
- CN Type:** 6-pin box header (1x6)
- CN Location:** See **Figure 4-9**
- CN Pinouts:** See **Table 4-8**

The keyboard and mouse connector is for connecting a PS/2 keyboard, PS/2 mouse, or both, to the board.

eKINO-945GSE Motherboard

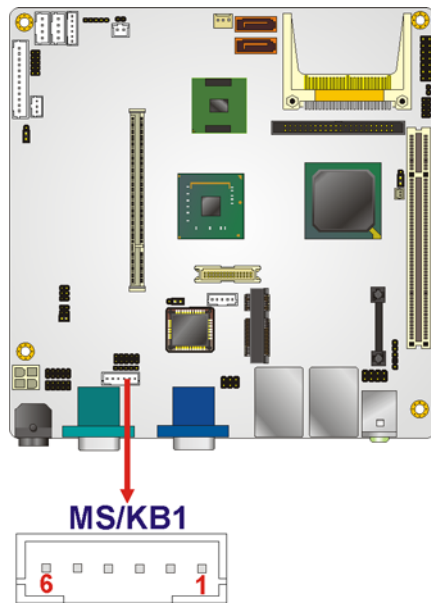

Figure 4-9: Keyboard/Mouse Connector Location

Pin No.	Description
1	Power (5 V)
2	Mouse data
3	Mouse clock
4	Keyboard data
5	Keyboard clock
6	Ground

Table 4-8: Keyboard/Mouse Connector Pinouts

4.2.9 LCD Backlight Inverter Connector

- CN Label:** INVERTER1
- CN Type:** 5-pin box header (1x5)
- CN Location:** See **Figure 4-10**
- CN Pinouts:** See **Table 4-9**

The backlight inverter connector provides the backlight on the LCD display connected to the eKINO-945GSE with +12 V of power.

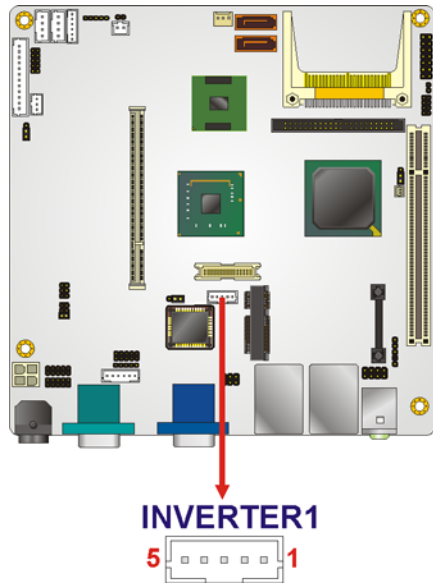

Figure 4-10: LCD Backlight Connector Pinout Locations

Pin No.	Description
1	Brightness
2	GND
3	12 V
4	GND
5	Backlight enable

Table 4-9: LCD Backlight Connector Pinouts

4.2.10 LED Connector

- CN Label:** J3
- CN Type:** 6-pin box header
- CN Location:** See **Figure 4-11**
- CN Pinouts:** See **Table 4-10**

The LED connector connects to LED indicators showing the status of the connected UPS battery.

eKINO-945GSE Motherboard

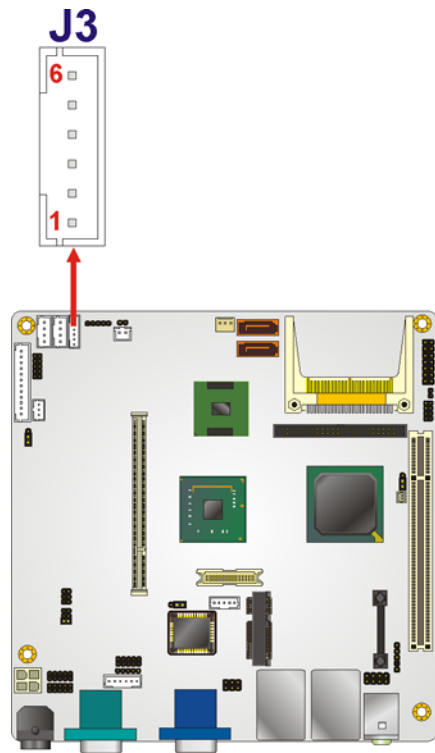

Figure 4-11: LED Connector Location

Pin No	Description	Function
1	Battery discharge+	Discharge
2	Battery discharge-	LED
3	Battery charging+	Charge
4	Battery charging-	LED
5	DC+	Power LED
6	DC-	(DC-IN)

Table 4-10: LED Connector Pinouts

4.2.11 LVDS LCD Connector

- CN Label:** LVDS1
- CN Type:** 30-pin crimp (2x10)
- CN Location:** See **Figure 4-12**
- CN Pinouts:** See **Table 4-11**

The 30-pin LVDS LCD connector can be connected to single channel or dual channel, 18-bit or 36-bit LVDS panel.

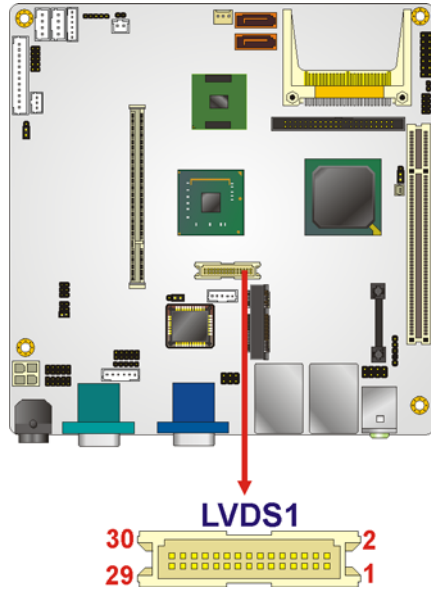

Figure 4-12: LVDS LCD Connector Pinout Locations

Pin No.	Description	Pin No.	Description
1	GROUND	2	GROUND
3	LVDS_A0+	4	LVDS_A0-
5	LVDS_A1+	6	LVDS_A1-
7	LVDS_A2+	8	LVDS_A2-
9	LVDS_ACLK+	10	LVDS_ACLK-
11	N/C	12	N/C
13	GROUND	14	GROUND
15	LVDS_B0+	16	LVDS_B0-
17	LVDS_B1+	18	LVDS_B1-
19	LVDS_B2+	20	LVDS_B2-
21	LVDS_BCLK+	22	LVDS_BCLK-
23	N/C	24	N/C
25	GROUND	26	GROUND
27	LCDVCC	28	LCDVCC

eKINO-945GSE Motherboard

Pin No.	Description	Pin No.	Description
29	LCDVCC	30	LCDVCC

Table 4-11: LVDS LCD Port Connector Pinouts

4.2.12 MCU LAN Connector

- CN Label:** J10
- CN Type:** 10-pin pin header
- CN Location:** See Figure 4-13
- CN Pinouts:** See Table 4-12

The MCU LAN connector allows remote monitoring of the UPS MCU.

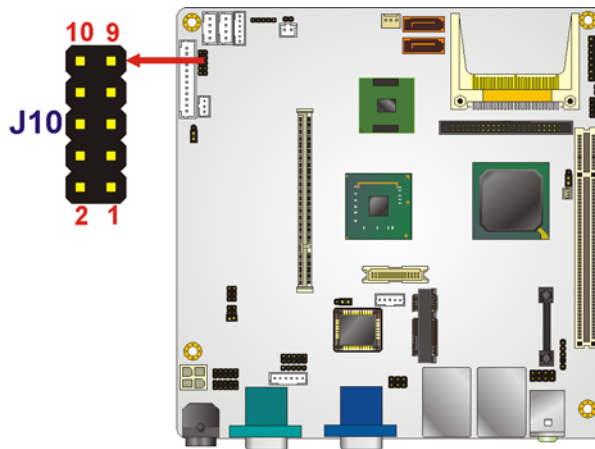

Figure 4-13: MCU LAN Connector Location

Pin No.	Description
1	N/C
2	N/C
3	RX+
4	RX-
5	N/C
6	Pair 3
7	N/C

Pin No.	Description
8	Pair 2
9	TX+
10	TX-

Table 4-12: MCU LAN Connector Pinouts

4.2.13 PCIe Mini Card Slot

- CN Label:** MINI_PCIE1
- CN Type:** 52-pin Mini PCIe Card Slot
- CN Location:** See **Figure 4-14**

The PCIe mini card slot enables a PCIe mini card expansion module to be connected to the board. Cards supported include among others wireless LAN (WLAN) cards.

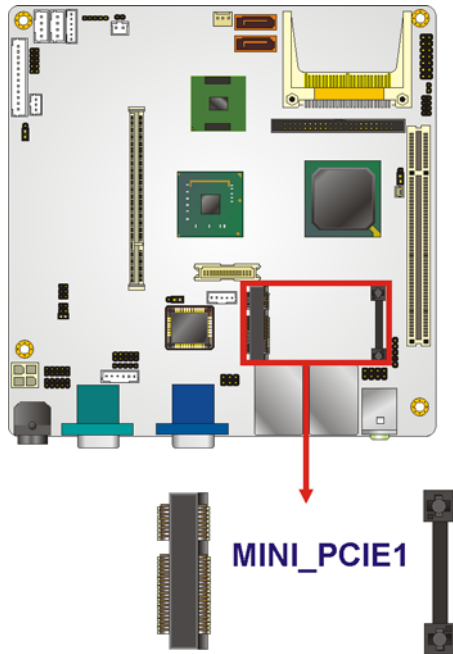

Figure 4-14: PCIe Mini Card Slot Location

eKINO-945GSE Motherboard

4.2.14 Power Connectors

- CN Label:** CN2
- CN Type:** 4-pin power connectors
- CN Location:** See **Figure 4-15**
- CN Pinouts:** See **Table 4-13**

The power connectors connect to a 9~28 V power supply.

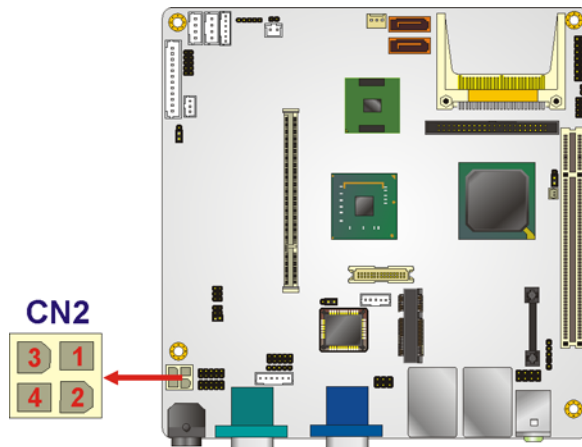

Figure 4-15: Power Connector Location

Pin No.	Description
1	Ground
2	Ground
3	Power (9~28 V)
4	Power (9~28 V)

Table 4-13: Power Connector Pinouts

4.2.15 SATA Drive Connectors

- CN Label:** SATA1, SATA2
- CN Type:** 7-pin SATA drive connectors
- CN Location:** See **Figure 4-16**
- CN Pinouts:** See **Table 4-14**

The four SATA drive connectors are each connected to a first generation SATA drive. First generation SATA drives transfer data at speeds as high as 150 Mb/s. The SATA drives can be configured in a RAID configuration.

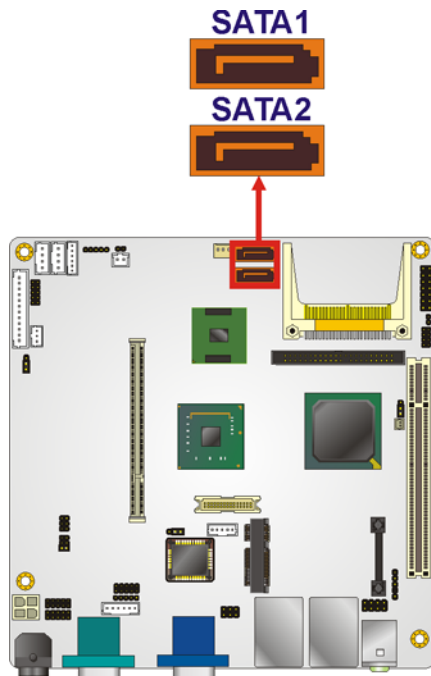

Figure 4-16: SATA Drive Connector Locations

4.2.16 SATA Power Connectors

- CN Label:** PW1 and PW2
- CN Type:** 4-pin box header
- CN Location:** See **Figure 4-16**
- CN Pinouts:** See **Table 4-14**

eKINO-945GSE Motherboard

The SATA power connectors provide power to SATA drives. These power connectors are connected to the UPS in case of power loss. Do not connect SATA drives to the main power supply.

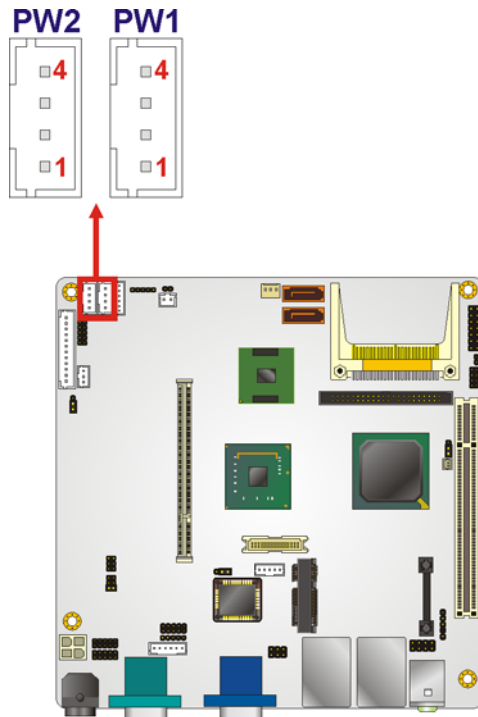

Figure 4-17: SATA Power Connector Location

Pin No.	Description
1	12 V
2	Ground
3	Ground
4	5 V

Table 4-14: SATA Power Connector Pinouts

4.2.17 Serial Port Connectors (RS-232)

- CN Label:** COM3 and COM4
- CN Type:** 10-pin header (2x5)
- CN Location:** See **Figure 4-18**
- CN Pinouts:** See **Table 4-15**

The 10-pin serial port connectors provide RS-232 serial communications channels. The COM serial port connectors can be connected to external RS-232 serial port devices. COM3 uses JP2 for RS-422 and RS-485 connectivity.

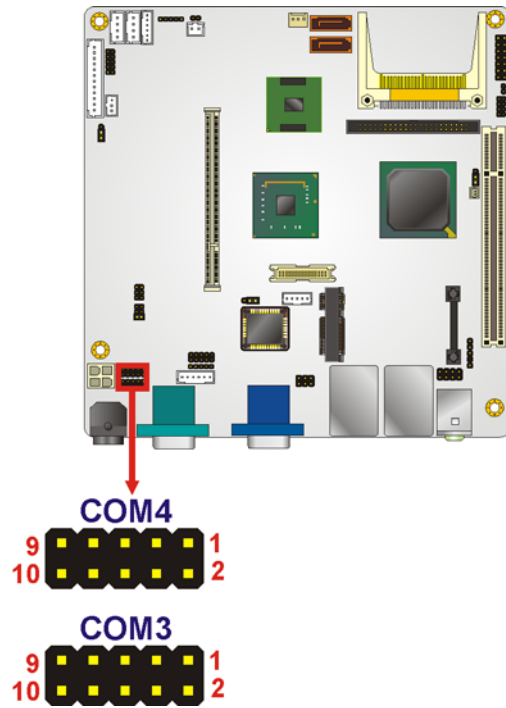

Figure 4-18: RS-232 Connector Pinout Locations

Pin No.	Description	Pin No.	Description
1	Data Carrier Direct (DCD)	2	Data Set Ready (DSR)
3	Receive Data (RXD)	4	Request To Send (RTS)
5	Transmit Data (TXD)	6	Clear To Send (CTS)
7	Data Terminal Ready (DTR)	8	Ring Indicator (RI)

eKINO-945GSE Motherboard

Pin No.	Description	Pin No.	Description
9	Ground (GND)	10	N/C

Table 4-15: RS-232 Connector Pinouts

4.2.18 Serial Port Connectors (RS-422/485)

- CN Label:** JP2
- CN Type:** 6-pin header (2x3)
- CN Location:** See **Figure 4-19**
- CN Pinouts:** See **Table 4-16**

The serial port connector provides the RS-422 and RS-485 pins for serial port COM3. JP1 sets COM3 to RS-232, RS-422 or RS-485, use the COM3 connector for RS-232 and the connectors on JP2 for RS-422 or RS-485 connectivity.

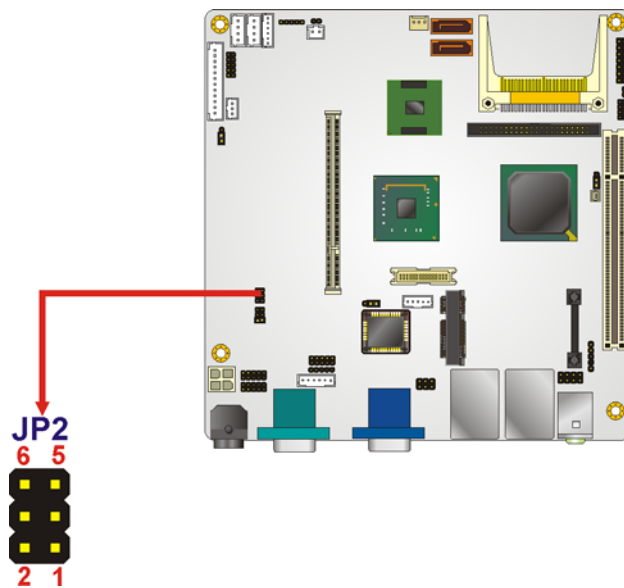

Figure 4-19: RS-422/485 Connector Pinout Locations

Pin No.	Description	Pin No.	Description
1	TX_422-	2	RX_422-
3	TX_422+	4	RX_422+
5	D_485+	6	D_485-

Table 4-16: RS-422/485 Connector Pinouts

4.2.19 SO-DIMM Socket

- CN Label:** DIMM1
- CN Type:** DDR2 SO-DIMM socket
- CN Location:** See **Figure 4-20**

The digital input/output connector is managed through a Super I/O chip. The DIO connector pins are user programmable.

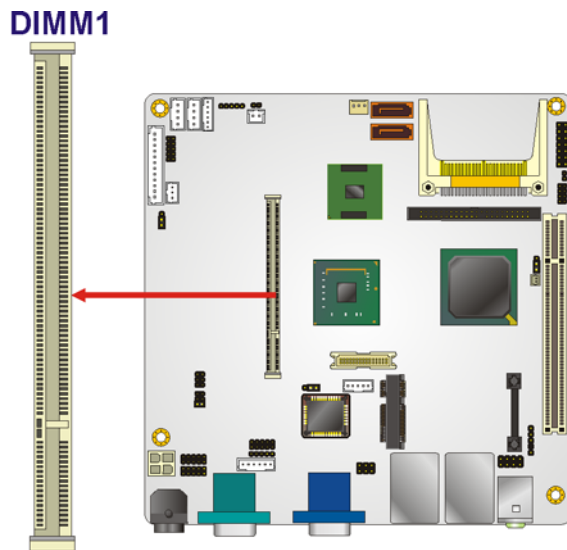

Figure 4-20: SO-DIMM Location

4.2.20 SPDIF Connector

- CN Label:** SPDIF1
- CN Type:** 5-pin header
- CN Location:** See **Figure 4-21**
- CN Pinouts:** See **Table 4-17**

Use the SPDIF connector to connect digital audio devices to the system.

eKINO-945GSE Motherboard

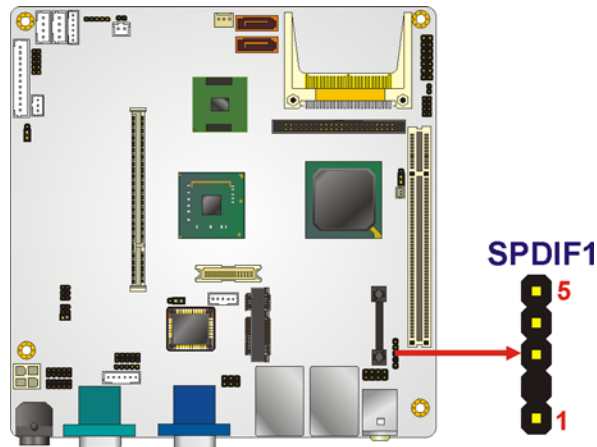

Figure 4-21: SPDIF Connector Location

Pin	Description
1	VCC5
2	NC
3	SPDIF OUT
4	GND AUDIO
5	SPDIF IN

Table 4-17: SPDIF Connector Pinouts

4.2.21 TV Out Connector

- CN Label:** TV1
- CN Type:** 6-pin header (2x3)
- CN Location:** See **Figure 4-22**
- CN Pinouts:** See **Table 4-18**

The 2x3 pin TV out connector connects to a TV output by using an S-Video or RCA connector. The TV out connector makes displaying media data on a television easier.

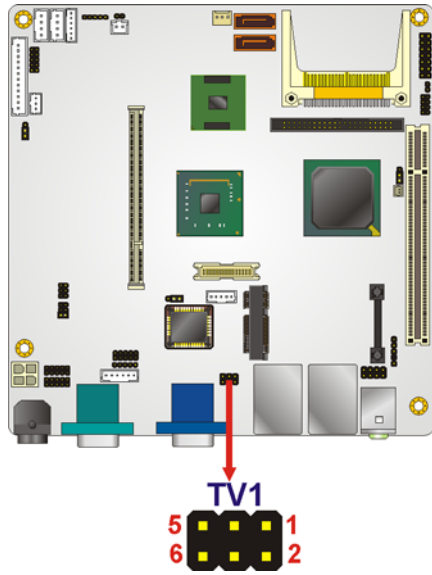

Figure 4-22: TV Connector Pinout Locations

Pin No.	Description	Pin No.	Description
1	GND	2	AGREEN_Y
3	GND	4	ARED_C
5	GND	6	ABLUE_CVBS

Table 4-18: TV Port Connector Pinouts

4.2.22 USB Connectors

- CN Label:** USB1
- CN Type:** 8-pin header (2x4)
- CN Location:** See **Figure 4-23**
- CN Pinouts:** See **Table 4-19**

The 2x4 USB pin connector provides connectivity to two USB 1.1 or two USB 2.0 ports. The USB connector can support two USB devices. Additional external USB ports are found on the rear panel. The USB ports are used for I/O bus expansion.

eKINO-945GSE Motherboard

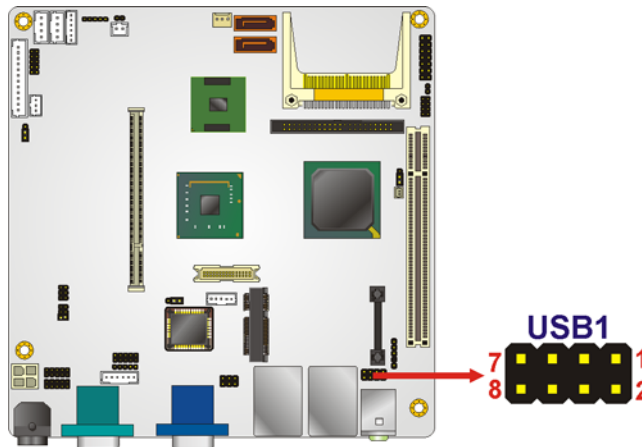

Figure 4-23: USB Connector Pinout Locations

Pin No.	Description	Pin No.	Description
USB Connector 1		USB Connector 2	
1	VCC	2	GND
3	DATA1-	4	DATA2+
5	DATA1+	6	DATA2-
7	GND	8	VCC

Table 4-19: USB Port Connector Pinouts

4.3 External Peripheral Interface Connector Panel

Figure 4-24 shows the eKINO-945GSE external peripheral interface connector (EPIC) panel. The eKINO-945GSE EPIC panel consists of the following:

- 2 x Audio jacks
- 1 x DVI connector
- 2 x RJ-45 LAN connectors
- 1 x Power DIN
- 2 x Serial port connectors
- 4 x USB connectors
- 1 x VGA connector

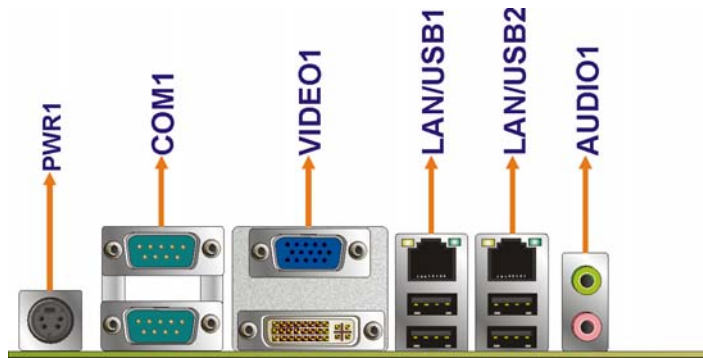

Figure 4-24: eKINO-945GSE External Peripheral Interface Connector

4.3.1 Audio Connector

CN Label:	AUDIO1
CN Type:	2 x audio jacks
CN Location:	See Figure 4-24

The two audio jacks connect to external audio devices as specified below.

- **Line Out port (Lime):** Connects to a headphone or a speaker. With multi-channel configurations, this port can also connect to front speakers.
- **Microphone (Pink):** Connects a microphone.



Figure 4-25: Audio Connector

4.3.2 DVI Connector

CN Label:	VIDEO1 (bottom)
CN Type:	DVI connector
CN Location:	See Figure 4-24
CN Pinouts:	See Table 4-20

eKINO-945GSE Motherboard

The 24-pin Digital Visual Interface (DVI) connector connects to high-speed, high-resolution digital displays. The DVI-I connector supports both digital and analog signals.

Pin	Signal Name	Pin	Signal Name	Pin	Signal Name
1	TMDS Data2-	9	TMDS Data1-	17	TMDS Data0-
2	TMDS Data2+	10	TMDS Data1+	18	TMDS Data0+
3	GND	11	GND	19	GND
4	N/C	12	NC	20	NC
5	N/C	13	NC	21	NC
6	DDC Clock [SCL]	14	PVDD1	22	GND
7	DDC Data [SDA]	15	GND	23	TMDS Clock +
8	Analog vertical sync	16	GND	24	TMDS Clock -
C1	Analog Red	--	--	--	--
C2	Analog Green	--	--	--	--
C3	Analog Blue	--	--	--	--
C4	Analog Horizontal Sync	--	--	--	--
C5	Analog GND	--	--	--	--

Table 4-20: DVI Connector Pinouts

4.3.3 LAN Connectors

CN Label: LAN/USB1 & LAN/USB2

CN Type: RJ-45

CN Location: See **Figure 4-24**

CN Pinouts: See **Table 4-21**

The RJ-45 connectors connect to a wired network.

Pin	Description	Pin	Description
1	MDIA3-	5	MDIA1+
2	MDIA3+	6	MDIA2+
3	MDIA2-	7	MDIA0-

Pin	Description	Pin	Description
4	MDIA1-	8	MDIA0+

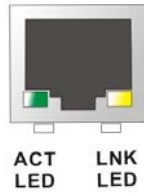
Table 4-21: LAN Pinouts

Figure 4-26: RJ-45 Ethernet Connector

The RJ-45 Ethernet connector has two status LEDs, one green and one yellow. The green LED indicates activity on the port and the yellow LED indicates the port is linked. See **Table 4-22**.

Status	Description	Status	Description
Green	Activity	Yellow	Linked

Table 4-22: RJ-45 Ethernet Connector LEDs

4.3.4 Serial Port Connectors

CN Label: COM1 (top) and COM2 (bottom)

CN Type: DB-9 connectors

CN Location: See **Figure 4-24**

CN Pinouts: See **Table 4-23** and **Figure 4-27**

The serial port connectors connect to RS-232 communications devices.

Pin No.	Description	Pin No.	Description
1	DCD	6	DSR
2	RX	7	RTS
3	TX	8	CTS
4	DTR	9	RI

eKINO-945GSE Motherboard

Pin No.	Description	Pin No.	Description
5	GND		

Table 4-23: RS-232 Serial Port Pinouts

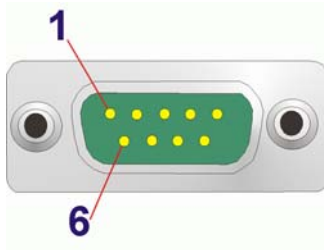

Figure 4-27: RS-232 Serial Port Pinout Locations

4.3.5 USB Connectors

CN Label: LAN/USB1 and LAN/USB2

CN Type: USB port

CN Location: See **Figure 4-24**

CN Pinouts: See **Table 4-24**

The eKINO-945GSE has one external USB 2.0 port. The ports connect to both USB 2.0 and USB 1.1 devices.

Pin No.	Description
1	VCC
2	DATA-
3	DATA+
4	GND

Table 4-24: USB Port Pinouts

4.3.6 VGA Connector

- CN Label:** VIDEO1 (top)
- CN Type:** 15-pin Female
- CN Location:** See **Figure 4-24**
- CN Pinouts:** See **Figure 4-28** and **Table 4-25**

The eKINO-945GSE has a single 15-pin female connector for connectivity to standard display devices.

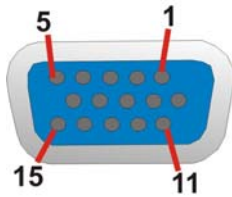

Figure 4-28: VGA Connector

Pin	Description	Pin	Description
1	RED	2	GREEN
3	BLUE	4	NC
5	GND	6	CRT_PLUG-
7	GND	8	GND
9	VCC	10	GND
11	NC	12	DDC DAT
13	HSYNC	14	VSYNC
15	DDCCLK		

Table 4-25: VGA Connector Pinouts

Chapter

5

Installation

5.1 Anti-static Precautions



WARNING:

Failure to take ESD precautions during the installation of the eKINO-945GSE may result in permanent damage to the eKINO-945GSE and severe injury to the user.

Electrostatic discharge (ESD) can cause serious damage to electronic components, including the eKINO-945GSE. Dry climates are especially susceptible to ESD. It is therefore critical that whenever the eKINO-945GSE or any other electrical component is handled, the following anti-static precautions are strictly adhered to.

- **Wear an anti-static wristband:** Wearing a simple anti-static wristband can help to prevent ESD from damaging the board.
- **Self-grounding:** Before handling the board, touch any grounded conducting material. During the time the board is handled, frequently touch any conducting materials that are connected to the ground.
- **Use an anti-static pad:** When configuring the eKINO-945GSE, place it on an anti-static pad. This reduces the possibility of ESD damaging the eKINO-945GSE.
- **Only handle the edges of the PCB:** When handling the PCB, hold the PCB by the edges.

5.2 Installation Considerations



NOTE:

The following installation notices and installation considerations should be read and understood before the eKINO-945GSE is installed. All installation notices pertaining to the installation of the eKINO-945GSE should be strictly adhered to. Failing to adhere to these precautions may lead to severe damage of the eKINO-945GSE and injury to the person installing the motherboard.

5.2.1 Installation Notices



WARNING:

The installation instructions described in this manual should be carefully followed in order to prevent damage to the eKINO-945GSE, eKINO-945GSE components and injury to the user.

Before and during the installation please **DO** the following:

- Read the user manual:
 - The user manual provides a complete description of the eKINO-945GSE installation instructions and configuration options.
- Wear an electrostatic discharge cuff (ESD):
 - Electronic components are easily damaged by ESD. Wearing an ESD cuff removes ESD from the body and helps prevent ESD damage.
- Place the eKINO-945GSE on an antistatic pad:
 - When installing or configuring the motherboard, place it on an antistatic pad. This helps to prevent potential ESD damage.
- Turn all power to the eKINO-945GSE off:
 - When working with the eKINO-945GSE, make sure that it is disconnected from all power supplies and that no electricity is being fed into the system.

Before and during the installation of the eKINO-945GSE **DO NOT**:

- **DO NOT** remove any of the stickers on the PCB board. These stickers are required for warranty validation.
- **DO NOT** use the product before verifying all the cables and power connectors are properly connected.
- **DO NOT** allow screws to come in contact with the PCB circuit, connector pins, or its components.

5.2.2 Installation Checklist

The following checklist is provided to ensure the eKINO-945GSE is properly installed.

- All the items in the packing list are present
- A compatible memory module is properly inserted into the slot
- The CF Type I or CF Type II card is properly installed into the CF socket
- The jumpers have been properly configured
- The eKINO-945GSE is inserted into a chassis with adequate ventilation
- The correct power supply is being used
- The following devices are properly connected
 - IDE devices
 - SATA drives
 - Power supply
 - USB cable
 - Serial port cable
- The following external peripheral devices are properly connected to the chassis:
 - VGA screen
 - Keyboard
 - Mouse
 - RS-232 serial communications device
 - USB devices

5.3 Unpacking

When the eKINO-945GSE is unpacked, please check all the unpacking list items listed in Chapter 3 are indeed present. If any of the unpacking list items are not available please

eKINO-945GSE Motherboard

contact the eKINO-945GSE vendor reseller/vendor where the eKINO-945GSE was purchased or contact an IEI sales representative.

5.4 SO-DIMM Installation



WARNING:

Using incorrectly specified SO-DIMM may cause permanently damage the eKINO-945GSE. Please make sure the purchased SO-DIMM complies with the memory specifications of the eKINO-945GSE. SO-DIMM specifications compliant with the eKINO-945GSE are listed in Chapter 2.

To install a SO-DIMM into a SO-DIMM socket, please follow the steps below and refer to **Figure 5-1**.

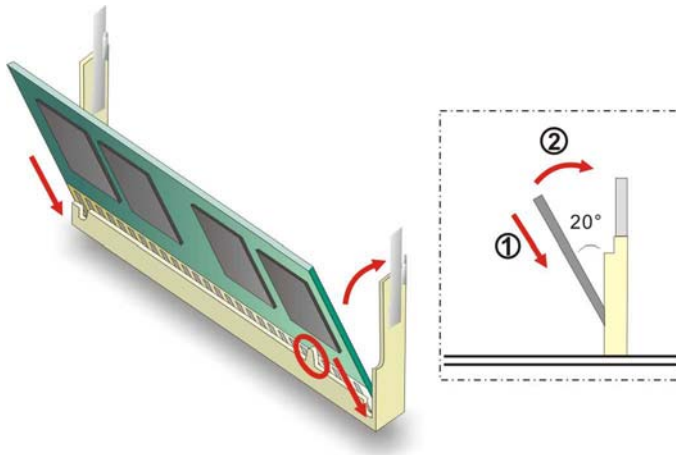

Figure 5-1: SO-DIMM Installation

Step 1: **Locate the SO-DIMM socket.** Place the eKINO-945GSE on an anti-static pad with the solder side facing up.

Step 2: **Align the SO-DIMM with the socket.** The SO-DIMM must be oriented in such a way that the notch in the middle of the SO-DIMM must be aligned with the plastic bridge in the socket.

- Step 3: Insert the SO-DIMM.** Push the SO-DIMM chip into the socket at an angle. (See **Figure 5-1**)
- Step 4: Open the SO-DIMM socket arms.** Gently pull the arms of the SO-DIMM socket out and push the rear of the SO-DIMM down. (See **Figure 5-1**)
- Step 5: Secure the SO-DIMM.** Release the arms on the SO-DIMM socket. They clip into place and secure the SO-DIMM in the socket.

5.5 CF Card Installation



NOTE:

The eKINO-945GSE can support both CF Type I cards and CF Type II cards. For the complete specifications of the supported CF cards please refer to Chapter 2.

To install a CF card (Type 1 or Type 2) onto the eKINO-945GSE, please follow the steps below:

- Step 1: Locate the CF card socket.** Place the eKINO-945GSE on an anti-static pad with the solder side facing up. Locate the CF card.
- Step 2: Align the CF card.** Make sure the CF card is properly aligned with the CF socket.
- Step 3: Insert the CF card.** Gently insert the CF card into the socket making sure the socket pins are properly inserted into the socket. See **Figure 5-2**.

eKINO-945GSE Motherboard

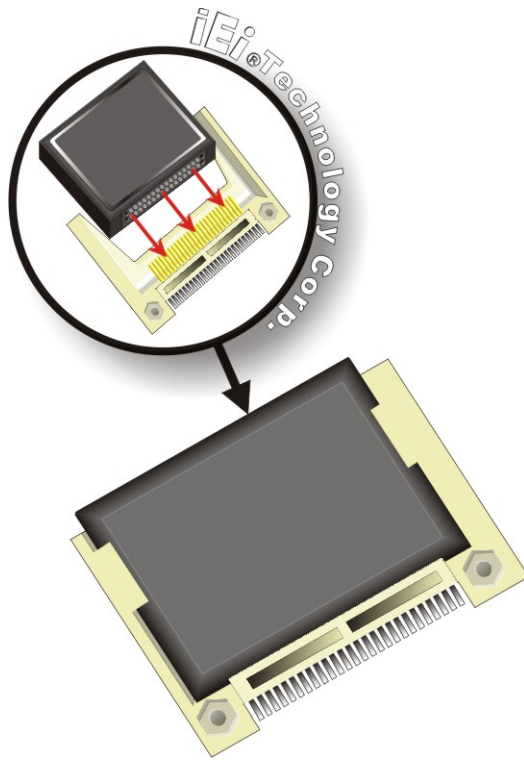

Figure 5-2: CF Card Installation

5.6 UPS Installation

To install the UPS, connect the UPS battery to the motherboard and connect the motherboard to the 9-28 V power supply as shown in the diagram below.

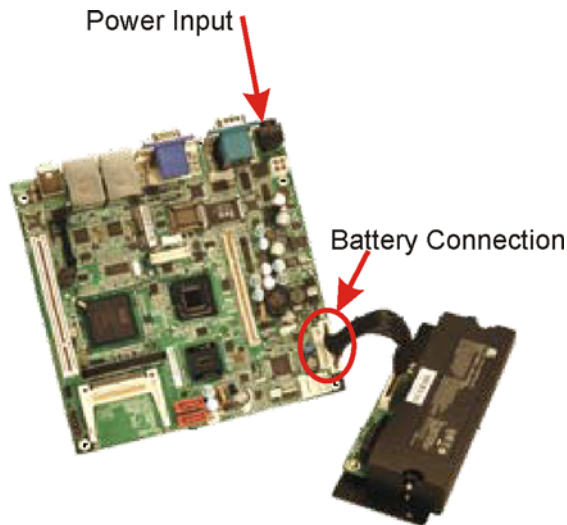

Figure 5-3: UPS Installation

5.7 Jumper Settings



NOTE:

A jumper is a metal bridge used to close an electrical circuit. It consists of two or three metal pins and a small metal clip (often protected by a plastic cover) that slides over the pins to connect them. To CLOSE/SHORT a jumper means connecting the pins of the jumper with the plastic clip and to OPEN a jumper means removing the plastic clip from a jumper.

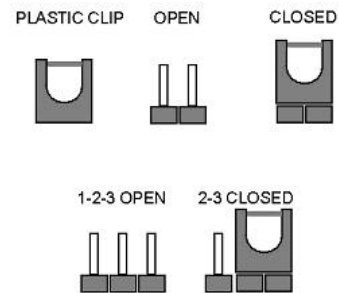

Jumper Locations

eKINO-945GSE Motherboard

Before the eKINO-945GSE is installed in the system, the jumpers must be set in accordance with the desired configuration. The jumpers on the eKINO-945GSE are listed in **Table 5-1**.

Description	Type	Label
ATX control	2-pin header	ATXCTL1
Clear CMOS	3-pin header	J_CMOS1
CompactFlash® master/slave	2-pin header	J_CF1
COM3 RS-232/422/485 selector	6-pin header	JP1
LCD panel type selector	8-pin header	J_LCD_TYPE1
LCD voltage selector	3-pin header	J_VLVDS1
UPS enable/disable	2-pin header	JP3
UPS/Battery mode selection	3-pin header	J_U/B1

Table 5-1: Jumpers

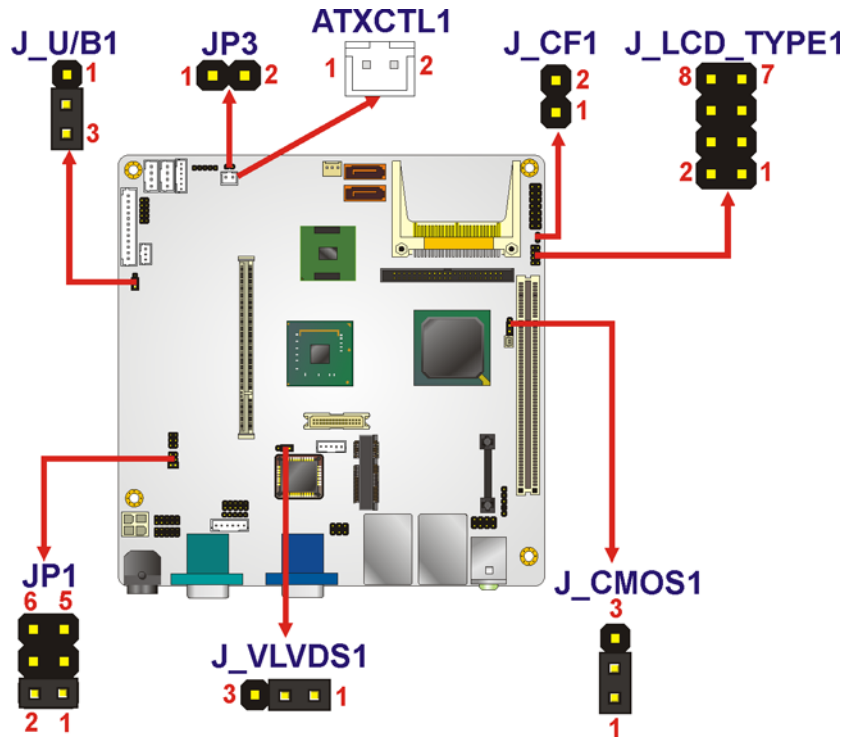

Figure 5-4: Jumpers

5.7.1 AT/ATX Selection

- Jumper Label:** ATXCTL1
- Jumper Type:** 2-pin header
- Jumper Settings:** See Table 5-2
- Jumper Location:** See Figure 5-4

The AT/ATX Power Selection jumper specifies the systems power mode as AT or ATX. Power Selection jumper settings are shown in **Table 5-2**.

Pin Setting	Description
Short	Use AT power
Open	Use ATX power

Table 5-2: AT/ATX Power Selection Jumper Settings

eKINO-945GSE Motherboard

5.7.2 Clear CMOS Jumper

Jumper Label:	J_CMOS1
Jumper Type:	3-pin header
Jumper Settings:	See Table 5-3
Jumper Location:	See Figure 5-4

If the eKINO-945GSE fails to boot due to improper BIOS settings, the clear CMOS jumper clears the CMOS data and resets the system BIOS information. To do this, use the jumper cap to close pins 2 and 3 for a few seconds then reinstall the jumper clip back to pins 1 and 2.

If the “CMOS Settings Wrong” message is displayed during the boot up process, the fault may be corrected by pressing the F1 to enter the CMOS Setup menu. Do one of the following:

- Enter the correct CMOS setting
- Load Optimal Defaults
- Load Failsafe Defaults.

After having done one of the above, save the changes and exit the CMOS Setup menu.

The clear CMOS jumper settings are shown in **Table 5-3**.

Pin Setting	Description
1-2	Keep CMOS Setup
2-3	Clear CMOS Setup

Table 5-3: Clear CMOS Jumper Settings

5.7.3 CF Card Setup

Jumper Label:	J_CF1
Jumper Type:	2-pin header
Jumper Settings:	See Table 5-4
Jumper Location:	See Figure 5-4

The CF Card Setup jumper sets the CF Type I card or CF Type II cards as either the slave device or the master device. CF Card Setup jumper settings are shown in **Table 5-4**.

Pin Setting	Description
Open	Slave
Closed	Master

Table 5-4: CF Card Setup Jumper Settings

5.7.4 COM3 RS-232/422/485 Selection Jumper

- Jumper Label:** JP1
- Jumper Type:** 6-pin header
- Jumper Settings:** See **Table 5-5**
- Jumper Location:** See **Figure 5-4**

The RS-232/422/485 Serial Port Select jumper sets the communication protocol used by COM3. The RS-232/422/485 Serial Port Select settings are shown in **Table 5-5**.

Pin Setting	Description
1-2	RS-232
3-4	RS-422
5-6	RS-485

Table 5-5: COM3 RS-232/422/485 Selection Jumper Pinouts

5.7.5 LCD Panel Type Selection

- Jumper Label:** J_LCD_TYPE1
- Jumper Type:** 8-pin header
- Jumper Settings:** See **Table 5-7**
- Jumper Location:** See **Figure 5-4**

The **LCD Panel Type Selection** jumper allows the LVDS screen voltage to be set. The **LCD Panel Type Selection** jumper settings are shown in **Table 5-7**.

eKINO-945GSE Motherboard

Pin Setting	Description
Open	640 x 480 (18-bit)
1-2	800 x 480 (18-bit)
3-4	800 x 600 (18-bit)
1-2, 3-4	1024 x 768 (18-bit)
5-6	1280 x 1024 (18-bit)
1-2, 5-6	1400 x 1050 (18-bit)
3-4, 5-6	1400 x 900 (18-bit)
1-2, 3-4, 5-6	1600 x 1200 (18-bit)

Table 5-6: LCD Panel Type Selection Jumper Settings

5.7.6 LVDS Voltage Selection



WARNING:

Permanent damage to the screen and eKINO-945GSE may occur if the wrong voltage is selected with this jumper. Please refer to the user guide that came with the monitor to select the correct voltage.

- Jumper Label:** J_VLVDS1
- Jumper Type:** 3-pin header
- Jumper Settings:** See **Table 5-7**
- Jumper Location:** See **Figure 5-4**

The **LVDS Voltage Selection** jumper allows the LVDS screen voltage to be set. The **LVDS Voltage Selection** jumper settings are shown in **Table 5-7**.

Pin Setting	Description
1-2	3.3 V
2-3	5 V

Table 5-7: LVDS Voltage Selection Jumper Settings

5.7.7 UPS Enable/Disable

- Jumper Label:** JP3
- Jumper Type:** 2-pin header
- Jumper Settings:** See **Table 5-8**
- Jumper Location:** See **Figure 5-4**

When this jumper is closed, the system will use the battery when needed, when open the system will not use the battery.

Pin Setting	Description
Open	Don't use the battery backup
Closed	Use the battery function

Table 5-8: UPS Enable/Disable Jumper Settings

5.7.8 UPS/Battery Mode Selection (eKINO-945GSE-N270UPS only)

- Jumper Label:** J_U/B1
- Jumper Type:** 3-pin header
- Jumper Settings:** See **Table 5-9**
- Jumper Location:** See **Figure 5-4**

This jumper sets the system to run off the battery exclusively, or to use the battery as a UPS.

Pin Setting	Description
1-2	UPS
2-3	Battery

Table 5-9: UPS/Battery Mode Selection Jumper Settings

5.8 Chassis Installation

5.8.1 Airflow



WARNING:

Airflow is critical to the cooling of the CPU and other onboard components. The chassis in which the eKINO-945GSE must have air vents to allow cool air to move into the system and hot air to move out.

The eKINO-945GSE must be installed in a chassis with ventilation holes on the sides allowing airflow to travel through the heat sink surface. In a system with an individual power supply unit, the cooling fan of a power supply can also help generate airflow through the board surface.



NOTE:

IEI has a wide range of backplanes available. Please contact your eKINO-945GSE vendor, reseller or an IEI sales representative at sales@iei.com.tw or visit the IEI website (<http://www.ieworld.com.tw>) to find out more about the available chassis.

5.8.2 Motherboard Installation

To install the eKINO-945GSE motherboard into the chassis please refer to the reference material that came with the chassis.

5.9 Internal Peripheral Device Connections

The cables listed in **Table 5-10** are shipped with the eKINO-945GSE.

Quantity	Type
1	Keyboard and Mouse cable
2	SATA drive cable

Quantity	Type
1	Power cable
1	Dual RS-232 cable

Table 5-10: IEI Provided Cables

Some optional items that can be purchased separately and installed on the eKINO-945GSE include:

- Dual port USB cable
- Parallel port cable
- RS-232/422/485 cable
- ATX power cable
- HDTV out cable

5.9.1 ATA Flat Cable Connection

The ATA 66/100 flat cable connects to the eKINO-945GSE to one or two IDE devices. To connect an IDE HDD to the eKINO-945GSE please follow the instructions below.

Step 1: Locate the IDE connector. The location/s of the IDE device connector/s is/are shown in **Chapter 3**.

Step 2: Insert the connector. Connect the IDE cable connector to the onboard connector. See **Figure 5-5**. A key on the front of the cable connector ensures it can only be inserted in one direction.

eKINO-945GSE Motherboard

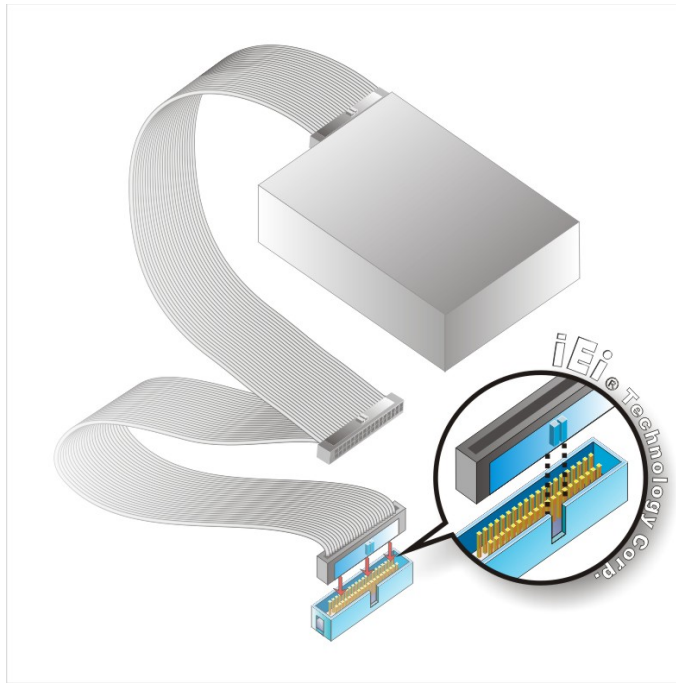

Figure 5-5: IDE Cable Connection

Step 3: **Connect the cable to an IDE device.** Connect the two connectors on the other side of the cable to one or two IDE devices. Make sure that pin 1 on the cable corresponds to pin 1 on the connector.

5.9.2 SATA Drive Connection

The eKINO-945GSE is shipped with two SATA drive cables and one SATA drive power cable. To connect the SATA drives to the connectors, please follow the steps below.

Step 1: **Locate the connectors.** The locations of the SATA drive connectors are shown in **Chapter 3**.

Step 2: **Insert the cable connector.** Press the clip on the connector at the end of the SATA cable and insert the cable connector into the onboard SATA drive connector. See **Figure 5-6**.

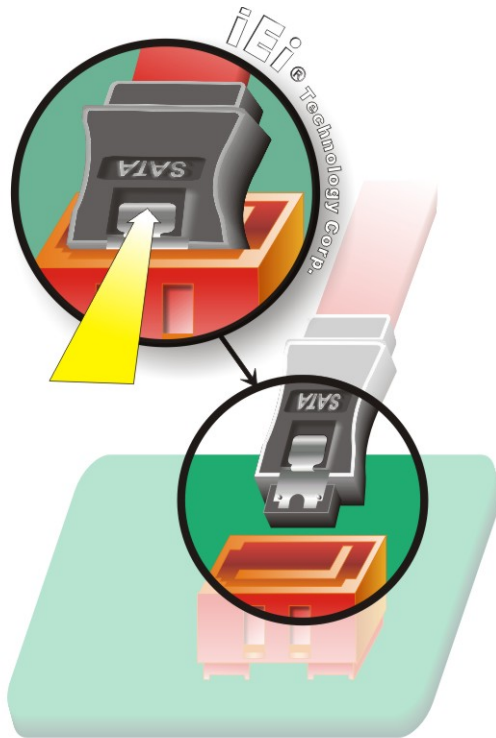

Figure 5-6: SATA Drive Cable Connection

Step 3: Connect the cable to the SATA disk. Connect the connector on the other end of the cable to the connector at the back of the SATA drive. See **Figure 5-7**.

Step 4: Connect the SATA power cable. Connect the SATA power connector to the back of the SATA drive. See **Figure 5-7**.

eKINO-945GSE Motherboard



Figure 5-7: SATA Power Drive Connection

5.9.3 Dual RS-232 Cable with Slot Bracket

The dual RS-232 cable slot connector consists of two connectors attached to two independent cables. Each cable is then attached to a D-sub 9 male connector that is mounted onto a slot. To install the dual RS-232 cable, please follow the steps below.

Step 1: Locate the connectors. The locations of the RS-232 connectors are shown in **Chapter 3**.

Step 2: Insert the cable connectors. Insert one connector into each serial port box headers. See **Figure 5-8**. A key on the front of the cable connectors ensures the connector can only be installed in one direction.

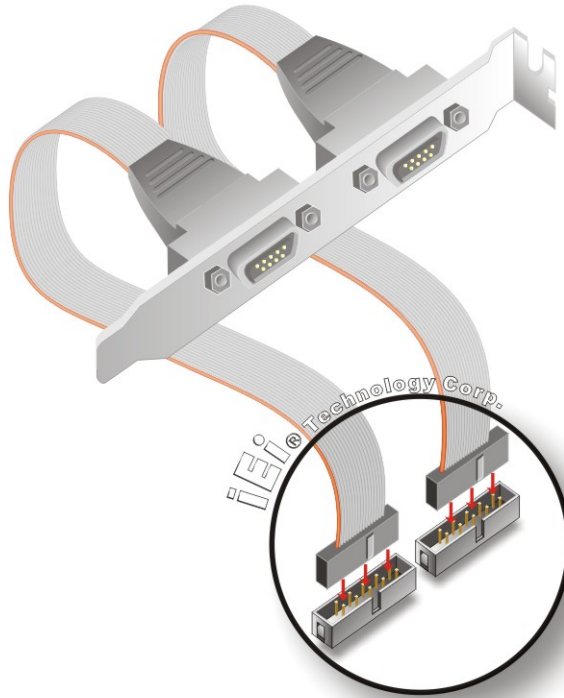

Figure 5-8: Dual RS-232 Cable Installation

Step 3: Secure the bracket. The dual RS-232 connector has two D-sub 9 male connectors secured on a bracket. To secure the bracket to the chassis please refer to the reference material that came with the chassis.

5.9.4 USB Cable (Dual Port) with Slot Bracket

The eKINO-945GSE is shipped with a dual port USB 2.0 cable. To connect the USB cable connector, please follow the steps below.

Step 1: Locate the connectors. The locations of the USB connectors are shown in Chapter 3.



WARNING:

If the USB pins are not properly aligned, the USB device can burn out.

eKINO-945GSE Motherboard

Step 2: **Align the connectors.** The cable has two connectors. Correctly align pin 1 on each cable connector with pin 1 on the eKINO-945GSE USB connector.

Step 3: **Insert the cable connectors.** Once the cable connectors are properly aligned with the USB connectors on the eKINO-945GSE, connect the cable connectors to the on-board connectors. See **Figure 5-9**.

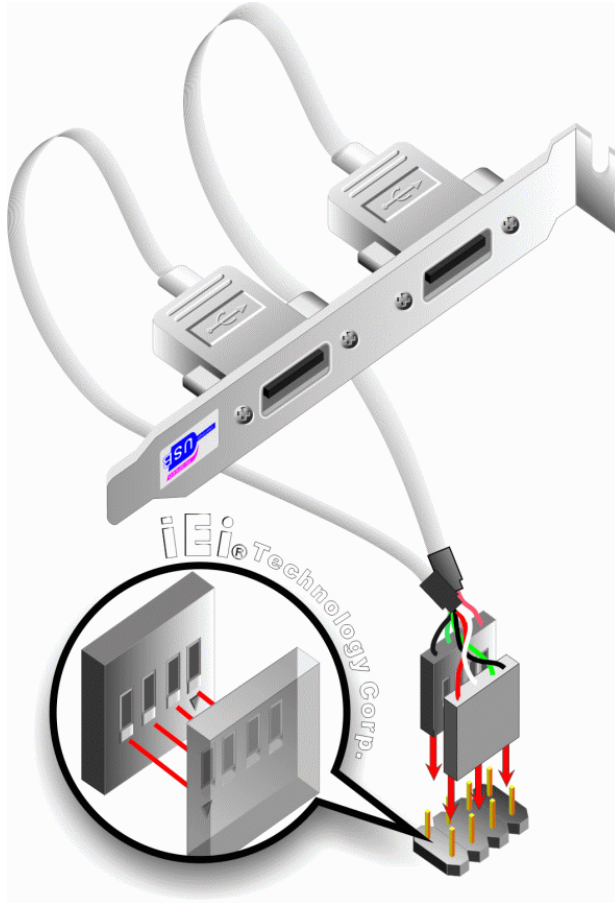

Figure 5-9: Dual USB Cable Connection

Step 4: **Attach the bracket to the chassis.** The USB 2.0 connectors are attached to a bracket. To secure the bracket to the chassis please refer to the installation instructions that came with the chassis.

5.9.5 Parallel Port Cable without Bracket

The optional parallel port (LPT) cable respectively connects the on-board LPT 26-pin box header to an external LPT device (like a printer). The cable comprises a 26-pin female header, to be connected to the on-board LPT box-header, on one side and on the other side a standard external LPT connector. To connect the LPT cable, please follow the steps below.

Step 1: Locate the connector. The LPT connector location is shown in **Chapter 4**.

Step 2: Align the connectors. Correctly align pin 1 on the cable connector with pin 1 on the eKINO-945GSE LPT box-header connector. See **Figure 5-10**.

Step 3: Insert the cable connectors Once the cable connector is properly aligned with the 26-pin box-header connector on the eKINO-945GSE, connect the cable connector to the on-board connector. See **Figure 5-10**.

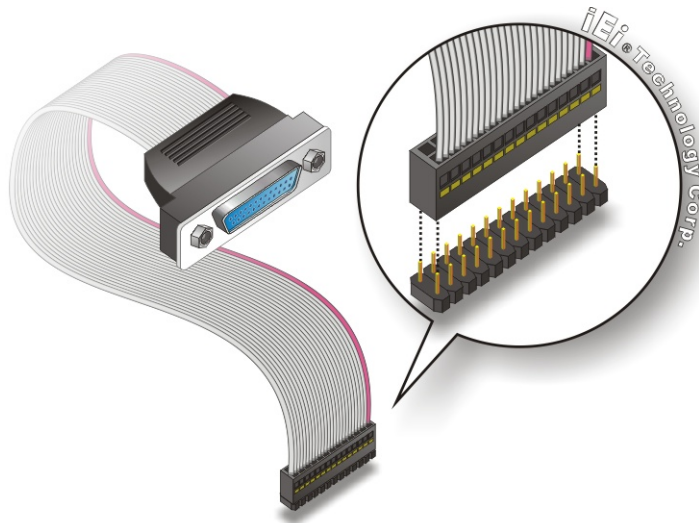

Figure 5-10: LPT Cable Connection

Step 4: Attach the LPT connector to the chassis. To secure the LPT interface connector to the chassis please refer to the installation instructions that came with the chassis.

eKINO-945GSE Motherboard

Step 5: Connect LPT device. Once the LPT interface connector is connected to the chassis, the LPT device can be connected to the LPT interface connector. See

Figure 5-11

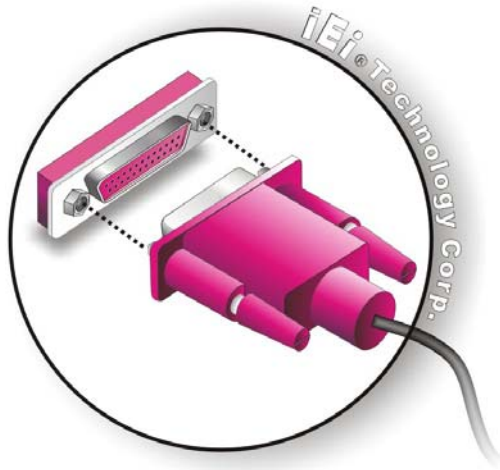

Figure 5-11: Connect the LPT Device

5.10 External Peripheral Interface Connection

The following external peripheral devices can be connected to the external peripheral interface connectors.

- RJ-45 Ethernet cable connectors
- PS/2 devices
- Serial port devices
- USB devices
- VGA monitors

To install these devices, connect the corresponding cable connector from the actual device to the corresponding eKINO-945GSE external peripheral interface connector making sure the pins are properly aligned.

5.10.1 LAN Connection (Single Connector)

There are two external RJ-45 LAN connectors. The RJ-45 connectors enable connection to an external network. To connect a LAN cable with an RJ-45 connector, please follow the instructions below.

Step 1: **Locate the RJ-45 connectors.** The locations of the USB connectors are shown in **Chapter 4**.

Step 2: **Align the connectors.** Align the RJ-45 connector on the LAN cable with one of the RJ-45 connectors on the eKINO-945GSE. See **Figure 5-12**.

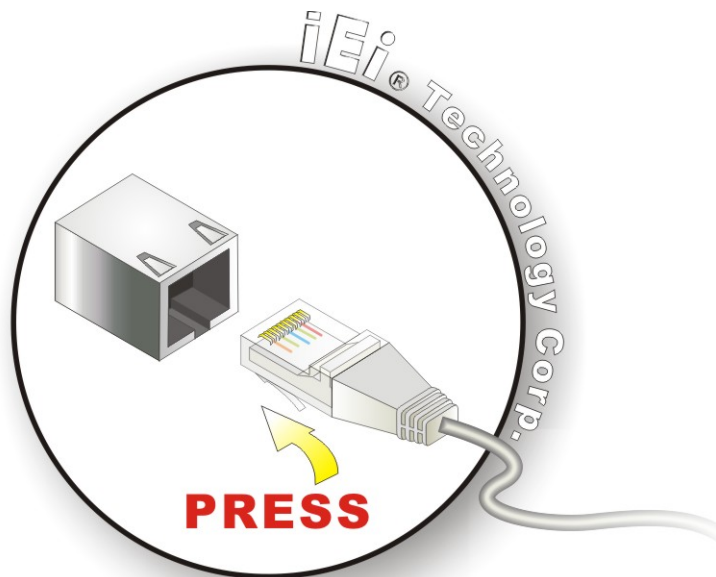

Figure 5-12: LAN Connection

Step 3: **Insert the LAN cable RJ-45 connector.** Once aligned, gently insert the LAN cable RJ-45 connector into the onboard RJ-45 connector.

5.10.2 PS/2 Y-Cable Connection

The eKINO-945GSE has a PS/2 connector on the external peripheral interface panel. The dual PS/2 connector is connected to the PS/2 Y-cable that came with the eKINO-945GSE. One of the PS/2 cables is connected to a keyboard and the other to a mouse to the system. Follow the steps below to connect a keyboard and mouse to the eKINO-945GSE.

eKINO-945GSE Motherboard

- Step 1:** Locate the dual PS/2 connector. The location of the PS/2 connector is shown in **Chapter 3**.
- Step 2:** Insert the keyboard/mouse connector. Insert the PS/2 connector on the end of the PS/2 y-cable into the external PS/2 connector. See **Figure 5-13**.

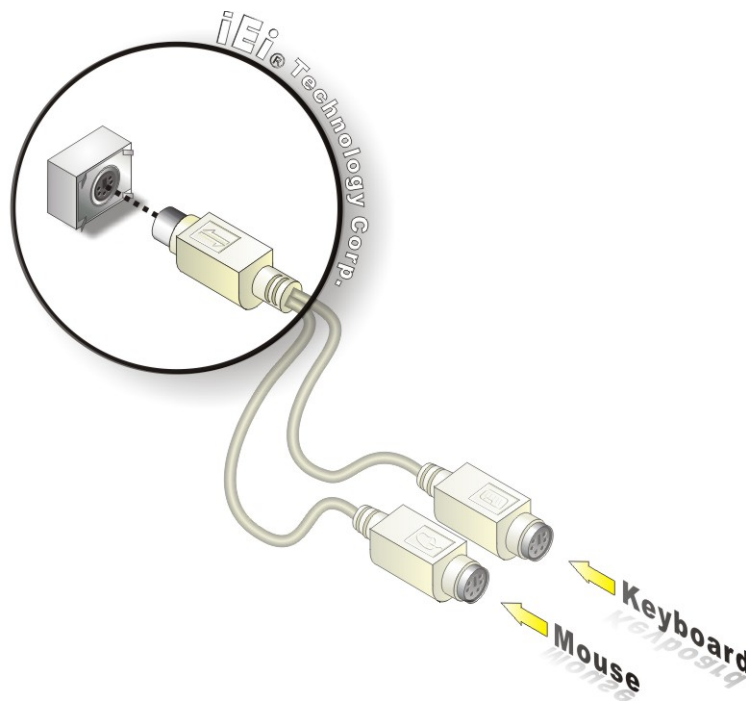

Figure 5-13: PS/2 Keyboard/Mouse Connector

- Step 3:** Connect the keyboard and mouse. Connect the keyboard and mouse to the appropriate connector. The keyboard and mouse connectors can be distinguished from each other by looking at the small graphic at the top of the connector.

5.10.3 Serial Device Connection

The eKINO-945GSE has a single female DB-9 connector on the external peripheral interface panel for a serial device. Follow the steps below to connect a serial device to the eKINO-945GSE.

Step 1: Locate the DB-9 connector. The location of the DB-9 connector is shown in Chapter 3.

Step 2: Insert the serial connector. Insert the DB-9 connector of a serial device into the DB-9 connector on the external peripheral interface. See Figure 5-14.

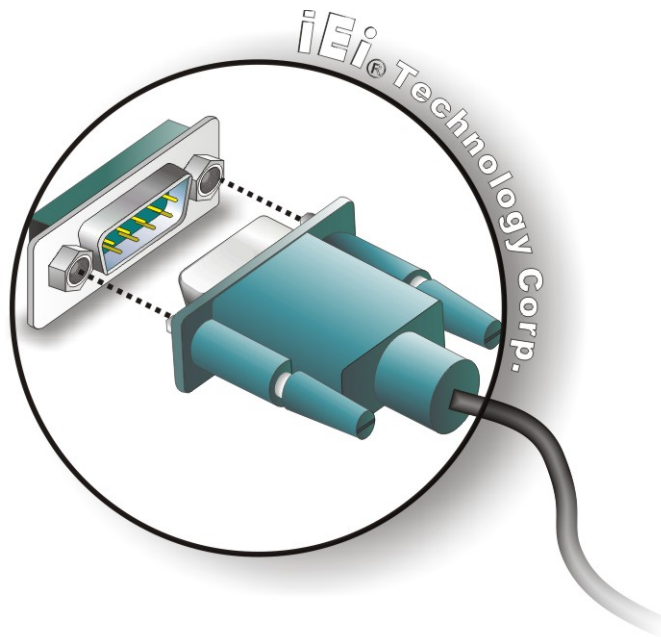

Figure 5-14: Serial Device Connector

Step 3: Secure the connector. Secure the serial device connector to the external interface by tightening the two retention screws on either side of the connector.

5.10.4 USB Connection (Dual Connector)

The external USB Series "A" receptacle connectors provide easier and quicker access to external USB devices. Follow the steps below to connect USB devices to the eKINO-945GSE.

Step 1: Locate the USB Series "A" receptacle connectors. The location of the USB Series "A" receptacle connectors are shown in Chapter 3.

eKINO-945GSE Motherboard

- Step 2:** Insert a **USB Series "A" plug**. Insert the USB Series "A" plug of a device into the USB Series "A" receptacle on the external peripheral interface. See **Figure 5-15**.

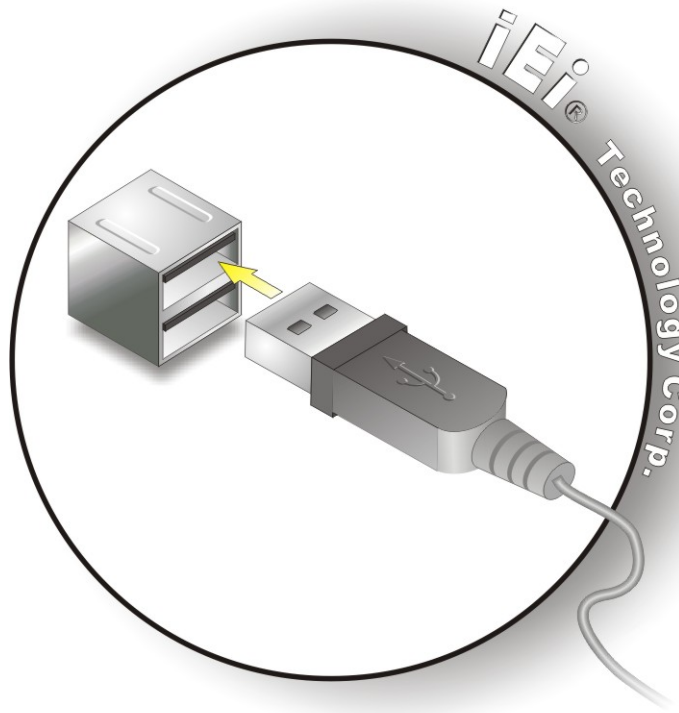

Figure 5-15: USB Connector

5.10.5 VGA Monitor Connection

The eKINO-945GSE has a single female DB-15 connector on the external peripheral interface panel. The DB-15 connector is connected to a CRT or VGA monitor. To connect a monitor to the eKINO-945GSE, please follow the instructions below.

- Step 1:** **Locate the female DB-15 connector.** The location of the female DB-15 connector is shown in **Chapter 3**.
- Step 2:** **Align the VGA connector.** Align the male DB-15 connector on the VGA screen cable with the female DB-15 connector on the external peripheral interface.

Step 3: Insert the VGA connector. Once the connectors are properly aligned with the insert the male connector from the VGA screen into the female connector on the eKINO-945GSE. See **Figure 5-16**.

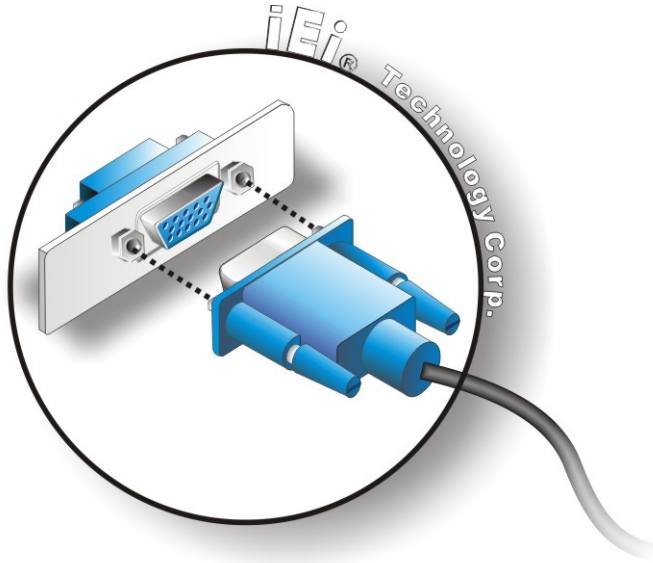

Figure 5-16: VGA Connector

Step 4: Secure the connector. Secure the DB-15 VGA connector from the VGA monitor to the external interface by tightening the two retention screws on either side of the connector.

Chapter

6

BIOS Setup

6.1 Introduction

A licensed copy of AMI BIOS is preprogrammed into the ROM BIOS. The BIOS setup program allows users to modify the basic system configuration. This chapter describes how to access the BIOS setup program and the configuration options that may be changed.

6.1.1 Starting Setup

The AMI BIOS is activated when the computer is turned on. The setup program can be activated in one of two ways.

1. Press the **DELETE** key as soon as the system is turned on or
2. Press the **DELETE** key when the “**Press Del to enter SETUP**” message appears on the screen.

If the message disappears before the **DELETE** key is pressed, restart the computer and try again.

6.1.2 Using Setup

Use the arrow keys to highlight items, press **ENTER** to select, use the PageUp and PageDown keys to change entries, press **F1** for help and press **ESC** to quit. Navigation keys are shown in.

Key	Function
Up arrow	Move to previous item
Down arrow	Move to next item
Left arrow	Move to the item on the left hand side
Right arrow	Move to the item on the right hand side
Esc key	Main Menu – Quit and not save changes into CMOS Status Page Setup Menu and Option Page Setup Menu -- Exit current page and return to Main Menu
Page Up key	Increase the numeric value or make changes
Page Dn key	Decrease the numeric value or make changes

eKINO-945GSE Motherboard

Key	Function
F1 key	General help, only for Status Page Setup Menu and Option Page Setup Menu
F2 /F3 key	Change color from total 16 colors. F2 to select color forward.
F10 key	Save all the CMOS changes, only for Main Menu

Table 6-1: BIOS Navigation Keys

6.1.3 Getting Help

When **F1** is pressed a small help window describing the appropriate keys to use and the possible selections for the highlighted item appears. To exit the Help Window press **Esc** or the **F1** key again.

6.1.4 Unable to Reboot After Configuration Changes

If the computer cannot boot after changes to the system configuration is made, CMOS defaults. Use the jumper described in **Chapter 5**.

6.1.5 BIOS Menu Bar

The **menu bar** on top of the BIOS screen has the following main items:

- **Main** Changes the basic system configuration.
- **Advanced** Changes the advanced system settings.
- **PCIPnP** Changes the advanced PCI/PnP Settings
- **Boot** Changes the system boot configuration.
- **Security** Sets User and Supervisor Passwords.
- **Chipset** Changes the chipset settings.
- **Power** Changes power management settings.
- **Exit** Selects exit options and loads default settings

The following sections completely describe the configuration options found in the menu items at the top of the BIOS screen and listed above.

6.2 Main

The **Main** BIOS menu (**BIOS Menu 1**) appears when the **BIOS Setup** program is entered. The **Main** menu gives an overview of the basic system information.

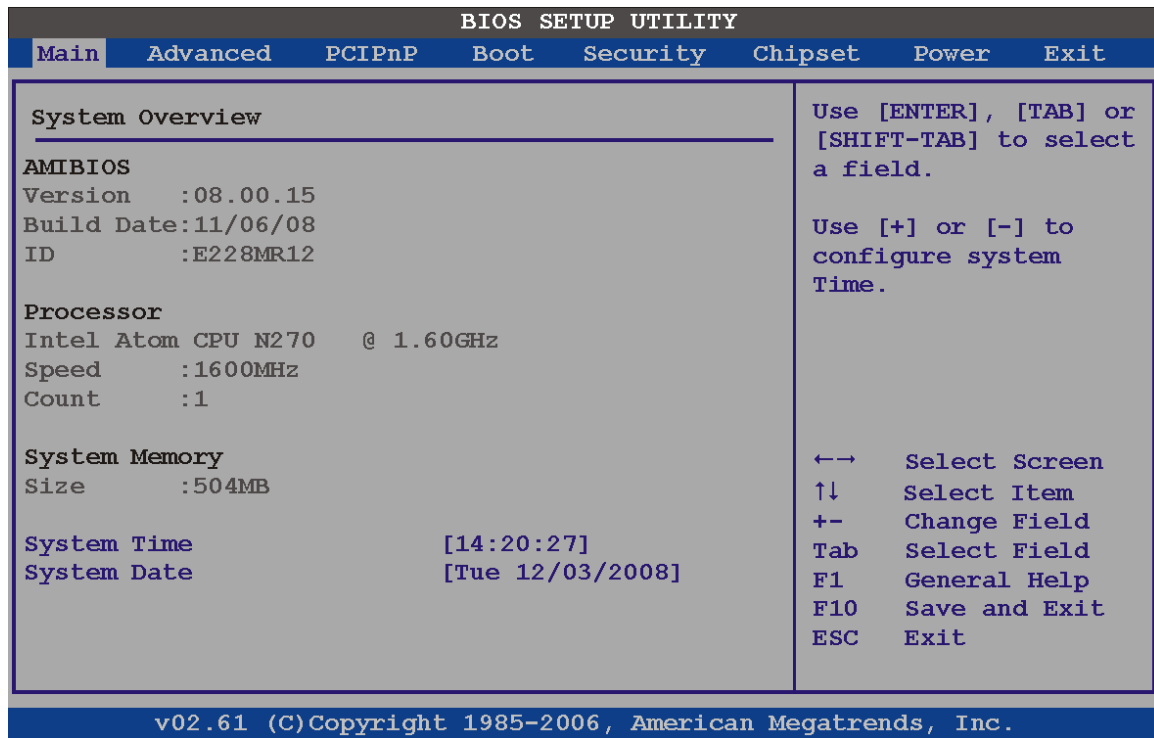

BIOS Menu 1: Main

→ System Overview

The **System Overview** lists a brief summary of different system components. The fields in **System Overview** cannot be changed. The items shown in the system overview include:

- **AMI BIOS:** Displays auto-detected BIOS information
 - Version: Current BIOS version
 - Build Date: Date the current BIOS version was made
 - ID: Installed BIOS ID
- **Processor:** Displays auto-detected CPU specifications
 - Type: Names the currently installed processor
 - Speed: Lists the processor speed
 - Count: The number of CPUs on the motherboard

eKINO-945GSE Motherboard

- **System Memory:** Displays the auto-detected system memory.
 - Size: Lists memory size

The **System Overview** field also has two user configurable fields:

→ **System Time [xx:xx:xx]**

Use the **System Time** option to set the system time. Manually enter the hours, minutes and seconds.

→ **System Date [xx/xx/xx]**

Use the **System Date** option to set the system date. Manually enter the day, month and year.

6.3 Advanced

Use the **Advanced** menu (**BIOS Menu 2**) to configure the CPU and peripheral devices through the following sub-menus:



WARNING:

Setting the wrong values in the sections below may cause the system to malfunction. Make sure that the settings made are compatible with the hardware.

▪ 6.3.1 CPU Configuration	95
▪ 6.3.2 IDE Configuration.....	96
▪ 6.3.3 Super IO Configuration	103
▪ 6.3.4 Hardware Health Configuration.....	106
▪ 6.3.5 Power Configuration.....	110
▪ 6.3.6 Remote Configuration	114
▪ 6.3.7 USB Configuration	118

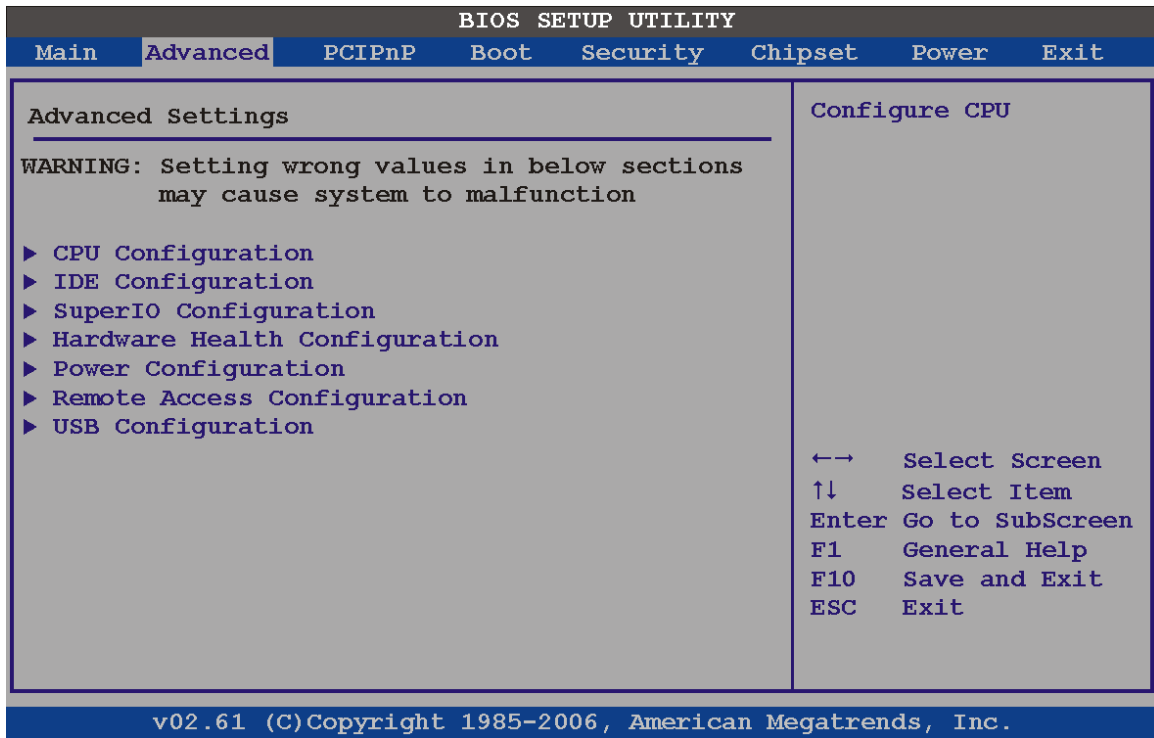
**BIOS Menu 2: Advanced**

eKINO-945GSE Motherboard

6.3.1 CPU Configuration

Use the **CPU Configuration** menu (**BIOS Menu 3**) to view detailed CPU specifications and configure the CPU.

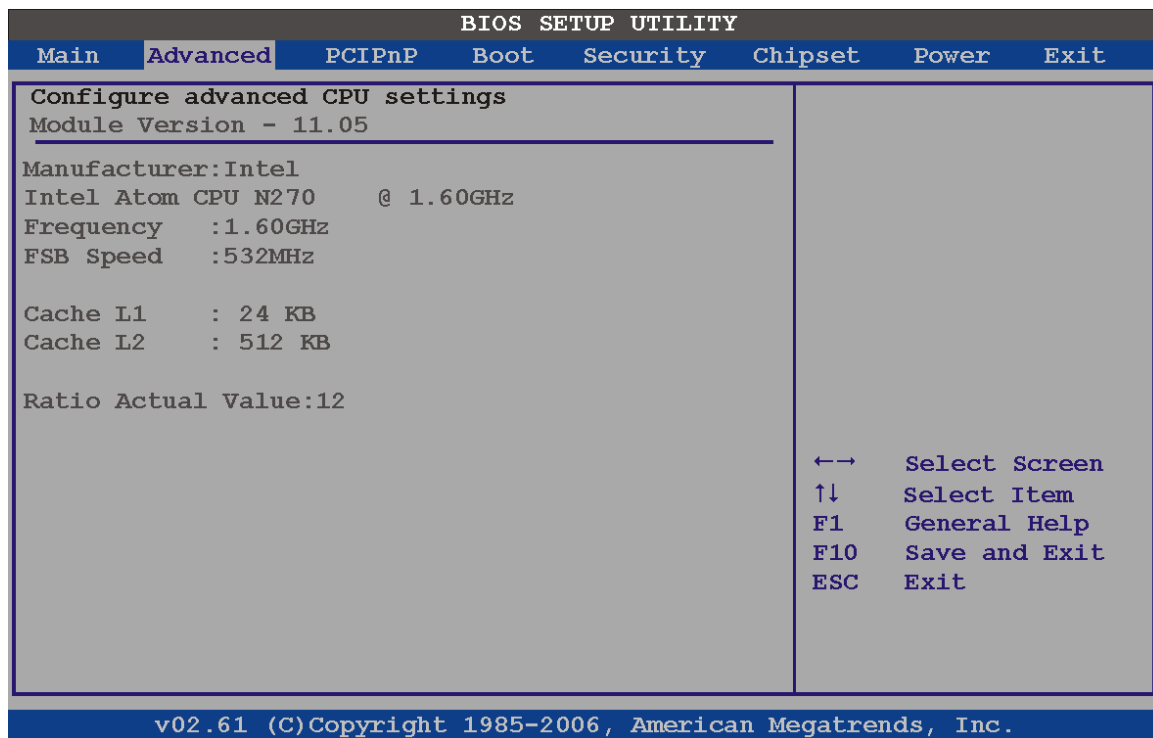

BIOS Menu 3: CPU Configuration

The CPU Configuration menu (**BIOS Menu 3**) lists the following CPU details:

- **Manufacturer:** Lists the name of the CPU manufacturer
- **Brand String:** Lists the brand name of the CPU being used
- **Frequency:** Lists the CPU processing speed
- **FSB Speed:** Lists the FSB speed
- **Cache L1:** Lists the CPU L1 cache size
- **Cache L2:** Lists the CPU L2 cache size

6.3.2 IDE Configuration

Use the **IDE Configuration** menu (**BIOS Menu 4**) to change and/or set the configuration of the IDE devices installed in the system.

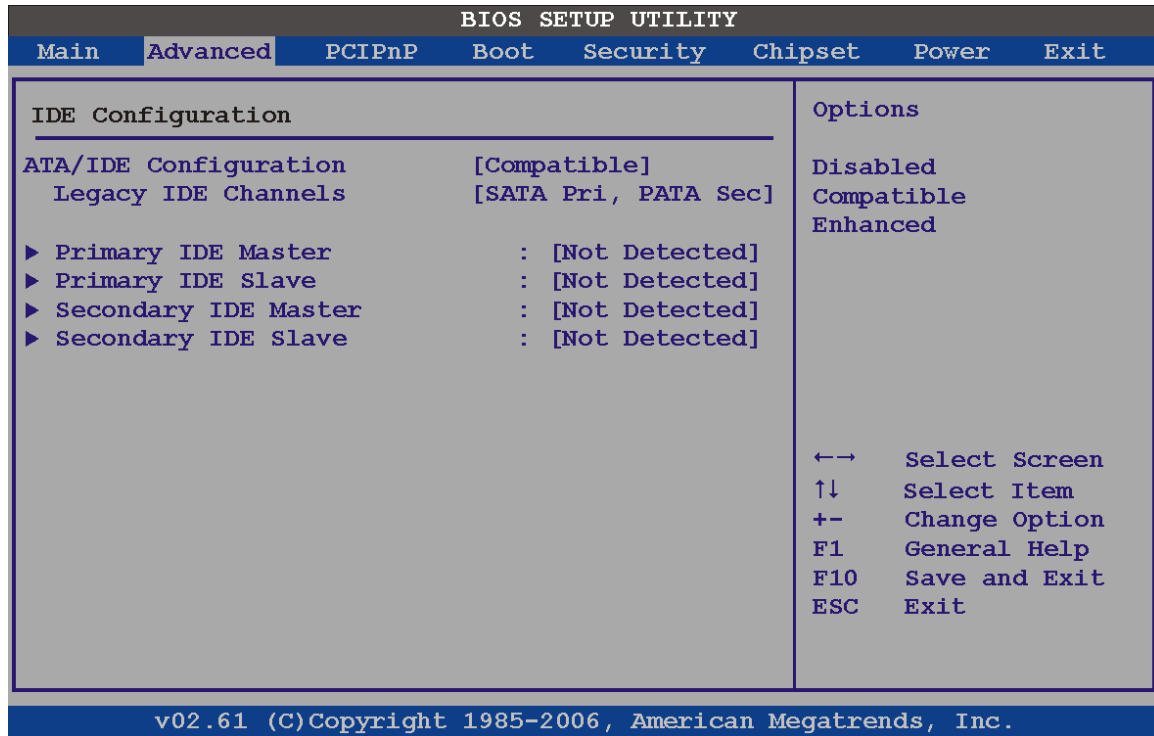

BIOS Menu 4: IDE Configuration

→ ATA/IDE Configurations [Compatible]

Use the **ATA/IDE Configurations** option to configure the ATA/IDE controller.

- **Disabled** Disables the on-board ATA/IDE controller.
- **Compatible** Configures the on-board ATA/IDE controller to be in compatible mode. In this mode, a SATA channel will replace one of the IDE channels. This mode supports up to 4 storage devices.

eKINO-945GSE Motherboard

- **Enhanced** **DEFAULT** Configures the on-board ATA/IDE controller to be in Enhanced mode. In this mode, IDE channels and SATA channels are separated. This mode supports up to 6 storage devices. Some legacy OS do not support this mode.

- **Legacy IDE Channels [PATA Pri, SATA Sec]**
 - **SATA Only** Only the SATA drives are enabled.
 - **SATA Pri, PATA Sec** **DEFAULT** The IDE drives are enabled on the Primary IDE channel. The SATA drives are enabled on the Secondary IDE channel.
 - **PATA Only** The IDE drives are enabled on the primary and secondary IDE channels. SATA drives are disabled.

→ IDE Master and IDE Slave

When entering setup, BIOS auto detects the presence of IDE devices. BIOS displays the status of the auto detected IDE devices. The following IDE devices are detected and are shown in the **IDE Configuration** menu:

- Primary IDE Master
- Primary IDE Slave
- Secondary IDE Master
- Secondary IDE Slave

The **IDE Configuration** menu (**BIOS Menu 4**) allows changes to the configurations for the IDE devices installed in the system. If an IDE device is detected, and one of the above listed four BIOS configuration options are selected, the IDE configuration options shown in **Section 876.3.2.1** appear.

6.3.2.1 IDE Master, IDE Slave

Use the **IDE Master** and **IDE Slave** configuration menu to view both primary and secondary IDE device details and configure the IDE devices connected to the system.

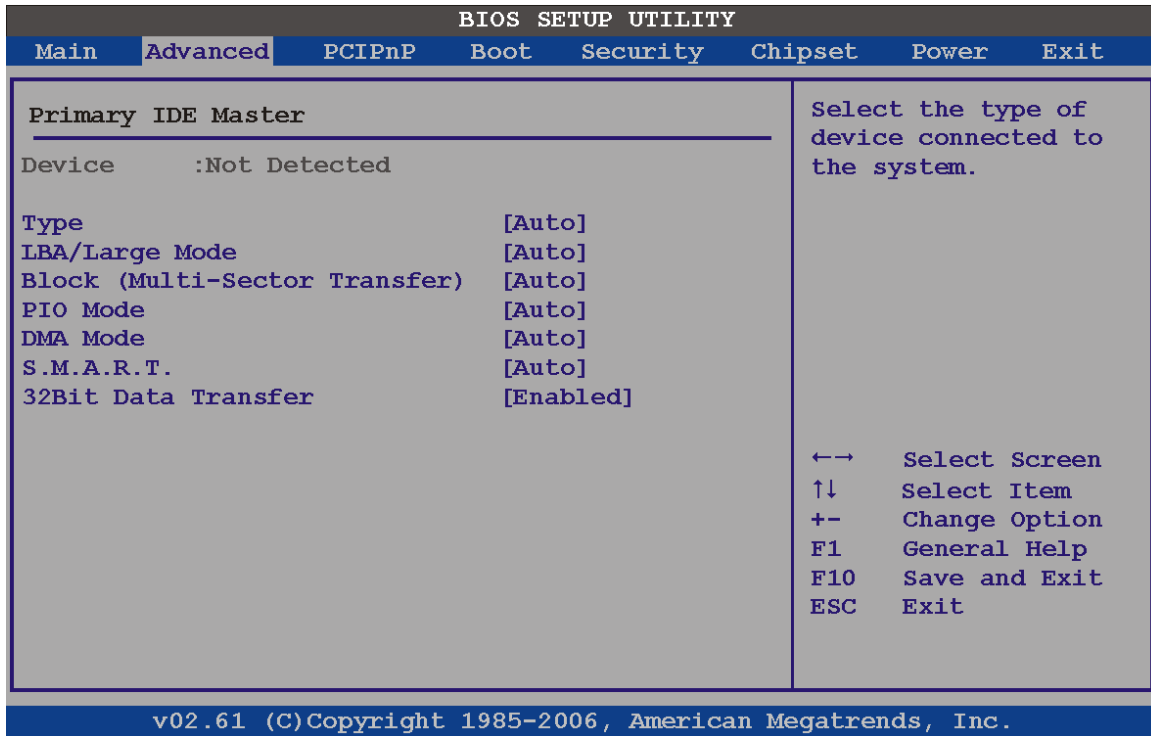

BIOS Menu 5: IDE Master and IDE Slave Configuration

➔ Auto-Detected Drive Parameters

The “grayed-out” items in the left frame are IDE disk drive parameters automatically detected from the firmware of the selected IDE disk drive. The drive parameters are listed as follows:

- **Device:** Lists the device type (e.g. hard disk, CD-ROM etc.)
- **Type:** Indicates the type of devices a user can manually select
- **Vendor:** Lists the device manufacturer
- **Size:** List the storage capacity of the device.
- **LBA Mode:** Indicates whether the LBA (Logical Block Addressing) is a method of addressing data on a disk drive is supported or not.

eKINO-945GSE Motherboard

- **Block Mode:** Block mode boosts IDE drive performance by increasing the amount of data transferred. Only 512 bytes of data can be transferred per interrupt if block mode is not used. Block mode allows transfers of up to 64 KB per interrupt.
- **PIO Mode:** Indicates the PIO mode of the installed device.
- **Async DMA:** Indicates the highest Asynchronous DMA Mode that is supported.
- **Ultra DMA:** Indicates the highest Synchronous DMA Mode that is supported.
- **S.M.A.R.T.:** Indicates whether or not the Self-Monitoring Analysis and Reporting Technology protocol is supported.
- **32Bit Data Transfer:** Enables 32-bit data transfer.

→ Type [Auto]

Use the **Type** BIOS option select the type of device the AMIBIOS attempts to boot from after the Power-On Self-Test (POST) is complete.

- | | | |
|---|----------------------------|---|
| → | Not Installed | BIOS is prevented from searching for an IDE disk drive on the specified channel. |
| → | Auto DEFAULT | The BIOS auto detects the IDE disk drive type attached to the specified channel. This setting should be used if an IDE hard disk drive is attached to the specified channel. |
| → | CD/DVD | The CD/DVD option specifies that an IDE CD-ROM drive is attached to the specified IDE channel. The BIOS does not attempt to search for other types of IDE disk drives on the specified channel. |
| → | ARMD | This option specifies an ATAPI Removable Media Device. These include, but are not limited to:

ZIP

LS-120 |

→ LBA/Large Mode [Auto]

Use the **LBA/Large Mode** option to disable or enable BIOS to auto detects LBA (Logical Block Addressing). LBA is a method of addressing data on a disk drive. In LBA mode, the maximum drive capacity is 137 GB.

- Disabled** BIOS is prevented from using the LBA mode control on the specified channel.
- Auto** **DEFAULT** BIOS auto detects the LBA mode control on the specified channel.

→ Block (Multi Sector Transfer) [Auto]

Use the **Block (Multi Sector Transfer)** to disable or enable BIOS to auto detect if the device supports multi-sector transfers.

- Disabled** BIOS is prevented from using Multi-Sector Transfer on the specified channel. The data to and from the device occurs one sector at a time.
- Auto** **DEFAULT** BIOS auto detects Multi-Sector Transfer support on the drive on the specified channel. If supported the data transfer to and from the device occurs multiple sectors at a time.

→ PIO Mode [Auto]

Use the **PIO Mode** option to select the IDE PIO (Programmable I/O) mode program timing cycles between the IDE drive and the programmable IDE controller. As the PIO mode increases, the cycle time decreases.

- Auto** **DEFAULT** BIOS auto detects the PIO mode. Use this value if the IDE disk drive support cannot be determined.
- 0** PIO mode 0 selected with a maximum transfer rate of 3.3 MB/s
- 1** PIO mode 1 selected with a maximum transfer rate of 5.2 MB/s
- 2** PIO mode 2 selected with a maximum transfer rate of 8.3 MB/s

eKINO-945GSE Motherboard

- 3 PIO mode 3 selected with a maximum transfer rate of 11.1 MB/s
- 4 PIO mode 4 selected with a maximum transfer rate of 16.6 MB/s
(This setting generally works with all hard disk drives manufactured after 1999. For other disk drives, such as IDE CD-ROM drives, check the specifications of the drive.)

→ DMA Mode [Auto]

Use the **DMA Mode** BIOS selection to adjust the DMA mode options.

- **Auto** **DEFAULT** BIOS auto detects the DMA mode. Use this value if the IDE disk drive support cannot be determined.
- **SWDMA0** Single Word DMA mode 0 selected with a maximum data transfer rate of 2.1 MB/s
- **SWDMA1** Single Word DMA mode 1 selected with a maximum data transfer rate of 4.2 MB/s
- **SWDMA2** Single Word DMA mode 2 selected with a maximum data transfer rate of 8.3 MB/s
- **MWDMA0** Multi Word DMA mode 0 selected with a maximum data transfer rate of 4.2 MB/s
- **MWDMA1** Multi Word DMA mode 1 selected with a maximum data transfer rate of 13.3 MB/s
- **MWDMA2** Multi Word DMA mode 2 selected with a maximum data transfer rate of 16.6 MB/s
- **UDMA1** Ultra DMA mode 0 selected with a maximum data transfer rate of 16.6 MB/s
- **UDMA1** Ultra DMA mode 1 selected with a maximum data transfer rate of 25 MB/s
- **UDMA2** Ultra DMA mode 2 selected with a maximum data transfer rate of 33.3 MB/s

- **UDMA3** Ultra DMA mode 3 selected with a maximum data transfer rate of 44 MB/s (To use this mode, it is required that an 80-conductor ATA cable is used.)
- **UDMA4** Ultra DMA mode 4 selected with a maximum data transfer rate of 66.6 MB/s (To use this mode, it is required that an 80-conductor ATA cable is used.)
- **UDMA5** Ultra DMA mode 5 selected with a maximum data transfer rate of 99.9 MB/s (To use this mode, it is required that an 80-conductor ATA cable is used.)

→ **S.M.A.R.T [Auto]**

Use the **S.M.A.R.T** option to auto-detect, disable or enable Self-Monitoring Analysis and Reporting Technology (SMART) on the drive on the specified channel. **S.M.A.R.T** predicts impending drive failures. The **S.M.A.R.T** BIOS option enables or disables this function.

- **Auto** **DEFAULT** BIOS auto detects HDD SMART support.
- **Disabled** Prevents BIOS from using the HDD SMART feature.
- **Enabled** Allows BIOS to use the HDD SMART feature

→ **32Bit Data Transfer [Enabled]**

Use the **32Bit Data Transfer** BIOS option to enables or disable 32-bit data transfers.

- **Disabled** Prevents the BIOS from using 32-bit data transfers.
- **Enabled** **DEFAULT** Allows BIOS to use 32-bit data transfers on supported hard disk drives.

eKINO-945GSE Motherboard

6.3.3 Super IO Configuration

Use the **Super IO Configuration** menu (**BIOS Menu 6**) to set or change the configurations for the FDD controllers, parallel ports and serial ports.

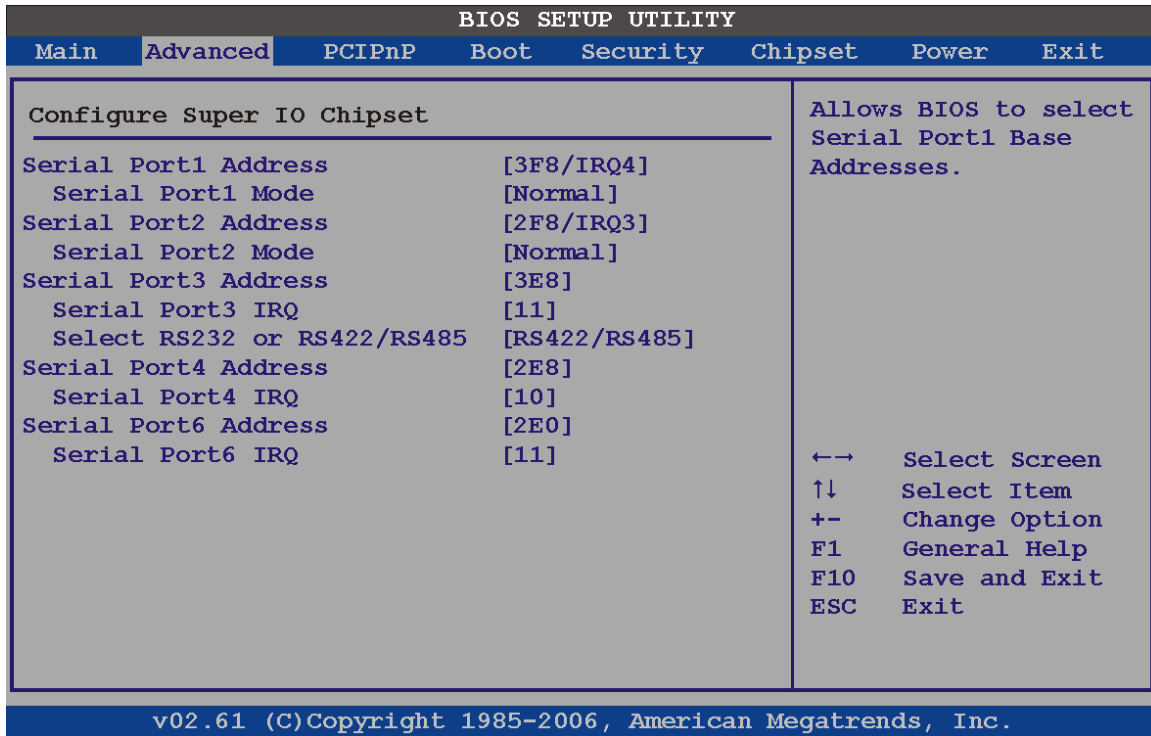

BIOS Menu 6: Super IO Configuration

➔ Serial Port1 Address [3F8/IRQ4]

Use the **Serial Port1 Address** option to select the I/O and IRQ base addresses.

- ➔ **Disabled** No base address is assigned to Serial Port 1
- ➔ **3F8/IRQ4** **DEFAULT** I/O port address is 3F8 and the interrupt address is IRQ4
- ➔ **3E8/IRQ4** I/O port address is 3E8 and the interrupt address is IRQ4
- ➔ **2E8/IRQ3** I/O port address is 2E8 and the interrupt address is IRQ3

➔ Serial Port1 Mode [Normal]

Use the **Serial Port1 Mode** option to select the transmitting and receiving mode.

- Normal Default
- IrDA
- ASK IR

➔ **Serial Port2 Address [2F8/IRQ3]**

Use the **Serial Port2 Address** option to select the I/O and IRQ addresses.

- ➔ **Disabled** No base address is assigned to Serial Port 2
- ➔ **2F8/IRQ3** **DEFAULT** I/O port address is 3F8 and the interrupt address is IRQ3
- ➔ **3E8/IRQ4** I/O port address is 3E8 and the interrupt address is IRQ4
- ➔ **2E8/IRQ3** I/O port address is 2E8 and the interrupt address is IRQ3

➔ **Serial Port2 Mode [Normal]**

Use the **Serial Port2 Mode** option to select the transmitting and receiving mode.

- Normal Default
- IrDA
- ASK IR

➔ **Serial Port3 Address [3E8]**

Use the **Serial Port 3 Address** option to set the I/O address.

- ➔ **Disabled** No I/O address assigned
- ➔ **3E8** **DEFAULT** The assigned I/O address is 3E8
- ➔ **2E8** The assigned I/O address is 2E8
- ➔ **2F0** The assigned I/O address is 2F0
- ➔ **2E0** The assigned I/O address is 2E0

➔ **Serial Port 3 IRQ [11]**

Use the **Serial Port 3 IRQ** option selects the IRQ.

- 11 Default

eKINO-945GSE Motherboard

- 10

→ Select RS232 or RS422/RS485 [RS232]

Use the **Select RS232 or RS422/RS485** option to select the transmitting and receiving mode.

- RS232 Default
- RS422/485

→ Serial Port4 Address [2E8]

Use the **Serial Port 4 Address** option to set the I/O address.

- **Disabled** No I/O address assigned
- **3E8** The assigned I/O address is 3E8
- **2E8** **DEFAULT** The assigned I/O address is 2E8
- **2F0** The assigned I/O address is 2F0
- **2E0** The assigned I/O address is 2E0

→ Serial Port 4 IRQ [10]

Use the **Serial Port 4 IRQ** option selects the IRQ.

- 11
- 10 Default

→ Serial Port6 Address [2E0]

Use the **Serial Port 6 Address** option to set the I/O address.

- **Disabled** No I/O address assigned
- **3E8** The assigned I/O address is 3E8
- **2E8** The assigned I/O address is 2E8
- **2F0** The assigned I/O address is 2F0

→ 2E0 **DEFAULT** The assigned I/O address is 2E0

→ **Serial Port 6 IRQ [11]**

Use the **Serial Port 4 IRQ** option selects the IRQ.

- 11 **DEFAULT**
- 10

6.3.4 Hardware Health Configuration

The **Hardware Health Configuration** menu (**BIOS Menu 7**) shows the operating temperature, fan speeds and system voltages.

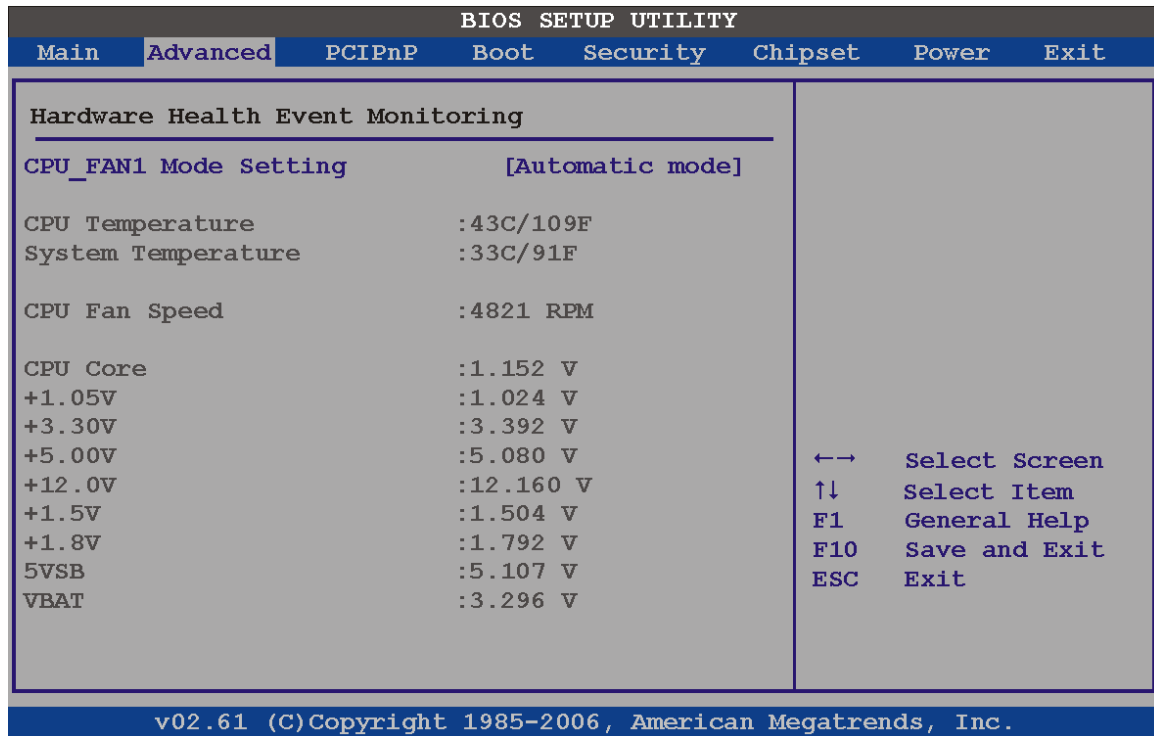

BIOS Menu 7: Hardware Health Configuration

→ **CPU FAN Mode Setting [Full On Mode]**

Use the **CPU FAN Mode Setting** option to configure the second fan.

eKINO-945GSE Motherboard

- | | | | |
|---|------------------------|----------------|--|
| → | Full On Mode | DEFAULT | Fan is on all the time |
| → | Automatic mode | | Fan is off when the temperature is low enough. Parameters must be set by the user. |
| → | PWM Manual mode | | Pulse width modulation set manually |

When the **CPU FAN Mode Setting** option is in the **Automatic Mode**, the following parameters can be set.

- CPU Temp. Limit of OFF
- CPU Temp. Limit of Start
- CPU Fan Start PWM
- Slope PWM 1

When the **CPU FAN Mode Setting** option is in the **PWM Manual Mode**, the following parameters can be set.

- CPU Fan PWM control

→ CPU Temp. Limit of OFF [000]



WARNING:

Setting this value too high may cause the fan to stop when the CPU is at a high temperature and therefore cause the system to be damaged.

The **CPU Temp. Limit of OFF** option can only be set if the **CPU FAN Mode Setting** option is set to **Automatic Mode**. Use the **CPU Temp. Limit of OFF** option to select the CPU temperature at which the cooling fan should automatically turn off. To select a value, select the **CPU Temp. Limit of OFF** option and enter a decimal number between 000 and 127. The temperature range is specified below.

- Minimum Value: 0°C
- Maximum Value: 127°C

→ CPU Temp. Limit of Start [020]



WARNING:

Setting this value too high may cause the fan to start only when the CPU is at a high temperature and therefore cause the system to be damaged.

The **CPU Temp. Limit of Start** option can only be set if the **CPU FAN Mode Setting** option is set to **Automatic Mode**. Use the **CPU Temp. Limit of Start** option to select the CPU temperature at which the cooling fan should automatically turn on. When the fan starts, it rotates using the starting pulse width modulation (PWM) specified in the **Fan 3 Start PWM** option below. To select a value, select the **CPU Temp. Limit of Start** option and enter a decimal number between 000 and 127. The temperature range is specified below.

- Minimum Value: 0°C
- Maximum Value: 127°C

→ CPU Fan Start PWM [070]

The **Fan 3 Start PWM** option can only be set if the **CPU FAN Mode Setting** option is set to **Automatic Mode**. Use the **Fan 3 Start PWM** option to select the PWM mode the fan starts to rotate with after the temperature specified in the **Temperature 3 Limit of Start** is exceeded. The Super I/O chipset supports 128 PWM modes. To select a value, select the **Fan 3 Start PWM** option and enter a decimal number between 000 and 127. The temperature range is specified below.

- PWM Minimum Mode: 0
- PWM Maximum Mode: 127

→ Slope PWM [0.5 PWM]

The **Slope PWM 1** option can only be set if the **CPU FAN Mode Setting** option is set to **Automatic Mode**. Use the **Slope PWM 1** option to select the linear rate at which the PWM mode increases with respect to an increase in temperature. A list of available options is shown below:

eKINO-945GSE Motherboard

- 0 PWM
- 1 PWM
- 2 PWM
- 4 PWM
- 8 PWM
- 16 PWM
- 32 PWM
- 64 PWM

The following system parameters and values are shown. The system parameters that are monitored are:

- **System Temperatures:** The following system temperatures are monitored
 - CPU Temperature
 - System Temperature
- **Fan Speeds:** The CPU cooling fan speed is monitored.
 - CPU Fan Speed
- **Voltages:** The following system voltages are monitored
 - CPU Core
 - +1.05 V
 - +3.30 V
 - +5.00 V
 - +12.0 V
 - +1.5 V
 - +1.8 V
 - 5 VSB
 - VBAT

6.3.5 Power Configuration

The **Power Configuration** menu (**BIOS Menu 8**) configures the Advanced Configuration and Power Interface (ACPI) and Power Management (APM) options.

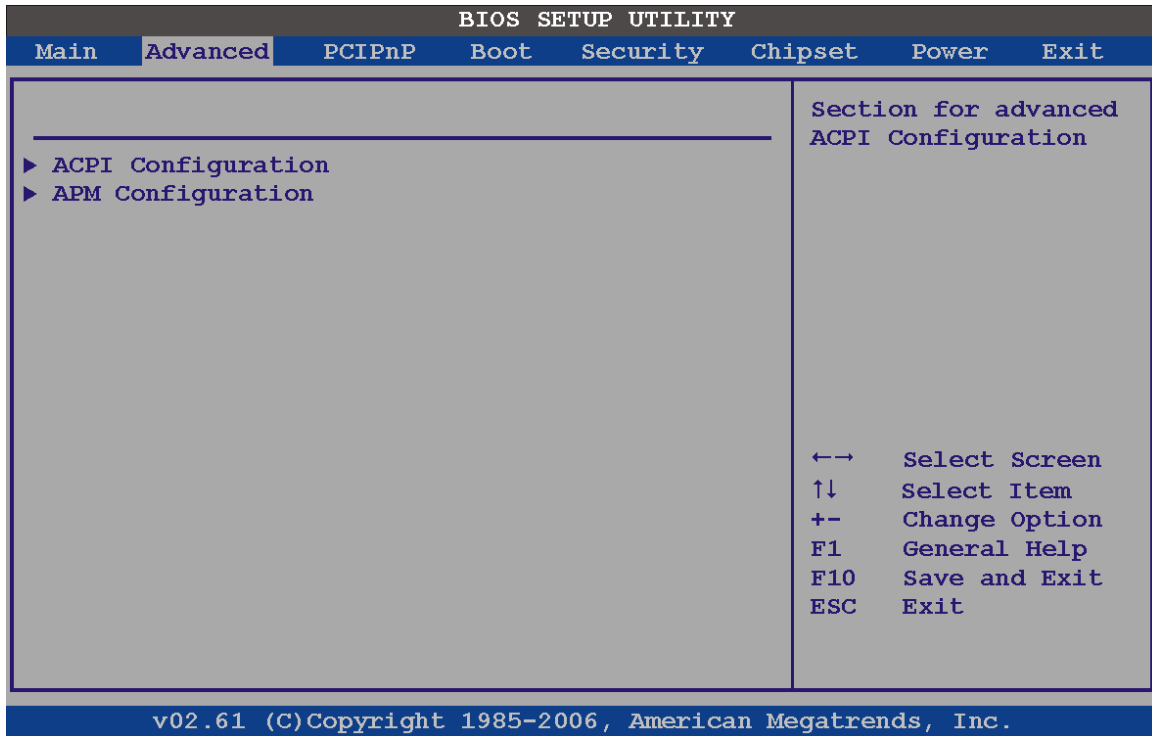

BIOS Menu 8: Power Configuration

6.3.5.1 ACPI Configuration

The **ACPI Configuration** menu (**BIOS Menu 9**) configures the Advanced Configuration and Power Interface (ACPI) and Power Management (APM) options.

eKINO-945GSE Motherboard

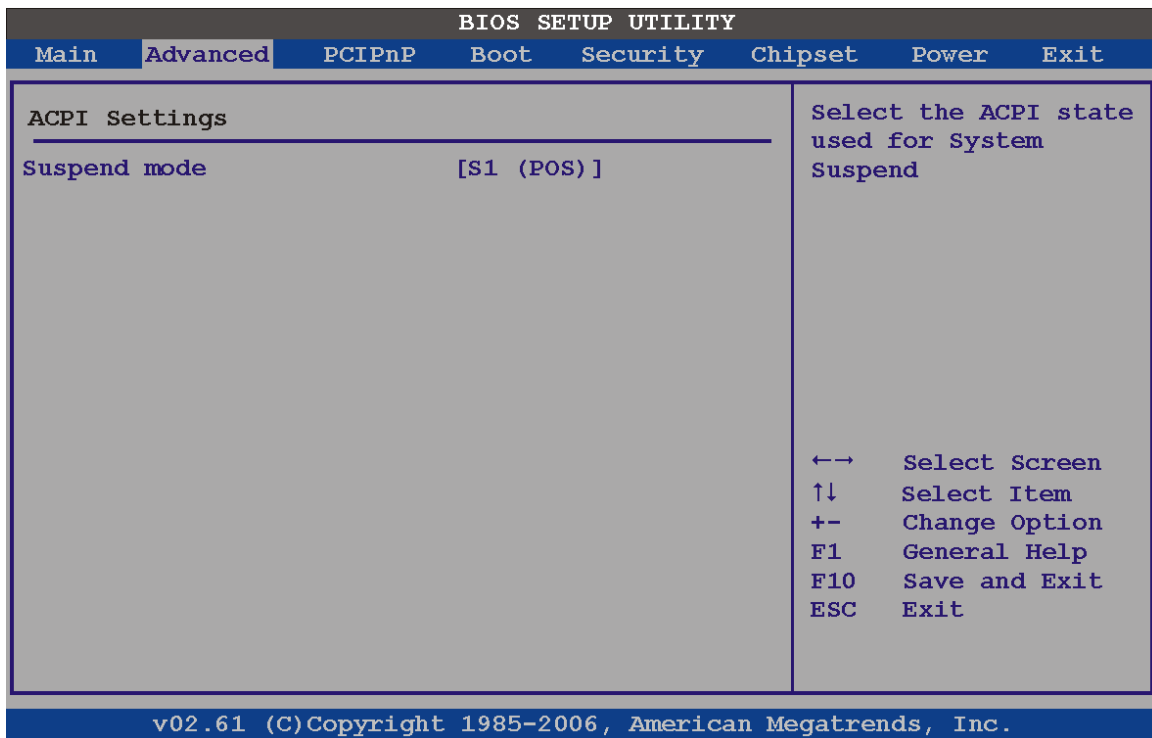

BIOS Menu 9: ACPI Configuration

→ Suspend Mode [S1(POS)]

Use the **Suspend Mode** option to specify the sleep state the system enters when it is not being used.

- **S1 (POS) DEFAULT** The system enters S1(POS) sleep state. The system appears off. The CPU is stopped; RAM is refreshed; the system is running in a low power mode.

6.3.5.2 APM Configuration

The **APM Configuration** menu (**BIOS Menu 10**) allows the advanced power management options to be configured.

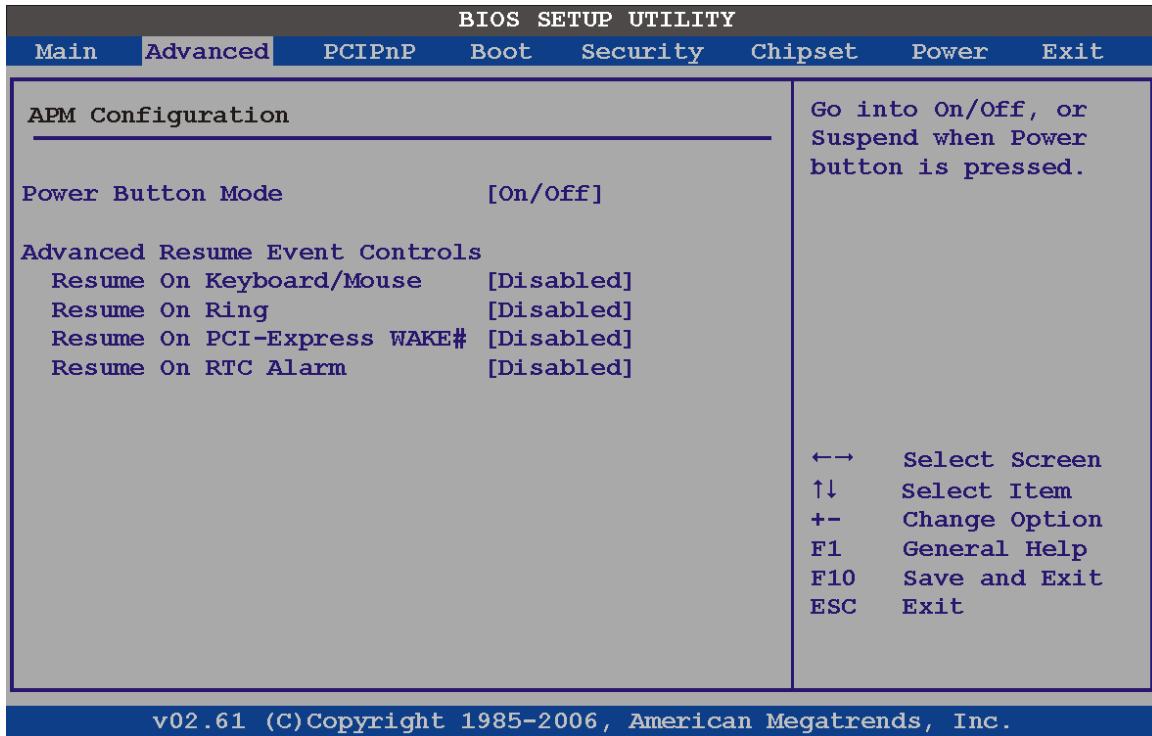

BIOS Menu 10:Advanced Power Management Configuration

→ Power Button Mode [On/Off]

Use the **Power Button Mode** BIOS to specify how the power button functions.

- **On/Off** **DEFAULT** When the power button is pressed the system is either turned on or off
- **Suspend** When the power button is pressed the system goes into suspend mode

eKINO-945GSE Motherboard

→ Resume on Keyboard/Mouse [Disabled]

Use the **Resume on Keyboard/Mouse** BIOS option to enable activity on either the keyboard or mouse to rouse the system from a suspend or standby state. That is, the system is roused when the mouse is moved or a button on the keyboard is pressed.

- **Disabled** **DEFAULT** Wake event not generated by activity on the keyboard or mouse
- **Enabled** Wake event generated by activity on the keyboard or mouse

→ Resume on Ring [Disabled]

Use the **Resume on Ring** BIOS option to enable activity on the RI (ring in) modem line to rouse the system from a suspend or standby state. That is, the system will be roused by an incoming call on a modem.

- **Disabled** **DEFAULT** Wake event not generated by an incoming call
- **Enabled** Wake event generated by an incoming call

→ Resume on PCI-Express WAKE# [Enabled]

Use the **Resume PCI-Express WAKE#** BIOS option to enable activity on the PCI-Express WAKE# signal to rouse the system from a suspend or standby state.

- **Disabled** Wake event not generated by PCI-Express WAKE# signal activity
- **Enabled** **DEFAULT** Wake event generated by PCI-Express WAKE# signal activity

→ Resume On RTC Alarm [Disabled]

Use the **Resume On RTC Alarm** option to specify the time the system should be roused from a suspended state.

- ➔ **Disabled** **DEFAULT** The real time clock (RTC) cannot generate a wake event
- ➔ **Enabled** If selected, the following appears with values that can be selected:
 - **RTC Alarm Date (Days)**
 - **RTC Alarm Time**
 After setting the alarm, the computer turns itself on from a suspend state when the alarm goes off.

6.3.6 Remote Configuration

Use the **Remote Access Configuration** menu (**BIOS Menu 11**) to configure remote access parameters. The **Remote Access Configuration** is an AMIBIOS feature and allows a remote host running a terminal program to display and configure the BIOS settings.

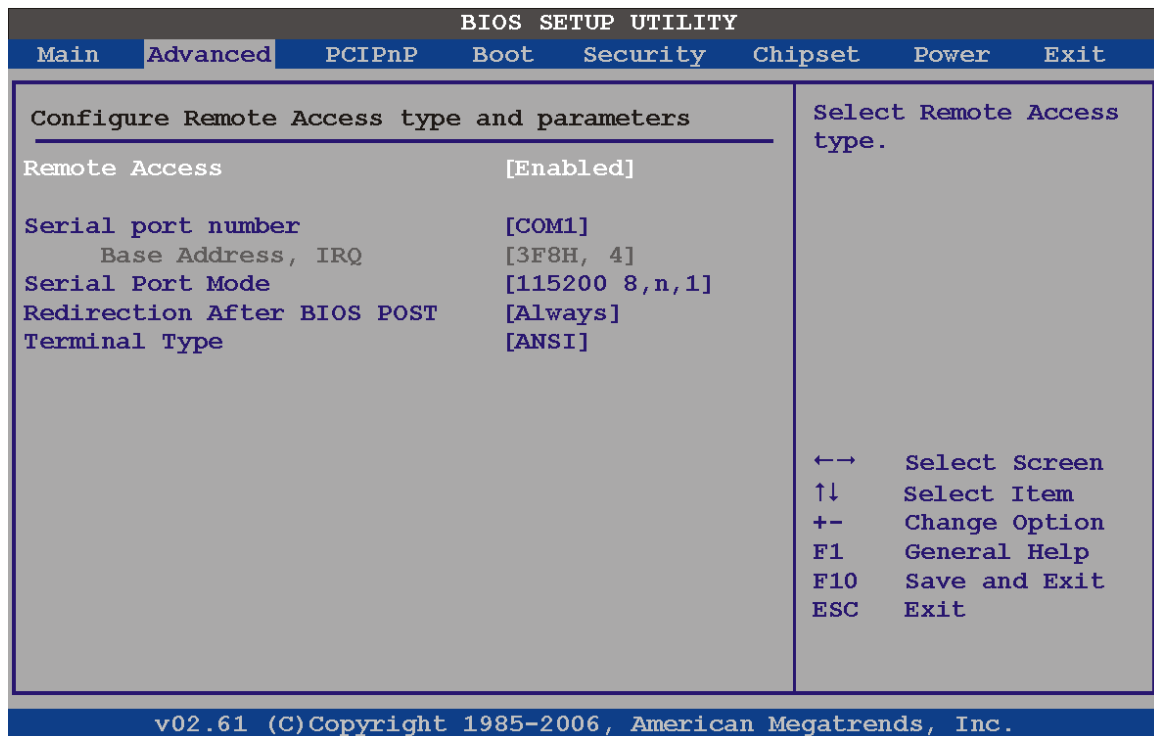

BIOS Menu 11: Remote Access Configuration

eKINO-945GSE Motherboard

→ Remote Access [Disabled]

Use the **Remote Access** option to enable or disable access to the remote functionalities of the system.

→ **Disabled** **DEFAULT** Remote access is disabled.

→ **Enabled** Remote access configuration options shown below appear:

- **Serial Port Number**
- **Serial Port Mode**
- **Flow Control**
- **Redirection after BIOS POST**
- **Terminal Type**
- **VT-UTF8 Combo Key Support**

These configuration options are discussed below.

→ Serial Port Number [COM1]

Use the **Serial Port Number** option allows to select the serial port used for remote access.

→ **COM1** **DEFAULT** System is remotely accessed through COM1

→ **COM2** System is remotely accessed through COM2

NOTE: Make sure the selected COM port is enabled through the Super I/O configuration menu.

→ Base Address, IRQ [2F8h,3]

The **Base Address, IRQ** option cannot be configured and only shows the interrupt address of the serial port listed above.

→ Serial Port Mode [115200 8,n,1]

Use the **Serial Port Mode** option to select baud rate through which the console redirection is made. The following configuration options are available

- 115200 8,n,1 DEFAULT
- 57600 8,n,1
- 38400 8,n,1
- 19200 8,n,1
- 09600 8,n,1



NOTE:

Identical baud rate setting must be set on the host (a management computer running a terminal software) and the slave

→ **Flow Control [None]**

Use the **Flow Control** option to report the flow control method for the console redirection application.

- **None** **DEFAULT** No control flow,
- **Hardware** Hardware is set as the console redirection
- **Software** Software is set as the console redirection

→ **Redirection After BIOS POST [Always]**

Use the **Redirection After BIOS POST** option to specify when console redirection should occur.

- **Disabled** The console is not redirected after POST
- **Boot Loader** Redirection is active during POST and during Boot Loader
- **Always** **DEFAULT** Redirection is always active (Some Oses may not work if set to Always)

→ **Terminal Type [ANSI]**

Use the **Terminal Type** BIOS option to specify the remote terminal type.

eKINO-945GSE Motherboard

- ➔ **ANSI** **DEFAULT** The target terminal type is ANSI
- ➔ **VT100** The target terminal type is VT100
- ➔ **VT-UTF8** The target terminal type is VT-UTF8

➔ **VT-UTF8 Combo Key Support [Disabled]**

Use the **VT-UFT8 Combo Key Support** option to enable additional keys that are not provided by VT100 for the PC 101 keyboard.

The VT100 Terminal Definition is the standard convention used to configure and conduct emergency management tasks with UNIX-based servers. VT100 does not support all keys on the standard PC 101-key layout, however. The VT-UTF8 convention makes available additional keys that are not provided by VT100 for the PC 101 keyboard.

- ➔ **Disabled** **DEFAULT** Disables the VT-UTF8 terminal keys
- ➔ **Enabled** Enables the VT-UTF8 combination key. Support for ANSI/VT100 terminals

➔ **Sredir Memory Display Delay [Disabled]**

Use the **Sredir Memory Display Delay** option to select the delay before memory information is displayed. Configuration options are listed below

- No Delay **DEFAULT**
- Delay 1 sec
- Delay 2 sec
- Delay 4 sec

6.3.7 USB Configuration

Use the **USB Configuration** menu (**BIOS Menu 12**) to read USB configuration information and configure the USB settings.

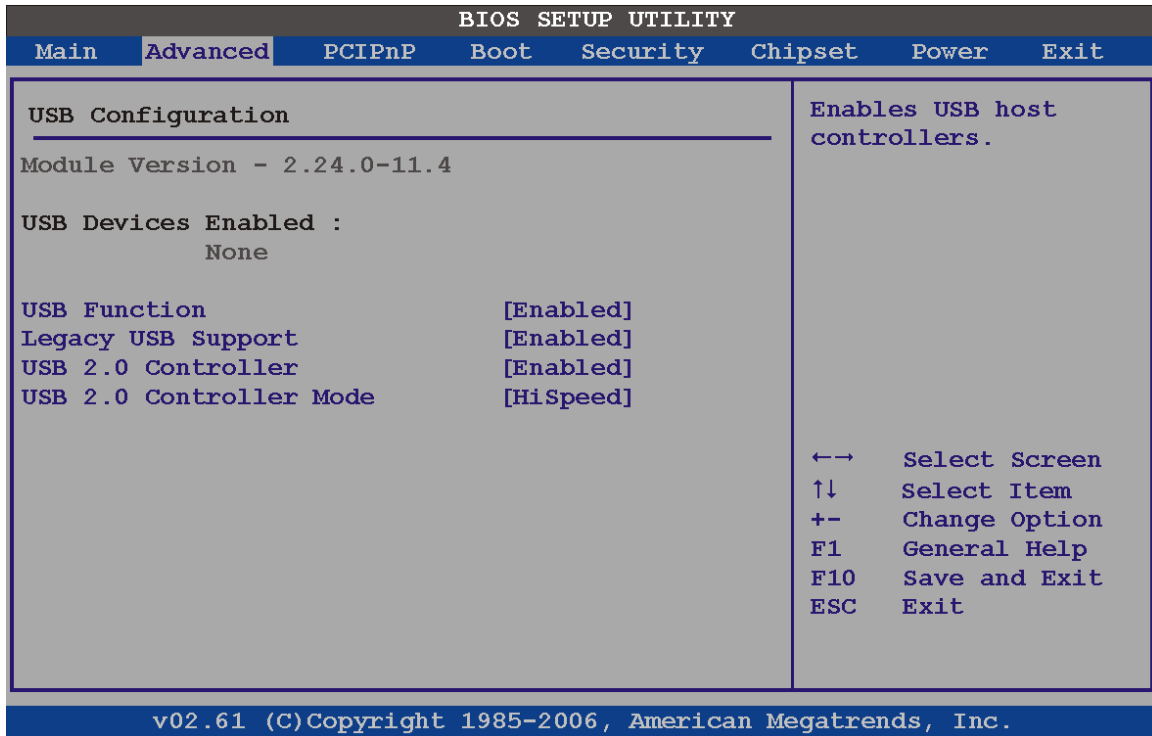

BIOS Menu 12: USB Configuration

→ USB Functions [Enabled]

Use the **USB Function** option to enable or disable the USB controllers.

- Disabled USB controllers are enabled
- Enabled **DEFAULT** USB controllers are disabled

→ USB 2.0 Controller [Enabled]

The **USB 2.0 Controller** BIOS option enables or disables the USB 2.0 controller

- Disabled USB function disabled

eKINO-945GSE Motherboard

→ **Enabled** **DEFAULT** USB function enabled

→ **USB2.0 Controller Mode [HiSpeed]**

The **USB2.0 Controller Mode** BIOS option sets the speed of the USB2.0 controller.

→ **FullSpeed** The controller is capable of operating at full speed
12 Mb/s

→ **HiSpeed** **DEFAULT** The controller is capable of operating at high speed
480 Mb/s

→ **Legacy USB Support [Enabled]**

Use the **Legacy USB Support** BIOS option to enable USB mouse and USB keyboard support.

Normally if this option is not enabled, any attached USB mouse or USB keyboard does not become available until a USB compatible operating system is fully booted with all USB drivers loaded. When this option is enabled, any attached USB mouse or USB keyboard can control the system even when there is no USB driver loaded onto the system.

→ **Disabled** Legacy USB support disabled

→ **Enabled** **DEFAULT** Legacy USB support enabled

→ **Auto** Legacy USB support disabled if no USB devices are
connected

6.4 PCI/PnP

Use the PCI/PnP menu (**BIOS Menu 13**) to configure advanced PCI and PnP settings.



WARNING:

Setting wrong values for the BIOS selections in the PCIPnP BIOS menu may cause the system to malfunction.

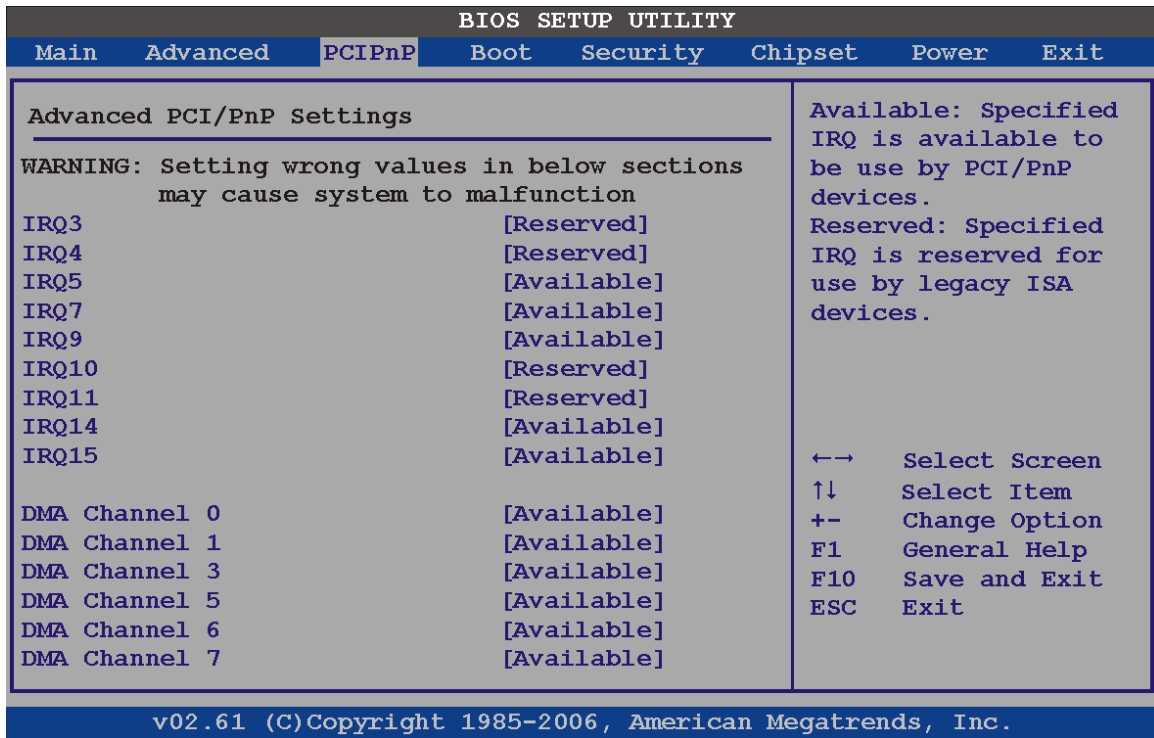

BIOS Menu 13: PCI/PnP Configuration

→ IRQ# [Available]

Use the **IRQ#** address to specify what IRQs can be assigned to a particular peripheral device.

- **Available** **DEFAULT** The specified IRQ is available to be used by PCI/PnP devices
- **Reserved** The specified IRQ is reserved for use by Legacy ISA devices

Available IRQ addresses are:

- IRQ3
- IRQ4
- IRQ5
- IRQ7
- IRQ9

eKINO-945GSE Motherboard

- IRQ10
- IRQ 11
- IRQ 14
- IRQ 15

→ DMA Channel# [Available]

Use the **DMA Channel#** option to assign a specific DMA channel to a particular PCI/PnP device.

- | | | | |
|---|------------------|----------------|--|
| → | Available | DEFAULT | The specified DMA is available to be used by PCI/PnP devices |
| → | Reserved | | The specified DMA is reserved for use by Legacy ISA devices |

Available DMA Channels are:

- DM Channel 0
- DM Channel 1
- DM Channel 3
- DM Channel 5
- DM Channel 6
- DM Channel 7

→ Reserved Memory Size [Disabled]

Use the **Reserved Memory Size** BIOS option to specify the amount of memory that should be reserved for legacy ISA devices.

- | | | | |
|---|-----------------|----------------|---|
| → | Disabled | DEFAULT | No memory block reserved for legacy ISA devices |
| → | 16K | | 16 KB reserved for legacy ISA devices |
| → | 32K | | 32 KB reserved for legacy ISA devices |
| → | 64K | | 54 KB reserved for legacy ISA devices |

6.5 Boot

Use the Boot menu (**BIOS Menu 14**) to configure system boot options.

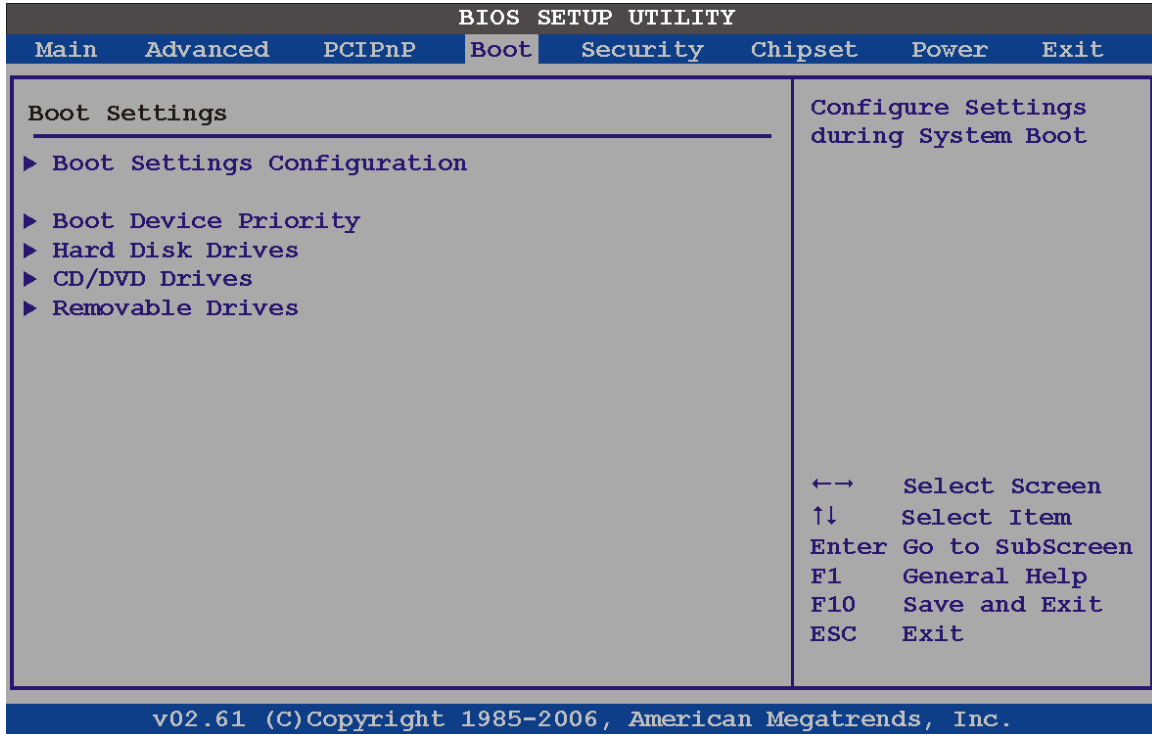

BIOS Menu 14: Boot

eKINO-945GSE Motherboard

6.5.1 Boot Settings Configuration

Use the Boot Settings Configuration menu (**BIOS Menu 14**) to configure advanced system boot options.

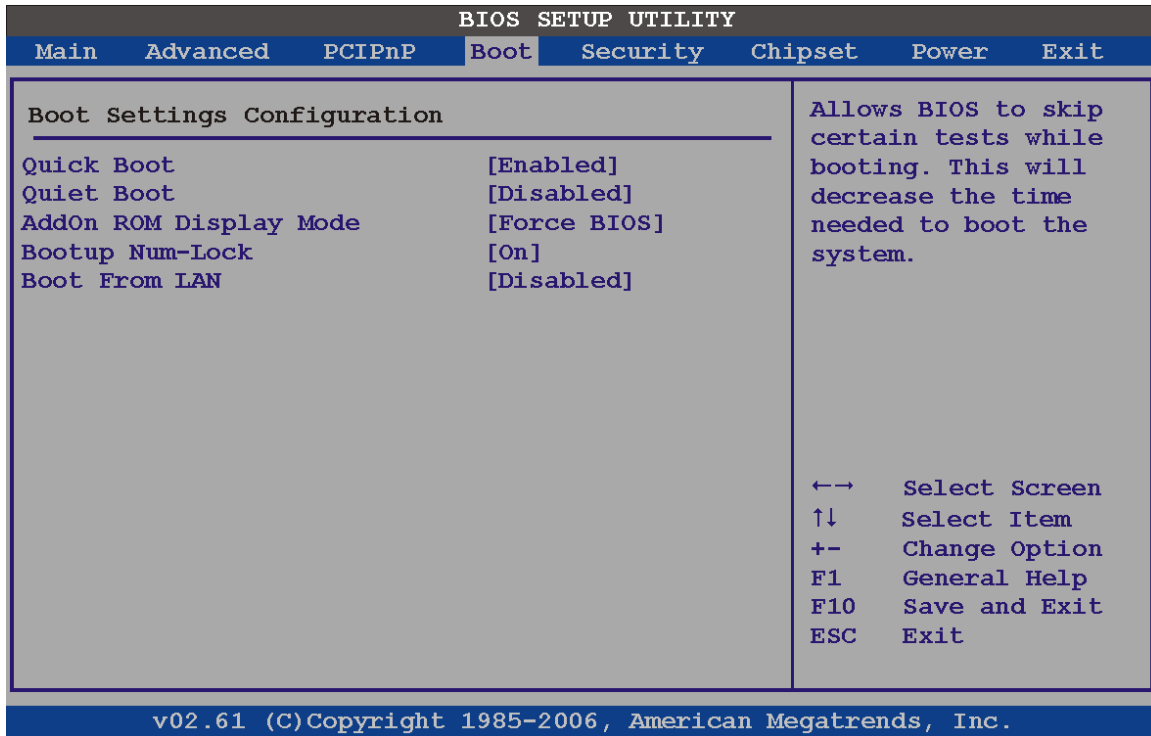

BIOS Menu 15: Boot Settings Configuration

→ Quick Boot [Enabled]

Use the **Quick Boot** BIOS option to make the computer speed up the boot process.

- Disabled No POST procedures are skipped
- Enabled **DEFAULT** Some POST procedures are skipped to decrease the system boot time

→ Quiet Boot [Disabled]

Use the **Quiet Boot** BIOS option to select the screen display when the system boots.

- Disabled **DEFAULT** Normal POST messages displayed

→ **Enabled** OEM Logo displayed instead of POST messages

→ **AddOn ROM Display Mode [Force BIOS]**

The **AddOn ROM Display Mode** option allows add-on ROM (read-only memory) messages to be displayed.

→ **Force BIOS** **DEFAULT** Allows the computer system to force a third party BIOS to display during system boot.

→ **Keep Current** Allows the computer system to display the information during system boot.

→ **Bootup Num-Lock [Off]**

The **Bootup Num-Lock** BIOS option allows the Number Lock setting to be modified during boot up.

→ **Off** **DEFAULT** Does not enable the keyboard Number Lock automatically. To use the 10-keys on the keyboard, press the Number Lock key located on the upper left-hand corner of the 10-key pad. The Number Lock LED on the keyboard lights up when the Number Lock is engaged.

→ **On** Allows the Number Lock on the keyboard to be enabled automatically when the computer system boots up. This allows the immediate use of the 10-key numeric keypad located on the right side of the keyboard. To confirm this, the Number Lock LED light on the keyboard is lit.

→ **Boot From LAN Support [Disabled]**

The **BOOT From LAN Support** option enables the system to be booted from a remote system.

→ **Disabled** **DEFAULT** Cannot be booted from a remote system through the LAN

eKINO-945GSE Motherboard

- ➔ **Enabled** **DEFAULT** Can be booted from a remote system through the LAN

6.5.2 Boot Device Priority

Use the **Boot Device Priority** menu (**BIOS Menu 16**) to specify the boot sequence from the available devices. The following options are available:

- 1st Boot Device
- 2nd Boot Device
- 3rd Boot Device

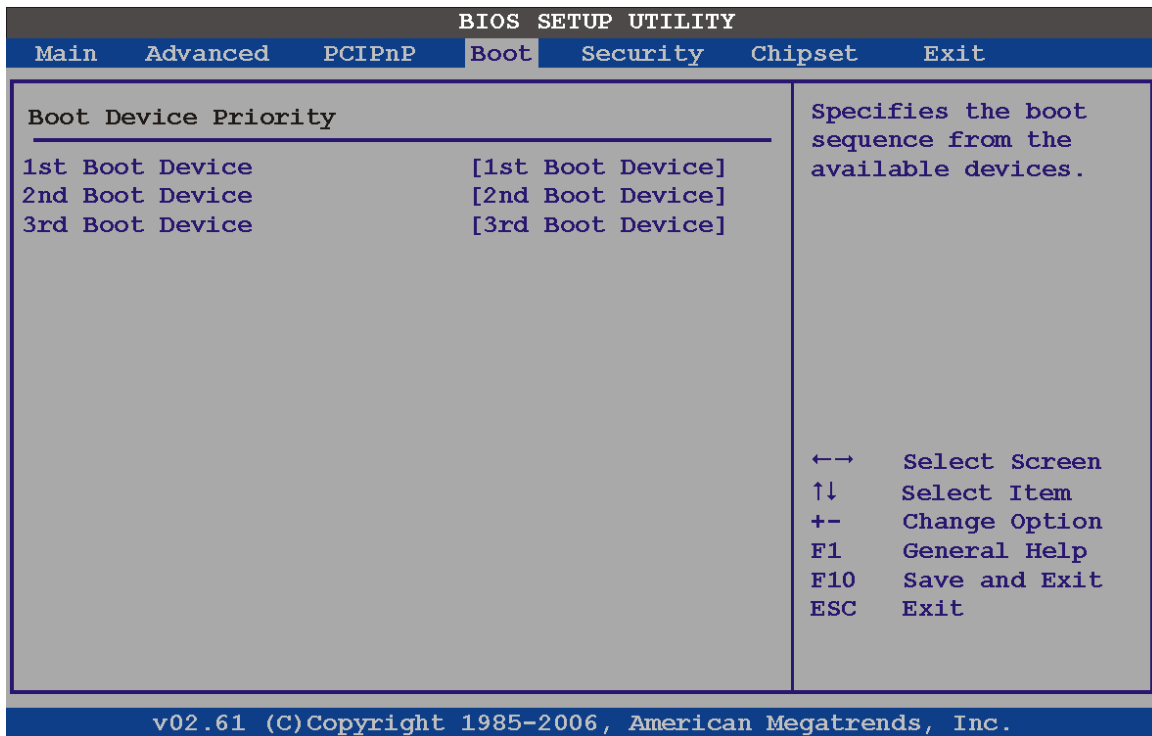

BIOS Menu 16: Boot Device Priority Settings

6.5.3 Hard Disk Drives

Use the **Hard Disk Drives** menu to specify the boot sequence of the available HDDs. When the menu is opened, the HDDs connected to the system are listed as shown below:

- 1st Drive
- 2nd Drive

- 3rd Drive

NOTE:

Only installed drives are shown in the list.

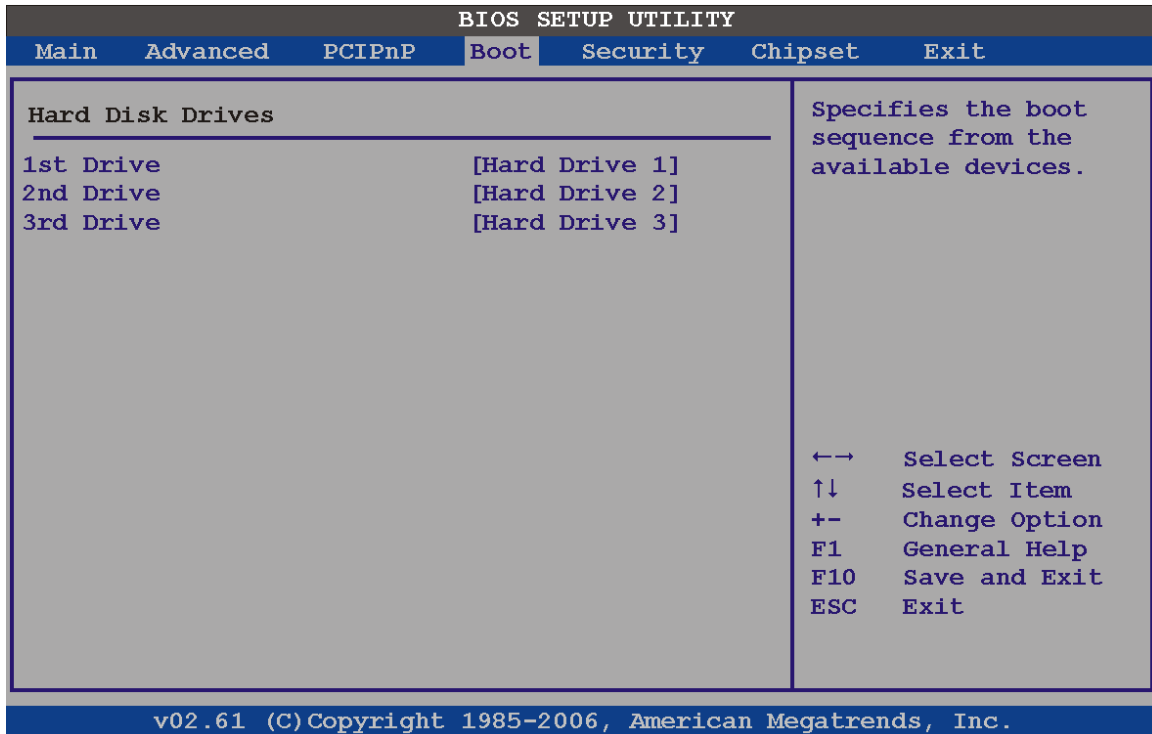
BIOS Menu 17: Hard Disk Drives

6.5.4 CD/DVD Drives

Use the **CD/DVD Drives** menu to specify the boot sequence of the available CD/DVD drives. When the menu is opened, the CD drives and DVD drives connected to the system are listed as shown below:

- 1st Drive
- 2nd Drive
- 3rd Drive

eKINO-945GSE Motherboard



NOTE:

Only installed CD and DVD drives are shown in the list

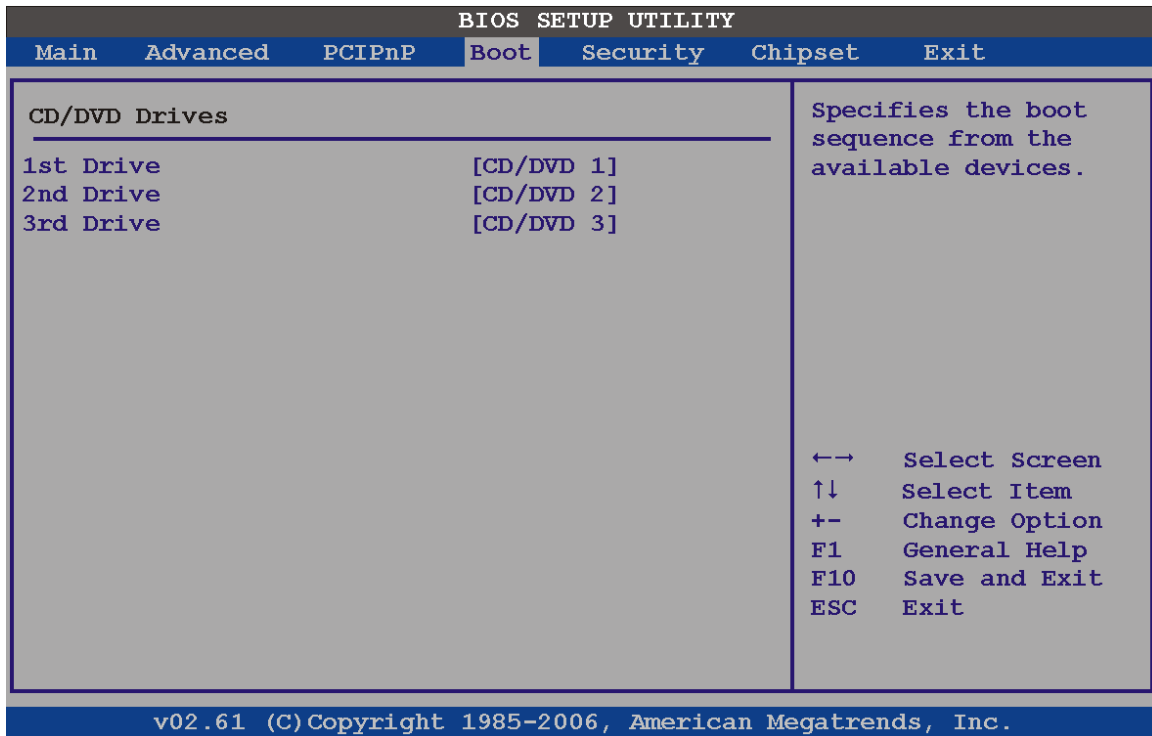

BIOS Menu 18: CD/DVD Drives

6.5.5 Removable Drives

Use the **Removable Drives** menu (**BIOS Menu 19**) to specify the boot sequence of the available FDDs. When the menu is opened, the FDDs connected to the system are listed as shown below:

- 1st Drive
- 2nd Drive

NOTE:

Only installed removable drives are shown in the list. This menu does not show if there are no removable drives.

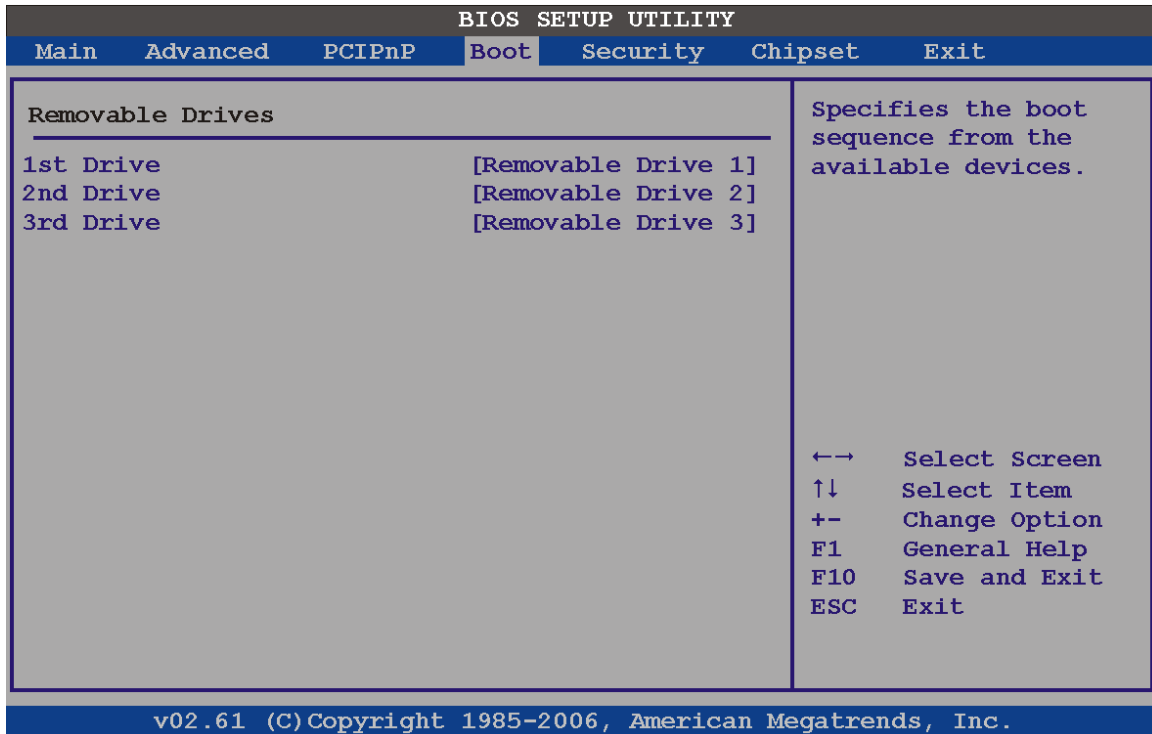

BIOS Menu 19: Removable Drives

6.6 Security

Use the Security menu (**BIOS Menu 20**) to set system and user passwords.

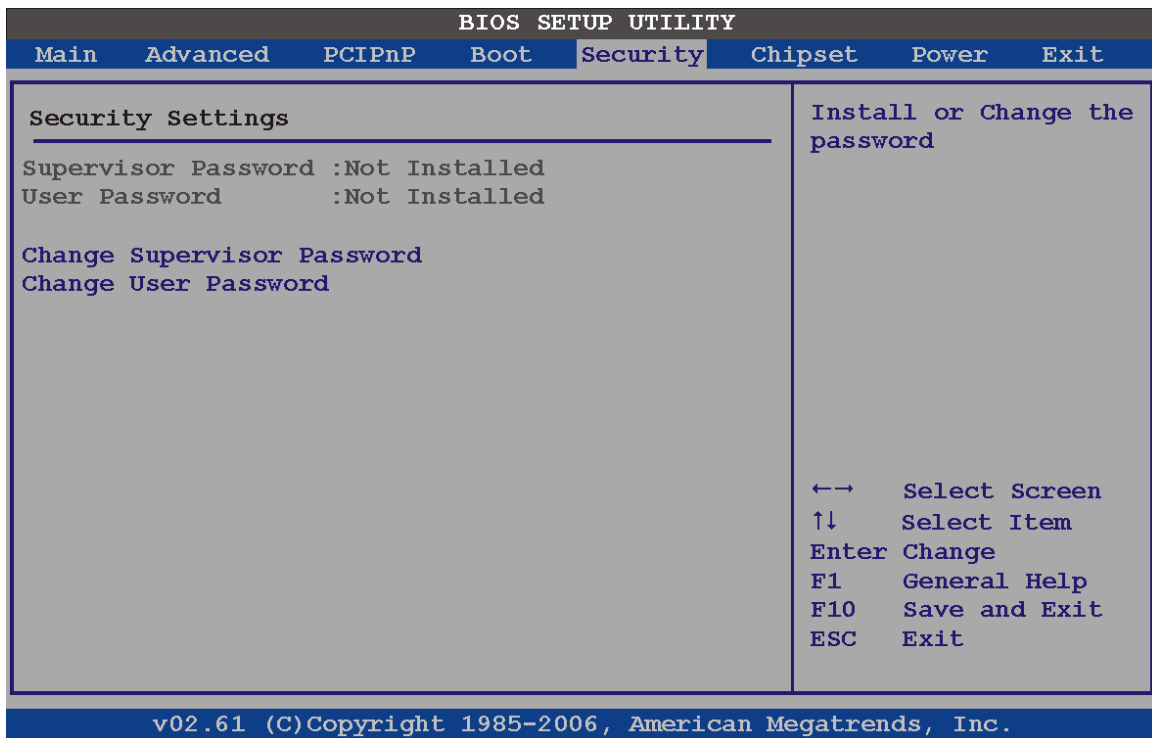

BIOS Menu 20: Security

→ Change Supervisor Password

Use the **Change Supervisor Password** to set or change a supervisor password. The default for this option is **Not Installed**. If a supervisor password must be installed, select this field and enter the password. After the password has been added, **Install** appears next to **Change Supervisor Password**.

→ Change User Password

Use the **Change User Password** to set or change a user password. The default for this option is **Not Installed**. If a user password must be installed, select this field and enter the password. After the password has been added, **Install** appears next to **Change User Password**.

6.7 Chipset

Use the **Chipset** menu (**BIOS Menu 21**) to access the Northbridge and Southbridge configuration menus

**WARNING!**

Setting the wrong values for the Chipset BIOS selections in the Chipset BIOS menu may cause the system to malfunction.

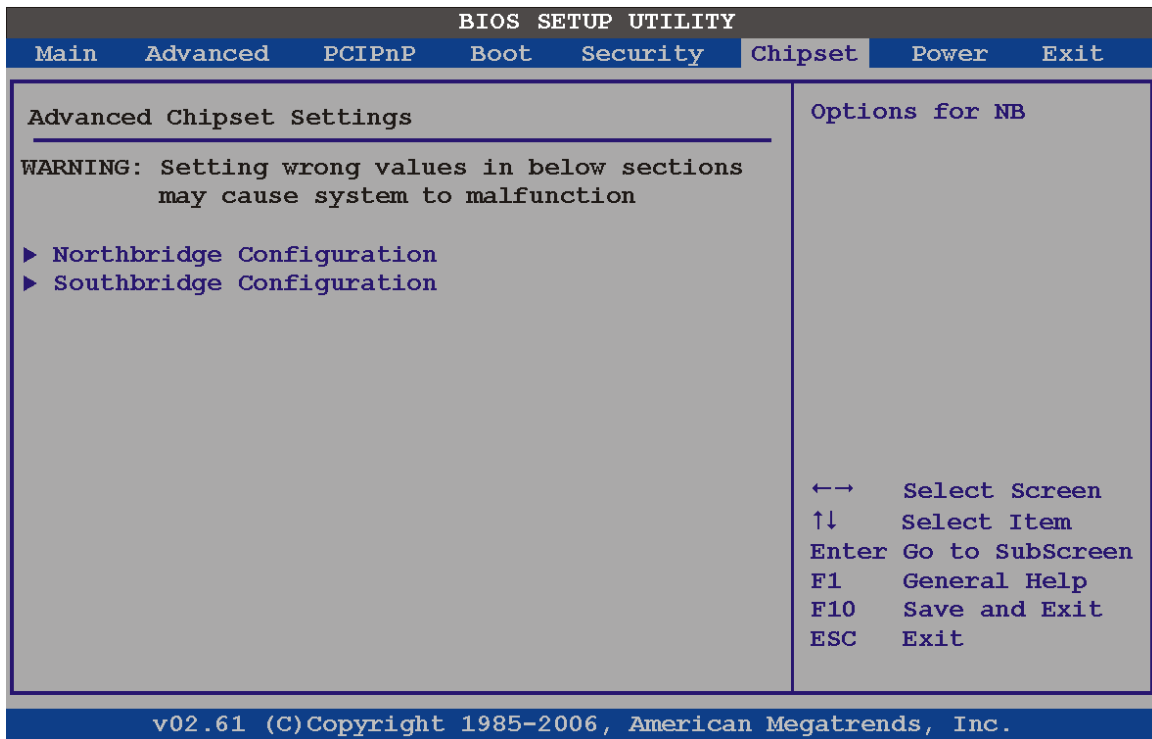
**BIOS Menu 21: Chipset**

eKINO-945GSE Motherboard

6.7.1 Northbridge Chipset Configuration

Use the **Northbridge Chipset Configuration** menu (**BIOS Menu 21**) to configure the Northbridge chipset settings.

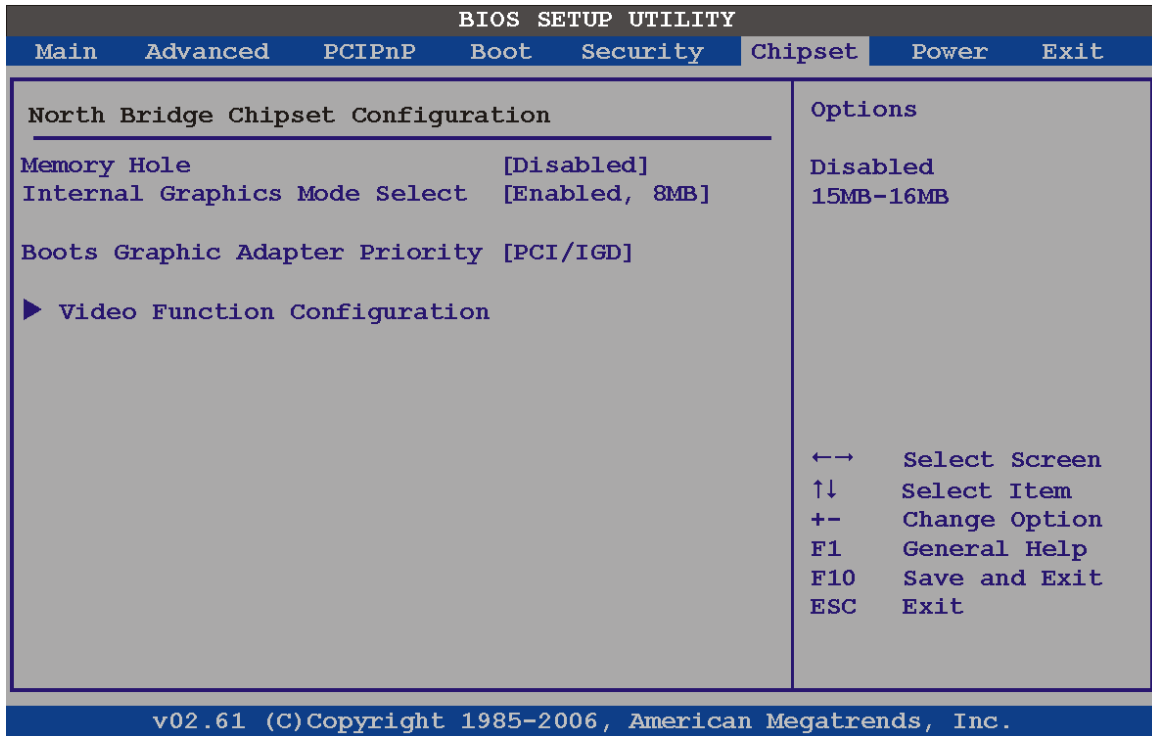

BIOS Menu 22: Northbridge Chipset Configuration

→ Memory Hole [Disabled]

The **Memory Hole** reserves the memory space between 15 MB and 16 MB for ISA expansion cards that require a specified area of memory to work properly. If an older ISA expansion card is used, please refer to the documentation that came with the card to see if it is necessary to reserve the space.

- **Disabled** **DEFAULT** Memory is not reserved for ISA expansion cards
- **Enabled** Memory is reserved for ISA expansion cards

→ Internal Graphics Mode Select [Enable, 8 MB]

The **Internal Graphic Mode Select** option determines the amount of system memory that can be used by the Internal graphics device.

- Disable**
- Enable, 1 MB** 1 MB of memory used by internal graphics device
- Enable, 8 MB** **DEFAULT** 8 MB of memory used by internal graphics device

→ Boot Graphic Adapter Priority [PCI/IGD]

The **Boot Graphic Adapter Priority** setting determines the priority of the attached graphics devices.

- IGD** Only the internal graphics devices are checked, these include VGA, LVDS, TV and SDVO.
- PCI/IGD** **DEFAULT** Graphics cards connected to the PCI expansion card slots on the backplane are checked first for graphics cards. Next, the internal devices, mentioned above, are checked.

eKINO-945GSE Motherboard

6.7.1.1 Video Function Configuration

Use the **Video Function Configuration** menu to configure the video device connected to the system.

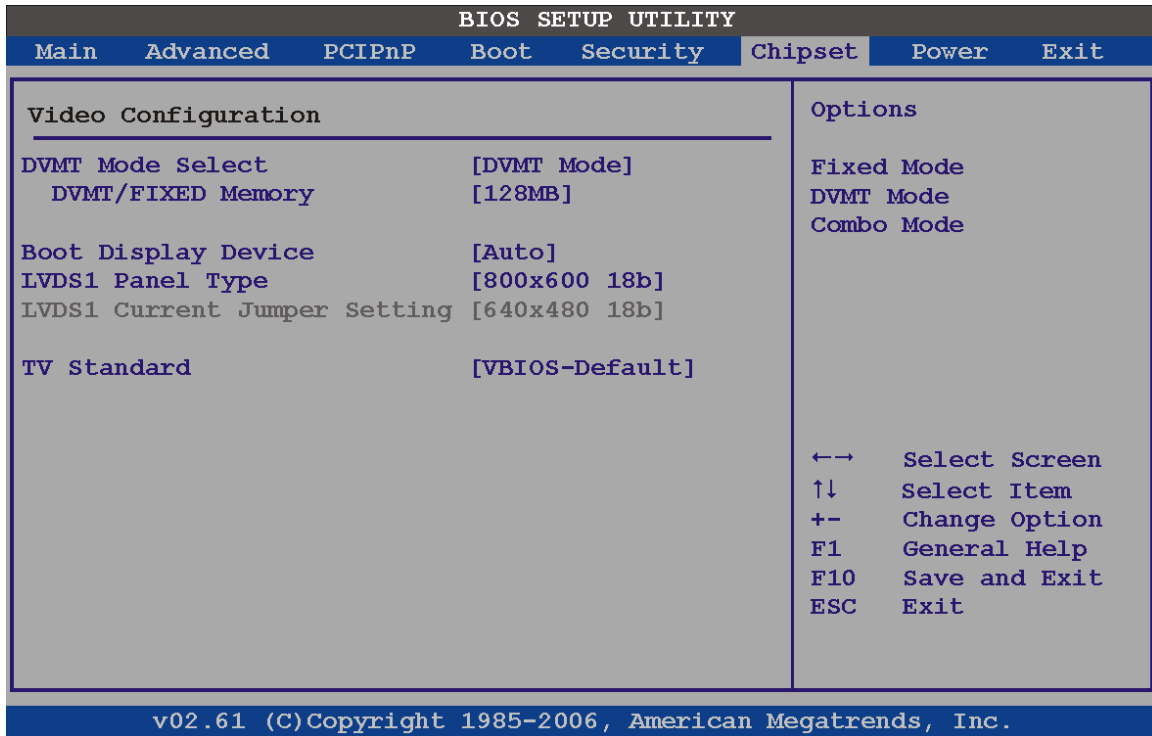

BIOS Menu 23: Video Function Configuration

➔ DVMT Mode Select [DVMT Mode]

Use the **DVMT Mode Select** option to select the Intel Dynamic Video Memory Technology (DVMT) operating mode.

- ➔ **Fixed Mode** A fixed portion of graphics memory is reserved as graphics memory.
- ➔ **DVMT Mode DEFAULT** Graphics memory is dynamically allocated according to the system and graphics needs.

→ Combo Mode

A fixed portion of graphics memory is reserved as graphics memory. If more memory is needed, graphics memory is dynamically allocated according to the system and graphics needs.

→ DVMT/FIXED Memory [128 MB]

Use the **DVMT/FIXED Memory** option to specify the maximum amount of memory that can be allocated as graphics memory. This option can only be configured for if **DVMT Mode** or **Fixed Mode** is selected in the **DVMT Mode Select** option. If **Combo Mode** is selected, the maximum amount of graphics memory is 128 MB. Configuration options are listed below.

- 64 MB
- 128 MB **DEFAULT**
- Maximum DVMT

→ Boot Display Device [Auto]

The **Boot Display Device** BIOS option selects the display device the system uses when it boots. The available options are listed below:

- Auto **DEFAULT**
- CRT
- TV
- EFP
- LFP

→ LVDS1 Panel Type [by H/W]

Use the **LVDS Panel Type** to determine the LCD panel resolution. Configuration options are listed below:

- 640 x 480 18-bit
- 800 x 480 18-bit
- 800 x 600 18-bit
- 1024 x 768 18-bit Default

eKINO-945GSE Motherboard

- 1280 x 1024 36-bit
- 1400 x 1050 36-bit
- 1440 x 900 36-bit
- 1600 x 1200 36-bit
- by H/W

→ LCD Current Jumper Setting [640x480 18bit]

Use the **LCD Current Jumper Setting** shows the current setting of the screen resolution hardware jumper.

→ TV Standard [VBIOS]

The **TV Standard** option specifies the TV type connected to the system.

- VBIOS Default
- NTSC
- PAL
- SECAM
- SMPTE240M
- ITU-R television
- SMPTE295M
- SMPTE296M
- EIA-770.2
- EIA-770.3

6.7.2 Southbridge Configuration

The **Southbridge Configuration** menu (**BIOS Menu 24**) allows the Southbridge chipset to be configured.

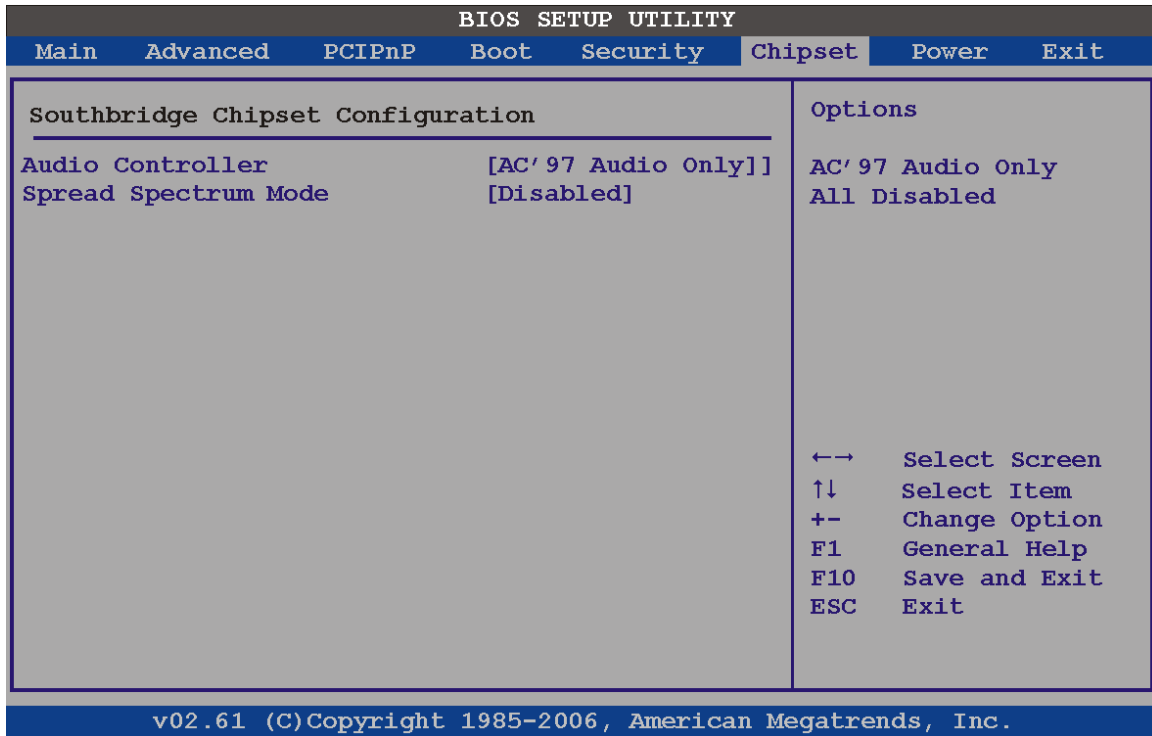

BIOS Menu 24: Southbridge Chipset Configuration

→ Audio Controller [All Disabled]

The **Audio Controller** option enables or disables the audio controller.

- **AC'97 Audio Only** DEFAULT AC'97 audio is enabled
- **All Disabled** Audio is disabled

eKINO-945GSE Motherboard

6.8 Exit

Use the **Exit** menu (**BIOS Menu 25**) to load default BIOS values, optimal failsafe values and to save configuration changes.

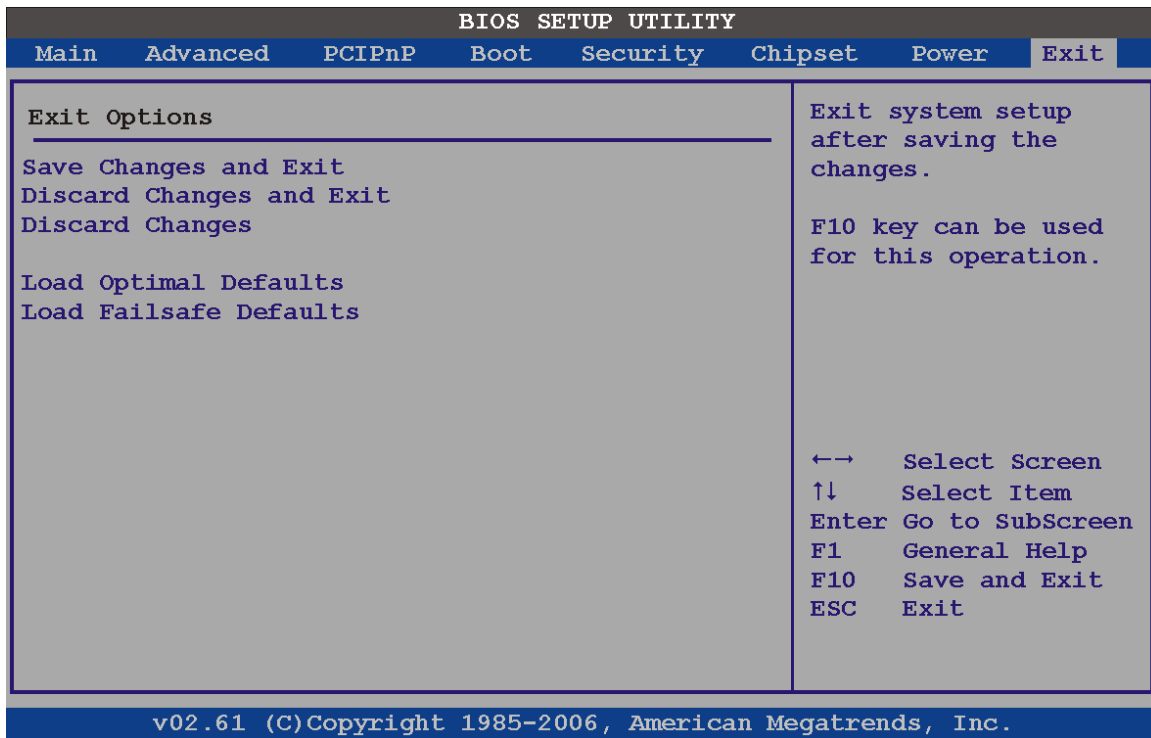

BIOS Menu 25: Exit

→ Save Changes and Exit

Use the **Save Changes and Exit** option to save the changes made to the BIOS options and to exit the BIOS configuration setup program.

→ Discard Changes and Exit

Use the **Discard Changes and Exit** option to exit the BIOS configuration setup program without saving the changes made to the system.

→ Discard Changes

Use the **Discard Changes** option to discard the changes and remain in the BIOS configuration setup program.

→ **Load Optimal Defaults**

Use the **Load Optimal Defaults** option to load the optimal default values for each of the parameters on the Setup menus. **F9 key can be used for this operation.**

→ **Load Failsafe Defaults**

Use the **Load Failsafe Defaults** option to load failsafe default values for each of the parameters on the Setup menus. **F8 key can be used for this operation.**

Chapter

7

Software Installation

7.1 Available Software Drivers



NOTE:

The content of the CD may vary throughout the life cycle of the product and is subject to change without prior notice. Visit the IEI website or contact technical support for the latest updates.

The following drivers can be installed on the system:

- Chipset
- VGA
- LAN
- Audio

Installation instructions are given below.

7.2 Starting the Driver Program

To access the driver installation programs, please do the following.

Step 1: Insert the CD-ROM that came with the system into a CD-ROM drive attached to the system.

eKINO-945GSE Motherboard

Step 2: The screen in **Figure 7-1** appears.

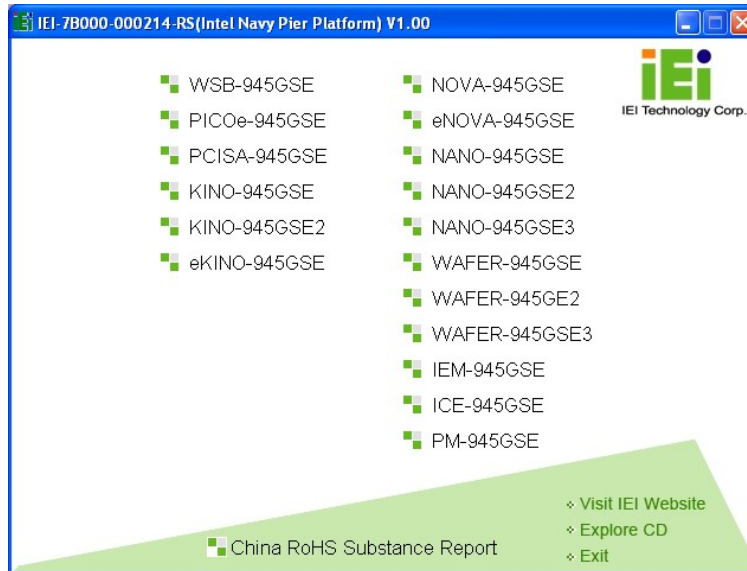

Figure 7-1: Start Up Screen

Step 3: Click **eKINO-945GSE**.

Step 4: The screen in **Figure 7-2** appears.

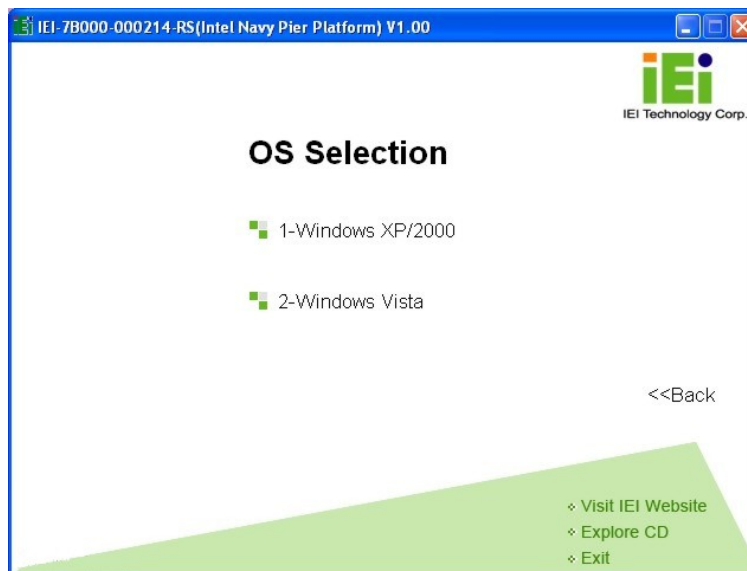

Figure 7-2: Select Operating System

Step 5: Select the operating system installed on the eKINO-945GSE system. This manual describes the installation for a **Windows XP** operating system.

Step 6: The list of drivers in **Figure 7-3** appears.

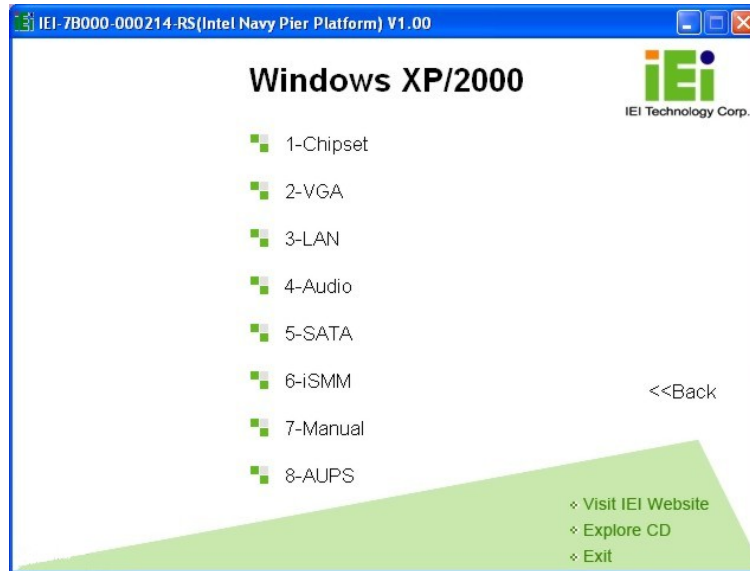

Figure 7-3: Drivers

7.3 Chipset Driver Installation

To install the chipset driver, please do the following.

Step 1: Access the driver list shown in **Figure 7-3**. (See **Section 7.2**)

Step 2: Click “1-Chipset Driver”

Step 3: When the setup files are completely extracted the **Welcome Screen** in **Figure 7-4** appears.

eKINO-945GSE Motherboard



Figure 7-4: Chipset Driver Welcome Screen

Step 4: Click **Next** to continue.

Step 5: The license agreement in **Figure 7-5** appears.



Figure 7-5: Chipset Driver License Agreement

Step 6: Read the **License Agreement**.

Step 7: Click the **YES** button to accept the license agreement and continue.

Step 8: The Read Me file in **Figure 7-6** appears.



Figure 7-6: Chipset Driver Read Me File

Step 9: Click **NEXT** to continue.

Step 10: **Setup Operations** are performed as shown in **Figure 7-7**.

eKINO-945GSE Motherboard

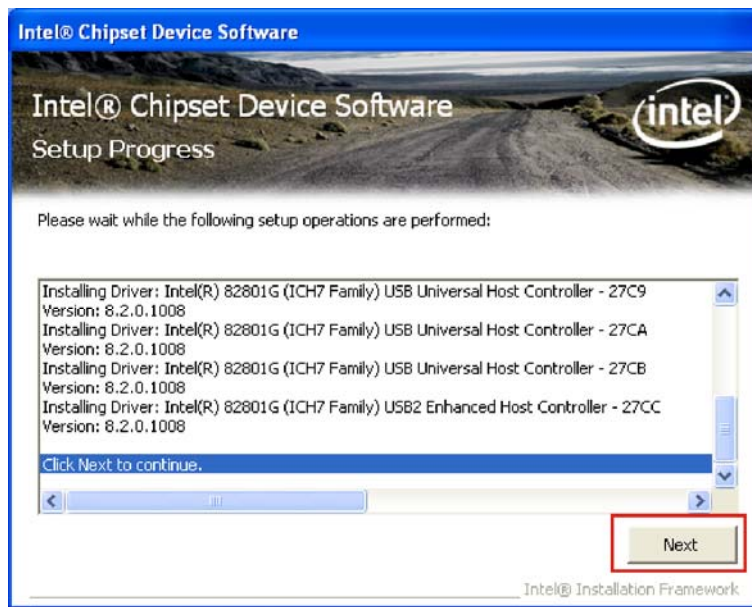

Figure 7-7: Chipset Driver Setup Operations

Step 11: Once the **Setup Operations** are complete, click the **NEXT** icon to continue.

Step 12: The **Finish** screen appears.



Figure 7-8: Chipset Driver Installation Finish Screen

Step 13: Select “Yes, I want to restart the computer now” and click the **Finish** icon.

See **Figure 7-8**.

7.4 VGA Driver Installation

To install the VGA driver, please do the following.

Step 1: Access the driver list shown in **Figure 7-3**. (See **Section 7.2**)

Step 2: Click “**2-VGA**”

Step 3: The VGA Read Me file in **Figure 7-9** appears.

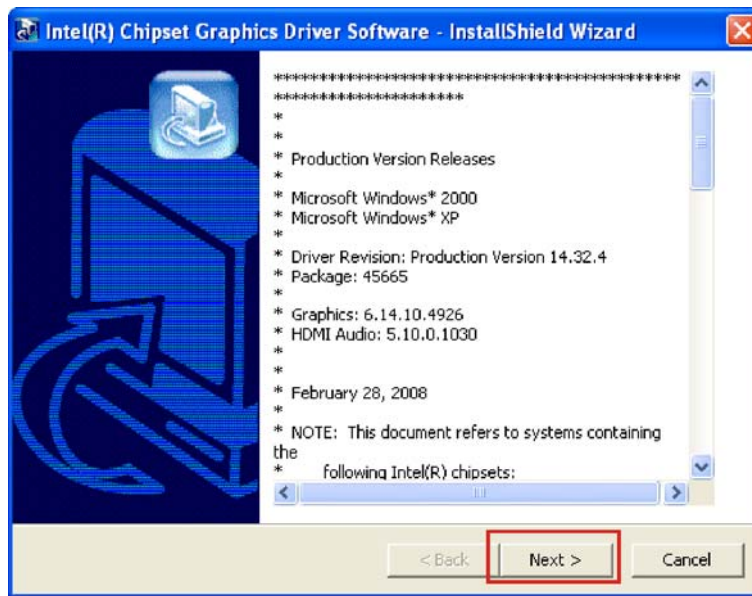

Figure 7-9: VGA Driver Read Me File

Step 4: Click **NEXT** to continue.

Step 5: The installation files are extracted. See **Figure 7-10**.

eKINO-945GSE Motherboard

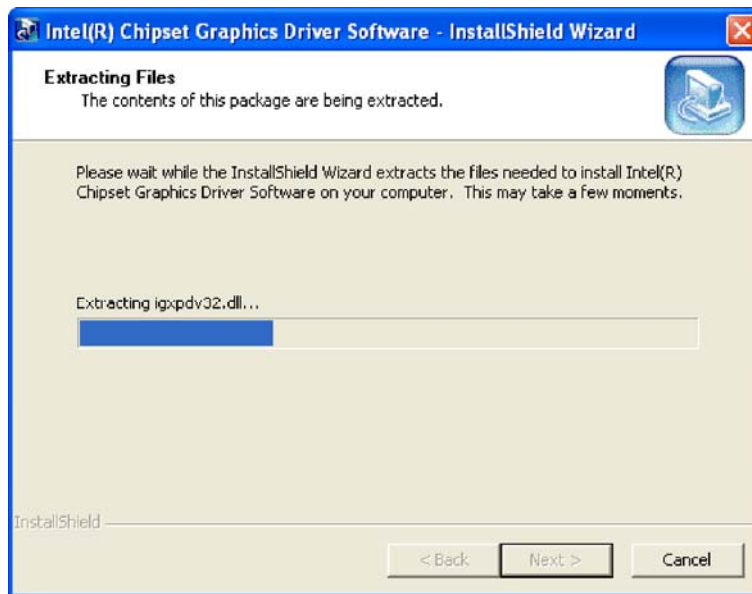

Figure 7-10: VGA Driver Setup Files Extracted

Step 6: The **Welcome Screen** in **Figure 7-11** appears.



Figure 7-11: VGA Driver Welcome Screen

Step 7: Click **NEXT** to continue.

Step 8: The license agreement in **Figure 7-12** appears.

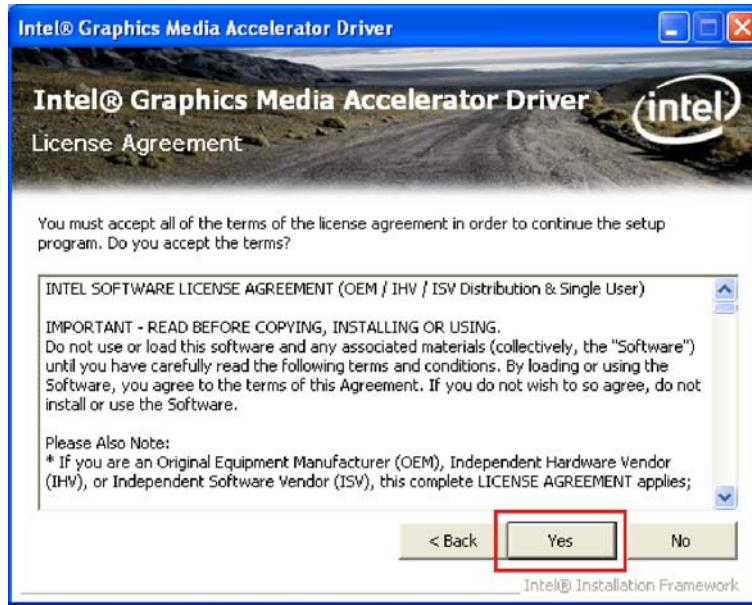

Figure 7-12: VGA Driver License Agreement

Step 9: Read the License Agreement.

Step 10: Click **YES** to accept the license agreement and continue.

Step 11: The Readme file in **Figure 7-13** appears.

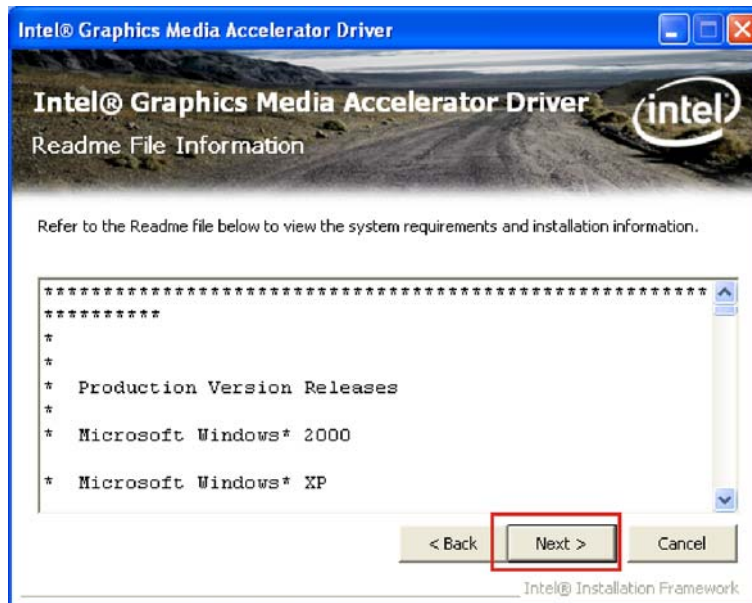

Figure 7-13: VGA Driver Read Me File

eKINO-945GSE Motherboard

Step 12: Click **NEXT** to continue.

Step 13: **Setup Operations** are performed as shown in **Figure 7-14**.



NOTE:

The “Found New Hardware Wizard” will appear and then disappear during this step. Do not adjust any settings in the “Found New Hardware Wizard” window.

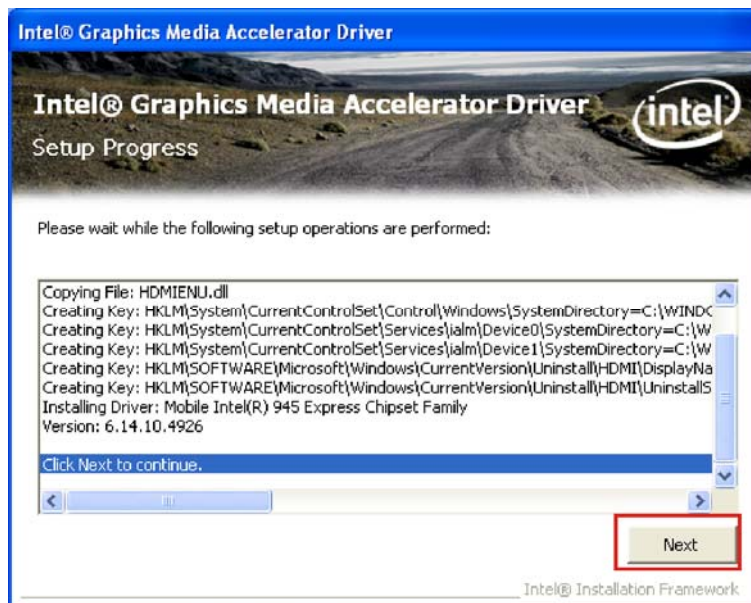

Figure 7-14: VGA Driver Setup Operations

Step 14: Once the **Setup Operations** are complete, click **NEXT** to continue.

Step 15: The **Finish** screen appears.

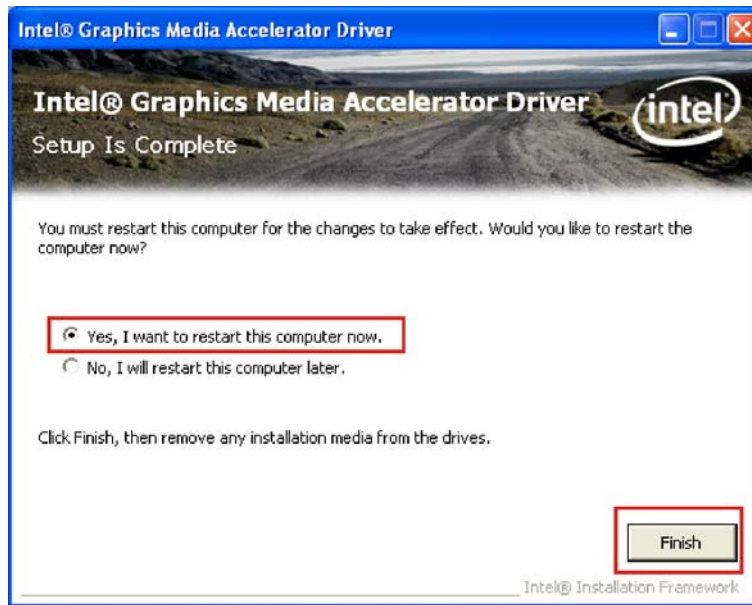

Figure 7-15: VGA Driver Installation Finish Screen

Step 16: Select “Yes, I want to restart the computer now” and click **FINISH**. See Figure 7-15.

7.5 LAN Driver Installation

To install the chipset driver, please do the following.

Step 1: Access the driver list shown in Figure 7-3. (See Section 7.2)

Step 2: Click “3-LAN”

Step 3: The **Welcome** screen in Figure 7-16 appears.

eKINO-945GSE Motherboard

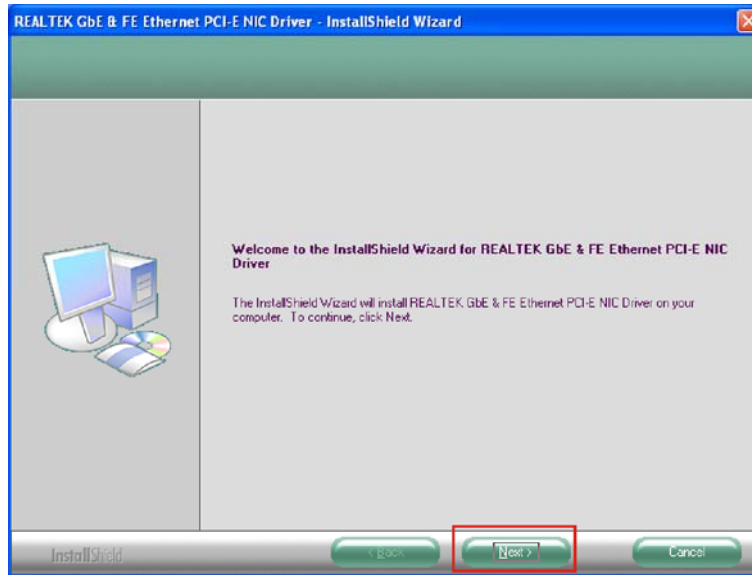

Figure 7-16: LAN Driver Welcome Screen

Step 4: Click **NEXT** to continue.

Step 5: The **Ready to Install** screen in **Figure 7-17** appears.

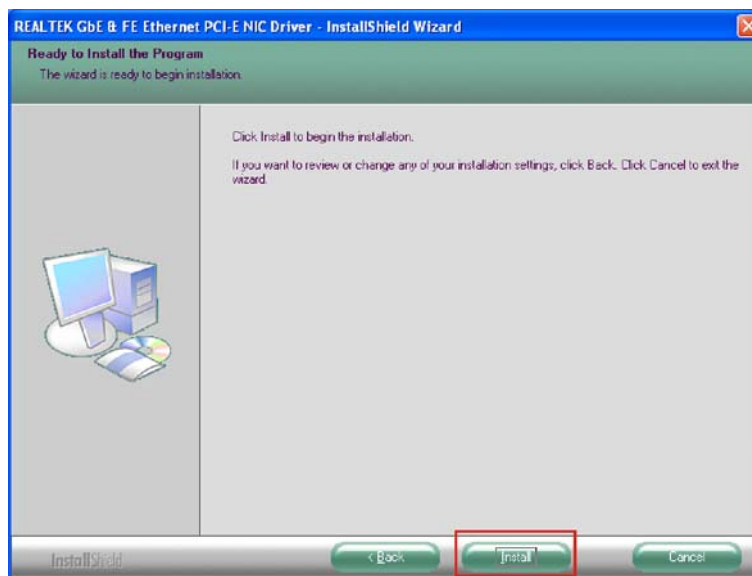

Figure 7-17: LAN Driver Welcome Screen

Step 6: Click **NEXT** to proceed with the installation.

Step 7: The program begins to install.

Step 8: The installation progress can be monitored in the progress bar shown in

Figure 7-18.

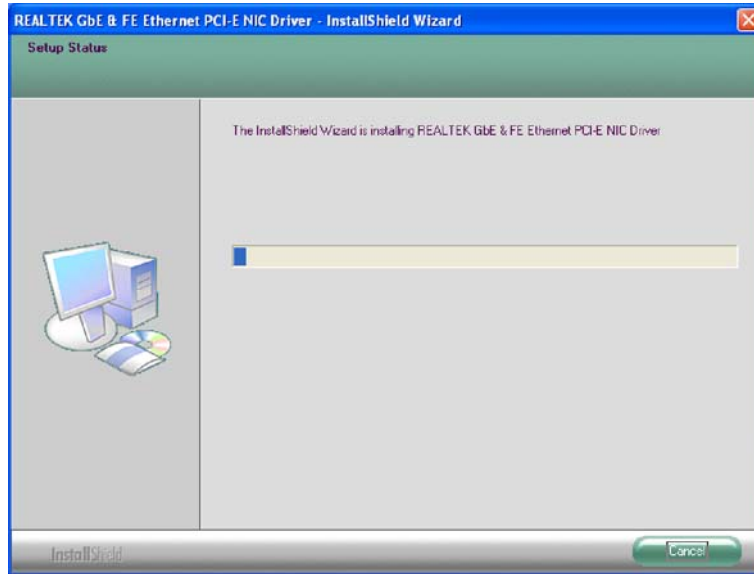

Figure 7-18: LAN Driver Installation

Step 9: When the driver installation is complete, the screen in **Figure 7-19** appears.

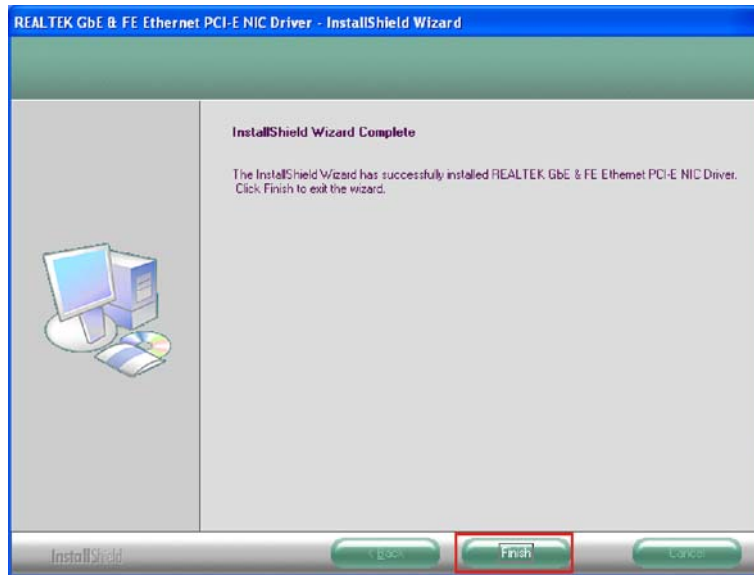

Figure 7-19: LAN Driver Installation Complete

Step 10: Click **FINISH** to exit the InstallShield Wizard (**Figure 7-19**).

eKINO-945GSE Motherboard

7.6 Audio Driver Installation

To install the chipset driver, please do the following.

Step 1: Access the driver list shown in **Figure 7-3**. (See **Section 7.2**)

Step 2: Click “4-Audio”

Step 3: Click “1-AC’97”

Step 4: Browse to “E:\4-Audio\Windows\Windows 98Gold, 98se, Me, 2000, XP, 2003(32,64 bits)\A3.84” Double-click the installation file in **Figure 7-20**.

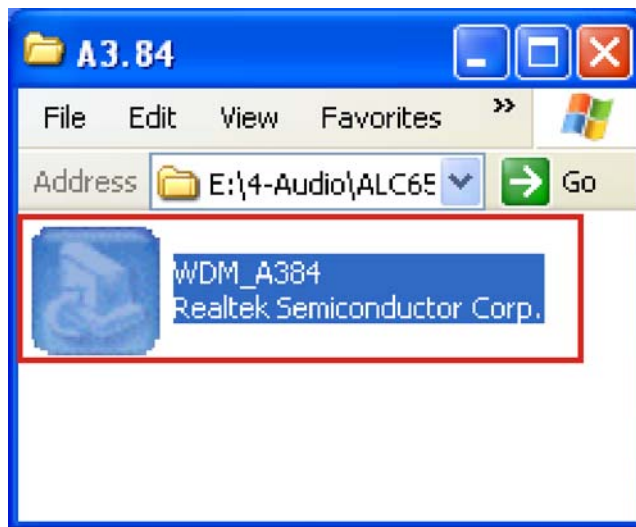

Figure 7-20: Audio Driver Options

Step 5: The AC'97 Driver Installation screen in **Figure 7-21** appears.

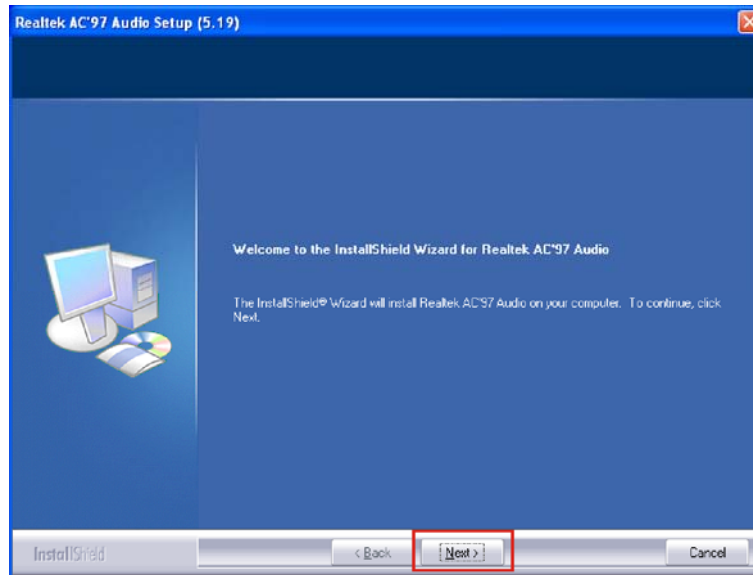

Figure 7-21: AC'97 Driver Installation Welcome Screen

Step 6: Click **NEXT** to continue.

Step 7: The Verification window in **Figure 7-22** may appear.



Figure 7-22: AC'97 Driver Installation Verification

Step 8: Click **CONTINUE ANYWAY**.

eKINO-945GSE Motherboard

Step 9: When the driver is installed, the driver installation finish screen in **Figure 7-23** appears.

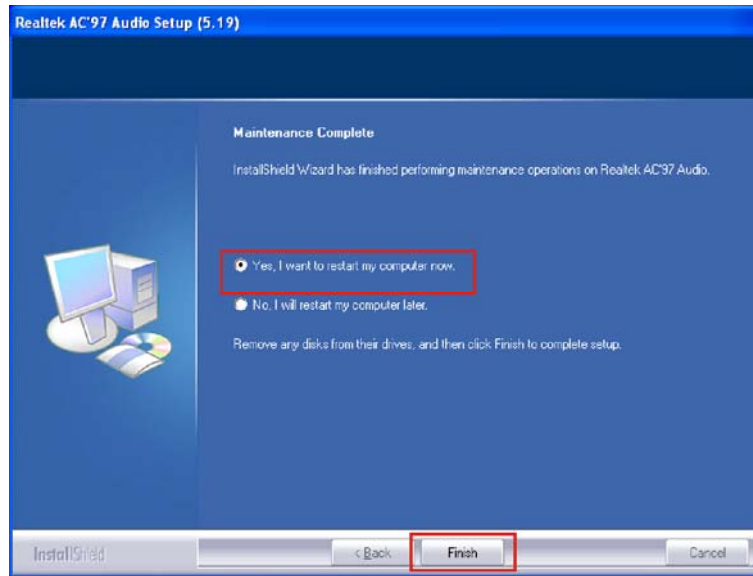

Figure 7-23: AC'97 Driver Installation Complete

Step 10: Select “Yes, I wish to restart my computer now” And click **FINISH** to exit the InstallShield Wizard and restart the computer.



Chapter

8

Battery Monitoring

8.1 Introduction

The IEI AUPS Battery Status Monitor application detects the information of the smart battery and monitors the battery status. It is recommended to execute this AUPS application in Windows XP SP2 environment.

8.2 Monitoring DC Power and Smart Battery

8.2.1 Application Installation

Follow the steps below to install the AUPS Battery Status Monitor application.

Step 1: Insert the driver CD into the system. Open the **x:\AUPS_Setup\AUPS_SetupV1.4** directory. Double click the **Setup.exe** icon.

Step 2: A welcome screen appears (**Figure 8-1**). To continue the installation process click **NEXT**.

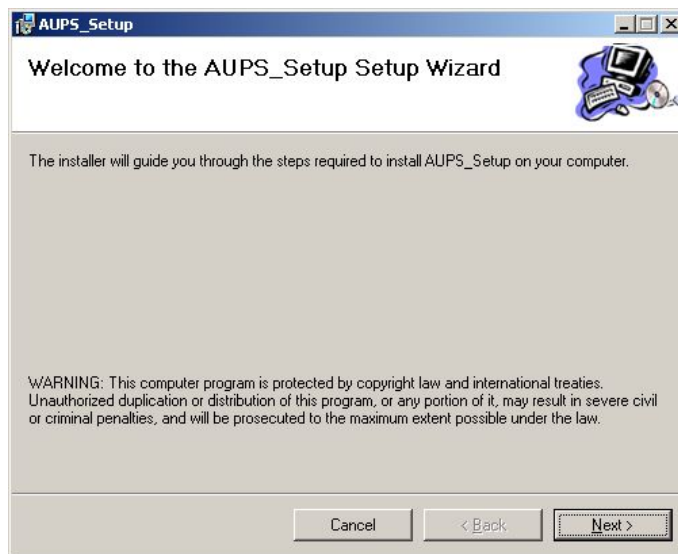

Figure 8-1: Welcome Screen

Step 3: The Select Installation Folder window appears (**Figure 8-2**). Select a folder to install the application.

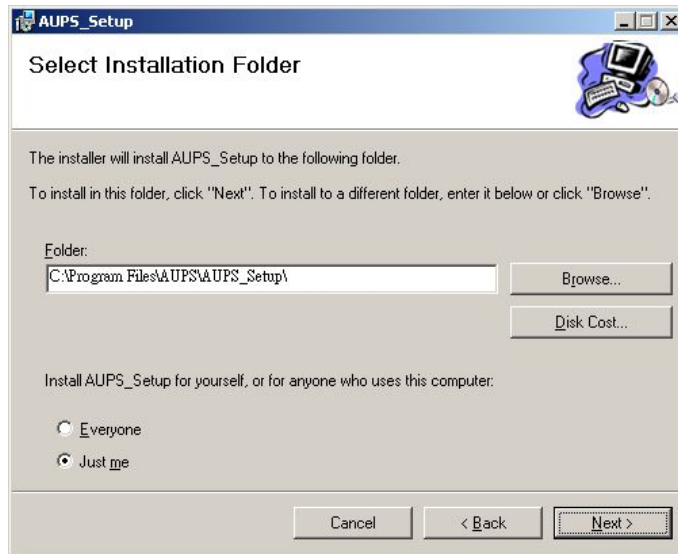

Figure 8-2: Select Installation Folder

Step 4: Click **NEXT** and the Installshield Wizard is ready to install the program

(**Figure 8-3**).

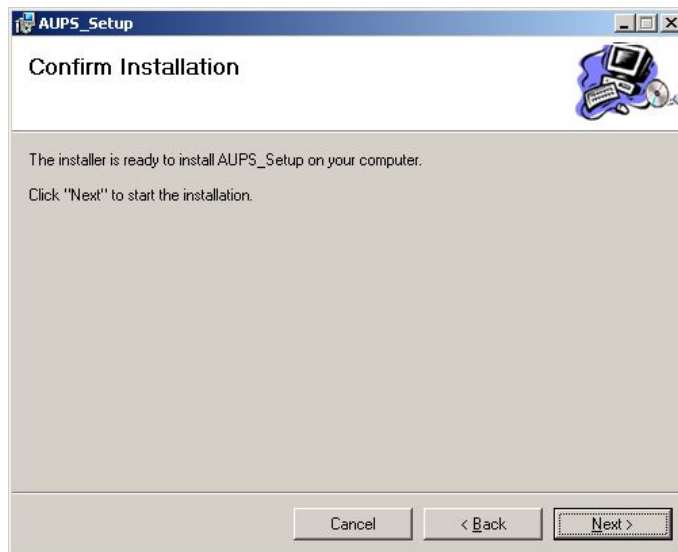

Figure 8-3: Ready to Install the Program

Step 5: Click **NEXT** to continue. The Installing AUPS_Setup screen appears as the program is installed (**Figure 8-4**).

eKINO-945GSE Motherboard

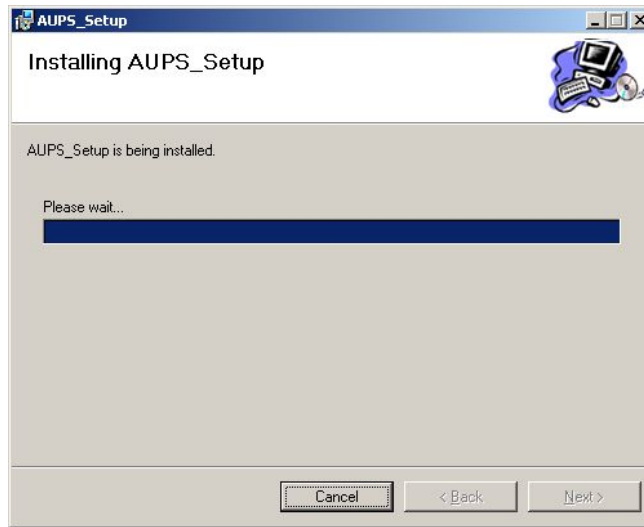

Figure 8-4: Installing AUPS

Step 6: The Installation Complete window appears (**Figure 8-5**). Click **Close** to exit.

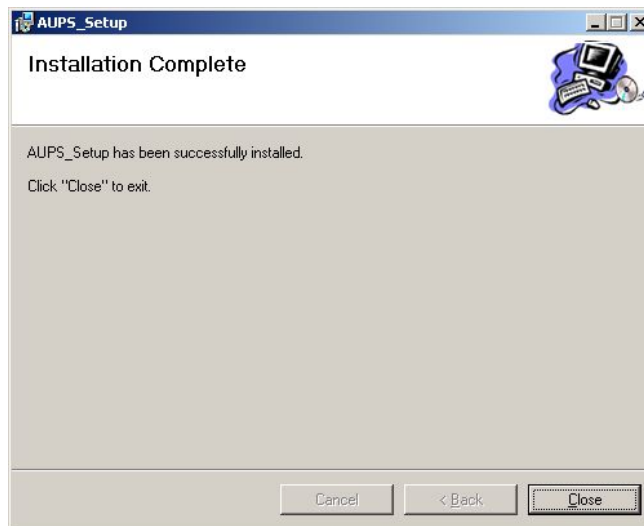

Figure 8-5: Installation Complete

Step 7: To launch the application, double click the shortcut (**Figure 8-6**) on the desktop



Figure 8-6: AUPS Battery Status Monitor Application

8.2.2 Status Information

The IEI AUPS Battery Status Monitor application shows the DC power status and battery status (**Figure 8-7**). The following sections describe the status information in details.

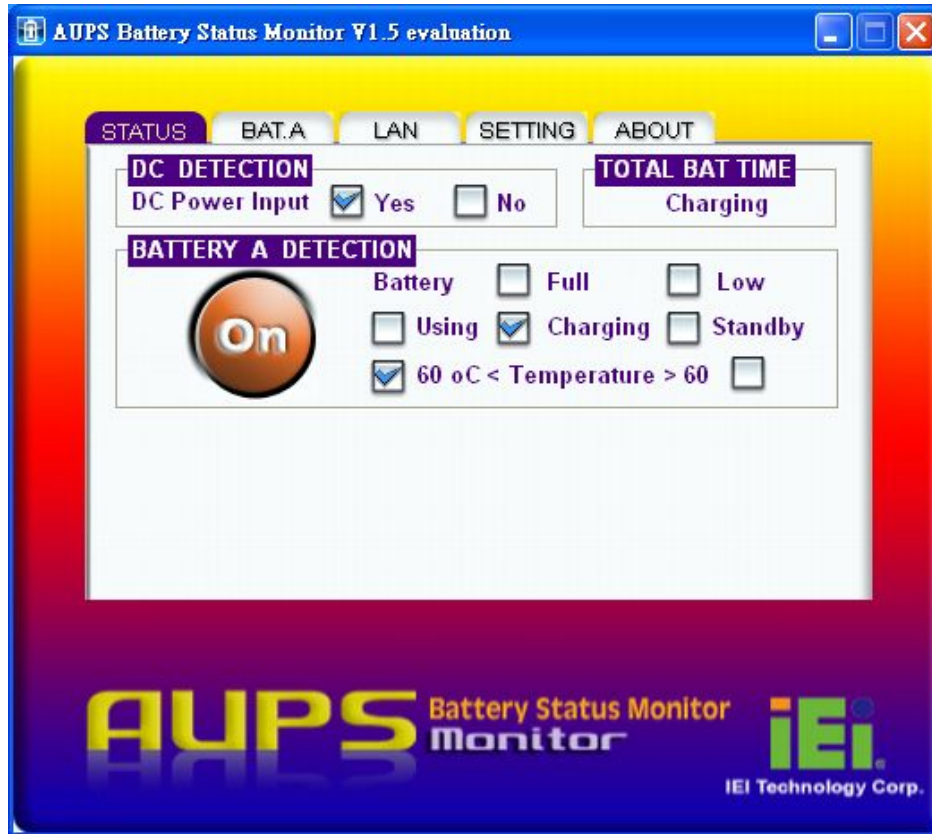

Figure 8-7: Status Information

8.2.2.1 DC Detection

When the DC power is connected to the AUPS series power module, the AUPS Battery Status Monitor detects it and shows in the screen as **Figure 8-8**.



Figure 8-8: DC Detection

8.2.2.2 Battery Detection

When the smart battery is connected to the AUPS series power module, the AUPS Battery Status Monitor detects it and shows in the screen as **Figure 8-9**. Two batteries can be connected to the AUPS series power module at the same time. The second battery information is shown in the **Battery A Detection** section if connected.

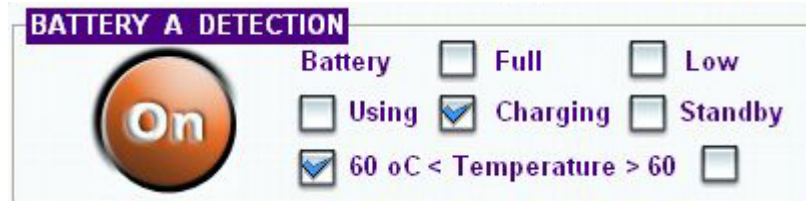

Figure 8-9: Battery Detection

	The battery is connected to the AUPS series.
Off	The battery is not connected to the AUPS series.
Battery <input type="checkbox"/> Full <input type="checkbox"/> Low	
Full	The battery is fully charged.
Low	The battery is low.
<input type="checkbox"/> Using <input checked="" type="checkbox"/> Charging <input type="checkbox"/> Standby	
Using	The battery is being used.
Charging	The battery is being charged.
Standby	The battery is fully charged and ready to be used anytime.
<input checked="" type="checkbox"/> 60 °C < Temperature > 60 <input type="checkbox"/>	
>60 C	The battery temperature is above 60°C.
<60 C	The battery temperature is below 60°C.

Table 8-1: Status Settings

8.2.2.3 Total Battery Time

The total battery time is shown in the top right corner (**Figure 8-10**) of the status screen to indicate the total battery remaining time.



Figure 8-10: Total Battery Time

8.2.3 Battery Information

Click on the **BAT. A** tab to view the information of battery. The listed information includes battery type, capacity, output voltage, temperature, charging rate, discharging rate and battery status (**Figure 8-11**). The values listed are updated per second.

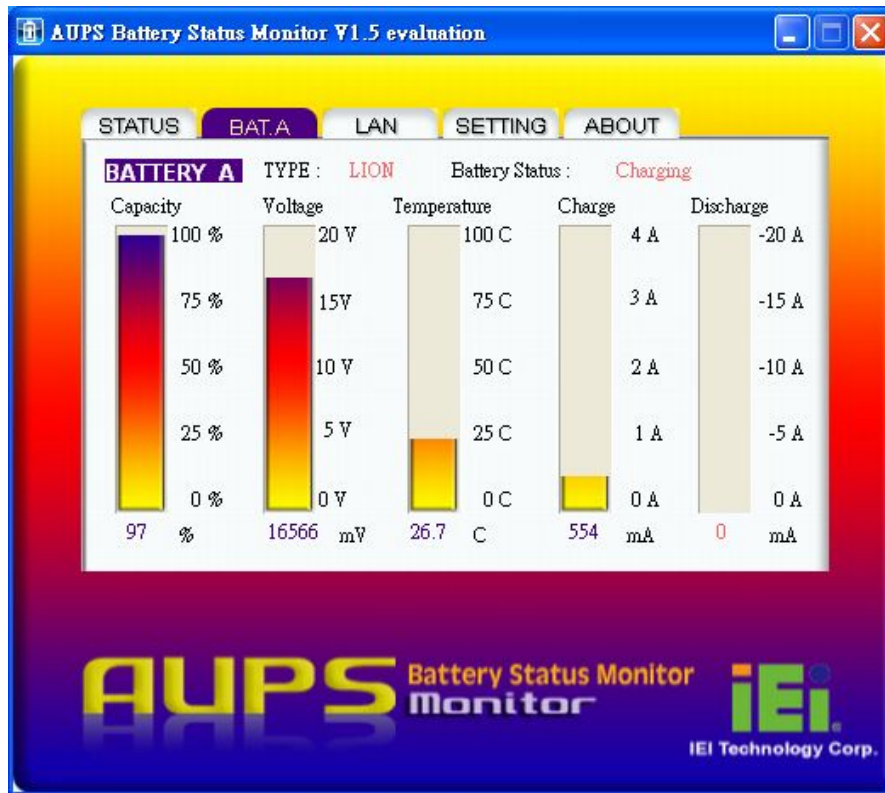

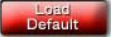

Figure 8-11: Battery Information

eKINO-945GSE Motherboard

8.2.4 LAN Setting

The LAN Setting page is where to configure the Remote LAN settings for power on/off remote control and battery monitoring. To save the modified parameters of this page, click the  button. To load the default settings, click  button.

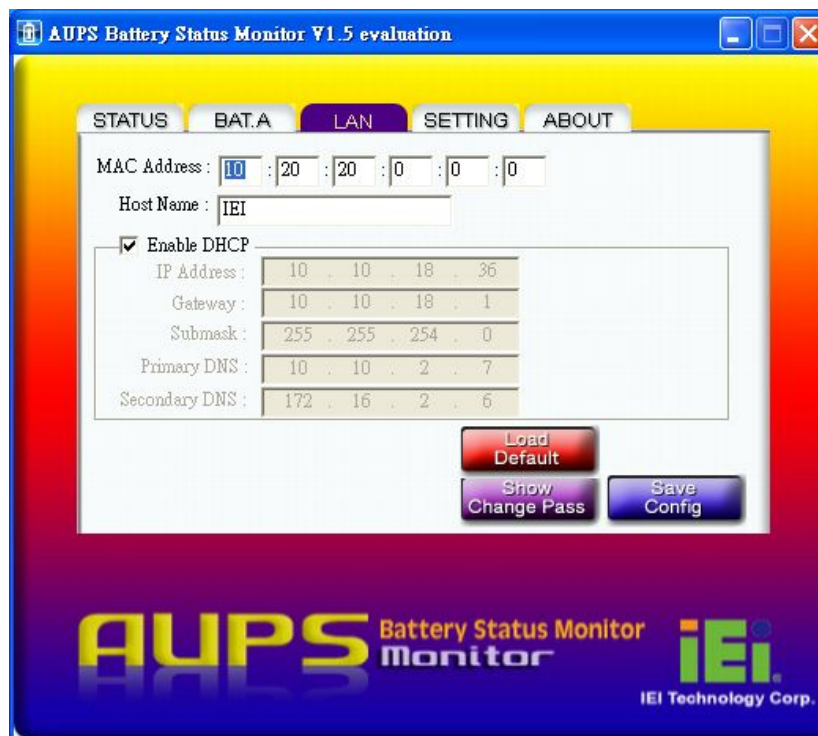
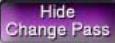



Figure 8-12: LAN Setting

The LAN Setting page can also setup the user name and password for remote monitoring. To change the user name and password, click  button. Enter the new user name and password (**Figure 8-13**). Click  button to save the settings. The default user name and password for the LAN setting page are:

- User name: admin
- Password: IEI

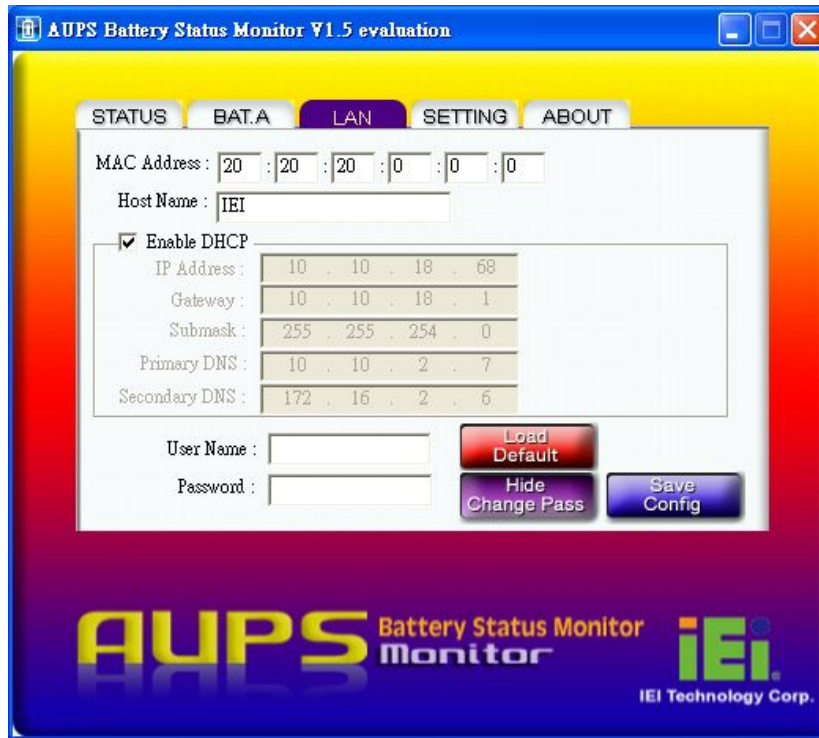

Figure 8-13: LAN Setting – Change Password

8.2.5 Setting

Click on the SETTING tab to select the COM port, enable/disable buzzer, LAN and DC output (Figure 8-14).

eKINO-945GSE Motherboard



Figure 8-14: Application Setting

When the AUPS Battery Status Monitor application starts up, it automatically scans all COM port (COM1~COM16) and shows the valid COM port. **Figure 8-15** shows the AUPS application is communicating with eKINO-945GSE through COM 6. To change the serial port to communicate, select a proper port number from the list and click Connect. Before changing, please make sure the selected serial port is not used by other devices.

COM 6 is Connected

Figure 8-15: COM Port Status

Other functions can be set in the SETTING tab include



 <input checked="" type="checkbox"/> NO BUZZER	Check to disable the buzzer that warns when the system is switching to use battery power.
 <input checked="" type="checkbox"/> Enable LAN	Check to enable the LAN for remote monitoring function.
 <input type="checkbox"/> Power On/Off	Check to enable the remote computer to turn the system power on or off. (This function is not available at this stage)
Shut down conditon (capacity %) <input type="text" value="5"/> <input type="button" value="Set"/>	
Set the battery capacity parameter for the system to shut down automatically. In this case, the system will shut down automatically when the battery capacity is below 5%.	

Table 8-2: Status Settings

8.3 Remote Control and Monitoring

The eKINO-945GSE can be controlled (power on/off) and monitored the battery status through a remote computer located in the same subnet with the eKINO-945GSE. To control and monitor the eKINO-945GSE remotely, follow the steps below.

- Step 1:** Connect the remote control connector J11 to the LAN.
- Step 2:** In a remote computer, install the IEI REMOTE AP. Double click the setup.exe file in the **x:\Other\AUPS REMOTE AP** directory. Follow the steps to install the IEI REMOTE AP. After installation, launch the AP. If there is a problem to launch the tool, execute the dotnetfxRedist20.exe first (located in the same directory of the driver CD).
- Step 3:** The IEI REMOTE AP tool appears (**Figure 8-16**). All the eKINO-945GSE panel PCs in the same subnet with this remote computer are shown in the list on the right. Click the function buttons on the left to control the eKINO-945GSE.

eKINO-945GSE Motherboard

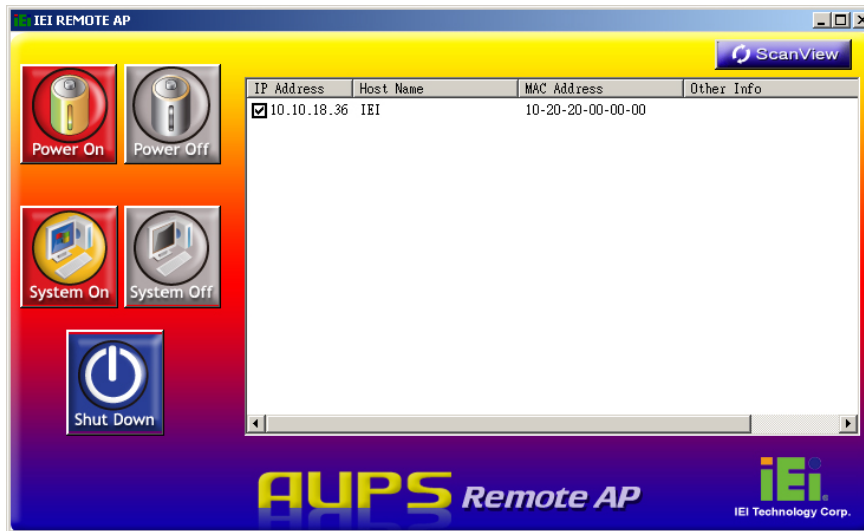

Figure 8-16: IEI REMOTE AP

Step 4: To access the web interface for advanced monitoring and functions, double click the IP address of the connected eKINO-945GSE (Figure 8-17).

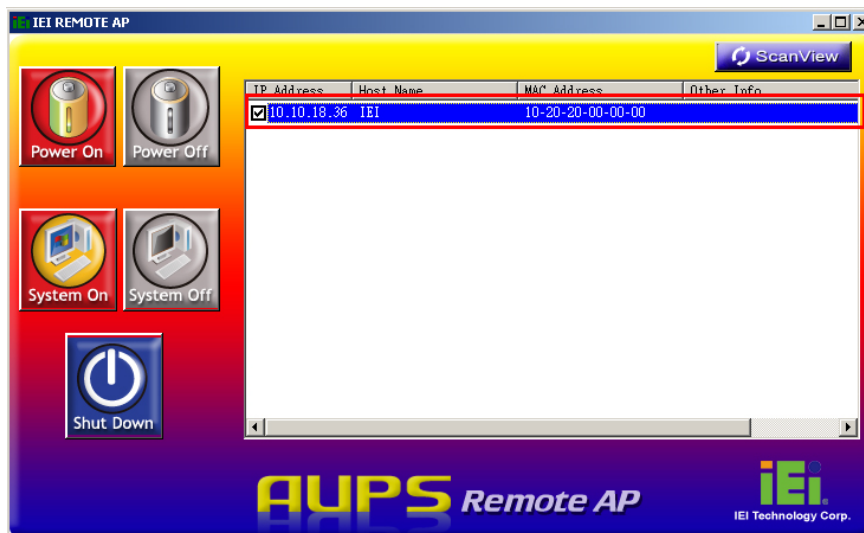

Figure 8-17: IEI REMOTE AP – IP Address

Step 5: Figure 8-18 shows in a web browser.

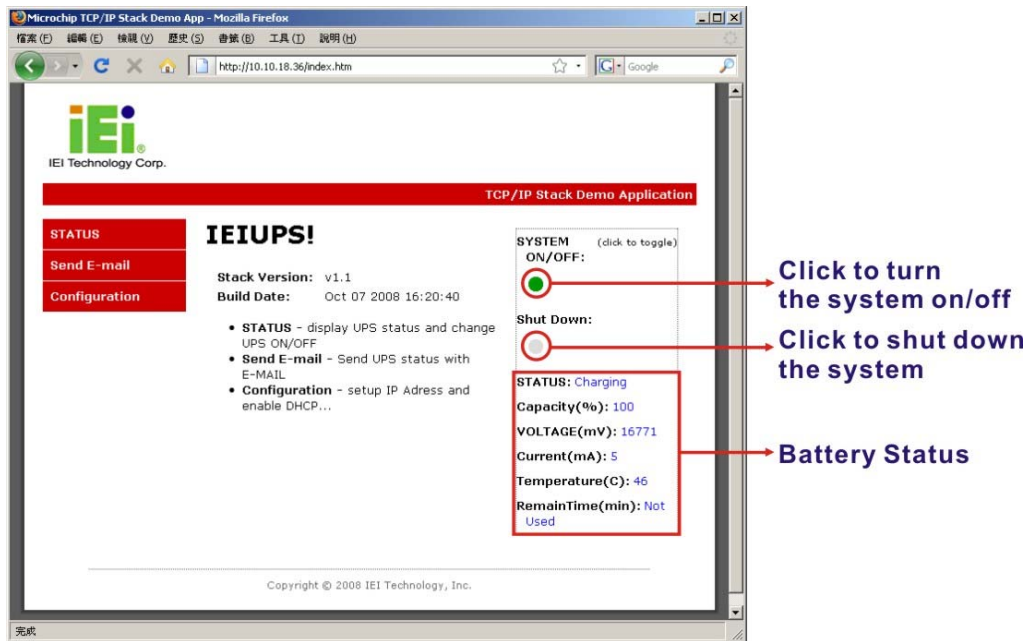

Figure 8-18: Remote Management Web Interface - Status

Step 6: To send an email to an administrator through the SMTP server, click Send E-mail button on the left. Fill out the information as indicated in **Figure 8-19**. Click the **Send Message** button to send the email.

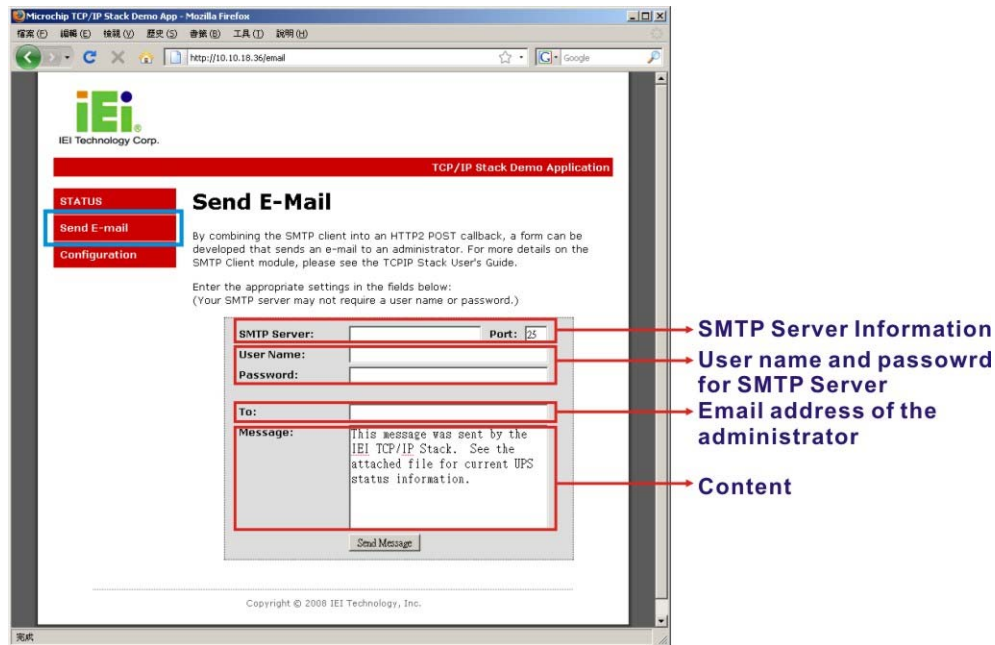

Figure 8-19: Remote Management Web Interface - Send Email

Step 7: To configure the eKINO-945GSE network setting, click the **Configuration** button on the left.

Step 8: A window prompts for the user name and password. The default user name and password for the LAN setting page are:

- User name: admin
- Password: IEI

If the user name and password has been change as described in **Section 8.2.4**, enter the new user name and password.

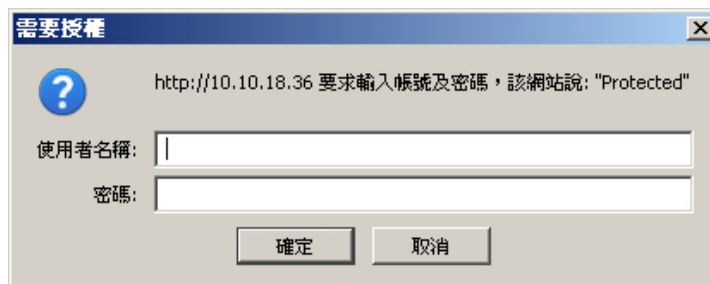

Figure 8-20: Enter User Name and Password

Step 9: The Board Configuration window appears. Configure the network settings and click the **Save Config** button. Incorrect settings may cause the board to lose network connectivity. Recovery options are provided on the next page.

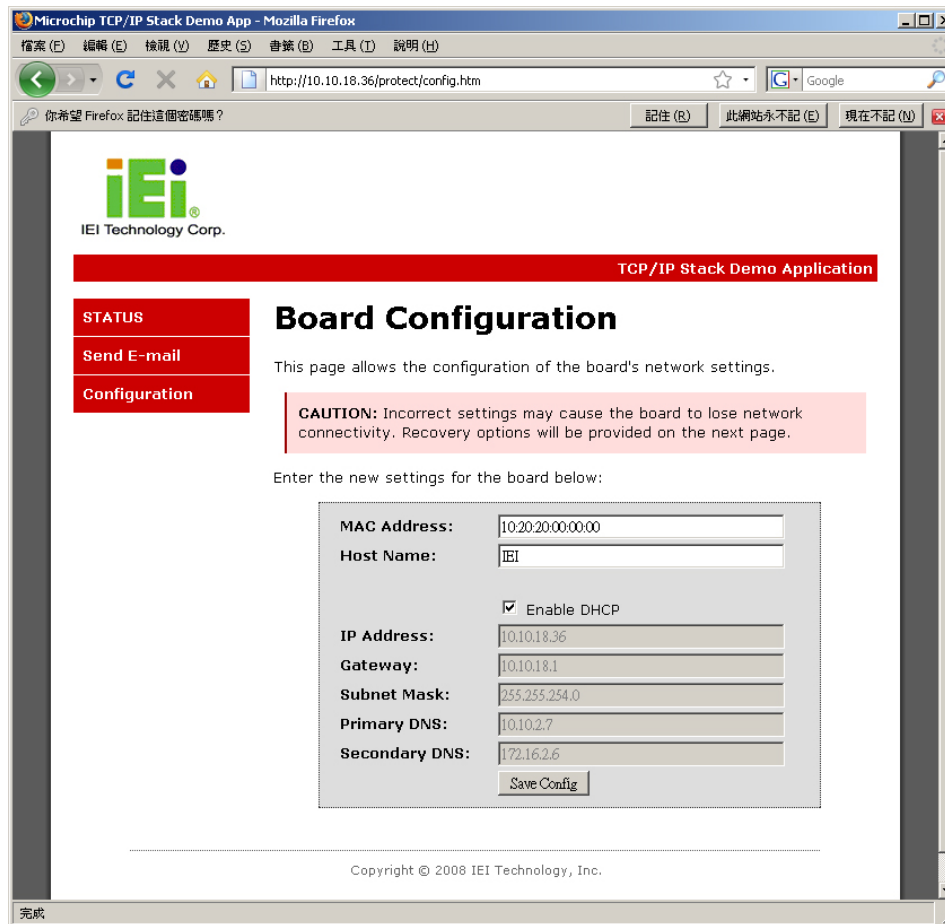

Figure 8-21: Board Configuration

Appendix

A

BIOS Options

Below is a list of BIOS configuration options in the BIOS chapter.

System Overview	92
System Time [xx:xx:xx]	93
System Date [xx/xx/xx]	93
ATA/IDE Configurations [Compatible]	96
Legacy IDE Channels [PATA Pri, SATA Sec]	97
IDE Master and IDE Slave	97
Auto-Detected Drive Parameters	98
Type [Auto]	99
LBA/Large Mode [Auto]	100
Block (Multi Sector Transfer) [Auto]	100
PIO Mode [Auto]	100
DMA Mode [Auto]	101
S.M.A.R.T [Auto]	102
32Bit Data Transfer [Enabled]	102
Serial Port1 Address [3F8/IRQ4]	103
Serial Port1 Mode [Normal]	103
Serial Port2 Address [2F8/IRQ3]	104
Serial Port2 Mode [Normal]	104
Serial Port3 Address [3E8]	104
Serial Port 3 IRQ [11]	104
Select RS232 or RS422/RS485 [RS232]	105
Serial Port4 Address [2E8]	105
Serial Port 4 IRQ [10]	105
Serial Port6 Address [2E0]	105
Serial Port 6 IRQ [11]	106
CPU FAN Mode Setting [Full On Mode]	106
CPU Temp. Limit of OFF [000]	107
CPU Temp. Limit of Start [020]	108
CPU Fan Start PWM [070]	108
Slope PWM [0.5 PWM]	108
Suspend Mode [S1(POS)]	111
Power Button Mode [On/Off]	112
Resume on Keyboard/Mouse [Disabled]	113

eKINO-945GSE Motherboard

Resume on Ring [Disabled]	113
Resume on PCI-Express WAKE# [Enabled].....	113
Resume On RTC Alarm [Disabled].....	113
Remote Access [Disabled].....	115
Serial Port Number [COM1].....	115
Base Address, IRQ [2F8h,3].....	115
Serial Port Mode [115200 8,n,1].....	115
Flow Control [None].....	116
Redirection After BIOS POST [Always]	116
Terminal Type [ANSI].....	116
VT-UTF8 Combo Key Support [Disabled].....	117
Sredir Memory Display Delay [Disabled].....	117
USB Functions [Enabled].....	118
USB 2.0 Controller [Enabled].....	118
USB2.0 Controller Mode [HiSpeed].....	119
Legacy USB Support [Enabled].....	119
IRQ# [Available].....	120
DMA Channel# [Available]	121
Reserved Memory Size [Disabled]	121
Quick Boot [Enabled]	123
Quiet Boot [Disabled]	123
AddOn ROM Display Mode [Force BIOS]	124
Bootup Num-Lock [Off]	124
Boot From LAN Support [Disabled]	124
Change Supervisor Password.....	129
Change User Password.....	129
Memory Hole [Disabled].....	131
Internal Graphics Mode Select [Enable, 8 MB]	132
Boot Graphic Adapter Priority [PCI/IGD]	132
DVMT Mode Select [DVMT Mode].....	133
DVMT/FIXED Memory [128 MB]	134
Boot Display Device [Auto].....	134
LVDS1 Panel Type [by H/W].....	134
LCD Current Jumper Setting [640x480 18bit]	135
TV Standard [VBIOS]	135

Audio Controller [All Disabled].....	136
Save Changes and Exit	137
Discard Changes and Exit.....	137
Discard Changes.....	137
Load Optimal Defaults.....	138
Load Failsafe Defaults.....	138

Appendix

B

Terminology

AC '97	Audio Codec 97 (AC'97) refers to a codec standard developed by Intel® in 1997.
ACPI	Advanced Configuration and Power Interface (ACPI) is an OS-directed configuration, power management, and thermal management interface.
AHCI	Advanced Host Controller Interface (AHCI) is a SATA Host controller register-level interface.
ATA	The Advanced Technology Attachment (ATA) interface connects storage devices including hard disks and CD-ROM drives to a computer.
ARMD	An ATAPI Removable Media Device (ARMD) is any ATAPI device that supports removable media, besides CD and DVD drives.
ASKIR	Amplitude Shift Keyed Infrared (ASKIR) is a form of modulation that represents a digital signal by varying the amplitude (“volume”) of the signal. A low amplitude signal represents a binary 0, while a high amplitude signal represents a binary 1.
BIOS	The Basic Input/Output System (BIOS) is firmware that is first run when the computer is turned on and can be configured by the end user
CODEC	The Compressor-Decompressor (CODEC) encodes and decodes digital audio data on the system.
CompactFlash®	CompactFlash® is a solid-state storage device. CompactFlash® devices use flash memory in a standard size enclosure. Type II is thicker than Type I, but a Type II slot can support both types.
CMOS	Complimentary metal-oxide-conductor is an integrated circuit used in chips like static RAM and microprocessors.
COM	COM refers to serial ports. Serial ports offer serial communication to expansion devices. The serial port on a personal computer is usually a male DB-9 connector.
DAC	The Digital-to-Analog Converter (DAC) converts digital signals to analog signals.
DDR	Double Data Rate refers to a data bus transferring data on both the rising and falling edges of the clock signal.

eKINO-945GSE Motherboard

DMA	Direct Memory Access (DMA) enables some peripheral devices to bypass the system processor and communicate directly with the system memory.
DIMM	Dual Inline Memory Modules are a type of RAM that offer a 64-bit data bus and have separate electrical contacts on each side of the module.
DIO	The digital inputs and digital outputs are general control signals that control the on/off circuit of external devices or TTL devices. Data can be read or written to the selected address to enable the DIO functions.
EHCI	The Enhanced Host Controller Interface (EHCI) specification is a register-level interface description for USB 2.0 Host Controllers.
EIDE	Enhanced IDE (EIDE) is a newer IDE interface standard that has data transfer rates between 4.0 MB/s and 16.6 MB/s.
EIST	Enhanced Intel® SpeedStep Technology (EIST) allows users to modify the power consumption levels and processor performance through application software. The application software changes the bus-to-core frequency ratio and the processor core voltage.
FSB	The Front Side Bus (FSB) is the bi-directional communication channel between the processor and the Northbridge chipset.
GbE	Gigabit Ethernet (GbE) is an Ethernet version that transfers data at 1.0 Gb/s and complies with the IEEE 802.3-2005 standard.
GPIO	General purpose input
HDD	Hard disk drive (HDD) is a type of magnetic, non-volatile computer storage device that stores digitally encoded data.
ICH	The Input/Output Control Hub (ICH) is an Intel® Southbridge chipset.
IrDA	Infrared Data Association (IrDA) specify infrared data transmission protocols used to enable electronic devices to wirelessly communicate with each other.
L1 Cache	The Level 1 Cache (L1 Cache) is a small memory cache built into the system processor.
L2 Cache	The Level 2 Cache (L2 Cache) is an external processor memory cache.

LCD	Liquid crystal display (LCD) is a flat, low-power display device that consists of two polarizing plates with a liquid crystal panel in between.
LVDS	Low-voltage differential signaling (LVDS) is a dual-wire, high-speed differential electrical signaling system commonly used to connect LCD displays to a computer.
POST	The Power-on Self Test (POST) is the pre-boot actions the system performs when the system is turned-on.
RAM	Random Access Memory (RAM) is volatile memory that loses data when power is lost. RAM has very fast data transfer rates compared to other storage like hard drives.
SATA	Serial ATA (SATA) is a serial communications bus designed for data transfers between storage devices and the computer chipsets. The SATA bus has transfer speeds up to 1.5 Gb/s and the SATA II bus has data transfer speeds of up to 3.0 Gb/s.
S.M.A.R.T	Self Monitoring Analysis and Reporting Technology (S.M.A.R.T) refers to automatic status checking technology implemented on hard disk drives.
UART	Universal Asynchronous Receiver-transmitter (UART) is responsible for asynchronous communications on the system and manages the system's serial communication (COM) ports.
UHCI	The Universal Host Controller Interface (UHCI) specification is a register-level interface description for USB 1.1 Host Controllers.
UPS	An Uninterruptible Power Supply allow system to continue operation after the loss of main power. This is usually accomplished by having a battery backup for when the main power is turned off.
USB	The Universal Serial Bus (USB) is an external bus standard for interfacing devices. USB 1.1 supports 12 Mb/s data transfer rates and USB 2.0 supports 480 Mb/s data transfer rates.
VGA	The Video Graphics Array (VGA) is a graphics display system developed by IBM.

Appendix

C

Digital I/O Interface

C.1 Introduction

The DIO connector on the eKINO-945GSE is interfaced to GPIO ports on the Super I/O chipset. The DIO has both 4-bit digital inputs and 4-bit digital outputs. The digital inputs and digital outputs are generally control signals that control the on/off circuit of external devices or TTL devices. Data can be read or written to the selected address to enable the DIO functions.



NOTE:

For further information, please refer to the datasheet for the Super I/O chipset.

C.2 DIO Connector Pinouts

The following table describes how the DIO connector pins are connected to the Digital I/O port.

Pin	Description	Super I/O Pin	Super I/O Pin Description
1	Ground	N/A	N/A
2	VCC	N/A	N/A
3	Output 3	24	General Purpose I/O 23
4	Output 2	25	General Purpose I/O 22
5	Output 1	26	General Purpose I/O 21
6	Output 0	27	General Purpose I/O 20
7	Input 3	16	General Purpose I/O 33
8	Input 2	17	General Purpose I/O 32
9	Input 1	18	General Purpose I/O 31
10	Input 0	19	General Purpose I/O 30

Table C-1: Digital I/O Connector Pinouts

C.3 Assembly Language Samples

C.3.1 Enable the DIO Input Function

The BIOS interrupt call INT 15H controls the digital I/O. An assembly program to enable digital I/O input functions is listed below.

MOV	AX, 6F08H	Sets the digital port as input
INT	15H	Initiates the INT 15H BIOS call

C.3.2 Enable the DIO Output Function

The BIOS interrupt call INT 15H controls the digital I/O. An assembly program to enable digital I/O output functions is listed below.

MOV	AX, 6F09H	Sets the digital port as output
MOV	BL, 09H	
INT	15H	Initiates the INT 15H BIOS call

Appendix

D

Watchdog Timer



NOTE:

The following discussion applies to DOS environment. IEI support is contacted or the IEI website visited for specific drivers for more sophisticated operating systems, e.g., Windows and Linux.

The Watchdog Timer is provided to ensure that standalone systems can always recover from catastrophic conditions that cause the CPU to crash. This condition may have occurred by external EMIs or a software bug. When the CPU stops working correctly, Watchdog Timer either performs a hardware reset (cold boot) or a Non-Maskable Interrupt (NMI) to bring the system back to a known state.

A BIOS function call (INT 15H) is used to control the Watchdog Timer.

INT 15H:

AH – 6FH Sub-function:	
AL – 2:	Sets the Watchdog Timer's period.
BL:	Time-out value (Its unit-second is dependent on the item "Watchdog Timer unit select" in CMOS setup).

Table D-1: AH-6FH Sub-function

Call sub-function 2 to set the time-out period of Watchdog Timer first. If the time-out value is not zero, the Watchdog Timer starts counting down. When the timer value reaches zero, the system resets. To ensure that this reset condition does not occur, calling sub-function 2 must periodically refresh the Watchdog Timer. However, the watchdog timer is disabled if the time-out value is set to zero.

A tolerance of at least 10% must be maintained to avoid unknown routines within the operating system (DOS), such as disk I/O that can be very time-consuming.

**NOTE:**

When exiting a program it is necessary to disable the Watchdog Timer, otherwise the system resets.

EXAMPLE PROGRAM:

; INITIAL TIMER PERIOD COUNTER

;

W_LOOP:

;

```
MOV     AX, 6F02H      ;setting the time-out value
MOV     BL, 30         ;time-out value is 48 seconds
INT     15H
```

;

; ADD THE APPLICATION PROGRAM HERE

;

```
CMP     EXIT_AP, 1     ;is the application over?
JNE     W_LOOP        ;No, restart the application
```

```
MOV     AX, 6F02H      ;disable Watchdog Timer
MOV     BL, 0          ;
INT     15H
```

;

; EXIT ;

Appendix

E

Address Mapping

E.1 Direct Memory Access (DMA)

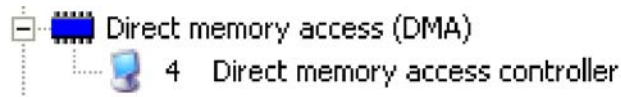

Figure E-1: Direct Memory Access (DMA)

E.2 Input/Output (IO)

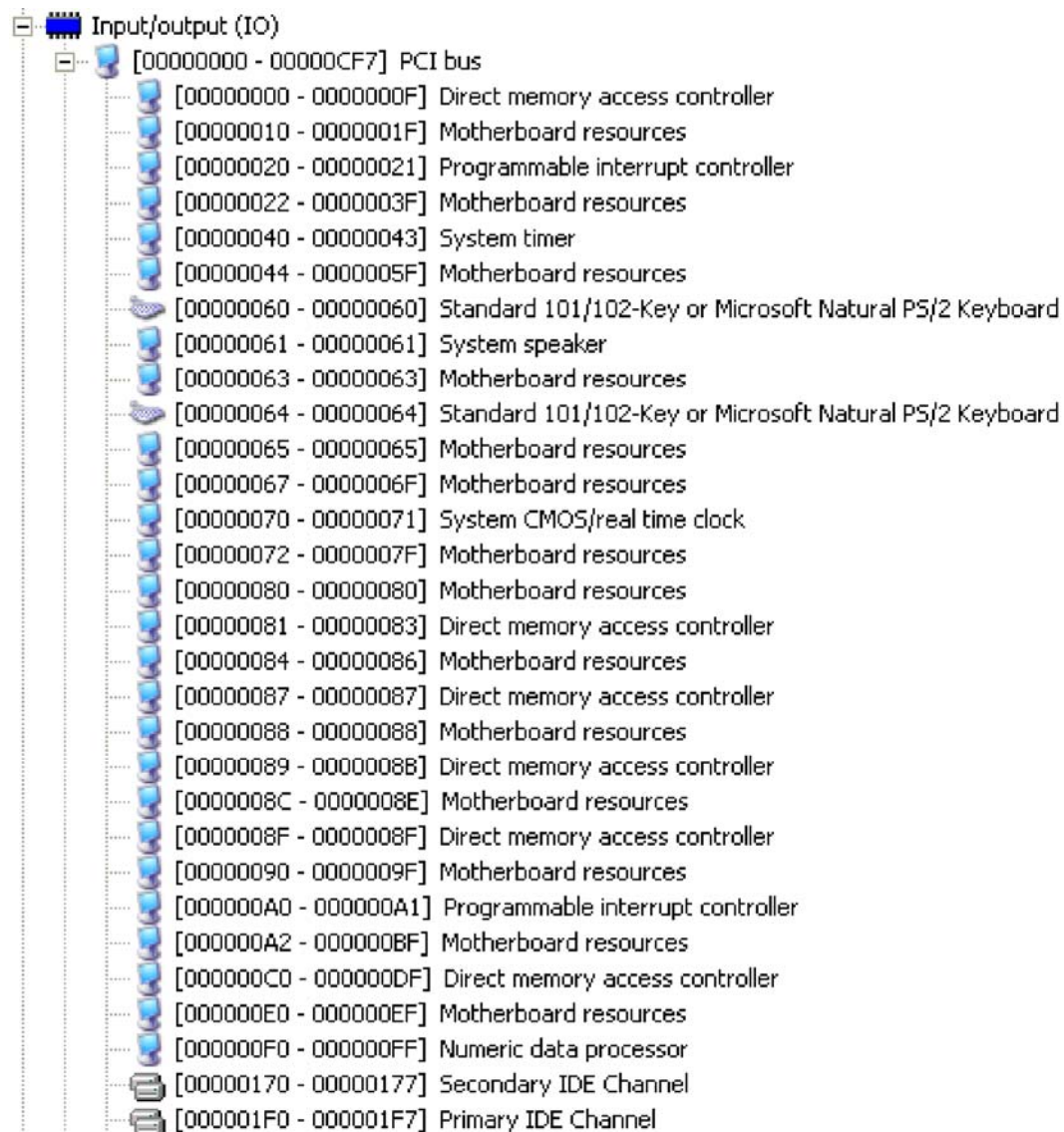

Figure E-2: Input/Output (1 of 2)

eKINO-945GSE Motherboard

[00000279 - 00000279]	ISAPNP Read Data Port
[000002E8 - 000002EF]	Communications Port (COM4)
[000002F8 - 000002FF]	Communications Port (COM2)
[00000376 - 00000376]	Secondary IDE Channel
[00000380 - 000003BB]	Mobile Intel(R) 945 Express Chipset Family
[000003C0 - 000003DF]	Mobile Intel(R) 945 Express Chipset Family
[000003E8 - 000003EF]	Communications Port (COM3)
[000003F6 - 000003F6]	Primary IDE Channel
[000003F8 - 000003FF]	Communications Port (COM1)
[00000400 - 0000041F]	Intel(R) 82801G (ICH7 Family) SMBus Controller - 27DA
[00000480 - 000004BF]	Motherboard resources
[000004D0 - 000004D1]	Motherboard resources
[00000800 - 0000087F]	Motherboard resources
[00000A00 - 00000A0F]	Motherboard resources
[00000A10 - 00000A1F]	Motherboard resources
[00000A20 - 00000A2F]	Motherboard resources
[00000A30 - 00000A3F]	Motherboard resources
[00000A60 - 00000A6F]	Motherboard resources
[00000A79 - 00000A79]	ISAPNP Read Data Port
[00000D00 - 0000FFFF]	PCI bus
[0000C000 - 0000C0FF]	Realtek AC'97 Audio
[0000C400 - 0000C43F]	Realtek AC'97 Audio
[0000C480 - 0000C49F]	Intel(R) 82801G (ICH7 Family) USB Universal Host Controller - 27CB
[0000C800 - 0000C81F]	Intel(R) 82801G (ICH7 Family) USB Universal Host Controller - 27CA
[0000C880 - 0000C89F]	Intel(R) 82801G (ICH7 Family) USB Universal Host Controller - 27C9
[0000CC00 - 0000CC1F]	Intel(R) 82801G (ICH7 Family) USB Universal Host Controller - 27C8
[0000CC80 - 0000CC87]	Mobile Intel(R) 945 Express Chipset Family
[0000D000 - 0000DFFF]	Intel(R) 82801G (ICH7 Family) PCI Express Root Port - 27D0
[0000DC00 - 0000DCFF]	Realtek RTL8168C(P)/8111C(P) PCI-E Gigabit Ethernet NIC #2
[0000E000 - 0000EFFF]	Intel(R) 82801G (ICH7 Family) PCI Express Root Port - 27D2
[0000EC00 - 0000ECFF]	Realtek RTL8168C(P)/8111C(P) PCI-E Gigabit Ethernet NIC
[0000FFA0 - 0000FFAF]	Intel(R) 82801GBM/GHM (ICH7-M Family) Serial ATA Storage Controller - 27C4

Figure E-3: Input/Output (2 of 2)

E.3 Interrupt Request (IRQ)

Interrupt request (IRQ)	
(ISA) 0	System timer
(ISA) 1	Standard 101/102-Key or Microsoft Natural PS/2 Keyboard
(ISA) 3	Communications Port (COM2)
(ISA) 4	Communications Port (COM1)
(ISA) 8	System CMOS/real time clock
(ISA) 9	Microsoft ACPI-Compliant System
(ISA) 10	Communications Port (COM4)
(ISA) 11	Communications Port (COM3)
(ISA) 12	Microsoft PS/2 Mouse
(ISA) 13	Numeric data processor
(ISA) 14	Primary IDE Channel
(ISA) 15	Secondary IDE Channel
(PCI) 5	Intel(R) 82801G (ICH7 Family) SMBus Controller - 27DA
(PCI) 16	Intel(R) 82801G (ICH7 Family) PCI Express Root Port - 27D0
(PCI) 16	Intel(R) 82801G (ICH7 Family) USB Universal Host Controller - 27CB
(PCI) 16	Mobile Intel(R) 945 Express Chipset Family
(PCI) 16	Realtek RTL8168C(P)/8111C(P) PCI-E Gigabit Ethernet NIC #2
(PCI) 17	Intel(R) 82801G (ICH7 Family) PCI Express Root Port - 27D2
(PCI) 17	Realtek AC'97 Audio
(PCI) 17	Realtek RTL8168C(P)/8111C(P) PCI-E Gigabit Ethernet NIC
(PCI) 18	Intel(R) 82801G (ICH7 Family) USB Universal Host Controller - 27CA
(PCI) 19	Intel(R) 82801G (ICH7 Family) USB Universal Host Controller - 27C9
(PCI) 23	Intel(R) 82801G (ICH7 Family) USB Universal Host Controller - 27C8
(PCI) 23	Intel(R) 82801G (ICH7 Family) USB2 Enhanced Host Controller - 27CC

Figure E-4: Interrupt Request (IRQ)

E.4 Memory

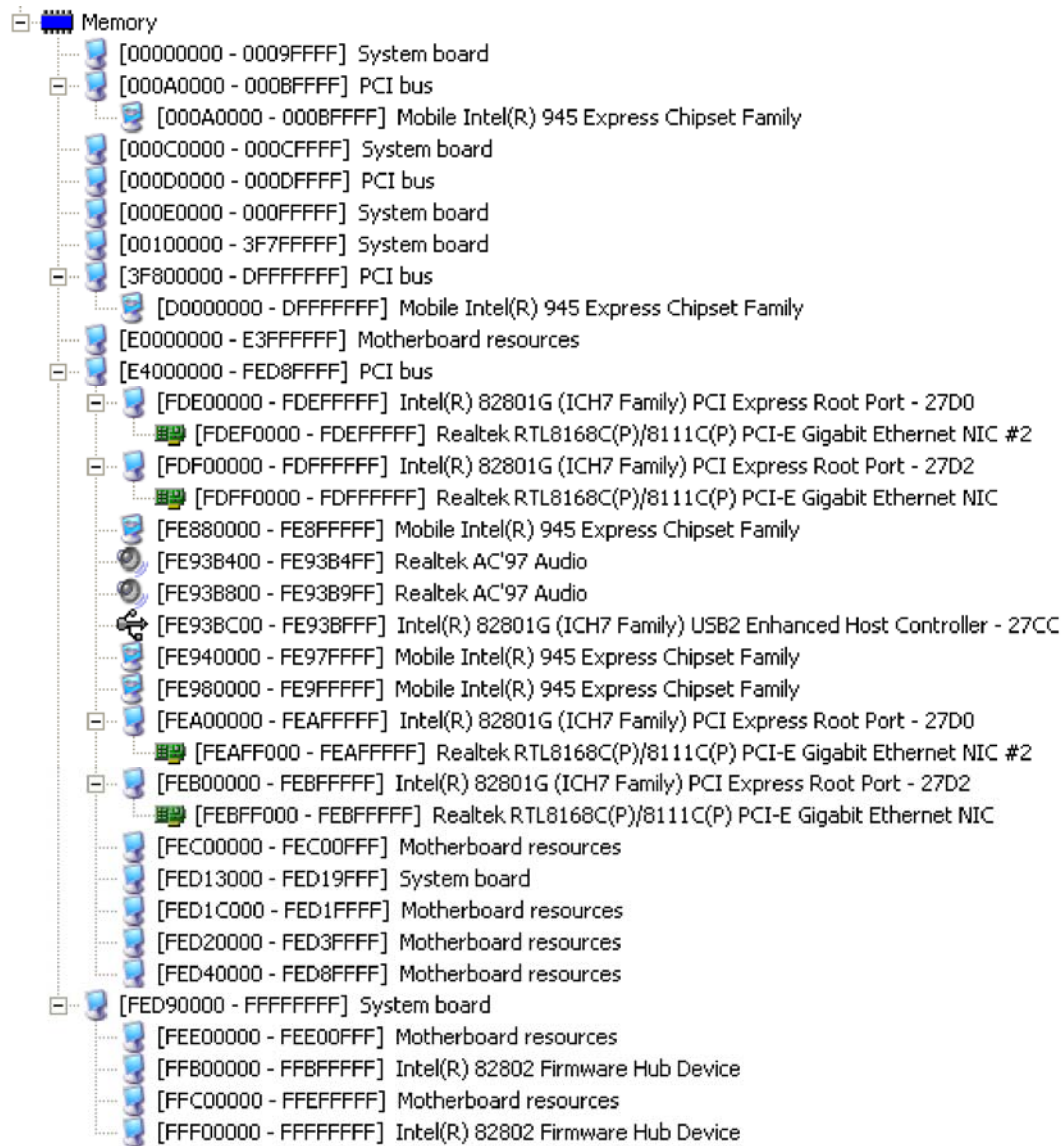

Figure E-5: Memory

Appendix

F

Hazardous Materials Disclosure

F.1 Hazardous Materials Disclosure Table for IPB Products Certified as RoHS Compliant Under 2002/95/EC Without Mercury

The details provided in this appendix are to ensure that the product is compliant with the Peoples Republic of China (China) RoHS standards. The table below acknowledges the presences of small quantities of certain materials in the product, and is applicable to China RoHS only.

A label will be placed on each product to indicate the estimated “Environmentally Friendly Use Period” (EFUP). This is an estimate of the number of years that these substances would “not leak out or undergo abrupt change.” This product may contain replaceable sub-assemblies/components which have a shorter EFUP such as batteries and lamps. These components will be separately marked.

Please refer to the table on the next page.

Part Name	Toxic or Hazardous Substances and Elements					
	Lead (Pb)	Mercury (Hg)	Cadmium (Cd)	Hexavalent Chromium (CR(VI))	Polybrominated Biphenyls (PBB)	Polybrominated Diphenyl Ethers (PBDE)
Housing	X	O	O	O	O	X
Display	X	O	O	O	O	X
Printed Circuit Board	X	O	O	O	O	X
Metal Fasteners	X	O	O	O	O	O
Cable Assembly	X	O	O	O	O	X
Fan Assembly	X	O	O	O	O	X
Power Supply Assemblies	X	O	O	O	O	X
Battery	O	O	O	O	O	O

O: This toxic or hazardous substance is contained in all of the homogeneous materials for the part is below the limit requirement in SJ/T11363-2006

X: This toxic or hazardous substance is contained in at least one of the homogeneous materials for this part is above the limit requirement in SJ/T11363-2006

eKINO-945GSE Motherboard

此附件旨在确保本产品符合中国 RoHS 标准。以下表格标示此产品中某有毒物质的含量符合中国 RoHS 标准规定的限量要求。

本产品上会附有“环境友好使用期限”的标签，此期限是估算这些物质“不会有泄漏或突变”的年限。本产品可能包含有较短的环境友好使用期限的可替换元件，像是电池或灯管，这些元件将会单独标示出来。

部件名称	有毒有害物质或元素					
	铅 (Pb)	汞 (Hg)	镉 (Cd)	六价铬 (CR(VI))	多溴联苯 (PBB)	多溴二苯 醚 (PBDE)
壳体	X	O	O	O	O	X
显示	X	O	O	O	O	X
印刷电路板	X	O	O	O	O	X
金属螺帽	X	O	O	O	O	O
电缆组装	X	O	O	O	O	X
风扇组装	X	O	O	O	O	X
电力供应组装	X	O	O	O	O	X
电池	O	O	O	O	O	O

O: 表示该有毒有害物质在该部件所有物质材料中的含量均在 SJ/T11363-2006 标准规定的限量要求以下。
X: 表示该有毒有害物质至少在该部件的某一均质材料中的含量超出 SJ/T11363-2006 标准规定的限量要求。

Index

eKINO-945GSE Motherboard

A

ACPI 110

airflow75

anti-static precautions.....26, 62

 anti-static pad26, 62

 anti-static wristband.....26, 62

 handling26, 62

 self-grounding.....26, 62

ASKIR interface39

AT power select jumper

 settings70

ATA flat cable76

Audio Codec '97 16

audio connector56

audio connector, external56

audio devices, external.....56

audio jack.....56

B

backlight inverter connector.....41

 location and pinouts41

backup battery34

battery connector.....34

 location and pinouts34

 reset CMOS.....34

BIOS .20, 90, 91, 92, 97, 116, 119, 124, 130,
137

BIOS chipset.....20

C

cables

 ATA flat cable76

 dual port USB80

 dual RS-232 cable79

 LPT82

 parallel port.....82

 SATA drive77

 SATA drive power77

CF card66

 installation.....66

 setup jumper71

CF card setup jumper 4, 71

 settings72

chassis75

 installation.....75

chipset.....12

 northbridge12

clear CMOS jumper 4, 71

 settings71

CMOS 34, 71

 clear CMOS connector34

 clear CMOS jumper71

codec16

 AC'9716

COM2

 RS-232/485 select72

connectors, external

 audio jacks.....56

 DVI connector.....56

 LAN connector.....57

RJ-45 connector	57
USB port	59
connectors, pinouts and location	
AT power	47
backlight inverter	41, 42
battery.....	33
COM 2 serial port	52
CompactFlash	34
digital input/output	35, 52
fan.....	36
front panel.....	37
IDE.....	38
infrared interface	39
keyboard/mouse.....	40, 45
LVDS LCD (30-pin).....	43
serial port (COM 2).....	50, 51, 52
TV out.....	53
USB (internal).....	54
cooling	75
airflow	75
cooling fan	36, 109
CRT.....	134

D

DB-15 connector.....	87
DB-9 connector.....	86
digital input/output connector.....	35, 52
location and pinouts	35, 52
dimensions.....	8
board	8
external peripheral interface connector	
panel	9
dual port USB cable.....	80
DVI connector	56

DVI connector	57
---------------------	----

E

electrostatic discharge	26, 62
Enhanced Hardware Monitor	21
external indicators.....	37
external peripheral interface	83
connection	83
connectors	83
external switches	37

F

fan connector	36
location and pinouts.....	36
fan speed controller	21
FDD.....	103
front panel connector	37
location and pinouts.....	37
FSB	95

H

hard disk drives	
SATA.....	48

I

IDE connector, 44-pin	38
location and pinouts.....	38
IDE device.....	76
ATA flat cable	76
connector	76
IDE interface	16, 17
infrared interface.....	39
Amplitude Shift Key Infrared.....	39

eKINO-945GSE Motherboard

ASKIR.....	39	location and pinouts.....	44
Serial Infrared.....	39	LVDS panel.....	44
SIR.....	39	18-bit.....	44
infrared interface connector.....	39	36-bit.....	44
location and pinouts.....	39	dual channel.....	44
installation checklist.....	64	single channel.....	44
		LVDS voltage selection jumper.....	72, 73, 74
		settings.....	72, 73
J			
jumper.....	69		
CF card setup.....	71		
clear CMOS.....	71		
jumper configuration.....	69		
jumper settings.....	68		
LVDS voltage selection.....	72, 73, 74		
RS-232/485 serial port select.....	72		
K			
keyboard controller.....	21		
L			
LAN connection.....	84		
LAN connector.....	57		
LCD display.....	41		
backlight inverter connector.....	41		
LPC bus.....	20		
LPC interface.....	17, 21		
LPT			
cable connection.....	82		
LPT cable.....	82		
LPT connection.....	82		
LVDS display.....	72, 73, 74		
voltage select.....	72, 73, 74		
LVDS LCD connector.....	44		
M			
memory module installation.....	65		
motherboard.....	75		
installation.....	75		
N			
northbridge chipset.....	12		
P			
parallel port			
cable connection.....	82		
parallel port cable.....	82		
parallel port connection.....	82		
PCI interface.....	17		
PCIe mini card slot.....	46		
location and pinouts.....	46		
peripheral connectors.....	33		
Power Button Mode.....	112		
PS/2 keyboard and mouse			
connection.....	84		
R			
RAID.....	48		
real time clock.....	19		

RJ-45 connection.....	84
single connector	84
RJ-45 connector	57
RJ-45 connector	58
RS-232.....	50, 79
cable connection	79
COM 2 location and pinouts.....	50
connector location and pinouts.....	50
dual cable	79
serial port devices	50
RS-232 serial port devices	50
RS-232/485 serial port select jumper	72
settings	72

S

SATA	
controller.....	19
SATA drive	77
cables	77
connection	77
power cable	77
SATA drive connector	48
location and pinouts	48
SATA drives.....	48
Serial Device	
connection	85
serial port connector	50
location and pinouts	50
serial ports	21
SIR interface	39
SODIMM	65
installation.....	65
specifications.....	65
Super I/O chipset.....	20

system voltages	106, 109
-----------------------	----------

T

technical specifications	5
temperature.....	106
TV out connector.....	53
location and pinouts.....	53

U

unpacking.....	26
unpacking checklist	27
unpacking precautions.....	26
USB.....	54, 80, 118, 119
cable	
dual port	80
cable	80
cable	80
cable connection.....	81
connectors	80
controller.....	19
devices	54
external USB device connection	86
port.....	54
USB 1.1	54
USB 2.0	54
USB 1.1.....	54
USB 2.0.....	54, 118
USB 2.0 port	59
USB cable	
dual port.....	80
USB connector, internal	54
location and pinouts.....	54
USB device connection.....	86
dual connector	86

eKINO-945GSE Motherboard

USB port59
USB2.0 119

V

VGA87
VGA connector.....60

VGA monitor.....87
connection87

W

warranty validation.....64