

IDS-141A/181A

► Industrial 4-port/8-port slim type serial to Ethernet device server

Features

- Operating Modes : Virtual Com, Serial Tunnel, TCP Server, TCP Client, UDP
- Multiple host devices :
5 host devices: Virtual COM, TCP Server, TCP Client mode;
4 IP ranges : UDP
- NAT Pass-Through : the user can manage IDS-181A/141A through NAT router
- Security : SSL data encryption; secured management by HTTPS and SSH
IP Access : IP White List
- Update DNS Hostname : DDNS
- Event Warning by Syslog, Email, SNMP trap and Relay
- Configurable by Web-based and Windows utility (DS-Tool)
- Various Windows O.S. supported :
Windows NT / 2000 / XP / 2003 / VISTA(32/64-bit) / Windows 7(32/64-bit)



Introduction

IDS-181A/141A is an innovative secure 8-port/4-port RS-232 to 1-port LAN serial to Ethernet device server featuring the standard features of device server, such like TCP/IP interface and versatile operation modes: Virtual Com, Serial Tunnel, TCP Server, TCP Client, UDP, Ethernet modem. In addition, the Windows utility, DS-Tool, could configure multiple devices and set up the mappings of Virtual Com. The features of NAT Router Pass-Through, and DDNS make it more convenient for administrators to configure ORing's device servers through NAT router from different IP domains or Internet via modem remotely. On the other hand, IDS-181A/141A can simultaneously transfer data up to 5 redundant host PCs to avoid Ethernet connection breakdown or any host PC fails. Further, IDS-181A/141A features HTTPS, SSH, and SSL encryption to assure the security of critical data transmission.

IDS-181A/141A provides dual redundant power inputs, 12~48VDC on terminal block and DC power jack to guarantee a non-stop operation. With wide operating temperature, -40~70°C, and rugged IP-30 housing design, IDS-181A/141A could operate in the harsh industrial environment. Therefore IDS-181A/141A is the best solution to the high demand of secure serial to Ethernet critical data communication.

DS-Tool

In practical operation of serial device servers, Windows utility (DS-Tool) is supported. This utility is very helpful for you to manage and monitor all of industrial device servers in the industrial network.

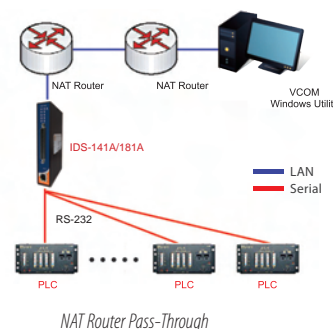
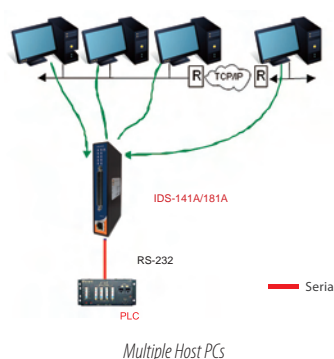

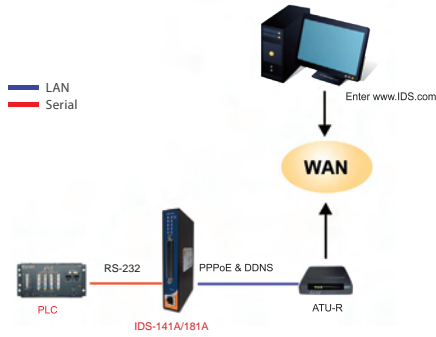

Connect Through PPPoE / DDNS



SSL Data Encryption



TCP Server/Client Mode

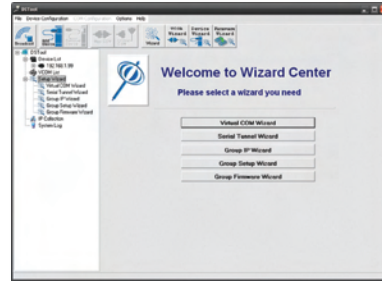
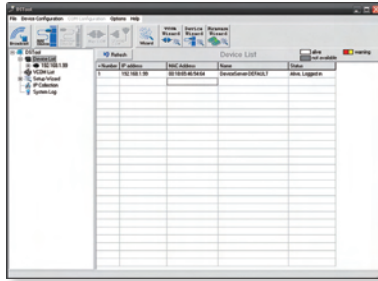

Monitoring and Configuration interface

Dimensions

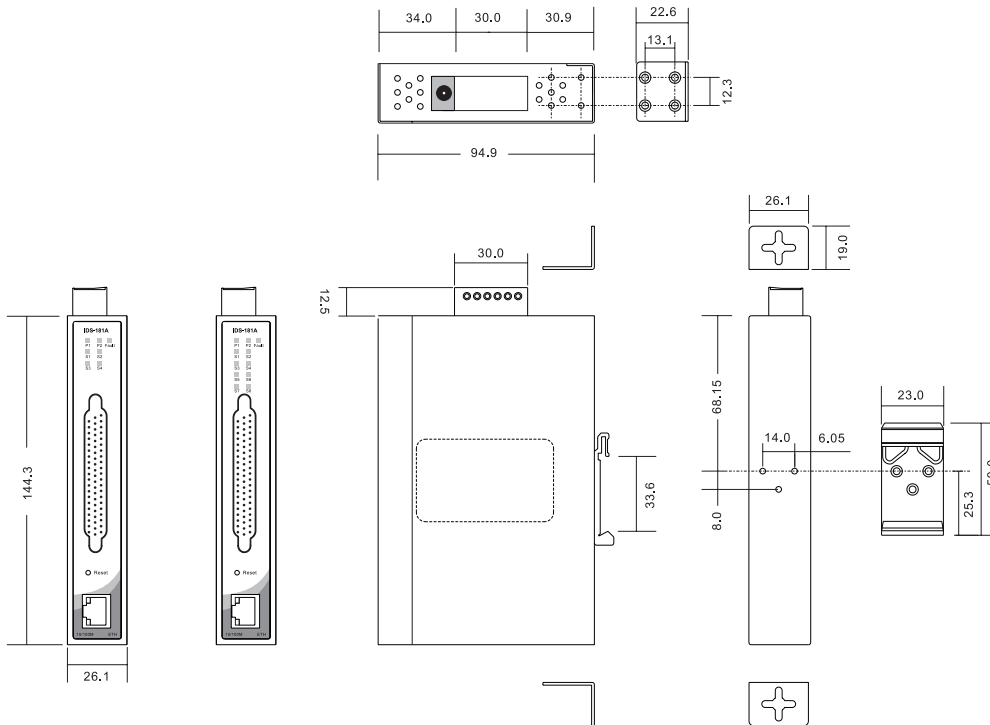

Unit=mm

Pin Definitions

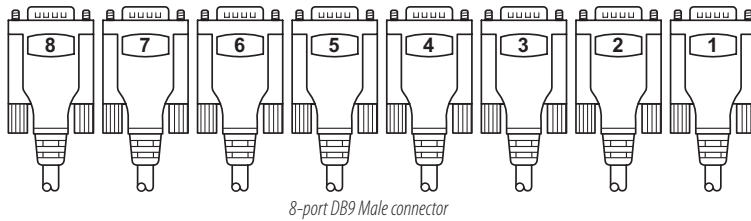

8-port DB9 Male connector

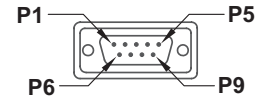

DB9 Male Pin Assignment

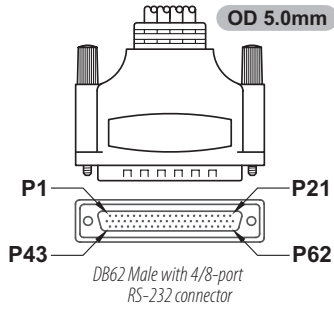

DB62 Male with 4/8-port RS-232 connector

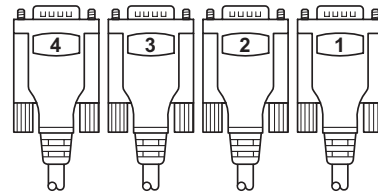

4-port DB9 Male connector

Pin #	RS-232
1	DCD
2	RXD
3	TXD
4	DTR
5	GND
6	DSR
7	RTS
8	CTS
9	N.C.
RS 232 mode act as DTE	

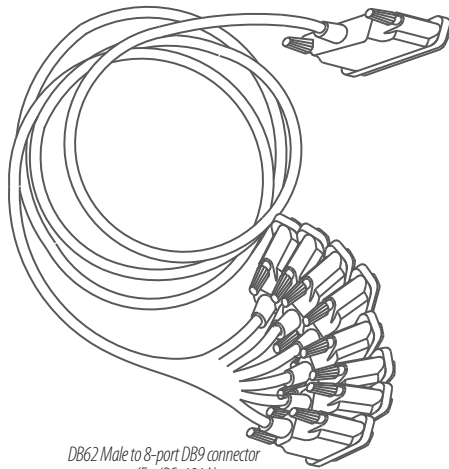

DB62 Male to 8-port DB9 connector (For IDS-181A)

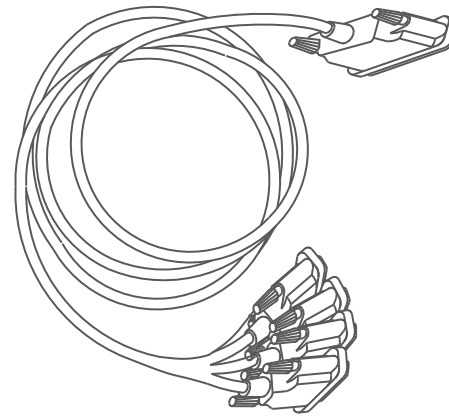

DB62 Male to 4-port DB9 connector (For IDS-141A)

- Industrial Ethernet Switch
- Industrial Media Converter
- Industrial Device Server
- Industrial Wireless Access Point
- Industrial Cellular VPN Router
- Industrial M2M Gateway
- Accessories
- Network Management Software

Specifications

ORing Device Server Model	IDS-181A	IDS-141A
Physical Ports		
10/100Base-T(X) Ports in RJ45 Auto MDI/MDIX	1	
Serial Ports		
RS-232 Serial port number	8	4
Connector	DB62 Female (provide DB62 to 8 ports DB9 cable)	DB62 Female (provide DB62 to 4 ports DB9 cable)
Operation Mode	RS-232	
Serial Baud Rate	110 bps to 115.2 Kbps	
Data Bits	5, 6, 7, 8	
Parity	odd, even, none, mark, space	
Stop Bits	1, 1.5, 2	
RS-232	TxD, RxD, RTS, CTS, DTR, DSR, DCD, GND	
Flow Control	XON/XOFF, RTS/CTS, DTR/DSR	
Network Features		
Network Protocols	ICMP, IP, TCP, UDP, DHCP, BOOTP, SSH, DNS, SNMP V1/V2c, HTTPS, SMTP, SSL, PPPoE, DDNS	
LED Indicators		
Power Indicator	PWR 1(2) / Ready : Green On : Power is on and functioning Normally. Green Blinking : Located by Administrator.	
10/100Base-T(X) RJ45 Port Indicator	Green for port Link/Act. Amber for port Link/Act at 100Mbps.	
Serial TX / RX LEDs	Red : Serial port is receiving data Green : Serial port is transmitting data	
Fault Contact		
Relay	Relay output to carry capacity of 1A at 24VDC	
Power		
Redundant Input Power	Triple DC inputs. 12~48VDC on 6-pin terminal block and power jack	
Power Consumption (Typ.)	4.5 Watts	3.7 Watts
Overload Current Protection	Present	
Reverse Polarity Protection	Present on terminal block	
Physical Characteristics		
Enclosure	IP-30	
Dimensions (W x D x H)	26.1(W) x 94.9(D) x 144.3(H) mm	
Weight (g)	358 g	355 g
Environmental		
Storage Temperature	-40 to 85°C (-40 to 185°F)	
Operating Temperature	-40 to 70°C (-40 to 158°F)	
Operating Humidity	5% to 95% Non-condensing	
Regulatory Approvals		
EMI	FCC Part 15, CISPR (EN55022) class A	
EMS	EN61000-4-2 (ESD), EN61000-4-3 (RS), EN61000-4-4 (EFT), EN61000-4-5 (Surge), EN61000-4-6 (CS), EN61000-4-8, EN61000-4-11	
Shock	IEC60068-2-27	
Free Fall	IEC60068-2-32	
Vibration	IEC60068-2-6	
Safety	EN60950-1	
MTBF (Hours) (MIL-HDBK-217F2, GB, GC, 25°C)	73,914	76,637
Warranty	5 years	

Ordering Information

IDS-1 **A** **B** -A

Code Definition	Serial Port Number	10/100Mbps Ethernet Port Number
Option	- 4 : 4 ports - 8 : 8 ports	- 1 : 1 port

	Model Name	Description
Available Model	IDS-181A-US	Industrial 8-port slim type secure serial to Ethernet device server with 8xRS-232 and 1x10/100Base-T(X), DB62 connector, US adapter
	IDS-181A-EU	Industrial 8-port slim type secure serial to Ethernet device server with 8xRS-232 and 1x10/100Base-T(X), DB62 connector, EU adapter
	IDS-141A-US	Industrial 4-port slim type secure serial to Ethernet device server with 4xRS-232 and 1x10/100Base-T(X), DB62 connector, US adapter
	IDS-141A-EU	Industrial 4-port slim type secure serial to Ethernet device server with 4xRS-232 and 1x10/100Base-T(X), DB62 connector, EU adapter

Packing List

- IDS-181A/141A
- DIN-Rail Kit
- Wall-mount Kit
- DB62 to DB9 Cable
- ORing Tool CD
- Quick Installation Guide

Optional Accessories (Can be purchased separately)

- DR-45 series, 45W DIN-Rail power supply
- DR-75 series, 75W DIN-Rail power supply
- DR-120 series, 120W DIN-Rail power supply
- SDR-240-48, 240W DIN-Rail power supply
- SDR-480-48, 480W DIN-Rail power supply
- PAA-121000, 12VDC/1000mA 12W Power Adapter, US plug
- PAE-121000, 12VDC/1000mA 12W Power Adapter, EU plug